

Details, Details  
Time for Giving  
First Office

What KieranTimberlake Learned  
Texas Remembers Charles Moore  
The "Affordable Luxury" Market  
Gaudí's Casa Vicens, Reborn

architectmagazine.com  
The Journal of the American  
Institute of Architects

## Residential Architect Design Awards



# Still buying **building**



**Only one company can provide fully-integrated building envelopes.**

An automobile is a complex machine made up of thousands of parts. You would never order an automobile one part at a time, so why specify a building envelope that way? We are the only manufacturer that designs, engineers, tests and manufactures curtain wall, windows, storefronts, skylights and glass seamlessly from one source. So let's build better, faster, with less risk, more reward—we're The Building Envelope Company.™ Call 1-866-Oldcastle (653-2278) or visit [obe.com](http://obe.com).

# envelopes this way?

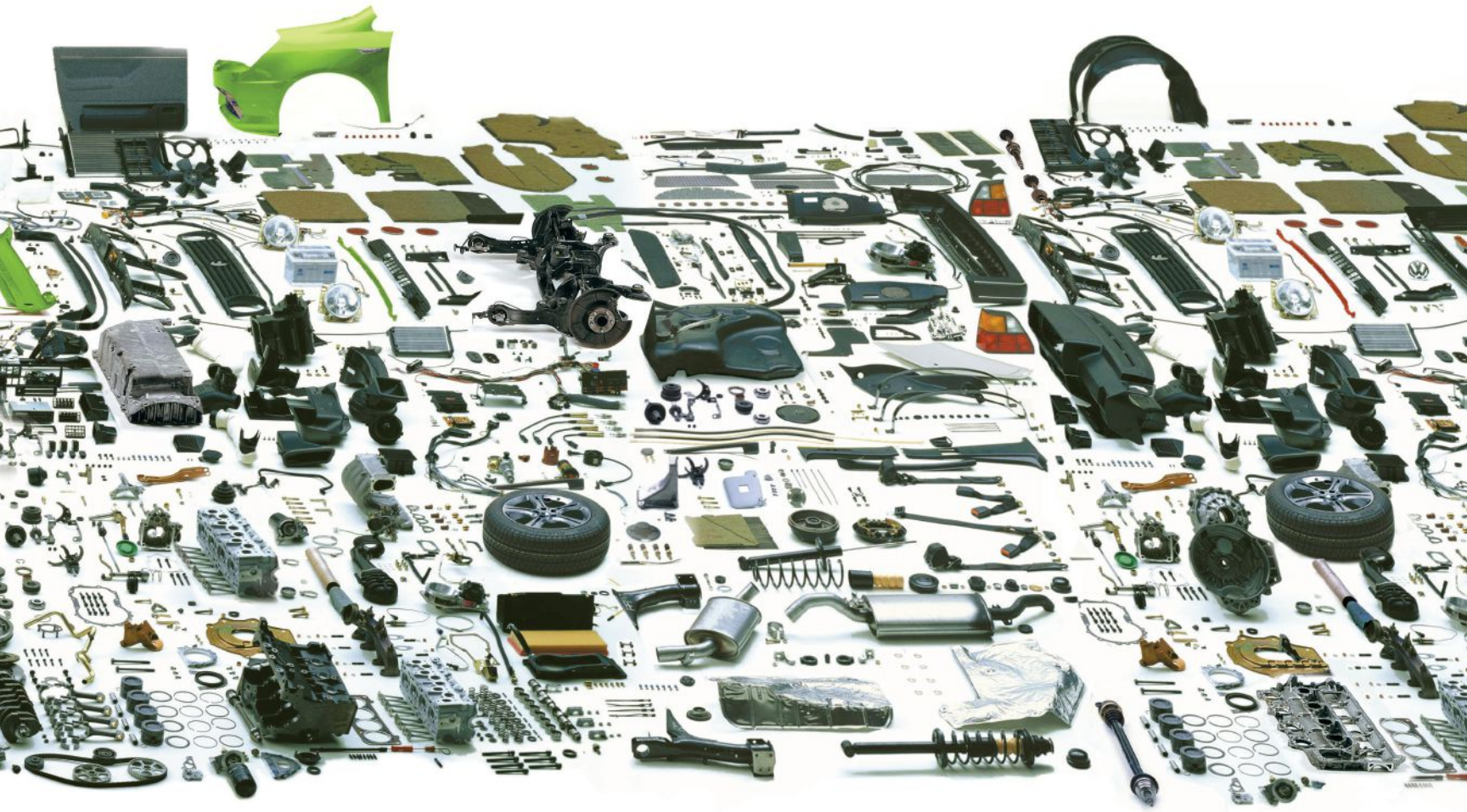

**Oldcastle BuildingEnvelope®**

*Engineering your creativity™*

curtain wall | storefronts | windows | skylights | glass

Black Butte Ranch, Hacker Architects, Photographer: Jeremy Bittermann, Joel B. Sanders Agency

# SOME VIEWS ARE WORTH A MORE CAREFULLY ENGINEERED WINDOW.

The way a window is made determines the way it will perform. That's why we make our own insulated glass with state-of-the-art glazing equipment, why we continuously upgrade our glass technology to address specific weather and environmental conditions, and why we use non-metal foam spacers that dramatically improve energy efficiency and seal integrity. Our no-compromise approach means every window and door we create is designed to withstand the elements, one stunning season after another.

[WWW.SIERRAPACIFICWINDOWS.COM](http://WWW.SIERRAPACIFICWINDOWS.COM) | 800-824-7744 | A DIVISION OF





SIERRA  
PACIFIC  
WINDOWS

# The Story Behind PPG's 2018 Color of the Year: **BLACK FLAME**

Each year the world's leading names in architecture, automotive, hotels, fashion, consumer electronics, and aerospace place multi-million dollar bets on a key product attribute that may not be revealed for a year or more.

Making a wager that may not see a payout in the immediate future may seem like corporate alchemy to some. A correct decision adds a crucial sales accelerator to the development process. A poor one may suppress, even compromise, wide product acceptance.

We're talking about color, of course. There may have been a time when color choice was a low-level decision. No more. Today a designer is expected to correctly identify "the right path forward" often years before the public disclosure. Yet, how do you anticipate the caprice of taste?

## RESPECTED ADVISOR

The PPG Global Color Forecasting team has emerged in recent years as the industry bellwether in matters of color for architecture, automotive, aerospace, and consumer products. Each year PPG, the over 130-year-old paints and coatings leader, assembles more than 20 color stylists from six countries for an intense three-day color forecasting summit. Those 72 hours yield the naming of the Color of the Year, a 135-page global forecasting book, and accredited CEU presentations.

The 2018 Color of the Year is Black Flame. PPG describes it as "a classic shade of Black with Blue undertones. Black Flame sets itself apart by its capacity to create a contemporary atmosphere, steeped in comfort and privacy."

## UNMATCHED SCOPE

Dee Schlotter, PPG senior color marketing manager and team lead for the Global Forecasting Team, says, "Black Flame represents stability, strength, and durability. It's a color every designer wants to use because it anchors every other color. It speaks to privacy, the meditative privacy many crave in a world crowded with online distractions."

The manner in which the team identified Black Flame—and the 120-color palette that supports it—is a highly-evolved, disciplined process.



The decision-making is informed a variety of ways, according to Schlotter. PPG color stylists are dedicated to geographies and industries that give them exclusive insights. Carmakers, for example, specify PPG coatings five years in advance of launch. "Architects want to see what's happening in the luxury car market. Luxury carmakers want to understand hotel trends. The same holds true for aerospace and consumer electronics, too."

"We know all sides of the story because we're directly involved in all sides."

## WIDELY INFORMED

The team also overlays the impact of current events. For 2017, the spirit of connection, privacy, naturalism, and rebellion stood out. Black Flame works well to reflect those influences across a wide spectrum of hard and soft goods applications.

Schlotter also cites industry partners and PPG's deep participation in global design conferences like Maison&Objet and NeoCon. Peer review helps correlate and cross-check color assumptions.

## GROUNDING INSPIRATION

PPG is a uniquely qualified in another way: manufacturing muscle. The Pittsburgh-based coating company supplies painting and coating products that architects and designers routinely specify. This close working relationship offers a windfall of real-world insight that's tough to match.

"We put so much validation behind every single color and especially the Color of the Year," Schlotter explains. "Even so, we're careful to call our trend forecasts a direction, not a directive. Our forecast book is a wonderful guide. It offers the architect and designer a robust, reasoned palette for consideration. Call it grounded inspiration."

To view the 2018/19 Global Color and Design Trends Book, visit [2018ColorTrends.ppgpaints.com](http://2018ColorTrends.ppgpaints.com).



- OVER -  
**130**  
YEARS OF  
INNOVATION



# YOU BRING THE INSPIRATION

*We help you make it a reality*

For an architect, it all comes down to details.  
PPG PAINTS™ offers an unsurpassed selection of products,  
colors and tools to help bring every bit of your vision to life.

*Our Paint*  
**YOUR PRIDE**

LEARN MORE AT [PPGPAINTS.COM/ARCHITECT](http://PPGPAINTS.COM/ARCHITECT).

The PPG Paints Logo is a trademark and the PPG Logo is a registered trademark of PPG Industries Ohio, Inc. © 2017 PPG Industries, Inc. All Rights Reserved.



# A Contents

Volume 106, number 12, December 2017.

On the cover: Hunters View Housing, Blocks 5 & 6 in San Francisco  
by Paulett Taggart Architects; photo by Bruce Damonte

- 20 The Best of L.A. Architecture
- 22 Bacteria-Activated Wallpaper
- 24 Hastings Pier Wins RIBA's Stirling Prize
- 26 A Decade of Donald Judd
- 28 Philip Johnson (feat. Snøhetta)

#### Tech + Practice

- 32 Best Practices: Tips for End-of-Year Giving
- 36 Next Progressives: First Office
- 40 Products: The Architect's Wish List

#### AIA Architect

- 63 A Renovation Dream Come True
- 65 Joining Forces, Making Change
- 66 Defined by Our Infrastructure
- 69 How AIA's Revised Contract Documents Affect Architects
- 71 A Rededication to Craft
- 72 Making an Impact
- 72 Onward, Upward

#### Columns

- 107 KieranTimberlake's Office Experiment  
by Witold Rybczynski
- 121 Toll Brothers Embraces Affordable Luxury  
by Elizabeth Greenspan

#### Residential

- 169 Charles Moore and Arthur Andersson Win Texas Society  
of Architects' 25-Year Award
- 170 Acid-Washed Steel Without the Metal
- 172 Nine "Living Spaces" by David Adjaye

#### Editorial

- 192 Investing in America  
by Ned Cramer



75 The 2017 Innovative Detail Projects



132 The 2017 Residential Architect Design Awards



Residential  
177 Martínez Lapeña - Torres Arquitectos  
and DAW Office





Private Residence, Wimberley, TX Architect: Carson Design Associates Installing contractor: Dean Contracting Co.  
Profiles: Snap-Clad Metal Roofing, Precision Series Wall Panel Color: Galvalume

Q. What roofing does an architect choose for his own home?

A. Metal roofing.

"We wanted our home to be as maintenance-free as possible. Metal is just a great option for residential construction."

-Jack Carson, President, Carson Design Associates

With a lifespan of more than 50 years, a PAC-CLAD metal roof can be the last roof you buy. More than 45 colors available, including Energy Star colors that can reduce heating and cooling costs.



Complete case study at [PAC-CLAD.COM/CARSON](https://www.pac-clad.com/carson)

PAC-CLAD.COM | [INFO@PAC-CLAD.COM](mailto:info@pac-clad.com)

IL: 1 800 PAC CLAD MD: 1 800 344 1400 TX: 1 800 441 8661  
GA: 1 800 272 4482 MN: 1 877 571 2025 AZ: 1 833 750 1935





 **SOLARBAN<sup>®</sup>90**  
Solar Control Low-E Glass  

 **SOLARBAN<sup>®</sup>72**  
Solar Control Low-E Glass  

 **SOLARBAN<sup>®</sup>70XL**  
Solar Control Low-E Glass  

 **SOLARBAN<sup>®</sup>Z50**  
Solar Control Low-E Glass  

 **SOLARBAN<sup>®</sup>60**  
Solar Control Low-E Glass  

 **SOLARBAN<sup>®</sup>R100**  
Solar Control Low-E Glass  

 **SOLARBAN<sup>®</sup>60 + STARPHIRE**  
Solar Control Low-E Glass + **STARPHIRE**  
ULTRA-CLEAR<sup>™</sup> GLASS  

 **SOLARBAN<sup>®</sup>Z75**  
Solar Control Low-E Glass  

 **SOLARBAN<sup>®</sup>67**  
Solar Control Low-E Glass  

# Find your comfort zone. On so many levels.

Establish a comfort zone with *Solarban*® glass by Vitro Architectural Glass (formerly PPG Flat Glass)—now under new ownership and driven by the same U.S.-based plants, people and products trusted by architects for years.

Within the *Solarban*® brand family of low-e glass coatings, you'll find a wide array of solar control performance and aesthetic options delivering unparalleled choices. Backed by 50 years of proven reliability and a formula for the future, you can find comfort in the *Solarban*® glass family.

Start your own stack of *Solarban*® samples at [vitroglazings.com/solarban](http://vitroglazings.com/solarban) or **855-VTRO-GLS (887-6457)**.



## METALS IN CONSTRUCTION MAGAZINE 2018 DESIGN CHALLENGE

# Design the Next-Generation Facade

Register at [metalsinconstruction.org](http://metalsinconstruction.org)  
to enter your vision for a facade  
system that can play a major role in  
enhancing employee health and  
well-being and earn a chance to win  
a \$15,000 grand prize.

SPONSORED BY

 **Ornamental Metal Institute of New York**

## ARCHITECT

The Journal of the American  
Institute of Architects

### Editor-in-Chief

Ned Cramer, ASSOC. AIA  
[ncramer@hanleywood.com](mailto:ncramer@hanleywood.com)  
@NedCramer

### Managing Editor

Greig O'Brien  
[gobrien@hanleywood.com](mailto:gobrien@hanleywood.com)

### Design

Editor  
Katie Gerfen  
[kgerfen@hanleywood.com](mailto:kgerfen@hanleywood.com)

### Associate Editor

Sara Johnson  
[sajohnson@hanleywood.com](mailto:sajohnson@hanleywood.com)  
@SaraA\_Johnson

### Features

Senior Editor  
Eric Wills  
[ewills@hanleywood.com](mailto:ewills@hanleywood.com)

### Editorial Intern

Ayda Ayoubi

### Technology and Practice

Editor  
Wanda Lau  
[wlau@hanleywood.com](mailto:wlau@hanleywood.com)  
@wandawlau

### Associate Editor

Katharine Keane  
[kkeane@hanleywood.com](mailto:kkeane@hanleywood.com)

### Assistant Editor

Selin Ashaboglu  
[sashaboglu@hanleywood.com](mailto:sashaboglu@hanleywood.com)

### Multimedia

Video Production Manager  
Lauren Honesty  
[lhonesty@hanleywood.com](mailto:lhonesty@hanleywood.com)

### Videographers/Video Editors

Jim Van Meer  
Dan Tayag

### Art Director

Robb Ogle  
[rogle@hanleywood.com](mailto:rogle@hanleywood.com)

### Contributing Editors

Aaron Betsky  
Blaine Brownell, AIA  
Thomas de Monchaux  
Elizabeth Evitts Dickinson  
John Morris Dixon, FAIA  
Thomas Fisher, ASSOC. AIA  
Joseph Giovannini  
Cathy Lang Ho  
Amanda Kolson Hurley  
Karrie Jacobs  
Edward Keegan, AIA  
Ian Volner  
Mimi Zeiger

### Design Group

Group President  
Ron Spink  
[rspink@hanleywood.com](mailto:rspink@hanleywood.com)  
202.736.3431

### Advertising

Northeast, Digital,  
International  
Christie Bardo  
[cbardo@hanleywood.com](mailto:cbardo@hanleywood.com)  
202.736.3363

### West

Suren Sagadevan  
[ssagadevan@hanleywood.com](mailto:ssagadevan@hanleywood.com)  
310.863.1153

China, Hong Kong, Taiwan  
Judy Wang  
[judywang2000@vip.126.com](mailto:judywang2000@vip.126.com)  
86.13810325171

### Production

Production Director  
Margaret Coulter

Mid Atlantic, Southeast  
Susan Shepherd  
[sshepherd@hanleywood.com](mailto:sshepherd@hanleywood.com)  
404.386.1709

### Lighting

Cliff Smith  
[csmith@hanleywood.com](mailto:csmith@hanleywood.com)  
864.642.9598

### Canada

D. John Magner  
[jmagner@yorkmedia.net](mailto:jmagner@yorkmedia.net)  
416.598.0101, ext. 220

### Canada

Colleen T. Curran  
[ctcurran@yorkmedia.net](mailto:ctcurran@yorkmedia.net)  
416.598.0101, ext. 230

### List Rentals

The Information Refinery  
Brian Clotworthy  
[brian@info refinery.com](mailto:brian@info refinery.com)  
800.529.9020

Midwest  
Michael Gilbert  
[mgilbert@hanleywood.com](mailto:mgilbert@hanleywood.com)  
773.824.2435

### New Account Setup

Jaeda Mohr  
[jmohr@hanleywood.com](mailto:jmohr@hanleywood.com)  
202.736.3453

### New Account Setup

Erika Taylor  
[etaylor@hanleywood.com](mailto:etaylor@hanleywood.com)  
202.380.3942

### Marketing

Vice President, Marketing  
Matthew Carollo

### Audience Marketing

Director  
Chris Lusan

Copyright 2017 by Hanley Wood. One Thomas Circle NW, Suite 600, Washington, DC 20005.  
202.452.0800. Reproduction in whole or in part prohibited without written authorization.  
All rights reserved. Printed in the USA.



[www.latch.com](http://www.latch.com) / [sales@latch.com](mailto:sales@latch.com)

**LATCH<sup>®</sup>**

## MAKE A STATEMENT WITH TAKTL

TAKTL® offers a full line of architectural elements utilizing proprietary formulations, in-house mold fabrication, and a tightly controlled, automated production process. With over four times the strength of traditional concrete, TAKTL panels and cast elements perform exceptionally well in rainscreen applications and demanding climates.

Uniting the superior strength, durability, and precision of TAKTL's Architectural Ultra High Performance Concrete (AIUHPC™) with unparalleled design possibilities, TAKTL will change the way you think about concrete.

---

SHOWN: TAKTL Panels | Smooth Texture | Custom White | Custom Aggregate

10 STANDARD TEXTURES + 12 STANDARD COLORS  
ASTM C1186: Grade IV Certification

PROJECT: Westfield Century City  
LOCATION: Los Angeles, CA  
OWNER: Westfield  
DESIGN ARCHITECT: Westfield  
INSTALLER: KHS&S

[WWW.TAKTL-LLC.COM](http://WWW.TAKTL-LLC.COM)





Westfield

EXIT ONLY EXIT ONLY EXIT ONLY

Architect: Rossetti  
 Structural Engineer: WSP Parsons Brinckerhoff  
 Photograph: Rafael Camo



# Top Seed

**Arthur Ashe Stadium at USTA's Billie Jean King National Tennis Center** is one of sport's most beloved venues.

But its roofless design meant rain often stopped play. To keep tournaments on schedule, the stadium's original designers, architect **Rossetti** and engineer **WSP Parsons Brinckerhoff**, proposed the tennis world's largest long-span retractable roof. With a 7-minute opening time and a design that keeps sightlines unobstructed, the new lightweight fabric and steel canopy is favored to win over athletes and fans alike. Read more about it in **Metals in Construction** online.

 **Steel Institute of New York**

WWW.SINY.ORG

## ARCHITECT

The Journal of the American Institute of Architects

### Hanley Wood Media

President  
 Dave Colford

### Vice Presidents, Editorial

Ned Cramer  
 John McManus

Senior Director,  
 Print Production  
 Cathy Underwood

Executive Vice President,  
 Operations  
 Sarah Welcome

Vice President,  
 Client Operations  
 Mari Skelnik

Director of Analytics  
 Jennifer Malkasian

Executive Vice President,  
 eCommerce and Digital  
 Jennifer Pearce

Vice President, Digital Strategy  
 and Operations  
 Bridget Forbes

Chief Design Director  
 Aubrey Altmann

### Hanley Wood

Chief Executive Officer  
 Peter Goldstone

Chief Revenue Officer/  
 President, Media  
 Dave Colford

Senior Vice President,  
 Corporate Accounts  
 Ryan Flom

Vice Chairman Emeritus  
 Frank Anton

Chief Data Officer/  
 President, Metrostudy  
 Andrew Reid

Vice President, Finance  
 Ron Kraft

Vice President,  
 Corporate Controller  
 Keith Rosenbloom

Chief Financial Officer  
 Matthew Flynn

President, Marketing  
 Jeanne Millbrath

Senior Vice President,  
 Marketing  
 Sheila Harris

Director of Sales,  
 Emerging Accounts Group  
 Philip Hernandez



The American Institute of Architects

### 2017 Board of Directors

Thomas V. Vonier, FAIA, President; Carl Elefante, FAIA, First Vice President; Bruce Sekanick, Secretary; Stuart Coppedge, AIA, Treasurer; Torrey Stanley Carleton, HON. AIA, CACE Director; Sarah Wahlgren, ASSOC. AIA, Student Director; Joseph Lai, AIA, Associate Director; Peter Exley, FAIA, Director; L. Jane Frederick, FAIA, Director; Donald I. King, FAIA, Director; Evelyn Lee, AIA, Director; Ron J. Miller, Director; Thierry Paret, FAIA, Director; Katharine Weymouth, Director; Jennifer Workman, AIA, Director; Robert A. Ivy, FAIA, EVP/Chief Executive Officer.  
 AIA Strategic Council: Jason Winters, AIA, Moderator.

### National Staff

Robert A. Ivy, FAIA, EVP/Chief Executive Officer; Abigail W. Gorman, MBA, Chief of Staff; Kathron Compton, Senior Vice President, Brand & Engagement; Pam Day, HON. AIA, Corporate Secretary & Managing Director, Governance Administration; Deborah DeBernard, AIA, NCARB, ARCHITECT AIBC, LEED BD+C, Senior Vice President, Global Innovation; Lisa Green, Vice President, Finance & Accounting; Susan McDaid, HON. AIA, Senior Vice President, Member & Component Services; Larry Robertson, SHRM-SCP, SPHR, CAE, Vice President, Human Resources; Phil Simon, HON. AIA, CAE, Vice President, Special Initiatives; Jay A. Stephens, ESQ., HON. AIA, Senior Vice President & General Counsel; Terri Stewart, CAE, HON. AIA, Senior Vice President, Knowledge and Practice.

### Management Team

Greg Appler, Managing Director, Brand & Creative; Suzanne Bagheri, CPA, Managing Director, Accounting; Gwen Berlekamp, CAE, Managing Director, Component Collaboration & Resources; Young Chang, PMP, Managing Director, Contract Documents Technology & Operations; Kenneth Cobleigh, ESQ., Managing Director & Counsel, Contract Documents Content & Risk Management; John Crosby, Managing Director, Corporate Partnerships; Andrew Goldberg, ASSOC. AIA, Managing Director, Government Relations & Advocacy; Christopher Gribbs, ASSOC. AIA, Managing Director, Convention; Damon Leverett, AIA, Managing Director, Diversity & Emerging Professionals; Stephen Martin, Managing Director, Professional Development & Resources; Philip O'Neal, Managing Director, Information Technology; Jeffrey Raymond, Managing Director, Product Strategy Group; Cedric Rush, Managing Director, Membership Strategy & Services; Frank Scanlan, Managing Director, Strategic Communications & Content.

hanleywood



BPA





# Save a ton.



Bobrick's B-823 universal foam soap dispenser delivers up to \$1,000 savings per sink, per year vs proprietary cartridges.

New ADA-compliant model features architectural design with chrome finish and a 57% reduction in post-consumer waste. Plus it accommodates patrons' growing preference for a rich, lathery, hygienic hand-wash. Nice.



**BUILDING VALUE SINCE 1906**  
**BOBRICK.COM**

© 2017 BOBRICK WASHROOM EQUIPMENT, INC.



Sophie Chien, Charlotte, NC  
Rhode Island School of Design  
2017–2018 Scholarship recipient

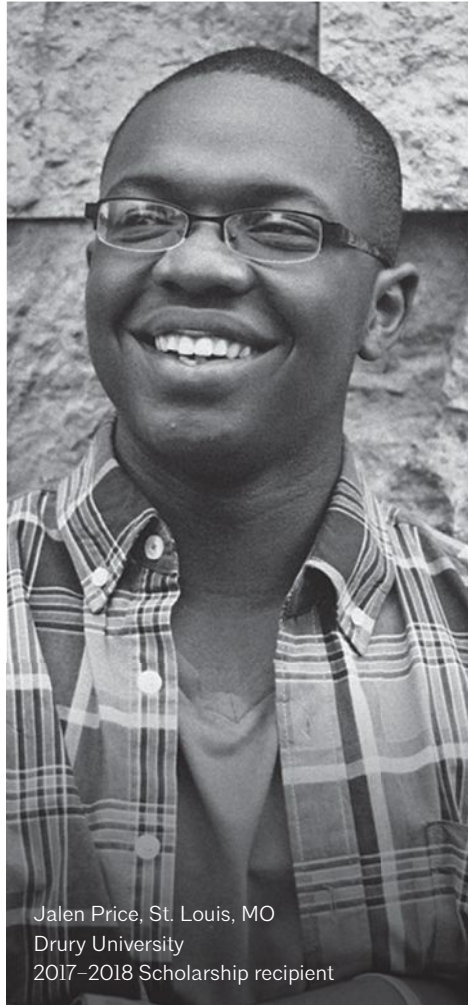

Jalen Price, St. Louis, MO  
Drury University  
2017–2018 Scholarship recipient



Kayla Allen, Chicago, IL  
University of Illinois at Urbana–Champaign  
2017–2018 Scholarship recipient

## Up to \$20K scholarship!

The Architects Foundation Diversity Advancement Scholarship can help high school and undergraduate minority students become architects with a multiyear scholarship, up to \$20,000. Applications are due January 17, 2018. Spread the word.

Learn more at [architectsfoundation.org/scholarships](http://architectsfoundation.org/scholarships).

**“We love living in a neighborhood where our kids can play outside and we can host backyard bbq’s.”**

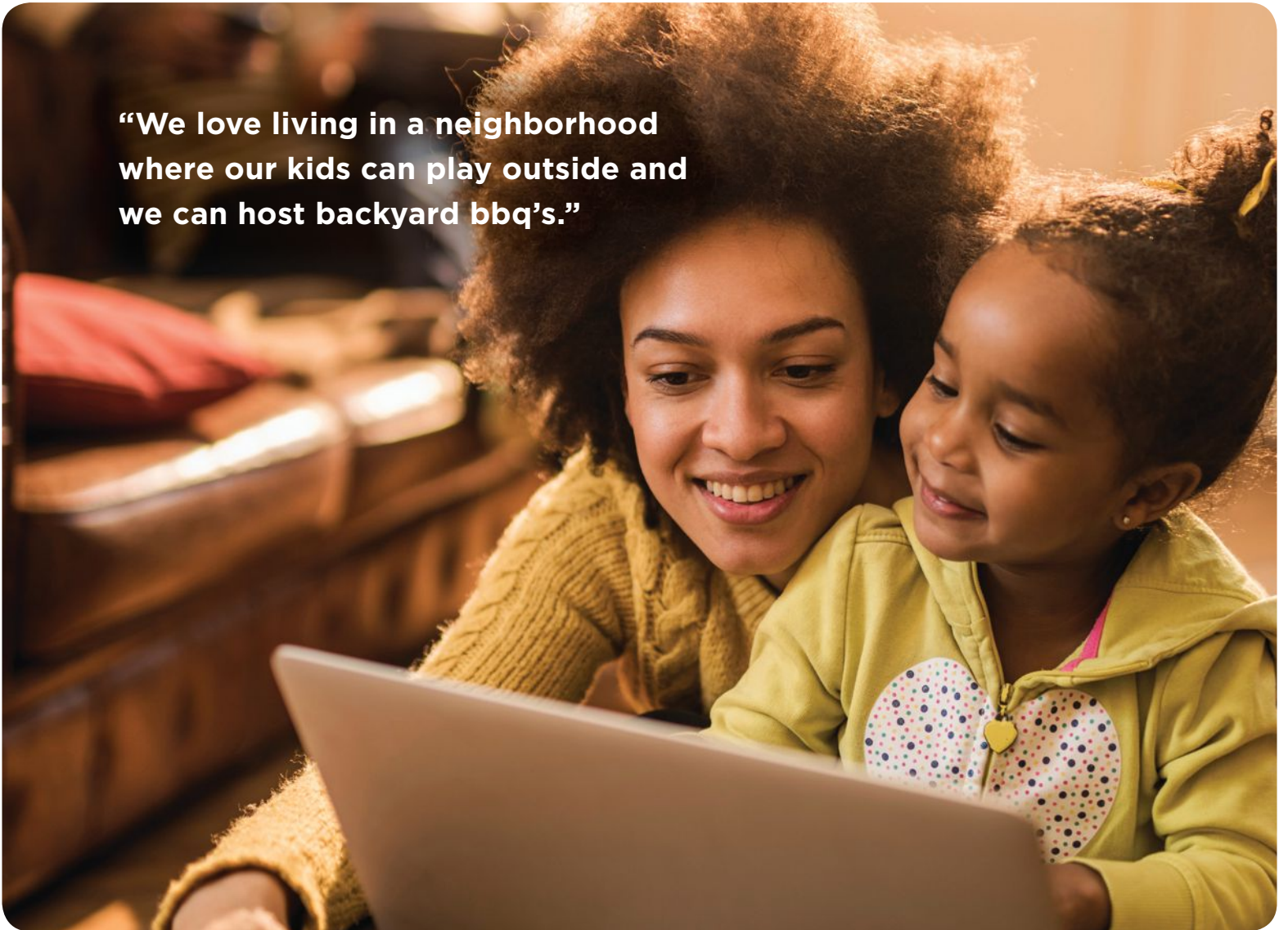

# Know who to target.

Introducing Metrostudy's **OnTarget** Consumer Intelligence. Your customer in detail.



**She wants a neighborhood where kids can grow** and build memories. Where everyone waves when they pass by and best friends live right down the street. She's just one of a wide array of customers we can help you understand. And reach.

**Learn more at [WhyOnTarget.com](http://WhyOnTarget.com)**



"To define a human-scale pedestrian walkway on the edge of a 7-story parking structure, we knew an overhead awning was a good solution. We selected Fabriccoil® as a durable exterior material with qualities of lightness and airiness that juxtapose with the heavy concrete structure. The stainless steel weave shimmers in the sunlight as it effortlessly drapes between the galvanized awning supports. It creates an overhead rhythm and gives definition to the walkway as a place for people, not cars."

Maxine Ward, AIA LEED AP Associate  
Studio E Architects

UC San Diego Athena Parking Structure, La Jolla, California

Stephen Whalen Photography

"Finding a product for a specific application was a challenge at the Tempe Transportation Center. Cascade Architectural's Fabriccoil system was durable and maintenance free while maintaining an elegant and visually transparent effect. Cascade Architectural, much like Architekton, is client-focused, and came up with a design solution and installation that helped us achieve the goals set forth by the project parameters."

John Kane FAIA LEED AP BD+C,  
Principal  
Architekton

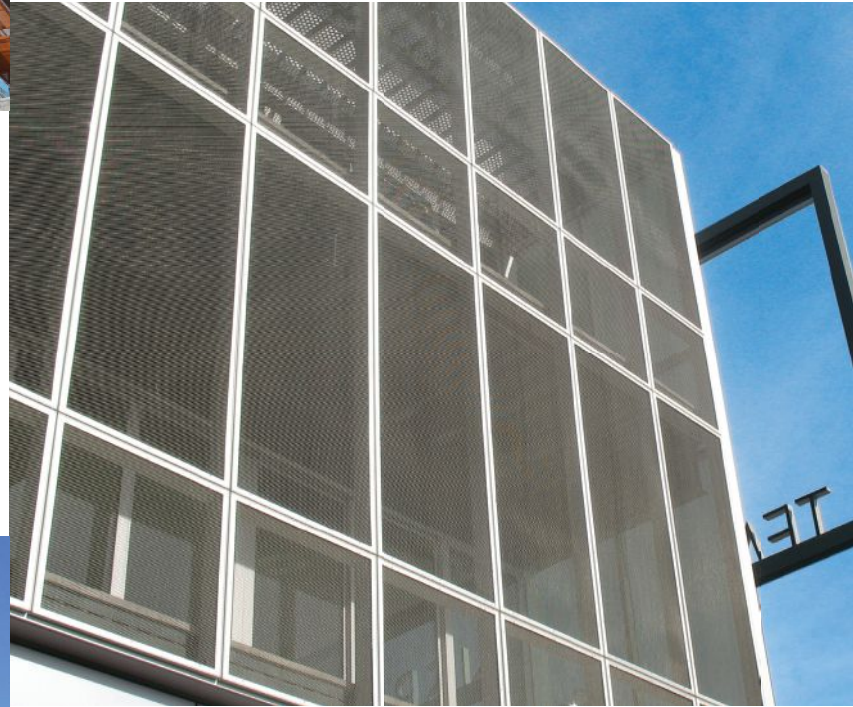

Tempe Transportation Center, Tempe, Arizona



© Cascade Coil

Portland Community College, Rock Creek Campus, Portland, Oregon

"Sustainability and the utilization of natural daylight were key design considerations for this LEED Gold student center. For the 2nd floor lounge, the vertical exterior sunshades had to be elegant, durable, visually transparent, and have the ability to shade the west facing glass. Fabriccoil achieved all these goals."

Aaron Schalou, AIA, LEED AP BD+C  
Opsis Architecture

"Our design for the Traditions residence hall at Tarleton State University locates social space for residents in two lantern-like elements along a primary pedestrian route from the campus to the football stadium. We explored several options for vertical sunshades, and ultimately selected Fabricoil due to its durability, functionality and aesthetic qualities. The graded translucency of the overlapping panels, and the shadows they cast, create a beautiful moiré effect that animates both the interior public spaces and the pedestrian mall."

Eric Van Hyfte, AIA  
Principal  
BOKA Powell Architects

*Fabricoil*®



© 2017 Erika Brown Photography

Tarleton State University, Traditions North, Stephenville, Texas

Fabricoil has become the material of choice for many common exterior applications. Fabricoil exterior systems feature robust corrosion-resistant materials and finishes, along with attachment hardware engineered to withstand the environmental loads they'll encounter. Explore the proven applications for Fabricoil today, or dream up your own. Fabricoil transforms otherwise ordinary exterior building elements - a shade, an awning, a security screen, or decorative panel - into a standout feature of your design.



### The Best of L.A. Architecture

The night before Halloween, AIA Los Angeles held a ceremony at Santa Monica College's Broad Stage celebrating several chapter awards programs: the Design Awards, the Next LA Awards for unbuilt work, and the COTE LA Awards from the chapter's Committee on the Environment. Thirty-five projects were recognized across the three programs, and include the West Hollywood Belltower by L.A. firm Tom Wiscombe Architecture (above), which won the only Honor Award in the Next LA Awards. The chapter's Presidential Honorees, first announced in August, were also recognized at the celebration. —SARA JOHNSON

> See all the winners of the 2017 AIA/LA awards at [bit.ly/AIALA2017awards](http://bit.ly/AIALA2017awards).



8958-58 Bubble Art

## Bubble Art. One of 32 new designs.

Explore the SurfaceSet® 2018 lookbook to inspire your vision. [Formica.com/lookbook](http://Formica.com/lookbook)

Meet **SurfaceSet® 2018** by Formica Corporation. Three dynamic palettes of creative contrasts, pushing the boundaries of calm to bold, organic to elegant, art to science. Bring beauty, durability and originality to your vision.

Formica® Surfaces. **FOR REAL.®**

Formica®, the Formica® Anvil Logo and SurfaceSet® 2018 are registered trademarks of The Diller Corporation. All rights reserved. ©2017 The Diller Corporation. A member of the Fletcher Building Group.



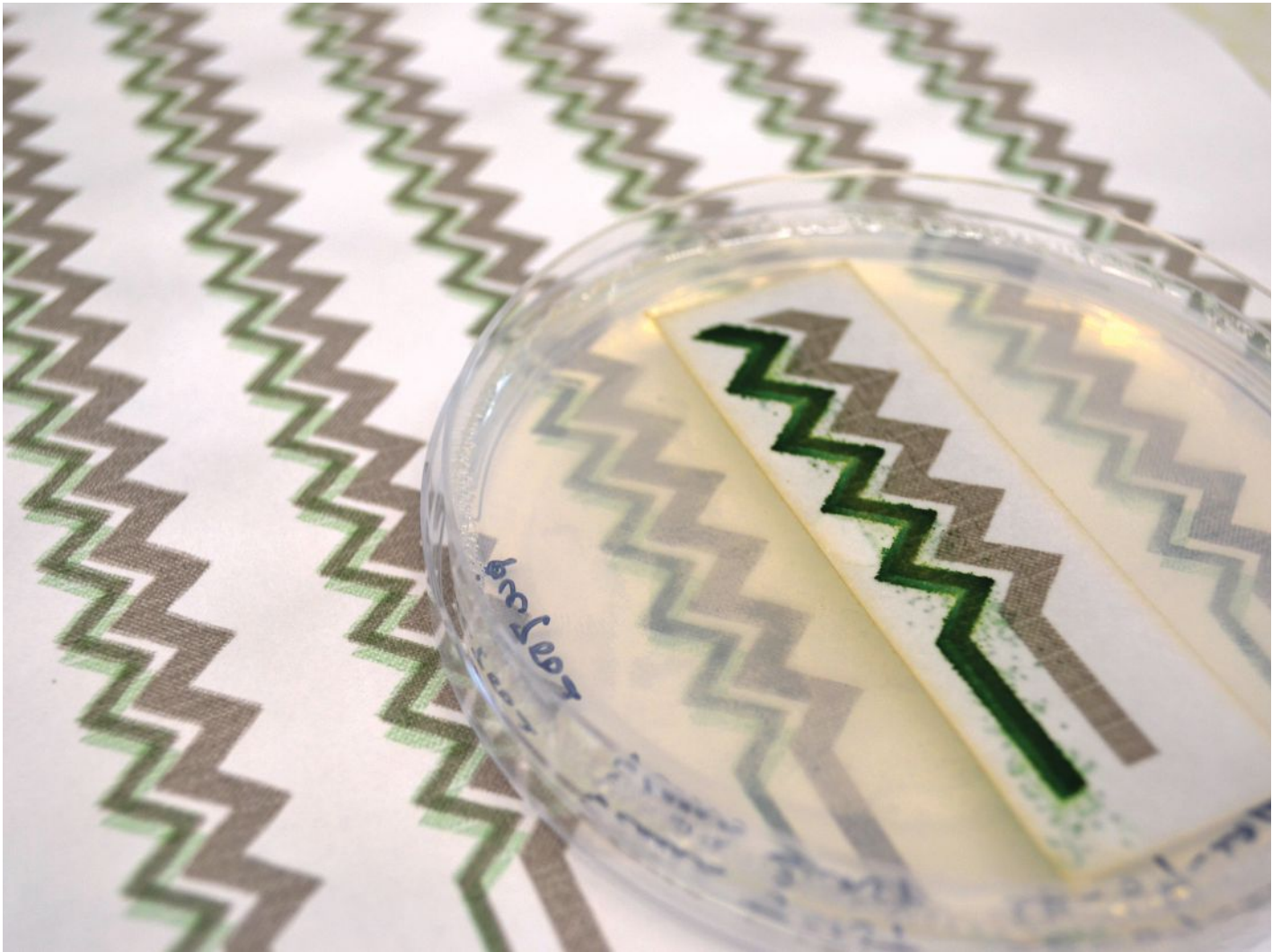

### **Bacteria-Activated Wallpaper**

Researchers from Imperial College London, the University of Cambridge, and Central Saint Martins have successfully created a wallpaper-like covering that acts as both a solar bio-battery and solar panel—and is biodegradable to boot. The team used an inkjet printer to print photosynthetic microorganisms called cyanobacteria onto conductive carbon nanotubes, all of which were then printed onto paper. The printed bacteria continue to perform photosynthesis, creating small amounts of electricity, which the researchers believe could power a small digital clock or LED lamp. —KATHARINE KEANE

> Read more about the research at [bit.ly/BPVwallpaper](https://bit.ly/BPVwallpaper).



# SOLID CABINET QUALITY. SOLID CABINET SAVINGS.

HOME  
DECORATORS  
COLLECTION



SAVE UP TO 40% ON SELECT HOME DECORATORS COLLECTION CABINETS

7-10 DAY SHIPPING

| KITCHEN PRICE ESTIMATOR

| FREE ONLINE PRO DESIGN SERVICE



HDCKITCHENS.COM

PRO



Home Decorators Collection Brookfield Kitchen in Pacific White

©2017 Home Depot Product Authority, LLC. All rights reserved.



### **Hastings Pier Wins RIBA's Stirling Prize**

Picked from six shortlisted projects, Hastings Pier by London firm dRMM Architects won this year's Stirling Prize from the Royal Institute of British Architects (RIBA), the annual prize recognizing "Britain's best new building." The project also won the people's vote. "Hastings Pier is a masterpiece of regeneration and inspiration," said jury chair and RIBA president Ben Derbyshire in a press release. "The architects and local community have transformed a neglected wreck into a stunning, flexible new pier to delight and inspire visitors and local people." —SARA JOHNSON

> Read more about the 2017 RIBA Stirling Prize at [bit.ly/2017StirlingPrize](http://bit.ly/2017StirlingPrize).



You should expect more  
from the glass you spec.

You get **more** from the world's largest  
manufacturer of architectural glass.

More **products** to choose from – exterior,  
interior, commercial, residential.

More **innovations** to elevate solar control  
and energy performance to new heights.

More technical and design **assistance** from  
more experienced and knowledgeable reps.

And more **value** to help make your vision  
more feasible – not to mention your clients  
more satisfied in you.

Visit [AGCglass.com/yourglass](http://AGCglass.com/yourglass).

**AGC**

GLASS UNLIMITED

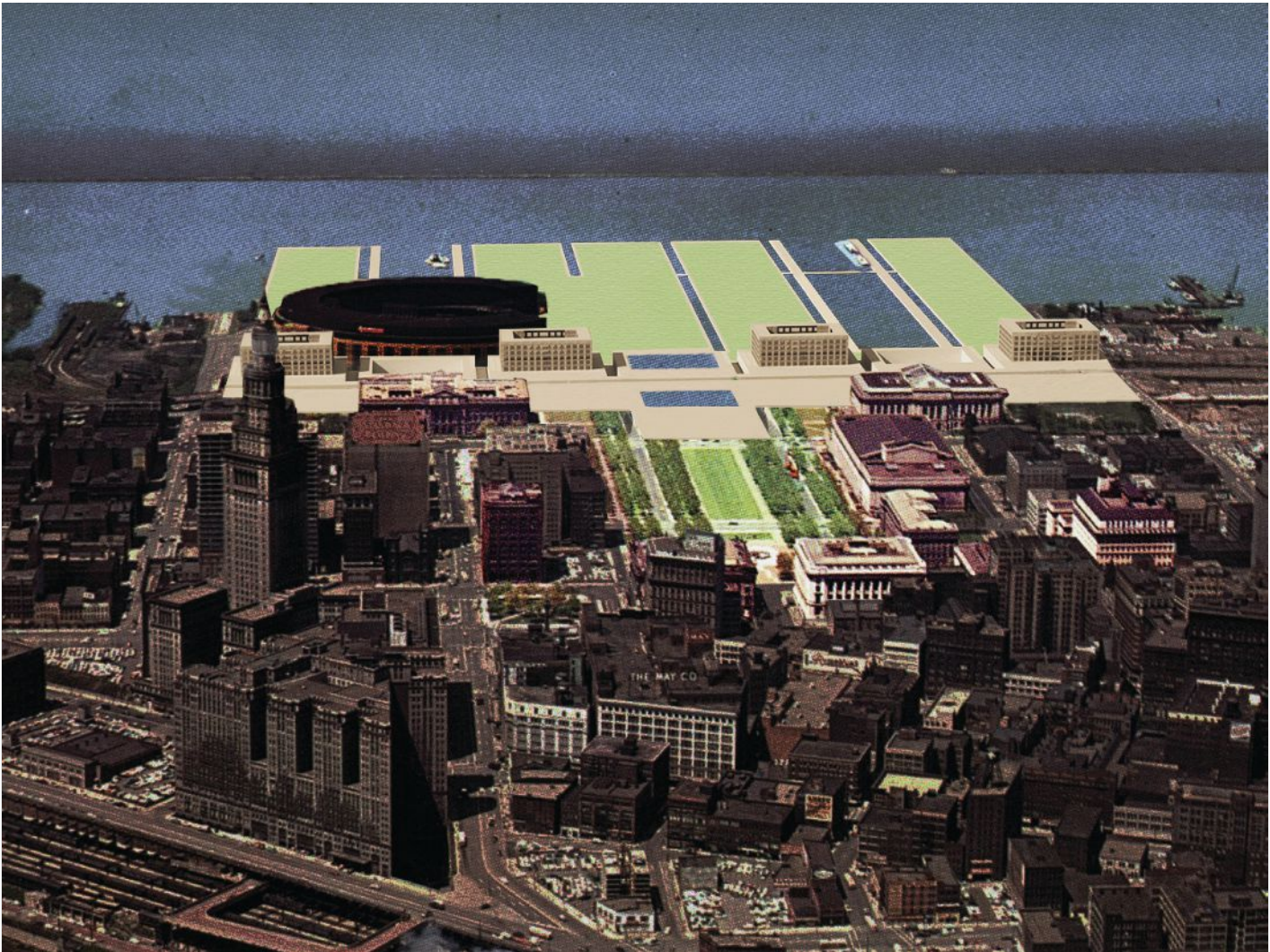

### A Decade of Donald Judd

An exhibition at New York's Center for Architecture, "Obdurate Space: Architecture of Donald Judd," centers on five built and unrealized projects by the late American artist and designer. Curators Claude Armstrong and Donna Cohen—today, partners at Gainesville, Fla.-based Armstrong + Cohen Architecture who were both formerly architectural assistants of Judd—examine the artist's architectural projects from 1984 to 1994. The exhibition, open through March 5, features models, photographs, drawings, and renderings. (A digital collage, above, shows Judd's Cleveland Proposal for the Ohio city.) —AYDA AYOUBI

> Read more about the exhibition at [bit.ly/DonaldJuddExhibit](http://bit.ly/DonaldJuddExhibit).



For clearly superior views,  
see it through Clearvision.

AGC Clearvision low-iron glass achieves an industry best 92% visible light transmittance\*. It also provides the most consistent neutral color rendering from one thickness to another, ensuring brilliant and uniform color optimization. Either exterior or interior applications, when color and light matter most – **See it through Clearvision.**

**AGC**

GLASS UNLIMITED

 **See for yourself.**

Request your free sample today at  
[agcglass.com/clearvision](http://agcglass.com/clearvision).

\*At 3mm thickness



### Philip Johnson (feat. Snøhetta)

Snøhetta recently dropped renderings for a renovation of 550 Madison Avenue, Philip Johnson's 1984 building for AT&T in New York City, prompting outrage in the architecture community. "Hands off my Johnson," read one activist's sign at a recent protest. Snøhetta claims that its proposal "stitches the life of the building back into the street," swapping out much of the stone base for a glass curtainwall and revising the public garden. ARCHITECT columnist Aaron Betsky writes: "It will not be torn down, but it will be emasculated. That act might make the city a better place, but it will cost us a modern monument of note." —SARA JOHNSON

> Read more about Snøhetta's renovation project at [bit.ly/550Madison](https://bit.ly/550Madison).



## Metal Roofing That Holds Superior Value

"The quality of the material as well as the quality of the installation was incredible! This is a roof which will provide exceptional protection as well as enhance the value of our home."

**Homeowner :** Glenn Boundy, Florida

[www.mbc.com/boundy](http://www.mbc.com/boundy)

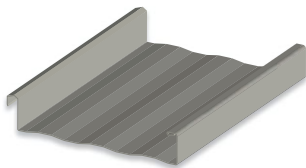

**SuperLok®** Panel

**PROJECT:** Boundy Residence  
**LOCATION:** Ft. Pierce, FL  
**CONTRACTOR:** Richard K. Davis  
**PANEL PROFILE:** SuperLok® (Galvalume Plus)

 **Quote.**  
 **Order.**  
 **Build.**

**SIGN UP TODAY**

[shop.MBCI.com](http://shop.MBCI.com)



JOURNEY THE WORLD.  
ARRIVE TRANSFORMED.

## CONTEMPORARY PENTHOUSE

Alison Habermehl

*This penthouse en suite is for a creative woman whose daytime life often rolls into the nighttime social. She loves the best of the best and is very particular.*

**Toronto** It is a city that never looks back, which is also a great definition for contemporary design. Even so, I wanted to create an elegant bathroom that deserves multiple looks. The rounded shower and dark tile work create a gracious cocoon that is designed to perform double duty. For relaxing in the evening, there's the double rain head shower system. For rejuvenation in the morning, I included the Percy® Personal Shower Set with Hand Shower.

I added a few luxurious touches like a floating vanity, then introduced custom ombré fabric, strategic lighting and soft colors like blush to add warmth and quiet drama to the room's clean lines. By incorporating two different sizes of under counter sinks from the Pop® Collection, I increased usability without threatening the room's minimalistic origins. All that's necessary, with nothing that's not.

For more on Alison's room,  
visit us online at [dxv.com](http://dxv.com)



THE PERCY® WIDESPREAD CROSS HANDLE FAUCET IS MY FAVORITE. ITS TACTILE NATURE MAKES YOU THINK A LITTLE MORE ABOUT WHAT YOU'RE USING AND APPRECIATE IT BECAUSE YOU USE IT SO OFTEN.

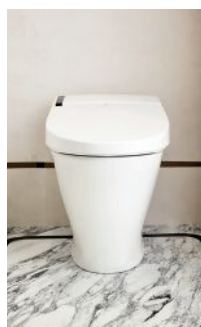





**JOURNEY THE WORLD.**  
ARRIVE TRANSFORMED.

**Toronto** Savor the luxe life in this feminine reimagining of the Contemporary Movement. Discover the breadth of our entire collection of bathroom products at [dxv.com](http://dxv.com)

This DXV bathroom was designed by **Alison Habermehl**.



CLASSIC      GOLDEN ERA      MODERN      CONTEMPORARY

© ASV (USA) Co., Inc. 2017  
DXV presents the Percy® Collection. Faucets...Pop® Under Counter Lavatory and AT200™ SpaLet® Integrated Bidet toilet.

# Best Practices: Tips for End-of-Year Giving

TEXT BY NATE BERG

While year-end giving can be a gesture of goodwill, it can also be a crucial part of reducing the tax burden associated with running a business. Here are some considerations for design practitioners to best direct their charitable intentions.

## What and How Much to Deduct

To qualify for tax deductions on charitable giving, organizations and individuals must make their donations by Dec. 31. But before tallying up every philanthropic gesture, architecture firms should be aware that not all giving qualifies for a deduction, which may affect how much a firm chooses to donate.

For design firms that are classified as C corporations, the revenue of the business is taxed separately from that of its owners. Tax laws limit deductible donations from these entities to 10 percent of taxable income of the entire business, says Joe Schneid, a certified public accountant partner at Aldrich CPAs + Advisors, in Portland, Ore.

Direct giving, be it in the form of cash or property, is the best way to take advantage of the 10-percent deduction allowance. However, Schneid says this form of charitable giving is relatively uncommon: "Most architecture firms are operating on a cash basis, only paying tax when they collect receipts. They tend to try to keep their taxable income low each year by paying out bonuses."

Donated services, such as pro bono design work or volunteering with nonprofits such as Habitat for Humanity, do not qualify for deductions. But,

Schneid says, "if you volunteer a day of time or if you have a couple of your staff members work on a project, you can still deduct it as overhead," referring to expenses incurred during the donation of those services, such as the cost of supplies or travel.

## Employee Bonuses as Donations

Some firms opt to use their employees as a funnel for their charitable giving at the end of the year. Because individuals can deduct significantly more than C corporations—up to 50 percent of their income—firms can direct money for donations through employee bonuses. "The firm issues a bonus to John Smith and he makes the donation in the name of John Smith at architecture firm XYZ," Schneid says. Thus, the firm gets the recognition and the employee gets the tax deduction.

This strategy is common when giving is part of the firm's culture, and the firm's leaders are involved in making donations and encouraging employee participation. "As long as the employee is entitled to the bonus and is not legally obliged to make the contribution, then it's fine," Schneid says. "If the employee and the firm are of like mind, then they can make that work."

## Give Back to the Design Community

Not all giving has to be tax related. New York-based CetraRuddy directs its giving to the field itself. Principal and co-founder John Cetra, FAIA, says his firm has contributed to organizations such

"If you volunteer ... or if you have staff members work on a project, you can still deduct it as overhead."

—Joe Schneid, partner, Aldrich CPAs + Advisors

as the Municipal Art Society of New York, the Architectural League of New York, and the local AIA chapter. But, after some time, the firm wanted to do more. "We wanted to do other things where we could see some direct impact," he says.

That led the firm to endow two graduate design studios at City College of New York's Bernard and Anne Spitzer School of Architecture, from which Cetra and co-founder and principal Nancy Ruddy graduated. Cetra says the school largely influenced the firm's work and approach to architecture, and wanted the next generation of students to benefit from a similar experience.

"We helped formulate the [studios'] program," which focuses on housing and community building, Cetra says. "We're also involved with the students. They come to our office, and we go up to the school for [critiques]."

Cetra would not disclose the amount the firm donated, but noted it is in the thousands. "We didn't do it for tax reasons or anything like that," he says. "It was just, 'We can afford to do this, and we're going to start doing it.'"



**This will shatter a window.**



**This will shatter every preconceived notion  
about brick the world has ever had.**

NewBrick delivers the classic beauty of traditional clay brick, with enormous advantages in weight, ease of use, environmental impact, system cost, and energy efficiency.

To learn more about why NewBrick is the choice of forward-thinking architects, builders, contractors, developers, and homeowners, visit [newbrick.com](http://newbrick.com) or call 1-833-NEWBRICK.

**NEWBRICK**<sup>®</sup>  
by dryvit



**Emerging professionals** are fueling today's design conversation with high-energy ideation that challenges stated norms.

Hanley Wood congratulates and thanks Valspar for its ongoing commitment to design innovation driven by architecture's next generation.

valspar

hanleywood

# Next Progressives: First Office

EDITED BY KATHARINE KEANE

**Location:**

Los Angeles

**Year founded:**

2011

**Firm leadership:**

Anna Neimark and Andrew Atwood

**Education:**

*Neimark:* B.Arch., Princeton University; M.Arch., Harvard Graduate School of Design (GSD); *Atwood:* B.A., University of Richmond; M.Arch., Harvard GSD

**Firm size:**

Four

**Mission:**

To bring architecture (and sometimes art) into a closer, more meaningful relationship with a—or the—public.

**Favorite project:**

Shotgun House was a rehabilitation proposal for a vernacular building type to accommodate a workshop and gallery for an artist in one very small house. We proposed an enfilade plan with eight rooms separated only by doors set into double-frames. As a door closed one room, it inadvertently opened another. This conundrum offered endless possibilities for molding that folded in and out of every corner of the doorjamb.

**Second favorite project:**

Completed this year, Studio for Art is our first built work that exemplifies how abstract ideas about materials and material interactions in models and installation works can translate to a building scale. We especially enjoyed working on the cladding finish, flashing details, and the gutters.

**Memorable learning experience:**

Check your line weights and line types. In a recent project we did not select the proper line weight and line type for the centerline on a foundation plan and the line was built as a contraction joint in the (exposed) concrete slab of the building.

**First commission:**

Pinterest HQ, with All of the Above and executive architect Schwartz and Architecture, both in San Francisco.

**Architecture hero:**

Denise Scott Brown, HON. FAIA, who described Los Angeles as “even” and

“open-ended.” We take similar pleasure in the everyday and the banal.

We also appreciate the early built work of Frank Gehry, FAIA, that is sprinkled throughout the city. Projects such as the Frances Howard Goldwyn, Hollywood Regional Library, and the Wells Fargo bank in Toluca Lake offer a sort of non-monumentality or art presence in the city with their blank façades and deadpan details.

**Origin of firm name:**

This was meant to be our first office—and not our last—so the name fit.

**Special item in your studio space:**

Additional electrical outlets, extension cords, and surge protectors. And a Stäubli robot arm.

**Design tool of choice:**

Foamcore. And a Stäubli robot arm.

**Modern-day architecture hero:**

Our students at the Southern California Institute of Architecture (Neimark) and the University of California, Berkeley (Atwood). They are f-ing amazing, smart, talented, and hard-working.

**Design aggravation:**

The use of the word “arbitrary” as a negative judgment.

**The best advice you have ever gotten:**

First, never be too specific. Second, surround yourself with smart people. We are sometimes bad at the first one.

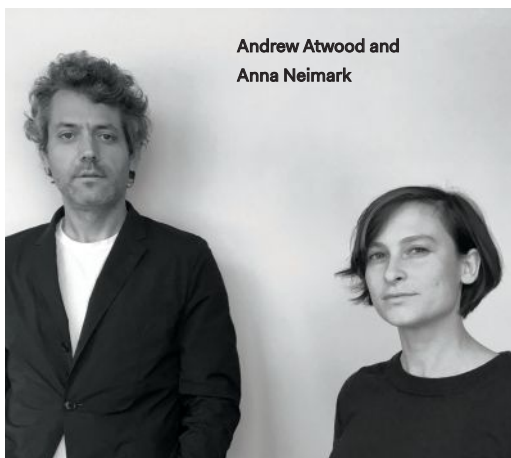

Andrew Atwood and  
Anna Neimark



**CHAMPAGNE AT  
7:48 PM PACIFIC TIME  
NEAR MONTEREY**

Not 7:47. Or 7:49. And definitely not Malibu.  
Because meaningful inspiration isn't arbitrary.  
That's why we make Fluropon® 70% PVDF coatings  
obsessively precise and relentlessly durable.  
So every vision shines exactly as imagined.

**REALIZE YOUR INSPIRATION**

[ColorObsessed.com](http://ColorObsessed.com)

**valspar**

**ARCHITECTURAL  
METAL COATINGS**

Next Progressives:  
First Office

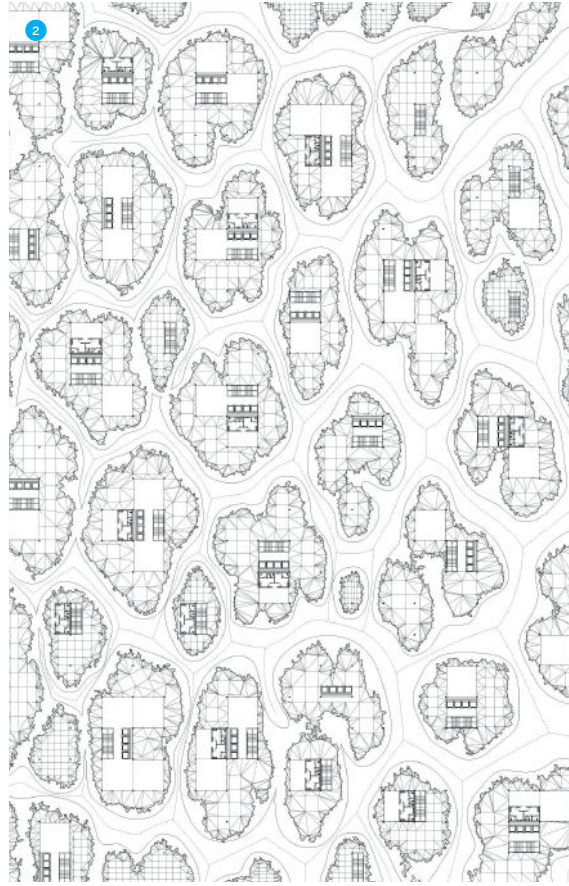
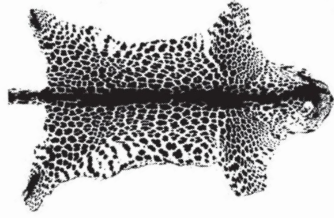



5

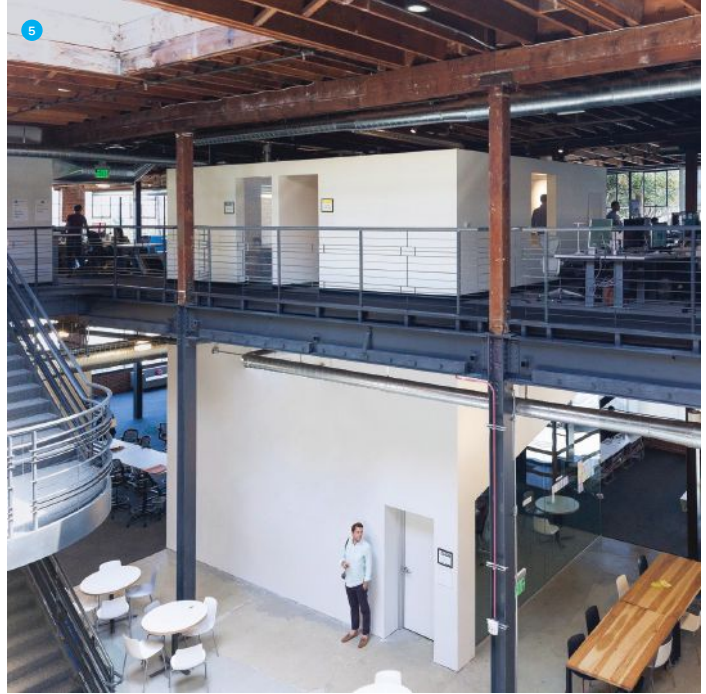
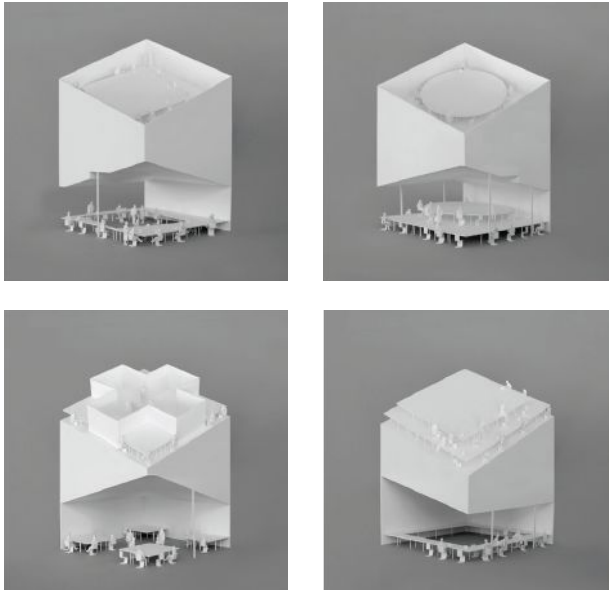

6



6

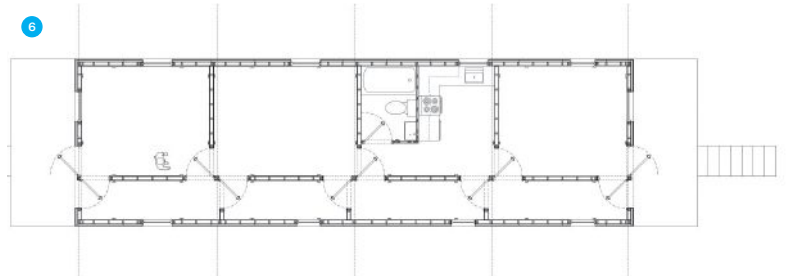

**1.** The owners of the 450-square-foot Studio for Art in Ivy, Va., originally requested a detached “dumb box that disappeared into the forest,” Atwood says. Ultimately, they opted for an addition to the existing residence that is clad in painted cedar strips with copper roofing and accents. **2.** In a collaboration with Los Angeles designer John May and Serbian architectural historian Tijana Vujosevic, the duo envisioned Zoopol, an abstract urban landscape that mimics the forms and layout of animal skins. **3.** In an effort to reimagine the classical column, the designers “hacked” software code to develop unusual plans, Atwood says, and then built their own CNC wire cutter to create foam molds. **4.** First Office’s 2016 MoMa PS1 finalist submission re-creates the megalithic forms of dolmens—prehistoric monuments that are often asymmetrical and awkward—situated on top of the courtyard. **5.** For Pinterest’s headquarters, in San Francisco, the firm worked with Schwartz and Architecture and All of the Above to introduce multistory geometric volumes into the 45,000-square-foot warehouse space, creating smaller pockets for work and creativity. **6.** First Office redesigned a traditional shotgun residence to accommodate a re-created double-door structure, first conceptualized by French-American artist Marcel Duchamp in 1927.

# Products: The Architect's Wish List

TEXT BY SELIN ASHABOGLU

**Field Notes Wallet,  
Bexar Goods Co. (\$145)**  
Recommended by David Lake, FAIA,  
and Ted Flato, FAIA, partners and  
co-founders, Lake|Flato Architects,  
San Antonio

This saddle-stitched leather wallet for on-the-go architects includes two credit card slots, a pocket for a passport, a pen slot, and an opening for a 3.5"-wide by 5.5"-long notebook (three notebooks are included with the purchase of the wallet). "Architects and designers always appreciate something well-crafted," say Lake and Flato. "Some of our favorite gifts [are those] that celebrate the artistry of local crafts persons." [bexargoods.com](http://bexargoods.com)



**Burnt Cocktail Toast Cross Body,  
WelcomeCompanions (\$510)**  
Recommended by Jennifer Bonner,  
director, Mass Architectural Loopty  
Loops, Boston

As part of Los Angeles-based architect Laurel Broughton's fashion line WelcomeCompanions, this toast-inspired leather purse features a tan taffeta lining and a hidden magnetic closure. The matte black or golden brown bag is "the perfect gift for your architect-loved-one who obsesses over black," Bonner says. The purse measures 7" tall, 6" wide, and 2" thick. [welcomecompanions.com](http://welcomecompanions.com)



**Lights Out Ultrasonic Diffuser Gift  
Set, Saje Natural Wellness (\$89.95)**  
Recommended by Fauzia Khanani,  
ASSOC. AIA, principal, Foz Design,  
New York

For the recipient who needs a little tranquility in life, this kit aims to reduce stress levels through the diffusion of essential oils. "Living in a New York City apartment, air quality is not always at its best," Khanani says, "so the diffuser not only helps with health and wellness, but also circulates and humidifies the air." The set includes Saje's geometric AromaGem Ultrasonic diffuser in matte black and two 0.17-ounce bottles of essential oil blends named Unwind and Tranquility. [saje.com](http://saje.com)

You're not dreaming.  
It's just your imagination...

*made into reality.*



Columbia Basin College - Pasco, WA  
Architect: MMEC Architecture & Interiors  
Contractors: Western Partitions, Inc. - Tigard  
Products: Aluratone 900 Acoustical Wood Veneer Panels,  
Flexible Flat Veneered Panels

Manufacturing the finest suspended wood ceilings,  
acoustical wood wall systems, engineered  
polymer ceiling and canopy systems

*All products made in the U.S.A. • We export!*



The mark of  
responsible forestry  
FSC® C103284



1-800-227-8566 • 904-584-1400

**RULON INTERNATIONAL**

[www.rulonco.com](http://www.rulonco.com)

**Products:**  
**The Architect's Wish List**



**Tsumiki - Building Blocks Wooden House, Kukkia (\$117.73)**  
Recommended by Christina Cho Yoo, AIA, and Ming Thompson, AIA, co-founders, Atelier Cho Thompson, San Francisco

For the budding architect, this pastel-colored wooden house encourages little ones to build with their imagination. "Blocks have been beloved toys for centuries," say Cho and Thompson, "because they allow for open-ended creative play by encouraging problem-solving and storytelling through design." The house contains 41 beech wood blocks in a variety of shapes, including a star, stairs, arches, and a sphere. Some of the blocks incorporate magnets that enable the assembly of more complex configurations. [kukkiakids.com](http://kukkiakids.com)



**Copic Sketch Set of Six Markers - Sketching Grays (\$33.66)**  
Recommended by Noah Marble, AIA, senior associate, Eskew+Dumez+Ripple, New Orleans

This set of sketching tools is perfect for documenting bouts of spontaneous creativity. "Having a quality set of tools is essential to any craftsman," Marble says. "These markers are an absolute pleasure to draw with." The kit includes five markers in a range of gray tones and a 0.5mm tip black pen. The refillable, alcohol-based ink markers feature a flat nib on one end and a brush-shaped nib on the other. [copic.jp](http://copic.jp)

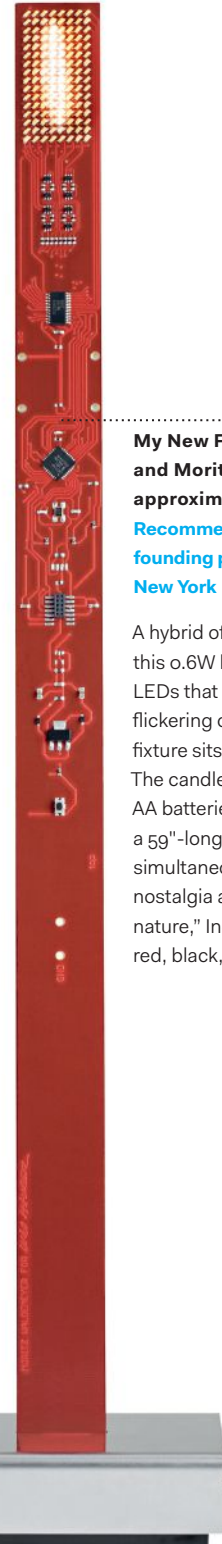

**My New Flame, Ingo Maurer and Moritz Waldemeyer (€420; approximately \$494)**  
Recommended by Bjarke Ingels, founding partner, Bjarke Ingels Group, New York

A hybrid of a circuit board and candle, this 0.6W luminaire is topped with 128 LEDs that digitally create the hypnotic flickering of a flame. The 15.7"-tall, 1"-wide fixture sits on a 3.5"-square metal base. The candle runs on four replaceable AA batteries or can be powered via a 59"-long USB cord (included). "It simultaneously delivers an illusion of nostalgia and still embraces its artificial nature," Ingels says. The fixture comes in red, black, and white. [ingo-maurer.com](http://ingo-maurer.com)

# Curtain Call.

Want a low-maintenance curtain wall that's recognized for performance? Our proprietary materials maintain color to make beauty sustainable. The durable NBK terracotta facade system keeps clean aesthetics in the limelight.

[NBKUSA.com](http://NBKUSA.com)

**NBK** | ARCHITECTURAL  
TERRACOTTA  
A Hunter Douglas Company 

TERRART™ LARGE, ROBERTS PAVILION AT CLAREMONT MCKENNA COLLEGE  
PROJECT ARCHITECT: JOHN FRIEDMAN ALICE KIMM ARCHITECTS

Presented by:

# FIRE PROTECTION FOR STEEL STRUCTURES



## LEARNING OBJECTIVES

Upon completion of this course the student will be able to:

1. Spell out the different roles that the architect, structural engineer, and fire protection engineer play in designing fire protection for steel structures.
2. Compare the behavior of wood, concrete, and steel structures in the presence of fire.
3. Identify important code allowances in fire protection designs.
4. Compare and contrast the pros and cons of sprinklers, spray-applied fire resistive materials, gypsum board, intumescent coatings and cementitious materials for structural steel frames.
5. Gain a better understanding of performance-based design, its applicability to structural steel framing systems and identify examples of its efficiencies in design.

## CONTINUING EDUCATION

AIA CREDIT: 1 LU-HSW  
AIA COURSE NUMBER: AR122017-3



Use the learning objectives above to focus your study as you read this article. To earn credit and obtain a certificate of completion, visit <http://go.hw.net/AR122017-3> and complete the quiz for free as you read this article. If you are new to Hanley Wood University, create a free learner account; returning users log in as usual.

Thin-film intumescent fire-protective materials were used as an aesthetic fire protection option on the exposed steel at the World Trade Center East in East Boston, MA. Photo courtesy of Shepley Bulfinch, 2000

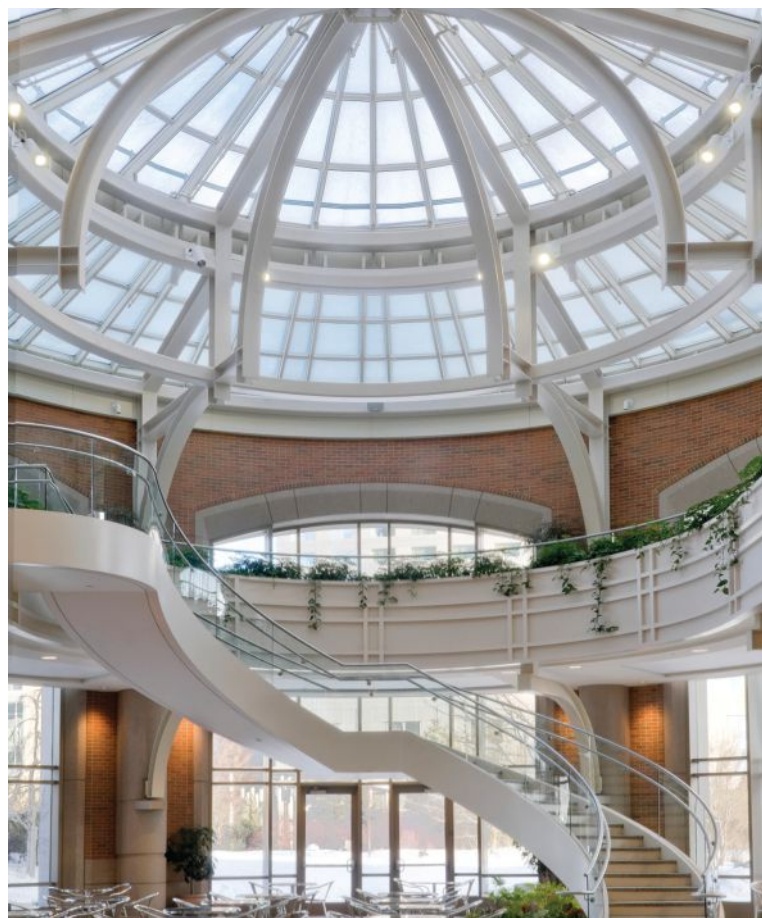

Known for its adaptability, durability, ductility, high strength, cost effectiveness, consistency of material properties, and aesthetic appeal, structural steel is the leading material of choice for all kinds of building applications.

Structures framed with structural steel, wood and concrete can all experience a building fire. But unlike wood, steel is a non-combustible construction material that does not burn. This combination of steel's non-combustibility and effective fire protection methods to minimize loss of strength in high intensity, long duration fires

have resulted in steel buildings being recognized as being no more vulnerable to fire than those well-designed and constructed of any other non-combustible material. Steel's superior performance record in fires is further demonstrated by the consistently lower insurance rates assigned to steel framed structures for both all-risk and builders-risk insurance, as compared to wood (2 times higher) or concrete structures (1.5 times higher).

But before delving into a discussion about the various approaches and technologies for protecting building occupants and steel structures

from fire damage, an understanding of the responsibilities of the building team members should be established.

While the primary responsibility for specifying passive fire protection (conformance to height and area limits, and the specification of rated assemblies) lies with the architect, both the structural engineer and fire protection engineer can be involved at the request of the architect, and with the specification of active protection systems (e.g. sprinklers, deluge, and gaseous protection) as well.



A performance-based design approach for San Francisco's Transbay Transit Center enabled Arup to meet two-hour fire resistance requirements by filling the large diameter hollow sections with concrete. Photo courtesy Transbay Transit Center

Laying out a general distinction of roles, Gerald R. Schultz, P.E., principal, The FPI Consortium, (Woodridge, IL), explains: "The architect identifies the means of meeting the code while ensuring their architectural design concept is achieved."

As stated in Section 101.3 of the International Building Code, the purpose of the code is to "establish the minimum requirements to provide a reasonable level of safety, public health and general welfare through structural strength, means of egress facilities... and safety to life and property from fire and other hazards..."

"The structural engineer addresses the feasibility of installing the product," continues Schultz, "and the fire protection engineer, when involved, reviews the design to ensure that the overall fire resistance objective has been met."

Building code fire protection requirements can be met through one of two compliance paths, either prescriptive or performance based.

A prescriptive approach can be taken, where the architect or fire protection engineer will determine the minimum fire-resistance rating for the elements in the building. These are based on the requirements of the prescriptive sections of the applicable building code which are determined by the construction type for the applicable occupancy groups and fire separation distances, explains Shane Cherney, P.E., FPE, LEED AP BD+C, fire protection engineer, HDR, (Omaha, NE).

"Once this has been established, the architect will work with the fire protection engineer and structural engineers to balance aesthetic, economic, and performance factors for achieving the required fire-resistance rating of

## PUTTING THE RESTRAINED VS. UNRESTRAINED DEBATE TO REST



An unrestrained, steel-framed floor specimen before and after a fire test. Photo courtesy AISC

Thanks to some innovative thinking and a proactive approach on the part of the American Institute of Steel Construction (AISC) and the American Iron and Steel Institute (AISI), any confusion over the required fire protection thickness for a structural steel floor construction and associated secondary members now has been put to rest.

Dubbed the "restrained" vs. "unrestrained" debate, there has been a lack of clarity regarding the ability of the structural members and the surrounding construction to resist thermal expansion during elevated temperatures.

With solid research as a foundation, for much of the past three decades, it was generally accepted that all typical structural steel construction was restrained. But Charles J. Carter, AISC's president and Farid Alfawakhiri, senior engineer for construction codes and standards, American Iron and Steel Institute (AISI), as reported in a September 2013 *Modern Steel Construction* article entitled "Restrained or Unrestrained?" indicated this acceptance gradually became obscured due to the influence of product manufacturers.

"It eventually became a matter for the building official, architects, and/or engineer of record to decide," they explain. "Yes, no, or maybe all became answers to the quest and the cost of defaulting to the conservative choice ensured arguments."

Despite substantial technical justification on the part of AISC and AISI, unrestrained ratings were still being selected. This, in turn, was forcing building owners to spend more money unnecessarily on fire protection as the protection thickness of an unrestrained assembly rating is about twice that for a restrained assembly rating.

To resolve this issue once and for all, AISC and AISI decided to test an unrestrained structural steel framed floor, under the auspices of Underwriters Laboratories, to prove that the unrestrained floor would perform just as well as a restrained floor under fire conditions.

"Simply stated, these test results are great. They provide a solution that eliminates the need to argue about what fire protection thickness is required," state Carter and Alfawakhiri.

Consequently, per the newer UL Design D982, a two-hour fire rating can be granted to an unrestrained assembly with an unprotected steel deck and spray-applied fire-resistant materials protection on the steel beam with a thickness equivalent to a one-hour unrestrained beam fire rating. In other words, the unrestrained floor can now receive the same thickness as the restrained floor when this design is used.

Furthermore, the standard covers both composite and non-composite designs, allows the use of normal and lightweight concrete, supports any welded wire fabric placement location in the concrete slab, and applies to a metal deck thickness from 1½ inches to 3 inches, inclusive.

The article Straightforward Specification which appeared in the June 2017 issue of *Modern Steel Construction* provides a concise summary of the background and details of the restrained versus unrestrained discussion. It can be found along with other relevant articles at [www.aisc.org/ULclarity](http://www.aisc.org/ULclarity).

the building elements,” he says. “Additional design development factors, such as flexibility for future changes in occupancy, may require the fire-resistance rating of building elements to exceed the minimum requirements.”

Jeff Tubbs, P.E., FSFPE, Arup, (Boston, MA), explains that performance-based designs for steel buildings require that the fire protection engineer performs a hazard assessment to determine fire scenarios and overall fire size in order to develop the credible worst case fire exposure to the structure.

“Then computer simulation models can be used to calculate smoke temperatures and the heat transfer to the structural members,” he notes. “This results in a prediction of the steel temperature based upon the hot gases from the fire, and a determination of the loss in structural capacity. The structural engineer then determines the structural performance based upon the structural capacity at the corresponding fire temperatures.”

### STAGES OF A FIRE

Before addressing the various fire protection methodologies and strategies, it’s important to understand the stages of a fire, how it impacts the building and some key terminology.

There are four stages to a fire. A fire event begins with **ignition** as a combustible fuel source begins to catch fire. Next the fire begins to grow as visible flaming **combustion** takes place. Once temperatures reach approximately 1,100 degrees F, this is called a **flashover** condition for a fully involved fire where anything combustible is burning. This is when the greatest damage occurs to the building systems, furniture, interior finishes and other building contents.

Once around 70 percent of the combustible materials in the area have burned out, the fire enters its fourth and final stage called **decay**. It is during this period that if the fire isn’t proactively extinguished, it runs the risk of migrating, both vertically and horizontally, thereby repeating the four-stage cycle in another segment of the building.

It is important to delineate the terms fire resistance and fire protection. These are defined in the ArchDaily’s authoritative *Architect’s Guide* as:

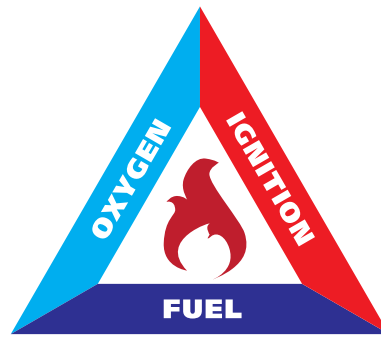

The Fire Triangle

- **Fire resistance** is the duration during which a structural assembly or element exhibits adequate structural integrity, stability, and temperature transmission. As tested in standards such as *ASTM E119 Standard Test Methods for Fire Tests of Building Construction and Materials* or *UL 263 Standard for Safety Fire Tests of Building Construction and Materials*, this fire rating is usually expressed in minutes or hours.
- **Fire protection** is described as anything that provides fire safety, e.g., sprinklers, fire detectors, fire separations, insulative materials, etc.

### BUILDING MATERIALS IN A FIRE

From a structural perspective, various building materials will behave in different ways when exposed to fire.

#### Wood

Wood is a combustible building material that burns during a fire event and is a contributing fuel source for a fire. According to Cherney, it provides minimal fire-resistance, the level of which depends on the type of structural member, physical form, and moisture content.

Even unprotected heavy timber offers only slight fire protection of less than one-hour. During fire events, heavy timber will burn and the resulting char will provide a limited insulative layer for the unburned wood of the member. However, this insulative member can easily be breached in areas where openings create a chimney or gravity compromises the char layer. For glued laminated timber members and panels, the char layer can shed once it burns to the glue line, thereby exposing previously uncharred wood and increasing the fire damage.

While this surface charring can slow the combustion of the underlying wood, Kasha Egan, P.E., associate, Wallace Engineering, (Oklahoma City, OK), points out that this will create a loss of gross cross sectional area for these members. This will reduce their load carrying ability, compromise their structural integrity, and lessen their resistance to future fire events. In addition, the water required to extinguish the char may result in mold, mildew, and rot of the member while introducing the undesirable odor of burned wood within the building envelope.

#### Concrete

Concrete is a non-combustible material that does not readily transmit heat, thereby serving as a strong fire barrier. Its performance will vary based upon application—i.e., beams vs. columns—but generally speaking, concrete can provide an effective insulating cover for reinforcing steel or structural members. The fire damaged cover, however, suffers permanent strength loss.

“Concrete also provides insulation from heat transfer through the element—typically a floor or wall—that may be required to be fire rated,” explains Grill.

The type of aggregate, moisture content, and size all contribute to concrete’s fire performance. When concrete is exposed to fire, it is vulnerable to cracking, spalling, and in the case of high strength concrete, explosive behavior.

Egan also notes that structural lightweight concrete is more fire resistant than normal weight concrete due to the mineral composition of the two types of aggregate.



When exposed to elevated fire conditions, concrete is prone to spalling, as pictured here in this slab on deck. Photo courtesy of Wallace Engineering



## Steel

Structural steel is also a non-combustible material. Since steel does not burn, it is not a source of fuel for a fire event. Although the physical properties of non-combustible materials may be adversely affected at elevated temperatures, unlike wood, steel and concrete do not contribute to either the duration or intensity of a fire. Tests by the National Institute of Science and Technology (NIST) have shown that fire severity is in direct correlation to the average weight of combustibles in a building. Steel does not contribute to that fire load.

Steel's strength will begin to decrease between 1,000 and 1,100 degrees F. But with adequate fire protection, the steel is shielded from the fire's heating process, so it can provide adequate load carrying capacity for several hours.

"At significantly high temperatures steel has a reduction in strength and stiffness," adds Egan, "however, upon cooling, steel (unlike wood or concrete), typically regains its strength and stiffness properties similar to before the fire."

It is important to note that for non-combustible framing, there is no assigned fire load. However, for conventional wood framing, a reasonable estimate of fire load for the structure is 7.5 to 10 psf. For heavy timber construction, the corresponding fire load might be on the order of 12.5 to 17.5 psf. As a result, building codes typically limit the permitted size (allowable height and area) of combustible buildings much more than for non-combustible buildings.

### THE BUILDING CODES

Any fire protection design always begins with the building codes. While the codes' primary goal is life safety protection from fire, the secondary goal is protecting the property and environment.

These goals are achieved by providing a safe means of escape (egress), or safe refuge, for the occupants in the event of a fire. In addition, the building can be designed to limit the progress and spread of fire and smoke, and minimize structural damage.

 This article continues on <http://go.hw.net/AR122017-3>. Go online to read the rest of the article and complete the corresponding quiz for credit.

## QUIZ

- The "flashover condition" of a fully involved fire is where anything combustible is burning at approximately...
  - 900 degrees Fahrenheit
  - 1,100 degrees Fahrenheit
  - 1,200 degrees Fahrenheit
  - 1,300 degrees Fahrenheit
- True or False: Typically, upon cooling, a structural steel exposed to fire will regain its strength and stiffness properties.
- A common overdesign mistake when it comes to structural steel fire protection is...
  - Specifying multiple kinds of fire protection
  - Only specifying sprinklers
  - Not making use of the allowable reductions in fire protection material thickness based on the real size of structural steel members
  - None of the above
- ASTM E119 includes...
  - Specific product names used for fire protection
  - The roles of the architect, structural engineer, and fire design engineer when it comes to specifying fire protection
  - The differences between prescriptive and performance-based design
  - Fire resistant requirements for columns, floors, walls, and other building elements
- Spray-Applied Fire Resistive Material is typically made from...
  - Mineral fiber
  - Cementitious materials
  - Mineral fiber or cementitious materials
  - None of the above
- When exposed to high temperatures, this fire protective material releases water to help mitigate fire induced temperatures...
  - Spray-applied fire resistive materials
  - Gypsum board
  - Concrete encasement
  - Cementitious materials
- What is structural fire engineering?
  - The responsibility of the architect
  - Prescriptive design
  - Performance-based design
  - All of the Above
- True or False: Performance-based design requires project teams to meet the prescriptive requirements of the building code.
- The potential damage that fire can cause to a steel structure depends upon...
  - The duration and intensity of the fire
  - The distance of the fire from the building's structural components
  - The type of fire protection used on the structural member
  - All of the above
- UL Design D982, which gives a two-hour fire rating to an unrestrained assembly with an unprotected steel deck and spray-applied fire-resistant materials protection on the steel beam, applies to a metal deck thickness of...
  - 1 1/2 inch to 3 inches
  - 3/4 inch to 3 inches
  - 1 inch to 3 1/2 inches
  - 1 inch to 4 inches

## SPONSOR INFORMATION



The AISC Steel Solutions Center provides a wide range of technical information and support services for building teams including information on the sustainable attributes of structural steel. To learn more about structural steel and sustainability, the Steel Solutions Center can be reached at 1-866-ASK-AISC or [solutions@aisc.org](mailto:solutions@aisc.org).



# IS IT TIME TO RETHINK WOOD?

---

**Discover for yourself.**

---

Read the white paper on  
Sustainability, Wood, and the Environment at  
[www.aisc.org/discover](http://www.aisc.org/discover).



There's always a solution in steel.™

American Institute of Steel Construction  
312.670.2400 [www.aisc.org](http://www.aisc.org)

# VIBRATION CONTROL WITH STRUCTURAL STEEL

Presented by:



## LEARNING OBJECTIVES

Upon completion of this course the student will be able to:

1. Identify the basic concepts of vibration and the common sources affecting steel-framed buildings.
2. Gain techniques for enabling structural steel construction to perform as well as concrete or better in controlling vibration.
3. Become familiar with the advantages and disadvantages of various stiffening and damping strategies.
4. Distinguish the causes of structurally hazardous resonance and identify strategies to prevent them.
5. Identify prominent case studies illustrating the ability of steel-framed buildings to control challenging sources of vibration.

## CONTINUING EDUCATION

AIA CREDIT: 1 LU/HSW  
AIA COURSE NUMBER: AR122017-2



Use the learning objectives above to focus your study as you read this article. To earn credit and obtain a certificate of completion, visit <http://go.hw.net/AR122017-2> and complete the quiz for free as you read this article. If you are new to Hanley Wood University, create a free learner account; returning users log in as usual.

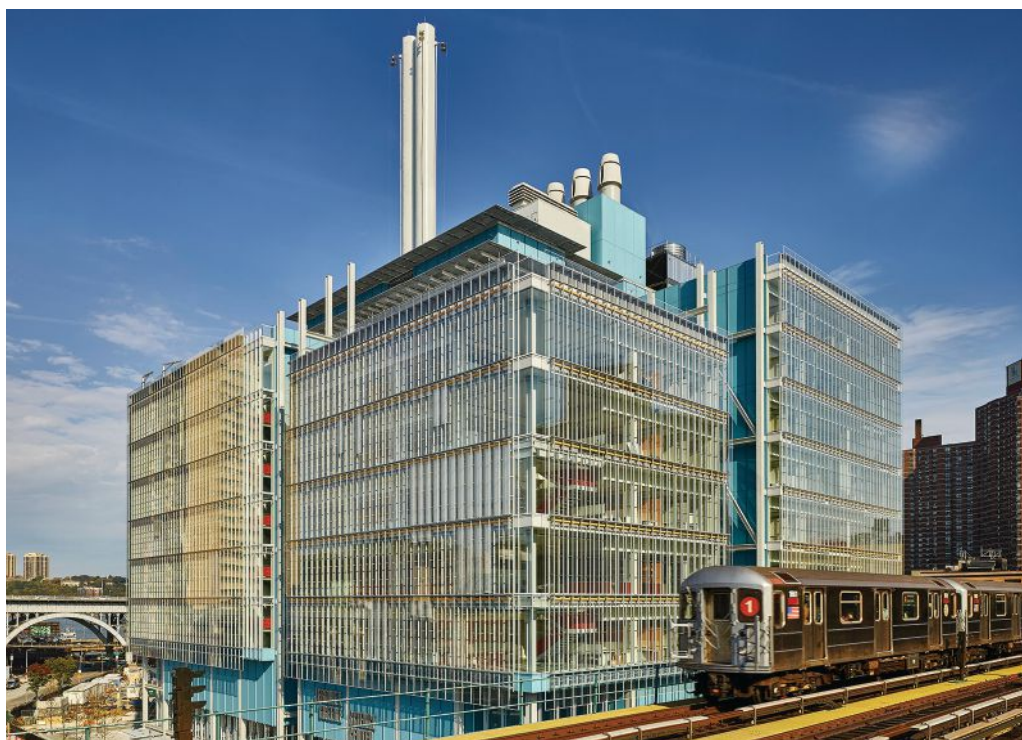

Columbia University's Jerome L. Greene Science Center, on the new Manhattanville campus, is located close to major transportation infrastructure, between the Metropolitan Transit Agency's elevated 1 line to the east and the Henry Hudson Parkway to the west. Photo by Frank Oudeman courtesy of Columbia University.

By Bill Millard

Imagine undergoing surgery on an eye, the brain or any other complicated, delicate part of the body. Would you want this procedure performed in a building subject to vibrations from a nearby subway line? The slightest imprecision in the movement of surgical instruments—or the stability of the structures supporting the surgeon and the patient—could have consequences no one involved would prefer to contemplate.

Whereas concrete has been the traditional first choice for most buildings where vibration must be kept to a minimum, such as surgical theaters, centers for magnetic resonance imaging (MRI) or electron microscopy, laboratories with highly sensitive equipment or projection facilities where small floor vibrations might cause images on screens to wobble unwatchable, steel is emerging

as a preferred solution. Factors unrelated to vibration control often make steel a preferable structural option: a need for large floor-to-floor heights, variability in costs of materials (including formwork and shoring), availability of expertise and quality control, a desire for fast construction or site-specific procedural requirements. Under such conditions, there is no need to accept “live” floors as a tradeoff for steel's other advantages. Given the contemporary science and art of vibration control, it is entirely possible to design a steel-framed structure that performs as well as concrete.

The need to measure, anticipate and control vibration is not limited to buildings with a medical or high-tech program. Vibration affects occupants' comfort and peace of mind in common residential,

commercial or public settings; even where vibration does not pose an actual threat to safety, architects and engineers must accommodate human perception of vibration that can be either conscious or subliminal.

Often, site conditions involving nearby sources of vibration, particularly transportation infrastructure, present vibration challenges. In tall residential buildings, the combination of wind loads and some occupants' high sensitivity to vibration in their own homes adds up to a challenge requiring attention and adaptation. (Seismic risks are a separate topic not considered here, though many technologies developed for seismic performance, such as base isolation of components or entire buildings, are useful for controlling less dramatic forms of vibration as well.)

Crowd movements, repetitive exercises like aerobics or dance and occasional deliberate attempts to excite a structural system by jumping in unison (“vandal jumping”) can be sources of hazardous deflection as well. As rare but notorious structural failures like the excitation and swaying of London’s Millennium (“Wobbly”) Bridge demonstrate, any type of rhythmic stresses, including massed pedestrians’ tendency to synchronize their movements unconsciously, can create resonance phenomena that render a structure unusable.

### CALCULATING THE MOVEMENTS

Whether the source of vibration is vehicles, footfalls, wind loads, HVAC or other machinery or some other cause, the core design principle governing its control is that deflection (measured in micro-inches per second or MIPS) varies directly with the dimensions of bays between columns and inversely with the stiffness of floors, structural members and other load-bearing components. Such deflection may be periodic if the material is subjected to regular stresses, as when any type of mechanical equipment contains a rotating element. These periodic or harmonic stresses can resonate with a floor or other component and amplify its deflections. By designing a structure so as to keep its natural frequency above the frequency of vibrations from footfalls or other occupant movements, machinery or environmental sources (and the first few harmonics, or integer multiples, of that frequency, usually the first three), an architect can be assured of avoiding resonance phenomena, essentially tuning the structure out of the frequency range of the vibration source.

The frequency calculations and other quantitative relationships, well understood by structural engineers and vibration consultants, are codified in the *Steel Design Guide 11*, published by the American Institute of Steel Construction (AISC).<sup>i</sup> In the United Kingdom and elsewhere, another widely used guideline is Steel Construction Institute (SCI) Publication P354, *Design of Floors for Vibration*.<sup>ii</sup> Further useful information is found in the International Standards Organization publications ISO 2631-2 on mechanical vibration<sup>iii</sup> and ISO 10137 on the design of buildings and walkways.<sup>iv</sup> Specific information on the vibration-related properties of HVAC systems appears in chapter 48 (Noise and Vibration Control) of the 2015 *ASHRAE Handbook on HVAC Applications*,<sup>v</sup> the most recent coverage of the topic in that handbook’s four-volume annual repeating series.

*Design Guide 11* sets standards governing specific details of floors, pedestrian bridges, stairs and

**Table 1. Allowable Vibration Criteria for Common Lab Occupancies**

Facility, Equipment or Use	MIPS ( $\mu\text{in}/\text{sec}$ )
Ordinary workshops	32,000
Offices	16,000
Residences, computer systems	8,000
Operating rooms, surgery suites, bench microscopes up to 100× magnification, laboratory robotst	4,000
Bench microscopes up to 400× magnification, optical and other precision balances, coordinate measuring machines, metrology laboratories, optical comparators, microelectronics manufacturing equipment—Class VC-A	2,000
Microsurgery, eye surgery, neurosurgery, bench microscopes at magnification more than 40×; optical equipment on isolation tables; microelectronics manufacturing equipment—Class VC-B	1,000
Electron microscopes up to 30,000× magnification, microtomes, magnetic resonance imagers (MRI), microelectronics manufacturing equipment—Class VC-C	500
Electron microscopes greater than 30,000× magnification, mass spectrometers, cell implant equipment, microelectronics manufacturing equipment—Class VC-D	250
Microelectronics manufacturing equipment—Class VC-E, unisolated laser and optical research equipment	125

Source: Sullivan, Andrew P., and Cheema, Muhammad A., *Minimizing Vibration in Sensitive Laboratory Areas*. *Healthcare Design*, March 1, 2006, <https://www.healthcaredesignmagazine.com/architecture/minimizing-vibration-sensitive-laboratory-areas/>.

other structures, as well as general principles, such as the recognition that occupants of residences and offices generally do not tolerate a peak acceleration above about 0.5% of the acceleration of gravity (0.5%*g* or 1.93 inches per second squared), whereas people on outdoor pedestrian bridges or monumental stairs will tolerate higher accelerations, people in proximity to common sources of vibration (dance, aerobics, shopping-mall crowds) will accept about 1.5%*g* and people participating in an activity will often accept 5% to 15%*g* or more. Special conceptual models in the guide account for the higher requirements of sensitive equipment.

The equations that proliferate in *Design Guide 11*—engineers’ bread and butter, vibration specialists say, though a background consideration for many architects—allow determination of key variables, particularly the natural frequency of a structure, and estimation of the feasibility of specific designs (including bridges, buildings housing sensitive equipment and spaces for crowd movements, exercise or other rhythmic activities) at particular scales. *Design Guide 11* is the basis of the vibration-analysis extensions in common building information modeling (BIM) software, e.g., Autodesk Revit Structure<sup>vi</sup> or Bentley’s RAM Structural System, and the source of the key terms collected in the **Vibration Glossary** at the end of this article.

Victoria J. Cerami, chief executive officer of New York-based acoustics/vibration technology

consulting firm Cerami and Associates, sets forth a series of general questions that architects should consider early in any project that is close to, or contains, a source of vibration: “What type of building is it? What is the project’s acoustical and vibration design criteria? What is the criticality of vibration? What are the sources around it, either criticality in the building type or the elements that may be environmental (trains, elevated rail, elevated roadways)?” A nanotechnology facility, a hotel, an apartment building and an academic building will all have different vibrational requirements; a corollary of this observation is that multifunction buildings, or buildings that may undergo reprogramming or adaptive reuse, require analysis for more uses than are initially planned.

For spaces housing scientific and biomedical equipment, a range of allowable vibration measurements, including the five standard Vibration Criteria levels VC-A through VC-E, appears in **Table 1**. (A more extensive set of vibration criteria—including the extremely challenging levels VC-F through VC-M—has also been promoted by isolator specialists working with academia, government and the aerospace industry<sup>vii</sup>; the levels beyond VC-E are practically unachievable and presented for evaluation, not design purposes.)

Cerami’s firm is frequently called in for analysis and remediation on a project after its completion or partial completion when a problem with

vibration and/or acoustics is detected. A preferable scenario, Cerami and chief technical officer James Perry emphasize, is for design teams to involve vibration specialists early enough in the design process that they can analyze environmental conditions, model the properties of the proposed structure and control potentially problematic vibration in advance.

Perry adds that one critical variable discussed in *Design Guide 11*, the fundamental natural frequency at which a structure vibrates when displaced and cleanly released, provides a rule-of-thumb threshold for consulting with engineers who specialize in vibration and acoustics. “If your structure is designed with anything less than a 4 Hz natural frequency, you really need to check with a specialist to see if this is going to be OK.” A natural frequency below 4 Hz is not automatically a disaster, but it calls for analysis depending on program requirements.

“There’s an uneasiness that people experience with vibration,” Cerami adds, “because they’re not able to figure out where it’s coming from.” Audible frequencies are easier to perceive, measure and even simulate through modeling technologies (auralization), she notes, than the inaudible low frequencies that can indicate serious problems; with “the numbers that we talk about that relate to vibration and those that correlate to actual sound, people then understand what those numbers mean. They can hear them.” Below the common audibility threshold, a frequency of about 20 Hz (with individual variation), vibrations are generally felt rather than heard. Vibrations below approximately 9 Hz must be considered in accommodating human comfort, as discussed in *Design Guide 11* with reference to floor vibrations and resonant buildup; for sensitive equipment, higher-frequency vibrations must be analyzed and controlled as well.

### VIBRATION, MASS AND DESIGN TRENDS

Modern construction methods and client preferences for lightweight structures can be conducive to vibration problems. “There’s always a push to make a structure more efficient and lighter,” observes Antoine AbiDargham, vice president and director of building engineering at AECOM in New York. “What really that transpires into is people putting some significant long spans with very light structural steel members and running up the deck to a point where, if you’re not really paying attention, you end up with a structure that’s so light and so flimsy that it dances under your feet as you’re walking on it.”

If a design/construction team treats vibration analysis as an afterthought, what a project can save in material costs and environmental footprint, or gain in the intangibles associated with open-plan designs (free-flowing circulation patterns, integrated group communications or broad views), it can lose in functionality and comfort. “When you lighten up the structure, when you feel that you’re pushing the limit with [a] structural field that’s high-strength, open-web joists that are going quite far, very thin slabs,” AbiDargham continues, “it’s mandatory for you to do a check on the vibration.”

“Office spaces have much less stringent vibration criteria than, say, a lab or performance center, because the load in use in those spaces is very low compared to those other spaces, and their acceptable threshold is much higher than for, say, specialized equipment,” observes AECOM structural engineer Chris Shipper. Yet vibration can be as irksome in commercial settings as in residential, and recent tendencies in office configuration and operations are conducive to it. The transition from paper-based to electronic offices, Perry points out, reduces the amount of bulky furniture that provides inertial damping to floors, so that a building that once met the design guidelines may no longer meet them after a tenant modernizes its operations or a new tenant with lighter equipment moves in. Another component that can help damp floor vibrations is internal partitions, also minimized by contemporary open-plan trends. Office buildings that incorporate health clubs are a superb amenity for workers but a mixture of very different vibration profiles for engineers; vibration levels should be calculated carefully and early when aerobics are part of the program, and lower floors are intuitively better sites for these facilities than higher ones.

For contemporary construction with high vibration-control requirements, “steel is almost as equally viable as concrete,” notes Shipper, “as long as you take the time and do the appropriate analysis and make sure that you’re not just considering strength—that you’re always considering serviceability and the design of the structure. As long as you choose the appropriate sizes and use things like composite framing, you can really take advantage of the properties of the steel to meet the same requirements.”

### CORRECTIVE MEASURES

Strategies for preventing or remediating an unacceptable vibration condition, depending on

the cause, can begin with low-tech, common-sense measures such as locating sensitive equipment at or below grade, close to a stable wall or column and away from large bays between columns. When performance testing, modeling and mathematical vibration analysis indicate that a structural system has a low natural frequency and is vulnerable to vibration from walking or other rhythmic sources, the first option is to increase its stiffness—preferably in design but sometimes through retrofitting, adding supporting elements that raise the natural frequency of the lowest-frequency components of the structural system, often along with isolation pads or dampers.

Jacking a floor system is recommended in *Design Guide 11* to introduce strain before welding of new stabilizing elements, producing a tightened retrofitted structure. If additional columns below a vibration-prone floor are acceptable to clients and occupants, they can effectively shorten affected bays and stiffen the floor, sometimes aided by viscous or friction-based damping devices. Replacing non-load-bearing partitions with light concrete masonry unit (CMU) walls helps stiffen girders. Where a beam or joist lacks adequate stiffness, another recommended option is horizontal reinforcement with a queen post hanger welded to the bottom flange (provided space allows for such an operation) and laterally supported, again with jacking to introduce stress in the hanger.

Base isolation can be particularly useful when the forces exciting a floor or other structure are vertical or involve high amplitudes, as in dance or exercise facilities involving synchronized group jumping. Floating floors mounted on soft springs or neoprene pads are often effective in isolating either vibrating machinery or rhythmically moving occupants. They have the advantage of being relatively easy to introduce or remove as programs change within a building, without major structural alterations.

A tuned mass damper (TMD), a smaller version of the large-scale mass-and-spring TMDs used to stabilize high-rise structures against lateral sway under wind loads, can be attached to a floor to prevent buildup of resonance vibration, transferring kinetic energy from the floor to the mass and dissipating it through damping devices. (Although TMDs used to stabilize skyscrapers can be several floors tall, weighing hundreds of tons, the same approach is effective on lower scales.) This passive control method depends on the natural frequency of the TMD being tuned to the undesirable mode of floor vibration,

and the device can go out of tune if the floor's natural frequency changes because of addition or removal of materials. Floors and structural systems with more than a single mode of vibration, particularly if those modes have proximate natural frequencies, derive less benefit from a TMD. Vibration from aerobics, dance and related activities require significantly more massive TMDs than vibration from walking does.

The experience of engineers and architects who have addressed particular vibration problems—sometimes anticipating and preventing them, sometimes responding to them—fleshes out the abstract principles that underlie the science of stabilization.

### SCIENCES AND ARTS SILENCING THE TRAINS

The design and engineering team for Columbia University's Manhattanville campus complex in West Harlem, New York, located between the Metropolitan Transit Authority's elevated 1 line above Broadway and the Henry Hudson Parkway along the Hudson River waterfront, confronted site conditions that posed multiple vibration challenges: trains to the east, high-speed autos to the west and heavy wind loads coming off the river. Attention to the interplay of vibration, technologies and design features provides a remarkable degree of stability in the first three buildings at the new campus despite the nearby vibration sources.

The complex includes the Jerome L. Greene Science Center, housing the interdisciplinary Mortimer B. Zuckerman Mind Brain Behavior Institute (MBB); the Lenfest Center for the Arts, a multipurpose facility stacking double-height spaces for film studies, the performing arts, a visual-art gallery and a top-floor space (the "Lantern") for lectures, recitals and gatherings; and the University Forum (under construction at this writing), the campus's public gateway building, with an auditorium, offices and meeting spaces. Project architect Antoine Chaaya of Renzo Piano Building Workshop (RPBW) has guided the Manhattanville project, and collaborators include AbiDargham and Shipper, who participated first at WSP, structural engineer of record on the first two buildings, and then with AECOM, structural engineer of record on the Forum. Arup provided acoustic consultation on all three buildings. All have steel frames above a reinforced concrete foundation.

 This article continues on <http://go.hv.net/AR122017-2>. Go online to read the rest of the article and complete the corresponding quiz for credit.

### QUIZ

- Vibration in floors, buildings and bridges can be detrimental to:
  - Structural stability
  - Precision scientific and medical instruments
  - Human comfort and perception of safety
  - All of the above
- Occupants of offices and residential buildings generally tolerate:
  - More vibration than persons participating in an activity.
  - Less vibration than persons participating in an activity.
  - More vibration than persons on an outdoor pedestrian bridge.
  - Less vibration than scientific equipment.
- True or False: When designed with attention to local sources of vibration and checked against the formulae of *AISC Design Guide 11*, structural steel can control vibration just as well as concrete construction.
- Features of a building's design or operations that can be conducive to problematic vibration include:
  - long spans for structural members
  - lightweight beams, girders and slabs
  - electronic office equipment rather than paper
  - all of the above
- It is strongly advisable to consult with vibration specialists if a structural system's natural frequency measures below:
  - 20 Hz
  - 9 Hz
  - 4 Hz
  - 2.5 Hz
- Vibration performance levels of a floor/ceiling system can be improved by:
  - additional columns below a "live" floor
  - reinforcement of a beam or joist
  - floating floors
  - tuned mass dampers
  - all of the above
- Practical testing procedures for nonseismic vibration analysis include:
  - wind-tunnel testing
  - shake-table testing
  - vibration simulation coupled to building information modeling software
  - all of the above
- A steel-frame building near major transportation infrastructure:
  - would require large enough members that it would be costlier to stabilize than an all-concrete structure.
  - can safely include multiple sensitive programs with appropriately sized cellular members and damping technologies.
  - can maintain recommended vibration-control levels for precision scientific instruments by locating them below grade.
  - b and c, but not a
- When specifying polyurethane for base isolation, precise load estimates are important because:
  - very stiff material would transfer vibration.
  - very flexible material would deflect excessively.
  - very flexible material could cause columns to settle.
  - all of the above.
- Floor span lengths over 100 feet with roof spans of 120 feet:
  - would inevitably be susceptible to unacceptable vibration levels.
  - would require an advanced carbon-nanofiber-reinforced concrete that cannot yet be manufactured economically.
  - have been safely constructed with a deep joist system in an American steel-framed sports complex.
  - are grounds for questioning the professional judgment of a structural engineer.

### SPONSOR INFORMATION

#### Steel Institute of New York

The Steel Institute of New York is a not-for-profit association created to advance the interests of the steel construction industry. The institute sponsors programs to help architects, engineers, developers and construction managers in the New York building community develop engineering solutions using structural steel construction. [www.siny.org](http://www.siny.org)

# DESIGNING VENTILATED FACADES WITH ARCHITECTURAL ULTRA HIGH PERFORMANCE CONCRETE

Presented by:

**TAKTL**<sup>®</sup>

## INTRODUCTION

The opaque walls of our buildings have become more complex over the past decade while becoming thinner and lighter at the same time. The history of building has progressed from piling up of heavy, solid materials to thinner and lighter strategically layered separations of the inside and outside. The industrial age and modern aesthetic brought lighter constructions and celebrated extreme thinness. Our walls now are mostly air—composed of a series of thin planes measured in centimeters or less, held together and apart by slivers of folded metal measured in millimeters or less. It is not by chance that we have become so keen on the qualities and characteristics of “surfaces.”

This course builds upon *Architectural Ultra High Performance Concrete* published in ARCHITECT in May 2016 ([available online at Hanley Wood University](#)), which focuses on the history, material characteristics, manufacturing methods, and range of facade elements and applications utilizing Architectural Ultra High Performance Concrete (UHPC). Three primary material characteristics make Architectural UHPC cladding panels and accessory elements an ideal material for ventilated cavity wall facade cladding:

- Surface: Wide range of designs and facade compositions possible with a cast product
- Thin Cladding: High strength to thickness ratio (compressive, flexural, and anchor capacity)
- Performance: Excellent long-term durability and serviceability

After completion of the course, participants will understand the inter-related elements of the back-ventilated and drained-cavity (BVDC [open-joint, “rainscreen” systems]) wall designs that determine performance, cost, and visual appearance and be equipped with questions and a framework to qualify manufacturers and work collaboratively to develop design solutions and specifications that leverage the unique advantages of Architectural UHPC.

Walls fundamentally serve to support themselves and adequately resist the live loads imposed upon them, keep inhabitants dry within prescribed thermal comfort zones, minimize energy input requirements, resist fire, and remain beautiful for as long as the building is standing in the world. There are several fundamental issues that designers must be aware of and address in construction:

- Structural Performance
- Building Movement
- Construction Tolerances
- Thermal + Moisture Performance
- Life Safety + Resilience

## LEARNING OBJECTIVES

Upon completion of this course, participants will::

1. Describe wall system options for cladding open-joint, back-ventilated facades with Architectural UHPC
2. Identify critical factors for wall assembly design
3. Explain cost drivers for manufacturing and installing Architectural UHPC facade panels
4. List the types and benefits of pre-fabricated, unitized solutions utilizing Architectural UHPC
5. Discuss how to work with a manufacturer to develop budget pricing, a specification, and timeline

## CONTINUING EDUCATION

CREDIT: 2 LU

COURSE NUMBER: AR122017-4

Use the learning objectives above to focus your study as you read this article. To earn credit and obtain a certificate of completion, visit <http://go.hw.net/AR122017-4> and complete the quiz for free as you read this article. If you are new to Hanley Wood University, create a free learner account; returning users log in as usual.





- Long-Term Durability
- Cladding Aesthetics + Installation Efficiencies

Cavity walls are considered by many to be the preferred building envelope and are applicable in most climate zones in the United States. Back-ventilated and drained-cavity (BVDC) walls with continuous insulation (CI) and durable cladding provide superior handling of bulk rainwater and have redundancies for strong thermal and moisture controls. The performance requirements for building envelopes track neatly with the layers of BVDC wall assemblies. Each layer serves to accomplish a limited number of tasks. This allows for installation quality control and phased inspection of each layer. Layers include:

- Substrate (backup wall)
- Air and Water Management (AVB and/or WRB)
- Thermal Insulation
- Air Space
- Cladding Support Structure (sub-frame)
- Cladding

## STANDARD BVDC WALL COMPONENTS AND DESIGN DRIVERS

### Building Movement

With all the requirements of facade design, it is easy to forget that buildings move—a lot! This movement can be designed into the facade from the outset. If building movement is not recognized and addressed, the facade can be visually scarred, or worse, failure of the building envelope. Building movement can be measured in very small distances (<1/8in) and short timeframes or larger distances (>2") over longer periods. For example, buffeting wind switching from positive to negative in a matter of seconds versus the expansion of a building wing in a months-long seasonal transition from cold to hot or creep over years. The two primary types of building movement that the envelope design must anticipate and accommodate are live load deflection (lateral wall deflection and vertical perimeter structure deflection) and thermal expansion/contraction (whole structure and wall assembly components). Wind-induced drift and seismic displacement will be discussed later in the article.

Properly designed BVDC wall assemblies account for the effects of vertical deflection by minimizing connection points at which sub-frame and cladding panels bridge floors

and where fixed points in the assembly meet structural components. Vertical deflection limits are often more restrictive than lateral deflection limits. Once the lateral loads are solved, the primary issue is floor deflection, namely, inter-story differential live load deflection at the slab edge. Live load floor deflection is limited by code (2015 International Building Code [IBC], Table 1604.3) to  $L/360$ , approximately 1-inch per 30-feet. This is easily accommodated with deflection tracks for stud walls in which the framing is held within a deeper track to resist transverse lateral loads while allowing movement vertically—thus isolating the stud wall from the primary structural movement. Another means of isolating the stud wall from the primary structure is to bypass the slab edge. This is a “fully-hung” backup wall that separates the wall from the frame and the inherent large frame tolerances.

Working within reasonable deflection limits is safer and less costly than building the primary structure to eliminate deflection completely. The AISC publication, *Serviceability Design Considerations for Steel Building*, recommends non-ground-supported cladding to limit vertical live load deflection to be less than  $L/360$  or  $1/4$  to  $1/2$ -inch, depending on the details. The details dictate how wall systems will avoid failure from undesirable stresses, long-term material fatigue, or weather-seal failures. Similar isolation details are employed for seismic design, along with specialized seismic joints that allow for greater movement horizontally in plane with the stud framing. Some details employ mechanical shock absorbers and sophisticated elastomeric (bellows) flashings capable of elongating many times their installed dimension or withstanding compressive forces repeatedly without rupturing or tearing.

The deflection limits for lateral loads for non-load bearing walls are as much about the structural integrity of the wall, as the ability of the materials used for exterior weatherseals and interior finishes to hold up under the extent of deformation or the frequency of movement. The limits for wall deflections are differentiated by the wall material; for example, they are greater for masonry than for gypsum board. BVDC walls on stud frames should be between  $L/180$  and  $L/240$ . Since BVDC walls typically have open joints without sealant, their cladding systems inherently have reduced stresses due to vertical or lateral movement. References for allowable deflection, in addition to the American Iron and Steel Institute, include: Brick Institute (BI) and American Concrete Institute (ACI).

All construction materials have a coefficient of thermal expansion and some materials are influenced by moisture along with temperature (e.g. masonry). The thermal coefficient of expansion can be translated into a measurement for material to elongate (expand) due to warming or shrink (contract) due to cooling. When many layers of materials are assembled, they can expand or contract at different rates. The southwest corner of a building could be expanding, while the northeast corner of the building is shrinking. Or, a cladding panel can expand very little relative to the metal frame that supports it. Thermal expansion comes in cycles, morning to afternoon, season to season, etc. Without the means to allow materials to move at different rates, stresses can build up that shorten the life of the materials. Small-scale connections can be fatigued, or large-scale building sections can grind against each other causing significant deterioration.

Checking the coefficient of thermal expansion of the materials is necessary when specifying wall assembly components and detailing proper connection design, component joints, and facade area expansion joints. Although cladding joints prevent thermal expansion conflicts at the finish plane, the metal behind panels will move and should be designed to move. Connections in the layers of the wall assembly differentiate between load-resisting (vertical and lateral) and having the freedom to move vertically or horizontally relative to the wall plane, while still resisting loads perpendicular to the wall.

Architectural UHPC panels are surprisingly flexible and able to deflect perpendicular to the panel face more than the code deflection requirements for typical wall construction. Since typical BVDC cladding is discontinuous panels with open joints, the deflection of the wall and risks of panel stresses beyond the allowable limits are reduced. Regarding panel deflections parallel to the plane of the wall, the  $L/360$  or  $1/8$ -inch deflection limit parallel to the plane of the panel is referring to a panel attachment condition in which a load, like a beam, is placed upon the panel and the panel is unable to move, or the intermediate attachment points are so closely spaced that they do not allow vertical deflection movement over the length. Designers often assume that the whole wall must conform to an  $L/360$  deflection; however, the deflection specifications for panels are specific to the panel attachment and the length of the panel. For example, the deflection of a floor

slab between column supports may be  $\frac{3}{4}$ -inch, but this amount of deflection may be divided (segmented) across 3 or 4 panels and sub-divided further across the panel attachment points. So, a 1/8-inch deflection limit for the panel, does not mean the slab edge of a floor that supports the wall must be limited to 1/8-inch. Panels are typically moving with the wall and slab and the limit in deflection is for differential deflection. The full deflection anticipated for the slab does need to be accommodated in the joints between panels attached to different floors.

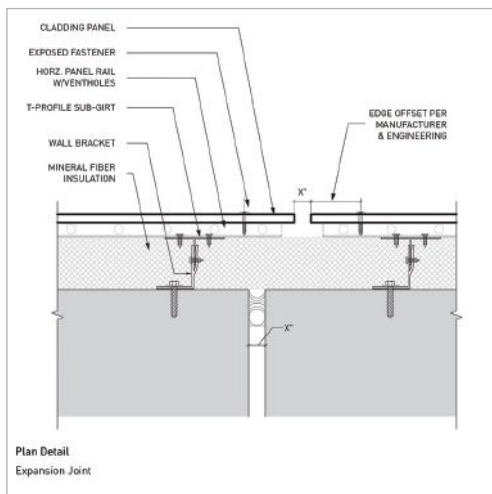

There will always be joints with sizes that disrupt the panel or joint pattern on a facade, whether for deflection or for thermal expansion. Deflection joints of  $\frac{3}{4}$  to 1-inch are common between floors. Vertical expansion joints often will be required for inside corners of tall buildings, at transitions between lower and taller building sections, or when structural systems or substrate conditions change. Detailing appropriate joint sizes early in project design will minimize the potential for disruptions of the facade design intent during the submittal phase.

### Construction Tolerances

Construction tolerances grow exponentially with each layer in a wall assembly. It is the designer's responsibility to prepare transitional detailing to pre-emptively and thoughtfully respond to connection points that will likely be impacted by construction tolerances either aesthetically or performance-wise. Designers, manufacturers, and contractors must plan for material and installation tolerances including:

- Building Structure
  - o Structural wall and floor inconsistencies
  - o Floor and wall penetration (windows, utility, etc.) placements

- Facade System
  - o Manufactured dimensional tolerances
  - o Erection tolerances
- Cladding Material
  - o Manufactured dimensional and thickness tolerances

Tolerances of substrates and backup walls must be ameliorated through the sub-frame to meet the finished standards for the cladding. Some sub-frame materials have built-in features that accommodate construction tolerances and others require shimming at connection points to adjust depths. For example, some extruded aluminum systems include means to hold girts in place with friction; so, installers can set other points and check for true, plumb and level position before setting the fasteners. Other aluminum systems adjust with a range of pre-drilled/punched connection points or slotted holes.

Cladding manufacturing tolerances will vary. Architectural UHPC manufacturers can deliver extremely precise surfaces and forms; however, designers and contractors must have realistic expectations for tolerances and acceptance criteria for an entire project scope. Although there can be significantly tighter tolerances for Architectural UHPC compared to thick, pre-cast products, Architectural UHPC is still concrete and there will be dimensional and thickness variations that should be anticipated and accommodated in the installation tolerances. Dimensional tolerances scale with the size of the parts; the larger the elements are, the larger the joints for movement of the sub-structure will need to be. Architectural UHPC manufacturers will outline acceptance criteria in their Quality Management Systems (QMS) and provide guidance to installers for accommodating installation tolerances within wall assemblies.

### Backup Walls

Backup walls can be cast-in-place concrete, Concrete Masonry Units (CMU), sheathed cold-formed steel framing and gypsum sheathing (metal stud), or hollow structural steel with structural insulated paneling. The layering of the sub-frame accommodates building movement, sets the space for insulation, and establishes air-space necessary for the cavity to function. It is rare for multi-story commercial and institutional buildings to have load-bearing walls as the typical means of enclosing the building today. Many of the specifications and assembly concepts discussed in this course can

be translated to load-bearing walls; however, the differences between non-load-bearing BVDC wall cladding and load-bearing BVDC wall cladding is mostly found in detailing. Back-up walls (substrates) provide the structure for insulation and sub-frames for exterior cladding that create flexibility to achieve the desired delineation of facade.

Light gauge cold-formed framing is the most common exterior wall used in commercial construction. Stud framing is perpendicular to the gravity load and is primarily designed to resist uniform lateral loads (wind pressure) with each stud loaded equally across the span (typically floor to floor). The orientation of the framing has implications for the cladding panel size and orientation and what cladding support system will be most efficient, structurally and economically. There must be a translation of the cladding load through a sub-frame that evenly distributes load to the backup wall stud frame. A horizontally-oriented sub-frame will do this most efficiently. However, panel sizes, orientation, and layout often do not align with what is most efficient for stud framing. BVDC wall assemblies provide for the flexibility to detach the aesthetic composition of the building skin from the structural elements. A balance between the economics of cladding support and composition of panels can be found to control costs required for sub-frames to effectively transfer lateral loads.

Stud spacing is restricted to 12, 16, and 24-inches by the standard dimensions of gypsum board sheathing. Stud depth, 4 or 6-inch, and steel gauge and grade are engineered together to meet the structural requirements for span and lateral loads. Higher stud grade increases the connection capacity of fasteners, which is a critical engineering factor when setting out the frequency of sub-frame components and therefore, a multiplier for sub-frame cost. A higher gauge and grade could mean the difference between 24-inch stud spacing or 16-inch stud spacing. For example, 6-inch, 18-ga/50-ksi studs at 16-inch on-center (OC) spacing is higher or equal in cost to 6-inch, 16-ga/50-ksi at 24-inch OC even without accounting for the increase in labor to install more studs.

### Air and Water Management

Water and moisture management and thermal insulation are the two functional aspects of building envelope that are much higher performing in BVDC with CI than in closed systems. Keeping building inhabitants dry is a relatively simple matter; however, walls need

to maintain their seals while accommodating building movement across penetrations and flashing transitions. There is also demand for single systems to be water-resistant and resilient air infiltration barriers. Air infiltration is the greatest source of energy loss. Water Resistant Barriers (WRB) or Air and Vapor Barriers (AVB) come in a broad range of product offerings to suit the specific design criteria and geographic region, climate, and wall assembly compatibility with substrate, flashing requirements, and building movement. Application methods include spray, roll-on, and self-adhered membrane sheets. Accessories such as primers and joint-prep sealants, flashing and flashing sealants need to be selected, detailed, and coordinated with AVB manufacturers.

The AVB may either be on the face of the insulation, or behind it, depending upon the wall design. In certain climate zones, such as Florida, the waterproof membrane will be situated behind rigid insulation; so, it is advisable to have a controlled drainage plane (grooved back of insulation board) at the interface of the AVB. BVDC walls have many advantages; high on this list is the fact that AVB is typically behind CI. Not only does the insulation coverage of the AVB provide protection of the membrane from the elements and extend the service life of the weather barrier, the relationship of insulation and AVB moves the dew point of the wall to the exterior surface of the AVB membrane. This minimizes risk for condensation inside buildings and the resultant mold and material deterioration and corrosion. Once typical wall condition designs are resolved, special attention should be given to the critical conditions for thermal and moisture performance including:

- **Inside and outside corners**—Details must be considered to ensure the WRB/AVB and insulation remain continuous at these connection points.
- **Expansion, seismic, drift, and deflection joint locations**—Off-the shelf expansion joints can often work at the weather seal plane; however, proper solutions for expansion and seismic joints in the cladding plane need careful coordination for standard hardware or custom solutions to perform properly. Locating these early with the structural engineer and designing them into the facade elevation produces better technical solutions and visual outcomes.
- **Parapets**—These are often a heat sink or insulation void that can create concealed

condensation with a path of thermal conduction or gap in the continuity of insulation.

- **Window perimeters**—Like the WRB/AVB, the thermal barrier must be continuous. A typical detail for windows will have the window set back at the stud wall, placing the thermal break a few inches offset from the wall insulation.



This article continues on  
<http://go.hw.net/AR122017-4>.  
 Go online to read the rest of the article and complete the corresponding quiz for credit.

## QUIZ

1. True or false, exposed fastening is more expensive than concealed fastening panel attachment.
  - a. True
  - b. False
2. Developing custom multi-textured molds with Architectural UHPC manufacturers can:
  - a. Promote opportunities for panel interchangeability
  - b. Standardize sub-frame component requirements
  - c. Minimize attachment points
  - d. All of the above
3. What is required for BVDC wall assemblies by code ASHRAE 90.1?
  - a. Fire-rating testing
  - b. Continuous insulation
  - c. Water barrier
  - d. None of the above
4. True or false, NFPA 285 is a materials test.
  - a. True
  - b. False
5. True or False, Architectural UHPC and BVDC assemblies can only be installed on new construction.
  - a. True
  - b. False
6. For resilience design, Architectural UHPC is well-suited in marine environments with high flood risks because of its:
  - a. Water tightness
  - b. High strength to thickness ratio
  - c. Resistance to salts and chemical degradation
  - d. All of the above
7. The sub-frame of a BVDC wall assembly supports the cladding and creates the cavity. What other important function(s) does the sub-frame serve?
  - a. Adjusts for building tolerances to establish a true and plumb cladding surface
  - b. Structurally stiffens the backup wall
  - c. Transfers the lateral loads on the cladding to the backup wall
  - d. Resists the vertical deflection of the floor slab
  - e. A and C
8. Water/moisture management and thermal insulation are the two functional aspects of building envelope that are much higher performing in BVDC with CI than in closed systems.
  - a. True
  - b. False
9. What is the most straightforward strategy for minimizing Architectural UHPC panel manufacturing and installation costs?
  - a. Minimizing unique part types
  - b. Counterboring parts for exposed fastening
  - c. Designing a running bond panel layout
  - d. Creating custom mold patterns
10. Which types of building movement will affect the cladding panel pattern or panel joints sizes?
  - a. Floor live load deflection
  - b. Interstory wind and/or seismic induced drift
  - c. Expansion joints within the backup wall
  - d. Vertical "crush" zones for earthquake movement
  - e. All of the above

## SPONSOR INFORMATION

# TAKTL®

TAKTL is the first company to fully integrate Ultra High Performance Concrete (UHPC) formulation, design, mold making and automated manufacturing to deliver high-quality architectural products made in the USA. TAKTL offers a variety of standard and custom programs to address the needs of projects spanning a wide range of design requirements, budgets and schedules.

# RAPID DIGITAL PROTOTYPING AND 3D PRINTING

USING THE POWER OF BUILDING INFORMATION MODELS TO EXPLORE DESIGN,  
SITE INTEGRATION AND CONSTRUCTION IN THREE DIMENSIONS

Presented by:



Three-dimensional prototyping and modeling can help create buildings that are better designed, easier to construct and safer to use, as shown here in the WPF CAD Shared Tower. Photo credit: Jan Philipp Wotschke; Courtesy of Vectorworks, Inc.

We live in a three-dimensional world, so it makes sense to design buildings in three dimensions. Architects have recognized this for some time by building scale models in their studios using cardboard, wood or other materials. Most, however, have made the switch to creating digital three-dimensional models using computer software. This allows faster conceptualization, easier modifications and more portable presentation abilities than hand-made, physical models. Nonetheless, there is still value in a physical three-dimensional model of all, or parts, of a building for better understanding and analysis. While the concept of creating models or prototypes is not new in the building design world, technological advances have taken the idea to new levels and created an explosion of new potential opportunities. Taking a nod from other industries such as automotive and

machinery design, architects are now engaging in the process of rapid prototyping of their designs using 3D printing technology. This process uses a digital model as the basis for creating a physical scale model using a variety of material choices. In this article, we will look at the link between digital and physical prototyping and provide some specific examples of architects who are using both to achieve many different objectives.

## DIGITAL AND PHYSICAL 3D PROTOTYPING

Buildings or their components all start with a human idea or a thought process. Capturing that thinking in a medium to understand its form or spatial characteristics is the essence of any design and, ultimately, construction. Toward that end, computers have become a highly valued and very effective tool to advance

## LEARNING OBJECTIVES

Upon completion of this course the student will be able to:

1. Discover the ways that creating prototypes can be applied to architecture, engineering and construction for structural and space analysis.
2. Identify the multiple benefits of creating digital and actual prototypes during the design process, including those related to safety in buildings.
3. Recognize the ways that digital and actual prototypes can aid with land-use and site analysis, integration of building systems and sustainability.
4. Explore the ways that rapid prototyping can aid with defining design parameters for code compliance.

## CONTINUING EDUCATION

AIA CREDIT: 1 AIA LU/HSW  
AIA COURSE NUMBER: AR122017-1



Use the learning objectives above to focus your study as you read this article. To earn credit and obtain a certificate of completion, visit <http://go.hw.net/AR122017-1> and complete the quiz for free as you read this article. If you are new to Hanley Wood University, create a free learner account; returning users log in as usual.

human thinking as projected through virtual or digital representations of designs and details. The computer software programs that make this possible have been developed from different professional disciplines or points of view, but they all focus on allowing a designer to create, direct, view and control a digital representation of reality and now even a physical 3D printed version.

## Virtual Models with 3D Software

Creating a virtual or digital model of a building is becoming the preferred process for designing a building and for extracting two-dimensional construction documents. This is done through Building Information Modeling (BIM) software that can incorporate as much or as little detail as needed in the design process. Such software allows designers to easily create and

compare different design options, quickly produce rendered visualizations and incorporate specification attributes to different components used in the design. Further, by using open access, interoperative software standards, different design disciplines can work on the same computerized model to coordinate architectural elements with structural systems, HVAC, plumbing, fire protection, lighting, wiring, fixtures, equipment, furnishings and any other building component. Overall, it allows the design team to virtually assemble and assess the building on a computer long before it ever gets to the point of actual construction.

Part of the strength of BIM, 3D modeling and other computer software used in this process is the programming behind it. Some BIM software allows for users to access that programming in order to further customize the software's tools and capabilities. But since most people aren't computer programmers, there is the need for a better, more intuitive process for individuals to use the programs productively. The term graphical scripting is used to describe one such alternative. In this case, what the user sees on the screen is not a series of letters or numbers but a graphic element that has the needed data or function embedded in it. The user "builds" a script or procedure by assembling these graphic elements together. This procedure can then be used to iterate 3D digital models by applying different parameters and constraints such as size or location of other objects.

Virtual models can be developed with very high levels of detail and accuracy and with excellent rendering and visualization capabilities, which can either be still life or animated walk-throughs for a full virtual experience. That means, in many cases, the virtual 3D model can do just as much or even more than a physical scale model of a building. In these situations, the design team and building owner can realize time and money savings by working in the virtual realm. This can be particularly helpful when multiple designs or prototypes are being created, assessed and revised as needed.

### Physical Models with 3D Printing

Once a virtual model is created in BIM or similar software, then the data contained in it can be used to produce a physical model using a three-dimensional printer. This process originated in the manufacturing world where the notion of "rapid prototyping" meant saving substantial time and money by being able to produce a

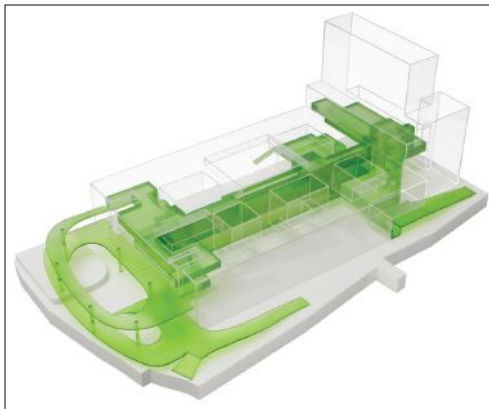

Computerized, digital, three-dimensional models allow designers to completely control and visualize different building design options. Photo Credit: EM2N; Courtesy of Vectorworks, Inc.

prototype product or component by using a 3D printer for a full-size or scaled result. A 3D printer commonly uses slightly heated plastics that are deposited and quickly cooled on a platform along the x, y and z axes. The two dimensional x and y components are controlled the same way as most computerized drawings and ink printers are. The third dimension, z, is controlled by lowering the platform after each horizontal pass or by keeping the platform level and raising the depositing arm of the 3D printer. Overall, this process creates a prototype model quickly and very inexpensively, compared to traditional methods of making molds, re-tooling manufacturing equipment, etc. The rapid prototype component can then be examined, assessed and the design adjusted as appropriate. When ready, the final designed product is then set up for full production.

When it comes to buildings, the same process has been adopted with excellent results. Through the appropriate use of computer software, the BIM or virtual model can be exported to a 3D printer, allowing for a quick and inexpensive scale model to be created. That model can be a simplified shell to show massing options or can be a detailed final model. It could also be used to print just specific components or details at a larger or even full-size scale, such as special structures, façade details, building elements, code related conditions, etc. In some cases, full-size custom building components have been 3D printed and used in the actual building, thus linking the architect directly to the finished product. At the most advanced stage, entire building structures have been prototyped and constructed using very large-scale 3D printers with fibrous concrete or steel instead of plastics as the printing medium.

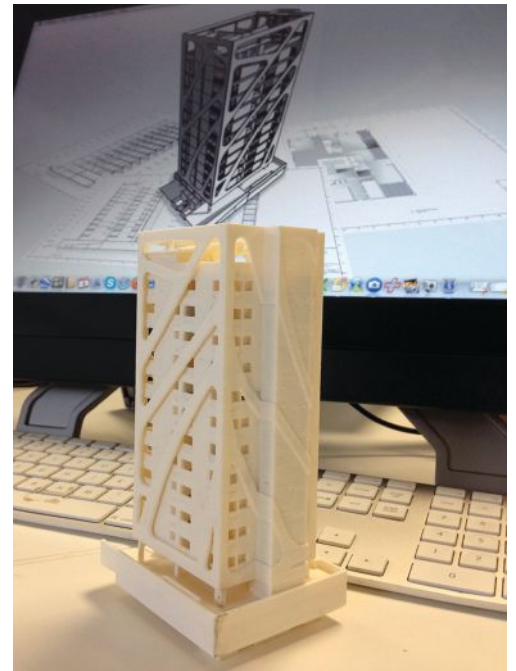

Physical models produced using a 3D printer and a digital design can be printed and created as a form of rapid prototyping of building designs. Photo courtesy of Vectorworks, Inc.

Clearly, there are new possibilities and new options available to architects and other design professionals that didn't exist previously. All of them begin with the use of a computerized, three-dimensional model. That model can then be the digital basis for design, visualization and construction, or it can be used to create physical versions of the desired parts of the building. To understand how these exciting possibilities can work in practice, we will explore four real world examples in the following sections.

 This article continues on <http://go.hw.net/AR122017-1>. Go online to read the rest of the article and complete the corresponding quiz for credit.

### SPONSOR INFORMATION



Vectorworks, Inc. is a global design and BIM software developer serving over 650,000 professionals in the architecture, landscape, and entertainment industries. With our cross-platform software, designers can build data-rich, visual models without sacrificing the design process, while collaborating efficiently throughout their project life-cycle. Learn more at [vectorworks.net](http://vectorworks.net).

# OVERCOMING FLOOR SQUEAKS IN WOOD-FRAMED CONSTRUCTION

Presented by:  
**AdvanTech**  
FLOORING

## What causes a floor to squeak?

Fundamentally, two pieces of material need to move or rub against each other, creating friction that emanates sound. Those materials can be wood against wood, such as subfloor panels rubbing against floor joists, or wood against metal, like fasteners or ductwork rubbing against floor trusses. It is this differential movement between components or materials that commonly causes squeaks in wood-framed floor systems. While the structural design of wood-framed floor systems has seen improvements, still floor squeaks remain a common complaint from occupants and an expensive remediation concern for owners. In today's build environment, which is stressed by labor crunch and housing demand, improper installation can easily give way to risk of movement in subfloor components, leading to pesky squeaks.

Advancements in subflooring materials have helped reduced vertical movement, or deflection, in the subflooring system — a common area where squeaks can generate. A stiffer subfloor means a more consistently strong, flat base for finished floors. AdvanTech® subflooring was the first innovation in engineered wood panels to receive third-party evaluation and documentation of higher design values for strength, stiffness and fastener-holding power than required by PS-2 code standards for structural wood panels (see ESR-1785)<sup>1</sup>. Since its introduction 20 years ago, AdvanTech subflooring has established a new standard of providing a panel that



is both strong and moisture-resistant, so that even after exposure to harsh jobsite conditions, it is able to maintain high levels of performance. Some design professionals even specify that subflooring must meet ESR-1785 to help ensure a high-quality base to receive floor finishes.

Another unique design feature to consider when designing to eliminate floor squeaks is the tongue-and-groove profile of subflooring panels. Traditional plywood or

---

***When a continuous, gap-filling bond is made, the subflooring system acts as a single unit, providing composite action to reduce movement and stiffen the joist.***

---



The unique tongue-and-groove profile of AdvanTech® subflooring provides a tight, secure fit to help reduce movement, which can lead to squeaks.



With advanced resin technology and high wood density, AdvanTech subflooring is engineered to perform at above-code values for strength, stiffness and fastener retention.

oriented strand board (OSB) panels often have a pointed wedge profile. In some cases, it may provide for an easy assembly, but the pointed tongue can create a fulcrum that may create deflection. Consider specifying materials with precisely milled multisided tongue for a more secure fit. This profile design provides distributed surface contact from multiple angles for a more secure fit to reduce squeak potential.

The subflooring veteran brand, AdvanTech subflooring, also launched a new polyurethane, foam-to-gel subfloor adhesive to further help reduce squeaks with a panel-to-joist bond that exceeds industry standards<sup>2</sup>. This critical connection between panels and framing members can be a highly vulnerable area for friction between components, which can lead to squeaks. When a continuous, gap-filling bond is made, the subflooring system acts as a single unit, providing composite action to reduce movement and stiffen the joist. With a gun-applied application, framing crews can easily apply consistent coverage and achieve up to eight times more product yield per can compared to traditional cartridge adhesive<sup>3</sup>.

With offices in Rhode Island and Massachusetts, and more than 350 union craftsmen, East Coast Interiors is one of the largest carpentry services providers on the East Coast. Whenever possible, the company requests AdvanTech subflooring and new

AdvanTech™ subfloor adhesive on its framing jobs. The company recently completed the Portside at East Pier multifamily project in Boston, in which the crew laid more than 9,000 panels of AdvanTech subflooring.

“When you’re dealing with multifamily projects, they’re looking at every penny, cost versus what you can get in rent,” said Patrick Caldwell, framing division vice president of ECI. “At the end of the day, if you have to go back in and fix the OSB, then is it really saving anything? We trust AdvanTech® panels’ strength on the jobsite. It is a stable, consistent product that has the longevity to withstand the weather and wear and tear that is often unavoidable.”

One of the key limitations of traditional plywood and OSB is that moisture or rain exposure can create buckled or swollen seams since the panel edges are prone to absorb water and expand or delaminate. This can create an uneven subfloor that can lead to squeaks, finish floor issues or other problems. While commodity panels can save money upfront, delays for sanding edge swell issues can add to both the timeline and bottom line.

“Gypsum concrete is self-leveling, so if you have dips in the subfloor, then it’s going to find its way into those,” Caldwell adds. “It’s really important that you have a strong, stiff subfloor before pouring the concrete, and

we know we get that with AdvanTech.” For the bayfront Boston job, AdvanTech subfloor adhesive was also a good fit for the jobsite conditions, though Caldwell expressed initial concerns about the aerosol cans being able to endure harsh treatment from jobsite crews. The gun application, however, helped crews overcome what can be a more challenging installation with traditional cartridge adhesive that can be hard to apply at cold temperatures.

“I really thought our team would break the cans,” Caldwell said. “After our team tried it on a few jobsites, I was quickly proven wrong. Not only did the can survive our abuse, we also found that the product had better coverage, ultimately saving money. The product’s ability to be applied to wet or frozen lumber also meant we could be more productive and keep projects moving.”

Learn more about “Design to Prevent Floor Squeaks” by taking the AdvanTech subflooring CEU on Hanley Wood University.

For more information on stronger, moisture-resistant, high-performance AdvanTech subflooring and AdvanTech subfloor adhesive, visit [AdvanTechPerforms.com](http://AdvanTechPerforms.com).



Visit <http://go.hw.net/Huber1217> to listen to the “Design to Prevent Floor Squeaks” CEU course, sponsored by AdvanTech® flooring.

1. ESR-1785 is an Evaluation Services Report (ESR) issued by the International Code Council Evaluation Service. Evaluation reports from ICC Evaluation Service are frequently used by code officials to verify that new and innovative building products comply with code requirements.  
2. When tested in accordance to ASTM D3498. 3. Coverage: One 24 oz. can of AdvanTech™ subfloor adhesive yields approximately 400 linear feet of gel adhesive at 1/2" bead compared to applying a 28 oz. cartridge adhesive at 3/8" bead. Coverage will vary based on bead size and weather conditions. Additional limitations and restrictions apply.

# DOUBLE VISION.



OUR SEVEN NEW SOAP DISPENSER  
DESIGNS MATCH OUR FAUCETS—**PERFECTLY.**

Making your vision a reality has never been easier: **seven styles** of perfectly matching faucet and soap dispenser combos with the performance standards you expect from Sloan. Plus, GOJO has designed soap refills exclusively for Sloan. Contact your Sloan rep for pricing and details.

**SLOAN**<sup>®</sup>

[sloan.com/soapdispensers](http://sloan.com/soapdispensers) | 800.982.5839





# AIA Architect

## AIA Voices



PHOTOGRAPHY: GABRIELLA MARKS

## A Renovation Dream Come True

### Every home needs an architect.

Sara Martin, AIA, is a co-founder of Open Door Architecture in Knoxville, Tenn. Along with her husband, Sean, she specializes in residential renovations and operates under the belief that every home needs an architect—“No house is too humble for an architect,” as she puts it—and she’s brought that mindset to a recent opportunity with HGTV. Open Door Architecture was chosen to renovate the home for the HGTV Urban Oasis 2017, an honor that illustrates just how far Martin’s firm has come in four short years.

As told to Steve Cimino

I spent roughly 10 years at Knoxville-based Ross/Fowler PC and—given its medium size—took on enough responsibility to learn that I like to be involved at as high of a level as possible. I began to think about how to advocate for the profession, and how to think about architecture differently. I like to talk about architecture on my own terms, and starting my own firm was a way to do that. It gave me an opportunity to be expressive, and it’s led to a lot of great clients.

Specializing in residential renovations was a strategic decision. We have a long history in the community of being involved with older homes; we’re in the old-house culture in Knoxville. And our timing was perfect: We had a lot of friends in their early 30s who were moving into big older homes that needed fixing up. Friends became clients, and we grew from there.

Working on the HGTV Urban Oasis 2017 has been so much fun. We’ve had conversations with other production companies about a series on architect couples, but we thought that sort of commitment would monopolize our practice. When this came along it was perfect: one episode, one year, and a great way to get some

exposure and experience without having to commit to a change in our practice.

You might think that being selected as the architect for a nationally publicized giveaway house would mean a lengthy audition process. But in reality this job came along the same way they all do: by referral. An architect friend of mine had worked with the production team before, and they called her to see who she’d recommend. When she heard the house was in Fourth and Gill, one of Knoxville’s prominent historic districts, she said, “You need to call Sara Martin.”

That’s when I really felt like we were starting to make a name for ourselves working on older homes. We sat down with the project manager at the house and talked through ideas. Sean sketched floor plans on the front porch. It felt so good—like we were the architects who were made for that job. It was five houses away from ours, and it’s a house we’ve admired for a long time. It felt like a dream come true. Now we can walk out of our front porch, look down the sidewalk, and see the construction of the HGTV Urban Oasis 2017. **AIA**

# Smile!

We have all the design staples  
you need this holiday season.



Klizia Stapler 97  
by Ellepi, Milan

## Need ideas?

The AIA Store Holiday Gift Guide  
is now online at [aia.org/store](http://aia.org/store)



The American  
Institute  
of Architects

# AIA Store

[aia.org/store](http://aia.org/store)  
[bookstore@aia.org](mailto:bookstore@aia.org)  
(800) 242 3837, #4

# AIA Collaboration

ARCHITECT: MICHAEL MALTZAN ARCHITECTURE | PHOTOGRAPHY: IWAN BAAN



## Joining Forces, Making Change

**When the impact of storytelling reaches far beyond anyone's expectations.**

When Brad Deal, AIA, professor of architecture at Louisiana Tech University, embarked on his first-ever filmmaking venture by registering as a participant in the 2016 I Look Up Film Challenge, he already had a story in mind.

"When I saw the prompt of the Film Challenge was 'Architecture as a Solution,' it seemed like the perfect fit and almost a serendipitous calling to share our work at Medcamps," Deal says.

Deal's short film, *Arch 335: Rebuilding Medcamps*, illustrated the partnership between Louisiana Tech University's Design Build Studios and Medcamps of Louisiana, a nonprofit organization that provides free summer camp experiences to children with chronic illnesses and disabilities. In the film, architecture students design and build a multipurpose space for gatherings, canoe boat ramps, and even archery stands—all within the context that their user group includes children with disabilities. But most of all the film showed how this experience changed the architecture students' lives as much as it changed the campers' lives.

The film not only took Grand Prize in the challenge, but also won the People's Choice Award with a whopping 46,339 votes. But that was only the beginning. What followed in the months after the Film Challenge was beyond what anyone expected.

"In a single screening at a fundraiser last summer, our film helped Medcamps raise over \$52,000 towards our 2017 project," Deal said in a letter addressed to AIA leaders. "That's nearly three times our typical project budget pledged in just 10 minutes!"

Later, the film raised \$18,000 for new tools—donated by architecture alumni and supporters from across the country—as well as about \$12,000 worth of donations from local vendors and Stanley Black & Decker, parent company of DeWalt tools. This one story inspired action from university alumni, supporters, and others who simply wanted to help.

The 2017 I Look Up Film Challenge's Grand Prize winner is Myles Kramer, director of the short film *Community by Design: Skid Row Housing Trust*. It illustrates how Los Angeles' Skid Row Housing Trust has placed emphasis on design techniques that provide natural lighting, open courtyards, and semi-public spaces that foster a sense of community for homeless communities. In partnership with Michael Maltzan Architecture and Brooks + Scarpa, the Trust now offers effective solutions to fighting homelessness.

"Los Angeles is in a homeless crisis, and it really shows," Kramer says. "Once I learned about the Skid Row Housing Trust, their missions, and their impactful body of work, the idea clicked."

The Trust plugged Kramer in to the communities that span between the buildings, which made the filmmaking process easier and more intimate.

"I'm thrilled that Myles was recognized for his extraordinary work, and pleased that the video highlights the conversation of how architecture and thoughtful design contribute to innovative solutions that address homelessness," says Mike Alvidrez, CEO of the Skid Row Housing Trust. "The creation of a safe, calm, and beautiful space that evokes a sense of community truly allows people the opportunity to heal and lead more positive and healthy lives."

There's no doubt that *Community by Design* will raise awareness of the homeless community in Los Angeles; the question is, to what extent? Whether that impact comes in the form of a large donation or even a kind gesture on the street, the people who watch this film will better understand the human side of homelessness and respond accordingly. Like all great stories, the ones told through the I Look Up Film Challenge have the potential to inspire tremendous change. **AIA**

Caitlin Reagan

## AIA Feature

# Defined by Our Infrastructure

Four experts examine urban success stories, buildings as infrastructure, and the very meaning of the word.

By Steve Cimino

In September, the AIA released a statement affirming an inclusive definition of infrastructure—roads and bridges, yes, but also the buildings that define our communities. Resilience needs to drive new infrastructure as well as repairs to the building blocks of our cities and transportation systems.

A poll commissioned last year by the Institute found that more than 80 percent of Americans see public buildings as part of the nation's infrastructure. Notably, schools are the second largest public infrastructure investment after transportation. Yet deferred maintenance by government at all levels has imperiled our communities. Likewise, when we repeal building codes that require structures to be more secure and resilient, we endanger life and property.

Below, four leading experts weigh in on infrastructure's challenge, as well as its promise, for this generation of Americans and future ones.

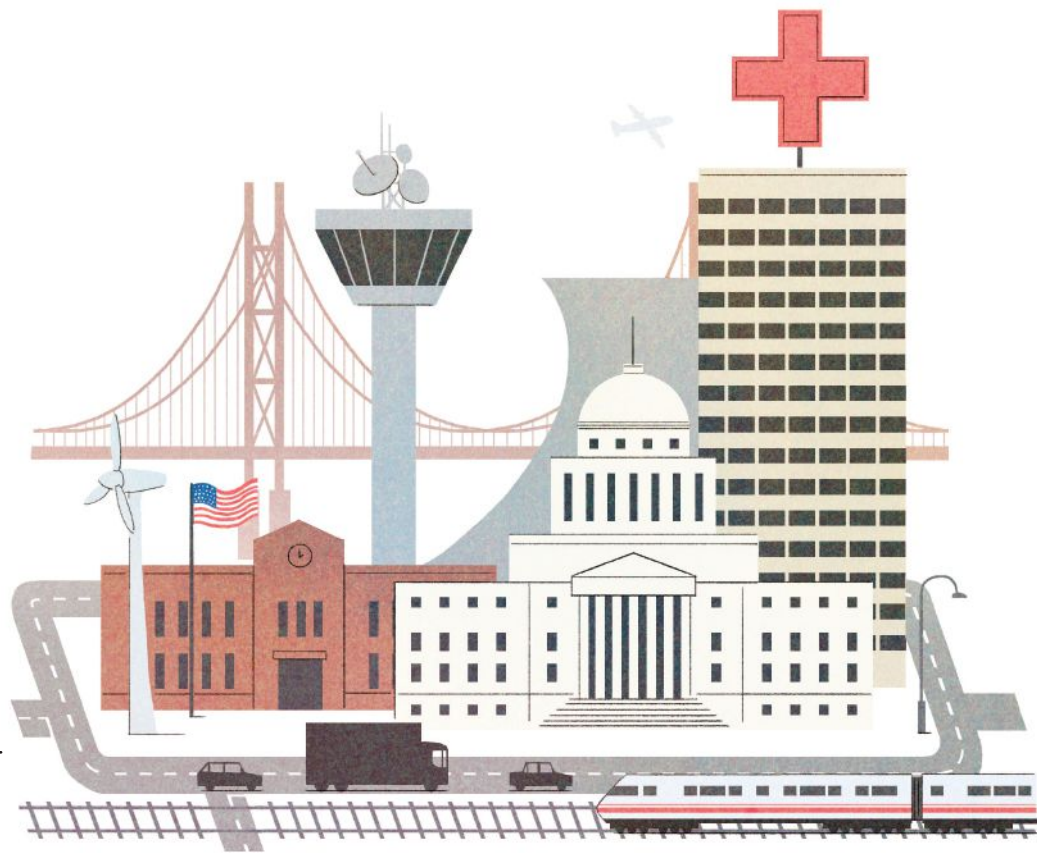

Ellory Monks, co-founder, the Atlas Marketplace infrastructure exchange

At the Atlas Marketplace, we take a more holistic approach to infrastructure. We consider infrastructure to be any public asset that provides essential services to citizens. It's a definition that is much broader than just roads and bridges. Water, wastewater, airports, schools, municipal buildings: We're talking about any public asset that provides critical services. At the local level, I think

there's a lot of support for a more inclusive approach to infrastructure. Local leaders are usually in tune with the problems on the ground; when it comes to buildings, they're often the most visible infrastructure that citizens encounter daily. Buildings and transportation tend to get the most attention when it comes to infrastructure because they tend to be the consistent pain points for

citizens. When schools are falling apart, that's super-visible, and it's something the mayor will usually be working very hard to address.

Effective city governments understand what matters most to citizens. When you see tangible progress being made on the local level regarding something like resilience, a lot of that progress may be because citizens are starting to experience impacts of sea level rise

or hurricane risk. There is a groundswell of support at the citizen level to do something, which in turn makes the local government leaders act.

In our work with cities, one of the things that we do is focus on short-term wins while keeping long-term outcomes always in mind. There's been a very positive shift in the climate community when it comes to acknowledging that doom-and-gloom messages are not inspiring action to combat and adapt to climate change. It has proven far more effective to focus on those six-month wins, one-year wins, three-year wins, while always keeping in mind the long-term outcomes you want. I think that's true always: In life, and in big infrastructure projects, you need to break things down into manageable chunks.

We frequently advise our partner cities to pursue integrated infrastructure projects, which to us means "projects that solve more than one urgent problem," like energy efficiency upgrades that are strategically combined with workforce development programs. The idea is that if you're going to be building expensive infrastructure, it's best to take an interdisciplinary, cross-department approach where everyone involved is getting the most bang for their buck. This is especially important because budgets are always shrinking: There's never enough money and pursuing an integrated project can often open new sources of funding or financing by bringing in a more diverse coalition of partners.

But I really can't emphasize this point enough: Don't let "perfect" be the enemy of "good." Don't let "perfect" be the enemy of getting started at all. This is especially important on the climate side of things. We see a lot of truly impressive designs and proposals, but for whatever reason a city or a county or a utility may not be ready for that shoot-for-the-stars proposal: It's too expensive, or it's too disruptive. So maybe the best idea is to pull the design back a little. Though you may not be able to install green infrastructure across your entire city right away, perhaps you can retrofit three of the biggest municipal buildings. Strategically sequencing and phasing ambitious projects can create the partnerships and funding required to go after the shoot-for-the-stars design. Proving success at a smaller scale, exposing citizens to what can be done—all while bringing in a valuable coalition of diverse partners—makes the biggest prize that much more achievable.



Darren Petrucci, AIA, founder and principal, Architecture-Infrastructure-Research Inc.

Infrastructure, by definition, facilitates. A road gets you from point A to point B; power lines provide electricity; conventional urban infrastructure facilitates some kind of function. When we think about our buildings, and what they facilitate, we historically think of them as one-dimensional. If it's a library, it functions as a repository for books. A freeway moves you across the country.

The contemporary way to think about infrastructure is not as a single-dimensional thing, but in a multivalent, multidimensional way. Everything we design infrastructurally must have more than one facilitation. You see that with public libraries now: It's not just a place that holds books; it's a place where people meet, learn things, attend events. It is, in some cases, an extension of the public realm. In the 20th century, we would think of infrastructural things as one-dimensional; in the 21st century, we have to think of them as multidimensional.

Twentieth-century infrastructure was about conquering the landscape. We built freeways, power plants, and other necessities regardless of the natural environment; we conquered it. We would blow through mountains, and we'd do whatever we needed to because we could, technologically, conquer nature. We're now recognizing—especially in the wake of the recent hurricanes Harvey, Irma, and Maria—how that kind of mentality leaves you with an unresilient system. Twenty-first-century infrastructure should work with the natural landscape in ways that are not about conquering, but are about adaptation.

When politicians and decision-makers are thinking about how to spend on infrastructure,

if you can provide them with multiple uses then you end up with multiple funding sources. "By the way, this energy plant has a ski slope on top that will attract tourists." "By the way, this street surrounded by parks and baseball fields is also a flood canal." It should be "By the way, it's this ..." It shouldn't just be "It's a flood canal." The conventional labels and singular functions that we put on things like "public library"—we need to rethink those.

Consider the Seattle Public Library: Rem Koolhaas, HON. FAIA, said, "No need to see the books." They put them in a spiral in the middle of the building and, through technology, they pull out the ones you want and deliver them to you. The rest of the building is then liberated to be a public venue for gatherings, classes, meetings. It's almost like an everyday convention center. And I think buildings are going to get even more radical in terms of being more integrated with multiple offerings.

The key, then, is to just design the infrastructural part, because the rest is going to change. All the elements have to be designed as multifunctioning. A staircase cannot be just a staircase anymore. It's a staircase and maybe an amphitheater. It's a staircase and a place for people to meet.

Every time one of these multidimensional public buildings is completed, it sets an example and precedent. The ability to design another one becomes much more feasible. When we're talking about what I like to call "amenity infrastructure," you don't need a lot of examples. When someone strikes gold, you can point to that city and that project and say, "What if we did something like that?" That's an extremely powerful form of advocacy: the work architects do.

# AIA Feature

CONTINUED



Debra Gerod, FAIA, partner,  
Gruen Associates

Right now in Los Angeles, where we do the bulk of our work, infrastructure and public buildings are booming. The public realm is becoming much more enhanced and pleasant, and a key component of that is forming linkages to major civic areas. We can design and build wonderful buildings and infrastructure to serve all our needs, but how you get people to them ends up being quite important.

In the past, pedestrians received very little attention in Los Angeles. Buildings were often entered from parking lots rather than from public sidewalks and plazas. As a city, we're trying to change the focus to create better public spaces, more landscaped open spaces, plazas, and bikeways. In our practice—which is an integration of urban planning, landscape architecture, and architecture—this is inherently part of the dialogue of every project. A decade ago it was much harder to make discussions about the public realm a priority. Today it is the main discussion.

I was born in Chicago, and when I go back there the thought of renting a car doesn't even cross my mind. I can take transit from the airport to all the places I need to go, and I spend a great amount of time walking. What's surprising is that the sidewalks and streets are not very well maintained, yet it is still pleasant to walk—and everyone does. I think it has a lot to do with the city planning: Buildings engage the sidewalks, and the neighborhoods are very diverse mixes of residential and commercial. That this leads to a threshold level of activity that makes walking down the street at 10 p.m. feel like a reasonable thing to do. In Los

Angeles, where our weather should be more conducive to walking than Chicago's, we are not there yet. But we are starting to get closer.

I think it also comes back to transit. With a robust transit system, people get used to walking. You accept your sidewalks, and you want to be part of that population on the street. Los Angeles obviously has challenges due to its size, but we are making great strides in correcting our deficiency in transit. We passed some major measures to fund a significant number of transit projects, which is evidence that there is public support for this.

When we were working on the master plan for the Los Angeles Union Station, which was completed in 2015 in collaboration with Grimshaw Architects, we became aware that most people felt Union Station was remote from the rest of the city. We decided it was critical to enhance pedestrian connections to the station, which will be among the first things from the plan to get implemented. Along with a tree-lined esplanade and a multiuse path to help people get to the station, a surface parking lot in front of the station is going to be converted to a public plaza, to improve engagement with the building's surroundings.

The historic station has a fantastic civic character, with landscaped courtyards that are integral to its civic quality. We did a lot of community outreach, and what we heard resoundingly was that people wanted Union Station to remain a civic space. There was a lot of concern that commercial interests could take over and alter that. In Los Angeles, we do not have an abundance of great civic spaces, so we need to make sure to protect the ones we have and develop them to address current needs without sacrificing their civic character.

Dawn Lehman, professor of civil and environmental engineering, University of Washington

For me, one of the big questions is, "Why are we investing in bridges and transportation infrastructure, and not buildings?" I think a primary reason is that on the transportation side there is a central agency overseeing the investment. Even if a bridge is being designed outside of the Department of Transportation (DOT), the DOT is taking ownership of its resilience. A real challenge I see for buildings is that there is not a single agency that is responsible for ensuring their resilience.

For example, when it comes to seismic design, we have seen decades of research and investment by Caltrans [California's DOT] to reduce earthquake damage to their bridges. California has seen its fair share of earthquakes over the years, with significant damage to bridges, and that spurs the state DOT to start investing in relevant research. We typically don't have a single central agency saying, "Oh, we saw in this last earthquake that this type of building didn't respond well. How do we improve on the design of that type of structure?" Some of that is happening through the National Science Foundation, but they're more focused on basic research and not applied research. Immediate investment in new technologies for resilient buildings is not occurring the same way it is for bridges or other types of infrastructure.

If you really want to think about buildings as infrastructure—and they are—we need to think about how to get the community together and focus on how and where to invest. How do we make them a priority? What are the serious problems? Earthquakes, for instance, will identify the problem for you. It's too often only

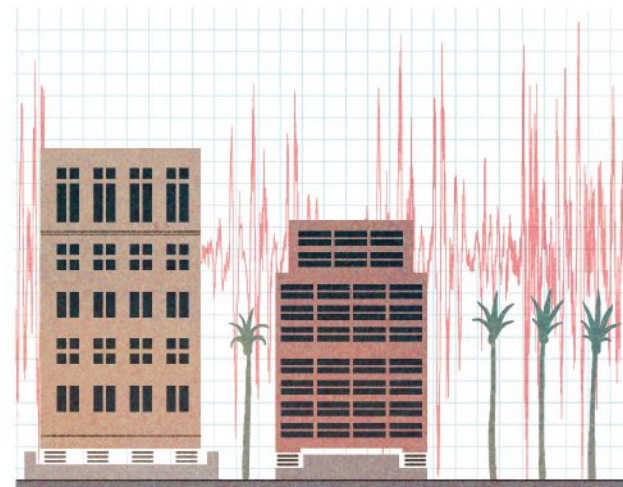

# AIA Practice

after a major event—national or international—that people come together and say, “We need to fix this.” That can be a very frustrating approach because the earthquakes are teaching us the same lesson again and again.

If I look at what public entity is really thinking of buildings as infrastructure, I look toward Los Angeles. We see them saying, “We have very high seismicity; we have buildings not built to current code. How do we identify those buildings vulnerable to collapse, and how do we retrofit them?” But because there are so many other issues coming up for cities across the country, it becomes very difficult to be able to focus on one element and say, “How do we make this happen?”

I think we all know the only way to do that on the building side is through building codes. But to get there we need some sort of entity like the DOT championing seismic resilience on the building side. Thinking about what they’re doing in Los Angeles and being able to mirror that in other cities really does make a lot of sense.

In Seattle, we’ve seen big changes in codes in terms of energy. It’s not impossible to change the course of a city if there’s investment from the community. If the lesson is being taught to you over and over—and especially if it’s costing people money—you’ll see willingness to make the necessary investments. The question then becomes, “How do we make this issue a part of people’s regular lives? How do we convince decision-makers or owners to invest an additional number of dollars so that their buildings won’t sustain damage in the next earthquake?” As we saw in Christchurch after the recent earthquakes in New Zealand, the city can be shut down for a long period of time: How long are we willing to let our cities be unusable after a major event? **AIA**

ILLUSTRATION: MICHAEL KIRKHAM

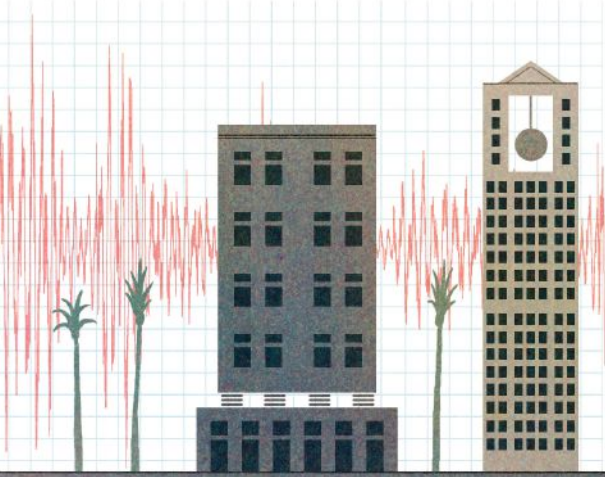

## How AIA’s Revised Contract Documents Affect Architects

**We help you understand how the 2017 updates to the AIA Contract Documents might affect you.**

In order to keep up with industry trends and important court decisions, every 10 years AIA Contract Documents are reviewed and updated. Changes to the 2017 documents that will affect architects include an added evaluation provision by the architect if the contractor proposes alternative means and methods; new agreements containing a fill point to prompt the parties to discuss and insert an appropriate “termination fee” for terminations for convenience; a single Sustainable Projects Exhibit that can be added to any AIA document to address the risks and responsibilities associated with sustainable projects; and AIA “scope” documents that describe, in detail, specialty services an architect can provide on a project.

### B101-2017, Owner/Architect Agreement Changes

The document that will affect architects the most is B101-2017, Standard Form of Agreement Between Owner and Architect. B101-2017 now allows the parties to indicate whether the architect will be compensated based on a stipulated sum, a percentage of the owner’s budget for the cost of the work, or on some “other” basis. If compensation is based on a “percentage basis,” the parties assign a percentage figure to each phase of basic services. Progress payments for each phase of basic services are calculated by multiplying the percentages by the owner’s most recent budget for the cost of the work. Compensation paid in previous progress payments is not adjusted to take into account subsequent updates to the owner’s budget. When compensation is on a percentage basis, and any portion of the project is deleted or otherwise not constructed, the architect is entitled to compensation for those portions to the extent services are performed.

Additionally, provisions related to the owner’s decision to terminate the agreement for the owner’s convenience now prompt the

parties to discuss an appropriate termination fee to compensate the architect for costs associated with the termination, such as lost overhead or profit on unperformed services. B101-2017 also now provides that if the owner requires the architect to modify the construction documents—and the bids or proposals exceed the budget due to market conditions the architect could not reasonably have anticipated—the architect is to be compensated for those modifications as an additional service.

### Addressing the Risks of Sustainable Projects

In addition, a new Sustainable Projects Exhibit, E204-2017, can now be added to any AIA document to address the risks and responsibilities associated with sustainable projects. This exhibit is meant to replace the Sustainable Projects documents included in the Conventional (A201) family of AIA Contract Documents.

In a single document, E204-2017 sets forth the roles and responsibilities for each of the project participants. The exhibit is to be used on a wide variety of sustainable projects, including those in which the Sustainable Objective includes obtaining a Sustainability Certification—such as LEED—or those in which the Sustainable Objective is based on incorporation of performance-based sustainable design or construction elements.

Finally, the AIA’s C203-2017 commissioning scope has been updated to now allow the commissioning agent’s involvement much earlier in the project, working with the design and construction team throughout. It is also no longer an “architect-only” scope, and commissioning professionals from all backgrounds can use it to perform these services.

Additional major changes to AIA scope documents include B203-2017, Site Evaluation and Project Feasibility, which allows the architect to assist an owner in selecting a site and determining the feasibility of a project. B205-2017, Historic Preservation, was also reorganized into four categories: Historic Assessment, Existing Buildings Assessment, Preservation Planning, and Specific State and Federal Services. To learn more about changes to AIA’s scope documents, or receive samples of the 2017 AIA documents, visit [aiacontracts.org/architectmag](http://aiacontracts.org/architectmag). **AIA**

Caitlin Sweeney



## A vibrant community

AIA is a vibrant community of architecture and industry professionals that are transforming our profession. Members enjoy access to industry-best benefits, products and services that support practice and professional development.

Visit [aia.org](https://www.aia.org) to learn more about how you can leverage all that we have to offer and become a member.

**Join us.**





# AIA Knowledge

## A Rededication to Craft

**Research into intelligent robots could free up architects to focus on their artistic impulses.**

And a robot will lead architecture back to craft.

So could read the coda to “Augmented Craft: Combining META Glasses and BIM for Advanced Masonry Construction,” a 2014 AIA Upjohn Research Initiative grant-winning project from University of Buffalo School of Architecture and Planning professor Michael Silver. The Upjohn Research Initiative provides material support of up to \$30,000 for projects that “enhance the value of design and professional practice knowledge.”

“Augmented Craft,” whose seedlings were planted during discussions in Silver’s classroom, started out as an exploration into how augmented reality tools—think Google Glass—could enhance and record the conditions of masonry construction. However, the project quickly snowballed into a blueprint for a smart device that meshes artificial intelligence (AI) and humanoid robotics with mechanical mastery. Silver likes to call these working machines “servant zombies”: intelligent robots that are capable of acting as extensions of “the bodies and desires of its owners.”

The Upjohn grant started “a chain reaction of interest,” Silver says, and the initial project has scaled up with additional support from Autodesk, the International Masonry Institute (IMI), and the National Science Foundation to aid in the creation of a robot that can be deployed on masonry construction sites. For Silver, these are robots that build, performing rote tasks such as dismantling bricks. In effect, though, their application could free the main individuals involved in architectural creation—the designer and the builder—to rededicate themselves to a nuanced sense of building as craft. Servant zombies, being insentient—and therefore incapable of expression—will embolden designer and builder toward a more realized artistic impulse in the art of building-making.

“Robots can make jobs easier,” Silver says. “The ‘servant zombies,’ they are tools to be exploited. The worker isn’t and shouldn’t be. The drudgery around hard labor is relieved. [Robots] become useful forms of new media.”

Silver is sensitive to the fact that AI and the encroachment of automated technologies



ILLUSTRATION: VIKTOR KOEN

**“The ‘servant zombies’ ... are tools to be exploited. The worker isn’t and shouldn’t be.” –Michael Silver**

threaten the trade industries, but believes that the promise of the robots—what they can technically accomplish—will actually draw individuals into masonry construction.

The support from the IMI is a heavy nod toward that sentiment. In 2015, Silver presented his concept to a group of union leaders at the group’s annual convention. He says the industry, knowing it is failing to attract younger workers, is increasingly looking toward new technologies as incentives to expand its workforce. “Any type of technological enhancement to craft will attract new members,” Silver says.

Momentum is building for the servant zombies’ premiere. Silver is hoping to produce an operating prototype of the robot next year. Equipped with LIDAR sensors and Wi-Fi, the 3D-printed titanium and machined aluminum robot will fold down itself into an easy transportable case, collapsing into an inert state when not activated for duty. Silver says he and his students spent “hours and hours looking at legs and mechanisms and the

design of individual parts,” and they should soon all be observable in built form.

Scott Peters, president and cofounder of fabrication firm Construction Robotics, has partnered with Silver on “Augmented Craft” to “assist with the practical aspects of building hardware.” He sees his firm’s work as helping break down the disconnect between engineering and architecture, and helping people like Silver’s students—as well as architects in general—“embrace the capabilities of tech as a practical application.”

Yet Silver sees potential even beyond the jobsite. “Architects, until now, have not been designing the means of production,” Silver says. “Architects are now developing systems at the material level, at the level of code. We’re developing a hardware and software ecology. This is a discursive project to think about the process of how new forms of architecture are made.” **AIA**

Ben Schulman

# AIAFuture

# AIA Perspective

## Making an Impact

**What the AIA diversity scholarship—and the power of design—have meant to three previous recipients.**

In 1969, the AIA and the Ford Foundation each pledged \$500,000 to support minority individuals pursuing an education in architecture. Today, the Architects Foundation Diversity Advancement Scholarship has been awarded to more than 2,300 students and recently received \$1 million from the AIA's board of directors to continue promoting increased diversity and equity in the profession. Below, three scholarship winners share their thoughts on what the assistance meant to them, and how it helped shape their approach to architecture.

PHOTOGRAPHY: CARL BOWEN



**Renee Kemp-Rotan, ASSOC. AIA:** “I was at my grandmother’s house in Washington, D.C., during the summer before 12th grade, and noticed a television commercial that said, ‘AIA is recruiting 20 African-American students interested in majoring in architecture.’ The commercial was clear: Architecture is a blending of the arts and sciences. I wanted to be a painter—a fine arts painter—but my family of doctors, lawyers, and educators said, ‘No starving artists.’ So architecture was the perfect compromise. I cannot put into words what that scholarship did for my life. Architecture opened my eyes to the world.”

**Tammy Eagle Bull, AIA:** “When I was young, [my father] saw that I had a knack for design, for drawing and thinking in 3D. He would tell me stories about architects who would show up to the reservation and—without asking questions—interpret for themselves what the local culture was: a turtle-shaped building, a buffalo-shaped building. He explained all the negatives that can come from poor design; after that, design that makes a positive impact became my singular focus.”

**Donald King, FAIA:** “My story is a crazy one: nine schools in 11 years, really trying to pull the pieces together to get an architectural degree. I had a goal in mind; it was just a haphazard way of doing it. When talking to students today, I try to give them a more efficient path than the one I took. Because I didn’t have a lot of people saying, ‘Don’t do this; do that.’ Mostly what I would get is, ‘You can’t work and go to school.’ And I would say, ‘I do not have that choice.’ I was bound and determined to get that degree.”

## Onward, Upward

After a rocky start to the year, most members once again see the AIA as speaking for their interests and representing their values. We have stood our ground on issues of profound concern: global climate accords, national spending priorities, immigration policies, and the environment.

But we’re not finished defending our interests—far from it—and we’re still not at the forefront of important public policy discussions. National infrastructure spending and a host of social and environmental issues demand our attention and our influence.

The AIA’s public outreach work has shifted from having an emphasis on custom residential design to addressing broad issues of design and civic engagement. We need to put more of an impetus on *public* investments—in libraries, schools, hospitals, city halls, recreation centers, public parks, and police, fire, and rescue facilities. These are the places and buildings that elevate all lives.

This year, we have stepped up the Institute’s investments in issues of social equity. Our profession’s future demographic profile—in terms of gender, age, ethnicity, and income levels—is now a matter of permanent, board-level concern. We are also making strides in research, identifying knowledge requirements, and reinforcing a network of organizations with strong research capabilities.

And we face another constant need: to remind members that the American Institute of Architects belongs to us—to the men and women who subscribe to its ethical canons, volunteer for its work, and, literally, pay its dues.

We, the stakeholders, must control what we own. To obtain the greatest benefit from our Institute, we must all take interest in its operations, in the value and outcomes of its programs, and in the nature of its expenditures. Yes, that duty is entrusted to our elected officers and board of directors, but only by knowing how funds are used can members know if their organization is transparent, accountable, and on the right track.

That is why we have opened the books wider, so to speak—making our IRS Form 990 more easily available, publishing strategic planning documents, and expanding the period and scope of budget reviews. The budget and operating plan are now the business of the *entire* board, rather than just a small subcommittee.

We have expanded opportunities for members to engage with the board and the Strategic Council—to strengthen connections between members, their elected representatives, and the bodies that shape and direct the Institute’s activities. The AIA presidency offers a platform that I have tried to use to ensure that our organization better serves its two core missions: to stimulate demand for architecture everywhere in society and to improve our capacity to deliver.

We are also taking new steps to ensure that resources are shared between the national organization and our component organizations. Better collaboration will reduce competition for sponsors, member dues, and continuing-education revenues. Architecture centers—our most effective public outreach vehicles, now numbering more than 30 nationwide—need to share programming, with the full support of our national resources.

Many architects in the United States and elsewhere are currently enjoying a prolonged period of ample work, near-full employment, and even a share of prosperity. This year, we also established a new chapter outside of the country this year, and it’s our largest: AIA Canada now joins the AIA International Region and chapters in the United Kingdom, Europe, Hong Kong, Japan, Shanghai, and the Middle East.

The AIA is strong. With record levels of membership, extraordinary reach, and new resolve, we are poised to use the power of our association for the good of society and the profession. To do that, we need the full participation all of our members—informed, determined, engaged. **AIA**

an authentic Italian masterpiece,  
built for the masterchef in you



**PEDINI®**

Los Angeles, **CA** 323.658.8801 - Mountain View, **CA** 650.390.9615 - San Diego, **CA** 858.874.5800 - San Francisco, **CA** 415.913.7841 - Denver, **CO** 720.409.7990  
Washington, **DC** 202.640.1976 - Miami, **FL** 305.567.2727 - Naples, **FL** 239.262.1144 - Sarasota, **FL** 41.371.4010 - Atlanta, **GA** 404.817.3313 - Glen Ellyn, **IL** 630.858.4848  
Newton, **MA** 617.244.3993 - Madison, **NJ** 973.937.6060 - Paramus, **NJ** 201.261.5221 - Brooklyn, **NY** 718.615.0850 - Long Island, **NY** 516.374.4675 - NY, **NY** 212.334.0944  
Dayton, **OH** 937.912.9130 - Portland, **OR** 971.254.9856 - Philadelphia, **PA** 215.600.2860 - Seattle, **WA** 206.767.4625 - Edmonton, **AB** 780.966.9066 - Vancouver, **BC** 604.971.3235  
Toronto, **ON** 416.256.4922 - Montreal, **QC** 514.341.3636

The Journal of the American  
Institute of Architects

**Innovation** is the hallmark of  
progressive design excellence.

Hanley Wood congratulates and thanks reThink Wood  
for its ongoing commitment to environmental responsibility,  
design leadership, and inspired built solutions.

reTHINK  
**WOOD**®

hanleywood



## Special Section: 2017 Innovative Detail

INTRO BY WANDA LAU  
TEXT BY TIMOTHY A. SCHULER

One mature tree can sequester about 48 pounds of carbon dioxide each year, equivalent to the emissions of a car driven 53 miles. Multiply that tree by several thousand, use them in construction, and *voilà!* A carbon sink that can assume nearly any shape and size. On the following pages you'll find 12 such carbon sinks of myriad forms but with one underlying function: helping to mitigate the effects of climate change.

---

## Washington Fruit & Produce Co. Headquarters Twisted Columns

The new headquarters of the Washington Fruit & Produce Co. in Yakima, Wash., is full of holes. The voids, however, are intentional, inspired by the raw beauty of a nearby abandoned barn, and serve to create a central courtyard and intersecting walkways in the large building volume.

Completed in 2016 for the family-owned company, which grows, packages, and ships fruit from its 90-acre production facility in central Washington, the 16,500-square-foot building takes the form of a long, low-slung barn, its pitched roof spanning some 68 feet. Initial meetings between the designers and the client were light on architectural direction. "The only thing [the client] did was drive us out of town to this barn," says Brett Baba, co-founder and principal of Seattle-based Graham Baba Architects. Behind the rotten wood and decay, an interior structure of heavy timber posts, beams, and diagonal struts, "or knee braces," was left exposed, he says. "You could really see how the forces were taken care of through these pieces of wood."

The barn inspired the exposed structure Graham Baba ultimately designed for Washington Fruit's headquarters. Double glulam rafters form the top chords of a series of hybrid wood-and-steel girder trusses. The duo-rafters continue outside, past expansive glass curtainwalls, to sandwich an array of approximately 18-foot-tall "scissor" columns, transferring their structural load to the columns via two steel

angles. The scissor columns comprise two Douglas fir glulam members angled at different directions—one lists inward toward building and the other stands perpendicular to the roof slope. Delicately crossing each other before tying into twin steel posts, the columns anchor into concrete piers.

Initial pencil sketches were followed by a series of physical and digital models in Autodesk AutoCAD in order to understand how the columns would look and feel. "We thought about doing the project in Revit, but this building is very much about the details," Baba says. "Getting that geometry right was tricky. In fact, we discovered just before we were going into shop drawings that the actual point where the two halves of the column almost touch was tighter than we wanted it to be." To allow for variations in construction tolerances, the firm increased the gap from "golf-ball" size to "softball" size.

To maintain a handcrafted look on the engineered glulam columns, which comprise six laminated 2x4s, the architects specified cladding the two column faces bearing the lamination seams with 2x8 lumber. "We tried to do things to the glulams so that they wouldn't look like glulams," Baba says.

Selkirk Timberwrights, a timber frame company based in Priest River, Idaho, fabricated the glulam columns before gluing on the lumber finish. Owner Mike MacAlevy says creating fully square columns and then notching the corners was simpler and more

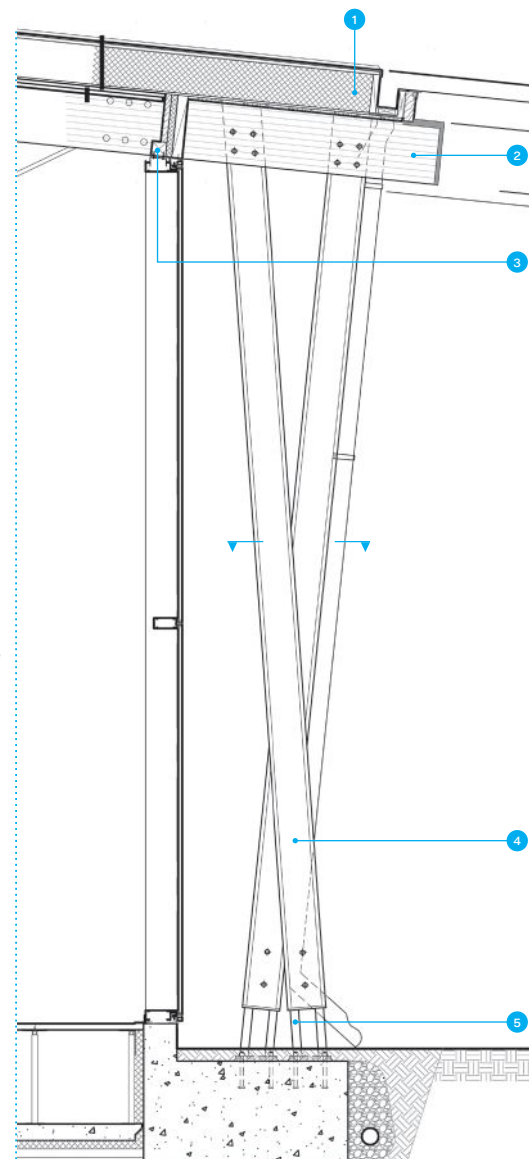

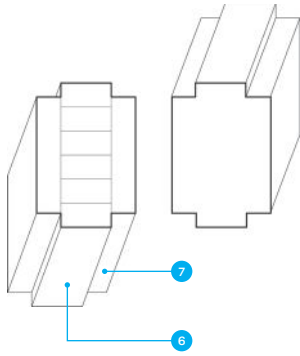

1. Structural insulated panel
2. Glulam rafter
3. Wood trim, rigid insulation, and wood blocking between rafters
4. Composite glulam column (see plan section and profile, left)
5. Steel post
6. Six 2x4s, laminated
7. Wood cladding, notched to 2x8



cost-effective than centering pre-cut 2x8s on the column faces. The grooves were machine cut and then refined and finished by hand.

The scissor columns are all identical with the exception of those that run along the building's west elevation. Still, erection was something of a puzzle, Baba says, "because, really, how do you do something like this when it hasn't been done before?" The general contractor, local firm Artisan, considered preassembling the columns and girder trusses but opted instead to erect a shoring wall at the roof's ridgeline and assembling the wood structure in the air.

Construction went smoothly, but the team was still nervous when it became time to remove the support wall, Baba says. The contractor suggested Baba and the structural engineer, Michael Wright, stand under the roof while they kicked the wall out. Before they could acquiesce, the construction crew finished hand-tightening the turnbuckles attached to each of the truss's metal tension rods, and the whole structure "popped up" and assumed its form, Baba says. "All that angst just disappeared. It was a great moment."

Baba, who grew up in Yakima, is particularly proud of the project's embodiment of the local architectural vernacular and its embrace of the surrounding hills. "I never started out to do a building that looks like this," he says. "It's so unexpected [but] there's something about the rigor of it that appeals."

## Thompson Exhibition Building Structure

The curvilinear Thompson Exhibition Building bears little resemblance to the rest of Mystic Seaport, a museum and re-created 19th-century maritime village on the banks of the Mystic River in Mystic, Conn. But Chad Floyd, FAIA, a principal at Centerbrook Architects and Planners, in Centerbrook, Conn., says the striking, 14,000-square-foot building relates equally to the museum's mission and history as its traditional counterparts. "Mystic Seaport calls itself the Museum of America and the Sea, and it's got the America part down great," he says. What was missing was the feeling of the sea.

Subsequently, the building assumes the form of a three-story wave cresting around the entrance to the building. Its northern roofline curls toward the ground while the southern roofline extends over a wraparound porch, supported by thick timber posts that recall the mast of early sailing ships. The prevalent use of exposed timber structure is reminiscent of wooden hulls.

Despite its metaphorical complexity, the asymmetrical building itself is relatively simple: a long-span structure that stands 32 feet in height and runs 175 feet in length and 75 feet in width. Interior spaces are configured to accommodate the program "but always using the full height of this structured volume." That simplicity made physical models unnecessary. The building was designed entirely in 3D using Autodesk Revit and rendered via Act-3D Lumion "quickly, early, and often," Floyd says.

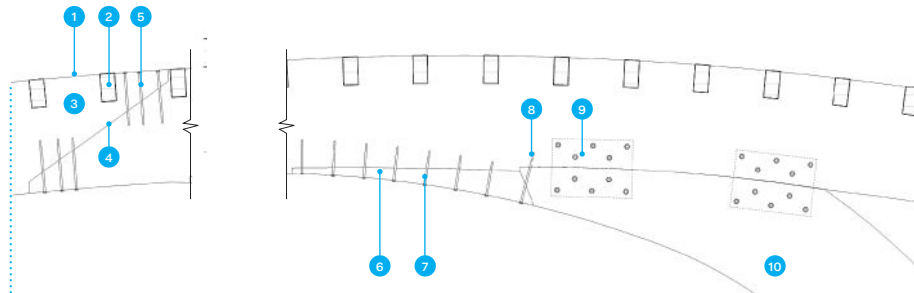

Clad in a cedar rainscreen, the building is formed by a series of 10 curving, glulam ribs made of Douglas fir, specified by Centerbrook for its strength and its role in historical shipbuilding. The ribs anchor into concrete footings on the structure's north side and rest atop glulam columns, which appear to continue the ribs' spiral, on the south building perimeter. Each rib is 39 inches deep and 105 feet long, requiring a splice near the column and a glulam wedge to complete the look of the curve. Glulam purlins, spaced 18 inches on center, run between the columns, providing support

1. Plywood roof deck
2. 5.125" × 8.75" glulam purlin (18" o.c.)
3. 8.75" × 39" Douglas fir glulam rib with 100'-radius curvature (19' o.c. between bays, 22' o.c. at end bays)
4. On-site splice made in rib
5. Ø0.625" × 18" lag bolts (typ.)
6. 8.75"-thick Douglas fir glulam wedge
7. Two Ø0.375" × 12" fasteners (10" o.c.) (typ.)
8. Two Ø0.625" × 18" lag bolts
9. 28" × 20" × 0.5" knife plate (typ.)
10. 8.75" × 43.5" Douglas fir glulam column, with 10'-radius curvature (spaced to match that of the glulam ribs)





to create a seamless-looking roof. Floyd is particularly pleased by the lack of exposed steel inside the building—steel knife plates, used to connect the glulam structural members, are cut into the members, giving the project “a much more elegant effect,” he says.

Outside, the glulam ribs extend beyond the building’s exterior to cover a mahogany deck and are supported by 18-inch-deep, 20-foot-tall Douglas fir posts and angled supports. To fabricate the timber structure, Centerbrook worked with Goodlam (a division of Goodfellow), in Delson, Quebec, just

outside Montreal, which specializes in custom glulam projects. To achieve the columns’ 10-foot-radius curvature, Goodlam used half-inch laminations, finger-jointed by hand and shaped by a custom steel jig to ensure consistency. For the ribs’ 100-foot radius, Goodlam used 1.375-inch laminations. It took 30 days to fabricate the glulam members, which totaled 22.5 miles in length.

The glulam structural members were trucked in sections to the site, where they were erected by the commercial contractor A/Z Corp., based in nearby North Stonington, Conn. The tight

tolerances required by the building’s connections posed a few challenges. Minor adjustments were required on-site and several glulam pieces had to be remade. “As accurate as we can be using technology, when ... you’re working from the structure that has been built in situ ... there’s always an inch here, an inch there, and you’re trying to insert a blade into a slot,” Floyd says. “You have to use a little ‘body English,’ let’s say, to get each one working.” Both the fabricator and contractor did excellent work, he adds, and overall construction went quicker than many anticipated.

## Ark Encounter Exterior Wall

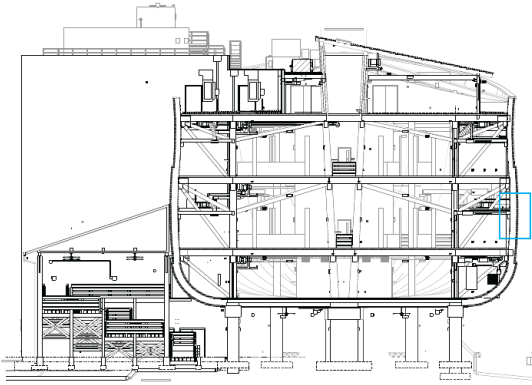

The term “of biblical proportions” is rarely meant literally, but a museum in Williamstown, Ky., may be an exception. Completed in July 2016, the Ark Encounter purports to be a full-scale replica of the titanic wooden vessel built “300 cubits long, 50 cubits wide, and 30 cubits tall” by the Prophet Noah to preserve life during an apocalyptic flood, according to the Book of Genesis. A Hebrew cubit—which biblical scholars say was based on the length of a person’s forearm, from elbow to fingertips—is estimated at 20.4 inches, making the ark replica an astounding 510 feet long, 85 feet wide, and 51 feet tall.

Owned and operated by the Petersburg, Ky.–based Christian organization Answers in Genesis (AIG), the \$102 million, 120,000-square-foot attraction aims to interpret the biblical narrative of the flood literally, a story that appears in Judaic and Islamic traditions in addition to Christianity. Built almost entirely of wood, the museum is reportedly the largest timber-framed structure in the world—but it is not the first ark replica. In 2013, Dutch carpenter Johan Huibers completed a 410-foot-long ark in the Netherlands. His model, however, has a steel core and a wood façade—a route AIG initially planned to pursue until LeRoy Troyer, FAIA, joined the conversation.

Growing up Amish, a Christian sect renowned for its Old World craftsmanship, the owner and president of the Troyer Group, in Mishawaka, Ind., spent his childhood on a farm outside

Middlebury, Ind., helping erect barns and other wood structures.

Still, turning to the Bible for building specs was a first for Troyer. Besides the ark’s dimensions, “there’s very little instruction in Genesis,” he says. Troyer envisioned the structure to be a hybrid that would employ traditional methods of shipbuilding and woodworking alongside cutting-edge technology and CNC machines. He worked with Tim Lovett, an ark researcher and exhibit designer for AIG who had developed computer models to understand how the ark might have been constructed.

Visitors to the museum make their way up a 450-foot-long ramp, entering near the ark’s stern. A 45-foot-tall main exhibit hall, or “hold,” is divided into three levels, which are accessed via interior ramps that wrap around a 65-foot-tall central atrium that delivers natural light from the roof deck to the lowest level. More than 130 exhibits line the museum perimeter.

Sitting above grade on 100 15-foot-tall concrete piers, the structure consists of a series of timber bents, or cross frames, spaced every 18 feet. Each timber bent spans the 85-foot width of the boat and stands 50 feet tall, and comprises two Engelmann spruce logs, each nearly 4 feet in diameter; two 20-inch-square Douglas fir posts; and two 18-inch-deep glulam ribs, which form the ark’s gently curved hull. Knife plates as long as 11 feet help tie the center logs in 16-inch-deep joists, all of which are tied together by equally large crossbeams and diagonal

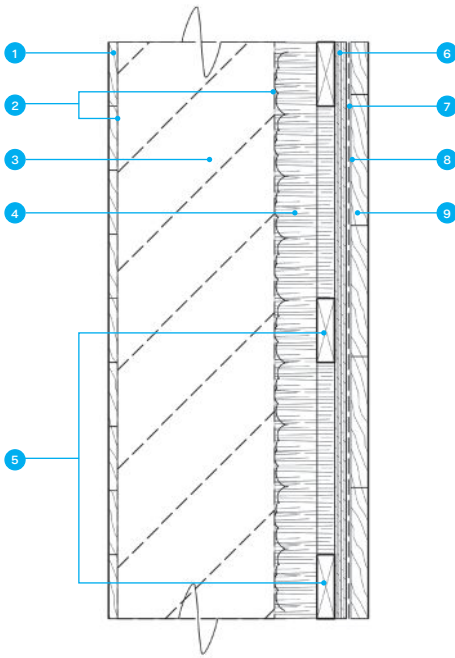
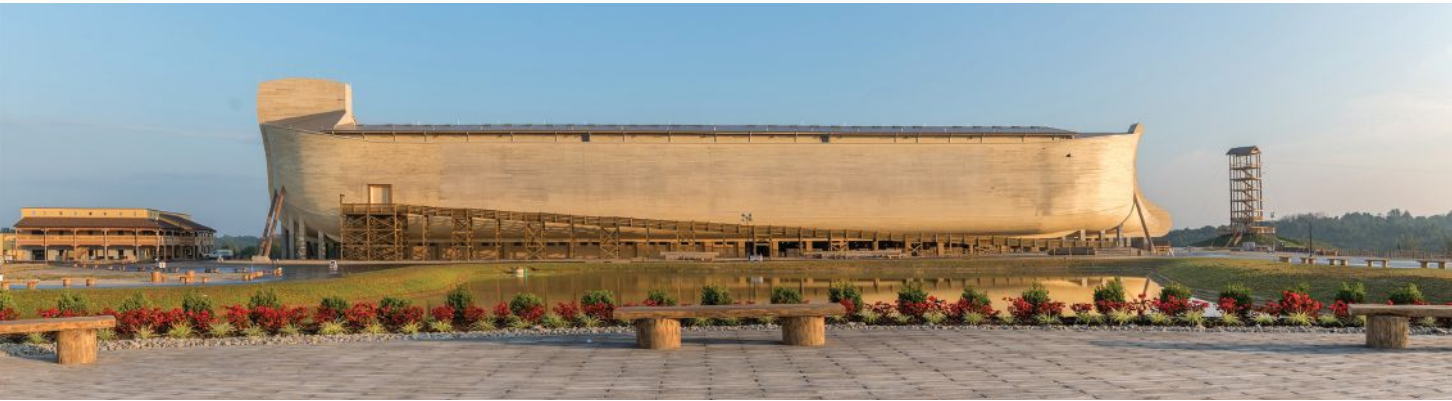

1. 1×12 rough-sawn shiplap
2. Fire Kote 100 flame-inhibitor coating
3. Glulam rib (beyond) at 6' o.c.
4. 4" closed-cell spray insulation
5. Fire-treated 2×6 at 24" o.c.
6. 1"-thick fire-treated plywood
7. Tyvek CommercialWrap
8. Rainscreen batten (16" o.c.)
9. 1×10 Accoya acetylated radiata pine shiplap

bracing. Infill joists and glulam ribs occur every 6 feet. The resulting dense grid of exposed timbers "is almost a wire frame structure with wood," Troyer says.

But the project component requiring the most research, Troyer says, was the exterior wood finish. Seeking a material that would last upwards of 150 years, he found Accoya, a weather- and pest-resistant wood product by London-based Accsys Group. The wood for the ark was harvested in New Zealand, then shipped to the Netherlands for the acetylation process, which uses a highly concentrated form of vinegar to alter the chemical makeup of the wood and render it extremely durable. The Accoya planks, left unfinished, will weather to gray over time.

Generally speaking, sourcing wood for the project was a challenge, Troyer says. The massive Engelmann spruce logs near the center of the structure, for instance, were originally meant to be yellow pine, but when the logs arrived for milling at Colorado Timberframe, in Lafayette, Colo., they didn't meet the structural requirements. Such large members are hard to locate, but Troyer was able to acquire the Engelmann spruce logs from a dead stand in Utah, which had the added benefit of being already dried. The longest spruce logs, however, were 17 feet short of the 65 feet required. The team made up the difference by splicing logs together, but the seams required additional support.

The diameter of the spruce logs also created an issue for manufacturer

Colorado Timberframe, whose CNC machines—despite being among the largest available in the U.S.—could only accommodate up to 24-inch-diameter logs. Consequently, the workers had to build an improvised jig with wood rails and a custom yoke. Measuring from the centerline, they then chiseled and drilled the notches by hand. Six workers could notch one log over two days.

Nearly 90 flatbed trailers transported the timber to Kentucky. Once the wood was on site, erecting the ark was relatively straightforward, thanks both to Bentley Systems' AECOSim BIM software used by the architects and to a sophisticated labeling system employed by Colorado Timberframe. Troyer says the construction efficiency was due in large part to the crew of approximately 100 Amish laborers, hailing from seven states, who erected the ark in 54 weeks. The giant timber bents, for example, were assembled in two pieces flat on grade following a template painted by the workers onto the ground. Multiple cranes then hoisted them into place.

All told, Troyer estimates that the project, which required nearly 5,000 pages of construction drawings, contains 3.3 million board feet of wood and 190,000 pounds of custom steel plates for its 4,000-plus structural connections. "We wanted to make sure that if we have thousands of people in the ark at one time, and there's a big storm, we've made them as safe as possible," Troyer says.

# LEARN & EARN

Learn how mass timber products allow for innovative structures with longer spans that are often required for commercial, institutional and industrial construction.

## DESIGN BUILDING

University of Massachusetts, Amherst  
The Design Building, completed in 2016, is a demonstration of leading-edge timber engineering, and sustainable design practice. As a demonstration project it is supported by the Massachusetts State Legislature and, under the direction of the designer, was the first project to meet alternative code requirements for wood timber construction. The building's structure features exposed cross laminated timber (CLT), and was the first university building in the northeast United States to do so. Informed by the school's research in next generation wood technology the building features a glue-laminated wood frame, and floor slabs of exposed CLT-concrete composites.

Location:  
Amherst, Massachusetts

Architect:  
Leers Weinzapfel Associates  
Architects of Boston

Photography:  
Alex Schreyer, UMass Amherst

### Mass Timber in North America



### Opportunities for Wood in Low-Rise Commercial Buildings



### Designing Modern Wood Schools



### Building Resilience: Expanding the Concept for Sustainability



Get CEUs at [reThinkWood.com/architect](http://reThinkWood.com/architect)

reTHINK  
**WOOD**®

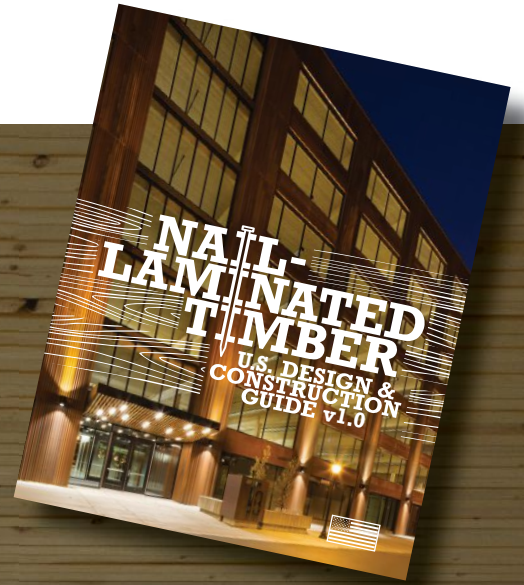

# Specify, Detail, and Install with NAIL-LAMINATED TIMBER

Download the U.S. Design and Construction Guide  
[rethinkwood.com/nlt](http://rethinkwood.com/nlt)

## Maggie's Manchester Centre Timber Frame

Less than a year after garden designer Maggie Keswick Jencks died in 1995, the nonprofit she founded in the final years of her life opened its first cancer care center in Edinburgh, Scotland. The center, designed by Richard Murphy, was not a treatment facility but a quiet space for contemplation and support, and a place where anyone affected by cancer could come and talk to counselors or fellow patients.

In the 22 years since, Maggie's Centres have inspired a new approach to cancer care. Today the organization, led by Jencks' husband Charles and former oncology nurse Laura Lee, operates 21 centers throughout the United Kingdom—with recent locations in China and Japan—all of them designed by distinguished architects, such as Zaha Hadid, Frank Gehry, FAIA, and Steven Holl, FAIA. In April 2016, the Maggie's Centre in Manchester, England, designed by Foster + Partners, opened.

Like many Maggie's Centres, the building is intended to feel more like a home than a hospital. Nestled within a residential neighborhood at the end of a tree-lined street (a short walk from the Christie, a renowned cancer hospital), the 5,400-square-foot, single-story building hosts a variety of intimate spaces, including a kitchen, a "living" room with a fireplace, and a covered veranda, which allows patients to sit outside even during the rainstorms for which Manchester is famous.

"It creates a sense of place," says Darron Haylock, a partner at the firm,

who visited Maggie's Centres around the U.K. to get a sense of their daily rhythms.

Lord Norman Foster, HON. FAIA, a Manchester native as well as a cancer survivor, was a natural choice to design the center. Haylock says Foster was intimately involved in the design process, from selecting finishes to choosing the center's furniture. "He had a very clear idea of what he felt the building should be," Haylock says.

The center's most distinctive element is its exposed timber structure. Inspired by early wooden aircraft as well as the common garden trellis, Foster + Partners designed a structure of 17 wooden portal frames with a central, light-filled atrium flanked by outstretched timber beams. Spaced every 10 feet, the portal frames divide the building into intimate spaces while the flanking beams, supported near their ends by slender metal posts, create open rooms at the perimeter.

Viewed from its south end, the structure resembles a steampunk airplane with broad wings and a prominent greenhouse as a lush, botanical "cockpit," as some design team members called it. If the building's form feels aeronautical from certain vantages, its underlying structure is rather human. "The structure is the protagonist," Foster scribbled on one early sketch. "Tiptoes lightly on the site."

It was an idea that Charles Jencks embraced during an early design review with Foster. "The wooden aeroplane," he remarked, "turns out to be a series of ballet dancers joining outstretched

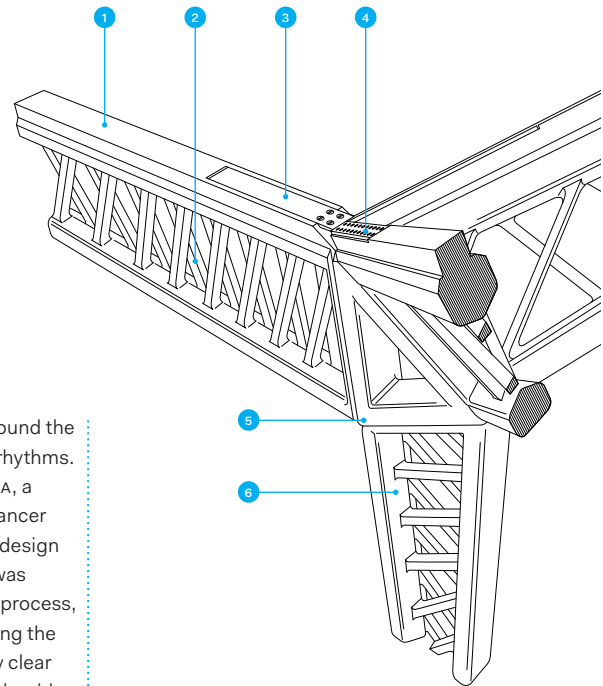

1. LVL tapered truss beam, 25' long, 23" × 5" at node to 2.3" × 4" at end
2. Web struts, routed from spruce plies
3. 50mm-wide steel plate
4. 30mm-wide steel plate
5. Wooden triangular node
6. LVL tapered truss column



arms—a good symbol of our collective cancer approach.”

Each beam, joist, and column is designed as a tapering truss, comprising laminated veneer lumber (LVL) routed to create an internal lattice-patterned web. Each beam member is 25 feet long and tapers from 23 inches deep and 5 inches wide at their column support, toward the building’s center, to 2.3 inches deep and 4 inches wide at their ends. At the frame’s haunch, the intersecting beam and column members tie into a triangular wooden node via small steel straps screwed into the timber.

The density of each truss web corresponds with the intensity of the loads that the member is carrying. Near

the triangular node, where bending forces are high, the lattice is tight; toward the beams’ ends, the lattice opens up. “The spacing of those struts is very closely linked and determined by the stresses of the beams and the spans they have to make,” Haylock says. “So it informed the architecture and created the architecture.”

Interested contractors had to build a full-scale mock-up of a portal frame before they qualified for the project. Blumer-Lehmann, a Switzerland-based timber engineering and fabrication company, was awarded the project. For the LVL trusses, Blumer-Lehmann cut plies of furniture-grade spruce using a five-axis milling machine to rout out each web member and then adhered the plies

in layers. The orientation of the angled struts comprising the web alternate, creating the lattice. The trusses were then shipped to the building site and erected in less than six weeks, Haylock says.

Like all Maggie’s Centres, the Manchester structure intertwines architecture and landscape, surrounding itself with fruit trees, shrubs, and water features. For Jencks, this was a vital acknowledgment of the importance of design, which Foster echoed in a testimonial on Maggie’s Centres website: “For so many people—more all the time—there is life after cancer, even if that is a changed life. I believe that quality in care and design can go hand-in-hand, and together be more effective.”

## Château d'Hardelot Theater Curved Panels

Initially designed from the inside out and without a predetermined site, Andrew Todd's Hardelot Elizabethan Theatre at France's Château d'Hardelot emerged from what he calls a "very peculiar process." Proposed as part of a design competition hosted in 2013 by the local government in the northern region of Pas-de-Calais—just across the English Channel from the U.K.—the theater needed to be discreet to avoid competing with the 13th-century castle that occupies much of the historic area.

The building would replace a temporary theater structure used by the Centre Culturel de l'Entente Cordiale, an institution dedicated to celebrating what Todd calls "Franco-British friendship," and though the brief called for an untreated wood cladding, the precise location of the structure would be left up to the architects.

For their submission—which ultimately won the competition and contract—the theater-design specialists at the Paris-based Studio Andrew Todd focused first on the auditorium. Inspired by early Shakespearean theaters, such as the Rose, in London, as well as contemporary spaces such as Peter Brooks' Bouffes du Nord, in Paris, Todd conceived of a three-story, cylindrical auditorium constructed almost entirely of wood, including a structure of curved cross-laminated timber (CLT) panels. "We had a few simple paradigms that we followed," Todd says. "One was: What are the absolute minimum volumes which can respond to the brief?"





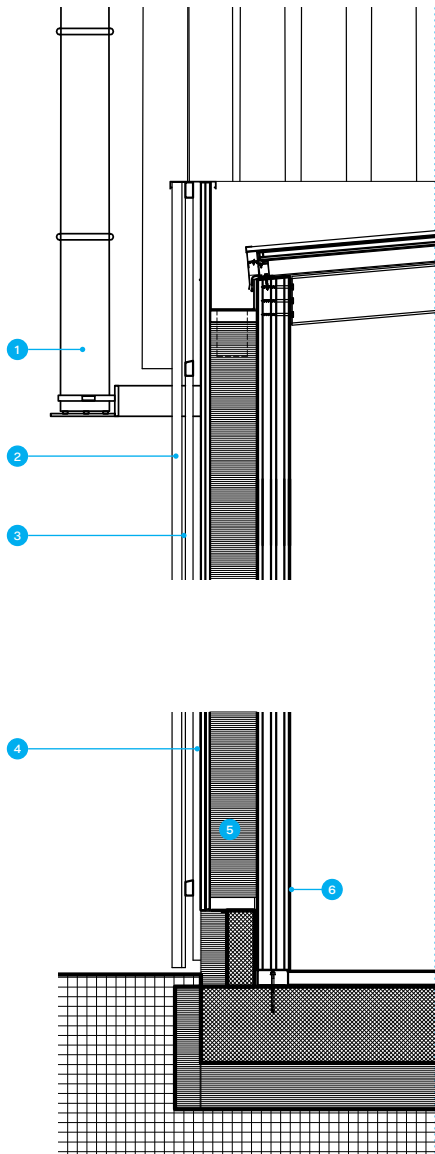

1. 12m bamboo culm
2. 40mm-square untreated larch battens
3. Rainscreen membrane
4. 2mm × 15mm CTB-X plywood form
5. 149mm Rockwool insulation in pine box frame
6. 109mm five-layer, vacuum-pressed CLT panel

[Another was:] What is the most intimate 400-seat auditorium that we can design?"

Still lacking an overall form, Todd's team continued to work from the inside out and honed the details. "We literally started drawing detailed sections, showing sight lines to get the balcony heights as low as possible, to get a rhythm of the columns that would follow a rhythm of the seats," he says.

"Once we'd gotten a handle on the core relations, we expanded outwards." They added the necessary stairwells, foyer, and backstage areas, wrapping the main volume in staggered, truncated layers until they arrived at a "lumpy-bumpy building" that was pleasingly asymmetrical and functionalist in nature.

Only then did the architects select a site for their proposed theater, nestled among a small copse of trees just outside the castle. To soften the building, the architects clad the façade in thin larch battens and added a circular screen of bamboo posts. "We realized that you could make it sort of vibrate with its surroundings a bit," Todd says, "and dematerialize the mass by using shadow and the contrast of platonic solids and very, very fine things."

The building was completed in June 2016, becoming France's first permanent Shakespearean theater and one of the first buildings in the world to be made entirely of curved CLT panels. Other than the concrete floor slab and a few steel elements for the stage, nearly the entire building is timber, a material Todd believes "presents numerous benefits in our faltering attempts to live in balance with our world."

All of the building's concentric layers, from the innermost circular auditorium to the exterior walls, are formed by the curved timber panels. A typical wall section comprises a 4-inch-deep curved spruce CLT panel, a vapor barrier, 6 inches of Rockwool insulation inside a pine-wood frame—also with a vapor barrier on the inner face and plywood on the outer—and Phaltex tape that serves as an acoustic barrier. On the outside is a rainscreen and then the

larch battens, twisted 45 degrees, giving the timber walls a monolithic feel. The vertical bamboo posts, which stand nearly 40 feet tall on steel footings, clip to a cantilevered galvanized steel ring, to which the radial horizontal members also attach. (Bamboo is not a recognized structural material in France.) The approach was akin to Brutalism, Todd says, "but instead of concrete we were doing it in wood."

The building's cylindrical form brought novel challenges. Because the geometries all related to one another, the architects eschewed parametric design tools. "We may just as well have drawn it from hand," Todd says. "When you're working with circles and you're offsetting radii, if you mess up with one thing, with an escape corridor, you have to redraw the entire building."

Fabrication of the curved CLT panels, on the other hand, was surprisingly simple (and less expensive than Todd expected). Not that every company was so sure it could be done. Todd called two CLT manufacturers about the possibility of doing curved panels. "The first one said, 'Not on your life, it's totally impossible.' And the second one said, 'Why not?'" That second company was Finnish brand Metsä Wood, which fabricated the panels in Bavaria using vault-like positive forms to create the six different radii of the building's curved walls. The panels, the largest of which were 30 feet tall and 10 feet wide, were then trucked to the site and erected in seven weeks.

This summer, Todd had the rare experience of performing in his own theater. To celebrate the building's first birthday, Todd and the department of Pas-de-Calais invited renowned Italian jazz pianist Enrico Pieranunzi to perform in the auditorium. Todd, who is also a professional-level jazz drummer, accompanied him. "It was so moving to experience it for myself," he says. "I got to play with one of the musicians I most admire in my building, which is a fairly unusual thing in the history of architecture, and a great privilege."

## UMass Amherst Design Building Zipper Trusses

"From the beginning, we knew that the Design Building would be a teaching tool," says Andrea Leers, FAIA, a principal at Leers Weinzapfel Associates (LWA). "Even in the interview, we talked about the idea that this kind of building needs to be a part of the pedagogy of the school."

What Leers did not know was that the facility, which brings together the architecture, landscape architecture, and building and construction technology programs at the University of Massachusetts Amherst, would evolve into the first mass-timber structure on the East Coast, and become the first project to use several cutting-edge building technologies, including a "zipper truss" and a composite floor system developed by the school's faculty.

Opened in January 2017, the 87,000-square-foot academic building embodies contemporary ideas: the importance of interdisciplinary collaboration and the urgency of climate change. The former is evident in the building but also in the design team: the project was led by LWA and Stephen Stimson Associates, a landscape architecture firm in Cambridge, Mass., with heavy input from instructors and department heads.

The building's physical and spiritual heart is the commons, which Leers describes as "a three-sided courtyard [that] spills out through the café, through the entryway, down into the main campus, and invites the campus in." But it also presented a structural challenge.

As the building's footprint morphed into a quasi-trapezoidal shape (in response to the site's topography), the 84-foot-long commons became increasingly complex in form: 56 feet wide at its west end and 33 feet wide at its east. On top of that, literally, the building needed to accommodate skylights and an inhabitable rooftop garden. "This was a real structural challenge," Leers says.

Then came the switch to timber. LWA was more than halfway through design development with a steel structure when the university decided to pursue a heavy timber frame, a major victory for the building and construction technology program, which for the past 10 years has focused on wood technology. Faculty members Alexander Schreyer and Peggi Clouston, both of whom had spent time at the University of British Columbia, arguably the epicenter of advanced timber design in North America, pushed for the building to incorporate as much wood as possible, using life cycle cost assessments to make the case that it

was the most sustainable structural option. "Everybody agreed," Clouston says. "But money speaks."

The concern, Clouston says, was that the new technology would come with a hefty price tag, especially given the lack of local expertise with materials like cross-laminated timber (CLT). Those concerns were eventually overcome when a former Massachusetts representative secured \$3 million in additional state funding and got the building listed as an official demonstration project.

Though LWA also lacked design experience with CLT, the firm embraced the change. "We knew this was a chance to learn about something important," Leers says. Clouston called Equilibrium Consulting, in Vancouver, whose portfolio includes many of North America's most well-known timber structures, which joined the design team alongside structural engineer Simpson Gumpertz & Heger, based in Waltham, Mass., and Suffolk Construction, in Boston.

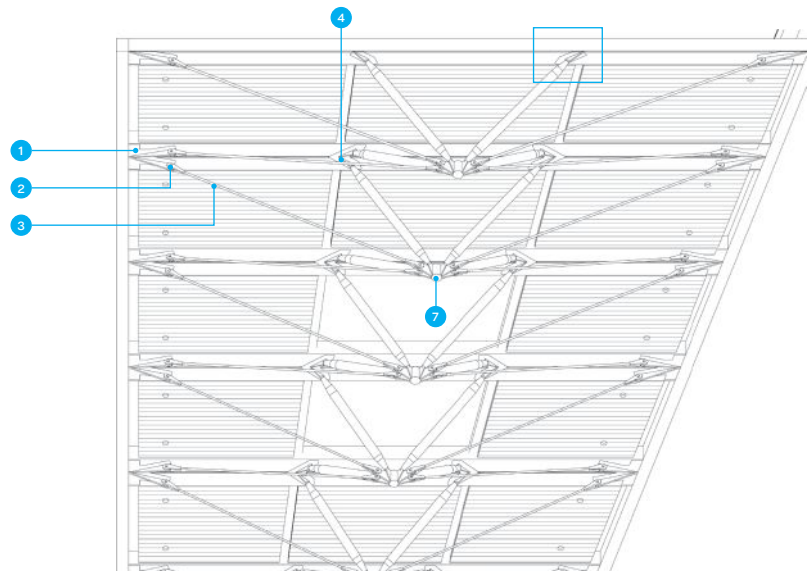

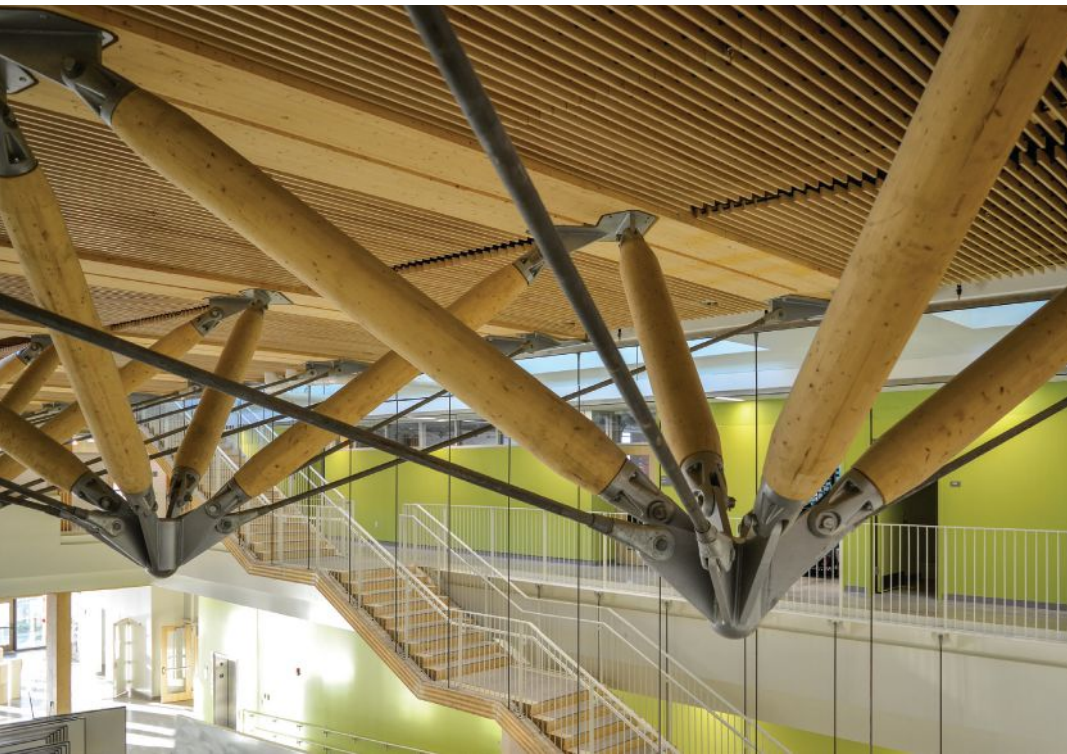
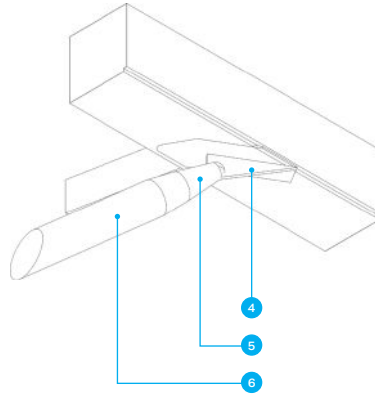

The custom steel-and-glulam zipper trusses, named for the way they converge multiple structural members to a single point, solved the challenge of the irregularly shaped commons. LWA toyed with several other solutions, says principal Tom Chung, AIA, but the zipper truss was the “best combination of a dynamic form, architectural consistency, structural efficiency, and cost. It reinforces the overall building column grid, allows for various span lengths while keeping the same form, and highlights the cost effectiveness of the digital fabrication process.”

Each of the seven trusses consists of four tubular glulam struts (9 inches in diameter) and four steel rods (between 1 inch and 2 inches in diameter). The 12-foot-wide trusses range between 7 feet and 9 feet deep, while their lengths vary with the span of the commons. The glulam compression members, which are capped with steel ends, transfer the roof’s structural load to a central steel node that Chung refers to as the “bullet connector.” The steel rods then work in tension to transfer the load to 18-inch-deep glulam beams, which span the width of the atrium and are supported by columns.

Clouston calls the zipper trusses “spectacular” and “a beautiful example” of how forces flow through a building, something she shared with her structural mechanics students on their first day—and illustrating how the building is already fulfilling its objective “to be the ambassador of change.”

1. 18" glulam beam
2. Steel tension rod clevis connector
3. Ø1" to Ø2" steel tension rod
4. Connection plates
5. Cast end connection
6. Ø9" diagonal glulam strut
7. Solid steel bullet

## Löyly Sauna Timber Skin

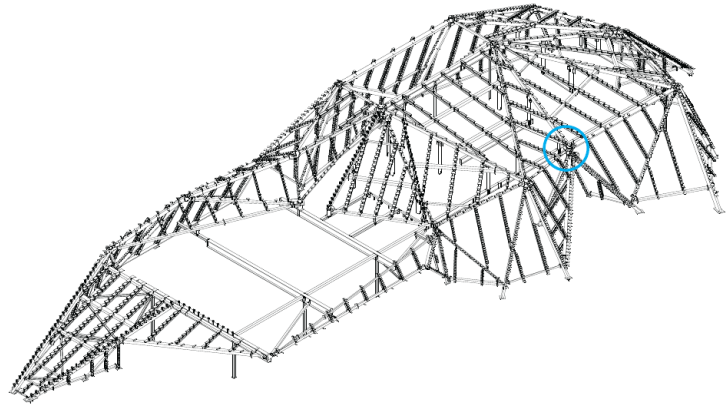

Ville Hara calls the timber skin of Helsinki's Löyly sauna "the cloak." The angular, geometric façade, interrupted by narrow slit entrances, conceals a second structure: a simple rectangular volume of black concrete that houses Löyly's restaurant and public saunas, providing visitors a sense of privacy without limiting their views of the Baltic Sea. "From inside you see outside, but from outside you don't see inside," says Hara, who founded Helsinki-based Avanto Architects with Anu Puustinen in 2004. "It acts like a venetian blind."

Opened in May 2016, Löyly—the Finnish word for the steam created by throwing water on heated stones—sits on the edge of a manmade peninsula just a mile from the center of Helsinki, as part of a planned residential development in what was once an industrial area. To preserve as much of the existing shoreline as possible—which was slated to be turned into a park—and avoid blocking the views of the soon-to-be-condo owners, Avanto Architects designed a low, narrow building whose free-form "cloak" is meant to evoke a natural landform, an effect that will intensify as the heat-treated pine weathers to a stony gray.

The project—spearheaded by actor Jasper Pääkkönen and entrepreneur and member of Parliament Antero Vartia—had several starts and stops following its initial 2011 proposal, but from the beginning, Hara says it was important to strike a balance between privacy and transparency. Formed by a series

of sloping triangular planes created by thousands of wood lamellas, the cloak creates transitional spaces—open, yet sheltered from the elements—for the periods before and after trips into the sauna, and also shades the glazed inner volume. To the south, the façade flattens out to become stairs, which lead to a pair of roof terraces.

Hara says the overall shape of the cloak was designed in Autodesk AutoCAD, but working out the dimensions and spacing of the lamellas took time. Half of the 4,000 lamellas are unique, he says, and each had to be modeled in three dimensions. The architects worked with the carpenters at local Puupalvelu Jari Rajala to build a full-scale mock-up of the façade. They initially used thinner wood members since structural requirements were minimal, but the skin was too transparent. Eventually they landed on 73 millimeters (2.9 inches) as the ideal depth, spaced 130 millimeters (5.1 inches) apart—the maximum height permitted for steps in Finland. (The dimensions of the lamellas do not change, even at the stair.) Avanto also used the model to test the lighting and painted a portion gray to show the client how it would look after a year of aging.

For Löyly's cloak, Avanto selected glued-laminated wood from a Finnish startup Nextimber. The company, founded in Kuopio, Finland, in 2014, makes glulam out of forest thinnings (small-diameter trees removed from timber forests) and core residues

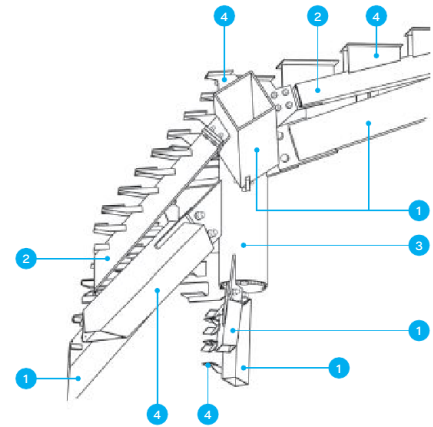

1. 300mm × 300mm or 200mm × 100mm rectangle hollow section (RHS) steel edge beam
2. 150mm × 150mm or 150mm × 50mm secondary RHS steel beam
3. Circular hollow section steel tube joint welded with joint plate and end plates
4. Steel support for lamellas

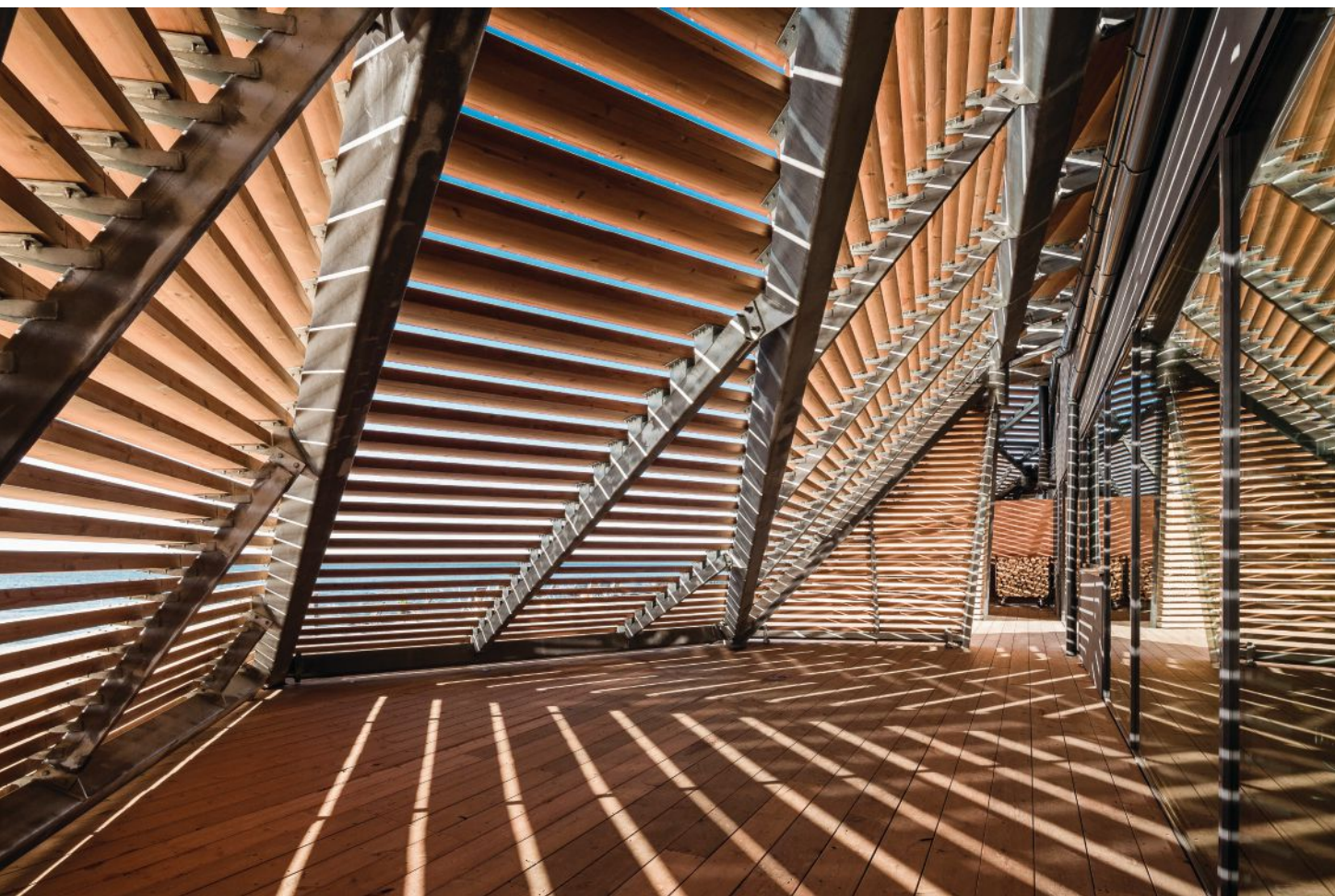

from plywood manufacturing. Löyly's heat-treated pine panels were baked and pressed to improve structural performance and weather resistance. According to Nextimber, this thermo-mechanically modified wood is 20 to 25 percent stronger than typical glulam.

The cloak's structure is a complex skeleton made of hollow steel tubes. Originally designed to be freestanding, the timber skin was eventually tied into the interior volume in a dozen places. Round steel nodes were designed to accommodate the structure's complex geometries, which created points where as many as six steel columns meet. Welded to each support are steel plates that support the wood lamella. With tens of thousands of connections, the joinery had to be "extremely simple," Hara says,

"because otherwise it starts to be very, very expensive."

The pine planks were milled on CNC machines in Kuopio. Their outer edges were cut diagonally to continue the angle of the façade; a chamfer at the tip prevents breakage. Planks were then numbered and shipped to the site, where they were bolted to the steel structure. A slight angle allows the timber to shed water, keeping interior spaces dry and ensuring that rainwater doesn't pool on the unfinished wood. Typically, Hara says, the glulam would be oiled, but the huge number of lamellas used on the project made this cost-prohibitive. If a single person were to oil all four sides of each lamella, it would take more than a year, Hara says, and by the time that person finished, they immediately "would need

to start from the beginning."

Thanks to its use of timber byproducts, Löyly became the first structure in Finland to be certified by the Forest Stewardship Council. But Hara is just as pleased that the sauna is being used. Public saunas have become rarities in the past few decades, and Löyly is now a popular destination, even attracting the attention of *The New York Times*. Its success, he says, is good for the architecture profession in Finland, which has a reputation for being too academic. "I see [Löyly] as a kind of propaganda tool," Hara says. "[W]e can show that architecture is a positive thing, and it brings joy to the people. Without this architecture, it would be just a box, or a standard building, and it would not be the same."

## Anil Drapes Retail Vault

A far cry from the large-scale multifamily housing projects that fill the portfolio of the Purple Ink Studio, Anil Drapes (AD) Retail is a showroom in Bengaluru, India, tucked inside an old warehouse with no access to daylight. "It completely contradicted our approach and the openness that we love," says Akshay Heranjal, principal architect at the local nine-person architecture and landscape architecture firm. The project,

commissioned by textile wholesaler Anil Drapes, would be the rare storefront with zero street presence. Purple Ink Studio had to work around the warehouse's existing structure and the owner's desire to maximize the number of products that could be displayed within the 650-square-foot space.

Beyond this mandate, Purple Ink Studio would have total creative control—but only two months to complete design

and construction. "In India, there's always an urge to finish everything yesterday," Heranjal says. Because the client had been considering adding a retail space for more than a year, to him the project "was a year late already."

However, the design freedom enabled Purple Ink Studio to draw from pavilion architecture and art more than a typical retail or residential project would allow. At the same time, with no street



frontage, the store interior itself had to become a destination, Heranjal says.

He and his team designed a freestanding, wooden arcade and vault at the center of the store's concrete shell. The 24-foot-long, 9-foot-tall structure partitions the store into reception and meeting areas while preserving wall space to display racks of fabrics. The designers drew the vault, which includes a series of double-curved arches, first by

hand and then in Trimble SketchUp. The contractor, Mumbai-based MM Interiors, then created a series of physical mock-ups. Made of indigenous Indian teak wood and Flexi Ply, a flexible plywood, the vault is supported by eight wood-framed columns that form a central aisle flanked by a series of three arches. Each arch varies slightly in dimension.

Each component of the arcade was manually measured, cut, and installed.

Even power sanders were eschewed in favor of sandpaper. "It was completely handcrafted," Heranjal says.

To build the arches, Heranjal's team worked alongside MM Interiors to form the curved profiles of the support ribs first in 0.5-inch plywood. Once the framework was completed to their satisfaction, the team duplicated the ribs in teak, about 0.5 inch thick, and attached them to 1-inch-thick teak battens nailed into the concrete slab ceiling. The team then cut a 6-millimeter-thick layer of Flexi Ply to fit the curved rib profiles and secured it to the teak framework. Finally, they adhered and nailed a 4-millimeter-thick teak veneer to the Flexi Ply. The contractor spent hours joining the veneer sheets and painstakingly filling every nail hole so that the final surface appeared seamless. Lastly, the workers applied a polyurethane coating.

To meet the deadline, the workers lived on-site during the construction. At any given time, between 15 and 20 people worked in the tight space—alongside the owner, who held client meetings there throughout construction.

Overall, the project was completed in 55 days, from the client's initial call to final touches. Despite its obscure location, AD Retail is garnering foot traffic. The owner previously had to travel to his clients, taking fabric samples with him. Now, buyers from hotels and other clients are visiting his showroom, Heranjal says. "It's a place that they want to experience."

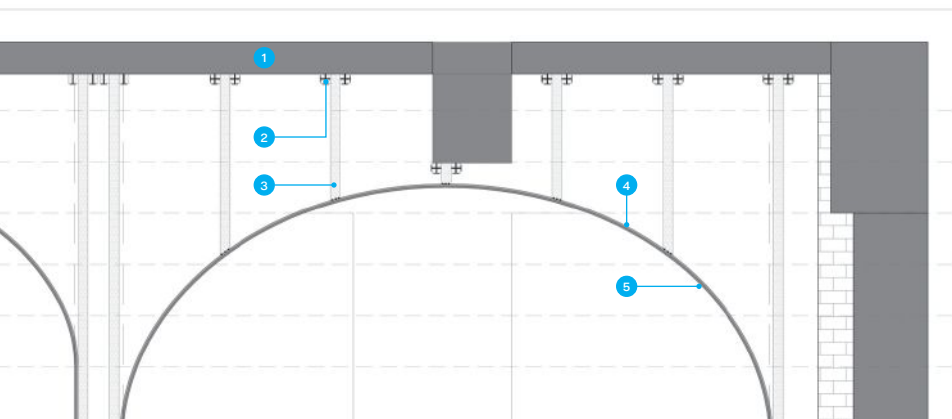

1. Existing concrete structure
2. 1" teak batten (typ.)
3. 0.5" teak rib, cut to curved profile (typ.)
4. 6mm Flexi Ply, cut to form vault surface and nailed to ribs
5. 4mm teak veneer, glued and nailed to Flexi Ply

# WOOD: TOPPING NEW HEIGHTS OF BUILDING SAFETY PERFORMANCE



Photo Credit: Brudder, courtesy of naturallywood.com

This year for “back to school”, over 400 University of British Columbia students made history by moving into what the former Vancouver Fire Chief depicts as “one of the safest buildings in the city.” What makes the Chief’s words especially noteworthy is that they describe the tallest mass timber structure in the world.

You have to envy the students living in Brock Commons Tallwood House. No other building on campus can match the views from the new 18-story, 404-bed upper year student residence now open on the Point Grey campus of the University of British Columbia (UBC) in Vancouver. Panoramic views from the world’s tallest mass timber building may be among the least of Brock Commons’ distinctions. What is winning praise is the way this breakthrough in tall wood mass timber construction has smartly answered all life safety questions.

## “Practical, Repeatable, And Safe”

In scale, Brock Commons is without precedent. Team collaboration was critical at every stage. “We made it clear from the outset our goal was to not build a signature architectural wonder,” says UBC managing director of infrastructure development John Metras. “What we did require was an integrated design approach representing all the key players; architects, structural engineers, construction managers, and the key trades were at the table working as one. Brock Commons had to be practical, repeatable, and safe.



## ADVERTISEMENT



Brock Commons is on track to receive LEED Gold certification and conforms to ASHRAE 90.1-2010. Its carbon footprint is nominal for a structure of this size. For example, an equivalent concrete structure would require 2,650 cubic meters of concrete. Brock Commons mass timber reduces CO<sub>2</sub> emissions by up to 500 tons, according to project architects, Vancouver-based Acton Ostry Architects. Photo Credit: KK Law, courtesy of naturallywood.com



Fire-rated drywall encapsulated cross-laminated timber and glue-laminated components, achieving the required one- and two-hour fire ratings. Active and passive fire safety measures are robust. For example, a 5,283-gallon reserve water tank can supply the sprinklers for 30 minutes if an earthquake cuts municipal water access. Sprinkler heads are recessed in the ceiling to reduce damage or tampering and pop-out when activated. Photo Credit: KK Law, courtesy of naturallywood.com



"Wood component delivery to the site was very carefully sequenced," says John Metras, UBC infrastructure director. So much so, no building material was stored at the worksite. "The installation team was able to install each element in about four to seven minutes. The team was very small, just eight to nine workers. They worked quickly and effectively. We were amazed at how quickly it went together." The 18-story structure and envelope was assembled in 9-1/2 weeks, 6-1/2 weeks ahead of schedule. Photo Credit: KK Law, courtesy of naturallywood.com

"We took a conservative safety approach," observes UBC managing director of infrastructure development John Metras. By code, no mass timber building can exceed six stories. As an innovative, precedent setting building, Canadian authorities provided specific regulation which set safety standards for the \$51.5 million, 162,697 sq.ft. building including fire and seismic standards that exceed those typical in this type of structure. "The process included a comprehensive examination by a panel of structural engineers, building safety officials, fire safety experts, and other specialists. By the end of the review, they were supportive of the strategy," Metras says.

In terms of fire safety, the building's compartmentalization, mass timber's inherent fire resistance, a large reserve water tank, backup pumps, sprinkler system, and other active and passive safety measures make Brock Commons "arguably safer in terms of life safety than a comparable building with a concrete or steel structure," states Acton Ostry Architects, the project's lead designers.

In addition, Brock Commons is a comparatively lightweight structure, meaning less mass/inertia during seismic events. The heavy concrete foundation and podium serve as a structural counterweight while the twin concrete cores provide lateral stability. Brock Commons is the first building in British Columbia built to 2015 National Building Code of Canada seismic standards.

### CLT & Glulam

The structural system is a hybrid with a one story concrete podium, two concrete elevator cores, and a prefabricated steel beam with a metal deck roof. The key building components were five-ply, 169-millimeter thick, cross-laminated timber panels (about 9'14" by 13'1") and glue-laminated columns. The façade is prefabricated wood fiber, high-pressure laminate in 26'3" sections with preinstalled windows.

### Saved: 6-1/2 Weeks

Construction was projected to take 16 weeks. It took 9-1/2 weeks. Metras attributes 3D

computer modeling and a 2,000 sq.ft. mock-up for the smooth sequencing and surprise-free assembly. "We had to actually slow the assembly down so drywall teams could keep pace," Metras says.

### Proof of Concept

Now that Brock Commons is a signature architectural wonder, what is the big takeaway for Metras? "The team came up with something that works really, really well. It truly is a design that can be replicated elsewhere."

**Owner:** The University of British Columbia

**Architect:** Acton Ostry Architects, Inc.

**Peer Review Architect:** Architekten Hermann Kaufmann ZT GmbH

**Structural Engineer:** Fast + Epp

**MEP Engineer:** Stantec Ltd.

**Project Manager:** UBC Properties Trust

**Construction Management:** Urban One Builders

**Wood Installer:** Seagate Structures, Ltd.

**Structural Timber:** Structurlam



**Innovative Detail** is a monthly presentation in ARCHITECT profiling distinct building design and modern architecture. It is sponsored by reThink Wood. Innovative technologies and building systems enable longer wood spans, taller walls, and higher buildings, and continue to expand the possibilities for use in construction.

To learn more about new and innovative wood uses, visit: [rethinkwood.com/architect](http://rethinkwood.com/architect).

## Parkhotel Jordanbad Sauna Village Wall

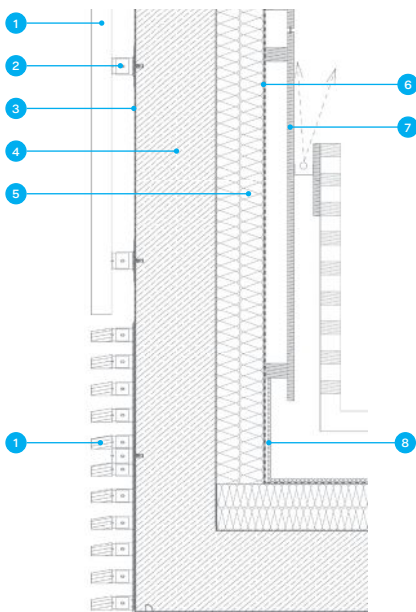

1. Black locust slats, tapered 60mm/40mm, in panels
2. T-shaped steel anchors (58mm o.c.)
3. Liquid waterproofing, three layers
4. 25cm concrete wall
5. 7cm Foamglas insulation, two layers
6. Joint adhesive with waterproofing ability
7. Rohol SaunaPly wood
8. Tile

For more than 500 years, Biberach an der Riss, in the Baden-Württemberg region of Germany, has catered to Europeans looking to reap the healing effects of the area's mineral-rich thermal waters. Among the destinations was Jordanbad, a site once occupied by a hospital that appears in historical documents dating to 1470. In 2003, a hotel built on the site in 1912 was renovated into the Parkhotel Jordanbad, with its spas, saunas, and thermal pools remaining signature amenities.

In 2012, Jordanbad Sauna Village, a collection of rustic log cottages, reached the tail end of a rather rapid decline. Just a decade old, the buildings had rotted beyond repair due to the perpetually damp environment. Plus, "they were pretty cheap," says Christina Jeschke, principal of Jeschke Architektur & Planung, the Munich-based firm hired to renovate the village.

Although nothing could be salvaged, Jeschke, an expert in spa architecture, had plenty to draw on, including the hotel's sylvan setting and the area's vernacular architecture. Biberach is part of Germany's Fachwerkstraße, or Half-Timbered House Road, which connects towns with exemplary timber-framed structures.

To create a place that felt both modern and welcoming to the hotel's well-heeled guests, Jeschke maintained the concept of a "village around a lake," with three sauna buildings and shower facilities clustered around a pond. In a nod to the region's heritage, the gable-

roof, residential-scale structures make extensive use of wood. At the same time, the buildings are simple, concrete boxes with floor-to-ceiling windows that face the pond. Each is wrapped in a wood lamella of black locust (*Robinia pseudoacacia*) slats, oriented horizontally and vertically.

Given the fate of the cottages' predecessors, Jeschke knew that specifying the right type of wood was crucial. For interior finishes, she chose SaunaPly, a plywood manufactured by Austria-based RoHol whose adhesive is unaffected by hot, humid air, thereby reducing formaldehyde emissions. For the saunas' benches, she selected lightweight obeche wood, a poor conductor of heat. "You cannot use just any wood for a sauna bench because you will burn [yourself]," she says.

The infusion sauna posed the biggest challenge. It had to accommodate up to 120 people at a time without obliterating the intimate scale of the surrounding 400-square-foot saunas. A supersized version of the gable-roofed form "looked somehow ridiculous," Jeschke recalls. Eventually, she cleaved the infusion sauna, creating two 900-square-foot volumes that intersect near their midpoint, creating a sufficiently large communal area while also offering secluded areas for everyday use. The final design "didn't just come to me," Jeschke says. "I had at least 40 versions."

The intersecting form required her team to 3D model in ArchiCAD everything from the angles of the



intersecting rooflines to the placement of the hemlock planks that finish the infusion sauna's walls and ceiling. Building the model required significant work, she says, "but there were some things I wanted to see before [it was constructed]."

Jeschke's work on the front end paid off. Because the hotel owners wanted to reopen for the fall season, the contractors had just five months to complete the sauna village. With the 3D model, they were able to prefabricate a majority of the buildings' components, including the wood skins. Made out of 1.5-inch-wide slats spaced 1.5 inches apart, the preassembled lamella was hung in 7.5-foot-tall panels ranging in width from 5 feet to 9 feet.

Schreinerei Harald Geng, one of two timber contractors, continued the look on the interior. In the herbal sauna building, the SaunaPly, which provides a backing for horizontal walnut slats in the fireplace sauna, is left exposed. In the large infusion sauna, 3- to 8-inch-wide hemlock planks create horizontal bands that further animate the dramatic geometries created by the roof planes.

Between the interior wood panels and the precast concrete walls is 5 inches of FoamGlas insulation. Despite being impervious to moisture, the rigid insulation was coated with a waterproofing paste on its interior face for added protection. For exterior walls, liquid waterproofing was applied the concrete. Interior and exterior wood

finishes are held at least 1 inch off the wall substrates to allow for continuous ventilation.

Opened in 2015, the Jordanbad Sauna Village is a modern update to a centuries-old pastime. The saunas rely solely on the waste heat recovered from the hotel's combined-heat-and-power facility, a first for a German spa, Jeschke says proudly. Her biggest accomplishment, however, may have been convincing her client that wood was not a liability. "It was quite some process to get the client on the [same page]," she says. Based on the owner's response thus far, the architecture appears to have struck the desired balance between comfortable and contemporary.

## The University of Essex's Geodesic Dome Roof

"If you're going to make a building complicated, this is it." That's how Derek Foster, contracts manager at U.K. construction company Morgan Sindall Group, summarizes the Essex Business School, a three-story timber-framed building designed by the London office of BDP under the direction of former chairman Tony McGuirk. The 59,200-square-foot, 590-foot-long academic building curves both in plan and in section and molds into a hillside with a 30-foot drop located at the edge of the University of Essex's campus in Colchester, England.

Realizing the structure was challenging both "geometrically and logistically," Foster says. "There wasn't a right angle in the place." Its crescent shape and distinctive "roundels"—circular lecture halls clad with traditional lime render that pop out of the building mass—emerged from a rigorous site analysis that examined solar exposure and wind patterns, among other things.

The largest roundel, 60 feet in diameter, houses the main lecture theater and is topped by a geodesic timber roof. A lattice of angled glulam beams, each 8.7 inches wide and ranging in depth from 25.2 inches to 26.7 inches, connect in diamond formation via steel knife plates welded to custom hollow steel tubes. As the lattice ascends to the dome's apex "almost like a crown," as McGuirk describes it, it meets a 118-inch-diameter steel ring beam, within which a central steel node with welded knife plates connects the six topmost



1. 15.7"-deep × 8.7"-wide glulam beam
2. Steel knife plate
3. Ø12.8" × 0.63"-thick cold-formed S355 hollow section
4. Ø24mm, grade 8.8 bolts (four per plate)
5. Timber plug in bolt head recess
6. 25mm chamfer

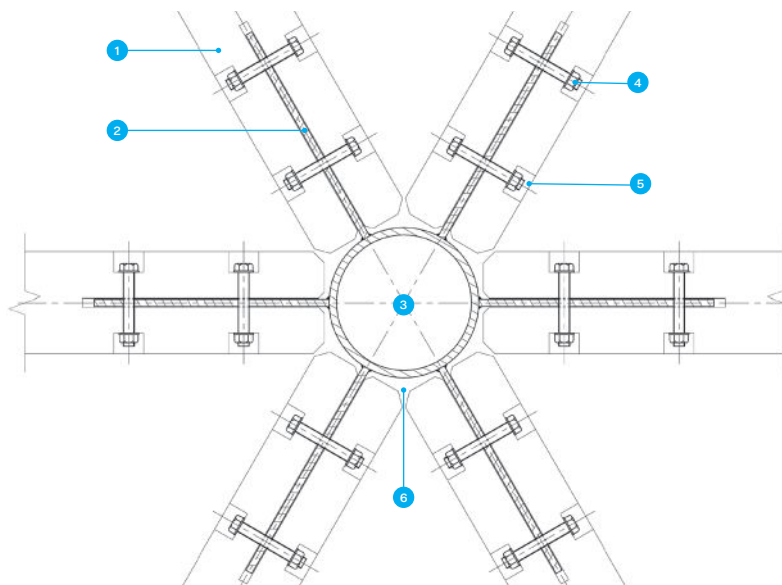
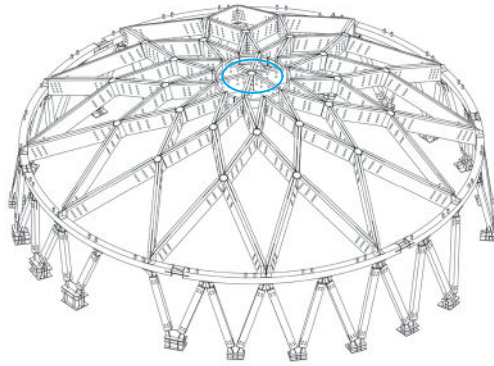

beams, each with a depth of 15.7 inches, in a radial array.

The geodesic structure was erected from the ground up, with temporary centering used for each ring until the “key,” or central node of the dome, was securely in place. “It was very much like building an arch,” Foster says. The roof was finished with 3-inch-thick cross-laminated timber decking, a waterproofing membrane, insulation, and living roof media.

At its base, the entire timber dome roof ties into an outer steel ring beam that sits on angled glulam

columns arranged in “V” formations, like the web of a truss, and tie into steel plates anchored into a circular concrete foundation. McGuirk says the dogtooth pattern was not only logical but also helped to unify the “very characterful” architecture.

Such a “characterful” building presented innumerable construction challenges, beginning with the creation of construction drawings for the building’s hodgepodge geometries, done in 2D using Bentley Systems’ MicroStation. McGuirk credits its realization to the entire

project team, including London-based structural engineer Engenuiti and Derby, England-based timber supplier and contractor B&K Structures.

At least seven types of wood appear in the school, including pine in the glulam structure and western red cedar and iroko for its exterior cladding, for a total of 45,000 cubic feet of timber. The glulam was manufactured by Rubner Holzbau at its facility in Austria, where it also grows its own timber. Given the project’s complexity and tolerance of just 1 millimeter for the glulam, Foster says it was “extraordinary how it all fit together.”

Additionally, every bolt hole in the glulam members had to be filled and sanded to match the wood. “There were thousands and thousands and thousands of plugs done, each of them by hand,” McGuirk says. “Modern construction tends to be fairly methodical, but this needed a lot of skill.”

McGuirk, who left BDP in 2014 to launch his own practice, says the academic building, completed in 2015, exceeded even his own expectations: “It’s almost like the building is a landscape as well as a building.”

Featuring prominent green roofs and an angled rooftop solar array, the timber-clad business school wraps around a 250-year-old English oak tree, which the architects kept despite the specimen looking somewhat worse for wear. (An arborist assured them it was healthy.) As a result, the building feels natural, which the architects intended.

## Pinterest's New York Office Scissor Stair

For the design of the New York office of Pinterest, Evan Sharp, the co-founder of the online idea-discovery and cataloging platform, suggested that San Francisco-based IwamotoScott Architecture seek inspiration from the New York Public Library's (NYPL's) Picture Collection. In a sense, the library's archive of more than 1 million print images is "the analog version of Pinterest," says principal Lisa Iwamoto. Beyond the collection itself, one aspect of the NYPL's 1911 Beaux-Arts building in particular caught the firm's eye: the crisscrossing internal stairway designed by late American architect John Mervin Carrère.

Pinterest's office, located on the fourth and fifth floors of the building directly across Fifth Avenue from the NYPL, needed an element of vertical connectivity. "To have to [take] the elevator to go up one floor is not the culture that they're trying to create," Iwamoto says. "They want a culture where people are flowing through the space seamlessly."

IwamotoScott, which also designed Pinterest's San Francisco headquarters, conceptualized a scissor stair that could be approached from opposite directions with each stair run meeting at a central landing. Working with the layout of the building's existing structural bays, IwamotoScott with New York-based Spector Group sited the stair at the office's center to maximize accessibility and its significance.

Intentionally oversized at 5.5 feet deep and about 14 feet wide, the landing

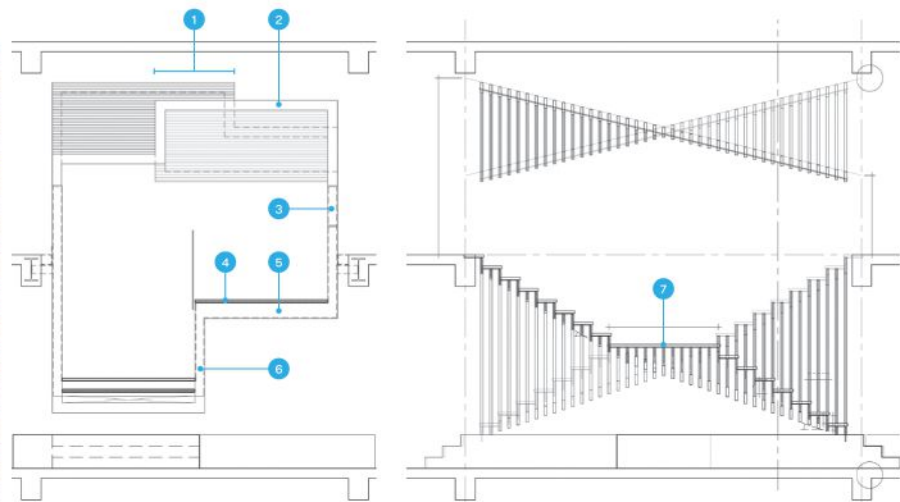

encourages organic interactions among employees as well as serves as "an architectural reference" that Iwamoto says resonated with the client "just like it resonated for us." However, a stair that is too open can also create acoustical distractions, she says: "We didn't want a big hole in the floor. We wanted to enclose it somehow and yet not enclose it so that it was a tunnel. It needed to be porous too."

The designers decided to wrap the steel stair structure in a series of vertical and horizontal white-ash fins, creating the effect of a wooden box that's been parsed into rectangular cross-sections. The perpendicular fins provide a degree of transparency and limit visual and acoustical disruptions to or from adjacent workspaces, while the wood, also used to finish the stair treads and landing, adds warmth to the space.

1. 4' overlap between overhead fins
2. 6.25" × 1.625" white-ash horizontal fins (5.5" o.c.)
3. 6.25" × 1.625" white-ash vertical fin-cladding over steel structure (5.5" o.c.)
4. 1.5"-thick white-ash tread
5. 0.375"-thick steel plate
6. Wood-clad steel plate with handrail
7. Stair landing

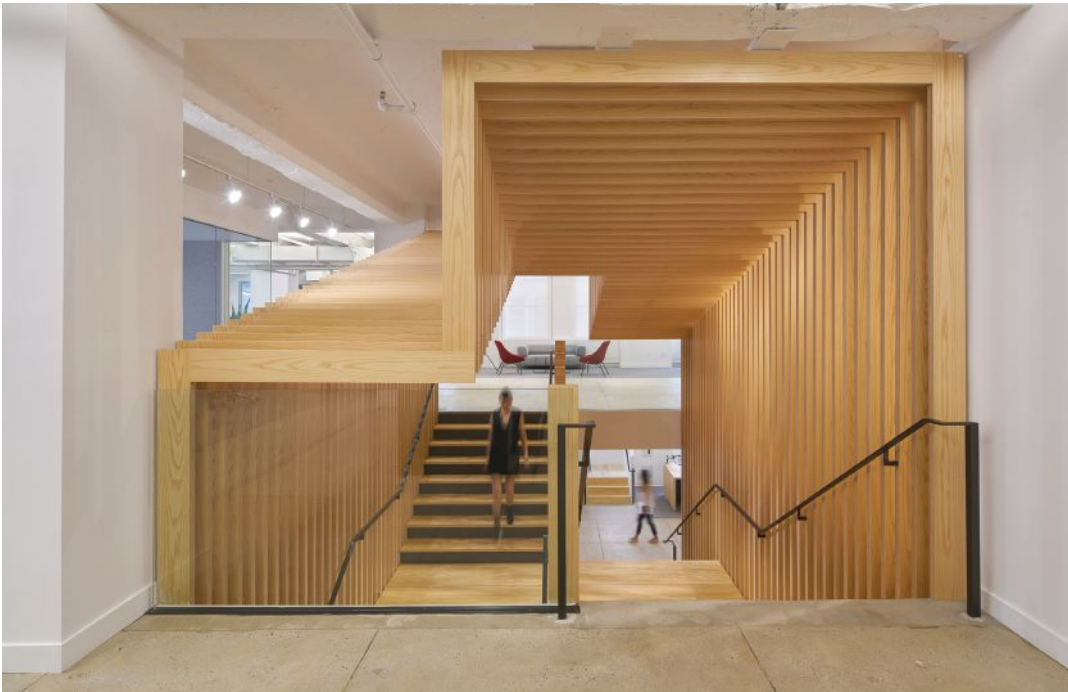

Pragmatically speaking, wood was also a much lighter option than metal fins, adds principal Craig Scott, AIA.

The fins follow the ascent and descent of the stair runs, creating a telescoping effect and the illusion of two intersecting volumes, 20 feet long by 16.5 feet wide and 20.5 feet tall, floating in the office. "It was really important for us that it form the heart of the space, and that as you were walking

around the space, you would naturally gravitate toward this sculptural element in the middle," Iwamoto says. The fins also exaggerate the intersection between the two volumes: The horizontal fins overhead overlap with the complementing fins of the adjacent stair above the central handrails rather than bypassing one another. "That was probably one of the more complicated moments," Iwamoto says.

IwamotoScott modeled various iterations of the stair's opacity in Rhino 3D and worked with Bronx, New York–based millwork company Miller Blaker and Englewood, N.J.–based steel fabricator Burgess Steel to build a physical mock-up. The team ultimately specified 42 wood fins 6.25 inches deep and 1.625 inches thick, spaced 5.5 inches on center. Because nearly every piece of wood is unique in length, aside from its twin on the opposite stair, each fin had its own CAD file, says Steve Samuels, the project manager for Miller Blaker.

Ranging between 11.5 feet and 13.5 feet long, the vertical wood fins were fabricated as separate L-shaped pieces and "clam-shelled" together over vertical steel plates, which are welded to the steel stringers. The solid horizontal fins, approximately 5.8 feet long, lock into the vertical fins via mortise-and-tenon joints to span the width of the stair.

The fins are anchored to black steel stair stringers, which tie into the main building structure at the fifth floor. Much of the stair, including the central landing, is hung from the beams of the floor above them via what Iwamoto describes as steel stirrups: "The default thing to do would be to put the landing on posts, but we didn't want to do that."

The topmost horizontal beam also ties into the ceiling beam via a pair of L-shaped metal plates. To prevent the fins from swaying or sagging, 0.25-inch steel cables run through the fins. "The ends of the cables were tightened within the body of the cross-beam, and the holes were plugged," Samuels says.

Even with a mock-up for reference, the steelwork was checked regularly for accuracy. "The tolerances that we had to work with in order to maintain the gap between each rib were pretty small," Samuels says—as tight as 0.19 inch."

Completed in 2016, the scissor stair has become both a functional centerpiece and means of vertical communication. "It's like a crossing of paths," Scott says. "When you go up either run or down either run, you have a choice of two ways to proceed."

### Toranoko Nursery Laminated Veneer Lumber Roof

Like the artist Katsushika Hokusai and his famous woodblock prints, Takashige Yamashita's first project under his own name is inspired by views of Mount Fuji. The project, a children's nursery in the small town of Fujikawaguchiko, in Japan's mountainous Yamanashi Prefecture, is for a client who also owns and operates several elderly and assisted-living facilities on the site. Hoping the nursery could double as a community gathering place, the client organized a design competition in 2015 to select an architect. Takashige, who left Tokyo-based firm Kazuyo Sejima + Ryue Nishizawa / SANAA the same year to open Takashige Yamashita Office in the Japanese capital, won the competition with a single-story building made up of several irregular volumes and a curved timber roof that billows like a sheet on a clothesline.

To Takashige, who spoke to ARCHITECT through an interpreter, the oversized roof is a unifying element, its various curves creating a "sequence of scenery" that divides the building into classroom, lounge, office, and garden while also connecting the individual spaces. Like a large tree in a plaza, the building aims to gather the community—many of whom might have family in the nursery or in the senior housing—at its center, with multiple entrances and approaches also cued by the roof's curves. The most dramatic roof section, which rises 24 feet over the terrace, perfectly frames Mount Fuji, some 16 miles away.

The roof structure is a combination of structural plywood and laminated veneer lumber (LVL), which allows for a thin profile even at long spans. Takashige became interested in LVL technology while at SANAA and had begun talking with experts at the Yamagata, Japan-based timber manufacturing company Shelter Co. about its applications.

For the Toranoko Nursery, Takashige modeled the curvature of each roof section, first with a paper model, then in Rhino 3D, consulting with Tokyo-based Sasaki and Partners. To prevent the need for support columns midspan, the design team developed a custom steel

1. 0.35mm galvalume steel plate
2. Waterproofing backing adhesive
3. 9mm-thick structural plywood (typ. 2)
4. 50mm × 50mm LVL rafter
5. Ø60.5mm, 4mm-thick steel pipe
6. 100mm × 100mm × 6mm × 8mm steel
7. 9mm gusset plate with high-tensile bolt

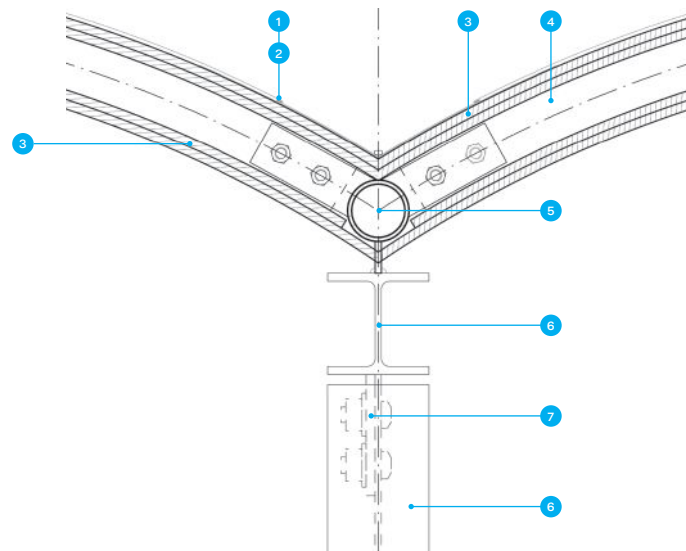

portal frame system, which features integrated steel plates to join the timber roof to the walls and form the basic structure of the building.

The final roof structure consists of two layers of structural plywood that sandwich a series of curved LVL ribs. The ribs were cut to the specified radii by CNC machines from 2-inch-thick panels. They attach to the portal frames via a 2-inch-diameter steel pipe with welded steel plates. For longer spans, the ribs are spaced at roughly 1 foot; for shorter spans, 2 feet was sufficient. Shelter Co.'s Yoshihiro Kimura, who managed the Toranoko Nursery project, says the roof



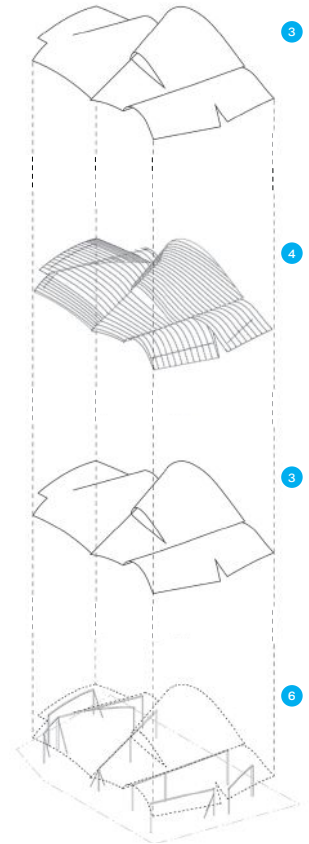

structure was so thin that he worried it would fail. So his team built a full-scale mock-up to test the roof's stability.

On either side of the ribs are two layers of 0.333-inch structural plywood, secured with both glue and nails. Unlike the top of the roof structure, where the plywood panels are 3 feet by 6 feet, Takashige specified panels just 3 inches wide for the ceiling that range from 2 to 3 feet in length to create the look of wood planks and give it a more luxurious aesthetic. The underside plywood is also finished with a clear coat of a finish called Nonrot. Above is a waterproofing adhesive layer and galvalume metal roof.

From top to bottom, the roof's profile measures just 3.5 inches deep.

As one might expect with so many structural connections, a number of adjustments had to be made on site during construction. "It didn't really go as we imagined," Takashige says. Several of the steel gusset plates were welded at the wrong angle and had to be bent into place to achieve the roof's curve. Takashige describes the process as both "ironic and interesting," given how much time had been spent on 3D modeling. Takashige admits that despite the extra work, he enjoyed the process. It gave him a sense of satisfaction, he

says, working directly with the wood as does a furniture maker.

Timber architecture has a long history in Japan, but also has experienced a renaissance in recent years thanks to new technologies and an awareness of climate change. Takashige hopes the nursery contributes to the country's growing collection of contemporary wooden buildings and helps push the limits of what is possible, particularly with regard to LVL technology and thin timber roofs. This building, he says, "suggests and shows another possibility of wood in Japanese architecture."

# Build your team at the AIA Career Center.

Put us to work for you. Post your firm's open positions with confidence and connect with 30,000+ highly qualified architecture and design professionals.

Visit the AIA Career Center today. [careercenter.aia.org/employers](http://careercenter.aia.org/employers)





The American  
Institute  
of Architects



# Firm salaries are on the rise.

Want to know salaries at architecture firms in your area? Get an exclusive look with the new AIA Compensation Report 2017!

Learn more at [aia.org/compensation](http://aia.org/compensation)

# High Quality Residential Ceiling MINI Diffusers



Model: **TT**



Model: **TX**

Sizes: 4", 6", 8"

- Low Diffusion Air Patterns
- Heavy Gauge Aluminum Body
- Vertical & Horizontal Throw (TX)
- Low Silhouette, Unobtrusive Profile



● Easy Operation!

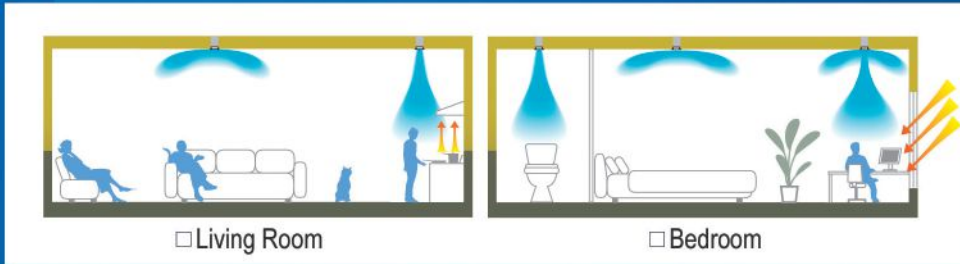

□ Living Room

□ Bedroom

● Custom Colors Available



## SpotDiffuser with Condensation Control Air Guide



Model: **PK-K**



- Restaurant Kitchens
- Food Processing Facilities
- Humidity Controlled Facilities
- High Heat Precision Manufacturing Plants
- Health and Fitness Centers

— Dual Air Flow design also helps to reduce condensation on Air Guide

— Made of low thermal conductance material (ABS Resin)

— Air envelope that is created by the air guide covers the cold surface of the diffuser and reduces condensation build-up



“We really had high hopes that we could make the building work without AC. We thought we had a good chance because the original bottling plant was designed for natural ventilation.”

The KieranTimberlake office is in a renovated mid-20th-century industrial building in Northern Liberties, an old neighborhood of central Philadelphia. Two stories tall, the building originally housed a bottling plant for a brewery, and the upper floor—now the studio—is a vast open space lit by strip windows and a roof monitor. When I first saw it in January 2015, the firm had just moved in. At the time, Stephen Kieran, FAIA, referred to the new office as “our huge sandbox.” Some of the toys included mobile workstations, adaptable meeting rooms, and plenty of flex space. The most radical innovation, in the service of energy conservation and green design, was the cooling system. Instead of air-conditioning, there was a combination of passive and active techniques: heavy insulation, automated sunshades, operable windows, natural and mechanically assisted ventilation, and dehumidification.

Because it was winter when I visited, it was impossible to know how well it would all work. “This is a daring experiment in Philadelphia, where summers are hot and humid,” I wrote at the time (see “KieranTimberlake’s New Sandbox,” May 2015, page 133). Three cooling seasons later it’s time to ask: How did the experiment fare?

Air-conditioning has been a part of American life since 1902, when Willis Haviland Carrier, a recent Cornell engineering grad working for a firm in Buffalo, N.Y., invented a mechanical dehumidification and air purification system for a Brooklyn printing company. Interestingly, what drove his invention was not the workers’ comfort but the integrity of the industrial process—high humidity was causing the printing company’s paper to swell. In fact, almost all of the early air-conditioning installations were for bakeries, candy factories, textile mills, and cigar and cigarette plants, all processes that benefit from humidity control. Air-conditioning for human comfort soon followed. As early as 1903, Alfred Wolff, who had earlier installed an ice-based ventilation system in New York City’s Carnegie Hall, used ammonia-absorption machines to dehumidify the trading floor of George B. Post’s newly constructed New York Stock Exchange building. Other early installations included movie theaters. In 1928, an air-conditioning system—designed by Willis Carrier—was installed for the first time in a high-rise office building.

In a typical office building, lighting, heating, and cooling represent as much as three-quarters of total energy consumption (depending on the local climate), so eliminating air-conditioning has potentially massive ramifications. The KieranTimberlake (KT) office was clearly prepared for the trial run. During the building renovation, which took two years, several hundred thermal sensors were embedded in the fabric of the

## What is your thermal sensation?



Much too hot

Too hot

Warm but comfortable

Comfortable

Cool but comfortable

Too cold

Much too cold

A screenshot of KT’s Roast app

building to enable the monitoring of temperatures, both on the surface and within the floors, walls, and roof. Dissatisfied with available off-the-shelf technology, the firm developed its own miniature wireless sensors and produced them in-house. (The sensors are now part of a KT product called Pointelist, a wireless network that monitors the thermal performance of workplaces; kits are currently being beta-tested.)

Measuring temperature and humidity is only half of the thermal comfort equation; the other half is finding out how people actually feel. To that end, the 120 KT staff were sent an online survey three times a day from April to October 2015. The questionnaire asked people to rate their current condition (“much too cold,” “warm but comfortable,” “too hot,” and so on), describe what they were wearing, and indicate where they were physically located in the building. Instant feedback was provided so that individuals knew where they stood compared to the entire office. (The survey has resulted in another product, called Roast, a cloud-based app that provides building managers with a way to ascertain occupants’ comfort levels.)

There was space on the questionnaire for comments, which produced some lively feedback ranging from the

# FALL IN LOVE WITH GLASS AGAIN

Guardian UltraClear® low-iron glass



UltraClear glass enhances your vision and creates spaces full of light and life.

Watch the story unfold at [UltraClearYourMind.com](http://UltraClearYourMind.com)



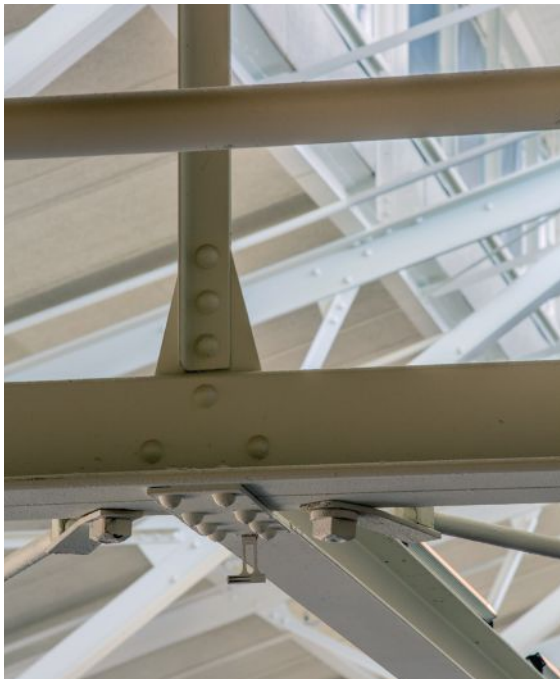
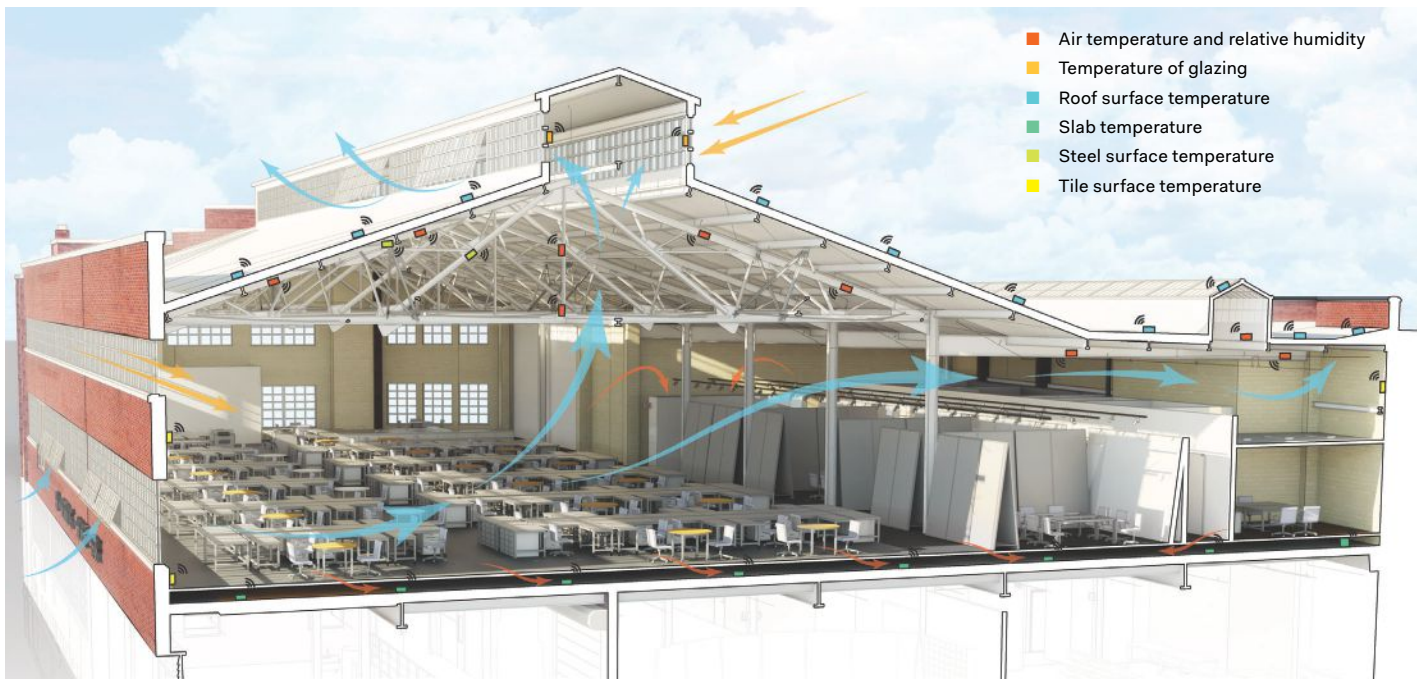

cheerful “I’m wearing my fanciest Hawaiian shirt today in honor of the warm weather,” to the slightly cranky “Ask not what the temperature survey can do for you; ask what you can do for your temperature survey.” As spring turned to summer and outdoor temperatures rose, however, the tenor of the remarks changed: “Large fan to the left of me, small desk fan to the right of me, sweat on the back of me,” and the succinct “I am physically melting.” The atmosphere in the studio was graphically described by this plaintive comment: “It’s like being in the Amazon rainforest but with phone noises in place of animal sounds.”

#### An Experiment Gone Awry

What was going wrong? The cooling system was designed to draw cooler night air into the building, dehumidify it, and then circulate it through a plenum beneath the raised floor of the studio. It wasn’t working. The concrete floor slab beneath the plenum was intended to remain cool, so that in the daytime cooled air could be supplied via individually controlled floor registers, but it turned out that the thermal transfer between the air and the concrete

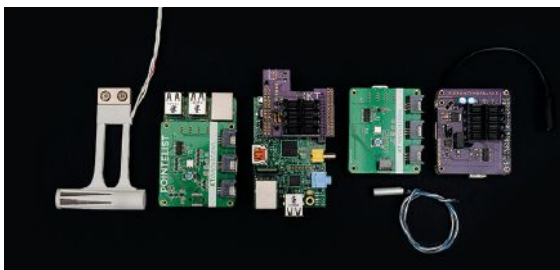

*Top:* A wide range of sensors track the KT office’s temperature

*Middle:* A close up of a sensor

*Bottom:* An early version of KT’s Pointelist network



# NEOREST®

## THE FUTURE OF THE BATHROOM IS NOW.

**Introducing the NEOREST AC –**  
The most intelligent toilet you've ever owned.



# TOTO®

TOTOUSA.COM | 800-350-TOTO

was less effective than anticipated. In addition, the overnight period wasn't long enough for there to be adequate dehumidification. The firm tried a different strategy: "flushing out" the studio space directly. At the end of the workday, warm air was evacuated via the overhead monitor, and cool night air was brought in through open windows. The windows were closed in the morning, keeping the cool air inside. This worked better, but as the summer nights became warmer, flushing was less effective and indoor temperatures increased yet again. The number of "much too hot" survey ratings increased, too.

At the time, the firm was working on a major project, the new American embassy in London. "We had a meeting scheduled with representatives of the State Department," Kieran says. "The outside temperature was 97 degrees, so we suggested that they wear shorts, which they did. We managed to bring down the interior temperature a couple of degrees, but it was still pretty hot." The image of visiting diplomats in short pants calls to mind a scene from a P.G. Wodehouse novel.

Various measures were taken to mitigate the heat. Large floor fans were placed in the studio and individual desk fans were distributed to the staff. The dress code was loosened to encourage lighter clothing. Flex work times allowed employees to come in early when the building was cooler. On selected days, water ice—a South Philadelphia summer staple—was distributed free. For a significant number of people, however, it was not enough. The survey responses showed that while some tolerated the heat, others felt uncomfortably warm even at relatively low temperatures. "Human beings turn out to have varying responses to heat and cold," Kieran says. "We're all really different. That's the problem with averaging out."

#### **The Advent of the Cool Room**

"Averaging out" originated in the 1960s when the American Society of Heating, Refrigerating, and Air-Conditioning Engineers (ASHRAE) established thermal guidelines for air-conditioned office interiors. The guidelines were based on what 80 percent of occupants felt was comfortable; the prototypical subject was a 154-pound man in a business suit—think *Mad Men's* Don Draper. These guidelines, with periodic modifications, have lasted more than five decades, but in 2015 a pair of Dutch researchers published a paper on the gender aspects of office comfort that called the ASHRAE premise into question. The researchers tested the metabolic rate for women engaged in office work and found that the rate was lower than the industry

standard, and that women consequently tended to find conventional cooling temperatures uncomfortably low.

Forty percent of the KT staff is female, and I asked Roderick Bates, a member of the in-house research group, if his survey supported the Dutch finding. He responded that the break point temperature at which 80 percent of the staff indicated that they still felt comfortable turned out to be 83 degrees—considerably warmer than the industry standard of 68 to 78 degrees—but there was no indication of gender differences. "What we've found so far is that women are much more likely to participate in the comfort survey but they don't differ greatly in comfort response for a given temperature relative to men," he wrote in an email. "I was expecting a significant difference and I wonder if it may be due to our more accommodating dress code that finds men and women wearing clothing of similar thermal values whereas in the past men wore outfits with a higher thermal value."

Even at 83 degrees, the 80 percent acceptance rate still left a couple of dozen people in the KT office feeling uncomfortable. To accommodate this sweaty group, an improvised air-conditioned workspace was created on the first floor and kept between 72 and 74 degrees. Some used the so-called Cool Room intermittently, while others moved in for the duration of the summer; according to the survey, about 20 people regularly worked there. Unexpectedly, despite their lower metabolic rates, women were disproportionately over-represented. The explanation? Gender is only one variable in how people experience thermal comfort—age, weight, and body type probably also matter, as well as cultural factors such as upbringing and where you grew up (KT staff members come from all parts of the country: from the hot South to the temperate Pacific Northwest).

At the end of that first summer, everyone felt a sense of relief. There were very few complaints during the ensuing heating season, even though the office was kept at a relatively cool 73 degrees. "There is no such thing as bad weather, only wrong clothes," goes an old Scandinavian saying, but of course it refers to cold weather. "Cold is much easier to deal with than heat," observed Bates. "Even though the winter inside/outside temperature differential is larger (40–50 degrees) compared to the summer (20–30 degrees), people deal with cold easily by simply adding a layer of clothing."

#### **The Human Problem**

Meanwhile, the partners at KT had to face a hard truth—their cooling experiment had failed. The solution was obvious: The following spring they

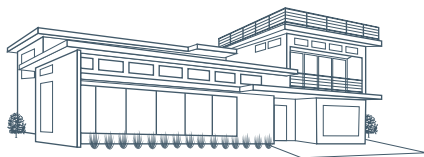

**BEAUTY SHOULD ENDURE WHEN THINGS GET UGLY.** Designing and building custom homes in challenging environments requires higher standards. Smarter glass, newer finishes, better engineering. Dramatic aesthetics with the structural integrity to withstand hurricanes. See the latest evolution at [weathershield.com](http://weathershield.com).

**WEATHER SHIELD®**  
WINDOWS & DOORS



A detail from KT's office, where one employee said of the summer without AC: "I am physically melting"



# CLEAR SOLUTION™

## GPX™ ARCHITECTURAL SERIES 60-90 MINUTE **ALUMINUM** FIRE DOORS WITH SUPERLITE™ II-XL

SINCE 1980



PROJECT: CSU Fullerton Recreation Center  
ARCHITECT: Langdon & Wilson  
GLAZIER: Woodbridge Glass  
PRODUCTS: SuperLite II-XL 90 (doors) &  
SuperLite II-XL 120 (wall) in GPX Architectural Series

GPX Architectural Series is code-approved for all jurisdictions with flexible hardware options and multiple finishes.



*Not all 60-90 minute glazed doors meet code and design requirements.*

Visit [www.safti.com/dooralert](http://www.safti.com/dooralert) to learn more and avoid costly mistakes.

www.safti.com  
888.653.3333



March 18–23, 2018

Frankfurt, Germany

## light+building

The world's leading trade show for  
lighting and building services technology

### Attractive and successful: Design embraces technology

Ensure tomorrow's success with the latest illumination designs. Discover a wealth of inspiration in the world's largest lighting showroom.

Design and technology blend on a floor area of around 150,000 m<sup>2</sup> – get ready! Inspiring tomorrow.

[www.light-building.com](http://www.light-building.com)  
info@usa.messefrankfurt.com  
Tel. +1 770 984 80 16

installed a cooling tower and air-conditioned the second floor. The ducted ventilation system had been designed to accommodate air-conditioning, and the raised floor in the studio meant that air could be circulated without any modifications to the workspace itself. "What swayed us to make the decision was the data we compiled, especially the thousands of staff surveys," Kieran says. "There were simply too many people who were not at all comfortable during too many hours of the summer. Some health issues arose. The heat generated by people and equipment, especially the computers, proved more difficult to overcome than we had anticipated." (A human body gives off about as much heat as a 100-watt lightbulb; an average desktop computer can give off 75 watts, while a large monitor can add up to 500 watts.)

Air-conditioning commenced in July 2016. The survey responses reflected a generally upbeat reaction. "So pleasant in here. I don't even need my usual vat of iced tea this morning," "The best thing about cooling is that there is no fan noise," and "A girl has no sweat." Some people missed the open windows, and there were still a few outliers who felt uncomfortably warm, but on the whole the studio was a happier place.

Kieran says that the decision to resort to air-conditioning was not an easy one. "We really had high hopes that we could make the building work without air-conditioning. We thought we had a good chance because the original bottling plant was designed for natural ventilation with operable windows and venting through the ridge dormer," he said. "We tried, we failed, and we learned."

What they learned is how to operate a dual-mode cooling system. As long as outside nighttime temperatures are below 67 degrees, the interior can be flushed out and cool nighttime air circulated through the plenum, enabling the building to function entirely with natural ventilation. Warmer weather requires air-conditioning, although the set point is 81 degrees, well above the industry standard. This temperature represents what 80 percent of the staff reported as "comfortable," and a permanent Cool Room continues to offer an option for those who fall outside the norm. The rest of the first floor, which houses the workshop and offices, is not air-conditioned. "It's generally 4 to 5 degrees warmer than upstairs," Bates wrote me. "This last summer, large floor fans were deployed and comfort requirements were met for the most part. If things got too warm, people typically went upstairs to work for a stretch."

I asked Bates how effective the dual-mode system has been in reducing energy usage. "We're in the process of creating a model to allow just such a

We're for the visionaries.®



My Vision:  
Create a home  
*both separate from*  
& intertwined with nature.

— Greg Wiedemann, AIA  
Wiedemann Architects, LLC

© 2017 Kolbe & Kolbe Millwork Co., Inc.



© Anice Hoachlander

This award-winning residence is perched on a limestone cliff overlooking the sweep of the Potomac River. Kolbe's VistaLuxe® Collection provided unmatched clean lines and large expanses of glass to savor nature in every season, blurring the line between inside and outside. Find your vision at [KolbeWindows.com](http://KolbeWindows.com).

**KOLBE**  
WINDOWS & DOORS



Lucy™ Tile ©modularArts, Inc. Patent Pending



Peale™ Panel ©modularArts, Inc.

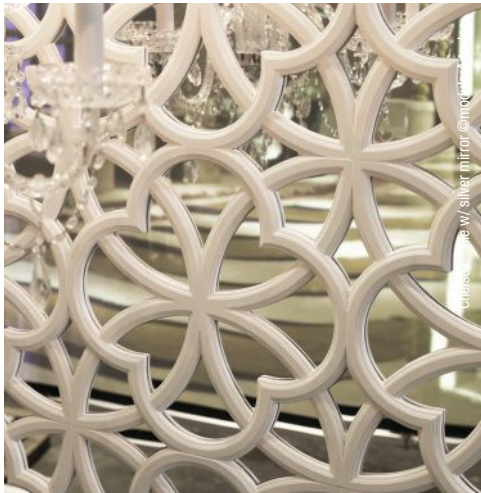

Orbis™ Panel ©modularArts, Inc.

**modulararts**

modularArts® new EZ-Seam™ panels and tiles include mirror inserts that cover the mount points. No filling and sanding! Walls come alive, reflecting light and movement. Paint the gypsum surface any color or leave natural white. Inserts are available in silver or gold mirror, as well as various woods.

[www.modularArts.com](http://www.modularArts.com)

calculation. However, we have projections based on our analysis of the comfort survey data that found that during the 2015 summer interior temperatures exceeded the comfort threshold for 80 percent of the staff for approximately 25 percent of the work hours,” he said. “From this we are assuming that we can meet the comfort needs with passive means 75 percent of

That is a key lesson of the KT experiment. The most challenging aspect of energy conservation may be not the technological devices but ourselves. Changing human behavior is never easy.

the time, running the AC only for the remaining 25 percent of the hours, which is a significant energy reduction.”

“The real question is whether we can un-adjust from air-conditioning,” Kieran says. That un-adjustment involves learning a variety of new habits: how to live with indoor temperature swings, changing clothing seasonally, and using natural ventilation—that is, opening windows. It sounds simple in theory, yet as Kieran observes, “Behavioral adaptation proved to be the most difficult part of our experiment.”

He explains that clothing and work-schedule changes were difficult to implement. Some of the staff were resistant to the idea of “dressing down”—shorts and T-shirts are not to everyone’s taste. Likewise, flexible work schedules that were adapted to temperature swings did not suit everyone. Once people experienced open windows, they complained when windows were closed after a nighttime flush-out. Others found street sounds distracting. The noise of fans was universally disliked. Nor was the idea of a Cool Room universally popular—some referred to it as the FEMA Room. For those who were accustomed to the ice-box-cool interiors of American offices and shopping malls, “warm but comfortable” felt like too much of a compromise.

That is a key lesson of the KT experiment. The most challenging aspect of energy conservation may be not the technological devices but ourselves. Changing human behavior is never easy, whether it involves consuming less, driving less, living smaller and leaner, or working in an office that’s not quite as cool.



CONTEMPORARY CLAD | A MATTER OF STILE



FOLD | SLIDE | SWING

[LaCANTINADOORS.COM](http://LaCANTINADOORS.COM)



OPEN SPACES®



**IT'S NOT A TREND. IT'S A REVOLUTION.**

Visit [ZIPRevolution.com](http://ZIPRevolution.com) to learn how easy it is to make the switch.

**ZIPsystem™**  
SHEATHING & TAPE

© 2017 Huber Engineered Woods LLC. ZIP System, the accompanying ZIP System logo and design are trademarks of Huber Engineered Woods LLC. Huber Engineered Woods' ZIP System® products are covered by various patents. Please see [ZIPSystem.com/Patents](http://ZIPSystem.com/Patents) for details. HUB 17804-2 10/17

Visit us at IBS 2018  
**BOOTH**  
**#W2883**

“It’s for the buyer who says, ‘Okay, maybe I don’t need a separate soaking tub in my bathroom, and I can live without a walk-in closet.’”

At the end of my recent conversation about the luxury condo market with David Von Spreckelsen, who founded Toll Brothers City Living (TBCL) nearly 15 years ago, he pitched me the company’s newest development, 91 Leonard, in New York City’s Tribeca neighborhood. Designed by Skidmore, Owings & Merrill, the building’s units start at \$795,000 for a studio, include one-bedrooms for \$1.3 million, and feature three- and four-bedroom penthouse units for \$8 million to \$10 million. “Much of Tribeca is filled with big, expensive lofts,” Von Spreckelsen said. “We’re bringing much more affordability to Tribeca.”

It’s the sort of statement only a luxury condo developer could make. Affordability in the \$1 million-plus price range? But it’s also the sort of statement one *doesn’t* expect a luxury developer to make. After all, luxury connotes unaffordability and extravagance. Moderation would seem like the wrong note to strike when marketing a multimillion-dollar condo replete with high-end finishes and appliances, and the full

complement of amenities—pools, weight rooms, movie screening rooms, and lavish rooftop decks.

But as the upper echelons of housing markets in cities across the country continue to soften, Von Spreckelsen’s pitch reflects a growing trend among luxury condo developers. They are both talking up and building more condos priced between \$1 million and \$3 million, a segment the industry increasingly calls “affordable luxury.” Jonathan Miller, president and CEO of the real estate appraisal firm Miller Samuel, identifies luxury condos priced at \$3 million and under as “the sweet spot of new development.” According to housing data that Miller Samuel collects for real estate company Douglas Elliman, this segment accounted for 38 percent of sales in New York City’s luxury housing market over the past year.

When Manhattan’s housing market peaked in 2014, sales were particularly robust for condos selling for \$10 million and higher, a segment the industry calls “superluxury.” Since then, the superluxury market



91 Leonard

Floor Plan for a 3,080-Square-Foot Penthouse



Floor Plan for a 1,453-Square-Foot Two-Bedroom



Floor Plan for a 478-Square-Foot Studio

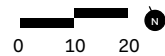

# CONTEMPORARY MADE EASY.



Create something truly one-of-a-kind.

Add a touch of modern to their home.

Andersen has the products and options to make their vision a reality.

View the collection at [andersenwindows.com](http://andersenwindows.com).



Recognized by J.D. Power for "Outstanding Customer Satisfaction with Windows and Patio Doors."\*

WINDOWS • DOORS  
**Andersen** 

\*Andersen received the second highest numerical score among 16 companies in the J.D. Power 2017 Windows & Patio Doors Satisfaction Study, based on 1,904 total responses, measuring the experiences and perceptions of customers who purchased windows and/or patio doors in the previous 12 months, surveyed February – March 2017. Your experiences may vary.

"Andersen" and all other marks where denoted are trademarks of Andersen Corporation. ©2017 Andersen Corporation. All rights reserved. MS1711\_1496

Percentage Change Year-Over-Year in Price per Square Foot for Manhattan Condos and Co-ops by Category

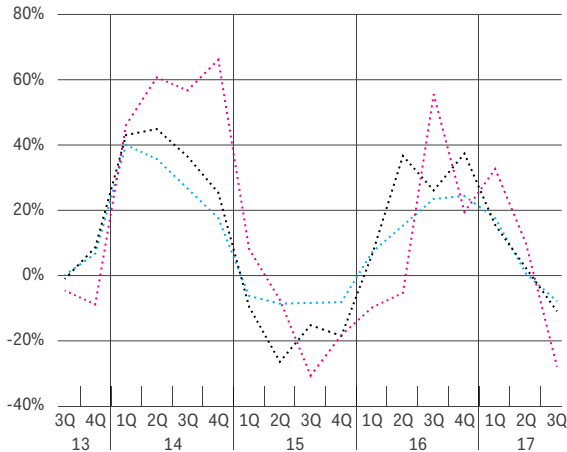

Price per Square Foot for Manhattan Condos and Co-ops by Category



Recent declines in the sales prices of trophy and luxury condos in Manhattan has inspired Toll Brothers and other developers to build more units that sell for less than \$2,000 a square foot.

has flattened. Penthouses priced at \$20 million, \$40 million, or \$60 million are more likely to sit on the market for months, maybe even a couple of years, and sell for less than their asking price. Of course, even a \$60 million condo that sells for \$45 million—25 percent under the asking price—is still likely to be the most expensive on the block. “Sellers are making bigger discounts and still helping the market set new records,” says Miller, who called this a defining paradox of today’s housing market.

Nonetheless, developers like Toll Brothers have begun to recalibrate. “There came a point a few years ago in Manhattan when it became almost impossible to buy [a condo] for less than \$2,000 a square foot. It even started stretching to \$2,500 and even \$3,000 in certain instances,” Von Spreckelsen said. “What happened next is that supply caught up with demand, and we started to run out of buyers who really had the wherewithal to pay these exorbitant prices.” Like other luxury developers, TBCL has started to offer occasional incentives to move its most expensive units, like paying buyers’ estate taxes, lawyers’ fees, and other closing costs.

But the company is also looking to build more condos that it can sell for less than \$2,000 a square foot, primarily by shrinking the footprints of units. Part of what a luxury condo buyer pays for is “a generosity of space,” Von Spreckelsen said, like large, five-piece bathrooms and walk-in closets. He imagines a buyer of less expensive luxury condos willing to forgo this kind of generosity. “It’s for the buyer who says, ‘Okay, maybe I don’t need a separate soaking tub in my bathroom, and I can live without a walk-in closet.’ ... If we can bring stuff to the market that’s below \$2 million, let’s say, when almost everything

is above \$2 million, we’re certainly looking for opportunities to do that.”

#### Branding for the Anxieties of Affluence

It turns out “affordable luxury” may be a particularly smart way to market expensive condos today. Rachel Sherman, a sociologist at the New School for Social Research in New York, explains in *Uneasy Street: The Anxieties of Affluence* (Princeton University Press, 2017), her study of wealthy New Yorkers, that many of today’s most affluent families are reluctant to display their wealth and instead value an ideal of moderate consumption. “Internal conflicts about their wealth cropped up especially in their feelings about their living space,” she writes. Some dislike using the word “penthouse” to describe their homes. Many prefer to think of themselves not as rich, Sherman writes, but as “symbolically belonging to the broad middle.”

“People want to be morally worthy, and moral worth in the U.S. is associated with middle-ness,” Sherman told me. It’s the idea that, she said, “we’re all hardworking Americans, who are being reasonable consumers and giving back to society in some way, and raising our kids not to be snobby and entitled.” She said a term like “affordable luxury” could be a successful way to brand expensive homes because it sounds “a little bit modest, relative to what you could have and relative to what people you might think of as more ostentatious would have.”

Sherman also noted the important difference between what someone buys and how they talk about it. Many families in her study framed their purchases as more moderate, as “one step down,” she said; Sherman recalled a woman who reported that she only bought clothes from “the cheap floor at Barneys”—the sales



We protect and beautify the world™

# Monumental protection from proven partners



Via 57 West • New York, NY • Duranar Sunstorm Coatings

## The PPG CERTIFIED APPLICATOR PROGRAM<sup>SM</sup> + DURANAR<sup>®</sup> Fluoropolymer Coatings

For fifty years, architects have trusted *Duranar* fluoropolymer coatings, expertly applied by members of the *PPG Certified Applicator Program* (CAP), to protect and beautify aluminum building components on landmark building projects.

*Duranar* coatings have been trusted to provide exceptional performance for extruded storefronts, curtainwalls, windows and louvers, offering high resistance to chalking, chipping, peeling and fading, and protection against chemical staining and environmental stresses.

PPG can connect you with an elite certified applicator trained and audited to deliver the world-class customer service, industry-leading technical expertise and the accelerated product delivery your project demands.

To learn more, visit [ppgideascapescapes.com](http://ppgideascapescapes.com) or call **1-800-258-6398**.



## PPG CAP MEMBERS

### Architectural Window

Rutherford, NJ • (201) 939-2200  
[architecturalwindow.com](http://architecturalwindow.com)

### Astro Shapes

Struthers, OH • (330) 755-1414  
[astroshapes.com](http://astroshapes.com)

### Bonnell Aluminum

Cathage, TN • (615) 683-8291  
[bonnalum.com](http://bonnalum.com)

### Durapaint Industries, Ltd.

Scarborough, ON • (416) 754-3664  
[durapaint.net](http://durapaint.net)

### Kawneer, an Arconic Company

Bloomsburg, PA • (570) 784-8000  
Cranberry Twp., PA • (724) 776-7000  
Lethbridge, AB • (403) 320-7755  
Springdale, AR • (479) 756-2740  
Visalia, CA • (559) 651-4000  
[kawneer.com](http://kawneer.com)

### Keymark Corporation

Fonda, NY • (518) 853-3421  
Lakeland, FL • (863) 858-5500  
[keymarkcorp.com](http://keymarkcorp.com)

### Sapa Extrusions Americas

Gainesville, GA • (770) 355-1560  
Mississauga, ON • (905) 890-8821  
Pointe Claire, QC • (514) 697-5120  
Portland, OR • (503) 285-0404  
[sapagroup.com](http://sapagroup.com)

### Spectrum Metal Finishing, Inc.

Youngstown, OH • (330) 758-8358  
[spectrummetal.com](http://spectrummetal.com)

### Trojan Architectural Coaters

Pompano Beach, FL • (954) 366-5319  
[trojanpowder.com](http://trojanpowder.com)

### Tecnoglass S.A.

Barranquilla, Colombia • 57-5-373-4000  
[tecnoglass.com](http://tecnoglass.com)

### Windsor Metal Finishing, Inc.

Kissimmee, FL • (407) 932-0008  
[1stchoicewindsor.com](http://1stchoicewindsor.com)

### YKK AP America Inc.

Austell, GA • (678) 838-6000  
[ykkap.com](http://ykkap.com)



*Top Left and Above:* The Sutton, which includes subsidized "middle-income" units

*Right:* 121 East 22nd, designed by OMA for TBCL



rack. For Toll Brothers, highlighting the affordability of a \$1 million condo is a similar performance of moderation; that is, it's a new brand rather than a new product. Von Spreckelsen acknowledged as much, too. "It's a little tweaking," he said of these smaller units. "We're not talking about doing something radically different." It's the difference, say, between a large bathroom with both a tub and a shower and a smaller bathroom with only the latter.

Toll Brothers has made a practice of stretching its brand to accommodate its customers' shifting tastes. About 15 years ago, Robert Toll, who has been mainly dedicated to building luxury single-family homes since he founded his company in 1967 with his brother Bruce, hired Von Spreckelsen to expand into urban centers, starting with Philadelphia and then New York City and New Jersey. "Bob saw his relatively affluent clientele selling their suburban homes and moving back to cities, so he followed his customers," Von Spreckelsen recalled, noting that TBCL is looking to break into Boston, Miami, and Los Angeles, among other markets. Building more lower-tier luxury units is another instance of the company following its customers' preferences and values. Ostentation is out; relative moderation is in.

Affordability, especially in the context of housing, hasn't always been regarded as a virtue, of course. When I spoke to Miller, he recalled hearing the phrase "affordable luxury" half a dozen years ago at a conference among developers and real estate brokers. "The audience was aghast," he said. Though he, and likely many others, correctly understood the phrase to mean "the entry level of luxury," as he calls it, he said it



# Opening Glass Walls that Completely Disappear



Tiburon Hills Residence, Tiburon CA • Architect: David Kotzebue Architecture • NanaWall Single Track HSW60 with open corner

## NanaWall Single Track Systems

Design around structural obstacles with the flexibility to park panels anywhere.

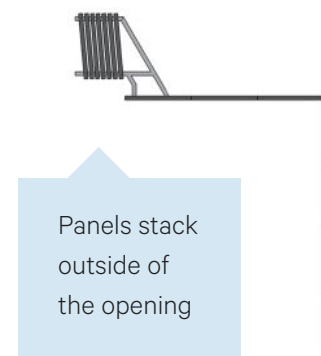

 Collaborate with our Design Team on your plans.

All the same performance qualities as NanaWall Folding Systems:



Wind & Water  
Resistant



Energy  
Efficient



Highly  
Secure



Easy Operation  
& Durable

Showrooms Nationwide

Visit [NanaWall.com](http://NanaWall.com)

800 873 5673

**NanaWall**<sup>®</sup>  
Engineering the Exceptional

Give your best ideas  
**the finishing touch**  
they deserve

## DUROPAL Gives You the Design Edge

When your designs stand out, so does your firm. With **DUROPAL**, a new line of HPL laminates from I 3 Surfaces, art and science come together to give you virtually unlimited design possibilities. These highly durable and unique finishes are engineered to help you create a competitive edge for your firm with designs that don't just meet expectations, but exceed them.

**DUROPAL's** 300 decorative laminate collection and 14 different finishes available, provides unlimited color and texture combinations to customize your designs.

**DUROPAL** microPLUS® antibacterial laminates delivers easy-to-clean, hygienic surfaces where you need them most.

**DUROPAL** XTREME MATT® is ideal for high usage solutions with its fingerprint-proof surfaces.



**DUROPAL** helps you realize  
your best design concepts  
and inspire new ones.



Request a  
Free Sample



View Creative  
Solutions



Request an  
in Person  
Consultation

To get free **DUROPAL** samples and downloads,  
visit [www.I3Surfaces.com](http://www.I3Surfaces.com) or call 888-975-7483.

**I 3 Surfaces**®

AUTHORIZED IMPORTER/DISTRIBUTOR FOR: **PFLEIDERER**

also sounded offensive, “a little too condescending to the general populous.” The phrase “affordable housing” once meant government-subsidized housing, with all of its associated stigmas. These days, however, as more people living in cities struggle to find housing they can afford, the connotations of the phrase have changed. “Today it means middle-class,” Miller said.

To the extent that condos branded as affordable luxury reflect wealthy customers’ anxieties, then, they also reflect the general public’s need for more affordable homes. Which is where such branding becomes problematic. Terms like “affordable luxury” and “superluxury” distort a sense of what’s reasonable. “These homes start to sound cheap when in fact they are still really expensive,” Sherman said. In 2016, New York City’s median income was \$58,856; according to calculations by Harvard University’s Joint Center for Housing Studies, an affordable home for a median-income household would be \$380,000.

But a shifting understanding of what constitutes “affordability” is only part of the problem. Does the simple fact of building more housing, even luxury housing, help alleviate the housing crisis in our most expensive cities?

#### The Shortcomings of Filtering

In an influential 2014 paper published in the *American Economic Review*, economist and Syracuse professor Stuart Rosenthal examined the process of filtering, by which yesteryears’ high-end homes become today’s lower- and middle-income homes. As wealthy people trade in their older expensive homes for new expensive homes, the theory goes, the older ones filter to less affluent residents. Filtering is the process by which the market, rather than government subsidies, provides renters and buyers with less expensive housing.

For years, Rosenthal wrote, economists simply assumed—without studying the phenomenon—that this filtering process happened. Examining housing data from 1985 to 2011, Rosenthal confirmed that filtering does indeed occur, and that it can be a reliable source of lower-income housing. But that discovery came with an important caveat. “Filtering is less pronounced in areas subject to high rates of house price appreciation,” he wrote. In other words, in the most heated housing markets—the markets that today are seeing the greatest numbers of new luxury condos—filtering is less reliable as a means of generating lower-income housing.



IC/Air3

: designed by Guto Indio da Costa  
modernfan.com



Ultra-efficient DC Motor | 2 or 3 Blades | Nickel, White or Dark Bronze Finish | Solid Color, Surface-printed Wood Grain or Clear Blades | Optional LED Lighting

Jonathan Spader, a senior research associate at the Joint Center for Housing Studies, explains why. “At the same time that units might be filtering down, there are pressures between regions,” he said, referring to the impact of people moving to a city for new jobs. Particularly in high-demand places like New York, new expensive condos coming online may only decrease prices slightly, if at all, before newly arrived groups of affluent professionals move in. Units that, in theory, could filter to lower-income residents often don’t because someone with greater resources takes them.

Spader said it’s difficult to measure these regional pressures. There’s also evidence that filtering may only slow the growth of rental and sale prices and not decrease them. For these reasons, he says, cities will only solve—or at least lessen—their affordability crises by building new market-rate housing and by using government programs like vouchers, inclusionary zoning, and public housing. “You have to do both,” Spader said. “Adding new units has to be part of the response, but adding new market-rate units at the

high-end, particularly in high pressure cities, may not alleviate pressures further down.”

Oddly enough, another Toll Brothers development illustrates the complexities of building truly affordable housing. The Sutton, on the Upper East Side, takes advantage of a controversial inclusionary zoning program in the city, 421a. Toll Brothers built 23 subsidized “middle-income” apartments, priced between \$330,000 to \$450,000, in exchange for a 14-year tax abatement on its 108 market-rate units, priced between \$1 million and \$8 million. Many housing advocates and experts have criticized the 421a program for waiving too much tax money: The city’s Independent Budget Office estimates that, over the next decade, 421a will cost New York \$8.4 billion in property taxes. All for a program that critics contend will only make a tiny dent in the housing crisis. Indeed, Toll Brothers received 1,243 applications for its 23 subsidized units. Creating an affordable luxury brand is easy. Building, and maintaining, actual affordable housing is not.

**MOCKETT**  
DUDD MOCKETT & COMPANY, INC.

***We can make anything!***

**From Your Concept to Completion**

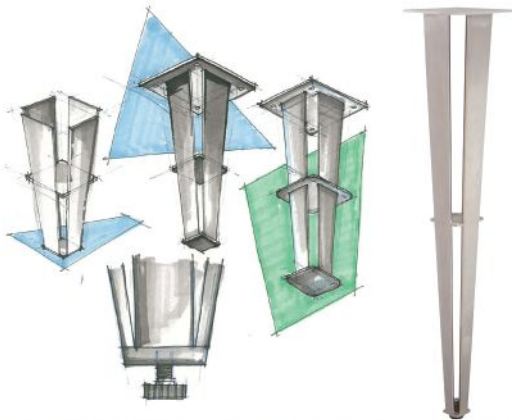

Your custom designs, sizes, finishes, or configurations.  
Fast, easy, economical.

Fine  
Architectural  
Hardware  
is Your  
Fine  
Furniture™

Plus, shop our 4,000+ in-stock parts. Same Day Shipping.  
Call or email for a quote 800-523-1269 or custom@mockett.com

**A**

# The Podcast

> [bit.ly/ArchitectChats](http://bit.ly/ArchitectChats)

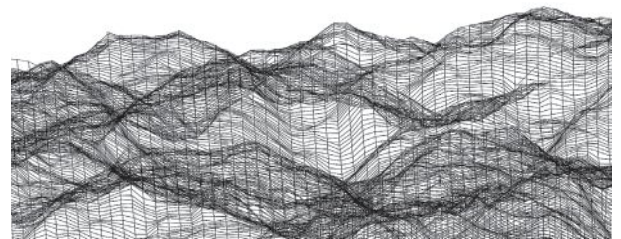

Now available on





# A BETTER SUSTAINABLE PRODUCT SEARCH

Insert credible green product information directly into  
your BIM project with the SPOT add-in for Revit®

Free download available at [ul.com/ArchitectMag](http://ul.com/ArchitectMag)

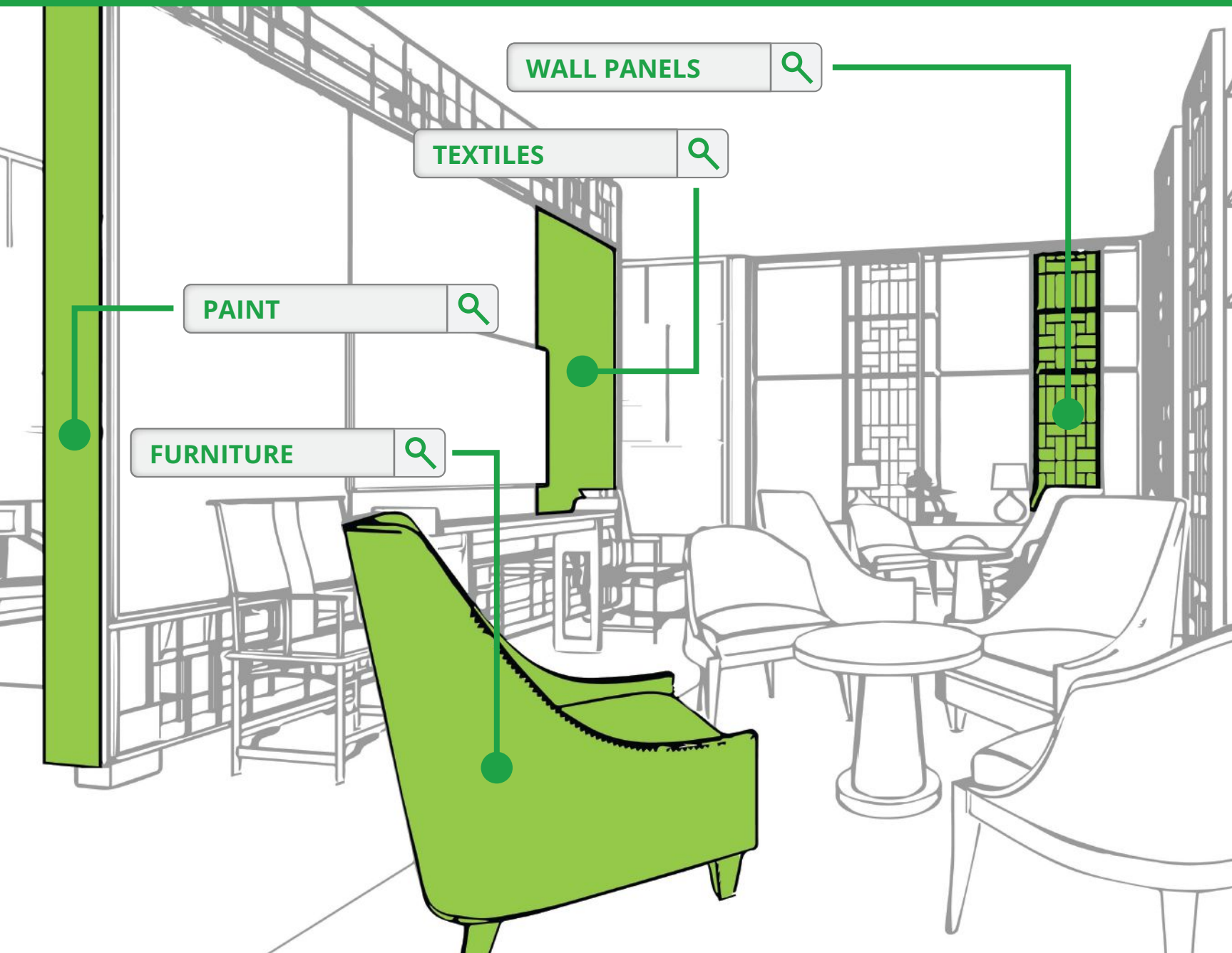

# RESIDENTIAL ARCHITECT DESIGN AWARDS

TEXT BY KATIE GERFEN AND EDWARD KEEGAN, AIA

The devil may be in the details, but careful attention to how materials meet and compositions come together is often what distinguishes an exceptional residential design from a merely good one. This year's jury—San Francisco-based David Baker, FAIA, New York-based Katherine Chia, AIA, and Chicago-based R. Michael Graham—selected 18 winners across every possible residential typology. Despite the winning projects' many differences, the thread that connects them all is this incredibly high level of, and attention to, craft.

## Judges

**David Baker**, FAIA, David Baker Architects

**Katherine Chia**, AIA, Desai Chia Architecture

**R. Michael Graham**, Liederbach and Graham Architects



The Bear Stand

**Custom House More Than 3,000 Square Feet** **AWARD** **The Bear Stand** is a 3,245-square-foot single-family residence located about 130 miles northeast of Toronto in **Gooderham, Ontario**. The design team at **Bohlin Cywinski Jackson in association with Bohlin Grauman Miller** was tasked with creating a family retreat for a couple that spends their professional life in Shanghai that could double as a vacation rental when they are away.

The extensively glazed two-story house is laid out east to west, parallel to the shoreline of Contau Lake. Primary public spaces are on the first floor, with a double-height living room anchored by a locally sourced granite fireplace that's shared with a screened porch. While a family room overlooks the living room, most of the second floor is dedicated to sleeping areas. The master suite encompasses a private wing to the south, with a bath outfitted with soaking tubs that opens out to the 100-acre woodland site.

The cabin aesthetic features a variety of wood: Exposed Douglas fir glulam beams and decking complement stained cedar siding, and wire brushed walnut floors. Black fiber-cement board panels and board-formed concrete walls supplement the varied woods, adding tactile variety within a constrained palette of carefully detailed finishes. "The whole house is really elegantly done, and the design makes it look effortless," David Baker said. "I just want to hang out there." —E.K.









**Outbuilding** There's a farm in [Norwich, Vt.](#), about an hour's drive southeast of Montpelier, that has a chicken coop with a handcrafted screen of site-harvested maple saplings over translucent fiberglass walls—not to mention a rolling pig pen that looks like it could take flight, a shingle-clad sauna on wheels, and a sugar shack whose evaporator is fueled by the split firewood that is stacked within wood frames to thermally insulate its walls. These are just some of the [Seven Rural Interventions](#) that have resulted from [Studio North](#), a six-day-long intensive design/build workshop run by Keith Moskow, FAIA, and Robert Linn, AIA, of Boston-based [Moskow Linn Architects](#).

**CITATION**

Each summer, seven to 10 students come together to create a new outbuilding on the farm using the same kit of parts: wood framing members, galvanized metal fasteners, translucent fiberglass, and site-harvested timbers. Each structure has its own program, and its own set of requirements, and many are made to be mobile to allow for easy relocation on the property.

What intrigued the jury was not only the design of the structures, but the importance of imparting an understanding of craft. "I think there's real whimsy to them, and I think there's real pedagogical value to having people make things," R. Michael Graham said. And as a bonus, "some of the individual pieces are quite nice." —K.G.



A striking dual-towered addition to a single-family residence in [San Marcos, Texas](#), provides a new entry sequence, exhibition gallery, and painting studio for a retired professor of fiber arts and interior design at Texas State University. Local firm [A.Gruppo Architects](#) designed the new 2,100-square-foot expansion of the [Laman Residence](#), and renovated the existing 1,800-square-foot house, a modest 1970s ranch.

The gambrel-roofed towers of the addition are clad in translucent polycarbonate that supplies filtered daylight, which is supplemented by skylights with adjustable ceiling baffles essential to the illumination of the client's art. Metal roofing extends to the ground on the sides of two towers, with white stucco on the entry

façade to contrast the polycarbonate on the opposite end. The monolithic stucco walls nod to the original house's exterior, and offer privacy from the street.

Inside, the entry hall supports a second-floor library that overlooks a double-height studio and gallery. Bookcases cantilever into the taller sculptural volumes, connecting each of the new spaces in an interplay of space and light. Renovations to the existing structure include a master suite that extends into a private garden, and a sculpture garden between the new gallery and master bedroom. The complex is a study in contrasts—new and old, public and private, open and closed, which form a composition that David Baker called “quirky, but controlled.” —E.K.

**Renovation**  
CITATION



Bar House



**Custom House More Than 3,000 Square Feet**  
**HONORABLE MENTION**

The 8,500-square-foot [Bar House](#) by [Audrey Matlock Architect](#) sits at the high point of a 13-acre site in [Sag Harbor, N.Y.](#) Its L-shaped composition encloses a south-facing courtyard with a pool at the center of its manicured gardens.

The primary living spaces—entry, kitchen, dining, and living (as well as two guest rooms)—are located in a single-story volume that runs along the north edge of the property. The flanking leg of the L houses the family’s private spaces, and floats above an outdoor living area. V-shaped columns that support the bedroom wing nod to the numerous trees that dot the site’s dual landscapes—natural forms and native vegetation to the north, and more formal layouts of trees and grasses to the south.

The house is clad predominantly in glass, but zinc panels along the north edge provide interior walls to showcase the owner’s contemporary art collection. The open-plan living areas open into the courtyard, providing continuity between interior and exterior. In the bedroom wing, metal sunshades protect east- and west-facing glazing from the sun, with deep overhangs along the south elevations. It was the order of the scheme that caught the eye of the jury: “It’s incredibly well detailed, and I particularly like the simplicity of the section,” R. Michael Graham said. —E.K.

A steeply sloped [Austin, Texas](#), infill site—complete with an existing 25-foot-tall rare oak tree—is not the easiest place to build a single-family home, but easy has never been a prerequisite for local firm [Alterstudio Architecture](#). For the 2,990-square-foot [South 5th Residence](#), the team created a sculptural blind façade, tucked behind a delicate 4-inch-wide gabion wall at the street, that gives way to a glazed, light-filled three-story interior that prioritizes views.

To preserve the oak tree’s root system, regular foundations were not an option, so the designers created a scheme where the living area is perched on two piers that anchor the structure while avoiding the roots. The overall ensemble caught the interest of the jury, especially Katherine Chia, who noted that “the use of materials is really beautiful, and I think that the house is shaped by really clear composition. I thought it was really successful in section as well.”

In addition to the suspended living room, the main level contains a kitchen and dining area, as well as a media room and guest bedroom, with an additional two bedrooms upstairs (including a master suite with panoramic views to Lake Austin), and a family room, gym, and deck on the basement level. Large site-glazed window walls—framed in rift-sawn oak—and ventilator doors throughout draw daylight and breezes through the house, and contrast with concrete and mill-finished steel surfaces. —K.G.

**Custom House Less Than 3,000 Square Feet**  
**AWARD**





South 5th Residence

CASEY DUNN







**Affordable  
Housing**

AWARD

The five-story-tall apartment complex dubbed **The Six** is a stunning new presence near MacArthur Park in **Los Angeles**. Designed by local firm **Brooks + Scarpa**, the building provides 52 units of architecturally distinguished affordable housing for disabled veterans.

The 18,390-square-foot structure is configured as a courtyard plan, with apartments on floors two through five facing a shared, protected interior space. Public circulation is along single-loaded exterior walkways overlooking the courtyard, with a modified L-shaped plan on floors three and four and a full doughnut layout on the fifth floor. The varied plans allow for multistory cutouts in the building's volume on the east and south sides, which, combined with the roof opening, induce breezes through the central courtyard.

The public amenities are tailored to enhance the building's sense of community; encouraging residents to occupy shared interactive spaces rather than be reclusive in private apartments. "This project captures the spirit of community space incredibly well," Katherine Chia said. The first-floor reception area is adjacent to veterans support spaces, offices, bike storage, and covered parking. A community room on the second floor, adjacent to the courtyard, provides a light-filled indoor/outdoor gathering space, and protected exterior spaces are reprised in the rooftop garden. —E.K.

Local firm **HBRA Architects** drew on a wide range of historic precedents for its **Lincoln Park House** in **Chicago**. But while the designers invoke Louis Sullivan and Frank Lloyd Wright's Charnley-Persky House and H.H. Richardson's Glessner House, the result displays few explicit historic references. "It's trying to be modern and traditional at the same time—and pulling it off," R. Michael Graham said. The façades seem timeless, with stone inset panels and an asymmetrical array of windows set within an abstract masonry grid.

The primary living spaces in the 7,011-square-foot house are on the second floor, where they overlook a shared semi-private park built atop a parking deck that serves the house and its neighbors. The kitchen faces the street, while the dining and living room open to the park. Third-floor bedrooms are topped by a fourth-floor solarium that opens to two rooftop living spaces. The need to provide efficient—and immediate—vertical access to the piano nobile led the architects to design a skylit central stair that distributes daylight throughout.

The simple interior palette consists of light stone and wood floors with bright white walls and ceilings. While solving the constraints associated with the classic double-party-wall townhouse typology, the designers have drawn on a sophisticated use of space, including extensions into the exterior at the second and fourth levels, to create a home that seems more like a freestanding single-family residence. —E.K.

**Custom  
House  
More  
Than  
3,000  
Square  
Feet**

CITATION



STEVE HALL/HERDRICH BLESSING



17856



**Renovation** [Montee Karp](#) is an extensive remodel of a house overlooking the Pacific Ocean in [Pacific Palisades, Calif.](#) Los Angeles-based [Patrick Tighe Architecture](#) reimaged the shallow gables of

**HONORABLE MENTION**

midcentury California design as a basis for a bold volumetric expression for the 21st century. Roof, walls, and floor are conceived as continuous planes that fold and unfold throughout the modest two-story, 2,200-square-foot structure on a steeply sloped site.

The opaque front façade, relieved solely by trapezoidal openings for the front door and a second-story office window, introduces the language of facets and folded surfaces. Inside, the design is driven by a double-height front-to-back gallery space that encompasses entry hall, art display, stair, and living areas within a single volume. It boasts views of Santa Monica Bay at the rear, with niches and open wall space that accommodate the owner's art collection.

Details are selectively deployed to enrich the experience: The 10-foot-tall entry door's height contrasts with the house's relatively modest size, but its custom 2-inch stainless steel tube frame—mounted on a hydraulic pivot with concealed magnetic locking device—establish notions of openness, geometry, and thoughtful invention upon one's arrival. "I thought this project was very inventive—they looked at the window placement, the finishes, the program, and rethought the whole thing," Katherine Chia said. —E.K.



**Custom  
House Less  
Than 3,000  
Square Feet**  
CITATION

Tucked away on a hilly site in the Westside neighborhood of [Kansas City, Mo.](#), is the blink-and-you'll-miss-it [Shelton Marshall Residence](#). But don't blink: This 2,500-square-foot house, designed by [El Dorado](#) for one of the firm's principals, is worth seeing. What is visible from the street is a wood-clad detached studio and garage—the landscaped lot next to it is actually the house's approach and its vegetated roof, the main U-shaped house being tucked into the hillside.

A concrete stair leads down to a terraced courtyard, outfitted with planters and a fire pit, and to the main entry. The living, kitchen, and dining areas are all laid out in an open plan around the courtyard to maximize

the flexibility of the space. Three family bedrooms, as well as two full baths, round out the main level. On the other side of the living area, a large covered porch runs the length of the house, and cantilevers out 20 feet above another street below. "This design is not just playing within a set of expected rules," R. Michael Graham said. "It's really thoughtful design."

Despite being partly below grade, the house is filled with daylight: Floor-to-ceiling glazing wraps the central courtyard and fronts the porch, and sliding glass doors allow for cross-breezes in the temperate months. Whole-house radiant-floor heating, careful insulation, and a wood-burning stove keep the house warm during long winters. —K.G.



The [Alamo Square Residence](#) in [San Francisco](#) has a foot in two eras: due to local preservation rules established in the 1960s, the Victorian façade of the 4,138-square-foot townhouse had to be preserved. But inside, the clients wanted a contemporary living space. Enter local firm [Jensen Architects](#), which restored the 1889 front to its former glory—removing prior additions—and created a sleek interior, as well as a new rear façade composed of floor-to-ceiling glazing behind perforated aluminum screens.

The restoration project was complicated by a dearth of records detailing the original design. Relying on the few existing historic photos, however, as well as evidence uncovered during the careful demolition of the

later modifications, the team was able to reconstruct a faithful rendition.

But walk through the front door, and there is no confusion about the contemporary aesthetic. A materials palette of white walls, glass accents, and light-colored wide-plank wood floors is deployed throughout the open-plan living spaces, which are flooded with light from the glazing at the rear. Joining the house’s three floors and roof terrace is a monumental wood-clad staircase that adds a boisterous element to the otherwise muted space. “I really like the vitality that the stair adds to the composition,” R. Michael Graham said. “As a piece of sculpture in the middle, it really works.” —K.G.

**Restoration**  
CITATION





Waldo Duplex



7509A

7509B

**Affordable  
Housing  
CITATION**

The [Waldo Duplex](#) was designed and built by the fifth-year students of the [El Dorado](#)–led [Design+Make Studio](#) at [Kansas State University](#).

Located amid the single-family bungalows and shotgun houses of the Waldo neighborhood in [Kansas City, Mo.](#), the 1,500-square-foot structure provides two units of affordable housing. “They really studied local typologies and used that in thinking about street life and transitions into a home,” Katherine Chia said.

The simple gable-roofed structure is clad in corrugated metal siding and roofing—a nod to the tight budget as well as vernacular construction. Each two-bedroom unit is laid out for maximum efficiency, with services located between the units. While some partitions were necessary for privacy within each unit, the feeling of an open-plan space was achieved by topping those walls with translucent panels that maximize daylight in each room. The kitchen, dining, and living areas are at the front of the structure, and connect to front porches via large glass walls; these porches give an individual identity to each of the two units, and are sheltered by wood siding and slats.

The project was built for a total construction cost of \$290,000, which will permit affordable rents for two moderately low-income families who make less than 80 percent of area median income. —E.K.

[Victoria Hall](#) is a 198-room student housing tower, developed by a private development agency, in the rapidly rebranding [London](#) district of King’s Cross. Designed by local firm [Stanton Williams](#), the structure consists of two 12-story wings connected by an eight-story volume, creating a sheltered courtyard atop the complex’s ground-floor plinth.

Inspired by the adobe architecture of the Middle East, the architects wanted to create a form that looked like the entire complex had been carved out of a single block. The towers are clad in brick, and their offset pattern, with the recessed blocks in a lighter color, gives the overall impression of lattice texture, without the perforation. “It has a level of refinement,” Katherine Chia said. “I think the façade with the brick pattern is great.”

Inside, public areas are flooded with natural light coming in from large expanses of glazing; in the living units, light is filtered through actual brick latticework in front of the floor-to-ceiling windows. Two courtyard gardens provide outdoor public space and the inside public areas are lined with white walls, marble floors, and light wood millwork, some of which creates perforated patterned screens in front of the glazing to continue the façade’s texture inside. The level of detailing is such that David Baker gave the project perhaps the highest praise an architect can give: “I could live in this place.” —K.G.

**Student  
Housing  
AWARD**



Victoria Hall





HUFTON + CROW





**Affordable  
Housing  
HONORABLE  
MENTION**

Built on a steeply sloped hillside overlooking [San Francisco Bay](#), [Hunters View Housing, Blocks 5 & 6](#) follows a courtyard configuration, with three- and four-story L-shaped structures following the contours of the public sidewalk. Shared, secure spaces reserved for its residents are “some of the best public spaces for affordable housing that I’ve ever seen,” R. Michael Graham said. The project is part of the HOPE SF initiative to revitalize the city’s public housing with new mixed-income developments; it replaces a poorly conceived development that initially served as temporary barracks during World War II.

Designed by San Francisco-based [Paulett Taggart Architects](#), the project’s 53 units are the first to be

redeveloped within the framework of a larger master plan by Mithun/Solomon. Small towers break down the overall mass and establish a neighborly scale that matches the scale, rhythm, and texture of San Francisco’s urban fabric.

“There is a certain elegance in the details and the proportion of the buildings, and how they work relative to the ground plane and the outdoor spaces,” Katherine Chia said. The change in grade across the site allows every unit to be accessed from either the street or courtyard at grade or via exterior stoops, eliminating entry corridors. A variety of apartment types are arrayed across multiple levels, with two-, three-, four-, and five-bedroom variations. —E.K.



The [Sonoma WeeHouse](#) is, in fact, not one but two houses—one main house and one guest house—on a hillside site in [Santa Rosa, Calif.](#), just north and west of the vineyard-rich region that gave it its name. These impeccably detailed, minimalist, steel-clad boxes were designed by St. Paul, Minn.-based firm [Alchemy Architects](#) for a client that knows a thing or two about fine-detailing and minimalism: namely Apple’s senior design director of real estate and development, himself an architect who collaborated on the design.

The structures were designed as part of Alchemy’s WeeHouse system of modular, prefabricated houses. The 640-square-foot main structure, which features an ipe-lined interior and a 9-foot-tall sliding glass door

on either side, was assembled in Oregon in two parts: a 16-foot by 40-foot module and a bolt-on porch, which were each shipped to the site largely complete. The 330-square-foot guest house, a single unit, followed suit. The steel-framed modules were then set on concrete plinths on site, ready to occupy. The porch cantilevers out over the hillside, offering views of the valley below.

Inside, the main house features a whitewashed oak bed in the middle of the structure, with the frame forming the bedroom walls and privacy screens pocketing into the bathroom ceiling. It was the precise, Swiss watchlike details that grabbed the jury: “It’s so tiny, but quite dramatic,” David Baker said. —K.G.

**Custom House Less Than 3,000 Square Feet HONORABLE MENTION**

Mr. Robinson







MATTHEW SEGAL

**Multifamily  
Housing  
CITATION**

[Mr. Robinson](#) is a refined essay in mixed-use development, located at a bend in [San Diego's](#) Park Boulevard. Designed by locally based [Jonathan Segal, FAIA](#), the exposed cast-in-place concrete building's mass both fills the site to the property lines and caught the eyes of the jury. "I like the trays and the overall frame. It's very nice," R. Michael Graham said. The architects carved out five courtyards on site to give all 36 units exterior exposure on three sides and cantilevered balconies extend each living area. The three sides of glass in every unit create permeable enclosures that facilitate views, natural daylighting, and cross ventilation.

The seven-story-tall structure has a mix of office suites, market-rate apartments, and affordable units, as well as a restaurant and café at ground level, each of which has outdoor seating that combine to provide a lively streetscape and resident amenities. And while the building's mixed-use program caters to a wide range of socio-economic strata, the architectural presentation of each space is egalitarian. The overarching outline of the property is dramatically displayed at the structure's corner, where a 70-foot-tall concrete column marks the outer limits of the complex.

"It looks luxurious," Katherine Chia said, "and it's very generous with outdoor space." —E.K.

Local firm [Arches](#) designed [Valley Villa](#) for a wooded site just outside [Vilnius, Lithuania](#). The two-story, 4,478-square-foot residence is a collision of eccentric geometries, with a U-shaped base that is ensconced in the sloped site supporting a V-shaped main living level above. A garage, family room, guest room, and office fill the lower level. The main floor's two wings contain public and private spaces, respectively—living, dining, and kitchen occupy a single open-plan space in one, and three bedrooms and two-and-a-half baths in compartmentalized rooms fill the other.

The design balances traditional and modern forms throughout: The interiors are clean and bereft of detail, while the main-level wings both have traditional gables. But these are abstractions of the typical "house" motif, topped with irregularly peaked roofs that pitch and yaw as they come together at the structure's core. The living area cantilevers out from the base, providing shelter for outdoor living space below and creating a form that Katherine Chia found "very compelling."

The base is sheathed in black slate, detailed to match the vertical timber expression of the upper level, which is clad in a softwood product from Norwegian company Kebony that has been treated to have the properties of hardwood. The vertical expression fits with the more traditional character of neighboring properties as well as mirroring the wooded site. —E.K.

**Custom  
House  
More  
Than  
3,000  
Square  
Feet**

**CITATION**



Valley Villa





NORBERT TOKAL



**Renovation**  
**AWARD** Restoring an 1879 [New York City](#) townhouse that had been divided into 17 apartments to its original status as a single-family residence was a challenge for local firm [Michael K Chen Architecture](#). The landmarked [Upper East Side Townhouse](#) required a great deal of reconstruction, which allowed the designers to completely reconceive the home’s interiors and backyard landscaping for contemporary living. The renovation of the 9,600-square-foot house included the insertion of a new steel-and-concrete structure and an expanded footprint at the rear.

Conceiving the architecture, interiors, and landscape design together, the architects chose to emphasize the interplay between technology and artistry. Highly crafted details are used throughout—a tribute to the original design’s Neo-Grec origins—but created with digital design, coordination, and fabrication. “This is a mind-bogglingly beautifully detailed, clear, and creative project,” David Baker said.

Innovative applications of terra-cotta display another noteworthy nod to tradition and invention: Crumbling brownstone on the house’s front façade was replaced with a custom terra-cotta material developed with specialty aggregates to simulate quarried stone. Tiles of the material line one of two new staircases in the house, and extruded and wire-struck terra-cotta units that yield a feathered texture form a rainscreen on the rear façade. —E.K.

The transit-oriented, mixed-use [3435 Main](#) project was designed by local firm [El Dorado](#) in Midtown [Kansas City, Mo.](#), a neighborhood with a vital mix of small businesses, restaurants, and residences south of downtown. Eighty units, targeted at young working professionals and students, occupy four stories above a ground floor plinth that contains covered parking, a lobby, and retail space.

The building’s aesthetic is established by the expression of its modular construction. A subtle modulation of the stacked units causes each individual piece to shift in and out on the north and south façades. Clad in aluminum composite panels in five different shades of gray, the design team varied the tone across the façade to maximize the illusion of depth and movement. Modular construction also helped deliver the building at the low price point of \$132 per square foot.

But a tight budget did not stop the architects from including moments of luxe detailing: The lobby opens through glass walls to the corner of Main Street and East 34th Terrace. It features a sculptural stair that cantilevers from the concrete elevator core, with each tread/riser/guardrail folded from a single sheet of plate steel. Overall, the project “does a tremendous job with an incredibly limited budget,” David Baker said. —E.K.

**Multifamily**  
**Housing**  
**CITATION**

3435 Main



MAIN STREET

M

J Lounge  
Hookah Bar & Cafe

MAIN STREET

M

MIKE SINCLAIR



*Davey's Uptown*  
RAMBLERS CLUB

RAMBLERS CLUB  
DAVEY'S UPTOWN



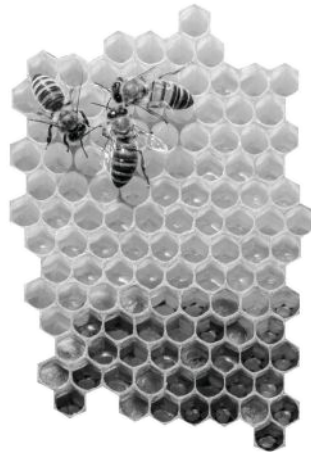

CUSTOMIZATION IS WHAT MAKES A CITY UNIQUE.

***STANDARDIZATION IS WHAT MAKES IT FUNCTION.***

At Tectura Designs, we've been innovators in paving, precast concrete and terrazzo technology for almost 70 years, but we're not afraid to get a little inspiration from other sources. It's why we're able to help you realize your vision with solutions that are as beautiful as they are lasting. And that means you can bring your vision to life without compromise.

**TECTURA**  
designs.

A WAUSAU TILE INC. BRAND

[TECTURADESIGNS.COM](http://TECTURADESIGNS.COM)

## Residential:

### Charles Moore and Arthur Andersson's Austin Compound Wins Texas Society of Architects' 25-Year Award



TEXT BY SARA JOHNSON

On Nov. 10, the Texas Society of Architects presented the Moore/Andersson Compound with its 25-Year Award, adding the Austin complex to a list that includes Renzo Piano, HON. FAIA's Menil Collection and Louis Kahn's Kimbell Art Museum.

In 1984, when AIA Gold Medalist Charles Moore moved to the city to teach at the University of Texas at Austin's School of Architecture, he and Arthur Andersson, FAIA, began constructing a complex on a site next to a freeway in the city's Tarrytown neighborhood. Already populated with a 1930s bungalow and addition, the site evolved into the two-house, one-studio complex where Moore lived until his death in 1993. Today, the compound houses the Charles Moore Foundation, which offers residencies and by-appointment tours.

"One of Charles Moore's last works, it is an outstanding representation of his approach—bold, with a strong sense of urbanism despite its modest size," wrote Robert A.M. Stern, FAIA, in his nomination letter. "The swing of its great room in plan and section makes for one of the most memorable interior spaces of our time."



## The Look of Acid-Washed Steel Without the Metal

TEXT BY SELIN ASHABOGLU

### **Radium, Dekton by Cosentino**

A new addition to the Dekton Industrial collection from Spanish solid surfaces company Cosentino, Radium was created in collaboration with Argentinian architect and designer Daniel Germani, and boasts a wide variety of applications, including interior and exterior cladding as well as countertops and indoor and outdoor flooring. This durable surface resembles acid-washed steel and is one of two colorways in the collection that is formed using 80 percent recycled materials—such as glass, porcelain, and natural quartz—harvested from the byproducts of Cosentino's production processes. Radium is made by using Dekton's proprietary Particle Sintering Technology (PST), which reduces the millennia-long compression process that natural stone endures to four hours. In order to achieve a resilient surface, PST exposes the slab to extreme heat and pressure to get rid of pores and micro-defects that may cause weak spots, making it resistant to UV rays and water. The outdoor-suitable product has a low thermal expansion coefficient, which allows it to withstand extremely low and high temperatures. Radium comes in 126" by 56" slabs that measure 0.3", 0.47", and 0.78" thick. [cosentino.com](http://cosentino.com)

# FIRST IMPRESSIONS ARE LASTING IMPRESSIONS



Kent State University CAED Building

## The Best Impressions are Made with Brick

Choosing brick over other alternatives is the foundation for a smart, long-term investment in durability and beauty. Brick gives you the highest quality, energy efficient, environmentally friendly product over other structural building materials. It has a life expectancy of hundreds of years. Belden Brick is the unparalleled choice above all other material options. Don't settle for less. Ask for the best. Ask for the industry leader delivering the largest selection of more than 500 colors, 20 sizes, 13 textures and unlimited shapes. Belden Brick can meet all your building needs with the time-honored quality and experience the Belden name represents.



An ISO 9001 Compliant Quality Management System.  
An ISO 14001 Compliant Environmental Management System.

[beldenbrick.com](http://beldenbrick.com)

# BELDEN

**THE BELDEN BRICK COMPANY**

*The Standard of Comparison Since 1885*



## Nine "Living Spaces" by David Adjaye

TEXT BY SARA JOHNSON

"Building houses is an opportunity to explore what constructed form can mean in the city and the wider environment, how it involves setting up layers of privacy and public engagement, and the implications for material expression," writes architect David Adjaye, HON. FAIA, founder and principal of London- and New York-based Adjaye Associates, in *David Adjaye: Living Spaces* (Thames & Hudson, 2017). Edited by writer and curator Peter Allison, the 304-page book surveys nine examples of private spaces designed by the architect, from studios to houses, including Seven (below), a gallery and single-family house in Manhattan, and his LN House (above) near his Museum of Contemporary Art Denver.



> See more photos of Adjaye's living spaces at [bit.ly/AdjayeLivingSpaces](http://bit.ly/AdjayeLivingSpaces).



**LEED:  
A LEGACY**

Leaders across the globe have made LEED the most widely used green building program in the world. Leave your legacy today.

#LEEDlegacy

[usgbc.org/LEED](http://usgbc.org/LEED)



hive

housing innovation,  
vision & economics

# THANK YOU TO OUR SPONSORS

TITLE & UNDERWRITING SPONSOR



FOUNDING SPONSORS



SAMSUNG

ALLIANCE SPONSORS



SUPPORTING SPONSORS



hanleywood





**Residential design** is the most personal and immediate touchstone for the impact architecture has on our lives.

Hanley Wood congratulates and thanks Jenn-Air for its ongoing commitment to excellence and innovation in home design.



## WE REDEFINE THE KITCHEN

Designers are no longer constrained by standard cooktop configurations. Jenn-Air brand's new customized cooktops redefine the idea of what a cooking surface can be. Customized cooktops provide a wide range of options that create a unified look whether traditional or flush installation is specified. No matter what the cooking style or design sensibility, Jenn-Air® customized cooktops propel every kitchen to be exceptional.

### IMAGINE THE POSSIBILITIES WITH CUSTOMIZED COOKTOPS

Each cooktop is 21" deep and 15" wide. When combined, they create a highly customized, seamless cooking area while delivering best-in-class performance. Combine multiple units for large cooktop areas, or use fewer for small spaces such as bars, prep stations or city apartments.

There are currently six cooktops from which to choose. Mix and match to meet your culinary style. Combine induction and gas technology. Kitchen design will never be the same.

For those who crave induction technology, Jenn-Air offers both a cooktop with a flexible element to accommodate various sized cookware and a unique induction wok that features a concave

design to cradle a round-bottom wok. Both of these induction options deliver fast, efficient and highly responsive cooking power.

For those who desire gas, designers may choose from a 2-burner cooktop and/or a single-burner cooktop with a wok attachment. The single-burner offers BTU output that ranges from a gentle 700 BTUs to a commercial-grade 20,000 BTU output, perfect for high heat wok cooking.

To round out the product offering, a chrome-infused, electric griddle delivers 1,800 watts for faster cooking while radiating less heat into the kitchen.

All customized cooktops may be paired with either a standard updraft ventilation system or with a new, sleek 4" downdraft vent. This downdraft vent works efficiently with any of the cooktops without interrupting kitchen sightlines.

Now there is no limit to what you can create in the kitchen.

**For more information, visit [jennair.com](http://jennair.com).**

 **JENN-AIR**

**Casa Vicens Gaudí**  
**Barcelona, Spain**  
**Martínez Lapeña - Torres Arquitectos**  
**and DAW Office**

TEXT BY CLAY RISEN  
PHOTOS BY POL VILADOMS



In 1883, Antoni Gaudí, the ink hardly dry on his architecture degree, received a commission to design a summer house in Barcelona, Spain, for Manuel Vicens i Montaner, a stock and currency broker. Completed in 1885, the four-story Casa Vicens was Gaudí's first significant work and one of the earliest examples of Art Nouveau architecture—a riot of contrasting colors and patterns, bearing the seeds of Gaudí's unique blend of Moorish, Neoclassical, and organic forms.

Vicens died in his house in 1895, and it was later enlarged and divided into four apartments. In 2014, MoraBanc, a private bank based in Andorra, bought the property with the goal of returning it to its original state and converting it into a museum and exhibition space. On Nov. 16 of this year, after nearly 130 years as a private residence, Casa Vicens Gaudí opened to the public, thanks to an extensive renovation overseen by two local architecture firms, Martínez Lapeña - Torres Arquitectos and David Architecture Workshop Office.

Making dramatic changes to a Gaudí building is an intimidating prospect; fortunately, the architects have done it before, with a major 1992 renovation of Gaudí's Park Güell, also in Barcelona. "We approached Casa Vicens with respect, but also with a healthy and independent distance," says Elías Torres, a partner with Martínez Lapeña - Torres Arquitectos. "There is a moment in the process when the important thing is to act with the most accuracy and without fear."

The building was structurally sound, but needed significant restoration. The conversion to apartments had involved removing Gaudí's original staircase, which the architects replaced, sans decoration;

they also added an elevator. Interior partition walls came out, and new electrical work, air conditioning, restrooms, and a café went in. The architects also removed two wings that had been tacked on in 1935 and 1964, making room for an expanded garden.

Though Casa Vicens was never exactly forgotten—in 2005 UNESCO named it, in combination with six other Gaudí works in or near Barcelona, as a World Heritage site—its place in art history as a demonstration of pre-modernist, orientalist design had been literally covered over by decades of paint and neglect. The architects and MoraBanc researched the original paint and glazed-ceramic schemes of individual rooms, and then meticulously restored them.

Perhaps the biggest challenge, says Mercedes Mora, who oversaw the project for her family's bank, was the smoking room on the first floor. Gaudí had filled the space with multicolored plaster *mocárabes* on the ceiling and papier-mâché tiles on the walls, a once-popular decorative element perfected by lithographer Hermenegildo Miralles. "This is one of the few buildings from that time that still has original pieces made using this technique, which began and reached its peak during the Modernism movement," she says.

The surfaces had been painted over, so the restorers first had to determine what lay beneath by drilling small test holes around the room. "The team discovered some surprising colors and restored the blue background, various tones of green on the leaves, and the golden highlights," Mora says. And now, thanks to two years of intense restoration, the rest of the world can see the uncovered details, too.

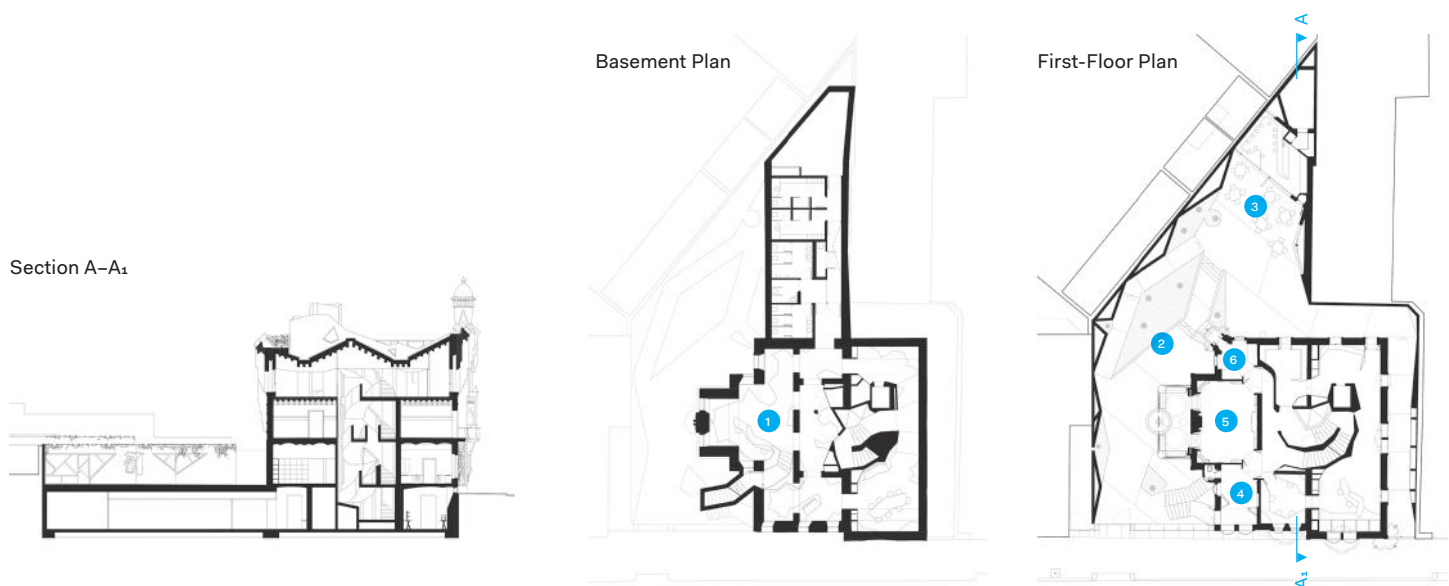



Second-Floor Plan

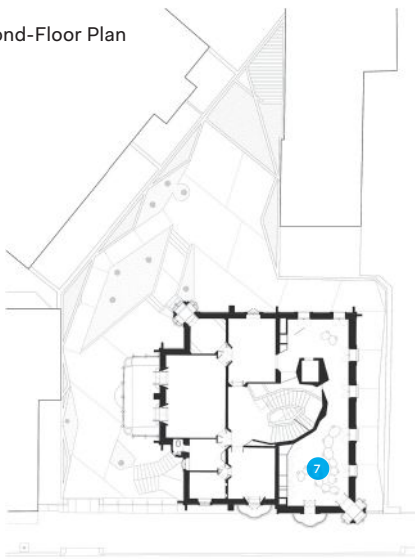

Third-Floor Plan

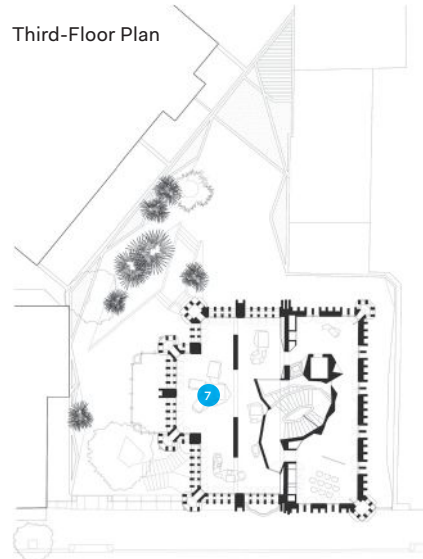

*Opening Page:* The entrance to the house is in the garden on the west side.

*This Page:* The first-floor dining room opens to an enclosed porch.

- 1. La Capell store
- 2. Garden
- 3. Hofmann Café
- 4. Lobby
- 5. Dining room
- 6. Smoking room
- 7. Galleries







Visitors move directly from the entrance lobby, reflected here in a large mirror, to the newly reinserted stair (shown at left) at the house's core.



The museum contains both temporary and permanent exhibition space, such as this third-floor gallery.





Formerly the house's coal cellar, the basement now contains the La Capell store.



*Top:* The building features a rooftop terrace with Gaudí's ceramic tile-clad chimney caps.

*Left:* A bathroom on the second floor overlooks the street.

#### **Project Credits**

*Project:* Casa Vicens Gaudí

*Client:* Casa Vicens Gaudí

*Developer:* UTE Calaf Constructora and AMC5

*Architects:* Martínez Lapeña - Torres

Arquitectos, Barcelona, Spain · José Antonio Martínez Lapeña, Elías Torres (partners), Adrià Orríols (project and site supervision); Carla Coromina, David Costa, Roger Panadès, Galo Pujana, and Jennifer Vera (office team); David Architecture Workshop Office, Barcelona, Spain · David García Martínez (founding architect), Violeta Linares, Jesús Amengual, Laura Pérez, Pablo Navas, Cristina Sarandeses, Aina Tugores, Silvia Ripoll, Aina Santesmasses, Diana Jiménez, and Carlos Tugores (office team)

*Structural Engineer:* Static Ingeniería

*Mechanical Engineer:* Consulting Oficina

Tècnica Lluís J. Duart

*Construction Site Management:* Dalmau-Morros Tècnics

*Restoration:* Restauracions Policromia

*Graphic Design:* Mucho

*Size:* 1,239 square meters (13,336 square feet)

*Cost:* €3.8 million (\$4.5 million)



 **THE OVEN THAT GOES **WHEREVER YOU DO**,**  
**EVEN IF IT'S ONLY ACROSS THE ROOM.**

The new Jenn-Air® Connected Wall Oven. With a stunning, easy-to-use 7-inch touch LCD display, enhanced Culinary Center and a companion mobile app, you'll always stay in control of the kitchen — no matter where you happen to be.

Text **CONNECT** to 31996 to experience our new oven from your phone.

[jennair.com/connect](http://jennair.com/connect)

 **JENN-AIR®**

©/™ ©2017 Jenn-Air. All rights reserved. Requires Wi-Fi and account creation. App features and functionality subject to change. Subject to Terms of Service available at [jennair.com/connect](http://jennair.com/connect). Data rates may apply. By responding "Yes" to Jenn-Air brand's invitation to opt in to this experience, I agree to receive one marketing text message about the Jenn-Air wall oven sent by an automatic telephone dialing system from Jenn-Air. Reply **HELP** to 31996 for help. Text **STOP** to 31996 to stop. May not be supported by all wireless carriers or handsets. See terms and conditions at [jennair.com/terms](http://jennair.com/terms). Message and data rates may apply.

Architectural Adventures



# Global travel for architecture enthusiasts



## Timeless Rome May 5 - 12 • 18 LUs

From the grandeur of the iconic Colosseum to the contemporary vision exemplified in Renzo Piano's Parco della Musica Auditorium, experience the architectural wonders of Rome on this eight-day tour, exclusive for ATA members, and their friends and family.

Image courtesy of Studio Fuksas ©Moreno Maggi



## Montreal May 30 - June 3 • 11 LUs

From the iconic Habitat 67 to the imposing Notre Dame Basilica to the recently-completed pavilions at the Montreal Museum of Fine Arts, discover the public places, historic buildings, and contemporary architecture of Montreal.



## Splendors of Eastern Europe May 8 - 24 • 18 LUs

Discover the stunning and preserved great cities of Warsaw and medieval Krakow, grand Budapest, Old World Bratislava, proud Prague and striking Vienna.



## Bauhaus & Beyond September 21 - 30 • 25 LUs

Experience the legendary Bauhaus movement on the brink of its 100th anniversary, and explore its legacy and impact through visits to original buildings and touring remarkable museum collections and exhibitions in the three iconic Bauhaus cities.

Other 2018 tours include Portugal and Southern Spain, Vienna, Cambodia, Detroit, Southwest England, Scandinavia, Japan, Portugal and Northern Spain and a cruise along the Rhine River. All tours include an architectural expert to ensure enjoyment for architecture enthusiasts and intellectually curious travelers alike.

Visit [architecturaladventures.org/architectmag](http://architecturaladventures.org/architectmag) to sign up for Architectural Adventures tour announcements. Ready to book a tour? Call us at **1.800.293.5725** ext. 3.

Architectural Adventures is a program of The American Institute of Architects.



**WhiteWalls®**

**Magnetic Whiteboard Steel Wall Panels**

WhiteWalls.com | 800-624-4154

**AV Adek**  
Walkway Cover Systems & Canopies

custom designed **canopies** and **trellis structures** for any location

contact us today to start the design process

www.avadek.com  
1.800.777.4031

**SCHWEISS**

**DOORS**

**YOU THINK IT, WE BUILD IT!**

**HYDRAULIC - OR - BIFOLD**  
ONE-PIECE DOORS STRAP LIFT DOORS

507-426-8273

"BUILDING BETTER DOORS"

**SCHWEISSDOORS.COM**

**NEW Hanover® Porcelain Pavers**

**HANOVER®**  
Architectural Products  
www.hanoverpavers.com • 800.426.4242

For clearly superior views, see it through Clearvision low-iron glass.

**AGC**  
GLASS UNLIMITED

AGCglass.com/clearvision

**LUMICHRON**  
The Illuminated Haven for Time

888-788-4838

Tower & Commercial Clocks  
Manufacture, Sales, and Service  
www.lumichron.com

**FOR INFORMATION**  
on how to be a part of the next  
**ARCHITECT MAGAZINE**  
special advertising section,  
contact Jaeda Mohr at  
202-736-3453.

**h w**

**SOME TALK THE TALK.**

**OTHERS WALK THE WALK.**

[www.aisc.org/sustainability](http://www.aisc.org/sustainability)

There's always a sustainable solution in steel.

**STOP PEST BIRDS!**

Discreet, Effective & Humane  
Bird Control Solutions To  
Keep Architecture Clean

**Request a FREE Catalog!**  
Nixalite.com • 800.624.1189

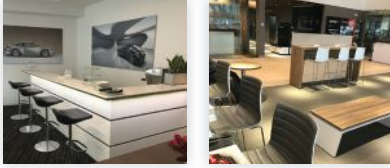

**DUROPAL** laminate helps you realize your best design concepts and inspire new ones.

[www.I3Surfaces.com](http://www.I3Surfaces.com)

**I3 Surfaces**  
AUTHORIZED IMPORTER/DISTRIBUTOR FOR PFLEIDERER

**PEDINI**<sup>®</sup>

[www.pediniusa.com](http://www.pediniusa.com)

**TECTURA**<sup>®</sup>  
 designs.  
A WAUSAU TILE INC. BRAND

PAVING | SITE FURNISHINGS | TERRAZZO

[TECTURADESIGNS.COM](http://TECTURADESIGNS.COM) | 800.388.8728

**PPG PAINTS**<sup>™</sup>  
**SPEEDHIDE**<sup>®</sup> INTERIOR LATEX

This high-hiding, low-VOC, low-odor paint enables a space to be painted while occupied and delivers the durable product performance professionals require.

[ppgpaints.com](http://ppgpaints.com) • 1-855-219-2083

**PPG PAINTS**<sup>™</sup>

**SHEERWEAVE**  
 BY PHIFER

The world's most trusted brand of solar screen fabrics.

**Quality. Service. American Made.**

**PHIFER**  
 INCORPORATED

[phifer.com/suncontrol](http://phifer.com/suncontrol)  
 800-221-5497

Expect more from the glass you spec.

[AGCglass.com/yourglass](http://AGCglass.com/yourglass)

**AGC**  
 GLASS UNLIMITED

American Standard VorMax Plus Toilet cleans the bowl with every flush. See how it works at [americanstandard.com](http://americanstandard.com).

*American Standard*

Find your comfort zone. On so many levels.

For more information call 1-855-VTRO-GLS or visit [VitroGlazings.com](http://VitroGlazings.com)

**SOLARBAN**<sup>®</sup>  
 Solar Control Low-E Glass

**Vitro**  
 Architectural Glass  
Formerly PPG Glass

*Fabriccoil*<sup>®</sup>

[fabriccoil.com](http://fabriccoil.com)  
 800.999.2645



# Congratulations

TO HANLEY WOOD'S JESSE H. NEAL AWARD WINNERS

Hanley Wood is committed to publishing quality content that serves the information needs of construction industry professionals. Our editors have once again been honored by the most prestigious editorial awards program. Join us in congratulating them.

### 2017 WINNERS

ARCHITECT  
Best Overall Art  
Direction/Design

ARCHITECTURAL LIGHTING  
Best Commentary/Blog

### 2017 FINALISTS

AFFORDABLE  
HOUSING FINANCE  
ARCHITECT  
ARCHITECTURAL  
LIGHTING  
BUILDER

JOURNAL OF LIGHT  
CONSTRUCTION  
MULTIFAMILY EXECUTIVE  
PROSALES  
REMODELING

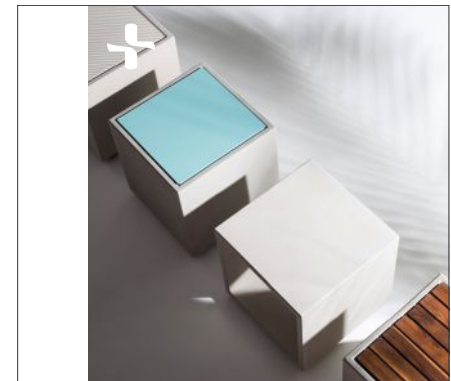

### QUADRA FAMILY

TENSL Ultra High Performance Concrete  
modular seats, benches, and planters

[www.forms-surfaces.com](http://www.forms-surfaces.com)

**FORMS+SURFACES®**

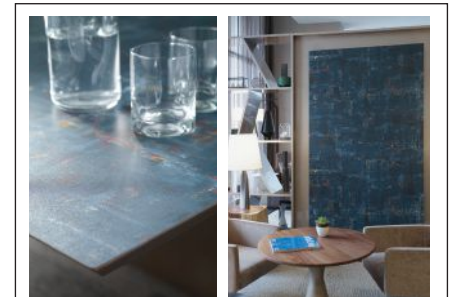

**Paint Scrape Steel.** One of 32 new designs in SurfaceSet® 2018 by Formica Corporation. Three dynamic palettes of creative contrasts, pushing the boundaries of calm to bold, organic to elegant, art to science. Bring beauty, durability and originality to your vision.

[www.Formica.com/lookbook](http://www.Formica.com/lookbook)  
[www.formica.com](http://www.formica.com)



[PAC-CLAD.COM](http://PAC-CLAD.COM) 1 800 PAC CLAD

Advertiser	Page	Website	Phone
AdvanTech	60-61	www.advantechperforms.com	
AGC Glass Company North America	27	www.AGCglass.com/clearvision	
AGC Glass Company North America	25	www.AGCglass.com/yourglass	
American Institute of Architects	64	www.aia.org/store	
American Institute of Architects	70	www.aia.org	
American Institute of Architects	16	www.architectsfoundation.org/scholarships	
American Institute of Architects	34	www.chicagoarchitecturebiennial.org	
American Institute of Architects	104	www.careercenter.aia.org/employers	
American Institute of Architects	186	www.architecturaladventures.org/architectmag	800.293.5725 ext 3
American Institute of Architects	105	www.aia.org/compensation	
American Institute of Steel Construction	44-49	www.aisc.org	312.670.2400
Andersen Windows & Doors	123*	www.andersenwindows.com	
ARCAT	C3	www.arcata.com	
Belden Brick	171	www.beldenbrick.com	
Bobrick	15	www.bobrick.com	
Brick Industry Association	16a-h*	www.gobrick.com	703.620.0010
Cascade Architectural	18-19	www.cascadearchitectural.com	800.999.2645
Doug Mockett & Co. Inc.	130	www.mockett.com	800.523.1269
Dryvit	33	www.newbrick.com	833.NEWBRIK
DXV	30, 31	www.d xv.com	
Formica	21	www.formica.com/lookbook	
Guardian Glass	109	www.UltraClearYourMind.com	
HIVE	174	-	
I3 Surfaces	128	www.I3Surfaces.com	888.975.7483
Jenn-Air	175-176	www.jennair.com	
Jenn-Air	185	www.jennair.com/connect	
Kolbe Windows & Doors	117	www.KolbeWindows.com	
LaCantina Doors USA	119	www.LaCANTINADOORS.com	
Latch	11	www.latch.com	
Lumion	C4	www.lumion.com	
MBCI	29	www.MBCI.com	844.338.6769
Messe Frankfurt	116	www.light-building.com	+1 770.084.8016
Metrostudy OnTarget	17	www.WhyOnTarget.com	



Advertiser	Page	Website	Phone
ModularArts	118	www.modularArts.com	
NanaWall	127	www.NanaWall.com	800.873.5673
NBK	43	www.NBKUSA.com	
Oldcastle BuildingEnvelope®	C2-1	www.obe.com	1.866.Oldcastle
Ornamental Metal Institute of New York	10	www.metalsinconstruction.org	
Pedini Spa	73	www.pediniusa.com	800.404.0004
Petersen Aluminum	7	www.PAC-CLAD.com	1.800.PAC.CLAD
PPG Industries (Metal Coatings)	125	www.ppgideascape.com	800.258.6398
PPG Paints	4-5	www.2018colortrends.ppgpaint.com, www.ppgpaints.com/architect	
reThink Wood	74	www.rethinkwood.com	
reThink Wood	82	www.reThinkWood.com/architect	
reThink Wood	83	www.rethinkwood.com/nlt	
reThink Wood	94-95	www.reThinkWood.com/architect	
Rulon International	41	www.rulonco.com	800.227.8566
SAFTI FIRST	115	www.safti.com/dooralert	888.653.3333
Seiho International, Inc	106	www.seiho.com	626.395.7299
Sierra Pacific Windows	2-3	www.SierraPacificWindows.com	800.824.7744
Sloan	62	www.sloan.com/soapdispensers	800.982.5839
Steel Institute of New York	50-53	WWW.SINY.ORG	
Steel Institute of New York	14	WWW.SINY.ORG	
TAKTL	12-13	WWW.TAKTL-LLC.COM	
TAKTL	54-57	WWW.TAKTL-LLC.COM	
The Home Depot	23	www.hdckitchens.com	
The Modern Fan Co.	129	www.modernfan.com	
The Valspar Corporation	35, 37	www.colorobsessed.com	
TOTO	111	www.TOTOUSA.com	800.350.TOTO
UL	131	www.ul.com/ArchitectMag	
USGBC	173	www.usgbc.org/LEED	
Vectorworks	58-59	-	
Vitro Architectural Glass (formerly PPG Glass)	8-9	www.vitroglazings.com/solarban	855.VTRO-GLS
Wausau Tile	168	www.TECTURADESIGNS.com	
Weather Shield Windows & Doors	113	www.weathershield.com	
Zip System Sheathing & Tape by Huber Engineered Wood	120	www.ziprevolution.com	

# Editorial: Investing in America

Congress hasn't updated the federal income tax code since Ronald Reagan was president, so an overhaul may be in order. But not this overhaul: Both the House and Senate tax plans, as they stand at press time, could seriously harm the profession, the built and natural environments, the working class, and the economy. The AIA did the right thing by opposing both plans (while noting that the Senate's is marginally preferable).

According to the AIA's 2016 Firm Survey Report, 57 percent of U.S. practices are set up as pass-throughs (e.g., S corporations). Both the House and Senate offer a new, lower maximum rate for pass-through businesses, but they pointedly exclude professional services such as architecture from the provision.

The Senate plan lowers the cap for the mortgage interest deduction from \$1.1 million to \$1 million, and the House plan lowers it from \$1.1 million to \$500,000. The latter scenario, in particular, could discourage potential clients from undertaking new-home construction, additions, and remodeling jobs.

The House plan is the more aggressive of the two, cutting items that the Senate retains. At a time of drastic shortages in affordable housing, the House plan ends the tax-exempt private activity bonds that fund roughly half of that market. If the bonds are eliminated, accounting firm Novogradac & Co. estimates that the future supply of affordable housing would fall by some 1 million units—or two-thirds of current production. Also on the House kill-list is the New Markets Tax Credit, which has funded some 178 million square feet of manufacturing, office, and retail space in low-income communities.

The House plan even terminates the incentives for historic preservation. The Senate keeps them, but barely, repealing the 10 percent tax credit for structures built before 1936 and lowering the credit for certified historic structures from 20 percent to 10 percent.

Both plans drop the 179D energy efficiency tax deduction for the installation of high-performance

interior-lighting, building-envelope, and cooling, heating, hot-water, and ventilation systems. (According to the AIA, an amendment could reinstate the deduction in the Senate. Keep your fingers crossed.)

A few perks for developers might help architects. "Both bills would allow businesses to deduct interest expenses for property development, construction, management, and other real estate activities, while limiting that same benefit for other industries," *The Washington Post* reports. "Another House provision would repeal a 'like-kind exchange' exemption that allows businesses to avoid taxes if they reinvest profits from one venture into another, but the bill would preserve the exchanges for commercial real estate. No other types of business would receive such a break."

According to the Joint Committee on Taxation, the top 0.3 percent get 17.8 percent of the benefit in the Senate plan and 21.6 percent in the House plan. Did the governing class learn nothing from the 2016 election? Shortchanging working families is unjust and unwise, and it's been occurring for decades, with disastrous results. Instead of tax cuts for rich people and large corporations, the economy needs investment in affordable housing, livable communities, resilient infrastructure, green technology, and well-paying jobs, which are all things that architecture can help deliver.



# Who's hungry?

Wait, not so fast. First you need to go to [ARCAT.com](http://ARCAT.com) to find that product information for your project.

So before you go to lunch, search the #1 used website for finding building products, specs, CAD, BIM, SpecWizard, catalogs, videos & more! ARCAT.com is free to use, and no registration required.

You can always bring ARCAT with you if you can't wait. Just don't get mustard on your phone.



# Beautiful Renders Within Reach



Within 15 minutes, any architect can learn to create images and videos.  
Render stunning images in seconds rather than hours.

**Try Lumion software for free. Go to [Lumion.com](https://lumion.com)**

Render made with Lumion 8.0, available now.