

INTERIORS



A · I · A

Journal

December 1966





Ice cream parlor floor: Kentile Architectural Marbles Vinyl Asbestos Tile. Comfortable, quiet underfoot. For residential as well as commercial use. Thicknesses: $\frac{3}{32}$ " and $\frac{1}{8}$ ". Ten colors. Step riser and wall base shown: KenCove® Vinyl. Consult your Kentile® Architectural Representative.

This new vinyl tile floor invites traffic—and takes it beautifully!

KENTILE
VINYL FLOORS

It's Architectural Marbles—a Kentile exclusive! Lasting beauty because the design flows through the entire thickness of every tile. Easy to maintain. Greaseproof. Low priced, too.

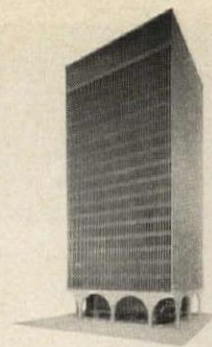
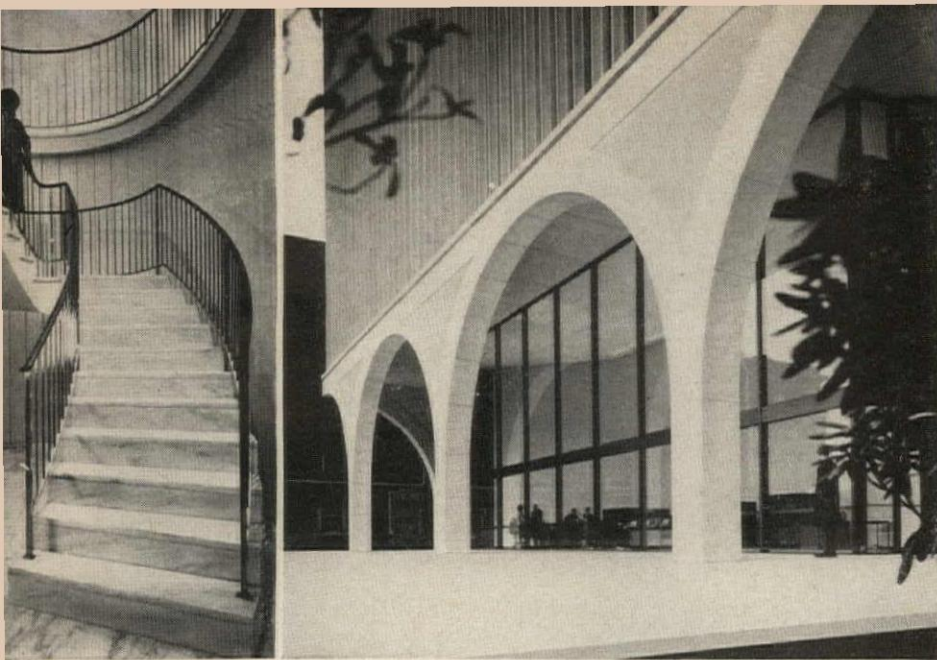

Exterior veneer is Vermarco White "A" Rutland Marble. Interior main staircase and walls are Vermarco Best Light Cloud. Floor is Montclair Danby.

Architects: Naramore, Bain, Brady & Johanson; Minoru Yamasaki & Associates.

Vermont Marble

*the architect's choice
for contemporary design*

IBM BUILDING, SEATTLE. Distinctive, durable marble from the world-famous Rutland and Danby quarries of the Vermont Marble Company add drama and elegance to the classic dignity of this new Seattle landmark. White Rutland Marble beautifies the

graceful arches and the interior stairs and walls; rugged Montclair Danby covers the lobby floor.

For further information on the use of these beautiful marbles, call in your Vermont Marble representative — or write to Dept. 12A.



VERMONT MARBLE COMPANY

Proctor, Vermont

Circle 214 on information card

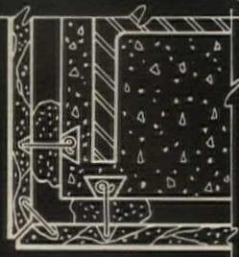

COLUMN
CORNER
PLAN

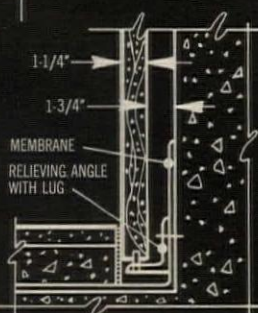

COLUMN
FACING
DETAIL
AT FLOOR

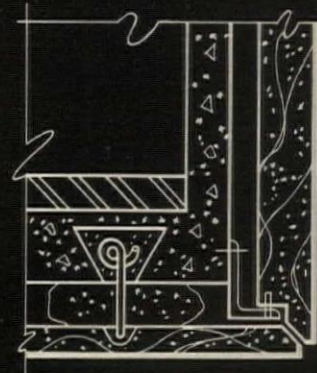
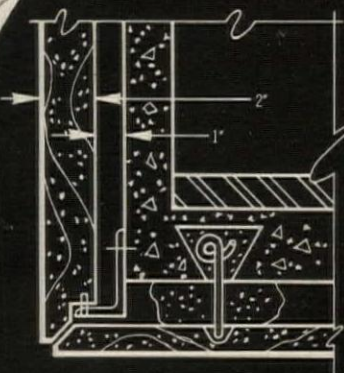

SOFFIT DETAIL SECTION

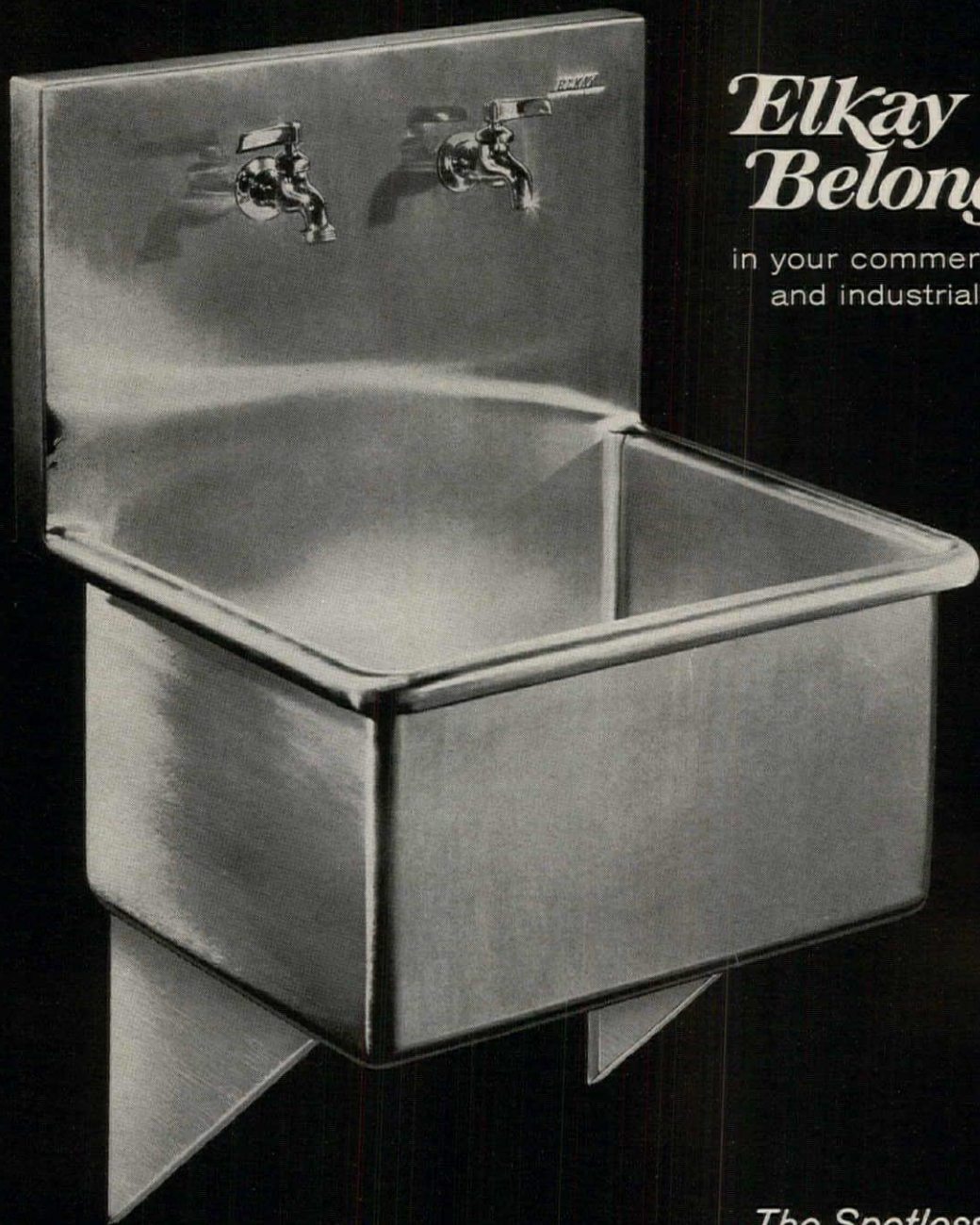

Elkay Belongs

in your commercial
and industrial planning

The Spotless Look

For service sinks that withstand heaviest institutional usage and are easy to maintain, look to Elkay.

These handsome nickel stainless steel sinks are of seamless construction. No hard-to-clean places, no rough corners where soil can lodge. Smooth, polished surface is never marred by chips, cracks, wear or stain.

No matter what your commercial, industrial or institutional needs may be, Elkay's years of experience in stainless steel are at your service to produce the stainless steel product you design or require. Many standard models are in stock, ready for prompt shipment.

Elkay is the world's first and largest producer of standard and custom-made stainless steel sinks. It seeks out and meets your product needs with more experience than any other stainless steel manufacturer.

ELKAY.

Write for free literature or specific information and quotations to: Elkay Manufacturing Company, 2700 S. 17th Avenue, Broadview, Illinois 60153.

© 1966 EMC



PUBLISHER
Wm. Dudley Hunt Jr. AIA

EDITOR
Robert E. Koehler

ASSISTANT EDITOR
Neil E. Gallagher

ASSISTANT EDITOR
Marilyn E. Ludwig

ART DIRECTOR
Marilyn S. Housell

BUSINESS MANAGER
Henry E. Kleiner

CIRCULATION MANAGER
Jane B. Solt

PRODUCTION ASSISTANT
Sandra M. Sturm

AIA Journal, Official Magazine of
The American Institute of Architects,
published monthly at the Octagon,
1735 New York Ave. N.W.,
Washington, D.C. 20006
Telephone: 393-7050

Subscriptions

For those who are, by title,
architects, engineers, architectural
employees (specification writers,
designers, draftsmen, estimators),
planners or landscape architects,
and to those in architectural
education (students, faculty and
schools), and to libraries, building
construction trade associations,
and building product manufacturers
and their employees: basic rate—\$5
one year, \$8 two years, in US,
its possessions and Canada. For
the same titles elsewhere: \$10 one year.
For all others: \$10 one year
in US, its possessions and Canada;
\$18 one year elsewhere. Single
copy: \$2. Payable in advance.
Publisher reserves the right to
refuse nonqualified subscriptions.

Change of Address

Give Circulation Department both
old and new addresses;
allow six weeks

Second class postage paid at
Washington, D.C.

© 1966 by The American Institute
of Architects



VOL. XLVI, NO. 6

Opinions expressed by contributors
are not necessarily those of AIA. ®

DECEMBER 1966

Interiors

- 34 **What Is the Architect's Role?**—The practitioner "no longer can ignore the complexities of interior furnishings and equipment"
- 36 **When Specialists Enter the Scene**—Professional/design rather than profit/decoration sets the tone for I.S.D., Inc.
- 41 **How a Small Firm Acts Big City**—A central Illinois office has a unique, though professional, arrangement with a furniture studio
- 44 **Design of the Luminous Environment 2: Formulating an Interior Logic**—The behavioral language is put to practical use

General Articles

- 49 **Documents to Keep Pace with Practice**—The AIA General Conditions are reorganized in terms of contemporary requirements
- 52 **For Beauty's Sake**—Othmar Hermann Ammann's legacy to New York City tempers practically with esthetic sensitivity
- 55 **William Gray Purcell**—The story of the contributions of this fascinating link in the modern movement is long overdue in telling
- 61 **Funding a Restoration**—Ainsley Hall House and garden, a tribute to the campaign know-how of the women of Columbia, S.C.

ACSA

- 63 **ACSA in Denver: From Tours to Testing**—The summation of the 52nd annual meeting produces an interesting interchange of ideas

News Feature

- 78 **Bury We Will, Says Bell**—A spokesman for the system sees all new telephone distribution plants underground by 1970

Departments

- | | |
|---------------------------------|----------------------------|
| 12 Comment & Opinion | 82 Books |
| 16 Newslines | 90 Calendar |
| 28 Necrology | 92 Letters |
| 30 Unfinished Business | 93 Information Card |

Cover: Stow/Davis Galleries, designed by I.S.D., Inc. (p. 36), and photographed by Warren Meyer, in Chicago's Merchandise Mart

LOOKING AHEAD TO JANUARY

The Immediate Environment: So frequent are the proclamations that man has arrived at one threshold or another that we hesitate to add to the excited dunning. Yet we must say that articles prepared for the next issue induce a sense of standing on the verge of a new day in housing. The word "housing," in fact, becomes wholly distasteful in the light of the content. It is a limiting, shelter-connoting term utterly incommensurate with the concept of a vitality-giving "immediate environment."

Growing Vegetables in Nongreenhouses: Many terms could be tried in attempting to describe this vastly richer view of housing, writes one author, hastening to add his own reluctance to use any one "lest it preconceive the answer. What single word could carry the meaning of a 'living-learning-self developmental-evolving-responsive-environmental, etc., unit?'" This same author suggests that man's intimate, personal environment may be guilty of making him a spectator, of robbing him of participation and of turning him into a "vegetable." To blame it all on television, he submits, may be missing the point.

On the Other Hand: And another author, having in mind the lower rungs on the economic ladder, writes that "we are beginning to recognize that the kind of house or home that a family enjoys is the end product of its experiences, not the essential inducement to positive experiences. It is far more productive for our society to invest public resources to regenerate human beings. . . . If during this period we need to develop decent housing as staging areas for shedding economic disability, let it be understood as such and nothing more."

Besides the Philosophy: Whatever the expectations of bricks and mortar—whether to reshape man or shelter him during a reshaping process—they will, these bricks and mortar and all the other building materials, be used in the decades ahead at an unprecedented rate. Yet so much remains to be adapted, adopted—and orphaned—if the immediate environment of this urban nation's burgeoning population is to 1) come into existence in necessary proportions and 2) possess reasonable quality. The logistical and qualitative challenges in housing are hardly half-hearted.

THE AMERICAN INSTITUTE OF ARCHITECTS

BOARD OF DIRECTORS

Officers

President

Charles M. Nes Jr. FAIA*
Baltimore, Md.

First Vice President

Robert L. Durham FAIA*
Seattle, Wash.

Vice Presidents

Samuel E. Homsey FAIA*
Wilmington, Del.

George E. Kassabaum AIA*
St. Louis, Mo.

Harold T. Spitznagel FAIA*
Sioux Falls, S.D.

Secretary

Rex Whitaker Allen FAIA*
San Francisco, Calif.

Treasurer

Daniel Schwartzman FAIA*
New York, N.Y.

Executive Director

William H. Scheick FAIA*

* Members of the Executive Committee of the Board

Directors

(Terms expire 1967)

East Central States

Walter Scholer Jr. AIA
Lafayette, Ind.

New England

Willis N. Mills FAIA
Stamford, Conn.

New York

Donald Q. Faragher FAIA
Rochester, N.Y.

North Central States

Victor C. Gilbertson FAIA
Minneapolis, Minn.

Ohio

Charles J. Mart FAIA
New Philadelphia, Ohio

Western Mountain

James M. Hunter FAIA
Boulder, Colo.

(Terms expire 1968)

Gulf States

Dan C. Cowling Jr. AIA
Little Rock, Ark.

Michigan

Philip J. Meathe AIA
Grosse Point, Mich.

Middle Atlantic

David N. Yerkes FAIA
Washington, D.C.

New Jersey

Jules Gregory AIA
Lambertville, N.J.

Northwest

Robert B. Martin AIA
Lincoln City, Ore.

South Atlantic

Bernard B. Rothschild FAIA
Atlanta, Ga.

(Terms expire 1969)

California

Cabell Gwathmey AIA
San Francisco, Calif.

Central States

Rex L. Becker AIA
St. Louis, Mo.

Florida

H. Samuel Krusé FAIA

Illinois

Jack D. Train AIA
Chicago, Ill.

Pennsylvania

G. Harold W. Haag FAIA
Jenkintown, Pa.

Texas

George F. Hartell FAIA
Dallas, Tex.

HEADQUARTERS

1735 New York Ave. N.W.
Washington, D.C. 20006

Executive Director

William H. Scheick FAIA

Secretary to

the Executive Director
Mabel Day

Department of Institute Services

Administrator

J. Winfield Rankin HON. AIA

State, Chapter
& Student Affairs
Raymond L. Gaio

Convention

John R. Carlson

Membership

Maureen Marx

Awards

Marie Gough

Department of Public Services

Administrator

M. Elliott Carroll AIA

Publisher of the JOURNAL

Wm. Dudley Hunt Jr. AIA

Editor of the JOURNAL

Robert E. Koehler

Government Affairs

Philip Hutchinson Jr.

Information Services

Richard S. Stitt

Librarian

George E. Pettengill HON. AIA

Hospital, School
& Theater Programs
Marilyn E. Ludwig

Department of Professional Services

Administrator

Robert J. Piper AIA

Research

Benjamin H. Evans AIA

Education

Richard R. Whitaker Jr.

Professional Practice

Leonard Mayer AIA

Urban Design

Andrew F. Euston Jr.

Technical Programs

Robert J. Cowling AIA

Department of Business Management

Controller

W. G. Wolverton

Chief Accountant

Ronald Panciera

Purchasing & Maintenance

Harry D. Jones

The above is intended to facilitate communications between the membership and the AIA Headquarters and is not a complete staff listing.

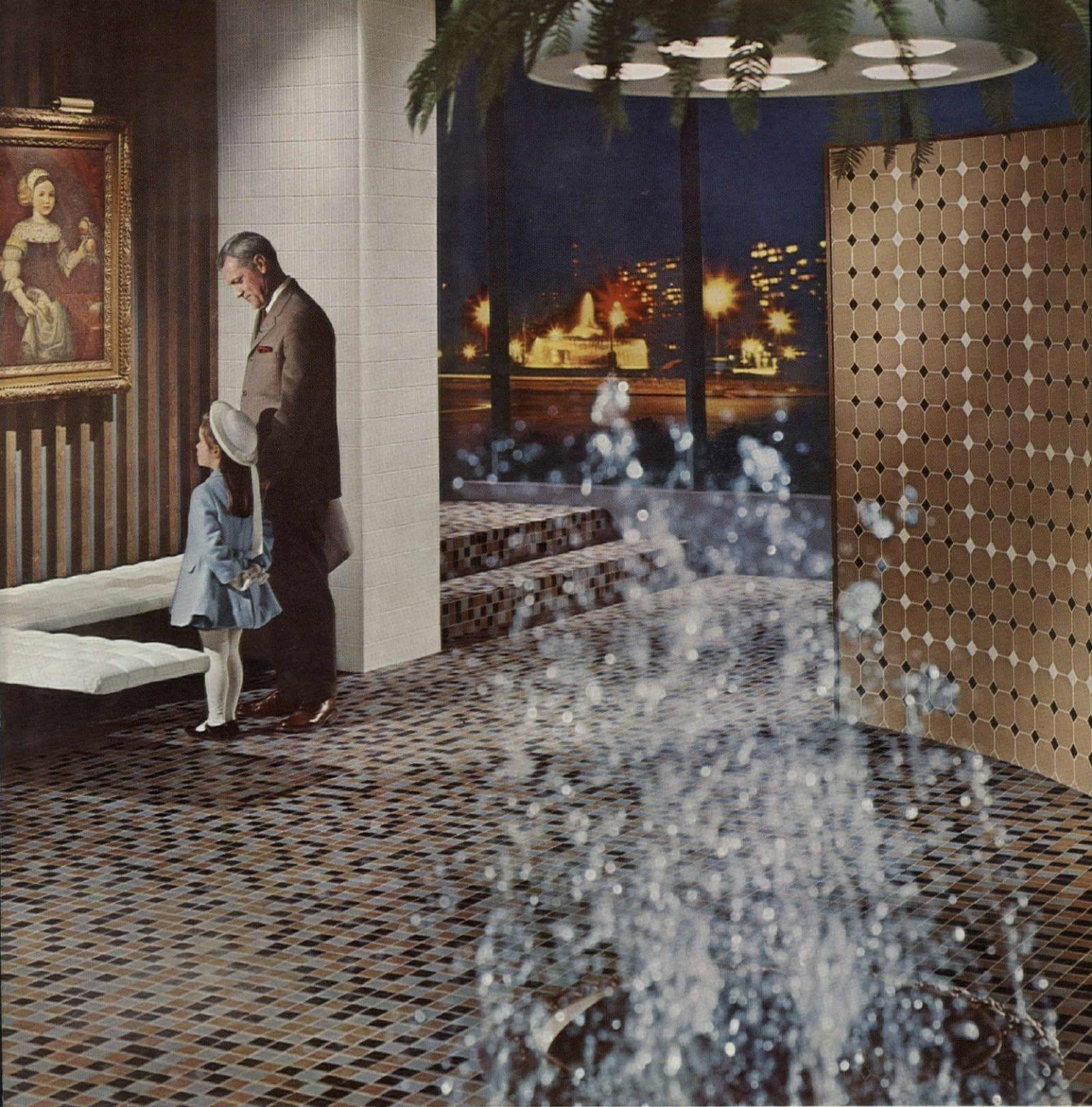

this lobby
says
welcome-
softly-with
ceramic tile

Here's a perfect transition from bustling street to quiet interior—a lobby that's muted in color, low key in mood.

American Olean ceramic tile in subtle colors sets that mood. On the floor, soft browns and blues in an original blend of ceramic mosaics. On the curved wall, soft brown Crystalline tile with discreet black and white accents. Sparkling white Crystalline scored tile highlights the supporting column.

The broad palette of ceramic tile colors available from American Olean lets you capture the mood you want—

whether it's soft and serene or bright and bold. See just how versatile ceramic tile can be. Write for American Olean's full-color booklet "Ceramic Tile in Architectural Design." Booklet 1100, American Olean Tile Company, 1013 Cannon Avenue, Lansdale, Pa.

CERAMIC TILE
**American
Olean**

A subsidiary of National Gypsum Company

For more technical data, circle 217 on information card

COMMENT & OPINION

Fun & Games: What with this the season to be jolly and all, our thoughts turn to less ponderous topics—and we even offer a few end-of-the-year Oscars of sorts. As one architect wrote the other day, in reference to Wilfred Owen's fable which appeared here in October, "How about a little more of this kind of humor in the AIA JOURNAL? It's a delightful thing."

Not only delightful, that piece—"The Fable of How the Cities Solved Their Transportation Problem" delivered at the Urban America conference—is our nomination for a Most Appropriate Speech. It had serious undertones, of course, and we remind our readers that a copy is yours for the asking and that quantity prices are available on request.

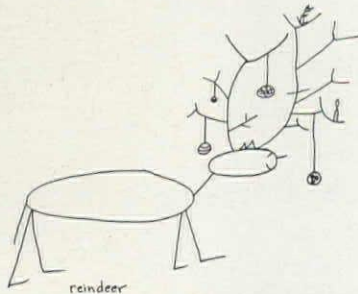

Lessons in Art: For a Most Entertaining Piece of Literature to come across our desk we select "The William Atkin Sketchbook," subtitled "Drawing Animals for Children." It seems to have a certain appeal to kids of various ages because they feel they can create better illustrations than those in the book, samplings from which allow each of you to pass judgement.

The author heads Silvermine Publishers of Norwalk, Conn., which produced Orin Bullock's *A Restoration Manual* (JOURNAL, May '66). An architectural and art editor for many years, Atkin de-



cided to found his own company to publish books of all kinds but with the accent on the humanities. He is the father of four children, "none of whom seems to be developing into an artist."

... A Joy Forever: Getting our nod for a Most Beautiful Book is *Pleasure of Ruins*, written by Britisher Rose Macaulay, with photographs by Canadian Roloff Beny. The 10½ x 14-inch volume contains 160 pages in photogravure, 12 handmounted plates and 29 maps and site plans. It was published in England by Thames & Hudson and has been imported in the United States and Canada for the International Book Society, a division of Time-Life Books.

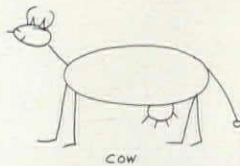

Do-It-Yourself Forecasting: Our candidate for a Most Intriguing Game, ironically, is not being offered for sale at this time. Called "Future," it has limited distribution as a simple form of "teaching machine" by Kaiser Aluminum & Chemical Corp. in keeping with a total corporate program for the year.

During the course of the game, players explore 60 possible events of the future and learn what experts consider to be the probability that they will occur by 1986. They also become aware of how the occurrence of one event, or its failure to occur, may affect other happenings in the game.

One of the many unique aspects to the individual pieces making up "Future" is the use of a plastic 20-sided die—an icosahedron, if you please—governing the chance element.

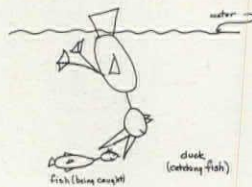

Colorado's Poet Laureate: In the field of personalities, we cast a vote for Thomas Hornsby Ferril, whose "Magenta" was published in last June's JOURNAL, as a Most Distinguished Poet. The poetry which he read at a luncheon during the annual meeting of the National Architectural Registration Boards in Denver appears in *Words for Denver and Other Poems*, just published by William Morrow & Co. of New York. Ferril's personal environment and heritage—the Rocky Mountain West—are an integral part of his poetry. He is a true poet, deeply

rooted in his surroundings, yet concerned with their universal applications. About him no less a man than Robert Frost has written: *A man is as tall as his height Plus the height of his home town. I know a Denverite Who, measured from sea to crown, Is one mile five-foot-ten, And he swings a commensurate pen.*

Way-Out Communications: For a Most Unique Press Conference we pick a long-distance Picturephone hookup between New York City and Washington, D.C. on the problem of air pollution. Bell Telephone reported it was the first such conference held, but the sponsor—the Electric Heating Association—hastened to add that it is "not treating it as a gimmick" and hopes to use the technique more in the future as the situation presents itself.

For the initial event, which tied in with "Clean Air Week," the guest speaker was Joseph W. Mullan, director of air pollution control, National Coal Association.

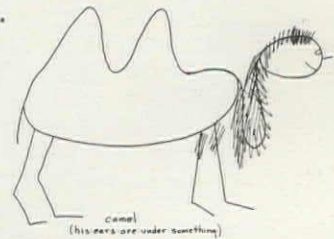

Horse-and-Carriage Trade: Finally, getting on to buildings, we acknowledge a Most Unusual Planning Problem in the Mackinac Island branch of the First National Bank, St. Ignace, Mich. The architects for the temporary facility—actually a mobile trailer office—had to establish the proper height for a trot-in banking window since autos are forbidden on the island, a familiar spot for the Michigan Society of Architects. The "office" was floated from St. Ignace by barge, then hauled by horsepower to its site.

Thus a hitching rack has replaced

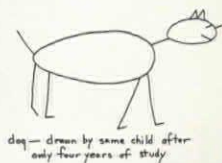

the usual parking lot, and it is even rumored that the management promised two lumps of sugar to each horse bringing a new customer to the bank on opening day.

ROBERT E. KOEHLER
Editor

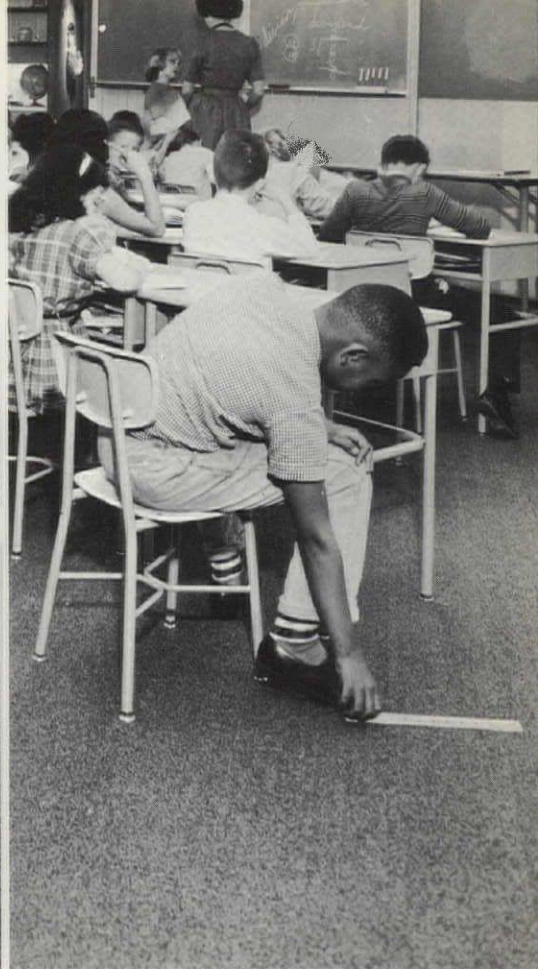
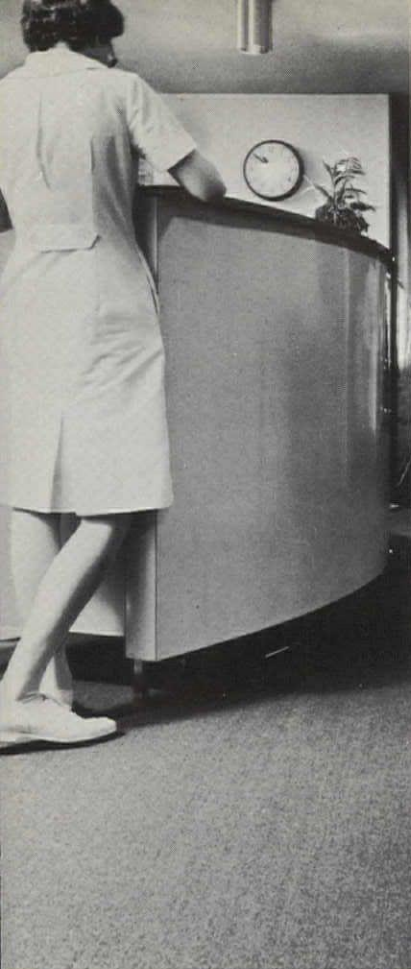

Here's DENSYLON— the new floor covering that's obsoleted tile and carpet for high-traffic areas

Engineered for commercial use with A.C.E.† nylon

Not only is our revolutionary new DENSYLON* different than any other kind of floor covering—it's *better*.

Better for *every* area of *every* kind of building—schools, hospitals, offices, restaurants (even restaurant kitchens!).

Easier maintenance is one reason. Dirt, grime, or soil can't penetrate DENSYLON's extra-tight-twist, high-density nylon pile. Any kind of spillage—fruit juice, honey, even hot grease—wipes right off with a damp sponge. DENSYLON vacuums clean as new with half the strokes required by carpet. And the savings on never having to scrub or wash or wax a bare floor will pay for a DENSYLON installation in just a few years!

Superb appearance is another reason. DENSYLON comes in a broad range of handsome colors and patterns. It has all the warmth and luxury of carpet—but none of its disadvantages. And, unlike tile, DENSYLON can't be marred, or scratched, or dented. Even by spike heels or heavy fixtures.

For comfort and quiet, DENSYLON is permanently and integrally bonded to a 3/16" B. F. Goodrich sponge-rubber backing (note—that's *sponge*, not foam.) It carries a lifetime guarantee. DENSYLON can never ripple or buckle. *Big benefit:* when things (or people) fall, they land on a *cushion*.

Finally, there's wear. Or rather, *no wear*. Because *no DENSYLON installation has ever worn out*. Even at the G.E. World's Fair Exhibit where 15 million people trudged over DENSYLON. DENSYLON can be put in the heaviest traffic areas without showing "traffic lanes."

CCC is the world's largest exclusive manufacturer of commercial carpet. We make miles and miles of conventional carpet. Every fiber, every construction. For those areas that require conventional carpet, we recommend it. Now we're making miles and miles of DENSYLON. For where tile used to go. For where carpet never could.

We have the industry's largest staff of

floor-covering specialists out in the field. One of them will be happy to explain why revolutionary new DENSYLON is making everything else obsolete. Or, we'll mail you the facts. Use the coupon. Now.

*CCC's trademark for its sponge-bonded, high-density nylon carpet

CCC
10 West 33rd Street
New York, New York 10001 Dept. AIA-12.
Attention: Mr. Oliver A. Wyman

- Send facts on revolutionary DENSYLON.
 Have representative give us estimate on approximately _____ square yards.

Name _____

Title _____ Phone _____

Organization _____

Address _____

City _____ State _____

†Trademark: Allied Chemical Corporation

Densylon

MANUFACTURED BY CCC WITH A.C.E. NYLON

...for every architect's library

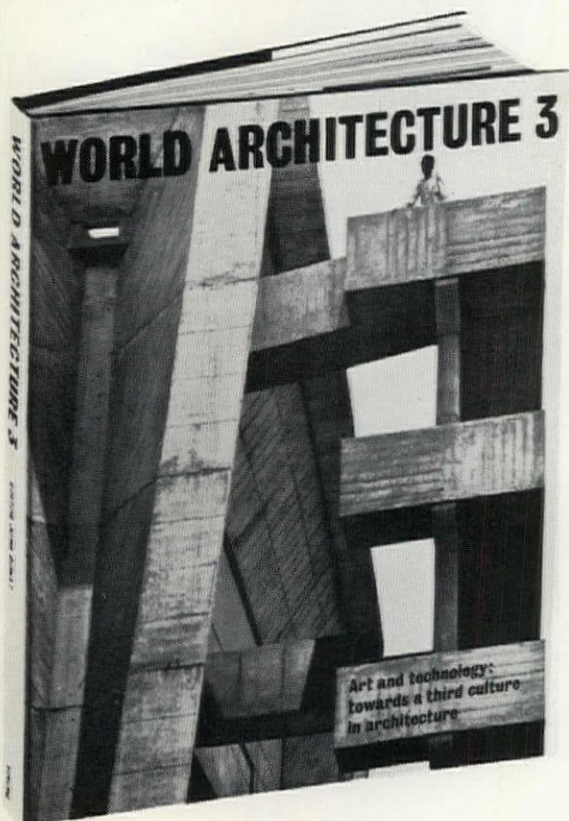

WORLD ARCHITECTURE 3

Edited by JOHN DONAT

The first volume in this splendid series to be devoted to a general theme—the schism developing between “art-architecture” and “system architecture.” Taken from fifteen countries, the handsome photographs and architectural drawings illustrate the many possible approaches to a reconciliation. The wide variety of interpretations includes a cathedral in Tokyo, a factory in Finland, and the designs of students in England and Ghana. This issue also contains a vigorous study of the recent work of B. V. Doshi in India, an essay by Aldo van Eyck, and a long overdue appreciation of the work of the Swedish architect, Sigurd Lewerentz—a “lost” master of the modern movement.

More than 480 illustrations, 8½" x 11" \$16.50

Also available:

WORLD ARCHITECTURE 2 \$15.00
WORLD ARCHITECTURE TODAY \$15.00

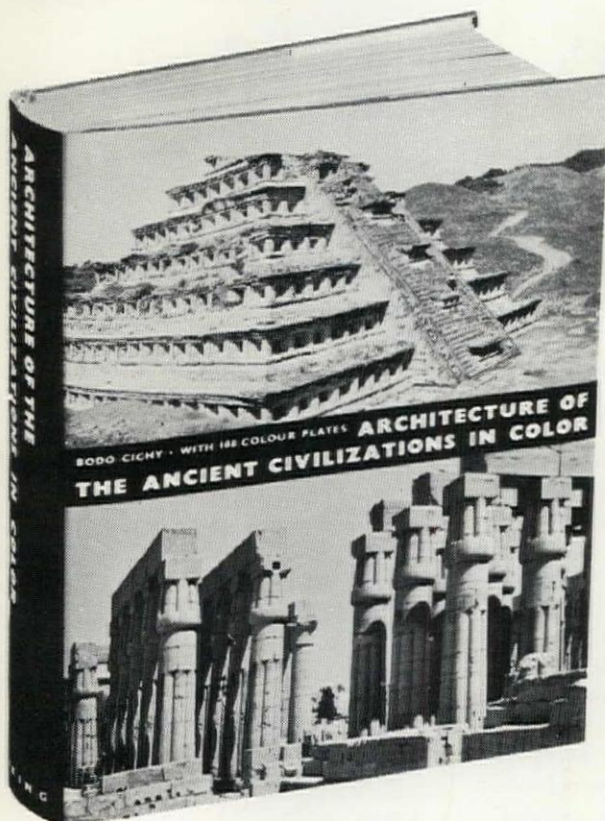

ARCHITECTURE OF THE ANCIENT CIVILIZATIONS IN COLOR

by BODO CICHY

Additional texts by Emma Brunner-Traut, Sibylle von Cles-Reden, Franz Fischer

This magnificent big book with its 108 full-page color plates is a living guide to cultural history and an authoritative study of early building and design. It carries the reader on a fascinating voyage of discovery from ancient Sumer, Babylon, Assyria, Dynastic Egypt, and through the Mediterranean lands. It tells of the Hittites, Minoan Crete, Mycenaean Greece, the Etruscans and the builders of the Megaliths. Beyond Europe and the Near East, are the ancient buildings of the Indus Valley and the astonishing creations of the early dwellers in Central America. An amazingly beautiful book, as well as an extremely important one.

108 full-page color plates, 8¾" x 11" \$25.00

THE VIKING PRESS, 625 Madison Avenue, New York, N.Y. 10022

THE RONZONE SCHOOL

first to employ the new plastic space

The first school to open its doors, following the "space versatility" concepts of SCSD*, is in Clark County, Nevada—not California! This first educational "space-age" building is Bertha Ronzone Elementary School, by Julius Gabriele, A.I.A., Las Vegas, a 46,700 sq. ft. structure completed July 21, 1965, 17 days ahead of schedule.

The key to the swift completion was Butler Space Grid™—the integrated structural-mechanical system developed by a consortium of national building component manufacturers**.

The unique Space Grid structural system achieves long-range performance advantages for all its mechanical systems. Advantages like integral support for the ceiling/lighting systems; extensive through-ceiling air entry and exhaust system allowing easy relocation of diffusers; and anchorage for movable partitions. Maximum rearrangement potential of partitions does not compromise these high environment standards.

Space Grid offers many options beyond SCSD specifications, which make it applicable to a considerably wider spectrum of requirements and end uses. See Sweets File 2A/Bu. Or write Architectural Systems Department, Butler Manufacturing Company, 7601 East 13th Street, Kansas City, Missouri 64126.

*SCSD is the School Construction Systems Development project of the Educational Facilities Laboratories.

**Consisting of Butler Manufacturing Company, E. F. Hauserman Company, Lennox Industries Incorporated, Owens-Corning Fiberglas Corporation, and other cooperating manufacturers.

™Space Grid is a trademark of Butler Manufacturing Company.

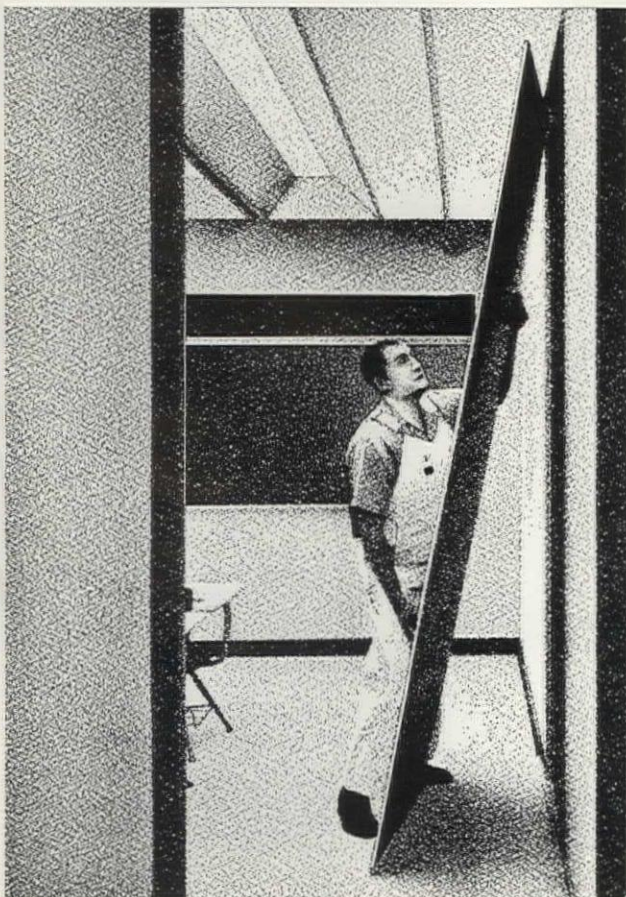

NEWSLINES

What Can We Say . . .

Sen. Harrison A. Williams Jr. (D-N. J.) late in the 89th Congress introduced a resolution to create a standing Committee on Urban Affairs. The resolution was never voted on, but the senator, who will reintroduce the proposal in the 90th Congress, presented a notably rugged argument.

—There is no formal committee of this body with exclusive jurisdiction over the life of our cities. Jurisdiction over urban affairs is scattered through half a dozen committees.

—The harried citizen of our overcrowded city has no place to turn in the Congress to plead his case.

—I do think that the affairs of our cities deserve to be treated as more than a sidebar operation of a major committee.

—These programs [highway, urban renewal, etc.] as well as air pollution, water pollution and mass transportation deserve to be treated as a whole. We need one committee which can aim a rifle shot at the problems of our cities . . .

—The Congress cannot ignore one of the basic facts of life—we are an urban nation.

—To perform its task, to survive and to grow in the internecine jungle warfare of downtown bureaucracy, it [Department of Housing and Urban Development] needs the assistance and support that only a full standing committee can give.

—Our order of priorities and values is seriously out of kilter if we spend more time on the beauties of pure scientific research than we do on the ugliness and the deprivation that scar and destroy the lives and happiness of the city dweller.

—What can we say of our own civilization if we allow these magnets for human ambition and hope [the cities] to become barren prisons of despair, locking out the sunlight and crushing the joy of living, in smog, squalor, and slums.

All Missions Accomplished in Initial Year, Weaver Tells President as HUD Celebrates Birthday

"I am proud to report," Robert C. Weaver told President Johnson, "that we have accomplished these missions."

The missions, reported the Secretary on the first anniversary of his Department of Housing and Urban Development, were to reorganize

five semiautonomous agencies into a cohesive whole, to set up the administrative machinery for new programs, to participate in the creation of further new programs and at the same time "maintain existing programs . . . in spite of the physical and administrative changes accompanying reorganization."

Weaver said in the report that Model Cities (formerly Demonstration Cities) and Metropolitan Development "are the most dramatic programs" of the new ventures.

"Model Cities," he said, "will bring together in a single package many existing federal aids and will provide a new and flexible supplemental grant."

"Through this program the cities can deal simultaneously with the gamut of physical, economic, social and human problems of the slums. Metropolitan Development will use a similar technique—a number of existing federal aids, as well as supplemental grants—to encourage localities to work together to bring order and coherence to the spreading metropolis. The new communities provisions offer the opportunity to experiment with entirely new kinds of urban settlements."

Mr. Johnson in his message on the anniversary said the department

Continued on page 19

Transportation's Birth Follows HUD by Year

The nation now has a Department of Transportation, second new department to be created in a year, and Alan S. Boyd is its head.

Government programs to improve transportation in urban areas remain with the Department of Housing and Urban Development, as urged by the AIA.

The new department will be without jurisdiction in several areas in which it might be expected to have regulatory powers, but it will have complete responsibility for travel safety.

It is a somewhat loose collection of more than 30 agencies including the Bureau of Public Roads and the Federal Aviation Agency.

Boyd, 44, is a lawyer who has been in the federal government since 1959. Last year President Johnson named him Under Secretary of Commerce for Transportation.

HUD's new home, to be ready for occupancy next fall.





makes products
better for you

outdoors inside at Notre Dame's new Center for Continuing Education



Whether the central court in the new Center for Continuing Education at the University of Notre Dame divides the building in two or joins two buildings together is a moot question. Either way, the court provides a pervading feeling of spaciousness and freedom—an ideal environment for relaxing between concentrated sessions of study in the Center's many seminar rooms.

A unique design feature is the porcelain enamel fascia, which flows from the exterior of the building right through the court. The rich earth-tone brown porcelain fascia above the second story of the court contrasts with the columns, and blends with stair railings, window frames, and trim.

On the building exterior, porcelain enamel window spandrels in the same rich tone as the fascia provide accents for the buff color brick walls. Brick walls were selected to harmonize with adjacent campus structures.

Enhance and accent the important design features of your buildings with imaginative use of porcelain enamel on Armco Enameling Iron. Porcelain enamel is available in the twenty-four NatureTone colors in matte finish—as well as hundreds of other colors in both matte and glossy finish. Whatever the colors or applications, you can depend on leading porcelain enamellers to supply you with the finest quality architectural porcelain. For their names or more information, write Armco Steel Corporation, Dept. E-3436, P.O. Box 600, Middletown, Ohio 45042.

Continuing the fascia from the exterior through the center court helped the architect achieve a feeling of space and freedom within the court.



ARMCO STEEL 

► Victor Hornbein AIA of Denver was named chairman of the Committee on Environmental Design of the Colorado Council on the Arts and Humanities.

► Andrew T. Kostanecki, industrial designer of New Canaan, Conn., is the recipient of the 1966 Alcoa Industrial Design Award for his design of "The Hideout," a portable vacation house and "notable achievement in the imaginative and effective use of aluminum."

► Earl F. Bennett, manager for architectural sales, Koppers Co., Inc., of Pittsburgh, is the new president of the Producers' Council.

► Vice President and Mrs. Hubert H. Humphrey have moved into a two-bedroom apartment in Washington's Southwest after selling their modest Maryland house. Harbour Square, the cooperative townhouse and apartment complex that is their new address, was designed by Chloethiel Woodard Smith FAIA.

► Past President Morris Ketchum Jr. FAIA has been named a Cheva-

lier de l'Ordre des Arts et Lettres, highest honor bestowed by the French government in the field of humanities, for his "international leadership in the architectural profession, creative accomplishments in the field of urban design, and high esteem in which he is held by his professional counterparts in France." He is the first American architect to be so honored.

► Charles Luckman FAIA was presented by Los Angeles Beautiful with a 1966 Community Award for "excellence in landscaping and other exterior contributions"—a reference to the new three-story headquarters of Charles Luckman Associates on Sunset Boulevard.

► Norman DeHaan AIA of Chicago has been appointed a member of the National Accessions Committee of the US Department of State's The Art in the Embassies Program.

James M. Hunter Heads Honor Awards Jury

Institute Director James M. Hunter FAIA of Boulder, Colo., is chairman of the 1967 Honor Awards Jury.

Serving with him on the panel to select architects for the nation's highest professional recognition are:

R. Max Brooks FAIA, Austin, Tex.; Vladimir Ossipoff FAIA, Honolulu; Joseph N. Smith AIA, Atlanta; and Philip Will Jr. FAIA, Chicago.

Director David N. Yerkes FAIA of Washington, D. C., will serve as adviser to the jury, which meets in Washington Feb. 15-17. Yerkes was the 1966 chairman.

education

Syracuse Gets Papers Tracing Work of Breuer

Marcel Breuer FAIA has given Syracuse University drawings and manuscripts that trace his work from 1934 to 1953.

As part of the Syracuse University Manuscript Collections, the Breuer papers will be available to the students and faculty of the School of Architecture as well as to researchers and scholars interested in architectural history, development and trends. The collection consists of more than 20,000 items.

► Pietro Belluschi FAIA, former dean of the MIT School of Archi-

Continued on page 25



A NEW CONCEPT IN FOLDING CHAIRS! *it doesn't fold.*

We're not trying to confuse you. It's just that when you learn the price of the new 26 ECON-O-STAK® Chair, you'd think it was a folding chair. But how many folding chairs do you know are attractive, comfortable, durable, lightweight, easy to handle and safely stack 26 high within easy reach? The ECON-O-STAK's flexible, thermoplastic seat assures individual comfort ... and it's guaranteed for five years. You can store 500 ECON-O-STAK chairs in a room 10' x 10'. For the same money you could buy a folding chair. But be careful...you might get pinched.

Write for information on the new 26 ECON-O-STAK chair today!

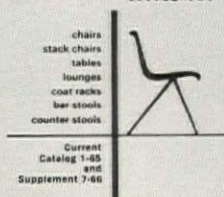

COMMERCIAL FURNITURE IN ADVANCED DESIGN

fixtures Mig. Corp.

1642-V Crystal ■ Kansas City, Missouri 64126

For more technical data, circle 225 on information card

Life
of
luxury...
610
feet
above
everybody!

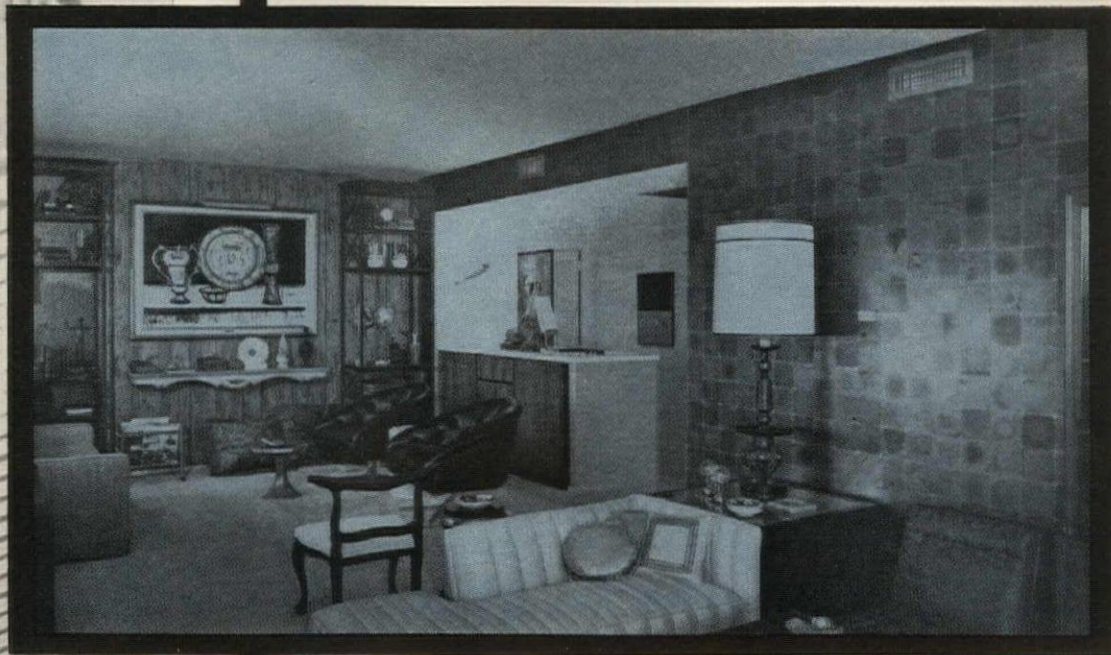

Tenants in the world's tallest apartment building, 1000 Lake Shore Plaza on Chicago's Gold Coast, get the best of everything . . . including *Bohn-Aire* heating and cooling. ■ Each tenant enjoys his own dual zone system with thermostatic control and choice of heating or cooling in each zone. ■ Baseboard radiation blankets outside walls and window areas, providing required heat until weather goes below freezing. Then, the *Bohn-Aire* system, with its steam reheat coils, furnishes the

balance of heat needed to maintain perfect comfort. ■ For cooling, chilled water is supplied to each apartment's individual air handling unit. Zone thermostats in the sleeping and living areas operate modulating steam valves on the zone reheat coils to maintain desired temperatures. ■ *Bohn-Aire* apartment units are designed with quietness in mind, with slow speed double inlet, double width fans sized to operate against external static pressure. Capacities: 200 CFM to 2,000 CFM. ■ Request Bulletin 461 from your BOHN rep, or write:

BOHN

ALUMINUM & BRASS COMPANY

Heat Transfer Division • Danville, Illinois

A DIVISION OF UNIVERSAL  AMERICAN CORPORATION

1000 LAKE SHORE PLAZA

Consulting Architects: Sidney H. Morris & Assocs.
Consulting Engineers: Nachman, Vragel & Assocs.
Ventilation Contractor: Pullman Sheet Metal Works, Inc.
Heating Contractor: Wm. Adams Engineers Inc.

IBM



LCN

for modern door control

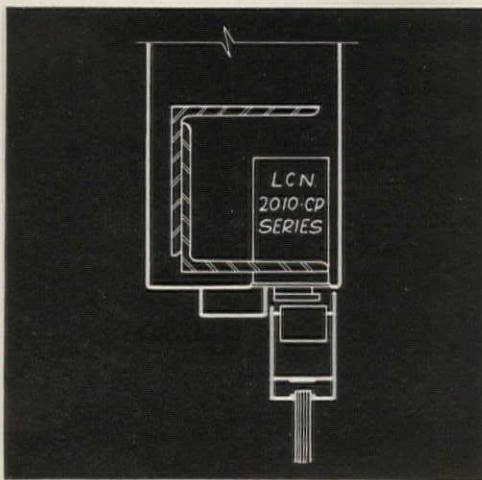

Detail at head for LCN overhead concealed closer installation shown in photograph

Main points of the LCN 2010 series closer:

- 1 Provides efficient, full rack-and-pinion, complete control of the door
- 2 Fully hydraulic, with highly stable fluid giving uniform operation over a wide range of high and low temperatures
- 3 Easily adjustable general speed, latch speed, back-check and spring power (may be increased 50%)
- 4 Closer arm disappears over door in closed position
- 5 Available with regular or hold-open arm (choice of 85°, 90°, 100° or 110°)

Full description on request
or see Sweet's 1966, Sec. 19e/Lc



LCN CLOSERS, PRINCETON, ILLINOIS
A Division of Schlage Lock Company

Canada: LCN Closers of Canada, Ltd.
P. O. Box 100, Port Credit, Ontario

PHOTO: IBM Office Building, Seattle, Washington.
Architects: Naramore, Bain, Brady and Johanson,
Seattle; Minoru Yamasaki and Associates, Birmingham,
Michigan.

766

Newslines from page 22

ecture and Planning, has been named consulting architect at Princeton University, succeeding the late Douglas W. Orr FAIA.

Princeton's faculty this year includes representatives of two of the world's outstanding architectural schools—the Bartlett School of London and Ulm, Germany's Hochschule für Gestaltung. They are Robert Maxwell, senior lecturer at Bartlett, and Tomas Maldonado, Hochschule director since 1964.

► Applications for the \$6,000 Brunner Scholarship must be submitted by Jan. 15. Forms are available at the headquarters of the New York Chapter AIA until Jan. 1.

► For the past 11 years senior students in architectural design at Clemson University have devoted their efforts to the preparation of intensive creative proposals for the revitalization of South Carolina communities. This year's efforts are focused on two contrasting projects, the city of Lancaster and the South Carolina State Fairgrounds at Columbia.

Schmidt Gets GSA Job On Permanent Basis

William A. Schmidt has been appointed commissioner of public buildings in the General Services Administration, a position he had been holding on an acting basis since the resignation of Casper Hegner AIA.

Schmidt was graduated from Marquette University, where he studied civil engineering, in 1934. He entered the federal government in 1935 and has been with GSA since 1941.

He was deputy commissioner to Hegner who resigned to return to the Veterans Administration where he is technical assistant to the assistant administrator for construction.

Four Firsts Awarded For Product Data

Four first prizes were won in the architects' division of a product literature and advertising awards competition held in New York last month.

The contest was sponsored by
Continued on page 28

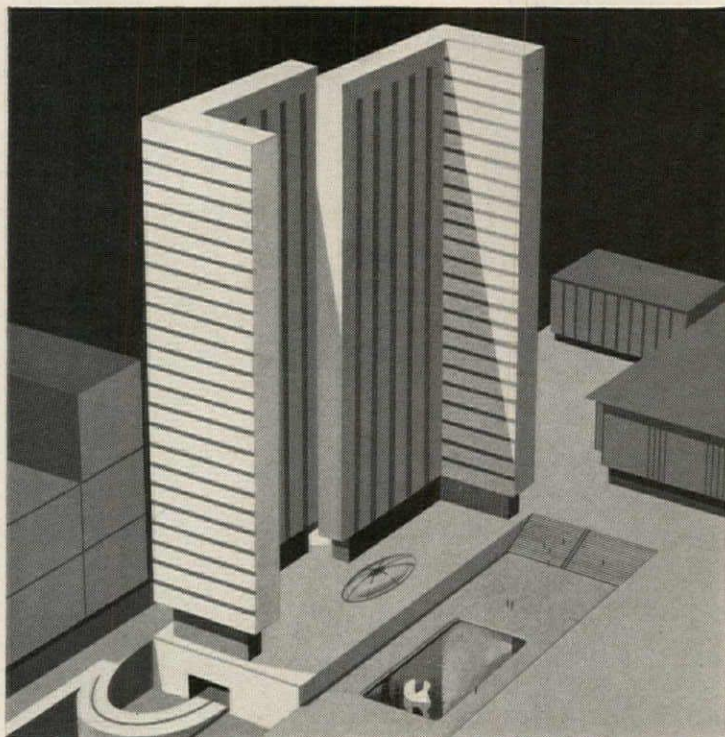

Modern businesses need such up-to-date communications as television, data transmission, teletypewriter, Tele-Lecture, and complex telephone systems.

These complex communication services are essential not only in office buildings but in all types of major buildings—plan for them in the blueprint stage. You'll avoid costly alterations and unsightly wiring later.

Just call your Bell Telephone Business Office and ask for the Architects and Builders Service.

AT&T  **Bell System**
American Telephone & Telegraph
and Associated Companies

For further information on communications planning,
see Sweet's Architectural File 33a/Be
and Sweet's Industrial Construction File 19f/Be.

For more technical data, circle 228 on information card

For more technical data, circle 229 on information card ►

The
beauty

of **SOLID BRASS HARDWARE**

...a long life feature of
Weis Toilet Compartments



This new wrap-around keeper, with its rubber tipped bumper, is designed for long, trouble-free service. Solid brass plus the brilliant beauty and protection of chromium plate.



WEIS

HENRY WEIS MFG. CO.
ELKHART, INDIANA

*Write for Catalog
See Weis in Sweet's*

The Time to Stop Roof Leaks is BEFORE THEY START!

Roof leaks that develop following building completion are costly and troublesome. Sometimes the roofing membrane itself leaks, but more often the leaks occur at the junction of the roofing with the metal gravel stops or flashings. Normally two felt strips are used to seal the junction between the gravel stop and the roofing membrane to prevent leaks. All too often, these felt strips crack and break open due to the expansion of the metal underneath. Leaks develop immediately. This is a common experience with extruded or plain metal that expands or contracts in its entirety at junction with the roofing.

Cheney Gravel Stop, with its $\frac{3}{16}$ " deep cross corrugations, is nailed solidly to the roof every 4 inches, preventing unbridled lateral movement at the roof flange. Expansion is controlled in these small 4-inch segments and completely absorbed in the small cross corrugations. There is no cracking of the felt strips . . . and consequently no leaks.

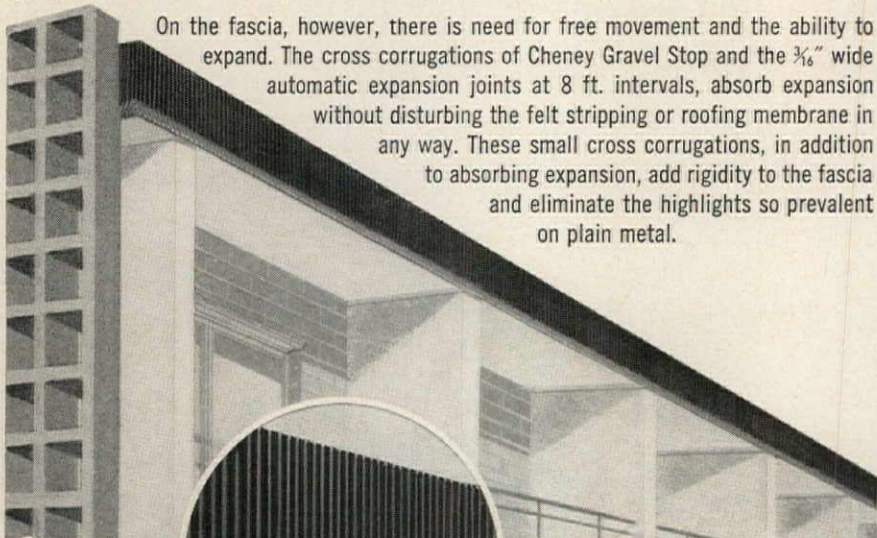

On the fascia, however, there is need for free movement and the ability to expand. The cross corrugations of Cheney Gravel Stop and the $\frac{3}{16}$ " wide automatic expansion joints at 8 ft. intervals, absorb expansion without disturbing the felt stripping or roofing membrane in any way. These small cross corrugations, in addition to absorbing expansion, add rigidity to the fascia and eliminate the highlights so prevalent on plain metal.

TYPE 7" in BLACK

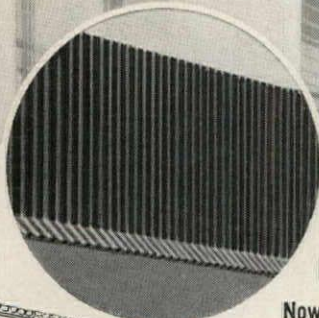

NEW! GRAVEL STOP in BLACK, RED, CREAM & GREEN as well as WHITE

Now you can specify Cheney Aluminum Gravel Stop in the color most complimentary to your building and its environment. You also have a choice of aluminum, Chinc, copper and stainless steel in mill finishes.

Cheney Gravel Stop is factory-prefabricated with built-in expansion joints and concealed splice plates. Deep $\frac{3}{16}$ " corrugations give extreme rigidity, eliminate exposed cover plates and highlights. Low in both material and installation costs. Made in one-piece fascias 3" to 7" and two-piece fascias 8" to 12". Made of Chinc No. 20 oz; aluminum .032"; stainless steel .018"; copper 16 oz. and of aluminum .032" in 5 standard colors: Cream No. 101, Green No. 102, Black No. 103, White No. 104, and Red No. 105. Samples, color chart, catalog, prices, and technical assistance will be furnished promptly upon request. Write or phone today.

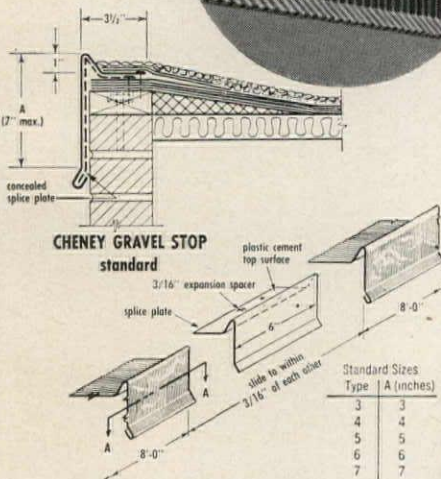

Standard Sizes	Type	A (inches)
3	3	3
4	4	4
5	5	5
6	6	6
7	7	7

Consult Section 8g/Che in Sweet's, or write to us direct.

CHENEY

FLASHING COMPANY Established 1928

623 Prospect St., Trenton, New Jersey 08605 Phone 609 394-8175

For more technical data, circle 230 on information card

Newslines from page 25

the Committee for Construction Industry Product Literature.

American Saint Gobain Corp. placed first in the space advertising category, Portland Cement Association was first in promotional literature, and Armstrong Cork Co. and United States Gypsum Co. each won a first award in the category of manufacturers technical literature.

There were no first awards in producers association technical material and no awards of any kind for maintenance literature.

In all, there were 21 prizes given in the architects division, the four firsts, nine seconds and eight thirds. For all divisions (engineers, etc.) award winners numbered 64.

The competition was sponsored by the AIA and five other organizations making up the newly formed Committee for Construction Industry Product Literature. They are the Consulting Engineers Council, National Association of Home Builders, National Lumber & Building Material Dealers Association, Producers Council and Sweet's Construction Catalog Services. ■

NECROLOGY

- BOETTCHER, HENRY
Lancaster, Pa.
- CARSWELL, ROBIN B.
Ft. Madison, Iowa
- DALEY, JAMES ALAN
San Francisco, Calif.
- GERHARDT, JR., PAUL, FAIA
Chicago, Ill.
- JONES, SAMUEL OTHO
Chicago, Ill.
- KAPLAN, SOLOMON
New Haven, Conn.
- KRUCKEMEYER, EDWARD
Cincinnati, Ohio
- LOGAN, FRANK
Pierceton, Ind.
- MEEKS, CARROLL L. V.
Hamden, Conn.
- MOSS, LESLIE E.
Cincinnati, Ohio
- NORDHEIM, HENRY
Bronx, N.Y.
- O'CONNOR, BEN HILLIARD
Glendale, Calif.
- ROSENBERG, ROBERT HAYS
New York, N.Y.
- ROBB, JOHN WESLEY
Tulsa, Okla.
- WILLIAMS, ALBERT ROOKER
San Francisco, Calif.

G-E Silicone Traffic Topping permanently hides unsightly surfaces, permanently protects new ones.

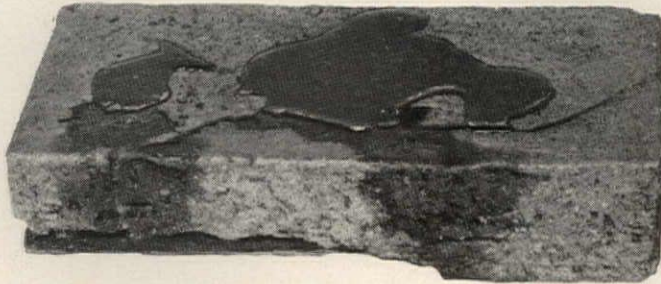

Waterproof. Traffic Topping prevents water penetration and moisture retention damage in concrete and other flooring construction materials. Protects against freeze-thaw cycles. Repairs previous damage. Ideal for outdoor ramps, platforms, walks, and traffic bearing roofs.

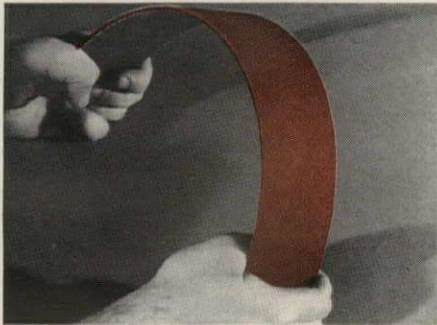

Permanently flexible. Made of silicone rubber, Traffic Topping keeps its resilience indefinitely. Won't harden, soften or become brittle, even at -65°F or 300°F . Provides a cushioned walking surface as it protects.



Wear resistant. Traffic Topping withstands wear and abrasion of shoes and vehicles. It's a superior surfacing medium for parking areas, garages, promenade decks, and light duty industrial floorings.



Quick, easy application. Traffic Topping adheres securely to most clean flooring construction materials, old or new. Needs no costly equipment. Cures to a tough, weatherproof surface. Looks great too. Six colors available.



Skidproof, too. Even when wet, Traffic Topping's textured surface assures safe, sure traction where it's needed most: pool copings, laundry rooms, public walking areas, tennis courts. And it even makes non-skid stair treads.



Fights chemicals. Because Traffic Topping resists many chemicals, organic acids, alkalis, salts and oils, it is an ideal surfacing medium for food processing and similar plants, where such materials present a problem.

For complete information and your distributor's name, write Section EA12248, Silicone Products Dept., General Electric Company, Waterford, N. Y. 12188

GENERAL  ELECTRIC

A 1939 Standard for a 1966 World



IN OCTOBER the AIA presented a paper to the General Accounting Office recommending repeal of the statutes which limit A-E fees on government work to 6 percent of estimated construction cost. If our recommendation is adopted by the Congress there will be a substantial improvement in A-E fees for some types of that work.

The original legislation which created the 6 percent fee limitation on A-E services was passed in 1939 during urgent Congressional consideration of vitally needed naval and military construction. It was part of major appropriations bills designed to bring our armed services to a readiness status, and authorized the utilization of outside architectural and engineering services by the armed forces, without regard to competitive bidding statutes, because they did not possess and could not economically maintain in-house capabilities in these areas.

For almost three decades, a fee limitation which was intended at the time of its adoption to compensate architects and engineers in a fair manner—comparable to the compensation prevailing in private industry—has been mechanically retained in succeeding military and civilian legislation, even though it no longer fulfills its original purpose.

Last summer the 89th Congress directed GAO to undertake a comprehensive governmentwide analysis of interpretations and applications of A-E contract limitations and to report findings and recommendations to Congress by January 1, 1967. GAO's study came about because the National Aeronautics Space Administration requested a waiver from the statutory fee limitation on the grounds that

a 6 percent limitation is unrealistic for high-risk space projects. Congress, reluctant to grant NASA a special exemption, asked GAO to determine whether other government agencies were having similar problems with the limitation.

Realizing the importance of GAO's study, Institute President Nes contacted the comptroller general and offered to document the experience of architects working under the 6 percent proviso. The comptroller general responded by suggesting that we not only describe our experience but also submit written comments explaining what action we believe the Congress should take with regard to the limitation.

After documenting the lack of Congressional inquiry in over 27 years, we recommend repeal of the limitation on A-E fees since it no longer serves the best interests of the government or the profession. We offered argumentation along the following lines:

- The 6 percent limitation, based on a 1939 standard, does not apply to today's complex buildings and does not reflect the cost of providing architectural services. One might assume that, since the limitation is based upon estimated construction cost, as the construction cost goes up, the architect's fee increases proportionately. Unfortunately, this assumption is fallacious for two reasons: first, the cost of providing architectural services has risen faster than the cost of construction; second, the limitation has no bearing on the nature of services rendered.

- Architects are suffering losses on some types of government work and are reluctant to accept future jobs unless fairly compensated.

- Because of the limitation, the government is losing some of the best talent—a situation which is likely to become aggravated.

- The limitation may force a reduction in design and research effort which in turn may drive building costs higher.

No doubt the establishment of a maximum fee limitation on A-E services had considerable appeal to members of the 1939 Congress concerned lest the government be overcharged. But we pointed out to GAO that there is little likelihood of this for several reasons:

- Charging excessive fees is against an architect's code of ethics.

- Government negotiators are familiar with prevailing fees for comparable work and an attempt to demand larger fees would be unsuccessful in view of competitive conditions.

- Federal law requires "truth in negotiating" with the right of the government (in contracts expected to exceed \$100,000) to adjust the fee *downward* if cost or pricing data furnished at the time of contracting was inaccurate.

- Post-audit provisions of federal law would quickly spot excessive fees.

Our final recommendation was that a comprehensive review of federal construction practices should be undertaken and that an effort should be made to establish uniform procedures throughout all agencies. It is our contention that a uniform government construction policy would eliminate many of the nonproductive hours and outdated practices now associated with government work.

While we are not unmindful of the works of Lewis Carroll and realize the pitfalls of over-optimism, nevertheless we believe GAO will buy our recommendation that the 6 percent limitation on A-E fees should be repealed, and we expect the 90th Congress will act accordingly.

PHILIP HUTCHINSON JR.

Director, Governmental Affairs



The Low Cost of the Long View

The unparalleled beauty of Hauserman Engineered Wall Systems, such as the Signature partition shown here, reflects an appreciation of value. Their recognized sound control and full function, however, are only part of the story.

A lifetime financial bonus appears on closer examination of the facts. Hauserman Systems are fully movable. The entire wall, or full floors of it, can be relocated, cleanly and quickly, when the need arises. The inevitable interior layout changes, over the life of the building, are resolved at a fraction of the cost of destroying and rebuilding fixed

walls. A return of 8% or more each year on the partition investment is the Hauserman movability bonus. For the full story, write today for "The Low Cost of Quality." The E. F. Hauserman Co., 5855 Grant Ave., Cleveland, Ohio.

HAUSERMAN

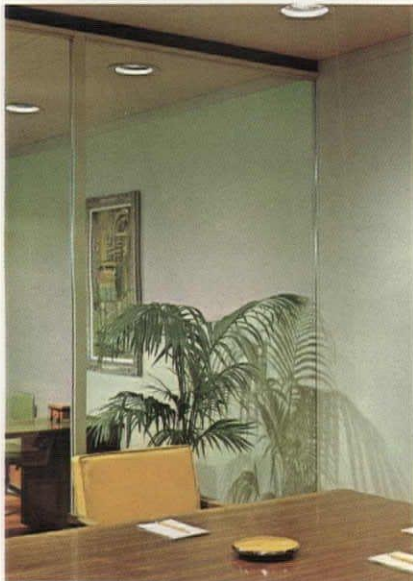

Had the soffits and fascias in the Nashville Library been installed in the conventional way, heavier material would have been required, along with a more massive supporting structure to take the weight. Thin marble on Zibell struts saves weight, saves cost.

TAYLOR and CRABTREE, Architects

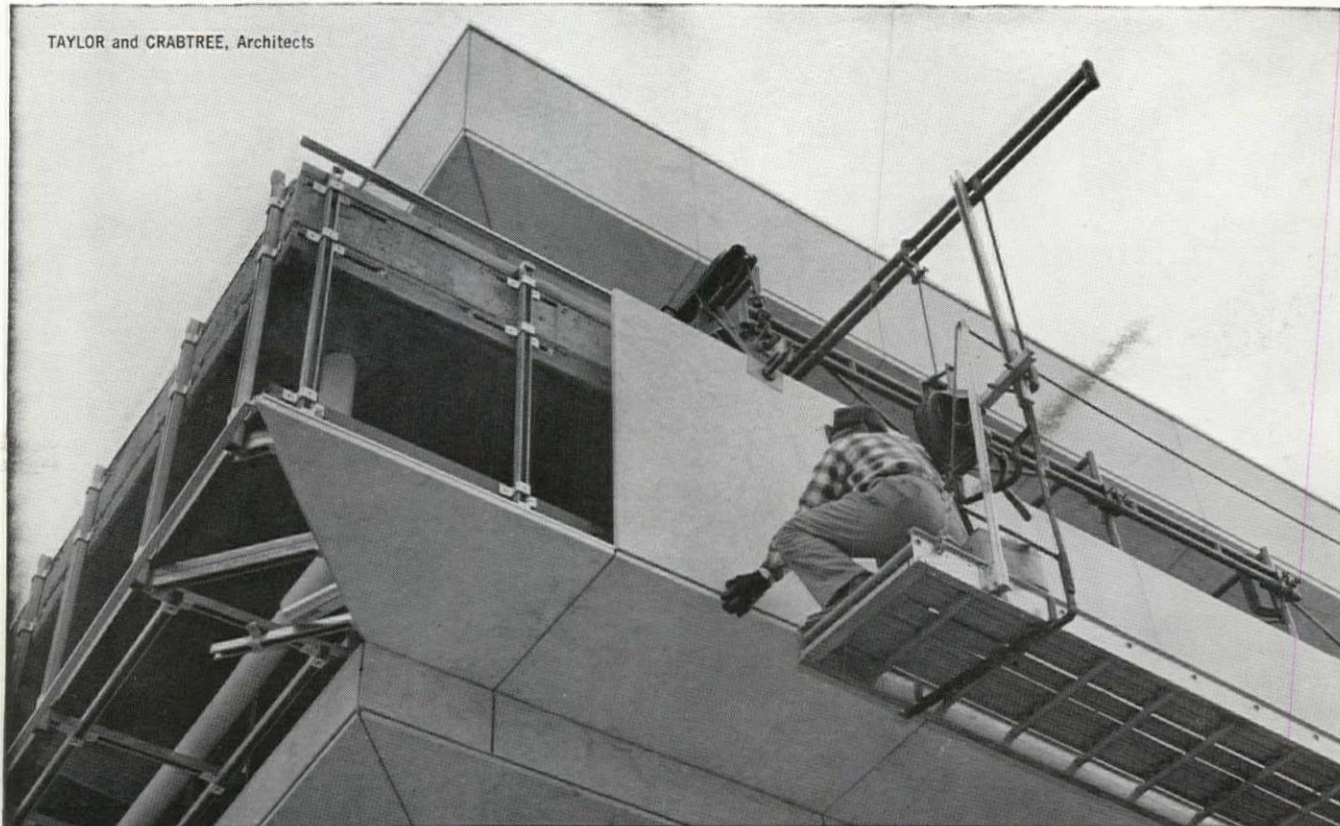

In New Work or Remodeling

THE ZIBELL SYSTEM CUTS COSTS AND GIVES NEW VERSATILITY TO MARBLE

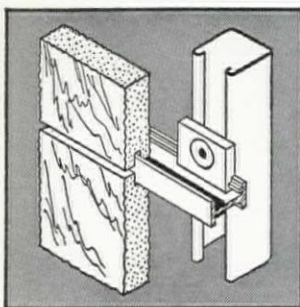

The Zibell System is a unique arrangement of metal struts and fastenings for installing marble as thin as $\frac{7}{8}$ ". A Zibell installation goes up quickly and creates a light, weathertight wall that requires no structural backup. Besides the obvious economies, the Zibell System gives the architect new freedom in designing. He can now make marble do things that were impractical or too costly before. But most important, he may find that he can pass up less desirable materials in favor of marble, the finest of all facing materials.

WRITE FOR OUR NEW BROCHURE ON THE ZIBELL ANCHORING SYSTEM

DEVELOPED BY **The Georgia Marble Company**

11 Pryor Street, S. W., Atlanta, Georgia 30303

COAST-TO-COAST CONSULTING SERVICE Our engineers stand ready to assist you any time anywhere on any subject involving marble or limestone. A phone call will put one of our men across the desk from you in a matter of hours. No obligation, of course.

INTERIORS



A · I · A

Journal

*Interior design
is of prime
significance
to total design
and
comprehensive
services.*

*But how does
the architect
achieve
the desired
ends?*

*What is his
role?*

*Should he equip
himself?*

*Or go "outside"
for interior
design?*

*What if
nary a thing
is to be found
outside?*

What Is the Architect's Role?

BY BROCK ARMS, AIA

TODAY'S ARCHITECTS have at last declared in favor of expanded practice, recognizing expanded opportunities. Prior to this belated change in attitude toward the scope of the profession, much was written about the influences on architecture of technology, of financing, of government restrictions or support and of sociological trends.

Little has been written (although much has been privately said) about interior design. The words "total environment" have been bandied about, but no one seems sure just what they mean. Presumably the phrase implies a harmony of the building shell with the loose furnishings within it.

There appear to be two somewhat schizophrenic aspects of the shaky marriage between architecture and interiors. One is that architects, who would like to control the interiors of their buildings, try to do so without knowing how. The other is that interior designers, who have traditionally been trained in the "home fashions" field, are not really prepared for the environmental complexities encountered in working with architects. (This is, of course, altogether aside from the fact that there is generally a divergence of taste.)

We all know the gifted architects who ably create fine interiors. There are also many talented interior designers who are, in effect, interior architects. What they have learned must concern us in this discussion.

They have learned that interiors can be designed, specified and contracted for in a manner similar to that for the building itself. They have learned, further, the totally different approaches to the design of a special structure for a tenant-owner, and for either an owner who will have tenants (in the case of an architect) or a tenant who will occupy someone else's building (in the case of an interior designer).

To take these points independently, we can start with training. The methods, materials and technology of interior design takes years to learn. One must know yarns, fibers, their colorfastness, their dimensional stability in different weaves, their durability, bonding methods; methods of laying carpet; workability and stitching qualities of draperies; cleaning methods for materials of various sorts—alone and in combination with other materials. One must be able to judge the suitability of various types of casters, the working parts of furniture and their construction, the varieties of choice in components of specialized furniture.

All of these, the architect may feel, he can rely on a manufacturer to provide. There are two pitfalls here. The manufacturer or his representative, interested primarily in the sale, will present only good points, not bad. And what architect really has the time to interview 20 to 40 different manufacturers, even if they were objective? Not all in-

terior design is as easy as choosing four Barcelona chairs for a lobby. Hospitals, offices, hotels, restaurants, educational institutions—all have intricacies of personal accommodation which are the purview of the interior designer.

It is important to remember here that the contract interior designer's fee averages out between 10 to 15 percent of the cost of furnishings for a building. The furnishings average plus-or-minus 10 percent of building construction cost for most types of projects. That means providing interior design would require adding 1 to 1.5 percent to the architect's fee, if full services are to be included in his contract package.

The average architect is not trained to take on this headache for himself, as a part of his contractual obligation, unless he has a trained interior designer working for him. I don't mean just a recent graduate from the average design school, because then both the architect and his young graduate will be babes in the wood about business control of the job. Most schools do not yet teach specification writing, bidding and office procedure to interior design students, and the details are different from those of architecture.

The significant fact is that if you are not a trained interior designer yourself, and you wish to control the design, you can do it efficiently only by obtaining the services of a trained interior designer (*not* a designing merchant but a fellow professional like yourself). Whether he is on your staff and salaried, or an associate, as an engineering firm would be, is relatively unimportant. Training equals profits. If you really wish to do the entire job yourself, be prepared to face the likelihood of diminished profits and potential client dissatisfaction while you go through your own on-the-job training.

Point 2 is the method of gaining a competitive price advantage for your client. The job will require many manufactured items. The price structure within the furnishings industry has certain basic characteristics and many variations.

First, there is a manufacturer, then his direct representatives, then dealers who may be of more than one kind. The pricing of furnishings is generally set but can, and will, be flexible if competition is introduced. We must first dispose of manufacturers who sell only to retail stores. They are growing fewer but some still exist. They do not concern us here. Then there are manufacturers whose dealers can sell at any price they wish. The tradition has been that a dealer doing a good volume will purchase at 50 percent off less 10 percent off. He, in turn, will sell at whatever markup he feels will earn him a fair profit. If he is required to provide service, his markup is higher. If several dealers are bidding and he is hungry, his markup is lower.

The architect, as a courtesy, is sometimes allowed a 33 $\frac{1}{3}$ to 40 percent discount from suggested "list" (retail) price. But by competitively bidding a job, the designer can get even greater savings for the architect's client—the extent of the saving being determined by the extent of the services required. In any event, he can get greater service because the contracting firm with the successful bid will ship, install, insure, guarantee and ride herd on *all* the manufacturers for proper delivery and performance.

An architect expects this service of his contractor for the building. He should expect his interior designer to obtain the same service from the contractor for the furnishings, in the interest of efficiency and economy.

The third point has to do with a source of friction between architect and interior designer which is basically the fault of neither. The mobility and growth of our society have caused a good many buildings to be constructed in advance of the known tenant. Office structures, apartment houses, real-estate developments, stores and general business space is built to be finished, furnished and used later; then remodeled, refinished and reused. This in itself breeds anonymous space. The interior designer cannot properly blame the architect for actions circumscribed by FHA or mortgage bankers or zoning laws and codes, but he does.

The architect should realize, in turn, that low budgets and inappropriate space often force a designer to use tricks to cheer the spirit. With better dialog between the professions, some of the limitations on both sides might be overcome.

The key to successful integration of interior design and architecture is collaboration. Successful collaboration depends upon shared tastes and attitudes, mutual understanding and enthusiasm.

Being able to buy furniture at 40 percent discount from retail price does *not* enable an architect, even a proficient one, to offer interior design service for a fee equivalent to the difference in price of furnishings. The client pays more than he should, and the architect adds overhead without commensurate fee.

Interior design as a collaborative profession is just emerging. It is beset with all the new challenges of our expanding technology and economy. The architect can add this discipline to his staff as he does structural, electrical and mechanical engineering and landscape architecture, or he can associate with qualified independent professionals. But he can no longer ignore the complexities of interior furnishings and equipment, nor the fact of the shrinking of his fee and its ability to cover his ever-broader services. ■

The author, who maintains an office in Glencoe, Illinois, devotes a good deal of his practice to interior design services. He holds membership in both the National Society of Interior Designers and the American Institute of Interior Designers.

When Specialists Enter the Scene

SOMEWHERE NEAR the middle of the range of choices open to architectural offices that regard interior design as important, if not crucial, to the fulfillment of their overall design concepts must fall such firms as I.S.D., Inc.

Born of the Perkins & Will Partnership, I.S.D. is an independent organization with an orientation that is professional/design rather than profit/decoration.

The interior design department of the architectural partnership became its nucleus as I.S.D. became a separate entity in 1961. Perkins & Will believed its clients would be better served by a team of specialists who could carry out a building's architectural intentions and, at the same time, devote needed time and attention to advanced design elements and the minutiae of detail requisite to completing interior design assignments. Separation, in other words, was good for the interior design activity, a strengthening beneficial to the development efforts of Perkins & Will.

With hopes high, the infant firm moved to increase the size of its staff, expand the scope of its work and broaden its base of commissions to attract top caliber personnel with interior architectural and design training.

The basic operating policy of the firm has been to develop its own business. In general, it accepts three kinds of assignments.



First, it works jointly with architects on commissions. Although 23 percent of the firm's total work comes from Perkins & Will, half again is with other architects. For example, the firm served as interior space designers in conjunction with Walk C. Jones Jr. FAIA for the First National Bank Building in Memphis, Tennessee.

Second, it works directly with the client organization, usually on new offices within a high-rise building. When Amsted Industries decided to occupy larger space in Chicago's Prudential Building, it called on I.S.D. to do the complete design of the new quarters because of recommendations from both current and past clients.

Third, it will conduct interior redesign projects of existing quarters, as in the case of the Natural Gas Pipeline Company of America, which occupied space on four floors in an old Chicago building. It initially asked I.S.D. to prepare a color schedule ("cleanup and paint work," as it was described). Upon preliminary investigation, I.S.D. suggested that a total replanning of existing quarters would make more effective use of the space as well as accommodate immediate expansion without the need to lease additional space. A space study not only supported that conclusion

but pointed to such a dramatically improved working environment that the company engaged I.S.D. to plan and redesign its headquarters space.

The firm has a number of operating policies which are adhered to rigidly. One is to develop and maintain long-term relationships with its clients. It does so for two reasons.

First, it may be important to infuse an interior design concept throughout many separate facilities of a client organization, not necessarily to create an "image" for the sake of conformity but to better reflect a basic business attitude of a company in various locations. For example, a progressive, innovative industrial chemical manufacturer sought to imply its modern management philosophy in the design of a headquarters complex and now is echoing this in sales office interiors throughout the country. The repeat business of I.S.D. has increased each year. This year about 20 percent of its assignments will have come from previously served clients (and about 40 percent from referrals).

In addition, the designers find a continuing working arrangement has another advantage to the client, namely, the maintenance of the total architectural design of the space. "After a struc-

Chicago office of the interior-space-design organization minimizes furnishings—neutral colors and textures—and emphasizes lighting—black and stainless steel fixtures—as the principal esthetic element. Shown here are the entrance corridor (1), corner executive office (2), reception area (3, 4) and the drafting room (5) with project managers' cubicles at left.

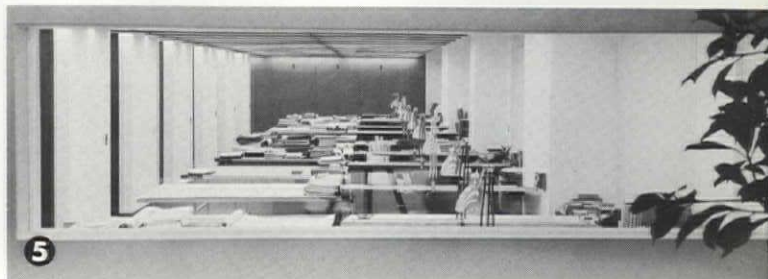
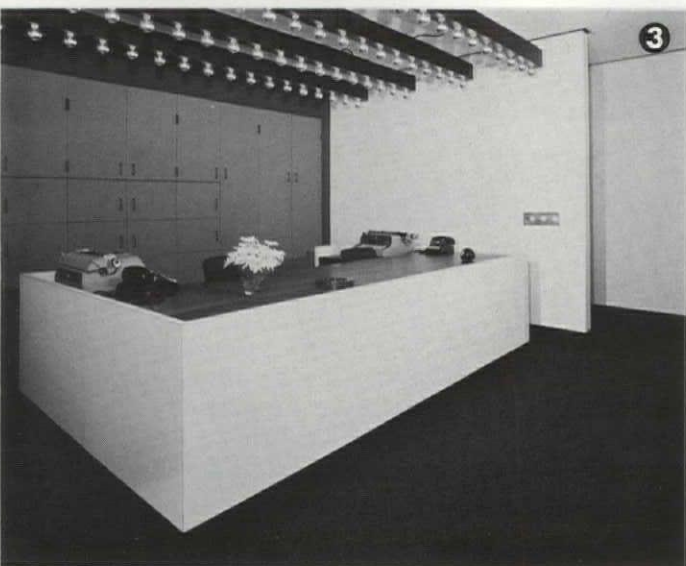

ture is in use," says Vice President Kenneth E. Johnson, "company personnel begin to make changes to 'improve' on the original design concept. We believe that interior design audits can help ensure that changes and furnishings subsequently installed are in keeping with the architect's original concepts."

I.S.D. strongly believes that the interior design of a project must be an integral part of the building's architecture. Its staff is able to work with architects on a mutual basis in solving the client's interior requirements. It wants to create an image of good design for the client, not an "I.S.D. design image," believing that if a design can be labeled as having been done by the firm it must have of necessity little rapport with either architect or client. Each commission is approached on its own needs, not as just another assignment onto which a preconceived solution is imposed.

In its business practices and its method of billing, I.S.D. patterns itself on the code of ethics of The American Institute of Architects. It does not advertise. It charges on a fee basis, each professional having his own billing rate based on a multiple of his salary

I.S.D. does not derive any income from furnishings bought or specified. To many clients, this has been a focal point of misunderstanding; they confuse I.S.D.'s services with that of the typical interior decorator or department store who earns all or part of its income from discounts on furniture and furnishings bought for customers. I.S.D. believes the fee basis is the only professional method for billing, and this enables the firm to objectively provide the most effective design at the most reasonable cost. This procedure orients the staff to design solutions and eliminates possible self-interest considerations.

In maintaining cost controls on this aspect of its work, I.S.D. will have the furnishings contractor who successfully bid the assignment bill the client directly for those items. It issues a certificate of payment to indicate work is in accordance with the specifications.

Also, I.S.D. has a policy against entering into a royalty agreement on any basis for designs created during a client project. Design becomes the property of the client or other assignee. "We believe the firm should be recognized and credited for its original designs of manufactured items," Johnson says. "However, we feel that any income derived from this source is too dear a price to pay for the loss of total design objectivity. We will use a piece we have previously designed, *only* if it solves a problem for the current client." For instance, in undertaking a remodeling assignment for a Chicago bank, a 'Centriform' unit was designed which enables



I.S.D. undertakes a considerable number of its commissions working in association with architects, as in the case of the First National Bank Building of Memphis (1, 2, 3), designed by the office of Walk C. Jones, Jr., FAIA. "Changes within industries call for entirely new solutions," comments I.S.D. Vice President Kenneth C. Johnson in explaining that a firm such as his may better meet project needs and also makes good business sense. "Banking, the first industry that will achieve a common computer information system, has added the electronic data processing dimensions to its operations and is becoming strongly oriented to marketing its services rather than merely housing them. Customer considerations, for example, have altered the design of the main banking room and many other departments."

Two other projects on which I.S.D. has served as interior consultants to architects suggest the variety of building types in which they are involved and hope to expand as the "space squeeze" requires new solutions to formerly standard problems. The Christian Theological Seminary for the Disciples of Christ in Indianapolis, the work of Edward Larrabee Barnes, AIA, is illustrated by the student lounge (1). Views of a private office (2) and a general office area (3) typify the Elizabethtown Consolidated Gas Co., Elizabeth, New Jersey, designed by Vincent G. Kling & Associates.

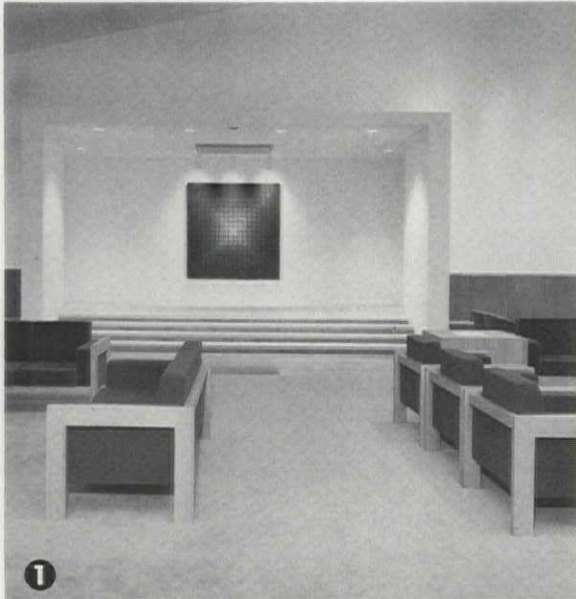

1



2



3

four offices per unit to have semiprivate space in an extremely compact area on the banking floor. The unit, which will have built-in desks, coat closets, telephones, files, tape recorders, drawers, and other items, will be produced by a major national furniture manufacturer.

I.S.D. provides a number of basic services. First, it conducts program and planning analyses of proposed building space, usually before the architect is selected. The firm is adamant that it fully detail the space needs, and does not suggest any design concepts in these assignments. This data is based on a detailed study of the client's organization, its business procedures, its existing space usage and a number of other factors.

"Because good architecture is oriented to the needs of individuals in the environment," Johnson says, "a program and planning analysis furnishes the architect with a thorough documentation for immediate and projected space needs, what kinds and amounts of space are needed, machine and people juxtaposition, and many other detailed factors on which he bases his design. In designing buildings which will hold great numbers of people and special operations, this kind of study is invaluable to the architect." The firm currently is conducting two such studies for industrial clients.

Next, the firm will undertake space studies for complete buildings or for those already in the design stage in order to prepare the most effective interior layout and design and to use the space efficiently and economically.

Its basic work, of course, is the layout and design of interior spaces themselves, which covers design, presentation and approvals, documentation, coordination, installation and follow-up services. Included in this broad area will be recommendations for furnishings; ceiling, wall, window and floor treatment; color selection and specification for surfaces and materials; bidding and cost control; project controls (including CPM or other methods); evaluation and inventorying of existing furniture; design of built-in or special furnishings to be made; and preparation of drawings as required.

One particular service the firm feels is important is the preparation of a maintenance manual for long-term care of furnishings' surfaces and materials. I.S.D. has found that at the completion of a design assignment, it has a great fund of information on interior furnishings whose maintenance is left to client personnel without knowledge of fabrics, woods, finishes and other items. The document that I.S.D. provides, enables the client to specify exactly how draperies are to be cleaned, carpeting maintained, desks polished and

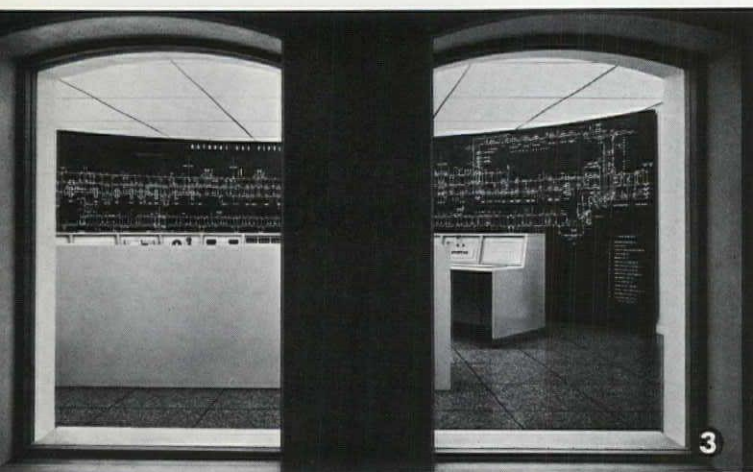
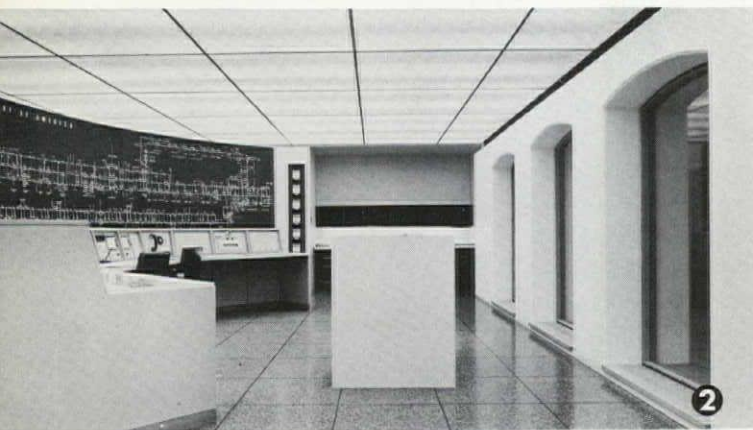
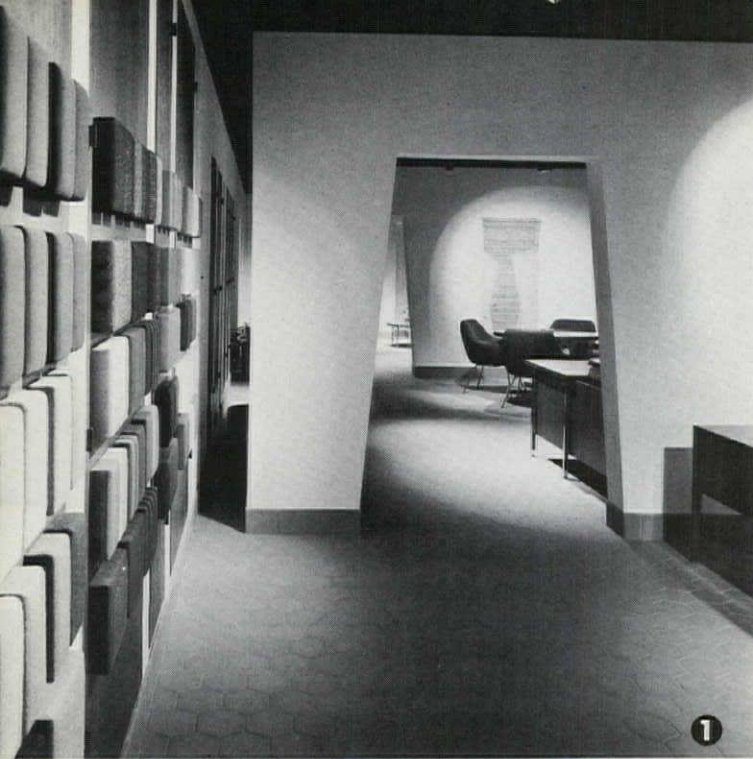

Assignments of a different nature are illustrated by two Chicago projects. The Stow/Davis Galleries (1 and cover photo) in the Merchandise Mart, representing new office space in an existing building, features upholstering fabric displays mounted on closet doors. Open-wall construction which permits glimpses of furniture on exhibit in adjacent areas, canted archways and 9-foot-high walls (with entire ceiling and service equipment exposed and painted flat black) are among the design elements used in developing the interiors. For the Natural Gas Pipeline Company of America, I.S.D. has created a new interior design program in a 55-year-old building. The focal point is the gas control room (2, 3) which faces the elevators and is seen through a series of arched windows. Half-inch glass set in thick walls conveys a sense of security.

other details that can save a company thousands of dollars in the long run.

I.S.D. has offices in New York and Chicago. Perkins & Will, with offices in Chicago, White Plains, New York, and Washington, will recommend to a client when appropriate the use of I.S.D.'s services, but the client has the final decision. Ownership of I.S.D. is primarily by some individual partners of Perkins & Will, but the partnership itself has no financial interest.

Each office is responsible for generating business and sustaining its staff, but the firm operates without territorial confines or other artificial restrictions. Projects are assigned to the best design team for the particular commission. If necessary, a team is formed from both offices.

The Chicago office, which in September doubled its space, is directed by Johnson, who holds a Bachelor of Arts degree in architecture from the University of Nebraska and who worked in three architectural offices before joining I.S.D. in 1961.

The New York office, which soon will move into new quarters (trebling its space), is headed by Louis M. S. Beal, who like Johnson is also a vice president and who holds a Bachelor of Science degree in interior design from the Rhode Island School of Design. Beal was with three interior design firms in Boston and New York before joining I.S.D. a few months after Johnson.

I.S.D. has a well-structured administrative staff of professional business managers and, in addition to the vice president in charge of each office, has one manager of business development, four senior project managers and six project managers. The remainder of the professional staff consists of senior designer-job captains and designer-draftsmen.

Each assignment is the direct responsibility of a project manager with overall direction provided by the respective vice president. Meetings of project managers and senior designers are held weekly, and the entire staff meets periodically.

In addition to its work with architects, I.S.D. will work with or call upon outside consultants to solve special problems. It designed illumination for its own offices but on other assignments has relied on lighting consultants. Among other specialists it has associated with have been real estate consultants, mechanical and electrical engineers and acoustical consultants.

I.S.D. keeps pushing back its geographic and operational frontiers, hopeful at present of doing more work for hospitals, health institutions and government agencies—federal, state and local. In the past two years its business has nearly doubled.

The firm is in an expanding field and looks toward the future with optimism and a sound, self-strengthening approach. ■

How a Small Firm Acts Big City

SMALL OFFICES in attempting to offer interior design services without the advantage of a metropolitan mart or related facilities often find the mechanics of purchasing and the problems of shipping no minor hurdles.

It is a condition of nonmetropolitan practice that confronted Donald E. Ferry AIA and Earl W. Henderson AIA when they organized a partnership (whose staff today numbers 13) five years ago in Springfield, Illinois. In statute distance, Springfield is 200 miles from Chicago, 100 from St. Louis; in design miles, the distances are far greater.

The young firm set out to engender a break with the traditional architecture blanketing its area, a continuing endeavor that holds interior concepts as important to the establishment of a design consciousness. In line with this effort, the architects are part of what is known as the Design Center, a building which houses their own offices, those of a consulting engineering firm (Ralph C. Hahn & Associates) and—across the courtyard—a contemporary retail furniture store for which the complex is named.

Henderson, who encouraged a retailer to set up the store, had encountered a somewhat similar arrangement when he was an architectural employee in Denver. While the architects are part owners of the Design Center building, they have no financial interest in the retail operation itself.

What they do have at their disposal is a kind of "miniature Merchandise Mart," as it were.

Furthermore, the association of the three design-oriented firms allows each to conduct its own separate business, yet in the pursuit of larger and more total projects, the mutual intrarelationship is most advantageous. As Henderson puts it:

"The architect should not be commissioned only to perform the duty of designing an envelope for a function described by the owner. If he is really doing his job, the challenge is to create the best possible environment which will enhance the building's function. Therefore, as the envelope itself is designed, certain considerations are made in the selection of colors, textures and materials, all of which become part of the total picture."

The architects find, however, that the majority of their commissions do not contain a budget per se for furniture. Sometimes their role may be limited to simply the arrangement of existing furniture and equipment or perhaps just refinishing. But in any event a contribution has been made toward the overall design concept, and possibly the client's sights have been raised a bit.

For their services, Ferry & Henderson receive a 10 percent fee (plus freight) of the actual cost of furnishings purchased for the job, the customary trade discounts being transmitted to the owner.

The partners find "this independent and yet



The Design Center, winner of an Honor Award from the Central Illinois Chapter AIA, occupies a generous site (1) which had no existing structure, permitting a parklike setting and the necessary parking to house three occupants with mutual interests. The prime tenant, a contemporary furniture studio (2), shares the quarters with the office of the architects (3) who designed the complex and an engineering firm, all facing a protected courtyard (4, 5) with north orientation. The arrangement has proved helpful to Ferry & Henderson in its efforts to provide a total design service, as indicated by two projects on the opposite page. For the Metropolitan Life Insurance Co. (6, 7), the architects provided a maximum usable area within a flexible space subdivided for office functions; for the Luers Children Shoe Store (8, 9) they created a structure which would become an identification for the retail operation within.

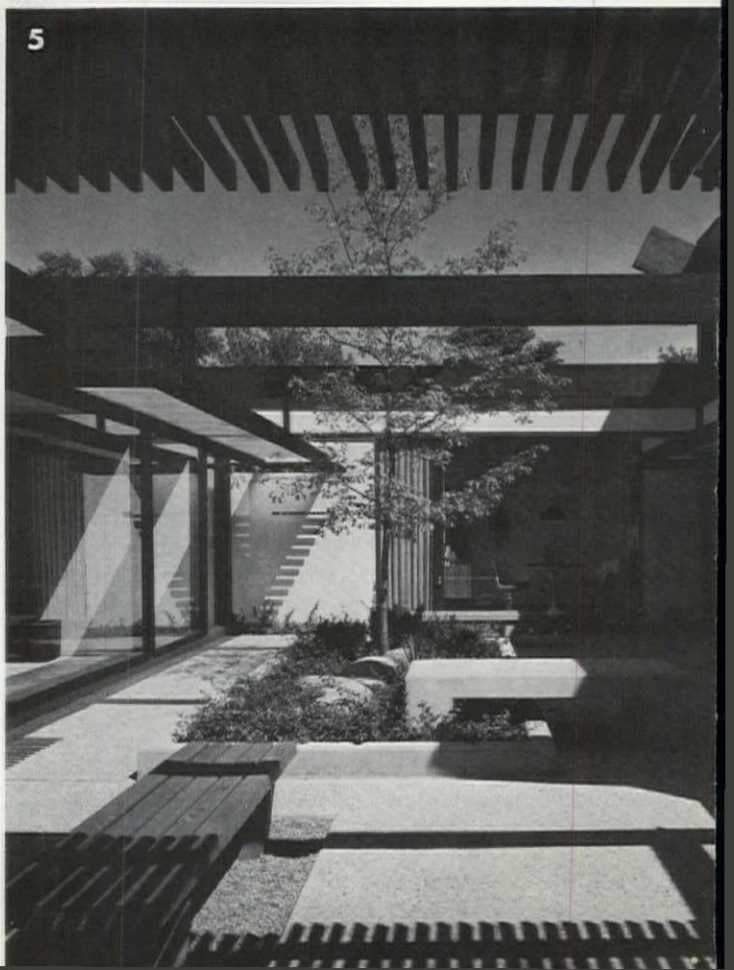
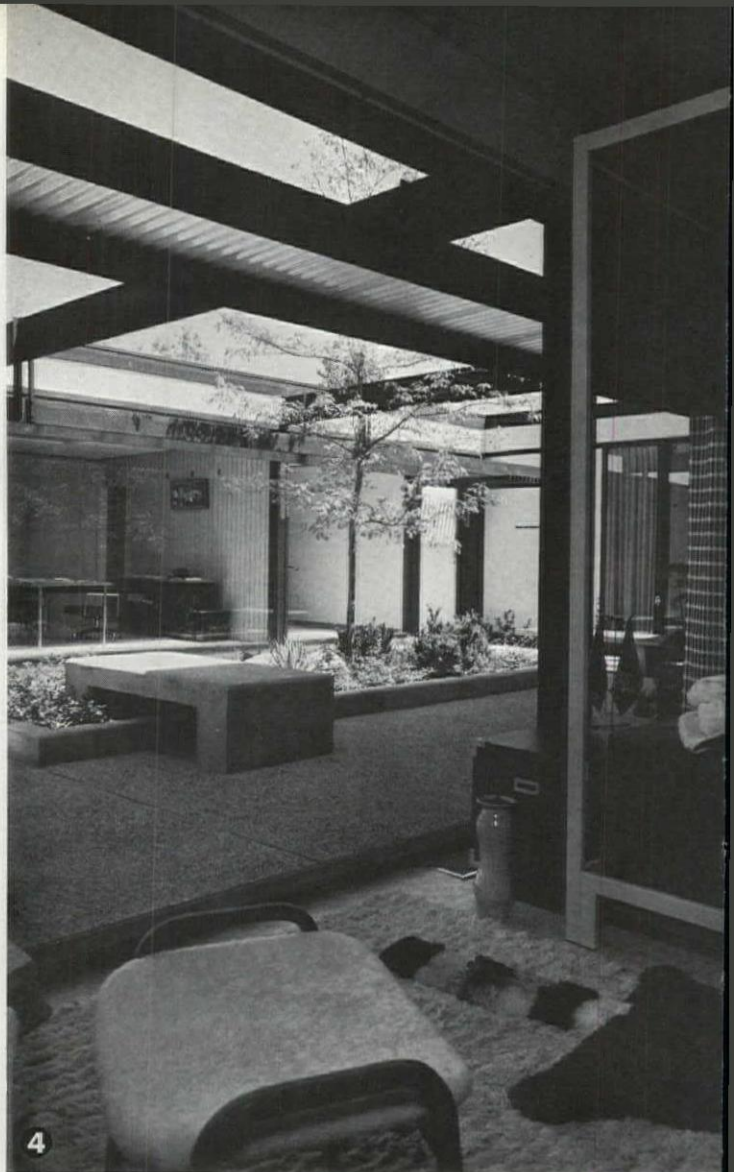
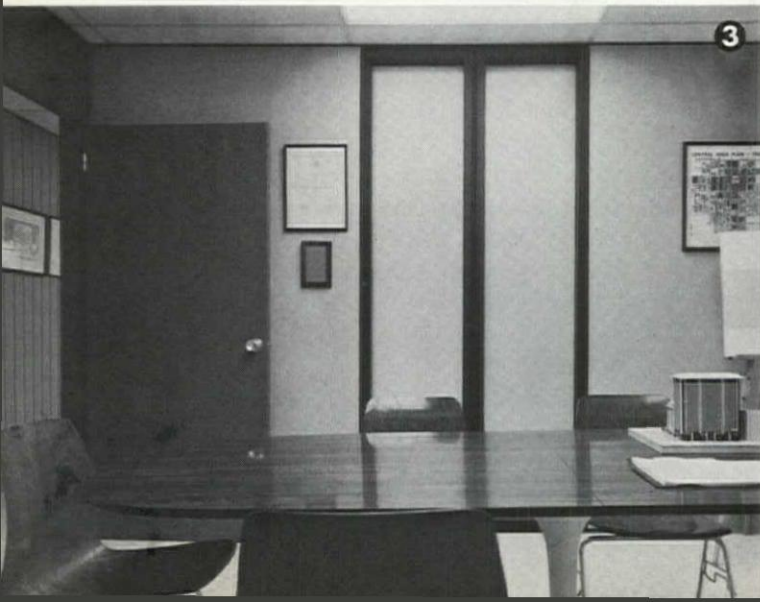
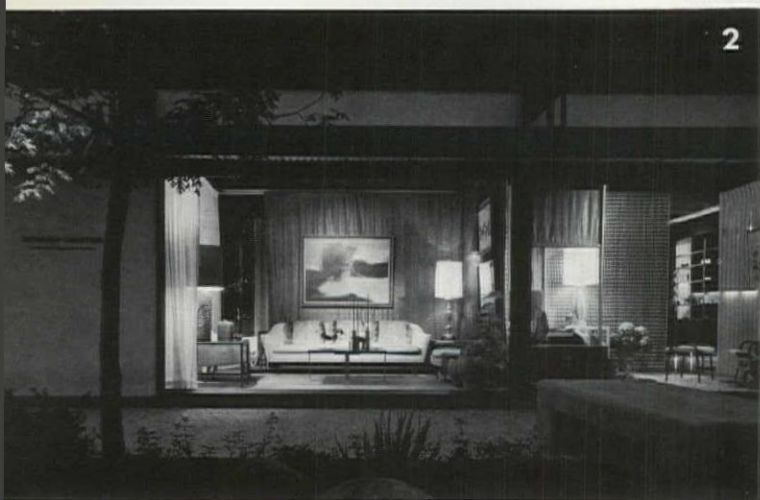

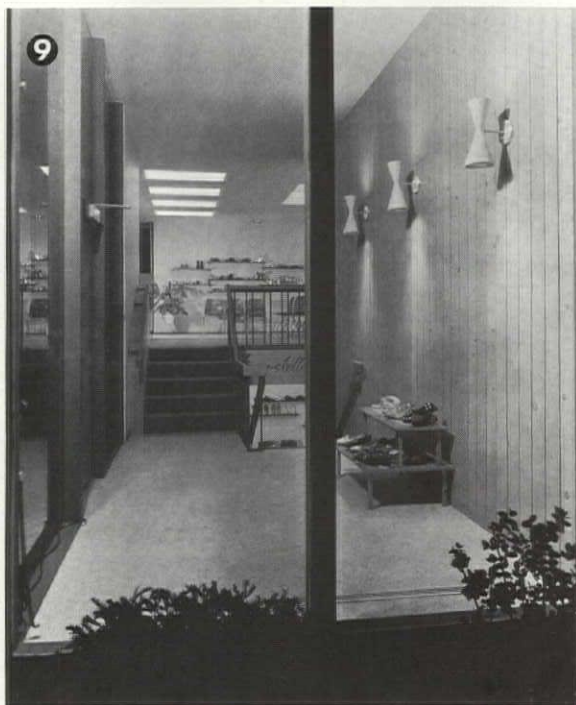
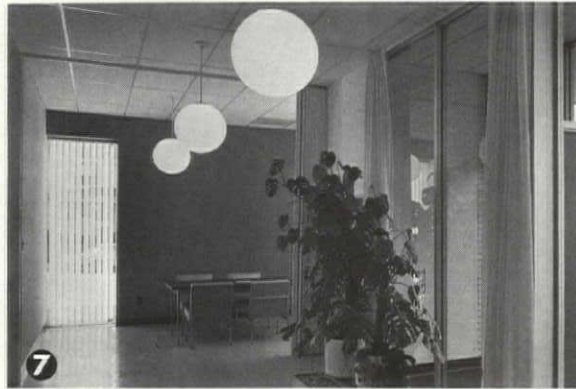

intrarelationship a very desirable and ideal situation since we have in fact the advantages of the merchandise for examination by our clients which often times is an inducement from red brick colonial to white precast concrete in the consideration of the structure.

"In short, the furniture studio becomes a tool in a front-line effort to orient the conservative area to a more contemporary expression." ■

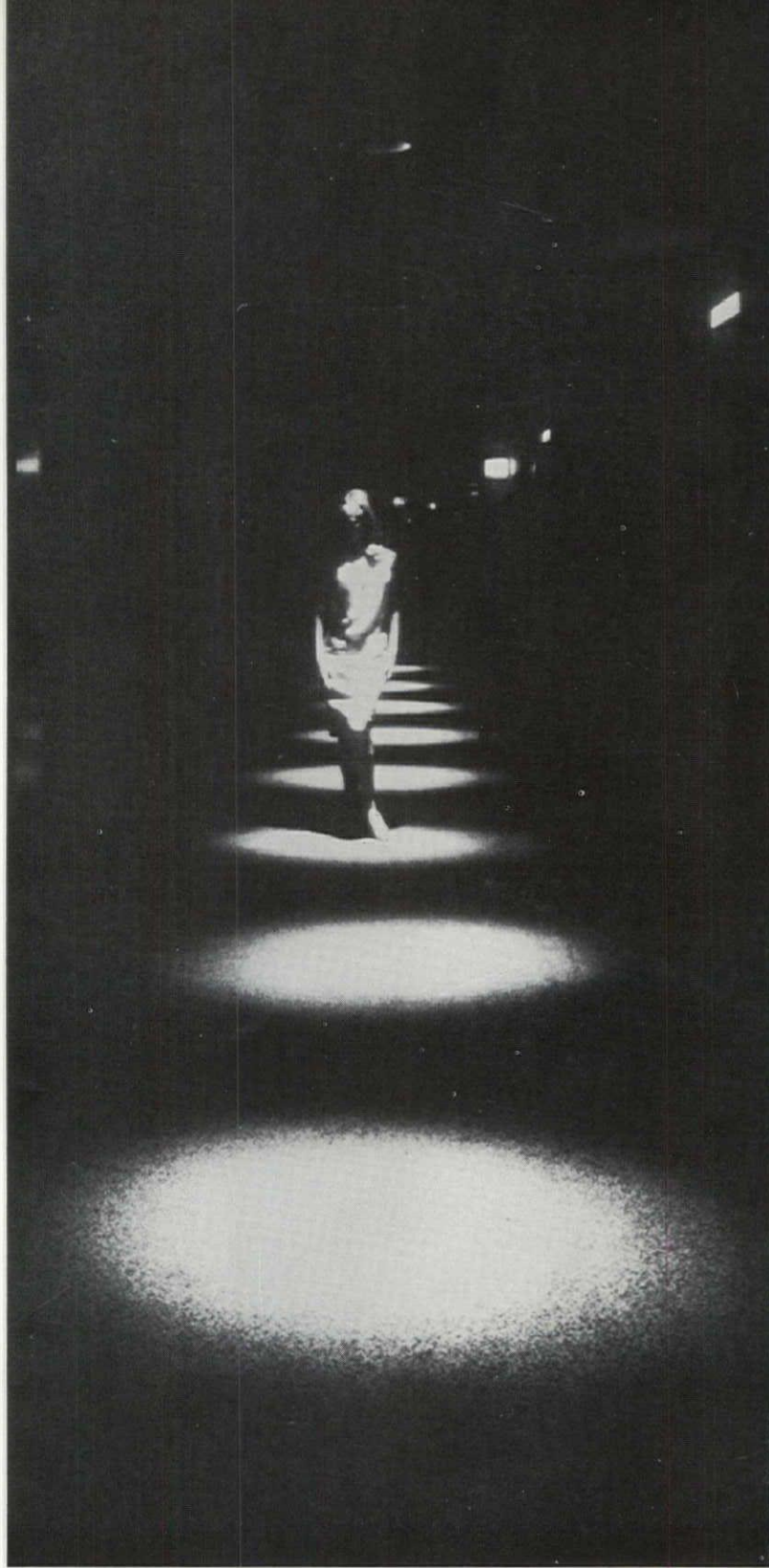
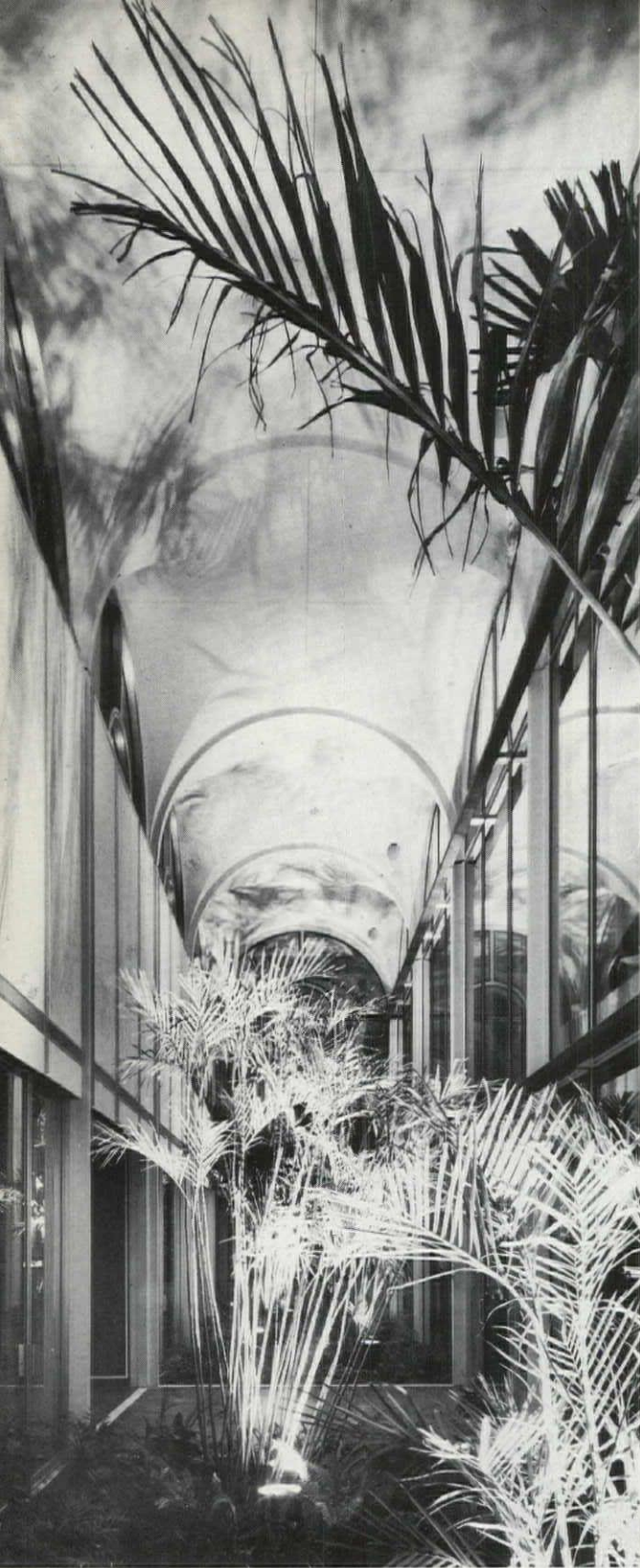

Architecture is the masterly, correct and magnificent play of masses brought together in light. Our eyes are made to see forms in light; light and shade reveal these forms; cubes, cones, spheres, cylinders or pyramids are the great primary forms which light reveals to advantage.

—LE CORBUSIER

Formulating an Interior Logic

BY SEYMOUR EVANS

WE PERCEIVE architecture as lighted forms and experience it as space and texture. The use of light can enrich or destroy that experience.

Architecturally, we should regard light as a three-dimensional material which is transparent and plastic. To achieve the luminous environment we want, we must be able to describe light accurately and control it physically. Part 1 in this series (Oct.) discussed the need for a behavioral language with which architects and technicians could communicate about the behavioral effects of a lighting installation. This behavioral language (the kind of light) would supplement the purely quantitative vocabulary (the amount of light) we use at present.

Across page: Automotive Life Insurance Co. Headquarters, New Orleans. Curtis & Davis, architects; Seymour Evans & Associates, lighting.

In the first article, an attempt was made to supply initial elements of this vocabulary and to discuss them as they occur in nature (and, by analogy, in architectural luminous environments). Those elements are:

Ambience—on the behavioral level, the overall glow of a luminous environment; on the structural level, a wide beam of noncolumnized light.

Beam—columnized light from a concealed source.

Change—the inclusion of shadows in the lighting pattern, the absence of monotony in the luminous environment.

Focus—the brightest object in the luminous environment.

Glitter—a series of objects of brightnesses up to the threshold of glare but not beyond it.

Silhouette—drama caused by the absence of light on one surface of an object (in architecture, generally produced by not lighting an object

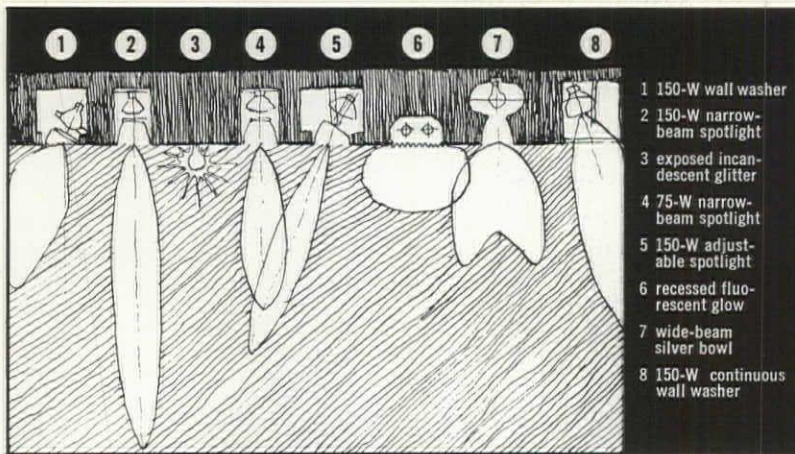

Light expressed as a transparent plastic material in architectural space

in front of a transilluminated or washed wall).

This article will discuss 1) the forms which the previously named qualities take, in terms of the photometrics, intensity and direction of the light; 2) a method of expressing combinations of these light forms as formulas; and 3) the importance of people in lighting.

The sketch above illustrates representative emittances which relate to the behavioral descriptions referred to above. Although these illustrations do not represent truly proportional photometric relationships, they are presented to show the correlations between various hardware and their emittances.

Thus it becomes important in architectural lighting design that each emittance (beam, glitter, glow) is as critical a factor in the choice of equipment as the detailing of the fixture itself.

Our purpose, then, is to investigate how these elements may be controlled and combined to compose an optimum luminous environment. When these elements are used in combination they interact in space to produce a variety of effects.

The drawings shown at right illustrate the results of all possible combinations of any two of the six elements previously identified, combined as in the chart above, right.

Specifically, we are illustrating that from a grid of identical apertures in an architectural space, surprise may be invoked instead of blandness, interest instead of monotony. The variety of possible results is limited only by the imaginative modulation of these techniques and recombinations of them.

To accomplish this complex interrelating of many elements with any accuracy, and to communicate our aims to all people of the various disciplines which are required to achieve them, we must be able to state precisely the relationship we desire for any given situation. A first step toward this end is a simple logic formula which expresses the luminous environment—a constant—as a function of the sum of the desired proportion of overall brightness produced by any of the six elements or combinations of them (modulated by their color temperature). It is important to note that this is not a working formula but a logic formula.

$$LE = \int \left(\frac{x_A}{\lambda_{c_1}} + \frac{y_B}{\lambda_{c_2}} + \frac{z_C}{\lambda_{c_3}} + \frac{x_1 F}{\lambda_{c_4}} + \frac{y_1 G}{\lambda_{c_5}} + \frac{z_1 S}{\lambda_{c_6}} \right)$$

... when $x + y + z + x_1 + y_1 + z_1 = 1$ (constant) overall brightness and λ_{c_n} = the color factor.

If color temperature is ignored, for purposes of simplicity, the formula at left would apply.

$$LE = xA + yB + zC + x_1 F + y_1 G + z_1 S$$

	A	B	C	F	G	S
A	AA	AB	AC	AF	AG	AS
B		BB	BC	BF	BG	BS
C			CC	CF	CG	CS
F				FF	FG	FS
G					GG	GS
S						SS

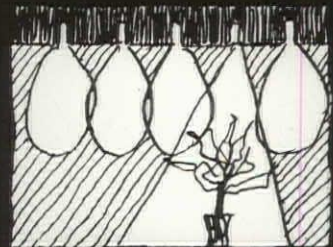

AF—ambience from many downlights with focus from single spot.



BC—change from narrow-beam spots creating dark and light floor patterns.



CC—maximum change in contrast from lighted focus to silhouette.

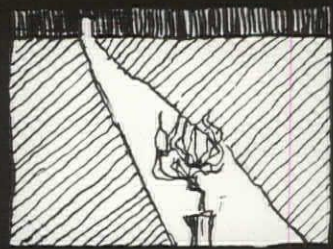

FF—focus from a single beam which concentrates attention.



GS—silhouette from bright glitter backlight.

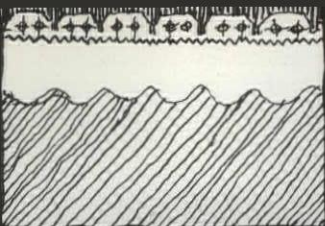

AA—ambience from fluorescent luminous ceiling.

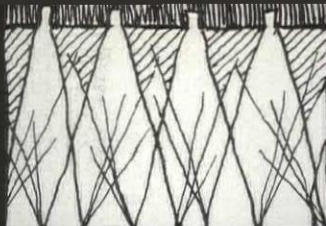

AB—ambience from reflection off floor from narrow-beam spotlights.

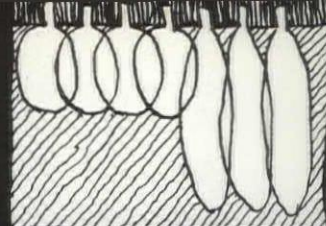

AC—change in ambience from flood downlights to narrow-beam spots.

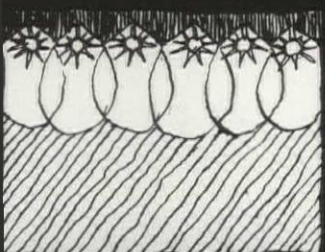

AG—ambience from many low-wattage bare incandescents (glitter).



AS—ambience from wide-beam downlights with silhouette from wall washers.

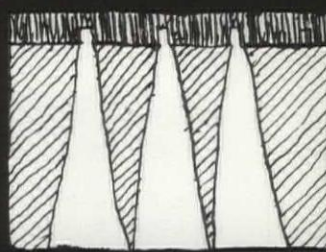

BB—beams from narrow-beam spots.



BF—focus from beams from adjustable spots.

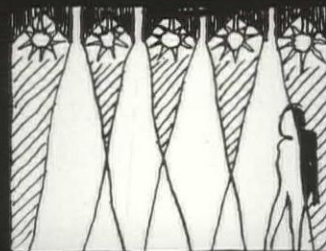

BG—glitter from clear incandescents combined with narrow-beam spots.



BS—glitter from clear incandescents combined with narrow-beam spots.



CF—changing foci of dark and light patterns from adjustable spots.

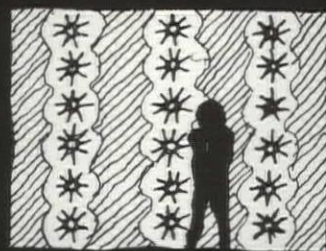

CG—change from bands of glitter.

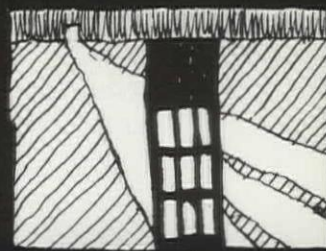

CS—change from light and dark patterns of perforated silhouette.



FG—focus of attention on glitter fixture.

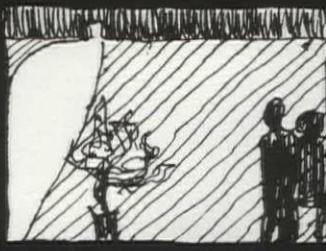

FS—focus from spot downlight combined with silhouette from wall washer.



GG—glitter from ceiling of bare incandescents.



SS—lone silhouette.

A	AMBIENCE	F	FOCUS
B	BEAM	G	GLITTER
C	CHANGE	S	SILHOUETTE

Where the same letter appears twice, it represents the combined use of a single element.

The sketches which follow represent three simplified hypothetical luminous environments and their formular expressions:

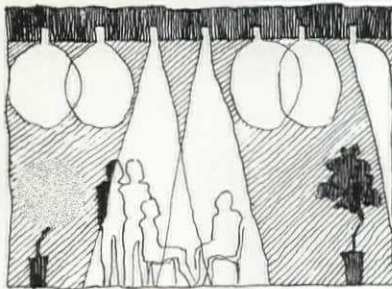

$$LE = 0.4B + 0.4A + 0.2S$$

In this situation, four-tenths of the overall brightness is provided by the beams of the spotlights, four-tenths by the ambient glow of ellipsoidal downlights and the remaining two-tenths by the brightness of the wall washing. Therefore, we see extremely brightly lit people in a gentle ambience, with one plant in shadow and one in silhouette.

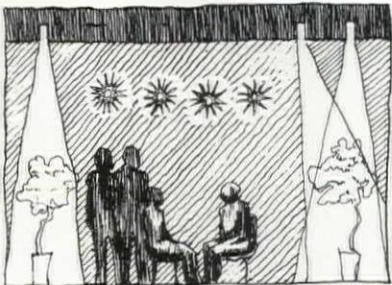

$$LE = 0.6BF + 0.4FG$$

This situation contains optical foci of glitter, which comprise four-tenths of the overall brightness. The people are not revealed; the plants are focused in narrow-beamed spotlights which provide the other six-tenths of the overall brightness. Therefore, the plants and the glitter are the dominant features.

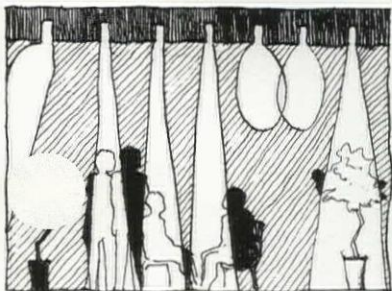

$$LE = 0.6BC + 0.2A + 0.1S + 0.1BF$$

A third environment can be created with the same ceiling grid, by using narrow-beamed spotlights which furnish six-tenths of the overall brightness, and wide-beamed

ellipsoidal, giving a soft glowing ambience which is another two-tenths. The remaining brightness is supplied equally by the wall washer and the narrow-beamed spotlight. In the resulting environment, the people are accented, one plant is silhouetted and one is in the focus of the spotlight.

Through further research, it will be possible to reduce this information to brightness data within a space grid with correlated behavioral information on the feeling and expression of the light. Ultimately, this will yield a computer program which could give the ideal fixture arrangements for any luminous environment.

Basically, the end results of most contemporary lighting schemes fall into one of three major systems: low brightness, high brightness and glitter. It is helpful to begin a lighting scheme with one of these three in mind. If more than one is to be employed, a balance must be established between the systems. These interrelationships are pre-

sented graphically to illustrate the desirable and undesirable combinations. Note that where circles overlap, combinations of these systems occur to either the detriment or betterment of the environment.

Whatever system is used, among the most important considerations for lighting design in an interior space are the people. Man has always enjoyed being the center of attraction, and it has often been said that successful architecture leads to the ennoblement of man. In the theater, where the techniques described above have been used for centuries, the lighting and accenting of people in motion make them dynamic components of the overall composition. In architectural installations employing a ceiling grid of identical apertures, people can be easily accented by the techniques illustrated. Artificial light should strongly identify architecture with life and motion. People-tracking systems become one of the ways in which this can be economically and dramatically accomplished. ■

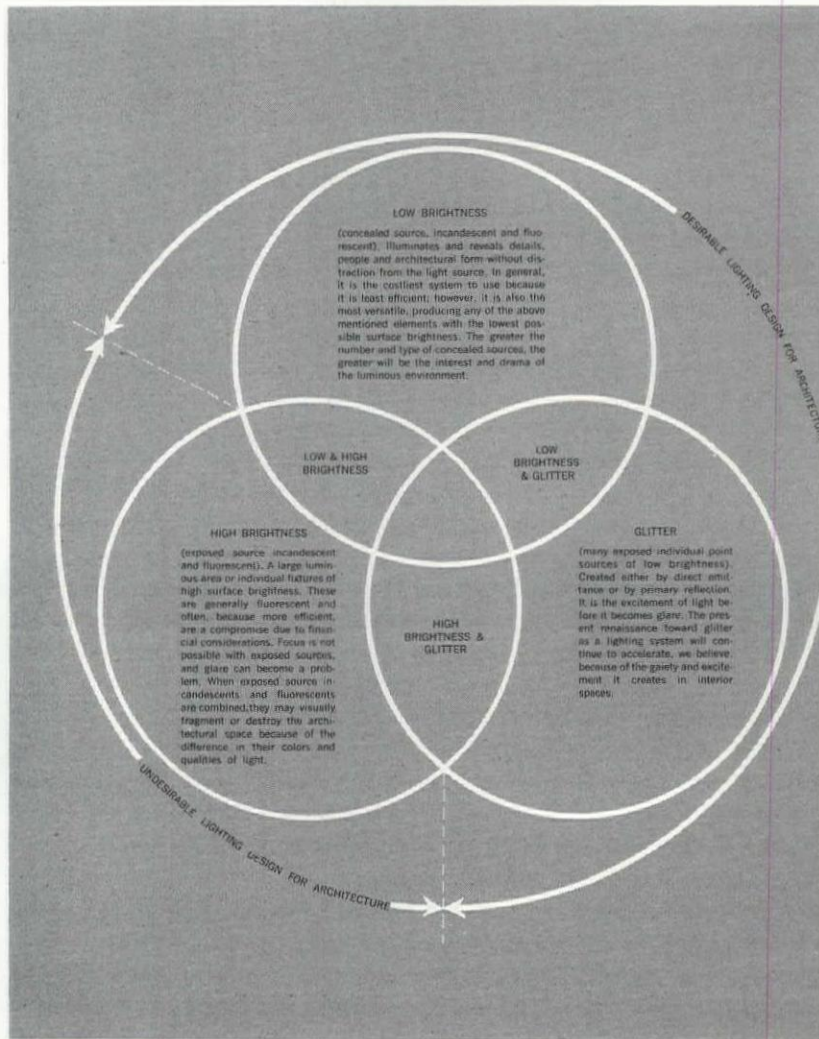

Documents to Keep Pace with Practice

*The 10th Edition of
the AIA General Conditions,
reviewed at a convention workshop,*
represent a complete rewriting
in terms of contemporary
requirements*

To AVOID unproductive administrative duties and maximize time available for design, the architect must be alert to business and legal requirements of contemporary practice. It is the duty of the Institute's Commission on Professional Practice, and its eight constituent committees, to aid the membership in this endeavor.

One such duty is the maintenance of the AIA Contract Documents, and for the past several months the commission—with the aid of legal and insurance counsel, numerous chapter committees, private practitioners, interested firms, outside organizations and Institute staff—has been preparing revisions to these documents in anticipation of their republication this fall.

Contemporary Requirements

Practitioners are generally aware of the requirements of contemporary practice and how these are

changing to increase business and legal exposures. However, the degree and nature of change are often not fully appreciated; these need to be brought into sharper focus:

- *Increasing complexity and sophistication of building technology* demand an ever higher level of technical proficiency and competence on the part of the architect.
- *Abandonment of the principle of privity of contract* has led to holding parties to the contract responsible for damages or injuries to third parties outside the contract.
- *The advent of the concept that persons damaged or injured by operations of society should be compensated* has influenced courts toward finding liability without fault and assessing compensation or re-

*Moderator: Dean F. Hilfinger FAIA; panelists: John R. Clark, attorney (speech delivered by Samuel Spencer, AIA legal counsel); Carl A. Anderson, Victor Schinnerer & Co.; and John E. Healy II, contractor.

dress for the damage or injury without regard as to who was at fault.

- *The growth of the philosophy favoring "spreading the risk"* has led to a tendency of the courts to assess larger damages where insurance is involved.

- *The organization of plaintiffs* has created effective and persuasive techniques for the pursuit of claims in the courts.

Certain basic legal principles also need be restated in view of increasing business and legal exposures in contemporary practice:

- *Tort liability* is imposed on one person for an injury to another person or to property. It is not dependent upon any contractual relationship but arises because the law imposes a duty to do or not to do a certain thing. A person breaching this duty may be held liable for injury to others if the injury results from the breach and if those injured are within the scope of foreseeable danger. Consider the case of the building marquee which collapsed two years after construction, injuring persons and damaging taxicabs. Investigation revealed that 12 supports were required, that the architect specified 11 and the contractor had installed 10. The architect breached his duty to design a safe structure, which caused injury and damage to persons and property within the scope of foreseeable danger. The fact that the contractor was also negligent is not important.

- *Contractual liability* arises from an agreement that may be written, oral or implied by law. The intent of the parties to the agreement should always be reduced to writing so all obligations are understood and easily proved. For instance, the 1966 Edition of the AIA Contract Documents is written to dovetail the architect's responsibilities during contract administration, as found in the Owner-Architect Agreement (Document B131), with these same responsibilities as related in the General Conditions of the Owner-Contractor Agreement (Document A201). Thus, when the O/A Agreement is executed, the owner understands what functions the architect intends performing during the construction phase.

- *The standard of care* expected of a professional is greater than that expected of a layman, and the law is critical of exculpatory language that relieves a professional of responsibility for performance of functions in accordance with the standards of his profession. The

O/A Agreement should not include language that relieves the architect from responsibilities that he, as a professional, should properly assume.

- *Apparent authority* is evidenced when one knowingly lets another appear to have authority to act for him. That one may not deny such authority if a third person has reasonably assumed it existed and relied upon it. The project representative is a case in point. The extent to which he may act on the architect's behalf should be reduced to writing and shown to the contractor. Thus both Documents B131 and A201 require an exhibit stating this authority. Document B352 may be used as a guide to preparing such an exhibit.

- *Inducing reliance* arises when one undertakes the performance of an act for another. The act, which if not done carefully can cause loss, must be done diligently and without negligence. One's actions may induce another to rely on him for a result. "Don't worry, I'll take care of that," is a typical example and one that can defeat carefully worded language in an agreement. This can become very important in the matter of preparing estimates, and the revised Document B131 makes it clearer that the architect's estimates cannot be expected to be 100 percent accurate.

- *Concurrent negligence* of another is not an excuse if one has been negligent himself. Nor does the fact that one is more negligent than another create an excuse. Thus, in the collapse of the marquee noted above, the owner, architect, engineer and contractor may all be liable for the injuries or damages suffered. Any might be sued separately and be obligated for the full verdict, or they might all be sued jointly and have to share equally in the verdict. The courts are not inclined to decide between those jointly negligent. This is important to remember when considering the matter of indemnification.

- *Control means responsibility for results.* If one has control over the performance of an act by another, he will be held responsible for the result. The term "supervision," as formerly used in the AIA Documents, connoted control and so was abandoned. Control of the construction work may not have been intended by the use of this term, but there have been enough cases in the courts to justify discontinuing its

use. The term now used is "observe as an architect," which indicates an educated review of the work by one with special or professional training.

A related consideration is safety precautions during the construction phase. Previously, the architect's responsibility for safety has not been clear and the new language of Document A201 clearly makes safety precautions the responsibility of the contractor. However, if the architect's design involves unusually hazardous tasks, he must provide certain safety instructions in the drawings or specifications. The same is true in the case of using new materials that are hazardous to the health of employees.

- *Whenever there is a right, there is a corresponding duty; whenever there is a privilege, there is a corresponding responsibility.* An example is the architect's right to direct the contractor to stop the work; under certain circumstances the architect has such a duty. His failure to fulfill it may constitute negligence.

1966 Documents

The September 1966 Edition of the AIA Documents focuses on a complete reorganization of the *General Conditions of the Contract for Construction* (A201). Revisions to the other documents, and to chapters of the Architect's Handbook of Professional Practice which discuss each of the documents in depth, all stem from work done on the A201 form. Work on this edition, the 10th since the document's initiation in 1911, was begun in December 1964.

During the review process two study documents were consulted: The CSI "White Paper" on the AIA General Conditions which suggested its major reorganization, and a group of commentaries on owner/contractor/architect relationships developed by the AGC. The final form of A201 contains many of the CSI and AGC recommendations, while preserving its historical continuity through retention of all the provisions of the 1963 Edition. This continuity was deemed imperative so that an unsuspecting practitioner would not become vulnerable in any areas previously covered by the General Conditions.

Important changes in Document A201 are noted here. The reader is referred to the September 1966 Editions of Handbook Chapters 7 (Insurance), 9 (Owner-Architect

Agreements), 13 (General Conditions), 14 (Specifications) and 17 (Owner-Contractor Agreements) for in-depth treatment of each revision incorporated into the 10th Edition of Document A201 and other AIA contract forms.

- The title of A201 has been shortened by dropping the words "of Buildings."

- The 44 articles of former A201 editions have been reorganized into 14 articles.

- A201 revisions are reflected in parallel revisions in O/A forms (see Handbook Chapter 9) and other O/C forms (Chapter 17).

- Decimal designations have been provided for every provision in the revised A201 Document.

- *Article 1, Contract Documents* contains new definitions including *addenda*, "issued prior to contract execution"; *modification*, "issued consequent thereto"; *work*, "all labor necessary to produce the construction . . . all materials and equipment incorporated"; and *project*, "total construction designed by the architect." Clarifications relating to the execution, correlation and intent of the documents and their interpretation by the architect are also included.

- *Article 2, Architect* is a compilation of the architect's functions as related to the construction phase. The language of this article parallels that of appropriate sections of the Owner-Architect Agreement, Document B131. Both A201 and B131 now contain a provision which in substance provides that the authority of the architect as the owner's representative during construction shall not be changed beyond that as set forth in Document A201.

- *Article 3, Owner* delineates the owner's responsibilities and specifies that the owner shall issue all instructions to the contractor through the architect.

- *Article 4, Contractor* covers provisions relating to the contractors which were previously scattered throughout A201. The principle that the contractor shall be solely responsible for all construction techniques, sequences and procedures is enunciated. Shop drawings and samples are defined.

A major change is the introduction of an indemnification, or "hold harmless" provision in Paragraph 4.18. A later provision (Clause 11.1.2) requires the contractor to insure his obligation under Paragraph 4.18 by including contractual liability coverage in his public lia-

bility policy. It is becoming common for owners to insist that the contractor assume all liability for accidents which may happen in the conduct of the work. In their study of this situation, those responsible for preparing this edition of A201 found that in the absence of a generally accepted standard, there were many, many different indemnification clauses—not only in owner-contractor agreements, but also in very many contractor-subcontractor agreements. Paragraph 4.18 relates only to claims which are caused in whole or in part by an error, omission or negligent act *on the part of the contractor or those for whose acts he is liable*. This offers a minimum of protection to the owner and architect against third-party claims where the contractor is actively at fault.

- *Article 5, Subcontractors* limits the term *subcontractor* to those having a direct contract with the contractor to perform work at the site. This article also clarifies the extent to which the owner and architect may indicate that a subcontractor is unacceptable to them. If a subcontractor is to be qualified prior to bidding, this requirement must be specifically stated in the bidding documents. The award of the contract changes the consequences of a refusal to accept a subcontractor, for it affects the right of the contractor to seek an increase in the contract sum because he is forced to change subcontractors.

- *Article 6, Separate Contracts* organizes into one article former Articles 34 and 35, and clarifies responsibilities for cutting, patching and cleaning-up where separate contracts are involved.

- *Article 7, Miscellaneous Provisions* includes those provisions that do not fit categorically into the other 13 articles. One of these is arbitration. Previous editions of the documents have referred to the AIA arbitration procedure. Earlier in 1966 the AIA, along with other major construction industry groups, approved a new set of Construction Industry Arbitration Rules of the American Arbitration Association. Paragraph 7.10 incorporates these new rules and procedures into A201. Disputes may be settled by other procedures if the parties agree.

- *Article 8, Time* defines contract time, establishes the date of commencement of the work, recognizes the notice to proceed and covers delays and extensions of time.

- *Article 9, Payments* defines con-

tract sum and covers the schedule of values, progress payments, certificates for payments, payments withheld, failure of payment, substantial completion and final payment. *Title to the Work* is clarified indicating that title to all work covered by an application for payment, whether incorporated in the project, will have passed to the owner free of all encumbrances prior to making of the application.

- *Article 10, Protection of Persons and Property* establishes the contractor's responsibility for initiating, maintaining and supervising all safety precautions and programs.

- *Article 11, Insurance* outlines the types of insurance appropriate for most projects. The supplementary conditions must specify amounts, limits and policies actually required. The owner should seek legal and insurance counsel on these specifics, and the architect should in no way permit an inference that he is giving professional advice on these matters. Suggested procedures are set forth in Handbook Chapter 7 together with prototype letters and a checklist of insurance coverages.

- *Article 12, Changes in the Work* defines change orders, noting that any change in contract sum or contract time must be authorized by change order. Field orders, a new project tool, are introduced as instruments which interpret the contract documents or record minor variations therefrom without change in contract sum or time.

- *Article 13, Examination and Correction of Work* is substantially an updating of former Articles 13, 17, 19 and 20, providing for the uncovering, examination and correction of work, and the acceptance of corrected or uncorrected work.

- *Article 14, Termination of the Contract* covers termination by either contractor or owner from former Articles 22 and 23.

The 10th Edition is more than just a major reorganization. Its final form represents a complete rewriting in which every word has been dissected in light of the contemporary requirements of architectural practice first noted above. The Institute is confident this edition will be a catalyst in bringing about similar changes in other general conditions published by industry components. Certainly this edition will continue the pre-eminent position in construction contract matters which the AIA General Conditions have enjoyed for more than half a century. ■

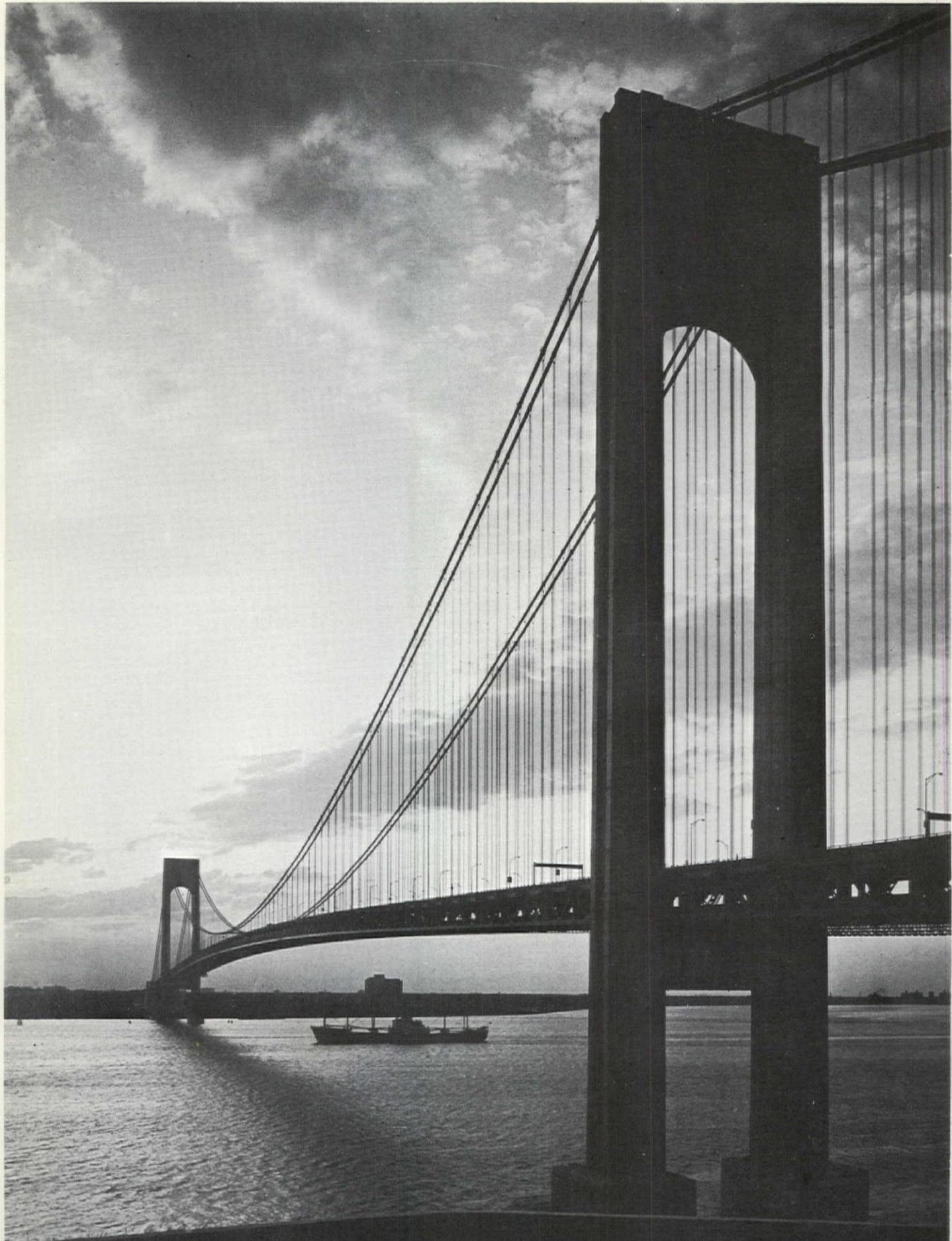

FOR BEAUTY'S SAKE

OTHMAR HERMANN AMMANN is gone, but the city which spreads over a peninsula, two islands and the tip of a third will not soon be destitute of his awesome handiwork.

How long will your bridges last? Ammann once was asked. "Well, you never know what men or civilizations will do with themselves," he answered. "But barring catastrophes . . . why, forever, of course."

Thus water-divided New York, where Ammann was responsible for the design of every major bridge over a 35-year period, will, barring catastrophe, live forever with his legacy.

Ammann, sensitive, fond of the arts, calm and soft-spoken, was also in his younger years a sports activist who climbed mountains and construction ladders with equal self-sufficiency. But he was a team man who equated "rugged individualist" with "egotist." He would say, "People are meant to work together. Nobody wants to see a one-man show."

He was called a poet in steel, an artist in steel—extravagancies, perhaps, when it seems adequate to say simply that he was a brilliant, honest, sensitive engineer.

The Swiss-born bridge builder, who died last year at the age of 86—he rated love of one's work as the key to longevity—had told the New York Academy of Sciences in a report on his Verrazano-Narrows Bridge:

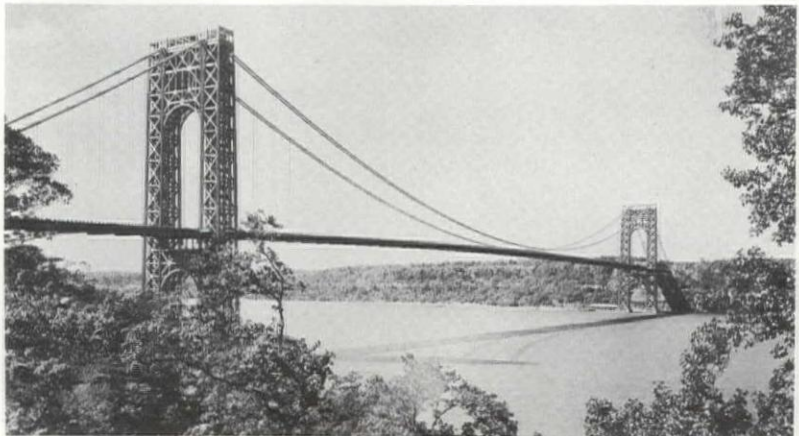
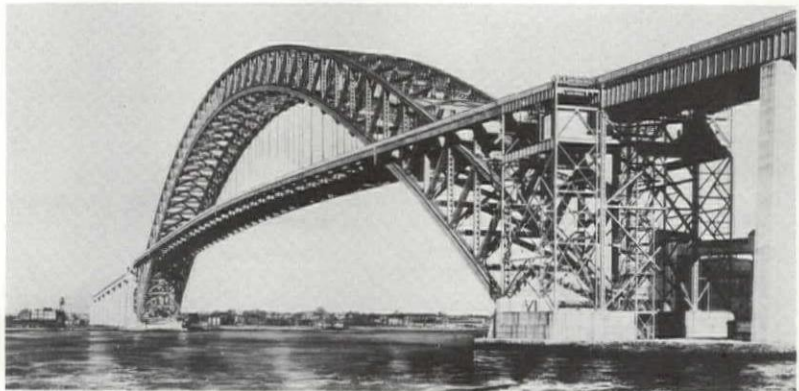

The Verrazano-Narrows Bridge (across page) and two Ammann favorites—the Bayonne Arch and his first long-span project, the George Washington.

"Esthetic considerations applied principally to the form of the struts at the top and below the deck, and to the structural makeup of the shafts and struts to produce a pleasing appearance of their surfaces. This was accomplished with very little metal not required for structural reasons."

He believed in simplicity and truthfulness but once cautioned

pragmatic peers that "economics and utility are not the engineer's only concerns. He must temper his practicality with esthetic sensitivity. His structures should please the eye. In fact, an engineer designing a bridge is justified in making a more expensive design for beauty's sake alone. After all, many people will have to look at the bridge for the rest of their lives. Few of us ap-

O. H. Ammann admonished his fellow engineers to temper practicality with esthetic sensitivity. Their structures, he was wont to say, "should please the eye."

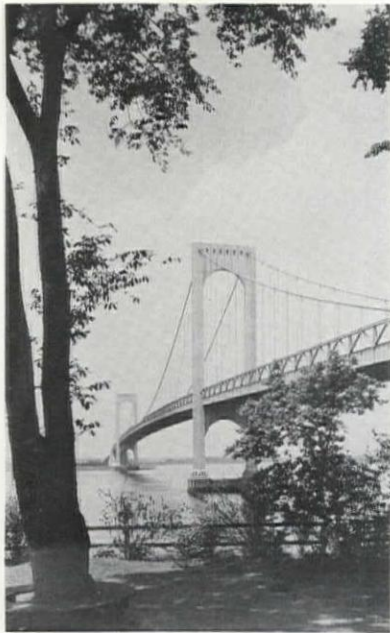

Bronx-Whitestone from Long Island.

preciate eyesores, even if we should save a little money by building them."

When architectural planning for his George Washington Bridge called for masonry on the towers, Ammann allowed as how he hoped the stone would never be installed. His hope was fulfilled; for economy reasons masonry was abandoned.

Still, the upper struts of all his suspension work bear "masonry arches" which tend to meddle in the natural province of the cable catenaries.

Suspension images rush to mind at the mention of Ammann's name, yet his most beautiful New York span was probably the Bayonne Arch Bridge.

He would list three favorites—the George Washington, the Ba-

yonne and the Golden Gate in San Francisco (he was consulting engineer for the latter)—but more than once he indicated that his fondness for the George Washington span stemmed from the sheer excitement of the task: "It was my first experience with a long-span bridge and it was quite a step forward, particularly for a young man."

And on another occasion when asked to name his favorite he led off with the George Washington—"This was my real 'first.' It was a big job that presented a great challenge—" then added significantly: "Yes, that along with the Bayonne Arch Bridge which I have always thought was a rather pleasant-looking arch structure."

Both the Bayonne Arch and George Washington opened in 1931 amid arguments over their relative merits, a controversy that failed to engulf the engineer who said, "One is as good as the other in the conditions for which they were built."

To Ammann, competitive measurements were equally inane. "Mere size and proportion," he once remarked, "are not the outstanding merits of a bridge; a bridge should be handed down to posterity as a truly monumental structure

which will cast credit on the esthetic sense of generations."

Ammann, who had once considered a career in architecture, was also responsible for the design of New York's Triborough, Bronx-Whitestone, Walt Whitman and Throgs Neck Bridges as well as the other two spans (besides the Bayonne) linking the city's Staten Island with New Jersey, the Goethals and Outerbridge Crossing.

He entered into partnership with Charles S. Whitney in 1946, and in 1962 the two engineers received the Allied Professions Medal of The American Institute of Architects, a posthumous honor for Whitney who died in 1959. Their names, said the medal citation, "have been practically synonymous with the major bridge building of the United States. . . . In addition, they have been associated with many notable architectural works of our day, of which not the least is the Dulles International Airport of this year's Gold Medalist, Eero Saarinen, and his associates."

And now, in 1966, the airport has won an AIA First Honor Award. O. H. Ammann, advocate of the "pleasing appearance," would have been pleased. ■

The Triborough looking north from Queens over main span.



The Throgs Neck Bridge, most recent Long Island connection to the mainland, with its squatty and businesslike towers.

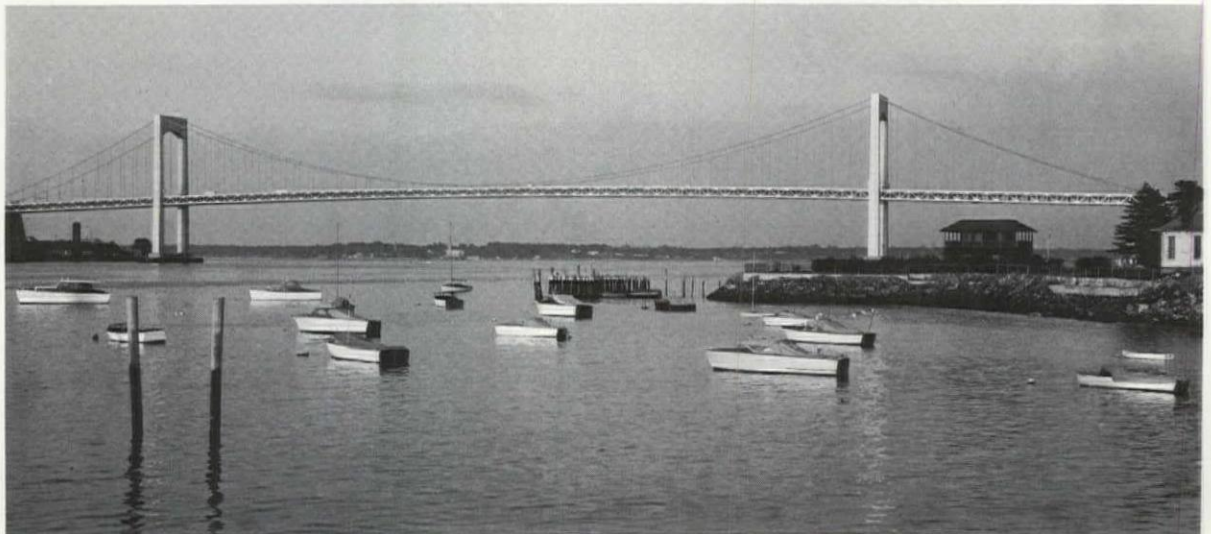

WILLIAM GRAY PURCELL

A Lively Link in the Modern Movement

BY DAVID GEBHARD



TAKING UP the subject of the then-current Secessionist architecture which was being built in the Chicago area, a young midwestern practitioner in 1912 wrote a series of papers intended for publication in *Outlook* magazine.

In the first of these papers he wrote "that 'the Young Man of the Middle West' does not desire or expect to create an American architecture. That he has no desire to produce an original architecture. That the reputation of what the past has done is far from his mind. . . . What he does demand . . . is a wholesome and fundamental honesty. What he does demand is that precedent shall be followed, not its outward forms duplicated."

The writer of those words was William Gray Purcell, who was one of the most active participants in the development of modern architecture in the United States. As a designer, he formed a fascinating link, not only between Louis H. Sullivan and Prairie architecture, but between the early Modern Movement on the West Coast and in the Midwest. Also, to a surprising degree, he was a major contributor to the interchange of ideas between Europe and the United States during the first and second decades of the century. Like other proponents of the early Modern Movement, he

involved himself not only with specific architectural problems—from individual buildings to city planning—but he also designed furniture, even automobiles. He did the layout and design for the printed page, and he was an accomplished painter.

Running hand in hand with his involvement in design were his activities as a writer, as a propagandist, for modern architecture. In a way Purcell's writings are akin to an iceberg, for only a small percentage of them were written for publication; most of his writings were in the form of personal letters. His correspondence comprises a virtual Who's Who of European and American architects, critics and historians of the first half of this century. Unlike so many of the major figures of 20th century architecture, he continually and unselfishly advanced the cause of one or another of his contemporaries. For example, after he returned to the Midwest (1907) from several years of work on the West Coast, he tried, on several occasions, to interest the editor of *Architectural Record* in the work of Bernard Maybeck (of which

The author is director of the Art Gallery and associate professor of art at the University of California, Santa Barbara. He was acquainted with both Mr. Purcell and George Grant Elmslie, to whose work he devoted his doctoral dissertation at the University of Minnesota.

the editor of the magazine in all candor had to admit complete ignorance).

Oftentimes Purcell pressed the cause of one of his contemporaries to such an extent that it meant the loss of a substantial commission. In 1910 Purcell, Feick & Elmslie had devoted months of painstaking study to the design for St. Paul's Methodist Episcopal Church in Cedar Rapids, Iowa, only to later lose the commission to Sullivan. As Purcell wrote of this episode, "I spent a number of hours (with the head of the building committee) in several sessions outlining the whole philosophy of modern architecture . . . and of course . . . proceeded to show him how this had originated in the mind of Louis Sullivan."

Although his relationship with Wright throughout his life was an on-again-off-again affair, Purcell was a steadfast admirer and defender of the master of Taliesin. Even during the 1920s when Wright's personal stock (both as an individual and as an architect) was at its lowest point, Purcell continually wrote and spoke in his defense. As late as the 1950s Purcell was instrumental in planning and in financing a film on Wright's West Coast architecture.

In addition to Sullivan and Wright, Purcell was involved with other members of the midwestern Prairie School. The firm of Purcell, Feick & Elmslie collaborated with Walter Burley Griffin on several projects before Griffin won the international competition for the city plan of Canberra, Australia. When Griffin's Canberra project was published in the *Western Architect* (Sept. 1912), Purcell wrote of him, "Mr. Griffin is one of the two or three younger men who have been thoroughly trained for the new movement in architecture, and who have kept carefully and thoughtfully to the work at hand, refusing to be led aside by novelty, desire to be original, or by personal egotism." The Purcell-Griffin correspondence of the teens and the twenties contain the whole history of Griffin's losing battle to see realized his scheme for the Australian capital.

There were a number of other figures of the Prairie School with whom Purcell corresponded and in some cases collaborated. He wrote the introductory article to a special issue of the *Western Architect* (April 1914) devoted to the work of his friend, Robert Spencer (Spencer & Powers). The firm collaborated as well with William Drummond and William Steele. Purcell was always enthusiastic about the attempt of Charles White and others to popularize the progressive architectural forms and to make them available to an even larger segment of the population.

When he traveled to Europe in 1906, Purcell's main purpose was to meet and establish contact with progressive European designers. In Holland

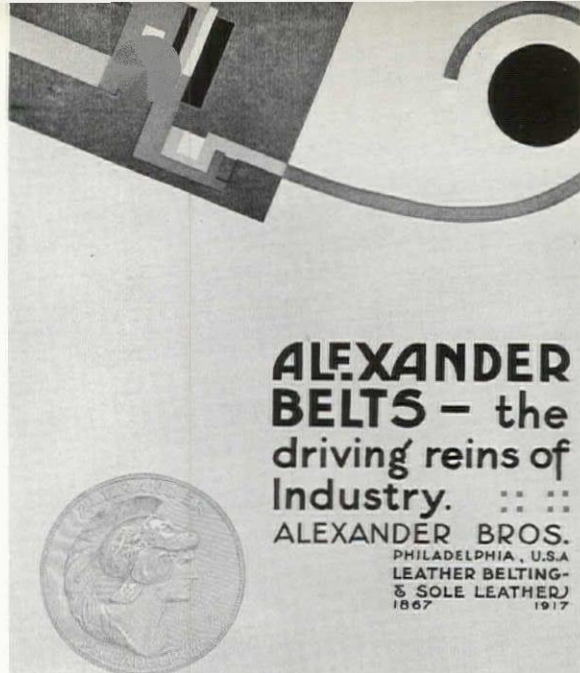

Cover of an Alexander Leather and Belting Corp. publication, Philadelphia, 1918, by Purcell and John Norton.

he met H. P. Berlage; in Denmark, Martin Nystrup; in Norway, Henrik Bull; and in Sweden, Ferdinand Boberg. It was Purcell, more than any single individual, who contributed to the Dutch interest in and enthusiasm for Prairie architecture. In 1911 Purcell was responsible for bringing Berlage to this country (he and George Elmslie wrote an article on Berlage for the Feb. 1912 *The Craftsman*), and after Berlage returned to Holland the Dutch architect became even more of an active propagandist for the new American architecture.

For many years Purcell corresponded with other architects whom he had met in Europe. Early in 1908 he sent photographs and other material illustrating Wright's work to Ferdinand Boberg in Stockholm, and in the accompanying letter (dated May 12, 1908) he wrote, "I will be happy to go into some detail with you concerning the work of Mr. Wright, the more especially because I believe that an exchange of ideas with the few in Europe who really seem to be awakening to the life of today, will benefit all of us."

Purcell felt strongly about the need to couple painting and sculpture with architecture, and whenever the project warranted it, murals and sculpture were an integral part of the design. Purcell & Elmslie commissioned both Alfonso Iannelli and Richard Bock to do relief sculpture for several of their buildings. The painters Charles Livingston Bull, Charles Chapman and John Norton did murals for many of their houses as well as their public and commercial buildings.

During 1917-19 Purcell worked in close collaboration with John Norton to produce a series of cover designs for the Alexander Leather and Belting Corporation of Philadelphia. These cover designs, composed of interlocking circles, squares

and lines, are remarkably similar in spirit to the work then being produced by the De Stijl group in Holland.

After Purcell had moved to Oregon in the early 1920s, he was instrumental in helping to establish the Oregon Society of Artists, and he wrote regularly on art in the publication *The Spectator*. In Portland he met the painter C. S. Price, and for over a decade he encouraged and, to a considerable extent, helped to support this struggling young artist, who is now recognized as one of America's leading West Coast painters of the 1920s and 30s.

Purcell's range of activities and interest is understandable when one looks back at the American Midwest and, specifically, the city of Chicago just before and after the turn of the century. There was, indeed, from the 1880s on a "Chicago School," but it was far more than just a departure in architecture, for the "Chicago School" equally represented other pioneering developments in politics, economics, education, psychology and literature. This was the atmosphere in which Purcell grew up. He was raised by his grandfather, William Cunningham Gray, a prominent literary figure of the day and the editor of the magazine *The Interior*. Across Forest Avenue from his grandfather's house, Wright had built his Oak Park house and studio. Through his grandparents, the young Purcell was exposed to the work and the personalities of Sullivan, Root and Burnham, and the whole Chicago architectural scene of the 1890s.

With such a background, it is not surprising that Purcell was a rebel before and during his exposure

to the École des Beaux-Arts program he experienced during his formal architectural education at Cornell University. A project for a wall fountain which he did for his grandfather's Oak Park garden in 1900 while he was still a student shows how he brought together classical Beaux-Arts ideas with the radical forms which were then current in Chicago. While the basic form of this fountain is classical, the terra-cotta frieze around the opening is unquestionably Mayan in feeling; the geometric pattern on the rear wall and the column capitals were obviously inspired by the work of Sullivan and Wright.

After his graduation, Purcell sought out, as soon as possible, a more liberal environment. He obtained employment first with Louis Sullivan in Chicago (1903) and later in Berkeley with John Galen Howard (1904). To broaden himself further, he spent much of 1906 in Europe seeing the newer work then being accomplished on the continent. The following year, at the age of 27, he established his own architectural practice in partnership with a Cornell classmate, George Feick, Jr. Referring to his first days in Minneapolis, he wrote that "these architects spread their drawing paper, tapped an old typewriter, radiated enthusiasm and wondered how they were going to secure some business in a strange city where the partners knew but one man."

Though the first year of Purcell & Feick's existence could hardly be considered a glowing business success, they were able to produce several remarkably accomplished designs. The drawings for the projected First National Bank at Winona,

Wall fountain for the William C. Gray House, Oak Park, Illinois, 1900 (drawing by Purcell).

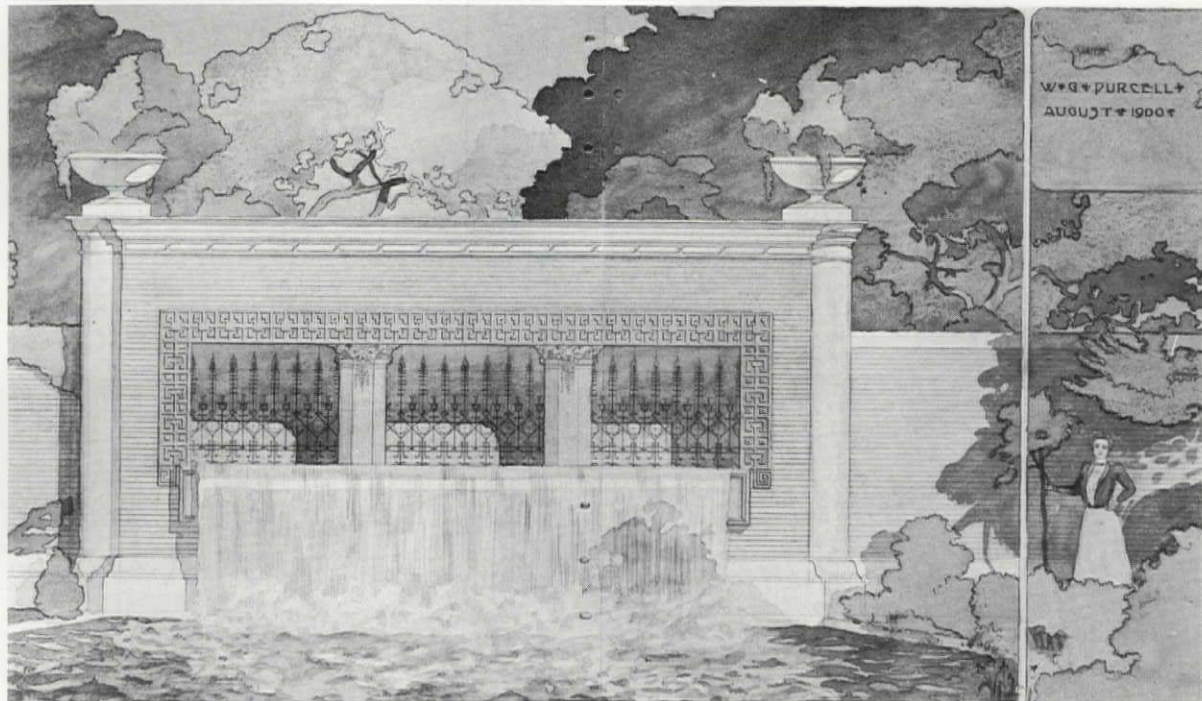

DWELLING FOR MRE. C. WARNER.
OVERLOOKING LAKE CALHOUN ~.
BY GRAY PURCELL AND GEORGE FEICK JR., ARCHITECTS.

VIEW DOWN THE LAKE

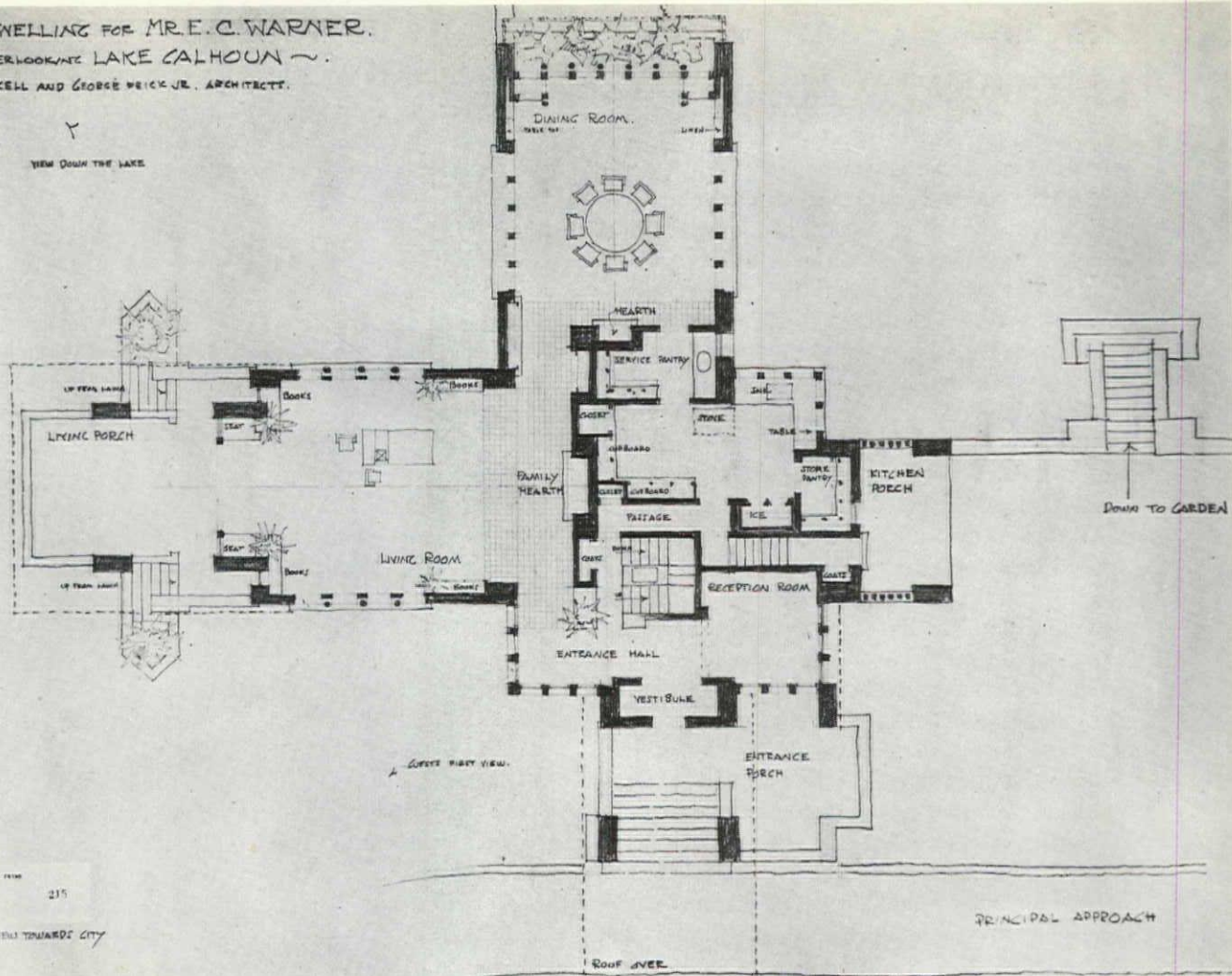

Plan of the Warner House in Minneapolis, 1909, by Purcell & Feick; and the First National Bank, Mankato, Minnesota, 1911, by Purcell, Feick & Elmslie (all drawings on the two pages by Purcell).

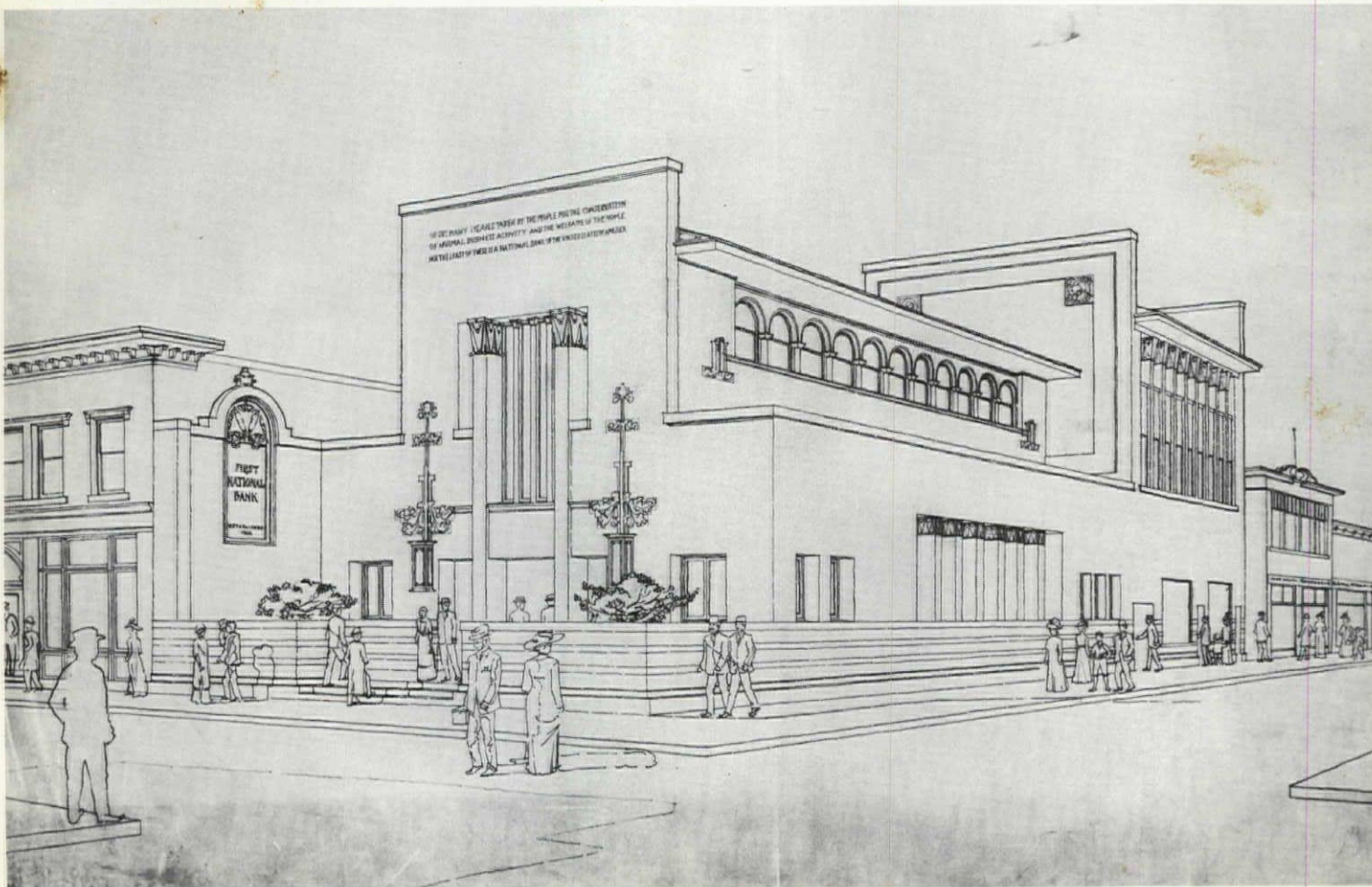

Minnesota, provide a clear indication of Purcell's ability as a designer. In this building the four perimeter walls were planned to be two-thirds of glass, while the skylight accounted for over half of the ceiling surface. The semitransparent leaded glass walls were designed to pass visually behind the structural piers so that from the interior the walls read as thin, almost two-dimensional, planes. The structure of the building, in terms of the vertical supports could be read from the exterior of the building, while the ceiling beams formed the horizontal grid for the large, central skylight.

The work produced during the three years of the Purcell & Feick firm (1907-09) is remarkable in its quality and in the variety of approaches which were utilized. Some of the work, such as the projected United Brethren Church, Minneapolis (1908), and the projected Elks Club for Mankato, Minnesota (1908), exists more within the framework of European than American Secessionist architecture. While all of their houses share points in common with the concurrent work of Wright, they still express a highly individual quality. The projected Warner house in Minneapolis (1909) was based upon Wright's cruciform plan, but still, the entrance and service area and the spatial relationship between the rooms and between the interior and exterior are decidedly different. The Gallaher house at Lake Minnetonka, Minnesota

Gallaher House, 1909, by Purcell & Feick.

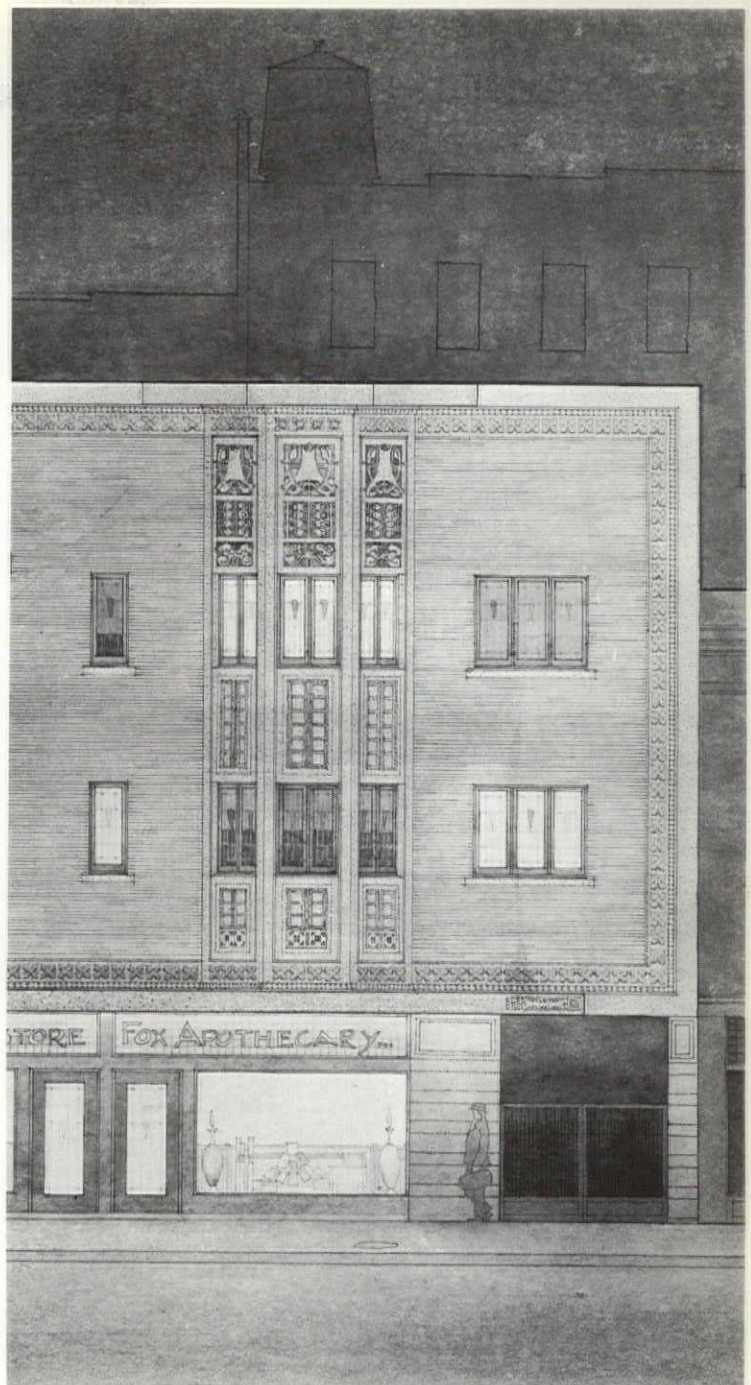
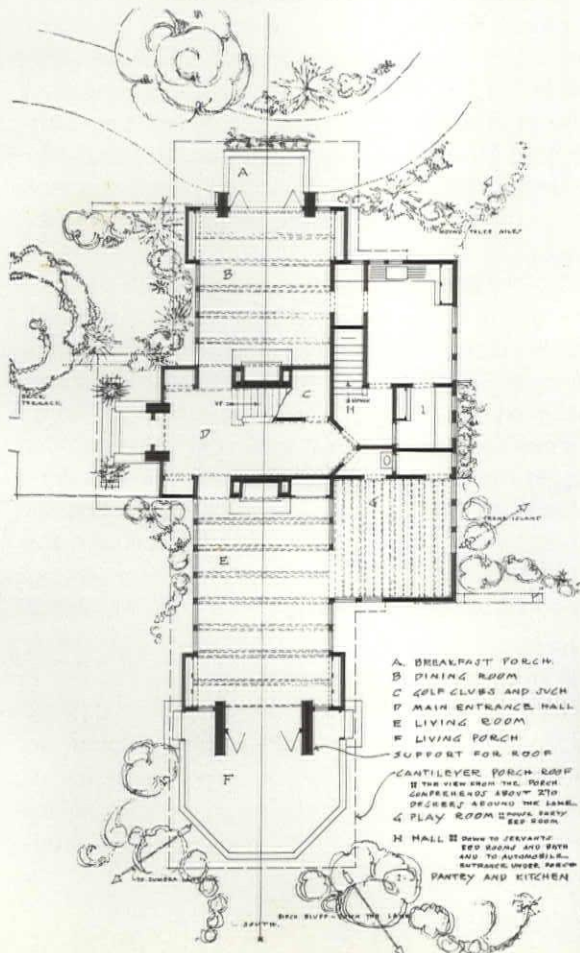

Welcome Inn, Rhinelander, Wisconsin, 1915, by Purcell & Elmslie; Councilor House, Rochester, 1927, by Purcell.

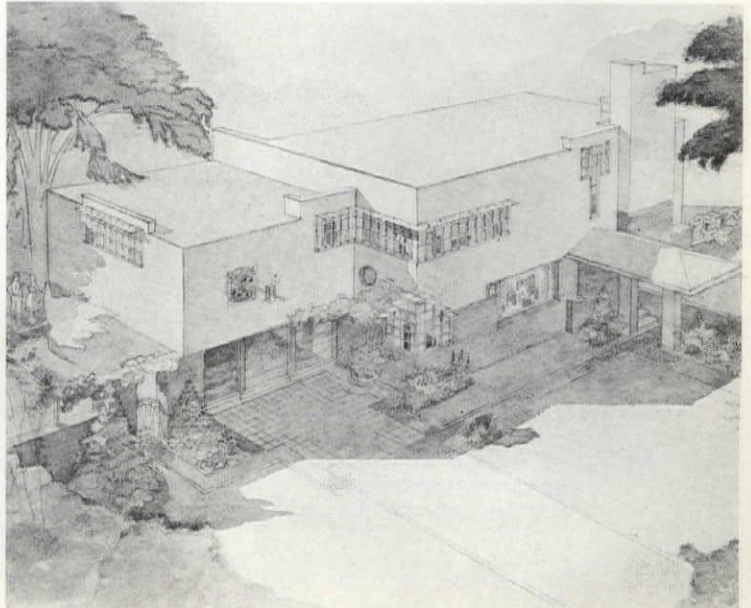

(1909), illustrates how Purcell, through the use of double folding doors, fully established a spatial flow between the interior and exterior of the house.

Elmslie's entrance into the firm in late 1909 was an extremely significant event. The relationship between him and Purcell (the firm was in existence from 1909 through 1922) was one of those rare affairs in architectural history; each would seem to have supplemented and to have stimulated the other, just where needed and in the right amount.

Almost from the start the buildings which they produced assumed a distinct quality which was decidedly different from that which both men had produced before 1909. Not that either of them had lost their own design personality, for it is readily possible to see which one of the partners had a predominant hand in this or that work. The point is that it is unlikely that either Purcell or Elmslie could have produced the work they did between 1909 and 1922 without the presence of the other. Thus the initial scheme for the projected First National Bank of Mankato, Minnesota (1912), or the later project for the Rhineland, Wisconsin, Hotel (1915) were arrived at by Purcell (as well as being rendered by him), yet it is unlikely that he would ever have arrived at their specific design solutions without the critical suggestions of his partner.

As one would expect, Purcell's West Coast work of the 1920s and 1930s is quite different in character from the designs produced during his partnership with Elmslie. In part, these were a return to the adventurous spirit of the earlier Purcell & Feick days, for he continued to display an openness of mind to the newer architectural forms then emerging in Europe. The Bell house in Portland, Oregon (1927), the projected Councilor house at Rochester, Minnesota (1928), and his own house at Palm Springs, California (1933, with Evera van Bailey), are, in a loose sense of the term, within the fold of the International Style; although in their concern with vertical as well as horizontal movements of space, they are closer to the work of R. M. Schindler than to any of the European Internationalists.

Side by side with Purcell's experiments in the International Style were the designs for a number of houses that were close in spirit to the vernacular-inspired buildings which Maybeck was doing in the Bay region of San Francisco. The romantic irregularity of plan, of high-pitched roofs of his own house in Portland, Oregon (1920), and of the projected Boysen house in Minneapolis (1928) are examples of his effort to develop forms out of the West Coast vernacular tradition.

The 1920s also marked an increased interest on his part in low-cost housing. He designed and built

over a dozen inexpensive houses, each of which was an experiment itself. He was intrigued as well by bungalow courts, which he felt entailed many ideas that could be used in urban planning. His illness in the late 1920s prevented him from building several bungalow courts which he had designed, and it also prevented him from completing a study, "Bungalow Courts: California's Approach to Multiple Dwellings," which he had hoped to publish.

His friendship in Portland with C. S. Price prompted him to devote an increased amount of his time to painting. The two men made many trips together into the mountains and forests of the Pacific Northwest. Purcell's small-scaled—almost miniature—landscapes in watercolor capture the underlying, hidden romance of nature through highly abstract forms which are solely the result of the media itself. At this time in America, only the paintings of Arthur Dove conveyed a similar organic feeling for nature.

Purcell's severe illness with tuberculosis in the late 1920s and early 1930s forced him to abandon his Portland architectural practice. But with his recovery in 1932, he again began to design in a limited way—first, for himself, the already cited house at Palm Springs, then a second house at Banning, California (1939), and several houses in Minneapolis. In 1941 he began to contribute regularly to the magazine *The Northwest Architect*.

In 1953 Purcell worked closely with Walker Art Center of Minneapolis in presenting an extensive exhibit of the work of Purcell & Elmslie. This exhibition and the interest it stimulated prompted him to compile a detailed record of the early Modern Movement in American architecture. The archives which Purcell assembled constitute one of the major sources for the history of this movement.

The 1950s and '60s were as active and productive as any earlier period. "Westwinds," his house on the mountainside overlooking Pasadena, was increasingly visited by American and European architects and scholars. He continued his voluminous correspondence with literally anyone who sought out information or criticism. He also continued and brought to completion his manuscript on the St. Croix Trail (to be published by the University of Minnesota Press). In 1963, in recognition of his contribution to design, he was made a fellow of The American Institute of Architects, just two years before his death.

In recent years Purcell's importance as a writer and critic on American architecture has come to be fully appreciated. The next step will be that of realizing his contribution as a designer: his ability to fuse together many of the major tenets of 20th century architecture. ■

Do send me what you can spare in the way of funds. Remember, I have everything to purchase, a small purse and a high spirit. ELIZA MILLS IN A LETTER TO HER HUSBAND, ARCHITECT ROBERT MILLS, IN THE 1820s



FUNDING A RESTORATION

BY WALTER F. PETTY, AIA

THE FUNDS CAMPAIGN for restoration of the Ainsley Hall House and its adjacent grounds, designated as the Robert Mills Memorial Garden and Park after the architect, in Columbia, South Carolina, is a most interesting part of the project's story. Opened to the public in October, the house, designed in the 1820s, and the garden are purely a tribute to the talents of the local women and to the citizens who gave them unstinted support.

Concern for the preservation of this significant house, acknowledged as one of the finest of Columbia's early 19th century residences and as one of Mills' outstanding works, began in 1960 following issuance of demolition permits. A group of interested persons who had been trying to generate efforts to save the house used the permit issuance to focus its concern, and the Historic Columbia Foundation was organized overnight. Quick funds were found to satisfy the wreckers' interest in the "old brick," and the property was fenced, the house boarded up and a campaign for private funds initiated.

From the beginning the drive faced the sobering fact that most male leaders in the community and the foundation felt the goal of almost \$400,000 for purchase and restoration was too ambitious to achieve success. Indeed, these fears had some substance, since by mid-1962 it was apparent that no method of private endowment would appear and that a public fund drive was the only hope.

Coincident with this realization, Mrs. James F. Dreher was elected foundation president. Two hundred ladies were recruited and organized for a fund campaign that began in November 1962. A 15-minute, professionally narrated color slide show, telling the Hall House story factually and dramatically, was created and booked all over the state—at service clubs, chambers of commerce, PTA meetings and even cocktail parties. "Founderships" were established for those giving a minimum of \$1,000, these names to be inscribed on a memorial plaque. This inducement proved to be the backbone of the campaign. Within a month

Chairman of the Restoration Advisory Committee of the Historic Columbia Foundation, the author is a corresponding member of the AIA Committee on Historic Buildings.



The north (top) and south (bottom) facades reveal the Ainsley Hall House before restoration. Concrete porch, sloped piazza roof and center window are not original elements. The restored house and flankers are illustrated on the preceding page by Gil Petroff.

over \$100,000 had been raised. Local government officials, impressed with the ladies' fund-raising success, were persuaded to commit \$20,000 annually for grounds maintenance and operation.

In December a purchase contract with a 90-day closing provision was negotiated, and the ladies proceeded with renewed vigor. Challenge gifts and foundation grants totaling almost \$50,000 were received. The South Carolina Chapter AIA agreed to underwrite architectural fees. As the deadline approached, the campaign was almost 20 percent short of its goal. The Historic Columbia Foundation, with city and county backing, picked up the purchase contract, borrowing from five local banks and using pledges to the property fund as collateral. In just four months the women of Columbia had assembled for the city the financial tools for saving a major part of their civic heritage.

There are, of course, other important details that fill out the total story of this funding operation: the state legislature's creation of the Richland County Historic Preservation Commission as a legally constituted authority to hold ownership of the house and grounds; the receipt of a grant

from the Open Space Land in Cities Program to wind up purchase details; the accumulation of furnishings in value of \$6,000; the establishment of "patronships" for those giving a second time over the \$1,000 foundership; several large, single bequests from local civic organizations; and, of course, numberless hours of time spent by the many, many people during the funding and reconstruction periods—their compensation so often intrinsic rather than material.

But throughout the progress of this project, all have been mindful of the passage quoted from the Eliza Mills letter. A "high spirit" has been the dominant note through each phase of the project and especially so of the ladies' fund-raising campaign. Those of us who have had the privilege of watching this operation have seen rules and red-tape chucked out the window, funds shifted from Peter to pay Paul, discouragement not accepted, every move sharp but strictly legal and the volunteer treasurer's books given a perfect score at every semiannual CPA audit. These efforts have accomplished something of real and lasting distinction worthy of our best traditions. ■



Editor: *Marcus Whiffen, College of Architecture, Arizona State University, Tempe.* **Contents:** *A summation of the 52nd annual meeting, which drew 157 registrants to the headquarters Brown Palace Hotel in Denver for the June 24-26 weekend of debate and discussion.*

ACSA in Denver: From Tours to Testing

THE THREE-DAY PROGRAM began with a bus tour—a departure from the usual order of things which was surely well considered in that it did something to satisfy the curiosity of those who had not been there before about the special character of the locale and also helped to acclimatize the lowlanders to the mile-high altitude before the rigors of debate and discussion made yet further demands upon them.

First stop was the Red Rocks Amphitheater (Burnham Hoyt, architect); the second was I. M. Pei's National Center for Atmospheric Research above Boulder. It would be difficult to find two works of architecture more different from each other in nearly every respect. Yet one thing they have in common: Both harmonize with, and humanize, sites of great natural beauty, even sublimity. This is no common achievement, and it may be that their images remained with more than one registrant, through a meeting in which so many analogies with law and mathematics and medicine were heard, as a reminder that architecture is after all one of the visual arts. As it happened, study of other than the visual aspects of Pei's "castle" proved impossible that afternoon, for a strike of construction workers required that the besieging ACSA forces keep their distance as if the towers had been manned with archers.

Once in Boulder, members found all doors open. The first to receive them were those of the hosts to the meeting, the University of Colorado School of Architecture, where an exhibition of student work had been put on for the occasion. From there the buses went to the new Engineering Center (Architectural Associates of Colorado, architects), another towered complex in whose design the *genius loci* was consulted, its forms and textures echoing the older buildings on the campus. Here, after Dean **DeVon Carlson** gave a word of

welcome, Dr. **Muriel Sibyl Wolle** of the University of Colorado art department lectured on the Ghost Towns of Colorado, with a series of slides made from her own sketches. The remarkable quality of the latter combined with the speaker's knowledge and enthusiasm and the intrinsic interest of her subject made this a rewarding hour.

The last scheduled event of the day was what Dean Henry L. Kamphoefner (North Carolina State University) in a later speech aptly described as a "swinging" cocktail party given by the host school at the University Country Club.

SECOND DAY: MORNING SESSION

Calling the meeting to order, President Walter Sanders acknowledged a quorum upon completion of the roll call. **Nolan Barrick** (Texas Technological College) announced that Dean **Kenneth Sargent** (Syracuse University) had been elected for a two-year term as director by a vote of 48 to 2. The next item of business had to do with applications for ACSA membership. Following the recommendations of the Board of Directors, the Department of Art, University of Hawaii, and the Division of Architecture, Tuskegee Institute, were accepted as associate members; and the Department of Architecture, Louisiana State University, and the Architecture Section of the School of Art and Architecture, University of Southwestern Louisiana, were advanced to full membership.

President Sanders yielded the chair to **Thomas H. Howarth** (University of Toronto) as moderator of a panel discussion of the subject "Implications for ACSA of New Approaches to Architectural Education." Having introduced the members of the panel, Gerald McCue (chairman, Department of Architecture, University of California, Berkeley),

Dean Joseph R. Passoneau (Washington University), and Dean George Dudley (University of California, Los Angeles), Dr. Howarth said:

"Our president suggested that the theme of this discussion should be all around the future of ACSA. We have changed that. We are going to talk about the educational pattern, keeping in back of our minds the problem of ACSA as we work through the material. . . . We will talk about the system, the 'before, during and after' aspects of architectural education. The 'before' professional education, the preprofessional degree concern will be dealt with by Gerald McCue. The 'during'—that is the professional, up to the attainment of the first professional degree—will be dealt with by Joe Passoneau; the 'after'—the master's and Ph.D. courses, postgraduate research, courses for professional registration and continuing education of architects—will be discussed by George Dudley.

"Our confused philosophy, or lack of philosophy, has been clearly apparent in our inability as educators and professional people to understand and satisfy human need in terms of physical environment. 'Why,' said an experienced Canadian lawyer to me the other day—a lawyer, I should add, who works with architects, planners and teaches planning students—'do architects hate human beings?' By this question, of course, he voiced the bewilderment of the intelligent layman at a profession that gives lip service to principles of environmental design, yet seems incapable of producing buildings that really function well and environments that really meet the needs of our changing society.

"As educators we have acknowledged the necessity for establishing human values; arts and humanities, social and behavioral science subjects are integrated with professional classes in many of our educational curricula at undergraduate level. Some educators believe that all professional programs should be at graduate level, that a preprofessional degree—in our case usually an arts degree—is an essential prerequisite to professional studies. But is it? Should these subjects be filtered out of the professional program and confined to the preprofessional degree? Is there not a danger that the student will consider them as something extraneous, too, rather than as part of his developing education? Should we have a preprofessional degree—if so, of what kind and how long should the program last?

"Although we all subscribe to the concept of 'design' as a total creative and intellectual process by which art, science and technology should be integrated and channeled to solve environmental problems, our educational programs have by no means provided a sound basis for professional growth. Despite our most strenuous efforts at cur-

ricula revision and philosophical self-examination, we have not yet resolved many basic problems. And why do we continually fail to build well? Can we truthfully claim that the output of the average and above-average architect is even reasonably satisfying esthetically, functionally and practically? What of mechanical and material failures; of the neglect of climatic factors, of our apparent ignorance of the characteristics of building materials, weathering and maintenance? What of economic factors, management and cost control? What of acoustics, color or furnishing?

"In the recent scramble to train 'urban designers,' are we educating men who will be such generalists that they will be incompetent to do anything but generalize? Who will design buildings and supervise their construction? What, in fact, do we mean in architectural terms by professional education? And what are we doing about 'diversification'—the opportunity for concentration at undergraduate level?

"Formal architectural education is simply a preparation for practice, research or scholarship—a time in which the intellect and the perceptive and creative processes are prepared and sharpened for exercise in the wider fields of professional and academic activity. We must examine carefully, therefore, ways and means by which the profession can share with us the responsibility for extending the educational process into the professional areas, at least to the point of registration for practice. How can we use more effectively the practitioner as a teacher and how can he be educated in peda-

ACSA participants enter the new Engineering Center on the Boulder campus of the University of Colorado.





gogic methods for this highly important and very critical role? Generally speaking a school is only as good as its teachers.

"What is or should be the purpose of graduate work—architecture in depth (research and specialization)? Architecture in breadth (urban design)? Or *more* general studies?

"What should be the role of the schools during the internship period between graduation and registration for practice? What should be the role of the schools in continuing education for architects in practice?"

McCue said he would begin with some consideration of the public image of architecture and of the aims and interests of the architectural profession. "I believe that, by and large, most of the public does not understand the purposes that we espouse, that the public image is probably more typically represented by the *Ayn Rands* and the slick magazines, the notion of the romantic architect who makes the sweeping decision with the flourish of the hand, is the leader of the community and always gets the blonde at the end of the story.

"The truth of the matter is that most people are directed into architecture by high school counselors, mechanical drawing teachers, art teachers who frequently don't know anything about this field. These people must be given an introduction to the capabilities and the problems to which our profession hopes to address itself. . . .

"I would like to put forth the notion that the difference in background of people before they get into the professional training has more to do with their effectiveness as architects later than which architectural school they attend. I think we address ourselves too often to the four, five and six years and argue these points during the period of collegiate work, not fully understanding the fact that our society is producing people who are frequently callous to the concerns of the rest of humanity and callous to the concerns that the profession wants to argue about.

"I would suggest that ACSA is almost the only organization which could direct itself in a non-professional way to the development of a program which would begin perhaps in elementary schools. And there is a parallel for this kind of development. The teachers of mathematics at the college level, beginning about 10 years ago, became totally dissatisfied with the kind of preparation given to people at the early school level, and they took it upon themselves to develop programs and to introduce them into the elementary schools and high schools in order to prepare a basis upon which they could build at the college level. . . .

"I would suggest that the issue as to whether general education is necessary ought to be dead. It seems to me that 10 or 15 years from now the

vast majority of our population will be expected to have college level education. . . . The question as to when it should come is a matter of personal choice. This is a matter of form, and I think that being architects we have a great tendency to want to overstructure curricula. An architect wants to design a curriculum the way he wants to design a building, to make all pieces precise with none left over and no gaps, and as a result it is a very neat whole.

"I think this is an unnecessary ordering of an educational process which might be better thought of as a series of magnetic fields which are in flux and will be changing. If we think of this general education as an educational process, then we will not relate it to a preconceived end result; we will try to relate it to the student and the student's particular motivations. I think these motivations are different and that it is essential that our programs have the degree of flexibility which will offer the student that part of his education which is of most interest to him at that time. . . .

"If we consider the total process as continuing, as beginning at day one, then we take a more humble view of what is possible in the three, four, five, six years they may be at the university. Think of this as being one more step in a total process by which these people become better informed, more responsible citizens, more capable of dealing with the problems that our society brings to them.

"Many students need this period of general education as a matter of fact really to understand the implications of the field. We find at Berkeley more and more students coming to us after they have completed work in another degree and not yet certain whether they want to be involved in architecture or perhaps planning or landscape architecture. Some period for these students to get their feet wet in professional work and at the same time have a preponderance of their time spent in general education will allow them to make their choices wisely and without overall loss of time.

"I believe ACSA should enlarge its own objective to deal with the problem area and not necessarily with the profession in its present form, that ACSA must be the forum in which different forms of professional education are argued, that it should discourage uniformity and encourage programs that are related to resources and not the rash of catalog entries to keep up with the latest fads."

Passoneau began by stating that he had no confidence in the ability of an architectural faculty to "educate" the student; this should be left to others better equipped academically. Among the factors he saw as contributing to the present climate of ideas were the debate between those who favored rational methods and those who favored intuitive methods of design—"I think there are many soph-

istries on both sides"—and the "debate between people who believe in a single profession on one hand and people who believe that architecture or the environment has to be dealt with by a group of discrete, related disciplines aimed at a common task, that of shaping the environment." He himself was arguing for the urbane generalist; he was also arguing against "the lumping principle."

"I agree," Passoneau said, "that everything is related to everything else. Mathematically you can state it: The world is just one big homogeneous equation; some things are related to other things in ways that are important, and the problem is to identify what connections are important and what we have to concern ourselves with, and what connections are unimportant and what connections can be ignored.

"I think the tendency to lump everything together permits us to treat all design problems alike. To judge a low-cost housing project by the same standards we would judge an exurban house for a wealthy, in-group client is not only wrong but dangerous. It also permits us to teach substitute courses without the foggiest notion of their relationship to the design process. I am talking about courses in materials, professional practice, even courses in structural engineering.

"When I look about I see architects doing very good work embodying what I think of as the structural principles. Most of these wouldn't know a vector from a pogo stick. I cannot trace the direct relationship of statics and strength of materials to the architectural design process."

There was, Passoneau insisted, such a thing as a design process. "There is a methodology in design that should be taught explicitly in substantive courses and demonstrated in each design problem." Selection of design problems, and what was emphasized in them, stated in the most explicit way the "world view" of a school.

Dudley, the member of the panel allotted the subject of graduate and continuing education and research, said he thought that design education for architects should be considered in terms of two-year increments. A student should be given the chance of taking a B.A. or B.Sc. at the end of four years instead of going on to a professional degree (which he felt should be a master's) at the end of six, and there should be a degree equivalent to a doctorate at the end of another two-year increment. In his own school at UCLA they were beginning with the master's program with the idea of working back to the junior years. The decision to do this originated from the belief that a student in a school should have the older students ahead; an advantage accruing from it was described by Dudley in the following terms:

"We already establish ourselves on the campus

in relation to the other disciplines as a mature, advanced study group, working on research projects, working with the other disciplines, taking our place on the campus at that level rather than—to exaggerate—as if we were just a first-year course, people putting together pieces of colored paper and studying visual fundamentals. Everybody would say that's what an architect does. We are saying that an architect is a guy who participates with the other disciplines, works on research activities—and we have some of these going."

Turning to the subject of continuing education for professionals, Dudley said he had been working on the idea of a mid-career educational process, such as already existed in England. "This would provide the opportunity for a person coming up through architecture or planning or law or public health or whatever to begin to emerge as a person capable of working on the urban problems, instead of simply filtering up through an office or agency or city planning department and maybe reading home at night and taking an occasional refresher course at MIT, etc.

"I think our setup in the country now needs a more formal process for a certain few people to be able to shift gears at that time in their life and to come back to a school for two years, say, and to be rounded out and learn the rest of the mechanics involved in the more comprehensive activity."

Moderator Howarth then invited questions and comment from the floor. First to rise was **Werner W. Dornberger** (University of Texas) who thought that the institution of a Boy Scout merit badge in architecture would open an avenue for recruitment to the profession. **Caleb Hornbostel** (NIAE) thought that service on school boards provided another means by which people in the high schools could be made conscious of architects. Sargent said that the trouble was that if everyone managed to get into the public school system with information about his particular profession, some essentials might go begging in the program; he thought that asking a young person what he would like to be at age 15 or 16 was asking the impossible.

A. H. Detweiler (Cornell University) described the system of interviewing used in the admission of students at his school, which he said had been found quite satisfactory. Passoneau questioned the value of the statistics cited by Detweiler; statistics were very dangerous. Dudley described the way in which the various courses were related to and integrated with studio work in the new curriculum at Zurich; in the master's program at UCLA there were not going to be separate courses, but the expert in other disciplines would come right into the design studio. He believed that there



should be fundamental research in architecture, comparable to medical research, and that credit should be given academically to such research, in appointments and the development of the faculty, as it was in medicine.

McCue thought that the procedure described by Dudley was extremely dangerous at other than the graduate level; it was of great benefit for architectural students to take courses with students in other fields. Passoneau doubted if there was such a thing as theoretical research in architecture. Dudley said that he agreed with McCue that in the lower years architectural students should be out and about in courses with students in other fields. But he believed that the relationship between these other courses and architectural design should be articulated, and that was why he had described the Zurich system.

Karol J. Kacimski (Iowa State University) said that Zurich, unfortunately, could not be taken as an example in the United States because of the incomparably better preparation of the Swiss student when he enters the professional part of the curriculum. **Leonard Currie** (University of Illinois, Chicago Circle) said he believed that many would agree with him that deferring the introduction of design until a student had finished his liberal arts education was neither practicable nor desirable. Detweiler had suggested that it was the interview technique employed by Cornell that had resulted in a lower attrition rate, but Currie thought it would be found that the attrition rate was lower in all schools because of higher selection standards, regardless of whether there were interviews. "A psychologist reiterated just yesterday that in his judgment the interview technique is the least

Archie Sherbourne (University of Waterloo, Ontario) said that, speaking as an observer, he found the discussions fascinating because exactly the same questions were being discussed in engineering circles. While he agreed that a liberal arts education was desirable, he questioned the wisdom of putting students in first-year courses when universities had freshman they tested in thousands; perhaps liberalization might better be encouraged by having professors in the professional schools know their colleagues in the liberal arts, English, history, etc. McCue, replying to Currie's comments, said that the question as to whether all the general education should come early could be debated all day; the point he had been trying to make was that it was wrong for anyone to impose his notion of which system is the best possible for students, that it was possible to have more than one method of getting through a professional program in architecture.

Thomas K. FitzPatrick (University of Virginia) related that several of his third-year students who took the Selective Service examinations had come back discouraged because architecture was not among the categories on the examination sheets, so that they had had to list themselves under "others." It was time that architects made it known to the federal government that they were a recognized profession. **Allen Bernholtz** (University of Toronto) said that the effectiveness of Detweiler's selection system could only be established by a controlled experiment in which the rejected applicants as well as those chosen were accepted into the school; over a five- or ten-year period this might show that those who were accepted should have been rejected, and vice versa. Dean **Kamp-hoefner** commented that this was a most intelligent suggestion, but that in most schools it could not be acted upon simply because of the matter of numbers. The School of Design at Raleigh was going to take in 147 students out of 700 applicants in the fall; it would have liked to take the 700 but did not have any place for them.

McCue, asked by moderator Howarth if he wished to make any further observations, said:

"I would like to come back to the statement I made at the beginning, the concern about the early education for the children. I think that as architectural teachers we have a tendency to be much too narrow in our objectives. My notion was not so much to improve the level of the people entering architectural schools as to demonstrate how people can make more effective use of their lives in terms of their physical environment.

"I think ACSA could really be the group that could come forth with a program. It is a major undertaking but that could perhaps do much more for the quality of the environment through a gen-



The National Center for Atmospheric Research is the second stop on the ACSA trip to Boulder.

reliable means you can use for selection." Moderator Howarth observed that there was nevertheless a good deal to be said for interviews: "The students feel that they are hand-picked; they are a selected group and tend to work more effectively."

eral upgrading of all of our society than we can do with our precious few students in our architectural schools, and if indeed we direct ourselves to the problem of environment, then we cannot limit the training of the few specialized people involved in it. We do have an obligation to the non-architect."

Summing up, Howarth said he was mindful of President Sanders' request that the implications of changes in education for ACSA should be considered, and he continued:

"ACSA, I think you would agree, is coming to an important point of life and we have to see what is going to happen to it in the future.

"It seems ACSA *per se* will be a central coordinating body of the regional divisions that it has now; that just because of the size of the country, difficulty of communication, expense of meeting, it would be much easier for us to meet in regions, and the region would become much more active and report back to the headquarters, much as the groups do in the AIA.

"In the area of communication, we have this excellent *Journal*, as you know. It may be in the future that ACSA through its regional groups can have regional newsletters or even regional journals, and perhaps the major journal itself can have an international flavor.

"The regional meetings are already working. They need to be much more effective, and we need the cooperation of all the schools in the regions. These are virtually the forums where the work of schools can be brought together. It may be that the regional groups can concentrate on this question of high school liaison contacts. In addition, the regional group might be helpful in the field of public relations, press, TV; even aptitude testing might be organized regionally. The regional group can be the key to the real vitality of ACSA.

"Then we come to the annual assembly. This perhaps should be the national forum for debating major issues of educational policy, questions of philosophy that we have only touched on this morning.

"What about teachers, and the training of teachers? What about teaching methods on a national basis? This should be the forum where the regional groups bring to the major body, it seems to me, the results of their experimental work. Isn't this the forum where we should have the latest information of the work of men at Harvard, MIT and other great centers on what is happening in this new world? Some of us can do it individually. Unless we bring all this information together in an assembly like this, we are beating the air.

"If you look at this on a national basis, it would seem that ACSA has a tremendously vital part to play in future development. ACSA relates

very closely to AIA. It is not a question of they and we; it is a question of us. Together we are trying to improve our environment and educate architects. There are not two groups at all.

"One final word. We can talk until the cows come home, to use the popular north of England expression, about curricula. But when the chips are down the thing that really matters is the teacher, and we have a tremendously important responsibility here. The school of architecture is only as good as its teaching staff. It doesn't matter what you write on the background. Therefore, we have to continually examine our own position in this setup and we have to determine how we are going to produce really good teachers and improve our own situation."

SECOND DAY: LUNCHEON SESSION

The luncheon speaker was **Robert Geddes**, dean of the School of Architecture at Princeton and director of the AIA Education Research Project, which was initiated last year, with a grant of \$100,000, to develop new approaches and curricula in schools of architecture.

Dean Geddes, who was introduced by **Richard R. Whitaker, Jr.**, AIA director of Education, said that he would describe as much as he could of the various things that were going on under the sponsorship of the AIA Education Research Project. To describe something was to go a long way toward explaining it. But there was the problem of communication; words meant different things to different people. For example, certain schools had embarked on courses leading to the degree of Master in Architecture and Urban Design, but investigation showed that the terms architecture and urban design meant quite different things in the different schools. Greater precision in describing activities and objectives was to be hoped for. "This would end the continuous dialogs that seem to occur at these meetings without much apparent progress from one year to the next."

It had been necessary to organize a series of grassroots meetings, and this was continuing. "We are finding out a great deal about the schools and the profession that I don't think any one person would have known before." Five probes were being conducted—into the views of the schools, of practitioners, of students, of clients and a probe "into other possible futures." The central effort of the work had been in developing means of communication.

"We have used some of the conventional means," Geddes continued. "We are charting curriculum charts in the conventional manner, with allocation of time and subject matter, etc. But



even more than that we are trying to find a way of establishing a new kind of communication, a new kind of language which can be used with precision to have each school state its own objectives and then be able to compare these objectives with other schools, with the profession, with the students or with the administration, or with government or foundations that need to have a more precise definition of what we in this room prefer to define as architecture."

It had emerged at the grassroots meetings, first, that there was a genuine desire to work more closely with a broad range of disciplines, including many branches of the physical sciences and the social and behavioral sciences; second, that the schools were keenly interested in finding ways to increase their involvement in the problems and activities of their states and regions; third, that there was a growth in research activities in support of the education program; and fourth, that there was growing concern about the relationship between professional and general education.

Passing on to more recent activities of the AIA Education Research Project, Dean Geddes reported that grants, most of them matching, had already been made for special studies aimed at the crystallization of educational objectives in specific areas to nine schools of architecture—namely, those of Washington University, Virginia Polytechnic In-



Princeton's Dean Geddes addresses the luncheon session.

stitute, Oklahoma State University, and the Universities of Kentucky, New Mexico, Oregon and Virginia. Then early in June a day-long working conference with 20 leading practicing architects had been held in Chicago; each participant answered a specially prepared questionnaire and gave his views on the planning of curriculum change in a roundtable discussion, in which the need for more intensive training and specialization in areas of practice other than conceptual design was much emphasized.

A study had been made of the recent experiences and future developments of professional education for the building industry and the organization of the environmental design field in Eng-

land. Departments of architecture, engineering, town planning, industrial design, industrial technology and building science in a number of English schools, including the Bartlett School in the University of London and the schools of the Architectural Association, Cambridge University, Liverpool University, Manchester University and the Royal College of Arts had been visited; in addition, there had been conferences with the RIBA and the Tavistock Institute and with a number of faculty and research staff involved in the development of systematic methods in design and in teaching.

Everywhere today, Dean Geddes said, there was a search for a rational, objective methodology, for ways to make teaching and problem-solving and decision-making more explicit. "The problem that I think we are recognizing is that we are switching from intuitive to more objective bases for working methods, but we are finding it terribly difficult to switch from the intuitive to the rational."

The AIA Education Research Project would not end up with a single prefabricated packaged proposal. "We shall not have that as an end product at all. . . . If anything, we are setting up a process that depends on clear communication and clear evaluation, a process that will not end with my particular task but probably go on for five, ten or more years. I think we have to recognize that implied in this picture is a view of architectural education which is not monolithic, which recognizes and desires a great number of efforts rather than single type of educational program for the country. . . . Clearly the fundamental enlargement of the role of the architect in our society is requiring a total reassessment of our education and professional preparation in the largest sense. In order to meet this challenge for leadership, we have to concern ourselves not just with the curriculum but also with the development of individual architects who are capable of mature growth and development. And it is perhaps the most important task of all to make the motivation of the student, the understanding of the student, central to our whole concern."

SECOND DAY: AFTERNOON SESSION

The first order of business dealt with the annual report of the board. In introducing it, President Sanders pointed out that approval of the various committee reports contained in this document (this year a printed one for the first time) would make any recommendations in them ACSA policy, to be implemented by the board in the best way it could. His own report was "more or less a statement of fact, of where we stand presently, some of our problems and some of our

hopes" and he thought that it was not necessary to call for any action on it.

The secretary's report, the treasurer's report, and the reports of the following committees were then approved in short order: Committee on Advancement of Architectural Education (T. Howarth, chairman), Committee on Continuing Education (Julian E. Kulski, George Washington University), Committee on Research and Graduate Studies (C. Theodore Larson, University of Michigan), Committee on Architectural Internship (Lawrence B. Anderson, MIT), Committee on Cooperation with Industry (Sargent), Committee on International Relations (Currie), Committee on Teaching of Structural Design (Charles Kahn, North Carolina State University).

Proposed amendments to ACSA's Constitution, copies of which had been sent to members six weeks previously, were then acted upon and approved. There was considerable discussion of the possibility of establishing a new category of membership, **William N. Lacy** (University of Tennessee) having pointed out that several new schools of architecture founded during the past year had found that they were not eligible for associate membership of ACSA under the existing constitution. Some members were anxious that a formula should be found for the immediate admission of these schools to the Association, and a motion was made to authorize the board to elect them to a new class of membership.

After **Raymond Reed** (Iowa State University) and **Elliot Whitaker** (Ohio State University) had questioned the wisdom of action that would have required a waiver of the constitution, a substitute motion made by **G. Holmes Perkins** (University of Pennsylvania) "that the board take steps to welcome these new schools into some form of membership, and that the precise way of doing this should be studied by the board and presented to this meeting a year from now" was carried with none dissenting. Currie, on behalf of the Committee on International Relations, then moved a resolution, which was adopted, that the board should take action to establish a corresponding membership in ACSA for schools of architecture outside the United States and Canada, in response to requests by several schools in Latin America and one in India for affiliation of this kind.

An amendment in the form of a new item providing for the assignment of member and associate member schools to six designated regions, and another providing that directors should be elected by member schools in the region they were to represent, were approved after President Sanders had observed that he thought that the board and the Association as a whole would be tolerant of any imperfections in the application of them

during the transition period. During the discussion, **W. W. Harper** (Texas A & M University) reported that at the last conference of the Southwestern Region the feeling had been that individual faculty participation in ACSA should be increased, to the extent of giving individual members voting privileges. President Sanders suggested that a report of the conference, with express recommendations, should be communicated to the Board for its consideration.

The Saturday afternoon session concluded with reports by Reed on the Student Exchange Program, by Howarth on the work of the Audio-Visual Aids Committee and **Eugene George** (University of Kansas) as ACSA representative on a joint committee of the American Society for Engineering Education, ACSA and the Office of Civil Defense.

Reed explained that 27 American architectural students had already arrived in London and that the same number of European students were expected to arrive in Boston shortly; among the recommendations he had to submit was one that the Student Exchange Program should be developed in West Germany, Finland, Sweden and Denmark, and another that if possible not more than half of the European students should be selected from any one country.

Howarth reported that between 200 and 300 cards in the ACSA card index of films on architecture were now available to schools at \$10 a set, and appealed for the cooperation of people interested in film-making in a project for making five pilot films for teaching purposes, for which the Audio-Visual Aids Committee hoped to raise money during the coming year. George invited ideas for future programs to be sponsored by the joint committee on which he served.

SECOND DAY: EVENING

The annual banquet was held in the ballroom of the Brown Palace Hotel. After introducing those at the high table, President Sanders called on ex-president Kamphoefner to present certificates of appreciation to former officers and directors of ACSA and to others who had made notable contributions to the welfare of the Association and the advancement of architectural education (see box on p. 72).

THIRD DAY: FINAL SESSION

The address by AIA President **Charles Nes Jr.** already has been published in the AIA JOURNAL (September, p. 99). His proposal that the AIA committees on education, scholarship internship,



continuing education, licensing, research and technician training should become joint committees with the ACSA, which would nominate the educators for the committees in question, was received with enthusiasm. **Olindo Grossi** (Pratt Institute) moved that it was the sense of the meeting that the proposal be implemented; the motion was seconded by **Harlan McClure** (Clemson University) and carried without dissent.

The 1966 AIA-ACSA Teacher Seminar, which had been held earlier in the month, was reported on by **Walter Bogner** (Harvard University), chairman of the seminar Steering Committee. After describing, with wit and affectionate irony, the way things had gone at Cranbrook, and emphasizing the need for permanent staff to organize the seminars, Bogner suggested that there were certain questions regarding their future that should be discussed among ACSA and AIA:

"1. Shall the format now established be continued? That format has been going for a long time, and I think that there is an opportunity for improvement; certainly an opportunity for strengthening of the organization of those seminars and for putting some solid substance behind them.

"2. Shall the seminars stay in Cranbrook? Cranbrook is a wonderful place. All the facilities for living and eating for a limited number of people are available there. But the facilities are limited in size and the question is: Is it the best place?

"3. Should the seminars be enlarged to bring to them participants that represent a greater balance in the people that are involved in architecture—a greater balance of the diverse attitudes of people involved in architecture?

"4. Should the program be oriented toward enlarging knowledge and the horizons of the practitioners as well as teachers?"

The editor of the *Journal of Architectural Education*, **Marcus Whiffen** (Arizona State University), reported a year of changes, of varying degrees of noticeability, for the publication; an important one of which only he, as editor, could be aware was the marked increase in the number of unsolicited literary contributions. He was followed by the president of the National Architectural Accrediting Board, **Samuel E. Homsey**, who reported that as of the termination of the board's annual meeting there would be 61 accredited schools. Homsey noted that the board had increasingly been asked for its policy in respect to the accreditability of new six-year programs which might lead to B.Arch. or M.Arch. degrees after a four-year baccalaureate degree. The answer was that NAAB would continue to follow the policy of reviewing and evaluating for accreditation the *first professional degree* programs of schools, whether they were B.Arch. or M.Arch. programs.

For the National Institute for Architectural Education, **Hornbostel**, director of education, had six main items to report: 1) that NIAE was actively engaged in the continuing architectural education for the postgraduate and the preprofessional, 2) that correspondence during the year with ACSA President Sanders had shown that the main objectives of ACSA and NIAE were now almost identical, so that a closer relationship between the two bodies might be beneficial, 3) that NIAE was dropping its regular elementary, intermediate and advanced programs and arranging in their place what it called a Special Competition, to be announced at the end of each spring term with the programs issued in September, 4) that the Floyd Warren Fellowship, the Paris Prize and the Thesis Awards were to be completely re-evaluated, 5) that the possibility of granting scholarships to graduating students from foreign universities to continue their studies for a master's degree at an American university was being explored, and 6) that NIAE was exploring means of informing the high school student about the architectural profession.

Hornbostel was followed by Dean **Sam T. Hurst** (University of Southern California) with a report on the UIA World Congress, held in Paris in July 1965, at which he represented ACSA as well as AIA. He thought that the congress had provided a valuable exchange of information, principally through exhibits and personal contacts, despite a poorly conceived and poorly executed formal program. The picture of architectural education that he had returned with after the congress and visits to schools of architecture in seven countries was not a cheerful one; most schools were "attended by students and faculty whose strongest consensus was the recognition of the need for change," and his very strongest impression was that in many schools in Europe the academy tradition was very much alive. "While American schools in the past century have been largely importers of European teachers, philosophy and influence, it would appear that we may be entering a reverse period."

In the exhibition of student work the United States had been represented by Harvard, IIT, MIT, Minnesota, North Carolina State, Southern California and Washington University, St. Louis, these schools having been selected to represent diversity of approach to architectural education in this country. Dean Hurst said that he had been surprised by the extremely modern character of the work from Russian schools: "Their models—they were among the few that sent models to the exhibition—were extremely well done and the quality of the student work would compare favorably with many of our good schools."

The report of the National Council of Architec-

tural Registration Boards was made by **C. J. Paderewski**, immediate past president. In the course of it, he gave the results of a survey conducted by an NCARB committee of the views of 16 schools and 21 AIA chapters on certain recommendations made by ACSA three years previously. One question asked was: "If a degree from a school of architecture were a prerequisite [for taking the state licensure examinations] would you favor reducing the extent of examining, generally eliminating subject matter satisfactorily covered in school?" To this, 30.8 percent of the schools had answered yes and 69.2 percent no; for the chapters the corresponding figures were 10 and 90 percent. Paderewski pointed out that the answers from the schools suggested that they did not agree with ACSA on this point, but he thought that the matter should be given further study.

CERTIFICATES OF APPRECIATION

Former ACSA officers or directors

Lawrence B. Anderson *
 Nolan Barrick
 Robert L. Bliss
 Walter Bogner
 Harold Bush-Brown *
 George Danforth
 Robert H. Dietz *
 Thomas R. FitzPatrick
 Olindo Grossi
 Harlan E. McClure
 Buford L. Pickens
 John A. Russell
 Elliot Whitaker

Former ACSA executive secretaries

Edith (Franchini) Bingham
 Jo Ann Chatelain

Former AIA director of Educational Programs

Maurice W. Perreault

* In absentia

The other question related to the recommendation that a degree from an accredited school of architecture be made a prerequisite for registration, with the provision that the licensing board had the right to waive the requirement in special cases. Eighty-seven per cent of the schools questioned and 68 percent of the chapters had been in favor of this, and only the day before, Paderewski related, the recommendation had been discussed at length in the NCARB convention. "A vote was taken and it was defeated, but it was not by a large majority. . . . A great many comments from the floor indicated that we are getting to the point now that, because of the quality of the edu-

cational curricula, we can more and more rely on the results that come from the schools and we should in fact insist on this prerequisite to registration."

To illustrate the philosophy of NCARB with regard to examinations, their form, content and conduct, Paderewski read a letter written by Professor Harry Rodman, chairman of the NCARB Examinations Committee, to Professor Richard H. Wheeler of the University of Cincinnati, a member of the Ohio board.

On the examination in history and theory Professor Rodman had this to say: "In practical terms it exists in all states and would seem to be necessary because of the large number of candidates who have not been to architectural schools, unless we are to have first- and second-class candidates."

Regarding the multiple-choice examination, Rodman said: "In my view, in the five sections with which we are concerned the multiple-choice examination is the best available for the special condition of listing grades. In college I prefer the essay. In the classroom there are numerous examinations, each with limited scope. The students are a known quantity. The examination sets the stage for what one hopes will be an intelligent application of principles previously presented to the group.

"Also, in college one should teach self-expression. Licensure is not a teaching process. More properly, candidates for licensure are an amorphous group, deliberately and carefully anonymous to avoid suspicion of favoritism, and are of a widely varying background. Some excellent men from foreign countries are slow with the language and cannot write distinctly. In three hours we must determine if they have sufficient knowledge of a total field such as building materials and structure to protect the interest of their clients and the public. Only an objective examination can possibly cover the fields involved."

Paderewski concluded his report for NCARB with an account of moves that were being made toward the development of an international licensing system.

After the report of the Audit Committee (**Emil Fischer**, Kansas State University, chairman) had been approved, and the Association had acted upon resolutions offered by **Anthony Ellner Jr.** (Arizona State University), chairman of the Resolutions Committee, to express its appreciation of a number of distinguished architectural educators, recently deceased or retired, together with its gratitude to Dean DeVon Carlson and his faculty at the School of Architecture of the University of Colorado, President Sanders declared the meeting adjourned. ■

STYLED FOR BEAUTY DESIGNED FOR SAFETY

NORTON® DOOR CONTROLS for labelled fire doors

As always, Norton door controls have the added dimension of beauty even on all controls with UL listing for application with listed fire doors. As always, you have a wide selection of styles from which to choose. You have the assurance of providing your building with maximum safety and attractive styling.

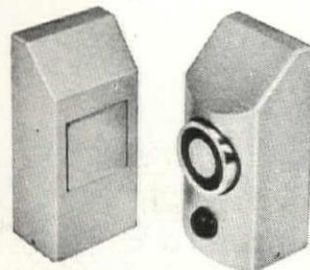

**ELECTROMAGNETIC
DOOR HOLDERS
NORTON SERIES 6900**

Attractive styling to match modern architecture and a design to afford maximum safety are incorporated into the Norton Series 6900 electromagnetic door holders. Both the armature for door mounting and the electromagnet for wall or floor mount are contained within attractively styled aluminum cases of either anodized aluminum or dull bronze finish.

All Norton Series 6900 door holders have UL listings and can be used with any approved smoke or fire detector system. Units fail safe, door recloses when power is off, to provide maximum safety. Units are available for use with 12, 24, or 120 volt a.c. systems. Design of matching magnet and armature surfaces permits installation in locations where door and wall vary as much as 30 degrees.

STYLED DOOR CLOSERS WITH APPROVED UL LISTING

REGULAR SURFACE—in all sizes self-closing doors without hold-open and in all sizes for hold-open arms with fusible links.

SERIES 700 NARROW PROJECTION—all sizes self-closing doors without hold open or hold-open arms with fusible links. Modern styling; unobtrusive installations.

SERIES 7000 WITH COVERS—all sizes self-closing doors without hold open and hold-open arms with fusible links. Modern styling, cover in 67 wood grains match door paneling; aluminum, bronze or brass match door hardware.

SERIES 1600 TRI-STYLE® CLOSERS—all sizes self-closing doors without hold open and hold-open arms with fusible links. Non-handed—regular arm, parallel arm, or top jamb mounting from one closer. Three mounting methods—exposed, back mounted, concealed.



REGULAR SURFACE



SERIES 700

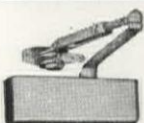

SERIES 7000

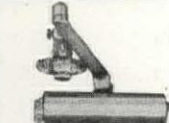

SERIES 1600

FOR COMPLETE DETAILS ON NORTON CONTROLS FOR
FIRE DOORS, WRITE FOR MANUAL FP OR CONTACT
YOUR NORTON REPRESENTATIVE



NORTON® DOOR CLOSER DIVISION
372 Meyer Road, Bensenville, Illinois, 60106

1124

For more technical data, circle 235 on information card

A free-form expression of its function

Northland Theatre At Northland—Detroit, Michigan
Architect: T. Rogvov Associates, Inc.

Overlooking the world's largest shopping center, the Northland Theatre is designed to show its function with exterior lines. Hence, the slope up to the high screen (which accommodates both Cinerama and Cinemascope) as well as the curved end wall. There is not a straight wall in the plan of the 24,050 sq ft column-free interior.

Resembling an outstretched hand placed on a table, this unique building was most economically framed with steel because of (1) the great variation in the plan dimensions, (2) the building slope, and (3) the long spans. Fabricated in two sections, trusses were shop-welded. They range in length from 88 to 101 ft.

Whatever shape you have in mind, remember that structural steel can be "tailored" to every architectural form. And it offers a set of practical advantages no other material can match.

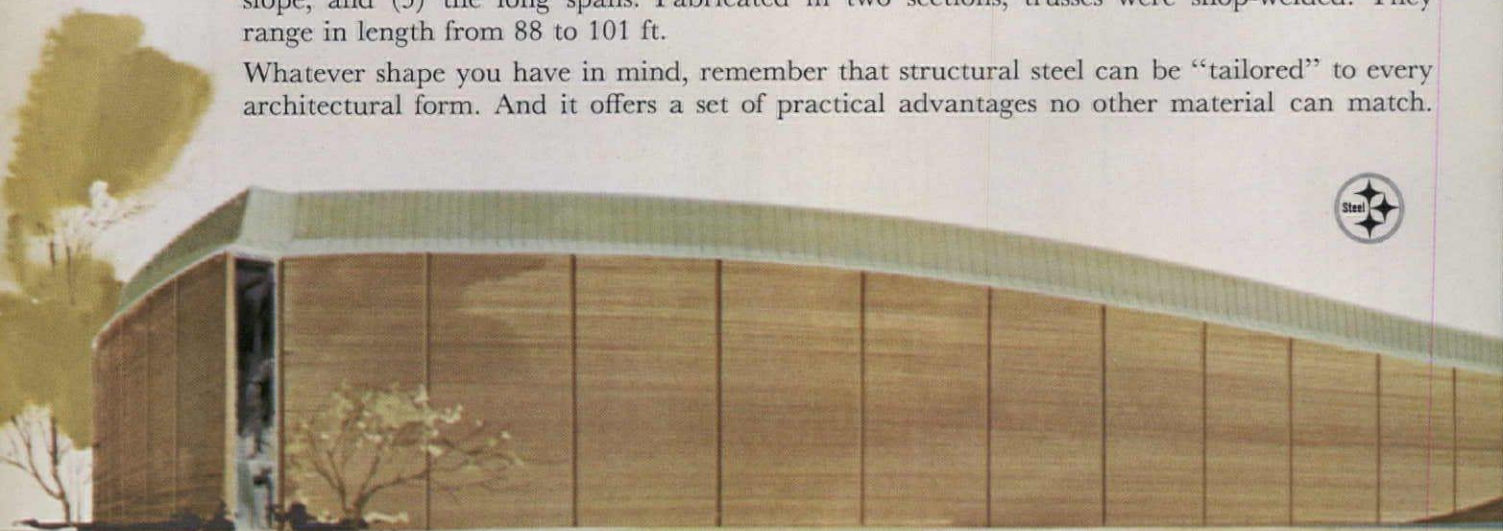

Exterior of the Northland Theatre is of grey-brown brick, with a limestone canopy fascia and a copper roof (copper was etched to assure even weathering).

BETHLEHEM STEEL

Bethlehem Steel Corporation, Bethlehem, Pa.



An architectural rendering of the Northland Theatre. The building features a prominent green, gabled roof and a facade of brick and wood paneling. A large, white, abstract sculpture is positioned in the foreground. A large, dark tree with sparse white blossoms stands in the immediate foreground on the right. The scene is set against a light, hazy background with a body of water visible in the distance.

*Owner: Northland Theatre.
Developer: E. Sloan & Co.
Structural Engineer: Ray W. Covey
& Associates, Inc.
Fabricator: Arrow Steel Company.
Erector: Argo Steel Construction Co.
General Contractor: Cronk and Tocco, Inc.*

when quality counts...

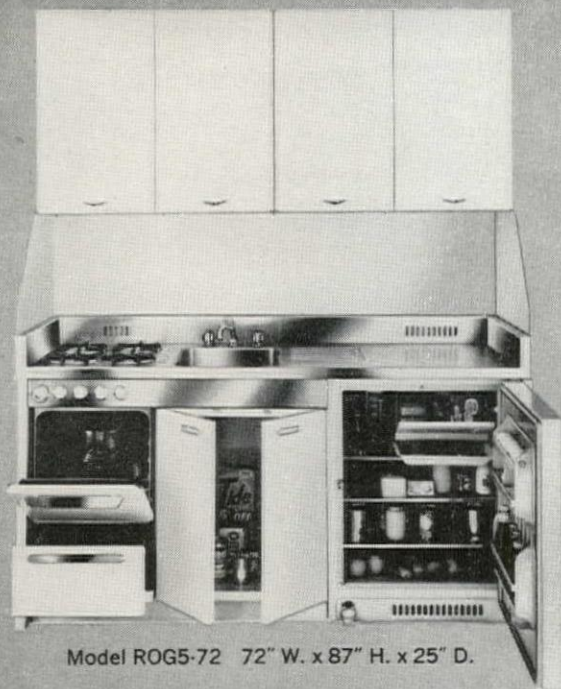

Model ROG5-72 72" W. x 87" H. x 25" D.

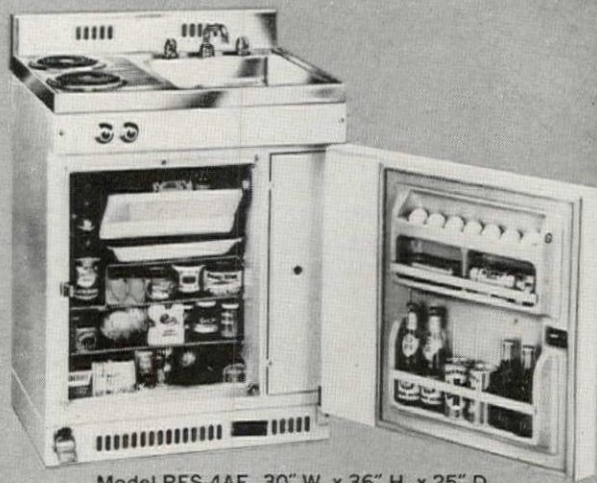

Model RES-4AF 30" W. x 36" H. x 25" D.

ACME compacts are specified again and again



IMPERIAL PLAZA (Elderly Housing) Richmond, Va.
H. D. Nottingham and Associates, Architect



ISABELLA HOUSE (Elderly Housing) N. Y.
Joseph Douglas Weiss, Architect



NEW YORK HILTON
William B. Tabler, Architect

ACME, America's most complete line of compact kitchens

Made by the oldest and largest manufacturer of compact kitchens to the exacting standards required for rugged institutional use. Write for catalog.

see our
catalog in
Sweet's



ACME NATIONAL REFRIGERATION CO., INC. Offices and Factory: 19-26 Hazen Street, Astoria, N. Y.
Mailing Address: P. O. Box 188, Astoria, N. Y. 11105

For more technical data, circle 237 on information card

Since

HOPE'S

1818

WEATHERSTRIPPED STEEL WINDOWS

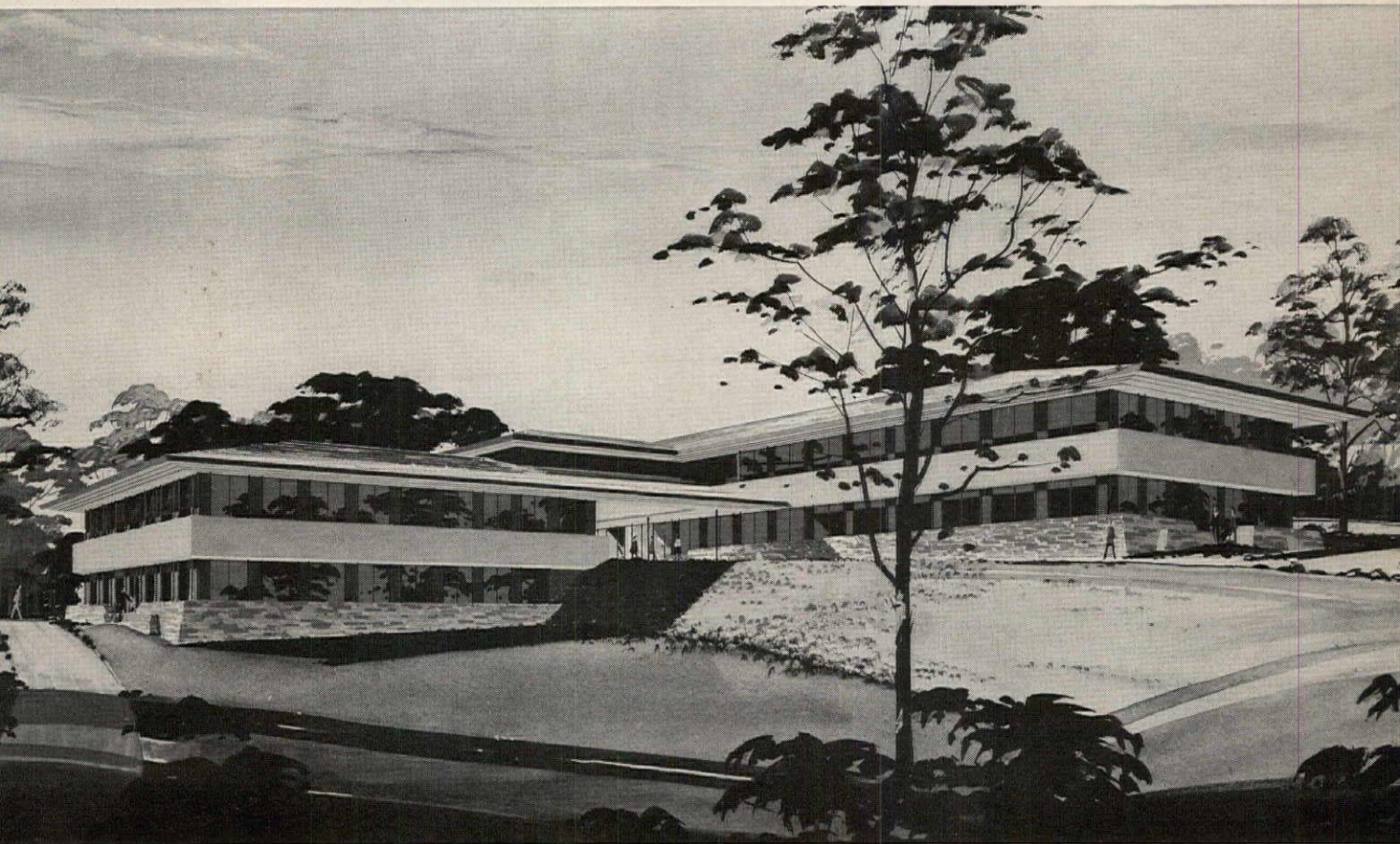

HOWARD COUNTY OFFICE BUILDING • ELLICOTT CITY, MARYLAND

Architect: Glen A. Watkins, Jr.

General Contractor: Frank R. McGuire Construction Co.

Today's increased interest in creating pleasant, attractive quarters to stimulate productivity is exemplified in this new office building. Beauty of line joins the consideration of occupant comfort in a modern design for business living. Hope's Weatherstripped Steel Windows contribute to the symmetry of the overall design, and to environmental comfort while providing unsurpassed weather protection. Air infiltration is reduced by more than 60% with Hope's exclusive Neoprene-weatherstripped steel windows (confirmed by independent laboratory tests).

Our catalogs are filed in Sweet's Architectural File and our sales offices and representatives are located in principal cities.



MEMBER
STEEL
WINDOW
INSTITUTE

HOPE'S WINDOWS, INC. *Jamestown, N.Y.*

HOPE'S WINDOWS ARE MADE IN AMERICA BY AMERICAN WORKMEN

Bury We Will, Says Bell

THE BELL SYSTEM WILL continue its emphasis on burying wires while its Bell Telephone Laboratories devotes "considerable" manpower and money to find better ways of doing the job.

This is the report of J. T. O'Connell, American Telephone & Telegraph Co. cable engineer.

"We have now had enough experience to be firmly convinced that buried telephone distribution plant is the optimum ultimate design," O'Connell explained.

"We are also further convinced that essentially all new urban distribution plant will be buried by 1970."

O'Connell said "plant" in new subdivisions can often be installed underground at a cost equal to or less than an aerial arrangement. There will always be some situations where buried plant will cost more than aerial, he acknowledged, "but we hope these may be ultimately balanced off by the favorable situations."

He has assured homebuilders that Bell companies are "anxious and willing to cooperate with you" in digging instead of stringing.

As proof of Bell's sincerity, O'Connell went back to 1955 when "we looked into three principal areas" in evaluating underground installations—"eliminating storm damage, providing safety and a type of plant more pleasing to the public."

Aerial installations are exposed to damages from wayward vehicles and storms and the public "has become increasingly intolerant of such failures."

Safety, too, was a factor. No more falls from poles and "we felt the hazards of electric shock would be substantially minimized."

But the big factor was the growth of the scope of house building to hundreds and even thousands of houses in a single development. "Here it was normal to strip all vegetation, construct all utilities and roads on a wholesale basis and systematically build on each successive lot until the entire development was completed. Furthermore, the trend was largely toward rambling one-story structures, or at least split levels.

"I think you will readily agree that this changed trend in residential construction had two outstand-

ing consequences. First, it greatly facilitated the wholesale placement of buried distribution facilities by the utilities; and second, it made aerial plant far more conspicuous."

And so, Bell looked underground and just as it did, O'Connell said, "we made a major breakthrough in cable design"—plastic-insulated conductor cables that could be buried.

The problem then became one of developing tools and methods of placing the cable in the ground, he said, adding: "We have essentially solved these problems."

From a small beginning in 1955 nearly a half million units were served by buried plant in 1965. "Thus we feel we are well along toward our goal of all new urban installations being buried by 1970."

"Unit" means lot—whether holding a single-family house or an apartment building.

Added O'Connell: "The majority of installations made to date have been where burying conditions are favorable and where cooperation has been obtained from the developer. We have discovered that the secret of any successful buried job is cooperation of all parties concerned.

"You as the builder or developer play an important part in making it possible for the telephone companies to provide buried facilities at a cost that compares favorably with aerial installations.

"It is imperative that we know the final grade; that we be allowed to install our facilities before streets, driveways or curbs are installed; and that easements for all utilities be clearly established and defined."

O'Connell said most of the telephone installations underground have been made "where power companies have elected to install aerial plant."

Telephone distribution facilities have been put in along the rear lot line, with pedestal terminals on every other lot line and service drops buried to each house. Another method has been to bury the plant along the rear of the house or along its front, looping the distribution cable to a terminal mounted on each house. In this case no service drops are required.

"It has been our experience," the engineer noted, "that where soil conditions are favorable, telephone

facilities can be placed underground by plowing more economically than by trenching, even if the trench is common.

"But there are a great many situations where the soil condition, layout of the subdivision or the terrain make plowing difficult if not impossible. In such cases a common trench with another utility or utilities appears to be the answer."

Where a common trench was most economical, Bell has made installations with power companies and other utilities. These have been of two distinct types.

"First, we have made joint installations with the power company in the same trench but at separations of 1 foot of well-tamped earth as specified by the National Electrical Safety Code. This type of installation has been done with the developer providing the trench, the telephone company or the power company doing the trenching.

"All three ways were tried and the results were good. However, experience indicates it simplifies the coordination problem to have the telephone or power company dig the trench rather than the developer.

"Second, we have made installations of power and telephone cables in the same trench with no attempt to provide separation between the cables. In telephone and power terminology this is known as random separation.

"However, permission to deviate from the National Electrical Safety Code, or other state or local codes in effect, was obtained from the proper administrative authority before such random installations were made.

"We have also made installations with other utilities such as water, gas and sewer and, in some instances, with two or more utilities in the same trench. Outside of the 'cooperation factor' our results to date indicate these installations to be satisfactory. By this we mean that when there are so many utilities involved, it is sometimes difficult for all of the parties to arrange to have their men and materials on the job at the proper time.

"To give you some comparison, of the 500,000 installations we made in 1965, about 20 percent were made in a common trench with another utility." ■



Round columns add REVERENCE to a shrine...

Entrance to Heian Shrine, Kyoto, Japan

Shrine of Fatima, Portugal

Japan—and Portugal—are literally a world apart in geography, in beliefs and in customs—yet the designers of religious edifices demonstrate here, at least *one* common approach—the instinct to design with **ROUND COLUMNS**.

And this is nothing new. As students of history, and architecture, will confirm—there has been a feeling through the ages that *round columns* do indeed *belong* in structures erected to shelter the faithful of many creeds.

Today—what the Greeks and Romans and other ancients started in temples and in public buildings—has spread to *multiple* uses for round columns, particularly **ROUND CONCRETE COLUMNS** . . . **SPECIFIED** in buildings and structures galore. Roundness remains—universal in use!



Send for SONOCO's brochure —
"A Portfolio of Round Columns —
Ancient, Modern, Worldwide."



THE VIRTUES OF ROUNDNESS

Modern structural design assignments still offer great challenges—to exploit the manifold virtues of **ROUND CONCRETE COLUMNS**. Poured quickly, inexpensively, exactly to your specifications—with **SONOCO SONOTUBE® Fibre Forms** . . . round concrete columns also save money!



SONOCO

construction products

SONOCO PRODUCTS COMPANY, HARTSVILLE, S. C. • Akron, Ind. • Atlanta, Ga. • City of Industry, Calif. • Hayward, Calif. • Holyoke, Mass. • Longview, Texas
Louisiana, Mo. • Lowell, Mass. • Montclair, N.J. • Munroe Falls, Ohio • Mystic, Conn. • Newport, Tenn. • Richmond, Va. • Tacoma, Wash. • **MEXICO:** Mexico City • **ALSO IN CANADA**

10002

THE CONTEMPORARY BRICK BEARING WALL

as designed by E. A. Anderson, AIA,
and Peter Looms, AIA

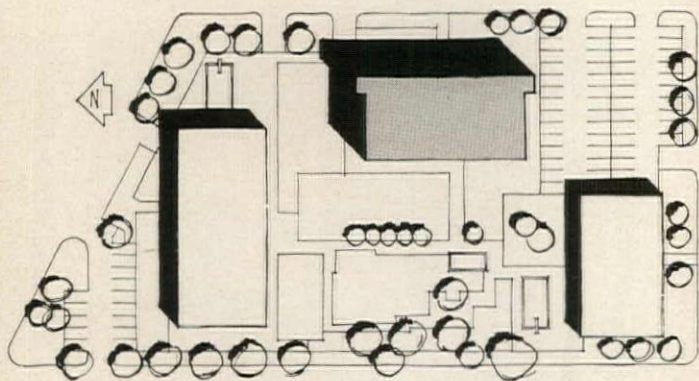

Park Mayfair East is the third building in Denver's only high-rise apartment complex. The first two buildings (one seven stories and the other eight stories high) are bearing wall structures. Park Mayfair East was originally designed as a 14-story structure with a steel frame. Bids on this original design showed that the steel structure, because of the additional fireproofing that was needed, would cost more than a masonry bearing wall structure. In addition, the owner's previous experience with bearing wall buildings showed him the significant advantages of masonry bearing walls acting as sound barriers between apartments. Other desirable advantages which masonry bearing wall design offered were speed of construction and low maintenance.

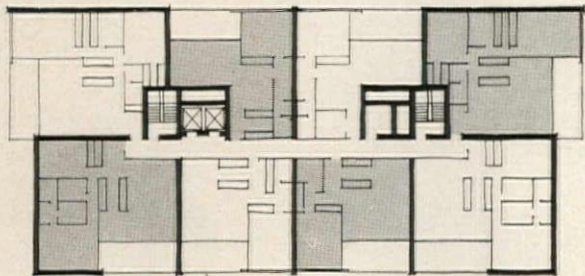

Redesigned as a 17-story, masonry bearing wall structure, Park Mayfair East contains 130 apartment units. The structural system consists of 11-inch-thick (two wythes of brick plus a grouted cavity) reinforced brick masonry walls and a precast concrete floor system. Brick bearing and shear walls, shown in this floor plan in heavy lines, are arranged to provide natural resistance to lateral as well as vertical forces. Apartments are separated by 11-inch brick walls which provide exceptional sound control (sound resistance of 58 decibels).

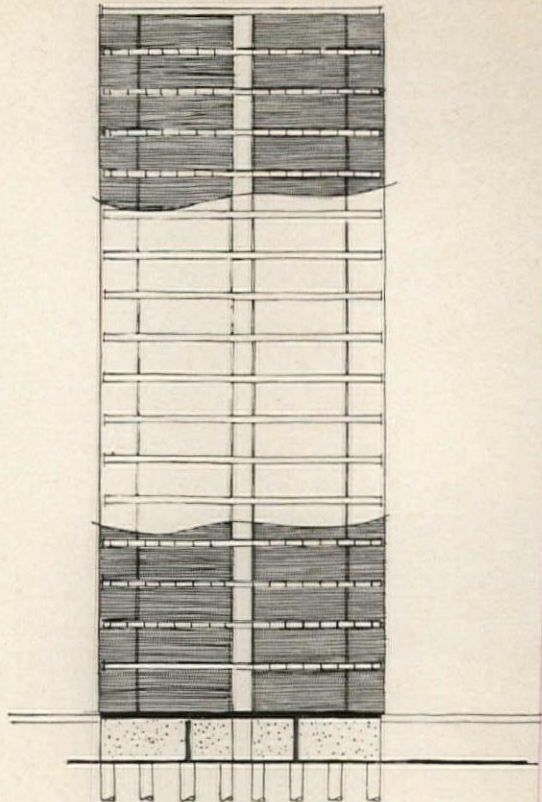

A partial section of an interior bearing wall shows the building structure. The floor system is of precast, prestressed concrete "T" slabs spanning between bearing walls. Spans range from 30 to 37 feet. The floor system is also an effective sound barrier (52 decibels). The bearing walls are founded on reinforced concrete grade beams supported on concrete piers drilled into bedrock.

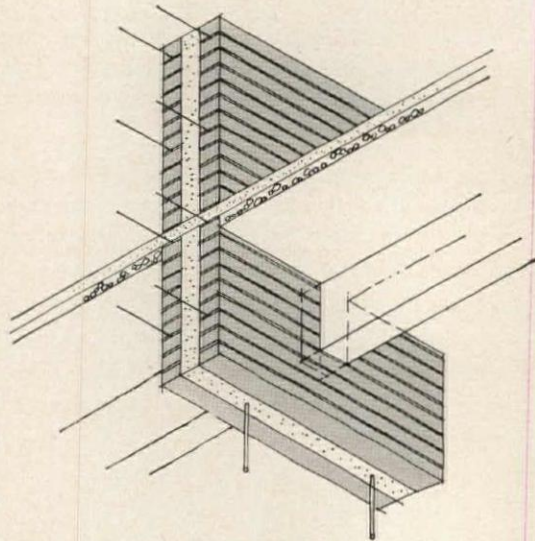

This detail shows the precast and prestressed concrete slabs framing into the bearing walls. Only the legs of the slabs bear on the walls, and the typical bearing distance is four inches. The 11-inch bearing walls have a full-grouted collar joint, with the grout consisting of a mix of portland cement, sand, and pea gravel. Vertical and horizontal reinforcing is sized and spaced as various loading conditions dictate. The slabs, averaging eight feet in width, are finished with concrete topping. At intervals, this topping carries through the bearing wall and contains reinforcing to insure diaphragm action. The sand-finish, light-brown brick are laid in a running bond. ASTM Type S mortar, with a strength of 2,500 psi, is used.

Structure and Beauty in a 17-story, High-Rise Building

Project: Park Mayfair East, Denver, Colo.

Architects: Anderson & Looms, AIA

Engineers: Sallada and Hanson

Owner: Park Mayfair Associates

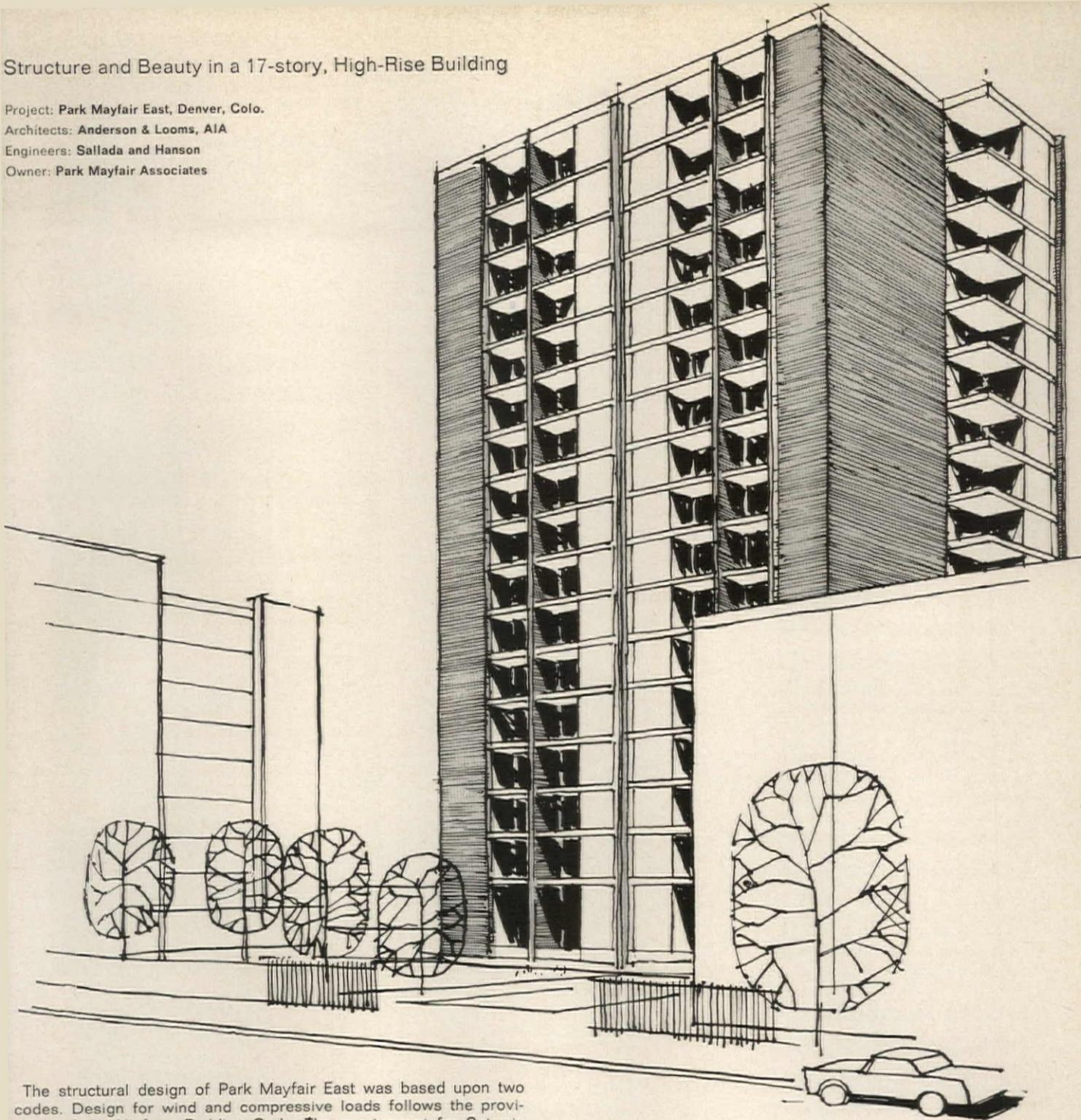

The structural design of Park Mayfair East was based upon two codes. Design for wind and compressive loads follows the provisions of the Uniform Building Code. The requirement for Seismic Zone One earthquake design is included in the new Denver building code.

The total height of the building is 164½ feet. Modern brick bearing walls were a practical answer to the design problems of Park Mayfair East—including height, seismic zone requirements, and other strict code provisions.

BRICK:
For
Bearing
And
Beauty

Structural Clay Products Institute, 1520 18th St., N.W., Washington, D.C.

sepi

For more technical data, circle 240 on information card



before you specify
SOUND
consult

Rauland

widest selection for every requirement

RAULAND offers the most complete selection of advanced sound distribution systems for Schools, Nursing Homes, Churches, Auditoriums, and Industry—quality systems to meet your exact job requirements.

solid-state leadership

RAULAND is the pioneer in Solid-State design—with many All-Transistorized system installations performing uninterrupted for more than five years.

proved reliability

RAULAND's 40-year-old reputation is upheld solidly by thousands of Sound Systems which are in constant daily use after ten or more years of continuous service.



ask for our

Rauland

SPECIFICATIONS MANUAL

Detailed specifications of RAULAND Sound Equipment are available to you. Ask for them on your letterhead. We specialize in working with architects and consulting engineers. Write today.

RAULAND-BORG CORPORATION
3535-L Addison St., Chicago, Ill. 60618

Circle 241 on information card

82

BOOKS

The Architects Collaborative, 1945-1965. Teufen AR (Switzerland): Arthur Niggli, Ltd., 1966. 300 pp. No price given

In recent years there have been a number of full-scale surveys of the works of individual architects—Marcel Breuer, Riccardo Morandi, Eero Saarinen, Pier Luigi Nervi—to note only a few. It is a fascinating pastime to study these works and to try to gain some insight into the personality responsible for the creative designs portrayed.

In contrast to these individual contributions there was published in 1963 a book about the architecture of Skidmore, Owings & Merrill, an archetype of the team office. Now another team office, also acclaimed for its architecture of high rank, presents a record, predominantly photographic, of its work from the time of its inception in 1945 until 1965.

The book itself is a team effort; various partners have contributed short essays about the firm's history, philosophy, organization, and manner of working. When the AIA bestowed upon TAC its Architectural Firm Award in 1964, the citation praised the firm for its "democratic association of equal partners." This record of the collaborative process applied to architectural practice is hailed also by Sam T. Hurst, dean of the School of Architecture and Fine Arts, University of Southern California, who states in his introduction to the book: "This is a record of victory of reconciliation between architecture and the larger society it must serve, reconciliation between advancing technology and the cultural continuities of the past. It is . . . a victory of service and self-restraint over destructive ambition and ego."

Philip Johnson: Architecture, 1949-1965. New York: Holt, Rinehart & Winston, 1966. 115 pp. \$15

This is a book that makes one wish he could see or see again every elegant structure illustrated in it. The blurb on the jacket states that the buildings themselves are the real text, but Henry-Russell Hitchcock's introductory essay in which he discusses Johnson's work so articulately is an essential part of the book. A chronology and bibliography add to the general usefulness of the volume. The photographs, the majority by Ezra Stoller, are splendid. *Continued on page 88*

Architect: James D. Masey, A.I.A. Montgomery, Alabama
Contractors: Andrew & Dawson, Montgomery, Alabama



Important records are protected in this new bankers building, with

SCHWAB Vault Doors

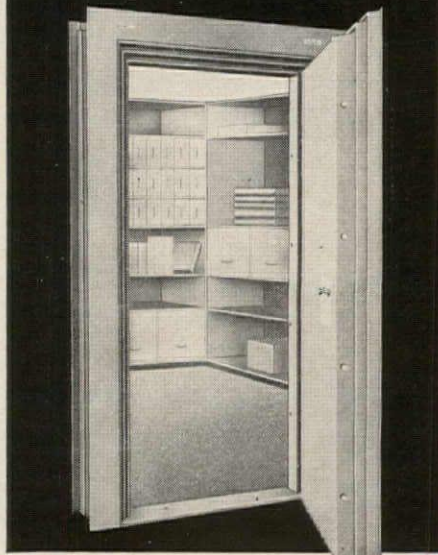

This handsome new building in Montgomery is headquarters for the Alabama Bankers Association. Located near the state capitol, it is a significant addition to Montgomery's highly successful urban renewal program.

Important association records are protected by Schwab's sturdy 4-hour Vault Door, with Underwriters' Laboratories, Inc. listed relocking device and fire label as well as Safe Manufacturers Association 4-hour fire label.

It is equipped with emergency escape mechanism, a beveled, flush vault entrance and drill resistant hard plate.

For complete specifications, see Sweet's 34-A or write for our latest illustrated catalog of vault and file storage room doors.

Our products are your protection



SCHWAB

Schwab Safe Co., Inc./Lafayette, Indiana

Circle 242 on information card

AIA JOURNAL



Title: Ensign Fire Extinguisher
Artist: The Ansul Company, Marinette, Wisconsin
Medium: Fiberglass



IF YOU HAVEN'T SPECIFIED NATCOR YET...

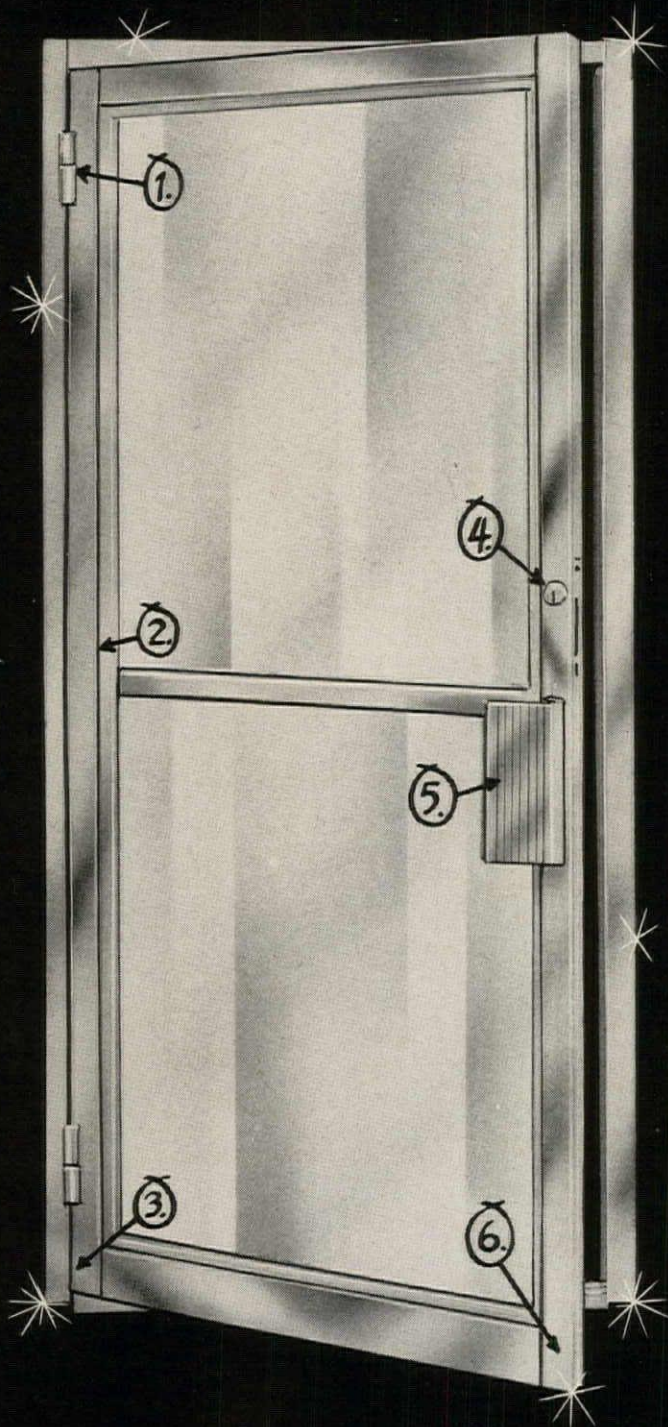

here are six solid reasons why you will soon!

Quality materials and advanced engineering principles of Natcor doors add six solid reasons why the beauty and dependability you specify will remain throughout a lifetime of trouble-free operation.

1. Patented, adjustable Butt Hinge — Ball Bearing with frame reinforcement for extra endurance.
2. Snap-In Vinyl Glazing Bead — Just one member to snap in during glazing — saves labor.
3. Quality Extrusions — Door stiles and rails of fully extruded aluminum, $\frac{1}{8}$ " wall thickness throughout, as specified by architects.
4. Maximum Security Lock — Extra Safe — with $1\frac{3}{8}$ " throw, case hardened steel bolt and weather-stripped face plate for pairs of doors.
5. "Sure-Grip" Pull Handle — Broad selection of contemporary styled stock, interchangeable — Push-Pull Hardware.
6. Reinforced Corner Construction — Heavy, concealed reinforcement brackets are firmly bolted to door stiles. Tri-Clad welding of each joint after bolting results in complete rigidity.

For full information on Natcor's complete line of doors and entrances, see our catalog in Sweets or write —



THE NATCOR COMPANY

since 1920

P.O. Box 9321, Nashville, Tenn.

Member NAAMM

Marble PRESTRESSED CONCRETE used for beauty, economy, long life

The new 22-story home of Manufacturers and Traders Trust Company in downtown Buffalo, was designed by Minoru Yamasaki, one of the country's pioneering architects.

3,450 white marble concrete prestressed facing elements prove the practicality of this striking material in modern building construction. Each typical member, 12 feet-0½ inch long, was prestressed on the neutral axis to eliminate camber and insure durability. They were honed to a satin finish to achieve an aesthetically-pleasing, marble-like appearance . . . and at lower initial cost than natural marble.

The advantages of prestressing were in providing a crack-proof, craze-proof unit that could be handled more readily. Being under compression, the facings are more impervious to dirt and weather, resulting in a long-lasting, clean surface.

CF&I-Roebling, largest manufacturer of prestressing wire and strand, will gladly send you information . . . please mention the type of structure you are considering. Write: CF&I Steel Corporation, Denver, Colorado 80202, or Trenton, New Jersey 08602.

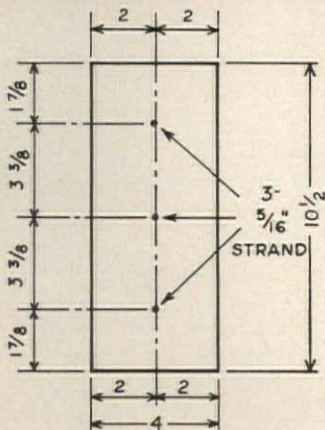

TYPICAL MULLION

Manufacturers & Traders Trust Co., Buffalo, N.Y.
 Architect: Minoru Yamasaki, Birmingham, Mich.
 Structural Engineer: Worthington, Skilling, Helle & Jackson, Seattle, Wash.
 Contractor: The John W. Cowper Co., Inc., Buffalo, N.Y.
 Prestressed Concrete Fabricator: The George Rackle & Sons Co., Cleveland, Ohio

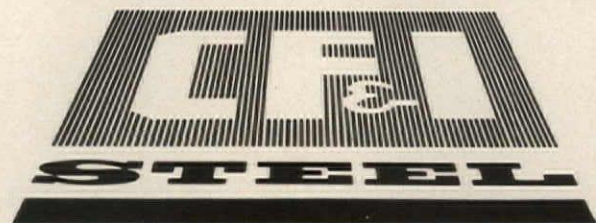

Should Elegance be Ruled Out of the Washroom?

"ABSOLUTELY NOT,"

say architects who have seen

CONTEMPORARY

The distinctive ASI line of accessories in elegant vinyl-clad and stainless steel

A look of elegance, a look of esthetic and functional integrity, is available in today's washrooms. It's the look of CONTEMPORARY. Architects and designers are responding to CONTEMPORARY washroom accessories, acknowledging their impeccable design and construction, making excellent professional use of them.

Here's one major reason why—their door members are handsomely clad in polyvinyl and are offered in four stocked wood-grain finishes available in 17 other colors and choice of textures on order. This gives the architect vast leeway in design. No two buildings need look alike in washroom areas—indeed no two floors in a building—thanks to the many combinations you can select.

Look into CONTEMPORARY as a means of adding a touch of quiet distinction where it will do the most good—and without upsetting the budget—in any commercial, industrial, or institutional building you may now be designing. See all technical data in Sweet's Architectural File, Section 25d/Ac, or write for complete, colorful, detailed catalog. Inquire too about the specialized services we are ready to offer you.

The durable vinyl laminate (bonded to doors of 20 gauge steel) is guaranteed for the life of the cabinets. All other exposed surfaces are fabricated of 22 gauge, type 304L, 18-8 alloy stainless steel with removable, protective plastic coating over a pre-polished #4 satin finish. One piece face trim; no mitres or welding.

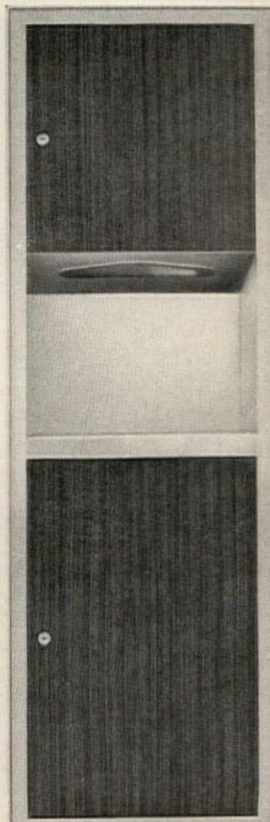

PAPER TOWEL COMBINATION DISPENSER AND DISPOSAL

Dispenses 500 C-fold, multifold or single-fold paper towels. Heavy duty stainless steel removable container. Overall: 17¼ x 54 x 6½. No. 2460



SOAP LEAF DISPENSER—RECESSED

Door hung with concealed pivoting rod and locked by theft-proof spring tensioned cam lock. Cartridge contains 1000 soap leaves. Overall: 7 x 13¾ x 2½. No. 308

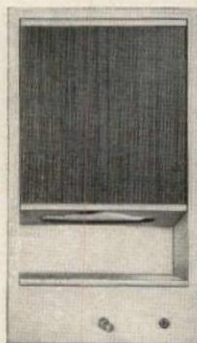

RECESSED CABINET WITH INTEGRAL SHELF, TOWEL DISPENSER AND LIQUID SOAP DISPENSER

Lather soap, additional mirror and adjustable shelf optional. Overall: 17¼ x 30½ x 4¼. No. 2430



SANITARY NAPKIN DISPENSER

Rotary coin mechanism dispenses all shapes and package sizes. 5c, 10c and gratis. Overall: 17¼ x 27¼ x 4¼. No. 2466



ACCESSORY SPECIALTIES, INC.

42-14 Astoria Boulevard, Long Island City, N. Y. 11103 Tel. 212 932-3525

Imaginative design and responsible manufacture of modern washroom accessories

You draw the windows.

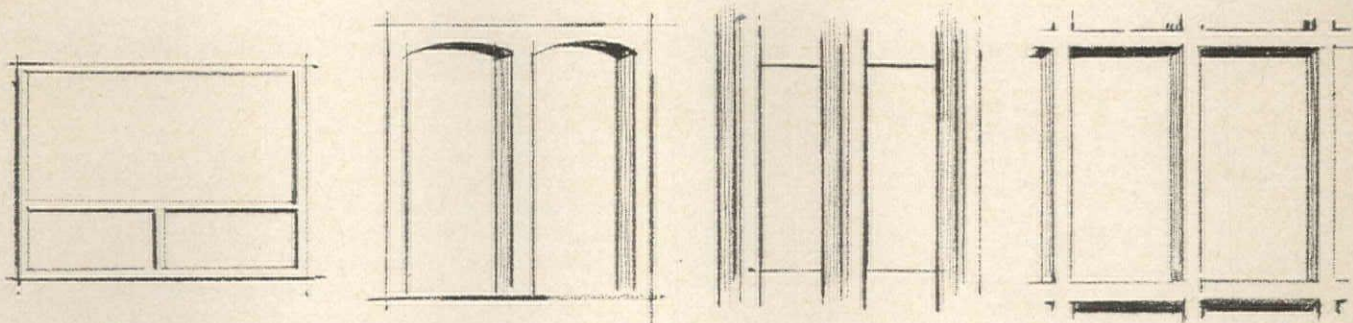

Let Architrac® draw the draperies.

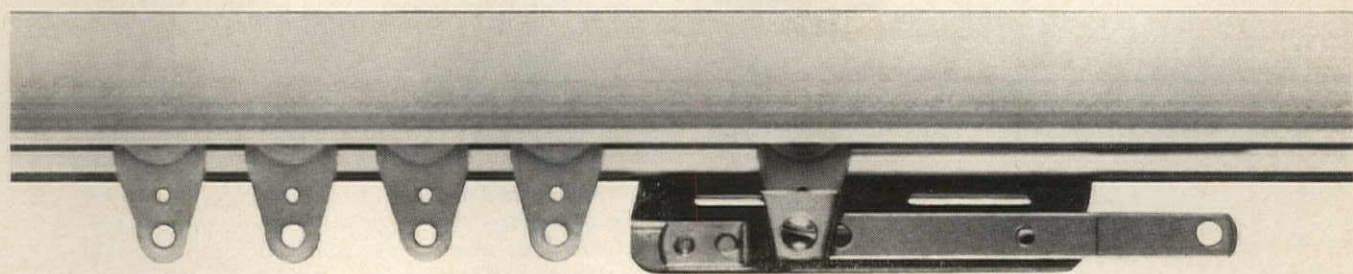

A system of drapery tracks designed for every window decorating and light control application

Specifying Architrac assures window treatment that complements your window design. Dual-channel anodized aluminum tracks harmonize with contemporary window casings and sliding glass doors. Openings are uncluttered because draperies pack *all the way* to the ends of the tracks. Architrac mounts easily on walls, casings and on or in ceilings. (Support clips are concealed on wall-mounted styles.) Operating cords and ball-bearing pulleys are hidden in rear channel; ball-bearing drapery carriers ride smoothly in front channel. Quiet and trouble-free. When you're ready to design windows, Kirsch is ready with *Architrac*. For full information see Sweet's 15F. Or write: Kirsch Company, Dept. AN-1266, Sturgis, Mich. 49091.

Dual-channel styles: single-draw to 24 ft.; double-draw to 36 ft.; multiple-draw to 48 ft. Single-channel styles for hand traverse: single-draw to 24 ft.; double-draw to 48 ft.

Kirsch

DRAPERY HARDWARE

For windows people care about.

**When the Owner
is OUT...
W & F should be IN**

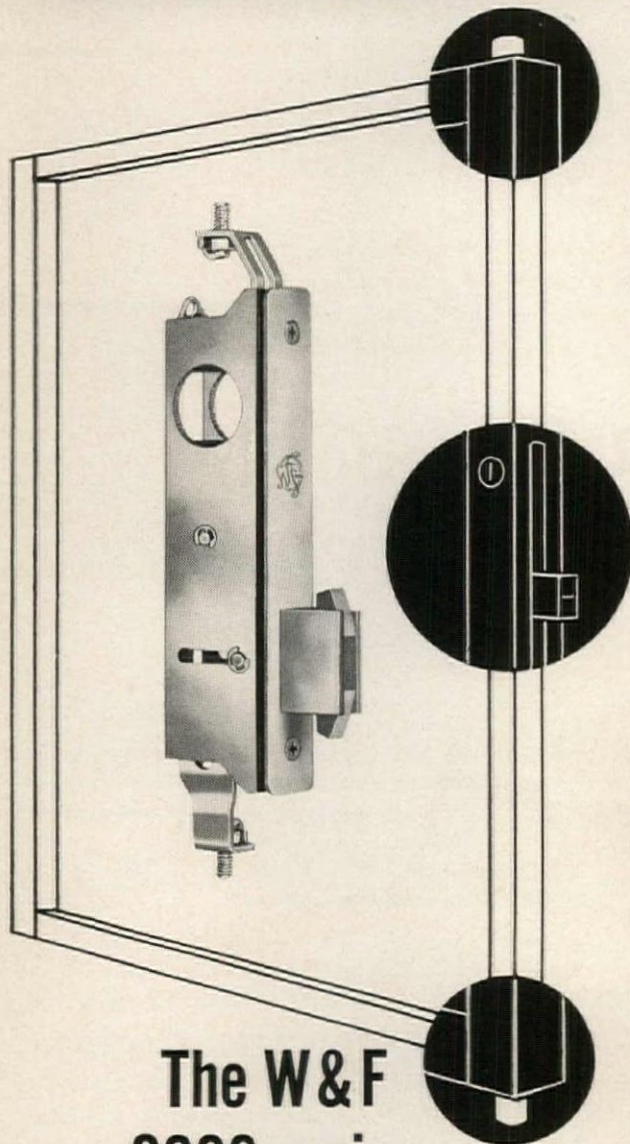

The W & F 6000 series

Deadlock, provides your client's entrance with one, two or three SECURITY points.

Jamb bolts, along with header and threshold bolts are available in any combination . . . designed to meet your Specification requirements in VARIED situations.

For technical and pricing information, contact:

W. & F. MFG., INC.

811 Air Way, Glendale, Calif. 91201 • Phone: (Area Code 213) 245-7441

For more technical data, circle 248 on information card

88

Books from page 82

Urban Renewal: The Record and the Controversy. John Q. Wilson. Cambridge: MIT Press, 1966. 683 pp. \$12.50

The editor of this provocative book is director of the Joint Center for Urban Studies of MIT and Harvard. He also is associate professor of government at Harvard. In his introduction he reminds the reader that urban renewal has a unique place in American political experience. One of the reasons is that it has emphasized direct federal-city relations instead of the earlier pattern of federal-state alliances, and it is one program that has started to change the shape of American federalism.

The overall aim of the book is to provide a ready source of materials written by a variety of authorities on the history, theory and practice of urban renewal and on the political, social and economic issues involved in this governmental program.

There is a continuing controversy about urban renewal, and this book presents all points of view. Wilson thinks the controversy may be due simply to the intellectual's ambivalent attitude toward the city and the fact that intellectual differences lead to different policy concerns. Whatever one's viewpoint, this book underscores the fact that we should give constant attention to the basic assumptions and performances of urban renewal, as Robert C. Weaver cautions in his article on "New Directions in Urban Renewal." He writes that urban renewal is not the magic some of its devotees think, but it does "perform certain functions that are indispensable and it is beginning to perform others."

Rebuilding Cities. Percy Johnson-Marshall. Chicago: Aldine, 1966. 374 pp. \$15.

Part 2 of this book is its real heart. It is a detailed analysis of three remarkable case studies in city planning—London, Coventry and Rotterdam. Johnson-Marshall, professor of urban design and regional planning at the University of Edinburgh, has had a tremendous amount of experience in the planning and rebuilding of cities devastated by war, and his book proves abundantly that he is thoughtful.

His penetrating comments on problems and on lessons learned make this a significant book in the literature of town planning. It has been a long time in preparation, for as early as 1962 it was already announced in bookdealers' catalogs. At first one is rather disappointed at having waited so long for its publication.

Lewis Mumford has written an introduction for the book, and he warns the reader not to lose sight of Johnson-Marshall's central contribution in the wealth of illustrations provided. The author's key contribution, Mumford believes, lies in his conception of the civic nucleus of the city, which is not just a shopping and office area but the focal point of the entire civic life of the community and region.

"By emphasizing the role of the pedestrian core, as an assembly place and meeting-place, Mr. Johnson-Marshall brings out the very elements that enable a city to function culturally as a city: the elements that pass on the cultural heritage and ultimately give form to all its subordinate activities," writes Mumford. There are other interesting ideas and topics in the book, but it is somehow disturbing to be warned that one may miss the more salient points. One wishes that the author had pruned his materials a bit. ■

If you plan ceilings, you should see this film.

NECA has prepared a film which shows how the integrated ceiling has given you new freedom in interior design. You are free to design a ceiling that heats, cools, lights, communicates, controls sound and beautifies just the way you want it to. Then you can depend on a qualified electrical contractor to install it—and guarantee its performance, too.

Why an electrical contractor? Because most of the functions of an integrated ceiling are powered or controlled by electricity . . . and electricity is the electrical contractor's business. He has plenty

of experience in coordinating the efforts of carpenters, sheet metal men, plasterers, plumbers, heating and refrigeration men and other specialists—and has available to him established and recognized procedures through which jurisdictional questions can be settled without delaying the job.

Put the integrated ceiling into the hands of your qualified electrical contractor by putting it in the electrical specifications. He'll guarantee the performance, not only of the electrical function, but of the entire job.

Your Qualified Electrical Contractor

NECA—National Electrical Contractors Association, 610 Ring Building, Washington, D.C. 20036

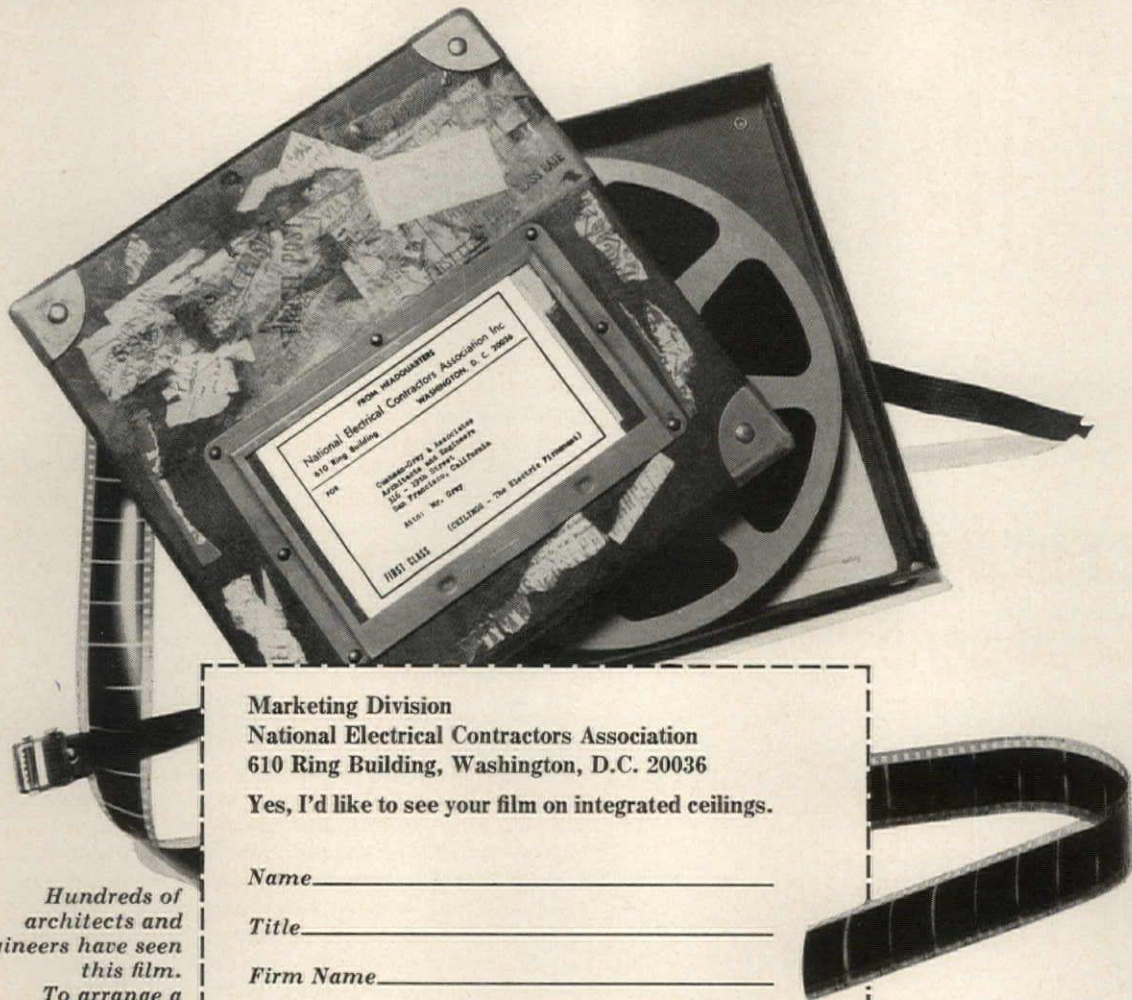

Marketing Division
National Electrical Contractors Association
610 Ring Building, Washington, D.C. 20036

Yes, I'd like to see your film on integrated ceilings.

Name _____

Title _____

Firm Name _____

Address _____

City _____ State _____ Zip _____

AIA-126

*Hundreds of
architects and
engineers have seen
this film.
To arrange a
showing, fill out
and mail
coupon today.*

SPECIFY

ZIG ZAG

LIME

ON YOUR PROJECTS

**IT IS USED IN
SO MANY
WAYS**

Interior plaster

Produces an easy-working finish coat for smooth, white durable walls.

Mortar

Creates a strong, moisture-proof, self-healing mixture.

Stucco

Creates a finish which endures weather and vibration stresses.

Concrete

Forms a mixture which is very placeable and homogeneous.

Grading and Landscaping

Conditions the soil for better lawns and gardens.



Ohio® Lime products meet all existing Federal and A.S.T.M. Specifications.



Literature is available to help you.

For complete specification data write to:

OHIO® LIME COMPANY
Woodville, Ohio 43469

For more technical data, circle 249 on information card

CALENDAR

National

Dec. 12-14: National Conference on Air Pollution, Sheraton Park Hotel, Washington, D. C.

Jan. 4-7: National Society of Professional Engineers, Winter Meeting, Americana Hotel, San Juan, Puerto Rico

Jan. 30-Feb. 2: International Heating & Airconditioning Exposition, Cobo Hall, Detroit

Jan. 31-Feb. 3: Annual Conference of the Reinforced Plastics Division, the Society of the Plastics Industry, Inc., Shoreham Hotel, Washington, D. C.

Feb. 12-15: American Society of Concrete Constructors, Annual Convention, Royal Orleans Hotel, New Orleans

April 1-6: National Planning Conference, American Society of Planning Officials, Shamrock Hilton Hotel, Houston

April 1-7: American Concrete Institute Annual Convention, Royal York Hotel, Toronto

May 14-16: Illuminating Engineering Society Annual Theater, Television and Film Lighting Symposium, Hollywood Roosevelt Hotel, Hollywood, Calif.

May 14-18: AIA Annual Convention, New York Hilton Hotel, New York

May 29-31: Construction Specifications Institute Annual Convention, Hotel Fontainebleau, Miami

AIA Regional and State Conventions

Feb. 8-10: Middle Atlantic Region, Conference Center, Williamsburg, Va.

April 5-7: North Central States Region, Sheraton-Schroeder Hotel, Milwaukee

AIA Committees and Related Meetings

(At the Octagon unless otherwise noted)

Dec. 5-7: Board of Directors

Jan. 11-12: Reynolds Architectural Student Jury; Council of Commissioners

Jan. 13-14: Grassroots East

Jan. 20-21: Grassroots Central, Bel Air West Motor Hotel, St. Louis

Jan. 23-25: Grassroots West, Mark Hopkins Hotel, San Francisco

International

June 19-28: International Commission on Illumination Session, Shoreham Hotel, Washington, D. C. (attendance by application only, to US National Committee of CIE, Secretary, L. E. Barrow, c/o National Bureau of Standards, Washington, D. C.)

July 3-8: UIA Congress, Prague

Tours

• Architects Grand Air Treks of Treasures of Egypt, the Middle East and Baghdad, 22 days each, departing New York and Washington, D. C., Jan. 27, Feb. 24 and March 31. Arranged for AIA members, their families and friends by United States Travel Agency Inc., 807 15th St. N. W., Washington, D. C.

• Mexican Architecture and Interior Design Seminar-Tour, meeting Mexico City Feb. 12, 14 days. (A second tour, also 14 days, meets Sept. 30.) Conducted by T. H. Hewitt. Reservations accepted in order received with deposit of \$50 per person toward cost of \$358, airmailed to T. H. Hewitt, Apartado Postal 5-251, Mexico 5, D. F. ■

Portland Cement Stucco ...an asset to good design

Portland cement stucco is in the limelight. This Berkeley, California apartment project won an AIA Merit Award for architects Roger Lee Associates. Using factory made finish coat portland cement stucco made with Trinity White they achieved a clean, crisp, contemporary look at a modest original cost. And they created a building that will keep its beauty with a minimum of maintenance.

Architects can get valuable help on the use of stucco from local plastering contractors or direct from the Trinity White Department of General Portland.

Trinity White
PORTLAND CEMENT



CREDITS: *Architect:* Roger Lee Associates. Stucco supplied by California Stucco Products Co., San Francisco. John Catanesi, Plastering Contractor, Richmond, Cal.



A PRODUCT OF GENERAL PORTLAND CEMENT COMPANY

Offices: Chicago - Dallas - Houston - Tampa - Miami - Chattanooga - Fort Wayne - Kansas City, Kan. - Fredonia, Kan. - Oklahoma City - Los Angeles

**Stainless
steel
fenestration
is now truly
cost-competitive.
Read all
about it.**

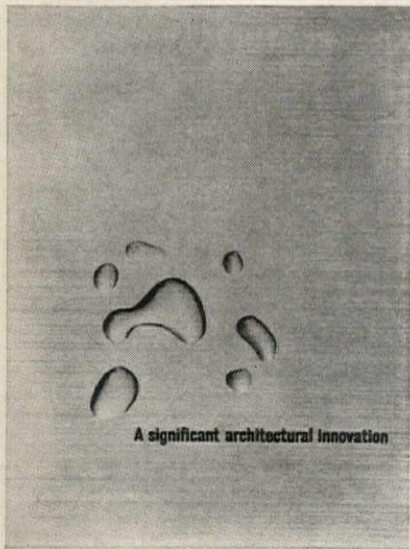

A significant architectural innovation

Send for this design manual for the world's first cost-competitive stainless steel fenestration system. For your free copy, write to United States Steel, Room 9400, 525 William Penn Place, Pittsburgh, Pennsylvania 15230.

USS is a registered trademark



United States Steel

LETTERS

Students and Mr. Belaunde

EDITOR:

I greatly appreciate your letter asking for my comments on the South American tour.*

Speaking generally about the architecture of the cities, we found the new architecture of Bogota, Colombia and the Inca ruins of Macchu Picchu to be the best examples of proper handling of materials. Certainly no one would argue with the fact that Inca stonework is the best in the world. Stone was the only material the natives had to build with, and they developed a system of cutting that gave them precision joints unsurpassed by the craftsmen of any other "stone" culture.

In Bogota we found wide use of unfinished concrete and brick. The outstanding thing was a true understanding of the uses of concrete, and a mastery of detailing and handling. Students there apologized for not having more of the steel, aluminum and glass with which we build our sterile canyons. We told them to be thankful; they have learned to use their few "earthy" materials to create interesting, human architecture.

The other cities we visited were either strictly colonial in feeling or overwhelmed by American influence.

Our visit with Peruvian President Belaunde Terry was a most interesting hour and a quarter. We were told that he usually spends no more than 15 minutes with such an audience, so we felt honored.

He is an architect, as you know. After some conversation in his office, we were taken to the great ballroom where Mr. Belaunde keeps large models of the various projects he has underway in Peru. We were impressed with his sincere desire to help his country and his people to a better life.

JACK J. WORTH III
President, AIA-ASC
Atlanta, Ga.

* ED. NOTE: Mr. Worth was one of six architectural students (the others: Morten O. Awes, James R. Diaz, Romeo Garcia, Jefferson A. Gore, Gerald C. Yurk) chosen to participate in an educational tour sponsored jointly by the AIA and the Department of State.

PHOTO CREDITS: David R. Phillips—pp. 35 (3), 40 (2, 3); Alexandre Georges—p. 38 (1-3); Warren Meyer—p. 40 (1); Richard K. Koch—pp. 42 (1-5), 43 (7); R&H Photography—p. 43 (6); Herbert Georg Studio—p. 43 (6); Frank Lotz Miller—p. 44 (right); Triborough Bridge and Tunnel Authority—p. 54 (upper left, center); Bethlehem Steel Co.—p. 54 (bottom); Alt-Lee Photographers—p. 62; Marcus Whiffen—pp. 64, 67, 69.

Progress in Concrete



**UNIQUE SLAB FORMING
PLYWOOD PANS AND
PRE-FAB SHORING SYSTEM**

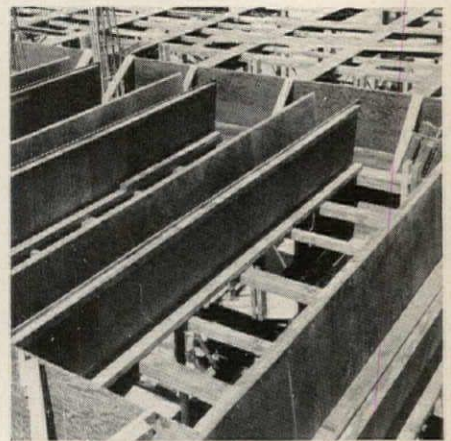

Gunnar I. Johnson, Minnesota contractor on the 4 story Science Hall at St. John's University, used a unique pan and joist construction shoring method to support 24" deep, 8½" wide joists. Joists were 4' c.c., and shoring had to be held exactly to these dimensions.

An adaptation of Symons Slab Shore system was employed, using just the shoring system. 3 x 4's, cut to exact length, were spanned from stringer to stringer. For stringer stabilization, 1" angle irons were run parallel to the 3 x 4's. The angle irons had holes drilled in each end, which captured the rivets on the stringer ledger angles.

Plywood pans were built atop the 3 x 4's; ¾" plywood was used for the joist bottoms. In stripping, the ledger angles were lowered 1½", allowing the removal of the 3 x 4's and plywood pans, for immediate reuse.

In addition to Symons shoring on the job, the building's haunched foundation walls were formed with ganged Symons Steel-Ply Forms. Column forming was also done with Symons panels.

Symons Forms can be rented, purchased or rented with purchase option.



CONCRETE FORMING EQUIPMENT
SYMONS MFG. COMPANY
152 EAST TOWN AVE., DEER PLAIN, ILL. 60018

MORE SAVINGS WITH SYMONS

Circle 251 on information card
AIA JOURNAL