

# PLAYGROUND





## Certain things you can depend on.

Mom and Rover are pretty reliable. So is the inevitability of taxes. You can also put your faith in a few, very select mechanical devices.

One of them, that a lot of architects have depended on for years, is a Halsey Taylor water cooler.

### Exclusive design features

It's no accident that our coolers deliver years of reliable service with very little maintenance. We've designed a lot of extras into them. Such as our exclusive automatic regulating valve that maintains a constant stream height regardless

of varying line pressures; heavy-duty start capacitors that assure compressor start-up, everytime; and our efficient pre-cooler that boosts cooling capacity by 60 percent.

We balance the complete cooling system for longer service and lower life cycle cost. And happier customers.

### Color and textural harmony

Each of our welded unitized cabinets is topped by a buffed stainless steel receptor and Halsey Taylor's

unique anti-squirt twin-stream bubbler. To harmonize with virtually any interior, we offer cabinets in satin finish stainless steel, PATINA bronze tone stainless, eight different Polychrome colors and a choice of vinyl clad steels. We also offer the widest selection of water coolers in the industry.

Halsey Taylor water coolers. Not a big item in your specs but something you can honestly depend on. We'd like you to have our new catalog. Write to Halsey Taylor Division, Route 75, Freeport, Illinois 61032.

**Halsey Taylor**<sup>®</sup>

KING-SEELEY **KST** THERMOS CO.

# Georgia-Pacific has more than 100 fire and sound rated wall, column and ceiling/floor systems. And a great delivery system, too.

## Our new 1976 catalog tells the whole story.

With our new catalog of gypsum systems, you can probably preselect a system that meets your requirements for sound and fire rating exactly. And meets your cost, weight and thickness needs, too.

Our catalog has dozens of different systems, some with fire ratings as high as 3 hours and STC ratings as high as 57. So we probably have something very close to what you had in mind. Or something better.

And it's all clearly shown with the specific information you need to make decisions in seconds.

## For example: System #106.

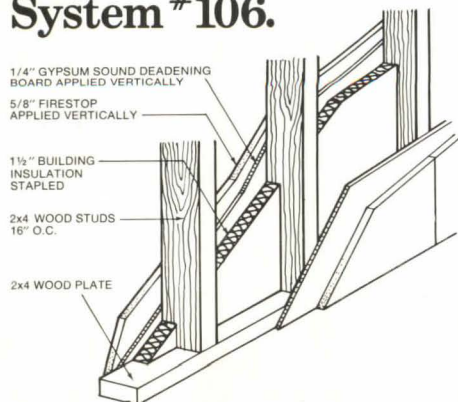

Circle 2 on information card

This interior wall system combines a layer of 1/4" gypsum sound deadening board with an overlay of 5/8" Firestop® Eternawall™ gypsum board. When combined with 2" insulation bats, the system provides a 1-hr. fire rating and an STC of 50.

The Firestop® Eternawall™ gypsum board also provides you with beauty. The vinyl-coated surface comes in 30 different colors and textures. (All of which are shown in full color—right in the catalog.)

## For another example: System #475.

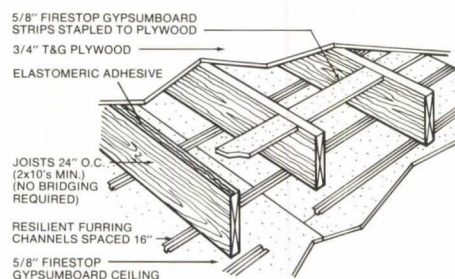

This is a floor/ceiling system that's excellent for most low-rise construction.

The system combines a 1-hr. combustibile fire rating with an STC of 50. And remember, the basis for every rating shown is clearly explained right in the catalog. One more "system" we're proud of.

It's our distribution system. A network of distribution centers that stretches all across the nation.

A system that assures you of consistent product quality and availability wherever you order it . . . coast to coast.

At competitive prices, too.

So, if you don't already have a copy, write us for the 1976 edition of our Gypsum Board systems catalog.

Get it . . . and everything that comes with it.

Georgia-Pacific  
900 S.W. Fifth Avenue  
Portland, Oregon 97204

Please mail me \_\_\_ copies of your 1976 Gypsum Board systems catalog.

(Name) \_\_\_\_\_

(Company) \_\_\_\_\_

(Address) \_\_\_\_\_

(State) \_\_\_\_\_

(Zip) \_\_\_\_\_

**Georgia-Pacific**  
The Growth Company



# Want to see a building come to life?



# Put on our glasses.



Architect—Laitala, Freeman,  
Smith, Fowler  
Lansing, Michigan

## Reglazing with LOF's Vari-Tran® can make an old building feel young again.

When the location is right, but the building isn't, a face-lift just might be the answer.

It happened in Lansing, Michigan. An old department store became a "new" office building, and its owners couldn't be happier with the result. The Plaza I is already near full occupancy.

But there's another side to Vari-Tran coated glass you might find equally interesting. Besides raising your clients' property values, it can mean good public relations for your firm. Everyone takes notice when creative architecture comes to the rescue of older neighborhoods.

And, available in five attractive

hues, glass with Vari-Tran coating can help add the kind of excitement that calls attention to a building and its occupants.

There's more to Vari-Tran than just an attractive appearance, however. With its wide variety of light transmissions and shading coefficients, it can also substantially cut heating and air conditioning costs.

Find out more about reglazing with Vari-Tran coated glass by writing Ralph Hayward at Libbey-Owens-Ford Company, 811 Madison Avenue, Toledo, Ohio 43695.

# LOF

Circle 3 on information card

AIA JOURNAL/SEPTEMBER 1976 3



Residence, Highland Park, Ill. Architect: Robert M. Roloson

## Red cedar complements a modern mansion.

The problem: Design a truly spacious residence of over 7000 square feet while maintaining graceful lines and complementing the oak forest environment.

Part of the solution: Red cedar Certigrade shingles. One of the key points in the rationale to specify red cedar: "... cedar shingles are uniquely compatible with both the environment and the home. Due to the complexity of the roof shapes, a material was needed that would assume almost any form. Frankly, I would be hard-pressed to think of another material providing both the function and appearance required for this job."

Even if your next residential project isn't quite as extensive as this one, consider the material with natural elegance, durability and superior insulative qualities. Red cedar shingles and shakes.

Red Cedar. A natural solution.

(For information on "How to Specify," write Red Cedar Shingle & Handsplit Shake Bureau, 5510A White Building, Seattle, Wa. 98101.

In Canada: 1055 West Hastings St., Vancouver, B.C., V6E 2H1)



These labels under the bandstick of red cedar shingles and handsplit shakes, are your guarantee of Bureau-graded quality. Insist on them.

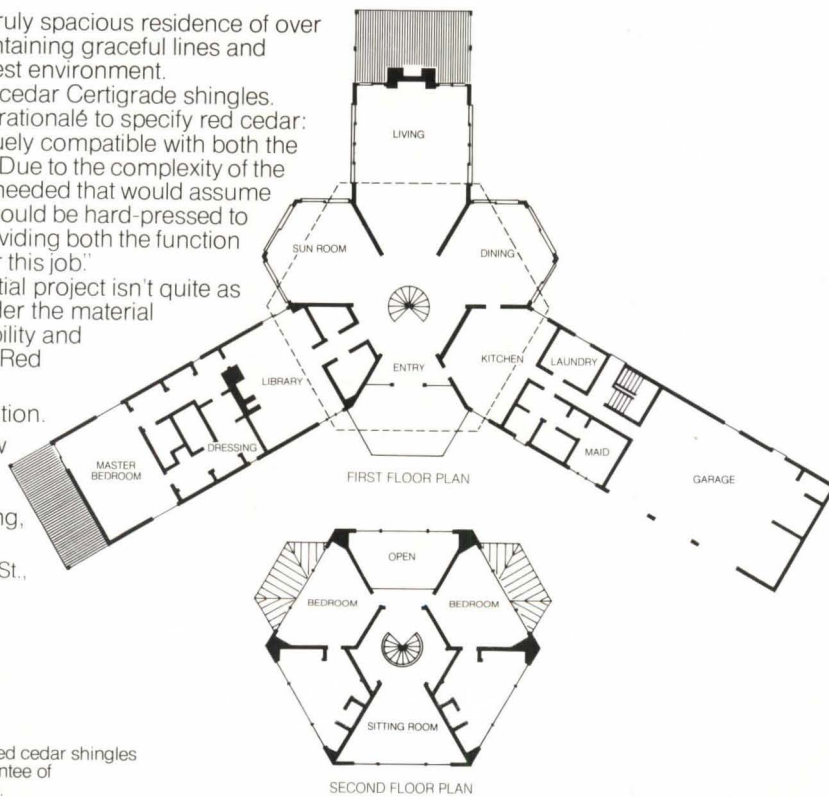

### Red Cedar Shingle & Handsplit Shake Bureau

## Board of Directors

### Officers

Louis de Moll, FAIA, *President*  
 John M. McGinty, FAIA, *First Vice President*  
 Elmer E. Botsai, FAIA, *Vice President*  
 Carl L. Bradley, FAIA, *Vice President*  
 Robert L. Wilson, AIA, *Vice President*  
 Hilliard T. Smith Jr., FAIA, *Secretary*  
 Charles E. Schwing, AIA, *Treasurer*  
 William L. Slayton, Hon. AIA,  
*Executive Vice President*

### Directors (Year indicates expiration of term)

Whitson W. Cox, FAIA ('77), *California*  
 Rex Lotery, FAIA ('76), *California*  
 Robert B. Marquis, FAIA ('78), *California*  
 Joseph F. Thomas, FAIA ('77), *California*  
 Robert C. Broshar, AIA ('78), *Central States*  
 Robert M. Lawrence, FAIA ('76), *Central States*  
 Harley B. Fisk, AIA ('76), *East Central States*  
 Frank R. Mudano, AIA ('78), *Florida/*

*Caribbean*  
 Herbert R. Savage, AIA ('77), *Florida/*

*Caribbean*  
 David L. Perkins, FAIA ('78), *Gulf States*

Zeno L. Yeates, AIA ('77), *Gulf States*

Eugene C. Swager, FAIA ('78), *Illinois*

William R. Jarratt, FAIA ('77), *Michigan*

William R. Peery, AIA ('77), *Middle Atlantic*

R. Randall Vosbeck, AIA ('78), *Middle Atlantic*

Robert A. Burley, AIA ('77), *New England*

Sarah P. Harkness, AIA ('76), *New England*

Adolph R. Scrimenti, FAIA ('77), *New Jersey*

James B. Baker, FAIA ('77), *New York*

Kenneth Klindtworth, AIA ('78), *New York*

Donald J. Stephens, FAIA ('76), *New York*

George A. D. Schuett, AIA ('76), *North*

*Central States*

A. P. DiBenedetto, AIA ('77), *Northwest*

James M. Harris, AIA ('78), *Northwest*

Willard C. Pistler Jr., AIA ('76), *Ohio*

Randolph J. Stauffer, AIA ('78), *Pennsylvania*

Leslie N. Boney Jr., FAIA ('76), *South Atlantic*

Jerome M. Cooper, FAIA ('77), *South Atlantic*

Howard R. Barr, FAIA ('76), *Texas*

J. Harold Box, FAIA ('78), *Texas*

Robert A. Fielden, AIA ('76), *Western Mountain*

Jerry Compton, ex officio, *President, ASC/AIA*

### Observers

Leon Bridges, AIA, *Chairman,*

*Commission on Community Services*

Herbert Epstein, FAIA, *Chairman,*

*Commission on Education and Research*

Ehrman B. Mitchell Jr., FAIA, *Chairman,*

*Commission on Institute and Component Affairs*

Daniel Sheridan, *Chairman,*

*Council of Architectural Component Executives*

### Headquarters

William L. Slayton, Hon. AIA,

*Executive Vice President*

James A. Scheeler, FAIA,

*Group Executive for Program Development*

J. Winfield Rankin, Hon. AIA, *Assistant*

*Secretary*

William G. Wolverton, Hon. AIA,

*Assistant Treasurer/Controller*

James E. Ellison, AIA, *Administrator,*

*Education and Research*

Michael B. Barker, AIP, *Administrator,*

*Environment and Design*

Arnold J. Prima Jr., AIA, *Administrator,*

*Government Affairs*

J. R. Kirkland, *Administrator,*

*Institute and Component Affairs*

Marshall Purnell, *Administrator,*

*Minority Affairs*

Edward G. Petrazio, AIA, *Administrator,*

*Professional Practice*

Muriel Campaglia, *Administrator,*

*Public Relations*

John P. Eberhard, AIA, *President,*

*AIA Research Corporation*

John H. Schruben, FAIA, *President,*

*Production Systems for Architects*

*and Engineers, Inc.*

# AIA JOURNAL

## Evaluation: A Small Office Building Asserts Itself, but with Respect— Donald Canty and Andrea O. Dean

22

The five-year-old Euram building retains its capacity to startle

## New Towns in America: Rumors of Their Demise May Yet Prove Premature— Jane A. Silverman

27

HUD remains optimistic about the long haul as it picks up the pieces of Title VII

## America's Best-Known New Towns Near Adolescence—Jane A. Silverman

30

Columbia, Md., and Reston, Va., experience financial and social growing pains

## Changing the Ground Rules of Architect, Contractor, Subcontractor Relationships— Mary E. Osman

38

A revised A201 modifies the architect's 'undue liability' in contract administration

## Student Competition: Using Energy as a Design Medium—Marguerite Villecco

40

Urban survival shelter informs and delights

41

Separate perspectives on living with nature

42

Community resource centers conserve energy resources

44

Garbage housing becomes respectable

46

Architect's home and office goes underground

46

A Quaker community respectfully designed

47

Energy agency models energy conscious design

48

Solar student center is prefabbed and fast-tracked

49

## A System of Ethics to Guide Man's Relation to the Land—Hugh B. Johnson, FAIA

50

All of nature is a heritage to be protected and passed to future generations

**Cover:** Photo by Robert C. Lautman of Lake Anne Center, Reston, Va.

### Departments

|          |    |                 |    |
|----------|----|-----------------|----|
| Going On | 8  | Books           | 64 |
| Letters  | 56 | Advertisers     | 68 |
| Events   | 56 | Acknowledgments | 68 |

**Donald Canty**, Editor; **Mary E. Osman**, **Andrea O. Dean**, **Allen Freeman**, Associate Editors; **Stephen A. Kliment**, AIA, Contributing Editor; **Suzy Thomas**, Art Director; **Sudsy Banks**, Editorial Assistant; **Michael J. Hanley**, Publisher; **Michael M. Wood**, Sales Manager; **George L. Dant**, Production and Business Manager; **Gloria J. Smith**, Circulation Manager; **Pam A. Honeyman**, Administrative Assistant.

AIA JOURNAL, official magazine of The American Institute of Architects, published monthly at 1735 New York Ave. N.W., Washington, D.C. 20006. Telephone: (202) 785-7300. Subscriptions: for those who are, by title, architects, architectural employees, and to those in architectural education (faculty and schools), and to libraries, building construction trade associations and building product manufacturers: basic rate \$12 a year; \$20 two years; \$8 to architectural students in the U.S., its possessions and Canada. For all others: \$18 a year in the U.S., its possessions and Canada; other countries to those who are by title, architects: \$18 a year. All others outside the U.S., its possessions and Canada: \$30 a year. Single copy: \$2, payable in advance. Publisher reserves the right to refuse unqualified subscriptions. For subscriptions: write Circulation Department; for change of address: send Circulation Department both old and new addresses; allow six weeks. Second class postage paid at Washington, D.C. Quotations on reprints of articles available. Microfilm copies available from University Microfilm, 300 N. Zeeb Road, Ann Arbor, Mich. 48106. Referenced in *The Architectural Index*, *Architectural Periodicals Index*, *Art Index*, *Avery Index to Architectural Periodicals*. © 1976 by The American Institute of Architects. Opinions expressed by contributors are not necessarily those of the AIA.® VOL. 65 NO. 9.







# Tectum Roof Deck. If you've had an earful of OSHA.

The passage of the Occupational Safety and Health Act (OSHA) makes noise control in manufacturing plants a primary consideration. Gold Bond® Tectum® Roof Deck gives you structural strength and depending upon thickness, a sound absorbing ceiling with up to .80 noise reduction coefficient.

And if you add Tectum wall panels, as Boeing did in its former 737 final assembly building, shown at left in 1969 photo, it's easier to minimize noise even if supplementary close-to-machinery baffles are required.

A Tectum Roof Deck absorbs rather than reflects noise to assist in "knocking down" the overall sound level to make it easier to comply with OSHA standards.

Tectum is adaptable to plant renovation. When OSHA requires better sound

absorption, Tectum wall and ceiling panels help lower noise levels.

Tectum is beautiful, but beauty is just a bonus. Here, it's a lightweight, but structurally strong roof deck suitable for built-up roofing. A thermal insulator with a 0.57 "k" factor.

Tectum is applicable to flat or pitched roofs with steel, wood or concrete framing. Tectum is durable because of the way it's put together. An exclusive inorganic binder bonds long wood fibers into a compact sheet under heat and pressure. Like wood, it's easy to cut, shape and install. Tectum has been given an uplift rating of Class 90.

For more information, write Gold Bond Building Products, Division of National Gypsum Company, Dept. AIA-66T, Buffalo, New York 14225.

**We're gypsum,  
and then some.**



## General Accounting Office Urges Repeal of Brooks Bill

The General Accounting Office recently issued a report in which Congress is urged to change the method of selecting architects and engineers for federal projects. GAO calls upon Congress to repeal the Brooks bill of 1972 (PL92-582) which has mandated that the government select A/Es on the basis of ability and competence rather than fees.

AIA has actively supported the Brooks bill method as a means of procuring the best available design talent for needed public facilities at a fair and reasonable cost to the government. AIA has long contended that the lowest fee will not save the taxpayer money because a low-price design consultant could possibly unknowingly add tremendously to the cost of a project.

In order to give all firms a fair chance at federal jobs, the Brooks bill requires that federal agencies advertise their intentions to secure A/E services. One reason for this is to allow smaller and less well-known firms to compete for federal jobs. GAO in its report, however, maintains that this policy has been ineffective in providing a large number of firms with work. It suggests that the General Services Administration is the only federal agency which has been successful in actually employing new professional designers under the Brooks bill and that military agencies have actually reduced the number of firms to whom contracts are awarded.

GAO contends that to increase competition, government procurement agencies should revise the public announcements. It maintains that A/Es should be required to make specific proposals for any particular federal job they may seek. GAO also strongly recommends that life-cycle costing techniques be used and that emphasis be placed upon long-term energy costs. In awarding a federal contract, moreover, GAO states that a basis of judgment should be the lowest fee submitted.

"The argument regarding how many new firms have received contracts involves a policy decision, namely, whether the

dominant selection factor should be 'spread the work' or 'select the best qualified firm,'" says Bruce Schafer, director of federal liaison for AIA. "The agencies now try to strike a balance between the two which appears to be the fairest approach. The real point is that the current procedure of public announcement and equal submission of government A/E selection forms by all interested firms gives all firms an equal opportunity to compete."

Schafer also points out that "competing proposals are never equal. All one needs to do is to look at the widely varying price proposals from presumably qualified firms in recent Maryland A/E procurements." The state of Maryland now requires price submissions in the selection of A/Es.

The project proposals and life-cycle costing estimates recommended by GAO would place an added cost burden on A/Es and government agencies, Schafer says. "It is a commonly held concept that life-cycle cost estimates have little validity prior to 30 to 40 percent completion of design documents. Any estimate prior to decision making places the A/Es in an adversary position. Estimates should be the collaborative effort of the designer working with the client during design development. Better buildings are a worthy goal which was given procedural potential with the passage of the Brooks bill."

One purpose of the Brooks bill is to assure that political pressure is not brought to bear in the award of contracts, and selection of A/Es is made by the use of impartial public panels and evaluation boards in the screening of firms. After extensive research, a special GSA study committee reported in June 1974 that there had not been a single instance of political influence in the award of GSA contracts since the passage of the Brooks bill.

The GAO report proposes that all A/Es who lose out in competition for a federal contract be reimbursed for the costs they incur in the preparation of technical proposals and life-cycle cost estimates.

"This would appear to open up an

avenue down which the taxpayer may not want to travel," Schafer comments. "In addition, the architect and engineer run the risk of not being reimbursed at all in view of the fact that the GAO report fails to define just what the term 'major significance' means in relation to federal construction."

Meanwhile, the Committee on the Federal Procurement of Architect-Engineer Services is preparing a formal response to GAO on the procurement report. Members of the committee include AIA, American Consulting Engineers Council, American Society of Civil Engineers, American Road Builders Association and National Society of Professional Engineers. AIA also is currently in the process of preparing a detailed review of the GAO report.

AIA members who wish to comment on the report may communicate with Schafer at Institute headquarters.

### Airport Construction Aid Extended Through 1980

President Ford has signed the Airport and Airways Development Act of 1976 (H.R. 9771). The legislation extends the air development program through fiscal 1980, providing more than \$5 billion in federal aid. The bill permits federal funds to be used for the construction, alteration, repair or acquisition of public use terminal buildings and facilities. It also provides funds for small airports, with an increase in the federal share to 90 percent of project cost through 1978 and 80 percent through 1979 and 1980.

The legislation defines, for the first time, types of airports eligible for federal funding, establishing a new category for "commuter airports." The airports, served by commuter carriers, are eligible for federal aid under the bill and also by means of discretionary funds controlled by the Secretary of Transportation.

The bill also permits federal funds to

*continued on page 16*

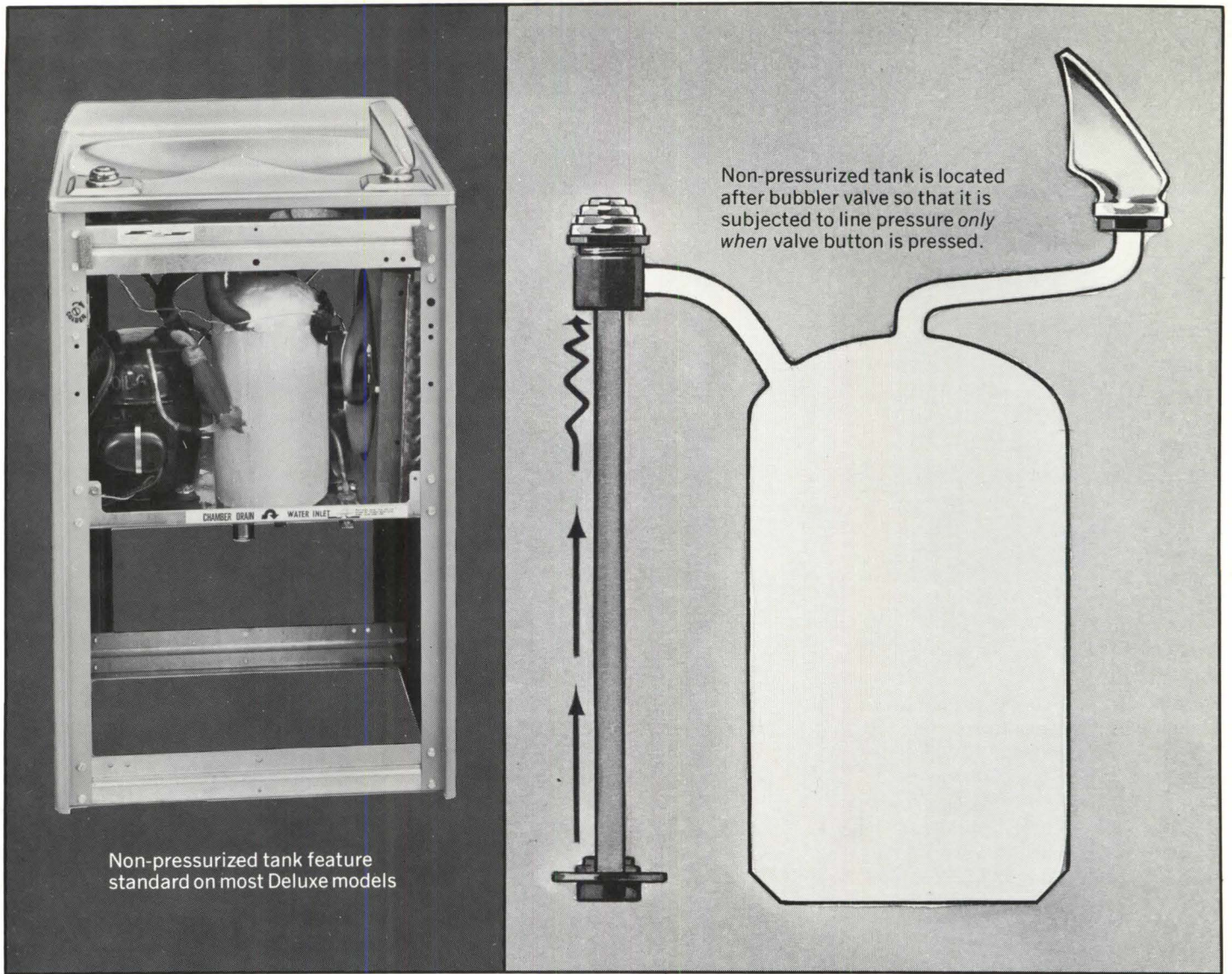

Non-pressurized tank feature standard on most Deluxe models

## Why Elkay's non-pressurized system gives maximum protection to a water cooler tank

A water cooler tank is one of the most important components to protect against possible stress. With Elkay's exclusive design, only when the regulator button is pressed is the tank system subjected to line pressure. This isolates the tank from the stresses of excessive pressure surges and water hammer, and also reduces the possibility of damage which could be caused by freezing from an improper setting or functioning of a thermostat. Far better than just adding extra thermostats. Non-pressurized systems are available on most Elkay Deluxe series models.

**ELKAY**<sup>®</sup>

Manufacturing Company  
2700 So. 17th Ave., Broadview, IL 60153



EFA Series Floor Models

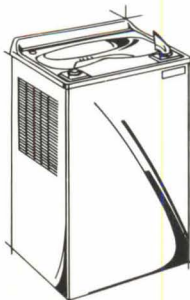

EWA Series Wall Models

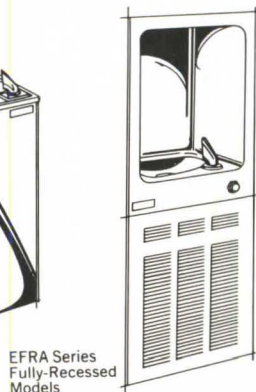

EFRA Series Fully-Recessed Models



ESRA Series Semi-Recessed Models

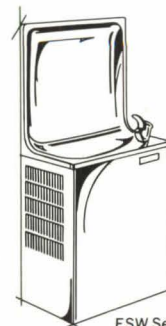

ESW Series Simulated Semi-Recessed Models

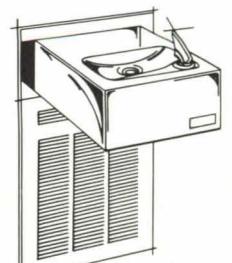

ERHF Series Wheelchair Level Models

Elkay offers a complete line of water cooler models for every requirement

# the largest moveable seating installation in the country...



## is in Kansas City at the H. Roe Bartle Convention Center

Fixtures' new 23S **Venus Thermoplastic Stack Chair** was selected for Kansas City's H. Roe Bartle Convention Center because it offered the best balance of all six essential features — Durability, Cost, Comfort, Appearance, Space Savings and Safety.

H. Roe Bartle Convention Center will

use the 22,000 Venus 23S chairs for multipurpose use in all areas — Exhibition/Convention floors and Meeting rooms.

To learn more about the Fixtures story write for a copy of our exciting New Catalog 10-76.

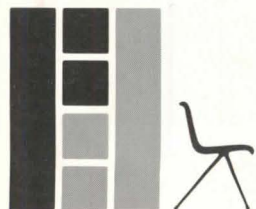

**FIXTURES MFG. CORP.**  
1642 CRYSTAL  
KANSAS CITY, MO. 64126

PHONE COLLECT  
816/241-4500

*Commercial Furniture in Advanced Design*  
Current Catalog 10-76



## The new Smok-Cheks



Fire/life safety standard  
Door frame mounted for superior  
protection. Provides early warning  
detection and automatic door closing,  
with that special assurance only the  
industry's pacesetter could provide.

**Now, first with optional photoelectric  
or ionization detector modules**

Details? Ask:

**RIXSON-FIREMARK, INC.**

A Subsidiary of Conrac Corporation  
9100 W. Belmont Ave., Franklin Park, IL 60131

LIVING HISTORY CENTER, Philadelphia, PA  
Architects: Mitchell and Giurgola Associates  
Hardware Supplier: McAuliffe & Sons, Inc.  
Hardware Consultant: William B. McAuliffe, D.A.H.C.

Circle 8 on information card

# Insulation is

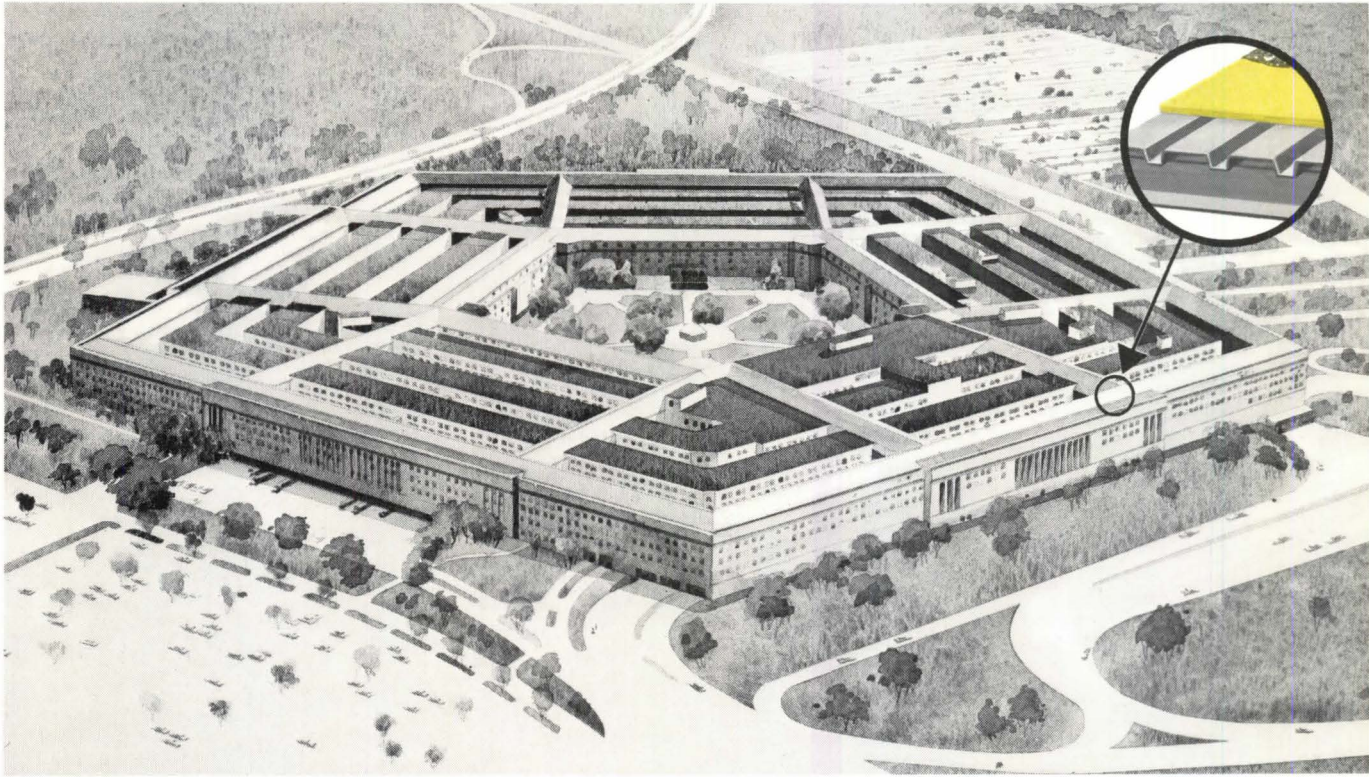

Projected cost to heat and cool the Pentagon for the next 20 years, if it were built today using only 15/16-inch Fiberglas roof insulation:

## \$2,541,454

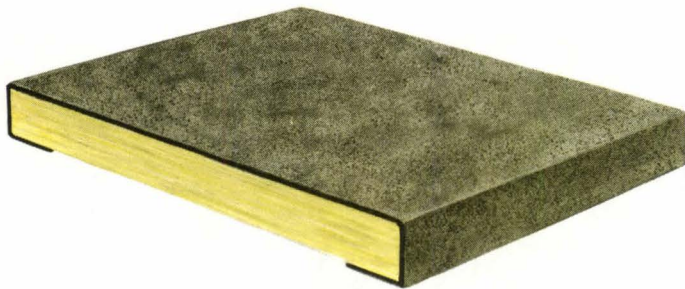

**Owens-Corning Fiberglas roof insulation – the only glass fiber roof insulation on the market.** Dimensionally stable. Retains thermal value. Easier to apply than organic/mineral boards. For over 30 years, the *best* base for built-up roof decks.

The Pentagon—world's largest office building.

If it were being designed by today's architects for today's soaring heating and cooling costs, we trust it would have the specifications of the version on the right.

This version has a full 2¼-inch layer of roof insulation, instead of the thinner layer that has been usual for offices, schools, stores and other commercial buildings for the past 20 or 30 years.

Using thicker 2¼-inch Fiberglas\*

\*T.M. Reg. O.-C.F.

# cheaper than oil

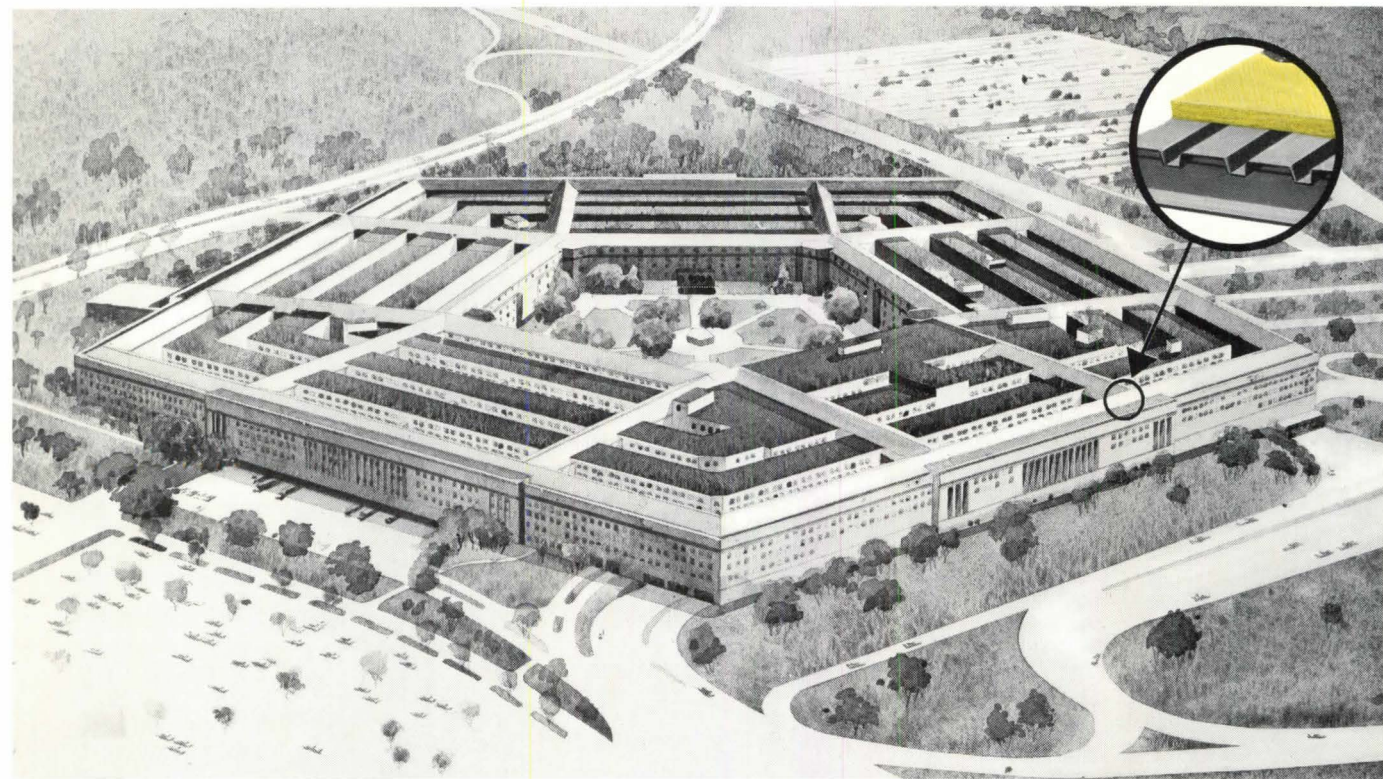

Projected cost to heat and cool the Pentagon for the next 20 years, if it were built today using thicker 2¼-inch Fiberglas roof insulation (after allowing for the cost of thicker insulation!):

## \$1,207,500

roof insulation saves money two different ways:

### A saving of \$1,333,954

1. It saves on energy costs. Estimated savings per year, based on gas heat and electric cooling in the Washington area, with a projected increase in energy costs at 7% per year and estimated future savings discounted at 10% per year: \$66,697 —or \$1,333,954 every 20 years.

2. It saves on construction costs. The estimated first cost of this en-

ergy-tight Pentagon would be *lower* than if the less efficient version were built! Reason: the improved thermal performance of the roof would permit use of smaller-capacity, *less costly* heating and cooling equipment. Amazingly, the estimated savings would be large enough to cover the added cost of the thicker roof insulation *twice* over.

**Important:** Thicker Fiberglas roof insulation also makes sense when it's time to re-roof *existing* buildings. It should pay for itself in a few

years, then go on saving thousands in fuel bills for years to come.

### Ask our "talking" computer

Our EMS II (Energy Management System) computer can give you savings figures on your next roofing job —by phone! You'll get projected energy *and* equipment savings, plus *payback* period. (Actual savings may vary.) For details, call your local O.-C.F. rep, or write: I.B. Meeks, Owens-Corning Fiberglas Corp., Fiberglas Tower, Toledo, Ohio 43659.

Owens-Corning is Fiberglas



# Owens-Corning tells why you this unusual picture next time



**T**he concept of open offices is gaining acceptance *quickly*. No wonder.

Both owners and architects are drawn to their airy, sweeping good looks. To the improved communications and increased efficiency they promote for workers. And to their astonishing economy of 50 cents vs. roughly 15 *dollars* per square foot for inevitable alterations to meet shifting work patterns.

But here's a word of caution. Plant our outlandish basketball "office" firmly in your mind. Because unless you base your design on *acoustics*, as well as aesthetics, you may never hear the end of it.

More than one open office has had to be modified—embarrassingly and *expensively* torn apart,

baffled, re-ceilinged, or refurnished—in order to achieve *workable* sound levels.

Owens-Corning has helped pioneer the development, testing, and matching of open-office components. Look over these highlights of what our experts have learned. Then call on us for *all* the details and *all* the components of a *successful* open-office system.

## **The ceiling. Handsome is as handsome does.**

The ceiling is the single most important acoustical component in an open office. It should absorb, not reflect, sound. A perfect ceiling would have the same

\*T.M. Reg. O.-C.F.



# should remember you design an open office

sound attenuation as the open sky—a Noise Isolation Class (NIC) rating of 23.

An independent acoustical testing laboratory examined eight ceilings, including costly coffered and baffled systems. Their verdict: Owens-Corning's Nubby II Fiberglas\* Ceiling Board, in any standard exposed grid suspension system, is *best* for achieving speech privacy at economical installed cost. In these tests, Nubby II was the *only* ceiling board with an NIC' as high as 20 in a flat configuration.

Some architects prefer the look of ceilings with *concealed* grids. Caution: As yet, *no* such ceiling provides the minimum NIC performance necessary to achieve satisfactory acoustical privacy in an open office.

In this league, handsome is as handsome *does*.

## Acoustical screens.

**"Don't just stand there. Do something."**

The sound screen, visual symbol of the open office, offers flexibility, economy, personal privacy, and acoustical control. It has *two* acoustical functions. First, to block direct sound transmission from one work zone to another. Second, to absorb sound, reducing flanking reflections into adjacent zones. Owens-Corning's sound screen is the *most* effective screen available. Its engineering features include:

1. A metal septum—to block sound transmission.
2. One-inch Fiberglas core on each side of septum—to absorb sound.
3. Sturdy special Fiberglas sound diffuser (Glastrate)—for abuse resistance.
4. Stain-resistant Dacron® Polyester fabrics. These fabrics are washable, colorfast, and fire-retardant (Class 25).

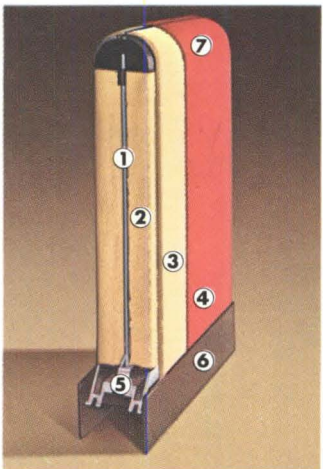

5. Extruded aluminum frame, fastened to septum—for strength and stability.

6. Painted anodized aluminum kickplates—for additional abuse resistance.

7. Top and side radii designed to minimize sound defraction over edges.

## Masking sounds. The sounds of silence.

Even the finest acoustical ceilings and screens cannot do the whole job of providing speech privacy. An electronic sound masking system of speakers, installed in the plenum, is necessary.

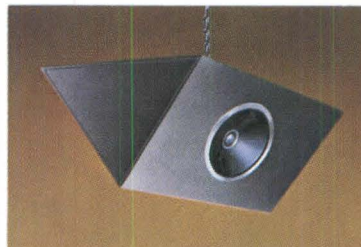

This sound must be unobtrusive—and *uniform*. Even at a few decibels above the desired NC<sub>40</sub> = 40 rating, the masking sound causes

people who are working in the office to begin raising their voices, defeating the whole purpose of the masking.

Owens-Corning's experts can recommend a background masking system that meets these requirements.

## Owens-Corning system gets it all together.

For the open-office concept to be successful, the ceilings and screens must be tuned carefully to work *together*, and *with* the masking system.

Owens-Corning will be happy to provide you with all necessary information on achieving acoustical control in your open office. Or to guide the development of the whole acoustical system for you.

Write E. W. Meeks, Building Products Operating Division, Owens-Corning Fiberglas Corporation, Fiberglas Tower, Toledo, Ohio 43659.

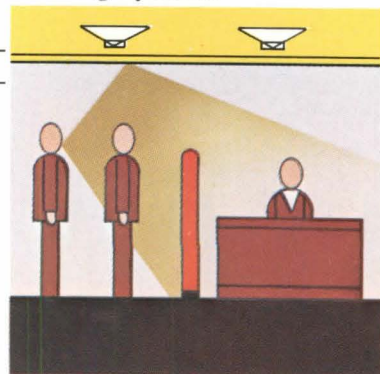

Owens-Corning is Fiberglas

OWENS/CORNING  
**FIBERGLAS**  
TRADEMARK®

*Going On from page 8*

be used for noise abatement, including the purchase of noise suppression equipment, landscaping, etc.

Federal funds, according to the legislation, may be used only by those airports which meet certain eligibility criteria, which the Federal Aviation Administration is now in the process of establishing. AIA has worked with FAA to clarify the language regarding terminal areas eligible for federal funding under legislation.

On Dec. 5-7, AIA, in association with the American Consulting Engineers Council, the American Road Builders Association and the Associated General Contractors of America, will sponsor a conference in Las Vegas on airport design and construction. Architects, engineers and contractors will discuss airport development, and representatives from FAA will be at the conference to help participants in the consideration of business opportunities in the air transit area. Information about the conference may be obtained from Bruce Schafer, director of federal liaison programs, at AIA headquarters (202) 785-7382.

## Submissions Sought for 1977 AIA Honors, Awards

Submission deadlines are near for the Institute's 1977 program of honors and awards. Information about submittal procedures for AIA components and members may be obtained from Maria Murray, director of awards programs, at AIA headquarters.

The AIA honor awards recognize "distinguished achievement by American architects." For the second year, submission will be judged in two categories by separate juries. One jury will judge projects designed and built since Jan. 1, 1966, which remain unaltered and in their original use; the second jury will consider projects which incorporate restoration, rehabilitation and adaptive reuse on which work has been completed since Jan. 1, 1966.

William Turnbull Jr., FAIA, chairman of the 1977 honor awards jury, says that members who wish to make submissions should fill out an entry slip and enclose a check for \$40 to cover entry fee for each project submitted. Postmark deadline is Sept. 30.

The "test of time" applies to AIA's 25-year award, which recognizes projects in the U.S. or abroad designed by American architects and completed 25 to 35 years ago. Each project, which "must have excellence in function," must still be standing "in a substantially complete form and in good condition." The project must be properly nominated by an AIA member, component group or committee.

Binders for submission may be obtained from Maria Murray. Submissions must be postmarked no later than Oct. 22.

Stanley Tigerman, FAIA, chairman of the 1977 jury on Institute honors, urges all AIA components "to actively participate in the selection of the highest honors which we, as architects, may bestow upon our fellow professionals." The AIA medal is awarded annually in such categories as artists and craftsmen whose work is related to architecture, illustrators and recorders of architectural accomplishments and individuals or organizations who have inspired and influenced the architectural profession. Nominations for Institute honors must be postmarked by Nov. 12.

## Bill Offers Court Costs To Faultless in Lawsuits

A New Jersey Society of Architects statement of some months ago called for action that would permit design professionals to recover legal expenses in damage suits where it was proved that the professionals were not at fault (*see Jan.*, p. 10). Now a landmark bill has been introduced in the New Jersey legislature by John J. Horn, state senator (D-Camden), which would permit recovery of court costs and legal fees in cases of action against professionals that are deemed "frivolous or vexatious." The measure has been referred to the senate judiciary committee.

"A typical frivolous suit would be one in which several defendants, one of them an architect, are named," explains the New Jersey organization. "The intent would be to summon a number of parties with real or fancied connection to the plaintiff in the hope of obtaining judgments against one or more of them."

The bill states that when architects are discharged from such actions on the grounds that there are no legal bases for claims against them, and that they were named "merely to force a contribution toward settlement, the practice demeans the legal process and imposes a needless expense upon the professional so named." A statement accompanying the bill says that "the expenses of defense of a groundless lawsuit are not now recoverable and are not reimbursable under professional liability insurance policies."

The bill, says Robert F. Grove, AIA, president of the NJSA, "would discourage such a practice and still protect the rights of a plaintiff to institute suit where there is a valid basis for such action."

Grove says that "many plaintiffs are unfairly using the legal system to their personal advantage by bringing meritless suits against innocent parties in an effort to reach an out-of-court settlement by intimidation. The public suffers from these

unscrupulous actions. The bill provides a mechanism by which persons who irresponsibly use the legal system as a means to harass others may be made responsible for their actions."

## New York AIA Finds Jobs Still on Decline

A recent survey of the New York chapter/AIA of member firms indicates a further decline in employment. The chapter asked its member firms to submit anonymously the total number of people on the payroll as of Dec. 31 of each year beginning with 1969 through 1975. The chapter reports that a "large number" of firms responded and that the figures "can be considered reliable."

In 1969, the total number of people employed by the architectural firms, including nonarchitectural personnel, was 3,255. By Dec. 31, 1975, the total number of employees had decreased to 2,070, a drop of 36.41 percent. The chapter estimates that the drop in the number of architectural employees is even greater. "Informed opinion in the chapter indicates that this number is down by 60 to 75 percent," says George S. Lewis, executive director.

The survey also asked architectural firms to report on the amount of new work undertaken. A 1974 survey indicated a drop in new work during 1973 equal to 55 percent of 1969. The 1975 survey showed a further drop of 50 percent during 1974, indicating a total of about 75 percent since 1969.

## Job Applicants Listed

Women and members of minority groups who are interested in faculty positions in schools of architecture are urged to send one-page résumés to the Association of Collegiate Schools of Architecture, 1735 New York Ave. N.W., Washington, D.C. 20006. Information should include the respondent's educational and professional background, particular interests and areas of competency and address and telephone number. A roster will be compiled which will be circulated to heads of architectural schools for use in employment. A similar effort was undertaken in 1972 by ACSA, resulting in job positions for "virtually everybody on the roster," says David Clarke, ACSA executive director.

## Marilyn Housell Dies

Marilyn Housell (nicknamed Smootie for her maiden name of Smoot) was an "editor's graphic artist," as was evident in the AIA JOURNAL when she served as its art director from 1964-1969. She used frills

*continued on page 56*

# AT&T Uses "Suppressed" Architecture And Computer-Controlled HVAC to Gently Fit Huge New Office Building Into a Tranquil Suburban Setting

Although enclosing more square feet than most office skyscrapers, this campus-style structure at its highest point rises only 48 feet above grade.

**Basking Ridge, N.J.** Riders along suburban roads have long grown accustomed to the sight of a type of building that keeps popping up in populous areas. This is the "speculative" office building, one that the builder erects in advance of any tenant commitments. They are almost of a common mold: squarish in shape, sheathed in dark glass and aluminum, enclosing about 100,000 square feet of rentable office space, and with their five or six stories looming tall and conspicuous above a large expanse of parking lot. With the coming upturn in the economy, many more of these buildings will rise no less obtrusively along the country's highways and byways.

But not in Basking Ridge! This is an area containing a mix of estates, farms and large homes in a rural environment of exceptional beauty. The people here treasure their countryside and guard it zealously through meticulously structured zoning regulations. Commercial development is almost unknown. Yet resting snugly in the midst of all of this is a vast horizontal office structure with more internal space than New York's Empire State Building, one of the world's most visible structures.

**Zip Factor.** The brand new Basking Ridge building of American Telephone & Telegraph Company encloses 2.7 million square feet of office and garage space. Yet the structure at its highest point rises only 48 feet above grade level. Set on a rolling campus-like tract, it will eventually accommodate 3400 AT&T administrative personnel. The complex is heated and cooled by an energy-conserving electric HVAC system with heat recovery capability and sophisticated computer control.

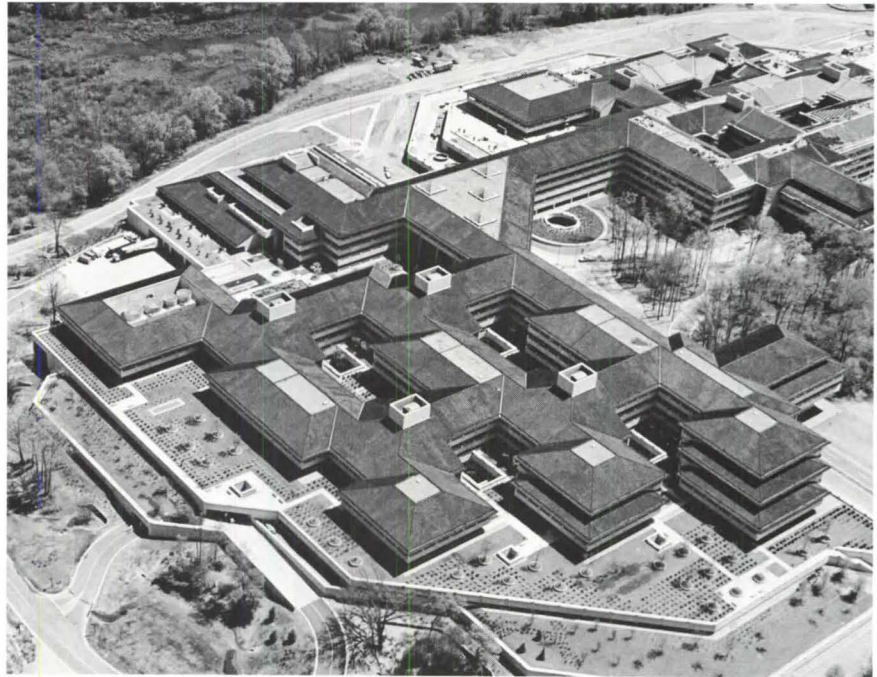

*Gently sloping roofs of terra-cotta tile help mask immensity of AT&T's new office complex.*

The new facility supplements AT&T national headquarters at 195 Broadway in the Wall Street area of New York City. In the postwar growth years, administrative departments had spilled out from the original building into leased quarters dispersed throughout the financial district. In 1969, finally, the company decided to bring scattered departments back under one roof and began looking for a suitable site.

In the search, AT&T explored many alternatives before electing to locate where travel time would be shortened for as many employees as possible. A computer scan of zip codes in employee addresses pinpointed this region of New Jersey as the center of density of employee population.

**Timely Entry.** In an unusual move, AT&T called its architects, The Kling Partnership, into the planning process before land was actually purchased. "The AT&T building became the largest design project ever undertaken by us", says Vincent G. Kling, founder and managing partner of the architec-

tural firm. "But it also proved to be the one we worked hardest to suppress. Our early entry into the project helped us immeasurably in fulfilling both the client's and the community's wishes.

"The community wanted the economic benefits that a large new office complex could bring to the area, but not at the expense of disturbing its tranquil, unspoiled environment. And the client wanted to provide the best possible conditions for its employees in a structure that would live in harmony with its surroundings. These goals are separate but not incompatible, and achieving them was made a bit easier because we were able to participate fully from the start."

**Science and Trees.** This early participation enabled the architects to lend their scientific expertise in the evaluation of potential sites. Available tracts were rated on the basis of complex criteria involving soil compaction, topographical profiles, flood plains, arterial logistics and the like. But, when the choice had narrowed to three sites that quali-

\*One of a series of reports giving recognition to the efforts of architects and engineers on behalf of resource conservation.

**Energy-conserving electric HVAC system has features for recovering and storing heat that would otherwise be wasted.**

fied equally on technical grounds, it was two clusters of 40-year old oak trees that tipped the balance.

The trees stand on 150 acres of rolling meadowland traversed by a small stream which finds its way to the Passaic River on the opposite side of the property. The architects have used the major grove, carefully preserved in the center of the site, as the entrance focus for their design. Around this focus, the low-rise office and "commons" elements, two to four stories in height, rest on landscaped terraces.

An ecological requirement was that the Passaic, which is a source of drinking water, be protected. To safeguard its purity during construction work, a settling pond was excavated in the brook's path to function as a catch basin for silt and debris. The pond functioned so effectively that regular clarity tests of downstream water indicated its quality was better than before work began. Following this utilitarian beginning, the six-acre pond has proved to be an attractive addition to the natural landscape and has been retained as a permanent feature.

**Passing Glance.** The building itself bears little resemblance to a conventional office structure. To the observer glimpsing it through the trees from the road or approaching it along the entrance drive, it has the residential character of the surrounding community. A series of three parallel office elements

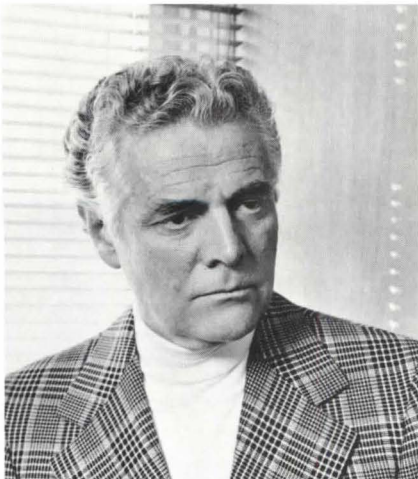

Architect Vincent G. Kling won the biggest design assignment of his professional lifetime but then had to play it down.



AT&T facilities control supervisor Louis W. Coscia checks bank of TV screens linked to cameras at each entrance to garage.

of two, three, and four stories step back from the water's edge. Their pitched roofs create shadows and overhangs, facades are fragmented to break up what might have been long, monotonous perspectives and the materials are natural and crafted.

Alternating bands of precast concrete panels and bronze anodized aluminum frames with double solar-tinted glazing comprise the exterior skin of the steel-frame structure. The precast panels are lightly sandblasted to expose the aggregate in warm tones of tan and gray. To lend a pleasing contrast, spandrel and soffit panels have received heavier sandblasting. The gently sloping, overhanging roofs are covered with dark red-brown terra-cotta tile.

To provide maximum exposure to outside views for those working within, the complex has been designed as a group of office elements clustered around interior courtyards and connected by service cores and corridors forming the "street system" of the building. The periphery of the office wings yields vistas of open courts, planted terraces, wooded areas, ponds.

**Introspection.** "On the subject of outside views", says architect Kling, "this is one place where a person looking out his window will see other parts of his building and other people working in a common effort. We feel strongly that this helps the employee identify better with his work and the company purpose. In a conventional office building, an occupant looks out on other buildings, other people that are totally unrelated to himself."

The triangular central core or "commons" serves as the crossroads of the complex. Included in the commons space are a two-story high reception lobby with a dramatic, towering foun-

tain display. Here also are lounges, barber and beauty shops, a 30,000-volume technical library, a broadcast-sized TV studio and data processing center.

A large central conference facility occupies the third level of the commons. This consists of five separate rooms, with tiered seating for from 30 to 60 persons, circling a common audio-visual laboratory for rear-view projection and closed-circuit television.

Dining facilities include a 650-seat cafeteria, 350-seat grill, four executive dining rooms seating 70 and a series of conference/dining rooms seating a total of 200. A wide semicircular staircase serves as the entrance to the cafeteria and adjoining lounge. Two log-burning fireplaces are focal points of the lounge and dining areas.

Nearby the dining area is a spacious variety store with an extensive assortment of toiletries, clothing, sundries, etc. The company has provided this convenience to make it unnecessary for employees to make quick lunchtime auto trips for incidental shopping.

**Unseen Sea.** The single element that most disturbs environmentalists about commercial development of suburban acreage is, unquestionably, the parking lot: that deadly sea of asphalt surrounding the usual shopping center or office building. Possibly, therefore, AT&T's most important move in insuring the environmental acceptance of its facility was to provide indoor parking space for 3000 cars. All during the working day there is not one parked auto to be seen at AT&T Basking Ridge.

The 1.4 million square feet of garage space is on two levels directly beneath the building and the surrounding terraces. Ceiling height in the garage area is nine feet, rather than the customary seven feet, to avoid giving employees



Engineer Del Birr sees in an electric boiler an excellent means for avoiding unnecessary correspondence with passersby.



One of the sculptured courtyards that penetrate terraces to introduce natural light and air into garage areas.

and visitors a closed-in feeling.

Offices are served directly by banks of elevators from the parking levels. The elevator banks are adjacent to courtyards which penetrate from the terraces above, introducing natural light and landscaping to the garage. Each employee is assigned a parking space near the elevators most convenient to his office. He drives to that space through one of the seven garage entrances leading from the access road.

Each entranceway is barred by a lift-arm that is linked to the same electronic computer that controls all of the building's operations, including the HVAC system. When an employee stops at the gate he inserts a coded card into a reader. Only if he is at his assigned entranceway will the gate lift.

"The system is almost foolproof", says Louis W. Coscia, AT&T facilities control supervisor. "Should an employee lose his card, he will be issued a new one coded for his assigned gate. But the computer will forever reject the card he lost, so it is worthless to an unauthorized finder attempting to use it."

**HVAC System.** Ceilings throughout the building are made up of identical 5-by-5-foot modules of a new type. Each factory-assembled module contains acoustical surface material, a fluorescent fixture, inlet for conditioned air, and perimeter slots for return air. The HVAC system supplying these modules is a forced-air variable-volume system

divided into peripheral and central zones served by adjoining core mechanical rooms. The space above the ceiling forms the return air plenum.

The temperature in each office is regulated by modulating the flow of cool air into the area. This is done by adjusting the position of dampers in the ceiling modules. Dampers may be open, shut, or anywhere in between as required by the thermostat for the area.

Four centrifugal chillers are located in the basement mechanical room. Two of these are used for cooling only. The

second pair are equipped with double-bundle condensers and capable of supplying hot and chilled water simultaneously. In the heating season, these machines operate as heat pumps, recovering heat from interior spaces that require constant cooling and transferring it to perimeter convectors.

**Boiler PR.** When the building is occupied, lights on, and office equipment functioning, sufficient heat is available for recovery to supply heating requirements in all but the coldest weather. In the first year of operation, supple-

### OPERATION OF HVAC SYSTEM

The all-electric central plant uses double-bundle chillers (Nos. 3 and 4) for one-third of the 4800 ton capacity, cooling towers for summer heat rejection a 6000-kw high-voltage electrode boiler for supplemental heating and 60,000 gallons of hot water storage capacity. The system is also used to preheat domestic water.

In the basic heat recovery cycle, return water from the air handling units is chilled in the heat recovery machines with the condenser heat being removed by the heating bundle and pumped out to perimeter convectors. A perfect balance between heating and cooling occurs only at the break-even temperature. As the cooling load increases and hot water temperature rises above the setpoint of the master controller, a portion of it is diverted into four storage tanks and the remainder mixed with cold water from the tanks. This continues until the tanks are loaded. Then they are shut off and economizer cycles on a portion of the air handling units are used to reduce the cooling load to the point where it balances the building heating requirement.

When the outside temperature rises to the point where it is no longer possible to use the economizer cycles, the condenser water is diverted to the cooling towers and the two-speed tower fans operated to balance the building load.

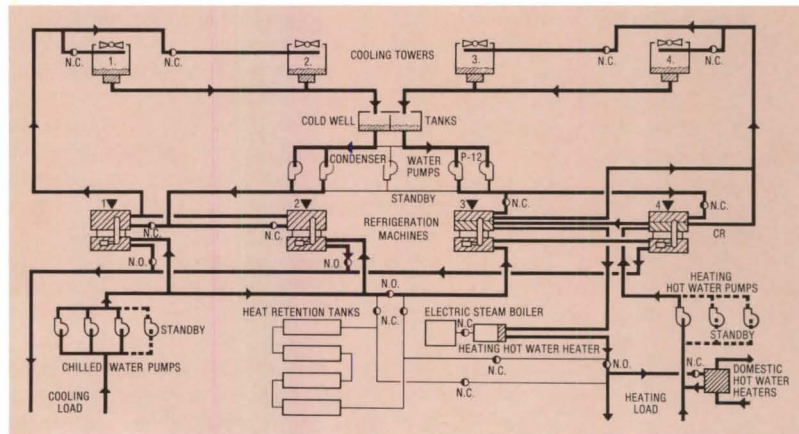

Returning to the basic heat recovery cycle, as the temperature falls below the break-even temperature, the cooling load cannot sustain the building heating requirement. Then the storage tanks are opened to the chilled water system and sufficient hot water is drawn from them to balance the heating demand. During nights and weekends when the building is shut down, the temperature in the tanks drops to the point where it is necessary to supplement the tanks by turning on the boiler. Eventually the tanks will become depleted and the chilled water system is shut down, leaving the boiler to carry the heating load.

Capability is built into the central plant operating cycles to use the boiler to charge the storage tanks. This could be used in the future for off-peak power consumption.

At night when the lights and air handling equipment are shut off, the building is allowed to cool to 65F. To warm it up prior to morning occupancy, the boiler is turned on along with the heat recovery chillers and a second hot water pump to meet the increased load in the air handling units.

Air for the office areas is supplied by a two-fan variable-volume system. One fan serves perimeter spaces and the other serves interior spaces. A thermostat in each office responds to the space load and varies the air supply into the space. Return air from the space passes through the lights into the ceiling plenum, removing about 25 percent of the heat from the lights, thereby reducing the air quantities needed to cool the offices. The return air is mixed with outside air, then passed through the cooling coil and through the fans for distribution into the space. The in-line fans respond to duct pressures, varying the pitch of the blades as the VAV terminals reduce flow. This results in a reduction in fan horsepower and energy consumption.

To aid morning warm-up the fans are started with the outside air dampers and cooling coil valve closed. Air flow through the cooling coil is reduced to 50 percent and a bypass damper and heating coil valve opened. The cold air returning from the building is mixed with warm air passed through the bypass heater to supply moderate temperature air to the VAV units. This aids the lights in warming up the building.



Display fountain in visitors' lobby aids humidity control in heating season.

mentary heat was not called for until temperatures dropped below 5F.

The source of supplementary heat for the system is a 6000-kw electric boiler in which water is flashed into steam by an arc struck between two electrodes. The entire heat output of the boiler is transferred to the hot water main through a steam-to-water heat exchanger measuring only 48 inches in length. Electrodes operate at 12,470 volts which is the primary voltage of the utility feeders. Use of this high primary voltage avoids the need for a step-down transformer with a consequent savings in first cost and elimination of the energy losses inherent in such transformers.

"The boiler performs a public relations function also", says AT&T engineer Del Birr. "In older systems of this type, the building lighting was often kept on when the building was unoccupied to heat the building at night. This was done to avoid the cost of installing a boiler. But if we did that here at Basking Ridge, we'd be constantly answering protests of passersby who believed we were wasting energy. So we have made a very conscious effort to minimize after-hours lighting—even the so-called 'stumble lighting' needed by our night watchmen."

**Computer Control.** The mechanical, lighting and security systems are managed by the H-316 computer, a powerful Honeywell data processor programmed specifically for control of building operations. The machine continuously monitors and regulates conditions at over 500 data points in the HVAC system. Only when these conditions are maintained consistently at their optimum levels can the most efficient use of energy be achieved.

The computer determines, for example, the exact number and configuration of chillers, pumps, fans, cooling towers, etc. required to satisfy the building's demand for cooling at any given moment in a summer day. The most efficient operation of the HVAC system at that moment depends on literally hundreds of variable conditions existing within the system itself (condenser water temperature, air pressure in the ducts, etc.); within the building (such as number of occupants and the business machines in use); and, finally, outdoors (temperature, humidity, etc.). Optimizing this complex mix could be done only by computer.

The HVAC system incorporates an economizer feature which at certain times permits the use of outside air for conditioning the building's environment, thereby reducing the cooling load on the central plant. The computer includes a program known as enthalpy control that refines the economizer process for added energy savings.

**The Canadian Vote.** AT&T is an important building because it demonstrates to what heights architecture and engineering can rise in easing man's ecological impact. Such environmental excellence is costly to be sure (over \$100 million in this case). But the knowledge that the appropriate technology exists should encourage both the developer and the environmentalist.

### DESIGN SUMMARY

#### GENERAL DESCRIPTION:

Area: 2,700,000 sq ft  
Number of floors: four  
Types of spaces: private and general offices, conference rooms, TV studio, computer rooms, dining rooms, cafeteria, kitchen, lounges, library, lobby, garage, mechanical rooms, storage

#### CONSTRUCTION DETAILS:

Glass: double solar bronze  
Exterior walls: 4" precast concrete panels, fiberglass insulation, gypsum board; U-factor: 0.2  
Roof and ceiling: clay tile, fiberglass insulation, concrete deck, suspended acoustical tile ceiling; U-factor: 0.18  
Floors: concrete slab

#### ENVIRONMENTAL DESIGN CONDITIONS:

##### Heating:

Heat loss Btuh: 21,000,000  
Normal degree days: 4600  
Ventilation requirements: 300,000 cfm  
Design conditions: 5F outdoors; 75F, 30% rh indoors

##### Cooling:

Heat gain Btuh: 52,500,000  
Ventilation requirements: 300,000 cfm  
Design conditions: 95F dbt, 78F wbt outdoors; 75F, 50% rh indoors

#### LIGHTING:

Levels in footcandles: 30-100  
Levels in watts/sq ft: 2-4  
Type: fluorescent, incandescent, mercury vapor

#### CONNECTED LOADS:

|                           |                  |
|---------------------------|------------------|
| Refrigeration (4800 tons) | 4,114 kw         |
| Heating                   | 9,258 kw         |
| HVAC Accessories          | 8,144 kw         |
| Lighting                  | 6,641 kw         |
| Water Heating             | 480 kw           |
| Cooking                   | 1,628 kw         |
| Elevators                 | 880 kw           |
| General and Misc.         | 2,703 kw         |
| <b>TOTAL</b>              | <b>33,848 kw</b> |

#### PERSONNEL:

Owner: American Telephone & Telegraph Company, Inc.  
Architects: The Kling Partnership  
Consulting Engineers: Kling/Lindquist  
Construction Manager: Frank Briscoe, Inc.  
Electrical Contractors: Nordling Dean Elec. Co.; Beach Elec. Co.  
Mechanical Contractors: Limbach Co.; Arace-McBride Joint Venture; John E. Joyce, Inc.  
Utility: Public Service Electric & Gas Co.

The summary verdict on this building remains to be written as the ecological professionals continue their evaluation of it. In the meantime, however, Kling has had approving votes from a number of knowledgeable sources—not the least of which were two broods of newly hatched Canada geese contentedly circling the settling pond early this spring.

## ENERGY MANAGEMENT PROGRAM

Conservation & Energy Management Division

**EDISON ELECTRIC INSTITUTE**

90 Park Avenue, New York, N.Y. 10016

# AIA JOURNAL

By the time this issue appears, national attention will be preoccupied by the Presidential campaign. Politics is not a prime concern of this magazine, but in a strictly nonpartisan way, we would like to offer the candidates a few words of wisdom by a whimsical scholar named Wilfred Owen, which originally appeared in a "fable" on urban America. The fable began: "There once was a nation of 200 million people that was the most powerful country in all the world. At the national level the inhabitants were very rich. At the local level they often turned out to be quite poor. And as luck would have it they all lived at the local level."

These words are offered to the candidates in reminder that the local level of American life is not only spotted with poverty, in terms of governments as well as individuals, but is not working all that well. For more than three-quarters of us, the localities in which we live are within metropolitan areas (in a very real sense, *are* metropolitan areas) and here the malfunction is particularly obvious and particularly painful.

Some of this has to do with distribution of resources in inverse ratio to need, some with a jurisdictional tangle that suggests a need for governmental reform at least as urgent on this level as the national. But much of it has to do with the way metropolitan America has grown, has been built, especially in postwar years. It has been a particularly planless way of building, each working for his own goals and profits, without the guidance of overall contract documents or any general supervision or coordination.

Among the results, to drop (as quickly as possible) the building metaphor and return to the realities of metropolitan America, are waste, inconvenience and worse. We have wasted energy; natural resources, especially land, and the most complete and valuable physical plant in metropolis, the central city. Outside the central city we have permitted a pattern of development that scatters the focal points of life, defies rational transportation systems, perpetuates social division and injustice—and turns the initial cost of waste into life-cycle costs of huge dimensions. It is a pattern called sprawl.

This is not the place to offer a program to the candidates (although we can recommend a reading of AIA's plan for national growth), nor to debate the extent to which metropolitan malfunction is a national problem. But judging by past campaigns, the candidates could use a reminder of where we live. *D. C.*







## Evaluation: A Small Office Building Asserts Itself, but with Respect

*Donald Canty and Andrea O. Dean*

Dupont Circle is one of the most pleasant and peopled of the spaces which punctuate Pierre L'Enfant's Washington. A meeting place of the city's chic, counter-cultural and art communities, it is also a locus of prestigious office space for firms and organizations which prefer the flavor of this neighborhood to the anonymously walled streets of Washington's commercial-administrative core.

The buildings ringing Dupont Circle have their share of anonymity, as well as banality and a few remnants of history. On the south side, on axis with the romantic fountain that is the circle's center-

piece, is a small but assertively individualistic office building that, nearly five years after completion, retains its capacity to startle. The eight-story Euram building, by architects Hartman & Cox, is a muscular composition of sharp-edged brick corners, side walls of glass sheets between massive concrete girders, and, facing the circle, an angular cavity spanned at three floors by pairs of girders with glass in between.

"The building was massed in relation to its urban obligations," says George Hartman, FAIA. "Its geometry mirrors the radial design of the circle. It main-

tains the axes of the circle and reinforces the edge." If the building was shaped in part by its context, its design also had a great deal to do with the aspirations of the client, Istituto Mobiliare Italiano (IMI), a Rome-based financial group anxious to establish an imposing presence in the American capital. Nello Picca, resident vice president in IMI's offices in the building's top floor (left), says frankly, "We wanted to create a landmark. It was a question of reflecting a good image of the company and I think we reached this goal." Part of this goal was that the building have "esthetic value for the city."

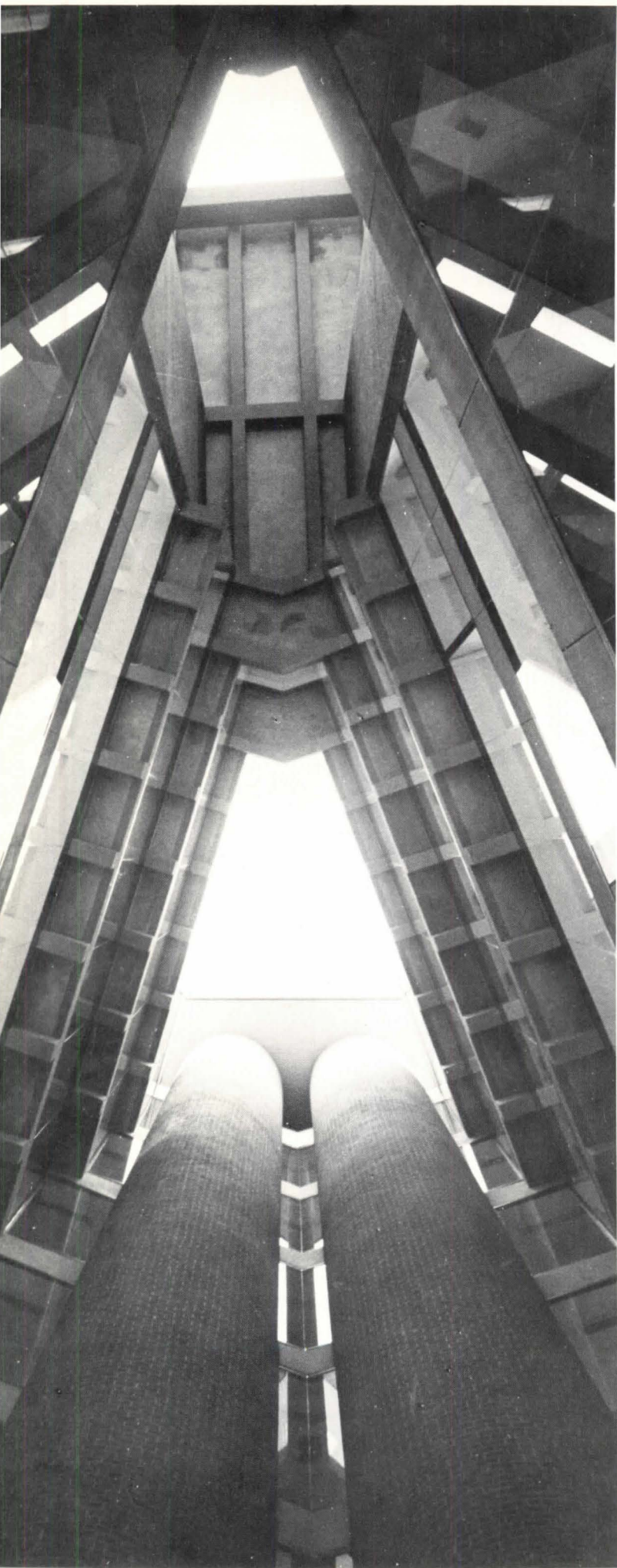

The other six floors are rental space, but IMI did not approach the project with a speculative real estate mentality. It was more "a kind of patronage," Picca says. In its initial presentation of the building, *Architectural Forum* took particular note of the differences between Euram's plan and that of typical spec buildings. The corners, instead of being used for prestige offices, are given over to the brick service towers that also function as the building's only columns. And only three floors, IMI's and the second, look directly onto the prime view of the circle. A key determinant of the plan, according to Warren Cox, AIA, was the feeling that "people like to look out. So we wanted to make the spaces as narrow as possible," with views to the exterior on one side and to the interior court on the other.

The court is the building's single most dramatic element, roughly triangular in shape, rising 86 feet to the skylit roof. Aside from contributing light to the interior spaces, "the purpose of all that space is bravado," says Cox. "We need more commodity and delight in architecture." Maximizing the court's contribution of light was the reason for leaving the circle-facing facade open on all but three floors. Adding to the drama of the court are two soaring brick cylinders housing the building's elevators.

The use of brick as a primary material in the building was dictated in part by the budget and in part by its affinity to the Dupont Circle neighborhood. The other primary exterior material is glass, used without mullions, its unbroken expanse making the 80-foot girders on the side walls look all the more heroic. The architects wanted gray glass, but "the client wanted to look at the world the way it is," Hartman says. He acknowledges that "the building was designed prior to energy consciousness." If he were designing the building today, he says, he would rethink the lavish use of glass "but not necessarily change it. The glass shows a lot of life, which is the building's strength."

Euram's rental office space has been

fully occupied since it opened in 1971. The majority of the tenants, as the architects anticipated, has been from Washington's abundant supply of law firms. The ground floor has been only sporadically occupied, partly because IMI will not rent it to just anybody. "We would like a library, bookshop, very good travel agent, a display of Italian cars, a bank," says Picca. "We are very selective in choosing tenants." Another factor may be that there is not all that much pedestrian traffic around the site, and not all of it is of a kind likely to be in the market for Italian cars or a "very good travel agent."

The working environment that Euram offers its office tenants is decidedly not a neutral one. From the moment of entering the building (through a nine-foot-high portal that makes the ensuing space of the court explode theatrically) the building asserts itself. "Office space is usually built by the square foot for an anonymous tenant with space being 'designed' only after the architect is finished," Cox says. "We built in the restriction of a narrow space that forces people to have offices in particular places. We've reduced the options of furniture designers." Even the structure is assertive in

*Below, the low entrance portal and a typical upstairs reception area opening from the elevator cylinders. At right, typical inward- and outward-facing offices. Note clerestory effect from slotted girders.*

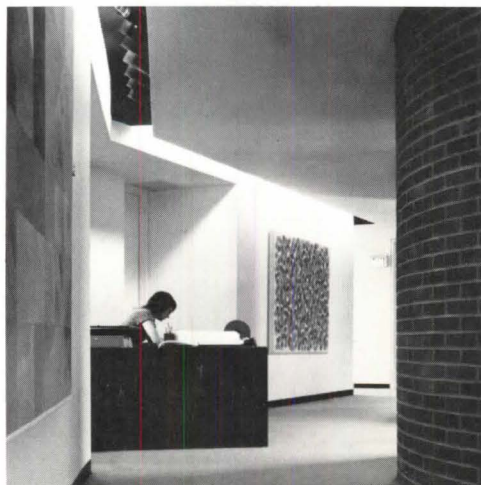
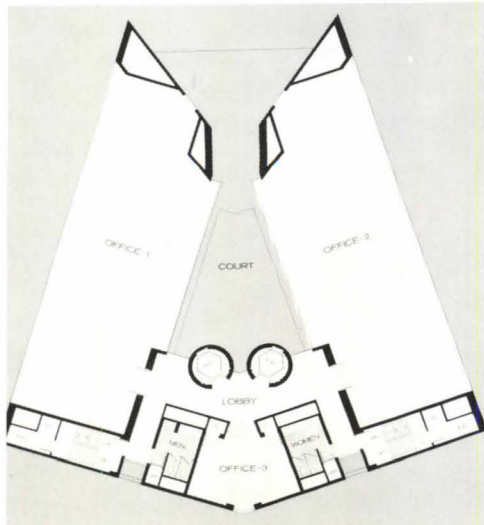

## Workers express attitudes on exposure to courtyard by adjusting their blinds.

exterior offices, the girders seemingly bearing down on the glass like a lid. And from interior spaces other parts of the building (and their occupants) are always in view.

Those who work in these spaces have mixed feeling about this exposure. Individuals cast their ballots about it, and about the profusion of glass in general, by opening or closing their blinds. "I keep mine closed," says a legal secretary. "I don't like to be working and know people see me. It's like someone breathing down my neck." Says another, "When I first came, I found the glass distracting, but it doesn't bother me anymore. I can talk to another secretary on the phone and see her while I'm talking. It's like having a TV phone." And a third, "What I like is how I feel when I'm on the inside, the feeling of spaciousness." Hartman says that "it isn't clear to us why some secretaries don't keep their blinds onto the court open. The other people are 30 to 40 feet away."

Occupants of exterior offices were generally positive about the glass walls, although some would prefer that the glass be tinted. Says a doctor employed by a medical association tenant, "Even if you don't look out, you have the feeling that you can, that you are a little more free. I keep the blinds half shut for the sun and half open for the sight. I never feel that the openness intrudes on my privacy. It is as though the outside is a cinema, not immediately related to oneself."

The views through all this glass are largely of decidedly uninteresting facades across the side streets. IMI's front offices look out on a splendid panorama of the circle and its flavorful surroundings, and the offices immediately closest to the circle on other floors look out obliquely on it. Otherwise it is out of view from the office space due to the decision to open the circle-facing facade. Virtually none of the offices' occupants interviewed complained of this, however. The reasons may have been summarized by a young associate in one of the law firms. "The shape of the property wouldn't have let them have many offices on the circle side anyway," he says. "These would have gone to the partners, of course, so it doesn't make much difference to me either way."

The opening of the facade also gave four of the building's floors the configuration of a U, and for tenants occupying the whole of these floors it's a long walk from one end of the U to the other. A partner in a law firm which outgrew the Euram

building and moved across the circle, says that "the U shape is bad for organizational cohesion and communications." Another law firm moved from an upper floor to the second to get the advantage of the space spanning the entry at that level, and opened this space into the arms of the U to get a continuous flow of circulation around the floor. Other full-floor tenants report that they find the U to be little or no problem.

Perhaps the most striking reaction of the occupants of the building is their consistent awareness that they are working in a work of architecture. This finds various forms of expression. A law librarian: "I like it; it's different." A doctor: "It's nice working in a slightly glamorous building." A partner in a law firm: "It's very important to me that the building is esthetically pleasing. It's a joy to come to the office. I appreciate the carefulness of detail." Sometimes the awareness of design was qualified. Says a secretary: "It's

architecturally interesting, but it's always cold in here."

Random conversations with passersby elicited some expressions of similar awareness among the building's external clientele, the people of the Dupont Circle area. Some sample reactions: "It fits the circle, blends well with the neighborhood." "It's scaled in proportion to the circle." "Most of the architecture around here is hideous; this building beats most of that stuff." "I love it, but I wouldn't want to work in the outside offices; you can see everything. There's one guy up there who's always after his secretary."

Clearly Euram is not a prototype of any kind. It is a very particular building, and it took a special boldness on the part of its architects, and especially its client, to get this much bravura out of an 86,000-square-foot building. Pressed for lessons it might hold for other architects, George Hartman says: "People should look at buildings in relation to their settings." □



# New Towns in America: Rumors of Their Demise May Yet Prove Premature

Jane A. Silverman

"America at its growing edge," began the *Plan for Urban Growth*, prepared by the national policy task force of the AIA in the early 1970s. The report exhorted the nation to "develop the capacity to build and rebuild at the neighborhood scale (the growth unit), ensuring open occupancy, environmental integrity and a full range of essential facilities and services."

The AIA's growth unit, a neighborhood module scaled to the needs and activities of people rather than institutions, has moved from rhetoric to reality in the form of new communities, many of which are planned along the neighborhood or village principle. Even before the AIA's official policy statement, the idea that there is a better way to build communities and that the federal government should be involved in that process had received official endorsement. It took the form first of Title IV of the Housing and Urban Development Act of 1968, and more extensively, of Title VII of the Housing and Urban Development Act of 1970.

Title VII, among other things, provided a list of incentives to private developers of new communities. Today, 13 new communities have received interest guarantees under the program. By HUD's own admission, most are in serious financial difficulties and five will probably be acquired by the federal government over the next year. The other major public sponsor of new communities, the New York Urban Development Corp. (UDC), nearly went bankrupt in the spring of 1975. Its three new communities may never be finished. Private developers of new communities have not fared much better. Reston, Va., and Columbia, Md., two of the most famous examples of private new town enterprises, are only beginning to emerge from the financial slough of the mid-1970s.

America's "growing edge" clearly is having growing pains, but it is premature

**Mrs. Silverman**, a city planner, is editor of *Environmental Comment*, a monthly magazine published by the Urban Land Institute in Washington, D.C. She is a frequent contributor to the JOURNAL.

to write an obituary for new community development, either public or private. In the short run, the management of Title VII has been a disaster by wide agreement, yet the federal government feels the concept is sound and is optimistic it can turn the program around in the long run. The New York UDC hopes to complete its new towns but in a scaled-down form and at a slower pace. Columbia and Reston think they will survive their financial difficulties and the odds are with them.

So, before we write an obituary for new communities, it bears looking at where we've been and where we're going. Most important, we should ask whether it is possible to design a public policy to encourage large-scale development, like new communities, as an alternative to prevailing patterns of suburban land use. There is almost universal agreement that the answer to this question must be "yes." The preamble to Title VII, noting that the U.S. will experience a population increase of about 75 million before the year 2000, found that "better patterns of urban development and revitalization are essential to accommodate future population growth; to prevent further deterioration of the nation's physical and social environment, and to make positive contributions to the quality of life."

"This country will grow by 25,000 people a week for the next 25 years," says Columbia's creator, James Rouse. "It doesn't make sense for us not to absorb that growth rationally."

Through Title VII, Congress created a series of financial incentives to private developers, the financial world and state and local governments to foster new communities. The chief incentive was the federal guarantee of new town obligations, making them similar to corporate bonds and thus, in theory, highly marketable on Wall Street. Title VII authorized the federal government to guarantee up to \$500 million worth of new communities bonds, although the amount for any one project could not exceed \$50 million.

In addition, Title VII established loans to developers to meet interest costs during the early years of development; interest

differential grants to public bodies to make up the difference in debt service between taxable and tax-exempt obligations; public service grants to local bodies to help pay for the cost of services during the early years of a new town when the tax base is not fully established; special planning assistance, and supplementary grants to state and local public bodies for water and sewer facilities and open space activities.

Thirteen new communities received loan guarantees from HUD, amounting to a federal commitment by Jan. 24, 1975, of \$336.5 million. HUD also made supplementary grant reservations and approvals of \$24.24 million to the new communities, including two projects sponsored by the New York UDC. If completed, the 13 Title VII communities will provide housing for close to 750,000 people during the next 20 years. Although most of the new towns are located in suburban fringe areas, like the Woodlands, outside of Houston, and Riverton, near Rochester, one, Soul City in North Carolina, would be a freestanding town and another, Cedar Riverside, is located in downtown Minneapolis.

New communities are also designed to provide a laboratory for innovations in a wide range of areas, including a comprehensive regional health care system (Gananda), wideband telecommunications (Jonathan), environmental monitoring (Newfields) and an elevated walkway system (Cedar Riverside).

An optimistic, eager staff guided the program through the early years, convinced that they were building a new and better America. Then something went sour. On Jan. 14, 1975, in a terse release,

## Can a public policy be designed to encourage an alternative to sprawl?

James T. Lynn, then HUD secretary, announced a moratorium on any new applications for guarantee assistance. "Many of the new community projects are experiencing severe financial difficulties and are substantially behind schedule," the announcement said, and Lynn ordered HUD to devote all of its resources to assisting the existing new community projects into which the federal government had already sunk millions of dollars.

The HUD moratorium was the first in a series of shockwaves that battered the new community developers. The New Communities Administration board of directors has voted to authorize federal takeover of Flower Mound, a Title VII new community near Dallas, and has given tentative agreement to assume short term management and ownership of the

5,800-acre Granada new town, near Rochester. In mid-August, James F. Dausch, the newly appointed administrator of the New Communities Administration, announced acquisition of Jonathan and Cedar Riverside, both in Minnesota. A fifth project, Park Forest South near Chicago, is in imminent danger of takeover by HUD, he says.

In July, HUD announced that it would assume responsibility for debt payments on federally guaranteed debentures for all but two of the remaining Title VII communities—St. Charles in Maryland and Soul City in North Carolina. This drastic gesture will mean an outlay of approximately \$18.5 million by the federal government on some \$250 million in outstanding bonds. But it may be the only way to stave off bankruptcy by many Title VII development companies, says Dausch, which are likely to run out of cash by mid-fiscal 1978 unless they are relieved of the onus of interest payments in the interim. Many felt that HUD was severely hampered in its efforts to bail out the projects by a ruling of the comptroller general this winter. The ruling prohibits HUD from using its revolving loan fund, set up by Title VII to provide payments to financially strapped projects. Dausch feels that the GAO ruling is "a blessing in disguise. It forced us to make the tough decisions that we couldn't make when we were putting in funds in drips and drabs."

Indeed, HUD's acquisition of Granada may be the most hopeful event in the Title VII's beleaguered history. That view is shared not only by federal officials but also by developers. Lester Gross, president of the League of New Community Developers and head of the Harbison Development Corp. which is involved in a Title VII new community outside Columbia, S.C., calls the HUD move "a positive step." He lauds HUD's realistic approach to the situation and notes that only through a restructuring and modification of the development plan can some new communities be saved.

There are many reasons why Title VII went sour: The developers blame HUD and HUD blames the developers. The truth lies somewhere in between, as it usually does. An important point to remember is that Title VII itself is probably not to blame. "Title VII was never fully tested," points out William Nicoson, the first administrator of the new communities program.

In fact, HUD only implemented two of the Title VII incentives—the loan guarantees and the supplemental grants. "It was a pennywise philosophy to go forward with the guarantee program without any of the other federal outlay programs" that might have helped developers get through the difficult early years of new town projects, Nicoson says.



In looking back at the six-year history of Title VII, Dausch, a tough, financially minded attorney who lives in Columbia, Md., now feels HUD's main task is to correct the lax management practices that led the projects into financial difficulty. "They just were not doing the kind of things that normal businesses should be doing anyway, like having sound budgets and marketing plans," he says.

HUD has just let a \$700,000 contract to two national accounting firms, Kenneth Leventhal & Co. of Los Angeles, and Coopers & Lybrand of New York City, to conduct detailed studies of the financial, economic, social and governmental problems associated with several of the Title VII new towns. Dausch's staff is also cracking down on the project management and requiring detailed five-year budget plans and annual budget control documents. He is optimistic about HUD's chances for turning the projects around but is realistic about the immediacy of the problem: "Nobody wants to be associated with a financial disaster. If we can't reverse the projects now when the housing market is on the upturn, we'll never do it. Columbia shows that it can be done with a little patience."

Dausch is also realistic about the problems within HUD bureaucracy. Marshall Kaplan, an urban consultant and former manager of the Flower Mound New Town, told oversight hearings on the new communities program held by the House subcommittee on housing and community development that there is a "severe lack of program continuity."

Each of the major developers has had a serious problem in maintaining staff and holding management, Kaplan testified, but HUD is not blameless. "Since 1970, HUD has had three secretaries, five general managers and several really severe shifts of top management staff. HUD's instability at the top has caused a continuity and predictability problem in a program that demands both."

Kaplan told the subcommittee of a severe type of mismatch between bureaucratic behavior and market needs. "I do

*New towns across the U.S.: Jonathan, Minn., (above), Raddison, N.Y. (above right) and Irvine, Calif. The major risks developers run concern market, capital financing, local politics and environment.*

not think we should have anticipated that HUD would be able to coordinate disparate federal reviews, speed up the review process, and do all the things that were necessary to meet market tests."

But to put all the blame on HUD bureaucracy or on mismanagement by the Title VII developers would be unfair. More than anything else, the Title VII new communities fell prey to the major difficulties and uncertainties that plague all large-scale development. As developer Simon put it: "If it hadn't been for the federal government, then Columbia's failure and Reston's problems would have done us in."

James W. Todd, president and chief operating officer of Gulf Reston, Inc., cites three major risks which the new community developer faces and which are generic to the new community process: market risks, capital financing and political risks, namely that "local governments are unwilling to make and keep commitments." To this list might be added a fourth—environmental risks.

The major problem affecting all the Title VII new communities as well as any other large-scale development undertaken in the early and mid-1970s was the "disastrous economy." The "large scale land developers were the hardest hit of all," former new communities administrator Nicoson points out. The national economic slump, coming as it did during the early years of most of the Title VII new towns, dealt a devastating psychological blow, one from which the development community is still reeling. That was coupled in many cases with a rising no-growth sentiment on the part of many local jurisdictions which had welcomed these large-scale projects in the first place.

Reston, for example, had to take Fairfax County, Va., to court to win the water and sewer commitments that the county



had originally made to complete the project's master plan. That time-consuming delay was costly beyond estimate for Reston.

The failure of local government to meet its commitments is high on the list of most new community developers when they cite the problems they have to deal with. The no-growth sentiment took its most extreme form in environmental suits. This is ironic because new communities are supposed to be an exemplary form of land use, a real alternative to suburban sprawl. The most serious environmental challenge was brought against Cedar Riverside, Minneapolis. The protracted two-year litigation ended in defeat for the developer when a federal judge ordered a new environmental impact statement (EIS) to be prepared by HUD because the previous statement failed adequately to assess the environmental effect of high density development of the sort proposed in Cedar Riverside. "The Cedar Riverside EIS was the most detailed we ever submitted," says HUD's Dausch. "It cost us well over \$1 million." That EIS was even more expensive than the dollar amount; HUD's defeat means that Cedar Riverside

may never be completed as a project and the chance for a demonstration of high density development of very high quality may have been irrevocably lost.

These problems add up to a major and often insurmountable hurdle for the new community developer: the psychological burden of failure. The developer of Brandermill, a new town near Richmond, Va., put it well: "When Kellogg is having financial problems, people still buy cereal. When a new community is having financial problems, people don't buy in that community. Success breeds success. Failure breeds failure."

Despite the psychological setback that large-scale development has received, many developers, financiers and public officials feel the concept can be made to work. The kinds of solutions they propose generally fall into two categories: financial and institutional. Here is a rundown of some of the current thinking in both areas.

**Financial:** Many involved in the new communities program, including HUD's Dausch, feel that Title VII, with some re-vamping, would be an adequate mechanism. In the future, Dausch would withhold the federal guarantee "until we can be sure of a going concern." One of the problems, he feels, is that HUD's backing has come too early in the development process, before the federal government can assess whether the project has a chance of making it.

Another important mechanism that is already in place is the wide range of federal programs for economic development infrastructure, housing and other services. "I don't believe that it takes subsidy," says Columbia's Rouse. "We should marshal the things that are going to happen anyway, like schools, highways and open space." Dausch feels that one of the reasons that Soul City, a freestanding Title VII new town, has been able to stay alive is that its developer, Floyd McKissick, has been so adept at marshaling federal improvement funds.

At present there are few resources, however, to finance the innovative pro-

grams that have been an important part of the new community mission. Some have proposed demonstration loans and grants to help pay for expensive innovations in the early stages of new community development. Developer Gross has recommended that HUD choose specific, individual demonstration sites for new towns for new technology and delivery of services to avoid some of the costly duplication of innovative programs that has occurred among Title VII projects.

A significant number of people involved in new communities believes that public policy must move beyond Title VII or at least a Title VII tied to HUD.

Rouse, for example, feels that Congress ought to establish a new financing institution, "clearly set up as a bank and not located in HUD. The creation of a financial institution means it would be clearly judged on how it did financing. A new communities program located in HUD is judged only in the administrative, bureaucratic sense." The bank would still be involved in guarantees, along the lines of Title VII, but the guarantee would take the form of insurance, with the developer paying the premium. David Rockefeller, the head of the Chase Manhattan Bank, also has advanced a financing institution—a community development bank.

**Institutional:** The other area of recommendations deal with changes in the institutional framework under which new communities are developed. Increasingly, these ideas focus on a public agency/private developer partnership. William Nicoson, for example, advocates state or metropolitan agencies with powers to assemble land at a sufficient scale to have an impact on growth policy, undertake master planning of the site, install infrastructure and dispose of the acreage in village segments to private developers who would build according to the master plan. Rep. Thomas L. Ashley, an Ohio Democrat who is chief sponsor of new communities legislation in Congress, feels so strongly about the public role in new community development that he would consider restricting Title VII guarantees to those states which have established public authorities for large scale development.

In fact, such a public/private partnership has been tested in the U.S., although it is too early to predict the outcome of the relationship. The New York Urban Development Corp. has sponsored three new towns which are in various stages of development. Two, Audubon, outside Buffalo, and Radisson, near Syracuse, will probably be completed according to their master plans, although the period of development will have to be extended. Radisson is a 2,700-acre project with a projected population of 8,000. Its first phase, which includes close to 400 hous-

ing units, will be completed shortly. Construction on the Audubon new town was curtailed in the spring of 1975 when UDC fell on hard financial times generally. Now, the building of the 2,800-acre new town with a projected population of 27,500 has been continued.

UDC's other new town is Roosevelt Island, a new town in-town in New York City. Roosevelt Island's first phase of 2,140 units is complete. That is about half of what master planners had envisioned for the total project. Unfortunately, Roosevelt Island has proved to be an extremely expensive enterprise and probably will not proceed past this first phase in the near future. In the case of Roosevelt Island, the state corporation was responsible for building the entire project, an endeavor that included a tramway, shops and other community services. In the case of Audubon and Radisson, UDC put in the infrastructure and private developers have undertaken the rest. It is these two new communities that may prove a better test of the public/private industry model.

The new communities of the future will probably have an altered form. The main change will be in scale. Both Rouse and Todd feel that the long-term financial commitment that characterized the development of Reston and Columbia is probably too risky and unfeasible. Instead, it is likely that developers will either undertake smaller projects or do them in smaller segments, adding "growth units" phased to a five-year sequence. A bunch of these units would, in fact, make up a new town along the lines of Columbia or Reston, but the risk would be greatly reduced.

The location of new communities will continue to be where markets are strongest, along the suburban fringes. But if new town prophets, like Rep. Ashley, have their way, we will also see more new towns in-town. He sees this as an antidote to urban decay and hopes that both HUD and Congress will "strongly encourage" new towns in the cities. One such example, which has risen phoenixlike through several near deaths, is Fort Lincoln on a 360-acre site in Washington, D.C. This spring Fort Lincoln opened its doors to the first home-buyers and hopes to have a population of 15,000 in 4,600 units. Although the problems of developing in a city are massive, if Fort Lincoln succeeds, it could provide a prototype for other large-scale redevelopment in ailing cities.

If some of the Title VII communities make it through their financial difficulties, and Columbia and Reston succeed as profit-making ventures, we will have an opportunity for other prototypes—examples of better ways to organize metropolitan growth and land use. For that reason alone it is important that public policy work to make new towns succeed.

## Our Best-Known New Towns Near Adolescence

**The first residents moved into Columbia, Md., and Reston, Va., nine and 12 years ago respectively. The birth of these pioneering, large-scale developments in the 1960s was greeted with enthusiasm and hope by developers, housing experts, sociologists and people looking for a better place to live.**

**Now Columbia and Reston are approaching adolescence and are experiencing growing pains—financial difficulties, social cleavages and, most important, a loss of the pioneering elan that drew early settlers to them. But just as growing pains are a natural process for humans, so they are for communities. Columbia and Reston are groping for identity so that they can continue their pace-setting example as mature cities.**

**The prognosis looks good. Columbia and Reston, even now, remain impressive achievements in community planning, and, though not utopias by any stretch of the imagination, to a large extent they have delivered on many of the promises they made to residents. Thus a return is worthwhile to observe some of the problems and achievements of planned communities during their crucial development periods.**

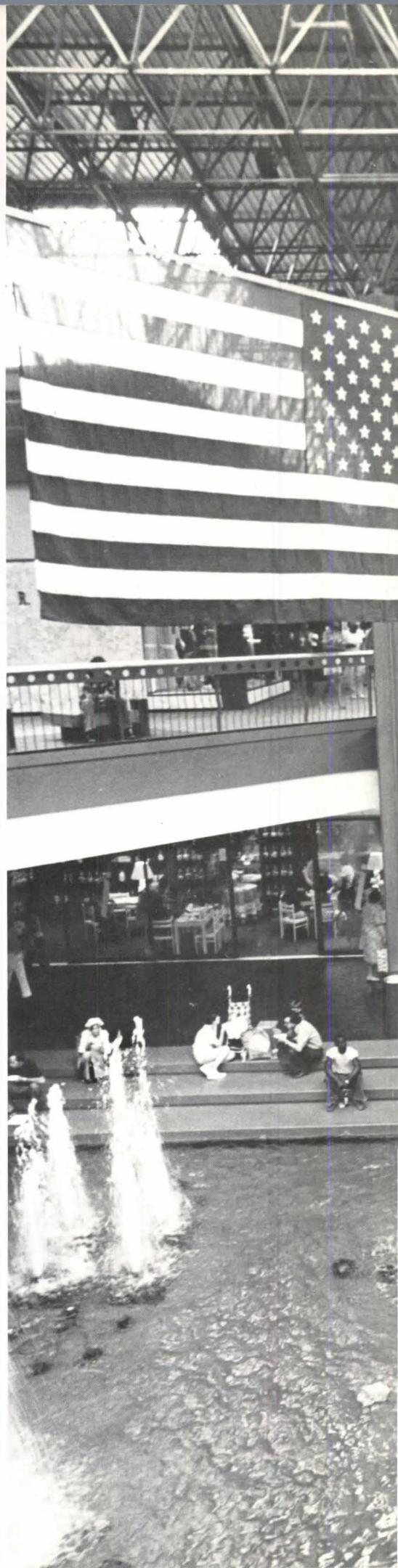





# Columbia, Md.

**Recession has slowed growth but the basic plan stands the test of time.**

"It's what you've always wanted," the slide show in the Columbia visitors center croons. "A fresh start . . . 153 million people on less than 2 percent of the land . . . Is this the way we really want to live? Or shouldn't we build a better kind of city? . . ."

The official rhetoric that greets visitors to Columbia raises two questions: Is the planned community a better place to live and will it provide those urban characteristics that draw people to a city? To a large extent, the answer to these two questions, especially the first, will provide the yardstick by which all such new communities should be measured.

The planners of Columbia, led by James Rouse, head of the Rouse Co., a major mortgage banker and developer based in Baltimore, set four goals for the project:

- "To build a complete and total city with all the interrelated systems that make up a city.
- "To preserve and protect the land.
- "To create the type of living environment that provides a healthy community.
- "To make an outstanding profit."

Today, Columbia sits on 14,000 acres of former farmland in the heart of megalopolis, roughly midway between Baltimore and Washington, D.C. It houses 40,000 in 12,500 single-family homes, townhouses and apartments and expects, when completed, to have a population of 110,000. In addition to an assortment of housing types, Columbia already provides many of the opportunities that one expects in a complete, self-contained community: more than 120 industries, including a massive General Electric plant; 600 businesses; 20 office buildings; a hotel; a 650,000-square-foot enclosed shopping mall, as well as four village centers with 59,150 square feet of office space and 260,445 square feet of commercial space, and a wide range of community facilities, including schools for all levels, branches of four colleges, a zoo, two interfaith centers and the 12,000-seat Merriweather Post Pavillion.

As the visitor drives down the Columbia Pike (Route 29) and sees highrise office buildings clustered around Lake Kittamaqundi, it is possible to imagine the city of

*Columbia Mall, the regional shopping centerpiece of the new town.*



the future already in progress. Such a development would have been hard to imagine in rural Howard County when Columbia was first proposed in the early '60s. The county at that time was a sleepy string of jurisdictions populated mostly by farmers. There was no water service there until 1958 and no sewers until the 1960s, but the county's development was inevitable, considering its location near several key highway corridors, including I-95.

In an adroitly handled land deal, James Rouse purchased 142 parcels through six straw corporations. A widely accepted rumor in Howard County was that the government of West Germany planned to build there the largest Volkswagen plant in the world. Hope Landauer, a longtime resident of Howard County and now an employee of the Columbia developers, says, "We knew we didn't want the VW plant."

But the relief that greeted Rouse's announcement that he was the purchaser and planned a new town on the acreage soon turned to apprehension. When Rouse made his announcement, only about 35,000 people lived in Howard County. Today, the county has a population of 108,000 with 40,000 living in Columbia.

The massive scale of development in what is still substantially a rural area remains one of the greatest challenges that faces both Columbia and Howard County today. Working in concert with the Howard Research and Development Corp. (HRD), developers of Columbia, the county drew up a special new town district as part of its zoning ordinance. The district calls for 20 percent of the land to be set aside in open space (the developer has actually set aside 23 percent) and 12 percent each for industrial and commercial uses. The residential densities under the ordinance are approximately 18 percent in single-family low-density (two persons per acre); 25 percent in single-family medium-density (four persons per acre); and no more than 10 percent in multi-family townhouses and apartments (10 and 15 persons per acre, respectively). The Columbia densities thus far have been slightly lower than those allowed under the new town district.

The general master plan, as established



*Although Columbia offers in-town centers of shopping, recreation and employment, some miss the variety of a 'downtown.'*



by the new town district ordinance, is the basic blueprint for the development. As the developer subdivides the total parcel, the final development and subdivision plans are recorded in the county courthouse, and the land use for the subdivided area are fixed by the county planning board. The developer installs all roads, sewers, water and underground utilities. HRD is reimbursed for 80 percent of the cost of sewers as new residences are hooked into the system. In addition, HRD sells the county the sites for schools at the raw land price and has donated the site and building for one firehouse in the community and the land for a second.

Relations with Howard County generally have been smooth, though there have been some rough times. Gerald Von Mayer, the county's director of comprehensive planning, says that "the planning board has worked in concert with HRD, and the developer has been pretty good about meeting its commitments." The process has been one of give and take, he

points out. "Howard County didn't realize what it was getting into, so we left some leeway in the ordinance. We didn't tie the developer down to the last inch, and we didn't tie the county down either."

Columbia has been an asset to the county in several respects. With 33 percent of the county's population, Columbia today provides more than 42 percent of the county's assessable tax base and has enabled the property tax rate for Howard County to drop to below what it was in 1967 when the development first opened. In fact, a study prepared for the Howard County planning commission comparing three alternative forms of future development for the county—present suburban subdivision, new town planning such as Columbia and a combination of the two—shows that development on the new town model will cost the county significantly less than the other two types.

There has been another asset to the county, too. Columbia provided a test case in how to urbanize. As a result, for example, all new subdivisions are now required to set aside a certain percentage of their land for open space. "Columbia has shrunk the time frame in which we would urbanize," says Von Mayer, but the county "has kept its head above water and has managed to achieve a Triple A rating on its municipal bonds.

"The biggest dissent to Columbia in Howard County," Von Mayer says, "comes from people who moved to other parts of the county recently to escape from the city." These people perceive Columbia as an extension of the urban environment they fled. To some degree they are right.

A study done by the Columbia Association, which represents landowners and residents of the new town, shows that the

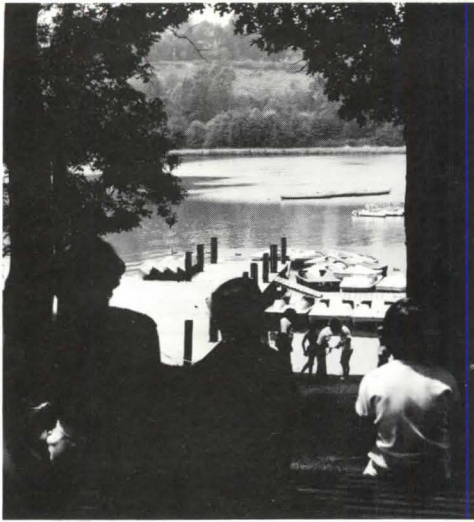

population has become more diversified by income, race and age, "though we are tending to be a bit more middle class than we had hoped or intended to be," according to an HRD staffer. In fact, the average income in Columbia today is about \$25,000 a year although approximately 6 percent of the housing is federally subsidized low- and moderate-income housing. Townhouses built in 1969 and sold for \$18,000 sold for \$40,000 in 1975. The community also has a growing number of female-headed households and, although the average resident is between 30 and 40 years old, the new town has an active chapter of the American Association of Retired Persons. "We have a black family on the ground level and an elderly couple on the top floor," one resident said of her garden apartment cluster. In short, there is more population diversity than you might find in a typical suburban subdivision.

Still, some of those cosmopolitan features that would make Columbia a city are missing and this is a source of disappointment to those residents who sought an urban place in suburbia. "There's a real lack of the cultural centers that would make Columbia 'a city,'" says Joanne Rhett, the drama and movie critic for the *Columbia Flier*, one of the local newspapers. She cites the lack of theater, movies and other attractions, but concedes that it is probably unfair to hold a new town at this stage to the standards of a major, full-blown metropolis. The signs in Columbia that point "downtown" remain a frustrating reminder that Columbia has no real downtown with a variety of buildings, shops and activities.

Even as they bemoan the city they left behind, Columbia residents extoll the convenience of a semiurban community in a rural setting. Indeed, Columbia offers a bewildering array of opportunities and services, from day care to sewing classes. And 25 percent of the residents of the town work in Columbia.

The planners of the new town tried to re-create the neighborhood of a city with-

out the urban anomie that often goes along with it. Houses are built in small groups of 800-1,200 families. Each neighborhood is planned around an elementary school, a playground, a day care facility and a swimming pool. The neighborhoods in turn are clustered around village centers serving 10,000-15,000 residents. The village centers have more extensive shops and services, such as supermarkets and secondary schools. "We have exploded a few myths," says Rose Landauer. "They told us you cannot put 50,000 homes across from a convenience store; you cannot put custom lots across from an elementary school."

The glue that holds this together is the Columbia Association, which builds, operates and maintains facilities, services and amenities beyond those provided by Howard County. Under the association's domain is Columbia's extensive open space and pathway system, preschool education, recreation facilities, such as swimming pools and tennis courts, and neighborhood and community centers. The association has already invested more than \$17 million in facilities and plans to spend \$36 million on additional facilities and improvements over the next 10 years. The association is financed through an assessment on all Columbia property owners, not just homeowners, of 75 cents per \$100 of assessed valuation. That assessment, which cannot be changed, is a first lien forming the part of the deed of every piece of assessable property in the community. The association also charges user fees for some of its facilities.

The association, which is governed by a board of directors composed of representa-

### **'There is no breathtaking beauty here but nothing horrendous either.'**

tives of the developer and residents, has tried to be responsive to the needs of the community. For example, the 10 percent of the Columbia population that is low-income cannot afford the user fee on many of the facilities. "Either we mean this community is open or we don't," says Roger Ralph, the association's director of development, who helped initiate a policy to provide a lower user fee with monthly payments for families living in subsidized housing. Ralph claims that the participation by low-income families in the association's facilities has doubled since the fee structure was instituted.

The association has also tried to expand employment and educational opportunities for women. Columbia's extensive day care network has proved a boon to mothers who want to pursue jobs and study, but the employment opportunities

for professional women within the new town nevertheless remain an elusive goal, according to a university professor who lives in the new community and has studied the needs of Columbia's female population. She notes a further problem for the professional women who work in Baltimore and Washington. The day care facilities do not open early enough to enable working mothers to catch the shuttle bus from Columbia to these two major employment centers.

Each village cluster is managed by a village association, which receives an annual budget from the Columbia Association and serves as an unofficial government in running the daily affairs of the grouping of homes. The basic framework for the village associations is established through a series of covenants which form a part of the need of each Columbia property owner. The covenants also govern architecture and maintenance "to assure good planning and design." Each village sets up a resident architectural committee to review all proposals for exterior alteration within the village cluster. Final approval must come from the architectural committee established by the developer, but in practice the decision to approve or disapprove an alteration proposal at the village level is generally upheld by the architectural committee.

The design of community buildings even in commercial and industrial areas is closely watched by the developer. Design attention has reached to the finest detail, even to the level of the sleek new traffic lights created for the development. As one resident put it: "There is no breathtaking beauty here, but there is nothing horrendous either."

Developer Rouse says Columbia is "extraordinary in social, institutional and human terms. It reaches or exceeds my expectations in reinforcement of community, increased openness, vitality and creativity. People living here perceive life as extraordinarily good."

Interviews with resident generally support his claim. "My kids walk out the back, across the parking lot, through the woods and they're in school," one resident said. "If I want to take a class or go to an exhibit, it's all going to be in the CA directory." Indeed, the richness and the variety of opportunities for leisure time and family life is one of the first things that a visitor to Columbia notices. This variety simply does not exist within a typical suburban subdivision.

At the same time, many of the urban-associated problems that exist outside Columbia are beginning to show up within. Crime is increasing, although not at an alarming rate. Black/white divisions are forming among high school kids, and the blacks, by and large, have chosen to form separate social cliques. A black

woman in Columbia points out that "all the black sororities and social clubs that existed in the city have been formed out here. Blacks even feel it necessary to cry 'racism' even though in reality this is a pretty integrated place." Close to 20 percent of the Columbia population is black, which makes it substantially "more mixed than your average suburban community," Rouse says.

The major disappointment to Rouse and an area in which his plan proved unfeasible was in providing an extensive system of public transportation. As it is, Columbia residents have an excellent bus system, which runs throughout the community, but Rouse's plans called for a much more innovative, comprehensive system. "We had hoped to eliminate the second car by providing intercity transportation," Rose Landauer says, "but we found that the American family is wedded to the second car."

If there ever was demonstrable proof that new town residents are not going to jettison their values and attitudes in the city or subdivision they left behind, it is in their attitude toward the car. The Columbia plan purposefully puts all key services, such as schools and convenience shopping, within walking distance of homes. Yet many Columbia residents can be seen driving their children to school or to the store for a quart of milk.

But the major and gnawing problem facing Columbia's creators continues to be financial. The housing recession of the early 1970s hit the new town severely. The Connecticut General Insurance Corp., which had provided an initial \$23.5 million to the Rouse Corp. as a joint venture partner in the development, engaged in a series of refinancings in 1975 designed to restructure the short-term debt of the development and provide initial operating funds during the tight money period. Connecticut General, which had owned 50 percent of the preferred stock before, now owns 85 percent and manages and controls the majority of the board of HRD, even though the Rouse Corp. retains responsibility for managing the project. Michael Spear, general manager of the development, feels that it is "too early to know how profitable it will be. Before the recession, Columbia was on track. Now it's taking longer, more money to develop the project. The long-term profit will not be as high as we had expected."

Although the pace of development has slowed, it has by no means stopped, Spear points out. During the 1974-1975 recession, Columbia added 2,500 families, 75 businesses and 500,000 square feet of commercial space. The developer also recently expanded the community hospital and added a second interfaith center.

Even though Connecticut General now

has a greater share of the stock (it always controlled the board), "there is no shift in overall policy," Spear says. The major change, which is partially due to a slowing down of growth as well as a more realistic approach toward financing, is a more cautious approach to preservicing, providing community facilities before the population is there to support them.

Columbia's growing pains reflect those of the rest of society. But the community's basic plan of neighborhoods and villages, with a variety of services and opportunities, has stood up well.

## Reston, Va.

**Design elements endure, finances are stable but social problems emerge.**

Reston has already endured two major developmental crises—a financial downturn and a series of bitter disputes with county government over public services. This is evidence of a healthy prognosis as this Virginia new town enters its teenage years. Nevertheless, many of the social issues beginning to emerge in Columbia are also showing up in Reston, and this community, too, will have to live with the fact that it falls short of the idealistic goals of its creators.

Reston is 18 miles west of Washington in Fairfax County, Va., a rapidly urbanizing and wealthy jurisdiction. The heavily wooded, undulating 7,419 acres of Reston have been virtually intact in single ownership since 1649 when King Charles II deeded a large parcel of what is now northern Virginia to noblemen. One of them, Lord Culpepper, acquired the entire parcel and passed it down through the generations until it was bought by Robert E. Simon. The name "Reston" is formed from the initials of Robert E. Simon's name.

Simon is a visionary who thinks in terms as grand and idealistic as his Maryland counterpart, James Rouse. It is worth remembering Simon's goals for Reston as we look at the new town today:

- "To build a community—a place where people can live, work and play without leaving their community. Where cultural, educational and recreational facilities are within easy reach of all residents.
- "To provide a complete range of housing within each neighborhood to meet the needs of everyone who wants to live in Reston—regardless of age, race, income, education and family status.
- "To include recreational, cultural and educational facilities as an integral part of

the community plan—easily accessible to both children and adults.

- "To plan with people in mind—not with the impersonal idea of providing as many units as the zoning laws will allow.
- "To create an esthetically pleasing environment for residents, where architectural structures complement the beauty of the natural land, and open space is within walking distance of every home and apartment."

Today, Reston has a population of 28,000, an employment base of 7,400 jobs and more than 250 businesses, professional firms and associations. Like Columbia, it offers a wide array of community services, recreation facilities and leisure opportunities through the Reston Homeowners Association. By 1985, when the master plan is completed, Reston expects to have a population of 75,000. At present, a little less than 50 percent of the total acreage of the site has been developed or is under development.

The Reston Homeowners Association is similar to the Columbia Association. It administers the community's commonly owned facilities and is supported at present by a flat fee of \$60 per household. At no time can the association assessment exceed 1 percent of the assessed valuation of the property. Like its counterpart in Columbia, the association administers a large variety of programs, including day care and nature facilities, for Reston residents, largely through a series of community centers located in the village clusters—the basic neighborhood module.

Exterior alterations in Reston are also subject to examination by an architectural board of review established in each village cluster. The basis for the review process is in the protective covenants which form part of the deed of homeownership for Reston residents.

One of the first things that strikes the visitor to Reston is the excellence of design. One of Simon's objectives was "that beauty—structural and natural—is a necessity of the good life and should be fostered.

"Physically, the development lives up to my expectations," Simon says. Indeed, Lake Anne Center, the showcase of Reston, is an "example of masterful, conceptual planning," says William Nicoson, a resident of Reston and the first administrator of HUD's Title VII new communities program. "It is an invaluable model for future developments in showing the importance of scale, expelling automobiles and turning activities inward toward the lake. It shows that hard-nosed developers like Gulf Reston can make profits with such projects."

Many Reston residents feel that design of the new town has not kept pace with the standards set by Lake Anne Center (architects: Whittlesey, Conklin & Ros-

sant). "There is a distinction between Lake Anne and the rest," a Reston resident says. "The architecture in the newer parts of the development is very ordinary, like a suburban subdivision." Several Reston residents say the "new Reston," being built by Gulf Reston which took over from Simon as developer, is of lesser architectural quality. But Simon, who invested heavily in good design at the outset of development, does not deplore this: "The last thing I wanted Reston to have was a unifying architectural vision. If someone wants a colonial Georgian contemporary house, God bless him."

Reston's progression into a full-blown new community has not been easy. Four years after construction began in 1963, the new town's progress was lagging way behind projections, although improvements and facilities were already in place. Simon had exhausted his financial resources, and his early backer, the Gulf Oil Corp., stepped in to protect its investment, assuming full financial and operational responsibility. Gulf's subsidiary, Gulf Reston, Inc., took over the planning, construction, financing, marketing and sales of the new town and turned the project around. Today, Reston's financial situation is much more stable, and is keeping pace with its development timetable in most respects.

This new town has overcome a series of obstacles with ingenuity and persistence. First of all, Reston does not have Columbia's prime location near or on main highway corridors. This problem is compounded by a glaring irony: Reston is bisected by a Dulles International Airport access road, which could be a main artery for the community between the Washington beltway and Dulles. But the highway is a limited access road, and, although the availability of a right of way exists, the

state of Virginia has been unwilling to finance the necessary construction. Francis C. Steinbauer, vice president of development operations for Gulf Reston, was the project designer for the Federal Aviation Administration on the Dulles highway.

The Dulles access road presents a further problem because it cuts right down the middle of the new community site. There is now only one bridge across the highway, reached by Reston Ave., a meandering road not suitable for heavy traffic. The developers have long sought approval for another bridge to connect the two Restons and have just received a commitment from the county for one.

Reston is also in a bad position to compete with other sites in Fairfax County for shopping and industry. Just 10 miles from the new town sits Tysons Corner, a mammoth shopping mall on the Capital Beltway. On the other side of the beltway

is Westgate Industrial Park. "Tysons Corner is the main reason why we don't have a shopping mall and are not likely to soon," says James Todd, president of Gulf Reston.

Reston has been able to attract certain types of industry, especially trade association headquarters. The new town is the site of the headquarters for the American Press Institute, the National Association of Letter Carriers and the Council for Exceptional Children, among others. The developers have parlayed their proximity to Washington and their easy access to Dulles airport into a competitive advantage, though they lack the rail and highway access to major markets that Columbia has. Another boost was the relocation to Reston of the U.S. Geological Survey, an agency that employs 2,800.

"We can't get away from the fact that we're in a suburban area," says Todd. "Fifty percent of our residents commute to Washington, 25 percent work nearby and 25 percent work in Reston. The reality of our marketplace is the proximity to a large employment center for middle-to high-income professionals. Reston is quite well adapted to that marketplace." Indeed it is, with housing units ranging in price from \$26,250 for a garden condominium to \$108,000 for a single-family home.

But the main obstacle that Reston has had to confront and the one that almost killed the project has been the municipal government of Fairfax County. In 1973, the county declared a water and sewer moratorium, which effectively stopped development dead in its tracks. "The sewer moratorium in 1973 made it impossible for us to come through for the industrial clients we had been grooming," says Fran Steinbauer. The sewer ban lasted 18 months and was only ended when Gulf Reston took the county to court and won. "The sewer moratorium hit us at a time when the market was high. We came out of the suit into housing depression," says Jim Todd. "A second such action would kill Reston."

The water and sewer moratorium symbolizes a long list of sour relations with the county, but the developer concedes that things are going better now. Local officials admit privately that they, too, felt that Reston had received a bad deal in this particular confrontation. But most county officials think that in general Fairfax County has treated Reston fairly and even generously. "We have gone more than the long mile," declares Martha Penningo, who represents Reston on the county board of supervisors. Alan Magainze, another supervisor who generally has been supportive of the new town, says, "Reston has gotten its fair share of county dollars, but we're not going to bankrupt the county for Reston."

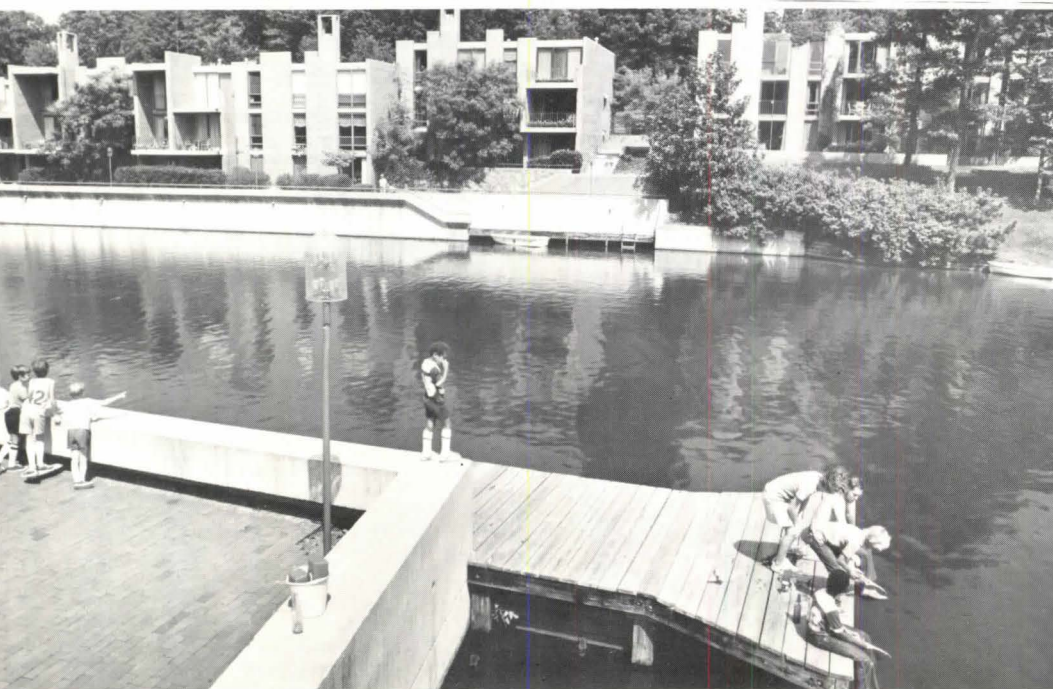

The county has been especially wary of Reston because of rapid growth in the area during the last decade. The preliminary master plan for the county says: "From 1960 to 1970, the Washington metropolitan area was the fastest growing metropolitan area in the U.S. Its population grew by more than 3 percent per year during that decade, adding three-quarters of a million new residents to its 1960 population of 2,076,610. The growth of the region, however, was not spread evenly among the jurisdictions. Indeed, Fairfax County grew nearly twice as fast as the entire metropolitan area."

Reston was viewed by the county government as a way to harness the rapid urbanization of the area and channel it to desired growth points. The new community is a "planned development center, a concept that was successfully pioneered in

## The pioneering spirit has changed, just as the developer feared.

Reston as a means of clustering and concentrating growth in order to achieve a balance between new development and protection of the environment." Working with Simon's master planners, Fairfax County adopted a residential planned community zoning ordinance, based on population density. The ordinance fixes the overall density at 13 persons per gross residential acre, but provides for three varying density types: high (60 persons per acre), medium (14 persons per acre) and low (3.8 persons per acre). The ordinance also mandates setting aside 45-50 percent of the land for public use, including lakes, recreational facilities, roads and rights of way, and services, such as schools and libraries. The county has also established a working group on the planning staff to review development at Reston, and the group has watched Reston's growth carefully to ensure that it expands according to the original principles. Even so, many of the major decisions affecting Reston are out of the county government's hands. For example, the widening of the Dulles access road is the purview of the state highway department. The construction of a high school for Reston was held up until approval at the polls by a county referendum.

Like Columbia, Reston has had a positive fiscal impact on the county. It produces 26 percent more revenue than needed to cover expenditures by the local government, according to a recent study, and its cost benefit balance sheet looks much better than that of conventional subdivisions in Fairfax County. Even so, "no one anticipated the problems" of such massive development, according to a

member of the county planning staff. "The county has an antipathy to growth," says David Hill, an attorney in Reston, "yet they have a planned growth area called Reston. That stalemate has cost the developer millions of dollars."

Even so, Gulf Reston is optimistic about the future. Jim Todd feels that the developer will complete its master plan, provided it has local government cooperation. And Martha Pennino, the Fairfax County supervisor, remains supportive: "There are those who wanted to stop Reston at Lake Anne Center. That's not what it's about. Reston is about a city of 75,000."

Although Reston is now only about 40 percent of that 75,000 population goal, its demographic picture is increasingly urban. A study prepared in July 1975 for the Reston Homeowners Association shows a growing heterogeneity of the population: an increase in the number of blacks, low-income residents, female headed households and the elderly. In addition, there is a continuing high number of apartments and rental units, as compared to single-family, owner-occupied homes. "In other words," the study says, "Reston is becoming even more urban as it grows denser in population and more diverse in its demographic makeup." The study notes a growing gap between rich and poor, with an increase in poverty-level families as well as households with incomes above the mean for the new community, a significant increase in the percentage of the population that is black, and a growth in nonfamily households with a major increase in the number of senior citizens. One Reston resident pointed out a differentiation among neighborhoods, with some already becoming more "prestigious." (A similar distinction is apparently also surfacing in Columbia.) In particular, the older Reston north of the Dulles access road has more cachet than the more recently built up southern portion.

As Reston has become more urban, it has also begun to show signs of the cleavages that characterize city populations. This is especially disturbing because new community developers and many who move to these projects do so out of a belief that many of the conflicts in society at large will be somewhat mitigated in a planned community. A recent *Washington Post* article chronicled the racial disturbances in Fox Mill, a federally subsidized housing project in Reston. "Strife Jolts Reston Dream of Harmonious Single Society," read the *Post* headline over the article.

Fox Mill, a project of 800 residents, has been beset by racial tension, vandalism, disrepair and crime. On a hot evening this summer, police were fired upon by an angry group of teenagers gathered in a

parking lot next to the project. The apartment of a white woman moving out of the project was vandalized and black residents heckled police who came to investigate the robbery at the woman's apartment.

Three of the four subsidized housing projects in Reston are located near the Fox Mill project. That amounts to a clustering of slightly more than 600 low- and moderate-income housing units. Reston developers justify the site selection because the projects are designed to provide low-cost housing for workers in the nearby U.S. Geological Survey offices. But more important, Reston's low- and moderate-income families are isolated by a lack of money to participate in many aspects of Reston's good life—tennis, riding, and other recreations. To the general, more affluent population of Reston, Fox Mill is coming to represent a disturbing symbol of some of the big city problems that have been transplanted to this bucolic Virginia site. And to many of the residents of Fox Mill, the sharp disparities between rich and poor America exist in abundance in Reston.

"The population is changing," the study concludes, "from the more heterogeneous 'new town believers' who first populated Reston, to a more differentiated society, which is more interested in the amenities and services provided to specific groups than in social experimentation and community spirit." It is one of the fears of Reston's founder, Robert E. Simon, that the pioneering spirit may have been lost among Reston residents. "The degree of involvement is less than it ought to be," he says, expressing disappointment about the decline in citizen participation. Martha Pennino feels that "earlier residents were more active." Joe Fisher, who represents Reston's part of northern Virginia in

## Gaps between rich and poor exist in abundance at Reston.

Congress, experienced his smallest turnout in Reston during a districtwide series of political caucuses. This is strong evidence that the population is changing.

But the perception of participation depends on whom you talk to. The homeowners association is a shadow government for a town without municipal incorporation, according to one leader of the group. It has an active vocal membership, which comes out in force. Alan Magainze, the county supervisor, notes, "When our county staff does a plan or analysis, you get a better one from Reston." Reston citizens came out in droves recently to oppose a 102-unit federally subsidized project, although the development was subse-



quently approved by the board of supervisors.

It is probably true that many of the newer Reston residents moved to the community less for the pioneer spirit and more for practical reasons. In that respect they are similar to those who have recently moved to Columbia. Susan Williams, who works for a U.S. congressman, says, "More of our needs are met out here than anywhere else. We moved here because it's a compromise between the urban and the rural. We find the natural setting very satisfying." Henry Ware, a resident of longer standing, found the prospect of close neighbors and a community spirit an important support for himself and his wife during their retirement years. "I've lived all over this county and this is the first time I've felt a real sense of community."

The pioneer spirit still blossoms in some quarters of Reston and Henry Ware is a good example of it. He is the founder of USE—Useful Services Exchange—a barter system in which participants exchange skills, such as tutoring, splitting firewood and giving bread-baking lessons. No money changes hands. USE users earn credits for services they perform, which can then be repaid by participants in services they need.

Reston may not be an incorporated municipality, but it already has a strong community identity, a maturing sense of place. The August 1975 *Ladies Home Journal* named it one of the 15 best suburbs in the nation. George McDonnell, a printing executive quoted in the article, expresses his feelings, and perhaps those of a majority: "What I like is that Reston is a community, so I'm not just living out in the middle of nowhere, in a subdivision."

In many ways, the picture drawn of Reston by the *Ladies Home Journal* remains remarkably true. It is, for most of the residents, a good place to live, a community with a sense of place. That in itself is a major achievement. But incidents like the disturbances at Fox Mill apartments show that some of the problems beyond Reston's boundaries are beginning to exist within them, too.

That should not be surprising. The people who live in Reston are of the same cast as those who live in the big city and the suburb. Their attitudes and values are not going to change very much, just because they move to a new community whose founders held out what are probably unrealistic ideals for a harmonious society, one in which all people can share in the good life equally.

Nevertheless, in its excellent planning and design and the wealth of opportunities provided for a wide range of residents, Reston remains an impressive example of community building. □

# Changing the Ground Rules of Architect, Contractor, Subcontractor Relationships

Mary E. Osman

The Institute's "General Conditions of the Contract for Construction," widely known as AIA document A201 by the nation's architects, contractors and owners, has been a standard of the construction industry for decades. A new and completely revised edition is now available. Although the basic philosophy is the same as its 12 predecessors, the new edition contains many changes which pertain specifically to the duties, responsibilities and procedures of the architect, owner, prime contractor and subcontractor. "There has been much fine-tuning and clarification in the new edition," says Alan B. Stover, AIA, director of the documents division at the Institute, "and the changes will affect virtually every AIA construction document."

The progenitor of the 1976 edition of A201 was the "Uniform Contract," first published by AIA in 1888. And in 1911, the Institute issued the first edition of the general conditions, which has been revised and amended over the years to meet changing conditions so that by 1970 A201 had gone through 12 editions, becoming the most widely used of all standard contract documents for construction.

Many of the changes in the 1976 edition of A201 have resulted from close collaboration by the AIA documents board with the Associated General Contractors of America (which has approved and endorsed the document), the American Subcontractors Association, the Associated Specialty Contractors, the National Society of Professional Engineers, the Construction Specifications Institute and the National Association of Surety Bond Producers.

The changes in the new edition resulted from a "long drawn out process," Stover says. The work started in 1973 when members of the documents board discussed the need for revision. Early in 1974, members of the documents board met with representatives of NSPE and CSI, with discussions resulting in general agreement as to placement of various kinds of provisions in either the general conditions, the supplementary conditions or "Division One of the Specifications."

During the latter part of 1974, the documents board went to work on changing the provisions in the general conditions which were clearly outdated, inapplicable or had been affected by court decisions.

At the end of 1974, AGC and ASA expressed interest in possible changes and started preparing their own comments and suggestions, as did AIA components and members. During 1975, the major portion of the time of the documents board was spent on working out the suggestions and on ways to improve A201. "Virtual shuttle diplomacy" was necessary, as Stover puts it, to get suggestions from one group, consider them and then relate them to another group for its consideration. "Then the process would start all over again if there were objections," Stover says. "But in late 1975 and early 1976, we got down to brass tacks, working toward AGC's approval of the document."

Over the two-year period when suggestions by cooperating organizations were considered and reconsidered, the documents board was chaired by Leo G. Shea, AIA (1974-75) and E. D. McCrary, AIA (1976). The documents board, which still has much work ahead on the other documents affected by A201 revisions, currently has 15 members.

Most changes in the revised A201 concern contract administration affecting the duties and procedures of the architect, the owner, the contractor and the subcontractor.

• **The architect:** "As in the past," Stover says, "AIA has been very conscious of undue liability of the architect arising out of construction contract administration duties, and further modifications in this regard have been made in the new A201."

The architect is no longer authorized to issue change orders without the owner's signature, partially as a result of cases in which architects had done so without the consent of the owners. Also, provisions have been deleted which required that the contractor's choice of superintendent be specifically approved by the architect. This change has come, Stover explains, "because of legal problems arising out of such direct control over employees of the

contractor." There are other provisions in the contract which "are deemed adequate to protect the owner from, and provide remedies for, the contractor's failure to have a really competent superintendent on the job."

The new document clarifies the architect's review and approval of shop drawings, including product data. It is known that many architects have attempted to avoid potential liability by deleting all references to the architect's approval of shop drawings in the contract documents, Stover says, "and after careful study, AIA has reaffirmed that the architect should give approval to shop drawings, although it is a limited approval that must not be given before the contractor himself has specifically approved the submittal."

The architect is no longer responsible for reviewing warranties submitted by the contractor, the consideration being that because of the complex technical and legal nature of the warranties, the review should be undertaken by the owner's legal counsel for a determination of their sufficiency.

---

## The new A201 represents three years of hard work and 'shuttle diplomacy.'

---

The architect will no longer specifically approve the contractor's progress schedule, schedule of values or proposed subcontractors, but will still review them and have the right to raise objections. "These are instances in which the prime responsibility for their adequacy and sufficiency should rest with the contractor," Stover says. "The reasons for the changes with regard to these approvals is to prevent earlier misinterpretations that, by having final authority over such items, the owner and architect were primarily responsible for them. The failure of the owner or architect to object to any such items will not relieve the contractor of his prime responsibility."



Stover emphasizes that there has been reiteration "in laymen's terms, understandable to a jury who might be called upon to decide the question, that the architect does not have control or charge over the contractor or his means, methods, techniques, sequences or procedures of construction.

"Finally, we have stated in the contract the principle (fully supported by legal decisions over the years) that the architect, in his quasi-judicial capacity as interpreter and judge of performance, will not be liable for decisions made in good faith. The

---

## The architect is not responsible for construction means, methods, sequences, procedures.

---

existence of this quasi-judicial immunity provides the best insurance that an architect will make impartial decisions favoring neither the client nor the contractor. Architects should make it clear to their clients at the outset of a project that the architect will be called upon to make decisions and that those decisions may sometimes be in the contractor's favor."

- **The owner:** There is now a requirement that the owner purchase "all risk" insurance for his project instead of the formerly required fire insurance with extended coverage.

Representatives of the insurance industry have cautioned, however, that this type of insurance may not be available in all instances, which would then require use of traditional types of insurance coverage.

The owner must provide full information on the site, including a legal description of the property, and the owner is responsible for procuring zoning approval, environmental impact statements and other approvals required before construction commences.

At the time the contract is executed, the owner must give evidence of his ability to carry out the project financially, such as disclosure of a loan commitment from a bank.

The owner has full responsibility for the coordination of separate contracts and work by his own forces. In turn, the architect may be asked to coordinate the work, or a construction manager may be hired to do it, or the owner's personnel may be used—but the final responsibility is placed squarely upon the owner.

There are miscellaneous responsibilities of the owner, such as the review of warranties and payment of any increase in taxes which may be imposed upon the contractor during the course of construction. Also, the owner is now required to give the contractor an additional seven

days warning before taking over the work because of the contractor's deficient performance.

- **The contractor:** It is now the prime responsibility of the contractor for the submittal of an accurate and realistic progress schedule and schedule of values, and for submitting the names of competent subcontractors for the owner's and architect's review. The owner and architect do not specifically approve the subcontractors, although they have the opportunity to reject the contractor's choice. Once a subcontractor is engaged, however, the owner and architect no longer have the power to require a change.

The contractor is required to afford subcontractors the benefits of those rights and remedies which the contractor has under the general conditions. Any variance in the subcontract must be brought to the subcontractor's attention before he enters the subcontract. "This provision," says Stover, "is designed to prevent the imposition of onerous conditions on subcontractors after they have been selected to do portions of the work."

The contractor must pay subcontractors promptly, not withholding more retainage than has been withheld from the contractor by the owner. "There was clear abuse," Stover says, "where the owner would be holding back 5 percent of the price on the contractor and the contractor would hold back 10 percent on the subcontractor."

The contractor remains fully responsible for compliance with laws and regulations affecting the execution of the work. The contractor must review the architect's drawings and specifications for any inconsistencies or code violations and bears the risk if he proceeds with the work knowing of such inconsistencies or violations.

"It is the contractor's responsibility to bring any problems to the architect for a decision," Stover says, "so that even if the architect has made an error, it can be corrected before it is built into the building. Under the contract, the architect decides any disputes. If the contractor does not like the architect's decision, the contractor can demand arbitration. The architect continues to have the ability to reject defective work, to withhold payment and to require special inspection and testing of any work that he thinks may be defective."

The contractor must pay for the general building permit and all other permits required during construction. He may now make claim for additional amounts because of concealed conditions within existing structures, whereas previously the contractor could only claim additional amounts for concealed conditions underground.

Any extension of time for adverse weather conditions must be based upon conditions that could have reasonably

been anticipated, usually based upon historical weather data over the previous 20 to 25 years. The contractor must allow in the progress schedule for weather conditions which would be as severe as could be expected during the period of construction. "The fact that a contractor didn't expect it to rain in any particular week or during any particular one of the operations should not provide basis for an extension of time," Stover says.

The one-year obligation on the contractor to return and correct defective work has specifically been distinguished from the contractor's original obligation to build the project in accordance with the contract documents, which may be enforced in the form of money damages throughout the longer period provided by the statute of limitations.

- **The subcontractor:** Some of the changes which affect the subcontractor, such as method of selection (which also applies to materials suppliers), have been mentioned. A201 provides that for the purposes of bidding the rights, responsibilities and remedies of both the contractor and the subcontractor under the subcontract "will reflect the same allocation as between the prime contractor and the owner," Stover emphasizes. Any variances must be brought to the attention of the subcontractor before the subcontract is signed.

In the July *ASA Review* there is a statement about the revised A201 that "most of the changes adopted improve the position of the subcontractor in regard to payments, settlement of claims and disputes, subcontractor's rights and remedies, the payment of interest at a fair rate on unpaid obligations, retainage provisions and indemnity clauses. Changes in various sections will have the effect of speeding progress and final payments, including retained amounts, to subcontractors who have in the past been unable to receive payment commensurate with their

---

## The same rights and remedies enjoyed by the contractor are available to subcontractors.

---

own progress because of payment delays under various guises."

Other changes in A201 concern:

- **Payments and completion:** The most significant changes in this area have been designed to ease and speed up the flow of payments from owner to contractor and down through the tiers of subcontractors. "Specific problems were brought to AIA's attention by subcontractors, particularly

*continued on page 52*

# Student Competition: Using Energy as a Design Medium

Marguerite Villecco

The media of architecture include energy. Design involves not only materials, methods and perceptions, but energy—its nature, supply and policy. The consideration of energy resources is not a constraint to design because it is of design, a part of the environmental integration that lends architecture strength and integrity.

This is not a universal opinion. There are many architects, among others, who see energy shortages and price increases as a short-lived threat to the design priorities they were taught and practice, or as simply irrelevant. They perceive energy issues to be external to the design process.

Some architects and many students, however, have already incorporated energy into design. They use it as architects already use other design media. Energy seems no more a constraint than an artist's tools—even a nonobjective painter accepts the limitations of his surface, paint, applicator and body. So too have architects.

Recently, more than 1,700 architectural students, representing 60 of the 89 schools of architecture in the U.S., participated in a national design competition. Their energy conscious designs are a clear message to the profession, not only as a model for design, but as a reflection of changing social priorities. The competition was sponsored by the AIA Research Corporation and supported by the Federal Energy Administration. It offered no prize as an incentive, except "recognition"; there was no mandatory program. Individuals, or teams of students, could work for one to 12 weeks; they could use existing studio problems; they could even establish their own energy conscious design criteria. The competition was designed to make it easy for schools to use. Each school could send up to three of its best designs for final comment by a national review board convened at the AIA Research Corporation. Twelve entries were adjudged "distinguished" of the 125

**Ms. Villecco** is director of a project on energy conscious design by architects at the AIA Research Corporation and former senior editor of *Architectural Forum* and *Architecture Plus*.

final entries sent to Washington. They are shown on the following nine pages.

The competition is important because students consider the issues important; more participated in it than in any other competition in recent years. Sometimes with strong faculty support, and sometimes without, the students produced a strong vision of their architectural world today and tomorrow.

Students have often been considered on the creative, if impractical, end of the professional spectrum. Juries have often looked at student work and pronounced it unrealistic, although with good ideas. The reading jury will here do the same because not all of the designs will be justified by costs and some of the trade-offs will be questioned; the most sensitive designers will look for a level of integration that is often lacking. Yet there is an overriding practicality evident in this work. And the students who welcome the new design opportunities that knowledge of energy provides are clearly in the forefront of an architectural idiom responsive to the challenges of the times. Are they really less practical than the professionals who ignore it?

Students have often provided the impetus for change, not only in architecture but society at large. The protesters of the 1960s are now rising in corporate management; some of them are in the Justice Department they defied. Some of the revolutionary ideals have been softened, but matured. Their values remain strongly influenced by early commitment and their impact grows. In architecture, the same movement contributed to a man-centered priority that helped define the issues of user needs and social responsibility.

Students do not have a vested interest in the way we do things now; they therefore have more freedom to respond to new issues. Walter Gropius encouraged this in establishing the Bauhaus: "... Youths should close their ears to wailers and weepers who fear that their sophisticated appetites will be not sufficiently titillated by a straightforward approach to present building problems."

The Bauhaus grew to define modern architecture; it is a model for change in

the profession. The ideas of its founders moved with its students and faculty out of Germany, in lectures, publications, exhibitions and commissioned work. Interestingly, the Bauhaus had fewer than 1,300 known students.

Today the Bauhaus is often cited in opposition to energy conscious design. One of its most prominent disciples recently was quoted as saying, "I don't like this energy business. Energy has become the excuse for bad design." The sleek glass boxes the Bauhaus helped to produce have become integral to the design esthetic of today. Corporate clients, as well as architects, still perceive status through transparent skins.

The products of the Bauhaus are not the spirit of the Bauhaus and it was its spirit that helped its idea survive. Gropius, Mies and others did not teach people to build glass boxes. They taught people to understand the architectural media of the times, psychologically and physically.

The architectural media of their times centered around the impact of industrialization and its impact on art, politics, technology and man. Their design responses mirrored these challenges. Gropius was clear: The Bauhaus was established to "evolve a kinship of expression . . . in response to the challenges of the day," not to formulate time-bound stylistic concepts.

The Bauhaus students would have sought objective knowledge of the world in the belief that it furnishes the vocabulary of the designer. The designer clearly had a responsibility to inform himself about his world and to forge his art accordingly. The conclusions of the Bauhaus, and therefore its products, were made about circumstances that have changed. But just as those buildings addressed the media of their times, our buildings must address the media of *our* times.

It is quite possible that the intellectual boldness of the Bauhaus, together with its call for architecture in context, would have led Gropius, Mies and other teachers and students to the forefront of energy conscious design today. Gropius himself cited biologist Julian Huxley saying that "sooner rather than later we must get away from a system based on artificially increasing the number of human wants and set about constructing one aimed at the qualitative satisfaction of real human needs, spiritual as well as material and psychological." Many of these energy conscious designs are notable for a renewed attention to spiritual issues: integrity with one's environment and comfort intrinsic to it.

Energy conscious design, including the work of the students published here, does not confront the ideals of the Bauhaus, but complements its central idea. A new architectural medium has emerged and the challenge awaits us.

## Criteria were offered as a common starting point

Competitors were told that energy should be considered in each step of the design process from inception through occupancy. They received typical guidelines that reflect this concern in the design of buildings, sites and communities and were told to follow them, interpret them or substitute their own views.

### The guidelines:

- Space planning should be reasonably related to client needs. Excessive spaces pose environmental comfort loads that may be excessive; try designing indoor activity programs to use less floor area than is now considered standard.
- Use natural daylight for activities requiring light where possible.
- Concentrate activities that have similar temperature, humidity, air circulation and light requirements and consider separate zones for their control.
- Take advantage of site conditions, such as variations in grade, landscaping, surfaces and adjacent buildings in locating the building. Consider additional measures such as planting deciduous or evergreen trees to control the building's exposure to solar rays in hot and cold weather.
- Try to protect openings and glazed areas from unwanted exposure to sun in the summer, but still provide for solar gain in the winter by locating them differently on different sides of the building and by shading or sheltering them architecturally.
- Use natural ventilation for cooling where possible and consider ways to store cool night air in the building during summer days, or hot air during winter nights to reduce the need for mechanical systems.
- Avoid wasting resources in the design or operation of the building; recycle elements.
- Use mass where it can relieve the need for mechanical intervention. For example, activities that do not require windows can be located underground, or surrounded by a berm for insulation.
- Design to accommodate alternative energy sources, such as sun and wind power for heating, cooling and electricity, where possible.
- Estimate the probable first cost increases, or savings, that energy conscious design has made in the cost of the design solution. Also consider life-cycle cost implications.

Architect Philip J. Meathe, FAIA, of Detroit chaired the jury. Serving with him were Fred S. Dubin, engineer; Boston architect Sarah P. Harkness, AIA; Jean J. Boulin of the Federal Energy Administration; graduate student of architecture Anita Picozzi; Lynda Simmons of Phipps Houses, New York City; Bradford Perkins of Llewellyn-Davies Associates, New York City; Los Angeles architect Thomas Vreeland Jr., AIA, and Henry Wright, AIA, editor and author.

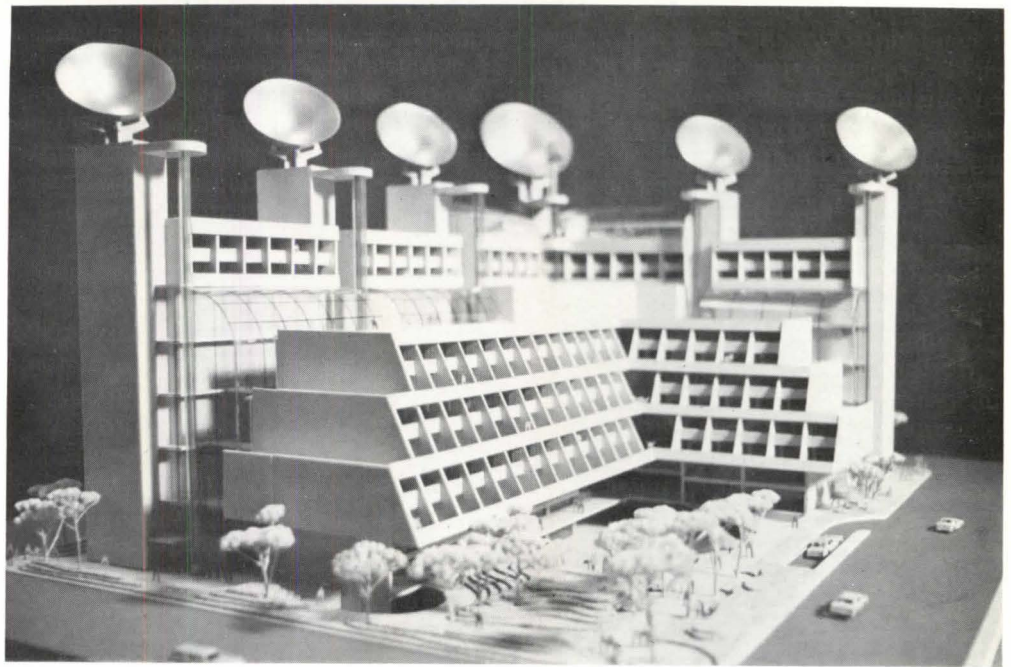

## Urban survival shelter informs and delights

Designed to promote an awareness of urban ecology, this mixed use Denver structure combines living, office and community spaces. Its varied population will also learn that energy conservation can be fun.

The building's precast concrete form evolved from its climate. It has minimal exposure to severe north and west winds, while opening up to sun and summer breezes on the south. Balconies edge hallways as thermal buffers. There is also an atrium.

Its University of Colorado (Boulder) designers wanted to make a strong visual statement about how their building works and why. All systems are highly visible and color coded to users and community alike. The building is envisioned as one of many around the country, all including

displays of community crafts, art and produce as well as indigenous energy design.

Nothing is wasted. The rooftop is a greenhouse that not only helps to humidify the building's air, but shows urban residents how they can grow their own food. Waste heat and products are recycled. Passive design techniques minimize power, heating and cooling loads.

The sun provides power, via an experimental SRTA collector system. Developed by W. Gene Steward, each unit consists of a fixed reflector concentrator in which a small absorber pipe tracks the movement of the sun.

The SRTA system provides a good defense against a new 20-story building to the south. Its collectors can be raised on towers.

Students: Russell A. Watson, Colin Shimokawa, Paul Flehmer, Bruce Flynn. Faculty: Phil Tabb, Chester Nagel.

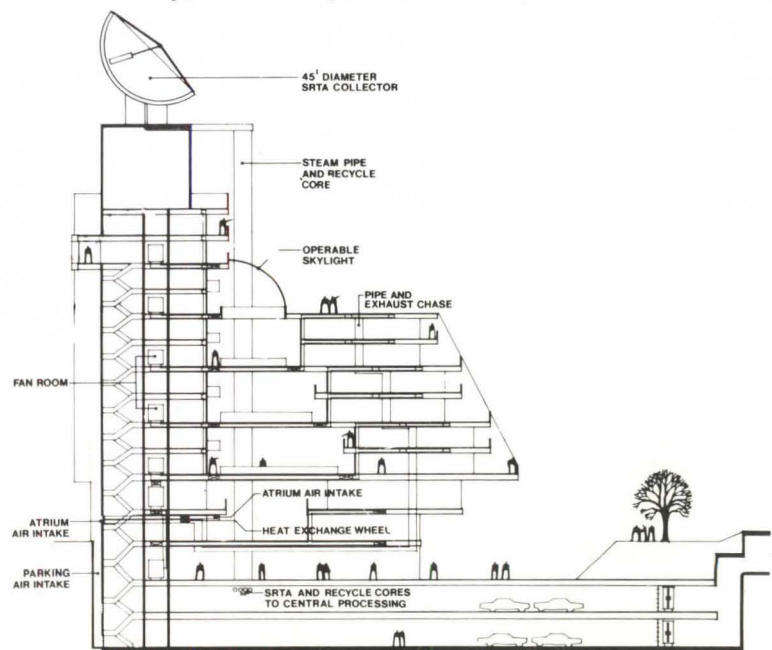

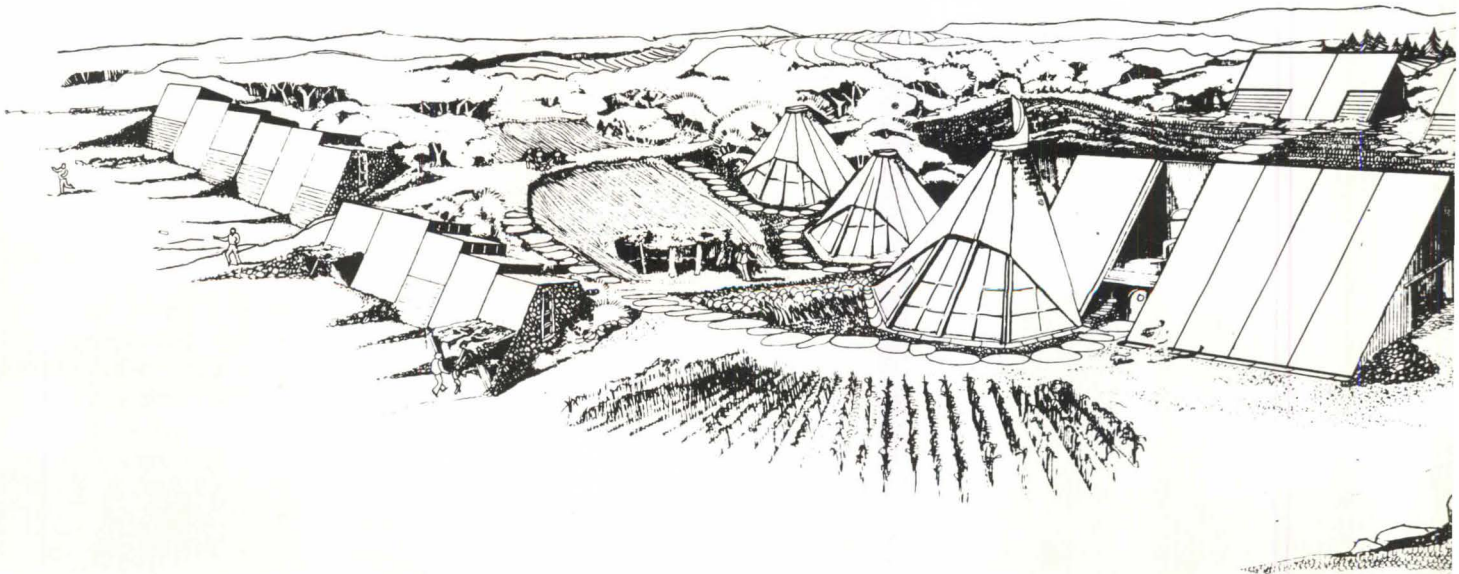
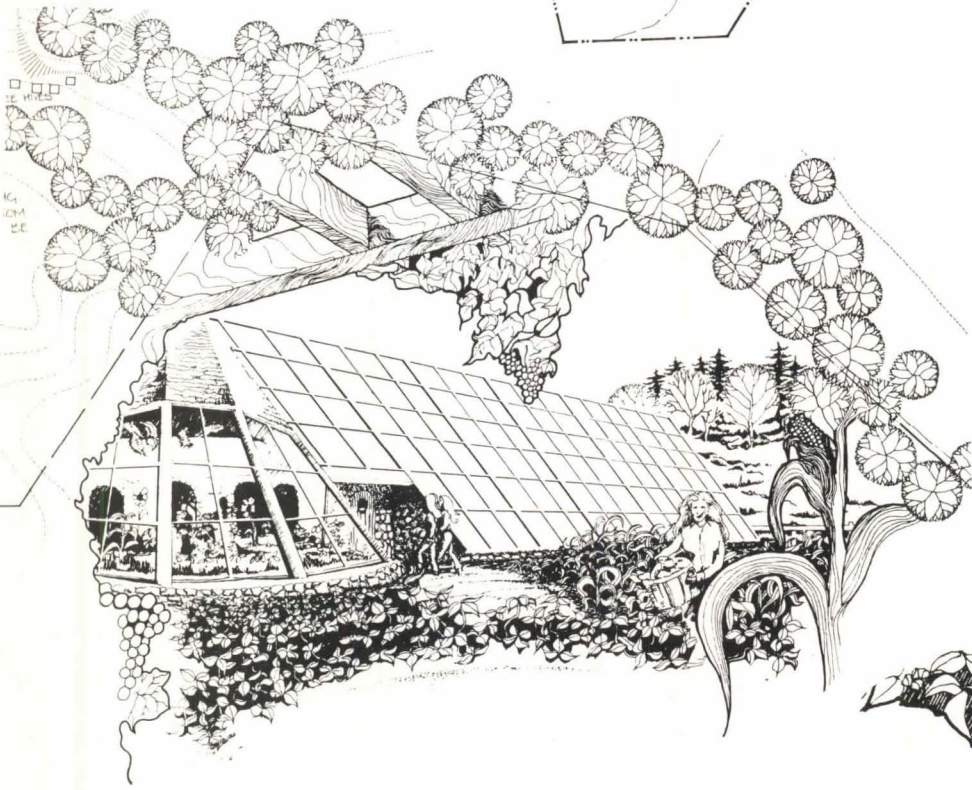
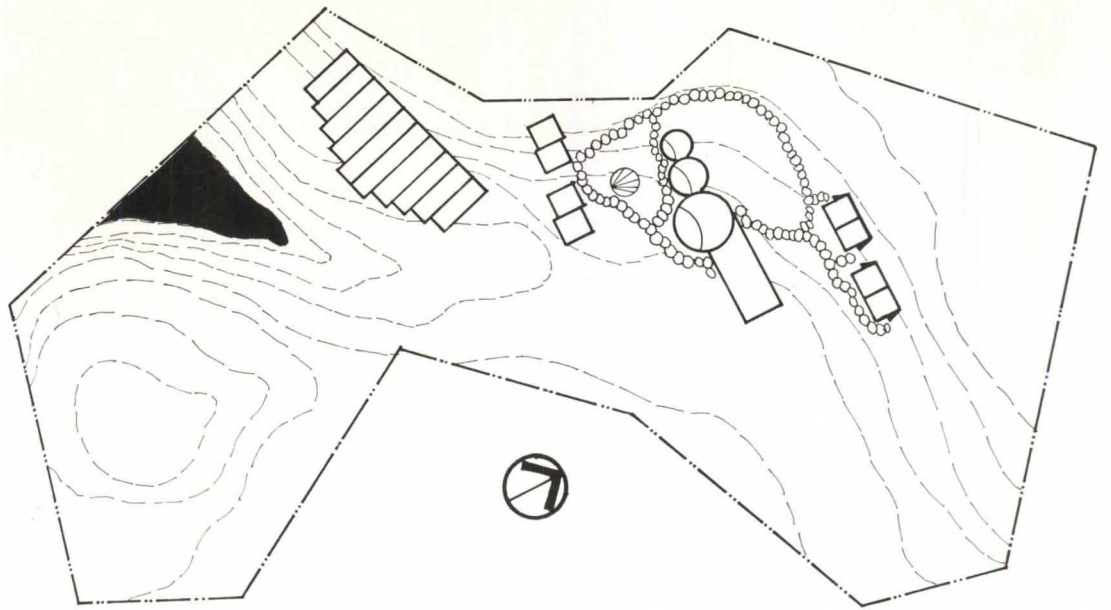

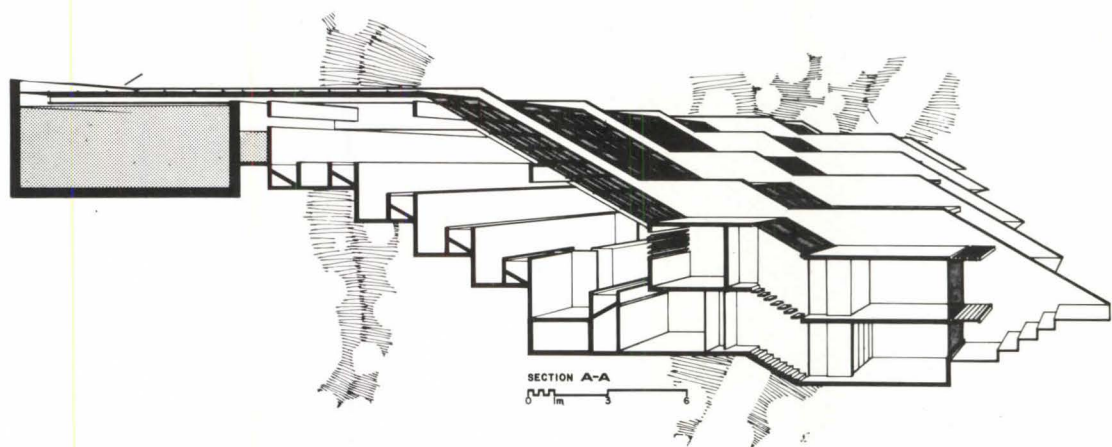
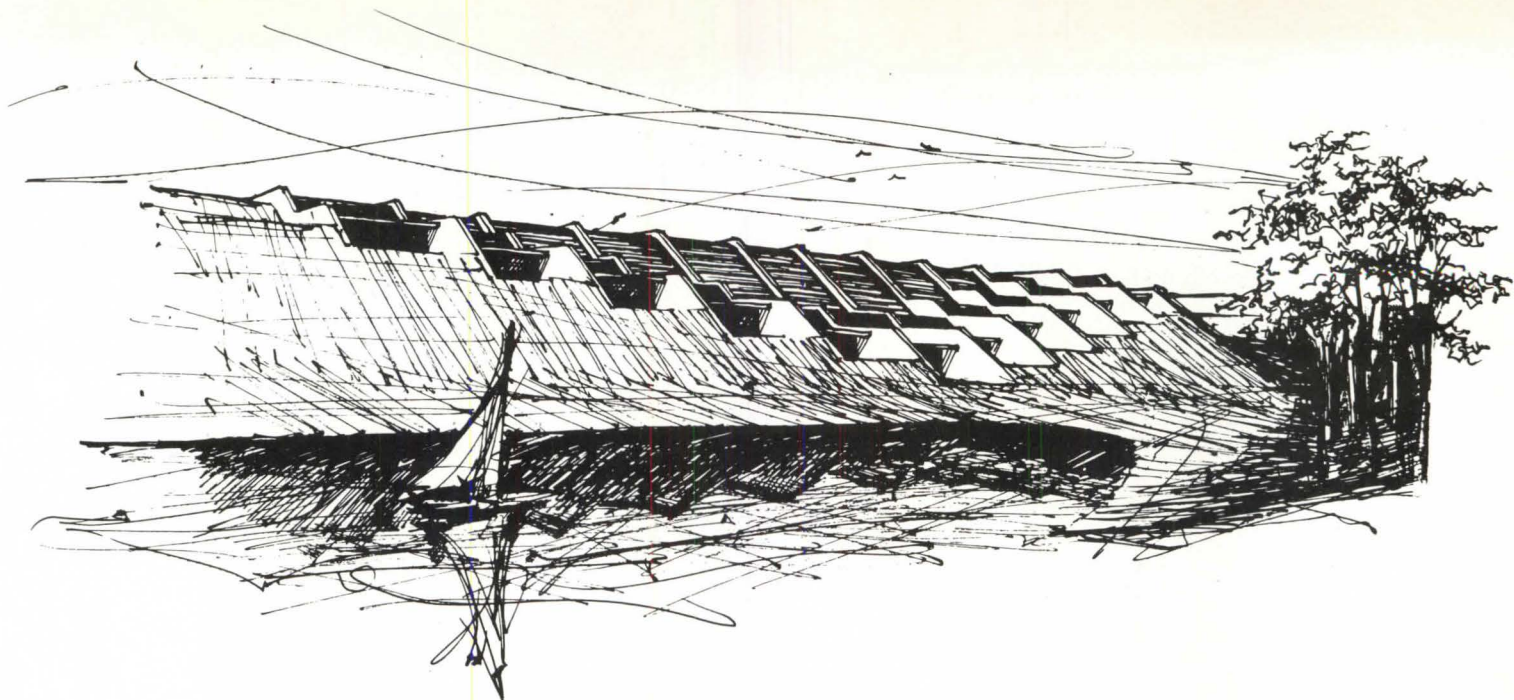

## Separate perspectives of living with nature

Structured, technological and singular in its design approach, the Iowa State University community (above) is an interesting contrast to the organic and diverse settlement evolved at Lawrence Institute of Technology (left). Both were responses to a single program: EPROM, an international competition organized for the United Nations' human settlements conference earlier this year. The program called for a community design for 10 families in a semirural area of eastern Ontario that is self-sufficient, ecologically balanced and uses the sun, wind and rainfall to advantage.

Iowa State's solution centers around a solar pond, architecturally and systematically. Within apparently traditional building forms, the community derives an ecological existence with food and heat from the pond and power from the wind. A serious attempt is made to integrate aquaculture into the community's life support systems.

The architecture is structural and rectangular in form. It is distinguished by common wall dwelling units that issue

from the hillside and cascade from it to take advantage of passive solar benefits and the earth's insulation.

The Lawrence design relies on the building forms and social structures of tribal communities, sensitively superimposing some more modern technologies. Teepee forms dominate, with solar-heated radiant floor slabs and vents to control convection.

Many community planning concepts were predetermined by the goal of self-sufficiency. Independence through Interdependence became a design credo. Both community life and buildings are integrated into the site. Residents build on the site, grow their food and find employment on the site.

The energy systems include windmills for power and solar collectors equivalent to one-half the habitable floor area. Water is cycled to sinks and showers, then to toilets as flush water. Wastes flow by gravity to storage, where they are converted to methane gas for cooking.

Iowa student: Raymond D. Greco.  
Faculty: Ray D. Crites, K. Kocimski.

Lawrence students: August S. Percha, Ric Licata, Alan Cobb. Faculty: Robert B. Powell, Harvey Ferrero.

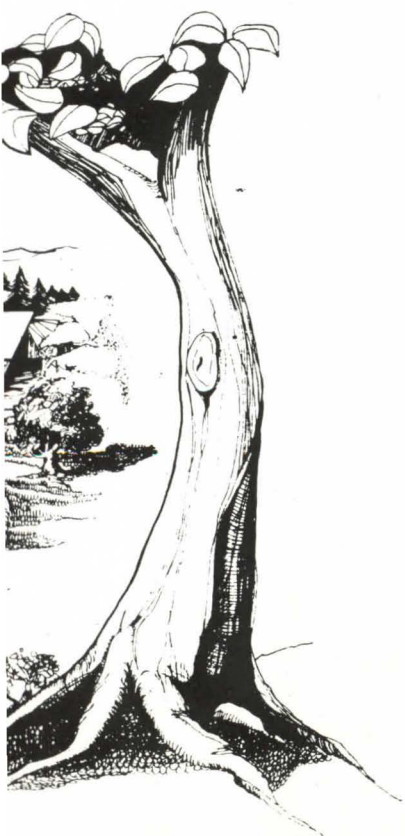

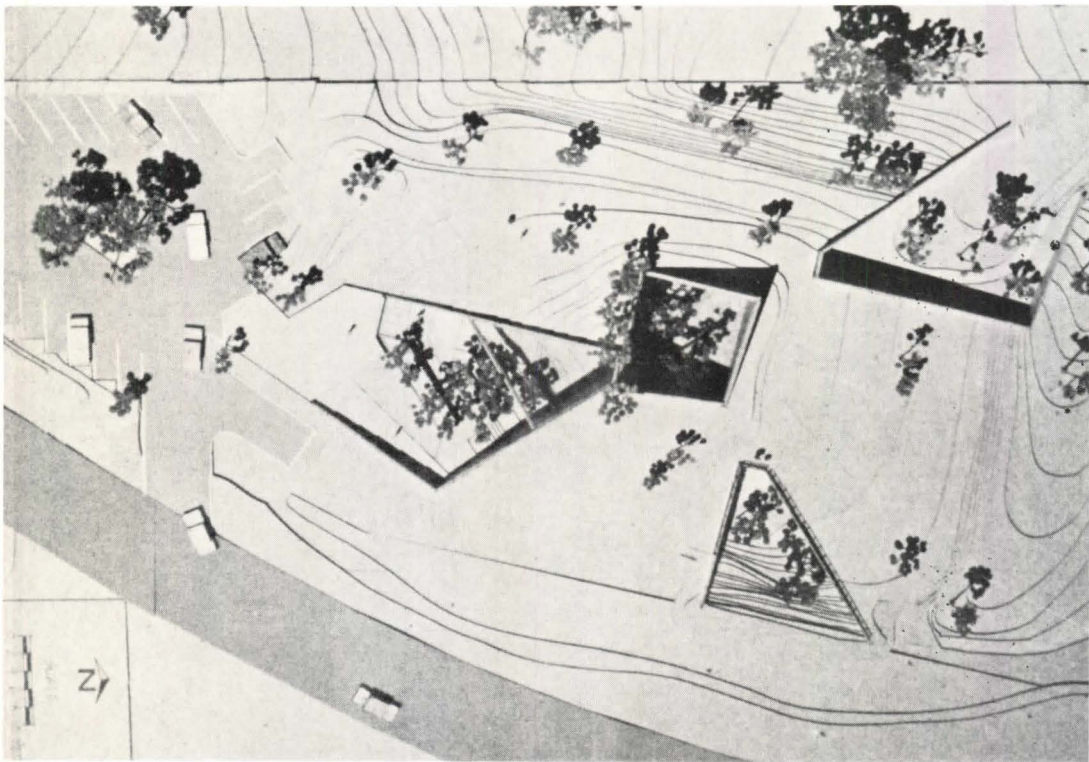
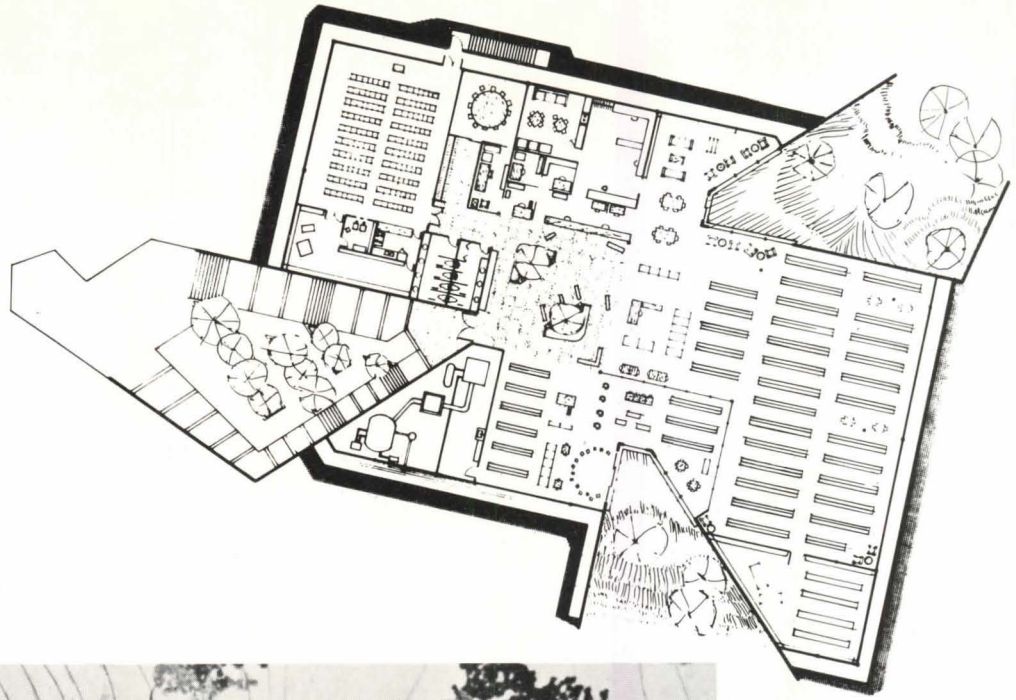

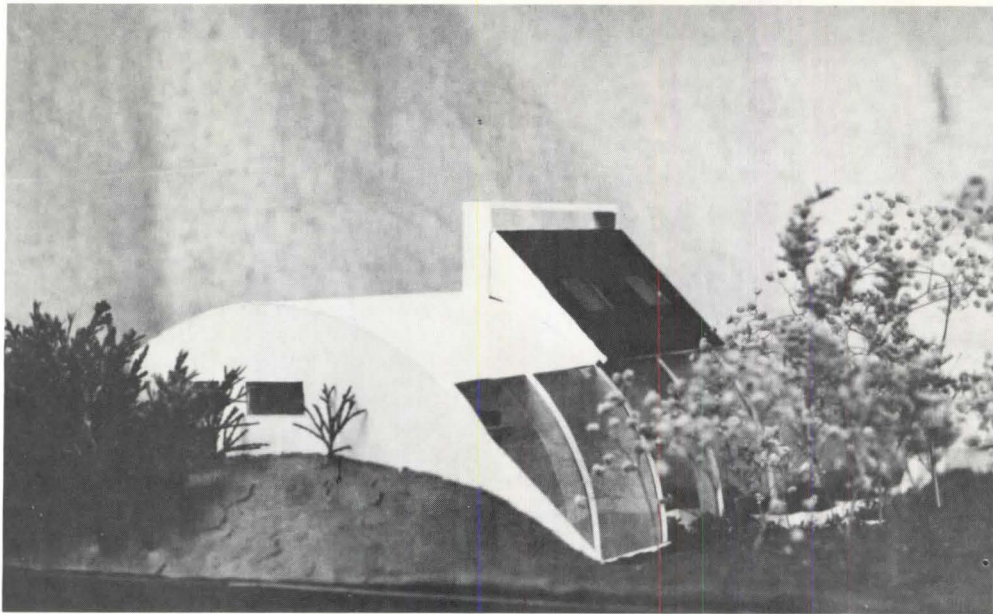

## Community resource centers conserve energy resources

A community resource center was included in the completion program as an option for schools wishing a specified program—almost one-half elected to use it, with three submitted entries judged distinguished: Kansas State University (top left), University of Michigan (lower left) and University of Wisconsin-Milwaukee (two entries this page).

The program described a CRC as a multiuse learning center, planned as a marketplace for community information activities and services. It includes an adult and children's media center and meeting, viewing, exhibition, counseling and leisure spaces. The CRC in this program serves a population of 24,000 persons, of which it is estimated that 120 will use the facility on an average weekday. A zoning ordinance limits building ground coverage to 15,000 square feet on the intown site.

Kansas State analyzed its Lakewood, Mo., CRC site and community and decided to bury its building. The underground situation maximized insulation, and allowed designers to use a 54 degree F. water table to pretemper air and so reduce mechanical system loads. Air is generally moved by convection currents caused by temperature differentials; the energy strategy is passive. Operable windows and underground ducts allow natural ventilation; mechanical systems are zoned. Natural lighting is priority. Vertical glazing is screened and double glazed; sloped glazing is reflective. Deciduous trees control summer heat gains, while allowing winter sun through.

Michigan's CRC evolved as a compromise between the need for a strong design to focus community attention and energy criteria suggesting a modest building form with a low profile, compact space and minimum heat loss. The resulting build-

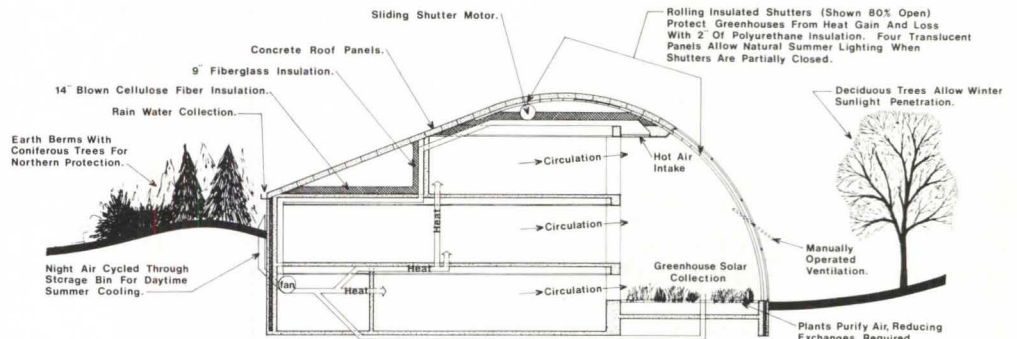

ing is a careful examination of design tradeoffs, incorporating task lighting in combination with heat-of-light systems, selective fenestration, a sod roof and berming for insulation, zoned mechanical systems, a southeast orientation and a solar collector that helps to block views of the parking lot.

Wisconsin's two entries were notable for extremely detailed load and, in some cases, payback analysis. The entry illustrated above was conceived as a living greenhouse, that its designer says could serve as a solar furnace were a dynamic exterior skin added. Passive heating and cooling systems account for 50 percent of the climatic needs; the design emphasis is on existing systems, buildable today.

The entry below also has a passive ori-

entation and a greenhouse lobby, in this case two stories high with folding insulating walls to prevent unwanted heat loss. Water trickles down the side of a black stone wall inside the greenhouse and is stored and released into the air later, thus extending the daily impact of solar heating. The CRC also uses low-water plumbing devices, lower level storage and other zones as thermal buffer zones and a heat pump for primary heating and cooling.

Kansas student: Paul Bilski. Faculty: Edward A. De Vilbis.

Michigan students: Mark Maridrosian, Jay C. Van Duren. Faculty: A. Peters Opperman.

Wisconsin students: Don E. Kraft (top), Bill Drewek and John P. Strege (bottom). Faculty: John Schade, Rick Jules.



## Garbage housing becomes respectable

This house is designed to conserve energy during its production as well as during use; virtually nothing in it is new. Consumer wastes are its building blocks.

Students at Rensselaer Polytechnic Institute actually built the prototype (bottom) for their winning design; they know their method works.

The home's south facade is mostly a solar collector made of no. 10 cans stacked on top of each other to form a honeycomb wall. The cans are painted flat black inside and out, with the backs removed. A translucent cover allows sunlight in; as air is drawn through and heated, the cans absorb and retain the heat.

Cans were also used to make gutters for a roof built up primarily by cardboard tubes. The walls gain structural support from cardboard tubes as columns, with infill of cans with mortar.

Windows are recycled from demolished buildings and insulation is recycled cotton. A Clivus Multrum recycles waste.

What started as a design challenge led to the students' conviction that garbage housing could lead to not only interesting and energy-conserving housing, but good housing.

Students: James Gleason, Scott Stinson, David Capelli, David Sadowsky.  
Faculty: Harry E. Rodman.

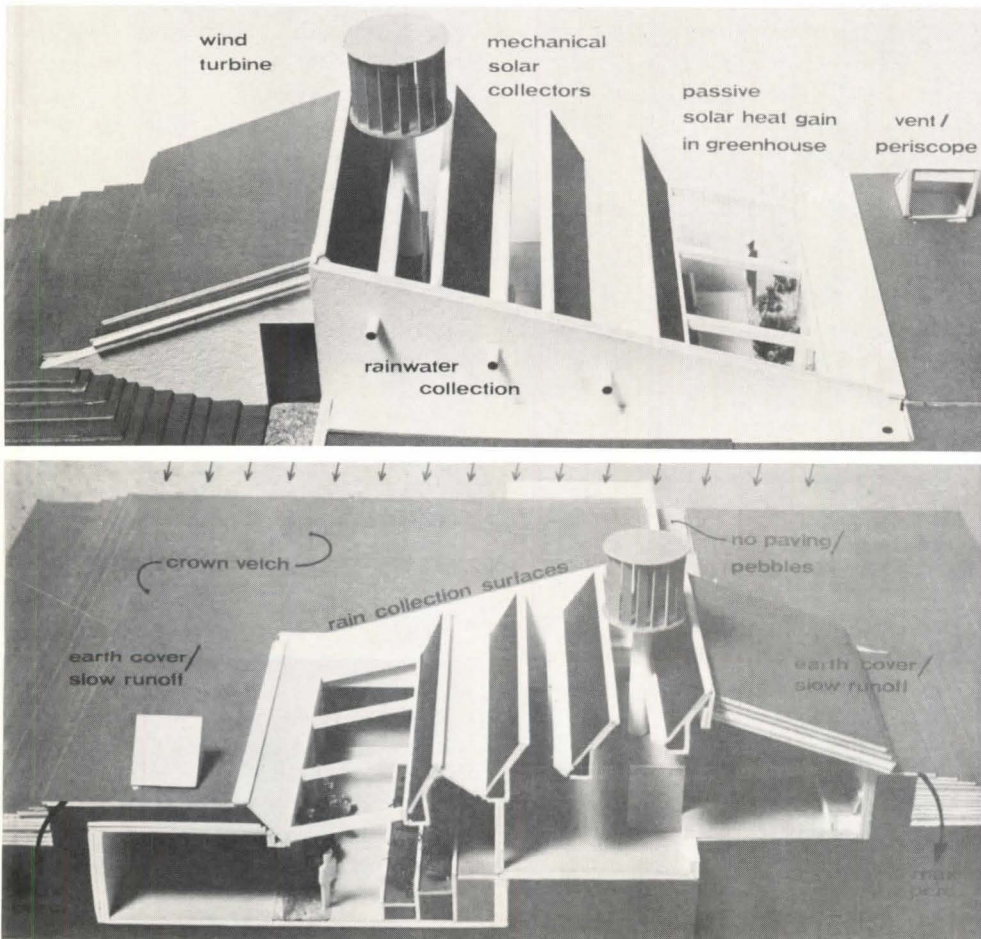
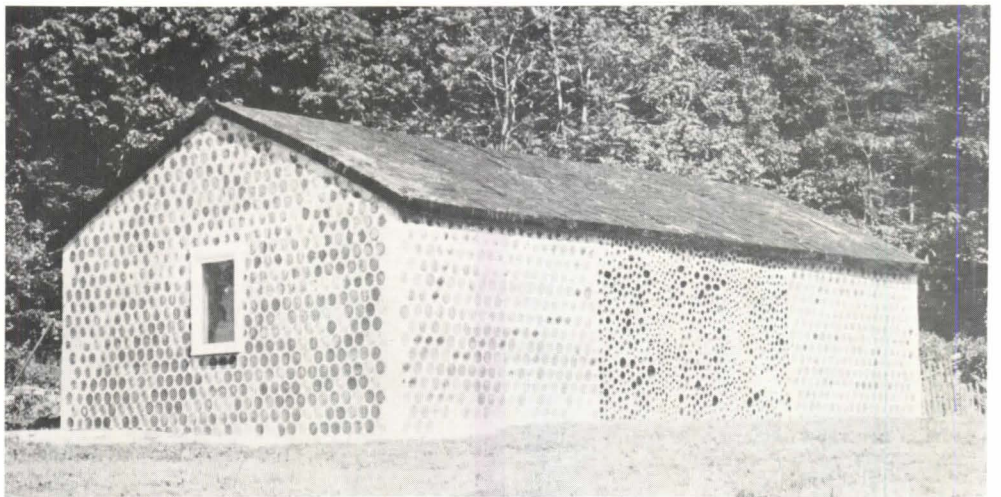
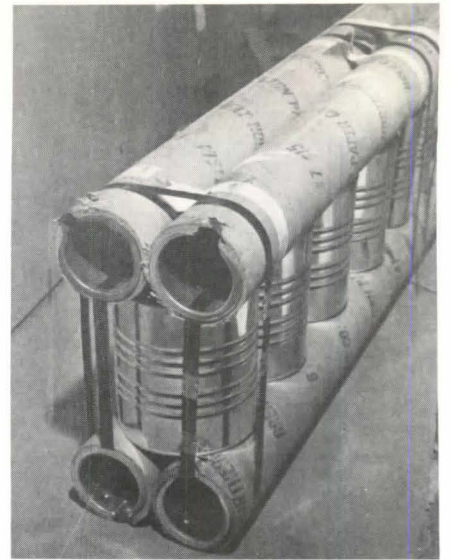
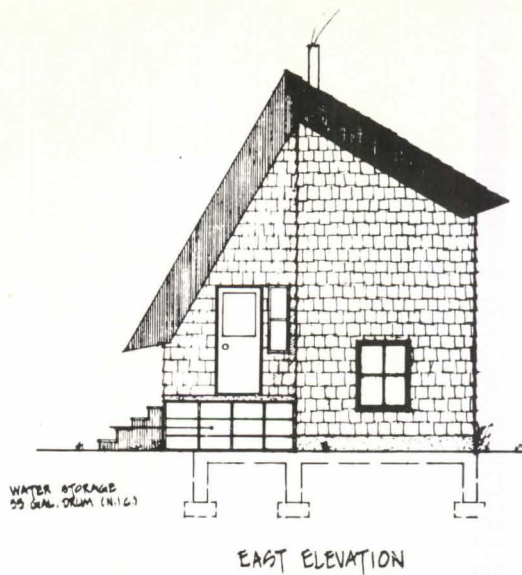

## Architect's home and office goes underground

Located on Staten Island and inspired by a land use study there by Ian McHarg, this house seems to enjoy the best of two worlds—it is a subterranean home with plenty of sunshine and views. It is also an underground building that expresses itself above ground, where its solar and wind systems show its ecological intent.

Designed at the New York Institute of Technology, the house combines living and studio spaces for an architect and family and augments the spaces with natural light, a heat-conserving fireplace, a sod roof, recycled wastes and wind and solar systems for power, heating and cooling.

The house is stepped into its site, using the earth for insulation, yet providing some open living areas. Winter winds from the north and west are pitched up and over the structure as well as into the vertical axis wind turbine. Summer winds are directed into turbine and used for natural ventilation. A scoop at the top of the interior studio rotates to catch breezes, provides a skylight and can even be used as a periscope to permit viewing.

Student: Michael Berthold. Faculty: Frederick R. Bentel.



## A Quaker community respectfully designed

The philosophy of design and the problem here seem in perfect accord. The Quakers wanted "a community in keeping with our Quaker testimony of simplicity. The design, construction and details of the building should be direct and functional. . . . Our population of elderly people . . . will want to be able to handle as many details in their lives as possible. . . . We wish to strive toward self-sufficiency." The Harvard designer examined the lives and location of the community and evolved his forms from both.

A remarkably comprehensive analysis of the 87-acre North Easton, Mass., site provided the basis for design, including vegetation, microclimate and on-site energy sources in its scope. Unit spacing was determined in part by sun movement studies to assure that one building would not shade another. The dwellings incorporate the full range of passive design techniques, including natural ventilation and daylight and manipulation of solar radiation to advantage. The passive approach was selected to provide residents with the greatest flexibility for all community components and to assure that all solutions could be economically justified. Nonexotic solutions were considered appropriate not only for the client, but expedient in dealing with government codes and regulations. Food production opportunities were sought everywhere and many units incorporate greenhouses. Patterns of social interaction were considered, along with amenities such as views and pastimes with nature. The design is not only comprehensive, but humane.

Student: Meñelaos Triantafyllou. Faculty for the joint Harvard/MIT energy studio: David Lord (Harvard), Timothy Johnson (MIT).

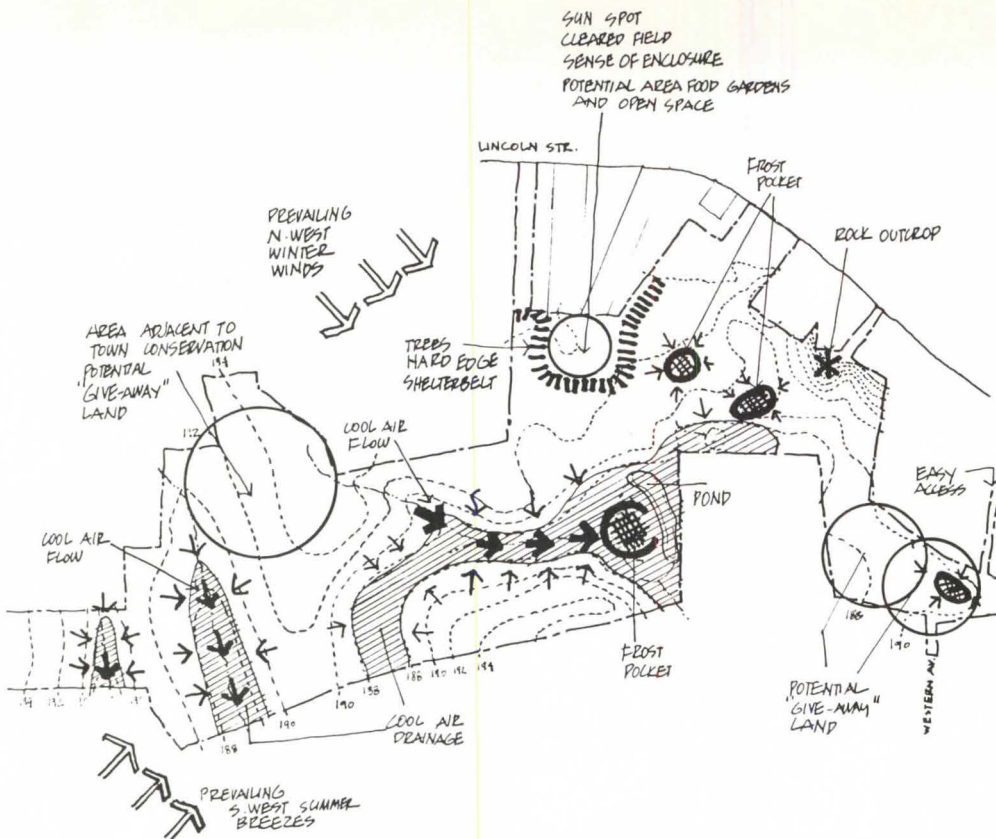

All of the competition entries will be published as a book later this year. Contact AIA/RC for further information.

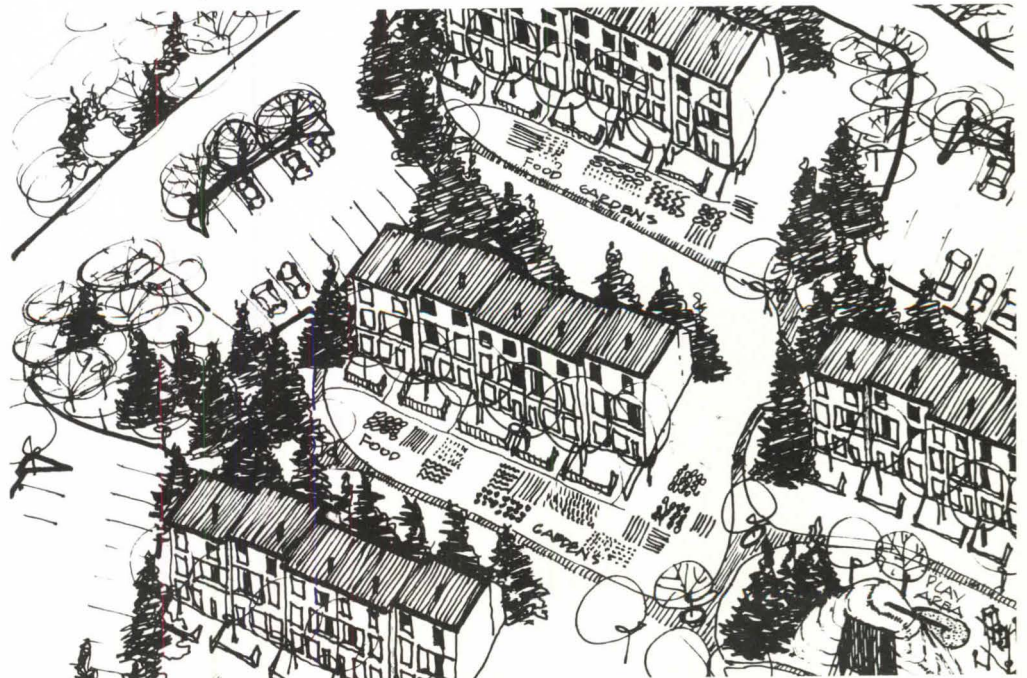

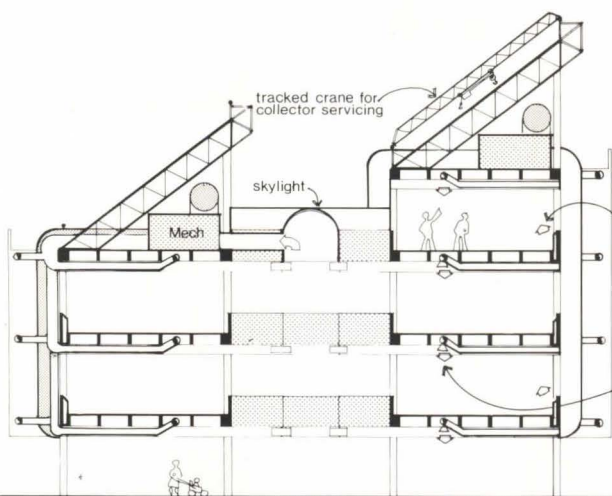

0 10 20

Section A-A

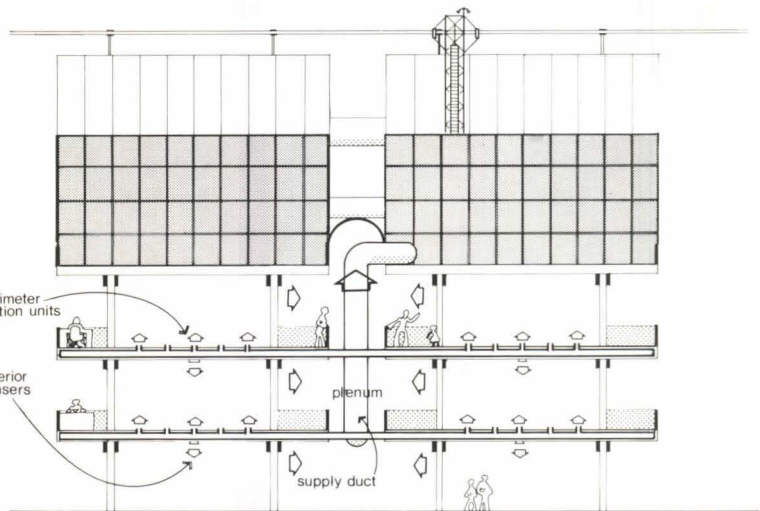

0 10 20

Section B-B

## Energy agency models energy conscious design

This "typical office building" is not. In it, employees of the Energy Resources Administration in Sacramento would enjoy spaces climatically responsive to their personal activity needs, controlled on the spot. Designed at the University of California, Berkeley, it uses a decentralized system to evolve with the climate and functional changes of the building.

This diverse approach is reflected in the complex forms of the roof, which also express the solar functions of the roof and wind considerations.

Sacramento has warm, dry summers and cool, moist winters. Evaporative cooling, helped in this case by fountains and trees, is effective. Heating is provided primarily by solar collectors.

The plan radiates, off center, around an atrium heated by sunlight penetrating its translucent roof. The building has a modular structural system that permits numerous lightwells in office areas and a variety of smaller dead-end spaces that lend personal scale to an otherwise huge floor area. Air returned vertically through the lightwells is recycled or exhausted by a wind-induced vacuum behind the top edge of the roof's solar collector support structure.

Students: Harry Siegel, Allen Lowry.  
Faculty: Sandy Hirshen, Edward Dean.

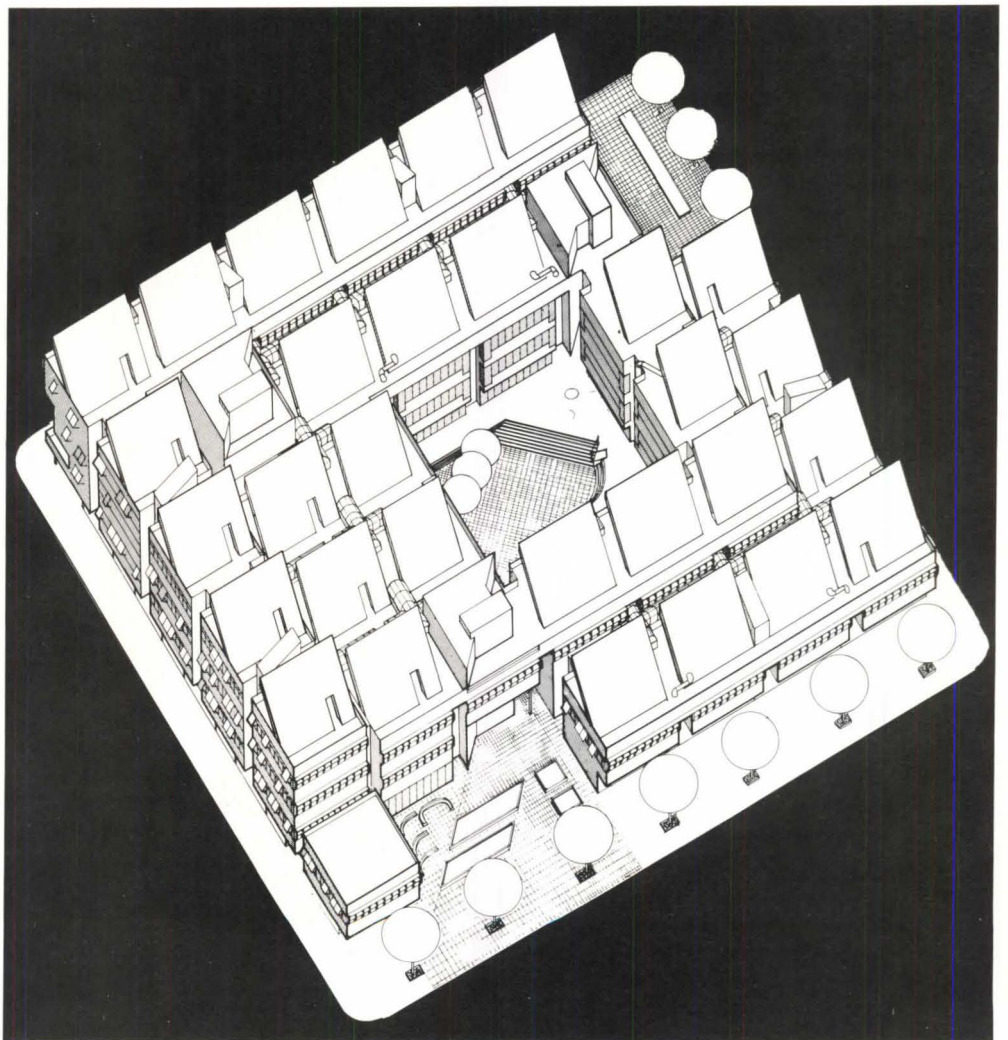

## Solar student center is prefabbed and fast-tracked

Often the most energy conserving building decision is the decision not to build. But this International Student Center, designed at Ohio State University, may be an exception. It requires that a building be demolished, but promises to furnish its own energy after construction and export some to the campus.

The building combines cultural and residential spaces for up to 400 students. The lobby is designed as a large heat sink and enjoys a chimney effect for ventilation. Natural daylight filters through solar collectors, which are translucent fiberglass hot air units. The space is partially heated by heat loss from surrounding areas as well.

The left side of the isometric illustrates the cooling mode of the building. The solar collectors heat the air, which is distributed to the ends of the building housing the chillers. There one-half of the contained energy is used to reconcentrate heat for the chillers; the rest is returned to the campus system.

The heating mode is illustrated by the right side of the isometric. The flow of heat through the panels is upward from the cool supply on one side of the panel to the hot return on the other. The hot air is then forced down to and through an underground rock storage area, which then reradiates the hot air into the building.

Students: Craig Stough, Bradley Oberg, Roger McLoney, Philip Skirball. Faculty: George M. Clark. □

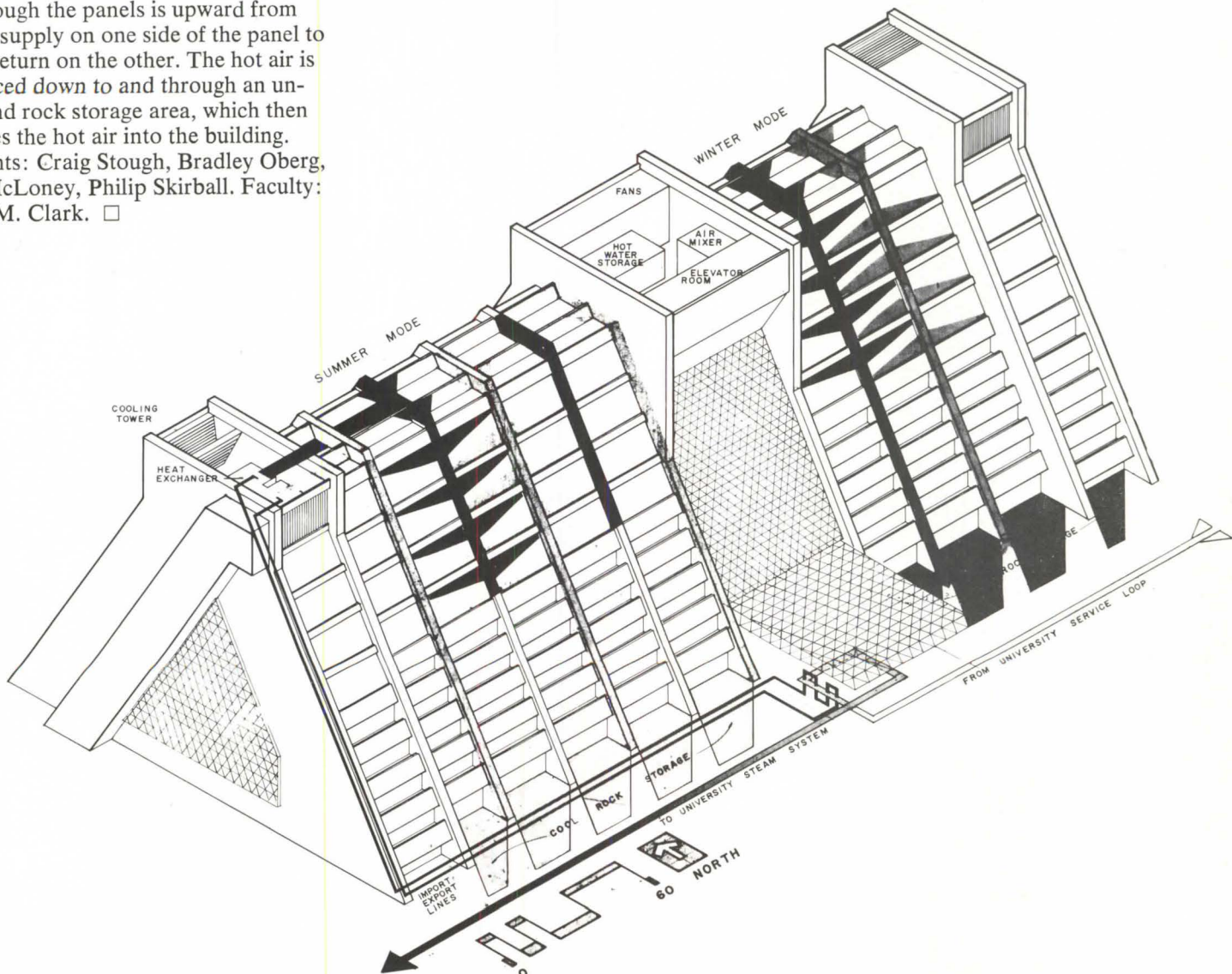
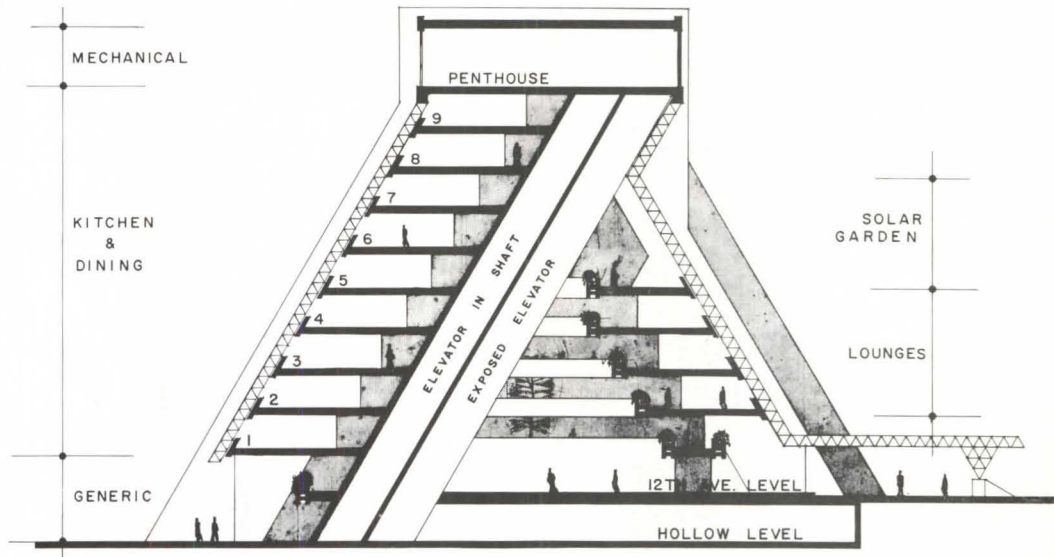

# A System of Ethics to Guide Man's Relation to the Land

Hugh B. Johnson, FAIA

Last December the AIA board approved as policy the statement that "there is a need for the study, development and public understanding of a system of land use ethics that does not exist in the U.S." The statement continued: "The 'highest and best use' does not mean maximum development and the highest tax return but that use which is of greatest good to the larger community."

Many people are concerned with the use and abuse of land and conservation of natural resources. This idea has become the "cause" of an army of "environmentalists" usually serving as lobbyists to save some particular aspect of the environment that seems to be endangered.

While protection of these critical areas is considered a moral issue by the environmentalists, there is no commonly recognized system of ethics or body of philosophy to guide the student, teacher or legislator in determining what is "right" and "wrong."

A system of ethics in human relationships is the codification of the ultimate in human conduct, the highest good. A land use ethic will not be separate from the ethics of human relationships but will be an extension of them. Each individual is a member of a community of independent persons and groups. His instincts prompt him to compete for a place in that community but his ethics indicate that he should cooperate with others for the good of the community so that the community may exist.

A land use ethic broadens this community to include the earth with its soil, water and air and all of the plants and creatures that it supports. Since man has dominion over the earth, or at least has the ability to destroy it, a system of ethics must be developed which will focus on the cooperation of man with all of the members of this domain for the greatest good of all. The role of man will then be changed from the conqueror of the community of

**Mr. Johnson** practices in Washington, D.C. He is a member and former chairman of AIA's regional development and natural resources committee and author of the full statement on land ethics adopted by the board.

land and water to a member and citizen of it.

At this time there seems to be no clear move in this direction by either scientists or philosophers, although contributions have been made by men like Aldo Leopold, who introduced the demand for land ethics in this century, and Benton MacKaye, who led his own crusade for making the earth more habitable for people and all of the earth's creatures.

At the present time most of the schools of planning are teaching more and more sophisticated methods of determining areas where development is environmentally acceptable and where it is not. The planning professionals—architects, landscape architects, planners and engineers—are probably more aware of the mistakes of the past and the growth problems of the future than are any other groups. The planning professionals are therefore best equipped to initiate and recommend studies in ethics for philosophers and scientists to pursue. As such a system takes form, it will again be the duty of architects and planners to introduce such principles in the work of land use planning and development. It is time now to propose this positive approach to a public that is being increasingly alarmed and discouraged by doomsday predictions, each connected with some specific environmental crisis and immediately followed by another.

A system of land ethics as a part of moral philosophy will relate to many areas of society in addition to the planning professions. These are only a few of the issues which it should address:

**Diversity:** The need to preserve the diversity of our scenery should become one of the tenets of our system of ethics. This diversity includes large-scale views such as coastal scenes, lakes and forests, and an endless sweep of grain fields or citrus groves, as well as back roads with small farms and old barns. Much of this diversity is endangered by increasing demands for land for a multiplicity of uses.

Durward L. Allen of Purdue University has made the following comment regarding this trend: "In such a situation, if we made purely political decisions and followed traditional practices, we would, a

few years hence, confront the future with a well-worn, totally developed world. It would be a world robbed of diversity, in which the big decisions had been made, the options foreclosed. It would be an environment of man-dominated scenery—in sociological terms a monotony of standardized and artificialized disturbance communities. The fauna and flora would have been largely homogenized, and the vulnerable specialized life forms would have gone down the drain of extinction. Much of this has already happened in parts of the world and much of it is in progress."

**Critical areas:** There are many uses of the term "critical areas," but here it implies a place where any form of development, a change in water supply or the pollution of either water or air will destroy the ecology and permanently change the landscape. This category includes steep mountain slopes, swamps and coastal wetlands, meandering streams (as opposed to channelized streams) and sand dunes. There is increasing public support for the protection of critical areas without general understanding of what areas are critical. An effort to establish tentative criteria and to map the areas is needed in every state. This should be followed by continued studies which would be a part of the work toward a land use ethic.

**Construction on flood plains:** A number of ethical questions are raised here, some in regard to human relationships and others relating to land use. Under natural conditions with no construction on the flood plain, periodic flooding generally has a beneficial effect on the land, with occasional exceptions. Construction increases the velocity and depth of flood waters. Engineering solutions (dams, levees, etc.) frequently increase rather than

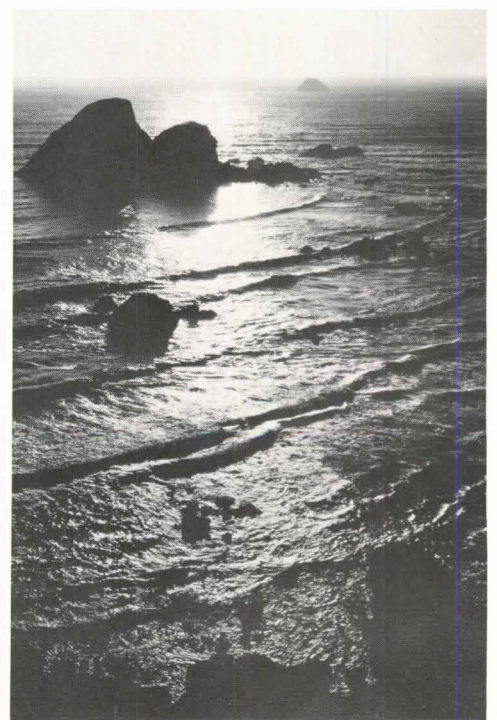

decrease the damage. The basic question of land use ethics would seem to relate to the original construction on the flood plain.

**Destruction of the natural landscape:**

Termination of practices which destroy the landscape on a large scale should be high on the list of ethical imperatives. Destructive practices include most strip mining or all strip mining that is not under rigid control to see that surfaces are restored to productive and scenic value equal to the premined state and that streams and ground water are not polluted.

There have been complaints about destructive lumbering practices in the U.S. for over 150 years, and some land that was cut over and burned in the 19th century has still not recovered. The use of heavy machinery in the forests now leads to extensive and frequently careless road construction for lumbering purposes as well as the tearing up of the soil in getting out logs, both leading to soil erosion and

*Preservation of our diverse scenery, from rocky coastlines to agricultural vistas, should be a tenet of our ethics system, and pesticides must be curtailed.*



silting of streams. Forests are considered one of our best renewable resources, but under such conditions the forests are not renewable.

A third type of destruction of land is caused by highway construction, particularly the superhighways of the interstate system. The scars of I-70 as it slashes its way through the delicate ecology of high altitude valleys in the Rocky Mountains will not be healed for hundreds of years and the scenery is changed forever. In this case most of the people who live in the area may welcome the highway as a boon to business, but we must find some way to educate people to a standard of ethics that will not tolerate this desecration in order to travel the shortest distance between two points at high speed.

**Erosion:** On most of the crop lands of the U.S., the topsoil is steadily and inexorably slipping into the rivers and the sea. A very small part has been stabilized as it has been done in parts of England and Western Europe. The government and the public took important steps toward reform during the depression of the 1930s. The gains from that effort have largely faded away and without stating it in so many words, the government's policies say to the farmer: Do what is profitable for you and the government will do the rest. And little or nothing is done. Topsoil is being built in the forest, but the loss through erosion is hundreds of times greater than the gain.

Apparently, more progress is being made in slowing down erosion resulting from construction. Laws and ordinances to prevent erosion and techniques for their enforcement are still in an experimental stage and architects and engineers can play an important role in the development of sound, reasonable standards.

**Endangered species:** One of our ethical principles must be that no species of bird or animal of land or sea be exterminated

by man. We must not be lulled into complacency by the presence of a few endangered species in a park or refuge. A species must be saved in many places if it is to be saved at all. In most instances the problem is one of habitat, although in the case of some of the ocean mammals it is one of deliberate and relentless killing. The Rocky Mountain big horn sheep offer an illustration of the habitat problem. There are now about 20,000 left in the U.S. and we know that this is the last stand. The problem is that in the winter the sheep must come down from the high mountains to graze in the meadows of the lower valleys as they have for thousands of years. In the early spring the young are born and the families begin their climb to the summer range. On much or most of the government land, overgrazing of the winter range by domestic sheep leaves nothing for the wild grazing animals. Overgrazing, meanwhile, is ruining the range for any animals, wild or domestic. The debate over use of public grazing lands has continued in Congress for decades. Meanwhile, the sheep nibble on and the wild grazing animals are pushed to extinction.

**Pesticides:** The widespread use of herbicides, insecticides, rodenticides, fungicides, plant growth regulators and others have caused disease and death to humans, domestic animals and domestic fowl and has nearly eliminated important bird species. There are now 46,000 pesticide products on the market using over 100 different active ingredients. Government regulatory agencies have inadequate funds, staff or authority to control the situation. The widespread application of poisons by spraying from airplanes or other means of application becomes an attack on nature itself and an important matter of ethics.

**Reverence for life:** The sensitivity toward the earth and its resources discussed here should include a reverence for life as described by Albert Schweitzer. Reverence for life may mean different things to different people, but at the very least it means that life should not be taken needlessly and for fun, and use should be made of animals or birds that are taken. Irreverence may begin with boys stoning frogs or shooting them with air rifles. It may become "scientific" with high-powered rifles and telescopic sights used to kill woodchucks a mile away. Shooting polar bears from airplanes may be the ultimate in lack of reverence for life, and lack of sportsmanship as well.

Finally, recognition that the whole complex earth system is a heritage that we must pass to future generations—rather than simply a collection of minerals, farms and forests to be exploited—is the first step toward development of a system of land ethics. □



---

## Entire payment should not be withheld because of a small portion of defective work.

---

A201 from page 39

in regard to payments, completion and retainage," says Stover, "and included were general and specific abuses or failures in the payment system whereby contractors would often withhold more from subcontractors than was being withheld from the contractors. Also, because of the retainage system, early finishing trades or subcontractors would have to wait long periods of time after their work had been fully completed to get final payment."

The architect's certification for payment provisions has been changed. If the architect is satisfied with only a portion of the work applied for, he will be expected to issue promptly a partial certificate for payment, rather than withholding the entire payment because of a small portion of defective work, and to notify the contractor of his action. "Consequently," Stover says, "subcontractors whose work is accepted should get paid, because no additional money is being withheld because of faulty work by others. By requiring the architect to certify the payment for accepted work, some money will be flowing through so that subcontractors whose work is not defective can be paid. If one element of system of the building is completed before the entire project is finished, such as elevators, the architect can issue a certificate of substantial completion on that portion of the work so that payment can be made without waiting for the entire building to be finished. To ensure that retainage is not abused, the contractor's application for payment must indicate the retainages applicable to the various portions of the work, the contractor must pay the subcontractors promptly and the contractor may retain from the subcontractor only the percentage retained from him by the owner."

A201 recognizes that various retainage methods may apply in varying situations and does not dictate the method. Long-standing AIA policy has recommended an effective 5 percent level of retainage through the reduction of retainage after 50 percent completion. With the new document, line-item payment and release of retainage may prove easier to administer and more equitable for all concerned. "The payment provisions are designed to facilitate the release of the bulk of the retained amounts at substantial completion," Stover says, "so that no more than is necessary to ensure completion of the punch list need be retained."

Provisions for determining the dollar amounts of change orders have been clarified in the new A201. Payment will be made for materials stored at the site, and late change orders which affect the date of final completion of the work may not be used to delay final payment. Stover cautions: "Payment provisions of the new A201 may conflict with certain lenders' policies for draws on the construction loan. Consequently, payment provisions may need to be modified to conform to the terms of construction loan agreement."

• **Miscellaneous legal considerations:**

Stover, who is an attorney as well as an architect, points to several other details in the new document. For example, the arbitration clause has been modified to place limitations on the bringing of multiple parties into arbitration proceedings.

In the 1974 editions of the owner/architect agreements, AIA specifically prohibited the architect from being brought into an owner/contractor dispute.

"We continue the prohibition on compulsory joinder of the architect," Stover says, "because there is a different legal standard of care that the architect is subject to as compared with the contractor. And in an arbitration panel, without judges and lawyers overseeing the process, we were afraid that the standard of care that applies to the architect would be lost. However, we do not prohibit the contractor from bringing in subcontractors when the contractor has a dispute with the owner. Or vice versa, so long as the parties are all closely connected with the dispute."

Another requirement that has been clarified is that the architect must specifically concur in any action by the owner to stop the work. The document now makes it clear that the power to stop the work is provided solely for the owner's benefit—not for the benefit, for example, says Stover, "of an injured employee who later contends that he was faced with a hazardous condition that the owner should have prevented."

• **Division One of the Specifications:** The basic philosophy is that detailed procedural requirements should be dealt with in "Division One of the Specifications," in accordance with the Uniform Construction Index (see AIA documents E101 and K103) and the project manual concept (see AIA JOURNAL, Feb. 1973). "Conversely," Stover says, "the general conditions had to retain reference to the basic responsibilities among the parties for such items. Consequently, several of these conditions were not deleted entirely from the revised A201. A minimum of language that we could live with was retained so that if the architect did not develop the specifications properly, there still would be an indication of the basic responsibilities."

More detailed specifications are now required to fill out the following provisions of A201: 4.10, progress schedule; 4.11, "record drawings"; 4.12, shop drawings, product data and samples; 4.15, cleaning up; 7.7, tests, and 9.2, schedule of values. "Basically," Stover says, "the streamlining of these portions of the general conditions allows the specifications writer to elaborate on the general conditions without having to change them by writing a supplementary condition to delete language in A201."

All the months of involved discussions, negotiations and arguments over the revisions in A201 will quickly bear fruit, Stover says, "by allowing other AIA documents affected by A201 to be revised in a minimum period of time."

The four documents most immediately affected by the revised A201, and now currently being revised, are: B141, the Owner-Architect Agreement, A701, Instruction to Bidders, A511, Guide for Supplementary Conditions and chapter 13, "General Conditions," of *The Architect's Handbook of Professional Practice*.

Related documents, which are affected to a greater or lesser degree, include: A101, Owner-Contractor Agreement (Stipulated Sum), A107, the Short Form Construction Contract, A111, Owner-Contractor Agreement (Cost Plus Fee), A401, the Subcontract, and many of the

---

## Virtually every AIA contract document is undergoing revision because of A201 changes.

---

G-series contract administration forms.

Stover cautions strongly: "On projects which were designed under the 1974 edition of B141 or earlier documents, but will be constructed under the new edition of A201, amendments to those already executed owner-architect agreements will need to be made to bring them in line with the architect's construction phase responsibilities under the new A201."

A side-by-side comparison of the 1970 and 1976 editions of A201, a commentary on the revisions and a cross-reference index of the two editions are included in a packet of materials available at \$2 per packet from the publications marketing department at Institute headquarters. Also, chapter 13 of *The Architect's Handbook of Professional Practice*, which goes into detail about the various changes and gives additional instructions on how to amend B141, will be available before the end of the year. Meanwhile, questions and comments may be directed to Stover at AIA headquarters (202) 785-7254. □

# PPG GLASS GAVE THIS AGING HOTEL A BEAUTIFUL FACE-LIFT.

Skirvin Tower in Oklahoma City isn't a hotel anymore (it isn't even Skirvin Tower anymore), but it is, once again, a useful, profitable building.

It was completely remodeled from the ground up and from the inside out.

Now, it's the 101 Park Avenue Building, home of some of the

poshest offices in the city, and headquarters of Continental Federal Savings & Loan.

It's a beautiful, modern office building. And PPG Solarban® 480 Twindow® reflective insulating glass played an important part in the transformation.

First of all, it looks sensational. Seeing the blue Oklahoma sky and

dazzling sunsets reflected in this building, it's hard to remember the dowdy, old bricks.

But, perhaps more important, the glass is incredibly practical. Its reflective coating reduces glare and solar heat gain. And during the burning summers on the Great Plains, this is a welcome relief to the air-conditioning system.

The glass is also double glazed for insulation. So when those bitter cold snaps blow down from the north, everybody stays warm and cozy.

Not all old buildings can or should be remodeled. They shouldn't all be destroyed either. Some, like the Skirvin Tower Hotel, present a genuine architectural opportunity. Not to mention a challenge.

We think there's no better way to meet the challenge and take advantage of the opportunity remodeling offers than with PPG reflective glass.

Write to us. We'll send you a Sweet's Catalog telling you more about it. PPG Industries, Inc., One Gateway Center, Pittsburgh, Pa. 15222.

PPG: a Concern for the Future

Owner: Continental Federal Savings & Loan.  
Architect: Noffsger, Lawrence, Lawrence and Flesher,  
Oklahoma City, Okla.

**PPG**  
INDUSTRIES

Circle 43 on information card



**Du Pont has invented a  
bottomless carpet cushion  
less than 1/2" thick.**



Du Pont has invented a suspension system for people to walk on.

Polyester pneumacel\* carpet cushion. It's neither an elastomeric foam nor a felt. Rather, it is billions of inflated cells in fiber form—masses of tiny pneumatic springs. Actually, pneumacel is a new form of matter.

Nothing cushions like pneumacel. It sinks in easily at first, then pushes back as pressure increases. Never fully compresses. Keeps its resilience.

Any carpet over pneumacel feels luxuriously thick underfoot. Pneumacel spreads the load to help prevent crushing of carpet face pile and stretching of its backing. Prolongs useful life of carpet.

**Composition:** Cellular polyethylene terephthalate (polyester) inflated with a fluorinated hydrocarbon and air. Fiber strands are bonded together with a thermoplastic binder.

**Advantages:** Outstanding cushioning together with protective firmness. High ratings as thermal insulator, and as impact-noise reducer. Highly resistant to moisture, mildew, carpet-cleaning chemicals. Unique combination of low flame spread and smoke generation characteristics. Excellent durability.

**Specifications:** Available through selected local dealers in two styles: "Dunleith" (0.39" thick) and "Lansdowne" (0.48" thick). Comes in rolls 72" wide.

Additional information is detailed in *Sweet's Architectural Catalog File* and *Interior Design File*, reference 9.29/Du. For further information write Du Pont, Pneumacel Marketing, Christina Site, Wilmington, Del. 19898.

\*Pneumacel is the generic term for pneumatic cellular polymeric cushioning material.



## Specify Du Pont Pneumacel Carpet Cushion

### Going On from page 16

when they were called for, no frills when none was demanded. Her artistry in later years is seen in numerous AIA publications; a major and more recent contribution was as designer of the book *Current Techniques in Architectural Practice*.

At the age of 37 Marilyn was blending her talents as artist and businesswoman as she developed her own graphic arts firm, The Associates Inc., in Arlington, Va. She was at her drawing board when a projectile from a workman's stud gun went through a wall, piercing her brain. She died the next day, Aug. 10, after surgery.

Marilyn leaves to the graphic arts profession in general and the architectural profession in particular the fruits of a dedication to detail, a devotion to good taste and a disciplined talent.

Robert E. Koehler, Hon. AIA

## Correction

The restoration architect of the Pennsylvania Academy of the Fine Arts in Philadelphia (July, p. 156) was Hyman Myers, AIA, of Day & Zimmermann Associates.

## LETTERS

**Bicentennial Good Wishes:** I am writing this letter on the eve of a most important date for the American people in order that it may be mailed precisely on July 4, 1976, when the American people celebrate the 200th anniversary of their independence.

As a vice president of the International Union of Architects and in my own behalf, it is a pleasure to send my congratulations to AIA on such a memorable date.

All the world knows, although not all acknowledge, the efforts made by the government and the people of the U.S. to promote and encourage better understanding among the nations living under the flag of democracy. American architects, through the Institute, have set an example for the world because the architecture they have created has gone far beyond their country's boundaries and has served as a guideline for all to follow.

I fervently hope that the American people in general and AIA members in particular will continue to work harmoniously for the betterment of living conditions throughout the world and that they will lend helping hands to the needy through the agency of the United Nations and the International Union of Architects.

Héctor Mestre, Hon. FAIA  
Mexico City

On the auspicious occasion of the bicentennial of the U.S., I take this opportunity

to greet AIA members on my own behalf and on behalf of the architectural profession in all parts of the world.

The architectural profession in the U.S., through persistent effort, has contributed significantly to the growth of contemporary architecture. The profession also has given a lead and impetus to the architectural profession in other countries to work toward the welfare and dignity of man—a contribution which is universally acknowledged and cherished.

I am confident AIA will continue to lead, to provide opportunities and necessary assistance to those who most need it in meeting the needs and aspirations of their communities and to contribute in enhancing the cultural values.

J. R. Bhalla, Hon. FAIA, President  
International Union of Architects  
New Delhi, India

## EVENTS

**Sept. 30-Oct. 1:** Workshop on Energy Management in Schools, Los Angeles. (Repeat workshops: Oct. 7-8, Dallas; Oct. 18-19, St. Louis; Nov. 1-2, Albany; Nov. 15-16, Denver; Nov. 18-19, Minneapolis; Nov. 22-23, Philadelphia; Dec. 13-14, Boston; Jan. 13-14, Atlanta; Jan. 24-25, Seattle.) Contact: Council of Educational Facility Planners International, 29 W. Woodruff Ave., Columbus, Ohio 43210.

**Oct. 1:** Professional Liability Insurance Loss Prevention Seminar, San Francisco. (Repeat seminars: Oct. 15, Atlanta; Dec. 3, Cherry Hill, N.J.; Feb. 3, 1977, Chicago; Feb. 4, Las Vegas; March 17, Houston; March 18, St. Louis; May 6, Boston.) Contact: Edward Petrazio, AIA Headquarters.

**Oct. 6-10:** Florida Association of Architects, Sarasota Hyatt House, Sarasota, Fla.

**Oct. 6-10:** National Office Products Association annual convention and exhibit, Palmer House and McCormick Place, Chicago. Contact: NOPA, 1500 Wilson Boulevard, Arlington, Va. 22209.

**Oct. 10-15:** Conference on Upward Mobility and Professional Development of Women Engineers, Tidewater Inn, Easton, Md. Contact: Engineering Foundation Conferences, 345 E. 47th St., New York, N.Y. 10017.

**Oct. 13-17:** Conference on the International Union of Women Architects, Ram-sar, Iran. Contact: James A. Scheeler, FAIA, AIA Headquarters.

**Oct. 18-19:** Short Course on Project Management, College of Industrial Management and Textile Science, Clemson University, Clemson, S.C.

**Oct. 18-19:** Seminars on Financial Management of Design Firms and on Person-

nel Management and Policies, Sheraton Airport Inn, Denver. Contact: Professional Services Management Association, c/o Frank Stasiowski, King & King, 1 Mony Plaza, Syracuse, N.Y. 13202.

**Oct. 18-20:** Conference on the Dynamics of Fire Prevention, Hyatt House at the International Airport, Los Angeles. Contact: National Fire Prevention and Control Administration, Washington, D.C. 20230.

**Oct. 20-22:** Workshop on the Philosophy and Issues in the Design of Play Environments, University of Wisconsin, Milwaukee.

**Oct. 22:** Postmark deadline, nominations for AIA 25-year award. Contact: Maria Murray, AIA Headquarters.

**Oct. 25-29:** Workshop on Acoustical Modeling, Center for Advanced Engineering Study, Massachusetts Institute of Technology, Cambridge, Mass.

**Oct. 27-31:** Energysave '76 Conference, Currihan Exhibition Hall, Denver. Contact: Kirk W. Fraser, Mefford Warren Weir, 555 17th St., Suite 1010, Denver, Colo. 80202.

**Oct. 28-30:** Louisiana Architects Association convention, Hyatt Regency Hotel, New Orleans.

**Oct. 30-Nov. 1:** Indiana Society of Architects annual meeting, Marriott Inn, Fort Wayne, Ind.

**Nov. 3-5:** Texas Society of Architects annual meeting, Dallas.

**Nov. 12:** Postmark deadline, nominations for AIA honors program. Contact: Maria Murray, AIA Headquarters.

**Nov. 15:** Entries deadline, CRS awards program. Contact: Concrete Reinforcing Steel Institute, 180 N. LaSalle St., Room 2111-D, Chicago, Ill. 60601.

**Dec. 1:** Entries deadline, plywood awards. Contact: American Plywood Association, 1119 A St., Tacoma, Wash. 98401.

**June 5-9, 1977:** AIA annual convention, San Diego.

## Deaths

Robert A. Atkinson Jr., Greensboro, N.C.

Forrest W. Coile, Newport News, Va.

Harold B. Davis, Cape Coral, Fla.

Edwin J. Gerard, Pittsburgh

Francis S. Gurda, Milwaukee

George Kent Hawks, White Plains, N.Y.

W. Remington Hodgson, San Rafael, Calif.

Eugene E. Hougham, Los Angeles

W. Asa Hudson, Beverly Hills, Calif.

Marcus C. Lester, Dallas

Paul V. Matkin, Indianapolis

Anthony J. Piccola, Harrisburg, Pa.

Stanley C. Podd, Elma, N.Y.

Leon A. Schute, High Point, N.C.

Anthony Signorelli, Pelham Manor, N.Y.

Aleck L. Wilson, San Francisco

George C. Zannoth, Fort Lauderdale, Fla.

continued on page 62

# Announcing a new super-tough finish for industrial walls



## It's Inryco Duofinish 700™

Now the same coating that protects offshore drilling rigs, refinery structures and chemical processing equipment is adapted to steel wall panels pre-finished with new Duofinish 700™: a urethane finish coating over epoxy-primed, galvanized steel (hot-dipped with full 1¼ oz. zinc).

**Duofinish 700 is super-tough.** It resists the corrosive, abrasive atmospheres of industrial areas—the hot sun and salt air of coastal sites. **It looks good right from the start and stays looking good longer,** because its smooth surface continues to shed grime and dirt.

Sometimes a corrosive atmosphere is **inside** a building. Duofinish 700 is available on **both exterior and interior** Inryco wall panels.

Duofinish 700 has been subjected to **recognized accelerated testing.** You can evaluate the results yourself in Catalog 22-16. Send for yours now with the handy coupon at the right.

Duofinish 700 is one of many new Inryco developments in building enclosure systems.

INRYCO, Inc., Building Panels Division  
Dept. J, 4127 W. Burnham Street; P.O. 393  
Milwaukee, Wisconsin 53201

I'd like to know more about Inryco Duofinish 700™  
Please send me Catalog 22-16.

Name \_\_\_\_\_

Title \_\_\_\_\_ Company \_\_\_\_\_

Address \_\_\_\_\_

City \_\_\_\_\_ State \_\_\_\_\_ Zip \_\_\_\_\_



**Inryco**

an Inland Steel company

General Offices: Melrose Park, Illinois  
Formerly Inland-Ryerson Construction Products Co.

# CONCRETE PROFESSIONALS



1ST FEDERAL  
DETROIT, MI



TURFLAND MALL CENTRAL BANK  
& TRUST CO., LEXINGTON, KY



LAKE CITY BANK  
MADISON, WI



CITY FEDERAL SAVINGS  
PLAINFIELD, NJ

## you can bank on us.



Strong financial institutions are one of the cornerstones of our free enterprise system. Financial institutions such as banks and savings and loans need modern, efficient and economical buildings to perform their services best. These institutions must not only serve our financial needs well but also inspire public confidence by presenting a solid and successful image.

MFG Concrete Forms have been used in numerous financial building projects. The use of MFG Concrete Forms has been a benefit to the architect, the contractor, the bank, the public, America. Beautiful, economical concrete surfaces from MFG Concrete Forms—in so many applications, you can bank on us.



**MOLDED FIBER GLASS CONCRETE FORMS COMPANY**

3714 Ann Ave. • P.O. Box 675A • Ashtabula, Ohio 44004 • 216/998-1241

"World's largest supplier of fiber glass forms for concrete construction"

when you need that extra something . . .

## GAIL CERAMICS

assure visible success

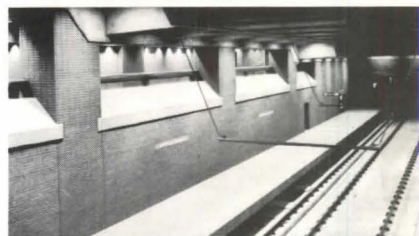

San Francisco Bay Area Rapid Transit Station at Castro and Market streets (Outer Market Street Station), San Francisco, California. Reid and Tarics, Architects.

Superior in every respect:

- beauty, color and variety in a range uniquely unlimited in the industry - in ceramic, quarry and pressed tile, glazed and unglazed, for facing, paving, interior, exterior.
- enduring quality, lifetime guaranteed.
- immediate availability of over 600 standard and specialty shapes, sizes and colors in local and factory stock.
- complete technical and professional service in design/detail development to meet custom specifications.

quality ceramics since 1891

# Gail

1201 Douglas Ave.,  
Redwood City, Ca. 94063

4740 East 26th Street  
Los Angeles, CA. 90040

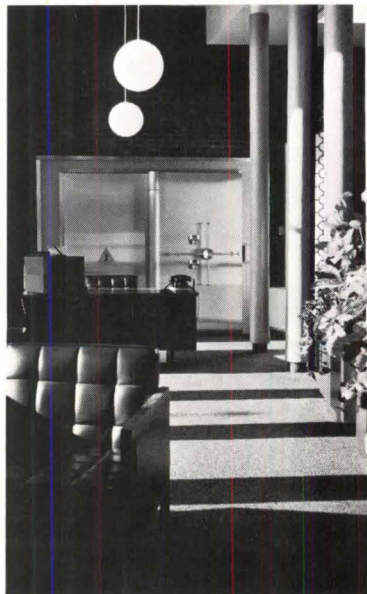
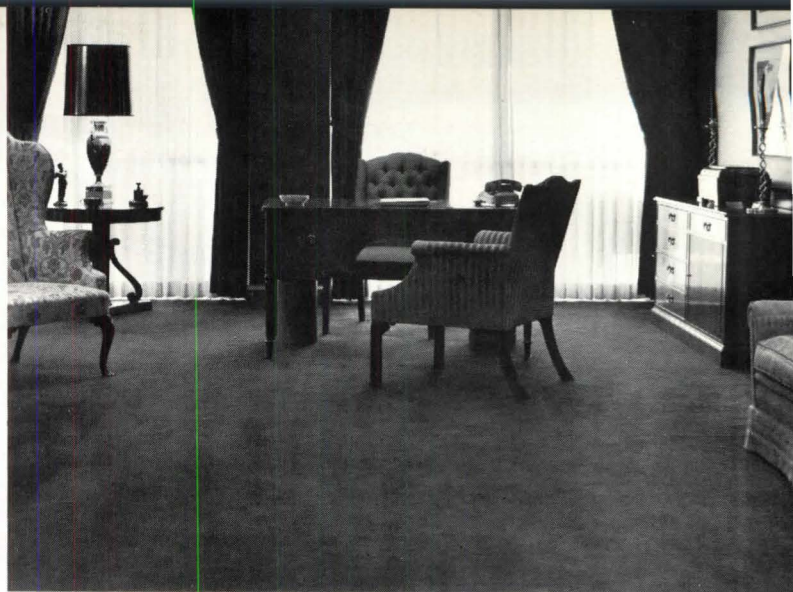
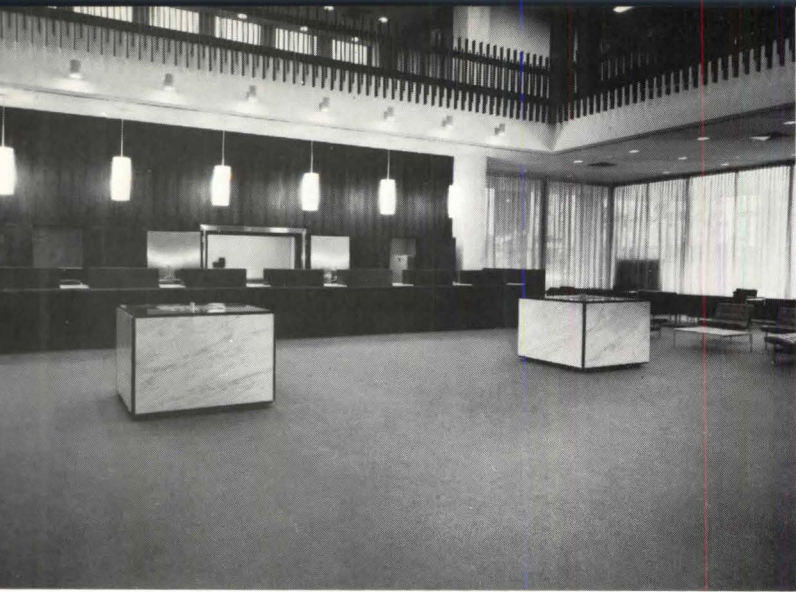

# Bank after bank after bank counts on proven carpet by Bigelow.

If you're doing a bank job, you can create your own specifications for the carpet you want. And we can make it for you.

However, Bigelow has another practical suggestion: specify carpeting that has already proven it can take the hard use (not to mention abuse) bank customers deal out. Carpet that has repeatedly demonstrated it can take a beating year after year after year.

Bigelow has that kind of proven in actual bank use carpeting ready for you in a wide selection of carpet styles and patterns. Carpet that is the result of research and development combined with the realistic experience gained in hundreds of bank installations.

And Bigelow will do more than just sell you proven carpet. We'll give you expert counselling in installation and the best advice available on maintenance. It's a total package designed to assure you that you can specify Bigelow with total confidence.

Bigelow-Sanford, Inc., Dept. N  
P.O. Box 3089, Greenville, SC 29602

I'd like to hear the proof on Bigelow's proven carpets for banks.

NAME \_\_\_\_\_ Print Clearly

TITLE \_\_\_\_\_

ADDRESS \_\_\_\_\_

CITY \_\_\_\_\_

STATE \_\_\_\_\_ ZIP \_\_\_\_\_

## Bigelow®

RUGS & CARPETS SINCE 1825  
A SPERRY AND HUTCHINSON COMPANY

AMERICA'S MOST EXPERIENCED CARPET MAKER

Circle 16 on information card



# READING THIS PAPERBACK CAN CHANGE YOUR MEANS OF SUPPORT.

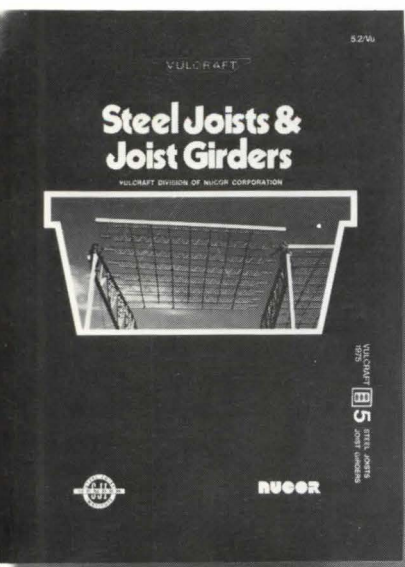

Find out how Vulcraft's system of steel joists and joist girders offers better support. Send for a free, 24-page Specification Guide. If you can't wait for the mail, just call (704) 366-7000 for more information.

I could use support from Vulcraft. Please send me a free Specification Guide immediately.

Name \_\_\_\_\_

Address \_\_\_\_\_

City \_\_\_\_\_

State \_\_\_\_\_ Zip \_\_\_\_\_

## VULCRAFT

P.O. Box 17656, Charlotte, N.C. 28211

Circle 18 on information card

## University of Petroleum & Minerals Dhahran, Saudi Arabia

A newly established Architectural Engineering Department at the University of Petroleum & Minerals, Dhahran, Saudi Arabia, has a faculty position opening for an architect or architectural engineer with teaching and/or practical experience in architectural design.

Minimum two-year renewable contract, competitive tax free salaries plus housing, transportation to and from Dhahran each two-year tour with annual two months' paid vacation plus other allowances and benefits in policy.

Apply immediately with complete resumé indicating marital status, age, nationality, home and office addresses and telephone numbers to:

**Dean of Faculty & Personnel Affairs  
University of Petroleum & Minerals  
Dhahran, Saudi Arabia.**

Circle 19 on information card ►

# PLANNING A WINNING POOL? PUT PARAGON POOL EQUIPMENT IN YOUR PLANS.

Let our design and manufacturing know-how work for you.

Paragon, for over two decades has been a leading manufacturer of swimming pool deck, underwater and filtration equipment. We can help you find the solutions to your problems and provide the best equipment for your design needs.

Our reputation for award winning design, precision engineering and meticulous care that are put into every one of our quality pool products is our benchmark and your guarantee of satisfaction.

To you the creative Architect, our Paraflyte Deck Equipment means total flexibility in design and materials. We offer a variation in grades of materials, superstructures, and price range.

While our catalog shows our many standard designs, we also have complete customizing services to meet your requirements with the highest standards in materials and design.

We have loads of technical data and information available at your request. See our catalog in Sweets Architectural File or write for a copy.

Make sure your winning designs are complimented by the best in pool equipment; specify Paragon and we'll do the rest.

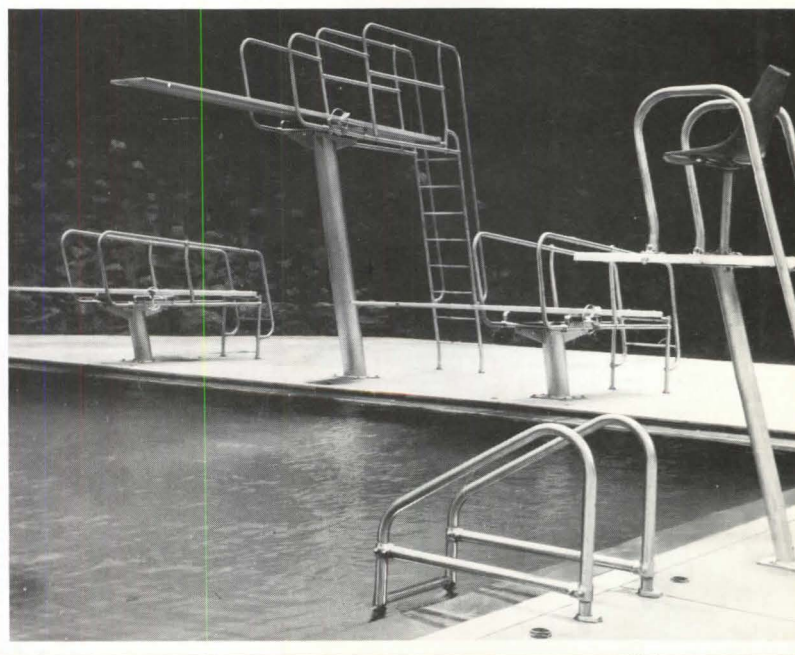
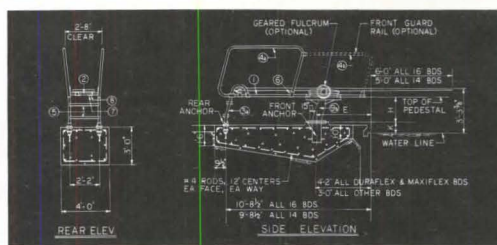

**KDI Paragon Inc. The People Who Care  
Manufacturers of Quality Swimming Pool Products**

KDI Paragon Inc.  
12 Paulding Street  
Pleasantville, N.Y. 10570  
914-769-6221  
TWX 710 572 2202

West Coast Rep.  
Corrick International  
206 Locust St.  
Santa Cruz, Ca. 95060  
408-426-9010



## Newslines

**Basil Honikman**, a native of Cape Town, South Africa, has been appointed chairman of the department of architecture, architectural engineering and planning at the University of Miami. He has been assistant dean of North Carolina State University's school of design since 1975, and prior to that was associated with the University of Kansas' school of architecture and urban design.

**The Lincoln Memorial** in Washington, D.C., now has an elevator, making this landmark accessible to the handicapped. Elevator installation and ramps have been installed also at the Jefferson Memorial, and about 200 curb ramps have been constructed near the Mall.

**Elmer E. Botsai, FAIA**, Institute vice president, has been named to a five-year term as chairman of the department of architecture at the University of Hawaii. Botsai will remain in his capacity as senior partner in the San Francisco firm of Botsai, Overstreet & Rosenberg, planning to spend 50 percent of his time with the firm and AIA.

**A solar heating and cooling information data bank** has been established at the Franklin Institute Research Laboratories

of Philadelphia under a HUD grant. The contract calls for a search of literature and data on both private and federal solar energy projects and dissemination of this information. Franklin also will design a full range of public relations tools, such as brochures, filmstrips, slide shows and exhibits.

**The "Fire Protection Handbook"** has been published in its 14th edition by the National Fire Protection Association. This 1,296-page "fire encyclopedia" incorporates the latest developments in fire technology. It is available for \$43.50 from NFPA, 470 Atlantic Ave., Boston, Mass. 02210.

**Joseph Esherick, FAIA**, president of the San Francisco-based firm of Esherick Homsey Dodge & Davis, and professor of architecture at the college of environmental design, University of California at Berkeley, has been elected an associate of the prestigious National Academy of Design. The academy was founded in 1825 for the "cultivation and extension of the arts of design"; members are selected upon the basis of "recognized excellence" in the arts.

**Thomas B. Muths, AIA**, of Jackson, Wyo., chairman of the Institute committee on historic resources in 1975, was recently sworn in as a member of the national Ad-

visory Council on Historic Preservation. The ceremonies were held at the White House, with the oath of office administered by Vice President Nelson Rockefeller. Muths is currently AIA state preservation coordinator for Wyoming and president of the Wyoming chapter/AIA.

**A public schools energy conservation service (PSECS)** is now being operated by the Educational Facilities Laboratories in conjunction with the Federal Energy Administration. The inexpensive, computer-based technical service is aimed at assisting school districts develop efficient energy conservation programs for physical facilities. For further information, write: John R. Boice, PSECS, 3000 Sand Hill Road, Menlo Park, Calif. 94025.

**The first Charles G. Rummel fellowship in architecture** has been won by Darsey Moore, a graduate of the University of Illinois. The fellowship was established this year by the Chicago-based consulting and architectural and construction management firm of Lester B. Knight & Associates, Inc., in honor of Rummel, who is an executive vice president of the firm. The \$10,000 award, plus tuition and fee waivers, is for five semesters of study toward graduate degrees in architecture at the University of Illinois at Urbana-Champaign. Ms. Moore resides in Delray Beach, Fla. □

### OKLAHOMA STATE UNIVERSITY

#### HEAD, SCHOOL OF ARCHITECTURE

Nominations and applications are sought from architectural educators and practicing architects interested in providing educational leadership to approximately fifteen faculty members and three hundred students.

Applicants should submit complete resumes with references. Nominations should include complete addresses. Closing date is October 31, 1976.

Send inquiries and materials to:

Professor Alan W. Brunken  
School of Architecture  
Oklahoma State University  
Stillwater, Oklahoma 74074

*Oklahoma State University is an equal opportunity/  
affirmative action employer.*

### Questions About Your Subscription

To insure fast service on inquiries concerning your *AIA JOURNAL* subscription, please include the address label from the most recent issue received.

ATTACH  
LABEL  
HERE

### Change of Address

Four weeks' notice required for change of address. Include address label from most recent issue and new address information in space provided below.

#### NEW SUBSCRIPTION

Please check here if you wish subscription rate information.

Name \_\_\_\_\_

Address \_\_\_\_\_

City \_\_\_\_\_

State \_\_\_\_\_ Zip \_\_\_\_\_

#### MAIL TO:

AIA JOURNAL  
Circulation Dept.  
1735 New York Ave., N.W.  
Washington, D.C. 20006



Trans Union Corporation, Lincolnshire, IL  
Harry Weese & Assoc., Ltd., Chicago

## LCN SERIES 2030-OPJ Pacer® Overhead Concealed Closer

THE DOORS LEADING TO THIS STRIKING ATRIUM LOBBY ARE CONTROLLED BY LCN 2030 SERIES CLOSERS CONCEALED IN THE HEADFRAME. LCN OFFSET PIVOTS COMPLEMENT THE INSTALLATION, WHEN THE DOORS ARE CLOSED THE CLOSERS DISAPPEAR LEAVING ONLY THE CLEAN LINES OF THE ENTRANCE. 2030 SERIES HAS THE SUPERIOR ACTION OF FULL RACK AND PINION DESIGN YET FITS IN A  $1\frac{3}{4} \times 4$ " TRANSOM BAR. SINGLE LEVER ARM RETAINS EFFICIENCY WITH QUIET, LOW FRICTION TRACK AND ROLLER.

SEE SWEETS, SEC. 8, OR WRITE FOR OVERHEAD CONCEALED CATALOG

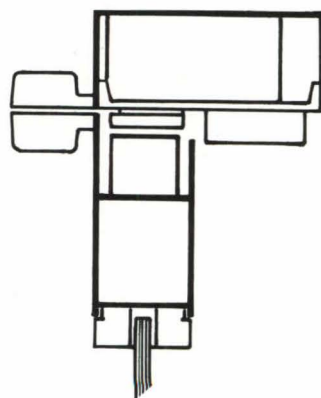

**LCN**  
DOOR CLOSERS

LCN CLOSERS, Princeton, Illinois 61356  
LCN CLOSERS OF CANADA, LTD., Mississauga, Ontario L5G4L5

Circle 20 on information card

## BOOKS

**Preservation and Conservation: Principles and Practices.** Edited by Sharon Timmons. Washington, D.C.: Smithsonian Institution Press, 1976. 547 pp. No price given.

This book contains the edited text of essays and commentaries written for the North American International Regional Conference held in Williamsburg, Va., and Philadelphia in 1972. The contributions are by 44 professionals actively engaged in preservation from the fields of architecture, conservation, law, planning and education, and there are summarized

discussions of the 140 participants at the conference.

The volume is a veritable encyclopedia, fulfilling a long-felt need for a complete reference book which includes every discipline and group concerned with conservation, preservation and restoration. It should be on the ready-reference shelf of every architect interested in the preservation of our structural heritage.

Virtually every material used in historic building construction, or the fine arts, is considered as to its source, composition, strengths, weaknesses, longevity, life expectancy, destructive agents and the means to preserve, restore or extend its life. Performance standards are considered, maintenance and visitor use, man-

agement organizations, and philosophy, criteria and guidelines are explored.

Against this background and the history of conservation in the U.S., the need for and the education accreditation and licensing of specialists in conservation and preservation are discussed.

The conference pointed up a conspicuous difference between the approach of the conservator and the architectural preservationist, the former scientific and laboratory-minded, and the latter more historically and design-oriented. Most of what architects know of chemical and biological actions has been learned empirically and by observation of the action of materials under field conditions. However, all the scientists' papers, except for a few paragraphs and some word usage, should be intelligible to architects.

Giorgio Torraca, deputy director of the International Center for the Study of the Preservation and Restoration of Cultural Property in Rome, wrote in his essay on hard masonry materials: "The importance and complexity of deterioration processes makes it absolutely necessary that these processes be identified before conservation measures are taken. The most important diagnostic aids now available to conservationists are the following:

"1. Analysis of the *chemical composition* and porosity of the masonry material.

"2. Analysis of deterioration products. In addition to the usual chemical analysis of sulfates, nitrates and chlorides, X-ray diffraction and thermogravimetric analyses can give important indications. Average samples taken over reasonably large but homogeneous surfaces should be used whenever possible.

"3. Temperature and humidity surveys of the whole structure in which the affected masonry is located. To be really effective such surveys should include daily and seasonal cycles and should be carried out at a large number of points.

"4. Identification of active vegetation and microorganisms.

"5. Careful inspection of the rainwater distribution in the structure."

Torraca goes on to point out in a table that water, which is the prime culprit, may enter the masonry in four different ways and that, having entered, one or more of four actions may induce stress in the structure and cause deterioration.

He then points out that "this method attributes any alteration of masonry materials to a combination of two causes: the way in which water gains access and some special process including mechanical or chemical stress. Twenty-four combinations are possible, each one causing a specific problem. The conservationist should first try to eliminate the causes of the problem and then to palliate its effect."

Lee H. Nelson, a restoration architect

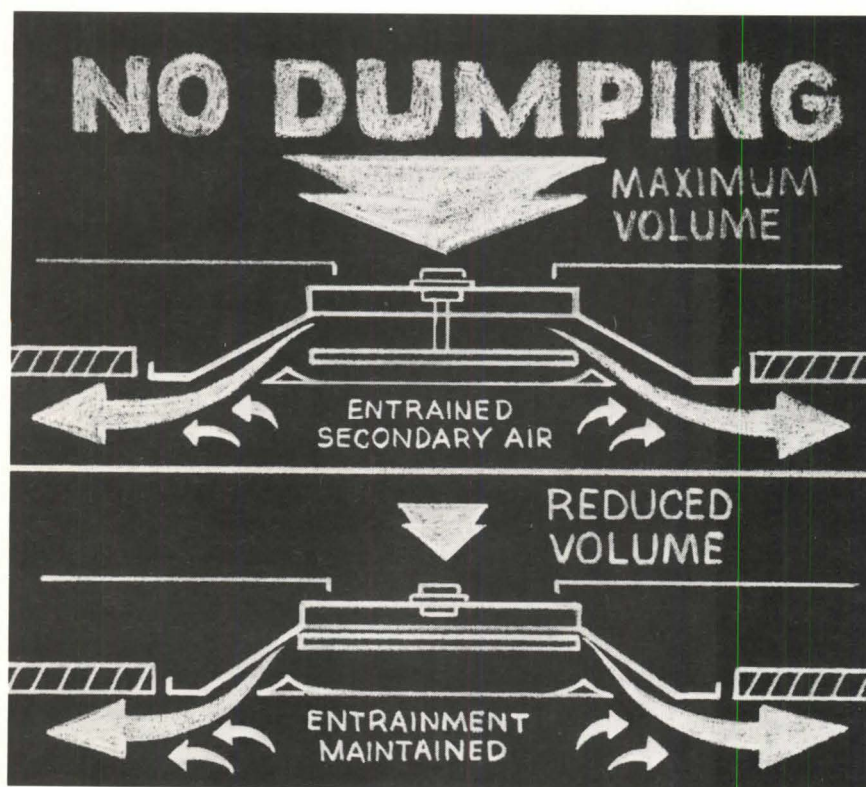

### Reduce air volume yet maintain air pattern and high entrainment with VAV system from Connor

Connor gives you a variable air volume system that provides electric or pneumatic motorized diffusers with variable orifices, constant discharge velocity and, constant air pattern for varying load requirements. Each model maintains primary air discharge velocity and air pattern, even at low air flow. The amount of secondary air entrained remains the same — No dumping!!

With CV-74, you dramatically reduce both initial costs (smaller capacity refrigeration, fan and filter network) and operating costs (less conditioned air distributed). Find out how Connor can solve your problems and save you money. Call your nearest Connor representative or:



**Connor** Incorporated

Shelter Rock Lane, Danbury CT 06810  
(203) 744-6700

Subsidiaries and offices in: New York, Los Angeles, Paris and Copenhagen. Licensees and representatives in: Europe - Middle East - Africa - South America - New Zealand

# Deciding on an insurer? Among the ENR 500, the shift is to Shand, Morahan.

We specialize in E&O coverage for the largest design-construction firms in the world.

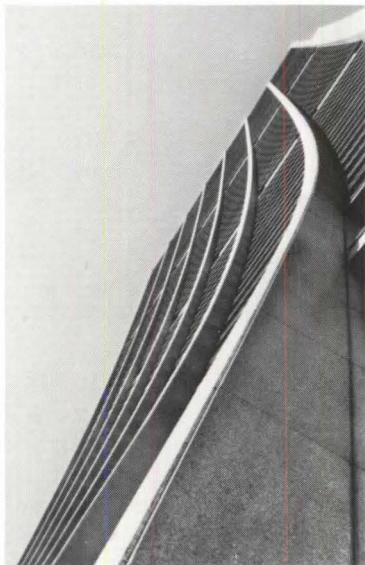

In fact, 24% of the top 55 and 20% of the remaining ENR top 500\* firms already insure with us. And more and more top companies are discovering us each day.

The reasons? Broader protection in many cases, competitive rates, and immediate, no-red-tape, no-long-wait quotes and service—to mention just a few. Switching your E&O insurance to the field's second largest underwriting manager—Shand, Morahan—puts your company right on the trend.

If yours is an ENR 500 firm, and you want to know more about us, ask your broker to give us a call. Our fast, efficient, professional approach to E&O insurance may be just what both of you need.

\*Engineering News-Record, May 20, 1976



**Shand, Morahan & Company, Inc.**

801 Davis Street Evanston, Illinois 60201 312/866-9010  
Cable Shanmor Telex 72-4328

with the National Park Service, presented a commentary on Torraca's paper in which he said: "Dr. Torraca's discussion of the deterioration processes that affect hard masonry materials seems remarkably clear. I must confess that some of us 'chemical illiterates' tend to regard people who profess to cure stone diseases with some suspicion. Admittedly, this suspicion derives from experiences with salesmen or advocates of particular proprietary products, rather than with scientists. It is refreshing, therefore, to read a discussion on the problems we architects face presented in an objective, scientific fashion; however, I have some questions."

Lee then quoted a few statements which he thought needed clarification. Among them: "... Dr. Torraca also states that 'the catastrophic effect of crystal growth on the cohesion of porous materials is a well-proved fact.' This is another instance of the need for a glossary of definitions and certainly the need for architects to be more knowledgeable about chemical processes that affect building materials. To most architects, the catastrophic effect of crystal growth on the cohesion porous materials is a little-known 'well-proved fact.'"

This exchange, poking fun, and many like it, enliven the book and point up the importance of science in the solutions of

the problems of stopping deterioration in the preservation of buildings, as well as the tremendous assistance that close collaboration with conservators can be to architects.

The book is delightful reading and is highly recommended as just plain fun or as a solid study leading to improved professional competence. The only serious fault I could find is the absence of an index, which would make it a textbook, indeed, but this shortcoming is largely compensated for by numerous footnotes and comprehensive bibliographies which accompany each essay. *Orin M. Bullock Jr., FAIA*

**Untaxing Open Space: An Evaluation of the Effectiveness of Differential Assessment of Farms and Open Space.** Council on Environmental Quality. Washington, D.C.: U.S. Government Printing Office, 1976. 401 pp. \$5.40. (Stock No.: 041-011-00031-9.)

So-called differential assessment laws are now in force in 42 states, the first such law having been enacted in Maryland in 1957. The laws have authorized the assessment of open land for real property taxes at the land's current or farm value rather than at its fair market value.

The assumption has been that by reduc-

ing the tax burden of land owners, open land would be preserved, reducing the rate at which land is converted into higher density uses.

The purpose of this report by the President's Council on Environmental Quality is to evaluate the effectiveness of the various types of differential assessment laws. The conclusion is made that such laws do reduce the farmer's tax burden, but that tax benefits depend upon land market, property tax and the characteristics of the particular law within an owner's state.

The conclusion is also made that "differential assessment is an inefficient and expensive tool for achieving land use objectives." The real property tax, says the report, is but one of the factors which influence a land owner in deciding whether to sell his land. More important factors are such things as the price offered for the open land, retirement, death and the presence of heirs. "Few farmers," says the report, "will be deterred from selling by a reduction in property taxes."

Rather, the report says, "It is only when such laws are combined with other effective land-use mechanisms in rural areas that they contribute to successful long-term preservation of open lands." Differential assessment laws alone are not "very effective." □

**Timeless style in white or color.  
Choose Haws drinking fountains  
in  
polymarble.**



Haws Model 1205



Haws Model 1400

Select from the Haws line of polymarble drinking fountains - in White, Cerulean Blue, Tan or Yellow Mist, at no extra cost. Heavy-duty bubbler and patented flush-mounted push-button valves are vandal resistant. Get complete information on Model 1205 and other one-, two- and three-bubbler polymarble models; contact...

**Haws Drinking Faucet Company,**  
1441 Fourth Street,  
Berkeley, CA  
94710



**How to pick up  
the latest information  
on loadbearing  
masonry walls.**

**Just turn to Sweet's**  
Catalog 4.4d/m in the architectural and engineering Sweet's files for the U.S. and Canada. There, for the first time, you will find eight illustrated pages filled with information on brick and concrete masonry units for the increasingly popular, thin-wall engineered loadbearing masonry system. Everything from design details to case histories and cost.

This indispensable booklet, "The New and Modern Capabilities of Engineered Loadbearing Walls" has been published by the INTERNATIONAL MASONRY INSTITUTE with the cooperation of the Brick Institute of America and the National Concrete Masonry Association. Listed on the back page are all the national masonry associations in

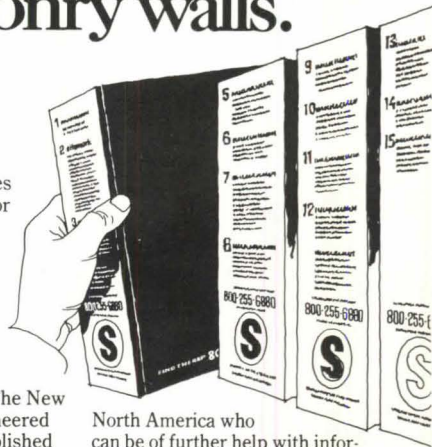

North America who can be of further help with information or technical counsel on this economical and revolutionary building system.

You cannot afford to overlook this Sweet's insert. Pick up the latest word on masonry now.



**The International Masonry Institute®**  
(The Mason Contractors & Bricklayers of the U.S. and Canada)  
823 Fifteenth Street, N.W., Washington, D.C. 20005 (202) 783-3908

NOTE: If you do not subscribe to Sweet's, contact IMI for your free copy of the brochure and a list of all masonry industry publications & films.

# Why Bruning Sure-Scale® drafting film is one of the cheapest insurance policies you can buy.

## VELLUM

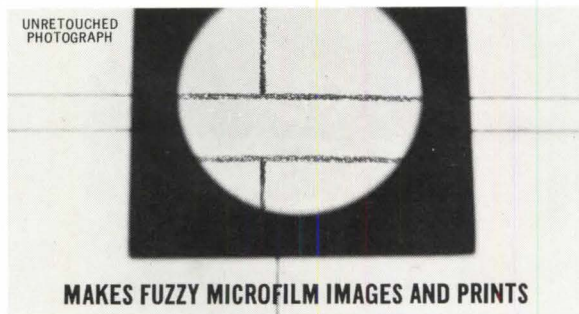
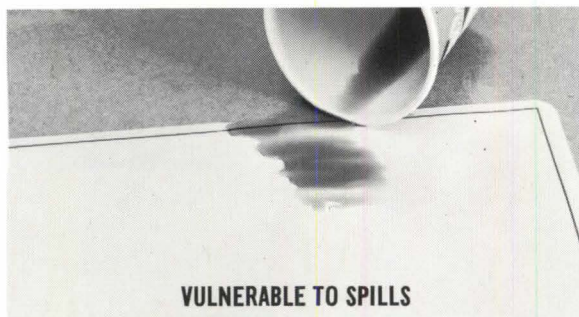
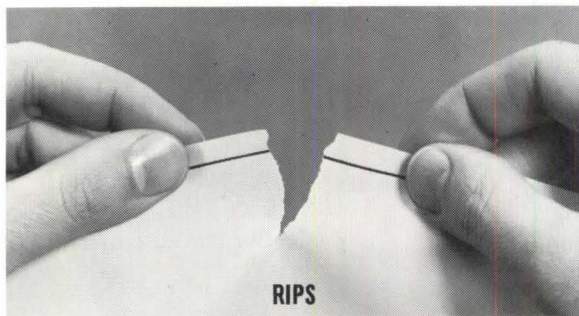

## SURE-SCALE FILM

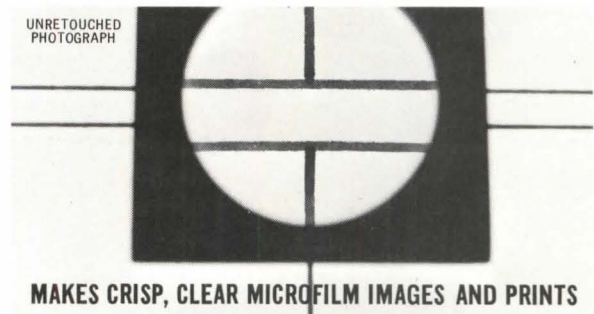
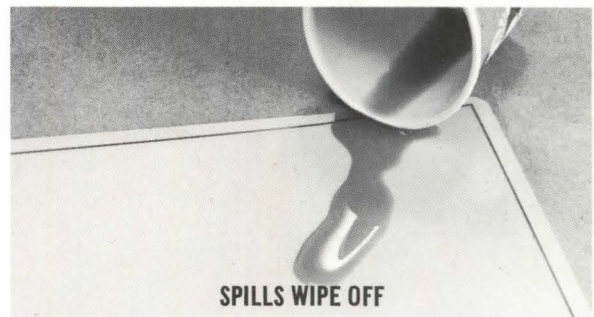
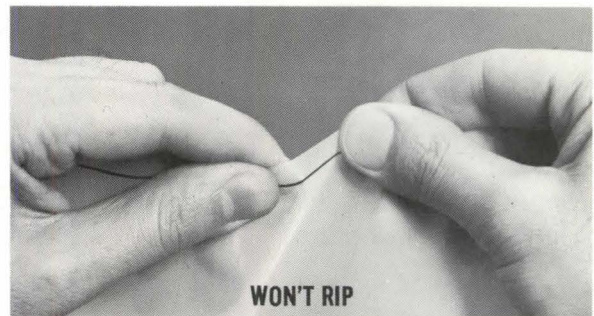
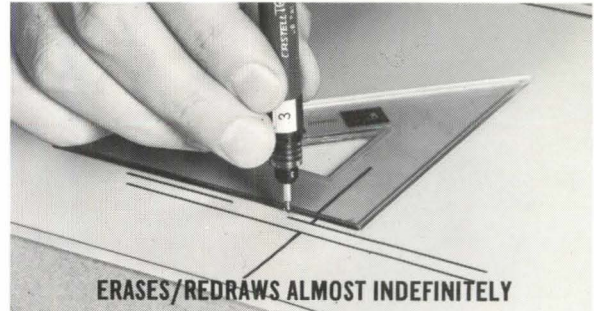

Stop to think for a minute about the investment you have in a completed engineering drawing. It mounts up to many man-hours, and possibly hundreds of dollars. If that drawing is prepared on a vulnerable medium like vellum, you've got a lot at risk. An additional investment of only a few cents, to put the drawing on Bruning Sure-Scale Film instead of vellum, can make that drawing a lot less vulnerable.

Plus, you'll get a better quality

drawing: Sure-Scale provides crisp, clear prints. Revisions can be made with complete line consistency and absolutely no ghosts. And drawings done on Sure-Scale film reproduce best on microfilm. (Important even if you don't use microfilm now, because you'll be prepared when the day comes.)

Bruning Sure-Scale Drafting Film. Don't think of it as an expensive drafting medium. Think of it as cheap insurance. For more infor-

mation, and a sample you can test, call your nearby Bruning Sales Office. Or write Bruning, 1834 Walden Office Square, Schaumburg, Illinois 60172.

**We help architects communicate.**



**BRUNING**

DIVISION OF  
ADDRESSOGRAPH MULTIGRAPH

# ADVERTISERS

**Michael J. Hanley**  
 Publisher

**Michael M. Wood**  
 Sales Manager

**Tom Crow**  
 National Accounts Manager

**Roger W. Carlson**  
 Central Sales Manager

**George L. Dant**  
 Manager, Production and Business  
 1735 New York Ave. N.W.  
 Washington, D. C. 20006  
 (202) 785-7300

## ADVERTISING SALES OFFICES

**New York** (201) 729-9331  
 Tom R. Crow  
 79 Hilltop Trail  
 Sparta, N.J. 07871

**Washington, D. C.** (202) 785-7271  
 Michael M. Wood  
 1735 New York Ave. N.W.  
 Washington, D. C. 20006

**Central Sales Manager** (312) 236-4545  
 Roger Carlson  
 20 North Wacker Drive  
 Room 1552  
 Chicago, Illinois 60606

**Western Regional Manager** (213) 550-827  
 Richard A. Sherwood  
 8899 Beverly Blvd.  
 Suite 405  
 Los Angeles, California 90048

**Acknowledgments:** 22, bottom left, Gorchev & Gorchev; 23, Allen Freeman; 24, Robert C. Lautman; 25, top right and bottom right, Allen Freeman; 25, center bottom, Jo Alexander; 26, top, Allen Freeman; 30-31, Robert C. Lautman; 32-33, Robert C. Lautman; 35, Robert C. Lautman; 37, Robert C. Lautman.

|   |             |  |             |
|---|-------------|--|-------------|
| Bigelow-Sanford, Inc. . . . .             | 59          | National Gypsum Co. . . . .                | 6-7         |
| <i>D'Arcy-McManus &amp; Masius</i>        |             | <i>Fuller &amp; Smith &amp; Ross, Inc.</i> |             |
| Brick Institute of America . . . . .      | Cov. 4      | Nucor Corp. (Vulcraft) . . . . .           | 61          |
| <i>Henry J. Kaufman &amp; Associates</i>  |             | <i>Cargill, Wilson &amp; Acree, Inc.</i>   |             |
| Bruning Div. of Addressograph             |             | Oklahoma State University . . . . .        | 62          |
| Multigraph Corp. . . . .                  | 11          | Owens-Corning Fiberglas                    |             |
| <i>Campbell-Mithun, Inc.</i>              |             | Corp. . . . .                              | 12-13-14-15 |
| Connor, Inc. . . . .                      | 64          | <i>Ogilvy &amp; Mather, Inc.</i>           |             |
| <i>Ads &amp; Images</i>                   |             | PPG (Glass) . . . . .                      | 53          |
| Dover Corp., Elevator Div. . . . .        | Cov. 3      | <i>Ketchum, MacLeod &amp; Grove, Inc.</i>  |             |
| <i>Caldwell, Bartlett, Wood</i>           |             | Producers' Council . . . . .               | 60          |
| DuPont, E. I. De Nemours, Inc. . .        | 54-55       | Red Cedar Shingle & Handsplit              |             |
| <i>N. W. Ayers &amp; Son, Inc.</i>        |             | Shake Bureau . . . . .                     | 4           |
| Edison Electric Institute . . .           | 17-18-19-20 | <i>Ayer/Baker</i>                          |             |
| <i>Charles E. Root, Inc.</i>              |             | Shand, Morahan & Co. . . . .               | 65          |
| Elkay Manufacturing Co. . . . .           | 9           | <i>Hakanson &amp; Associates</i>           |             |
| <i>The Biddle Advertising Co.</i>         |             | University of Petroleum & Minerals .       | 61          |
| Fixtures Mfg. Corp. . . . .               | 10          |  |             |
| <i>Sher, Jones &amp; Litman, Inc.</i>     |             |  |             |
| Gail Ceramics . . . . .                   | 64          |  |             |
| <i>Aizawa Associates</i>                  |             |  |             |
| Georgia-Pacific Corp. . . . .             | 1           |  |             |
| <i>McCann-Erickson, Inc.</i>              |             |  |             |
| Halsey Taylor . . . . .                   | Cov. 2      |  |             |
| <i>Dudreck, DePaul &amp; Morgan, Inc.</i> |             |  |             |
| Haws Drinking Faucet Co. . . . .          | 66          |  |             |
| <i>Pacific Advertising Staff (PAS)</i>    |             |  |             |
| Inryco, Inc. . . . .                      | 57          |  |             |
| <i>Melrose Advertising Associates</i>     |             |  |             |
| International Masonry Institute . . . . . | 66          |  |             |
| <i>Henry J. Kaufman &amp; Associates</i>  |             |  |             |
| KDI Paragon . . . . .                     | 61          |  |             |
| <i>Robert Gretczko Graphic Design</i>     |             |  |             |
| LCN Closers . . . . .                     | 63          |  |             |
| <i>Alex T. Franz, Inc.</i>                |             |  |             |
| LOF . . . . .                             | 2-3         |  |             |
| <i>Campbell-Ewald, Inc.</i>               |             |  |             |
| MFG Concrete Forms Co. . . . .            | 58          |  |             |
| <i>2M Advertising Agency</i>              |             |  |             |



A palace in the sky in Las Vegas.

# ELEVATORS BY DOVER

In a city devoted to the pursuit of happiness, Caesars Palace leads the way. This enormous hotel, with more than 1200 guest rooms, boasts a dazzling complex of lounges, casinos, and restaurants. A recent addition to one of these restaurants, the Palace Court, features a spectacular glass-enclosed Dover Oilraulic Passenger Elevator to move diners between the three levels. For more information on Dover Elevators, write Elevator

Division, Dover Corporation, Dept. G, P.O. Box 2177, Memphis, Tennessee 38101.

Palace Court, Caesars Palace, Las Vegas.  
Architect: Marnell Corrao Associates.  
Contractor: Corrao Construction Co., Inc.  
Interior Design: Franklin Design, San Francisco.  
Dover Oilraulic Passenger Elevator sold and installed by Dover Elevator Co., Los Angeles.

**DOVER**

Circle 42 on information card

# America's oldest building for higher learning has a lesson in it for us.

The Christopher Wren Building of the College of William and Mary. America's oldest academic building in continuous use. And a testament to the permanence, the practicality and the beauty of brick in architecture.

Executed after the design of renowned English architect Christopher Wren in 1699, the structure stands today as a fitting monument to America's educational history. Solid,

functional and simplistically handsome, it serves as a reminder of man's persistent appreciation of the material and suggests the wisdom of its continued use.

All that brick was to the architects of the past, it remains for those of the present and the future. Today's new shapes, new colors, and new concepts for the use of brick assure its place in building history.



To celebrate the nation's bicentennial, BIA has produced a timely film—*Th. Jefferson: Man from Monticello*, a look at Jefferson the architect, the planner. Write us to arrange a special presentation.

**Brick Institute of America**



1750 Old Meadow Rd., McClean, Va. 22101

Circle 52 on information card

