

# The Armstrong Commercial Corlon® Flooring System. A new concept that's been proved in use for over 20 years.



Sandoval™, newest of the Vinyl Corlons, is a styling breakthrough in resilient flooring. It offers the expensive look of terrazzo at a sheet vinyl flooring price.

Today, all across the nation, many millions of square yards of Armstrong Vinyl Corlon are performing beautifully. And many of these installations have been in place for over 20 years. That's just one reason Armstrong .090" gauge sheet Vinyl Corlon is one of the most widely



specified commercial floors. Another is the system that makes it work.

### It looks monolithic.

Corlon comes in 6'-wide rolls up to 90' long. You get a monolithic look because there are few seams. For example, you'll have about 93% fewer seams with Vinyl Corlon than with the same area of 12" x 12" tile.



### Chemically welded seams.

An exclusive Armstrong adhesive chemically welds the seams without heat or special tools. They won't come apart. And they won't trap dirt and moisture.

### Wide range of colors and designs.

Armstrong Vinyl Corlon comes in five distinctive chip patterns and 28 colors ranging from bright and modern to neutral and natural.



### Coving where dirt can't hide.

Flash-coving makes it simple to create a gentle radius where floor meets wall, eliminating the sharp corner where dirt can hide.

### The pattern lasts and lasts.

Armstrong Vinyl Corlons are inlaid materials. Because the pattern and color go all the way through to the backing, they won't wear off like printed products. And

because the inlaid construction is smooth and dense, spills wipe right up. Simple regular maintenance keeps the floor looking like new. These resilient floors meet the flame-spread and smoke-developed requirements of the most widely recognized building codes and regulations.



Vinyl Corlon floors can be installed with a perimeter bonding system developed by Armstrong. In most cases, you can install them right over an old floor and eliminate a lot of work and expense.

The Armstrong Vinyl Corlon Commercial Flooring System. Specify it, and you'll get one beautiful long-lasting floor. For more information, write Dept. 95FAJ, Lancaster, PA 17604.

FROM THE  INDOOR WORLD® OF

# Armstrong

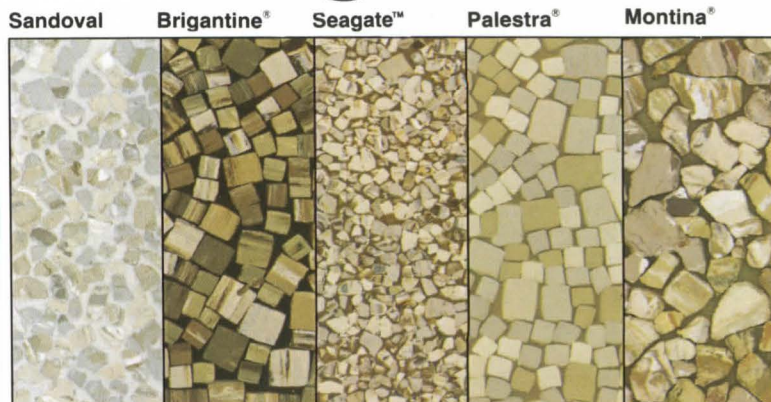

Circle 1 on information card



Doorpulls Geometric forms in cast bronze

# FORMS+SURFACES 80

Forms & Surfaces Box 5215 Santa Barbara, California 93108 (805) 969-4767  
Circle 2 on information card

# CONTENTS

## THE '70s

### The American Institute of Architects

#### Officers

Charles E. Schwing, FAIA, *President*  
R. Randall Vosbeck, FAIA, *First Vice President*  
Gerald L. Clark, FAIA, *Vice President*  
Anna M. Halpin, FAIA, *Vice President*  
Thomas H. Teasdale, AIA, *Vice President*  
Robert M. Lawrence, FAIA, *Secretary*  
J. W. Barnes, FAIA, *Treasurer*  
David Olan Meeker Jr., FAIA, *Executive Vice President*

#### Directors (Year indicates expiration of term)

William Blurock, FAIA ('82), *California*  
James C. Dodd, AIA ('81), *California*  
Donald L. Hardison, FAIA ('80), *California*  
Harry W. Harmon, FAIA ('80), *California*  
R. Bruce Patty, AIA ('82), *Central States*  
Henry W. Schirmer, AIA ('81), *Central States*  
P. Whitney Webb, AIA ('82), *East Central States*  
Ellis W. Bullock Jr., AIA ('81), *Florida/Caribbean*  
E. H. McDowell, FAIA ('81), *Florida/Caribbean*  
Gaines B. Hall, AIA ('81), *Gulf States*  
Ray K. Parker, AIA ('80), *Gulf States*  
Raymond C. Ovresat, FAIA ('81), *Illinois*  
Paul D. Bowers Jr., AIA ('80), *Michigan*  
David A. Holtz, AIA ('80), *Middle Atlantic*  
James R. Nelson, AIA ('81), *Middle Atlantic*  
John Avery Carter, AIA ('82), *New England*  
George M. Notter Jr., FAIA ('80), *New England*  
Harold D. Glucksman, AIA ('80), *New Jersey*  
Joseph Monticciolo ('82), *New York*  
William A. Rose Jr., AIA ('81), *New York*  
Leroy Bean, AIA ('82), *North Central States*  
Edwin B. Crittenden, FAIA ('81), *Northwest*  
William H. Trogdon, AIA ('80), *Northwest*  
Robert Gramann, AIA ('82), *Ohio*  
Derek Martin, AIA ('81), *Pennsylvania*  
John A. Busby Jr., FAIA ('82), *South Atlantic*  
Michael D. Newman, AIA ('80), *South Atlantic*  
William Caudill, FAIA ('82), *Texas*  
Theodore S. Maffitt Jr., FAIA ('81), *Texas*  
Pat Y. Spillman, FAIA ('81), *Texas*  
Thomas B. Muths, AIA ('82), *Western Mountain*  
John B. Rogers, FAIA ('81), *Western Mountain*  
Robert B. Pease, Hon. AIA, *ex officio, Public Director*  
Richard Martini, *ex officio, President, ASC/AIA*  
Ann Stacy, Hon. AIA, *ex officio, Chairwoman, Council of Architectural Component Executives*

#### Headquarters

David Olan Meeker Jr., FAIA, *Executive Vice President*  
James A. Scheeler, FAIA, *Group Executive, Program Development*  
Nancy W. Truscott, *General Counsel*  
William G. Wolverton, Hon. AIA, *Assistant Treasurer/Controllor*  
Michael B. Barker, AICP, *Administrator, Practice and Design*  
Francis X. Brown, *Administrator, Conventions*  
Muriel Campaglia, *Administrator, Public Relations*  
James E. Ellison, AIA, *Administrator, Education and Professional Development*  
Arnold J. Prima Jr., AIA, *Administrator, Government Affairs*  
James A. Schuping, *Administrator, Component Affairs*  
David Olan Meeker Jr., FAIA, *President, AIA Corporation*  
Jeanne Butler Hodges, *President, AIA Foundation*  
Charles R. Ince Jr., *President, AIA Research Corporation*  
John H. Schruben, FAIA, *President, Production Systems for Architects and Engineers, Inc.*

### 38 RECAP: Highlighting Events of the Decade. By Stanley Abercrombie, AIA

#### Big in the '70s:

- 51 *Interior Design—S.A.*  
54 *Recycling and Restoration—S.A.*  
57 *Energy-Conscious Design. By Marguerite Villecco*  
60 *Architectural Drawings—S.A.*

#### Reflections:

- 64 *The Reluctant Acceptance of Finitly. By Gerald Allen*  
65 *Working with an Inherited Language. By Peter Smithson*  
66 *A Funny Thing Happened on the Way to the '80s. By James Marston Fitch*  
68 *A Decade of Trial and Success. By Bernard P. Spring, FAIA*  
70 *In Conclusion, a Multidisciplinary Discourse. By Donald Canty*

### 74 The Celebration of Architecture in Retrospect By Ernest Wood

4	Events and Letters	80	Books
11	News	118	Advertisers

**Cover:** Photograph by John Tennant of a proposed theater design (c. 1850) for an Ecole des Beaux-Arts project by Richard Morris Hunt (AIA Foundation, Prints and Drawings Collection, see p. 19). It is used here to symbolize the new attention to drawings, and to history, that marked the '70s.

**Donald Canty**, Editor; **Suzy Thomas**, Art Director; **Carole Palmer**, Associate Art Director; **Stanley Abercrombie**, AIA, Senior Editor, Architecture; **Mary E. Osman**, Senior Editor, Departments; **Andrea O. Dean**, Senior Editor, Articles; **Allen Freeman**, Managing Editor; **Nora Richter**, Associate Editor; **Michael J. Hanley**, Publisher; **Michael M. Wood**, National Sales Director; **George L. Dant**, Production and Business Manager; **Gladys O. McIntosh**, Circulation Manager; **Lisa Moore**, Administrative Assistant.

The AIA JOURNAL, publication number: ISSN0001-1479, official magazine of The American Institute of Architects, is published 14 times yearly at 1735 New York Ave. N.W., Washington, D.C. 20006. Second class postage paid at Washington, D.C., and additional mailing offices. © 1979 by The American Institute of Architects. Opinions expressed by the editors and contributors are not necessarily those of AIA. VOL. 69, NO. 1.

## EVENTS

**Feb. 3-7:** American Society of Heating, Refrigerating and Air-Conditioning Engineers semiannual meeting, Los Angeles Hilton, Los Angeles. Contact: ASHRAE, 345 E. 47th St., New York, N.Y. 10017.

**Feb. 5-6:** Health Facility Codes and Standards Workshop, Clearwater Beach, Fla. Contact: American Hospital Association, 840 N. Lake Shore Drive, Chicago, Ill. 60611.

**Feb. 6-9:** Conference on Regional Architecture Considered/Reconsidered, San Francisco. Contact: Wayne Attoe, San Francisco Center for Architecture and Urban Studies, Abbott Building, 1045 Sansome St., San Francisco, Calif. 94111.

**Feb. 7-8:** Virginia Society of Architects/AIA winter meeting, Richmond.

**Feb. 9-10:** Seminar on earthquakes, University of California at Davis.

**Feb. 10-13:** Air Conditioning Contractors of America annual convention, St. Francis Hotel, San Francisco. Contact: ACCA, 1228 17th St. N.W., Washington, D.C. 20036.

**Feb. 14-15:** Seminar on regional industrial energy conservation, Sheraton Atlanta Hotel, Atlanta. (Repeat seminars: Apr. 24-25, Lowes Summit Hotel, New York City; June 19-30, Sheraton Plaza Hotel, Chicago.) Contact: Association of Energy Engineers, 4205 Pleasantdale Road, Suite 340, Atlanta Ga. 30340.

**Feb. 14-15:** Structural Design of Industrial Buildings Workshop, University of Wisconsin, Madison.

**Feb. 15-16:** Workshop on Passive Solar Energy Conservation, University of Texas, Austin.

**Feb. 21:** Designing for Barrier-Free Mobility I (second seminar on Mar. 6), New York Institute of Technology, sponsored by the Long Island Chapter/AIA. Contact: Perry B. Goldstein, AIA, 600 Old Country Road, Garden City, N.Y. 11530.

**Feb. 22-23:** Earth-Sheltered Housing Conference, Portland, Ore. Contact: Underground Space Center, 11 Mines and Metallurgy, 221 Church St. S.E., University of Minnesota, Minneapolis, Minn. 55455.

**Feb. 24-27:** National Roofing Contractors Association convention and exhibition, New Orleans. Contact: NRCA, 1515 N. Harlem Ave., Oak Park, Ill. 60302.

**Feb. 26-28:** Engineers Public Affairs Forum, Hyatt Regency Hotel, Washington, D.C. Contact: American Consulting Engineers Council, Public Affairs Forum, 1015 15th St. N.W., Washington, D.C. 20005.

**Mar. 2-6:** Environmental Design Research Association annual conference, Charleston, S.C. Contact: Stephanie Sanders, Center for Metropolitan Affairs, College

of Charleston, Charleston, S.C. 29401.

**Mar. 20-22:** South Carolina Chapter/AIA annual meeting, Columbia.

**Mar. 25-27:** Seminar on the Modernization and Rebuilding of Hospitals, Caribbean Gulf Hotel, Clearwater Beach, Fla. Contact: A. J. Fifer, Ontario Association of Consulting Quantity Surveyors, 584 Dickinson Ave., Ottawa, Ontario, K1V, 7J4, Canada.

**Mar. 27-28:** A/Es Federal Marketplace for the '80s, Sheraton Harbor Island Hotel, San Diego, sponsored by the Committee on Federal Procurement of Architectural/Engineering Services. Contact: Government Affairs Department, AIA Headquarters.

**Apr. 15:** Applications deadline, Kate Neal Kinley Memorial Fellowship in architecture, art and music. Contact: Dean J. H. McKenzie, College of Fine and Applied Arts, 110 Architecture Building, University of Illinois, Urbana, Ill. 61801.

**May 20:** Entries deadline, 1980 photographic exhibit scheduled for June 22-27, Palmer House, Chicago, sponsored by the American Society for Testing and Materials. Contact: ASTM Developmental Operations Division, 1916 Race St., Philadelphia, Pa. 19103.

**June 1-4:** AIA annual convention, Cincinnati.

## LETTERS

**Frank Lloyd Wright Foundation:** Every time the name of Robert Twombly surfaces, there is some mention of the Frank Lloyd Wright Foundation's "closing its files to all but 'approved' scholars," as there was in the review of Twombly's book *Frank Lloyd Wright: His Life and His Architecture* in the September '79 issue (p. 100).

Contrary to the impression given in the review, the foundation, through Bruce Brooks Pfeiffer, has not only been responsive to requests of scholars and quite cooperative, but also has devoted countless hours lending them invaluable assistance. As for "approved" scholars, it is customary for private organizations to ask for references from those who seek to use their resources and archives. I wish that the reviewer had at least checked with us.

Although the primary objectives of the foundation have never been stated in this way, I believe that the staff generally considers them to be the conservation of the landmark properties, Taliesin and Taliesin West, and of the drawings of Frank Lloyd Wright for the general benefit of mankind.

Pfeiffer undertook the enormous task of preserving, cataloging and recording

the drawings and files. His first efforts were directed toward gathering the material, much of which had been handled somewhat unsystematically during the architect's lifetime. Some drawings were irretrievably lost, others not returned by clients and some stolen. Now, the drawings and files are carefully kept in storage pending the eventual construction of a library to house them permanently.

*Charles Montooth  
Taliesin West  
Scottsdale, Ariz.*

**Natural Light:** It was a delight to read the September '79 issue regarding use of natural light.

We architects, during the last two decades, have been falling into the clever clutches of proponents for artificially contrived environments. The architecture has reflected this trend. Design and honor awards were given to windowless, airconditioned, artificially contrived buildings. The worst offenders were schools. A generation of students has been horribly deprived of a natural learning environment. The results are already coming into focus. It is hoped that the human spirit will prevail.

We are still building these scientific monsters here in south Florida, to this very day. Energy be damned. We have probably the most desirable natural environment in the country.

The future in architectural design has been enhanced by the energy crisis. Opportunities to create a better environment are in the architect's hands.

*F. Louis Wolff, AIA  
Fort Lauderdale, Fla.*

This is to commend the September 1979 issue on natural light and, in particular, the article "Strategies of Daylight Design" by Marguerite Villecco with Steve Selkowitz and J. W. Griffith (p. 68). I receive three professional publications each month and find the JOURNAL consistently the most useful.

The small practitioner (what an awful phrase) works in an environment in which his contact with other design professionals is limited. It is from informative materials in periodicals and other media that he is able to keep in touch with the state of the art. Keep up the good work.

*Jerry L. Germer, AIA  
Salt Lake City*

Congratulations! The September issue on the use of natural light underlines one of the eternal verities of architecture. I also discovered that editors can be human: Le Corbusier's Villa Roche entrance hall (p. 57) looks as good upside down as right side up.

*Frederick Kuhn, AIA  
Detroit*

# ANNOUNCING THE OWENS-CORNING ENERGY AWARD WINNERS FOR 1979.

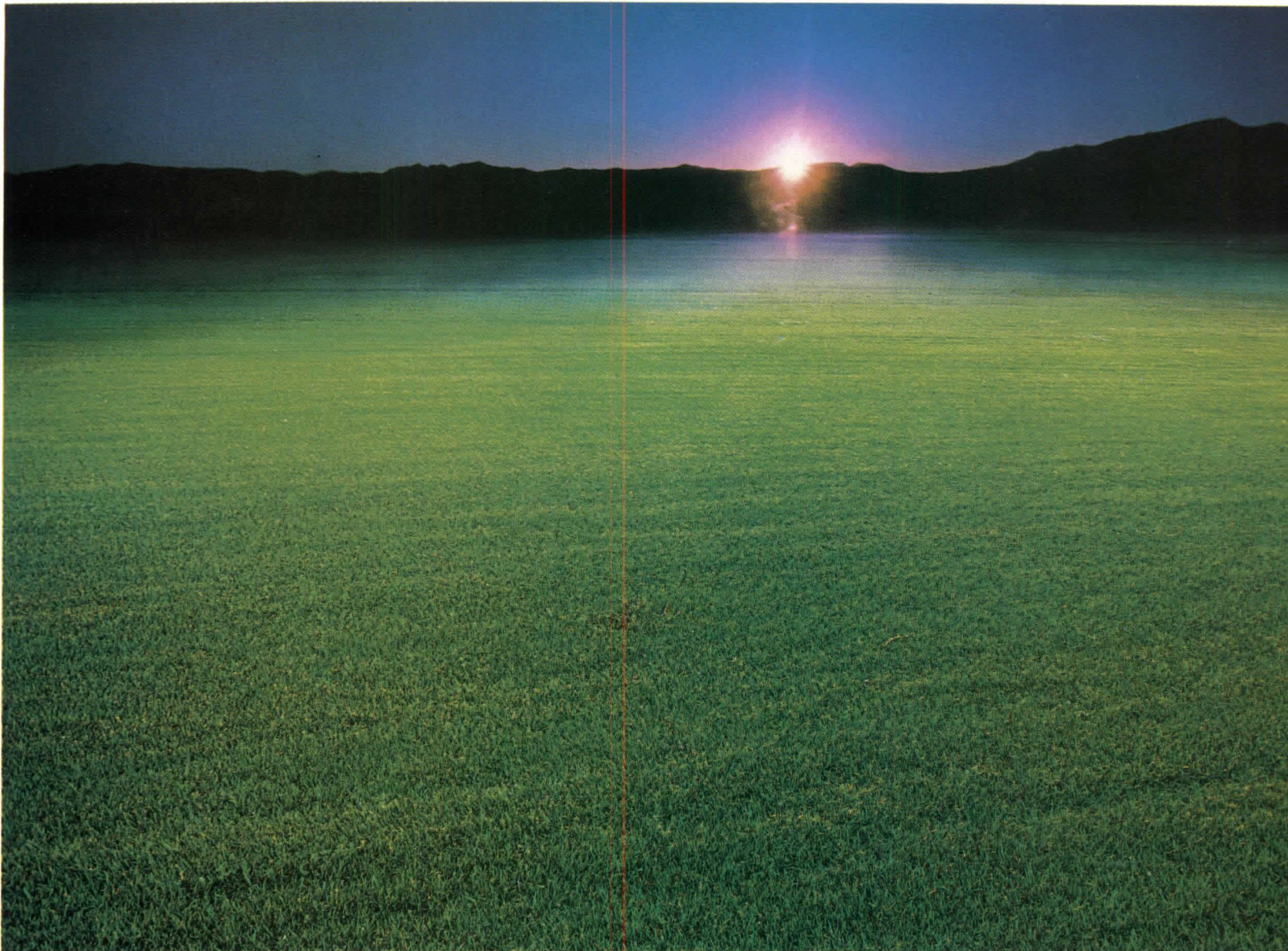

**FOUR WINNERS.** Seven honorable mentions. In all, eleven designs as efficient with their environment as they are with energy.

Designs representing the labors of an elite corps of architects and engineers. Individuals who realize that the need to create exciting, energy-efficient buildings is not just a noble gesture but a necessity.

On the following pages are the four winning designs. Their creators. And the environment with which each structure will coexist.

**THE AWARD JUDGES:** C. William Brubaker, executive vice-president of Perkins & Will, Architects, Chicago/ G. Day Ding, head of the Department of Architecture at the University of Illinois/ David L. Grumman, president of Enercon, Ltd., Energy Consultants, Evanston, Illinois/ George E. Hartman, a partner in Hartman-Cox Architects, Washington, D.C./ Roderick R. Kirkwood, a partner in John Graham and Company, Architects, Seattle/ Mortimer M. Marshall, Jr., director for Construction Standards and Design, Office of the Secretary of Defense, Washington, D.C.

**PROJECT: Solar Energy Research Institute, Golden, Colorado.**

This research center is a perfect example of practicing what one preaches.

A steplike complex of two-, three- and four-story buildings interspersed with greenhouses and solar courts. All nestled in a natural "sun bowl" on the south slope of a Colorado mesa. Protected from the winds, yet open to the full force of the sun.

Over 80 percent of the building's power is passively and actively supplied by energy systems using renewable resources.

In total, this "tribute" to solar power will consume less than a quarter of the energy required by comparable buildings.

*MR. DING: This structure not only houses energy research facilities, but also demonstrates state-of-the-art technology in solar and other renewable energy sources.*



Paul Kennon, Caudill Rowlett Scott, Archt., Houston, Tex.; John Anderson, John D. Anderson & Assoc., Archt., Denver, Col.; Vic Langhart, Rogers Nagel Langhart, Archt., Denver, Col.; Fred Dubin, Dubin-Bloome Associates, Eng., New York, N.Y.



Helmut Jahn, C.F. Murphy Assoc., Archt.; Frank Bridgers, Bridgers and Paxton, Eng., Albuquerque, N. Mex.; James Goettsch, C.F. Murphy Assoc., Archt., Chicago, Ill.



**PROJECT: Department of Energy/Argonne National Laboratories Program Support Facility, Argonne, Illinois.**

It's four-fifths office building. And one-fifth water retention pond. Circular and compact. A design that's perfectly tuned to the nondirectional nature of the building site. And one that offers minimum exterior wall space; maximum office space.

Skylights are interspersed across the undulating roof providing up to 65 percent of the interior lighting.

On the southside overlooking the pond are three canted, vertical rows of solar collectors.

The mechanical system utilizes solar for heating and cooling, internal heat recovery and a low-velocity air distribution system.

MR. GRUMMAN: *This building has a projected energy consumption of slightly over 27,000 Btu's per square foot per year. And that's quite an accomplishment in a northern climate.*

Sam Davis AIA, Berkeley, Cal.; Vladimir Bazjanac Ph.D., Berkeley, Cal.



**PROJECT: Summertree Housing Development, Sacramento, Cal.**

Think of this development as 144 individual energy-conserving dwellings. All existing on eight acres of suburban Sacramento soil.

The quintessential housing project. Combining some of the best architectural features of the single-family house with energy efficiency.

Each unit is equipped with both active and passive energy components. Including solar collectors with individual computer controls.

Landscaping and site planning contribute heavily to the development's energy performance as well as to its livability.

Each unit has a southern orientation. Double-glazed windows. And clerestory windows for natural lighting and ventilation.

*MR. MARSHALL: The project is architecturally compatible with the environment. It's refreshing to see a residential developer who is concerned with the integration of energy conservation and architecture.*

**PROJECT: California Farm Bureau, Sacramento, Cal.**

When completed, this two-story structure will be recessed into the earth. With the appropriate sides utilizing screen planting; the west side being bermed out.

The heating, ventilating and air-conditioning systems are designed to save 74 percent of the heating and cooling energy as compared to a conventional plan. The energy savings will be achieved through the evaporative cooling at night of chilled water which is stored and utilized for cooling. Also by computer room heat recovery, and a solar-assisted domestic hot water heater.

MR. HARTMAN: *Here is a very careful pairing of a simple energy-conserving design with sophisticated controls of conventional mechanical equipment.*



Bill Hutcheson, John Pflueger, Pflueger Architects, San Francisco, Cal.; Arthur Zigas, Shlomo Rosenfeld, Syska & Hennessy Inc., Eng., San Francisco, Cal.

**HONORABLE MENTIONS**—Commercial: Central Pre-Mix Concrete Co., Spokane, Wash.; Walker McGough Foltz Lyerla, P.S./Commercial: Sunstructure Office Building, Albuquerque, N.Mex.; The Burns/Peters Group./Institutional: Milford Reservation Environmental Center, Pike County, Pa.; Kelbaugh & Lee Architects./Commercial: North Spokane Branch, Seattle First National Bank, Spokane, Wash.; Walker McGough Foltz Lyerla, P.S./Institutional: Gloria Floyd Elementary School, Miami, Fla.; Saez/Pacetti Architects/Planners./Special: Solar House, Lake Tahoe, Cal.; MWM, Mackinlay/Winnacker/McNeil AIA & Assoc./Commercial: San Francisco Downtown Airlines Terminal, San Francisco, Cal.; Jacques de Brer, AIA, John Ellis, RIBA. ©1980 O.-C.F. Corp.

**FOR A FREE BOOKLET** with highlights of this year's winners, write C. C. Meeks, Owens-Corning Fiberglas Corp., Fiberglas Tower, Toledo, Ohio 43659.



Circle 3 on information card

# Columbia supertube!

Fluorescent lighting that goes up ...  
over... down... or around corners...  
wherever you want it!



Columbia Operation  
TA Box 2787  
Spokane, WA 99220  
(509) 924-7000

**SYLVANIA**

Specification  
Lighting

Columbia Lighting's versatile aluminum supertube brings flexibility and sparkling colors to architectural lighting. They may be suspended from ceilings or bracket mounted on walls in standard or custom sizes to fit your job. Lamp openings are symmetrically centered and each fixture retains its own "turnability" . . . you can aim it. For more information contact your Columbia agent or write us; we have answers to lighting questions you've yet to ask.

**GTE**

Circle 4 on information card

*The Institute*

## Board Launches Investigation Of the Entire Ethics Concept

If the December meeting of AIA's board of directors is a portent of things to come, there will be lively debate at grassroots meetings and at the March meeting of the board and perhaps still more heated discussion at the AIA convention in June. According to board action taken in December, the March meeting could result in a resolution to be taken to the convention that would call for either repeal of AIA's code of ethics and professional conduct or revision of it to remove any anticompetitive aspects.

After hearing a preliminary report by the legal decision impact task force, formed in 1979 to study the effects of recent legal decisions on AIA's ethical code and the related impact upon the Institute's documents, publications and structure, the board voted to adopt a procedure to be followed regarding the report's recommendations. Although in December the board did not adopt the task force recommendation that, in principle, the code be replaced by a new statement, it voted to seek the views of AIA members at grassroots meetings, to be reported at the March meeting.

Participants in the grassroots meetings

### The Institute

<i>Board looks at ethics</i>	above
<i>Schwing installed as president</i>	14
<i>Epstein to receive Kemper</i>	19
<i>Campbell honored posthumously</i>	19
<b>Energy</b>	
<i>Performance standards issued</i>	22
<i>Eighth century airconditioning</i>	27
<b>Government</b>	
<i>New public buildings proposal</i>	27
<i>Goldschmidt says no to highway</i>	30
<i>Competition in Portland, Ore.</i>	34
<i>Tallgrass prairie bill</i>	104
<b>Practice</b>	
<i>Manhattan highrise opposition</i>	104
<i>de Moll and the UIA</i>	106
<i>Barrier free standard</i>	108
<i>Real estate outlook called bright</i>	108

will be asked to consider three options: (1) revision of the ethical code in order to minimize any anticompetitive effects, with enforcement maintained; (2) repeal of the code, adopting a new statement of principles free of anticompetitive positions that would be mandatory and enforced, or (3) repeal of the code, replacing it with a new and comprehensive statement of principles of professional conduct which would be voluntary. Under the third option, enforcement of professional conduct standards would be solely the responsibility of registration boards.

Pending action at the March meeting, the board directed Secretary Robert M. Lawrence, FAIA, to process no further charges under the present ethical code that "in the opinion of legal counsel could be considered anticompetitive by enforcement agencies." At this writing, it appears that charges which would not be processed would pertain to certain business procedures dealt with in the present code, such as unethical advertising, rather than personal misconduct charges.

The board also heard a report by the government affairs commission regarding public policies of the Institute. Under procedures adopted by the board in May 1979, every public policy is subject to review at least every three years. Any policy not reaffirmed or amended after three years is automatically rescinded upon notification of the board. The board rescinded several policies. Some of these were outdated, such as the 1970 policy on product boycotts, which called for legislation to prevent union boycotts of ready to install building products and materials. Other policies rescinded are included in other AIA policy statements, such as the 1972 policy on the Occupational Safety and Health Act in support of legislative or administrative action to remove provisions more appropriately included in recognized building codes, which is now a part of a new policy on

codes. Still other policies dropped by the board are to be rewritten this year, such as the 1970 policy on urban planning which called for support of programs to revise property tax systems, devise new zoning concepts for diversity of land use and simplify building codes.

The board adopted an urban design public policy statement, calling for the nation to focus renewed attention on its cities. The policy says that AIA shall support the conservation of nonrenewable resources, shall urge citizen interest to be integrated into policies and decisions which "impact them and their communities," shall call upon federal, state and local governments "to support urban design as an essential element in all policies and programs affecting our cities and communities," shall encourage the "formation of public-private partnerships as a means of realizing both public and private development goals" and shall affirm "that architects must continue to play a crucial role in the interdisciplinary urban design process."

Among the policies reaffirmed were: support of a barrier-free environment for the handicapped; support of the recognition and strengthening "of the integrative leadership role that the practicing architect and the future practitioner will have in energy conservation programs at the building scale" and support of the adoption of the metric system as the national standard of weights and measurements in the U.S.

The board also reaffirmed and adopted a policy regarding energy units which calls for the Department of Energy "to recognize the role of architects" in the performance of energy audits. The board also reaffirmed its support of the Department of Energy's building energy performance standards (see p. 22).

In other action, the board approved the Institute's 1980 legislative program. Among the policies considered "significant" are legislation to allow a tax deduction for contributions to self-insurance liability trusts and architect selection procedures based on competence and qualifications.

Among other action taken by the board were the following:

- approval of the proposed agreement of affiliation between AIA and the Architect-

*continued on page 14*

# IF YOU THINK ALUCOBOND™ MATERIAL IS GREAT FLAT OUT, WAIT TILL YOU SEE HOW IT TAKES



The building on the left is an example of what ALUCOBOND material doesn't do.

Namely ripple, buckle, or bulge.

Thanks to this remarkably flat composite of two aluminum sheets and a thermoplastic core, oil-canning has been totally eliminated on Kubota Tractor's streamlined U.S. headquarters in Compton, California.

The building on the right is an example of what ALUCOBOND material does do.

Wrap around corners in sinuously graceful lines.

The incredibly smooth curves and uniform color of this Consolidated Aluminum product help create a beautiful first impression for Trailer Life Publishing Company in Agoura, California.

Available in six siliconized polyester resin colors and four handsome

*When Daniel Dworsky, FAIA, of Daniel L. Dworsky FAIA and Associates, Inc., selected ALUCOBOND material, a key consideration was the easy expansion it permits.*

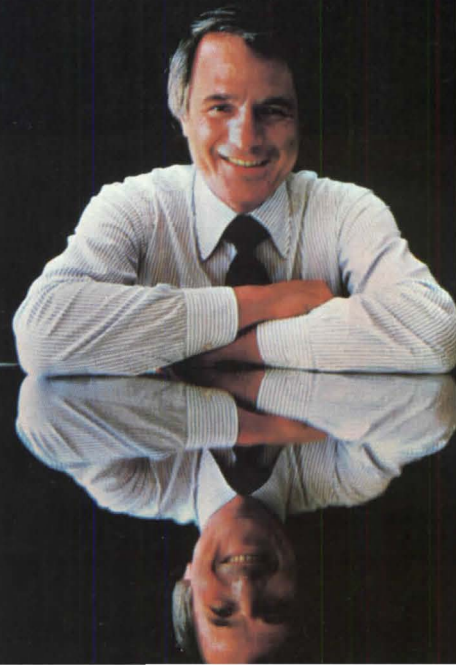

# THE CURVES.

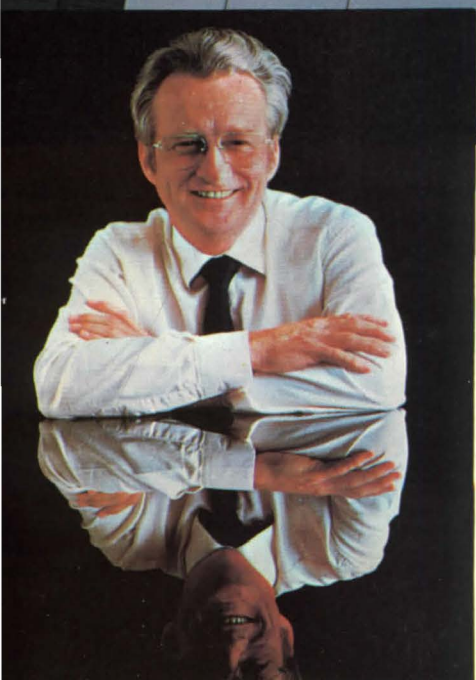

anodized finishes, ALUCOBOND material comes in panel sizes up to 5' X 28' and thicknesses of three, four, and six millimeters.

And its extraordinary adaptability offers architects design possibilities as diverse as their imaginations.

Why not find out more by calling our Product Manager, Carla Lane, right now at (314) 878-6950.

*Jerrold Lomax, AIA, of Lomax-Mills-Architects, shares credit for his creative use of ALUCOBOND material with Project Architect John Rock.*

She can provide you with samples and additional information on ALUCOBOND material. An innovative product from Consolidated that's smoothing the way for creative architects everywhere.



Circle 5 on information card

**The Institute** from page 11  
tural Secretaries Association, subject to  
ASA ratification;

- approval of an increase, by an average of 15 percent, in the retail price of the seven "most popular" AIA documents and of all new and revised documents released in 1979;
- approval of the formation of the Durham Section of the North Carolina Chapter/AIA, to be composed of members in Durham and Orange Counties, and the formation of the West Tennessee Chapter/AIA, to include members in all counties in the western part of the state, with the exception of Shelby County, in which the city of Memphis is located;
- approval of the change of the name of Southern California Chapter to the Los Angeles Chapter/AIA;
- approval of eight new documents, including new construction management editions of the owner-contractor agreement and the owner-architect agreement;
- acceptance of reports by regional directors which, in general, agree with the report of the Middle Atlantic region that economic health "continues to remain steady," and with other reports which indicate that major concerns among practitioners are competitive bidding and liability, and that architecture's "celebration" will go on (see p. 74).

## Schwing, New Officers Installed Along with 12 New Directors

Charles E. Schwing, FAIA, president of the Baton Rouge, La., firm of Charles E. Schwing & Associates, was inaugurated as president of AIA on Dec. 7, 1979. The ceremonies took place at the Pension Building in Washington, D.C., site of the proposed national museum of the building arts. Schwing, who succeeds Ehrman B. Mitchell Jr., FAIA, of Philadelphia, has served the Institute as first vice president, vice president and treasurer. He has also been treasurer of the AIA Research Corporation and of the AIA Foundation. He has been vice president and secretary/treasurer of the Baton Rouge Chapter/AIA and president, vice president and secretary/treasurer of the Louisiana Architects Association/AIA. He studied at the Georgia Institute of Technology and the Ecole des Beaux-Arts.

Also installed were five other national officers: R. Randall Vosbeck, FAIA, Alexandria, Va., first vice president/president elect; Gerald L. Clark, FAIA, Phoenix, Anna M. Halpin, FAIA, New York City, and Thomas H. Teasdale, AIA, St. Louis, vice presidents, and Jay W. Barnes, FAIA, Austin, Tex., treas-

urer. Secretary Robert M. Lawrence, FAIA, of Oklahoma City continues a two-year term as secretary.

Twelve new members of the board of directors were also installed. By region, they are: California, William E. Blurock, FAIA, Newport Beach; Central States, R. Bruce Patty, AIA, Kansas City, Mo.; East Central States, P. Whitney Webb, AIA, Lexington, Ky.; New England, John A. Carter, AIA, Nashua, N.H.; New York, Joseph D. Monticciolo, AIA, New York City; North Central States, Leroy E. Bean, AIA, Sioux Falls, S.D.; Ohio, Robert E. Gramann, AIA, Cincinnati; South Atlantic States, John A. Busby Jr., FAIA, Atlanta; Texas, William W. Caudill, FAIA, Houston; Western Mountain States, Thomas B. Muths, AIA, Jackson, Wyo.

Two ex officio members round out the new membership of 12: Robert B. Pease, Hon. AIA, Pittsburgh, as public director, and Ann Stacy, Hon. AIA, Detroit, chairwoman of the Council of Architectural Component Executives. Pease is executive director of the Allegheny Conference on Community Development, which has spearheaded Pittsburgh's rebuilding program for the past 36 years. Stacy is executive director of both the Michigan Society/AIA and the Detroit Chapter/AIA.

*continued on page 19*

## WHEN YOU WANT TO USE ALUCOBOND™ MATERIAL, THESE DISTRIBUTORS WILL SMOOTH THE WAY:

Adammetal Supply  
Elizabeth, NJ 07207  
(201) 351-2550

Associated Specialties Co.  
Salt Lake City, UT 84106  
(801) 487-8501

Attaway & Howell Co., Inc.  
Tucker, GA 30084  
(404) 938-7830

Building Specialties of Pittsburgh  
Pittsburgh, PA 15209  
(412) 821-5310

Casewin, Inc.  
Minneapolis, MN 55416  
(612) 545-1635

Century Insulation Mfg. Co.  
Union, MS 39365  
(601) 774-8285

Condit Construction Products  
Dayton, OH 45409  
(513) 298-9922  
Columbus, OH 43228  
(614) 274-2283  
Cincinnati, OH 45229  
(513) 242-4029

Demarest Company, Inc.  
Oneco, FL 33558  
(813) 758-3811

Eastern Metal Mill Supply  
Dedham, MA 02026  
(617) 329-1200

Elward, Inc.  
Denver, CO 80223  
(303) 936-7201

Fletcher & Associates  
Birmingham, AL 35203  
(205) 328-0525

The Fox Steel Company  
Orange, CT 06477  
(203) 799-2356

J.M. Power Company, Inc.  
Trenton, MI 48183  
(313) 479-2200

John W. McDougall Company  
Nashville, TN 37209  
(615) 383-4036

Payne & Howard, Inc.  
Dallas, TX 75234  
(214) 243-5050

Penco, Inc.  
Louisville, KY 40204  
(502) 584-1166

RPS Architectural Systems\*  
North Hollywood, CA 91605  
(213) 982-5866

Swanson Gentleman Hart, Inc.  
Omaha, NB 68154  
(402) 493-9393

Swanson Gentleman, Inc.  
Des Moines, IA 50309  
(515) 244-0186

*ALUCOBOND is the trademark of Consolidated Aluminum Corporation for its aluminum composite material.*

*Technical information with reference to ALUCOBOND™ material test results can be obtained by writing to Consolidated Aluminum, Attention: Carla Lane. Always consult local building codes before use.*

*\*System design and fabrication for the buildings on the preceding page were by RPS Architectural Systems.*



11960 Westline Industrial Drive  
St. Louis, Missouri 63141





**HOW CAN TODAY'S  
STEEL BUILDING SYSTEMS  
WORK FOR THE ARCHITECT?  
BEAUTIFULLY.**

**SEE FOR YOURSELF..**

# LOOK HOW YOU AND STEEL BUILDING SYSTEMS CAN CREATE TRULY DISTINCTIVE STRUCTURES.

In case you haven't noticed lately, steel buildings are looking better than ever. Thanks, in large part, to what architects have been doing with them.

Design versatility, with just about any exterior material you want, is one of their outstanding attractions. And, you're not restricted to simple buildings either. More and more, steel building systems are being specified in more complex projects, as you can see on these pages.



Century Lincoln-Mercury  
Greenville, South Carolina  
Architect:  
Ard-Wood Associates Architects, Inc.  
Greenville, South Carolina



Gator Hawk External Tester, Inc.  
Lafayette, Louisiana  
Architect:  
Weimer and Associates  
Lafayette, Louisiana



Plaza 75 Shopping Center  
Phoenix, Arizona  
Architect:  
W.W. Witte  
Phoenix, Arizona



Tucson Industrial Center  
Tucson, Arizona  
Architect  
Richard Reif  
Tucson, Arizona



Columbus Indoor Tennis Club,  
North-Oak Creek Gymnastics Academy-Columbus, Ohio  
Architect:  
Acock White and Associates-Columbus, Ohio



Web International Warehouse  
Jacksonville, Florida  
Architect:  
Howard H. Humburg, A.I.A.  
Jacksonville, Florida



Ballou, Johnson & Nichols  
Cranston, Rhode Island  
Architect:  
Bowman Bros. Inc.  
Providence, Rhode Island



Jim West Realtors  
Houston, Texas  
Architect:  
Teal Construction Co.  
Houston, Texas



Falls City Boat Works, Inc.  
Louisville, Kentucky  
Architect:  
Raymond Berry, A.I.A.  
Louisville, Kentucky



Westland Medical Center  
Wichita, Kansas  
Architect:  
Howard V. Harrison  
Wichita, Kansas

A steel building system functions beautifully as a complete system in itself, as an addition to an existing structure or as a source of sub-systems. And, with today's inflationary pressures, steel buildings become irresistible in many applications. Costs are more readily controlled, thanks to factory-controlled quality, computerized procurement scheduling, and reduced on-site field work.

For the architect, this steel building system is a vital part of his modern repertoire.

Manufacturers of pre-engineered steel buildings and their dealers in your area are eager to work with you. Call them—you'll find they are valuable sources of useful information and ideas.



Architect's Office  
Gainesville, Florida  
Architect:  
John Don Puckett  
Gainesville, Florida



Georgia Pacific Corp.  
Distribution Div.  
Baton Rouge, Louisiana  
Architect:  
Pesce Clendening Associates  
Dallas, Texas



Indianapolis Freightliner-White  
Indianapolis, Indiana  
Architect:  
Fisher Medalen Corp.  
Indianapolis, Indiana



California Recreational Park  
Chicago, Illinois  
Architect:  
J. Ahrendt Heinzelman  
Chicago, Illinois



Don Kazery's Furniture Co. Inc.  
Jackson, Mississippi  
Architect:  
Dean & Dean  
Jackson, Mississippi



Ming Auto Beauty Center  
North Miami, Florida  
Architect:  
Curtis & Associates  
Shawnee Mission, Kansas

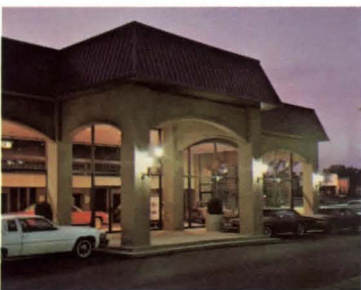

Parker Cadillac  
Little Rock, Arkansas  
Architect:  
Weaver & Heigel Associated  
Little Rock, Arkansas



Fowler Brothers  
Furniture Store  
Knoxville, Tennessee  
Architect:  
James R. Johnson &  
Associates  
Knoxville, Tennessee



Weis Companies Office/Warehouse  
Rochester, Minnesota  
Architect:  
Chris Colby  
Rochester, Minnesota



Office Building  
Spokane, Washington  
Architect:  
Robert J. Randall, Jr.  
Spokane, Washington



Century Harbor Racquetball Club  
Middleton, Wisconsin  
Architect:  
Douthitt Associates, Inc.  
Madison, Wisconsin



Maumelle Community Center  
Maumelle New Town, Arkansas  
Architect:  
Fletcher, Miller, Dean & Associates  
Little Rock, Arkansas

Circle 10 on information card

# EnerCon<sup>®</sup> surrounds Auto Owners Insurance with energy efficiency.

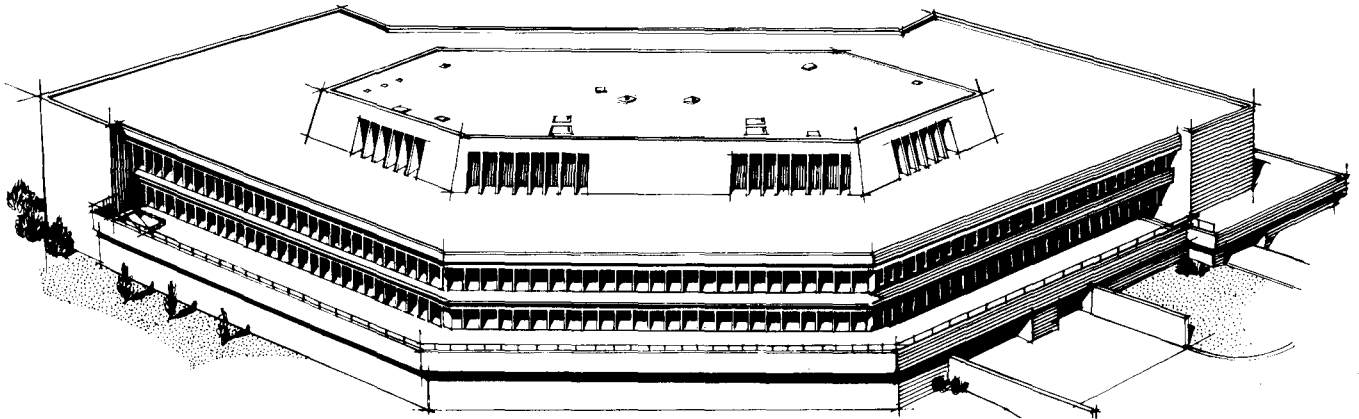

## AAF's reverse-cycle air conditioner provides year-round energy savings.

When Auto Owners Insurance Company built its new \$12 million corporate headquarters in Lansing, Michigan, they were just as concerned with operating expense as the initial cost. They realized the heating and cooling system would constitute a sizeable segment of the operating expense, so they wanted the most energy efficient and cost effective system available.

Based on the criteria provided, the engineering firm of Syska & Hennessey, Inc. recommended a combination of a central station Variable Air Volume system for the building interior and American Air Filter EnerCon reverse-cycle air conditioners for the building perimeter.

The EnerCon system pipe loop interconnects all the EnerCon system reverse-cycle air conditioners with system auxiliaries such as the boiler and evaporative cooler. To minimize operating hours of these system auxiliaries, thereby reducing operating cost, the mass of the

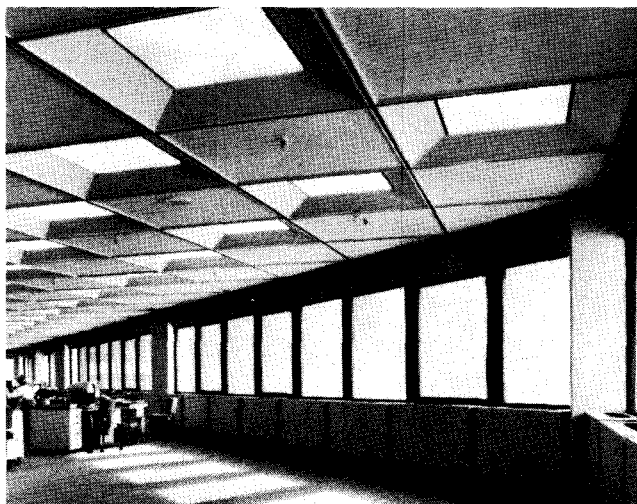

water was increased with the addition of a 10,000 gallon water storage tank. System optimization was further achieved by tying heat sources into the primary pipe loop that would normally reject their heat to the atmosphere. Separate secondary pipe loops interconnect the two VAV system chillers, which reject heat into the water loop whenever they are operating, and a third loop extracts heat from water cooled air conditioners serving the computer room. All three of these loops tie into the primary pipe loop.

The EnerCon system is unique in its ability to accept heat that is normally rejected and transfer

that heat at mild temperature levels via the closed pipe loop to units on the perimeter of the building calling for heat. The EnerCon system picks up this heat and utilizes it immediately where it is needed or stores it in the water loop for nighttime use.

So with the VAV system working in the core, EnerCon solves the perimeter zone problems. The ability to easily fluctuate

demand over a 12-month period ranging from full heating in cold weather to simultaneous heating and cooling in mild weather to full cooling in hot weather made EnerCon the ideal choice. Not only because it is effective, but because EnerCon saves energy and keeps operating costs down.

For more information about EnerCon and how it has helped reduce Auto Owners Insurance Company's energy usage due to increasing its energy efficiency, contact your nearest AAF representative or write: American Air Filter Co., Inc., Dept 592, 215 Central Avenue, Louisville, Ky. 40277. **Better Air is Our Business<sup>®</sup>**

**AAF** American Air Filter  
REVERSE-CYCLE AIR CONDITIONING SYSTEMS

AN ALLIS-CHALMERS COMPANY

Circle 7 on information card

## Donations Ensure Preservation Of Drawings by Richard Hunt

The AIA Foundation has received grants totaling more than \$105,000 from a variety of sources to provide for the conservation and storage of the architectural records of Richard Morris Hunt (1827-1895). A founder of the Institute, Hunt was AIA's first secretary (1857-1860) and third president (1887-1890). He was the first American to study at the Ecole des Beaux-Arts in Paris, bringing back to this country a knowledge of French Renaissance architecture which continued to dominate his style and, in turn, was influential in the development of American architecture. (See cover for a rendering from the collection made while Hunt was a student at the Beaux-Arts.)

The grants will provide for cleaning and conservation of more than 2,000 drawings and photographs given to AIA in 1926 by Hunt's widow, Catherine Howland Hunt, and administered by the foundation since 1977. The drawings will be cleaned for archivally safe storage in acid-free polyester folders.

Eleven of Hunt's drawings from the collection are currently in an exhibition called "The American Renaissance," which opened at the Brooklyn (N.Y.) Museum and is scheduled to travel to Washington, D.C., San Francisco and Denver.

## Epstein Is Kemper Recipient

Herbert Epstein, FAIA, president of the architectural/engineering firm of Epstein/Greenfield, Brooklyn Heights, N.Y., has been selected by AIA's board of directors to receive the 1980 Kemper award given annually to "one AIA member who has contributed significantly to the Institute and the profession." He will receive the award at AIA's convention in Cincinnati in June.

Epstein served two terms as Institute vice president (1976-77 and 1977-78), eight terms as president of AIA component organizations, three years as an AIA regional director and has worked on more than 50 committees and task forces and in other leadership positions regarding the profession.

According to the nomination statement, Epstein for the past three years has been the Institute's spokesman on performance standards for energy conservation and solar energy. He has testified before Congress and governmental agencies on many occasions. Responsible for the restructuring of AIA's energy committee, he guided the publication of AIA's book *Energy Planning for Buildings*.

Active in educational affairs as well as energy conservation, Epstein played a major role in the development of the intern-architect development program (IDP), cochairing the joint AIA/National Council of Architectural Registration Boards IDP task group, and serving for three years as chairman of the AIA commission on education and research.

## Campbell Given Young Citation

"No tribute is too great for this giant and brother of our profession," said Robert J. Nash, FAIA, a former vice president of the Institute, in an obituary for Leroy Miller Campbell, AIA, a Washington, D.C., architect who died on Aug. 28, 1977 (see Jan. '78, p. 52). The most recent tribute to Mr. Campbell comes from AIA's board of directors which has selected him to receive posthumously its 1980 Whitney M. Young citation. The citation, named in honor of the late civil rights leader, recognizes the "significant contributions of an architect or architecturally-oriented organization toward meeting the architectural profession's responsibility to the social issues of today."

Mr. Campbell, said Nash, was a "pioneer in the black/white venture" of the

1960s. He was cited by Whitney Young and the Urban League for his participation in the black executive exchange program, a project in which he worked without pay to lecture at black colleges on his experience in the architectural profession.

"His work as a practitioner helped to make it possible for the poor and the underprivileged to benefit from the technical advances of architecture," said the nomination statement. He also helped provide affordable housing to low-income persons in several housing projects, the statement continued, and "he worked tirelessly to obtain accreditation" for predominantly black architectural schools when only one such institution was accredited in architecture—Howard University, where he was a member of the commission on the school of architecture.

A charter member and president of the National Organization of Minority Architects, Mr. Campbell also served on the board of the AIA Foundation and of the Metropolitan Washington Planning and Housing Association. He was a member of AIA's housing committee and chairman of the resolutions committee, working as well to show "young blacks that the doors of architecture are indeed open to all."

*News continued on page 22*



**A Precedent-Setting Complex:** The housing above, in Trenton, N.J., is the first non-profit, architect sponsored and managed residential community for low-income elderly people in the nation. In order to help ease the critical shortage of quality housing for the financially hard-pressed elderly, members of the Central Chapter of the New Jersey Society of Architects/AIA formed the Architects Housing Co. in 1974. A competition was held for the design of the complex, and Geddes Brecher Qualls Cunningham won. The winning design was approved by the New Jersey Housing Finance Agency, which funded the \$5.2 million project, and the complex officially opened in October 1979. The tenants pay only 25 percent of their income in rent, the remainder being subsidized by HUD. The design takes the needs of the elderly into consideration and emphasizes diversity rather than similarity. This melding of architecture with community service is a "singular example of professionals practicing what they preach," says Robert L. Geddes, FAIA.

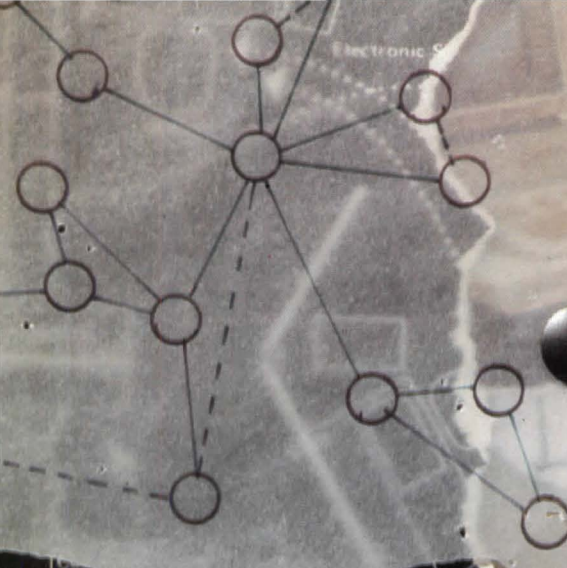

MICROFICHE UNIT



Hinge trim covers ends of the base - three-way hinged as...

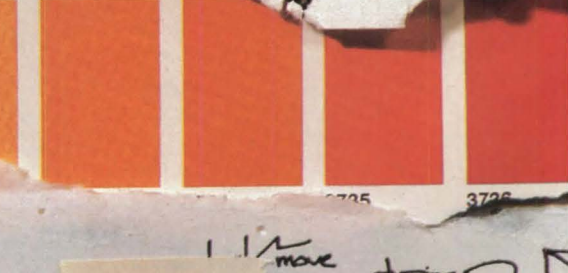
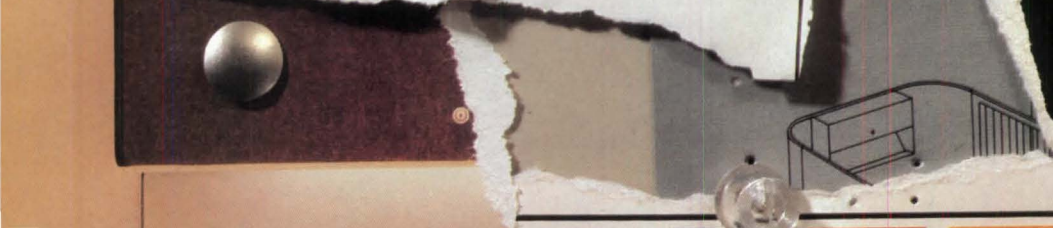
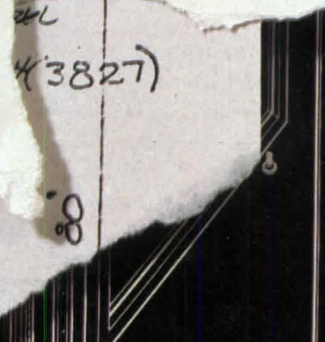
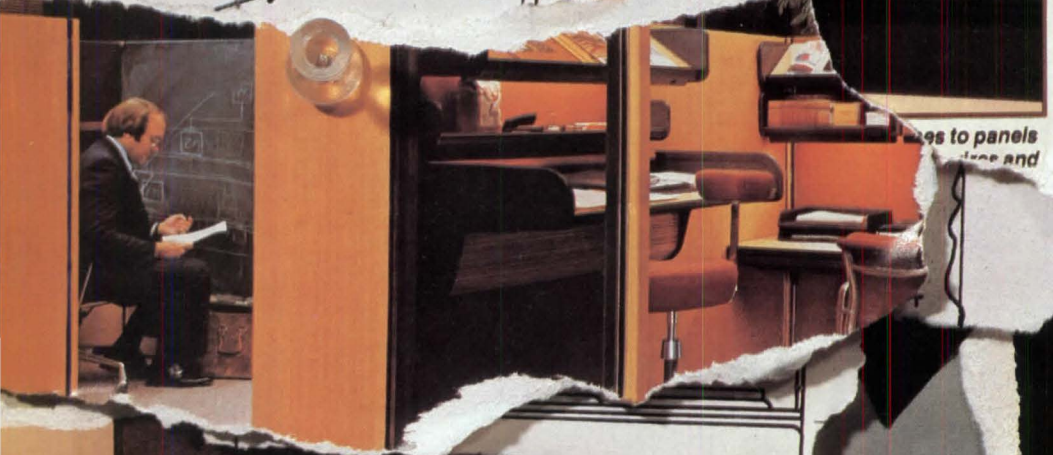
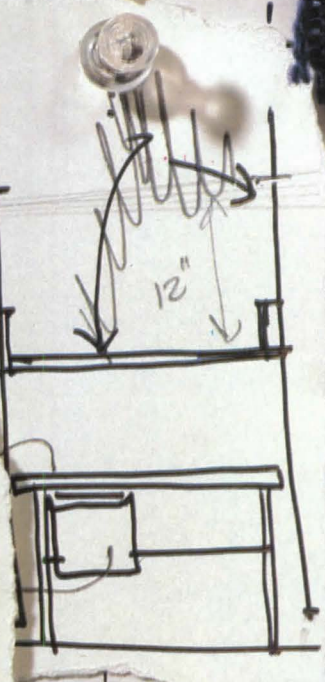
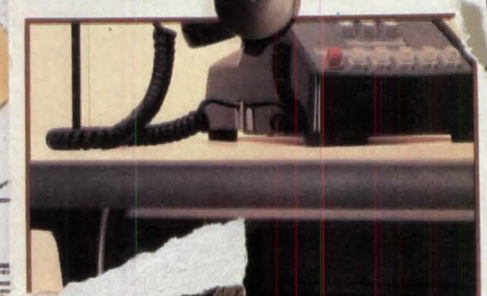

ALL FINISH BAKED NOTE: ALL INTERIOR EXTERIOR PRIMED RESISTANT FINAL COLOR GRAPHIC IMAGE



move typing 107 2' shelf 328 176

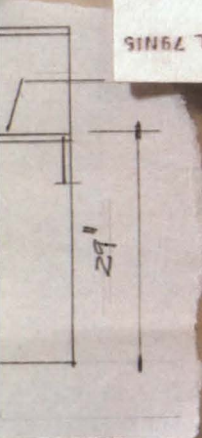

**When you specify the Action Office® system, you're also specifying Herman Miller.**

The Action Office system gives your clients a sense of control, the ability to plan and deliver, the methods and means to deal with frustrating problems.

It does so because the system was designed out of intensive research into how people work and how organizations manage.

What's more, with Herman Miller you'll have access to a sophisticated knowledge base that ensures smoothly functioning environments. From ROI studies to communications analyses, from employee orientation through facility management programs—offered in whatever form best blends with your own methods and procedures.

So you'll not only be delivering an effective open plan system, but the software and services to back it up.

For information write  
Herman Miller Inc., Marketing  
Department, Zeeland, MI 49464.

Sales/education facilities in Atlanta, Boston, Chicago, Dallas, Detroit, Houston, Los Angeles, New York, San Francisco, Washington, D.C., Amsterdam, Basel (Herman Miller AG), Brussels, London, Paris, Toronto and other key cities internationally.

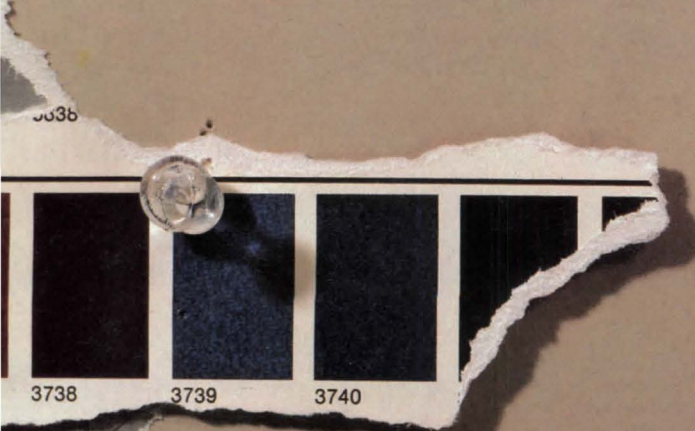

# Performance Standards Issued By DOE; 5 Hearings Scheduled

The Department of Energy recently issued its proposed energy performance standards for new commercial and residential buildings. National compliance with the standards could reduce energy consumption by 22 to 51 percent in residential buildings and 17 to 52 percent in commercial buildings, estimates DOE. The proposed standards gained the immediate support of AIA.

Building energy performance standards (BEPS) would limit the amount of energy a building should consume, expressed in Btus per square foot per year. A building would be tested at the design stage rather than by actual performance (thus the term design energy budgets). Energy codes now in use apply to the thermal characteristics of individual parts of the building. BEPS would apply to the building as a whole. The amount of the design energy budget would vary according to building type (19 classifications), climate zone (38 zones) and type of fuel used. The standards would simply require that the design energy consumption of all installed components and systems add up to no more than the assigned budget.

Of the country's total fuel consumption, buildings now account for 37 percent. DOE estimates that the standards, if implemented, would save 216,000 barrels of oil a day by 1990. And, say DOE officials, the proposed standards will result in greater conservation than existing building standards such as HUD's minimum property standards and standard 90-75 of the American Society of Heating, Refrigerating and Air-Conditioning Engineers (ASHRAE).

The standards are designed to encourage use of renewable sources of energy and discourage use of nonrenewable fuel sources. For each building the calculated energy use would be multiplied by a weighting factor assigned to nonrenewable energy sources (for single-family residential, natural gas weighed 1, oil 1.22, electricity 2.79; for commercial and multifamily residential, gas 1, oil 1.2 and electricity 3.08). This weighting factor was developed on an economic assessment of the desirability of one energy source over another.

In the proposed standards the stringency level is toughest for most commercial buildings. The level for hospitals and multifamily lowrise residential buildings is the least strict. For example, a commercial building in Kansas City, Mo.,

could consume no more than 46,000 Btus per square foot per year, a number which is below that of buildings constructed there in recent years.

In the preamble to the proposed rulings, DOE offered ways to meet the proposed BEPS in three locations for gas and electric heated dwellings. For example, for a gas heated home in Chicago, a designer could use the "average" window area and distribution, triple glazing and R-38 ceiling and R-19 wall insulation. Or the designer could increase window area with southern exposure by 75 percent, decrease north-facing windows by 25 percent, use double glazing and R-38 ceiling and R-19 wall insulation.

The 1976 law calling for the development of BEPS requires that they be put into effect a year after they are promulgated. Enforcement is to be handled by the local or state governmental agency which grants building permits. DOE has suggested that the implementation process may be flexible to allow local or state agencies to use other building energy codes such as ASHRAE 90-75 or the Federal Housing Administration's minimum property standards, but only if they are revised to be as stringent as BEPS.

If local or state codes are not brought up to BEPS level or if BEPS are not implemented in a year's time, Congress can vote to halt federal financial assistance for building projects in the noncomplying jurisdiction. That means that any form of federal assistance or loans made by any bank or savings and loan association which is subject to regulation by the Federal Reserve system, Federal Deposit Insurance Corporation, the Federal Home Loan Bank Board, the Federal Savings and Loan Insurance Corporation will be denied.

At this point there is no definite time period for implementation to begin, and even DOE officials do not have a clear prediction. DOE officials say that a delay of implementation until January 1981 may be acceptable. AIA supports implementation of BEPS as soon as possible. The American Consulting Engineers Council wants the use of BEPS to be voluntary for the first five years.

To evaluate a building's energy performance, DOE has suggested three different computer programs: DOE-2, used to calculate the design energy requirements of nonsolar single-family residential buildings and commercial buildings

with central HVAC systems; TRNSYS, used to calculate the contribution of an active solar energy system toward a building's heating, and DEROB, used to calculate the design energy requirements of single-family residential building designs which incorporate passive solar energy systems. The evaluation will take into account the building's occupancy rate, electrical lighting, domestic hot water, elevators and escalators, toilet exhaust, general exhaust and indoor temperature conditions.

DOE has scheduled five public hearings on BEPS: Jan. 28-30, Washington, D.C.; Feb. 4-6, Atlanta and Kansas City, Mo., and Feb. 11-13, Los Angeles and Boston. For information contact: Joanne Bakos, U.S. Department of Energy, Office of Conservation and Solar Energy, 20 Massachusetts Ave. N.W., Washington, D.C. 20585.

Immediately after BEPS were proposed, there were strong pro and con reactions. At the AIA board meeting last month the directors endorsed BEPS as a major step toward achieving the nation's goal of energy self-sufficiency. "The Institute has strongly encouraged the establishment of federally developed building energy performance standards since issuing its first energy policy statement in 1974," said President Charles E. Schwing, FAIA. "Architects will continue to play a crucial role in maximizing energy conservation in the built environment. These proposed standards will achieve substantial energy savings as well as allow architects to design innovative and dynamic buildings." He continued: "In light of international events and consequent uncertainty about world oil prices and supply, the Institute strongly urges early implementation of the BEPS in both the national and public interests." The Consumer Energy Council of America (CECA) wrote in a consumer primer on BEPS: "Ultimately BEPS could become the nucleus of America's efforts to regain its energy independence through its largest untapped energy potential—conservation." In the primer, CECA also said that BEPS will result in an enhancement of the natural environment and that water and air quality will be improved.

Other groups were not so enthusiastic about BEPS. Herman J. Smith, vice president/treasurer of the National Association of Home Builders, said, "We are concerned that the amount of energy that would be saved by this proposal may not be justified by the added expense." ASHRAE spokesmen said that BEPS are unacceptable in that the energy budgets provided cannot be uniformly applied because of the difference in function of buildings within a single category. They

*continued on page 27*



# Beautiful... Permanent Economical... Energy Efficient



*Richmond Hills Savings Bank, Carle Place, N.Y. / Arch: Balduz Peter / Contr: Marlboro Stone Co., Inc.*

Yes, White Cherokee Marble is all of these and much more. In fact, White Cherokee Marble is quite unlike any other marble found anywhere on earth... a marble containing myriads of crystals that reflect its beauty like diamonds in the sunlight. One of the densest and most durable marbles known. White Cherokee's extreme hardness and unique low absorptancy provide it with a natural cleaning action that all but eliminates exterior maintenance requirements.

Economical in price and flexible in design, White Cherokee is available in large size panels for cost effective slab to slab erection, or in weight saving veneers which utilize special anchoring systems designed to significantly reduce building loads by eliminating heavy masonry backup... a factor which could reflect appreciable savings in overall costs of

the structural system.

And to further enhance the appeal of this unique stone, it comes in two exclusive new finishes. Distinctive GAMARTEX, as seen above, is a uniform deep texturing treatment that softens the veining of the stone, making it brighter and more reflective. RIBTEX is bold, masculine, with ruggedly handsome vertical ribs slightly softened with a subtle texture.

White Cherokee Marble, a uniquely different building stone that offers exciting new finishes, timely delivery schedules, competitive prices, minimum maintenance requirements, innovative erection systems and a flexibility in design that awaits only your imagination.

Yes, White Cherokee is beautiful, permanent, economical and energy efficient because of its white crystalline composition, being highly reflective to sunlight, thereby offering a significant savings in energy costs.



**georgia marble**  
company

STRUCTURAL DIVISION  
Nelson, Georgia 30151 / (404) 735 - 2591

a Jim Walter company



# FOR A HUNDRED YEARS, ARCHITECTS HAVE BEEN BLAMED FOR LEAKY ROOFS. SO CELOTEX DECIDED TO MAKE THEM NOT SO LEAKY.

---

**Finally, an improved roofing system that is easy to apply properly, so it eliminates the major roofing problems.**

---

We don't announce new products lightly. So when we do come up with something new, you can be sure it's a winner. After all, with our predecessor companies, we've been in the roofing business since 1854.

Celo-Glass IV is a special type of fiberglass asphalt mat that makes proper installation easier and thereby achieves the most problem-free roof on the market today.

Other fiberglass felts allow hot bitumen to penetrate immediately, making it difficult for workmen to broom properly. Celo-Glass IV has uniformly distributed fibers that permit controlled penetration of the bitumen, assuring good interply adhesion. In addition, Celo-Glass IV

felts are stronger, weigh less, lay smoother and resist moisture and rotting better than conventional asphalt felts.

What's more, Celo-Glass IV meets ASTM 2178 Type IV requirements, the most stringent of all. It is approved for all sections of the country.

In short, Celo-Glass IV represents the most problem-free roof that can be designed today. We realize that architects will still get the blame for leaks, should they ever occur, but now you won't be blamed as often.

For more information, contact Peter G. Nazaretian at Celotex Roofing Products Division, P.O. Box 22602, Tampa, Florida 33622. (813) 871-4584.



"Between the world and the weather since 1854."  
a Jim Walter company

Circle 8 on information card

# A dash of dazzle in a shopping center. **ELEVATOR BY DOVER**

It's quite a trip for shoppers when they move from the main level to the promenade level of the Rolling Acres Mall in West Akron. Designer James B. Heller of Keeva J. Kekst Associates combined glass, chrome, and incandescent lamps to create a "vista" elevator that dazzles and delights. At the heart of these glamorous trappings is a Dover IVO Elevator, the high quality, pre-engineered Oildraulic<sup>®</sup> elevator made for add-on or new construction of three stories or less. For more information on the complete Dover line of traction and hydraulic elevators, write Dover Corporation, Elevator Division, P.O. Box 2177, Dept. G, Memphis, Tenn. 38101.

**DOVER**<sup>®</sup>  
The elevator  
innovators.

Rolling Acres Mall,  
Akron, Ohio  
Developer:  
Forest City Rental Properties  
Corporation and  
Richard B. Buchholzer  
General Contractor:  
Forest City Dillon, Inc.  
Architect: Keeva J. Kekst  
Associates, Architect, Inc.  
Cab Designer:  
James B. Heller  
Dover IVO Elevator sold  
and installed by  
Dover Elevator Company

Frontier Fruit & Nut Co.

## Energy from page 22

also called the procedures excessively complex and said that the enforcement would be very difficult. The National Electrical Manufacturers Association says that as a result of the high weighting factor given to electricity designers are "more likely to reduce electricity if the value-based weighting factors given in this proposed rule are used."

These concerns and others will be raised at the public hearings. What costs are involved in BEPS? DOE estimates that BEPS would add 75 cents to \$1 per square foot to the price of single-family homes and would increase the cost of commercial buildings by 3 to 5 percent. At the same time, the outlay would be paid back in fuel savings in three to five years, says DOE. How will the indoor and outdoor environment be affected? The Environmental Protection Agency is concerned that indoor air quality will decrease if the new standards cause buildings to be designed with less ventilation. But environmentalists say that BEPS would dramatically reduce air pollution.

The development, implementation and administration of BEPS was mandated by the Energy Conservation and Production Act of 1976. The act directed HUD to develop performance standards for new buildings that will "achieve the maximum practicable improvements in energy efficiency and increase the use of nondepletable sources of energy." Authority for the development of BEPS was transferred to DOE in January 1979. In developing BEPS, DOE analyzed building designs according to energy efficiency, use of renewable resources, building functions and operating conditions, environmental impacts, climatic conditions and economic costs and benefits.

HUD (and later DOE) contracted with AIA Research Corporation to survey 1,661 commercial buildings built after 1973 (see Sept. 1978, p. 59). AIA/RC then asked the original designers of 168 buildings to redesign them to be as energy efficient as possible, but filling the same needs at approximately the same costs. The energy requirements of the original buildings, the redesigned buildings and buildings modified to conform to existing energy standards were compared.

Energy performance budget standards were developed separately for the residential category. First, the National Association of Home Builders Research Foundation survey of over 120,000 houses constructed in 1975 and '76 provided a data base of estimated energy use. Then 20 design teams were selected to develop new residential designs using four prototype designs. The energy budgets for single residential buildings were based on the minimum range of the life cycle cost curves of the redesigned buildings.

## Eighth Century Airconditioning Is Uncovered at Buddhist Site

Archeologists excavating at Antichak, a village in the Bhaglapur district of India on the banks of the River Ganga, have uncovered what is believed to be an air-conditioning device that was in use in the eighth century. The site was once that of a flourishing Buddhist monastery, and probably an ancient university. The cooling mechanism was discovered on the southern side of the main monastery complex.

A rectangular building to one side of the complex contains a water reservoir,

### Government

## New Bill Mandates Competitions For Projects Under \$25 Million

An entirely new legislative charter for GSA's public buildings program was introduced in December by Senator Daniel Patrick Moynihan (D.-N.Y.). Among other things, it calls for use of limited design competitions on projects costing between \$2,500 and \$25 million and increased use of in-house architects for project design.

The bill, labeled the Public Buildings Act of 1979 and cosponsored by all 14 members of the Senate committee on environment and public works, proposes a selection mechanism that falls somewhere between a formal competition and GSA's present "level three" process.

From three to 10 architects would be invited to compete for a given project in the above cost range. They would have two months from receipt of the competition program to produce preliminary design concepts and would be compensated up to \$50,000.

The bill in effect replaces an earlier Moynihan offering called the Architectural Quality Act of 1979 (S461) which called for use of design competitions on all federal projects over \$25 million. In the newer bill, for projects expected to cost more than \$25 million, GSA would use "such methods, including design competitions," appropriate to the project. Compensation would be up to \$250,000. A spokesman for the environment and public works committee said the change resulted from October hearings on S461 which produced sharply divergent views on the value of competitions.

At the hearings Moynihan said: "It is astonishing that in our country, which so prides itself on its competitive spirit, which bases its government on the free competition of ideas and its economy on

recently unearthed. Sloping channels lead from the reservoir to the other side of the main monastery building. The Indian magazine *Design* (September '79), in reporting the discovery, quotes archeologist B. S. Verma as saying that the channels carried air which was cooled after coming into contact with cold water. Verma contends that the channels led to cells in the monastery where fragile manuscripts were kept, and that the cooling was for their protection.

After 400 years of existence, the monastery was destroyed by fire, probably in a planned attack by rivals of a different religion, Verma says.

free competition in the marketplace, architectural competitions are so few and far between. . . . Competitions are surely no guarantee of great architecture, but they are a guarantee that design, and the talent to design, are the criteria we rely on in choosing an architect."

Also speaking in support of design competitions was Livingston L. Biddle Jr., chairman of the National Endowment for the Arts and the National Council on the Arts. He said, "It is crucial that our public buildings reflect the best of our culture and be a product of our highest design talent. Given this situation, we believe that the process which maximizes the participation of the users, the clients and the general public is intrinsic to democratic principles. We believe that the design competition is such a process."

At that same hearings, A. R. Marschall, commissioner of GSA's public building service (PBS), said, "We find no great advantage in the design competitions in contrast with our present selection system. . . . We have found that our current process [level three] provides a blend of objective evaluation with reasonable subjectivity in making these decisions." Marschall also spoke against the use of public advisory panels and said he would like to replace the panels with a board made up of professional architects and engineers on GSA's staff.

George E. Kassabaum, FAIA, testifying for AIA, said that while competitions may have their place for monuments and single-function buildings, they are not appropriate in most government buildings "where there are complex factors to be weighed" (see Nov., '79, p. 36). AIA supports the Brooks bill approach, which

*continued on page 30*

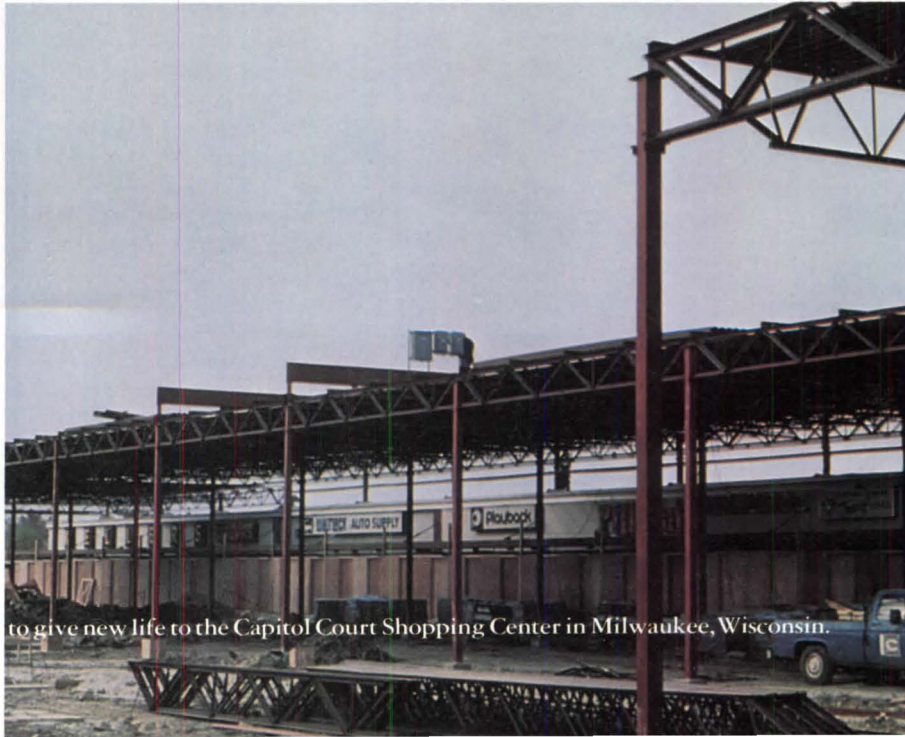
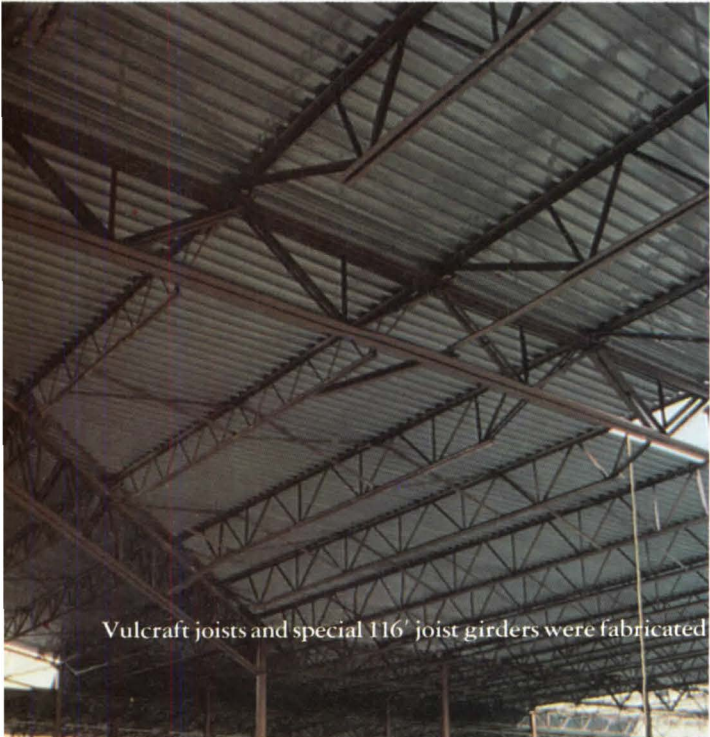

Vulcraft joists and special 116' joist girders were fabricated to give new life to the Capitol Court Shopping Center in Milwaukee, Wisconsin.

# HOW VULCRAFT HELPS OLDER SHOPPING CENTERS CLOSE IN ON THE COMPETITION.

Consider this.

Over half of all new shopping centers are enclosed malls.

Then consider the plight of older, unenclosed shopping centers. It's difficult for them to compete with a mall that protects shoppers from bad weather, is visually attractive and offers expansive space for merchants.

Unless they put Vulcraft overhead.

Vulcraft's lightweight steel joists and joist girders can quickly transform the appearance and appeal of an older shopping center. And in doing so, help to minimize the weight load on existing structures, while increasing the available square footage. They can be delivered and erected in

less time and with lighter weight equipment than conventional steel I-beams. And they can be made to fit specific size and weight needs for design flexibility.

For these reasons, you should consider Vulcraft products and expertise if you're involved with a shopping center remodeling.

Simply contact your local Vulcraft representative, or write P.O. Box 17656, Charlotte, North Carolina, 28211, for your Joist & Joist Girder Guide (See Sweet's 5.2VU). Or call (704) 366-7000.

There's just no better way to close out competition than to close in with Vulcraft.

Owner: Capitol Court Corp.  
Joint Venture Partners: Winmar Co., Inc. and Northwestern Mutual Life Insurance Co.  
Design-Build Contractor: Pankow Const. Co.  
Architect: Charles Kober Associates  
Engineer: Svend Sorensen, Inc.  
Steel Framing System: McLean Steel, Inc.



The Capitol Court Shopping Center finds internal youth.

## VULCRAFT

A Division of Nucor Corporation

P.O. Box 3009, Florence, S.C. 29501 803/662-0381 P.O. Box 169, Fort Payne, Ala. 35967 205/845-2460 P.O. Box 186, Grapeland, Tx. 75844 713/687-4665  
P.O. Box 59, Norfolk, Neb. 68701 402/371-0020 P.O. Box 1000, St. Joe, Ind. 46785 219/337-5411

Circle 13 on information card

### **Government** from page 27

calls for negotiation of a contract for services to be made on the basis of competence and qualifications.

The Public Buildings Act of 1979 also would elevate the role of GSA's in-house architects. The position of supervising architect would be established to oversee all design activities of PBS. Such a position existed from the 1840s until 1939. The GSA in-house architectural staff would be responsible for at least 25 percent of construction and renovation projects each year, which, say committee members, would attract and retain talented designers.

The bill would require GSA to submit an annual report of all building activities and a five-year plan for housing federal agencies. As is law now, priority for office space would be given first to existing government-owned buildings and second to acquiring historic buildings (mandated in the Public Buildings Cooperative Use Act of 1976). The leasing of offices would be limited to emergency or temporary situations or where the size of government activities does not warrant a public building. The bill states that within five years of the date of enactment no more than 40 percent of government offices shall be leased and by 10 years no more than 20 percent. In certain circumstances—such as for major computer operations, courtrooms, activities related to national defense or security—leasing would be prohibited. And "lease-construct" projects would be eliminated.

These provisions, along with some budgetary changes, are meant to curb the "dramatically" escalating amount of leased space. The public building program has a budget of \$1.4 billion for fiscal year '80, of which only \$16.2 million is for new construction. Officials say the Carter Administration may request \$137 million for new construction in FY '81. Over half of all the federal work force is housed in leased offices, the cost of which will be \$700 million in fiscal year '81 and is estimated to reach \$1 billion annually in the near future. Between 1966 and 1979 leased space increased by over 100 percent from 44.6 million to 93.3 million square feet, while there has been no appreciable increase in government-owned space from construction. GSA has identified a backlog of \$664 million in construction projects.

Last March the environment and public works committee placed a moratorium on new building and leasing projects because of the financial problems that plagued GSA. The new public buildings bill was a direct result of this moratorium. "All of us experienced in this matter agree that a thorough overhaul of the program is needed and that this bill provides us the tools with which to set it aright," said Moynihan. Some of its other provisions:

- The GSA design staff would be directed to conduct research and systematic evaluations and undertake demonstration projects "to determine the effectiveness of existing and planned public buildings in providing productive, safe, economical, conveniently located, energy efficient and architecturally distinguished accommodations for federal agency offices."
- In urbanized areas, federal offices are to be located in a central business district, near public transportation and close to public and commercial services.
- A city or town, except for Washington, D.C., should have only one federal building and one federal courthouse of monumental design and all other federal buildings should be designed to the same standards as "first class private buildings."
- In new buildings, design attention should be paid to scale, conformance to local zoning, energy-saving features and architectural details. All new or renovated public buildings should be fully accessible to the handicapped.
- GSA shall "design and maintain public buildings in such manner that they bear visual testimony to the dignity, enterprise, vigor and stability of the American government, embody the finest contemporary American architectural thought and, where appropriate, reflect regional architectural tradition." This statement is essentially the guiding principle for federal architecture which was prepared in 1962 for President Kennedy, and in which Moynihan played a key role.
- A program would be established for circulation of exhibits of art, culture, society, science and industry in federal buildings. For acquiring art work, one-half of 1 percent of the annual GSA construction, renovation, acquisition and maintenance budget and one-twelfth of 1 percent of the leasing budget would be available. This would establish the art in architecture program on a statutory basis for the first time.

### **Dayton Highway Link Rejected As Conflict with Urban Goals**

A recent decision by Secretary of Transportation Neil Goldschmidt puts into effect one aspect of President Carter's urban policy aimed at strengthening central business districts and economic bases of cities. Goldschmidt turned down a request of the Ohio department of transportation to build a 13.5-mile section of interstate highway in suburban Dayton. The road would have bypassed the east end of the city's metropolitan area. Goldschmidt said the proposal conflicted with Carter's urban policy by threatening to take jobs and businesses away from the inner city.

Goldschmidt pointed out that Dayton is "heavily dependent" on a municipal wage

tax and that a business exodus could have a "critical impact" on the tax structure and the pool of available jobs. He said that "for too many years, we have made transportation investments that did not build up cities, but instead pulled people, jobs and economic resources away from them."

Goldschmidt also said that "any new transportation project we consider today must be measured in terms of its impact on energy consumption and energy costs." It makes no sense to build highways that encourage lengthy commuting and urban sprawl, he said. In practice, he contended, city officials should plan transportation, housing, economic development and related projects together on a compact scale that would require less energy consumption in our daily lives.

Goldschmidt, however, approved a three-mile section of the highway that, he said, would be a "logical connection with existing roads." The present highway ends in a field, and this short extension will help link an air force base and Wright State University with downtown Dayton.

### **Charrette Selects Joint Venture To Plan San Francisco Project**

A joint venture of the San Francisco architectural and planning firm of Robinson Mills & Williams and the SWA Group, landscape architects, will develop a master plan for the Fort Mason Center in San Francisco. The joint venture was selected in a two-stage design charrette conducted on the site over a five-day period. The center is located on a vacated military base with magnificent views of the Golden Gate Bridge and Marin Headlands. The site, defined by steep banks and a cypress ridge, is on a point in the heart of the Golden Gate national recreation area. The recently renovated military warehouses provide offices for some 40 of the Bay Area's nonprofit organizations.

The winning master plan (photo of model p. 33) focuses on access, parking, circulation, accommodation of large crowds for special events, energy-capturing devices and environmental treatment of buildings and landscape, providing an organizational structure which will be responsive to a variety of future needs.

The U.S. Army turned the abandoned embarkation military facilities over to the National Park Service, and in May 1976 the Fort Mason Foundation, a nonprofit organization working under a cooperative agreement with NPS, began to transform the neglected warehouses, piers and support buildings into a community center. Now, more than 400 free or low-cost programs are offered monthly, ranging from puppet festivals to classes in solar installa-

*continued on page 33*



# There are 2 sides to every fountain



## THE SIDE YOU SEE

- Chrome-plated bubblers
- Circular stainless steel receptors
- Self-closing lever valve handles
- Extended receptor for wheelchair access
- Stainless steel backplate and louvered grille

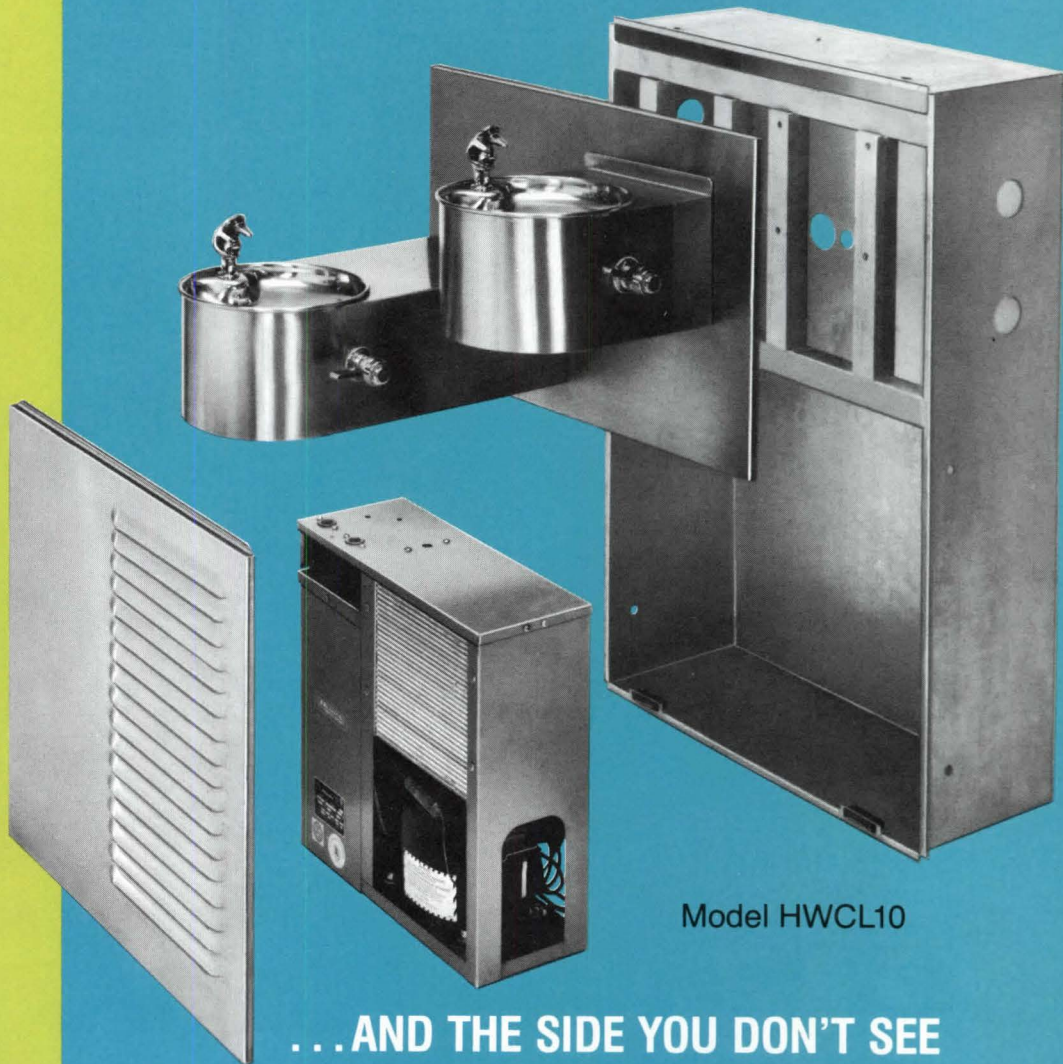

## ...AND THE SIDE YOU DON'T SEE

- Angle steel support struts
- Steel mounting box
- Automatic stream control
- Vandal-resistant bottom plates
- 9.5 gallon per hour chiller with 1/4 hp compressor

At Haws we make the side you see stylish, strong and practical. We put that same quality workmanship in where you don't see it, too, because we know the hidden features pay off in performance. Look at the HWCL10. You don't see the steel mounting box with angle steel struts that provide added support and strength. You don't see the automatic stream control that keeps the flow arched and even... or the vandal-resistant bottom plate\* that keeps vital parts safe from mischief makers. And you don't see the efficient chiller unit that can satisfy 114 thirsty users per hour with a cold drink of water. Haws takes care to include these and other special features — because even when you don't see them, you do benefit!

HAWS DRINKING FAUCET COMPANY  
P.O. Box 1999 Berkeley, California 94701

Circle 14 on information card

\*Optional at extra cost.



**Haws**

# Cedar can have bottom line beauty, too.

Designs can be beautifully realized in Western red cedar. That's a given. But when you specify quality PenPly exterior 303 *plywood* panels, beauty becomes more than a surface thing. The savings are also beautiful. The bottom line is *real* economy that comes from reducing labor intensity. For example, a 2,000 square foot surface requires only 62 panels, minus windows and doors. And, PenPly goes on in less time, using less manpower than masonry and other piecework sidings. This means faster completions, and quicker sales with greater profits.

Our Western red cedar plywood panels also give you the advantage of low maintenance, weather resistance and the ability to take a wide variety of stains. Side with PenPly and show a good-looking bottom line, too.

For additional information, contact your nearest wood products distributor or see Sweet's General Building and Light Residential Files under Siding/Cladding Section (7.6 Pen).

**PenPly**

Wood Products from ITT Rayonier, Inc.

Circle 15 on information card

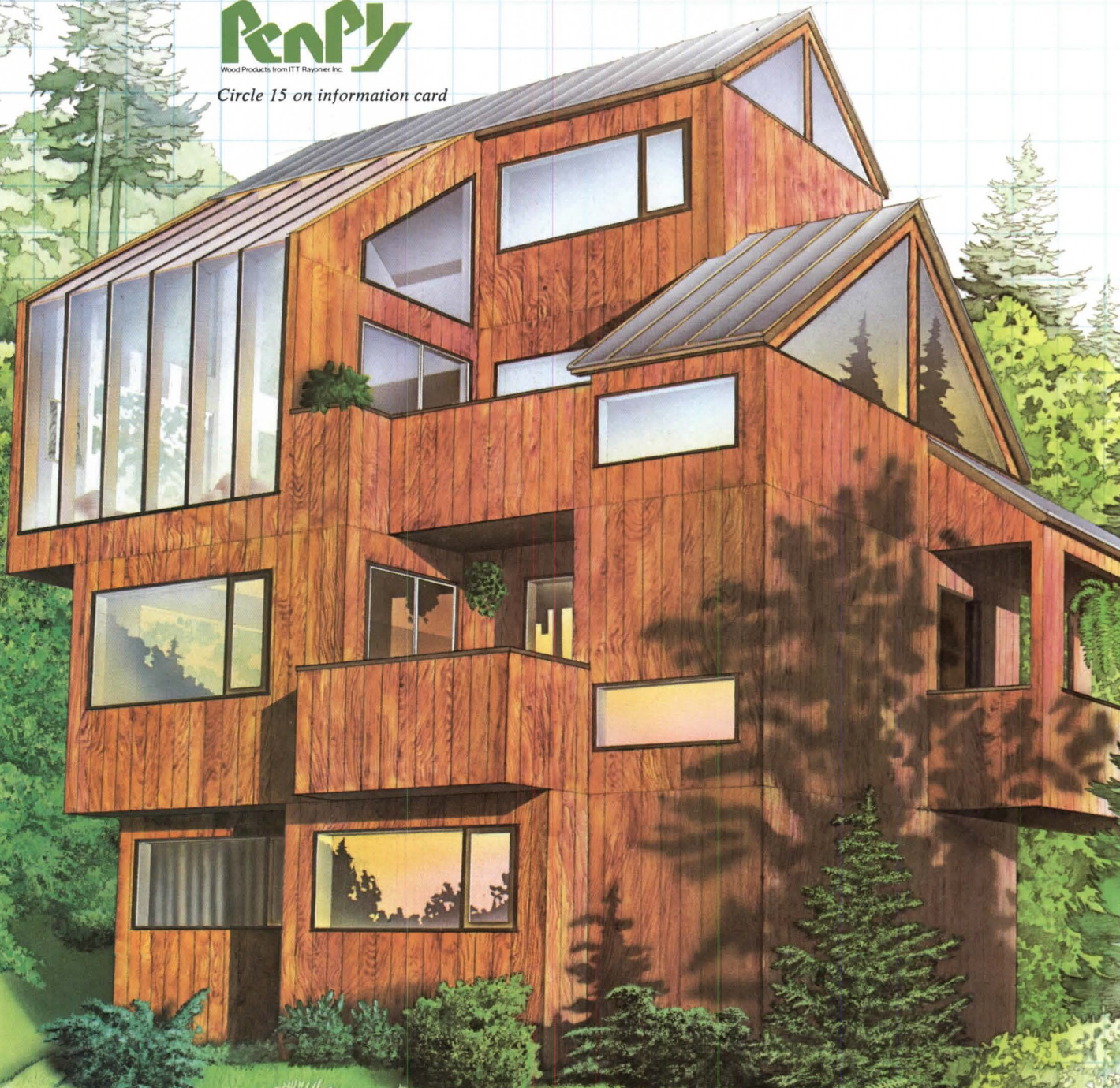

**RAYONIER**  
WOOD PRODUCTS

Residential design concept by:  
Phillip Brown, A.I.A., Seattle, WA

## Government from page 30

tion, and serving more than 400,000 persons yearly.

The charrette evolved when the Golden Gate national recreation committee, an arm of NPS, wished to obtain maximum information in minimum time regarding a master plan that would delineate use and space needs of the resident groups who provide the programs for the public in more than 300,000 square feet of covered space. Only a part of the former military base, the center is considered the facility's most critical element. Currently, pedestrian access is minimal, there is lack of order in specific areas of use, direct access to the water level is prevented by the piers, there is limited parking capacity and there is no focal point for the purposes and aims of the Fort Mason Center.

Conducted under a grant from the National Endowment for the Arts, the first stage of the competition took place over a three-day period, following which eight finalists made presentations for two days to the jury. Each of the competing teams received \$1,000. In addition to the winner, the competitors in the final stage were representatives of Marquis Associates; Gordon Chung & Associates; Bull Field Volkman & Stockwell; Charles Hall Page & Associates; Treffinger Walz & MacLeod, with Royston Hanamoto Beck & Abey; Planning Collaborative, and the Office of Waterfront Architecture. The winner received \$30,000 and will prepare a master plan report upon which future development and funding for the center will be based.

The winning team says that the appropriate solution seemed to be one that would disturb the present character and ambience as little as possible, preserving the "working port" atmosphere. The team worked on the theory that the handsome, solidly constructed buildings, which appear to be "standing at attention," should be put "at ease," without "being taken out

of uniform." The design focus includes improved internal circulation, provision of expanded lobbies, redesign of the parking lot, interbuilding access, improved signage and provision of outdoor space for public events. An overall organizational grid work is fundamental to the design, as well as two main pedestrian "streets."

Climatic conditions, say the architects, particularly wind and sun, suggest methods to capture energy. Two large wind-driven propeller-type electric generators are proposed at the west end to absorb the wind's force and to connect to the public gas and electric distribution system. In front of one of the piers, "four large towers will generate hologram images visible from across the bay and many points in the city." Slips between the piers will be used to develop major stepped access to the docks to serve as a public marine reception area. The piers themselves, the architects say, lend themselves to a solar heating system using existing clerestories with increased glazing to admit heat into a plenum with a translucent bottom. Heat collected in the plenum would be stored in thermal mass pods constructed within the roof trusses.

The charrette, whose aim was to promote cross-fertilization of ideas among the competing teams and to engage the designers in a dialogue with the witnessing public, was judged by a jury consisting of Edward Charles Bassett, FAIA; Richard Bender, dean of the college of environmental design, University of California, Berkeley; designer Ray Eames; Rudy Hurwich, Fort Mason Foundation board member; Rai Okamoto, San Francisco planning director; Lynn Thompson, superintendent of the Golden Gate national recreation area, and Harry Weese, FAIA. (Based upon information supplied by Suzan Swabacker, Ratcliff Architects, Berkeley, Calif., and Robinson Mills & Williams.)

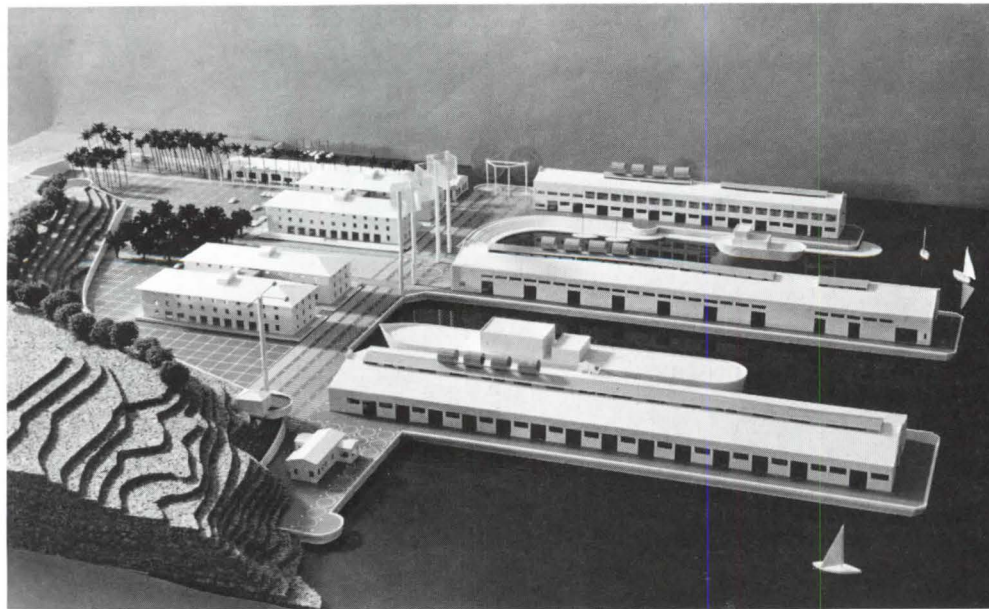

## U.S. Construction Volume Down 5 Percent, Commerce Estimates

According to a report released by the Department of Commerce, an estimated \$222.5 billion was expended for new construction in 1979, but physical volume declined by about 5 percent. Expenditures in private construction, which accounts for 80 percent of construction activity, rose by \$16 billion, while public construction rose by less than \$500 million due to a trend toward fiscal conservatism, particularly at the local level. Increases in nonresidential construction served to offset a 13 percent drop in housing starts.

The department predicts that in 1980 construction cost outlays will stay about the same as in 1979, but physical volume in 1980 will decline by about 9 percent. It is estimated that public construction spending will increase in 1980 by about 3 percent, or \$1.25 billion. Some projects slated for 1980 construction, however, have already been delayed due to rising costs in both construction and financing.

The department estimates that residential construction will be hardest hit in 1980, with only 1.4 million housing starts, of which 32 percent will be multiunit structures. It predicts that outlays for industrial building will increase in 1980 by 17 percent, office structures by 8 percent. No growth is anticipated for highway or sewer construction. Also, the department believes that there will be a moderately lower rate of inflation, which in 1979 ran more than 12 percent.

## 12 School Projects Recognized For 'Architectural Achievement'

During the 1979 annual meeting of the Association of School Business Officials, 12 projects were recognized for "outstanding architectural achievement" by ASBO's school facilities council division. The selected projects were included in ASBO's 1979 exhibition of school architecture, having been voted upon by a jury of architects and educators. The award-winning projects are in three categories:

- New school buildings: Certificates of excellence went to Cone & Dornbusch, Chicago, for the Hinsdale Junior High School, Hinsdale, Ill.; to Benham-Blair & Affiliates, Inc., Oklahoma City, for the Casady School Fine Arts Center, Oklahoma City, and to Cavitt McKnight Weymouth Inc., Houston, for the Fort Bend Athletic Facility, near Sugar Land, Tex. Architectural merit certificates were awarded to Ferendino Grafton Spillis Candela, Coral Gables, Fla., for the Miami Dade Community College medical center campus, Miami; to Skidmore, Owings & Merrill, Chicago, for Miami

University Art Museum and Cultural Center; to Locke Wright Foster, Inc., Oklahoma City, for the Edison Elementary School, Bristow, Okla.; to Williams, Shields, Snyder & Goas, Harrisburg, Pa., for the G. C. Hartman Elementary School, Catawissa, Pa., and to Yearwood & Johnson, Nashville, Tenn., for the Coffee County High School, Manchester, Tenn.

- Modernization of existing buildings: A certificate of excellence was awarded to HTB, Inc., Oklahoma City, for the Tulsa Junior College Student Center, Tulsa, Okla., and an architectural merit certificate went to Aaberg & Associates, Huntsville, Ala., for the Educational Center for Special Services, Madison County, Ala.
- Additions to existing buildings: Architectural merit certificates were given to

Warren Holmes-Kenneth Black Co., Lansing, Mich., for the Slauson Intermediate School, Ann Arbor, Mich., and to Perkins & Will, White Plains, N.Y., for the Chatham High School, Chatham, N.J.

Members of the jury were Joel Bloom, AIA; Brooks Godfrey, AIA; K. Forbis Jordan, Library of Congress; Albert Michejda, AIA, and William R. Wilkerson, Indiana University.

## Design Competition in Portland

The city of Portland, Ore., has announced a competition for schematic designs to turn a square in the city's prime downtown area into a day and evening attraction. The site, once graced by the Portland Hotel designed by Stanford

White, has served as a two-level parking garage. The block was recently acquired by the city. An improvements budget of \$2.9 million has been allocated for the block, which is considered a key to Portland's downtown renaissance.

The competition program calls for jury selection of five designers to prepare schematics over a 60-day period. Each of the five competitors will receive \$10,000 in compensation.

For additional information, write: Donald J. Stastny, AIA, Professional Adviser, City of Portland Development Commission, 1500 S.W. First Ave., Portland, Ore. 97201.

## Retired Partner's Work for Firm Endangers Social Security Pay

If you are thinking of retiring from your architectural partnership firm and want to do a little consulting work for the firm to make some extra money, think twice. Such dreams could end in financial disaster, says Albert Ellentuck, a tax partner with the accounting firm of Laventhol & Horwath in Philadelphia.

"Under ordinary circumstances," he explains, "a retired partner does not have to count the retired payments he receives from the partnership as part of his earnings" to get Social Security benefits, but "because of the peculiar way the law is drafted, if he does *any work at all* for the partnership after his retirement, his retirement benefits will be counted, which could cause him to lose all or part of his Social Security benefits."

Generally, Social Security benefits will be reduced when a retired person 65 through 70 years of age earns in excess of a specified amount—\$5,000 in 1980. For every \$2 earned over and above that amount, Social Security benefits are reduced by \$1.

Using the \$4,500 amount allowed in 1979, Ellentuck says, a retired partner who receives retirement payments of \$23,000 and Social Security benefits of \$9,000 will have a total of \$32,000 "without lifting a finger." But, because of the statutory language, if he does some work for his old firm and receives \$1,000 for that work, he could lose all of his Social Security benefits, ending up with a yearly income of \$24,000. But if the retiree works for a different firm, earning \$1,000, he will have a total of \$33,000 in yearly income.

Ellentuck argues against the way the Social Security Administration interprets the law. "Consulting exclusively for your old firm is not a trade or business, and should not be considered income of the partner in computing his Social Security benefits. Any other interpretation pro-

*continued on page 104*

# Granite.

## The beauty touch that needs no touching up.

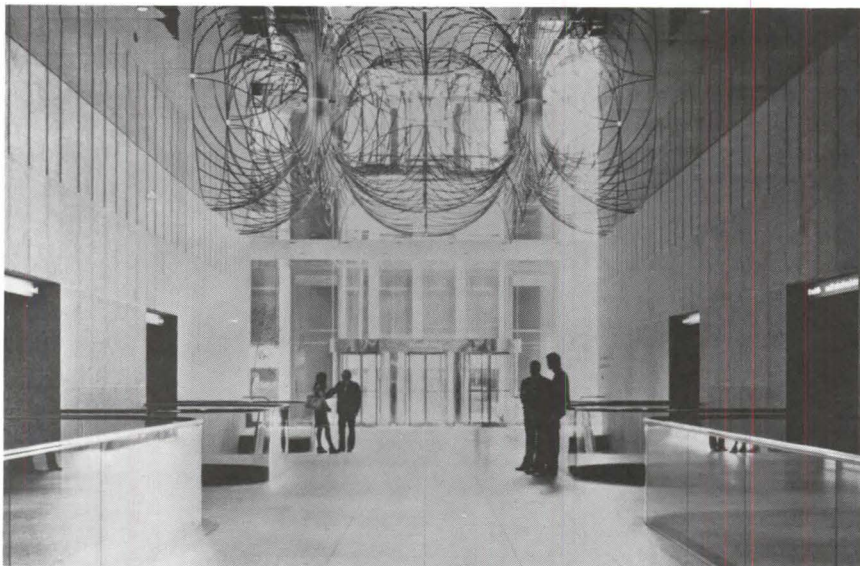

First International Building, Dallas, Texas  
Architect: Harwood K. Smith and H.O.K., Dallas, Texas  
Photo courtesy Form & Function Magazine.

Maintenance-free core walls stay as beautiful in high traffic areas as the day they go up. A beautiful way to accent, to add texture, to maintain value. Choose from twenty granite colors, seven finishes. All for the beauty touch that needs no touching up.

For more information, and a packet of full color literature illustrating Cold Spring Granite products in use, call toll free 800-328-7038. In Minnesota call (612) 685-3621, or write to the address below.

**Cold Spring Granite Company,**  
Dept. AIA-1  
202 South 3rd Avenue,  
Cold Spring, MN 56320



Circle 16 on information card

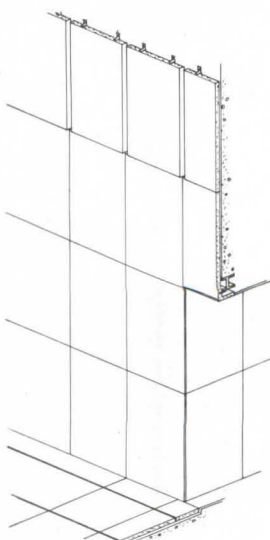



## We help tomorrow take shape today.

The look of the future is here now in architectural design. And permanent fabric architecture offers distinctive and practical building alternatives as well as some uncommon technical challenges.

No one understands this better than Birdair Structures because we pioneered the technology, and we're still the leader in the field. We offer single source responsibility for engineering, fabrication and installation of permanent fabric structures using SHEERFILL<sup>®</sup>, a woven fiberglass fabric coated with TEFLON<sup>®</sup>. SHEERFILL is pound for pound stronger than steel, classified as incombustible under fire codes and has a life expectancy of more than 20 years.

If you are interested in changing the shape of tomorrow, come to the leader today. Write or phone: Birdair Structures, 2015 Walden Avenue, Buffalo, New York 14225 U.S.A. (716) 684-9500 Telex: 091-353 Cable: Birdair Buffalo.

## **BIRDAIR STRUCTURES**

A DIVISION OF CHEMFAB

The LaVerne College Student Center roof, shown above, is made from SHEERFILL, CHEMFAB's architectural fabric of fiberglass coated with TEFLON. Architect: The Shaver Partnership

\* SHEERFILL is a registered trademark of CHEMFAB.

\* TEFLON is a registered trademark for DuPont fluorocarbon resins.  
Photo: Christopher Springman.

Circle 17 on information card



## A creative challenge, superbly met.

When the architect finds the solution to a design problem, it's a triumph. At Schinnerer we've been working with architects and engineers in the field of professional liability long enough to appreciate their creativity and expertise — and long enough to be fully aware of the insurance problems they face.

Now we've met a challenge of our own. At a time when the cost of everything else is going up, Continental Casualty Company, one of the CNA insurance companies, has stabilized its rates for a period of at least 27 months (from March, 1978) and added to its Professional Liability Program some new features that can save you money.

One exclusive CNA feature is called the Deductible Credit Plan. It can lower your deductible obligation by as much as 50%, or lower your premium if you select a higher deductible. The Deductible Credit Plan and other new features mean that we can now provide you with the most comprehensive coverage available, at a very reasonable cost.

At Schinnerer and CNA, we're always working to improve our coverage and hold the line on cost. You'll find our latest achievements go a long way toward meeting that challenge. Call your broker and get a quote.

Victor O.  
**Schinnerer**  
& Company, Inc.

*The first is still the best.*

5028 Wisconsin Avenue, N.W.  
Washington, D.C. 20016  
Phone: (202) 686-2850

Other offices in:  
New York  
Chicago  
San Francisco

*Circle 18 on information card*

AIA JOURNAL

***THE***  
***'70s***

# RECAP

By Stanley Abercrombie, AIA

## *Yale A&A in Ruins; Some See End of Modernism*

As the decade opened, Paul Rudolph's 1963 Yale school of arts and architecture was a shambles, victim not only of makeshift student-built interior partitioning, but also of a series of explosions—with consequent fire and water damage—that had blasted through the building in the early morning hours of June 14, 1969. The fourth and fifth floors had been gutted, and floors above that rendered unusable.

Restoration of the building was delayed pending the reorganization of the school. Some observers speculated that there had been a willful attack on the monumental example of modern architecture, and saw the attack as indicative of a trend away from the popularity of the modern movement.

## *Architects and the War*

As the Vietnam war continued into the '70s and spread into Cambodia (where Angkor Wat's restoration was interrupted and the ancient complex surrounded by land mines), many architects united in protest. One such group, called Architects and Planners for Peace, marched in New York City and was angrily confronted by building trades "hardhats." Other groups, lobbying in Washington, D.C., were 100 Designers for Peace and the Committee of the Planning Professions to End the War in Vietnam.

## *Exhibition: The Rise of an American Architecture*

Assembled by historian Edgar Kaufmann jr. and concentrating on American architecture of the years 1815-1915, a handsome exhibition opened at New York's Metropolitan Museum in the summer of 1970 and moved to Chicago's Art Institute the following

summer. It presented three aspects of architectural development — commercial work, residential work and parks —and each aspect was represented by three examples. As a poignant postscript to the exhibition, sounds of tolling bells accompanied a multiscreen film sequence of historic buildings being demolished by wrecking balls. The exhibition was designed by James Stewart Polshek, and Kaufmann edited an accompanying book, also titled *The Rise of an American Architecture*.

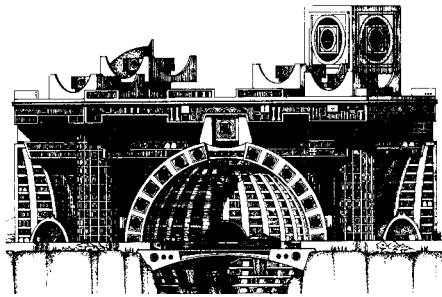

## *Exhibition: Soleri*

Architect Paolo Soleri's work was shown at Washington, D.C.'s Corcoran Gallery in 1970, then in New York City, Chapel Hill, N.C., Chicago and Berkeley, Calif. With huge models and 80-foot-long drawings, the show was overwhelming in presentation. Its content was overwhelming also: schemes for whole populations of several million people each to be concentrated in Soleri-designed "arcologies" (a Soleri-designed word combining architecture and ecology).

## *Exhibitions: Lapidus And Progress*

In the fall of 1970, the major exhibition of New York's Architectural League presented the Miami Beach hotel architecture of Morris Lapidus. John Margolies, who organized the show, termed it "The Architecture of Delight." The delight, however, was not universal; Ulrich Franzen, a former president of the league, called Lapidus "the Lawrence Welk of hotel

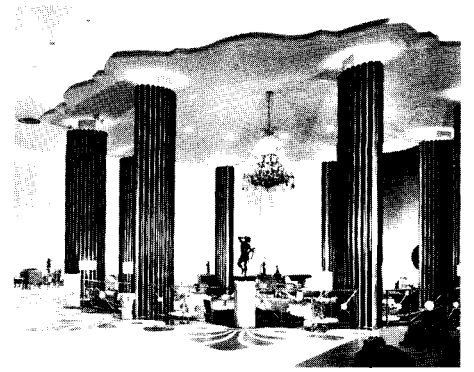

architecture," and said that the show represented "an esthetic backlash."

Across town, the Museum of Modern Art presented recent drawings and models from the offices of Philip Johnson, Kevin Roche and Paul Rudolph in a show called "Work in Progress."

## *St. Louis Housing Demolished; Some See End of Modernism*

On July 15, 1972, some 14-story blocks of Minoru Yamasaki's Pruitt-Igoe housing complex in an urban renewal area of St. Louis were dynamited. The buildings had been considered elegant, rational and progressive when built in 1951, but had recently become victims of defacement, vandalism and a high crime rate. Oscar Newman, in his book *Defensible Space*, laid the blame to planning errors such as circulation areas difficult for tenants to observe, while others suspected poor management and tenant selection policies to be at fault. In any case, Charles Jencks, in *The Language of Post-Modern Architecture*, declared that "we can date the death of modern architecture" to the "precise moment in time" of the destruction of "infamous" Pruitt-Igoe. "Boom," he wrote, "boom, boom."

## *Competition: Centre Pompidou*

An international competition for Paris' Centre Pompidou had attracted almost 700 entries from 71 countries, and the jury, headed by Philip Johnson, had voted eight-to-one for the entry by the Italian-British team of Renzo Piano and Richard Rogers. In 1976 the building was completed, omitting some electronic billboard facade treatments suggested by the competition entry, but retaining all the entry's facilities for change and flexibility and all its structural and mechanical exhibitionism. By the end of the decade Pompidou was attracting bigger crowds than the Eiffel Tower and Louvre together.



## Rediscovery: Goff

Still active and innovative in his Tyler, Tex., practice, Bruce Goff was given fresh attention in the last few years. Half a dozen books on Goff appeared during the decade, most notably David DeLong's thorough *The Architecture of Bruce Goff: Buildings and Projects, 1916-1974*; a number of magazines reviewed his work including an entire issue of England's *Architectural Design*, and Goff served as guest critic at Yale and as lecturer in the U.S., Canada, Australia and Japan. Reacting to a show of Goff's work early in the decade at New York's Architectural League, Ada Louise Huxtable of the *New York Times* wrote, "This is one of the most provocative manifestations of the American architectural genius. . . . If you can shed that eugenically frightening New England-Calvinist-Harvard-Bauhaus intellectual fridity,

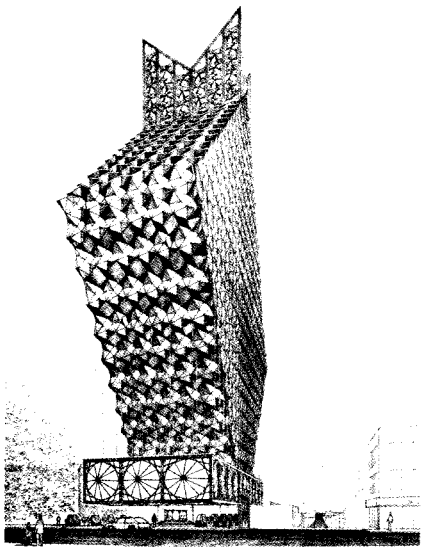

Goff's 1970 design for First National Bank, Independence, Mo. (not built).

if you can suppress a reaction to some obviously home-grown corn, there is an artist here. There is a consistent statement of art and purpose, a sensitivity to the land, a last-stand half-triumph of the romantic individualist in a world that is forcing the architect to conform increasingly to standardized formulas and business practice. Bruce Goff is a phenomenon. . . ."

## Historic Preservation: Early in the Decade, The Outlook Was Mixed

On the preservation front, losses and gains were just about even in the beginning of the '70s. Henry Hardenburgh's Plaza Hotel, New York City, was declared a landmark in 1970, but Irving Gill's Dodge house, Los Angeles, was bulldozed the same year. In

1971 Richardson's Glessner house was saved in Chicago, but Baltard's Les Halles market pavilions hit the dust in Paris. In 1972 the Metropolitan Museum bought Frank Lloyd Wright's threatened Little house; it was moved from its site near Minneapolis, but there were plans to reconstruct its living room as part of the museum's new American wing, nearing completion as the decade ended to designs by Roche-Dinkeloo. Also in 1972, Adler and Sullivan's Old Stock Exchange was demolished in Chicago. Recording the building's details during demolition, architectural photographer Richard Nickel was killed by falling masonry.

And in 1973 a curious thing happened to James Bogardus' 1849 Laing Stores on the way to preservation. The lower Manhattan buildings, thought to have had the first castiron facades, were doomed by an urban renewal plan, but it was decided to dismantle the facades, store them temporarily and re-erect them a few blocks north as part of a new college complex. Unfortunately, the stored facade elements were all stolen before they could be reused.

## Architects' Fees Deregulated

At its 1972 convention in Houston, AIA agreed to abide by a consent decree issued by the Department of Justice that standards governing fees and prohibiting competitive bidding on the basis of fees were illegal restraints of trade. AIA, however, maintained the right to continue its advocacy of qualifications, not fees, as the basis for architects' selection.

## Boston Tower Sheds Glass; Some See End of Modernism

I. M. Pei's John Hancock Tower, an elegant addition to Boston's Copley Square, was temporarily transformed

from glass to plywood as shattered panes of insulated glass were replaced; the plywood, in turn, was replaced by lighter half-inch tempered glass. Despite careful wind tunnel tests at Purdue University 18 months before construction, over 3,000 of the tower's 10,000 panes had fallen out or been damaged. Some observers interpreted this surprising and still unexplained technical failure to signal the end of an architectural style largely based on faith in technology.



Courtesy Boston Globe

## Competition: New Math Building for Yale

Winners were announced in 1970 in the competition for the design of a new mathematics building for Yale University, and the jury's unanimous choice among 468 entries was that of Venturi & Rauch (below). Charles W. Moore was professional adviser for the competition, and the jury included Edward L. Barnes, Kevin Roche, Romaldo Giurgola and Yale's Vincent Scully. Charles E. Rickart, chairman of the mathematics department and also a jury member, said that the Venturi design "does exactly what a math department building should do." Giurgola

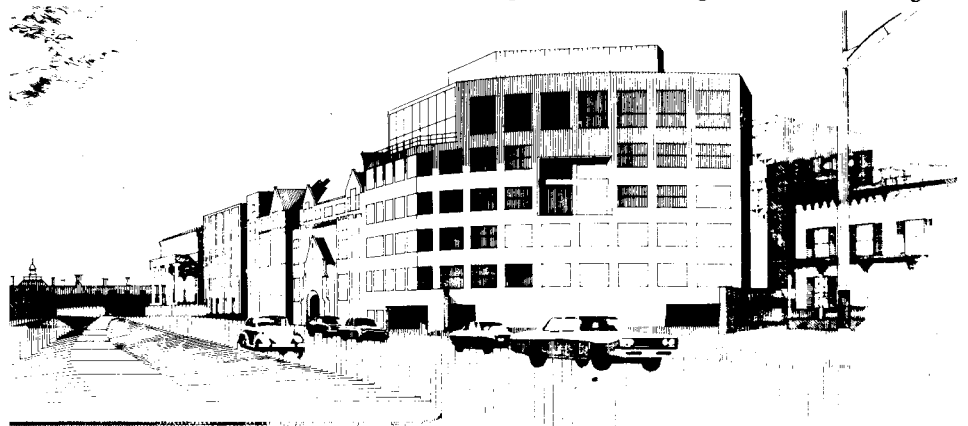

considered it "a fresh statement of great hope for an architecture of measure, of selectivity, of passion for the simplest thing, and highly sensitive to the human condition." "It is absolutely straightforward, eloquently simple," Scully said. "This choice could never have been made in the '50s." Barnes said the jury members "were all very much moved by it, the unpretentious approach." And Roche felt the Venturi entry demonstrated "the very highest level of the ability to design."

Some nonjury members expressed less enthusiasm about the choice. For both Serge Chermayeff and Sibyl Moholy-Nagy, it was a case of *dèjà vu*. Chermayeff wrote that "the model suggests that the new Yale building was designed by Connell, Wood & Lucas in the '20s," and Moholy-Nagy remarked that "in every architectural school, *Neue Sachlichkeit* à la '20s is considered 50 years behind the future—not at Yale."

The competition resulted in a 1974 book edited by Moore and Nicholas Pyle, but, as the decade ended, the winning design remained unbuilt.

## Exhibition: Breuer at Met

In 1972, for the first time, New York's Metropolitan Museum of Art honored a living architect with a one-man show of his work. The architect was Marcel Breuer, and the exhibition, designed by Breuer's own office, included not only the usual drawings and photographs, but also models, furniture, decorative objects, mockups of actual building elements and even Breuer-designed tapestries. The show later traveled to Paris where it was seen at the Musée des Arts Décoratifs.

**MARCEL BREUER  
MARCEL BREUER**



Cheryl Rossum

## Exhibition: Ants

Under the direction of artist Alan Sonfist, the Architectural League of New York in 1972 imported an estimated three million Army Ants and displayed them in an enormous sandbox. These were meant to produce patterns and constructions that would be instructive to league members and visitors. Before these patterns could be produced, however, the ants found a hole in the plastic covering of their box, escaped in a long file and were sprayed to death by a terrified night watchman. Just in time for the opening; two million more ants were fetched from Panama. This second battalion failed to find a means of escape, but died within the week.

## Ducks and Sheds

In 1972 Robert Venturi, Denise Scott Brown and Steven Izenour brought us the fresh perception of two ways in which building images contradict building forms. *Learning from Las Vegas*

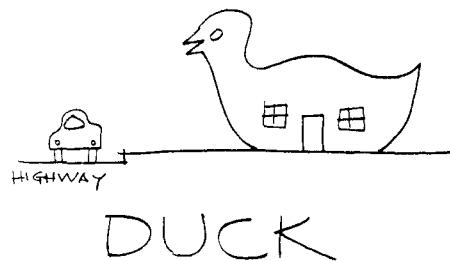

contrasted the *decorated shed* ("where systems of space and structure are directly at the service of the program, and ornament is applied independently of them") with the *duck* ("where the architectural systems . . . are submerged and distorted by an overall symbolic form"). The latter kind of "building-becoming-structure" was named in honor of a duck-shaped Long Island roadside shop (selling duck eggs) that had made its public debut in Peter Blake's 1964 book, *God's Own Junkyard*.

James Wines of the SITE group (known for the peeling and crumbling brickwork of its Best Products buildings), defended the building type. "The Big Duck," he said, was "a congenial presence" and represented "an exceptional individuality."

While, on the whole, he found *Learning from Las Vegas* to be "witty and immensely erudite," James Marston Fitch warned of a "critical difference between looking at pretty pictures of hell and actually having to live there."

## Exhibition: Beaux-Arts

"The Architecture of the Ecole des Beaux-Arts" at New York's Museum of Modern Art in 1975 was both the most visually spectacular and the most philosophically influential show of the decade. It was organized by Arthur Drexler with the aid of Richard Chafee, David Van Zanten and Neil Levine, and a book of the same title, edited by the same four, appeared in 1977. Some saw the show and book as symbols of the renewed interest in drawing and as great boosts to that revival; some saw them as symbols of renewed interest in historicism. Denise Scott Brown wrote that "although the modern establishment claims to like the Beaux-Arts for its good drawings, I believe it is turning to the Beaux-Arts now to find some way of accepting at last the 15-year-old critique of the modern movement. This was MOMA's way of finally agreeing that you could not be for steel and glass structures in 1977, at least, not simple-mindedly, and not for everything."

## AIA Builds

Although six years of difficulties had followed a competition, won by Mitchell/Giurgola, for design of the AIA's headquarters building, the structure was finally built in 1973 to designs by The Architects Collaborative. The winning design had been unbuilt because of an increase in program requirements, and two later Mitchell/Giurgola designs had been rejected by Washington, D.C.'s Commission of Fine Arts. After three tries, Mitchell/Giurgola resigned the commission, and TAC was chosen to replace them. Fine Arts Commissioner Gordon Bunshaft called the TAC design "wonderful."

## Hollywood Sees Buildings As Villains

A rash of new films characterized architecture as oppressive and even dangerous. In "Clockwork Orange" and "Fahrenheit 451" frighteningly barren buildings were the background for the films' action. In "Playtime" Jacques Tati was hilariously victimized by sleek new office blocks, and in "Earthquake" and "The Towering Inferno" buildings were shown as threats to life itself. Such "essentially hostile" presentation should give architects considerable pause," wrote San Francisco architect Herb McLaughlin in 1975. "The message is that they really don't seem to like us."

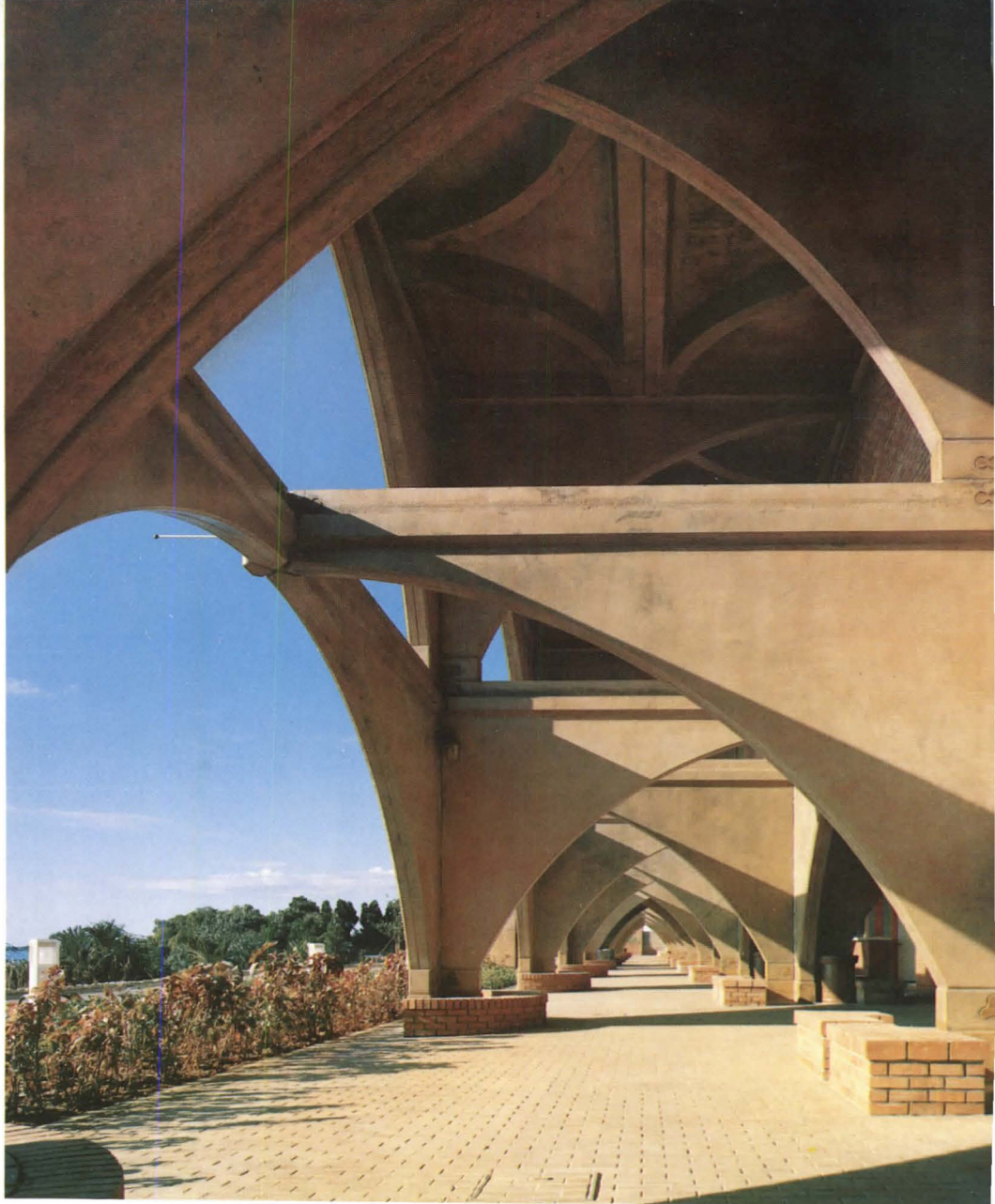

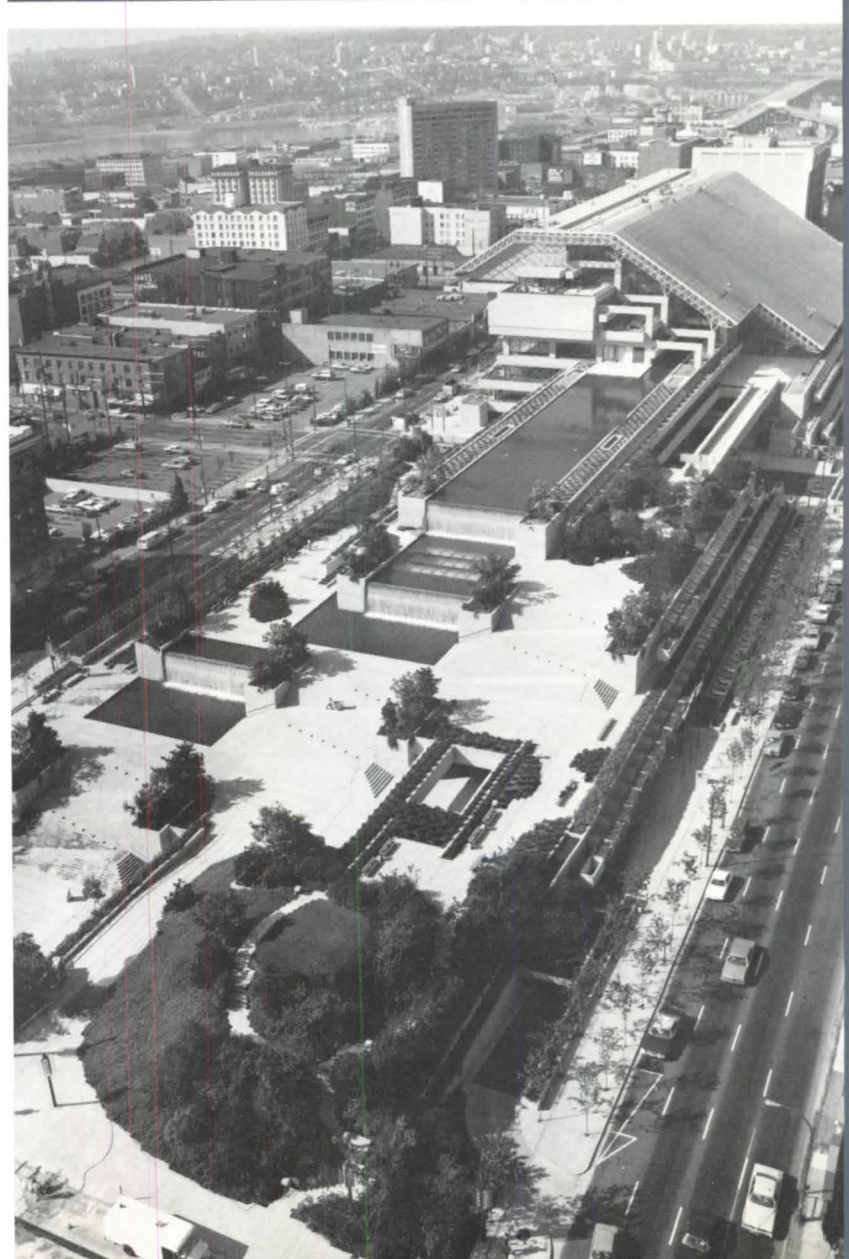
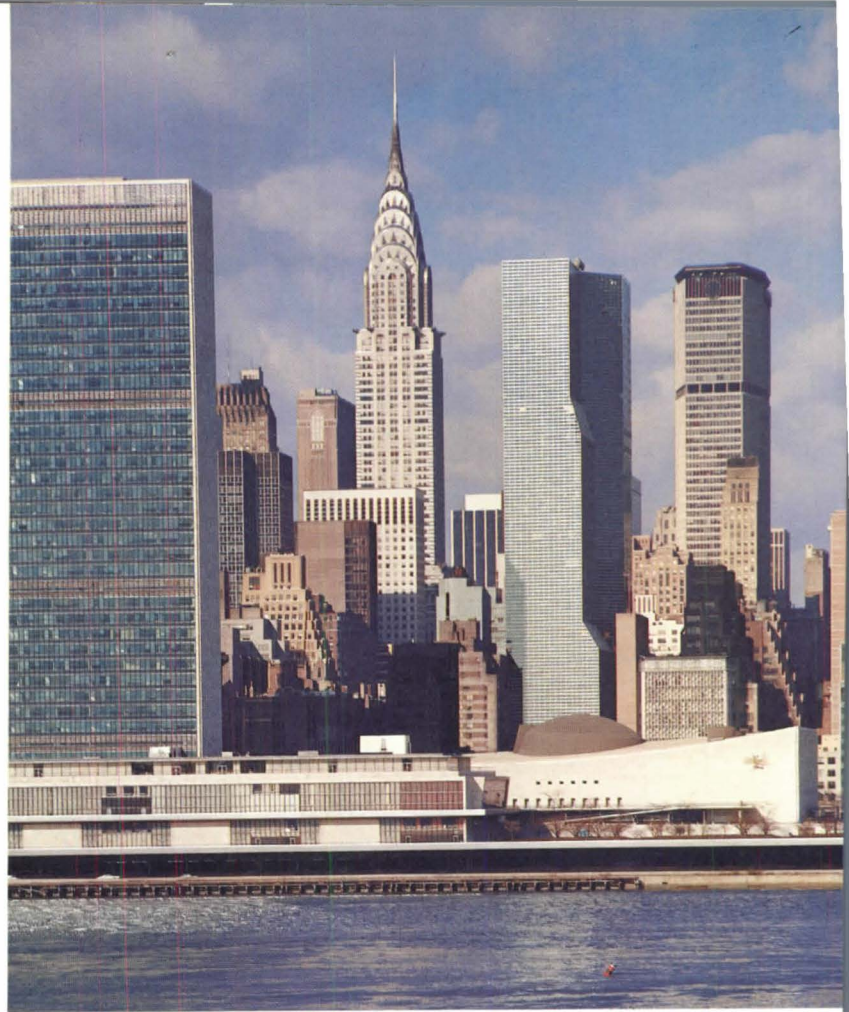

## Rediscovery: Gray

Architect and furniture designer Eileen Gray received new attention during the decade, first in Yale's *Perspecta* in 1971, then in an exhibit of her work organized for the Royal Institute of British Architects by Alan Irvine in 1973. In 1975 the exhibit traveled to Los Angeles, Princeton, N.J., New York City and Boston, and in 1979 another show followed, opening at London's Victoria and Albert and also coming to this country. Half a dozen magazine articles on Gray appeared, Stendig introduced in 1978 a table designed by Gray in 1927, and the Museum of Modern Art added the table and a Gray folding screen to its design collection. Perhaps the most fulsome praise was Joseph Rykwert's in *Perspecta*: He detected "quality high enough to set her among the masters of the modern movement however condensed her accomplishment." Gray died in Paris in 1976.

## Exhibition: Signs of Life

At the Renwick Gallery in Washington (restored in 1972 by John Carl Warnecke and Hugh Newell Jacobsen), Venturi and Rauch presented "Signs of Life: Symbols in the American City." In the form of model rooms, with objects labeled "Comfortable Chippendale," "Colonial Convivial," and "Regency Gazebo," the show attempted "to survey the pluralist aesthetic of the American city and its suburbs."

## Deaths

In 1970, Richard Neutra, Charles Abrams and Egon Eiermann. In 1971, Robin Boyd, Sibyl Moholy-Nagy, Rudolph Wittkower and Arne Jacobsen. In 1972, Aline Saarinen, John Lloyd Wright, Hans Scharoun and Sven Markelius. In 1973, Shadrach Woods and Willem Dudok. In 1974, Louis Kahn. In 1975, Clarence Stein and Sir Robert Matthew.

## AIA to Venturi: Not Yet; Scully to AIA: No Thanks

In a dramatic moment prior to the 1976 AIA convention, historian Vincent Scully refused to accept either an honorary AIA membership or a medal honoring his writing because AIA's college of fellows had refused to accept Robert Venturi, "the most important architect of my generation," in Scully's opinion. Venturi became a fellow in 1978.

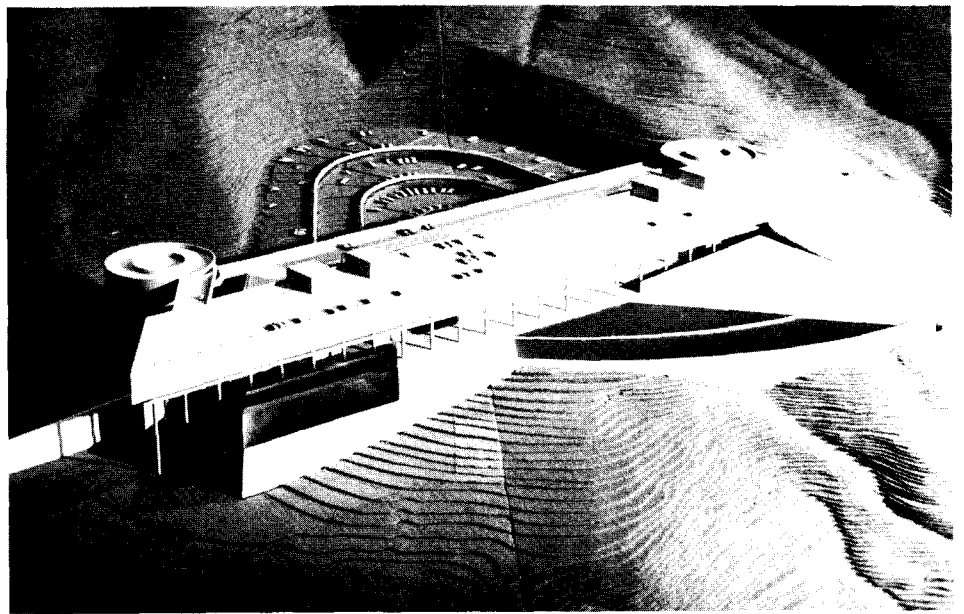

## Competition: Johns-Manville

Nine strong firms waited for the good news at the 1973 AIA convention in San Francisco. Of the nine, the winner was The Architects Collaborative, and its design for Johns-Manville's headquarters was completed in 1977. Was there a lesson for future competition entrants? Mildred Schmertz in *Architectural Record* said, "The TAC team boldly deviated from the program because it could not have been successfully solved as written. The others did not. TAC won hands down."

## Aalto Dies in '76; Some See End of Modernism

Although Kahn's death two years earlier—on a train platform in New York City—had been considered a tragic loss, it was Alvar Aalto's death in 1976 that was considered the end of a whole period. Writing in *Collier's Encyclopedia Yearbook*, Nicholas Polites said, "In many ways 1976 marked the official end of one architectural era and the beginning of a new age of transition. . . . Perhaps symbolizing the

decline of modernism was the death this year of Alvar Aalto." Ada Louise Huxtable, in the *New York Times*, June 27, 1976, wrote that "modern architecture is at a turning point. . . . The theory and practice of modernism are under serious attack." And the 1976 AIA honor awards jury remarked that "the old formulas are no longer valid. . . . We are in a searching period, questioning the rules, breaking from convention. There is no direction that is wrong."

## Exhibition: Aalto

Aalto himself was one of the few modernists whose reputation seemed to have come through the decade greatly enhanced. His widow and former collaborator Elissa Aalto continued the firm's work in Helsinki, completing two churches and several other projects begun before Aalto's death. A number of books of Aalto's buildings, sketches and writings appeared, and there were two exhibitions that traveled widely in the U.S.: one, organized just after his death by ICF, importers of Aalto furniture designs, and a later one organized by the Museum of Finnish Architecture in Helsinki.

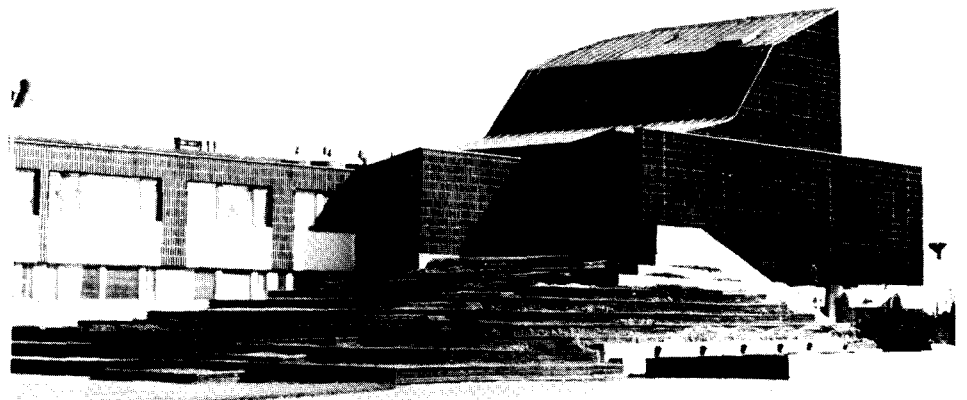

## Economy Dips; Construction Follows

Following one of the most robust construction booms ever, the American economy suffered a severe decline. By the middle of the decade, construction seemed to be at its lowest ebb since the Great Depression. Architectural offices trimmed their staffs accordingly, and a number of projects were doomed to be unrealized.

Accompanying this real change was a change in attitude. F. W. Schumacher told us that *Small Is Beautiful*, and the Club of Rome warned of *Limits to Growth*.

Some firms turned to the Middle East, seeking commissions and often returning with vague contracts and nightmarish accounts of Middle Eastern hotels, airports and customs. Some of these commissions developed into actual buildings; some vanished along with the Shah's regime in Iran.

At the decade's end, the economy had recovered considerably from its situation five years earlier, but still remained less healthy than at the decade's start.

## Zaps out: Guitars in

All those "let's-try-to-make-it-look-indigenous" arcades on American work for the Middle East were not the only cause of a boom in sales of circle templates and French curves. In addition, a change of fashion had swept through schools and drafting rooms. A favorite device of the '60s had been the 45-degree-angle. At Princeton, Pennsylvania and Yale, according to C. Ray Ed Stoecklein

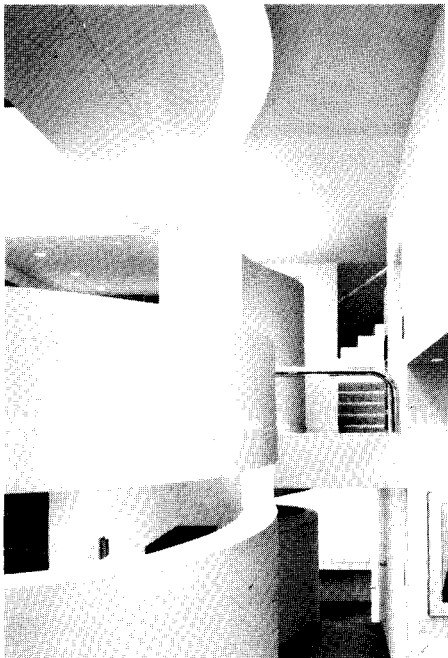

N.Y. townhouse by Robert A. M. Stern.

Smith, the angled elements were called "zaps" or "zaps," while "in California the 45° wall was often called a 'zoot wall.'" By whatever name, it had flourished in the plans of Pei, Franzen and Rudolph, in the shed roofs of Barnes, Moore and Esherick, and in Walter Netsch's "field theory." But the angle grew tiresome to many, and the winning new device that replaced it was the undulating guitar-shaped (or, perhaps, piano-shaped) contour that had appeared in Le Corbusier's work of the '20s and in innumerable Cubist paintings. Hejduk and Graves had used the curve in the late '60s, and in the '70s it appeared in works by Stirling, Isozaki, Stern, Gwathmey Siegel, Meier and innumerable others.

## Cooper-Hewitt: A New Force

In 1976, the Cooper-Hewitt Museum opened in new quarters and became established as the Smithsonian Institution's branch for the study of architecture and decorative arts. Lisa Taylor was the director and Richard Oliver the curator for architecture. The mu-

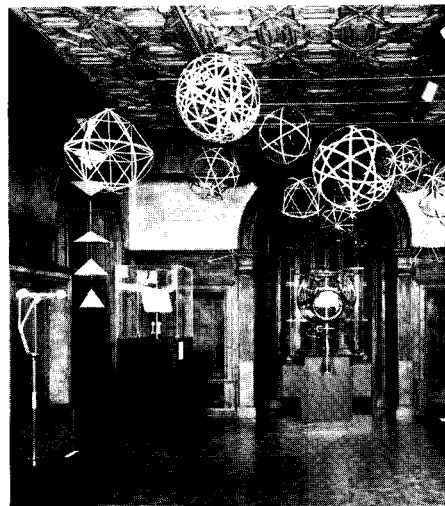

Cooper-Hewitt Museum

seum's new home was the former Andrew Carnegie mansion in New York City, restored by Hardy Holzman Pfeiffer, and the opening show, "Man Transforms," was conceived by Austrian architect Hans Hollein and included contributions by Buckminster Fuller, Arata Isozaki, Ettore Sottsass, Richard Meier and others.

## Historic Preservation: The Outlook Improved

Although, at the end of the decade, the dynamite was booming in Atlantic City, the outlook for historic preservation, on the whole, had improved. The National Trust for Historic Preserva-



Wide World Photos

tion took steps to save Sullivan's Wainwright building, and the commission for its renovation was awarded to Hastings & Chivetta and Mitchell/Giurgola. Working for better laws protecting the built environment, Preservation Action was founded in 1975 and the National Center for Preservation Law in 1978. Furness & Hewitt's Pennsylvania Academy of Fine Arts was restored; Atlanta's Fox Theatre was saved; and Frank Lloyd Wright's house-studio in Oak Park, Ill., was purchased by a citizens' group for restoration. Abroad, concern continued about the sinking of Venice; the sinking also continued.

In 1975 the New York Supreme Court denied landmark status for Grand Central Station, but in 1978 the U.S. Supreme Court overturned the decision. Throughout the decade, there were alarms and preservation efforts concerning the Old Post Office in Washington, D.C., the west front of the U.S. Capitol and H. H. Richardson's railroad station in New London, Conn. At the end of the decade, all were intact.

The Museum of Modern Art



## Rediscovery: Lutyens

Although Sir Edwin Lutyens had been one of the most prominent English architects of his time (1869-1944), and although Le Corbusier had praised his work at New Delhi, he was an obscure

figure, for modernists, throughout the quarter century after his death. Allan Greenberg, in Yale's *Perspecta 12* (1969), was the first to dust off Lutyens's reputation, and, as the sense of modernism as the one worthy style began to fade, it became possible in the '70s for there to be a minor Lutyens revival. Articles about his work appeared in many periodicals, and the Museum of Modern Art presented an exhibition of his work in 1979.

## 1973: The Year of Palladio

The City Council of Vicenza, Italy, declared 1973 to be "The Year of Palladio," mounted an exhibition in his honor in the town's Palladio-remodeled basilica, and promoted a large number of Palladio-related books, events and exhibitions. An outstanding one, sent to the U.S. as a bicentennial gift in 1976 by the Centro Internazionale di Studi di Architettura Andrea Palladio with the assistance of the Italian gov-

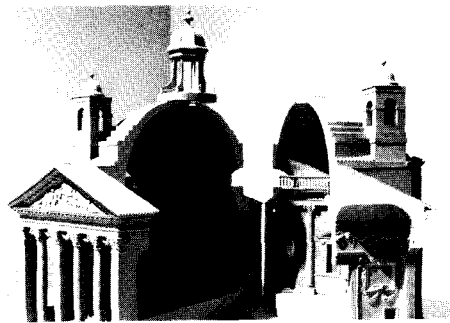

ernment, included 600 photographs, more than a hundred drawings and a dozen impressive wood models of built and partially built Palladian designs. It was accompanied by a book, *Palladio in America*, by Walter Muir Whitehill and Frederick D. Nichols. James Grady's *The Architecture of Neel Reid in Georgia* and Guinness and Sadler's *Mr. Jefferson, Architect*, both published in 1973, traced aspects of Palladio's influence in America, and Rudolf Wittkower's *Palladio and Palladianism* was published posthumously in 1974. At the end of the decade, Roche-Dinkeloo's corporate headquarters project for General Foods, spreading itself symmetrically around a central rotunda, was clearly Palladian in inspiration.

## Deaths

In 1976, Antonin Raymond and Alvar Aalto. In 1977, Jacques Carlu and Eliot Noyes. In 1978, Charles Eames, Frank Lloyd Wright Jr. and Edward Durell Stone. In 1979, Gio Ponti, Pier Luigi Nervi and Douglas Haskell.

## Gold Medalists

AIA's highest honor, the gold medal, was awarded six times during the decade: in 1970 to Buckminster Fuller, in '71 to Louis Kahn, in '72 to Pietro Belluschi, and, after a hiatus, in '77 to Richard Neutra (posthumously), in '78 to Philip Johnson and in '79 to I. M. Pei.

## Retirements

John Entenza, from the post of creative director of the Graham Foundation for Advanced Studies in the Fine Arts; Marcel Breuer, from his firm (which continued practice under the name Marcel Breuer Associates); Gordon Bunshaft, from Skidmore Owings & Merrill.

## Women in Architecture

The women's movement had its impact upon architecture, most forcefully in the 1977 touring exhibit, "Women in American Architecture," organized by the Architectural League of New York through its archive of women in architecture (founded in 1972), and in an accompanying book of the same name edited by Susana Torre. Other landmarks were articles on the subject by Ellen Perry Berkeley in 1972 and



Adele Chatfield-Taylor in 1973, Doris Cole's 1973 book, *From Tipi to Skyscraper*, and "Status of Women in the Architectural Profession," the 1975 report of the AIA task force on women in architecture, chaired by Judith Edelman. In 1976 the American Society of Interior Designers presented a "Salute to Women in Design" and gave its Thomas Jefferson award to Lisa Taylor of the Cooper-Hewitt Museum. In 1977 the American Institute of Planners elected Constance Lieder its first woman president.

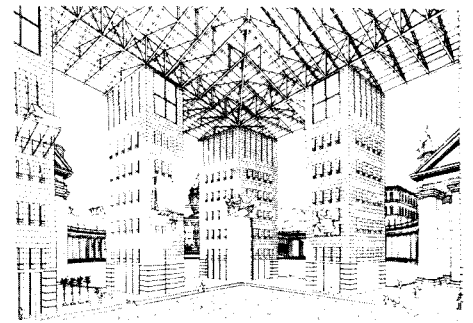

Cooper-Hewitt Museum

## Exhibition: Roma Interrotta

One of the most perplexing exercises of the decade was the assignment of the city of Rome as a redesign problem to a dozen contemporary architects and writers. The basis for redesign was the 12-section plan of the city drawn in 1748 by Giambattista Nolli—one section, one designer. Participants were James Stirling, Aldo Rossi, Robert Venturi, Romaldo Giurgola, Robert Krier, Leon Krier (above), Paolo Portoghesi, Michael Graves, Colin Rowe, Piero Sartogo, Constantino Dardi and Antoine Grumbach. The results, seen in Rome, Paris, London and several American cities, were more distinguished by virtuoso draftsmanship than by serious schemes for changing Rome (which seemed just as well).

## Technical Failures

The decade ended not with a whimper, but a bang. Several bangs. First, in January 1979 the roof of the Kling Partnership's Civic Center Coliseum in Hartford, Conn., collapsed. In June down came the roof of C. F. Murphy's AIA-award-winning Kemper arena in Kansas City, Mo. In August it was the roof of Anthony Rossi's Rosemont Stadium, under construction near Chicago, this last failure killing five workers and injuring 15. In addition, Edward Durell Stone's Kennedy Center was leaking in Washington, and marble sheathing was being replaced on Wallace Harrison's Rockefeller Mall in Albany, N.Y., and on SOM's Lyndon Baines Johnson Library in Austin, Tex. "Whoever may be at fault," Walter McQuade wrote in *Fortune*, "the ironic truth is that we live in an age of great technological talent but waning on-the-job competence." Unfortunately, these isolated failures affected not a few but the whole profession. AIA appointed a committee to review long-span building technology, and, as buildings came down, there were distressing corollaries that public confidence also might go down and liability insurance rates might go up.

## Authors See Modernism As Failure, Fiasco

A rash of new books in the '70s proclaimed that modernism had come to a deservedly beastly end. Of these, the most sensational account was Charles Jencks' *The Language of Post-Modern Architecture*; the most dour was Brent Brolin's *The Failure of Modern Architecture*; the most encyclopedic was C. Ray Smith's *Supermannerism: New Attitudes in Post-Modern Architecture*; the most entertaining was Peter Blake's *Form Follows Fiasco: Why Modern Architecture Hasn't Worked*, and the most informative about the nature of modernism's possible replacement was Robert A. M. Stern's *New Directions in Post-Modern Architecture* (first published in 1969, but considerably enlarged in 1977).

## Other Views

Other books on other subjects included: Alison and Peter Smithson, *Ordinariness and Light*; Oscar Newman, *Defensible Space*; Ian McHarg, *Design with Nature*; Hassan Fathy, *Architecture for the Poor*; Richard Stein, *Architecture and Energy*; Colin Rowe, *The Mathematics of the Ideal Villa and Other Essays*, and Philip Johnson Writings.

## Architects May Advertise

In 1977 the AIA rejected a proposal to allow members to advertise, but a Supreme Court decision soon after—that bar associations could not prohibit lawyers' advertising—led to the appointment of a task force to study the issue and to the approval, in 1978, of advertising.



David Macaulay drawing, courtesy Spaced Gallery (purchased by Philip Johnson).

## Architects May Build

Also in 1978 a resolution was passed to allow AIA members to act as both architects and developers of the same projects. The design/build resolution, put into effect for a three-year experimental period, did not so much open a new opportunity as sanction an already existing practice.

## Publications and Institutes

In 1972 Peter Blake left the editorship of *Architectural Forum* to found *Architecture Plus*, which was published until the end of 1974 when it became a victim of the recession. Meanwhile the venerable *Forum*, edited in its last months by William Marlin, had also folded.

Throughout the decade, the Institute for Architecture and Urban Studies, directed by Peter Eisenman, continued to offer the perceptions and provocations of an intellectual establishment and began publication of two periodicals, the tabloid *Skyline* and the high-density quarterly *Oppositions*.

In 1970 Ann Ferebee founded and began editing *Design and Environment* magazine, which changed its name in 1976 to *Urban Design*. In 1979, with funds from the National Endowment for the Arts, Ferebee established the Institute for Urban Design and began publishing the bimonthly *Urban Design International* for its members. The institute, despite its acronym, promised to be a fertile source of ideas about design at urban scale, with 1980 plans for conferences at Harvard, in Helsinki and elsewhere.

And from England in 1979 came *International Architect*, edited by Haig Beck and appearing to be a colorful large-scale counterpart of *Oppositions*.

## Exhibition: Transformations

No one could say it was a small show, but they said almost everything else. Arthur Drexler had packed the Museum of Modern Art with 400 photographs of work by 300 architects over the last 20 years, almost all buildings being represented by only one exterior view, and apparently organized on the basis of visual similarities. Exactly what Drexler meant by all of it was a matter of controversy. Martin Filler thought Drexler, in a "petulant, eccentric exercise," had "made a mockery of his institution's past pioneering contribution to the development of a meaningful contemporary architecture," and Kenneth Frampton concluded that the whole MOMA had "entered its decline." At the end of 1979, the show was scheduled to travel to Cleveland, then on to Toronto in 1980, and it was hoped that 1980 would also bring the publication of a catalog in which Drexler would explain his intention.

## Decade Finally Ends; Some Foresee End of Postmodernism

As 1980 arrived, a change in modernism during the decade seemed undeniable; clearly what Charles Moore had called the movement's "Puritan Revolution" was long past. As art critic Hilton Kramer put it, modernism was "a famous battle successfully concluded." But the change was perhaps not so much the death as the maturing of a style and the modifying of its youthful oversimplifications. A few strong trends had emerged (see the following pages), and a few general outlines could be discerned (see the essays that close this issue), but the profession was driven by no single passion. Some professed such passion for postmodernism, but, by the decade's end, that alleged style remained more discussed than built, and some suspected that it was an itch too vague to be satisfactorily scratched. Robert A. M. Stern, at least, had been articulate about postmodernism, listing its characteristics as "contextualism, allusionism and ornamentation," but these, important as they were, did not necessarily define a new style. And so postmodernism, like "relevance" a decade before, appeared to be a word architects had almost worn out. What would follow? The story continues in our next hundred issues. □





Balthazar Korab

# Big in the '70s: Interior Design

On the previous page, 3D International's Hyatt Regency in Indianapolis, one of the decade's many atrium-centered hotels. Right, Callister & Payne's Heritage Village Bazaar, Southbury, Conn.; graphics by Barbara Stauffacher. Below, Mount Healthy School, Columbus, Ind., by Hardy Holzman Pfeiffer. Bottom, Pearl's Restaurant, New York City, by Gwathmey Siegel. Across page, Torczyner law office, New York City, by Susana Torre; George Segal sculpture.

Norman McGrath

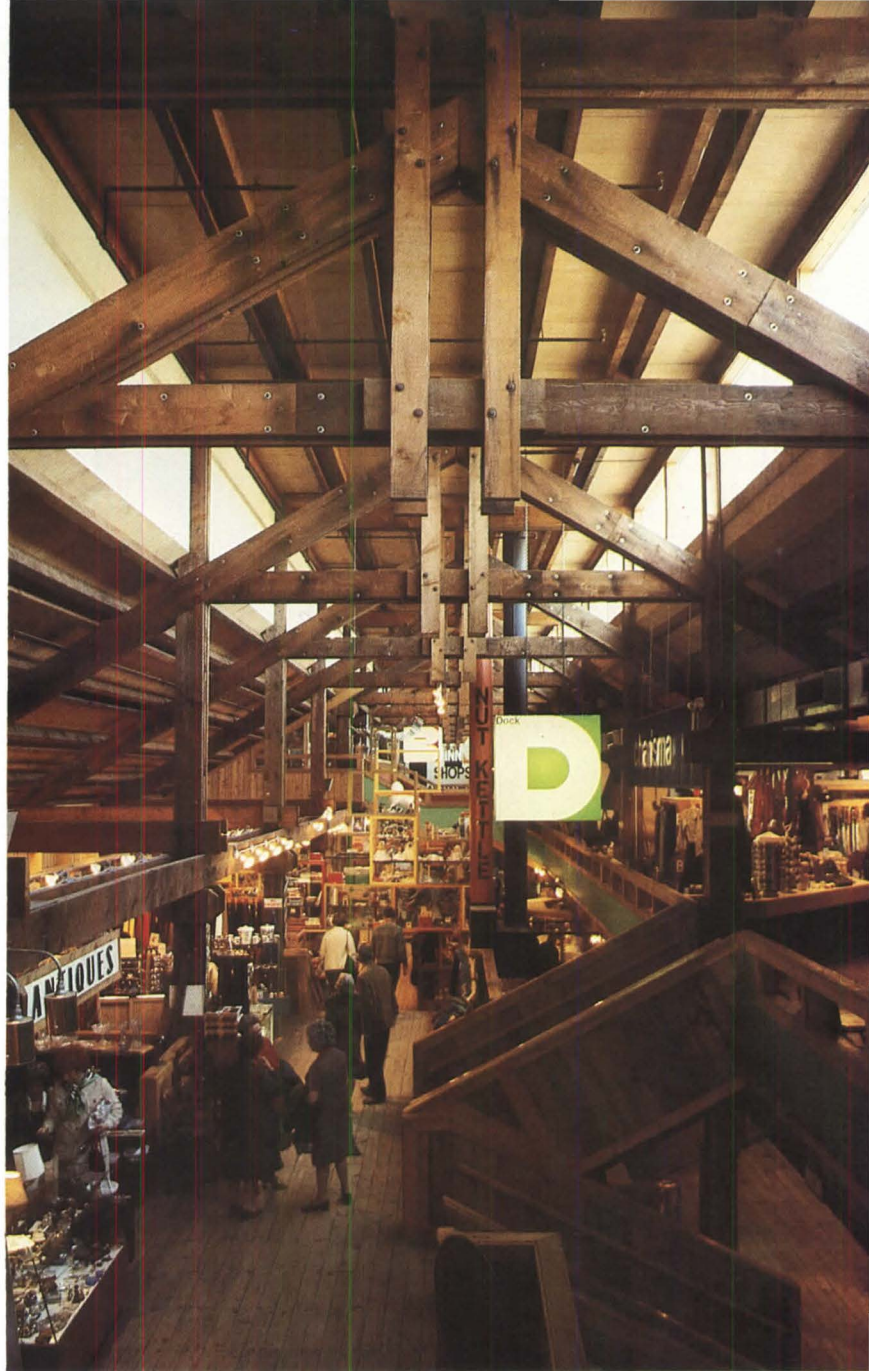

Charles Callister, Jr.

Traditionally an integral part of architecture, interior design had become a separate—even a somewhat estranged—discipline in the years prior to the '70s. But this schism was largely healed during the decade.

It was a time when the interior design profession literally pulled itself together: In 1975 two rival groups, the 8,000-member American Institute of Interior Designers and the 5,400-member National Society of Interior Designers joined to form the American Society of Interior Designers. It was also a time in which architecture and interior design came closer together: Led by Atlanta architect Bill Pulgram, AIA, and others, a joint committee of AIA and ASID members devised for the first time a series of jointly approved documents for interiors work.

It was a time when a recession in architectural commissions turned the attention of many firms toward interior design. In general, they found it both more interesting and more profitable than they had expected, and interior design and space planning staffs were added to many architectural firms. As tight budgets increasingly limited the manipulation of masses and volumes, it was natural for architects to turn to the manipulation of colors and surfaces. Adaptive use projects also focused attention on the interiors of existing building shells. And these changes corresponded to two philosophical attitudes of the decade—first,

to the feeling that architecture should not serve as a polemic for future social change but as a testable environment for present social behavior, and, second, to the renewed taste for complexity and ornamentation. While the term "decorator" still could hardly be said without a sneer, certainly "ornament" was no longer a crime.

It was also a time when interior design came to be subject, to an unprecedented degree, to considerations of health, safety and energy conservation. Strict flammability laws, still a matter of controversy at the decade's end, began to limit the use of

natural fibers and fabrics. New laws also required more accommodations for the handicapped. Office systems proliferated, becoming increasingly sophisticated in their inclusion of wiring and lighting. In furniture design, considerations of "ergonomics" (which in simpler days had been known as "human factors") concentrated on proper posture and body support. In short, interior design had become recognized as a much more serious business than just making rooms look pretty.

In 1970 interior design had been the neglected stepchild of architecture; by 1980 it had again become a legitimate partner. *S.A.*



Norman McGrath

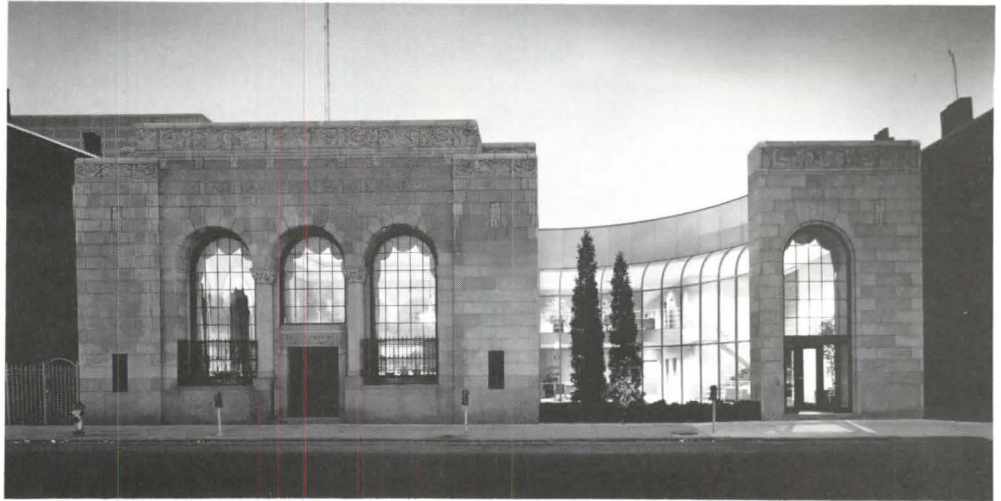

# Big in the '70s: Recycling and Restoration

In other countries, the adaptive use of older buildings is so commonplace that it passes unremarked. Until the '70s, however, prominent spectacles of the American scene had been venerable structures standing vacant and others being demolished to make way for newer ones (or even just to make way for parking lots). Such behavior had been supported not only by a now-outgrown American penchant for disposability, but also by an American tax structure that allowed depreciation advantages for new construction but not for rehabilitation. In the first half of the decade, even the cost of demolishing a landmark could be used as a tax deduction. And, of course, many zoning laws permitted the erection of large new buildings where small old ones were standing. In short, our economy had been organized so that destruction of our architectural heritage was simply sound business practice. By the end of the decade, both our laws and our attitudes had changed.

One helpful new law was the Public Buildings Cooperative Use Act of 1975, which, incorporating AIA-suggested amendments, encouraged the policy of having expanding federal agencies fill empty space in historic structures. Also important was the Tax Reform Act of 1976, which promoted adaptive use by allowing total depreciation for tax purposes of rehabilitated buildings and which penalized demolition of historic ones; the act also denied the advantages of accelerated depreciation to the builder of a new structure on the site of a demolished landmark. The Revenue Act of 1978 and the Tax Credit Bill of 1979 gave promise of further encouraging preservation. These new economic rewards coincided with an economic recession limiting new construction, and the attention of architects turned enthusiastically to adaptive use. In addition, Supreme Court decisions seemed to give teeth to local landmarks preservation laws. In recognition of the new concern for old buildings, the AIA in 1976 instituted a separate honor awards jury for an "extended Use" category.

The change in attitude included a relaxation of our early modern reverence for function as formgiver. Long after a building's original function had moved away or become obsolete, we learned that we were likely to find its shell still rich with intrinsic architectural assets, assets we could adjust to accommodate any number of new functions never imagined by the original archi-

*The East Cambridge Savings Bank, left above, as added to by Warren Schwartz of Charles G. Hilgenhurst & Associates, reused a side bay as part of an extended front facade. Boston's 1826 Quincy Markets, left, were transformed by Benjamin Thompson & Associates into the highly popular Faneuil Hall Marketplace. Right above, the Renwick Gallery in Washington, D.C., was salvaged and restored by John Carl Warnecke & Associates and Hugh Newell Jacobsen. The former Bell Laboratories in lower Manhattan, right, became Westbeth; Richard Meier was the architect for this first large-scale commercial adaptation for residential use.*

Robert C. Lautman



Ezra Stoller-ESTO

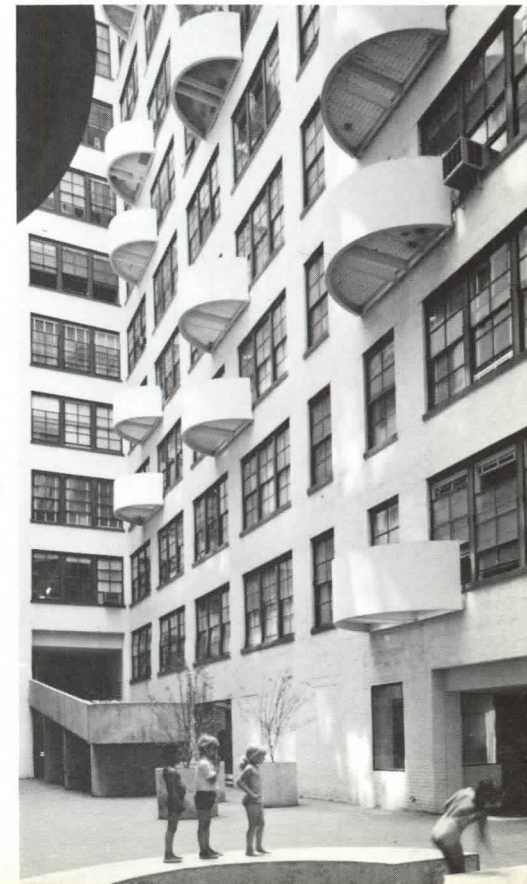

tect. We often found, indeed, that the greater the disparity between a building's original use and its new use, the greater might be the complexities, contradictions, surprises and delights of the adaptation.

The change in attitude was attuned as well to the decade's renewed concern for conservation, thrift, modesty and limited growth. Adapting the old rather than replacing it was a manifestation of a new architectural sensibility—perhaps even a new architectural morality. As Paris art critic Pierre Schneider said (in a 1974 issue of *Architecture Plus* devoted to what it called "recycling"), the best advice an architect can give his client, in some cases, is not to build.

Adaptive use has urban implications as well, for it is naturally in the oldest parts of our cities—generally the central parts—

that our oldest structures stand. Rehabilitating and reusing them can be a fundamental factor in downtown revitalization.

Most obviously of all, the enthusiasm for adaptive use was hand in glove with historicism, with our renewed interest in our architectural past and with our realization that modern architecture was—and continues to be—not revolutionary but evolutionary. One very welcome characteristic of the present stage of modernism is that we have outgrown our fear and loathing of the premodern. In 1960 modern architects had already begun to protest the replacement of important architectural monuments such as New York City's Pennsylvania Station. Even so, there remained a last vestige of missionary zeal attached to modernism, and one wouldn't have liked to be seen hanging around *too* many old buildings; now they can be our best friends. *S.A.*



*On the Princeton campus, Gwathmey Siegel's conversion of Whig Hall into new classroom uses demonstrated great brio. Their adaptation was among the first winners of the AIA extended use honor award. Below, Venturi & Rauch's Franklin Court in Philadelphia evoked the 18th century with a stone floor plan and a simple house frame.*

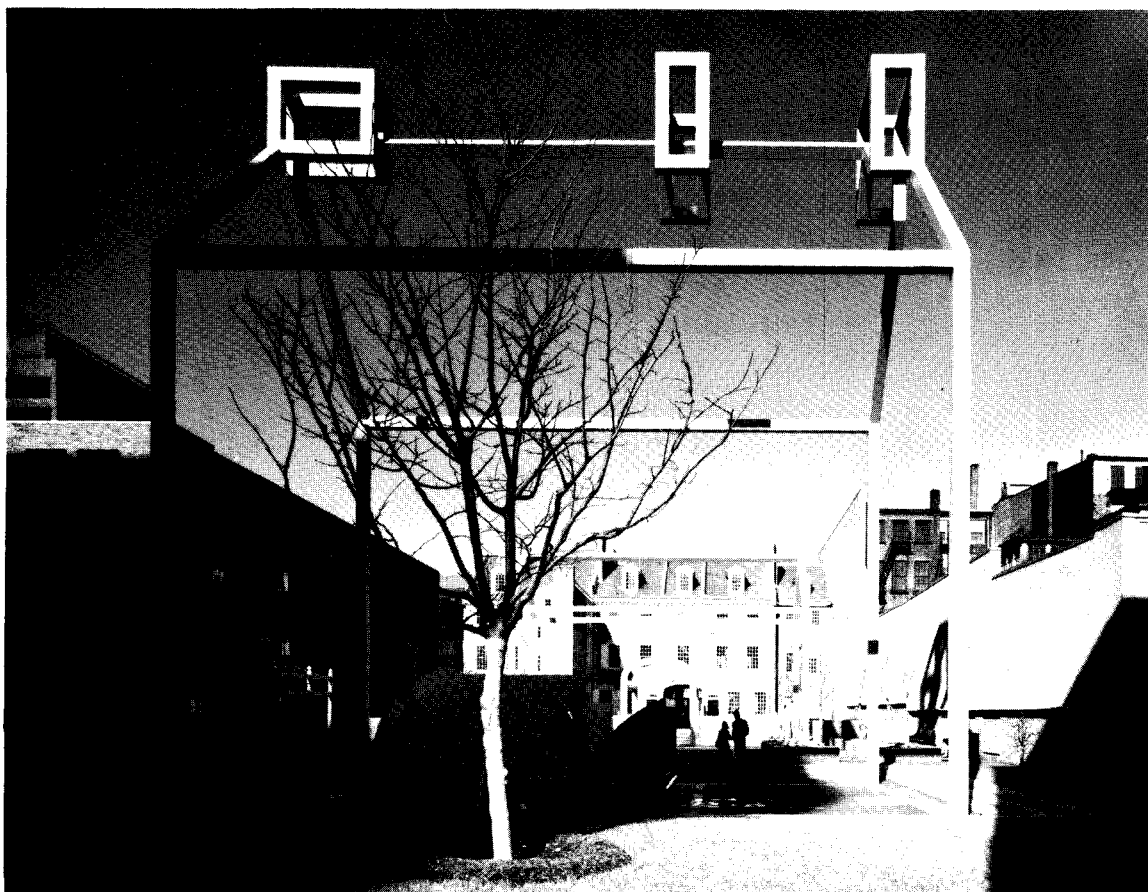

Mark Cohn

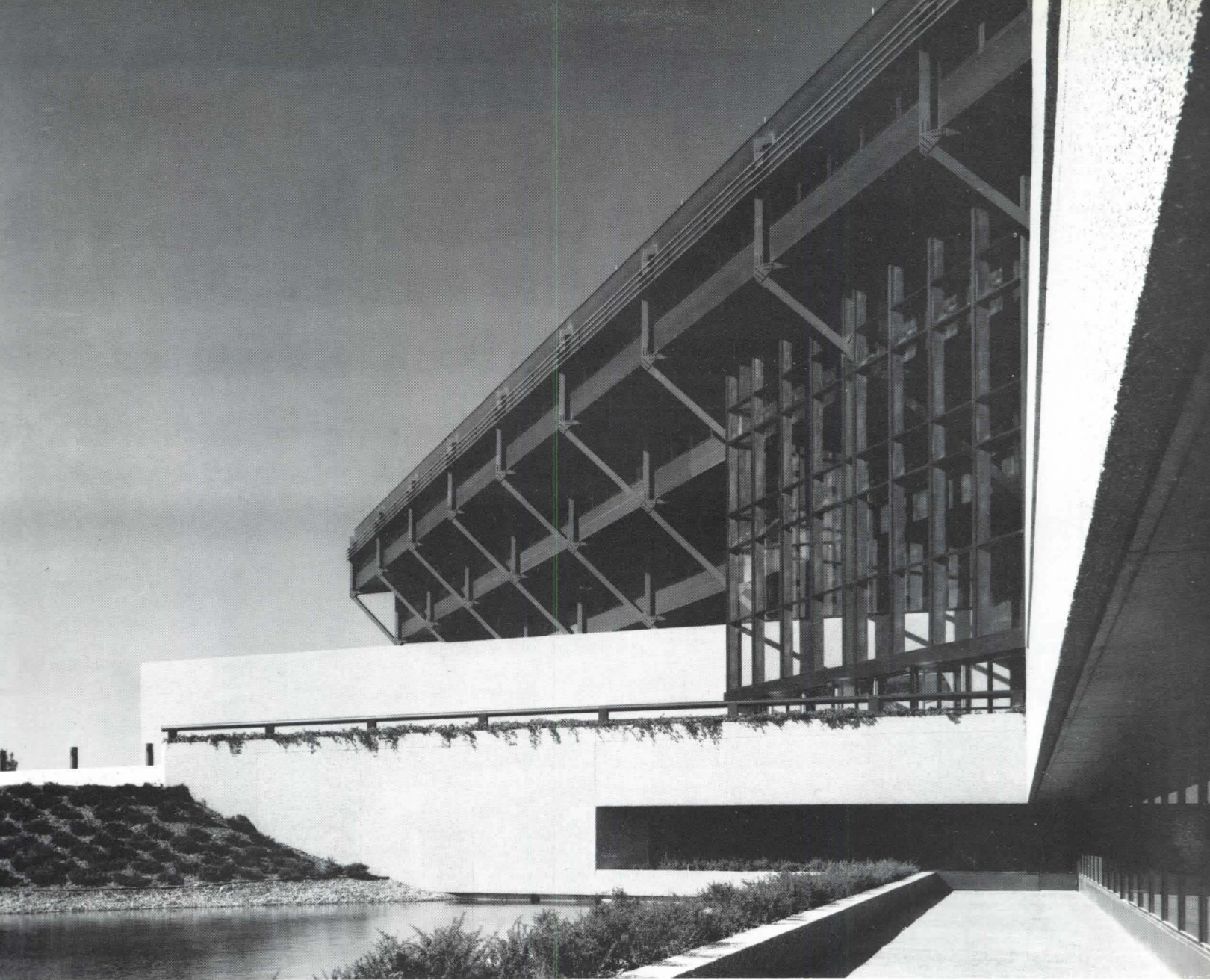

# Big in the '70s: Energy Conservation

By Marguerite Villecco



Jeff Cook

In 1971, as a senior editor of *Architectural Forum*, I was surprised at being told that I had two visitors who wanted to talk to me about energy. I resisted, muttering about products and salesmen. Not only did I know nothing about energy, but what did it have to do with architecture anyway? What did it have to do with design? My two visitors were sure that it had to do with mechanical efficiency in buildings and with a new market for insulation. I listened, was of little help to them and put the matter aside with my questions unanswered and soon forgotten.

It is ironic, then, that I spent much of the decade concerned about the relationship between energy and design. The concern still has little to do with machines and insulation, but it has

---

**Ms. Villecco** is energy and design consultant to the design arts program of the National Endowment for the Arts. Subsequent to her tenure at *Architectural Forum*, she was a senior editor at *Architecture Plus* and later was a senior research associate at AIA Research Corporation. She served as consulting editor for the September 1979 natural light issue of this magazine.



*Previous page, top, the south facade of the Western Life Insurance Co., Woodbury, Minn., by Ellerbe, Inc., steps forward to let each floor shade the one below. Previous page, below, Steve Baer's own house near Albuquerque is a 'zome' (asymmetrical faceted dome) with windmill. Left, the University of Minnesota's Williamson Hall bookstore by Myers & Bennett is almost completely underground, preserving important campus open space. Right, Fuller Moore's own house with solar collector, near Oxford, Ohio. Right below, in the Maine countryside, Roc Caivano's passively heated house with Trombe wall.*

## Moving from quantitative to qualitative issues.

everything to do with the relationships between the natural and the built environments and between buildings and their dynamic surround of sun, wind, land and water. These are not new concerns, but their implications in the context of fuel and resource conservation are newly understood. As we enter the 1980s, I am convinced that not only does energy have a great deal to do with architecture, but that its formal implications and influence on contemporary value sets may signal the most significant change in architectural design since the Bauhaus.

Architecture has been seeking a new vocabulary for design, to the point of using linguistic analogy to structure the search. Energy has spurred a formal investigation of an esthetic so obvious that we design our lives around it and yet we do not recognize it. That esthetic is our response to our own world—a changing world of day and night, contrasting seasons. Therein lies an opportunity to develop an architecture of diversity, richness and dynamic form. Instead of stylistic mimicry, here is a truthful basis for esthetic expression in building and urban forms that acknowledge their, and our, place in time and space, using form to keep tempo with their world. Here is an issue that transcends topical concerns and offers expression of ethical and value change through architectural form.

The energy issue started as an issue remote from any of these qualitative concerns. Diminishing fossil fuels and rising prices in the early 1970s led to a concern with the quantitative performance of buildings and with a new set of engineering criteria for fuel efficiency. Technical prowess dominated early building solutions. But, as the decade passed, it became clear that too much concern and resources had been spent trying to solve the wrong problems.

My visitors in 1971 were sure of the problems and the solutions; over the next few years their perceptions were institutionalized as federal policy and professional responsibility. One-third of the nation's energy was used to heat and cool buildings. Large machines do that work and use energy to do it. If the machines used less energy, so would buildings. The oil embargo resulted in a great campaign, therefore, to make building machines work better. We sealed up buildings so that uncontrolled climatic variations wouldn't disturb the machines. We reduced the amount of sunlight and natural ventilation through

windows by passing laws to limit the size and number of windows. We added insulation and made the machines more efficient.

By the mid-1970s, we had become even more clever. Not only could we make the machines more efficient, but we could design machines that didn't need fossil fuels at all. The active solar era began.

The new solar buildings were similar to conventional buildings except that they boasted great arrays of collectors on their roofs, proclaiming a new relationship to the sun in dramatic, if expensive, terms. Active solar systems were similar to other mechanical systems except that they used the sun, not oil or gas, as fuel. Engineers designed and installed the systems; architects sought to hide the hardware or make it look better. In the 1930s some solar hot water storage tanks were disguised as chimneys, but the new space heating systems were too large for that and new cosmetic solutions were needed.

By the third quarter of the decade, the cost and awkwardness of most active systems had led to disillusionment with solar energy. But a new solar era was already on its way. Designers rediscovered that the location and form of the building could be strategies not only to conserve energy, but to provide human comfort and amenity. The comfort of machines became less important and designers sought to re-establish a complement between the natural and artificial. Suddenly, with passive solar design, energy started to become a design issue and a fundamental architectural issue.

The exploration of design adaptations to sun, wind, land and water plumbed the past for principles of design. Differentiation, orientation and regionalism re-entered the architectural vocabulary. H. H. Richardson's Glessner house in Chicago was reinvestigated for its concern with orientation. Not only did Richardson protect its residents from the city, but he provided them with a massive north wall with few windows and buffer corridor alongside it. On the south he provided a sunlit courtyard and a south-facing window wall to allow the penetration of sunlight and heat. Richardson wasn't concerned specifically with energy, but he was certainly concerned with human comfort and good design; he knew where the sun was and designed to take advantage of it. Studies of the pueblos became important sources of passive design strategies. Given the state of their technology, those early settlements took maximum advantage of the sun by absorbing





Jeff Cook

Robert Perron



its heat in winter and shielding occupants from its rays in summer. Louisiana houses with belvederes, shutters, sleeping porches and the free circulation of cooling breezes around and through the houses were studied anew, as were the New England saltbox and underground dwellings. The conservation of ideas provided a starting point for passive design today and a basis for innovation.

Still, concern was focused on thermal design. Attention to the sun as a source of heat nearly obscured its value as a light source. The old concerns that daylight was difficult to predict and control and a problem for efficient building performance hung on. But this concern was based on the old mechanical assumptions of energy conservation; a perception of the natural world as a resource that could complement energy-conscious design changes these assumptions. Daylight is consistent with many of the design principles of passive design and its implica-

tions for the qualitative and quantitative performance of a building are only now being rediscovered.

Energy for illumination of commercial buildings may account for three-quarters of their consumption. The relationships between the heat and light of the sun must be carefully evaluated, but the solution lies in design and complement. Natural light is an unquestioned medium of architectural expressions; its relationship to energy performance is clearly the province of design.

The last year has not only provided a new forum for daylight design, but increased attention to the relationships between buildings and urban form. Issues such as solar access and policies that express public value for the sun are yielding new form implications for the design and growth of cities. New kinds of design information and new images are challenging the conventional models for urban form, offering the potential for new richness amidst the sterility of the recent past. The legibility of the city is again an issue, as is a concern for human scale and orientation. Urban forms whose images describe a relation to the sun provide cues to natural time and phenomena that help us understand where we are. One side of a street may look different from another, just as one side of an energy-conscious building may look different from another.

Federal policy and programs tend to lag in this evolution from technology to design. The bulk of human energy is still devoted to technological innovation as a solution. But designers are becoming more important in showing where innovation is required and how to use it. The state of California, under architect Sim van der Ryn, showed a new paradigm for large-scale design that tries to work with and not in spite of the environment. Other state and federal programs with similar concerns are growing.

The design implications of energy are only now being recognized. The imageability as well as the performance of energy-conscious design is engaging. The creative desire to look beyond simple eclecticism to a rational basis for design promises diversity and change for the architectural forms and values of the 1980s. □

*Below, James Stirling's Olivetti headquarters. Right, Bernstein house by John Hejduk. Facing page, top, Michael Graves' cultural center to ford the Red River of the North between Fargo, N.D., and Moorhead, Minn.; below, a bridge by Edmond Garrel (1847), and right, Peter Eisenman's House IV.*

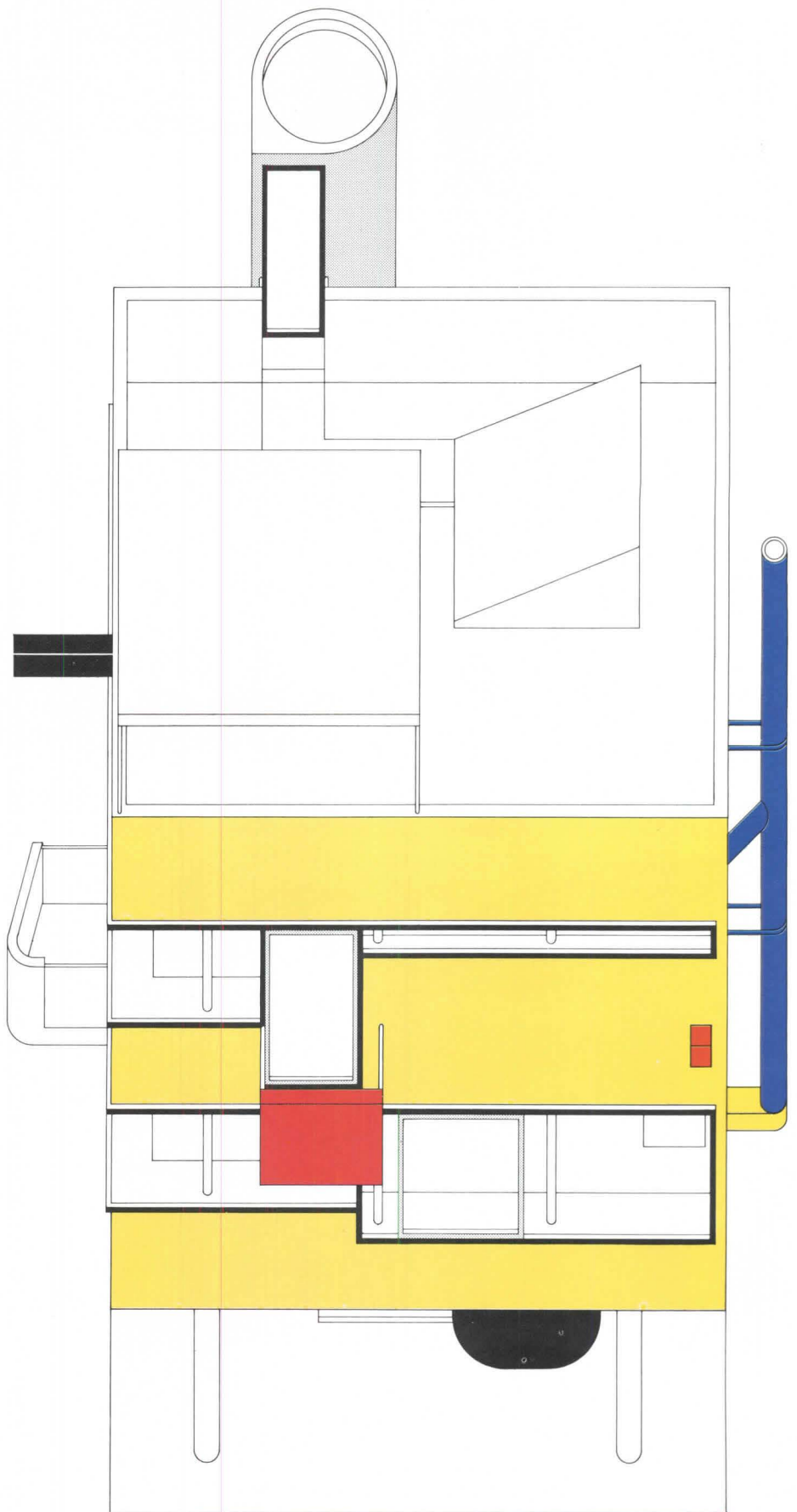
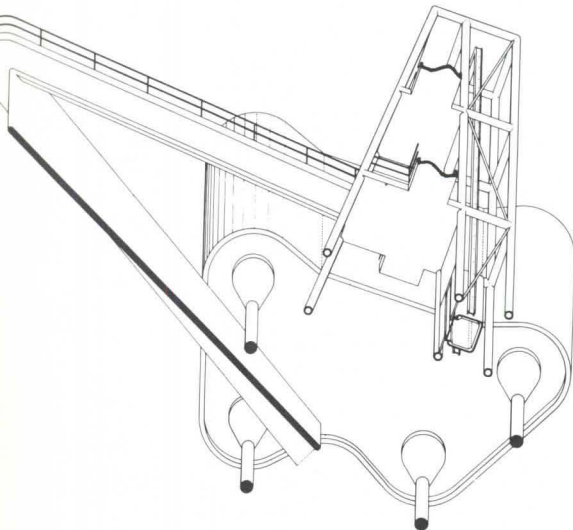

# Big in the '70s: Architectural Drawings

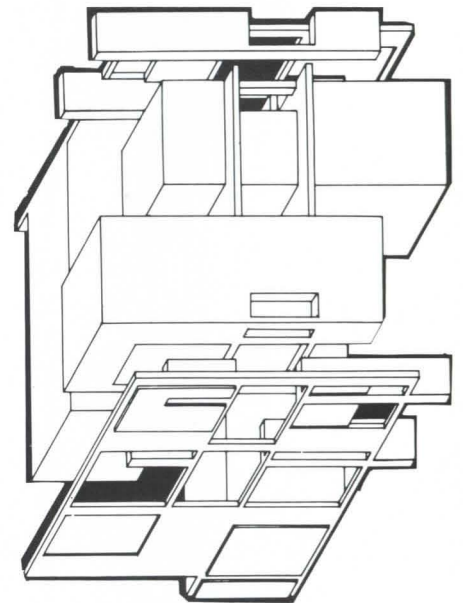
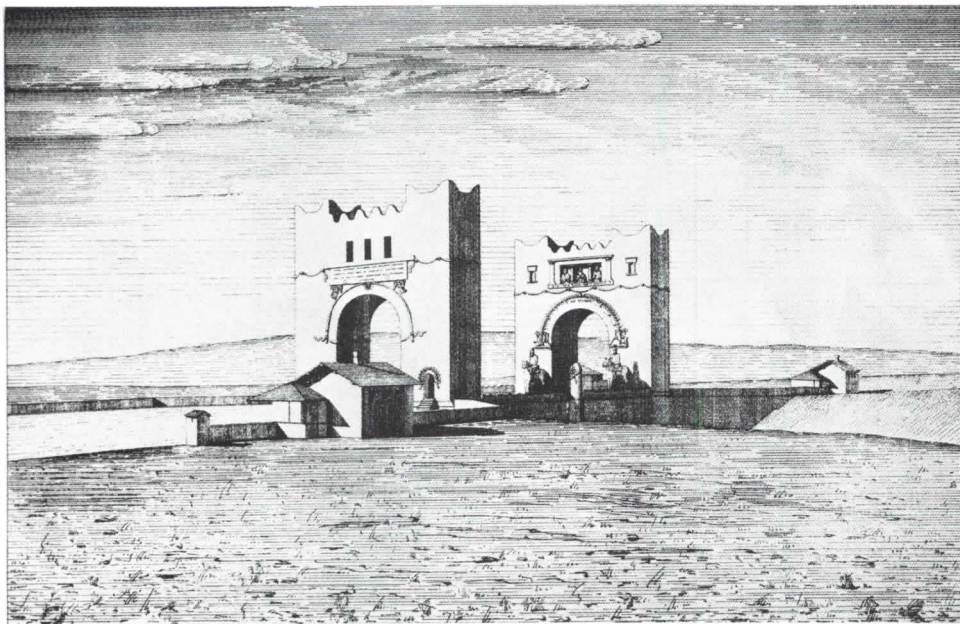
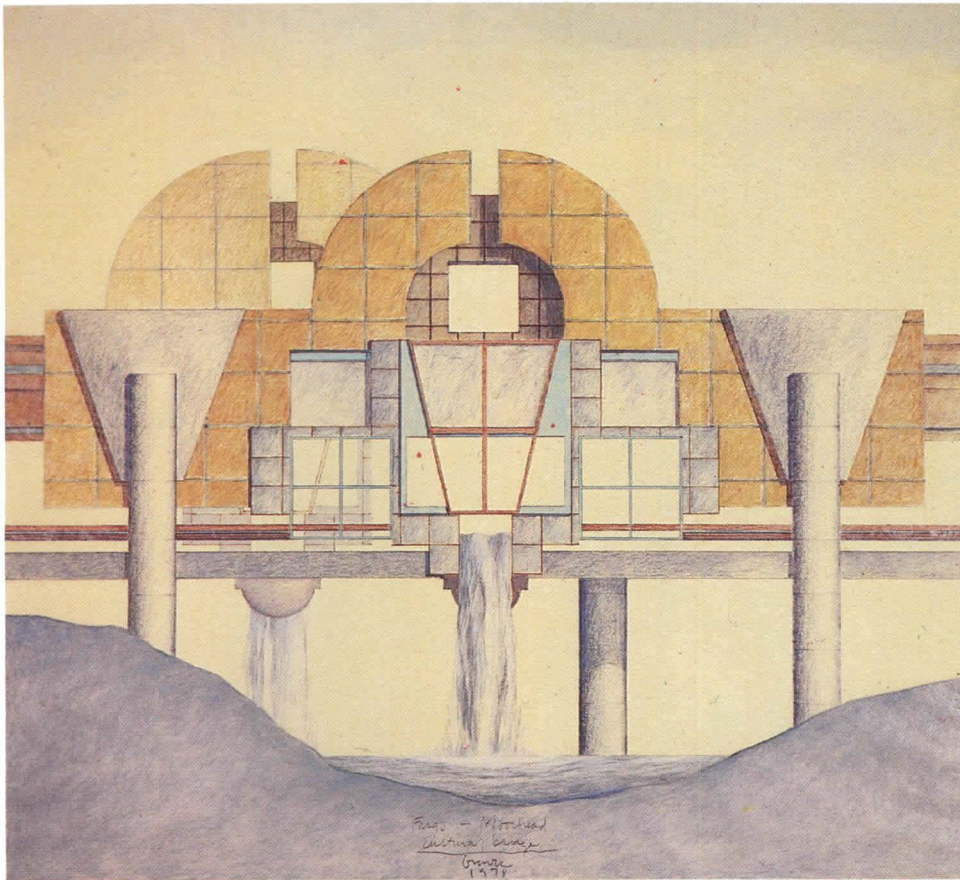

In a way, John Hejduk, head of New York's Cooper Union School of Architecture, both opened and closed a decade of greatly revived interest in architectural drawing. The opening was a stunning show of Cooper Union student work at the Museum of Modern Art (coming after the late '60s, when architecture students seemed to talk much more than they drew, the show was a very welcome surprise); and the close was a show of Hejduk's own delightful drawings at New York's Max Protetch Gallery. In between, the most spectacular drawing show had been Arthur Drexler's mid-decade presentation of Beaux-Arts drawings at MOMA, and another special highlight was a show of Michael Graves' drawings at Protetch. (Even Graves' rough sketches on yellow tracing paper were being snapped up, and at three-figure prices.)

Architectural drawings came, during the '70s, to be accepted as works of art, collectible by museums as well as by private enthusiasts. Important in encouraging this trend were new galleries specializing in architectural drawings, perhaps the earliest being Judith York Newman's Spaced Gallery in New York, which opened in 1975 and which was followed in 1977 by the founding of the Drawing Center. James Rossant was the subject of Newman's first one-man show, and a more recent one showed drawings by Paul Rudolph. As Susan Braybrooke wrote of the Rudolph show, his "fine drawings are well known and always worth another look. They have their share of both the visionary and the practical, and perhaps this exhibition suggests that it is time also to take another look at Rudolph's architecture."

## Images never meant to be built.

The exhibit "200 Years of American Architectural Drawings" opened in 1977 and toured the country, and the accompanying book by David Gebhard and Deborah Nevins intelligently documented the show; the book was revised and enlarged in 1979. Other books included James O'Gorman's on the drawings of H. H. Richardson, Goran Schildt's on those of Alvar Aalto, Paul Sprague's on those of Louis Sullivan, and George Collins' on "visionary" drawings. *The Architect's Eye*, a book of drawings selected by Deborah Nevins and Robert A. M. Stern, was published in late 1979.

Related developments in other fields included a 1976 AIA medal to Saul Steinberg (who had been trained as an architect)

and a retrospective show of his drawings in London in 1979. At urban scale, Richard Haas and others covered blank city walls with beguiling *trompe l'oeil* effects.

One significant phase of the drawing revival was the new body of highly theoretical and analytical drawings, most of them in the form of isometrics or axonometrics, and many of them covered with lines that represented concepts but nothing meant to be actually built. If the complexity of some of these drawings sometimes seemed an end in itself, the genre at least reflected serious concern for architecture as an art form.

The drawing revival was, indeed, one of the most heartening aspects of the decade: Not only had architects come to value fine architectural drawing again; so, it seemed, had the general public. *S.A.*

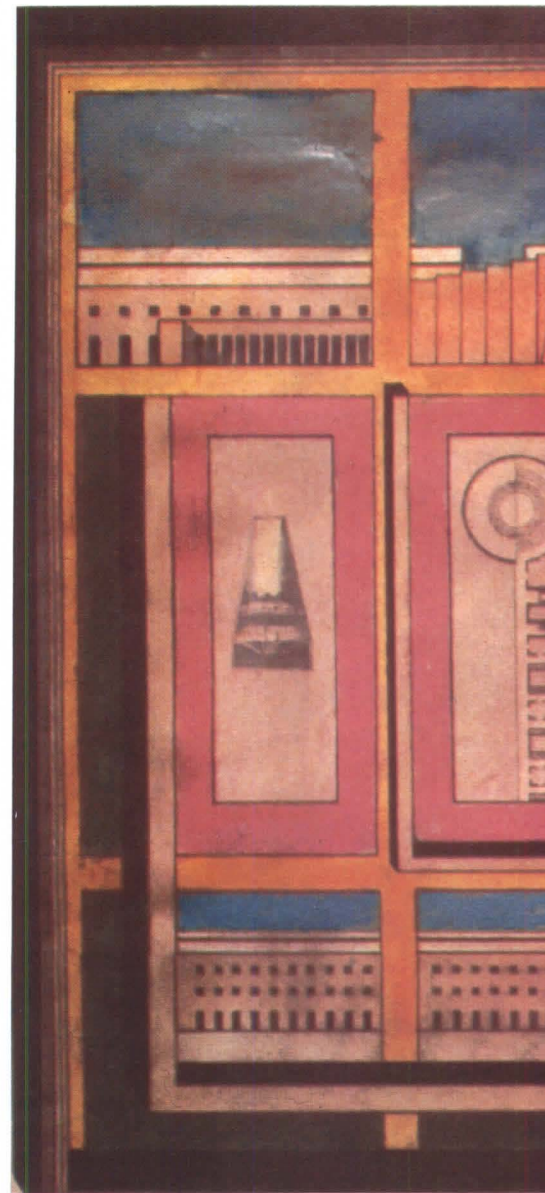
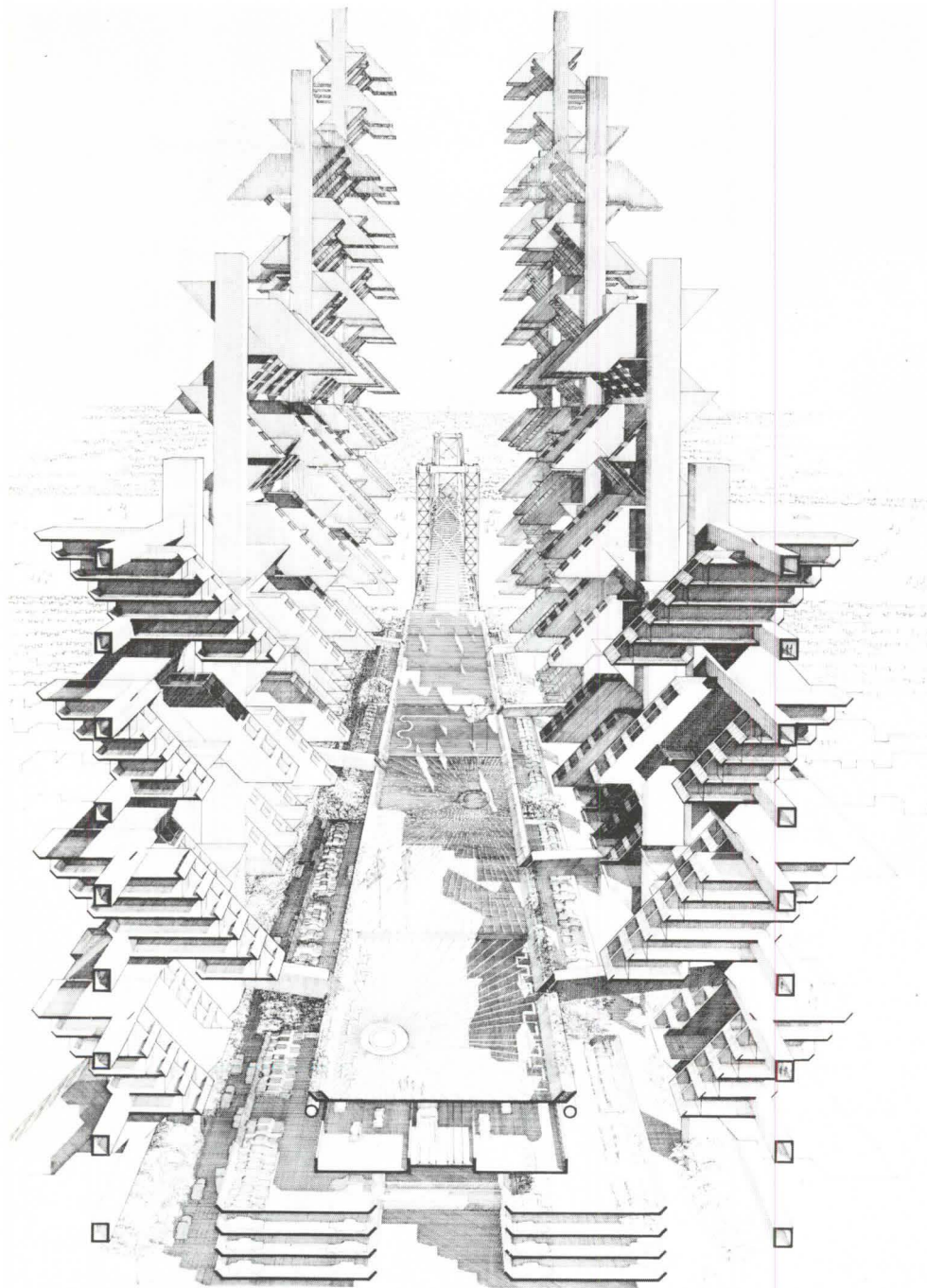

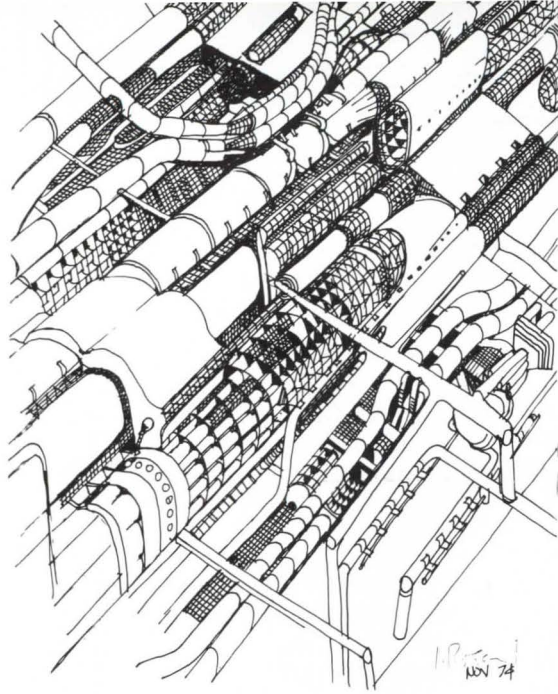

*Far left, an urban design project by Paul Rudolph. Above, drawings by James Rossant, left, and Robert Venturi, right. Left, Aldo Rossi's 'Modena Cemetery Composition with St. Apollonia.'*

# REFLECTIONS

## The Reluctant Acceptance of Finitude

By Gerald Allen

When I was a student in architecture school in the early 1970s, a classmate of mine named Harry Teague, who now works in Colorado, made a movie called "The Four Rolls of the Architect." The rolls in question were delicatessen hard rolls, each with a number stenciled on and each serving to introduce a sequence in the film, in which the author starred. Roll One featured the architect as servant of the rich, dressed in a custom-tailored, three-piece suit and sweeping across the plaza of the Seagram Building to a waiting limousine—undoubtedly headed for the board room of some multinational corporation. The second Roll portrayed the architect as advocate, jiving in what would then have been psychedelic, now disco, drag along 125th Street, meeting and greeting his constituency. I can't remember what the third and fourth Rolls were, but it is fair to speculate that they might have involved the architect as academic, designing in shirt sleeves, lovingly criticizing student work, and emerging full blown at last at a cocktail party celebrating the opening of a show of his work at the Museum of Modern Art. Or they might have involved the architect as golfer, stealthfully putting to his disadvantage only to score later on in the cocktail lounge of the country club. Or they might also have involved the architect locked into some really global problem—like the provision of housing for the poor in Manila—and triumphing over greed and impossibility nonetheless.

In any case, at the end of the film Harry Teague ate, on screen, all four rolls, suggesting to the more hopeful members of the audience that there was indeed some consistent thread of intention in all of the strangely disparate activities that had been dramatized.

I don't know how Harry feels about all this now, or indeed what the consistent lurch he seemed to imply then was. But I am sure that the lurch toward trying to seek out consistency of purpose at least, if not a consistency of activity or product, is important to all of us as a way of seeing for ourselves why we have spent, or do and will spend, our lives being architects.

The better architecture schools are correctly fond of pointing out in the introductions of their catalogs that architecture, the mother art, is unique among all the arts in that it so vividly combines the practical with the esthetic, the social with the more generally cultural. This is already combination aplenty, but there is more still. Architects have the chance to compose the stew in

many more rich ways, opting for becoming high-style or middle-style designers, for being media blitzers or pursuers of the quieter pleasures of making just a few buildings of lasting power, or for simply getting as much stuff of as high a quality possible built. Finally, there is also the slightly eerie proposition abroad that, for many people, architecture in its abstract and human implications is interesting as something merely to *think* about, which leads to the current controversial, but nonetheless defensible, notion that even drawings, not just buildings, are actually architecture too.

And so with all of this richness of direction it is perhaps forgivable that a person, standing on the threshold of a new decade and being asked, "What happened in architecture in the 1970s?" should reply with another question: "What happened in architecture *where*?" I hope that it is also forgivable, since I have been asked the former question, at least to try to make some tentative connections between those diverse professional realms.

Some clear things obviously did happen. The construction industry continued through the 1970s to eat up a smaller and smaller piece of what is brutally known as the Gross National Product, confirming the belief of pessimists that built America, in the spectacular sense of yore, had indeed been built. Energy, whose ready availability had been one of the posits of the International Style, making it possible to do the same kind of building anywhere, seemed suddenly to be no longer so readily available. On the operations front, the businesses of historic preservation, adaptive reuse, recycling and retrofitting transformed themselves from a trend into a boom. Even the resurgence of the old cities was darkly hinted at, vigorously—or desperately—to be denied by architects and planners in the motor cities. On the purely stylistic front, it seemed suddenly all right for buildings to recall other buildings from the past, or to play with something of their spirit in a cartoon-like way, or indeed just to be like them.

I remember jokingly saying, when I was in architecture school, that it was time for a new eclectic revival (I had gotten there by a circuitous route that had induced a respect for old buildings much more than a knowledge of contemporary ones); little did I know at the time that all I had to do was sit around and wait, and for not very long.

What could all of these supposedly clear but nonetheless diverse developments have in common? I think one realm in which their commonality can be found is in the national spirit of our times, of which it is any kind of architecture's purpose, or fate, to be expressive. For anyone who grew up in the U.S. in the 1950s or in the early- to mid-1960s, learning about things and how to do them was surely a process of creating a wave of virtually unlimited promise. Almost anything seemed do-able: Boundless economic prosperity was at hand, political change seemed possible, social justice was thinkable and even worldwide peace was at least conceivable.

This giant wave of promise did, of course, break—through a series of economic, social, political and military misadventures, plus a few more that were gratuitously thrown in by fate. This is, I will readily grant since this is admittedly a personal appraisal, another way of saying merely that those of us who began to grow up during this period did indeed begin to grow up. So that by the 1970s many promises on many fronts seemed to have been rudely broken, and so many options rudely cut off

---

**Mr. Allen** works with Peter Gluck & Associates, New York City, and is coauthor of *The Place of Houses* and *Dimensions: Space, Shape & Scale in Architecture*.

like slamming doors along an endless corridor. Thus, the urgent questions began to shift from "How will we do it?" to "What can we do?"

Powerful and recent exercises in collective consciousness-raising, like the apparent energy crunch that seemed to, but didn't, begin in 1973, or the real constitutional crisis that happened in 1974, or the ongoing and currently underrated crisis of world ecology—plus, of course, the war—have added to and confirmed the accumulating data that can be summarized in this one point: All of our resources are limited. And among these are not just the physical ones with which we make things and do things, but also our own resources of imagination, intellect, mental energy and even the resource of life itself. One of the sweeping and profound perceptions of the decade just past—a perception so profound that it has yet to be fully appreciated—is that the real promises held out to us, however exciting and however hopeful, are still in the end finite.

The realizations that much of America is now built, that we cannot go on forever wasting energy to build new buildings and maintain them, that we can learn to reuse whole collections of old buildings we already have, and even that we can once again cherish merely the ideas that buildings in the past have embodied—all of these things are, I think, specific responses to a

# Working Within an Inherited Language

By Peter Smithson

In Europe in the 1970s, outcroppings of the formations laid down in the '50s and '60s came fresh to the surface. For those architects who had been members of Team 10, there were some results of their search for new patterns of association and of their recognitions that the city's fabric is something immensely valuable and that a building's first duty is to that fabric's continuing life; these results could at last be walked over on the ground. Some observable examples were:

In 1972, Alison and Peter Smithson's Robin Hood Gardens, London.

In 1973, Candilis/Woods/Schiedhelm's Free University, Berlin (first phase; second phase now under construction).

In 1978, Giancarlo De Carlo's Magistero, Urbino.

And in 1979, Aldo van Eyck's Mother's Home, Amsterdam.

There was in the decade on both sides of the Atlantic a wide acceptance of the architect's traditional responsibilities toward the existing built fabric and toward its inhabitants as patrons. What now separates architect from architect more bitterly than I have known in my lifetime is the question of style and the morality of style.

For me, pictorial eclecticism is quite impossible: It seems to be a sort of stealing. Therefore, even if one can acknowledge a shared concern for the city as a whole, the sky-blue restatement

new and broad ethic of conservation which is itself a response to the perception that our resources are limited.

Gloomy? Perhaps, but realistic also comes to mind, and with that the chance to make architecture really responsive to the real world. And hopeful as well, since the situation that we now find ourselves in suggests that simple-minded orthodoxies are not what we need. What seems required in place of them is wit rather than fatuous self-assuredness, imagination rather than stubborn firmness.

Poetic also comes to mind. Poetic in general, and pastoral in particular, since surely in the headlong rush to preserve almost everything in sight, to recycle much of the rest and to relive in our own new designs the dramas of buildings from the past there must be something that is, well, escapist, just as pastoral poetry often seems to describe a wistful escape from the complicated affairs of the world to the sylvan landscape of Arcadia. And this would seem to be just the opposite of realistic. But it is also important to point out that in fact the pastoral ideal does not portray flight so much as retreat, the temporary sojourn by on the whole very urbane people in a place where fundamental issues can be seen with clarity, and with any luck can be resolved. The pastoral landscape is a place for, in the broadest sense of the word, recreation. □

of the Edwardian street or of the colonial Fascist piazzetta carries emotional baggage that I find unacceptably distasteful. It is too easy, too condescending; it assumes a too acquiescent user.

For me, the general devastation of European cities under the empty patronage of the last 30 years makes the need for an active reciprocity—for forms that can generate affection between building and building, between buildings and their occupants, between initiators and successors—seem as urgent and as obvious as was the need for a new beginning and a new language in the '20s.

The model the '20s left us is of committed intention and a matching brilliance of formal invention. The language of modern architecture that we inherited from the heroic period is proving endlessly open to the invention of new words and changes of syntax to meet new moods and new circumstances.

As the '40s and '50s recede, we can see that Eames and Prouvé enlarged the vocabulary and permanently changed the inherited language, for many architects now speak that extended language with fluency. The '60s are still too close for us to see clearly where the language ran; and of the decade just past one can speak authoritatively only of one's personal work.

Our own quite conscious effort since 1970 has been to try to evolve from within the inherited language an esthetic for the fixed form that is dense enough to be used and read in different ways by different generations of users, and that can claim in each generation those users' affection and their offerings from the arts of inhabitation.

Throughout the decade we have been working with layers. □

**Mr. Smithson** practices architecture in London in collaboration with his wife Alison. He was a founder and key figure of Team 10, an outgrowth of CIAM (Congrès International d'Architecture Moderne).

# A Funny Thing Happened . . .

By James Marston Fitch

A funny thing happened on our way to the '80s: After half a century during which the profession was committed to helping society in a rational solution to its architectural needs, we are now being urged to abandon—indeed, to reverse—that course. We are being told that the only way forward is retreat—retreat to that waxwork museum of historicizing anecdote, that prison house of antique gesture which was *fin-de-siècle* eclecticism. Not merely do the postmodernists propose to reverse the whole evolutionary course of architectural theory since the Bauhaus. They propose to expunge that half-century of experience from the written record. The postmodernists are now telling us that content and expression, function and form, have no more fundamental a connection in architecture than in-scene painting, dressmaking or hat design. They are attacking the entire theoretical structure of rational response to experiential reality.

The situation is at once perilous and comic. One might liken it to the sacking of Rome by the barbarians. But a more apt analogy might be to those merry, mad and murderous children who, in Richard Hughes' *High Wind in Jamaica*, took control of a ship at sea and forced the adults to walk the plank.

That contemporary architecture is in a state of crisis is perfectly obvious to anyone who moves around the world today—for the crisis is international. And crisis invests the whole field—theory and practice, architect and critic, builder and client. It is clearest of all in the malfunction (dysfunction) of architecture itself. Under such circumstances, it is not surprising that there is a rising tide of dissatisfaction from both inside and outside the architectural profession. Nor should it surprise us that the controversy is most intense in the U.S.A. The American building industry has been in the economic doldrums with extensive unemployment among both architects and construction workers. Moreover, the proportion of all construction under the control of the architect himself seems to be steadily diminishing. (Estimates vary from a high of 50 percent down to 25 percent or lower; it would be hard to imagine a similar state of affairs among doctors, lawyers, dentists or, for that matter, even morticians!)

Dissatisfaction with this state of affairs takes the form of two lines of polemics: Who is to blame for our situation and what is to be done about it? Since it is always easier to blame someone else for one's dilemma than to analyze one's own contributions to it, the search is on for a scapegoat. A small but influential group of architects and critics has found the scapegoat—modernism, the International Style and, above all, the Bauhaus. And they have a tidy recipe for extricating us from the current mess. Abandon all rational efforts to mediate man's environmental problems—the task first seriously addressed by modern architecture—and return to the ateliers of the Beaux-Arts. This is rather like asking us to give up the exhilarating experience of a bright December day at Wright's Taliesin in the desert in exchange for the airless darkened boudoir in which Marcel Proust wrote his *À la recherche du temps perdu*.

This is an ironic turn of events, to put it mildly, since it was the revolution in architectural theory, epitomized by the opening

of the Bauhaus 60 years ago, which has given today's architects a degree of esthetic freedom unparalleled in the whole history of architecture. It has given them their first coherent and internally consistent ideology since the rise of the Gothic style in the 12th century. Simultaneously, it has given them a whole new language of form with which to express it. The Bauhaus did, indeed, mark a successful revolution; and it was exactly comparable with contemporaneous revolutions in painting (Picasso), sculpture (Brancusi), music (Stravinsky), dance (Isadora Duncan), in the novel (James Joyce)—even in science with Einstein. Together, these creative persons cleared the ground for the whole structure of modern artistic and intellectual consciousness.

The Bauhaus revolution did, indeed, disestablish the grip of the past from the curriculum of architecture. Its conscious and explicit intention was to liberate the creative architect from the shackles of historicism, eclecticism, academicism. This may seem a small matter to the grandsons of that revolution. But their counter-revolutionary attack today reveals their fundamental misapprehension of two critically important facts: their failure to understand what it was like to have been an architect under the dictatorship of *fin-de-siècle* eclecticism; and their failure to appreciate the freedom of esthetic action which the revolution has given them. For the paradox is that the Bauhaus did *not* destroy history. On the contrary, it cleared the intellectual landscape of so much eclectic clutter that today's serious architectural historiographers are more numerous and productive than ever before. In fact, their present success is due in large part to that interregnum, the cleared land and open air, which now permits them a whole new perspective of the past.

Yet it is this historic development which is being singled out by many American and British theoreticians as the cause of all our troubles. Such a position is either a-historical or anti-historical, depending upon how tolerant a view one is able to take of it. It is symptomatic of the peculiar vulnerability of architecture as a profession, poised as it is midway between art and science, that it can make such fundamental theoretical errors. One does not find similar propositions being seriously advanced either among artists or scientists. Can one imagine Einstein being attacked because his theory of relativity led ultimately to the atomic bomb? Or Picasso expunged from the record because his attack on visual orthodoxy led ultimately to Jackson Pollock? Or a Mary Wigman disparaged because her contribution to modern dance made a Merce Cunningham possible?

Postmodernists are celebrating the new freedom which they find in eclecticism. But they seem not to have noticed that two distinctly different varieties of eclecticism are involved. There is the ordinary or garden variety, in which the young artist borrows the artistic languages of his contemporaries—"tries them on for fit"—in the process of evolving his own personal modes of expression. The other variety is *historicizing* eclecticism: Here the artist rejects the language of his peers and turns deliberately and consciously to the past, preferably the long ago or far away, in search of modes of expression which he can adopt as his own. The first variety of eclecticism is a normal process, very much like learning how to read or write. But historicizing eclecticism is not at all a "normal" phenomenon. On the con-

**Mr. Fitch**, the eminent architectural historian and author, is director of historic preservation for the New York City firm of Beyer, Blinder & Belle.



trary, it has been a peculiarity of the architecture of the Western world—and that only since the opening of the Renaissance.

When Renaissance architects rejected late Gothic forms in favor of those of classic antiquity, they ruptured the seamless fabric of a thousand years of evolutionary development in architecture. And in the 400 years between Brunelleschi's *Ospedale dei Innocenti* and Jefferson's campus at Charlottesville, the Western world had no system of expression, no syntax of ornament and iconography other than those which derived ultimately from classical antiquity. For both men, as for hundreds of architects and builders in between, historicizing eclecticism had proved adequate to the exigencies of European and American societies.

Indeed, after four centuries of continuous experimentation with the same centroid of form and iconography, it might be argued that Western architecture had ceased to be either eclectic or historicizing. Renaissance, baroque, rococco had evolved smoothly, one out of the other. Even the "national" styles of Jefferson's day—the French empire, the English regency, the American federal—were merely regional variants of the same root stock.

Inspired by the political paintings of the French revolutionary artist David and by the polemics of Tom Paine, Jefferson made the conscious and deliberate effort to return American architecture to the language of republican Rome. From the modern point of view, this might appear to have been historicizing eclecticism with a vengeance. Yet it is clear from their writings that both Jefferson and Paine saw this as merely a long-overdue effort to purge the classic idiom of the accumulated adulterations and pollutions of the baroque and rococco.

**H**owever, just at the time of Jefferson's death in 1826, the four-century dominance of classic antiquity began to weaken. New cultural forces appeared which were to challenge and, ultimately, to destroy, its hegemony. The rising urban middle classes were the new patrons of architecture; and with their new literacy, mass media and wide travels, they were responding to a whole new spectrum of esthetic stimuli. The orthodox language of classic antiquity would seem to them increasingly unsatisfactory. They would replace it with a succession of other stylistic revivals—the Gothic, the Chinois, the Egyptian; the Italianate, the Etruscan, the Hindoo; the Japanese, the Indian, the Aztec. Each of these revivals was rationalized by its sponsors as the means of escape from the crippling bonds of earlier historicizing eclecticism. But each, by the very nature of the process, dragged the architect still deeper into the widening sinkhole of stylistic anarchy. Thus eclecticism underwent a qualitative change—no longer a single, internally consistent language from the past but a dozen, simultaneously clamoring for attention. This was the situation at the century's end to which Sullivan and Wright reacted with such anger. For them, the question was no longer *which* historic idiom could serve their artistic ambitions; it was rather that *none* of them was any longer viable.

It was in this context that the first demands for an end to *all* eclecticism began to be raised. For orthodox designers they might still serve as a crutch. But for powerful and innovative artists they imposed intolerable restraints upon creative freedom. Thus, conformists like Charles Follen McKim and William A. Delano, once having mastered the syntax of the Beaux-Arts, could glide through decades of upper class commissions as gracefully as skaters on ice. But for their more powerful contemporaries, intent on responding to the new demands and potentialities of science and technology, eclecticism was simply a straitjacket, a jail cell, a ball and chain.

It takes an effort of imagination for us, today, to understand that passionate rejection of traditional modes of expression.

Those revolutionaries saw quite clearly that an entire new language of architectural form, with its own grammar and syntax, was the urgent issue of the day. Moreover, these innovators understood that merely to be "new" was not enough. They had seen Art Nouveau, Jugendstil, secessionist and other movements appear and vanish like soap bubbles. They had learned that to be viable the new language must necessarily have a broader base than personal prejudice, idiosyncratic whimsy. They began to perceive that valid form could derive only from function properly served.

Thus, historicizing eclecticism was bankrupt on two counts. It absolutely prevented the invention of a new esthetic. But it was ethically unacceptable as well, because it depended upon a whole discredited iconography of caste, class and inherited status. Thus, Sullivan *could not* design a satisfactory department store if he were compelled to build it of superimposed Roman temples. And he *would not* use Roman temples because their iconography was that of those ruling class figures whom he detested. It was this secret interconnection between ethic and esthetic which Adolf Loos had denounced in his famous essay, "Ornament Is Crime."

In urging a literal return to *fin-de-siècle* eclecticism, the postmodernists display their misreading of their own immediate past. Despite their show of erudition, they appear ignorant of the *reason* for the passion and anger which suffused the polemics of Sullivan, Wright and Loos, of Gropius, Corbu and Moholy-Nagy. The manifestoes and polemics of the period reveal that creative architects, like creative persons in other fields, were driven into angry rebellion by the crippling shackles of historicizing eclecticism. They felt themselves suffocated, manacled, castrated by the Iron Maiden of conformism. For them, freedom from that prison house of empty gesture was a matter of life and death. Yet it is precisely back into this airless cul-de-sac that the postmodernists plan to lead us.

A truly objective re-examination of the past 50 years of modern architecture would reveal that its failures are due not to its having been "too functional" but to its having been not functional enough. The esthetic of modernism was based on the revolutionary proposition that the interconnection of form and function was indissoluble. Yet from the very first appearance of the International Style—the first show at the Museum of Modern Art in 1932 and the first book on the subject the next year, Hitchcock and Johnson's *International Style*—a campaign began to split the unity of form and function, esthetic and ethic, which the first great revolutionaries aspired to. The profession may have shifted its allegiance from the florid exuberance of the Beaux-Arts to the astringent purity of the Bauhaus. But it continued to celebrate the formal and increasingly to denigrate the functional.

**F**or at least two generations, we American architects have been content to employ the formal language created by those four great form-makers, Wright, Gropius, Mies and Corbu. But few of us have been willing to carry on the basic work of exploration begun by them. We have employed the whole range of liberating devices they invented—the hovering room, the glass wall, the *brise-soleil*, the exposed skeleton and cantilevered slab. But we have been unwilling to carry on the patient research into the experiential consequences of their general use. If this institutionalization of the formal at the expense of the functional has led contemporary architecture into its present cul-de-sac, then it is our performance, not theirs, which we must critically examine.

Like all the rest of us, postmodernist architects operate at several different levels of experiential reality—they are simultaneously citizens, history buffs, connoisseurs and professional practitioners. As citizens, at the level of civil liberties, they are

clearly entitled to think and act as they please. As history buffs, they are certainly within their rights to insist that the Beaux-Arts Grand Central Terminal and the Art Deco Chrysler Building deserve historic preservation quite as much as Wright's Robie house or Le Corbusier's Villa Savoye. As connoisseurs they can collect furniture by the Herter brothers or stained glass windows by Louis Comfort Tiffany with as much enthusiasm as those unreconstructed modernists who still prefer the chrome and leather chairs of Mies or the clear glass walls of the Bauhaus. We now have the freedom to view *all* of these artifacts as integral parts of our historic and artistic patrimony.

But as practitioners of architecture, the postmodernists share with the rest of the profession responsibilities of quite another and more serious order. And they place these responsibilities in jeopardy when they transpose value judgments from the personal to the professional plane, when they abandon the distinction between their private subjective prejudices and their objective obligations as licensed professionals.

And this is what, precisely, the literature of the postmodernists insists upon doing.

Perhaps the sheer absurdity of their position would be clearer if they asked themselves questions like these: What trust could they place in a physician who, because he was a collector of craftsman furniture, limited himself to the pharmacopeia of Elbert Hubbard's day? What confidence could they have in an attorney who, because he lived in a Greek revival house, stopped with the Dred Scott decision in arguing civil rights cases? Or in a mechanical engineer who, because of his admiration for Lord Kelvin's pioneering work in refrigeration, used only the machinery available to Queen Victoria and the Prince Consort? At some point, surely, even the postmodernists would begin to wonder when such doctors, lawyers and engineers might not expect to see their licenses lifted.

The period which is closing opened with the enormous success of Robert Venturi's *Complexity and Contradiction in Architecture*. Whatever he intended to accomplish with this erudite and provocative polemic, it can scarcely have been to see the period close with Charles Jencks' *Language of Post-Modern Architecture*. For the Venturi book could have provoked a truly philosophical examination of a whole range of architectonic paradox and contradiction. For example: Does the column push up or the roof bear down? And does this negate or validate the esthetic function of the capital? For example: Does the rib in Gothic vaulting serve a structural or a constructional function? Or is it merely the diagrammatic explication of the resolution of forces in the vaulting as a system? For example: What kind of behavior does the geometry of the stair permit the user, on the one hand, and require of him, on the other? And what are the implications for his safety, comfort, esthetic satisfaction? For example: How can the architect resolve, at optimal experiential levels, his ambition for formal symmetry in his constructs and the dictates of the asymmetric microclimate in which they will be submerged? How resolve the contradiction between esthetic ambition and energy conservation?

But instead of leading to serious and principled investigations of architectural *performance*, Venturi's book led straight to Jencks'; and they have become the magna carta for frivolity, idiosyncrasy and self-indulgent exhibitionism in architectural *form*. They have helped mightily to create an intellectual climate in which social responsibility and functional efficiency are ridiculed as irrelevant qualities in architecture.

The actual productions of the postmodernists have, until recently, been mostly literary—lectures, seminars, essays. The visual consequences have been largely confined to exhibitions of drawings, models and photographs of unbuilt (and unbuildable) projects. But now we can begin to see, in four dimensional reality, the architectural consequences of their theoretical apparatus. They are anything but reassuring. A prefabricated ruin at a new shopping center whose cascading brick is frozen into a sort

of permanent scree (are there bodies buried in the rubble?). An elegant country house whose cantilevered stairway has no handrail and inadequate head room for the adult members of the family (such paradoxes, the architect tells us, aim at raising the level of consciousness of the owners). A new trellised back porch added to an ordinary suburban bungalow and raised to the level of a major artistic event (like Corbu's Pavillon de l'Esprit Nouveau) by flattering photography and portentous prose.

The new freedom afforded by historicizing eclecticism brings us the new fad of "facadism." Already New York City's Fifth Avenue has two examples, both attached to new highrise apartment houses. One consists of a three-story screen wall, nominally free of the tower, detailed with the grace and subtlety of a subway washroom, executed in limestone instead of white tile. The other project, a 23-story tower, has several features including a facade which paraphrases the moldings and rustication of its neighbors with the firmness of a Carvel ice cream pie; and a windbraced "false front" borrowed from a Western mining town and here inflated to the scale of the Parthenon. A third facade—this too in New York—takes the form of a giant Chippendale chest mounted on top of the Pazzi Chapel. Behind it hides a 660 foot high office block.

Architects, like doctors and engineers, are licensed to practice under the public welfare clause of the Constitution. The time may very well be coming when the public will scrutinize our obligations under its provisions less genially than it has in the past. The collapse of three great roofs at Hartford, Chicago and Kansas City will certainly be reflected in escalating costs of liability insurance. There is obviously an upper limit to the number of mistakes which, like the Pruitt-Igoe in St. Louis, can only be corrected by having them blown up. Surely, these are the sorts of complexities and contradictions which deserve our attention in the '80s, not the jackdaw-and-magpie esthetic doctrines of postmodernism. □

## A Decade of Trial and Success

By Bernard P. Spring, FAIA

My personal view of the 1970s is colored by all of my experiences in architecture since I received my first degree three decades ago, in 1949. I should like to put on record the result of this collected experience, *Spring's Axiom*. Like most rules of thumb, it is so approximate that it matches very few real situations exactly; nevertheless, I think it matches many situations closely enough to be useful.

The axiom: "In each decade it becomes twice as difficult to practice (and teach) architecture in a responsible way." I am working twice as hard, worrying twice as much as I did in 1970 to maintain what I consider the high standards of knowledge and performance called for in the profession of architecture. If this axiom is correct, by the end of this decade, in 1990, I will be working 16 times as hard as I did when I was fresh out of school! Notice that I do not think this situation is intolerable or impossible.

Whenever they may have started and at whatever level of per-

**Mr. Spring** is dean of the school of architecture, City College of the City University of New York, and director of the Perkins & Will research group, New York City.

formance, the good news today about the practitioners of architecture is that most of us are, in fact, meeting these exponential, escalating challenges. For all our foibles, the level and scope of services we provide to the entire public (rather than a few wealthy clients) far surpasses what architects have been able to do at any time in the past. I agree with last year's AIA president, Ehrman B. Mitchell Jr., FAIA, that the time has come to stop agonizing over our problems and to begin to find some joy and delight in a celebration of architecture.

What paths did we take in the 1970s to lead us to the privilege of celebration? None was straight or narrow.

In the 1970s we began to produce, in considerable quantity, buildings and places that demonstrated some key tenets of the founders of the modern movement. We were able to squeeze an expressive design vocabulary out of the workings of building technology. At first, there were expressions of structure; later, expressions of various environmental systems and, most lately, expressions of the technology of the building envelope or skin. Yet in the late 1970s we also stopped trying to let technology generate a formal esthetic and started to search once more for an abstract and stylish vocabulary of form and space. At the same time, some of us search, thus far in desperation, for a vocabulary of form that will speak clearly and directly to our nonprofessional audience.

In the 1970s we tried to borrow concepts and knowledge from the behavioral sciences—psychology, sociology and anthropology—to make our building programs and designs more responsive to every group of users; not just those who sat in executive offices and spoke only for the client's interests. From time to time there seemed to be research results that could help us to fit human behavior more sympathetically into that part of the designed world which we could control through architecture. But in the 1970s we also stopped trying to extract from the behavioral disciplines the kind of knowledge that the better practitioners of these disciplines never claimed—direct cause and effect relationships between environment and behavior. People who use buildings remained as complicated, changeable and unpredictable as they had been when their psychic needs were ignored or overlooked by architects.

In a related effort in the 1970s, we tried to let many groups of users participate directly in the process of programming; to add their say to that of the traditional client (the folks who paid the bills). The theory or, better said, the supposition involved in this approach was more sophisticated than the previously mentioned search for direct relationships among form, space and behavior. The expectation was that an opportunity to be engaged in the process of design would cause the ultimate occupants of a building to be happy with what they would see as *their* place. In the 1970s we also stopped trying to get so much advice from putative users. We learned that these users had some unexpected habits. They changed their minds about what they wanted in the two- to ten-year period between programming and occupancy. Just as often, the group that occupied a building had in its number very few of the people who had earlier participated in the programming process.

In the 1970s we tried out a staggering number of new materials and methods of construction. Almost all of these innovative developments flowed from costly research and development efforts aimed at some genuine problems such as rain penetration or hyperactive maintenance schedules. As a result of the availability of so many more choices, we, as a profession, had some serious cases of "future shock." Many of the new materials and methods that tested well in the research laboratory behaved in unexpected ways in a real building, exposed to a real climate. Yet in the 1970s we also stopped searching so diligently for a research "fix" for our problems. We learned to search instead for a more detailed and fundamental understanding of the physical principles that govern the dynamic behavior of the tried and true systems of brick and mortar, wood, concrete and steel.

In the 1970s we continued to try to use machines and energy to create the perfect interior climate—isolated and quite different from the climate that nature has provided. In the latter days of the 1970s we were in the process of stopping this effort to use the brute force of energy, once cheap but now scarce and costly, to provide a livable interior environment. Two major changes we all acknowledge as urgent and necessary are slow in coming: the shaping of buildings and spaces to take advantage of the mighty forces embodied in the natural climate and the adjustment of the often costly psychological-physiological expectations we have acquired for the limits of discomfort in buildings over the years.

In the 1970s, as in earlier postwar decades, we responded obediently to the needs of absentee investors for buildings that were first and foremost a salable commodity. We were instructed to make our buildings look like those that were most easily traded in the real estate market. And, many of us followed this imperative regardless of the character of the region, the climate or the nature of adjoining land use and building design. In the 1970s we also learned that this homogenization of design was destructive of human values to the extent that it showed signs of diminishing rather than increasing real estate values. We began to learn once again what values could be reclaimed from dealing sympathetically with the unique characteristics of a particular place on the land. By 1989, we may even be able to know where we are in the nation by looking at the way the newer buildings are designed.

**I**n the 1970s we sought ways of transferring responsibility for potential shortcomings and failures of our designs to other segments of the building industry. Nevertheless, the premiums for errors and omissions insurance skyrocketed beyond belief. The message: We architects have to face up to "public accountability," the consumer movement. However we may understand justice and equity, we are now faced with a financial responsibility that matches the leadership role we have made great efforts to establish. In the 1970s we discovered that when it worked, the rhetoric of "leadership of the building team" brought us heavy responsibilities as well as privileges.

In the very early 1970s we made an honest attempt to search out the ways that architectural decisions could be instrumental in helping to correct the injustices of poverty, racial and religious discrimination and the disabling urban, suburban and rural blight and disintegration caused in large measure by such biases. As the 1970s went on, we found that our work as the architects of physical change in the environment made few inroads into the mechanisms that caused these social and political problems. Yes, we could fill a substantial book with the stories of buildings that have been a catalyst for the improvement of life in disadvantaged communities. Yet a six-foot shelf of encyclopedic proportions would be needed to record the tribulations of communities in which public service buildings have made no impact at all on the core problems of poverty and alienation.

Except for the few of us who are gifted with the art of leadership in the political realm, architects can only respond to and serve a politically arranged mandate that calls forth our ability to conceive changes in the man-made environment. But we must understand that this kind of service to our community will, in the next decade, come only to those who seek it out.

It may seem that I have characterized the 1970s as a decade of trial and error. To return to my initial theme, I believe it was even more a decade of trial and success. In learning how to work twice as effectively as we did 10 years ago, we have set the stage for the architecture of the 1980s. *What I will be looking for in the work of my colleagues is more self-assurance, competence, craftsmanship, a sense of humor and a happy marriage between the man-made and the natural world.* □

# In Conclusion, A Multidisciplinary Discourse

By Donald Canty

A frequent professional self-criticism is that architects spend too much time talking to architects. Mindful of this, and in the spirit of the fondness for inter-, or multi-, or cross-disciplinary contact that marked the '60s and carried over into the decade just past, we made an effort to draw others into this discussion of the '70s.

They are, in order of appearance, a psychiatrist, a priest and a sociologist.

The three were chosen partly for a demonstrated interest in architecture. They were granted anonymity to encourage freedom of expression and asked, simply, how they would characterize the major architectural direction(s) of the decade. Their responses follow.

The psychiatrist: "Interesting you should ask someone in my profession such a question. After all, were I looking for directions in architecture, I would ask a professional journal such as yours. I wonder if your asking my help signifies a certain lack of confidence, or perhaps a simple rejection of the authority role on your part.

"Whatever the motivation, I'm glad you asked. As you know, I have been watching the recent architectural scene with some fascination. Seldom have I seen the wielders of influence in any profession exhibit such a consistent syndrome. And it is a syndrome with which I am quite familiar.

"Let me sketch it briefly for you in lay terms. The individual openly, even contemptuously, challenges authority. He rejects the very styles and standards that his parents hold most dear, yet exhibits nostalgia for times he never knew (often returning to his grandfather's trunk, for example, for costumes and artifacts). He is experimental, adventurous, motivated more by instinct than by an explicit set of beliefs that he has formulated to replace those that have been cast aside.

"These are, of course, characteristics often exhibited by those between childhood and adulthood. They are also, I would suggest, traits exhibited by adherents of some of the more publicized architectural movements of the '70s, which I believe you variously call postmodernism, postfunctionalism, adhocism, and Freud knows what else.

"The major direction I discern in the '70s, then, is the emergence of the Architecture of Adolescence."

The priest: "As usual, I fear that my humanistic medical friend has misread motivation out of an aversion to belief, to faith. When I look at those who are proclaiming a new architecture—the posties, or whatever you want to call them—I see just the opposite of a band of impulsive rebels. I see the dedicated apostles of a new faith, a new religion.

"Certainly their preachments have all the hallmarks of religion. They are issued in a language all their own; a language, as once was that of my church, quite different from that used in worldly discourse. They have their own icons, even idols; witness the veneration of the Palladian window.

"They advance a set of commandments for architectural conduct: Thou shalt not draw form from function, thou shalt worship architecture as an art and put no other arts before it. They have a full firmament of dieties and saints, from ancient (pre-modern) prophets such as Lutyens to Philip, the presiding pope

of the posties. They also have a complete demonology headed by the fallen angels mean Mies and corrupt Corbusier.

"Interestingly, the theologians of the posties criticize the modernists for making architecture into a secular religion with the goal (usually, in my profession, more revered than reviled) of trying to save the world. But what they propose to substitute for it is too intuitive to be a science and too ideological to be an art. No, it is another religion. What we have seen in architecture in the '70s, then, is the flowering of the Formalist Reformation."

The sociologist: "With all respect to the good father, I would suggest that what is going on in architecture had more to do with the world around us than the heavens above. It is a matter more morphological than metaphysical.

"I find, in fact, many parallels between the course of architecture and of society at large during the decade just past. Perhaps most obvious is that between the reaction to the social interventions of the '60s and the architectural interventions of that and earlier modernist decades in our cities. Both are now widely regarded to have been largely failures.

"But it must be said that in both cases those who in the '70s most vocally labeled these earlier efforts failures had a vested interest (political, economic or personal) in ceasing to try to solve our urban problems and putting our resources and energies elsewhere. Society emerged from the '60s somewhat fatigued, ready to turn inward from reformist to more individually rewarding pursuits. So did architecture.

"An intriguing corollary to this observation is to be found in the urging of some architectural theorists that we learn from such previously disdained environments as Las Vegas. Interestingly, they offer no methodology for such learning, no means of making distinctions between what is valuable in such environments, and should be emulated, and what is not. Instead, they simply urge acceptance of them as what "the people" want.

"The sociopolitical analogue of such advice is to be found in the majoritarianism of the '70s. Concentration on the needs of the poor and minorities in the '60s inevitably produced a backlash. At just about the turn of the decade, many of my colleagues simultaneously discovered the 'blue-collar blues,' turning their attention to the white working-to-middle classes and their undisputed needs. Simultaneously, national political figures rediscovered that here was where the votes were. Even television began to find charming idiosyncrasy in what had previously been regarded as social and moral failure.

"I am not suggesting for a moment that the previously cited theorists share these attitudes. But their uncritical acceptance of what sells and their jettisoning of esthetic standards as elitist could, and in some cases did, produce what could accurately be called the Architecture of Archie Bunker.

"Yet I remain hopeful. For if in the sociopolitical realm we continue to cater to the lowest common denominator of the perceived public will, and architecture responds by retreating into self-indulgence, these are so obviously and proximately dead ends that they must generate a reaction in more positive directions. So I look to the 1980s as a time of rebirth of both social and architectural responsibility." □

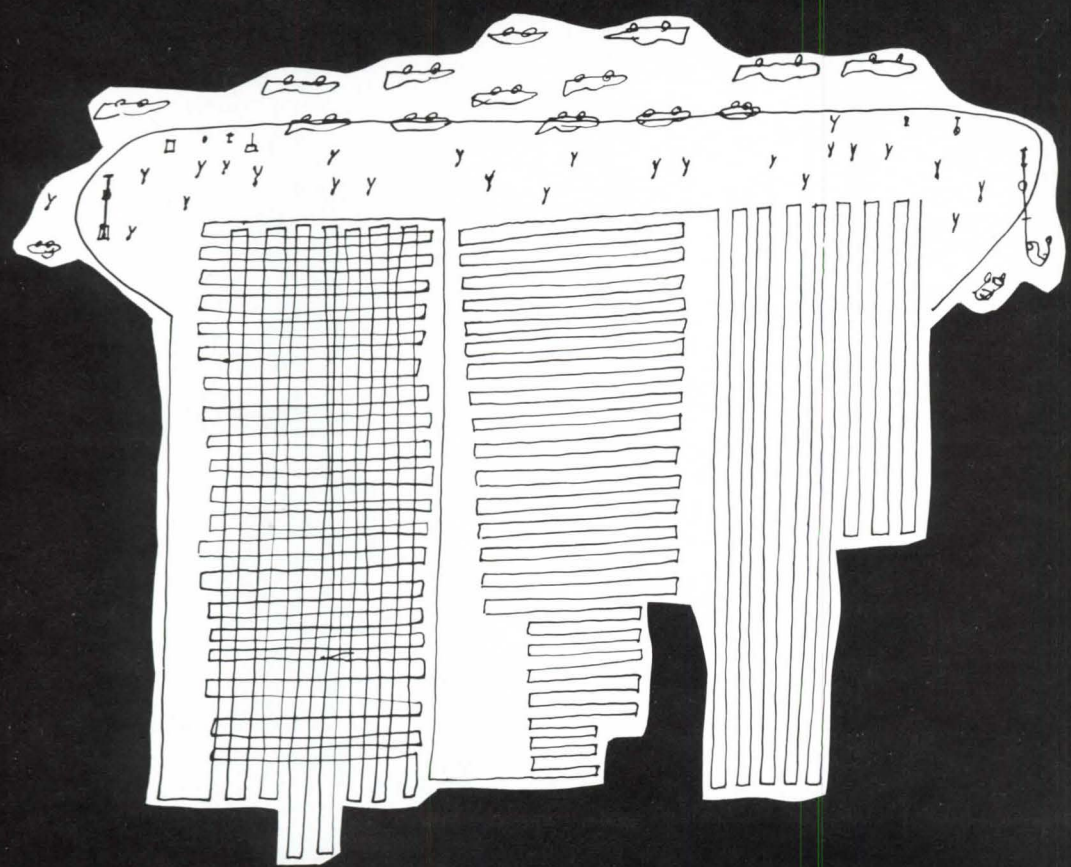
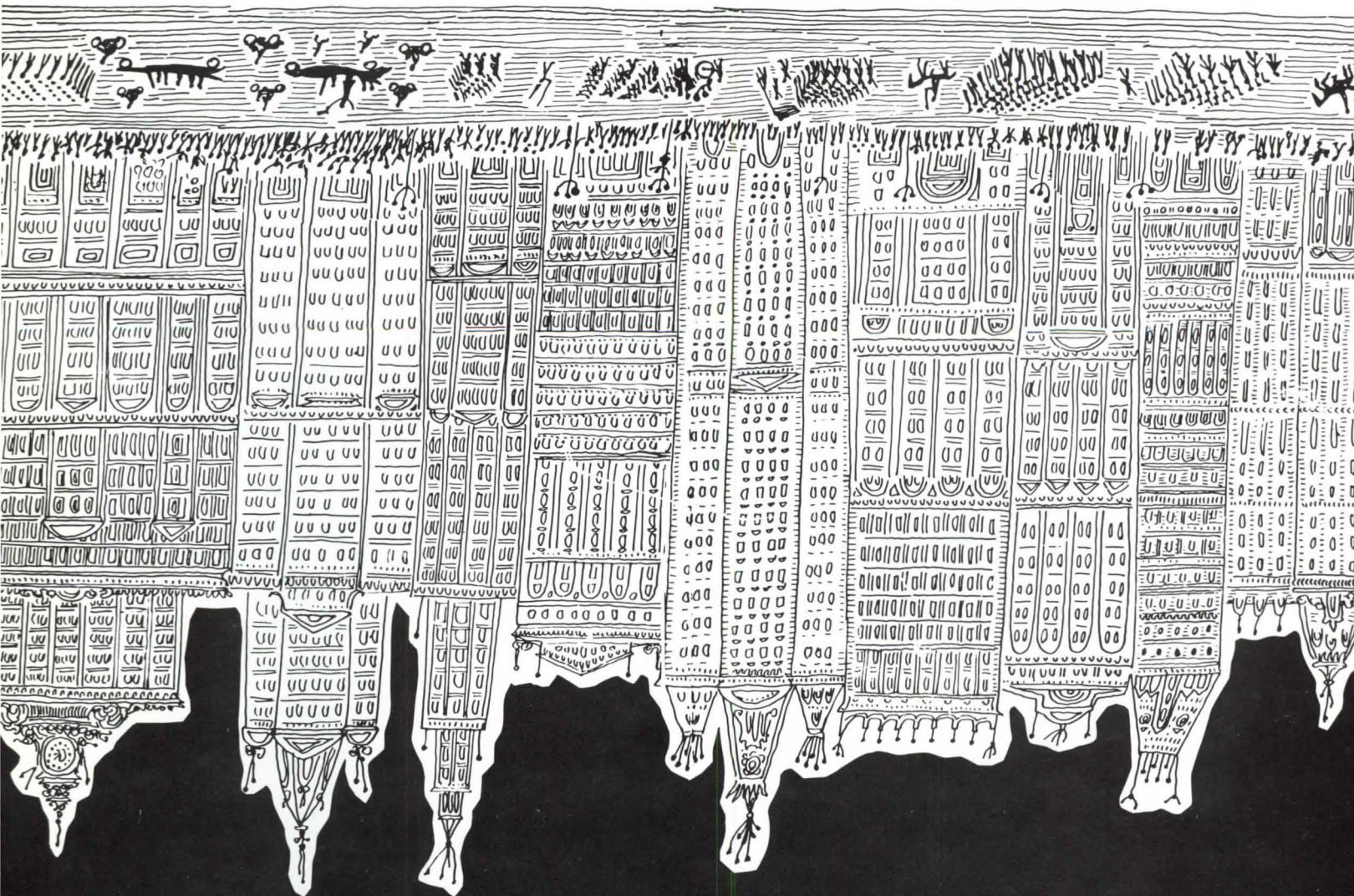

When these two Saul Steenberg drawings appeared in the American Institute of Planners' Journal in 1961, it could be assumed that the one at right represented the city of the future and the one below the city of the past. Today the meanings might be reversed.



# Double dribble.

Keeping the water off the roof. And off the floor.

That's the name of the game.

And the reason why it pays to specify Johns-Manville—the first name in lasting built-up roof protection.

With J-M, you get expertise based on over 120 years of solving roofing problems. You get quality that's consistently tops throughout a complete

line of roofing products, components and systems. Plus technical assistance from America's most experienced team of roofing specialists. And a degree of roof guarantee coverage that tops any in the industry.

Score with the built-up roof that offers real protection. For details, consult Sweet's. Or contact George Constantin, Johns-Manville, Ken-Caryl Ranch, Denver, Colorado 80217, 303/979-1000.

**Keeping the water out.  
That's what this business is all about.**



**Johns-Manville**

*Circle 21 on information card*

# The Celebration of Architecture in Retrospect

By Ernest Wood

In 1979 AIA President Ehrman B. Mitchell Jr., FAIA, had a favorite way of describing his pet project, the Institute's year-long "celebration of architecture." The year, he would say, was to be a time when "architects came out of their corrals where we normally stand around and pat each other on the back, snort around and tell each other how wonderful we are."

Mitchell has a dry and colorful wit. He also was known to talk about "putting on our celebration hats" or to call the celebration a "magic carpet."

The celebration of architecture, however, had a serious side as well, and it was this side that Mitchell passionately believed in and promoted. The goals were twofold, as Mitchell told an audience in Dallas in November: "to focus public attention on architecture of consequence" and "to inspire architects to know what it is to do better within their own profession." The idea was to bring architects and the public together to celebrate because they come together to build.

Many architects during the year would express pleasure that the AIA presidency had fallen to an architect who cared so much about design and whose own firm, Mitchell/Giurgola of Philadelphia and New York City, was celebrated for its own design accomplishments. (Mitchell, wit operating full tilt, would point out at another November lecture in Dallas that when Sylvester Stallone bounded up the steps of the Philadelphia Museum of Art in the 1977 movie "Rocky" and, in a celebration of his own, turned and raised his arms in victory to the city of Philadelphia, he was staring two Mitchell/Giurgola buildings right in the face and may, in fact, have been greeting them as well.) But in 1979's celebration of architecture, Mitchell always gave full credit to a building's owner, to a city administrator or to someone else who shared responsibility for a building's construction. In October, at the New York State Association of Architects/AIA convention in Albany, he presented a citation honoring "the quest for excellence" to Albany Mayor Erastus Corning II in recognition of the city's efforts in revitalizing its downtown. Mitchell noted then that throughout the year, "we have made it a point to search for people and go to places where excellence occurs." In the course of the celebration, Mitchell presented 31 such citations in the form of celebration of architecture posters around the country. They went to mayors and governors and members of Congress, developers and planners—and to a few architects.

In 1979 Mitchell traveled to most of the 77 celebrations that AIA's public relations office has record of. But the celebration of architecture was not by any means a one-man show—any more than a building is a one-man show. AIA's president always does a considerable amount of traveling during his term in office. The real job of celebrating architecture lay, to great extent, with AIA's state and local component organizations, sometimes acting on their own and sometimes aided by AIA, which over the year handed out \$9,000—17 grants averaging \$500 to \$700—earmarked for the celebration.

AIA's convention in Kansas City, Mo., in early June, was billed as the "maturing" of the year's celebration, and although a few local celebrations did occur earlier, as did several events of national significance in such places as Chicago, New Orleans, Los Angeles and San Francisco, most local celebrations did, in

fact, occur after the national meeting in Kansas City.

Many local officials proclaimed an "architecture week" or "architecture day" in their cities. There were sandcastle contests, guidebooks and tours, exhibits and lectures—lots of tours, exhibits and lectures. The Mississippi Chapter/AIA made its annual fall tour of Natchez a special celebration event. The Michigan Society/AIA selected the "50 most significant works of architecture in Michigan" and displayed photos of the buildings in the rotunda of the state capitol during the architects' annual convention. The Florida Association of Architects/AIA held a marathon talk-fest of 40 architects organized into eight teams who for two days in October set out to explore design in the state. There were some old architects and some young architects, some men and some women, some from large firms and some from small firms, some from every part of the state and from the islands of the Carribean. This diverse group was to look at a diverse set of questions about design: regionalism, high-tech, postmodernism and more. Their task was to ask, in the words of Jacksonville architect William Morgan, FAIA, who was chairman of the event: "If there is any architecture in Florida, will it please stand up?"

Other places looked seriously at design issues, too. The Northern California Chapter/AIA rounded up a distinguished jury and sponsored an awards program for interiors called "inside architecture—a decade of excellence." In Louisville, Ky., the East Central Region/AIA's convention featured a series of "miniseminars" on design. And in Columbus, Ohio, architects held a three day design charrette—much like a do-it-yourself-R/UDAT—on the city's central business district.

Then there were the off-beat or "just for fun" events, like the Minnesota Society of Architects/AIA's kite fest and contest or the New Jersey celebration at the opening of a penthouse restaurant at a racetrack.

In some places, architects combined their celebration with other events. The New Mexico Society of Architects/AIA joined up with the United Nations' "Year of the Child" and sponsored architects-in-the-schools programs. In Topeka, Kan., architects joined in with a city celebration called "Oktoberfest" which also featured children's activities. First, architects sponsored tours of buildings and an open house at their new headquarters building, where awards entries were on display. Then, when the children's arts festival (dubbed OZ II) began, they contributed by providing, among other things, nine large sets of Lego building blocks—some for the children to use and some for the architects to demonstrate their own building ability.

And in other places, architects combined many different sorts of events under their own "celebration" umbrella. In Santa Barbara, Calif., architects sponsored a 10 kilometer race, gave an award to one of its leading members, sponsored lectures, held exhibitions of arts related to architecture such as graphics or stained glass, had an "Ask an Architect" display and led walking tours. In one of the more wide-reaching celebrations, the Northern Indiana Chapter/AIA fanned out into three cities, South Bend, Calumet and Fort Wayne, for a series of events that included exhibits, seminars, tours (of buildings and of architects' offices), sale of celebration of architecture T-shirts and, in conjunction with the South Bend civic center which was celebrating its own second anniversary, a dance with the Count Basie band.

November saw a series of events in the space of three days in

*continued on page 78*

**Mr. Wood** is a Raleigh, N.C., writer and editor currently working on a book on historic preservation in the South.





# The wonderful touch of tile.

Potter's Touch is turning up everywhere in today's elegant homes. And no wonder! Potter's Touch is created from special clays fired to a rich deep glaze. There's a variety of decorator colors to choose from. And once you actually see and touch the quality of this distinctive ceramic tile, you'll know exactly why we named it Potter's Touch. For information as to where you can find Potter's Touch, mail the coupon and we'll send you the name of your local Florida Tile source. If you prefer, enclose \$1.00 and we'll send you an actual sample plus additional information.

## Potter's Touch<sup>®</sup>

Potter's Touch is a registered trademark of Sikes Corporation ©1979  
Circle 20 on information card

I would like additional information concerning Potter's Touch Tile. Please send me the name of my local Florida Tile source at no charge.

Enclosed is \$1.00 for an actual sample of Potter's Touch.

NAME \_\_\_\_\_

COMPANY \_\_\_\_\_

ADDRESS \_\_\_\_\_

CITY \_\_\_\_\_ STATE \_\_\_\_\_ ZIP \_\_\_\_\_

TELEPHONE \_\_\_\_\_

Florida Tile  
Sikes Corporation  
Lakeland • FL 33802

AJ180

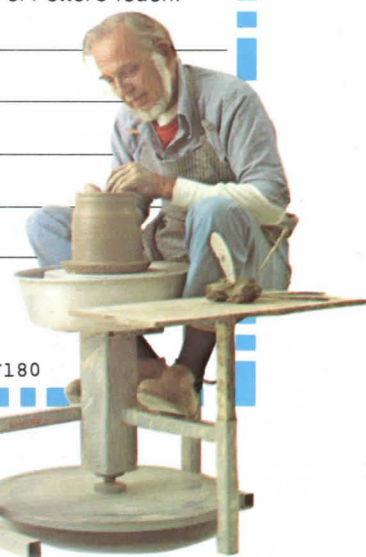

florida tile 



## A LOOK INSIDE

### Design Solutions for Living Spaces

**\*Houses Architects Live In (3-M302)**

By Barbara Plumb. Presents brilliantly designed houses and apartments—from modest to lavish, all emphasizing ingenious ways of combining beauty and practicality. All have interiors alive with ideas suitable for adaptation to all types of living situations. The author reviews concerns that determine architects' choices in designing their own environments, noting how they individually deal with such matters as situation, space, scale, balance, color, and light to create a home that meets their needs and interests. Hardcover, 168 pages, 168 color illustrations (1977). \$17.95 Non-member, \$16.15 AIA member

**\*Interior Plantscaping: Building Design for Interior Foliage Plants (3-M301)**

By Richard L. Gaines. Gives complete guidelines for use of this increasingly important element of interior design. Includes information on physical requirements of plants, what conditions they need, and how to select plants that do best indoors. A special full-color section displays and discusses over 75 of the most popular varieties for indoor use. An invaluable reference for anyone interested in plantscaping homes and offices. Hardcover, 200 pages, 150 illustrations (1977). \$22.95 Non-member, \$20.65 AIA member

**\*Looking Into Houses: 60 Solutions to Design Problems (3-M294)**

By James Brett. A photographic portfolio of some of America's most personable homes, selected for the problem-solving skill and ingenuity shown in creating inviting living space. Case studies include one-room houses, compacts, townhouses, and barns transformed into houses; and concludes with crown's nests and green rooms. Hardcover, 192 pages, 225 illustrations (1976). \$22.50 Non-member, \$20.25 AIA member

**\*The Spacemaker Book (3-M295)**

By Ellen Liman. The author analyzes every aspect of creating (and more efficiently arranging) adequate space in which to eat, sleep, dine, plan, and live. More than 300 specifically detailed illustrations pin-point innovative solutions to the commonly encountered traumas of modern living arrangements. Hardcover, 128 pages (1977). \$9.95 Non-member, \$8.95 AIA member

**\*Ten by Warren Platner (4-M276)**

By Warren Platner. Presents ten projects by Mr. Platner, one of the United States' best-known architects, interior designers, and furniture designers. Sumptuously illustrated, printed and bound, this magnificent volume will be an informative and delightful gift for the graduate as well as an addition to libraries of architects and non-architects alike. Hardcover, 224 pages (1975). Only \$15.00

**\*The Use of Color in Interiors (3-M372)**

By Albert O. Halse. Unique in its broad treatment of color design, this richly illustrated volume provides an overview and complete, detailed description of the principles and procedures involved in the determination of color plans. Discusses various methods and materials that may be used to solve any interior architectural color problem. With this information, architects and interior designers can arrive at results that are uniquely individual, but which incorporate all elements to be considered when developing a color plan. Hardcover, 164 pages, 32 pages in full color (1978). \$27.50 Non-member, \$24.75 AIA member

\*Denotes books published by organizations other than AIA; may not be in accord with AIA policy.

#### TO ORDER

Send letter with item number and quantity you wish to order, including payment, to: Manager, AIA Publications Marketing, 1735 New York Avenue, N.W., Washington, D.C. 20006.

Furnish firm name, correct mailing address, and name of person to receive order.

Checks may be made payable to The American Institute of Architects. District of Columbia residents add 5 percent sales tax.

Foreign orders must be accompanied with check or money order made payable in U.S. dollars, and include 20 percent of total amount of order for postage and handling.

# The AIA is like a smorgasbord.

**Once you've paid, you might as well eat everything.**

**1** Continue your education. Attend an AIA architectural training laboratory on energy audits; take a correspondence course like "Land Development Game Seminar."

**2** Use AIA contract forms. Over and over, these documents have been used by the courts to determine accepted practice.

**3** Buy publications at a discount. Choose from nearly 300 titles—order "Standardized Accounting for Architects."

**4** Get energy-conscious. Subscribe to AIA's practice-oriented Energy Service, a 300-page Energy Notebook with quarterly updates and monthly newsletters.

**5** Insure yourself and your firm. Enlist in some of the best group insurance plans in the country—at rates much lower than those available to individuals or most firms.

**6** Get involved in your profession. Participate, as much or as little as you want, in one of AIA's 22 open committees. Make a difference in your community. Become active in your local AIA chapter.

**7** Call our librarians. Ask them to track down historical figures, obscure data, unfamiliar quotations. Choose from 23 films and slide shows, 10,000 slides, and 20,000 books.

**8** Keep informed. Read the AIA Journal and the MEMO. As a member, you'll receive both.

**9** Get answers to your questions. Dial 202-785-5954, the AIA's membership Hotline, to ask about programs and membership services.

I am not an AIA member, but I'm interested. Please send me "Architects in Action" for information on membership.

I am an AIA member, and I'm interested in finding out more. Please send me specific information on point(s) #\_\_\_ above.

Mail to: The American Institute of Architects, 1735 New York Avenue, N.W., Washington, D.C. 20006

Name \_\_\_\_\_  
Address \_\_\_\_\_ Phone \_\_\_\_\_  
City \_\_\_\_\_ State \_\_\_\_\_ Zip \_\_\_\_\_

## Learning new ways of reaching the public.

*Continued from page 74*

Dallas that, taken as a whole, presented an interesting sample of ways architects can talk to themselves and to different segments of the public about design: architects talking to laymen concerned about the art of architecture in a University of Dallas continuing education course; architects talking to each other at the University of Texas at Arlington's school of architecture, and architects talking to laymen interested in the business of design. (Unfortunately, a lunchtime celebration in downtown Dallas' Thanks Giving Square that would have spoken to the man-on-the-street and would have rounded out the series was canceled at the last minute. That celebration was to have honored civic leaders for their support of the arts. But it would have followed by only a few days a bond referendum on whether to build a new art museum for the city. Celebration organizers, fearing the referendum might not pass, canceled the event rather than face an awkward "celebration" of a failure. (The referendum passed.)

In Dallas, Mitchell once again set the tone for the three days with a lecture on the Institute's celebration at the University of Dallas. To the rhetorical question asking why one should be concerned with the quality of architecture, he answered: "Quality of life is determined by what's left after we as architects have put our hand to a building." Lyle Novinski, chairman of the university's art department, followed with a poetic description of O'Neil Ford's contribution to the campus' quality of life. "We ought to celebrate, too, as we live in O'Neil Ford spaces," he said. "And nothing nicer could happen to anyone in the latter half of the 20th century."

The next night at the University of Texas at Arlington, Mitchell prefaced remarks about his firm's own work with a slightly different pitch to architects: "One of the wonderful things about celebrating architecture is we begin to look at it more closely." He noted, again, the celebration's mission "to show people how they participate" in design but reminded the architects that in architecture "what we're talking about is the development of ideas that affect human life." A building begins, he said, with an individual with a program who may know little of design. "We are the interpreters of what to do about those ideas. . . . We affect the land, cities and certainly people."

The following day, about a thousand business people gathered to hear about the future of their city at a luncheon sponsored by the Dallas Chapter/AIA and local business and planning organizations. Mitchell, reminding them that if the city continues to grow at its current rate in 20 years it will have more people than now live between New York City and Washington, D.C., noted: "I challenge you to get on with looking at a vision and a vista that can be the role model for the world to follow." And E. Jack Schoop, the city's new planning director, after outlining growth potentials and issues for the city, noted: "In this week of celebration of architecture, we note the opportunity to improve the design of the city." The luncheon was an event which had occurred in previous years (though this was only the second time AIA has cosponsored it). The impact of such events is hard to judge, but it apparently was well received—as one observer noted, its effect was "largely educational" and long term.

A month earlier in Albany, N.Y., Mitchell also had reminded architects, this time at the annual convention of the New York State Association of Architects/AIA, that "one great privilege (of the profession) is to have the burden of responsibility of the built environment, of making places for people."

The New York Chapter/AIA meeting was another kind of celebration, one in which a local component simply gave a "celebration" theme to an annual event. There were the usual convention activities: tours of the city, luncheons and dinners, design awards and speakers. But there did seem to be a special "celebration" tone to even the more serious events.

Ezra D. Ehrenkrantz, FAIA, speaking to the design awards dinner, sought to find optimistic messages for architects in the energy crisis, noting that "design is crucial to the survival of our society," for the only solution to the energy crisis is to use our resources "in an integrated way." Many energy solutions, he charged, are only short term—but a more appropriate approach may be to question fundamental facts of modern life: For example, is it more effective to question energy efficiency of automobiles or to question the way we scatter housing in suburbia in the first place, making autos so necessary?

Ehrenkrantz's remarks may have been a reinforcement of architects' importance and, in that sense, optimistic for the profession—but the next day Bernard P. Spring, FAIA, dean of the school of architecture at City College of the City University of New York, reflecting on the closing decade of the '70s, sounded a lighter note—and one that was really more in tune with the general concepts of the celebration. "In the '70s," he said, "we tried to use architecture to solve social problems . . . but, as Mitch said, only people can do that and then turn over the work to architects to implement it." As for meetings and celebrations, Spring said, "I don't come to meetings like this—and I don't think you come to meetings like this—to hear about problems and headaches. They're with us every day. We come to meetings like this so we can go back to the office refreshed." So "celebration," he concluded, is the proper theme for any AIA meeting. (*For more Spring, see page 68.—Ed.*)

Indeed, the long-range effect of 1979's celebration of architecture may be as important for what it taught the profession as for what it taught the public.

The celebration was a public relations tool, no doubt about it. It generated an unprecedented amount of publicity for the profession—from coverage of local celebrations and interviews Mitchell gave to local newspapers, radio and television stations on his travels to articles in national news magazines about this year's national design awards.

But it was the best kind of public relations tool, for it went beyond mere publicity to generate positive responses from the public. Already, Chicago Mayor Jane Byrne has created a mayor's architectural advisory committee made up of local architects to study and make recommendations on the city's physical planning—largely in response to last May's national design conference held in the city. In Kansas City, where the convention celebration was a joint effort of AIA and the local chapter, results are appearing as well. The R/UDAT study made at the convention on the city's Northland area already has been used successfully to halt a zoning change, and on the basis of the R/UDAT the mayor has been asked to appoint a committee to oversee a proposed capital improvement bond issue for the area. A nonprofit committee has been created to sponsor future annual arts festivals in the city modeled after the celebration. And the business community has formed its own arts council to coordinate corporate grants to the arts.

But most such "public education" programs as the celebration take a long time to show results. It can be true, instead, that the educators learn faster than the objects of their lessons. It may be that architects really did come "out of their corrals" this year and learn new ways to communicate with the public. And the celebration, as an event focusing principally on design, may have involved design-oriented architects who usually do not participate in such Institute activities as legislative action or office management seminars. Many architects this year were pleased to see AIA concentrating on architecture rather than on architects.

At least one celebration event is still to come. The North Carolina Chapter/AIA will have its main celebration at its annual convention this spring. Caught with scheduling problems, the chapter felt it could not stage the quality event it wanted to in 1979, so it opted to wait. Besides, the chapter felt that architecture lasts a long time, so a celebration of architecture need not be tied to one calendar year either. □



**Primitive Encore.  
In the tradition  
of things  
created one piece  
at a time.**

In the beginning, everything was created one of a kind. Because everything was created by hand.

Today American Olean has recaptured this look in new Primitive<sup>®</sup> Encore<sup>™</sup> Ceramic Tile. Where each tile has its own special shading and character. It's a look synthetics can't even approach.

Recommended for floors, walls and counter tops, it's highly resistant to scratching and wear. And it offers superior slip-resistance.

New Primitive<sup>®</sup> Encore. See it at an American Olean Color Center. (Check the Yellow Pages.) For a full color brochure, write to American Olean Tile Company,

2581 Cannon Avenue,  
Lansdale, Pa. 19446.



A National Gypsum Company

Shown - 11" x 11", 806 Blue. Other Encore colors and sizes and harmonizing grouts also available.

**American Olean is Ceramic Tile.**

Circle 22 on information card

# BOOKS

## Memories of War By a Child of Warsaw

**Dying, We Live.** Julian Eugeniusz Kulski. New York: Holt, Rinehart & Winston, 1979. 304 pp. \$18.95.

Last October, while attending one of the luncheons of the annual meeting of the American Planning Association in Baltimore, I chanced to sit next to architect Julian Kulski. After discovering our mutual interest in architecture, the conversation touched on the subject of architects as authors. We exchanged thoughts on Archibald Rogers' book *The Monticello Fault*, recently published and being sold at the meeting (see Feb. '79, p. 40 and Aug. '79, p. 78). Kulski mentioned that he had just authored another book and had presented a copy to Pope John Paul II the previous week during the Pontiff's historic visit to the nation's capital. Why would Pope John Paul II have an interest in a book by an architect?

The connection, simply, was that during the Nazi occupation of Poland, both Julian Kulski and Pope John Paul II were resistance freedom fighters. Kulski's service was in Warsaw while the Pope's was in Cracow, some 250 miles south of Warsaw.

On Sept. 1, 1939, the Nazis stormed into Poland, precipitating World War II. Julian Kulski, destined to become a distinguished architect and a fellow of AIA, was a 10-year-old boy, the son of the mayor of Warsaw. The book is young Julian's diary. Each chapter represents one year, starting with 1939 and ending with 1945. One can see the transformation of a precocious youth from a well-to-do influential family into a veteran commando, battle-toughened and world weary, in five short violent years. The author has enriched his account with copious photographs, illustrations and maps indicative of the times and events during this bloody period of Poland's history. This is an adventure story, and a tragedy.

The story in many ways is surrealistic: fighting skirmishes in the streets, being captured and incarcerated by the Gestapo, harrowing escapes through the sewers of Warsaw, brutality practiced by both sides, the formation and death of the Warsaw ghetto and its inhabitants, attempts to maintain family order and survival, the

utter destruction of a once beautiful city and, finally, the Red Army standing aside while the rebellion of the resistance is crushed by the Germans, the Soviet purpose being to weaken patriotic groups in the country so that the Russian takeover would be complete once the Germans were routed.

At the end of the war, after Kulski escaped from a prison camp in Germany with some early liberated British prisoners, he was encouraged by doctors in London to set down all of his recollections, no matter how horrible, so that he could put them aside physically and psychologically in order to begin life anew.

Kulski decided to publish these memories only recently as a tribute to those brave young men and women who fought with him in the resistance and did not survive. This book is *their* epitaph, and hence the title of the volume.

This incredible book is highly recommended. *Michael Barker, AICP, Administrator, AIA Department of Practice and Design*

**Borromini.** Anthony Blunt. Cambridge, Mass.: Harvard University Press, 1979. 240 pp. \$15.

Blunt begins this book: "From his own day till the end of the 19th century Borromini was vilified as the great anarchist of architecture, the man who overthrew all the laws of the ancients and replaced them with disorder, and who corrupted the taste of many architects in Italy and Central Europe for generations. Now students of architecture are more inclined to agree with the few almost fanatical admirers who supported him during his lifetime, and he is generally acknowledged as one of the greatest geniuses—perhaps  
*continued on page 84*

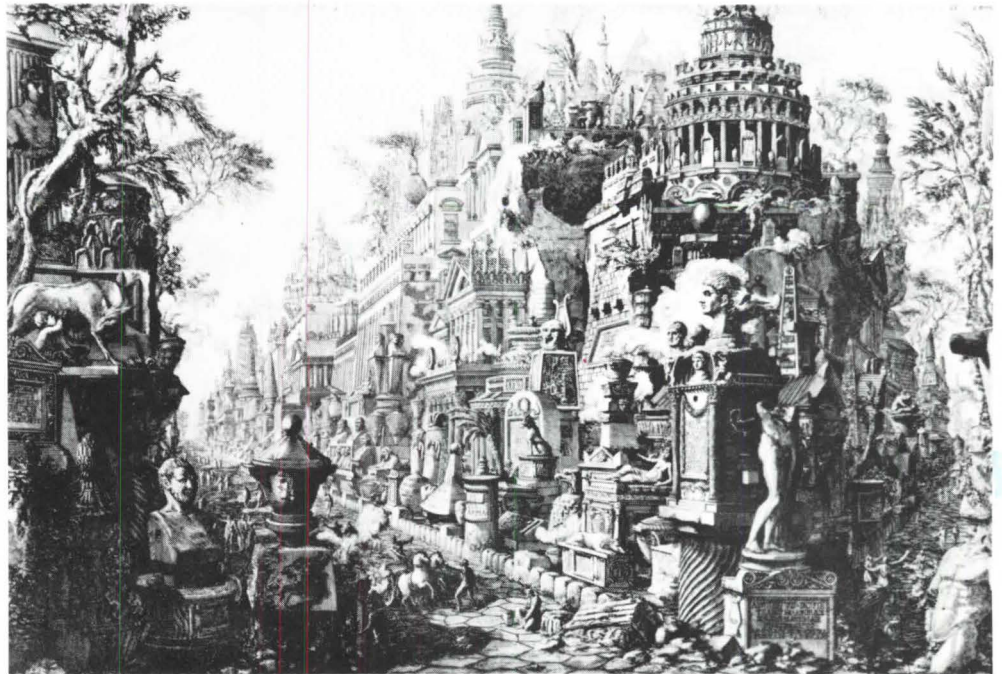

**Piranesi: The Imaginary Views.** Miranda Harvey. New York: Harmony Books, 1979. 80 pp. \$12.95 hardbound, \$5.95 paperbound. Piranesi is universally known for his etchings of ancient ruins, prisons and imaginative reconstructions. Tremendously influential on the development of the neoclassical and romantic movements in architecture, he championed Roman over Greek architecture. In this book in which many of his imaginary views are presented, the author says that Piranesi "presaged the gothic novel which found visual expression in the works of Fuseli and the visions of Blake." There are 80 full-page black and white illustrations, dating from 1743 to 1769. Above is depicted Roman antiquity as it existed in Piranesi's fertile mind, revealing that this architect antedated the movement we call surrealism, launched in 1924 by the French poet André Breton, by many years. Harvey also provides a chronology for Piranesi, showing the "artistic influence and financial patronage that guided the artist through his own life's labyrinths."

# Let the sun shine in.

Brighten things up with MODUSPAN<sup>®</sup>, the space frame that opens new horizons for interior design. Pictured below: The Orange Park Mall in Jacksonville, Florida. Where our space frame experts provided the design and technical assistance needed to turn an architect's vision into reality. For more information about Moduspan... call the Unistrut Service Center nearest you. Or see our catalog in Sweet's. It'll shed some light on your latest design.

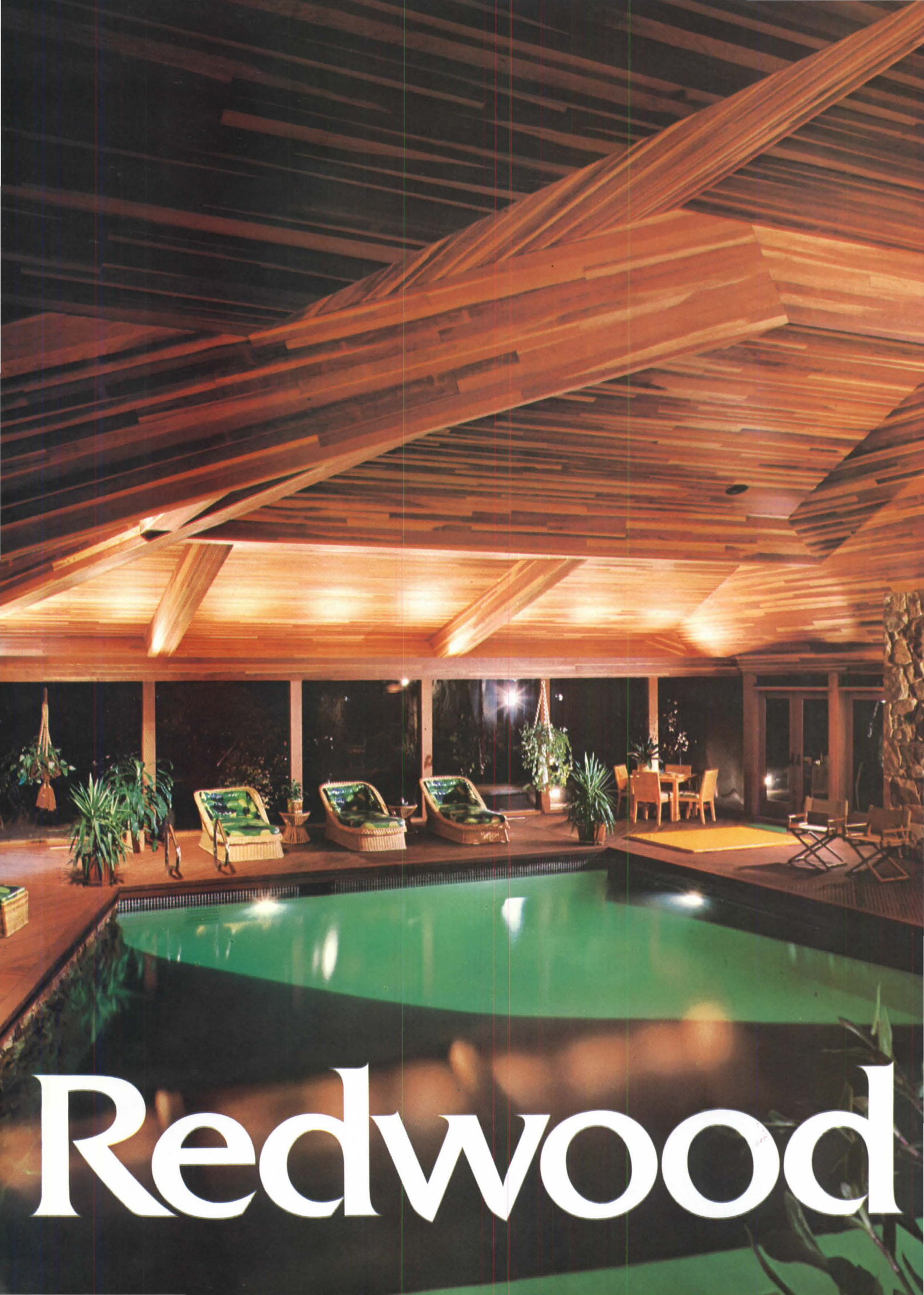

# Redwood





**Redwood comes in a much wider variety of grades, shades, textures and types than most people think.**

Redwood, as the work shown here clearly demonstrates, is not only beautiful, it's versatile. Redwood can be warm and rich. It can be bright and colorful. Redwood can be smooth and handsome. It can be rough and striking. Redwood has almost infinite possibilities.

And redwood adds enduring value to whatever you design or build. No other wood weathers like redwood. No other wood is as resistant to warping, checking, and age. No other wood takes and holds a finish better, or needs a finish less. Redwood insulates against heat, cold and noise. Redwood resists flame spread.

Redwood. There is, literally, no other wood like it.

*Credits:*

*Clear grade residential ceiling*  
Architect: Norman Jaffee, AIA  
Interior: Maurice Weir, FASID

*Clear All Heart siding, multi-unit*  
Architects: Fisher-Friedman Associates, AIA

*Knot and sap textured siding, multi-unit*  
Architect: Kermit Dorius, FAIA  
Architects and Associates

*Finger joint interior accent wall*  
Architect: Richard E. Huston  
Architect, Incorporated

*Garden grades deck*  
Designer: Elsebet Jegstrup

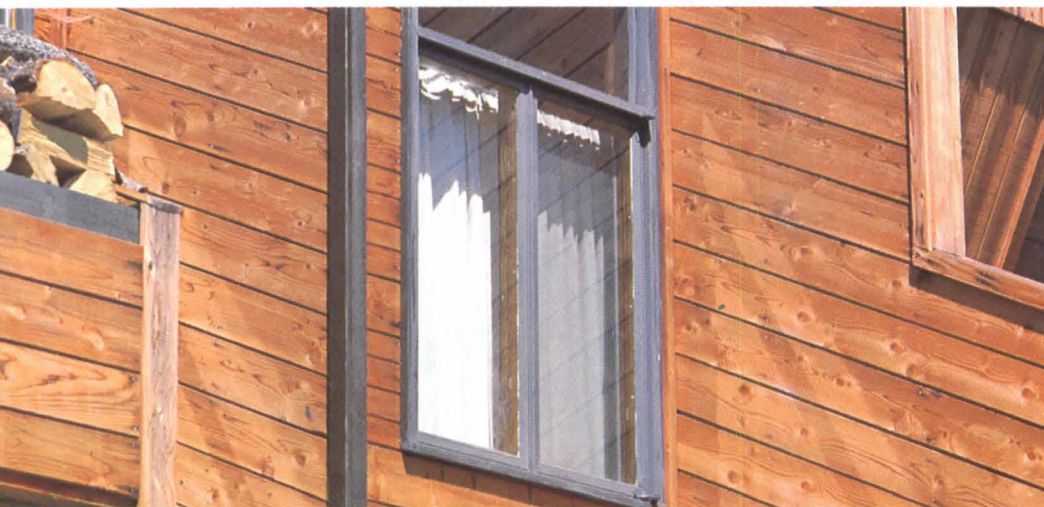

 **CALIFORNIA  
REDWOOD  
ASSOCIATION**

One Lombard Street  
San Francisco, California 94111

*Redwood—A renewable resource*

*Circle 24 on information card*

Introducing a new dimension in "convenience" copying

For the finest prints from your drawings.  
for superlative intermediates...

## THE NEW AM Bruning 148 copier is a star performer.



The ammonia developing system requires no venting, so the AM Bruning 148 can be placed anywhere — in the drafting room, in a field office or wherever convenient. The print-quality is a

rich, dark blue or black line, and intermediates are of top reproductive quality — all in the Bruning tradition. It is ideal as a print-maker for organizations with lower-volume requirements or as a satellite machine augmenting central reproduction departments. New, flexible original and print receivers require less room than the rigid trays of conventional design. The AM Bruning 148 is compact, easy-to-use and economical. It can be placed on a table or on its optional stand, and is available on lease or purchase plans. See your Bruning representative for a demonstration now.

**AM Bruning**

*We help bring your vision to life*

1834 Walden Office Square  
Schaumburg, Illinois 60196

In Canada: 165 Milner Ave., Scarborough, Ontario M1S 4G7  
Subsidiaries and dealers throughout the world

AM and Bruning are registered trade marks of AM International, Inc.

### Books from page 80

the greatest—of baroque architecture.”

Why the long vilification of Borromini and why is he now widely admired? These two questions, as specific as they may seem, quickly spread like rings from a stone dropped in water. Why had the entire baroque been so long rejected as a decadent style (the term baroque was coined as one of derision; it was not until the late 1800s that it began to be accepted as an art historical term for an important style), and why our current and still increasing interest in it? What insights into the essence of architecture did Borromini share with Michelangelo? And what does an understanding of Borromini have to offer us in understanding architecture today? Blunt's book addresses none of these questions directly, but in being an excellent survey of Borromini's work, it becomes the background for the reader's own exploration of them.

Following the drier geometry of the Renaissance, the baroque replaces the static circle with the dynamic ellipse and bursts forth with an exuberance which encompassed the richness and complexity of the human experience. It related interior to exterior through the sculptural play of the *poché*; it engaged the street with the undulating facade, and it stretched the boulevard across the city, all of which make the baroque a truly urban architecture. As such, it contains lessons for us today. The mathematics of Mies van der Rohe's "ideal villa" and the work of today's American and Italian neorationalists represent a Renaissance perspective, one which has historically proven inadequate for the city. Our current interest in the baroque comes, perhaps, from our recognition of its power at the urban scale, a power which has been harnessed to advantage by Edmund Bacon.

Borromini was the great master of the baroque. He had perceived in the architecture of Michelangelo revolutionary possibilities in decorative effect and spatial manipulation, and was able to exploit these possibilities through a combination of passionate inventiveness and geometric control. The result was an explosion of visual and experiential effects which define the baroque. Criticism of Borromini's architecture, like that of Michelangelo before him, came precisely because of his truly original creative talent. Architecture, like all fields of human endeavor, is advanced by the creative forces of individual genius, but is maintained by codified and teachable rules. The same forces which maintain the rules (which are supposed to assure a decent background architecture) also stifle the efforts of creative genius.

Our appreciation of Borromini's individuality comes, I suspect, from the fact that we are for the moment without an

*continued on page 88*



# Tools of the trade.

It can be what you want it to be, do what you want it to do.

Masonry is a thousand colors, textures, shapes and sizes. It creates patterns of light and shadow that move with the sun; it creates a visual mood for the structure. It provides a texture of contrast, or unity — whatever you intend.

Yet with all of the aesthetic freedom masonry gives architects and designers, it remains fundamentally a very practical and economical tool of the trade.

Masonry buildings go up faster so they can be occupied sooner. They have lower maintenance costs, never need painting, virtually no repairing. Masonry walls, because of their mass or density, reduce heating and cooling costs, thus saving energy. And masonry fulfills many functions — structure, enclosure, fire walls, sound barriers, finish walls.

Because masonry lasts, all of these aesthetic and practical advantages are multiplied over the years.

Masonry: Brick, block, tile, stone — craftsmanship.

Tools of the trade. Consider them for your next building.

## **INTERNATIONAL MASONRY INSTITUTE**

(The Bricklayers' International Union and the  
Mason Contractors in the U.S. and Canada)

823 Fifteenth St., N.W.  
Washington, D.C. 20005  
202/783-3908



Circle 26 on information card

# New, broad-base steel building cuts costs by \$1-million.

Recently, in Chicago, a conventional design for a 50-story office tower was turned down by the owner/developer, Draper & Kramer, Inc., in favor of a broad-base 28-story building with the same rentable space. The shorter building—with a series of atriums—provided more *first-class* leasable space, and could be built for substantially less.

According to the architect and engineer, Skidmore, Owings & Merrill, and construction manager Schal Associates, the broad-base building cut costs by \$1.25 per sq. ft. So total savings on the handsome new \$55-million building known as 33 West Monroe amount to \$1-million.

## Three Interior Atriums

One great benefit of lower, broader buildings, which addresses the energy problem of the 80's and 90's, is that they have less outside surface than tall towers: this cuts heat movement through the buildings' skin and results in lower energy consumption.

But broad-base buildings, by pulling large areas of space indoors, can limit the outside views that tenants want. At 33 West Monroe the answer was three interior atriums...at various heights of five, eight and ten stories...making the new structure the first multi-atrium office building in America.

The atrium configuration created an imaginative interior of great qual-

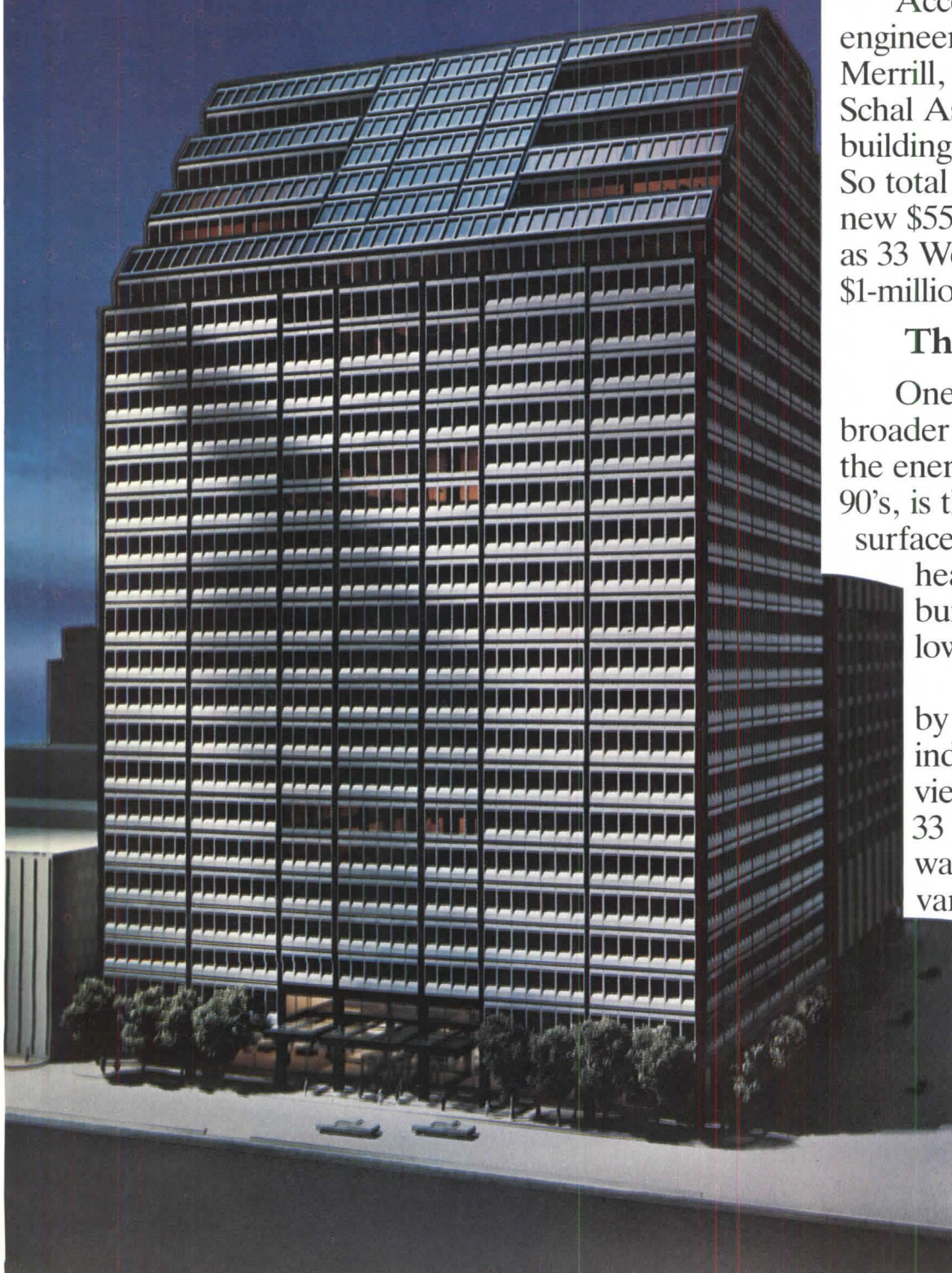

ity, a variety of floor areas and almost 900,000 sq. ft. of usable space. Virtually all leasable space will either overlook the atriums or have a prime external view, and no place in the building is more than 35 feet from a window. Extra



money was invested in the atrium treatment, elevator system, and superior window-walls and lighting to produce one of the highest quality office buildings in Chicago.

### Many Economies

33 West Monroe, even with its revolutionary, three-atrium design, saved money in many ways. Diffusing the mass of the building over a broader area reduced foundation requirements.

The lower, broader structure, requiring less resistance to lateral wind loads, permitted use of a lighter steel frame: this resulted in a much shorter construction schedule and lower material costs.

6,750 tons of A-36 and A-572 grade 50 structural steels were supplied by U.S. Steel. The steel frame with composite decking makes it easier for tenants to connect to electrical and telephone services. Also, stairs and other interior additions can be easily built into a steel framing system.

Circle 27 on information card

This innovative building demonstrates how, once again, structural steel can be used to implement imaginative design...economically.

For information regarding the many applications for structural steel, contact a USS Construction Representative through your nearest U.S. Steel Sales Office. Or write to United States Steel, P.O. Box 86, (C1244), Pittsburgh, PA 15230.



## United States Steel

*Owner:* Draper & Kramer, Inc., Chicago, Ill.

*Architect and Engineer:* Skidmore, Owings & Merrill, Inc., Chicago, Ill.

*Construction Manager:* Schal Associates, Inc. Chicago, Ill.

*Steel Fabricator/Erector:* The American Bridge Division of United States Steel.



### Books from page 84

orthodoxy which can condemn it. We are no longer bound by the modern movement, and a new orthodoxy has not yet risen to replace it. In this hiatus we can appreciate the individuality of such modern architects as Lutyens, Goff, Aalto and Wright. We can appreciate this individuality in historical architects such as Borromini.

The reaction by some of Borromini's contemporaries to his architecture is strikingly similar to that of some critics today of Robert Venturi's architecture. Blunt quotes one of Borromini's critics: ". . . everyone imagines in his head a new idea or phantom of architecture in his own manner . . . so that they deform buildings, even towns and monuments. They use, almost deliriously, angles and broken and distorted lines, they tear apart bases, capitals and columns with crowded stucco decoration and trivial ornaments and with faulty proportions, in spite of the fact that Vitruvius condemns such novelties."

The fact is, of course, that with all his imaginative creativity, Borromini had precedents both in Michelangelo and in antiquity for everything that he did, even if the precedent was only in his understanding of the true potentials of the orders. Such examples of Roman architecture as the rock tombs of Petra which look remarkably like Borromini's San Carlo were not discovered until more than a hundred years after Borromini's death. Similarly, many of Venturi's devices, such as the false facade, have their precedents. The false facade was used in the Step Pyramid complex at Saqqara, the first architecture in stone.

Only two of Borromini's buildings, the small churches of San Carlo and San Ivo, bear full witness to his creative abilities. The rest of his commissions were either compromised by the involvement of other architects or were only alterations and additions. The great commissions of the time went to Borromini's rival, Bernini. Borromini lacked Bernini's personal charm and political connections. After years of frustration, he died, ill and bitter, by his own hand.

Blunt's book is an excellent account of Borromini's career, although my taste is for more interpretative work. I would be interested, for example, in the relationship of Borromini's architecture to the other arts of the baroque period and to the religious, social and economic conditions in Rome at the time. Blunt generously places his book in the larger context of Borromini scholarship in his extensive notes on further reading. Paolo Portoghesi's *The Rome of Borromini* comes to mind. Portoghesi's book uses the current Italian vogue of a "semiological" approach (it is subtitled "Architecture as



Language") which, as Blunt states, can be difficult to follow.

I have not yet read Portoghesi's book, but in flipping through it, I did not find much semiology beyond the preface. Blunt also comments that the photographs in Portoghesi's book "while brilliant as photographs, often falsify the effects of the originals." The photographs in Blunt's book, while adequate to illustrate the writing, have a dry textbook quality to them. I recommend the reading of Blunt's book, but I must also say that Portoghesi's book has some of the most handsome photographs I have seen, and should certainly be looked at if not also read. *John Lobell, Associate Professor of Architecture, Pratt Institute*

**Connections: Ways to Discover and Realize Community Potentials.** Jim Burns. New York: McGraw-Hill, 1979. 155 pp.

This book is a sensitivity session for city design funded by the architectural and environmental division of the National Endowment for the Arts. It could represent a substantial change in the way this nation has traditionally viewed urban areas. Basically, throughout our history, cities have been maligned as necessary evils for the production of wealth. This was true in Jefferson's time and even more dramatically true after World War II when the average family had the means to reject the city, with a lemming-like rush to the suburbs. Could this book, and others like it, signify a change, or are we faced with a set of values based on federal grants programs?

Because urban design is of particular interest to me, I found *Connections* a fascinating if somewhat disjointed book. Up front the author presents four essays

on cities: "Continuity and Change," "Connections," "The Awareness-to-Action Process" and "Awareness Portfolio." Citizen participation and public awareness are viewed as key to political action in improving city design.

After setting the stage, 10 cities are explored in a way that reflects the values expressed in the earlier essays. The cities are Oakland, Calif.; Bath, Me.; Cache Valley, Utah; Boulder, Colo.; Atlantic City, N.J.; Astoria, Ore.; Terre Haute, Ind.; El Paso, Tex.; Biloxi, Miss., and Memphis. Why these cities? Why not?

While the book itself is not a benchmark, it certainly is very entertaining urban design reading which will be highly useful to fans of cities, both those who earn their living in city design and those with a general interest only. Discussions of the cities themselves are very much like those contained in the *AIA JOURNAL* prior to Institute conventions.

Before you go to Biloxi, Miss., read this book. *Michael B. Barker, AICP, Administrator, AIA Department of Practice and Design*

**Will It Make a Theatre?** Edited by Eldon Elder, Marsha Imhof and Sharon Lee Ryder. New York: Drama Book Specialists, 1979. 206 pp. \$6.95. (Available from Ooba, 150 W. 52nd St., New York, N.Y. 10019.)

Sponsored by the Off-Off-Broadway Alliance—a league of not-for-profit professional developmental theaters in New York City—this book is essentially a guide to converting found spaces into experimental theaters.

Since the economic base for small performing companies in Manhattan and elsewhere is minimal and must rely heavily on local and federal subsidy, questions of the esthetics of relating performers to limited audiences yield immediately to considerations of getting the most for the least. Therefore, emphasis is placed on finding and bringing up to code loft buildings, warehouses, storefronts, banks, churches and any other no longer functioning facilities which might, with minor revision, yield suitable theatrical environments. It also explores the pros and cons of accommodating theaters within already designated landmark buildings.

An interesting insight into the economics of experimental production is given by an account of the impact of building codes on the permissible size of audiences. Whenever the audience space accommodates more than 74 persons, the code requirements become considerably more stringent. When the audience exceeds 100, Actors' Equity Association makes further demands on support facilities for the performers.

As a compendium of information con-

*continued on page 90*

# PPG OFFERS A STUNNING ALTERNATIVE TO THE DRAB SLAB.

Discover a spectacular exterior wall treatment that puts new designs on all that it surrounds. Discover PPG's Solarcool® Spandrelite® wall cladding.

In addition to dramatic beauty, Solarcool Spandrelite wall cladding offers outstanding performance capabilities. In new or existing applications. And at a cost that's lower than the expected exterior wall treatments: masonry, aluminum, stone and polished stainless steel.

An advanced structural silicone glazing system with the mullions inside can make Solarcool Spandrelite wall cladding appear seamless.

You're free to choose glass types and thicknesses previously unimagined.

And Solarcool Spandrelite works as an energy-efficient opaque curtain wall or a window area. Can even hang in front of insulation.

Since 1965, PPG has led the world in creative application of structural

silicone glazing systems. And began to build more "oohs" and "aahs" into buildings.

Find out more. See Sweet's 8.26/Pp. Or write Environmental Glass Sales, PPG Industries, Inc., One Gateway Center, Pittsburgh, Pa. 15222.

PPG: a Concern for the Future



Architect: Robert Bridges Associates, New York  
Circle 28 on information card

### Books from page 88

cerning minimal requirements for performance and nonperformance areas, this book is of considerable value. In basic terms, it analyzes sightlines, platform arrangements, ceiling heights adequate to allow for stage lighting, as well as such necessary backup facilities as dressing rooms and administrative office space.

Small experimental theaters provide a forum for plays in their earliest stages of evolution. This handbook deals effectively with the techniques for creating and maintaining so essential a resource.

*Martin Bloom, AIA*

**Landscapes and Gardens for Historic Buildings: A Handbook for Reproducing and Creating Authentic Landscape Settings.** Rudy J. and Joy Putnam Favretti. Nashville, Tenn.: American Association for State and Local History, 1978. 202 pp. \$10.

In this year after the "year of the garden" in Britain, and nearly five years after the watershed conference on the preservation and restoration of historic gardens and landscapes sponsored by the National Trust for Historic Preservation and Dumbarton Oaks, a basic philosophical question of landscape preservation is still unanswered. That question, applicable to historic buildings as well as historic landscapes, is: Should the garden be returned to its original state or should it be allowed to reflect the changes of taste and use over its entire history? Two related questions, which should be answered before restoration work is undertaken, are: May we legitimately use modern, sturdier plant materials to present historic materials, or is authenticity dependent on using the original plants? And how do we accommodate the growth and change of all living materials in the frozen reproduction of the past?

The husband and wife team of Rudy and Joy Favretti have chosen not to deal explicitly with these questions in this book, and yet one understands that their efforts are directed toward those who are sympathetic to reproducing historic landscapes and gardens as accurately as possible. Indeed, many of the more than a hundred projects which Rudy Favretti has consulted on, such as Old Sturbridge Village, Mystic Seaport and Monticello, are excellent examples of historically rigorous reproduction.

Many authors, however, disagree with the idea of freezing a landscape in time. The noted landscape observer and critic J.B. Jackson denounces this variety of preservation, saying, "Reconstructed landscapes . . . are essentially sterile . . . the power which an ancient environment possesses to command our affection and respect derives from its having accepted changes of function (and not) from having

been isolated and protected." A similar comment is made by David Lowenthal, a cultural geographer, in a recent article: "When the recognizable past falls short of our historical ideals, we remold it to our desires . . . total restoration subverts historical awareness. The newly minted completeness of Williamsburg and Old Sturbridge Village makes it difficult to imagine oneself in the past. Milieus that deliberately exclude the remote and the more immediate past—a tastefully restored colonial village, a ghost mining town, a Gay Nineties downtown street—are as sterile and atypical of their own period as a brand new subdivision today."

Once the decision is made, however, to return a garden or landscape to the past, this is an extremely useful sourcebook. It opens with a brief, yet fairly complete, summary of Western traditions in American landscapes and gardens from the colonial through the Victorian periods. Most of the gardens and landscapes described are those of private houses and estates. The role of public landscapes is also briefly examined.

The second section of the book is concerned with methods of researching historic gardens and landscapes and means for developing a restoration plan. Site analysis, photographic recording, documentation through graphic or printed material, archeological investigation and oral history are discussed as methods for authenticating the landscape. In developing the restoration plan, not only must historic accuracy be confirmed, but modern day problems of handling vehicular and pedestrian traffic and signage must be accommodated. Guidelines are offered.

The penultimate section provides an extensive (it runs for more than 50 pages) listing of plant materials typical of American gardens from 1600 to 1900. There is also a list of seed houses and nurseries which can supply a number of the plants. Both these lists are the most comprehensive currently publicly available.

The final section of the volume addresses the question of maintaining the restored landscape. The problems of pruning, mowing, mulching, soil fertility and visitor wear and tear, as well as pest control, are discussed. In keeping with the authenticity of pre-1850s landscapes, the authors suggest that mowing be done only when the grass is about to seed, and then only with a scythe (historically accurate but expensive) or with a sickle-bar mower (which will approximate the effect of scything but is less expensive). Mulching should not be done with current wood chip or bark chip mulches (a post-World War II method), but should be done with historically correct mulches such as grass clippings, compost or salt-marsh hay. Modern pest control, say the authors, is allowable only if done before or after

visitors' hours and with chemicals that leave no residue. Alternatively, one may wish to use historically correct pest control methods, which presumably may be applied in front of the public, such as spraying for squash bugs with water in which dead fish have been allowed to soak for several days or controlling aphids with a mixture of water and tobacco.

The book is illustrated with period engravings and photographs as well as with line drawings by the authors. While the volume is well produced and contains much information concerning accepted methods of reproducing and creating authentic landscapes and gardens, one must read it while keeping in mind that the past can only be understood and appreciated within the context of the present. As Kevin Lynch has said, "A sense of the stream of time is more valuable, more poignant and engaging than a formal knowledge of remote periods." *Richard Wagner, Assistant Professor, College of Architecture and Design, Kansas State University*

**Netherlandish Scrolled Gables of the Sixteenth and Early Seventeenth Centuries.** Henry-Russell Hitchcock. New York: New York University Press, 1978. (College Art Association Monographs, vol. 34.) 152 pp. \$22.50.

This book is limited in time, subject and interest. Architectural historians may find the recitation of names of architects and sculptors, not a familiar group, to be of special value. The text is pedantic, but the book should be useful for reference. It is in English, which the preface tells us is unusual for the subject. There are many illustrations, grouped at the end of the book, and a study of these pages reveals the flights of fancy produced by this frontispiece building style.

The author, a well-known art historian, has written the text in a tedious style. He reels off convoluted sentences to match the architecture discussed. To make the going tougher, he uses obscure words, double negatives and reams of boring minutiae. Netherlandish history has never had a high priority in the American educational system, so a greater effort at historical background would certainly have produced a more enjoyable book. Hitchcock could have made this work jolly to match the architecture.

But the illustrations are rewarding. Since architecture seems to be heading, by way of Philip Johnson, in a more decorative direction, perhaps the scrolled gables of the Netherlands will inspire lofty skyscrapers topped off with gables full of volutes and scrolls. The pictures in the book offer many ideas for a renaissance of neomannerist style. Johnson et al., take it away. *Elizabeth Class, Washington, D.C.*

*Books continued on page 94*





## Owens-Corning sound dividers. Designed so your design gets noticed. Not ours.

We don't expect people at work to appreciate the classic lines of our sound divider system.

They may not notice the handsome fabric covering. Or how beautifully the dividers fit together.

They may never see the electrical raceway hidden in the base or the shelf-hanging capability.

And they can't possibly know that their privacy comes from our special sound-absorbent Fiberglas\* core inside each panel.

*Circle 30 on information card*

What they will notice is what really matters: the total landscape you've created.

For a free sound divider catalog, color selector, and booklet, "Speech Privacy in the Open Office," write D. F. Meeks, Owens-Corning Fiberglas Corporation, Fiberglas Tower, Toledo, Ohio 43659.

\*T.M. Reg. O.-C.F. © O.-C.F. Corp. 1978

OWENS/CORNING  
**FIBERGLAS**  
TRADE MARK (S)

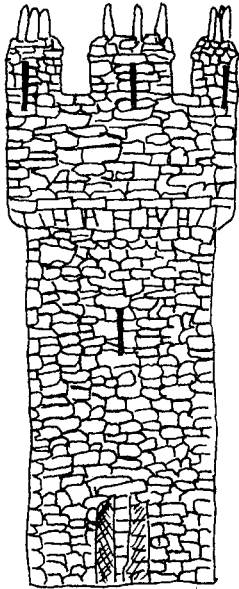

**Castle**, is based in concept, structural process, and physical appearance on several castles built to aid in the conquest of Wales between 1277 and 1305 A.D. Hardcover, 80 pages (1977). \$9.95 Non-member, \$8.95 AIA member. Catalog #3M284

**Cathedral**, illustrates the creation of a French Gothic cathedral. Hardcover, 80 pages (1973). \$9.95 Non-member, \$8.95 AIA member. Catalog #3M192



**Pyramid** follows the intricate step-by-step process of the building of an ancient Egyptian pyramid and the complex of surrounding temples and tombs. Hardcover, 80 pages (1975). \$8.95 Non-member, \$8.05 AIA member. Catalog #3M282

**Underground** is Macaulay's exploration of the complicated below-ground life-support systems: water, electricity, gas, telephone, sewage and drainage lines, and explains construction of a subway. Hardcover, 112 pages (1976). \$9.95 Non-member, \$8.95 AIA member. Catalog #3M283

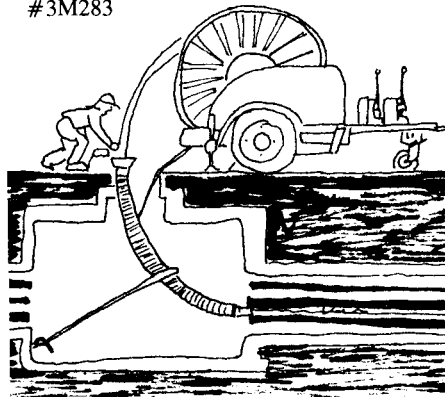

**City** details the Roman mastery of the art of city planning—constructing their cities for the people who live within them. Hardcover, 112 pages (1974). \$9.95 Non-member, \$8.95 AIA member. Catalog #3M193

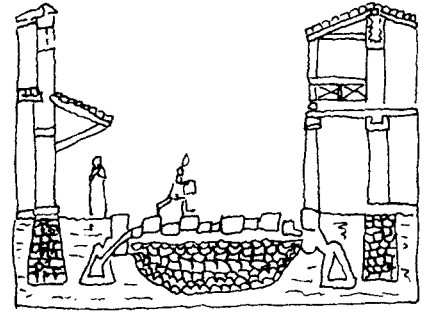

### TO ORDER

Order from: Manager, AIA Publications Marketing, 1735 New York Avenue, N.W., Washington, D.C. 20006.

District of Columbia residents add 5 percent sales tax.

Make checks payable to The American Institute of Architects.

For special handling, e.g. first class, air mail, special delivery, air express, add 20 percent to total amount of order.

Foreign orders must include postage in the amount of 20 percent added to total amount of order. Check or money order must be payable in U.S. dollars.

## ARCHITECTURAL PROFESSIONALS DESIGN YOUR OWN FUTURE

**DEVELOPMENT, EXPANSION, GROWTH** describes the present direction of Holiday Inns, Inc. As a direct result of this growth, we can offer unparalleled opportunities for your future.

**ARCHITECTURAL PROFESSIONALS** are needed to staff our new hotel architectural and design department. To qualify you must have 7-10 years architectural experience with at least 3 years as a lead architect in hotel design and be a degreed, licensed architect. We are also looking for **DESIGN/DRAFTSPERSONS** with 3-5 years experience in drafting with preference in shop and working drawings with some perspective drawing.

For more information, and the opportunity to design your own future, please send your resume with salary requirements to:

**HOLIDAY INNS, INC.**

**AIA HANNA**

Hotel Group Personnel

3796 Lamar Ave., 3rd Floor

Memphis, Tennessee 38195

EQUAL OPPORTUNITY EMPLOYER M/F/H

*Holiday Inn*®

## Questions About Your Subscription

To insure fast service on inquiries concerning your *AIA JOURNAL* subscription, please include the address label from the most recent issue received.

## Change of Address

Four weeks' notice required for change of address. Include address label from most recent issue and new address information in space provided below.

### NEW SUBSCRIPTION

Please check here if you wish subscription rate information.

Name \_\_\_\_\_

Address \_\_\_\_\_

City \_\_\_\_\_

State \_\_\_\_\_ Zip \_\_\_\_\_

### MAIL TO:

AIA JOURNAL  
Circulation Dept.  
1735 New York Ave., N.W.  
Washington, D.C. 20006

ATTACH  
LABEL  
HERE

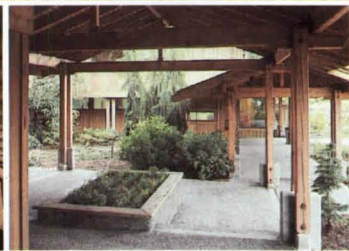
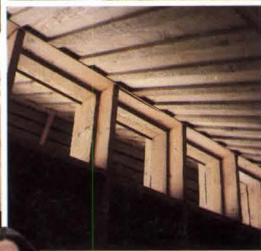
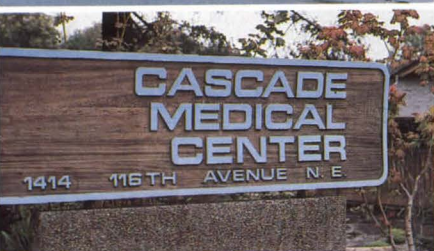

**"My new medical center doesn't look like a medical center... thanks to Western Wood."**

*FRED BROWN, THE MITHUN ASSOCIATES.*

People are often surprised by the sign in front of this unique complex. The building is warm. Charming. Functional. It doesn't look like a "medical center."

The appeal is due to its design. And to the liberal use of Western Wood—inside and out, visually and structurally. Other building materials simply can't duplicate Western Wood's soft, comfortable look. Used on the exterior, in halls, in patient waiting rooms, its rustic beauty has a mellowing effect on many people.

Western Wood is readily available, too. And it's a familiar building material for most contractors and builders. But perhaps its primary advantage in the Cascade Medical Center is its natural warmth: it puts people at ease.

Altogether, this medical center is friendly, inviting, and relaxing. Thanks to thoughtful design. And Western Wood.

*Circle 29 on information card*



**Western Wood Products Association**

Dept. AIA-180, Yeon Building, Portland, Oregon 97204  
One of a series by members of the American Wood Council.

Free Product Literature and Technical Assistance.

Tell me more about Western Wood's use in light commercial construction. Send your free booklets.

I want free technical assistance. Have your representative phone for an appointment.

NAME \_\_\_\_\_

TITLE \_\_\_\_\_

FIRM \_\_\_\_\_ PHONE \_\_\_\_\_

ADDRESS \_\_\_\_\_

CITY \_\_\_\_\_ STATE \_\_\_\_\_ ZIP \_\_\_\_\_

Books from page 90

**The Framed Houses of Massachusetts Bay, 1625-1725.** Abbott Lowell Cummings. Cambridge, Mass.: Belknap Press of Harvard University Press, 1979. 261 pp. \$35.

This book, the product of 30 years' research, is the first full-length study of the 17th century houses of Massachusetts Bay (northeastern Massachusetts). As such, it is the most important work on New England building to appear since J. Frederick Kelly's *Early Domestic Architecture of Connecticut* (1924) and is a major contribution to American architectural history. Fortunately, its importance goes far beyond its priority.

The comparison with Kelly is an appropriate one. Like Kelly, Cummings concentrates in minute detail on the physical facts of architecture. Preliminary chapters sketch the English background of New England traditions and the first shelters of the colonists. These are the weakest sections, since nothing new is offered in the way of information or interpretation. Cummings then divides consideration of the Massachusetts house into sections on the plan, the builders, the frame, the chimney and the interior and exterior finish. The frame is treated at greatest length, with separate chapters devoted to its parts, its assembly and erection and its development over the course of the century. Almost as much space is devoted to the interior finish, which includes such diverse topics as the decoration of the frame, wall treatment, stairs and carved and painted decoration.

Cummings' work is superior to Kelly's on two counts. First, he treats the framing and the decoration as unified systems, rather than devoting a chapter to each member, as his predecessor did. This permits a keener analysis of the interrelation of the parts and the ways that changes in one induced changes in the others.

Second, Cummings confronts his reader with far greater detail than Kelly did. It would be hard to think of a material aspect of the 17th century Massachusetts

Bay house that Cummings has not treated closely and effectively.

The word material is important, for this is in many ways a resolutely old-fashioned work. It is the tangible that intrigues Cummings—the wood, the nails, the ways that they fit together. He avoids any discussion of the effects of New England's social history on the buildings, except to say that it would be hard to assess. Neither is he interested, as many recent scholars have been, in the mental structures of house design and use. There is no case where we are not offered a full description of the range of specific choices made by the New England builder, but there are few where he has ventured to consider the reasons for choosing one alternative over another.

Because Cummings' assumptions about the builders' thinking go unexamined, he often makes questionable functionalist and climatic-determinist statements. He resorts to the old explanation of the New England and Chesapeake traditions of chimney and kitchen placement as reflections of the relative warmth of the two regions. And he accepts implicitly the traditional evolutionary model of New England house planning, so that a house less than two rooms long becomes for him a "half" house.

Any reservations that one might have about the work, though, pale in the face of the solidly researched, eloquently presented text. The principal theme—the creation of an American architecture from English traditions—is a familiar one, in part from Cummings' own earlier work, but never before has the process been so carefully and clearly described. Professionals will appreciate the precision, and amateurs will find many of their most cherished myths about early American architecture gently but irrefutably laid to rest. I have found that students, particularly, find the book helpful and engaging. In short, *The Framed Houses of Massachusetts Bay* will be the standard reference for architects, architectural historians and preservationists for many years to come.

A word about price: It's worth it. There are 280 exceptionally clear photographs and measured drawings. The latter are skillfully done and are rendered large enough to be easily read. In fact, the plans may have been printed a little too large for their sparse detailing. The text is fully annotated, and the evidence of the standing building is supplemented by a multi-part appendix summarizing architectural data that are available in a variety of primary sources. But the publisher might have chosen a more convenient shape for the volume than a wide rectangle, which fits neither shelf nor lap. *Dell Upton, architectural historian, Richmond, Va.*

**Between Silence and Light: Spirit in the Architecture of Louis I. Kahn.** John Lobell. Boulder, Colo.: Shambhala, 1979. 120 pp. \$15, hardbound; \$7.95 paperbound.

"Louis Kahn saw architecture as the meeting of the measurable and the unmeasurable. He used the word 'Silence' for the unmeasurable, for that which is not yet; and the word 'Light' for the measurable, for that which is," says John Lobell, author of this handsome book on Kahn. Lobell, a frequent contributor to this magazine, studied under Kahn at the University of Pennsylvania.

He reveals Kahn as "architect, visionary and poet," selecting Kahn's own words on an array of subjects—joy, knowledge, order, form and design, place and space, the architect and the teacher. "Think of meaningful space and you invent an environment, and it can be your invention. Therein lies the architect," Kahn wrote.

Following an essay by Lobell on "Architecture as Spirit," in which he says that Kahn "taught us to understand the Order of the Shadow—what lies between idea and reality, between Silence and Light," there are descriptions of some of Kahn's notable buildings, ranging from the Salk Institute to the Kimbell Art Museum. The book is filled with black

*continued on page 96*

# SOUNDBLOX<sup>®</sup>

## Sound-Absorbing Structural Masonry Units

### CONTROL NOISE



The Proudfoot Company, Inc. ACOUSTICAL PRODUCTS P.O. BOX 9, GREENWICH, CONNECTICUT 06830 A/C 203 869-9031

See Sweet's General Building (Architectural) or Industrial Construction Files (9.1/P) or Spec-Data, or phone us collect. Nationwide availability... made near your jobsite!

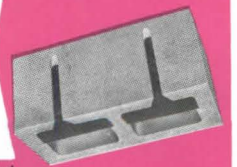

# INTRODUCING QUIET-COR.<sup>®</sup> THE BIGGEST THING TO EVER COME BETWEEN A FLOOR AND A CEILING.



**M**ost builders and architects will agree that floor tiles are tough, their beauty far outlasting other types of residential flooring. But, up until now, there was just one thing that kept them from being at home in apartment buildings. They were noisy.

That's why GAF has created Gafstar<sup>®</sup> Quiet-Cor<sup>®</sup> underlayment. A revolution in apartment flooring.

You install it right over concrete. And although Quiet-Cor measures only 1/16th of an inch, it makes a big difference in how floor tiles sound one floor below.

Tests proved it. In fact, its use has already been approved by many municipal housing codes across the country.

Which not only means less noise for tenants. It also means less headaches for you.

And speaking of less headaches for you, Quiet-Cor is available as a complete flooring program that includes adhesives, Quiet-Cor underlayment in 3-foot rolls, and your choice of floor tiles.

GAF makes them all. And sells them all.

So now you can have the beauty and performance of floor tiles in the apartments you build.

And not have to worry about disturbing the neighbors.

© GAF Corporation 1979

Circle 32 on information card

GAF Corporation, 140 W. 51st Street  
P.O. Box 1121, Radio City Station  
New York, New York 10019

Please send me more information on Gafstar  
Quiet-Cor underlayment.

Name \_\_\_\_\_ Company \_\_\_\_\_  
Title \_\_\_\_\_ Address \_\_\_\_\_  
City \_\_\_\_\_ State \_\_\_\_\_ Zip \_\_\_\_\_

**GAF**<sup>®</sup> **GAFSTAR**<sup>®</sup>  
**QUIET-COR**<sup>®</sup>  
UNDERLAYMENT

## Books from page 94

and white illustrations.

Shambhala books are distributed by Random House.

**Alvar Aalto.** Edited by David Dunster. New York: Rizzoli, 1979. 112 pp. \$13.95.

This valuable contribution to Aalto studies contains three important articles by Demetri Porphyrios, the late Raija-Liisa Heinonen and Steven Groak; an updated list of the architect's buildings and projects and a bibliography, and new photographs and other documentation on selected buildings and projects. Its principal contribution derives from Heinonen's dissertation (to be published in English as *The Breakthrough of Functionalism in Finland*) and her work as archivist of the Architectural Museum in Finland. This provides both a closer view of Aalto's earliest work which he customarily suppressed, and of its setting in classical architecture which now appears of importance comparable to the national romantic style as described by earlier Aalto scholars.

The publication here of architectural drawings for competitions and other unexecuted projects is an especially convincing illustration of the Mediterranean sources upon which Aalto drew—but more startling, his use of Le Corbusier's inspiration from the same source as in the Töölö church competition drawing (1927) and Le Corbusier's Acropolis drawing reproduced in *Vers une architecture*.

New photography, much of it by Steven Groak, shows significant changes in many buildings such as the Paimio sanitarium and the Viipuri library, and valuable color photography of later work. The reproduction and presentation are excellent.

This is an important source which no serious student of Aalto will ignore. It is No. 4 in the "Architectural Monographs" series. *Frederick Gutheim, Hon. AIA, Washington, D.C.*

**The Simple Home.** Charles Keeler. With a new introduction by Dimitri Shipounoff. Santa Barbara, Calif.: Peregrine Smith, 1979. 55 pp. \$9.95.

Charles Keeler was a poet and naturalist who lived in the San Francisco Bay area at the turn of the century. He revolted against the gingerbread of the Victorian era, dreaming of a utopian community that would embody the ideals of the arts and crafts movement. He gave Bernard Maybeck his first private commission—the design of Keeler's house at Highland Place in north Berkeley.

Keeler initiated the formation of the Hillside Club for the purpose of persuading future neighbors to build compatible

houses. This book was first published in 1904 when Keeler was president of the club. In his introduction to this reprint, Shipounoff says that Maybeck became the club's idol, Keeler its high priest and *The Simple Home* its bible. Keeler's book, says Shipounoff, not only introduced a new kind of architecture that shaped the Berkeley environment, but it also helped create the Bay region tradition of architecture.

Although Keeler did not advocate one architectural style over another, he wanted all in the "simple home" to be "quiet in effect, restrained in tone, yet natural and joyous in its frank use of unadorned material." Keeler went beyond the house, its garden and its furnishings to discuss the ideal home life which, he thought, would be affected by the very planning, building and furnishing of the simple home.

**Homestyles: How-to Projects, Room Designs and Awareness Activities That Build Feelings into Your Home.** Curt Lamb. New York: St. Martin's Press, 1979. 208 pp. \$14.95.

The author of this book, an architect, has been involved in participatory design projects, developing and using a variety of techniques to involve users in the design of buildings and public spaces. He decided the techniques could be applied by the do-it-yourselfer who wants to turn the home into a place that is "complex and simple, peaceful and lively."

The book, Lamb explains, "is grounded in the idea that hidden within the rooms we inhabit are reflections of the many sides of our personalities." Moving from bedroom to bathroom to living room to kitchen to places for children, he describes "room themes," giving the user suggestions on how to "liberate" the rooms so that they make a difference in one's life.

For each room there is a sequence of activities and information to parallel steps in the participatory design process. Through "fantasies" and self-administered surveys, the reader is supposed to discover feelings about the rooms he dwells in. In the middle of each chapter are "goals/solutions" and "inspirations" to aid in the making of changes.

Take the bathroom, for example. First of all, one of the fantasies suggested is to shut one's eyes and dream up a bathing ritual in Istanbul. Lamb suggests a "nudism survey" and an "efficiency survey," the latter asking such questions as is there a water-saving device in the toilet tank. In the goals section, Lamb tells how to make a bathroom better for kids, more health-related, more sensual and to seem bigger and better. Among his projects for "bathroom inspirations" is a planter put over the shower. In the section on room design, he suggests among other things, a

social bathroom (how to do away with the "one-at-a-time, wait-till-I'm-finished" syndrome).

If your predilections lean toward reality rather than fantasy, a basic and unmitigated dislike of sharing a bathroom with any person and worry about ivy gripping you while you're showering, you may get the idea that this book does not contain some sound advice. You'd be wrong. Lamb has said that his book is intended for the popular audience, but that much of its methodology is relevant for the design professional. And he is correct, if all the self-surveys and exercises don't turn you off. Sometimes, perhaps, participatory design is simply for other people, even when the bathroom, for example, needs a lot of long overdue attention. To say nothing of changes also overdue in personality.

**Facility Planning, Design and Construction of Rural Health Centers.** Terry W. Alford. Cambridge, Mass.: Ballinger Publishing Co., 1979. 238 pp. \$17.50.

This book stresses that the rural health center is an essential community institution which "under optimal conditions, is woven into the economic, political and social fabric of the community it serves." The book contains a great deal of helpful information on the planning and programming of facility requirements for a rural health center, its spaces and equipment. Case studies in facility development further document the basic principles set forth. The book is part of the "Rural Health Center Development Series" prepared by the University of North Carolina's health services research center and North Carolina's office of rural health services. It will be of tremendous help to the architect who is called upon to design a rural health facility.

**The Architectural Legacy of the Lower Chattahoochee Valley in Alabama and Georgia.** D. Gregory Jeane, editor: Douglas Clare Purcell, associate editor. University of Alabama Press for the Historic Chattahoochee Commission, 1978. 280 pp. \$45.

The product of a project designed to record endangered buildings along the Alabama-Georgia border, this book is a good amateur production. The architectural information is naive and there are organizational problems, but the editors' inclusion of plans, elevations and details, as well as a profusion of clear but undistinguished photographs of every one of the 55 sites treated, makes this a useful book to those interested in "everyday architecture" of the deep South.

The structures are grouped in six chapters. Each chapter has a short introductory statement, followed by descrip-

*continued on page 100*

**“You don't have to be  
the biggest to be insured  
by the best.”**

**“Shand, Morahan?”**

**“Shand, Morahan.”**



It's the growing consensus of the leading architectural and engineering firms in the land: the E&O program available through Shand, Morahan & Company is about the best coverage you can have, at a most competitive premium rate. That's why so many of the ENR top 500 design and construction firms are choosing our insurance.

But your firm doesn't have to be among the biggest to enjoy the best in Architects and Engineers Professional Liability insurance. Shand, Morahan also extends its uniformly excellent claims-made program and unmatched standard of service to more and more medium and smaller-sized firms as well. These firms enjoy the same experience and attention that only the nation's foremost source for professional liability insurance can provide.

If your present Architects and Engineers Liability policy or premium might benefit from an analysis and comparison with ours, we welcome your insurance broker's inquiry. Whether you're among the biggest, or just want the best.

**SM Shand, Morahan  
& Company, Inc.**

*One American Plaza, Evanston IL 60201*

*Circle 32 on information card*

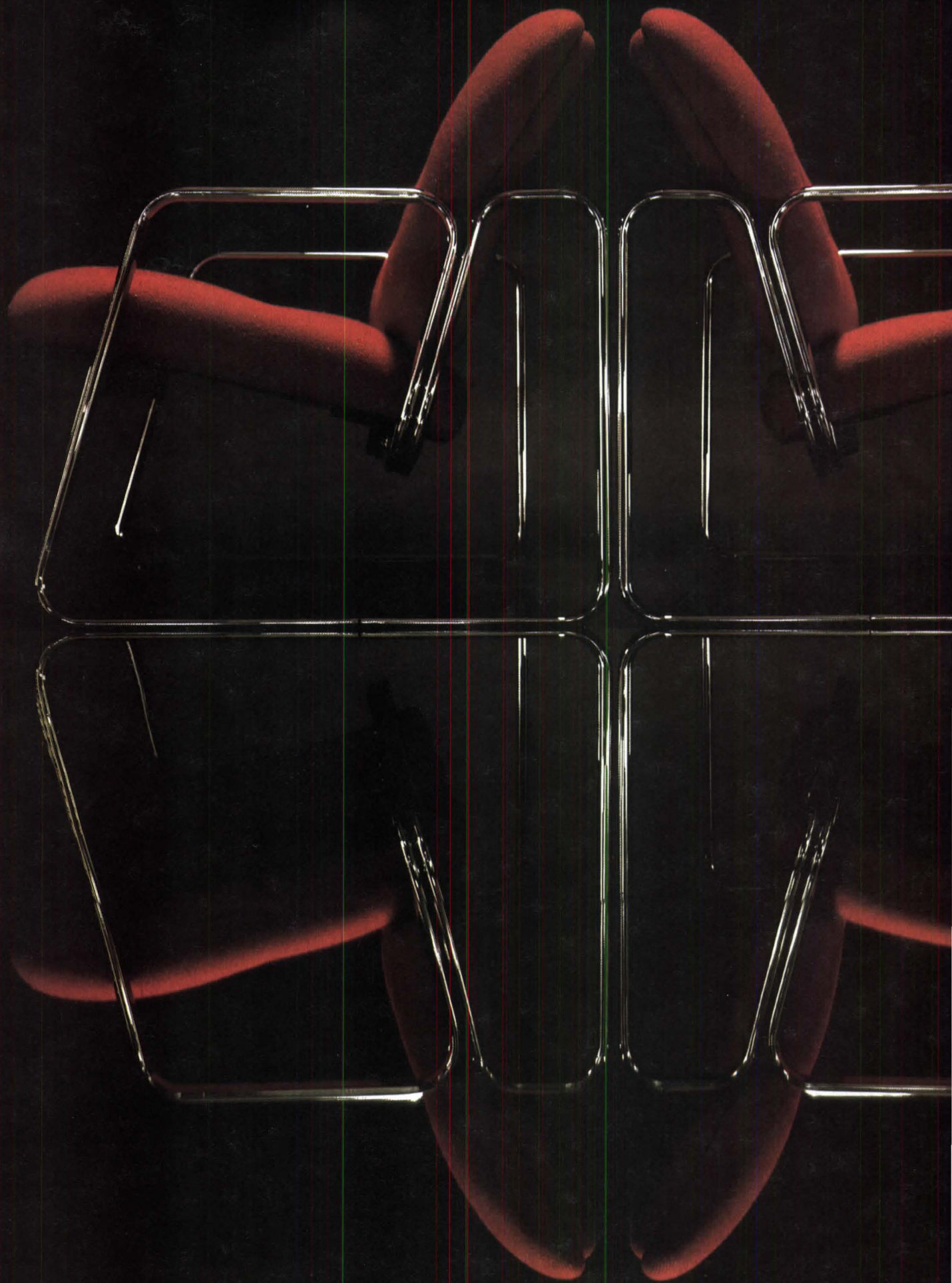





## More to choose from, more to work with.

People, and their jobs, come in all sizes. So do your client requests.

That's why Steelcase offers you the full spectrum of seating, including this new 441 Series for lobbies and reception areas.

This new, modular Series will turn corners, skip past posts, and give you a beautiful, orderly seating look. The beauty stems from the classic simplicity of the design. A clean, lean look that's as functional as it is beautiful and comfortable.

The 441 Series is just one of the many lines of seating available from Steelcase, the world's largest manufacturer of office seating, producing over 1½ million units annually.

So, when your clients come to you expecting a lot in office seating, you know where to come.

For more information, visit your Steelcase Dealer or Regional Office or call toll-free 800-447-4700; in Illinois 800-322-4400.

# Steelcase

Steelcase Inc., Grand Rapids, MI 49501, Los Angeles, CA 90067, Ontario, Canada; Steelcase Kurogane, Ltd., Osaka, Japan; Steelcase Strafor, S.A. Sarrebourg, France.

Steelcase products and services are also available in the Middle East. Please call or write.

*Circle 34 on information card*

### Books from page 96

tions and illustrations of individual buildings. The houses in the first four chapters are classified according to implicit, confused criteria of age, form, material and architectural style, the whole strung along an evolutionary chronology.

The chapter on Victorian architecture epitomizes the editors' uncertainty of material. They assert first that there is a "Victorian" style, then that there are several Victorian styles and finally that most buildings in their area are difficult to fit neatly into any of them. Perhaps fresh categories from their own data rather than from standard art and historical classifications would have served them better.

The final two chapters are on "Architectural Potpourri," presenting mostly public and other nonresidential buildings, including courthouses, churches, mills, stores and farm buildings. Buried in all this confusion is a lot of helpful information. Many of these structures—metal truss bridges, and plain village banks and shops—are rarely included in works of this kind.

The editors' interest goes beyond individual buildings. They record a number of grave sheds, a traditional form little known outside certain parts of the South. In contrast to the usual unsatisfactory analysis of buildings, this section is accompanied by an intelligent speculative discussion of the origin and meaning of these sheds.

A map showing the location of each of the sites included and a glossary and selected bibliography will be useful to many readers. The book is marred in several places by its assembly and the sloppy proofreading. The table of contents is difficult to use. Figures and drawings are listed in separate tabulations, and there is no indication of where the written description of each structure begins. Finally, the copy editors have let stand passages of writing that will set the reader's teeth on edge, for instance, the statement that "I have made an attempt to synthesize a number of approaches into a meaningful dialogue." *Dell Upton, architectural historian, Richmond, Va.*

### Simplified Design of Structural Wood.

Harry Parker. 3d edition prepared by Harold D. Hauf. New York: Wiley, 1979. 269 pp. \$16.95.

In 1948, the late Harry Parker wrote the first edition of this book which has since become something of a classic for dealing with the everyday problems of structural design in wood construction. The third edition, prepared by Harold D. Hauf, FAIA, maintains Parker's "general spirit and approach" in that no previous training is required on the part of the user, a knowledge of high school arith-

metic and algebra being sufficient. The "wide acceptance" of the book's previous two editions (published under the title of *Simplified Design of Structural Timbers*), Hauf says, "attests to the soundness of this point of view."

The basic principles of structural mechanics are explained, with the major portion of the book given over to illustrative examples, keyed in general to the National Forests Products Association's *National Design Specification for Wood Construction* (1977 edition).

Some of the problems in the design of certain timber structural systems are complex, as Hauf points out, and their solutions are "beyond the scope of the book." The intent, rather, is to give those employed in offices of architects, designers and builders a working knowledge of structural design so that they can handle day-to-day problems and to give them as well an ability to work with consulting engineers on more complex projects.

**Pompeii.** Richard Seaford. New York: Thames & Hudson, 1979. 80 pp. \$9.95.

The story still boggles the mind of how in August 79 A.D. the city of Pompeii and the smaller town of Herculaneum were covered by an eruption of Mount Vesuvius. We are told by Pliny of the "shrieking of women, the crying of children and the shouting of men. . . . Many

prayed to the gods, but even more said that there were no gods left, and that the world was plunged in eternal darkness." This lavishly illustrated book does not dwell on the destruction, but rather on the life that went before. There are brief discussions of Pompeian society and economics ("compared with our own, both fragmented and static"); politics and public life (women and slaves had no political rights and those in command exhibited wealth and power to the people); religion ("used nakedly for public ends"), and the Pompeian villa and its wall paintings ("painted architectural illusion turned the wealthy Pompeian's villa into a Hellenistic palace").

**Papers of the American Association of Architectural Bibliographers, vol. 12.** \$18. Edited by Frederick D. Nicols. New York: Garland Publishing, Inc., 1978. 145 pp.

There are two bibliographies in this volume. The first, compiled by Jack Perry Brown, is a list of writings by and about Louis I. Kahn from 1924 to 1976. The second bibliography, compiled by Arnold L. Markowitz, pertains to the writings by and about Paul Zucker whose architectural practice was ended during the days of Adolf Hitler. He came to this country and became noted as a teacher, art historian and writer on esthetics.

*Books continued on page 102*



**Venice for Pleasure.** J. G. Links. New York: Farrar Straus Giroux, 1979. 256 pp. \$10.95. A critic in the *London Times* has called this not only the best guidebook to Venice that has ever been written, but also the best guide "to any city ever written." It is delightful to read sitting in an armchair in the old US of A, and in one's hands in that incomparable city of canals where one can walk unmolested by vehicular traffic, it will undoubtedly give the user the pleasure suggested in its title. Walks are planned for leisurely joy. If you have a friend going to that unique city, this book would be a most appropriate gift, guiding the visitor into the "pleasures of Venice without its pains," as the author says. Its purpose is to lead him to places he might miss and, "having reached them, to tell him what he might wish to know and then leave him to admire, to enjoy or, perhaps, to be disappointed." Above is a view of the Riva degli Schiavoni by the Venetian painter Canaletto.

**Facts for  
architects  
about the  
NSF SEAL  
OF PROTECTION**



When you see the NSF seal or logo on a unit of health-related equipment you know that the design, construction, materials and performance of the product fulfill the requirements of an NSF standard. This, in itself, is an important assurance, but when it comes to the protection of the public health, more is needed—and much more is provided—for products that bear the NSF seal. This symbol means that:

1. Committees of volunteer scientists developed the standard. Members of these committees not only included public health officials and manufacturers, but representatives of such consumer-concerned organizations as the American Dietetic Association, the American Public Health Association, the National Plastics Institute, the National Swimming Pool Institute and the armed forces of the United States. Plus 29 members of the NSF Council of Public Health Consultants, and the NSF Board of Trustees.
2. Each product bearing the NSF seal or logo was subjected to original evaluation and testing in the NSF Testing

Laboratory to establish its compliance with an NSF standard.

3. Each year, NSF field representatives make repeated unannounced visits to factories to confirm manufacturing and inspection standards.
4. Products bearing the NSF seal or logo are also sent to the laboratory in Ann Arbor for *re*-testing when there is evidence that the state of the art may have outpaced these products.
5. There are no obsolete NSF standards. Periodic review and updating of all NSF standards is provided for in the standards themselves.
6. A program of informative literature, free distribution of copies of NSF standards to public officials, as well as paid messages in professional/trade journals is used to encourage suggestions, and invite participation in NSF programs.

No system of health protection is perfect, but thousands of health officials feel that the NSF seal and its elements of support are a valuable contribution to American public health.



National Sanitation Foundation—an independent non profit, non governmental organization dedicated to environmental quality. Offices and laboratories: NSF Building, Ann Arbor, Mich. 48105 (313)-769-8010

Circle 35 on information card

### Books from page 100

**The Architecture of John F. Staub: Houston and the South.** Howard Barnstone, with the assistance of Stephen Fox, Jerome Iowa and David Courtwright; photography by Rick Gardner and Rob Muir. Austin: University of Texas Press, 1979. 363 pp. \$35.

The career of John F. Staub, FAIA, extended over five decades, during which time he designed many outstanding residences in Houston, in particular, and in the South, in general. But there have been few thoughtful evaluations of his architecture. This, says Howard Barnstone, FAIA, is because eclectic architects, such as Staubs, have not been acknowledged despite the quality of their work. The adaptation of historic forms to contemporary use has drawn the disdain of critics rather than praise. But views regarding eclecticism are changing, Vincent Scully points out in a foreword, and it is hoped that Barnstone's analysis of Staub's architecture "will encourage the critical re-evaluation of the work of many other eclectic architects in the years to come."

The first 66 pages of the book form an introduction to Staub's contributions, with detailed notes appended. The remainder of the 363 pages is devoted to an analysis of individual projects. A color portfolio and black and white illustrations add a dimension to the text. There are also a chronological list of Staub's work, maps of Houston that indicate locations of his houses, a list of the books Staub gave to the University of Houston in 1968, bibliographical references to Staub, a selected bibliography, a glossary of terms and an index.

**Architectural Stained Glass.** Edited by Brian Clarke. New York: McGraw-Hill, 1979. 234 pp. \$29.50.

Divided into two parts, this book is edited by a painter whose glass designs are in churches, universities and commercial buildings in England. The first half of the book contains essays by seven people, including Clarke. The second section is a portfolio of work by modern American and European artists who work in large-scale stained glass for architecture. The examples shown are extremely beautiful, revealing, as one essayist says, the "promise of stained glass as an architectural medium of the future."

**Energy-Efficient Community Planning.** James Ridgeway with Carolyn S. Projan-sky. Emmaus, Pa.: JG Press (Box 351, Emmaus, Pa. 18049), 1979. 225 pp. \$14.95 hardbound, \$9.95 paperbound.

The authors of this book discuss the ways in which nine different communities have found methods to lessen their dependence upon fossil fuels. Some of the solutions are simple enough, and certainly painless. For example, in Davis, Calif.,

the city council passed a law which sanctions the use of outdoor clotheslines. The book also gives ordinances and codes that communities anywhere may use in conservation programs and in introducing alternative energy systems. Also useful is a checklist for energy action.



**The Houses of Mankind.** Colin Duly. New York: Thames & Hudson, 1979. 96 pp. \$6.95.

Social anthropologist and linguist Colin Duly introduces the reader to a wide variety of primitive buildings in Africa, Oceania, Eurasia and the Americas in this book (a ceremonial house for men in New Guinea depicted above). Duly refutes the notion of stereotypical "primitive hut" by explaining the formation of various buildings and the considerations that go into their design: material, climate, skill, cultural practice and economy. He says that the examples in the book may not deserve being called architecture, because they lack impressiveness. But the structures built by primitive man are "generally built on a human scale, by human skills for human needs." Surely this is architecture.

**Pride of the South: A Social History of Southern Architecture.** Wayne Andrews. New York: Atheneum, 1979. 181 pp. \$20 hardbound; \$10.95 paperbound.

With brief text and a plethora of photographs, Wayne Andrews covers the architecture of the South—from Thomas Jefferson's Virginia Capitol to Johnson/Burgee's Pennzoil Place in Houston. He ranges from upper to lower to deep, and even ends up with the so-called new South. One wonders why he didn't include Louis Kahn's Kimbell Art Museum in Fort Worth, if he's going to call Texas Southern. The book makes no pretense of being comprehensive, however. And it doesn't live up to its subtitle either. The

many black and white photographs are enough, nonetheless, to please any prideful Southerner.

**The Victorian Country House.** Mark Girouard. New Haven, Conn.: Yale University Press, 1979. 467 pp. \$35.

Those who are fortunate enough to have read Girouard's *The English Country House* (see Feb. '79, p. 70) know that he writes with wit and knowledge. This is an enlarged edition of a book first published in 1971, reflecting new materials that have been published since that time. In addition to substantial revision and expansion of the original text, this edition adds two new sections on individual houses, extra plans and 32 pages of color. Girouard says that Victorian country houses form a "fascinating collection," because of "their size, their complexity and their social background, the occasional masterpieces and many curiosities among them, and the mixture of piety, snobbery, romanticism, idealism and pretentiousness." And Girouard writes fascinatingly of the houses, their architects and the people who lived in them. This is, in brief, a most entertaining look at 31 houses and their social and economic history.

**Hans Scharoun: A Monograph.** Peter Blundell Jones. London: Gordon Fraser Gallery (distributed in this country by ISBS, Inc., P.O. Box 555, Forest Grove, Ore. 97116), 1978. 134 pp.

In what purports to be the first critical monograph in any language to be published on Hans Scharoun (1893-1972), this book describes and analyzes a selection of the German architect's post-World War II buildings in the first section—schools, theaters, concert halls and housing. The latter part of the book is a biographical and chronological study. Jones says that Scharoun's career is of "fundamental importance" because he was the only major architect "to bridge the gap between the German architecture of the '20s and that of the postwar period," and also because he was the most important exponent of "new building," which Jones calls the "one movement contemporary with and opposed to the International Style."

Jones says that the arrangement of the book is to give readers "some idea of Scharoun's achievements before they investigate his early life." Thus Jones is allowed to develop Scharoun's theory of design in a cumulative manner. According to Jones, Scharoun had a similar approach to Frank Lloyd Wright, considering his buildings not "as isolated objects but as places," and endeavoring to have his overall plan "grow" out of a relationship between functions and site. The book has many photographs and plans to allow the reader unfamiliar with Scharoun's work to comprehend it better. □

# “One floor every five days ...Ceco makes forming look easy.”

Ceco formed the 25 floors of the St. James Condominium, Houston, Texas, allowing Quanah Construction to complete one 18,525 square-foot floor every five working days.

“Ceco helped us beat the clock on this job,” said A. J. Owrey, President of Quanah Construction Company. “We came in ahead of schedule. That’s one reason we keep using Ceco. They’re professionals.”

In the early planning stages, Ceco can provide structural design assistance and make practical forming recommendations that help buildings go up fast and keep costs down. And Ceco provides complete forming services nationwide. Experienced field crews. Ready-to-use equipment. And standardized forming systems for the most sophisticated architectural design—all on a lump sum basis and at a firm price. Talk to the pros in concrete forming. See the Yellow Pages for the Ceco office in your area.



**CECO**

concrete  
forming  
services

The Ceco Corporation • General Offices  
5601 W. 26th Street • Chicago, Illinois 60650

A Project Of: Mark Lee & Assoc., Inc.  
Architects: Newhaus and Taylor  
Contractor: Quanah Construction Co.  
Structural Engineers: Ellisor Engineers, Inc.

Circle 30 on information card

**Government** from page 34

duces a horrendous result that is completely inequitable."

He says as well that a retired partner performing services for his old firm could also lose the exemption from the self-employment tax "which his retirement payments would ordinarily enjoy."

Ellentuck warns retired partners of architectural and other professional firms "to beware. If you consult for your firm, you could lose all your Social Security benefits and get taxed on your retirement benefits." He points to a bill (HR 5295) now pending before Congress which could remedy some of the problems, but it is unknown when it will be voted on.

## Bill Would Preserve a Portion Of Vanishing Tallgrass Prairie

At one time, the tallgrass prairie stretched from Illinois to Nebraska and from Minnesota into Texas, encompassing 400,000 square miles. Today, however, only about 1 percent of the tallgrass prairie remains in the Flint and Osage Hills of Kansas and Oklahoma and there is continuing threat of its complete disappearance (see July '76, p. 172). In order to preserve the last remnants of the prairie and also to ensure that the existing ranching culture will be maintained, Congressmen Larry Winn Jr. (R.-Kan.) and Morris Udall (D.-Ariz.) have introduced legislation (HR 5592) which would establish a tallgrass prairie national reserve.

Federal purchase of land would be permitted in three separate areas in Kansas (Wabaunsee and Chase Counties) and along the Kansas-Oklahoma border. A parkway would connect the three areas which encompass a total of 374,000 acres. Winn emphasizes that the bill "will recognize and respect the contributions of private landowners," and the federal government would be authorized to purchase land only from willing sellers. The Interior Department would have "right of first refusal" at a price the owner would establish if the land came on the open market. Property could be acquired through condemnation only where it is being used in a manner "substantially detrimental" to the purposes of the special conservation area.

The legislation does not call for an immediate prairie park or preserve, but is designed only to protect the landscape in a reasonable manner so that park designation would be possible at a future time, following sufficient land acquisition in a manageable block.

Winn and Udall say that the tallgrass prairie "is truly a national resource. Only by thinking ahead and setting in motion a responsible plan now can we hope to be successful in guaranteeing a future for some of our prairie heritage."

## News/Practice

### Highrise Spurt in Midtown Raises Manhattan Opposition

Midtown Manhattan is experiencing an unparalleled period of construction. Growth, of course, is welcomed by most city officials. But other New Yorkers are concerned that a new generation of skyscrapers will soon block midtown's sun, degrade the air quality, disrupt the delivery of city services, increase the population density to an unacceptable level and destroy the distinctive character of this area.

Twenty-one major buildings are either under construction or planned in midtown. Most are in the corridor from 40th to 60th Streets and from Fifth Avenue east to Third Avenue. Among them are the IBM and AT&T buildings, which are within a block of one another. Additions are planned over the Museum of Modern Art (53rd Street), the Racket and Tennis Club (Park Avenue), the Villard Houses (Madison Avenue at 50th Street) and the Saks Fifth Avenue building. On the site of the old Bonwit Teller building (Fifth Avenue and 56th Street) a retail/condominium structure is planned by developer Donald Trump.

This development rise is in sharp contrast to the early '70s when the bottom fell out of the real estate market as the city was experiencing severe financial problems. The recent upsurge in development is welcomed by city financial officials. "I believe in paying bills, and if it's not going to come from the midtown area, where is this city going to make its money?" asked Peter Solomon, deputy mayor for economic development. He and others want development to continue in the city rather than in the suburbs.

In an article on the op-ed page of the *New York Times*, Der Scutt, AIA, of Poor, Swanke, Hayden & Connell and architect of the Trump building, spoke out for continued development without severe restrictions. "The Citicorp complex on Lexington Avenue, the imminent IBM and AT&T headquarters are projects that give, or will give, unique architectural experiences to people. Such buildings do not violate the environment but contribute to its continuing renaissance through design excellence." Scutt advocates zoning laws that allow developers and corporations to construct buildings without having to follow a uniform land use review procedure. He continues: "It is depressing to think of how much more beautiful and functional many of our buildings could be if outdated zoning laws had not made better design too costly and time-consuming." Scutt maintains that if

the review process is not eliminated "we risk the curtailment of both the development and the perpetuation of our architectural heritage; we would encourage a new exodus of business out of the city; we would threaten New York City's position as the world's most symbolic urban center, and we should then be prepared for more ugly buildings, with no public amenities, disgracing our skyline."

While Scutt is not advocating turning Fifth Avenue into a shadowy canyon lined by towers in excess of 50 stories, there are some who say that without strict zoning laws this will happen. One architect warned of the "Houstonization of New York City." A group was recently formed, the New York City committee for a balanced building boom, to "retain the present character, quality, scale, ambience and appearance of buildings in the midtown area, while at the same time supporting the continued growth and vitality of the midtown area and the city as the whole." The group includes prominent New Yorkers, among them a former New York state commissioner for environment affairs, Peter Berle; Disque Dean, a partner in Lazard Freres; Joel Harnet, president of United Business Publications; William Hubbard, president of the Center for Housing Partnership, and Donald Weeden, investment banker and stockbroker.

"We are not trying to stop the building boom, because that's good for the city," explains attorney Berle. "But there is an overall problem of proliferation of density in a way that could endanger midtown as we know it and no longer make it an exciting place to be. We currently have a patchwork of special districts . . . and no one yet has taken a comprehensive look at all of it. That's what we want to do."

The committee recently protested the Trump development before the New York City planning commission by maintaining that the project violates the New York state environmental quality review act and city zoning regulations. It contends that the total floor area of the building will exceed by more than 20 percent the amount allowed under existing zoning, that the height of the building (a proposed 58 stories) will restrict access to light and air and cause congestion, that the demand for energy and the generation of solid waste and sewage will be exceedingly large, that it will have a negative impact on the character of the area because its proposed reflective glass surface would be in sharp contrast to the soft tones of neighboring Tiffany's limestone front. The Trump proposal passed the planning commission with slight modifications of building height and bulk, a decision which Berle doubts would stand up in a court of law. The next step is approval by the board of estimates, and the

committee will probably protest against the Trump development at the public hearing before the board.

Basically, the controversy lies with the zoning regulations. In 1973, midtown was designated a special district to ensure that the area would remain a retail shopping and restaurant district, that the relationship between landmark and new buildings would be improved, that public amenities would be developed and that the city tax base would be protected. If a developer introduces open space, covered pedestrian space or other public amenities, he can obtain permission to increase the average floor ratio, and thus the bulk of the building.

A study by the planning firm Abeles, Schwartz, Harchel & Siverblatt found that "as to right" bonuses may be coupled with other zoning techniques to achieve very high densities within the special district. "We now know," says the committee for a balanced building boom, "that the special bonus provisions which were introduced to enhance the special character of Fifth Avenue may ensure that it becomes a canyon situated between a stereotyped chain of multiple-use buildings instead of the stereotyped chain of office buildings which the drafters of the special district regulations sought to avoid."

Earlier this year, Robert Wagner, then chairman of the city planning commission and now a deputy mayor, announced a major review of the zoning regulations. To the planning commission, the central challenge is not to stop construction but to spread it to less developed parts of midtown Manhattan. Charles Smith, executive director of the planning commission, says, "We are looking at the zoning regulations to determine where the results (of the bonus system) have been beneficial and where those results have been less beneficial. We are re-examining the whole premise. It isn't bulk alone. It's where that bulk occurs." The study is to be completed next spring.

The New York Chapter/AIA supports a review of the existing zoning laws, along with the Municipal Arts Society, the park's council and the Regional Plan Association. "We feel," says George Lewis, FAIA, executive director of the chapter, "that it would be healthier for the city if certain other parts of midtown were developed instead of everybody trying to shoehorn buildings into that area. . . . We are fortunate that woven all through the densest parts of town are many fine old buildings which constitute the visual character of the central business district. We have remarkably inter-related new and old buildings. . . . We don't want to see everything demolished and a whole bunch of new buildings put

*continued on page 106*

# BANG IT. BUMP IT. WHACK IT. THUMP IT.

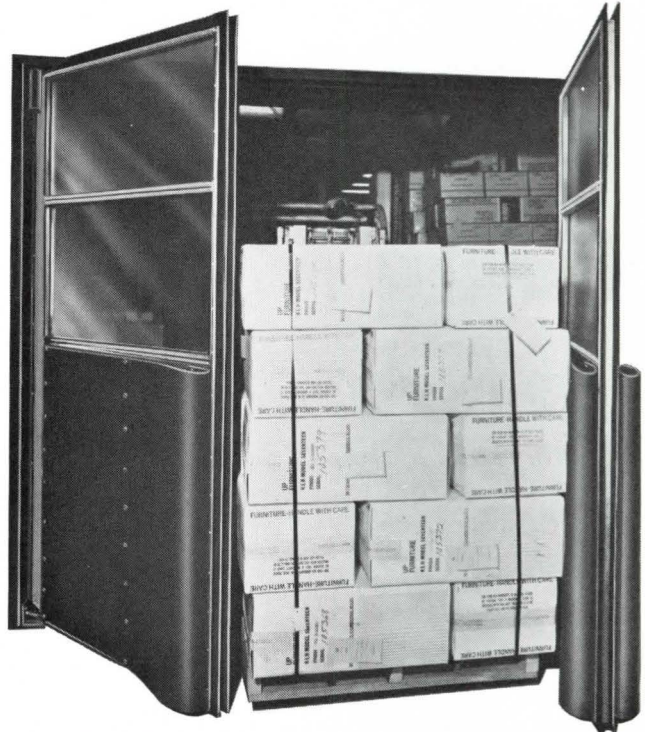

## McGUIRE TRAFFIC DOORS STAND UP TO HARD KNOCKS AND COME BACK SWINGING.

Designed to conserve energy, McGuire's Fendor features welded tubular steel frame construction, large Lexan® vision areas, insulated panels, double gasketing, massive V-Cam gravity action hinges, thick wall hinge posts, and formed ½" thick rubber centerpointed bumpers.

For all your traffic door requirements, contact your McGuire rep or **W. B. McGuire Co., Inc., 1 Hudson Avenue, Hudson, N.Y. 12534. (518) 828-7652, AUTODOK, Telex: 145-490 HUON**

# McGUIRE

Circle 37 on information card

# Write today for free sample of one of world's best roof insulations:

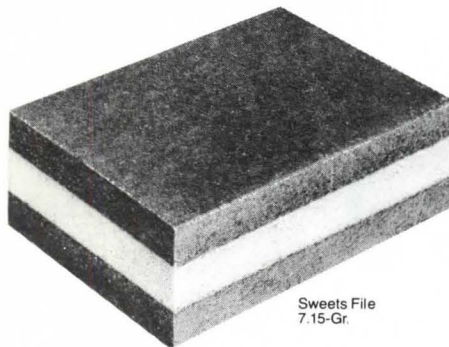

Sweets File  
7.15-Gr.

## Permalite® Pk® Plus perlite/urethane/perlite 3-part composite roof insulation

Specify it when you want long-life insulation having a "C" value of .10 or better for industrial/commercial roofs.

•Permalite Pk Plus is a true sandwich board. The top and bottom perlite layers maintain the efficiency of the polyurethane core by protecting it from the effects of high rooftop temperature changes. The top perlite layer also protects the core from hot asphalt during membrane application. And both perlite layers contribute to the dimensional stability of the insulation panel and help dissipate both heat and moisture during application. SEND FOR FREE SAMPLE.

# Permalite®

GREFCO, Inc. / Building Products Division  
GENERAL OFFICE: 3450 Wilshire Blvd.,  
Los Angeles, CA 90010  
SALES OFFICE: 2905 Butterfield Road,  
Oak Brook, IL 60521 (312) 654-4500

 A subsidiary of General Refractories Company

Circle 38 on information card

### Practice from page 105

up no matter how many amenities they have. We feel it would be far better to adjust things in such a way that people are encouraged to build a little bit farther out."

Meanwhile, San Franciscans defeated a referendum that would have lowered permissible building heights from 500 feet (about 50 stories) to 260. During the last decade, similar proposals failed twice in San Francisco, which is one of several large cities that is beginning to think that highrise buildings may represent a net deficit in municipal accounting because of extended water, sewage, energy usage and increased congestion problems.

### Louis de Moll Tells Goals For His Term as UIA President

Last October, Louis de Moll, FAIA, was elected president of the International Union of Architects (UIA), the first president from the U.S. in the organization's 30-year history. In a recent interview with the AIA JOURNAL, de Moll outlined what he hopes to accomplish during his 30-month tenure, his personal reasons for being involved and how and why American architects can become associated with UIA activities.

UIA is composed of representatives of architectural societies of 80 nations, with a governing board of 35 members. Funding comes primarily from these national societies and Unesco (United Nations Educational, Scientific & Cultural Organization). De Moll explains UIA's role: "It is really quite like AIA, although on an international scale. We conduct liaison cooperative efforts with Unesco and other international organizations in an attempt to keep the architect involved in what's going on in the world and to create a better world climate for architecture. Things an architect himself can't do, as an association maybe we can do." The UIA provides basic information for those who are interested in what is happening internationally, principally through meetings and conferences.

There are seven working UIA groups (committees) covering such topics as health, housing, town planning, industrial architecture and education. Each group holds seminars and meetings. Once a year there is an international conference (last year 7,000 architects attended the conference in Mexico City). Every member of AIA is automatically a member of UIA and has the opportunity to attend any meeting.

Because UIA's members live throughout the world and the organization meets as a council only once a year, "you can't accomplish much," says de Moll. "It is

difficult to bridge the gap of distance; communication is difficult." One of de Moll's first steps as president was to make an analysis of the organization and set out some specific goals. The council adopted these goals. "I think this has given them all a feeling that maybe we can get organized, we can do something. It isn't impossible."

UIA, under de Moll's direction, is developing an information service which will allow individuals or firms to subscribe at varying minimal amounts of money to participate in UIA activities and receive all available information. De Moll hopes to tap national architectural societies for information that can be shared internationally. He feels that this service could become quite popular and provide for a convenient process of information exchange among nations.

Another project of UIA is the development of training and education programs for architects serving in developing countries. UIA plans to hold a meeting this year, sponsored by Unesco, to establish criteria for training architects and local people to serve the architectural needs of these countries. Says de Moll: "I see possibilities with the large number of architects whom we are producing through our education system, who are not able to be absorbed in the traditional architectural practice here in the U.S. We could develop some programs through which these people could move out into the developing countries and get some of this expertise going. Not to solve the problem of the developing countries, but to work with the people to help them in the process of solving the problems themselves." He envisions a project similar to AIA-sponsored R/UDATs, but for a longer time span.

As president of UIA, de Moll has the opportunity to meet many non-American architects. He perceives a deep concern for the changing role and influence of the architect throughout the world, except in North America. "I always thought that particularly in Europe the architect is placed on a pedestal. What has happened is that these people, the architects, are suddenly just saying that they are totally scared. They are confused in the whole new world." De Moll thinks this is related directly to the economic development of a country and is felt most deeply in Germany and Japan, where the economy has "grown like mad, and it's build, build, build and the architects' influence is going down." He continues: "The architects from other parts of the world say, 'you in the U.S. are respected.' A German architect recently told me that in his country it is inconceivable that an architect would get the kind of publicity and be able to do the kinds of things that say, I. M. Pei and

*continued on page 108*



# WATTS ENERGY

## ENERGY MANAGEMENT VIEWS FROM THE NATIONAL ELECTRICAL CONTRACTORS ASSOCIATION VOL. III NO. 2

### LIFE SAFETY SYSTEMS — THE LIFE AND PROPERTY SAVED MAY BE YOURS.

The first life safety system was probably a full bucket of water and a heavy wooden bar going across a door. Unfortunately, methods for protecting buildings and their occupants from the ravages of fire and crime have progressed little beyond that stage until relatively recently.

It was only in the mid-1960's that the need for more effective fire detection systems became obvious. Until then, most large buildings used a superstructure of steel rods embedded in concrete. They had windows that opened to the outside, and rather limited ventilation systems. In general, they were pretty fire-safe.

More contemporary buildings, however, often employ steel beam superstructures, sealed exterior windows and extensive ventilation systems. New wall and ceiling materials are frequently flammable, and extensive ductwork can spread a fire very rapidly.

The fire vulnerability of these buildings has been clearly demonstrated by a number of major fires in this country and overseas in the past ten years. In every case, an up-to-date, centralized fire detection system would have greatly reduced loss of life and property damage.

The 1960's were also a time when crime prevention became a major concern for building owners. The many entrances to buildings and the thousands of people moving in and out of major structures provided the ideal environment for criminals. And from 1960 to 1973, reported burglaries rose 181%.

At first, building owners attacked intrusion and fire detection problems piecemeal, instead of as a whole. A bewildering array of detectors and alarms could be found — often within one building.

But, as progress in electronic technology continued, with its computers, audio-visual displays and automatic control devices, the system approach to life and property safety became a practical idea.

The best fire safety system combines many elements. They can include fire detectors, firesafe stairwells, automatic smoke controls,

fire doors, voice alarms, fire walls, automatic sprinklers, fire extinguishers, safety areas, fire-resistant building materials, automatic elevator recall, two-way communicators, mechanical equipment monitors, a comprehensive fire protection plan, an emergency generator, water standpipes, and — most important — a 24-hour fire control center.

This computerized control center can also double as your crime prevention control center, connecting to the latest intrusion protection equipment such as ultrasonic detectors, area protection devices, perimeter protection, motion detectors, and protective lighting.

As the heart of a complete life safety system, the computer command center can identify the type of emergency and pinpoint its exact location. Audio or visual alarms can be activated and corrective measures set in motion.

Today, life safety systems are at work in hospitals, factories, high-rise apartments and office buildings, shopping malls, and universities. The systems are viewed as excellent investments, because no matter how comprehensive, insurance can never cover the loss of human life, and rarely covers the business losses inherent in any major fire. A good life safety system can protect both and often reduces fire and theft insurance rates.

For a life safety system designed to meet the unique needs of your building or building complex, it's a good idea to talk with a qualified electrical contractor. He may not design the system for you, but he can give expert advice

on the types of equipment and devices you may need, and objectively recommend the most efficient means of wiring your desired system.

For more information, request, on your letterhead, a free copy of the NECA publication "The Life and Property You Save May Be Your Own," Index No. 30043.



**THE NATIONAL ELECTRICAL  
CONTRACTORS ASSOCIATION**  
Department AI-10  
7315 Wisconsin Avenue  
Washington, D.C. 20014

## Practice from page 106

Philip Johnson have been doing recently."

De Moll feels that architects in other countries are experiencing conditions that U.S. architects experienced 30 to 50 years ago. "When I first started getting involved with the committees in AIA," says de Moll, "the whole concern was this question of the influence and image of the architect. . . . Other countries are now confronting this drop in image, and the next thing they are going to confront is some of the demands that we have had and wrestled with." De Moll points to American architects confronting competitive bidding, design/build, advertising and other ethical questions. He says: "I just think there are so many ways that we can help. That is not to say our way is the best. But we have confronted these problems, and I really think that in many ways we have improved. The more I get involved with UIA the more I feel that giving and sharing our knowledge and our ideas can make the profession better throughout the world."

The greatest assets de Moll may bring to UIA are his leadership and organizational abilities, which were exhibited when he was president of AIA in 1976. In an interview with the AIA JOURNAL in 1976 (see Jan., p. 14), he stated: "There is a certain logic in the way I do things that seems to impress people. I think my greatest strength is organizational ability, being able to sort things out, compromise and find solutions. I'm very pragmatic and not a flare-up-type person. I think I'm a steady influence."

De Moll spends 20 to 30 percent of his time on UIA work, which he compares to the amount of time spent on AIA by a regional director. He says that when he first thought about becoming a nominee for UIA president he didn't want to get involved, but "after I thought about it for a while I decided I would really enjoy it and I am enjoying it very much. . . . My problem is that I'm one of those people who has always given a tremendous chunk of my time to the professional society, and UIA is just really a continuation. I guess one of the reasons I do it is because maybe in helping improve the profession, I can make more of a contribution to the environment than I ever can in my own private firm—in the limited number of buildings I design. I'm sacrificing my business, there is no doubt about it." De Moll is chairman of the board of Ballinger, a Philadelphia architectural and engineering firm. Long active in AIA, he served as vice president and chairman of many committees before assuming the Institute presidency. He has represented the U.S. on the UIA work group on working places, and participated in this group's conferences in Rio de Janeiro, Budapest and Detroit.

## New Barrier Free Standard

Based upon requirements that resulted from five years of research, the American National Standard Institute has approved a greatly expanded revision of a 1961 standard to make buildings barrier free. Called the "American National Standard Specifications for Making Buildings and Facilities Accessible to and Usable by Physically Handicapped People" (A117.1), the revised standard differs from the earlier one in that it includes requirements for residential in addition to public buildings. The standard embraces both architectural features and site design.

The purpose of the revised standard is to allow people with physical handicaps to get to, enter and fully use buildings. It concerns the needs of people with walking, sight, hearing, incoordination, reaching and manipulation disabilities, as well as those who lack stamina or have difficulty in interpreting and reacting to sensory information.

HUD sponsored the research work required to revise the older standard. HUD, the National Easter Seal Society for Crippled Children and Adults and the President's Committee on Employment of the Handicapped served as the secretariat of the committee which developed the revised standard. The new standard is to be referenced in federal regulations and building code regulations this year.

## Real Estate: 'Bright' Outlook

The outlook for real estate markets in the next five years is "remarkably bright," according to a study prepared by the Real Estate Research Corporation for the First National Bank of Chicago's real estate section.

The study, entitled "Major Trends in Real Estate," predicts that financing will be available for both debt and equity realty projects, despite the current unease about the high cost and limited availability of mortgage credit.

The report gives the outlook for real estate development over the next five years in five sections:

- Office space: The pace of new office construction "will rival that of the 1968-72 period." Already office building booms are underway in Houston, Chicago, Los Angeles, Dallas and Washington, D.C., and other cities "poised for significant increases" are New York, Detroit and Atlanta.
- Retail space: The report predicts major changes in retail space realignment. For example, construction of shopping centers with four to six department stores will decrease substantially. "Efforts will be concentrated on 'miniregional' shopping centers, with two to at most three smaller

anchor stores." Over the next five years, the success of established regional shopping centers and of newly constructed ones will relate to energy and gas availability.

Consequently, stores in the downtown, especially in mass transit-oriented cities, "will show signs of revival."

- Hotel/motel space: The greatest concern with future development of hotels in central city areas is not market potential, the report says, but financial feasibility. Luxury downtown hotels in large cities currently bear construction costs of \$75,000 to \$85,000 per room, casting doubt on their "viability particularly when low weekend occupancy rates are factored in." There probably will be less growth in highway-oriented motels due to energy shortages.

- Industrial space: *The most difficult* of all land use markets to generalize about, industrial construction declined from \$7.5 billion in 1970 to \$4.9 billion in 1977. This decrease, however, probably will create a strong demand for new industrial space in the '80s. Crucial in the siting of new plants will be availability of energy, which the report considers more important than price.

- Residential space: If supply and demand remain in approximate balance, the demand for new housing starts will be 2.3 million annually through 1985. The mainstay of housing starts will continue to be ownership units, but because of costs there will be an increase in town houses, patio homes and other clustered units rather than the independent house on a private lot. New construction of condominiums and of conversion of older apartment buildings will expand nationwide. Rehabilitation will increase, but it will not be a major component of the overall housing market in the next five years.

If the predictions materialize, "1980 will be the midpoint of the longest period of sustained real estate growth in American history," the report says.

## DEATHS

**Andrew T. Hass, FAIA**, Los Gatos, Calif.  
**William B. Ittner Jr.**, St. Louis  
**Eugene J. Reilly**, Hampton, N.J.

**Orville H. Bauer, FAIA**: Senior partner in the Toledo, Ohio, firm of Bauer, Stark & Lashbrook, Mr. Bauer was a past president of the Architects Society of Ohio/AIA and of the Toledo Chapter/AIA. He was recently elected to a second term as president of the Ohio State Board of Examiners of Architects. Injured in an automobile accident several months ago, he died on Sept. 6 at the age of 58.

A graduate in architecture from the

University of Cincinnati in 1947, Mr. Bauer worked in the Toledo firm of Mills, Rhines, Bellman & Nordoff while still a student. He became a partner in the firm then known as Bellman, Gillett & Richards in 1954. The firm's name was later changed to Richards, Bauer & Moorhead and early this year became Bauer, Stark & Lashbrook.

Mr. Bauer, who served on AIA's committee on architecture for educational facilities, became a specialist in the design of educational buildings. He participated in the design of such structures as the science complex at Bowling Green State University, the student center and auditorium at Ohio State University, a dormitory at Heidelberg University and the engineering-science building at the University of Toledo, as well as high schools in Toledo.

Mr. Bauer was actively involved in many community projects and organizations. He was an infantry captain in World War II, and was awarded a Bronze Star.

**Frank James Duane, AIA:** President of the Washington Metropolitan Chapter/AIA in 1957-58, Mr. Duane was a partner in the Kensington, Md., firm of Duane, Duane & Cahill, organized in 1968. Upon graduation from the Uni-

versity of Pennsylvania's school of architecture in 1927, he worked for the Philadelphia City Planning Commission. In 1934, he moved to Washington, D.C., to work for the Federal Housing Authority, becoming chief of the technical section. He remained as a federal housing official until 1947 when he established his own architectural firm.

Mr. Duane, who died on Oct. 29 at the age of 77, was the architect of more than 400 projects before his retirement in 1970, including St. Michael's Catholic Church and the Memorial Evangelical United Brethren Church in Silver Spring, Md., the Bradley Hills Presbyterian Church in Bethesda, Md., the award-winning Montgomery Village Junior High School in Gaithersburg, Md., and the National Park Service substation, Prince George's County, Md.

From 1950 to 1962, Mr. Duane was an associate professor of architecture at Catholic University. Active in civic, church and professional affairs, he was a member of the D.C. Architectural Registration Board, chairman of the Montgomery County Library Board, president of the Seven Oaks Citizens Association, a member of AIA's committee on the national capitol and a member of the board of directors of the Catholic Youth Organization.

**Gustave W. Iser, AIA:** The Austria-born architect of many housing projects and religious and institutional buildings in New York City, Mr. Iser was associated with the noted planner, Clarence Stein, from 1925 to 1931, participating in the planning of two acclaimed urban housing developments, Sunnyside Gardens and Phipps Gardens in Queens. Mr. Iser died on Oct. 27, 1979, at the age of 83.

In 1931, Mr. Iser established his own architectural office and was the designer of many projects, including the Hillcrest General Hospital, Queens, the Church of the Transfiguration in Corona, Queens, and the Seth Low houses in Brooklyn. He served as a consultant for the conversion of hundreds of brownstone houses in New York City's west side urban renewal area.

Mr. Iser studied at Pratt Institute and Columbia University's school of architecture. He taught at Columbia from 1958 to 1960. He retired in 1972 and was living in Hollywood, Fla., at the time of his death.

**Pipsan Saarinen Swanson, Hon. AIA:** The daughter of Eliel and Loja Saarinen, Mrs. Swanson was born in Finland and studied fabric design, metal work, weaving and ceramics at the University of Helsinki's school of art. She came to this country when her father accepted a teach-

**NOW . . . All the benefits of Carpeting . . . with better STATIC PROTECTION than tile.**

**COMPU-CARPET™**

High Performance Anti-Static Carpeting

COMPU-CARPET permanently anti-static carpets and COMPU-MATS™ • Eliminate static problems in computer and terminal areas • Protect sensitive electronic equipment • Meet IBM recommendations • Provide comfort and acoustical advantages of high quality carpeting • Carry a 5-Year wear and static warranty.

U.S. Pat. No. 4,153,749.  
Dept. A

32 Southwest Industrial Park  
Westwood, MA 02090  
(617) 326-7611

**UTP UNITED TECHNICAL PRODUCTS, INC.**  
THE STATIC CONTROL PEOPLE

Circle 40 on information card

**61 hospitals depend on EPICORE® Deck for hanging, loading and fire ratings.**

Life-cycle flexibility is critical in hospital design. EPICORE's dovetail ribs and two hangers are the key. Both hangers can be inserted without tools anytime after the slab has cured, allowing mechanical and medical support equipment to be installed with the greatest efficiency and the least disruption.

Find out what EPICORE's lifetime hanger system, heavy loading and top fire ratings can do for your next project. Contact Bob Ault, Vice President - Engineering.



**EPIC**  
METALS CORPORATION

Eleven Talbot Avenue  
Rankin, Pennsylvania 15104  
(412) 351-3913

Standard Hanger.  
Safe load capacity:  
200 pounds.\*

Wedge Bolt Hanger.  
Safe Load capacity:  
1000 pounds.\*

\*Providing the floor system is designed to support this load.

Circle 41 on information card

AIA JOURNAL/JANUARY 1980 109

# FROM CHENEY

# QUALITY

Cheney Flashing Company offers a complete line of quality, factory pre-fabricated mansard batten panels fascia panels soffit panels soffit vents framing systems concrete reglets masonry reglets thru-wall flashing gravel stop, coping covers

Send for current literature.



A company in touch with your needs.

## CHENEY FLASHING COMPANY

ESTABLISHED 1928  
623 Prospect Street  
P.O. Box 818  
Trenton, N.J. 08605  
Phone 609-394-8175

ing position at the University of Michigan's school of architecture. Later, he became president of Cranbrook Academy and was in charge of the design of the campus.

Mrs. Swanson, who died on Oct. 23, 1979, at the age of 74, was married in 1926 to R. Robert F. Swanson who had an architectural office in Bloomfield Hills, Mich., and was associated with Eliel Saarinen on many projects. Mrs. Swanson became a color consultant in her husband's firm and won many awards for her design interiors. In 1970, her work was recognized by AIA when she became an honorary member of the Institute. For the past several years, she was a partner in the firm of Countryside Design in Bloomfield Hills.

## BRIEFS

**Concerning the Guggenheim Museum** in Manhattan, famed art collector Peggy Guggenheim at age 81 said recently: "My things won't be shown in what I call my uncle's garage, that Frank Lloyd Wright thing on Fifth Avenue."

**Maury I. Wolfe**, partner in DiMarinisi & Wolfe in Boston, has been appointed chairman of the school of architecture, Boston Architectural Center, for the current academic year.

**R. Buckminster Fuller, FAIA**, Institute gold medalist in 1970, is now serving as president of International Mensa, headquartered in Wolverhampton, England. The organization's members must have scored in the top 2 percent of the population on qualifying I.Q. tests.

**Carlos Sanz, FAIA**, is the recipient of Catholic University's 1979 alumni achievement award in the field of architecture.

**Eason H. Leonard, FAIA**, managing partner for I. M. Pei & Partners, New York City, has been inducted into Oklahoma State University's engineering hall of fame.

**David W. Marohn**, an architect with Venturi & Rauch in Philadelphia, and **Larry R. Young**, an architect with Sasaki Associates, Watertown, Mass., have been awarded grants by the English-Speaking Union of the U.S. for travel and research in the United Kingdom in the field of reuse and recycling of landmark structures.

**NAME Report** is the title of a new semi-monthly guide to business opportunities in North African and Middle East countries. A recent issue, for example, announces recreational parks to be built in

Medina, Saudi Arabia, and hospitals planned for Abu Dhabi, U.A.E. Subscriptions for \$365 yearly may be obtained from *NAME Report*, 4614 Fifth Ave., Pittsburgh, Pa. 15213.

**"Compendium: Architect Selection Laws"** is a recent AIA publication (no. 4N509) that contains laws of 17 states with legislation on A/E procurement for public construction projects. It is available free to AIA members, \$5 to nonmembers, from AIA's publications marketing department.

**"Conserve Neighborhoods,"** a bimonthly newsletter that gives practical advice, tips and tactics to neighborhood groups, is available for \$2.50 for six issues from the National Trust for Historic Preservation, 1785 Massachusetts Ave. N.W., Washington, D.C. 20036.

**Moshe Safdie**, who maintains offices in Boston and elsewhere and is director of the urban design program, graduate school of design, Harvard University, has been named program chairman for the 30th international design conference in Aspen, Colo., to be held June 15-20.

**Lewis Mumford, Hon. AIA**, celebrated his 80th birthday in October 1979. He recently signed a contract with publishers Harper & Row for an autobiography to be published in the fall of 1981. "I was keeping this to the end," he says. "This is the last word."

**George Anselevicius, AIA**, has been reappointed for a three-year term as chairman of the department of architecture of the school of architecture and environmental design, State University of New York at Buffalo.

**The National Institute of Building Sciences**, created by Congress as a non-government instrument to help bring about better building through technological innovation and more rational regulation, has elected Joseph H. Newman as chairman of its board of directors. He is executive vice president of Tishman Realty & Construction Co., Inc., New York City.

**Douglas A. Bevis, AIA**, chief financial officer for Naramore, Bain, Brady & Johanson, Seattle, has been elected president of the Professional Services Management Association.

**A professional team to develop a master plan** for Miami Beach's Art Deco district (listed in the National Register of Historic Places) is being sought by the Miami Design Preservation League. Contact:

*continued on page 112*

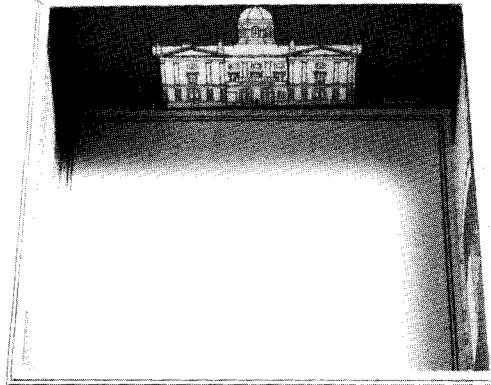

Announcing an  
opportunity to design

## PIONEER COURTHOUSE SQUARE

—the most significant  
space in downtown  
Portland, Oregon

The City of Portland will focus on the development of a new public space in the heart of the city. This project is a key element of the city's urban renewal program. The City of Portland is pleased to announce a design competition for this project.

Adjacent to Portland's acclaimed transit mall and the

in the heart of one of the nation's finest cities through **A Design Competition** Adjacent to Portland's acclaimed transit mall and the

Portland is about to undertake a project almost unheard of in American cities. The City is pleased to announce a Design Competition to transform a parking lot on its central downtown block into a city square; a place for people in the heart of the city.

Located adjacent to the Portland Transit Mall and historic Pioneer Courthouse, Pioneer Courthouse Square will be a central focus for the retail and commercial heart of the city. When completed, it will be the missing link in downtown's acclaimed network of pedestrian walkways, parks, fountains, art, plazas, and open space. The City invites participation of all interested designers in a design competition.

Designers responding to this invitation will be forwarded Competition Submission Packets. From submissions jurors will select 10 designers to interview for a final decision on five competitors. Each will be compensated \$10,000 to prepare conceptual plans during a 60-day competition period. Competition Submission Packets may be obtained by written request and payment of a \$25.00 non-refundable fee to:

*Donald J. Stastny, AIA, Professional Advisor  
c/o City of Portland Development Commission  
1500 S.W. First Avenue  
Portland, Oregon 97201*

Submission packets will contain competition procedures, the design program, submission requirements and essential background data. Submissions must be postmarked or received no later than March 3, 1980.

Circle 43 on information card

Washroom  
directions

## The Men's Room— For Office Buildings

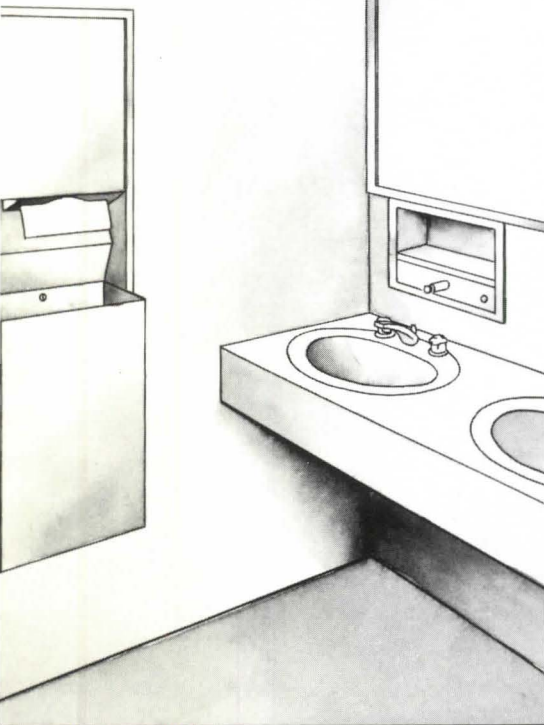

**WASHROOM DIRECTIONS** are reference manuals designed to guide specifiers in selecting the right marker equipment for use in each of a wide variety of washroom categories. The stainless steel units in this washroom were taken from a **WASHROOM DIRECTIONS** checklist of essential and optional recessed units for use in a men's washroom in an office building. They include:

**WASTE RECEPTACLE & PAPER TOWEL DISPENSER** — No. 654  
**MIRROR** — No. 3020  
**SHELF & SOAP DISPENSER** — No. 634

If recessed units are not desired, **WASHROOM DIRECTIONS** also provides checklists for surface mounted, space-saving, barrier-free and concealall washroom designs. Send for your **WASHROOM DIRECTIONS** and find out how easy specifying Parker units can be, whatever direction your washroom plans are taking.

 **charles  
parker**

290 PRATT ST., MERIDEN, CT 06450  
TEL: 203-235-6365

Circle 44 on information card

### Briefs from page 110

Barbara Capitan, MDPL, 1630 Euclid Ave., Miami Beach, Fla. 33139.

**The National Sculpture Society** is seeking nominations for its Henry Hering medal, given "as occasion warrants" for outstanding collaboration among architect, owner and sculptor in the "distinguished use of sculpture" in an architectural project. Deadline for receipt for materials is Mar. 3. Contact: NSS, 15 E. 26th St., New York, N.Y. 10010.

**One of the nation's largest solar energy projects** is in place at Chicago's Museum of Science and Industry. The \$728,230 solar demonstration unit services a ground floor cafeteria, the visitors center and part of the balcony area, heating 71,333 square feet and cooling 65,133 square feet. An accompanying exhibit explains the system and contains a closed circuit TV view of the collector panels on the roof. Architect/engineer for the project was V. A. Scavo & Associates.

**Rudard A. Jones, AIA**, research professor of architecture at the University of Illinois and director of the Small Homes Council-Building Research Council, is the 1979 recipient of the Walter C. Voss award of the American Society for Testing and Materials. Jones was cited for his "long and valued service to the construction industry and the promotion of the housing and building technology field."

**Gerald M. McCue, FAIA**, associate dean and professor of architecture and urban design in Harvard University's graduate school of design, will become the dean of the faculty of design on July 1, 1980.

**The United Professional Network** has been established as an "advanced marketing tool" for its member-architects. The concept, similar to the nationwide networks of real estate agents, was developed in the Dallas office of SHWC, Inc., an A/E firm. In addition to national advertising and marketing, UPN intends to offer a "computer bank of information on other members' expertise, production capabilities and workloads."

**Louis G. Redstone, FAIA**, of Livonia, Mich., has been elected an honorary fellow of the Royal Academy of Fine and Applied Arts of the Netherlands.

**Legal problems of the construction industry** are discussed in a special issue of St. Louis University's *Law Journal*. A copy may be obtained from: St. Louis University, *Law Journal*, 3700 Lindell Boulevard, St. Louis, Mo. 63108.

**"Four Landmark Buildings in Chicago's Loop"** is the title of a study prepared by Harry Weese & Associates for the Heritage Conservation and Recreation Service. Although it focuses on Chicago buildings, it contains lessons for other cities faced with the problems of inner city revitalization while preserving architectural landmarks. Order from U.S. Government Printing Office, Washington, D.C. 20402 (stock no. 024-016-00104-4). The price is \$4.50.

**The first recipient** of the Raymond E. Means memorial fellowship at Oklahoma State University is Rekki Helms of Lawton, Okla. The fellowship is named in honor of the late OSU professor emeritus of architecture who died in July 1977.

**"If You're Interested in Engineering"** is the title of a new career guide for consulting engineering for high school students. A free copy will be supplied by the American Consulting Engineers Council, 1015 15th St. N.W., Washington, D.C. 20005.

**AIA is one of four organizations** to receive the first annual "agora award" of The Marketplace in Philadelphia. The award recognizes "outstanding contributions in the field of interior design."

**This country's only royal residence**, the Iolani Palace in Honolulu, is depicted on a 10-cent postal card in the U.S. Post Office's historic preservation series. Completed in 1882, the palace was occupied by the last three kings before the monarchy was overthrown in 1893. The card is the third in the series which includes the Galveston, Tex., court house and the Cincinnati Music Hall.

**An exhibition about the New York World's Fair of 1939/40** will open in the summer of 1980 at the Queen's Museum in Flushing, N.Y., on the site of the fair. An advisory committee, preparing for the show and a catalog, asks for information and documentation about the fair, almost of all the architecture, murals and sculpture having been destroyed. Contact: Helen A. Harrison, Queen's Museum, Flushing Meadow-Corona Park, Flushing, N.Y. 11368.

**Ingeborg Barbara Rose, AIA**, of Pasadena, Calif., has been named the 1979 "honored alumnus" of the school of architecture and environmental design at California Polytechnic State University. She is associated with the Los Angeles firm of Architects & Engineers Collaborative and has done studies in energy conservation and solar energy.

News continued on page 114

# Vernitron and Better Built have joined forces.

---

## What's in it for you?

---

*Two forces together—combining the best of both!*

**GIVING US** increased in-house capabilities. Greater production economies. An ideal combination of advanced engineering expertise. And a *doubly* quality-oriented management team.

**GIVING YOU** the broadest product range of sterilizers, autoclaves, washers, and dryers. Backed by more than 90 years of industry experience. Serviced by a *localized* network of sales and service professionals, coast to coast.

---

## What's in it for you?

---

The Vernitron/Better Built Commitment: To provide the finest quality equipment, accurately matched to our customers' needs, and supported by the highest degree of customer-oriented service.

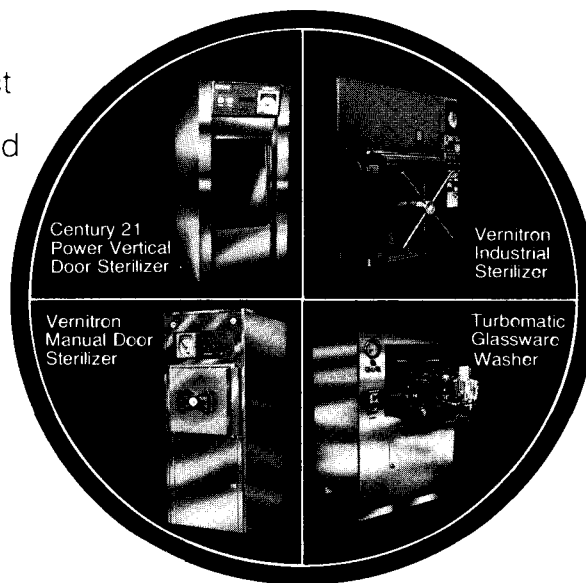

For more information, write or call today.

## Vernitron/Better Built



**VERNITRON MEDICAL PRODUCTS**  
5 Empire Boulevard, Carlstadt, New Jersey 07072 (201) 641-5500  
TELEX: 13-3345 CABLE: VERNIMED NEWYORK

AIA180

## PRODUCTS

### Desk and floor lamps.

Koch & Lowy has introduced two new lamps: Madeleine II, a 14-inch desk and study lamp of solid brass, with a tent shade and enclosed swivel; Eyeshade, a floor lamp, stands 34 to 48 inches tall, has a perforated black shade, chrome handle and white or green translucent end panels. (Koch & Lowy, Inc., Long Island City, N.Y. Circle 200 on information card.)

### Glass products literature.

A 16-page color brochure lists description, sizes, specifications, values and applications for all Environmental Glass Products offerings. (Environmental Glass Products Division, Shatterproof Glass Corporation, Detroit. Circle 175 on information card.)

### Energy conservation data terminal.

A Texas Instruments desktop data terminal can be used to control energy costs and operating expenses in an individual structure or a complex of buildings. The TI Silent 700 Model data terminal works with an automated energy management system (the Marks Control Corporation Powers) to tell, for example, a building

supervisor or a plant manager how much energy is being used in a building and where energy can be conserved. (Texas Instruments, Houston. Circle 181 on information card.)

### Hardwood flooring.

The product line of Kentucky Wood Floors products is presented in a new brochure which details "custom classics," "endgrain," strip, plank and parquet designs. (Kentucky Wood Floors, Inc., Louisville, Ky. Circle 182 on information card.)

### Earth-colored double-hung windows.

Andersen has added Terratone (earth-hued color) to its Perma-Shield Narroline double-hung window product line. The wood core sash and frames of the double-paned, insulating glass windows are sheathed with rigid vinyl. (Andersen Corporation, Bayport, Minn. Circle 183 on information card.)

### Ceramic wall and floor tiles catalog.

A catalog detailing the products of the United States Ceramic Tile Co. includes many styles of glazed wall tile, unglazed quarry-type pavers, ceramic mosaic and various kinds of specialty products, decorative insert tile, conductive tile, trim, bath accessories and installation prod-

ucts. (United States Ceramic Tile Co., Canton, Ohio. Circle 180 on information card.)

### PLEXIGLAS balcony enclosures.

Open-View Balcony Closures are sliding panels glazed with bronze-tinted solar-control PLEXIGLAS brand acrylic plastic. (Rohm & Haas Co., Philadelphia. Circle 184 on information card.)

### Push-button plumbing.

Ultraflo is marketing push-button water distribution systems which take the place of standard faucets. Push-buttons regulate water temperature and flow at the kitchen sink, lavatory basin, tub, shower, etc. For example, at the kitchen sink, the user has a choice of hot, warm and cold water and high and low flow rates. (Ultraflo Corporation, Sandusky, Ohio. Circle 185 on information card.)

### Solar energy skylight.

Wasco has introduced the Solar Energy Skydome, which has a thermal-break aluminum curb and high-performance gasket and butyl seals. The product is described in a 22-page handbook along with an explanation of the principles of solar energy daylighting and its application to industrial, commercial and insti-

*continued on page 116*

## Heart attack or stroke could knock you down on your way up.

You're working for the challenge, the satisfaction, the success. The last thing you want is a heart attack or stroke. Yet nearly one million Americans die of heart disease and stroke every year. And 200,000 of them die before retirement age.

The American Heart Association is fighting to reduce early death and disability from heart disease and stroke with research, professional and public education, and community service programs.

But more needs to be done. You can help us find the answers by sending your dollars today to your local Heart Association, listed in your telephone directory.



**Put your money where  
your Heart is.**



**American  
Heart  
Association**

WE'RE FIGHTING FOR YOUR LIFE

## ILLINOIS INSTITUTE OF TECHNOLOGY

Nominations and applications are invited for the position of Chairman of the Department of Architecture. A person with significant architectural achievement is sought.

The Department has approximately 400 students and a faculty of 25.

The Chairman reports to the Dean of the College of Architecture, Planning and Design; and is responsible for the administration of the department and its undergraduate and graduate program, program development and budget. The Chairman will work closely with the Dean in formulating goals.

Rank and salary will be commensurate with qualifications and experience. Starting date: Fall 1980.

Send letters of nomination and applications to:

**Office of the Dean  
College of Architecture, Planning and Design  
Illinois Institute of Technology  
3300 South Federal Street  
Chicago, Illinois 60616  
Attention: Paul Thomas, Chairman of Search Committee**

*To assure full consideration, nominations and applications should be received by February 15, 1980.*

IIT is an equal opportunity/affirmative action employer. Applicants will be considered on the basis of merit without regard to race, creed, color, national origin, sex, age or physical or mental disability unrelated to duties and demands of the position.





# COFPAES FEDERAL PROGRAMS CONFERENCE

**“A/E’s Federal Marketplace for the ’80s”**

March 27-28, 1980  
Sheraton Harbor Island Hotel  
San Diego, Calif.

The real dollars (and where to find them) in the federal marketplace is the focus of the eighth national COFPAES conference, sponsored by the Committee on Federal Procurement of Architectural/Engineering Services.

*Meet the key federal officials* who administer the programs and contract for A/E services in over 40 governmental agencies.

*Learn first hand about the federal programs* that are important to the 400 architects and engineers who have attended the COFPAES conference each year.

*This year, you’ll learn where the real dollars are in the federal marketplace* in a fast paced two-day session of workshops, discussions and informal dialogues with architects, engineers and federal administrators.

*To register for the COFPAES Federal Programs Conference*, fill out the coupon below.

COFPAES includes members from the American Consulting Engineers Council; The American Institute of Architects; American Road & Transportation Builders Association; American Society of Civil Engineers, and National Society of Professional Engineers.

Yes, I'd like to register for the COFPAES conference March 27-28, 1980 in San Diego. My check, made payable to COFPAES/AIA, is enclosed.

Name(s) \_\_\_\_\_

Check # \_\_\_\_\_

Amount \$ \_\_\_\_\_

Firm \_\_\_\_\_

Firm \_\_\_\_\_ Personal \_\_\_\_\_

Address \_\_\_\_\_

Other \_\_\_\_\_

City \_\_\_\_\_ State \_\_\_\_\_ Zip \_\_\_\_\_

Dated \_\_\_\_\_

Registration Fee: First registrant \$150; second registrant from same firm \$125.

Registration fee includes luncheons and the reception on the 27th.

Please return to: 1980 FEDERAL PROGRAMS CONFERENCE, c/o The American Institute of Architects, Federal Agency Liaison Program, 1735 New York Ave., N.W., Washington, D.C. 20006 (202) 785-7383

Circle 48 on information card

**Products from page 114**  
tutional buildings. (Wasco Products, Inc., Sanford, Me. Circle 187 on information card.)

**Insulation literature.**  
"Energy, Economics and Insulation" describes Johns-Manville's ERA Energy Reduction Analysis program. ERA is a computerized version of the Economic Thickness of Insulation calculation used to determine what thickness of insulation on a given pipe or vessel will yield the largest overall savings. (Insulation Center, Johns-Manville, Denver. Circle 189 on information card.)

How a number of difficult insulation installation problems were solved by product design and shop fabrication is illustrated in a new brochure featuring Johns-Manville's Washington, D.C., Insulation Contract Unit. (Insulation Center, Johns-Manville, Denver. Circle 188 on information card.)

**Solar-control glass.**  
A bronze-tinted solar-control glass has been introduced by Ford Motor Co. The glass helps reduce airconditioning costs by absorbing the sun's heat and reradiating it to the outside. Ford previously introduced Sunglas, a green-tinted solar

glass that blocks 24 percent of the sun's heat. (Glass Division, Ford Motor Co., Detroit. Circle 192 on information card.)

**Carpet "encyclopedia."**  
An encyclopedia of Anso and Anso-x Nylon patterned carpets, produced by Allied Chemical, is now available. (Fibers Division, Allied Chemical Corporation, New York City. Circle 193 on information card.)

**Lighting conservation publications.**  
Three new booklets offer lighting energy conservation recommendations and information on polarized lighting for existing and new buildings: "Guide to Energy Lighting Design," "Energy Savings Recommended Levels of Illumination" and "Polarized Lighting." (Polarized Corporation of America, Northridge, Calif. Circle 194 on information card.)

**Solar equipment catalog.**  
The revised and expanded edition of "Do-It-Yourself Solar Heating Supply Shop and Mail Order Warehouse" catalog is now available. Included is information on collector covers, sealants and fasteners, installation accessories, absorber plates (air and water), absorber coatings, insulation, differential controllers and more. \$2. (Solar Components

Division, Kalwall Corporation, Manchester, N.H. Circle 177 on information card.)

**Stained glass.**  
NOTOGLASS—a solid, unleaded glass panel cut to job specifications—consists of two layers of glass, with a central core of artwork, translucent pigments and textured resins. (San Diego Art Productions, San Diego. Circle 186 on information card.)

**Communication lights.**  
Halo Lighting recently introduced a complete line of communication lights. They are available in 28 different internationally recognizable symbols, such as those indicating restrooms, smoking or no smoking and first aid. (Halo Lighting Division, McGraw-Edison Co., Elk Grove Village, Ill. Circle 176 on information card.)

**Floor products literature.**  
The 1980 edition of Azrock's catalog of resilient flooring products is now available. The 20-page catalog contains information on vinyl composition floor tiles, asphalt floor tiles, feature strips and vinyl cove bases. Free. (Azrock Floor Products, San Antonio, Tex. Circle 197 on information card.)

THE MOST VALUABLE ARCHITECTURAL INSTRUMENT FOR THE ENERGY CONSCIOUS EIGHTIES

## SOLAR PATHFINDER™

"THE ENERGY EVALUATOR"

A TRULY PROFESSIONAL SOLAR SITE SURVEY DEVICE IS FINALLY AVAILABLE.

The reflected image from the surface of the SOLAR PATHFINDER'S™ transparent dome combines with the transmitted image of the Sunpath Diagram to display the following site dependent characteristics: (1) Sunrise and sunset times, (2) Sunrise and sunset directions, (3) Interim shading patterns and (4) "Percentage of Daily Total" radiation figures for each one-half hour interval.



A quick tracing on the Sunpath Diagram provides a permanent record of the full year's solar patterns and associated energy values.

Sunpath Diagrams unique to each six-degree latitude band and collector orientation provide energy values for horizontal, vertical, angled and solar-tracking collector surfaces.

The clients of consulting solar professionals and architects are provided with a quick, clear and graphic display of both passive and active solar site potential. Rapid comparison of SOLAR PATHFINDER™ observations at various locations greatly facilitates accurate structure placement and orientation. Active collector placement on existing structures is similarly enhanced.

The SOLAR PATHFINDER™ is supplied complete with tripod, compass, magnetic declination adjustment, multiple Sunpath Diagrams, worksheets, informative manual, and carrying case.

\$124.00 (Colorado residents add 3% sales tax). VISA/Master Charge and telephone orders accepted. COD orders add \$6.00.

SOLAR PATHWAYS, INC., Marketing Department  
3710 Highway 82, Glenwood Springs, Colorado 81601  
(303) 945-6503

A NATIONALLY KNOWN CONSULTING FIRM OFFERING ALTERNATIVE ENERGY SYSTEM DESIGN AND ANALYSIS

MANUFACTURED UNDER EXCLUSIVE LICENSE FROM BERNARD HAINES



## FACULTY POSITIONS OPEN

KING FAISAL UNIVERSITY  
COLLEGE OF ARCHITECTURE AND PLANNING  
DAMMAM, SAUDI ARABIA

New positions for faculty at all levels have been created for the academic year 1980-1981 in the following areas:

ARCHITECTURE	URBAN/REGIONAL PLANNING
ENGINEERING SCIENCES	BUILDING TECHNOLOGY
LANDSCAPE ARCHITECTURE	MATHEMATICS/PHYSICS

**PREREQUISITES:** Ph.D., M.A. or equivalent degree; practical and/or teaching experience; membership in professional organization.

**SALARIES:** Competitive with western academic institutions.

**BENEFITS:** Include free furnished accommodations, educational allowance for four children, air tickets to and from Saudi Arabia once a year for husband, wife and two children, 60-day summer holiday, no Saudi income tax.

Language of instruction is English. Positions begin in September 1980.

Please send complete resume, including daytime telephone numbers, and a listing of three references to:

DEAN AHMED FARID MOUSTAPHA  
COLLEGE OF ARCHITECTURE AND PLANNING  
KING FAISAL UNIVERSITY  
C/O SAUDI ARABIAN EDUCATIONAL MISSION  
2221 WEST LOOP SOUTH  
HOUSTON, TEXAS 77027

A catalog describing VPI floor products includes solid vinyl tile line, seam-welding bead, rubber and vinyl wall base, adhesives and corner guard and Sure-Grip carpet runner. (Vinyl Plastics Inc., Sheboygan, Wis. Circle 196 on information card.)

GAF offers a commercial sampler which illustrates GAFSTAR architectural vinyl floor tiles, Regency and Royal Stoneglow vinyl composition floor tiles and Contract-floor sheet vinyl. (GAF Corporation, New York City. Circle 195 on information card.)

#### Lighting design.

WESTELL, a calculator software program, has five programs for general and detailed lighting design for interior lighting, floodlighting, roadway lighting and cost analysis. It is contained in a solid-state module that plugs into a Texas Instruments TI-59 hand-held programmable calculator. (Lighting Division, Westinghouse Electric Corporation, Pittsburgh. Circle 199 on information card.)

Westinghouse also offers a revised edition of its "Guide to Incandescent Lamps," which contains information on lamp parts and manufacture, filament design, bulbs and bases, lamp types and classes, operat-

ing characteristics, economics and efficiency. 50 cents. (Lamp Commercial Division, Westinghouse Electric Corporation, Bloomfield, N.J. Circle 198 on information card.)

#### Office and commercial ceilings.

Armstrong has introduced several new office and commercial ceilings. Cortega Colortone is a mineral-fiber lay-in ceiling available in four earth tone colors plus brown and black and in 2x4-foot lay-in panels and 2x2-foot tegular-edged panels. Reflections offers a clear reflective surface available in mirror silver, bronze, reflective black and a brushed-aluminum visual. Natural Fissured Travertone is a new 12x12-inch ceiling tile. Lineage Embossed Travertone is a 1x2-foot tile embossed to create four linear strips, each three inches wide. The company has also introduced Luminaire, Gallery, Second Look III and Quietlook Silok. (Armstrong Cork Co., Lancaster, Pa. Circle 190 on information card.)

#### Energy conservation manual.

Honeywell has published the second edition of its energy conservation manual, a 115-page guidebook for reducing energy consumption in existing commercial buildings. Included are guidelines for establishing a corporate energy con-

servation department, forms and procedures for conducting a building energy audit and a number of heating/cooling control applications. Free. (Commercial Construction Division, Honeywell Inc., Minneapolis. Circle 179 on information card.)

#### Energy savings calculator.

A slide rule style calculator designed to show estimates of thermal efficiencies and energy savings of Varco-Pruden's newly developed VP300 wall and roof panel is available. The calculator compares Varco-Pruden's product with the efficiencies of different types of building materials and allows the builder to calculate the savings of one over the other in Btus per thousand square feet of wall or roof. (Varco-Pruden Metal Building Systems, Memphis. Circle 178 on information card.)

#### Prismatic control lens.

K-S-H now offers the Triumph I prismatic control lens for 2x2-foot high-intensity-discharge light fixtures. The lens distributes the high-efficacy h.i.d. lighting vertically 40 to 45 degrees rather than directly beneath the fixture. The Triumph I catalog (no. 1417) is available. (K-Lite Division, K-S-H, Inc., St. Louis. Circle 191 on information card.) □

## PEDESTRIAN BRIDGES



Route 5, Box 178 • Alexandria, MN 56308  
612-852-7500

For Government Procurement, see FSC Class 5420  
Contract #GS-00S-64465

—WANTED—

### ARCHITECTURAL/DESIGN FIRM

Nationwide chain of Women's Jr. Apparel stores is seeking an architectural/design firm experienced in store design and construction supervision. Chain store experience is essential. Will be responsible for total design package including store plan, lease review, bid-letting, and construction inspection and administration. Our 5000 to 7500 sq. feet stores are located in major malls. Send letter of introduction together with range of services and experience.

P.O. Box 705  
Midtown Station  
New York City, NY 10018

# ADVERTISERS

**Michael J. Hanley**

Publisher

**Michael M. Wood**

National Sales Director

**George L. Dant**

Manager, Production and Business

1735 New York Ave. N.W.

Washington, D.C. 20006

(202) 785-7300

**ADVERTISING SALES OFFICES**

**Washington, DC. (202) 785-7271**

Michael M. Wood

1735 New York Ave. N.W.

Washington, D.C. 20006

**New York (201) 729-4937**

Thomas R. Crow

46 Main Street

Sparta, N.J. 07871

**New England/New York State**

(617) 632 8185

Robert L. Tegen

87 State Road West

Westminster, Massachusetts 01473

**Chicago (312) 887-1171**

Robert M. Brown

201 E. Ogden Avenue

Hinsdale, Illinois 60521

**St. Louis (314) 569-3210**

Richard D. Grater

1466 Summerhaven

St. Louis, Missouri 63141

**San Francisco (415) 348-8222**

Jules E. Thompson

1290 Howard Avenue #303

Burlingame, California 94010

American Air Filter Co. ....	18	Kimball Office Furniture Co. ...	Cov. 3
<i>Doe-Anderson Advertising Agency</i>		<i>Keller-Crescent</i>	
American Olean Tile .....	79	King Faisal University .....	116
<i>Lewis &amp; Gilman</i>		Levolor Lorentzen .....	Cov. 4
Armstrong Cork. Co. ....	Cov. 2-pg. 1	<i>Muller, Jordan, Weiss</i>	
<i>Marsteller, Inc.</i>		McGuire Co., W. B. ....	105
Better Built/Vernitron .....	113	<i>R. T. Blass</i>	
<i>Alden Advertising Agency</i>		National Electrical Contractors	
Birdair Structures Div. of		Assoc. (NECA) .....	107
Chem-Fab .....	35	<i>Vansant Dugdale</i>	
<i>N. W. Ayer ABH International</i>		National Sanitation Foundation ...	101
Bruning (AM) .....	84	<i>The Connelly Company</i>	
<i>100R Advertising Co.</i>		Nucor (Vulcraft) .....	28-29
California Redwood Assoc. ....	82-83	<i>Faller, Klenk &amp; Quinlan</i>	
<i>Foote, Cone &amp; Belding/Honig</i>		Owens-Corning Fiberglas	
Ceco Corporation .....	103	Corp. ....	5-6-7-8-9
<i>Fensholt, Inc.</i>		<i>Ogilvy &amp; Mather</i>	
Celotex Corporation .....	24-25	Owens-Corning Fiberglas	
<i>Mike Sloan</i>		Corp. ....	91
Charles Parker Co. ....	112	<i>Ogilvy &amp; Mather</i>	
<i>Les Howe Advertising</i>		Pen Ply .....	32
Cheney Flashing Co. ....	110	<i>Soderberg, Thompson, MacEwan</i>	
<i>MR Associates</i>		PPG Industries (Glass) .....	89
City of Portland, Oregon .....	111	<i>Ketchum, MacLeod &amp; Grove</i>	
Cold Spring Granite Co. ....	34	Proudfoot Co., Inc. ....	94
<i>Kerker &amp; Associates</i>		<i>Harrison House</i>	
Columbia Lighting .....	10	Schinnerer, Victor O. & Co. ....	36
Consolidated Aluminum ....	12-13-14	<i>Govatos/Dunn, Inc.</i>	
<i>Weitzman &amp; Associates</i>		Shand, Morahan Co. ....	97
Continental Custom Bridge Co. ...	117	<i>Hakanson &amp; Associates</i>	
Dover Corp., Elevator Division ...	26	Solar Pathfinder .....	116
<i>Caldwell, Bartlett, Wood</i>		<i>Solar Pathways, Inc.</i>	
Epic Metals Corporation .....	109	Steelcase .....	98-99
Florida Tile (Sikes Corp.) .....	75	<i>Aves Advertising</i>	
<i>Fry, Hammond, Barr, Inc.</i>		Unistrut-Moduspan-GTE Sylvania	81
Forms & Surfaces .....	2	<i>Doyle, Dane, Bernbach, Inc.</i>	
<i>Sherrill Broudy &amp; Assoc.</i>		United States Steel Co. ....	15-16-17
GAF Corporation .....	95	<i>Compton Advertising</i>	
<i>Scali, McCabe, Sloves</i>		United States Steel Co. ....	86-87
Georgia Marble .....	23	<i>Compton Advertising</i>	
<i>Corporate Communications</i>		United Technical Products .....	109
<i>&amp; Marketing</i>		<i>Group 4 Advertising</i>	
Grefco, Inc. (Permalite) .....	106	Vernitron/Better Built .....	113
<i>Boylhart, Lovett &amp; Dean</i>		<i>Alden Advertising Agency</i>	
Haws Drinking Faucet Co. ....	31	Western Wood Products Assoc. ...	93
<i>Pacific Advertising Staff</i>		<i>McCann-Erickson, Inc.</i>	
Herman Miller, Inc. ....	20-21		
<i>The Cox Company</i>			
Holiday Inn Hotel Group .....	92		
<i>Bernard Hodes Advertising</i>			
Illinois Institute of Technology ....	114		
International Masonry Institute ....	85		
<i>Henry J. Kaufman &amp; Assoc.</i>			
Johns-Manville Bldg. Systems Div. 72-73			
<i>Broyles, Allebaugh &amp; Davis</i>			

**Subscriptions:** for those who are, by title, architects, architectural employees and to those in architectural education (faculty, schools and students), and to libraries, building construction trade associations and building products manufacturers: basic rate \$12 a year; \$8 to ASC/AIA affiliate members and student chapters (bulk orders) in the U.S., its possessions and Canada. For all others: \$18 a year in the U.S., its possessions and Canada; other countries to those who are by title, architects: \$18 a year. All others outside the U.S., its possessions and Canada: \$30 a year. Single copies: \$2.50 each. Publisher reserves the right to refuse unqualified subscriptions. For subscriptions: write Circulation Department; for change of address: send Circulation Department both old and new addresses; allow six weeks. Quotations on reprints of articles available. Microfilm copies available from University Microfilm, 300 N. Zeeb Road, Ann Arbor, Mich. 48106. Referenced in *The Architectural Index, Architectural Periodicals Index, Art Index, Avery Index to Architectural Periodicals.*

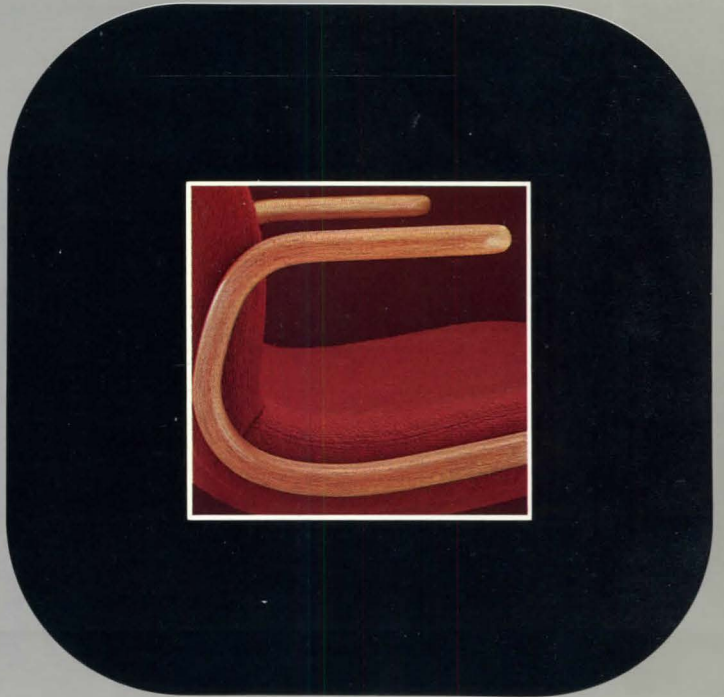

**FOCUS ON KIMBALL** Focus on the solid white oak radius of the 7000 Series, and the curved oak arms of FOCUS 1 chairs. Timeless, contemporary styling that stimulates the development of creative office interiors.



FOCUS 1 + 7000 SERIES



**kimball®**

KIMBALL OFFICE FURNITURE CO.  
A Division of Kimball International, Inc.  
1549 Royal Street • Jasper, Indiana 47546  
Telephone (812) 482-1600

Circle 53 on information card



## The Galaxy™ Suncontroller Blinds by Levolor. A friend in high places.

There's nothing like a skylight or overhead window to add drama to an interior. But these glass surfaces create problems, too, like annoying glare and heat build up.

Such problems can be solved beautifully with Galaxy Suncontroller Blinds by Levolor.

Galaxy Suncontroller Blinds are specially designed for hard to reach and hard to fit glazings: vertical or inclined windows, horizontal skylights and greenhouse areas of almost any shape and degree of incline.

You can use the Galaxy system in solaria, covered malls and walkways, even the highest atria. Wherever you want to admit sunlight, but not glare and heat. Controls can be manual or motorized.

The Galaxy Suncontroller is avail-

able with any one of three different slat sizes: Galaxy 25mm (one inch), 50mm and 80mm; in a wide choice of colors.

If you'd like to shed more light on how to handle special situations, write:

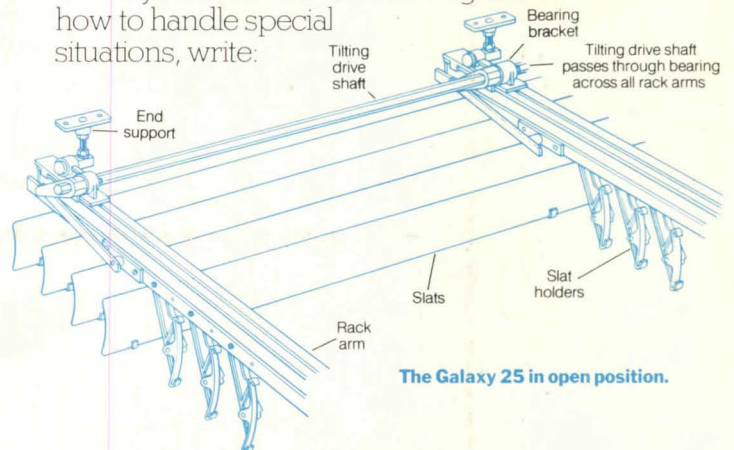

The Galaxy 25 in open position.

Levolor Lorentzen, Inc., 720 Monroe Street, Hoboken, N.J. 07030.

Ask for Levolor's Architects' Manual.

# LEVOLOR®

Made better Looks better

Circle 54 on information card