

# AAJOURNA

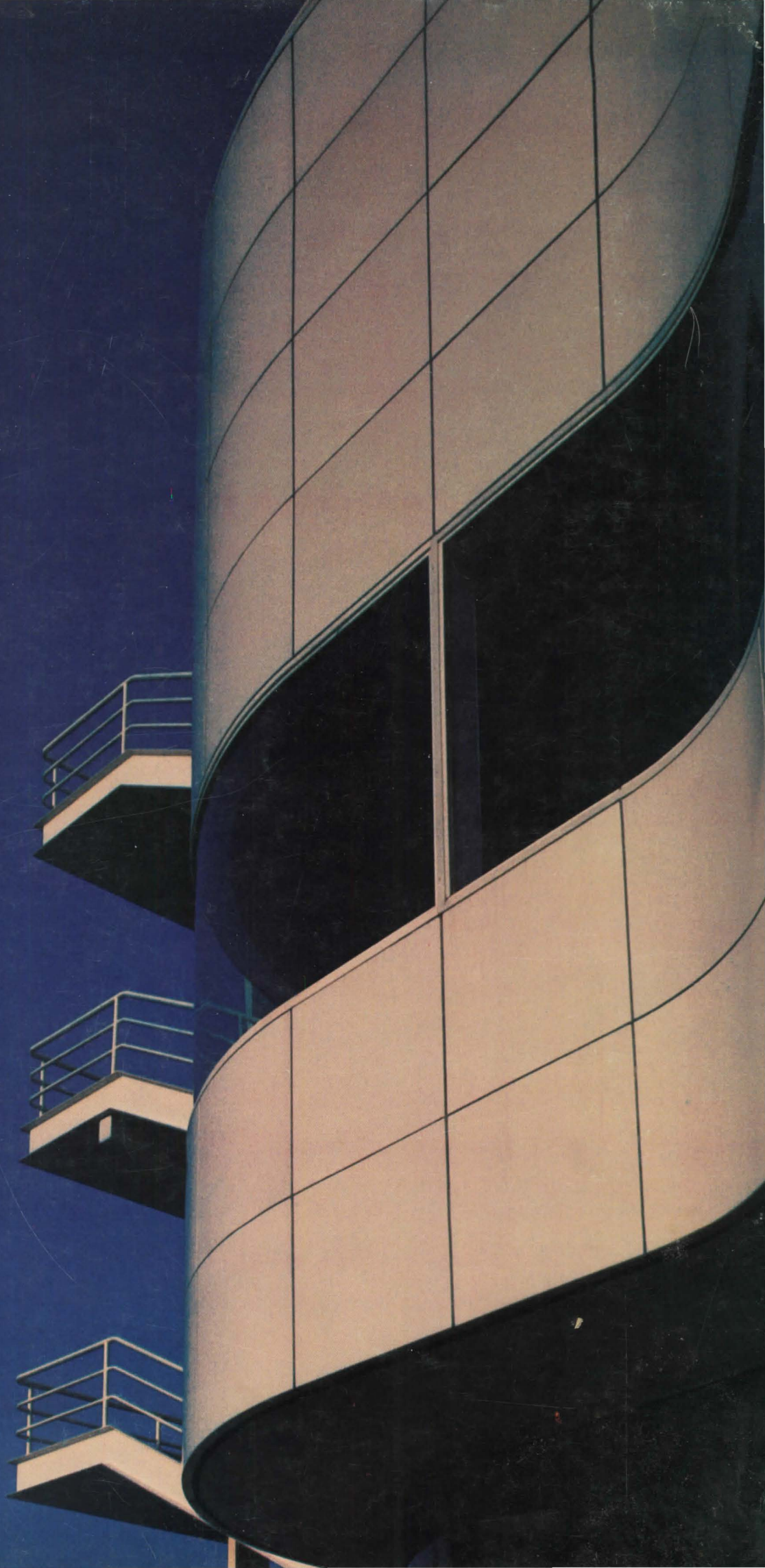





**EVERYONE WANTS A  
LINEAR-LOOK CEILING.  
NOW, EVERYONE CAN  
AFFORD IT.**

Now you can achieve the visual effect of an expensive linear-look ceiling—without all the expense.

Because Lineage Travertone™, a new acoustical ceiling from Armstrong, takes the contemporary look of linear ceilings popular in hotels, airports, and prestigious offices and translates it into a beautiful mineral-fiber ceiling tile.

Lineage Travertone is fire-retardant and installs easily in a concealed grid system. 12"x24"x3/4" tiles create the visual drama. And this Travertone design has an NRC range of .60-.70 and an STC range of .35-.39. Light reflectance is LR-1—over 75%.

Now, when you want to make the popular linear look a part of your design, you can do it at the reasonable cost of a quality mineral-fiber ceiling. For more information, see your Armstrong Representative, or write Armstrong, Dept. 05NAJ, Lancaster, PA 17604.

FROM THE  INDOOR WORLD® OF

**Armstrong**

*Circle 1 on information card*

**A** remarkable group of glazing products from the group at GE.

AT&T's Toll Call Relay Center in Atlanta. When it was designed, security was an important consideration. So was aesthetics. LEXAN<sup>®</sup> Sheet provided the solution for both.

Installation was trouble-free. And, eight years later, the LEXAN Sheet is still in place—still doing its job, and still looking good.

LEXAN Sheet glazing products are guaranteed against breakage.\* So tough, they're listed burglary-resistant by Underwriters' Laboratories.

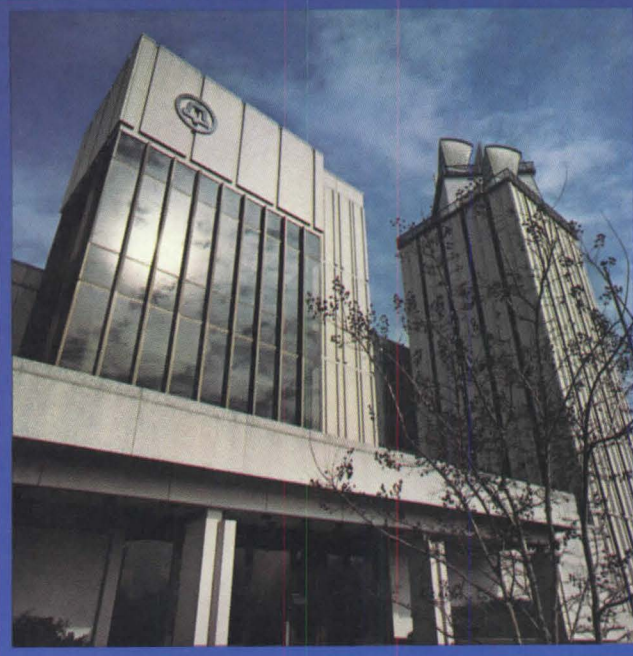

Available transparent, tinted, or pebble grained to suit your needs.

LEXAN Sheet gives you the freedom to create versatile, imaginative designs. Designs that stand up to the practical demands of the real world.

General Electric Company  
Sheet Products Section  
1 Plastics Avenue  
Pittsfield, Massachusetts  
01201

\*General Electric guarantees that if LEXAN sheet glazing breaks within three years from the date of purchase, replacement material will be provided at no charge. See Sweets Catalog 8.261GE for the specific details of the limited warranty.

® Registered Trademark of General Electric Company.

**Innovative design for a very real world.  
With LEXAN<sup>®</sup> Sheet from General Electric Company.**

**GE  
SHEET**

**GENERAL  ELECTRIC**

*Circle 2 on information card*

# CONTENTS

## The American Institute of Architects

### Officers

Charles E. Schwing, FAIA, *President*  
R. Randall Vosbeck, FAIA, *First Vice President*  
Gerald L. Clark, FAIA, *Vice President*  
Anna M. Halpin, FAIA, *Vice President*  
Thomas H. Teasdale, FAIA, *Vice President*  
Robert M. Lawrence, FAIA, *Secretary*  
J. W. Barnes, FAIA, *Treasurer*  
David Olan Meeker Jr., FAIA, *Executive Vice President*

### Directors (Year indicates expiration of term)

William Blurock, FAIA ('82), *California*  
James C. Dodd, AIA ('81), *California*  
Donald L. Hardison, FAIA ('80), *California*  
Harry W. Harmon, FAIA ('80), *California*  
R. Bruce Patty, FAIA ('82), *Central States*  
Henry W. Schirmer, AIA ('81), *Central States*  
P. Whitney Webb, AIA ('82), *East Central States*  
Ellis W. Bullock Jr., AIA ('81) *Florida/Caribbean*  
E. H. McDowell, FAIA ('81), *Florida/Caribbean*  
Gaines B. Hall, AIA ('81), *Gulf States*  
Ray K. Parker, AIA ('80), *Gulf States*  
Raymond C. Ovresat, FAIA ('81), *Illinois*  
Paul D. Bowers Jr., AIA ('80), *Michigan*  
David A. Holtz, AIA ('80), *Middle Atlantic*  
James R. Nelson, AIA ('81), *Middle Atlantic*  
John Avery Carter, AIA ('82), *New England*  
George M. Notter Jr., FAIA ('80), *New England*  
Harold D. Glucksman, AIA ('80), *New Jersey*  
Joseph Monticciolo, AIA  
William A. Rose Jr., AIA ('81), *New York*  
Leroy Bean, AIA ('82), *North Central States*  
Edwin B. Crittenden, FAIA ('81), *Northwest*  
William H. Trogdon, AIA ('80), *Northwest*  
Robert Gramann, AIA ('82), *Ohio*  
Derek Martin, AIA ('81), *Pennsylvania*  
John A. Busby Jr., FAIA ('82), *South Atlantic*  
Michael D. Newman, AIA ('80), *South Atlantic*  
William Caudill, FAIA ('82), *Texas*  
Theodore S. Maffitt Jr., FAIA ('81), *Texas*  
Pat Y. Spillman, FAIA ('81), *Texas*  
Thomas B. Muths, AIA ('82), *Western Mountain*  
John B. Rogers, FAIA ('81), *Western Mountain*  
Robert B. Pease, Hon. AIA, *ex officio, Public Director*  
Richard Martini, *ex officio, President, ASC/AIA*  
Ann Stacy, Hon. AIA, *ex officio, Chairwoman, Council of Architectural Component Executives*

### Headquarters

David Olan Meeker Jr., FAIA, *Executive Vice President*  
James A. Scheeler, FAIA, *Group Executive, Program and Services Management*  
Alan B. Stover, AIA, *Acting General Counsel*  
James A. Schuping, *Assistant Secretary*  
William G. Wolverton, Hon. AIA, *Assistant Treasurer/Controller*  
Michael B. Barker, AICP, *Administrator, Practice and Design*  
Francis X. Brown, *Administrator, Conventions*  
Muriel Campaglia, *Administrator, Public Relations*  
James E. Ellison, AIA, *Administrator, Education and Professional Development*  
David S. Godfrey, *Administrator, Publications*  
Arnold J. Prima Jr., AIA, *Administrator, Government Affairs*  
David Olan Meeker Jr., FAIA, *President, AIA Corporation*  
Jeanne Butler Hodges, *President, AIA Foundation*  
Charles R. Ince Jr., *President, AIA Research Corporation*  
John H. Schruben, FAIA, *President, Production Systems for Architects and Engineers, Inc.*

## The Third Annual Review of New American Architecture

- 125 A Vision Continued—Stanley Abercrombie, AIA  
138 Small in Everything but Quality—Allen Freeman  
144 An Exercise in 'Competence and Confidence'—S.A.  
156 When a Building Becomes a Machine—S.A.  
163 Federal Contribution to a City's Cohesion—S.A.  
165 Four-Faced Response to Energy Concern—Andrea O. Dean  
169 Of Art, Self-Revelation and Iconoclasm—John Pastier  
174 'Modularity Without Missionary Fervor'—S.A.  
181 Complicated Shapes, Moving Experiences—S.A.
- 
- 190 **What's Next for Architecture?**  
Answers from a varied group of practitioners and observers
- 
- 196 **Three Phenomena**  
The rise of regionalism, replication and exterior coloration—Donald Canty
- 
- 212 **The 1980 AIA Honor Awards**  
Seven new and six recycled buildings premiated—Mary E. Osman
- 
- 55 **AIA Component Awards**  
A sampling of state and local winners—Nora Richter
- 
- |                             |                        |
|-----------------------------|------------------------|
| 8 <b>Events and Letters</b> | 80 <b>Books</b>        |
| 15 <b>News</b>              | 348 <b>Advertisers</b> |

**Cover:** Photograph by Allen Freeman of Richard Meier's Atheneum, New Harmony, Ind. (see page 125).

**Donald Canty**, Editor; **Suzy Thomas**, Art Director; **Carole Palmer**, Associate Art Director; **Stanley Abercrombie**, AIA, Senior Editor, Architecture; **Mary E. Osman**, Senior Editor, Departments; **Andrea O. Dean**, Senior Editor, Articles; **Allen Freeman**, Managing Editor; **Nora Richter**, Associate Editor; **Virginia Dart**, Editorial Assistant; **Michael J. Hanley**, Publisher; **Michael M. Wood**, National Sales Director; **George L. Dant**, Production and Business Manager; **Terry L. Peck**, Circulation Manager; **David S. Godfrey**, General Manager

The AIA JOURNAL, publication number: ISSN0001-1471, official magazine of The American Institute of Architects, is published 14 times yearly at 1735 New York Ave. N.W., Washington, D.C. 20006. **Subscriptions:** for those who are, by title, architects, architectural employees and to those in architectural education (faculty, schools and students), and to libraries, building construction trade associations and building products manufacturers: base rate \$12 a year in the U.S., its possessions and Canada. For all others: \$18 a year in the U.S., its possessions and Canada; other countries to those who are by title, architects: \$18 a year. All others outside the U.S., its possessions and Canada: \$30 a year. Single copies, \$11.00 each. Publisher reserves the right to refuse unqualified subscriptions. For subscriptions: write Circulation Department; for change of address: send Circulation Department both old and new addresses; allow six weeks. Quotations on reprints of articles available. Microfilm copies available from University Microfilm, 300 N. Zeeb Road, Ann Arbor, Mich. 48106. Referenced in *The Architectural Index*, *Architectural Periodicals Index*, *Art Index*, *Avery Index to Architectural Periodicals*. Second class postage paid at Washington, D.C., and additional mailing offices. © 1980 by The American Institute of Architects. Opinions expressed by the editors and contributors are not necessarily those of AIA, vol 69, no. 6.

# Howmet's ideas and imagination

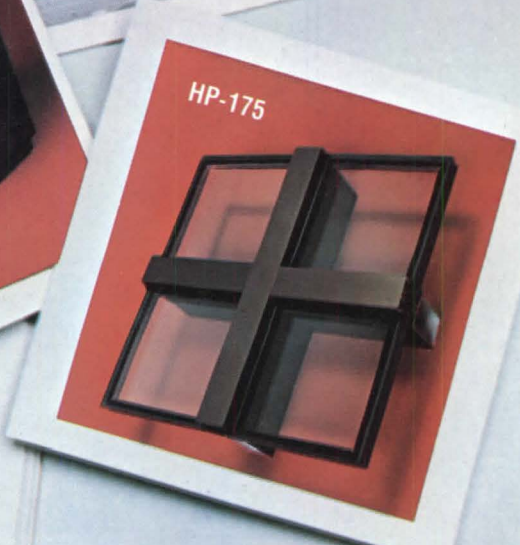

## Specifications

### PART II—PRODUCTS

- 2.1 CURTAINWALL: HP-175 Series as manufactured by Howmet Aluminum Corp.
- 2.2 VENTILATORS: Revolv-O-Vent as manufactured by Howmet Aluminum Corp.

# made saving energy beautiful.

Remodeling the First Alabama Bank in Montgomery presented several challenges. Not only did it need an easily installed, modern exterior, but increased energy efficiency for the 70 year old structure was also a major goal.

That's why Howmet's Architectural Products Division was called in early.

Their answer was Howmet's HP-175 Aluminum Thermal Wall System. HP-175 is the only system combining two important design features. First, it is completely thermally isolated since interior components are protected from heat and cold transfer by non-reversible, non-conductive injection molded clips. Additionally, HP-175 has a continuous, patented P.V.C. water diverter in horizontals to prevent water infiltration.

Howmet also brought a breath of fresh air to the project with Revolv-o-vent. Designed to glaze in like glass, this unique aluminum ventilator system lets employees totally control the amount of fresh air flow. The vent stays open at any position without latches or fasteners. When closed, Revolv-o-vent's fin-seal weathering material assures a tight, thermally efficient seal.

Both Howmet products were installed with virtually no interruption to the bank's normal routine.

In remodeling or new construction, Howmet meets customers' unique needs with custom-tailored solutions. Call us at (214-563-2624) and see.

#### HOWMET ALUMINUM CORPORATION

 A Member of the Pechiney Ugine Kuhlmann Group  
ARCHITECTURAL PRODUCTS DIVISION  
P. O. Box 629 - Terrell, TX 75160 - (214) 563-2624

Where Ideas and Imagination Are Only The Beginning

Circle 3 on information card

**“You don't have to be  
the biggest to be insured  
by the best.”**

**“Shand, Morahan?”**

**“Shand, Morahan.”**



It's the growing consensus of the leading architectural and engineering firms in the land: the E&O program available through Shand, Morahan & Company is about the best coverage you can have, at a most competitive premium rate. That's why so many of the ENR top 500 design and construction firms are choosing our insurance.

But your firm doesn't have to be among the biggest to enjoy the best in Architects and Engineers Professional Liability insurance. Shand, Morahan also extends its uniformly excellent claims-made program and unmatched standard of service to more and more medium and smaller-sized firms as well. These firms enjoy the same experience and attention that only the nation's foremost source for professional liability insurance can provide.

If your present Architects and Engineers Liability policy or premium might benefit from an analysis and comparison with ours, we welcome your insurance broker's inquiry. Whether you're among the biggest, or just want the best.

**SM Shand, Morahan  
& Company, Inc.**

*One American Plaza, Evanston, IL 60201*



# Rebuilding America

REMODELING AND RESTORATION OF COMMERCIAL, INDUSTRIAL AND MULTI-FAMILY BUILDINGS

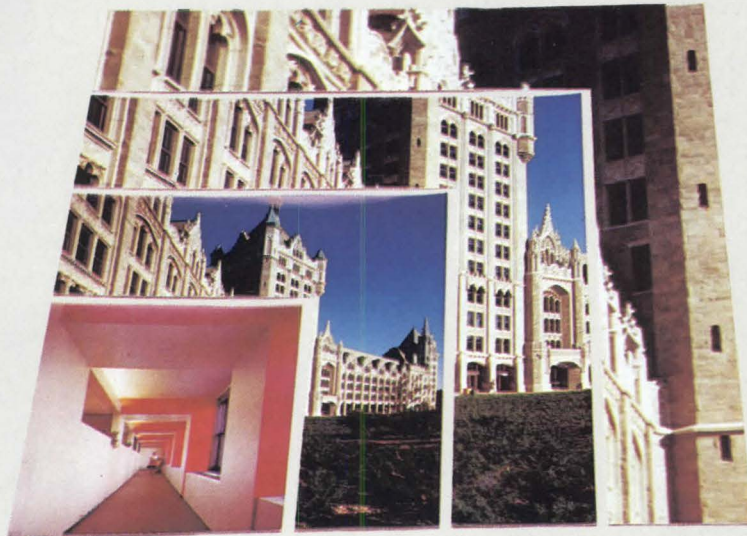

**Before you renovate,  
reconstruct, remodel, retrofit...  
send for this free booklet.**

This colorful 32-page booklet shows you actual case histories of a wide variety of projects plus information about specialized products. Included is a request card you can use to get specific information on those areas of particular interest to you.

Call it by any other name, remodeling is the fastest-growing trend in the building industry. And just as U.S.G. is a leader in the new construction field, we're also far ahead with products, systems and on-the-job experience in all phases of remodeling. We believe this expertise can be most helpful to you and we invite you to send in the coupon for your booklet today.

*Circle 5 on information card*

Commercial Remodeling, Dept. AJ580B  
United States Gypsum Company  
101 S. Wacker Drive, Chicago, Ill. 60606

Please send RE-Building America booklet to:

Name \_\_\_\_\_

Title \_\_\_\_\_

Company \_\_\_\_\_

Address \_\_\_\_\_

City \_\_\_\_\_ State \_\_\_\_\_ Zip \_\_\_\_\_

**UNITED STATES GYPSUM**   
BUILDING AMERICA

## EVENTS

**June 15-20:** International Design Conference, Aspen, Colo. Contact: IDC, Box 664, Aspen, Colo. 81611, (303) 925-2257.

**June 15-21:** Daylighting Institute, University of California, Berkeley. Contact: Michael Wilde, Daylighting Institute, Lawrence Berkeley Laboratory, University of California, Building 90, Room 3111, Berkeley, Calif. 94720.

**June 19-20:** Clean Air Act Seminar, Washington, D.C. Contact: Government Institutes, Box 5918, Washington, D.C. 20014.

**June 19-21:** Mid-Atlantic Solar Energy Association Solar Retrofit Conference, Princeton University, Princeton, N.J. Contact: MASEA, 2233 Gray's Ferry Ave., Philadelphia, Pa. 19146.

**June 21-26:** Association of Collegiate Schools of Architecture/AIA Teachers Seminar, Cranbrook, Mich. Contact: ACSA, 1735 New York Ave. N.W., Washington, D.C. 20006.

**June 23-27:** Advances in Color Technology Course, Rensselaer Polytechnic Institute, Troy, N.Y.

**June 24-25:** Land Use Issues of Non-metropolitan America Conference, University of Maryland, College Park, sponsored by the Association of American Geographers. Contact: AAG, 1710 16th St. N.W., Washington, D.C. 20009.

**June 24-25:** Windfall Profit Tax Conference, New York City. Contact: Energy Bureau, 41 E. 42nd St., New York, N.Y. 10017.

**June 25-July 1:** Interior Architecture Workshop, Kansas State University, Manhattan.

**June 27:** Deadline for letters of intent to enter, Owens-Corning Fiberglas annual energy awards program. Contact: Mary G. Reinbolt, Owens-Corning Fiberglas Corporation, Fiberglas Tower, Toledo, Ohio 43659.

**June 27-29:** Revitalization of Historic Neighborhoods Workshop, University of Wisconsin, Milwaukee.

**June 30:** Deadline for registration, international competition for students of architecture on the rehabilitation of a small unit in a degraded urban environment. Contact: Organizing Committee of the 14th International Union of Architects Congress, Foksal 2, B.P. 6-00-950 Warsaw, Poland.

**July 2-8:** Computer Graphics in the Design Profession Workshop, Kansas State University, Manhattan.

**July 6-11:** Summer Design Workshops, University of Illinois at Champaign-Urbana, sponsored by the Industrial Designers Society of America. Contact: IDSA, 1717 N St. N.W., Washington, D.C. 20036.

**July 9-11:** Understanding the Opportuni-

ties and Dangers of Nuclear Energy Course, George Washington University, Washington, D.C.

**July 9-15:** Energy and Community Workshop, Kansas State University, Manhattan.

**July 13-18:** Arts and Cultures of Native North Americans Workshop, Kampsville Archeological Center, Ill. Contact: Foundation for Illinois Archeology, Box 1499, Evanston, Ill. 60204.

**July 14-18:** Workshop on the use of solar technology in new and existing federal buildings, Oakland, Calif. (Repeat workshops: Aug. 11-15, Arlington, Va.; Sept. 22-26, Santa Fe, N.M.) Contact: Conferences Group, Solar Energy Research Institute, 1617 Cole Boulevard, Golden, Colo. 80401, (303) 231-7361.

**July 17-20:** North Carolina Chapter/AIA summer meeting, Wrightsville, N.C.

**July 26-31:** Energy + Design Summer Institute, Massachusetts Institute of Technology, Cambridge, Mass., sponsored by Association of Collegiate Schools of Architecture and the Department of Energy. Contact: ACSA, 1735 New York Ave. N.W., Washington, D.C. 20006.

## LETTERS

### More About Iran Than Is in the News:

There is an ironical twist to one of the principles laid down by Ralph Knowles in his excellent article, "Solar Access and Urban Forms" (Feb., p. 42).

In Teheran, and the more modern parts of other Iranian cities, residential streets run east to west. Houses on the north side of the streets—usually joined in continuous rows—are set back to the rear of the lots, behind a walled garden. The garden and the front of these houses receive maximum sunshine all winter long. (Teheran is at about the same latitude as New York City.) Houses on the south side of the street are built close to the street and have their gardens in the rear. Most of the garden and the rear wall of these (usually two-story) houses also receive maximum winter sunshine. This is the only consistent observation of solar principles at the city planning level that I have observed.

If you sketch a cross section of the Iranian arrangement of streets, houses and gardens, you will immediately be struck by its simple good sense. The equally spaced rows of houses it achieves (as opposed to the tendency in most row house schemes to place *both* rows of houses close to the street and to separate them on their rear sides with *two* deep garden spaces) offer increased privacy along with ideal solar orientation.

Now for the siting. The sketch will reveal that the Iranians have invented a scheme that assures that the *streets* will receive practically *no* winter sunshine.

I tend to feel that in the trade-off the Iranian scheme is better than the King of Spain's 45-degree street orientation, which is beneficial only if it is assumed that the traffic-way will be flanked by contiguous structures of two or more stories. I have shown, however, that a north-south street orientation 15 degrees off the compass is advantageous for single-story, free-standing houses (see Fitch's *American Building: The Environmental Forces That Shape It*, p. 102).

The Iranian scheme might also be improved, so far as the street is concerned, by leaving a shallow open space on the north side of the north-facing houses—expending a bit more land for this purpose. But it must be remembered that such a row house "front yard" would receive little sunshine except in summer.

In all of the above, it has been assumed that the architects of the houses have been sufficiently aware of solar orientation to develop quite different plans for the houses on opposite sides of the street. I'm not sure whether Iranian architects do this or do not, but I do know that they frequently attach glazed plant rooms to their houses, and *never* put them on the north side.

Henry Wright, AIA  
Wellfleet, Mass.

**A Toast to Seattle:** I would like to set the record straight regarding David Bowes' comment on Seattle in his article "The Shaping of a City's Character" in the March issue (p. 52). He tried to portray Cincinnati as a conservative, traditional community with a solid economic base. His contrasting remark was: "Forget Seattle, Detroit and other towns with one crop economies." Seattle is not a "one crop town."

Boeing, without a doubt, is the major manufacturing firm, but Seattle is also the second largest container cargo port in North America. It also is the commercial, governmental, medical and cultural center for the Pacific Northwest and Alaska.

Seattle probably has the soundest, most varied economy on the West Coast. Our economy is a blending of manufacturing, government and retail. Besides planes and missiles, we produce food, fish and lumber products, trucks, electronic components and projects for architects!

I think that Bowes' approach of relating a city's character to its economic base and architecture is admirable, but I wish he had done a little more research before making off-base commentary. Keith L. Boe  
Seattle

**Please note:** The change of AIA headquarters telephone numbers has been postponed from May 31 to June 27. On that date, the main number will become (202) 626-7300 and all extensions also will be changed.



**Primitive Encore.  
In the tradition  
of things  
created one piece  
at a time.**

In the beginning, everything was created one of a kind. Because everything was created by hand.

Today American Olean has recaptured this look in new Primitive Encore™ Ceramic Tile. Where each tile has its own special shading and character. It's a look synthetics can't even approach.

Recommended for floors, walls and counter tops, it's highly resistant to scratching and wear. And it offers superior slip resistance.

New Primitive® Encore. See it at an American Olean Color Center. (Check the Yellow Pages.) For a full color brochure, write to American Olean Tile Company, 2581 Cannon Avenue, Lansdale, Pa. 19446.



A National Gypsum Company

Shown—12" x 12", 806 Blue. Other Encore colors and sizes and harmonizing grouts also available.

**American Olean is Ceramic Tile.**

Circle 6 on information card



# 1980 OWENS-CORNING ENERGY CONSERVATION AWARDS: CALL FOR ENTRIES.



**AN ENERGY-EFFICIENT DESIGN** isn't created by a committee on a one-dimensional blackboard.

Rather each design is born in the mind of an architect or engineer. A three-dimensional world where an idea can be developed. Shaped to an environment. Built in theory even before pencil has been put to paper.

Owens-Corning would like to honor those specific architects and engineers responsible for conceiving and creating the most energy-efficient designs of 1980.

Registered architects or professional engineers practicing in the United States may enter as

individuals or in teams. The building entry must be a commissioned project: new or remodeled, in the design process, under construction or completed.

A panel of proven professionals in architecture and engineering will act as jury. Entries must be submitted by August 29th, 1980. Winners will be notified in early October.

The Call for Entries has full details. For your copy, write today to Mary Reinbolt, Department 125, Owens-Corning Fiberglas Corporation, Fiberglas Tower, Toledo, Ohio 43659. Or call her at this number: (419) 248-7419.

© O.-C.F. Corp. 1980



Circle 7 on information card

# A dash of dazzle in a shopping center. **ELEVATOR BY DOVER**

It's quite a trip for shoppers when they move from the main level to the promenade level of the Rolling Acres Mall in West Akron. Designer James B. Heller of Keeva J. Kekst Associates combined glass, chrome, and incandescent lamps to create a "vista" elevator that dazzles and delights. At the heart of these glamorous trappings is a Dover IVO Elevator, the high quality, pre-engineered Oildraulic<sup>®</sup> elevator made for add-on or new construction of three stories or less. For more information on the complete Dover line of traction and hydraulic elevators, write Dover Corporation, Elevator Division, P.O. Box 2177, Dept. G, Memphis, Tenn. 38101.

**DOVER**<sup>®</sup>  
The elevator  
innovators.

Rolling Acres Mall,  
Akron, Ohio  
Developer:  
Forest City Rental Properties  
Corporation and  
Richard B. Buchholzer  
General Contractor:  
Forest City Dillon, Inc.  
Architect: Keeva J. Kekst  
Associates, Architect, Inc.  
Cab Designer:  
James B. Heller  
Dover IVO Elevator sold  
and installed by  
Dover Elevator Company

Frontier Fruit & Nut Co.

**Location:** Jackie Robinson Middle School, New Haven, Ct.  
**General Contractor:** The Fusco—Amatruda Company  
**Architect:** Stull Associates, Boston, Mass.



Exposed ductwork is often required in a building design. This may be by necessity or application of the architectural function – beauty design concept. Function may produce beauty, but ductwork needs all the help it can get.

United Sheet Metal's standardized, factory machine-formed duct and fittings make exposed ductwork an economical, attractive, architectural design feature.

Available in both spiral round and flat oval configurations, the complete uniformity and smooth lockseam construction make it a design asset in any exposed installation. And, you can specify any desired paint finish on our 'Paint Grip' galvanized steel duct.

Where noise and thermal control are critical, United's internally insulated, Acousti k-27 duct and fittings are the answer, and provide the same attractive exterior appearance.

# How to turn exposed duct into a work of Art

Of course, the beauty of our duct and fittings is more than skin deep. We have been the leading manufacturer of quality, factory-made duct and fittings for all types of commercial and industrial HVAC applications for over a quarter of a century.

**Send for our comprehensive Engineering Bulletin on "Exposed Duct Work" - Vol. 1**

**No. 3.** Circle the reader service number below or contact: United Sheet Metal, 200 E. Broadway, Westerville, Ohio 43081. Telephone: 614/882-7401.

**United McGill**  
Corporation

**United Sheet Metal**

Circle 9 on information card

Forms & Surfaces presents a comprehensive collection of wood grilles for room dividers, walls and ceilings. Constructed of the finest quality solid woods or selected hardwood veneers on composite wood cores, these grilles are handsomely detailed and handcrafted. Available unfinished, finished, or with Thermo-lag fire retardant finish.

Forms & Surfaces Box 5215  
Santa Barbara, CA 93108 (805) 969-4767

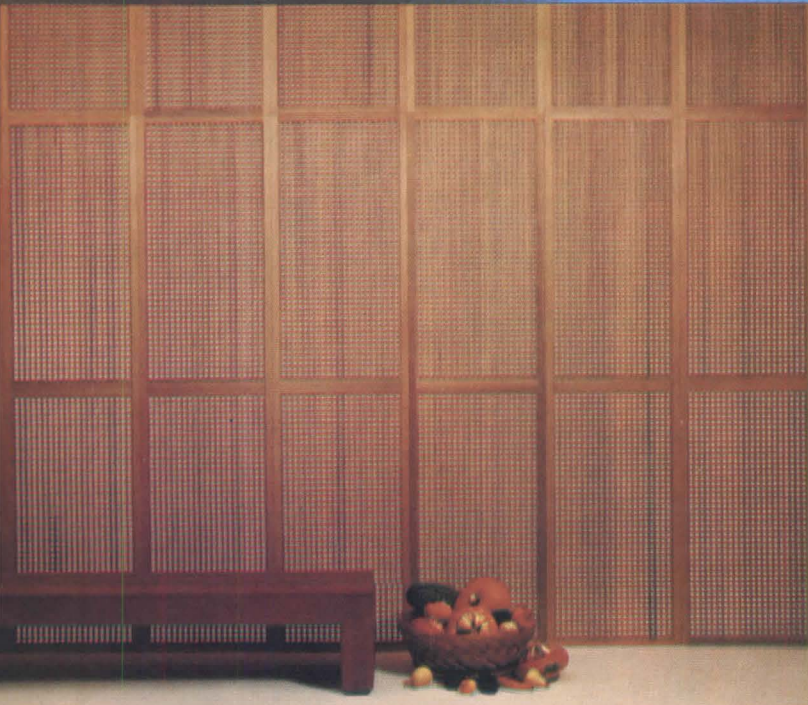

FORMS+SURFACES



## Repository for Buddhist Temple In Japan Wins Reynolds Award

A treasury building for a Buddhist sect in Japan, designed by Shozo Uchii, is the recipient of the 1980 R. S. Reynolds memorial award, given annually in recognition of a "permanent, significant work of architecture, in the creation of which aluminum has been an important contribution." J. Rodgers Critz, fifth-year student at the University of Arkansas, is the winner of the 1980 Reynolds aluminum prize for architectural students for his design of a passive solar wall panel.

The Minobusan Kuonji Temple, sited at densely forested Mount Minobu in central Japan, is headquarters for the Nichiren sect of Buddhism. For more than 700 years it has been visited by worshippers. Its treasury building, erected to replace a deteriorated *godown* (warehouse), stores and preserves the temple's objects of religious faith—sutras, religious documents, statuary and art objects and other cultural possessions. The treasury, one of the temple's most important elements, necessarily has a spatial relationship in its siting with other buildings that make up the temple complex. Located at 1,625 feet above sea level in a deep forest, the treasury conforms to the natural topography, with its back abutting a steep cliff.

Uchii says that the problem of architectural form for the treasury was difficult because the structure had to be in keeping with the general image of Buddhist architecture, and yet make use of modern technology in fulfilling its function as a protector of priceless objects from humidity, natural disasters and crime. The problem was confounded by the site conditions of limited space and of weak ground base where there are frequent landslips. Also, many temple buildings in the past had been destroyed by forest fires.

The treasury is comprised of two small buildings, clad with cast aluminum panels, that are separated by a white granite stairway. "The main storage floor of the structures is raised above ground just more than the height of a human and is

cantilevered from a concrete base forming a small open storage space under the building," says Ehrman B. Mitchell Jr., FAIA, chairman of the jury, on which Bill N. Lacy, FAIA, and Michael Austin-Smith, Hon. FAIA, of Great Britain also served.

The panels, says Mitchell, establish a "disciplined module appropriate for the size of the buildings." The size of the panels and their proportions and the raised horizontal ribs appropriately set the scale of the treasury. "They impart a very real sense of dignity and give a distinctive quality to the buildings. Their careful detailing and the high craftsmanship of their manufacture are truly representative of the symbolic importance of the treasury to the monastery."

Mitchell also comments on the detailing of the eaves that overhang the walls, saying they are reminiscent of early wood temple structures. Designer Uchii also

says that it is the treatment of details that causes the treasury to exhibit the image that people "expect of a temple building." He mentions the copper roofing that not only reinforces the roof, but also enriches the building's architectural expression.

There is a triple wall system with double air layers. A concrete wall is sandwiched by a wooden interior wall and the cast aluminum skin. This triple wall system helps control humidity. There is natural ventilation and, except for electric lighting, there are no other mechanical systems.

The interiors are of Japanese cypress, covering floors, walls and the sloped ceilings that follow the rake of the roof. Storage cabinets and shelving to house the treasures are of the same material. "Fine craftsmanship has never been better demonstrated," says Mitchell.

The Reynolds prize for architectural students is awarded annually "for the best original design in which creative use of aluminum is an important contributing factor." The passive solar wall panel designed by J. Rodgers Critz uses aluminum louvers to block the summer sun and let in the sun in winter. The design provides a wafer of salt hydrates to provide ther-

*continued on page 20*



O. Murai

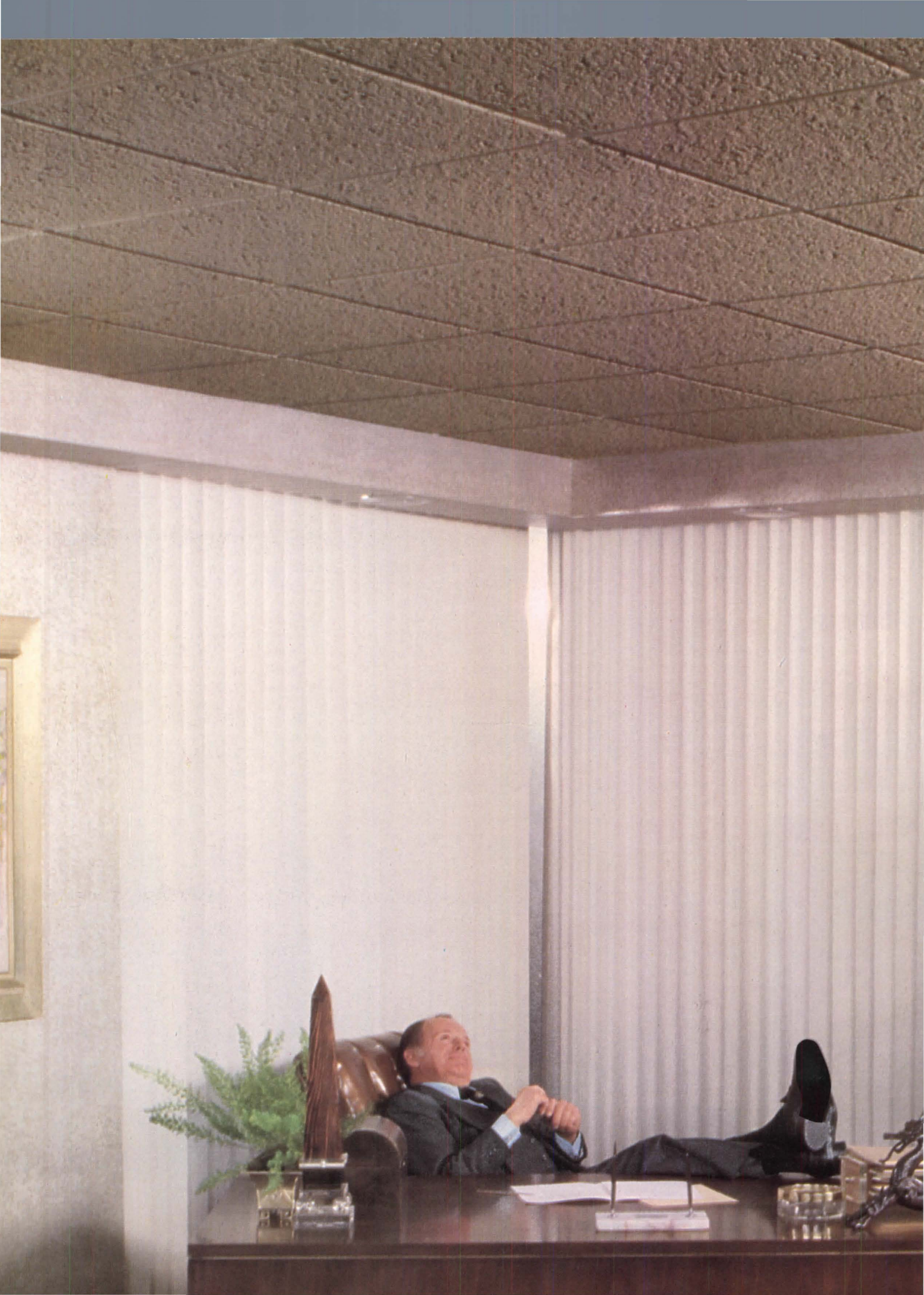



**WHEN THE  
CHAIRMAN  
OF THE  
BOARD  
HAS NOTHING  
TO DO  
BUT STARE  
AT THE  
CEILING,  
GIVE HIM  
SOMETHING  
BEAUTIFUL  
TO STARE AT.**

*Celotex has just come up with a new line of prestige acoustical ceiling panels for executive suites.*

*We call it Celotex Colortone. And we designed it to go over the heads of most of the heads of business.*

*Celotex Colortone is very special for several reasons.*

*To start, it comes in five rich and luxurious colors. The names alone will probably make you want to get hold of a sample. Cattail, Jute, Reed, Pampas and Sage.*

*The colors of these high-quality panels go right through. From top to bottom. So if they chip or get cut, you'll never notice it.*

*And they have a "reveal edge" design.*

*Giving the installation a handsome custom-designed three-dimensional look.*

*For more information about Celotex Colortone acoustical ceilings, contact your Celotex representative.*

*Celotex Colortone. They'll definitely make the suite smell of success.*

**Celotex<sup>®</sup>**

a Jim Walter company

Circle 11 on information card



## Design Concepts

A New Age in Laminate

A group of thirty-eight extraordinary expressions—unique, preemptive. Originated in decorative laminate exclusively by Formica Corporation with guidance from its Design Advisory Board.

Design Concepts. Solid colors. Highest gloss lacquer finishes. Surface textures creating basic shapes of the purest form.

To receive samples, refer to our listing in Sweet's Catalog, Section 6, or contact your nearest Formica Corporation Distributor.



decorative laminate

FORMICA® is a registered trademark of Formica Corporation, Subsidiary of American Cyanamid Company, Wayne, N.J. 07470.

Circle 12 on information card



## Integrated Ceilings gets technical.

Introducing *Linea*, the brand new ceiling with the high-tech attitude.

Brightly painted baffles are hung below the structural ceiling. Piping, air vents and utility systems are painted out black. Lighting comes from down lights, track or both.

The look is quite bold.

However, your client may not be. In that case, *Linea* becomes a more conventional luminous ceiling simply by laying inexpensive light diffusers



on the grid above the baffles, with fluorescent strips providing the light from above.

Either way, *Linea* is a handsome, one-directional look that's flexible, easy to maintain, easy to specify, damage resistant and surprisingly affordable.

*Linea*. High-tech up high. From Integrated Ceilings. Send for information.

*We don't just have your ceiling. We've got your color. And if we don't, we'll do a little mixing. And then we will.*

**Integrated Ceilings, Inc.**

2231 Colby Avenue, Los Angeles, California 90064 (213) 478-0043

Circle 13 on information card

AIA JOURNAL/MID-MAY 1980 19

## 29 HUD-Supported Projects Cited in 1980 Design Program

HUD's Secretary Moon Landrieu recently presented 29 design awards. The winners were chosen from more than 350 entries, all HUD-supported projects.

Honor awards for project design were divided into four categories—housing, community facilities, open space and downtown revitalization. Winners in the housing category were the Gardens Apartments, San Mateo, Calif. (Backen, Arrigoni & Ross, architect); Glencoe Apartments, Cincinnati (Goetzman & Follmer); Ponderosa Village, Camarillo, Calif. (Kamnitzer, Cotton, Vreeland); Villa Victoria, Boston (John Sharratt Associates), and Walnut Hill Apartments, Haverstraw, N.Y. (Smotrich & Platt).

The Butterfield Senior Center, Cincinnati (Smith-Stevens), was the sole winner in the community facilities category.

The open space category winners were Heritage Plaza, Salem, Mass. (Delta Group); Western Canal and Ecumenical Plaza, Lowell, Mass. (Paul C. K. Lu & Associates), and World War II Veterans Memorial Park, Woonsocket, R.I. (Albert Veri, landscape architect). Special mention went to Gas Works Park, Seattle (Olson/Walker, consulting architect; Richard Haag Associates, consulting landscape architect).

In the downtown revitalization category, awards were presented for the Gallery at Market East, Philadelphia (Bower Fradley Lewis Thrower); the pedestrian mall and revitalization program, Boulder, Colo. (Everett, Zeisel, Tumper & Hand), and the waterfront urban renewal project, Boston (administrative team of the Boston Redevelopment Authority).

Special mentions in this category were the Downtown Public Square, Wilkes-Barre, Pa. (Bohlin Powell Brown Larkin Cywinski); New London (Conn.) Union Station (Anderson Notter Finegold), and the renovation of the central business district, Hudson, N.Y. (Historic Design Associates and Robert Pollack, AIA).

Honor awards for urban design concepts were given for the Cambridge (Mass.) urban environmental design process (administrative team for the Alewife and River Front development concepts) and the Coldspring new town, Baltimore (Moshe Safdie & Associates). Special mentions went to the downtown waterfront development strategy, Portland, Ore. (Zimmer, Gungel & Frasca Partnership; Skidmore, Owings & Merrill; Allen, McMath, Hawkins; Arkitektgruppe) and to the Washington Avenue revitalization program, Miami Beach (Venturi, Rauch & Scott-Brown).

Awards for urban design administration  
*continued on page 27*

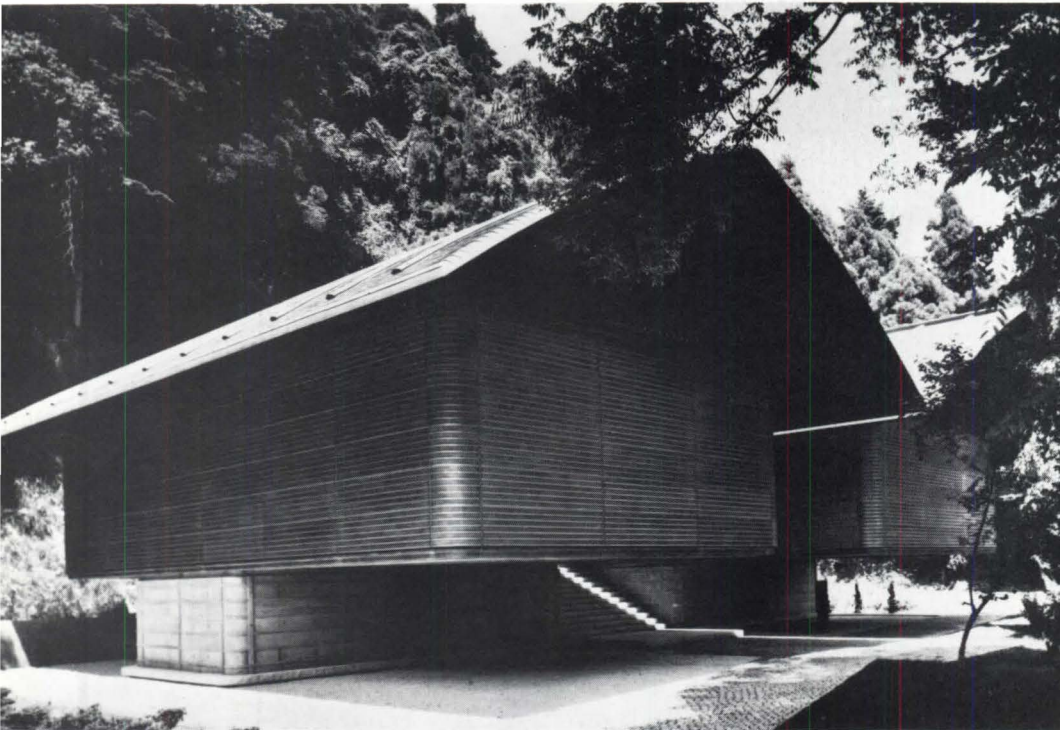

*The treasury consists of two identical, parallel aluminum buildings with widely overhanging copper roofs, joined by a granite stairway leading to their entries.*

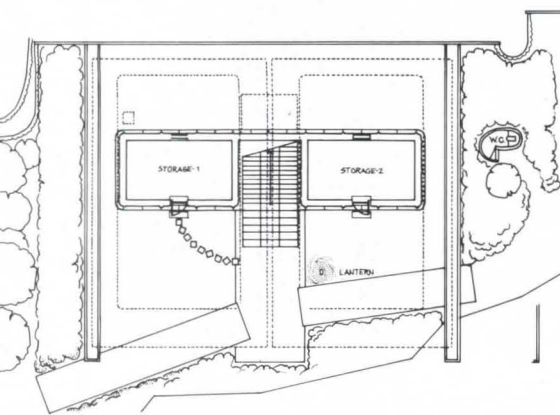

### News from page 15

mal storage. The air that comes in from openings at floor level is heated between the salt wafer and a sandwich of aluminum/urethane foam insulation. The space created permits the heated air to rise and escape through automatic thermal valves at ceiling level and to circulate into the room by thermosiphoning. Critz says that the panels can be used in both small and large building projects for either new construction or adaptive use in existing structures.

Two honorable mentions were given: to Stephen Lu, a student at Pennsylvania State University, for an emergency shelter that could be brought into a disaster area by helicopter and to Tina A. Christiansen and James C. Cauthorn, students at Virginia Polytechnic Institute and State University, for the design of an "articulating solar shutter" to improve the energy efficiency of a window using reflective/insulative panels. Four certificates of excellence were given to Modesto Padilla, Texas Technical University; Robert Tad Silance, Cynthia Jean Cantwell, Walter James Montgomery and Philip Lance Kianka of Clemson University; Robert Condia and Wendy Orenelas-Condia, and to Faziur Ali, Jose Bon and George Hernandez, students at the University of Miami at Coral Gables, Fla.

Jurors were Donn Logan, AIA (chairman); Ray D. Crites, FAIA; Janelle Forgette, student at Washington University; Warren R. Freyer, student at Pratt Institute, and George Kewin, 1979 national prize winner.



# Introducing Sunglas® Reflective, it blocks up to 65% of the sun's heat.

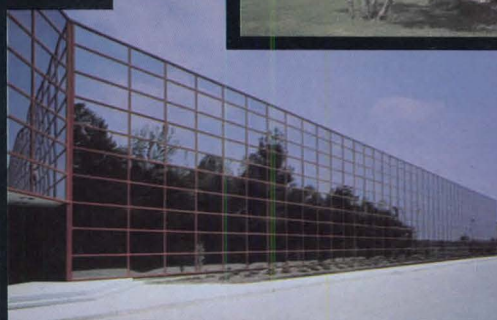
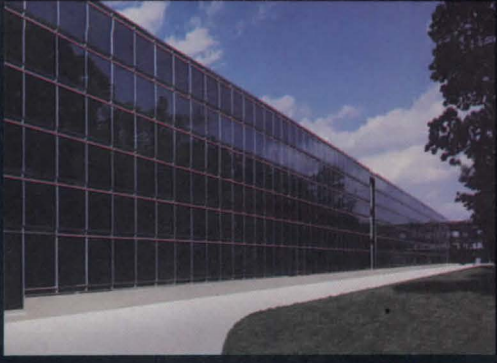

## New Sunglas Reflective blocks the heat to help reduce the high cost of air conditioning.

Installing Sunglas Reflective can, over the lifetime of your building, amount to a saving of thousands of dollars. Because it blocks up to 65% of the sun's heat, it can aid in cutting air-conditioning operating costs and may allow for the use of smaller air-conditioning units.

## A new concept – blocks the heat. Yet lets in the daylight.

While Sunglas blocks the sun's heat, it lets in more daylight than most other reflective glass products. This means reduced solar heat load while permitting the use of natural daylight for illumination – this

unique property presents another big saving potential. It also helps minimize hot spots so room temperatures remain more uniform and comfortable.

## Ford Sunglas Reflective for a natural color view of the outdoors.

Sunglas Reflective lets in the beauty of the outdoors without noticeably affecting its natural color. The neutral silver coating reflects the surrounding outside environment and provides a full-color view of colors throughout the day.

## New Computer Program shows you how to S.A.V.E.

Ford's new computerized S.A.V.E. program (Systems to Analyze Value and Energy) can help you determine your solar glass requirements and savings quickly. Find out more about the S.A.V.E. program and Sunglas Reflective so you can take the heat off you *and* your budget. Sunglas Reflective is available now and it can be

cut, tempered and fabricated locally. You'll find that choosing Ford Sunglas Reflective will be a nice reflection on you.

## Sunglas Reflective is backed by Ford experience and a 10-year warranty.

Before we ever marketed Sunglas Reflective, we field-tested more than 2,000,000 square feet of it. The result? When the heat was on, Sunglas Reflective performed very cool. For more information, send for our detailed product information kit including all the specifics of our warranty by writing: Ford Glass Division, 300 Renaissance Center, P.O. Box 43343, Detroit, Michigan 48243, or call toll free 1-800-521-6346.

 **GLASS DIVISION**

Circle 14 on information card

# When you order an open office ceiling Ron Moulder free.

Every Open Office Ceiling System from Owens-Corning comes with its own acoustician.

He's part of the package, along with the acoustically designed lighting, air delivery system, ceiling boards, and a sound masking system.

If you've worked with open offices before, you know the biggest challenge is *speech privacy*. That's why you need your own independent acoustical consultant right from the start *and* the right ceiling.

Owens-Corning has the ceiling. We make eleven different Integrated Ceiling Systems. Each one absorbs and camouflages sound, so the people working under them get the speech privacy they need.

Here's how the Open Office Ceiling System works:

**1. The Fiberglas\* ceiling boards** soak up office noises. They have a speech privacy Noise Isolation Class rating of 20—the ideal rating for open offices. (The open sky has a rating of 23.)

**2. The air delivery system** distributes air quietly and evenly along the gridwork without ugly diffusers. It's one of the few systems that can promise no hot or cold spots.

**3. The light fixtures** are engineered for high visibility, low glare, energy conservation, and acoustical performance.

**4. The sound masking system** installed above the ceiling emits a precisely tuned sound that makes conversation unintelligible from office to office.

This system is absolutely crucial to open office speech privacy.

**5. Acoustician Ron Moulder** is an Owens-Corning exclusive.

He and his team of acousticians come and fine-tune the sound masking system to the particular requirements of your environment. Their adjustments are a major step your consultant will require to

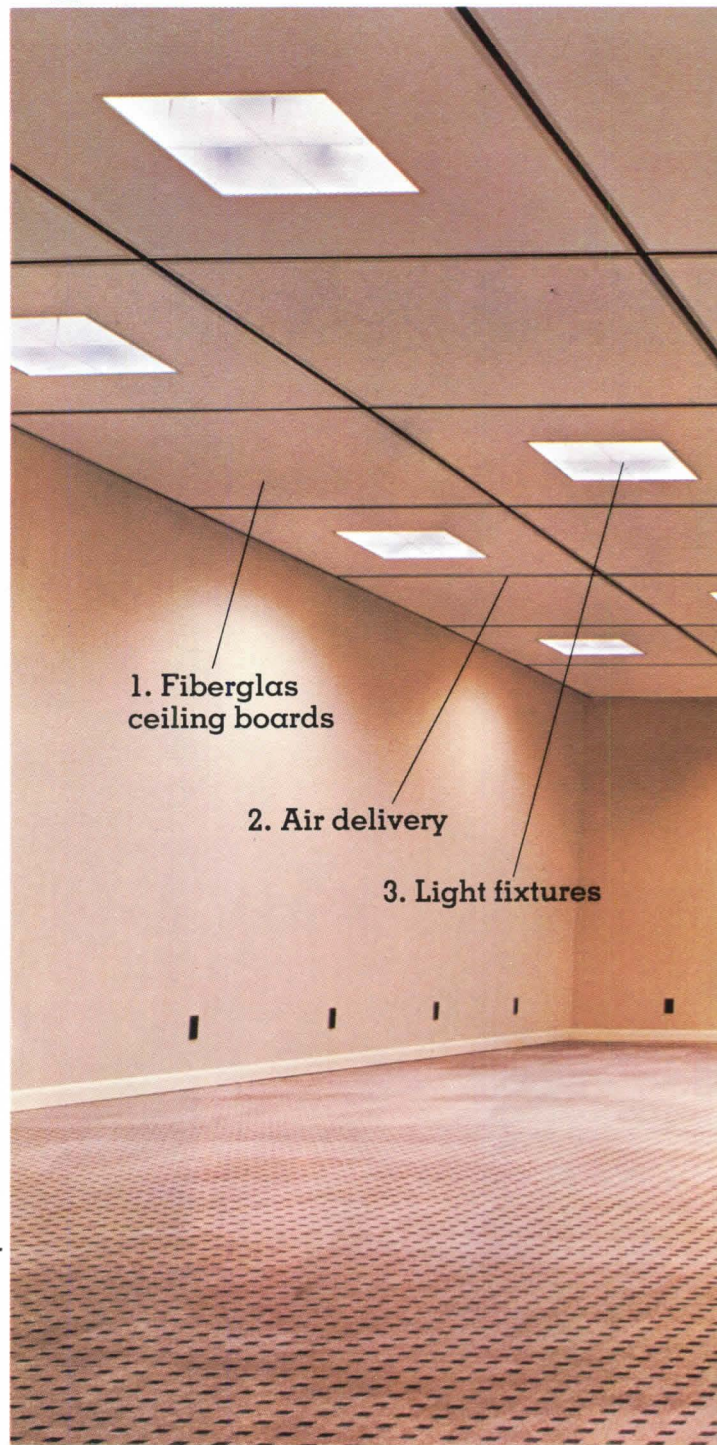

ensure the total performance of your open office.

Give your specifications to Owens-Corning, and our experts will help you select the right system for your open office.

Send for the free *Integrated Ceiling Systems Manual* with this coupon. (Or look it up in *Sweet's Catalog*, Section 13.5.)

Your big beautiful space doesn't have to become another big noisy place.



# system from Owens-Corning you get

®T.M. Reg. O.-C. F. Corp. ©1979 O.-C.F. Corp.



4. Sound masking system  
(hidden in plenum)

5. Ron Moulder, acoustician



**The only open office that works** is the one that's designed acoustically.

We will be glad to share with you the things we've learned.

Please send me the following booklets:

- Integrated Ceiling Systems
- Speech Privacy in the Open Office
- Sound Dividers
- Acoustical Wall Panels

Name \_\_\_\_\_

Title \_\_\_\_\_

Company \_\_\_\_\_

Address \_\_\_\_\_

City \_\_\_\_\_

State \_\_\_\_\_ Zip \_\_\_\_\_

Mail to: A.H.Q. Meeks, Owens-Corning  
Fiberglas Corporation,  
Fiberglas Tower,  
Toledo, Ohio 43659.

Circle 15 on information card

# THE CORRIDOR SOLUTION

We couldn't help but notice that most corridors are 8 feet wide. So we make our beautiful Flor-Ever<sup>®</sup> sheet vinyl flooring 9 feet wide. And look-no seams!



## THE ALTERNATIVES

An alternative to our 9' commercial vinyl is 6' flooring which results in unnecessary seams.

The Congoleum<sup>®</sup> corridor solution saves installation time and money, too. Furthermore, maintenance is minimal. Our

commercial grade Congoleum sheet vinyl has a tough, non-porous wear-layer that usually needs nothing but damp mopping or buffing to keep it looking new for years.

The real workhorse of our commercial line is called *Flor-Ever*, which is engineered for durability at an extremely competitive price, making it the best value on the market. Also, *Flor-Ever* is styled and colored to meet your design needs.

In addition to our efficient 9' widths, all Congoleum commercial vinyl comes in 12' widths, too. So for every corridor or floor you specify, you'll find we have a beautiful solution.

For further information, call a Congoleum flooring contractor, Sweet's Toll-Free Buy Line (800)447-1980, or write Director of Marketing, Congoleum Corp., 195 Belgrove Drive, Kearny, N. J. 07032.

# Congoleum

The United States Davis Cup team is sponsored by Congoleum.



## THE COMPANY OF FIRSTS

First printed felt-based flooring 1906 • First inlaid vinyl sheet flooring 1948 • First 12' rotogravure vinyl flooring 1957 • First chemical embossing 1963 • First family of no-wax floors 1968 • First 15' vinyl flooring 1974 • First Chromabond<sup>®</sup> system 1978 • First dimensionally stable unbacked vinyl flooring 1980

Circle 16 on information card

# Thick Skinned and Open Minded

Seating in the Open Plan System should adapt to the working environment.

Chairs move. They impact against walls, work surfaces, tables, storage units and people.

The GF 570 chair is soft self-skinned urethane outside. Tough structural steel inside. It protects people and hardware.

Seven task-oriented models stand firm on four or five star bases; move freely on dual wheeled casters and absorb impact with flexing leg bumpers.

The 570's adjustable comfort settings adapt to varied human postures and scale. The gentle sloping of the seat edge reduces muscle tension and leg fatigue.

Available in three frame colors and a wide range of upholstery materials, it adapts to your open plan specifications.

The GF 570. Thick skinned and open minded.



GF Business Equipment



## The GF 570 Chair for the Open Plan System

Contact us for the Dealer nearest you. GF Business Equipment / Youngstown, Ohio 44501/216-746-7271

*Circle 17 on information card*

# More power to you.



**Tempo 3 delivers.** It's the open office system designed to manage the electronics explosion. Easily. Effectively.

**Real Capacity.** Our unique design offers four raceways in each panel base—room for up to *sixteen* 25-pair cables and six 20-amp circuits.

**True Flexibility.** Our modular wiring makes rearranging easy. Order pre-wired outlets on one or both sides, in the base or at desk height. And outlets can be added anytime.

So don't get caught with your power down. Let us show you *all* the advantages of Tempo 3. Call your Shaw-Walker representative. Or write Shaw-Walker, 935 Division Street, Muskegon, Michigan 49443.



**SHAW | WALKER**

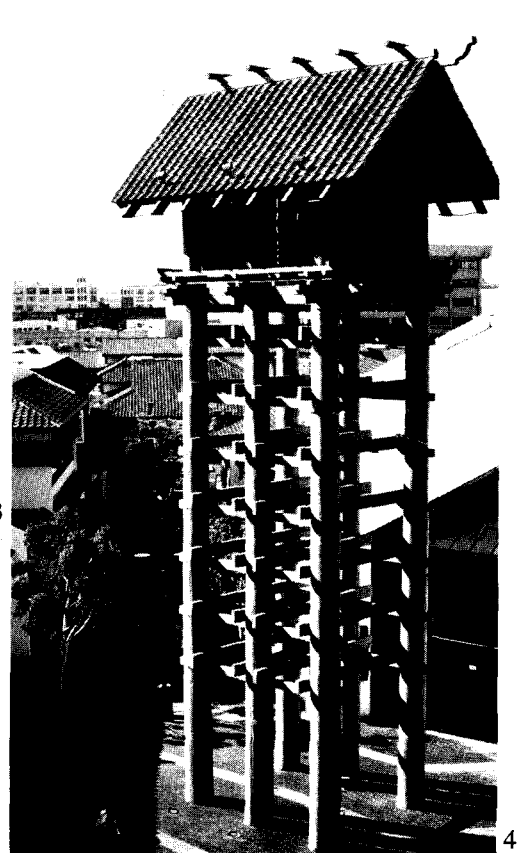
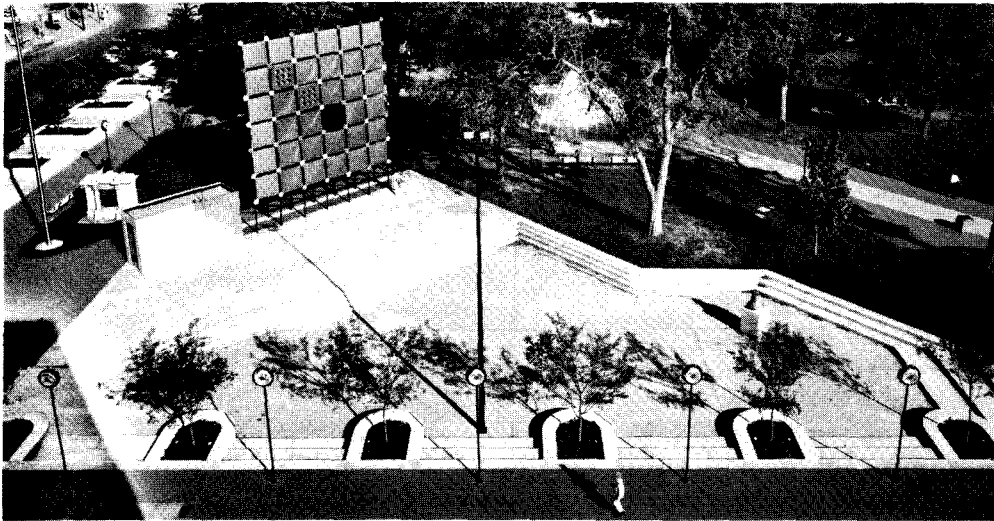
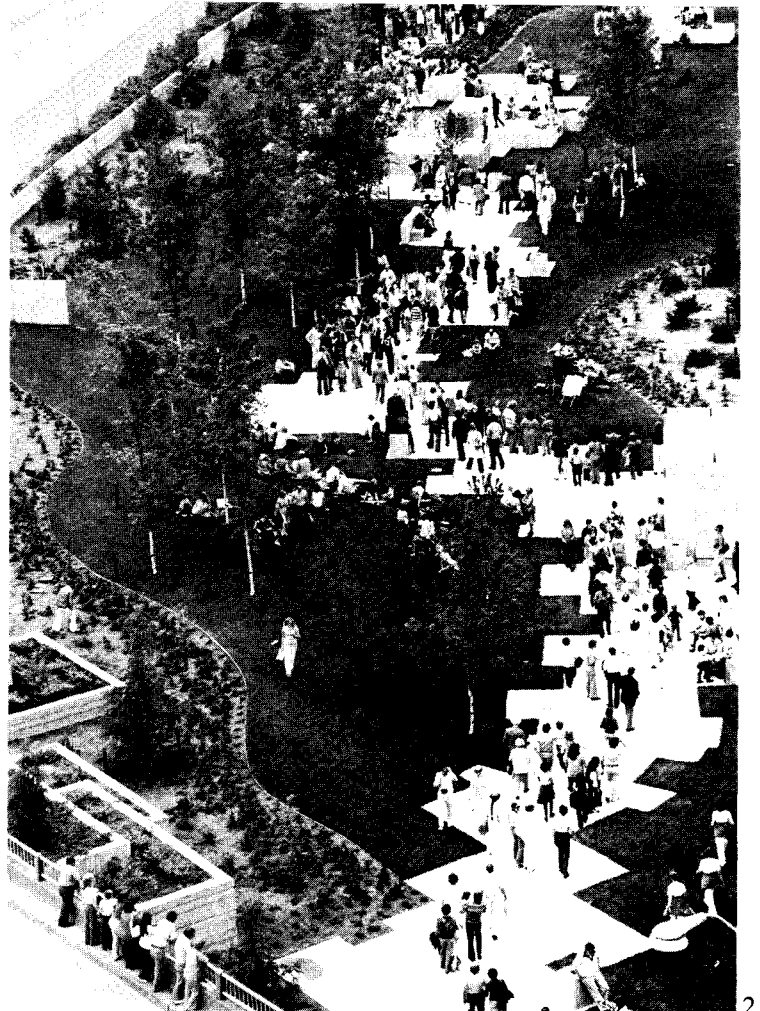
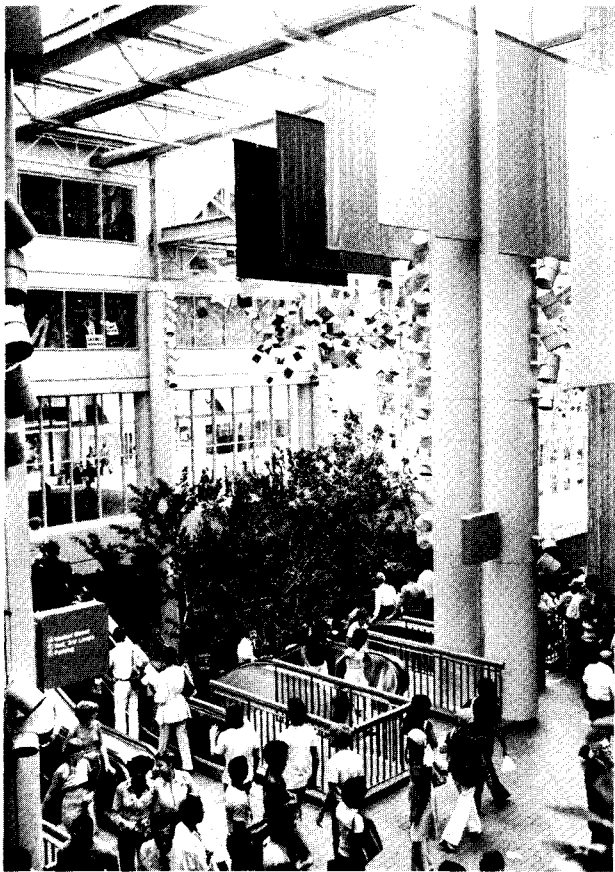

**News from page 20**

tion were given for the *Focus* community development newsletter, Milwaukee (Milwaukee Department of City Development), Freeway Park, Seattle (Lawrence Halprin & Associates, landscape architect); the Gallery at Market East, Philadelphia (Bower Fradley Lewis Thrower); Japanese Village Plaza, Los Angeles (David Huyn Associates) and the old city study and facade easement program, Philadelphia (Philadelphia Historical Commission).

Special mentions in this category were awarded for the facade/rehabilitation grants program, Macon, Ga. (James P. Thomas and Brittain, Thompson, Olson & Bray, urban designers); housing development guidelines, Albuquerque, N.M. (Robert E. Strell, Albuquerque Housing

Authority architect); Mount Hermon conservation and redevelopment process, Portsmouth, Va. (administrative team, Portsmouth Redevelopment and Housing Authority), and Pike Place Market, Seattle (George R. Bartholick, Karlis Rekevics, Fred Bassetti & Associates, Arnie Bystrom, Harader & Mebust Associates).

The jurors were Cincinnati Mayor J. Kenneth Blackwell; Donald Mehlburger, engineer and former mayor of Little Rock, Ark.; Pierto Belluschi, FAIA; Barry Elbasani, AIA; Mary Means, director of the National Trust for Historic Preservation's main street project; Raquel Ramati, New York City Planning Commission, and Jerome Pratter, attorney. Andrew Euston Jr., AIA, HUD's urban design adviser, assisted the jury.

*News continued on page 32*

*HUD design awards: (1) the Gallery at Market East, Philadelphia; (2) east plaza, Freeway Park, Seattle; (3) downtown public square, Wilkes-Barre, Penn.; (4) the Japanese Village Plaza, Los Angeles.*



# **An architectural crisis.**

---

# **Versacor: Robertson's response.**

---



### **International in scope.**

Acid precipitation has become an architectural crisis of international proportions. And it's a crisis that directly affects your buildings, wherever they may be.

Last year alone, three international conferences addressed the problem. A recent *Scientific American* article reported: "On an annual basis, rain and snow over large regions of the world are now from five to 30 times more acid than unpolluted rain. The rain of individual storms can be from several hundred to several thousand times more acid than expected."

What causes acid rain? Airborne sulfur and nitrogen pollutants (from automobiles, smelters, and power plants, among others), often traveling hundreds of miles before combin-



Acid rain had already begun corroding buildings in Scandinavia in the 1950s.



### The global effects of acid rain.

**Adirondack Mts., New York**—Nearly 200 lakes devoid of fish life, more lakes in danger.

**Alabama**—Average rainfall shifts from a normal pH 5.6 in 1956 to ten times normal acidity in 1972.

**Alaska, Greenland, Arctic Circle**—Springtime haze, at times as intense as Los Angeles smog, apparently caused by pollution in Japan.

**Allegheny National Forest, Pennsylvania**—acid storm more acidic than vinegar, pH 2.3.

**Eastern U.S.**—Average rains as acidic as tomato juice, individual storms as acidic as vinegar.

**Minnesota**—Boundary Waters Canoe Area lakes reaching critical acidity levels.

**New Hampshire**—Storm at Hubbard Brook measures pH 2.8, more than 500 times normal, acidic enough to seriously damage vegetation.

**Nova Scotia**—15 to 20% of lakes reported dead or with decreased fish population.

**Ontario**—140 lakes reported dead, 48,000 more throughout Canada are threatened over the next 20 years.

**People's Republic of China**—Dead lakes reported, especially near Manchuria.

**San Francisco, California**—Dry acid fallout, even more potent than acid rain, able to eat holes in leaves and to corrode plastics.

**Scandinavia**—Earliest afflicted area, first studies in the 1950s. 5,000 lakes now devoid of fish life, annual liming of lakes to counter the acid problem.

product to meet the specific problems of metal walls and roofs in Scandinavia, where acid rain had already begun corroding buildings in the 1950s. Versacor was initially tested there and has outperformed every other paint system in over 10 years of exposure.

Now the Versacor multi-layer protective coating system, with its unique epoxy base coat, is available in the U.S. Versacor has been proven superior to competitive finishes in a battery of independent laboratory tests—

especially the Kesternich test, an accurate predictor of resistance to actual acid rain conditions.

Available in flat wall and profiled shapes, Versacor can meet your most demanding aesthetic criteria for all kinds of buildings. And that's essential—because all kinds of buildings now face the long-term challenge of acid rain.

For more information about Versacor, write to H. H. Robertson Company, Department J-5, 400 Holiday Drive, Pittsburgh, PA 15220.

ing with water vapor to form an acid solution, can fall unpredictably—perhaps on your latest building site.

### The end of the non-corrosive building environment.

The fact is, almost every location—rural or urban, commercial as well as industrial—is now subject to ever-increasing corrosive attack from acid rain.

Already stone,

masonry, automotive finishes, and single-layer metal wall finishes are proving inadequate—in fact, even the timeless beauty of the Taj Mahal in India is beginning to deteriorate. It's for this kind of world that Robertson created Versacor®.

**Versacor—beauty that's proven itself in acid rain.**

Robertson saw the necessity for a special



**Robertson**

Circle 19 on information card



## The natural look of aluminum . . . works beautifully in Denver.

The Denver National Bank Plaza is a beautiful example of the use of Alcoa® architectural sheet in a major curtain-wall project. An office complex consisting of a 26-story tower and two adjacent buildings, it was designed to meet the Denver Urban Renewal Authority exterior facade specifications.

Alcoa supplied approximately 400,000 lbs of specially controlled 5005 alloy sheet to PPG Industries for fabrication and finishing of the spandrel panels. The pleasing natural aluminum finish is Alumilite 215, Alcoa 1 etched and anodized (AA-M10C22), providing a long lasting, corrosion resistant protective coating.

Bill Manning, PPG Branch Manager, sums up Alcoa's contribution to the project: "The Denver National Bank Plaza is typical of the quality and service we continually receive from Alcoa. From the supplying of high quality aluminum sheet to the furnishing of fine technical information and service, Alcoa plays an important part in our success in this field."

Let Alcoa help you on your next curtain-wall application. For more information, write Aluminum Company of America, 1208 Alcoa Building, Pittsburgh, PA 15219.

The Denver National Bank Plaza,  
Denver, Colorado  
Fabricator: PPG Industries, Inc.  
Architect: Skidmore, Owings and Merrill  
Contractor: N. G. Petry Construction Co.  
Developer: N. G. Petry Construction Co.  
Owner: L. C. Fulenwider, Inc.

We can't wait for tomorrow.

 **ALCOA**



# This 3/8" thick Romany® Paver meets all quarry tile performance standards...and more.

Even though Romany Pavers are 3/8" thick, they exceed all current A-137.1 performance standards for 1/2" quarry tile. When measured against seven physical properties, ASTM test results show that Romany Pavers are stronger, more durable, and of consistently high quality thanks to a rigidly controlled, dry-press manufacturing process.

The unglazed, smooth surface of Romany Pavers makes it ideal for interior and exterior floors, walls and other surfaces in institutional, commercial and residential applications. Rich, earth-tone colors like flashed or blended red, brown and camel, provide a truly natural look.

In addition, Romany Pavers can be used with our unique Orsan Heavy-Duty tile which is also 3/8" thick, to provide unusual and imaginative designs. Sizes include 6" x 6" and 3-5/8" x 7-5/8".

For details on Romany Pavers, contact your Romany-Spartan distributor. Or write United States Ceramic Tile Company.



**United States  
Ceramic Tile  
Company**

Subsidiary of  
**Spartek**  
Inc.

1375 Raff Road, S.W.  
Canton, Ohio 44711

Circle 21 on information card

## First 'Railroad and Environment' Awards Go to 18 U.S. Projects

There are nine winners of "outstanding achievement" and nine of "special achievement" awards in the Federal Railroad Administration's first design awards program, "The Railroad and Its Environment." The program is aimed at showing that the railroad community "is effectively combining its facility and equipment needs with good design, energy consciousness and more efficient operations," says John M. Sullivan, FRA administrator. "The results of our first program were very encouraging. The range of the entries was impressive and the quality was consistently high."

The winners of outstanding achievement awards are:

- Architecture/urban design and joint development categories: Providence (R.I.) Capital Center; Skidmore, Owings & Merrill.
- Intermodal, urban design and preservation categories: Hartford Union Station; Tai Soon Kim/Hartford Design Group.
- Preservation and enhancement of an architecturally significant railroad facility category (three recipients): Wilmington (Del.) Station; Skidmore, Owings & Merrill. New London (Conn.) Union Station; Anderson Notter Finegold, Inc.



- Baltimore & Ohio Railroad Museum; Cochran, Stephenson & Donkervoet.
- Inclusion of works of art category: Baltimore Penn Station mural; Donald Duncan.
- Innovative freight intermodal facility or classification yard category: Pride (Alaska) Transloader; Southern Railway Co.
- Equipment design category (two recipients): Santa Fe Railway ten-pack fuel foiler; shops of Santa Fe Railway, Topeka, Kan. Operations Control Center for Port Authority of New York/New Jersey; Sundberg-Ferar and Gibbs & Hill.

Special achievement award winners are:

- Preservation and enhancement of an architecturally significant railroad facility category: Station Square, Pittsburgh; Pittsburgh History and Landmarks Foundation.
- Joint development and preservation categories: Duluth (Minn.) Depot; William Moser, AIA, and Donald Melander, Melander & Melander.
- Inclusion of works of art category: Penn Station, Baltimore, sculptural fence and windscreen; William Leizman.
- Innovative freight intermodal facility or classification yard (two recipients): Southern Railway Spencer Yard, Lin-

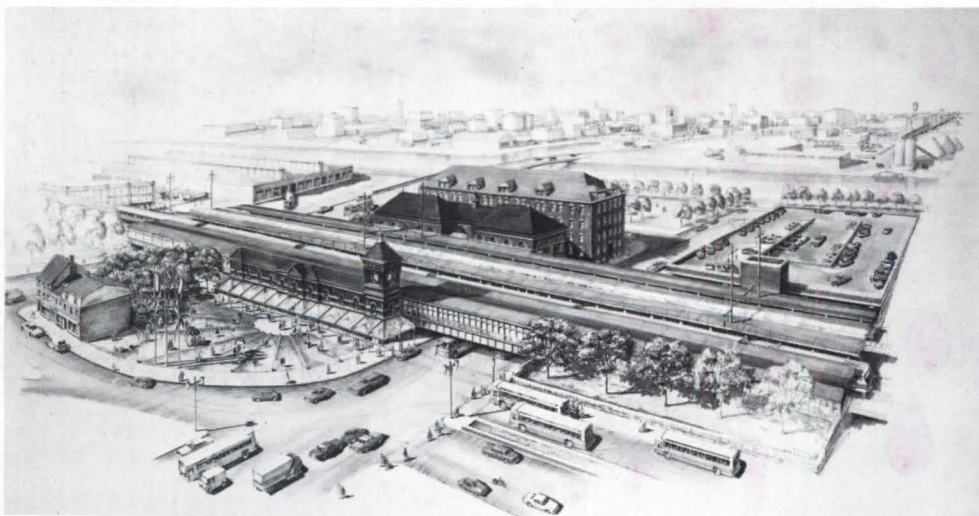
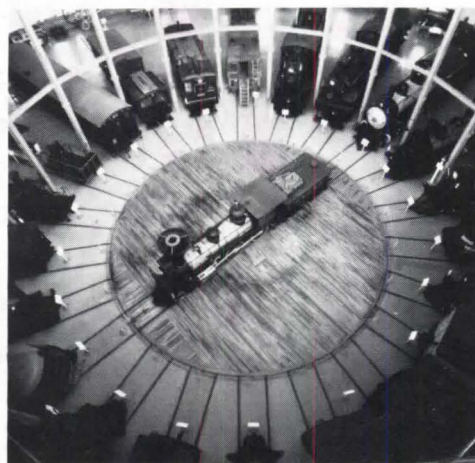

Railroad awards winners: New London (Conn.) Union Station, top left; Baltimore & Ohio Railroad Museum, top right; Wilmington (Del.) station, above.

wood, S.C. Union Pacific Railroad North Platte, Neb., Yard.

- Equipment design category (three recipients): Roadtrailer bimodal rail-truck trailer; Bimodal Corporation. Solar Powered Signals; Communications & Signals Department, Southern Railway Co. Union Pacific storage and dismantling facility, Pocatello, Idaho.
- Community involvement and contribution category: Jackson (Mich.) Rail Depot.

Jurors were Stanley Allen, AIA, president of Harry Weese Associates, Chicago; Donald Canty, editor, AIA JOURNAL; Paul Weidlinger, general partner, Weidlinger Associates, New York City, and Rogers E. M. Whitaker, contributor on transportation subjects to *The New Yorker*.

## John Andrews Wins Competition For INTELSAT Headquarters

The Sydney, Australia, architectural firm of John Andrews International has won an invitational competition for the design of the new headquarters building in Washington, D.C., of International Telecommunications Satellite Organization (INTELSAT). The selection was made by an assessment panel, which included architects chosen with the assistance of the International Union of Architects—Pietro Belluschi, FAIA, of the U.S., John Michael Austin-Smith of Great Britain and Marco Zanuso of Italy—and five senior management representatives of INTELSAT. Paul Spreiregen, FAIA, chairman of the Institute's competitions committee, was professional adviser to INTELSAT.

Six architectural firms from a list of nearly 100 who had indicated to INTELSAT their willingness to compete were chosen for the invitational competition by INTELSAT and a panel of architects from Australia, France and the U.S.

The six firms to present design proposals were Arthur Erickson Architects, Canada; Hellmuth, Obata & Kassabaum, St. Louis; Hentrich, Petschnigg & Partner, West Germany; Holabird & Root, Chicago; Raili & Reima Pietilae, Finland, and John Andrews.

The headquarters building has been designed for an eight-acre portion of a 12-acre site in northwest Washington, on Connecticut Avenue. The site is part of the so-called international center complex, and is owned by the U.S. government. Originally intended for occupancy by the Organization of American States, which decided to locate elsewhere, the site's availability to INTELSAT will depend upon the State Department's obtaining permission from Congress. In the event the desired site is not available,

*continued on page 39*

# EICHENBERGER



# Stendig

EICHENBERGER lounge chair with pivoting clamp on table, with ottoman. Designed by Hans Eichenberger. New York: 410 East 62 Street. Chicago: 950 Merchandise Mart. Los Angeles: 201 Pacific Design Center. Other showrooms in Atlanta, Denver, Detroit, San Francisco, Seattle. Representatives in major cities. Write or call Stendig® International, 410 East 62 Street, New York 10021 (212) 838-6050. Stendig Inc., a subsidiary of Stendig International, Inc.

*Circle 22 on information card*

*Owners:*

Allen Center Company—  
A Joint Venture of  
Century Development  
Corporation, American  
General Realty Company  
and Centennial Equities  
Corporation (a subsidiary  
of Metropolitan Life  
Insurance Company).

*Architect:*

Lloyd Jones Brewer  
Associates.

*Structural Engineer:*

Ellisor and Tanner, Inc.

*General Contractor:*

Miner-Turner, A Joint  
Venture of Miner-  
Dederick Construction  
Company and Turner  
Construction Company  
of Texas.

*Steel Fabricator:*

Mosher Steel Company.

*Steel Erector:*

Peterson Brothers Steel  
Erection Company.

*All of Houston, Texas.*

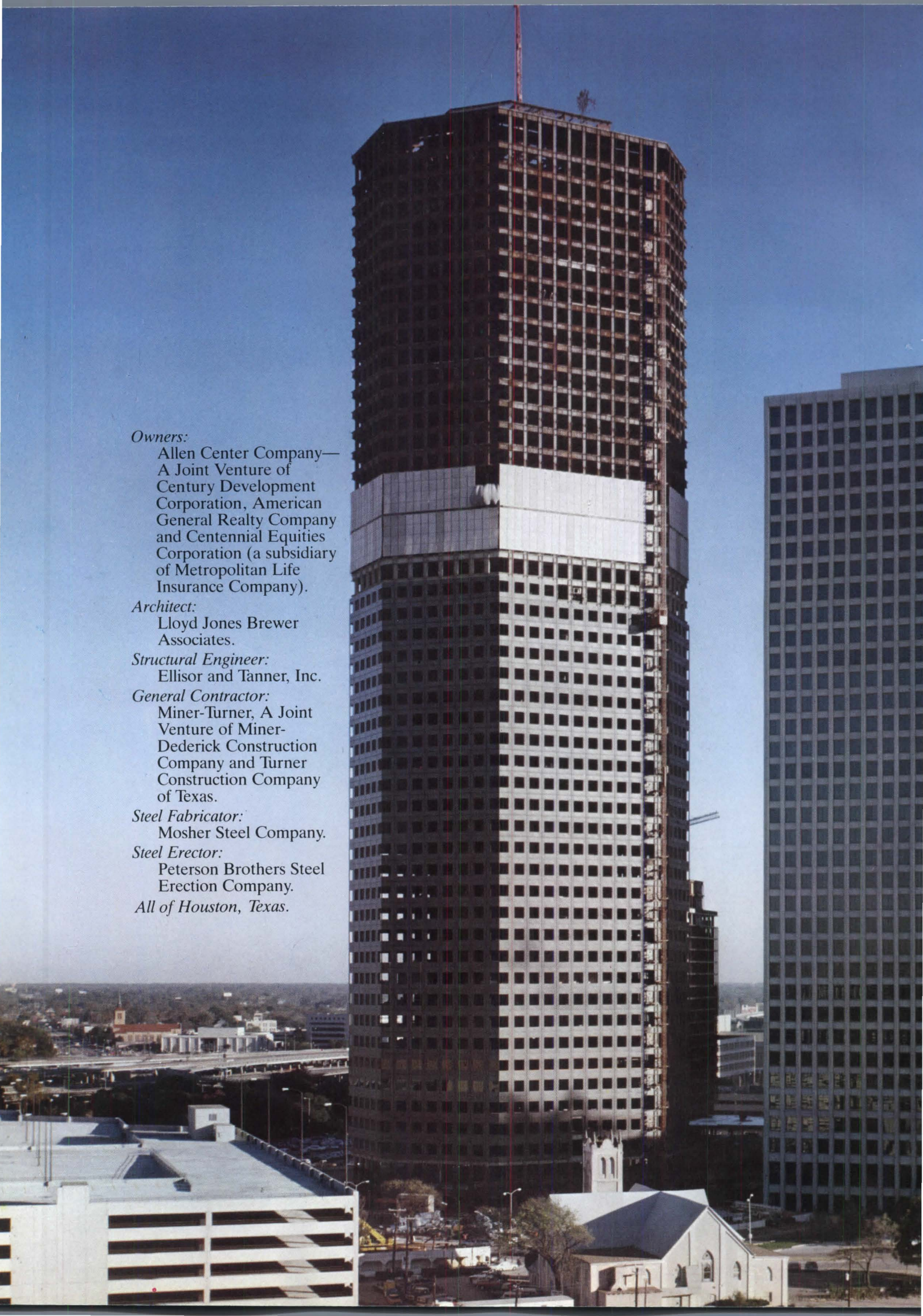

# Only steel made possible a major redesign in Houston's newest Allen Center building.



When the steel for Allen Center's newest building, a 50-story, 1.3-million square foot tower, was almost half erected, a major downtown banking institution, Capital National Bank, requested a large

block of space on the lower floors. To accommodate the bank's needs, the floors were redesigned to provide an open atrium-like area for banking and office levels. This major redesign was only possible because of the building's steel frame.

The imposing, bronze-tinted Capital National Bank Plaza building is one of Houston's tallest skyscrapers, a \$100-million addition to Allen Center—a \$1-billion complex in the central business district.

## Steel Tubular Design Frame

The steel tubular design frame—the first of its kind in Houston—is made up of 54 perimeter tree columns on 10-foot centers.

Two stories high, these narrow prefabricated assemblies of exterior columns and exterior beams not only help reduce construction time but provide more window area, enhancing the leasability of the space.

The building's unusual eight-sided shape, intended to provide tenants with a variety of views and extra corner offices, also created eccentric wind loadings which are more efficiently handled by tubular design. 16,500 tons of steel went into the building—most of it supplied by U.S. Steel.

The unique story of this newest Allen Center tower is one more example of the flexibility of structural steel. In this case it permitted redesign and changes in a part of the structure already completed; without affecting the scheduled opening date of June, 1980.

To find out more about this building, and for information regarding the many applications for structural steel, contact a USS Construction Representative through your nearest U.S. Steel Sales Office. Or write for the USS Building Report (ADUSS 27-7675-01) to P.O. Box 86 (C1269), Pittsburgh, PA 15230.



**United States Steel**

*Circle 23 on information card*

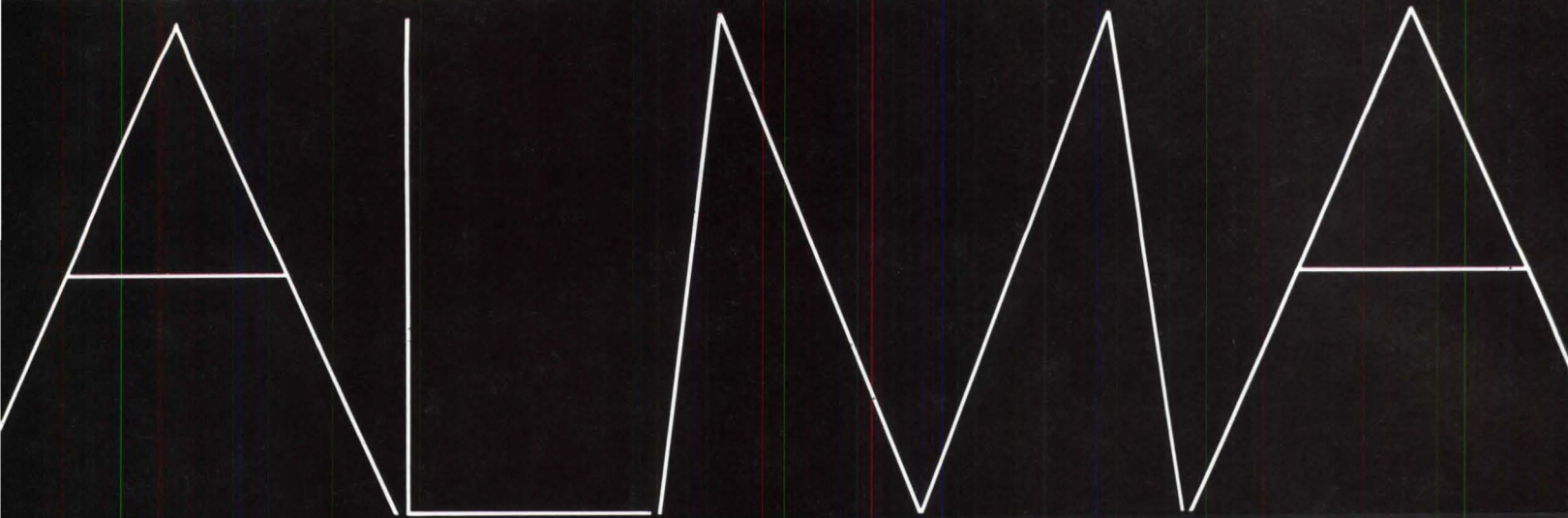

When you want more than just an office



Open plan designs to  
set your imagination free. Alma.  
This AD office system, plus desks  
and seating, all designed for  
the designer.

**alma**

Alma Desk Company, Box 2250, High Point, NC 27261, Showrooms: 919 Third Ave., New York;  
1140 Merchandise Mart Plaza, Chicago; Southern Furniture Market Center, High Point;  
Atlanta; Dallas; Houston; Kansas City; Seattle; Denver; San Francisco & Los Angeles.

Circle 24 on information card



Attractive home on Cape Cod, Massachusetts; Architects Bedar & Alpers, Boston, Massachusetts; Wood siding and wood trim treated with Cabot products.

## Wood and Cabot's Stains...made for each other

# Cabot's STAINS



Here is a wood at its wonderful best. The architect, in specifying a finish for this home, sought beauty and more...a finish that would stand up to summer sun and winter cold, that would require minimum maintenance while protecting the wood for a long, trouble-free life. His choice: Cabot's Stains.

Cabot's Stains, in 87 unique colors, enhance the wood grain, grow old gracefully, never crack, peel, or blister...are ideal for shingles, siding, clapboards, paneling, and decking. In terms of natural beauty, economy, and ease of application, Cabot's Stains

are best for all types of wood, exterior or interior, and all wood surfaces, smooth, striated, or rough-sawn.

Cabot's patented colloidal manufacturing process assures exacting standards of color, deep penetration, and wood preservation. In a world that is constantly shouting "new," Cabot's Stains are very proud to be "old, the original, and still the best."

For color cards and information, write:

**Samuel Cabot Inc.**

One Union St., Dept. 545, Boston, Massachusetts 02108

**"Cabot's Stains, the Original Stains and Standard for the Nation since 1877"**

Circle 25 on information card

# SEAL UP PENETRATIONS IN HIGH RISE FIRES!

## THERMAFIBER® Safing Insulation

effectively cuts off fire at utility cut-outs in multi-storied buildings — keeps flames from spreading floor to floor.

A recent 2½-hour fire test employing THERMAFIBER Safing Insulation dramatically proved the remarkable capabilities of this unique fire-stopping material. THERMAFIBER Safing Insulation

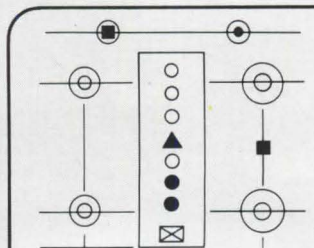

**LEGEND:**

- PLUMBING PIPE
- ELECTRIC CONDUIT
- ▲ POWER CABLE
- ⊠ METAL DUCT
- SURFACE TELEPHONE CONDUIT

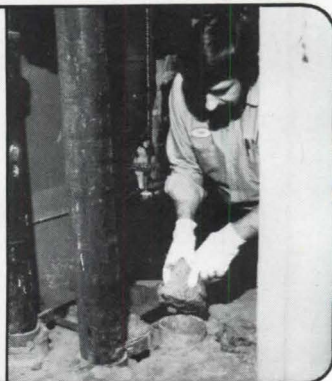

was used to seal openings of various sizes. These openings provided access for steel pipe, copper pipe, steel conduit, metal air ducts and power transmission cables run through a fire-rated floor.

■ For convincing test results, fire containment ratings and other specifics, call your U.S.G. Representative. Or write to us at 101 South Wacker Drive, Chicago, Illinois 60606, Dept. AJ 580C

**UNITED STATES GYPSUM**  
BUILDING AMERICA

Circle 26 on information card

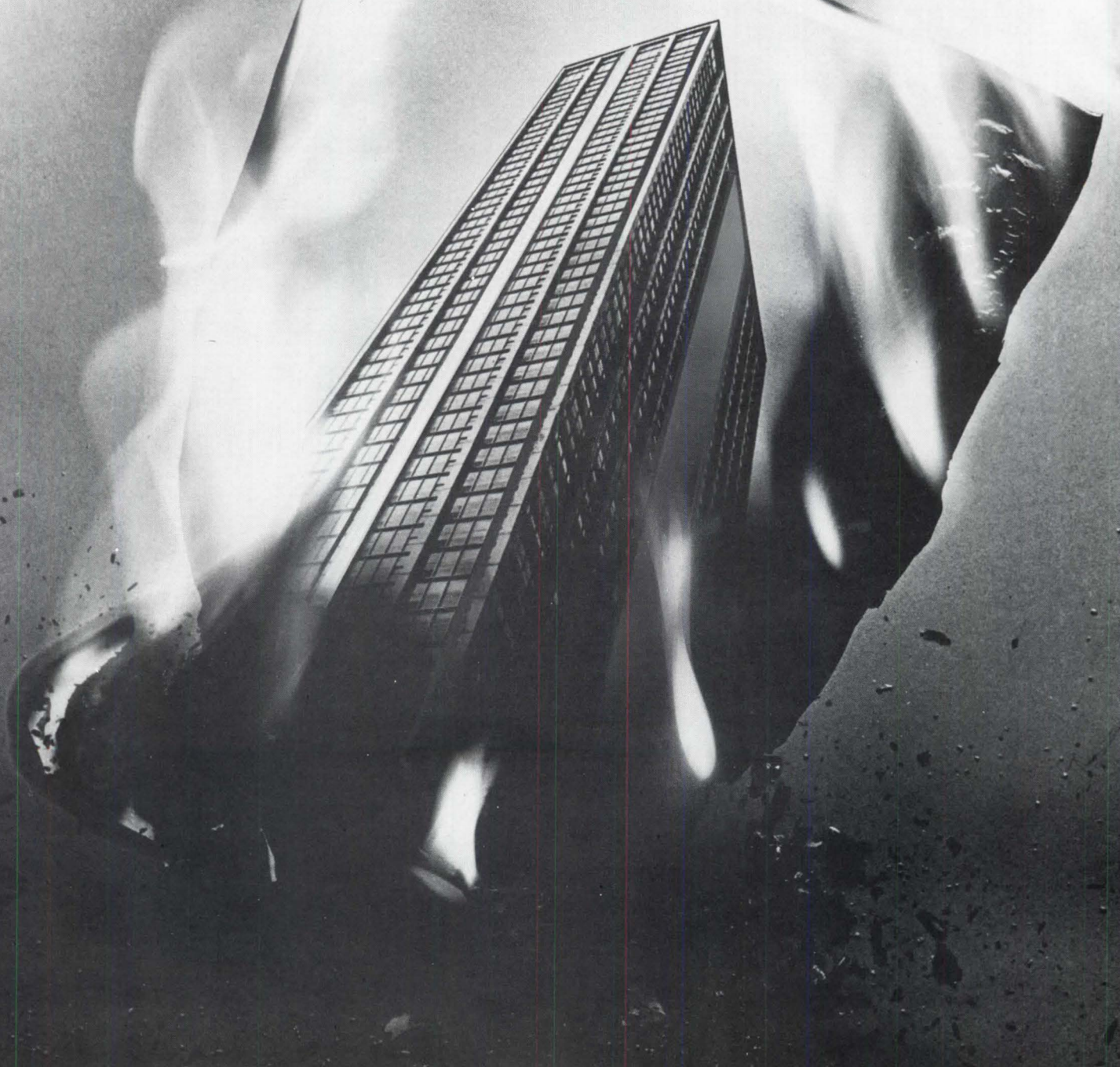



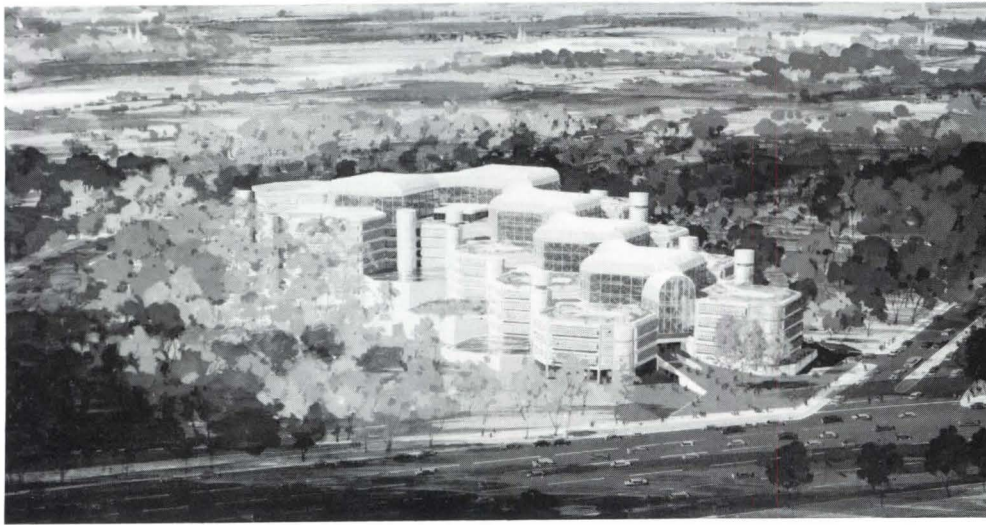

#### News from page 32

INTELSAT says that Andrews will be retained to design its headquarters building elsewhere.

The building, which will contain offices, operations center, satellite control tower, conference areas and other facilities, is composed of a series of 85x85-foot "pods," each about four or five stories high (rendering above). The arrangement permits an interior core, 45x45 feet, resulting in a daylit periphery constituting 70 percent of the pod's floor area, with the interior core being 30 percent of the area. "These figures reflect exactly the functional division of INTELSAT's office floor area needs," says the organization.

Stacked vertically, the pods are connected diagonally at the corners, creating a series of interior atriums. The pod configuration is also used for assembly areas, delegates lounges and offices and satellite technical facilities. The arrangement gives the workers natural daylight and views of the surrounding site or into the atriums, where there will be pools of water to cool the summer air.

The exterior will appear as a series of cube-like elements, with a facade of stainless steel and acrylic sun screens in front of floor-to-ceiling glass walls, and the entire structure will be seen through a screen of trees. The roof of each pod will be used as a terrace for another pod, and the roofs will be landscaped for increased insulation.

INTELSAT says that the atriums, maximum use of natural daylight, individually serviced pods, sun screens, pools and trees in the surrounding parks will make the building highly energy efficient, requiring only 24,500 BTUs per square foot per year, compared to the typical office building in Washington that requires an energy budget of 65,000 BTUs.

Overall cost of building and landscaping is expected to be about \$30 million, and it is hoped that the building will be completed by 1983.

### Concrete Reinforcing Steel Awards Include Energy Citation

There are five winners in the Concrete Reinforcing Steel Institute's annual design awards program, which recognizes "creative achievement in esthetics, engineering, functional excellence and economy." This year's program includes an award for energy conservation, which goes to the Douglas County Correctional Center in Omaha (Dana Larson Roubal & Associates of Omaha and Phoenix, architect and structural engineer).

Other winners are:

- Baltimore Convention Center (Naramore Bain Brady & Johanson, Seattle, architect; Cochran, Stephenson & Donkervoet, Inc., Baltimore, associated architect).
- Reunion Tower, Dallas (Welton Becket Associates, Los Angeles, architect and structural engineer).
- Mecklenburg County Courthouse, Charlotte, N.C. (Wolf Associates, Charlotte, architect).
- Chapel of Thanks-Giving Square, Dallas (Philip Johnson & John Burgee, New York City, architect).

### Plywood Association Selects 13 Projects for Design Honors

Thirteen projects were recently honored by the American Plywood Association and *Professional Builder & Apartment* magazine in the ninth annual plywood design awards competition.

The first award in the single-family house category went to Charles M. Sieger, AIA, for his Miami residence (see page 174). Citations of merit were awarded to Paul Silver, AIA, Gruzen & Partners, for the Silver residence, White Plains, N.Y.; Rowe Holmes Associates Architects, Inc., for the Logan residence, Tampa, Fla.; Robert C. Goodwin for his Jacksonville, Fla., residence, and Rafael Franco for his Los Angeles residence.

Top winner in the multifamily housing category went to Fisher-Friedman Associates for the Orchard, Citrus Heights, Calif. Citations of merit were awarded to Mark Litwin & Jon Quint, Land Development Systems, Inc., for the Oaks, Walnut Creek, Calif.; Lorenzo D. Williams, FAIA, Williams/O'Brien Associates, Inc., for Findley Place housing, Minneapolis, and Donald MacDonald, AIA, for Russian Hill town house, San Francisco.

The first award in the commercial/institutional category went to Henry Horowitz, AIA, for the Health Center for Rutgers Community Health Plan, New Brunswick, N.J. Citations of merit went to John P. Clarke, AIA, and Fred Travisano, AIA, for the Cooper Field Bathhouse, Trenton, N.J.; Patrick M. Sullivan, AIA, for the San Luis Obispo (Calif.) County Airport Fire Station, and to Warren Douglas Thompson, AIA, & Andrew J. Kerr, AIA, the Thompson Architectural Group, Inc., for the Thomas Luckey Construction Co., Inc., office building, Stockton, Calif.

Jury members were John D. Bloodgood, AIA, Homer Delawie, FAIA, and E. Fay Jones, FAIA. *News Summary, page 44*



Plywood design awards winner: the Orchard by Fisher-Friedman Associates.

**Leadership in technology.**



Plastics, metal, glass, masonry; different construction materials require different sealants. General Electric now offers a broad line of silicone sealants based on different technologies so you can specify the GE silicone sealant designed to meet specific application needs.

For glazing, there's the newest GE silicone

sealant, Silglaze<sup>®</sup> 2400. This low-modulus, translucent silicone sealant provides a good balance between tooling and curing time.

For weatherproofing, GE Silpruf<sup>®</sup> silicone sealant provides a low modulus, primerless seal for masonry-to-masonry and masonry-to-metal joints.

And for high performance glazing, GE 1200

silicone sealant offers excellent adhesion, weatherability and elasticity.

To find out how the GE Silicone Seal offers an outstanding combination of technology, products, quality and service, write: General Electric Co., Silicone Products Div., RTV Products Dept., Section 463, Waterford, N.Y. 12188.

## GE Silicone Sealants. Three product technologies serve your needs.



\*Trademark of General Electric Company

GENERAL  ELECTRIC

*Circle 27 on information card*

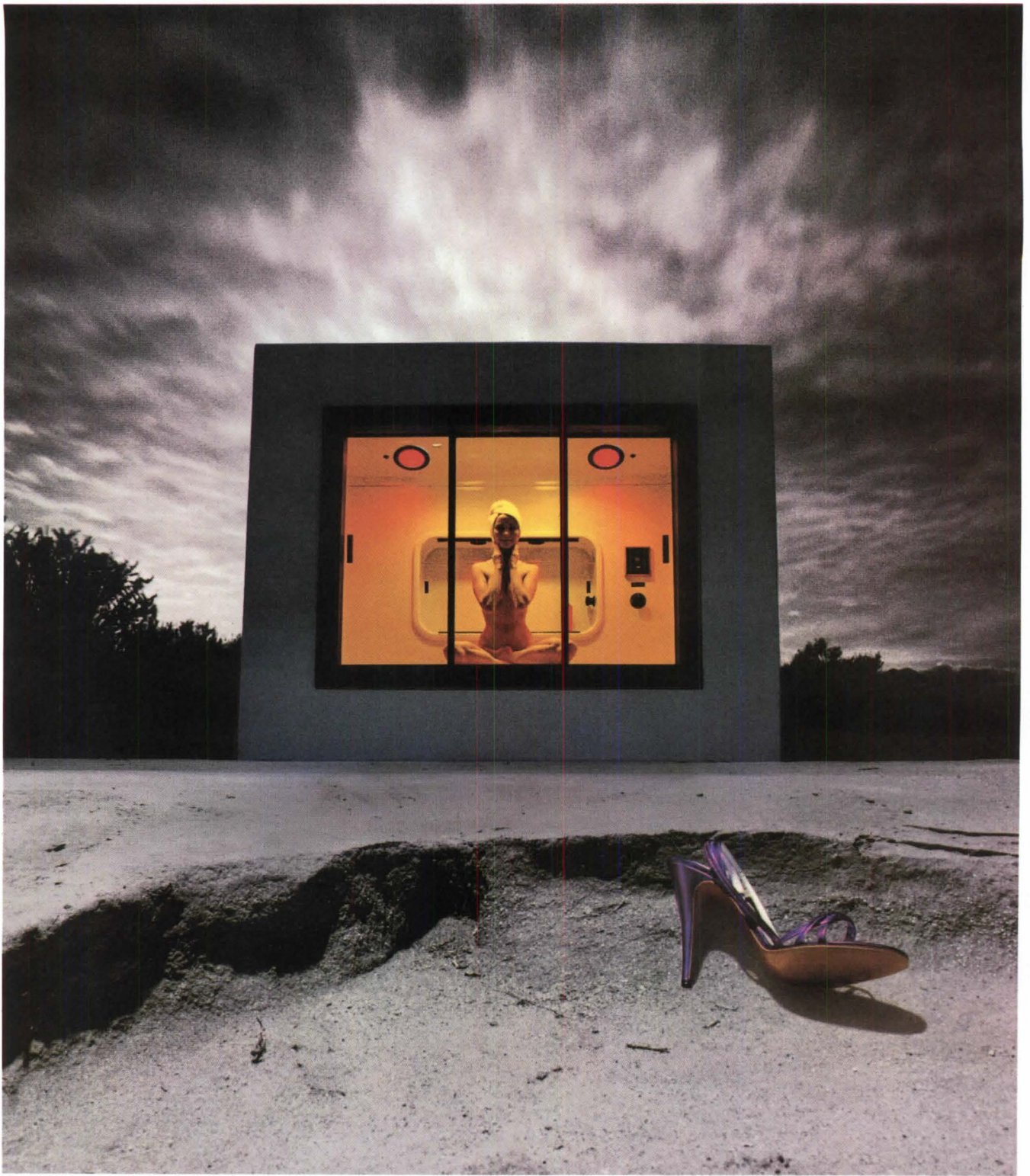

THE BOLD LOOK  
OF **KOHLER**

At the edge of your imagination is a world cut off from harsh reality. Sun, steam, soft rain, and gentle breezes obey your every whim, restoring body and soul in the enclosed environment of Habitat.<sup>™</sup> Includes interior control panel, acrylic interior surface, cypress deck, and a variety of options. For more information about Kohler products, write: Kohler Company, Dept. AA, Kohler, Wisconsin 53044.

*Circle 28 on information card*

# You now have a better choice. THE ANSO ALTERNATIVE

Now you can get it all. Fashion *and* Performance.  
The most exquisite fashion...in patterns, plushes  
and berbers...combined with the rugged  
reliability of Anso-X<sup>®</sup> Nylon.



 **Allied  
Chemical**  
Home Furnishings

Circle 29 on information card

# Summary of the Year's News

From building energy performance standards to AIA's debate over a new statement of ethical principles, the following is a compilation of events of the past 12 months considered important to the profession. Topics begin with energy (below), followed by the economy, the environment, government, cities, preservation, AIA and ethics.

## Energy: Introduction and Fine Tuning of Building Performance Standards

Late last year the Department of Energy issued its proposed energy performance standards for new commercial and residential buildings. National compliance with the standards would reduce energy consumption by 22 to 51 percent in residential buildings and 17 to 52 percent in commercial buildings, DOE estimates.

The building energy performance standards (BEPS) would limit the amount of energy a building could consume, expressed in BTUs per square foot per year. A building would be tested at the design stage rather than by actual performance (thus the term design energy budgets). Energy codes now in use, such as the American Society of Heating, Refrigerating and Air-Conditioning Engineers' standard 90-75, apply to the thermal characteristics of individual parts of the building. BEPS would apply to the building as a whole. The amount of the design energy budget would vary according to building type, climate zone and type of fuel used (see Jan., p. 22).

AIA has supported the concept of BEPS since it was first suggested in 1974. More recently, the AIA task force on BEPS has focused on a detailed analysis of BEPS and how it would affect the architectural community. A brief summary of its findings follows. The performance-oriented BEPS would allow for more flexibility in design, which in turn would encourage design creativity and innovation. Regionalism would be a major benefit. Since BEPS contains no built-in preference for certain building materials or technology, this could encourage manufacturers and product suppliers to develop new energy efficient products. Natural design elements—daylighting, solar heat gain, trees, landscaping—would begin to have greater significance.

While BEPS has received the support of many design, engineering, construction, energy and consumer organizations, most groups singled out specific problems that they felt made the standards unworkable as written. At DOE hearings in six

cities in March and April, specific complaints were voiced concerning the implementation of BEPS, equivalency between BEPS and ASHRAE 90-75, the proposed energy budgets, the role of passive and active solar energy, the fuel type weighting factors, evaluation of a project's energy budget, additional design and construction costs imposed by BEPS (see May, p. 11). DOE expects to present the final proposed rulings of BEPS in August.

Conservation has been singled out by various energy studies as being of prime importance in solving the energy crisis. *Energy Future: Report of the Energy Project at the Harvard Business School* (Random House), edited by Robert Stobaugh and Daniel Yergin, concluded that conservation and the use of renewable resources are the only viable solutions to the energy crisis. "The key to correcting our bias toward fossil fuels and nuclear power is by offering comparable incentives to solar energy and conservation," said the authors. The first major government-sponsored study to conclude that conservation offers the greatest potential for easing the nation's long-range energy problems was issued by the National Academy of Sciences. "Conservation should be given the highest priority in a national program, although it alone cannot solve our energy problems," says the report based on the study. "To meet our electrical energy needs for the next 20 years, the nation will have to rely on coal and nuclear power."

The case for renewable resources is advocated by Barry Commoner in *The Politics of Energy* (Alfred A. Knopf). He finds coal and conventional nuclear power unacceptable because they are inherently uneconomical. The answer, he maintains, is to develop solar and other renewable resources.

At the Dumbarton Oaks Symposium on the Dynamics of Energy Efficiency, held under the auspices of the Alliance to Save Energy, participants concluded that the full potential of improvements in energy efficiency has not been realized. This is due to "confusing signals from the political and economic environment," the lack of capital to invest in the retrofit of buildings, lack of commitment by the industrial sector and lack of knowledge of

energy costs, among others.

A hindrance to any substantial energy conservation efforts or to any technical breakthroughs may be that most Americans don't believe there is an energy crisis in the U.S. At least they didn't in 1978, according to the report "Public Opinion about Energy: A Literature Survey," prepared by the staff of the Solar Energy Research Institute. Although about 40 percent of the people surveyed perceived the situation as "serious," they viewed inflation, unemployment and crime as matters of graver concern. A majority thought that the nation faces energy shortages and rising energy costs, but a large minority said that the problem is contrived by oil companies and the federal government. A smaller number blamed the OPEC countries, industry, business and environmentalists as contributors to the energy problems.

However, there are some encouraging signs. A study prepared by the Office of Technology Assessment, entitled "Residential Energy Conservation, Volume 1," reported that residential energy use which grew at an annual rate of 4.6 percent in the 1960s has declined to 2.6 percent since 1970. The primary motivation for the reduction is seen as the desire on the part of the consumer to reduce rising energy costs—achieved principally through a change in energy habits.

On the local level, the city of Portland, Ore., adopted a comprehensive and aggressive energy policy, which was largely developed by a broad-based citizen participation. The policy calls for the retrofit of existing buildings to make them as energy efficient as possible, that renewable resources and alternative energy systems should be given first priority in new building projects, that administrative obstacles to the installation of solar and waste heat systems be removed, among others.

On the national level, President Carter signed into law in April the windfall profits tax on the oil industry, which is expected to raise at least \$227.3 billion in 10 years. The law calls for \$136.4 billion in income tax reductions, \$56.8 billion to help low-income families deal with rising energy prices and \$34.1 billion for energy and transportation programs. The Administration also had requested \$21.1 billion for energy programs and \$5.4 billion for energy tax credits.

Meanwhile, HUD announced a \$11 million grants awards program aimed at encouraging energy conservation activities. Ten to 20 projects will be funded to enable grant recipients to follow energy conservation activities and alternative energy supply technologies that can be applied in housing rehabilitation, neighborhood revitalization or other economic development strategies.

*News Summary continued on page 51*



## Owens-Corning sound dividers. Designed so your design gets noticed. Not ours.

We don't expect people at work to appreciate the classic lines of our sound divider system.

They may not notice the handsome fabric covering. Or how beautifully the dividers fit together.

They may never see the electrical raceway hidden in the base or the shelf-hanging capability.

And they can't possibly know that their privacy comes from our special sound-absorbent Fiberglas\* core inside each panel.

What they will notice is what really matters: the total landscape you've created.

For a free sound divider catalog, color selector, and booklet, "Speech Privacy in the Open Office," write A.J.S. Meeks, Owens-Corning Fiberglas Corporation, Fiberglas Tower, Toledo, Ohio 43659.

\*T.M. Reg. O.-C.F. ©O.-C.F. Corp. 1978

OWENS/CORNING  
**FIBERGLAS**  
TRADEMARK

# STYROFOAM

BR

## YOU SPECIFIED IT. BE SURE YOU GET IT.

There's only one STYROFOAM® brand insulation and The Dow Chemical Company stands squarely behind it. STYROFOAM, with thirty years of proven performance, keeps on delivering consistent energy savings for the life of a building.

Don't confuse STYROFOAM brand insulation with porous foam products made with today's throw-away technology, like molded foam cups and picnic coolers. This whole category of disposable foam products is made an entirely different way.

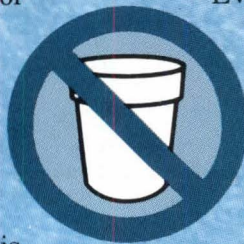

This is not STYROFOAM  
brand insulation.

One product made with this same short-life, throw-away technology is "beadboard" insulation. Ever had a foam cup leak in your hand?

That's exactly how these porous imitations can work in buildings. Think about it next time you specify insulation.

STYROFOAM brand insulation keeps the wet out. Moisture absorption is the most common cause of thermal resistance deterioration in perimeter, sidewall and roof insulation. Since water is a good conductor of heat, soggy insulation robs a building of the



# foam AND INSULAT

energy it's supposed to be saving. The unique closed cell structure of STYROFOAM repels water and retains R-value.

STYROFOAM brand insulation also meets many of the tough new building codes for demanding applications, like *below grade*. Because when moisture gets in and freezes, porous imitations can crumble—along with their insulation value. STYROFOAM will continue to perform long after other materials fail.

*Accept no substitutes.* Specify STYROFOAM brand insulation and make sure it's actually

applied. Then you can be confident that you and your clients have invested in the proven answer for energy savings from frostline to skyline.

For more information, write:

The Dow Chemical Company, STYROFOAM Brand Insulation, Dept. E57, Midland, MI 48640.

**The Proven Answer**



\*Trademark of The Dow Chemical Company

WARNING: STYROFOAM brand insulation is combustible and should be properly installed. A gypsum board interior finish should be used in commercial construction. For roofing applications, STYROFOAM brand insulation should be provided with an adequate protection. For specific instructions see Dow literature available from your supplier or from Dow.

Circle 31 on information card

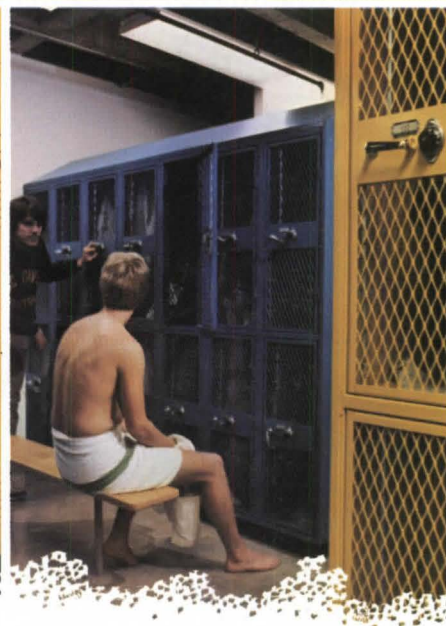

## Republic designed its locker line the way you would have.

Clean lines. Classic colors. Economically functional. Aesthetically pleasing. And a wide selection for you to choose from.

So the Republic locker installation you specify will look custom-designed for the architectural environment you put it in.

In schools, offices, plants, clubs, recreational facilities, Republic Steel lockers offer a range of types, sizes, accessories and colors to satisfy virtually every clothing storage need. Standard lockers, with over 80 years of Republic Steel locker experience

behind them. Expanded metal lockers, combining maximum ventilation and strength. And Republic's MONDRIAN\*—the most advanced locker available today. Clean, crisp, innovative design. Recessed handle. Flush front. Bold colors.

Economically, Republic lockers are long-term money-savers. Easy to install. Long-lasting. Tough enough to require only minimum maintenance.

So, design with Republic lockers in mind. And specify them with confidence—in their performance, aesthetics, economy and client satisfaction.

For full information on Republic's complete locker line, write Republic Steel Corporation, Industrial Products Division, 1038 Belden Avenue N.E., Canton, Ohio 44705. Or call your nearest Republic Distributor. You'll find him in the Yellow Pages.

\*MONDRIAN is a trademark of Republic Steel Corporation.

**SHELVING • LOCKERS  
SHOP EQUIPMENT**

# Republicsteel

# "One floor every five days ...Ceco makes forming look easy."

Ceco formed the 25 floors of the St. James Condominium, Houston, Texas, allowing Quanah Construction to complete one 18,525 square-foot floor every five working days.

"Ceco helped us beat the clock on this job," said A. J. Owrey, President of Quanah Construction Company. "We came in ahead of schedule. That's one reason we keep using Ceco. They're professionals."

In the early planning stages, Ceco can provide structural design assistance and make practical forming recommendations that help buildings go up fast and keep costs down. And Ceco provides complete forming services nationwide. Experienced field crews. Ready-to-use equipment. And standardized forming systems for the most sophisticated architectural design — all on a lump sum basis and at a firm price. Talk to the pros in concrete forming. See the Yellow Pages for the Ceco office in your area.



concrete  
forming  
services

The Ceco Corporation • General Offices  
5601 W. 26th Street • Chicago, Illinois 60650

A Project Of: Mark Lee & Assoc., Inc.  
Architects: 3D/International  
Contractor: Quanah Construction Co.  
Structural Engineers: Ellisor Engineers, Inc.

Circle 33 on information card

# Reading here is a beautiful experience.

The Central Library Building in Beaumont, Texas, is a beautiful example of an energy-efficient use of glass. Its full-height window walls of bronze-tinted LOF float glass absorb summer heat far more effectively than clear glass. And wide building overhangs shield the library's glass from the intense Texas sun further reducing its cooling requirements. At the same time, the large glass areas still admit plenty of natural light for reading during daytime hours. By utilizing natural daylight, electrical consumption for lighting can be reduced.

Building owners across the country are also finding that windows not only give their employees a better outlook on their world. But on their work, too. Studies have shown that worker performance and the amount of window area in the work environment often go hand in hand.

Want more details? Send \$1.00 for "Predicting Daylight as Interior Illumination," a

43-page definitive study on building design to conserve energy and increase visual performance. Libbey-Owens-Ford Company, 811 Madison Ave., Toledo, Ohio 43695.



## LOF Glass

A Libbey-Owens-Ford Company

Circle 34 on information card

## Economy: A Slowdown In Construction After The Fed Pulls Reins

Inflation, nascent recession, the energy crisis and other calamities are intertwined in the economic picture of the past year. The high cost of capital became a major problem for the construction industry in 1979 after the Federal Reserve Board moved in October to attack inflation by making money scarce and costly. The complex policy, including the tightening of credit, sent interest rates soaring to unprecedented heights, causing a falloff in sales of existing houses, followed inevitably by a steeper decline in housing starts.

Housing—always the trend setter in construction and considered a barometer of the nation's economic health—took a tumble last November. By January of this year, the decline in housing starts had cut the seasonally adjusted annual rate to 1.4 million units, the lowest number in three years. Last year, according to estimates by the National Association of Home Builders, housing starts were at 1.7 million, and the association forecast a drop this year to 1 million. The resale of existing houses dropped from a September annual rate of 4 million to a March '80 rate of about 2.7 million.

According to Bureau of the Census figures released in April, housing starts were down by 42 percent from December '79; building permits dropped 25 percent. NAHB economists say that these figures "underestimate the severity of the situation," because of prior commitments and presold houses. "But now the cancellation rate has exploded, and units are sitting in the field either partly finished, or finished without a buyer."

In February, the government further increased the discount rate on loans to commercial banks from 12 to 13 percent, pushing home mortgages to 15 percent and higher. In March, the discount rate was raised another 3 percentage points, and mortgage rates climbed higher. Jack Carlson, executive vice president and chief economist of the National Association of Realtors, says that the housing industry "is in the midst of a recession that is the worst ever for the market in the post-World War II era." He reports that activity is off in every region of the country, with the West leading by a 39 percent drop in the resale of houses.

People in the housing industry are quick to point out the effect of the slump on the nation's general economy. They point to the influence on other businesses, such as manufacturers of furniture and

appliances, also reminding the policy makers that the construction industry is the biggest employer in the nation, even exceeding agriculture. And, according to NAHB, new construction is being postponed, causing builders to lay off workers.

*New York Times* writer Stephen Engleberg recently interviewed federal officials about the crisis. One official is quoted as saying that "everyone acknowledges that the (housing) industry is in critical condition, but the Administration's primary concern is getting control of inflation and reassuring the financial markets." He said a "rescue" of builders "would cast doubt upon the Carter Administration's commitment to fighting inflation." Carlson blames the difficulties on federal government policies: "high deficit spending, a too rapid growth in money supply in 1977, 1978 and 1979 and excessive growth in federal taxes."

To date, the tightening of credit has done little to contain inflation. The Department of Labor reported that consumer prices for March rose 1.4 percent for an annual inflation rate of 18 percent. The increase brought the price index to 239.8 as against 100 in 1967; goods that cost \$10 in 1967 cost \$23.98 in March. The principal contributor to increased inflation over the last year has been increases in energy prices, but the March figure is "particularly worrisome," said an economic analyst, because the high inflation rate has continued, although there has been a decline in the rate of increases in energy prices.

The F. W. Dodge division of McGraw-Hill Information Systems Co. recently issued a report which shows that the Dodge index of construction contract value dropped another 10 percent in March, due to soaring interest rates that curtailed all but a "few surviving building categories." This drop in the index, which is seasonally adjusted with 1972 as the 100 base, followed a similar percentage drop in February. "The March index, at 155, reflected a total of \$11.3 billion of newly started construction." The level was 25 percent below the value a year ago.

"The construction market's reaction to anti-inflationary restraint is no longer limited to housing," says George A. Christie, vice president and chief economist for Dodge. "As housing starts plunged toward the one-million unit rate in March, minus signs began spreading to several types of nonresidential building and public works." According to Christie, March contracting for housing fell to \$4.6 billion—34 percent less than the year earlier total. The first quarter contract value of \$13 billion is 19 percent below last year, he says.

In March 1979, nonbuilding construction contracts were "booming," Christie says, but in March of this year, the total

of such contracts was \$2.4 billion, down 36 percent from a year ago. This sector is depressed, he says, because of the year-long suspension of nuclear power plant construction and the "more recent restraint on federal funding of highways and other public works."

Nonresidential building fared a little better, with March contracts valued at \$4.3 billion—a 3 percent lead over last year's amount. "But the month's support was narrowly based," says Christie. New office projects of more than \$1 billion "sustained the momentum of the non-residential market in March, offsetting declines in stores, warehouses and institutional buildings."

Meanwhile, the Administration is trying to stimulate new housing construction through existing programs, although major new subsidies are evidently ruled out. For example, it is proposed to provide subsidy relief through an expansion of HUD's section 235 homeownership assistance program, which creates 4 percent mortgages, using money impounded under the Nixon Administration. This would generate, says HUD, about 18,000 mortgage commitments this year in its present form.

Carlson of the National Association of Realtors says that HUD's proposal announced last month shows that the Administration recognizes housing's "plight," but that this effort "does nothing to address the underlying causes of the problems facing housing." He estimates that the revision in section 235 might contribute about 1 percent to the two million units annual need for housing construction. What's suppressing the industry, he says, are "the state of the economy, high inflation, poor fiscal and monetary policy mix at the federal level and oppressive taxes and interest rates."

## Environment: Celebrating Ten Years of Cleanup With Much Yet Undone

A decade ago, the National Environment Policy Act was signed into law, mandating environmental impact assessments of proposed federal actions, and the first "Earth Day" was celebrated by ecologists, drawing nationwide attention to the need to protect the environment. The environment was front-page news. When Earth Day was celebrated this April, there were the teach-ins, the seminars, the exhibits and the sunrise ceremonies, but the zeal of a decade ago had diminished.

"Ten years ago there were only a handful of adults in this country who knew what the word 'ecology' meant," Douglas

*continued on page 246*



Bullock's, San Jose, California—the world's first department store under a permanent Owens-Corning Fiberglas fabric structure. Environmental Planning and Research, Inc., architects and planners. Geiger-Berger Associates, structural engineers.

Circle 35 on information card

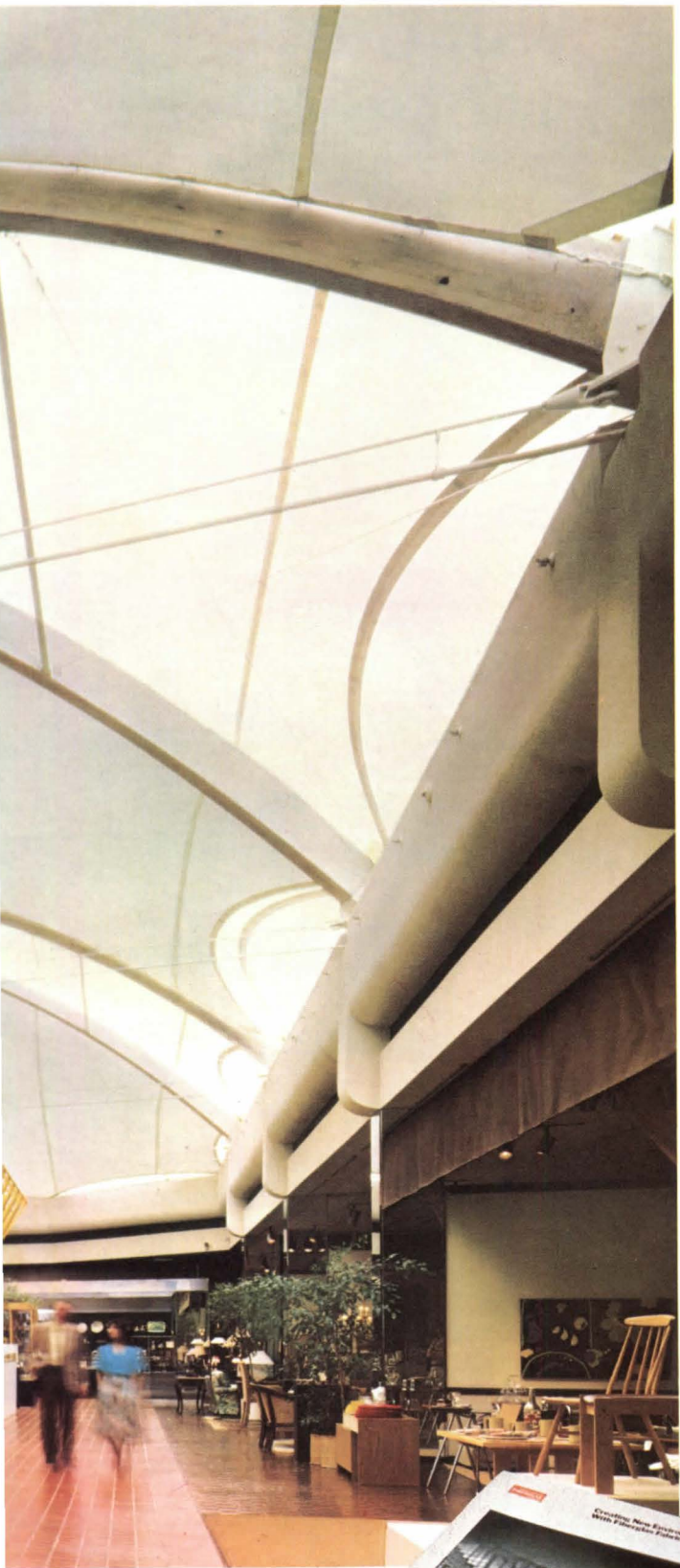

## Create your own energy-efficient environment with an Owens-Corning Fiberglas® Fabric Structure.

This is the beautiful new Bullock's in San Jose, California. The world's first department store with a permanent fabric roof—made of rugged Owens-Corning *Fiberglas* yarn coated with *Teflon*®.

The fabric roof gave the architects the freedom to create a unique environment—open, airy. A lot like a park.

Since the roof is translucent, it lets in soft daylight, thus cutting the need for daytime lighting and the use of energy. And Bullock's is projecting energy savings of \$18,000 a year. (They're now planning a second store with a larger *Fiberglas* fabric roof.)

### More savings.

An Owens-Corning *Fiberglas* fabric roof structure can cost less to build than a conventional roof. And generally, the longer the span, the greater the savings. Plus the fabric roof goes up in a fraction of the time, which can result in even more savings.

The Pontiac Silverdome, home of the Detroit Lions, could not have been built with a conventional roof without going over budget. Today, the Silverdome has a 10-acre *Fiberglas* fabric roof that cost a third the price of a steel-vault one.

### Seven years of success stories.

Owens-Corning has been involved in every *Fiberglas* fabric structure project in the world. We've found there's practically no limit to what you can do with *Fiberglas* fabric structures.

You can use them to create exciting new environments for schools, malls, zoos, libraries, restaurants, hospitals, office buildings, and even airport terminals. (We're now working on the Haj Terminal in Saudi Arabia—larger than 80 football fields.)

### One-stop shopping.

No one is better equipped to help you with your project than Owens-Corning *Fiberglas*. Call on us for assistance during preliminary design as well as for budget estimating. Count on us for materials, fabrication and construction. In short, depend on us for everything from A to Z. Don't hesitate to contact us at the earliest stages of your project.

For a free brochure, just send us this coupon.



### Free brochure

Write to A. I. J. Meeks, Owens-Corning *Fiberglas* Corporation, Fiberglas Tower, Toledo, Ohio 43659

Name \_\_\_\_\_

Title \_\_\_\_\_

Company \_\_\_\_\_

Address \_\_\_\_\_

City \_\_\_\_\_

State \_\_\_\_\_

Zip \_\_\_\_\_

OWENS-CORNING  
**FIBERGLAS**  
TRADE MARK

# 63 hospitals have been built with the EPICORE® Composite Floor System.

## See one for yourself.

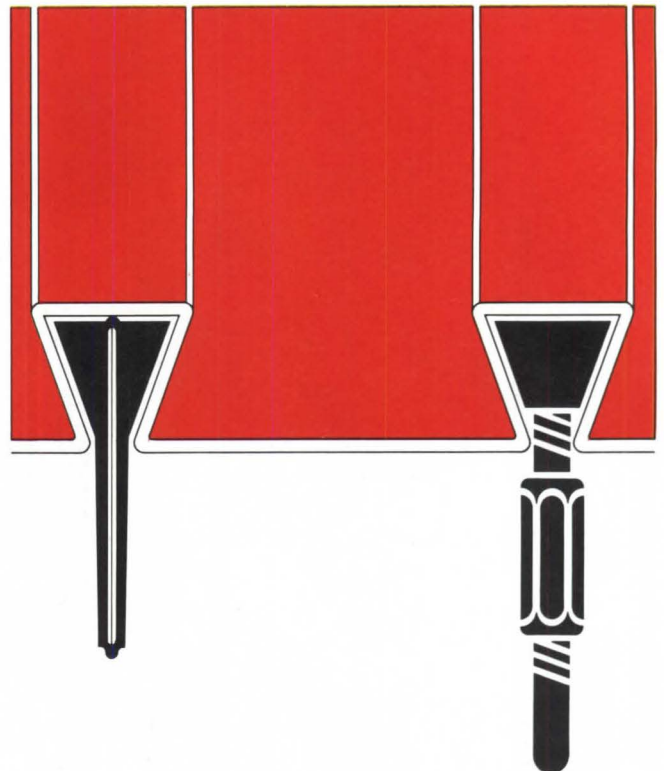
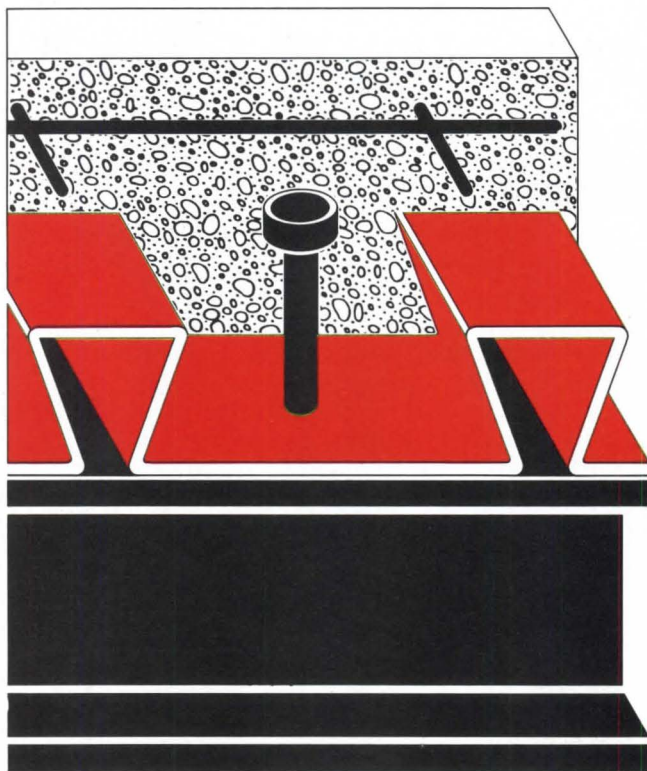

Visit an Epic hospital project. Take a close look at EPICORE's dovetail ribs. They're the key to a permanent integral hanging system and to an unmatched capacity for uniform heavy loading. Because of these two features, managing a hospital facility becomes much more efficient and much less expensive.

Adaptability is assured, principally by EPICORE's hanging system. Two hangers, a clip for loads up to 200 pounds and a wedge bolt for loads up to 1000 pounds can be installed as soon as the concrete slab is finished, and throughout the life of the building. Piping, ducts, mechanical, and medical support equipment can be suspended from the EPICORE Deck whenever it's necessary or convenient. Research, diagnostic, and treatment procedures can be revised or relocated with minimum interruption of normal routine.

Furthermore, EPICORE is engineered to meet the extreme variations in loading necessitated by frequent additions and changes. In composite beam assemblies, for example, full AISC shear connector values and solid slab design are applicable because of EPICORE's distinctive shape.

To visit an EPICORE hospital project, or to find out more about the system, call or write Bob Ault, Vice President - Engineering.

**EPIC**  
METALS CORPORATION

Eleven Talbot Avenue  
Rankin (Pittsburgh), Pa. 15104  
(412) 351-3913

Circle 36 on information card



# AIA Component Awards

Many of AIA's local, state and regional component organizations conduct an annual honor awards program. A sampling of recent award winners, chosen for a range of building types and locations, is seen here and on following pages.

Nora Richter

**Alaska Chapter.** St. Nicholas Russian Orthodox Church restoration, Juneau; Douglas Ackley, AIA, Juneau (right). The entire wood frame building—built in 1893, with belfry added in 1915—has been refinished: The wood foundation was replaced with reinforced concrete, the beams were reinforced, the Celotex wall covering was replaced with plaster board, updated heating and electrical systems were installed. The refinished exterior adheres to the original design concept and materials as closely as possible. Wayne Jensen, photographer.



**Los Angeles Chapter.** Mid-Atlantic Toyota office interiors, Glen Burnie, Md.; Frank O. Gehry & Associates, Santa Monica (left). At the building's entrance the predominant focal point is a brightly lit glass-enclosed stairway leading to the second floor administrative offices. Upstairs, regular and irregular "cutouts" provide for open yet private offices. The pastel walls of pink, blue, yellow and green are highlighted by natural light admitted by skylights. The structural elements of the ceiling are exposed as "industrial references," while suspended chain-link fence parallelograms hang from the ceiling. A jury member commented, "A truly exciting and highly appropriate alternative to the typical office space. You feel as though you are inside a large cubist painting within a loft. There is a great clarity of the plan within the complexity of forms and a feeling of total spatial comprehension throughout."

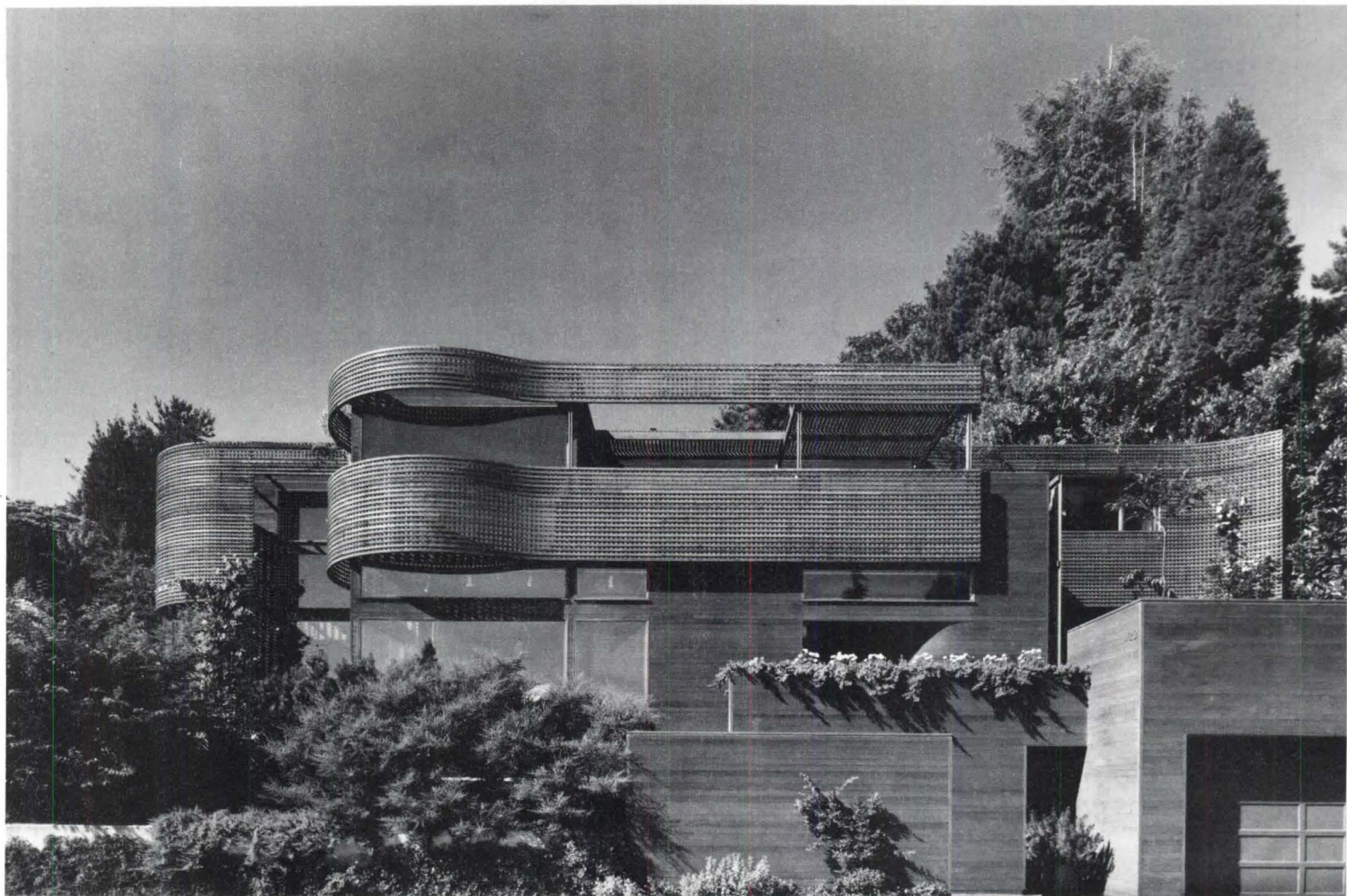

**Seattle Chapter.** Williams residence, Seattle; Gerald A. Williams, FAIA, Seattle (above). The house for the architect's family of four is a wood frame structure with carefully proportioned windows to take advantage of views and natural light. A fluid shaped cedar lath structure covers the south and west facades to provide shade and to support vines. Inside, sec-

tions of both the living room and kitchen extend to the second level. "A surprising variety of well-proportioned spaces were handsomely integrated with the hillside setting. A sensitive exterior solution appropriate for the Northwest," the jury commented. Christian Staub, photographer.

**Pike and Virginia Building, Seattle;** Olson/Walker & Partners, Seattle (right). Because of site restrictions and the low scale of buildings on Pike Street, the building is divided into two sections: The front has three levels and houses a garden shop, wine store and delicatessen; the rear portion has 14 apartments on six levels. Each apartment has its own entrance and balcony space. The building is of natural colored poured-in-place concrete frame and natural masonry block infill. The jury commented, "A clearly stated and consistently executed single architectural idea well suited to its mixed residential and commercial uses." Gregory Minaker, photographer.

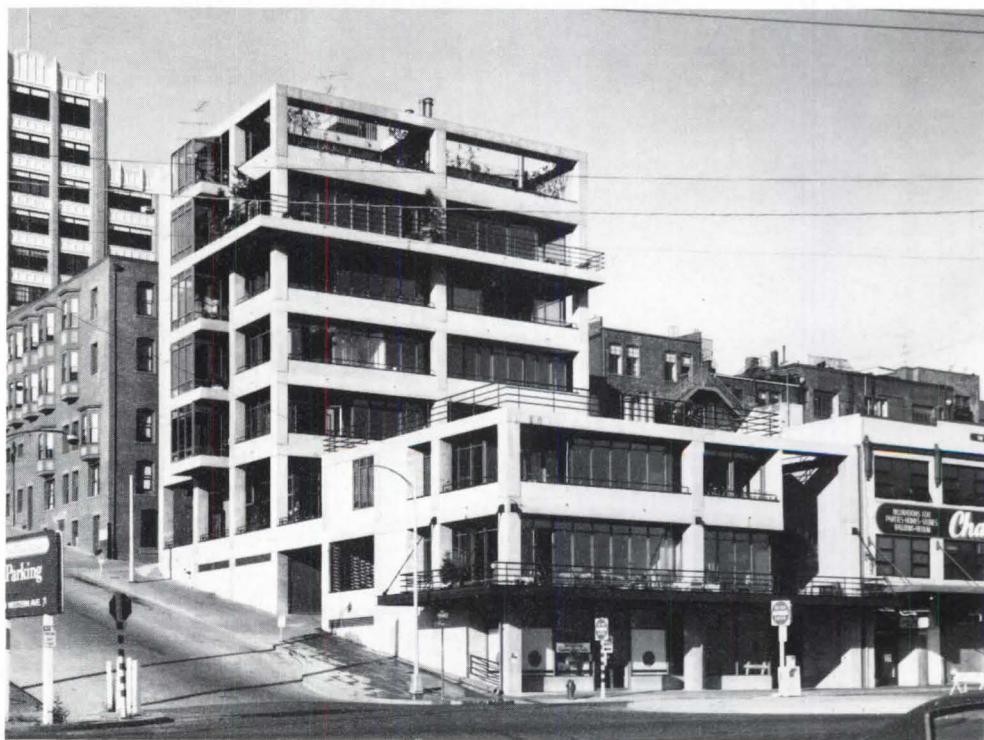



**WHEN IT RAINS IT POURS. RIGHT OFF.**

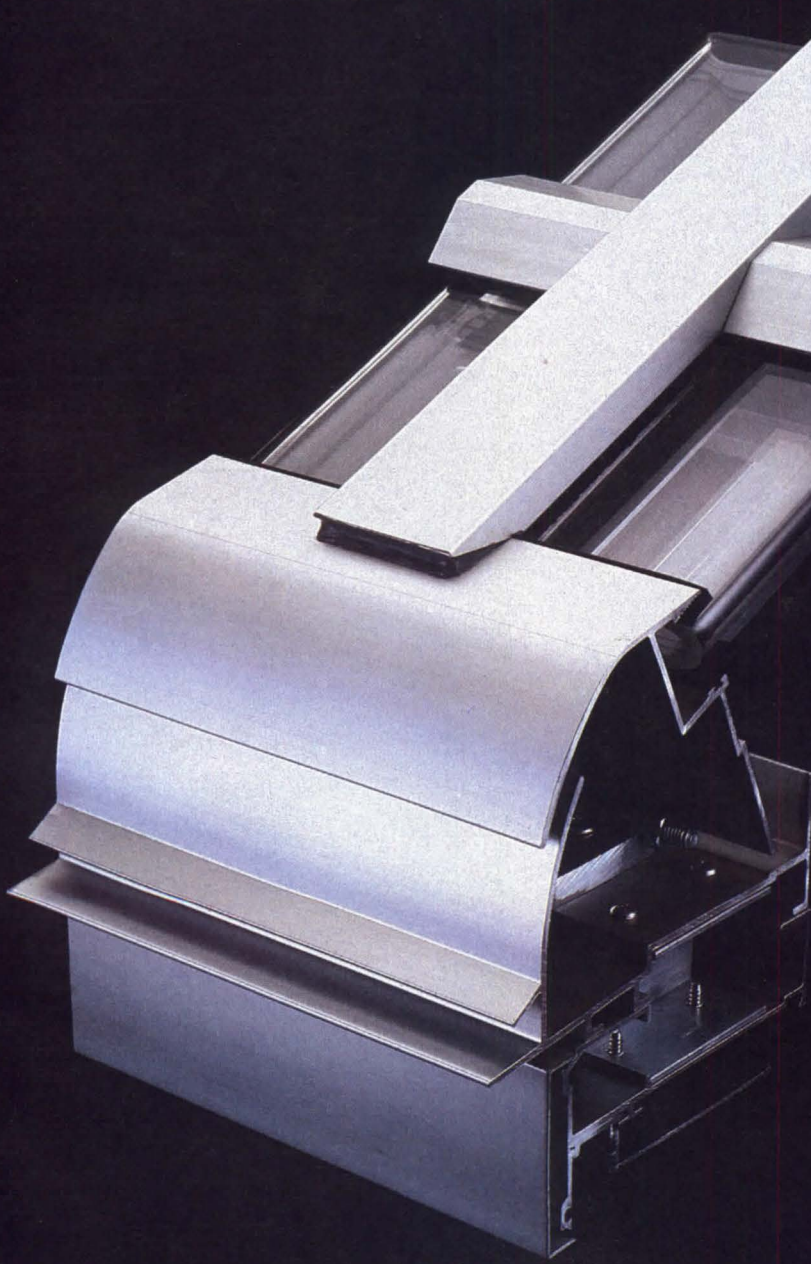

Amarlite smugly introduces an all new slope glazing wall that quite simply works. In the worst kind of weather. With condensation gutters on both single and double glazed systems. With a neoprene sponge gasket inside and pre-shim tape outside with a cap head of wet sealant. With a complete system of internal drainage for exterior weepage should water somehow penetrate the exterior sealant. With interior and exterior members thermally isolated by neoprene to prevent heat transfer.

Specially equipped with a rotating anchor clip that provides for easy installation and compensates for minor changes in the angle of slope so that the framework can actually flex with the structure. Designed for all Amarlite curtain walls but best suited to the PBS-380, 383 and 386 models.

The New Slope Glazing System — Oblique Wall™ from Amarlite. Include it in your forecast.

For more information, write to Amarlite Anaconda, P.O. Box 1719, Atlanta, Ga. 30301. Or you can call us at (404) 691-5750.

**AMARLITE**

ANACONDA Aluminum  
Division of Anaconda Industries



Circle 57 on information card



# This office system can save you up to 20% in office rent, up to 50% on energy, up to 97% on your next move. And it's 100% Westinghouse.

The Westinghouse Open Office System: Today's beautiful way to cut the cost of doing business.

To develop it, we drew upon the talents of professionals throughout the Westinghouse Electric Corporation. Special-

ists in human sciences, lighting, power distribution and acoustics.

And here's how that pays off for you.

Each work station you see here is just as comfortable to work in as the average conventional office, but takes up to 20% less space.

Multiply that 20% saving by the number of conventional offices you use now, and imagine how much our system could save you in total space and rent.

When a change is called for, each work station here can be disassembled and reassembled quickly and easily with a few simple tools. And you won't have to touch lighting, heating, air-conditioning or electrical systems. Compare this to the cost of tearing down walls, reworking the

mechanical systems and recutting carpet. Know how much we could save you on your next move or change? Up to 97%.

Lights? Westinghouse lighting experts developed a unique system



that directs light only where it's needed. Compared with traditional lighting, it uses only half the watts per square foot to provide the needed illumination, and gives better quality light at the same time.

Know how much the Westinghouse

Open Office System could cut from your lighting bill? Up to 50%. But that's just half the beauty of the Westinghouse Open Office System.

Let's talk about productivity. We've

designed the Westinghouse Open Office System for *people*—designed it to fit individual needs, individual tasks and individual tastes. So people work in comfort with as much efficiency as good design can bring about. Beautiful.

Add it up: The Westinghouse Open Office System helps make more people more productive in less space at lower cost. And major corporations using our system are proving it.

For detailed information, contact Westinghouse Architectural Systems Division,

4300 36th Street, S.E., Grand Rapids MI 49508. Or in the continental U.S., call toll-free (800) 821-7700. In Missouri (800) 892-7655. In Canada, call collect (416) 362-7796. In Geneva, Switzerland, call 022/21.16.66.



## Westinghouse Open Office System

Making more people more productive in less space at lower cost.

Circle 38 on information card

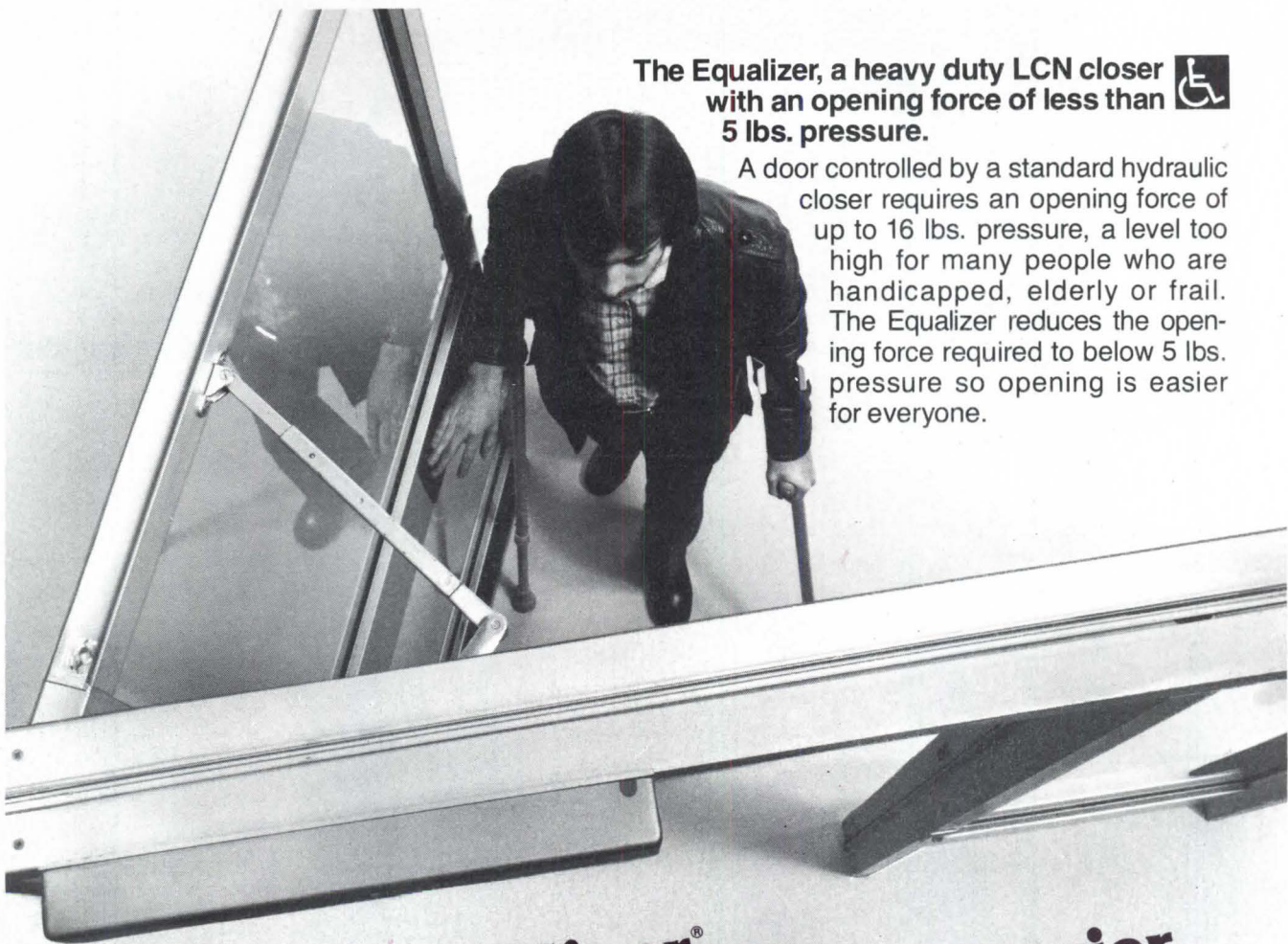

**The Equalizer, a heavy duty LCN closer with an opening force of less than 5 lbs. pressure.** 

A door controlled by a standard hydraulic closer requires an opening force of up to 16 lbs. pressure, a level too high for many people who are handicapped, elderly or frail. The Equalizer reduces the opening force required to below 5 lbs. pressure so opening is easier for everyone.

**With an Equalizer,<sup>®</sup>  
a door is no longer a barrier.**

**A touch of a button reduces the opening force by as much as 75%.**

The Equalizer is a power assist door closer for interior or exterior use. Reduced opening force and an adjustable closing delay facilitates movement through the door. Full door control provided in closing cycle. Equalizer can be installed

on new or existing entrances to meet architectural barrier codes.

Send for Free Equalizer Catalog. Includes information on entrance accessibility and special closers for doors used by people who are handicapped.



## **LCN CLOSERS**

Part of worldwide Ingersoll-Rand

LCN CLOSERS, Princeton, IL 61356 • LCN CANADA, Mississauga, Ontario L5G4L5

Circle 39 on information card

# KIM BOLLARDS

Daytime looks, nighttime performance



# KIM LIGHTING

Subsidiary of Walter Kidde & Company, Inc.

**KIDDE**

16555 E. Gale, Box 1275, Industry, Calif. 91749  
Phone (213) 968-5666

Outdoor Lighting and Architectural Fountains

*Circle 40 on information card*



**Western Mountain Region.** Quad One Planned Unit Development, House 2 and 4, Salt Lake City, Utah; Hallet, Herman-son & Associates, Salt Lake City (left). Both houses use a 12x12-foot planning module with diagonals used to accommodate larger spaces. Passive energy principles are incorporated in both houses: small glass areas on the north side; larger glass areas facing south; shading devices such as awnings and framed canopies. Materials include natural cedar and red-wood exteriors.

St. Mary's Convent, Tucson, Ariz.; Anderson DeBartolo Pan Architects Inc., Tucson (below). The convent was designed to accommodate 22 sisters and provide for future expansion. The first phase of the project consists of one small and one large house, each containing living, dining and activity rooms, kitchen, laundry and storage facilities and hobby and craft space. Energy measures are incorporated.







## TRICKS OF THE TRADE, EXPLAINED.

To be a blinding success, just use your imagination. And the Blind Imagination of Bali one-inch blinds.

When you specify Bali, you'll be giving your building a more uniform appearance. With none of the visual distractions so common with drapes.

That's only our outside story.

Our inside story is this: Bali Blinds do a better job controlling light than other types of window coverings. That saves energy. Even when they're wide open, Bali Blinds still work at 25% efficiency.

Bali saves time, too. Because when it's time to move walls as office arrangements change, inside and recessed or pocket-mount blinds don't have to be moved.

But there's one thing Bali won't leave to your imagination. That's our specifications.

Bali Blinds have been specified in a simple

CSI format to permit ready reference for procurement packages.

And we'll make these specs available to you, for you to write your requirements around them.

So, if you want to be a blinding success in business, build around Bali. And use the coupon below for a copy of our brochure, *The Tricks of the Trade*.

BALI BLINDS  
 ©1978, Marathon Carey-McFall Company, Loyalsock Avenue, Montoursville, Pennsylvania 17754. Division of Marathon Manufacturing Company.

Show me *The Tricks of the Trade*, free.

Name \_\_\_\_\_

Company \_\_\_\_\_

Address \_\_\_\_\_

City \_\_\_\_\_ State \_\_\_\_\_ Zip \_\_\_\_\_

Telephone \_\_\_\_\_

 **BALI BLINDS**  
**BALI IS BLIND IMAGINATION.**

Circle 41 on information card



**Nevada Society of Architects.** Stern residence, Reno; Theodore E. Selden, AIA, & Maurice J. Nesper, AIA, Reno (above). The three-story, 3,019-square-foot house employs passive solar design concepts. The southwest roof extends to the ground, deflecting cold winter winds over the structure. Cool summer evening breezes are collected by adjustable awning scoops and directed into and through the interior spaces. The open design of the interior spaces aids air circulation. The jury commented that the form is derived not "from stylistic concerns but rather from the owners' needs and local environmental conditions. . . . The interiors are rich and exciting and, although complex, there is much spatial fun."

**Montana Chapter.** Rex Hotel, Billings; A & E Partnership, Billings (right). The exterior facade of the 1916 building (designed by Curtis Oehme) was restored to its original state; interior spaces were redesigned. The main floor consists of a restaurant with original metal pan ceiling and newly designed bar, furnishings and plant decor. The second floor contains leased office space, and the third provides offices of the owners, A & E Partnership. The project was the initial renovation effort in a previously decaying area and resulted in the establishment of the Townsite Historic District.



**Colorado Society of Architects.** Mountain Bell Denver Service Center; RNL, Inc., Denver (right). The buildings at the base of the project vary from one to three stories and house employee and public affairs functions. These structures are located to protect the plaza and main entrance from cold winter winds. The 23-story tower has solar bronze glass, bronze toned granite and bronze insulating reflective glass. Julius Shulman, photographer.

Colorado School of Mines Student Dormitory, Golden; John D. Anderson Associates, Denver (below). Two housing towers are joined at the base by a single level commons area. Each tower contains suites with a living room and sleeping space for eight or nine students. The suites are grouped around a central enclosed atrium. A 3,000-square-foot flat plate solar collector bank is supported on a triangular truss that spans the two towers at roof level. Solar energy is used for domestic hot water and space heating. Andrew Kramer, AIA, photographer.

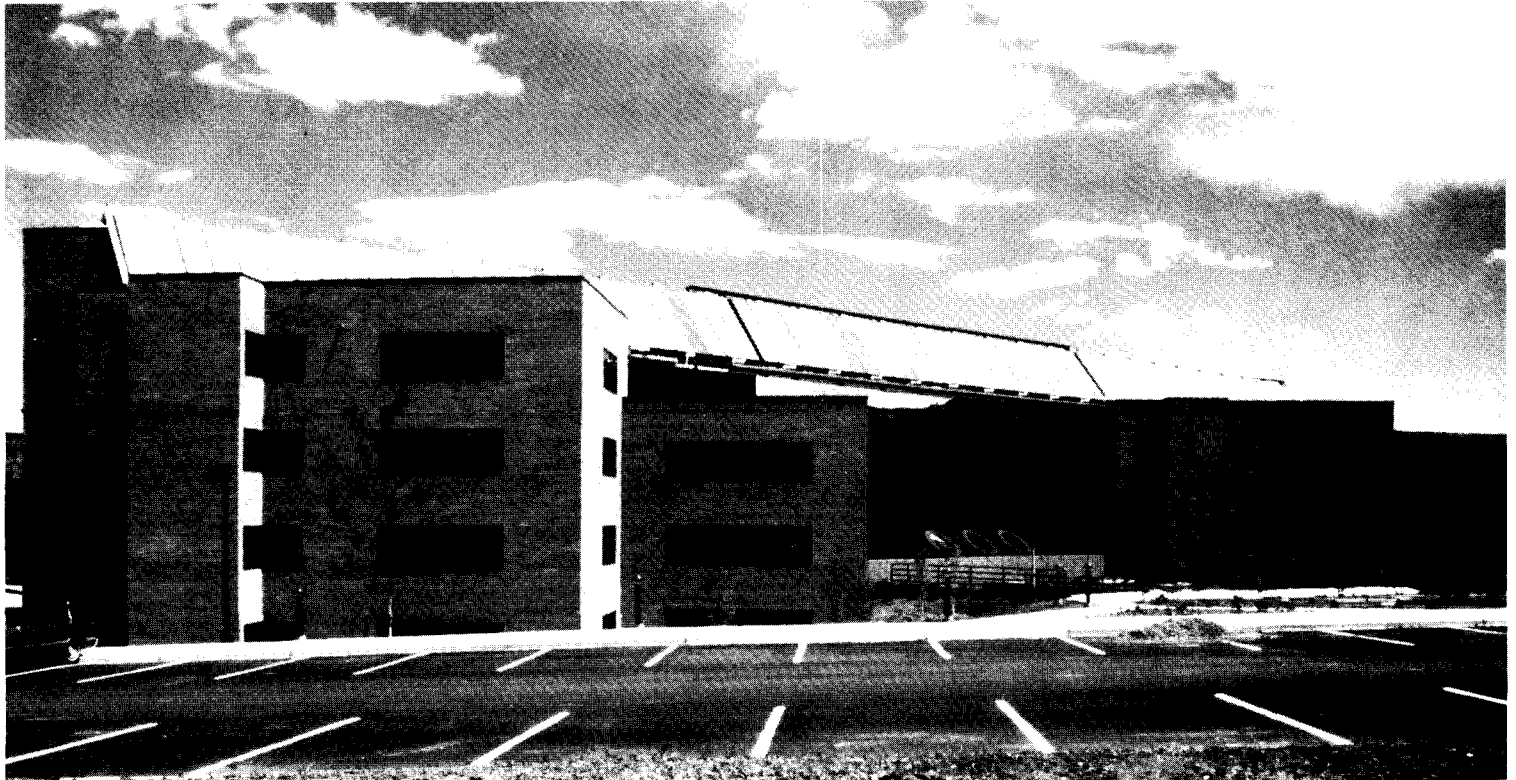

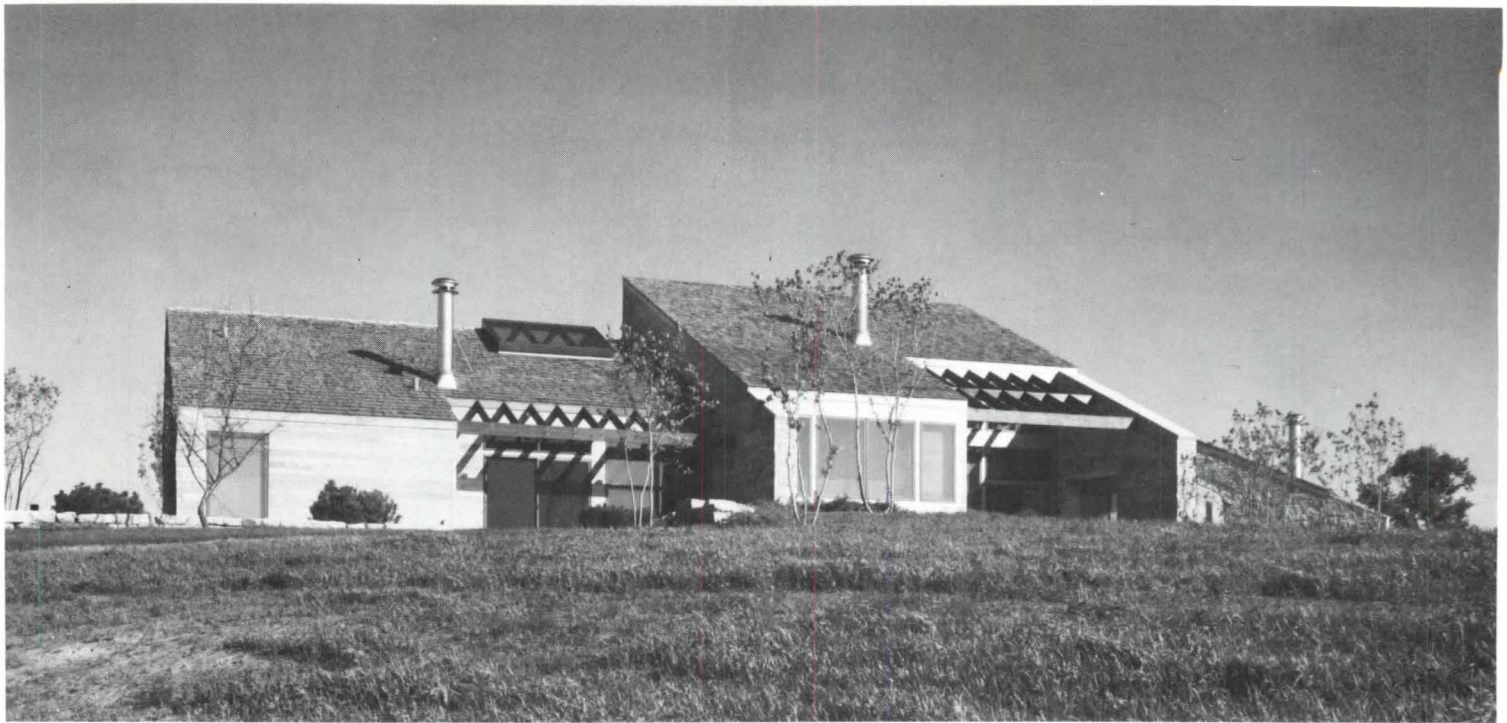

**South Dakota Society.** Pasley residence, Sioux Falls; Architecture, Inc., Sioux Falls (above). The owner requested a horizontal separation of spaces, and the architect turned the house around a hill to create a variety of views and privacy. The master bedroom is at one end, convenient to the living room, dining room and kitchen. Connected on the other side is a den, two bedrooms, game room and family room. A solar collector is located on the garage roof oriented to the south. Materials include native stone and cedar. Joel Strasser, photographer.

Southeast Town Houses, Sioux Falls; Architecture Inc., Sioux Falls (below). The six-unit, 7,688-square-foot town house is oriented toward the southwest for a view of a city park and the Sioux River. Each unit is set back from the previous one to allow for a greater view and privacy, and has a garage, living room, dining room and deck on the second floor and a bedroom on the third. Exterior walls are of cedar siding.

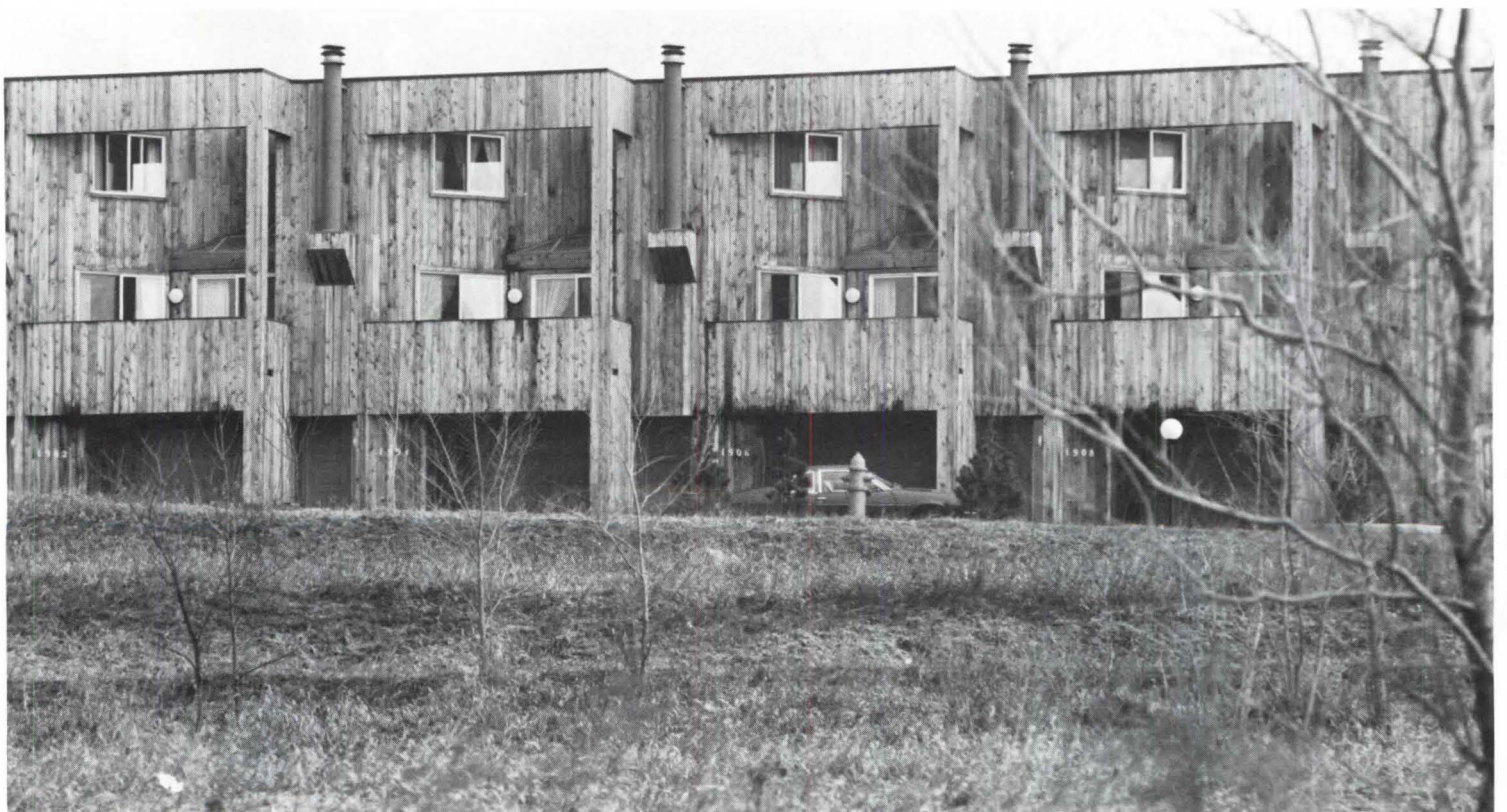

# Columbia does it again!



## **P2** Parabolume...the low energy lighting for the 80's!

P2 Parabolume is the most practical innovation in parabolic fluorescent luminaires since Columbia Lighting introduced the original fifteen years ago. P2 Parabolume optimizes energy performance while maintaining the high visual comfort commensurate with good lighting practice. Specify P2 Parabolume...the most precise lighting device in today's recessed fluorescent market. Call your Columbia Agent or write us.

Columbia Operation  
GTE Products Corporation  
T. A. Box 2787/N. 3808 Sullivan  
Spokane, WA 99220

**GTE** | **Specification  
Lighting**

*Circle 42 on information card*

# VULCRAFT IMPORTANT ROLE ON



# PLAYED AN SUPPORTING BROADWAY.



Vulcraft now manufactures a broad line of steel deck along with steel joists and joist girders.



The simplicity and light weight of Vulcraft joists and joist girders make erection fast and easy.

Vulcraft provided steel joists, joist girders and steel deck for the three-story Broadway Executive Building on the Broadway Extension in Oklahoma City.

Since Vulcraft is the only company that manufactures and sells all three, the steel fabricator ordered them all from Vulcraft. By dealing with a single source, he gained several advantages.

When heavy load considerations required specially-designed joists and joist girders, Vulcraft designed just what was needed.

When detailed drawings were called for, Vulcraft provided them for the joists, joist girders and deck.

When simultaneous delivery was requested for all three elements, Vulcraft delivered them together.

When purchase orders were processed, Vulcraft needed one, not three.

And when maximum coordination was required during erection, Vulcraft's ability to deliver joists, joist girders and deck paid off in a savings of time and money for the customer.

So if you'd like the advantages of a single source for steel joists, joist girders and steel deck, talk to Vulcraft.

We'd like to play an important supporting role in your next production. Even if it's Off-Broadway.

Just contact your local Vulcraft representative. Or write Vulcraft, P.O. Box 220646, Charlotte, North Carolina 28222, for our steel deck and joist catalogs.

Architects: Architectural Design Group  
Developers: Spaulding and Slye Corp.  
Steel Fabricators: Kraeger Structures, Inc.  
Steel Erector: Allied Steel Construction Co.

## VULCRAFT

A Division of Nucor Corporation.

P.O. Box F-2, Florence, SC 29502 803/662-0381  
P.O. Box 169, Fort Payne, AL 35967 205/845-2460  
P.O. Box 186, Grapeland, TX 75844 713/687-4665  
P.O. Box 59, Norfolk, NE 68701 402/371-0020  
P.O. Box 1000, St. Joe, IN 46785 219/337-5411

**PPG SETS THE  
GOLD STANDARD  
IN GLASS.**

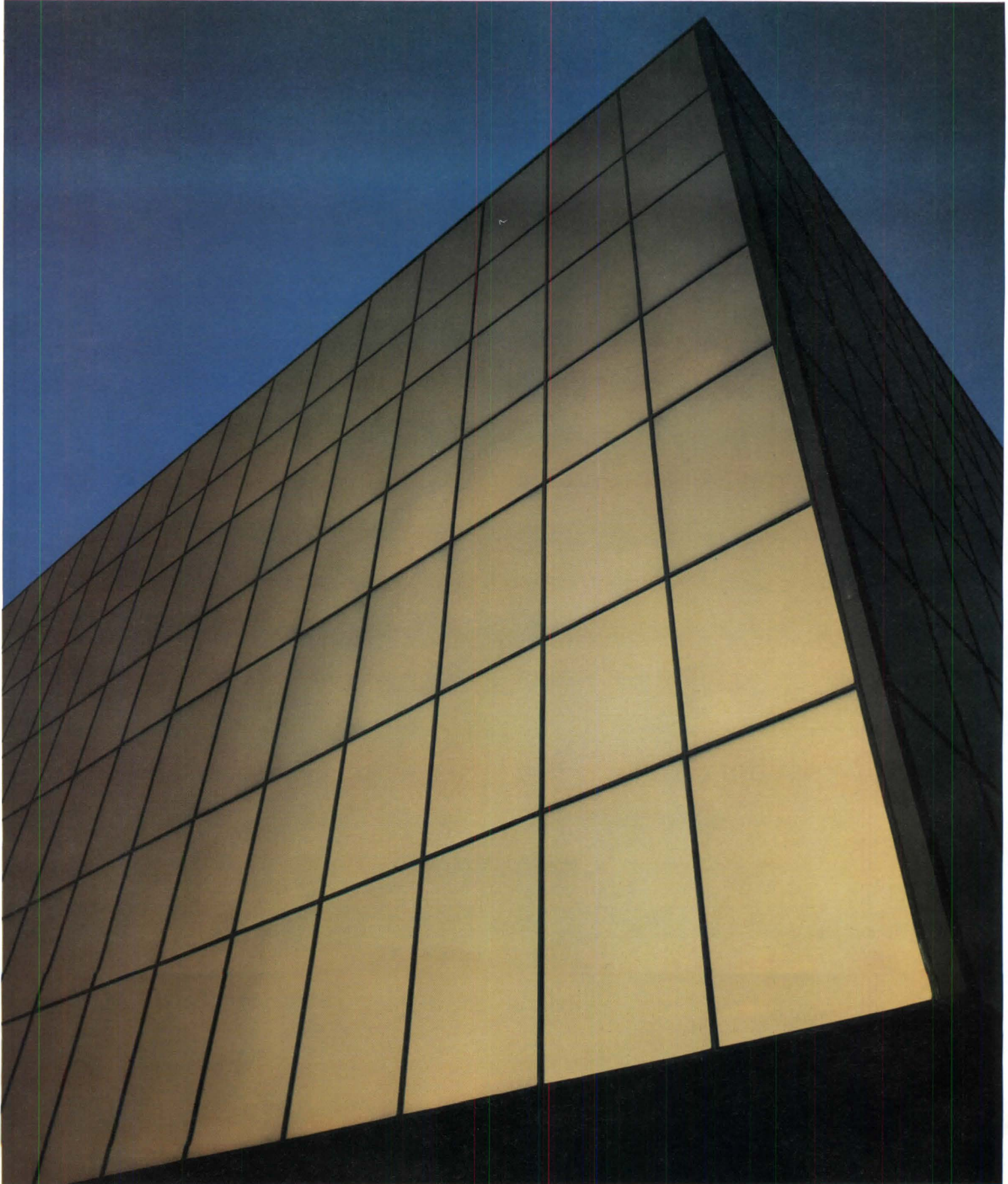



The Midland Life Insurance Building, Sioux Falls, South Dakota. The centerpiece of a far-reaching urban renewal program. And a triumph in modern center city architecture.

One reason for the building's success is 26,000 square feet of energy-conserving PPG *Solarban*<sup>®</sup> Gold *Twindow*<sup>®</sup> reflective glass. A breathtaking building skin that, literally, has earned its way into this design.

### THE STANDARD FOR BEAUTY.

Perhaps the most striking characteristic of *Solarban* Gold is its true color. It isn't brassy or greenish like many other gold reflective glasses. Instead, its rich golden tone is distinctive and elegant. An excellent way to bring out the best in any innovative design.

Yet *Solarban* Gold never looks out of place. Its reflective qualities

allow it to blend easily and naturally into practically any surroundings.

### THE STANDARD FOR ENERGY EFFICIENCY.

But beauty is only half the story. *Solarban* Gold is also the most energy effective of all PPG's high performance glasses. Each panel boasts a U-value of .30. And spandrel units are available with even more impressive U-values of .08.

That kind of insulating efficiency is coupled with other energy-saving features to meet the design goal of a building that needs no heat until the outside temperature dips below 10 degrees Fahrenheit.

*Solarban* Gold is effective during the summer, too. By reflecting the sun's heat, it reduces solar heat gain as well as the need for air-conditioning.

There's much more to learn about PPG's spectacular gold standard in glass. For more details, see Sweet's 8.26 Pp, or write PPG Industries, Inc., One Gateway Center, Pittsburgh, PA 15222.

PPG: a Concern for the Future



Architect:  
Henningson, Durham & Richardson, Inc.,  
Omaha, Nebraska.  
Owner:  
Midland National Life Insurance Company,  
Sioux Falls, South Dakota.



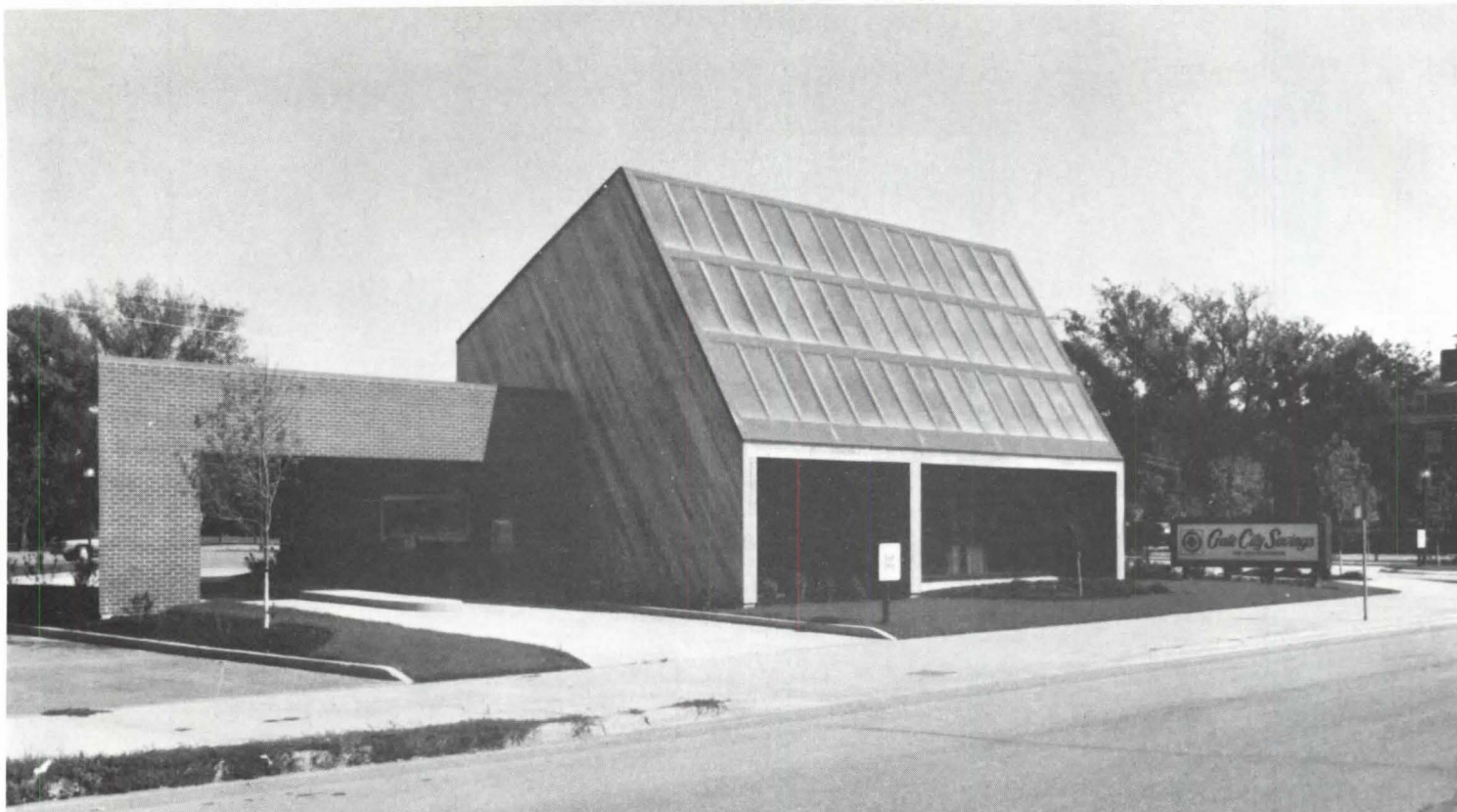

**North Dakota Chapter.** Gate City Savings and Loan, Wahpeton; Hunter-Grobe, Fargo (above). The owner's primary design objective was an "attractive" structure that would gain attention and have visibility despite small space program requirements. The architects placed solar panels and portions of the mechanical system on the second level adjacent to the street. The year-round heating, cooling solar system provides approximately 60 percent of the energy needs. The triangular plan permits easy customer access to the drive-in teller stations.

**Texas Society of Architects.** Peck beach house, Galveston; Ray B. Bailey Architects, Inc., Houston (right). The owners requested a weekend house for their family of five that would have a feeling of openness while maintaining private areas and would maximize views of the Gulf of Mexico. The plan focuses on a two-story-high living area that is overlooked by the third floor sleeping loft. Decks adjoin each living level and the roof. The relatively closed north wall limits views toward adjacent houses. Richard Payne, AIA, photographer.

*(More AIA component awards begin on page 260.)*



# USG<sup>®</sup> LIGHT STEEL FRAMING

full line  
national service  
on the line  
for you!

Atlanta, GA: (404) 393-0770  
Kearny, NJ: (201) 997-1600  
Los Angeles, CA: (213) 775-3696  
Chicago, IL: (312) 321-3979 or 4137



We're strictly heavyweights when it comes to steel framing for light commercial and industrial applications. And we speak your language (coast-to-coast) with full line savings, selection, service and more! The "more" is our exceptional product quality. Precision-engineered USG steel studs, joists and runners are the cost-cutting answer for buildings up to four stories high; offer you the styles, sizes and versatility you need to handle different building types at low in-place cost. You'll find adaptable USG Light Steel Framing gives you many other advantages over wood and masonry systems. Pre-cut erection speed. Fire and sound ratings. Predictable pricing. Dependable national availability. Lighter financing load. ■ Call us today. Or mail coupon for details.

United States Gypsum, 101 S. Wacker Dr.,  
Chicago, IL 60606, Dept. AJ 580D

Please send latest literature on USG Light Steel Framing to:

Name  Title

Firm

Address

City  State  Zip

**UNITED STATES GYPSUM**  
BUILDING AMERICA

Circle 45 on information card

# BOOKS

## An 'Education' in Drawings As Well as in Architecture

**The Architect's Eye: American Architectural Drawings from 1799-1978.** Deborah Nevins and Robert A. M. Stern. (Pantheon Books, \$35.)

When I was in school in the early '60s, I acquired a book entitled *The Architecture of Fantasy* by Conrads and Sperlich. The book had a lot of futurist, expressionist and visionary work in it, most of it represented by drawings. For many years, this was the most architectural drawing in one place that I saw. Mainstream architecture in the '60s was defined narrowly, and the most important drawings generally published were Mies van der Rohe's exquisitely drawn corner details and an occasional black and white reproduction of a Frank Lloyd Wright color pencil rendering. During this time, Bruce Goff was doing drawings of strange buildings, and Paolo Soleri was rendering whole cities out in the desert, but neither was taken seriously. On the whole, architectural drawing and the visionary architecture made possible through drawings were dead issues.

All that has changed, and architectural drawings are everywhere: on students' boards, in galleries, in museums, in magazines, in books. *The Architect's Eye* is a sumptuous presentation of 80 drawings, 40 in color, in oversized format on coated paper. The selection covers American architecture from 1799 to 1978, and there is an introduction by Robert A. M. Stern, AIA, plus commentaries by Deborah Nevins. The book is an outgrowth of the show, "200 Years of American Architectural Drawing," organized in 1976 by David Gebhard and Deborah Nevins for the Architectural League of New York and the American Federation of Arts, published as a book of the same title by Whitney Library of Design. *The Architect's Eye* differs from the previous book in that it presents fewer drawings, better reproduced, and with a lot of color. It appears less cluttered and is intended for a general audience as well as an architectural one.

This book is a treat. Working slowly through it, one moves through the periods and styles of American architecture: Palladian, Greek revivals, Gothic revivals, romantic castles, gingerbread houses, per-

sonal heroics, sensitive brickwork, towering skyscrapers, expressionist fantasies. It is an education in architecture as well as drawing, a reminder of dozens of styles, periods and architects we might have forgotten.

Why the current interest in architectural drawings? It seems to me that the interest is synonymous with an increased interest in architecture itself. Although there are doubtless exceptions, I suspect that there is a very strong correlation between good drawing and good architecture. For the architect, drawing is thinking, and what the pencil or pen cannot render is not there as thought and will not be there in the building. The weakness of much modern architecture is probably connected with the inability of many contemporary architects to draw well. In much of the modern orthodoxy, good drawing was regarded with suspicion. It smacked of the Beaux-Arts. Anyway, the building should be a consequence of the serial piling up of prefabricated components, it was thought, so esthetic decisions had little place in design. Thus were lost the subtleties of the ground meeting the sky, the play of light, response to seasons, modulation of surfaces.

The drawings that have emerged in the late 1970s are strong on conceptual issues, and, as the genre evolves, I hope they will also become strong in detail: in sensitivity to materials, textures, finishes, light and the character of the site. If draw-

ings combine these strengths, buildings eventually will also.

In commenting on her book on women painters, *The Obstacle Race*, Germaine Greer said that she hoped it would be the last book of its kind. Having established the importance of women painters, Greer feels that the next task is to deal with specific women of importance. The same, I hope, will be true for architectural drawing. *The Architect's Eye* is wonderful as a survey, but beyond Wright and Louis Kahn, we have little access to the drawings of dozens of architects from which we could derive much pleasure and benefit. Let us hope that the efforts of Gebhard, Nevins and Stern will lead to extensive presentations of the work of individual architects. *John Lobell, Associate Professor of Architecture, Pratt Institute*

**White Towers.** Paul Hirshorn and Steven Izenour. (MIT Press, \$17.50.)

Gleaming white with large areas of glass, a small tower and open all night, the White Tower hamburger stand has become an ubiquitous presence on the American landscape. Squat and boxy, sleek and streamlined or moderne with zig-zag trim, the White Tower has changed in details over the years while remaining constant in image. This book on the architectural history of a fast food enterprise is both important and at the same time disappointing. Or, like the

*continued on page 82*

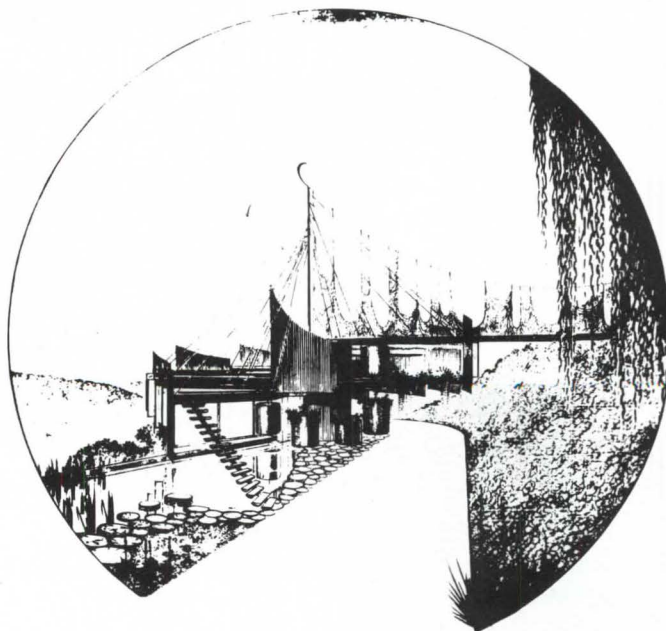

*Bruce Goff's drawing for the Barnes house project in Canyon, Calif.*



# We make mountains out of malls.

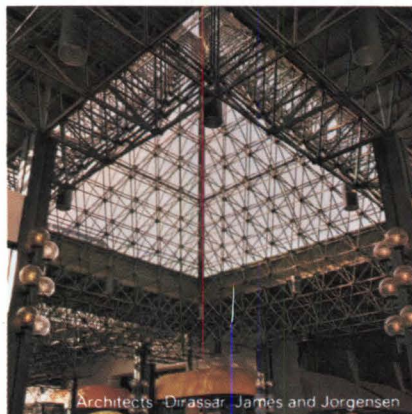

Here at the Guildford Town Centre shopping mall in Vancouver, B.C., a man-made landscape rises to the sky, while natural light floods downward into an equally spectacular interior.

It's a remarkable design; almost timeless.

And yet, thanks to Moduspan<sup>®</sup> space frame and the technical assistance of Unistrut's space frame experts, the architect didn't have to move mountains to achieve it.

For more information on how Moduspan can

help you reach new pinnacles with your own projects, call the Unistrut Service Center nearest you. Or see our catalogue in Sweets.

**UNISTRUT**



Circle 46 on information card

**Books from page 80**

food served, the anticipation is greater than the reward.

Founded in Milwaukee in 1926 by a father and son team, J. E. and T. E. Sax, the White Tower firm grew until at its height in the mid-1950s more than 230 shops were in operation. Clean and hygienic in appearance, the shops provided a known quality and quantity of food: "Hamburger 5¢ 'Buy a Bagful' Rolls 5¢ Donuts 5¢ Pie 10¢ Coffee 5¢ Milk 5¢ Pop 5¢ Buttermilk 5¢."

The firm's initial success came in densely populated urban areas, such as on public transportation routes under the elevated or next to subway stops, or squeezed into narrow ground floors of 10 feet in width. They were the quick bite shops of both the blue collar and the office work force. With changing social patterns in the 1930s and the growing infatuation with the automobile, White Tower moved to the roadways and highways, adding parking areas and in some cases carhop service to attract a new breed of customers.

White Tower succeeded until the early 1960s when the firm began to lose ground to a new type of fast food chain not dependent upon public transportation and not appealing entirely to workers but to all elements of society including mom and the kids. Careful marketing and media images of clowns and the appeal of an "ATTACK" supplanted the White Tower that never developed an advertising campaign. Today, White Tower as a subsidiary of the Tombrock Corporation operates about 80 shops.

The success of the White Tower for a time raises the question of how much this success and subsequent decline had to do with the architectural image. The initial source for the motif of a White Tower came from the Wichita, Kan., hamburger chain, White Castle, that had been founded in 1921 and had spread throughout the Midwest. The first White Towers were designed by construction company draftsmen and were constructed entirely of white glazed brick. A tower was asymmetrically placed over the entrance and, with modifications from the early crenellations to 1930s moderne setbacks, and 1950s and '60s cubes, the tower identified the enterprise.

Different materials were experimented with, and in the 1930s porcelain enamel panels and Vitrolite panels came into use. Different designers were employed over the years, both company architects and, in some cases, local architects. Some of the most interesting streamlined roadside designs of the 1930s came from local architects or from competitors who tried to cash in on the White Tower image, erected a building and then discovered the mechanics of running the shop were too

much and sold out. Since 1935, the company architect has been Charles J. Johnson, who followed not only esthetics, but, as he claimed: "We're in business to make a buck." The gleaming, slick and White Tower image was maintained until the competition became rugged. Then color was introduced, the tower became less obvious and, in extreme cases, the suburban mansard served as a replacement. Today, the image has been dissipated.

The White Tower image has become passé, too identified with nickel hamburgers. But one wonders. An unidentified quotation (perhaps by architect Charles Johnson)—the very last in the book—claims: "So if you were going to rank the order of importance, I guess having the right location—you've got to have that. Second, the internal layout. Third is the service and, fourth, maybe just the visual impact of the restaurant from the outside." If one accepts this observation, architectural image has minimal importance.

After many years of ignoring the commercial vernacular environment, it is suddenly "in." Nostalgia for what was formerly despised, from roadside diners to Tuscan-columned Texaco stations, has hit, and the books are rolling off the presses. This one is an example. A small amount of text, beautiful photographs—most of which are period pieces taken by commercial photographers and are from

the White Tower archives—make up the book. The photographs are the reason for buying the book. The text only superficially recounts the history of the firm and the development of the design. It is largely uncritical and filled with a sentimental longing for days past.

The authors became infatuated with the White Tower image while working for the Venturi & Rauch firm in Philadelphia in 1970. Some of the iconoclastic spirit of *Learning from Las Vegas* (Izenour was a coauthor with Robert Venturi and Denise Scott Brown) pervades *White Towers*. Personal appreciation is but one level of understanding an architectural image. A critical analysis of the history of the image must be put into a context of national history and corporate development before any true understanding can be reached. Was the architectural imagery of any importance? And if it did help to sell hamburgers, then why the decline of the firm in recent years? There is no single or simple answer, but it might help to explain the design evolution. To many, of course, White Towers are not worthy of consideration; they are not architecture. But they are there, and in the direct appeal of the classic White Tower there is an undeniable presence. *Richard Guy Wilson, Chairman, Division of Architectural History, University of Virginia, Charlottesville*

*Books continued on page 85*



**A Field Guide to American Architecture.** Carole Rifkind. (New American Library, \$19.95). Using as source the measured drawings compiled during the Depression, Rifkind guides the reader through this country's architectural history, describing successive stylistic phases—from 17th century houses to the skyscrapers of the first half of the 20th century. The more than 450 line drawings and photographs, with Rifkind's instructive text, give insights into the various architectural styles. Intended for the layman as well as the professional architect, the book is, as a critic has said, a "fun companion for walking through American cities, and for walking through time too." Above is the Chateau-sur-Mer, Newport, R.I., which shows how Richard Morris Hunt handled the remodeling (1871-72) of an 1851 structure.

# We bring buildings out of their shells.

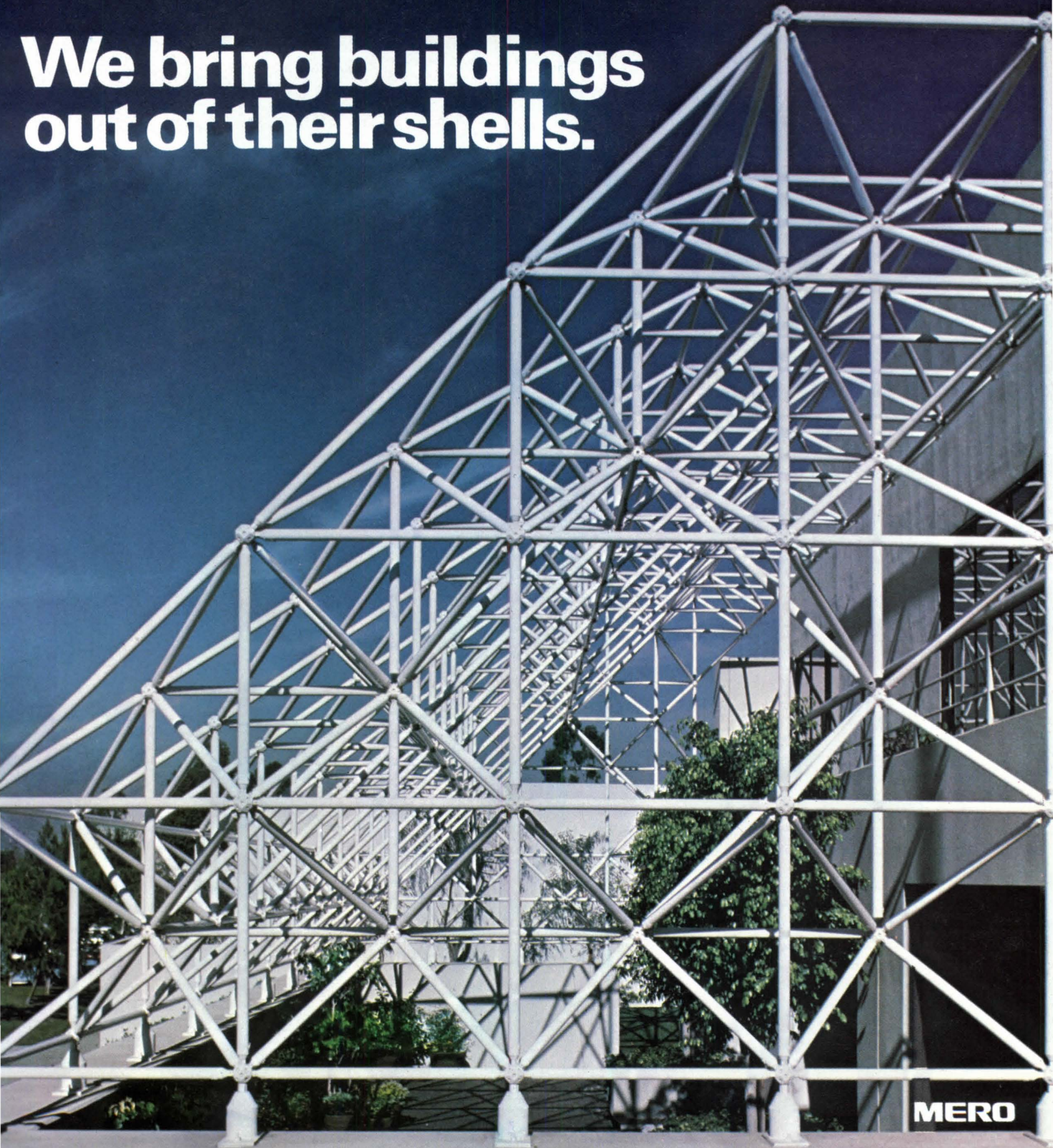

**MERO**

This extroverted structure is Shiley Laboratories, in Irvine, California, where an architect with something to say said it with Mero,<sup>®</sup> the space frame that helps

buildings do more than just take up space.

For more information on how Mero can help you make your own design

statements more assertive, call or write Unistrut Corporation, Wayne, Michigan, 48184, (313) 721-4040. In other states, call (800) 521-7730 toll-free.

Keisker-Johnson & Partners, Architects

Circle 47 on information card

**UNISTRUT** Mero Systems





# Xerox copied the original 550 times and cut energy costs.

Thanks to 550 EnerCon® water-source heat pumps, the new Xerox Corporate Headquarters in Stamford, Connecticut is much more energy-efficient than most buildings of comparable size subject to similar climatic conditions. Energy consumption is estimated to be reduced 25-35%.\*

## Size & Design vs. Heating & Cooling

The Xerox building is a well-insulated, limestone structure containing 255,000 square feet, divided into four bays by three atriums. Heating and cooling such a structure presented many problems. But Syska & Hennessy, New York, designers of the mechanical systems, provided a highly efficient solution.

They specified a central computerized management system to monitor the fluctuating demands for electricity,

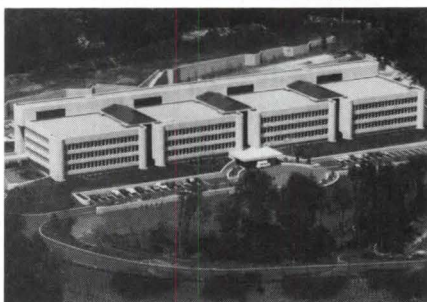

temperature and lighting throughout the building, and to control the HVAC system for ultimate energy conservation.

## EnerCon ties in with other components

EnerCon console units were placed in each perimeter office, while above-ceiling horizontal EnerCon units were installed in other offices. All of the EnerCon units were interconnected by means of a closed water pipe

loop with a central system serving the building interior and with a 40,000-gallon underground water storage tank.

## Here's what Xerox thinks about EnerCon

Of the EnerCon water-source heat pump system, Xerox officials say, "Individual units in exterior zones consume less energy than central heating, ventilating and air conditioning systems. Body and lighting heat are factored into the computer which then regulates the heat pump's level of warming or cooling the building."

For more information on how EnerCon can help cut your building's energy costs, contact your local AAF representative. Or write: American Air Filter Company, Inc., Dept. 592, 215 Central Avenue, Louisville, Kentucky 40277.

**Better Air is Our Business®**

\*Calculated from data obtained from similar installations with similar climatic conditions.

**AAF** American Air Filter  
AN ALLIS-CHALMERS COMPANY



Books from page 82

**'Fill 'Er Up': An Architectural History of America's Gas Stations.** Daniel I. Vieyra. (Collier Books, \$7.95.)

Why an architectural history of America's gas stations? This book, with other recent studies of diners, motels and White Tower restaurants, reflects a recent interest in the artifacts of America's roadways that is rooted in a re-examination of American commercial culture. The intellectual parents of the movement are Robert Venturi, Denise Scott Brown and Steven Izenour. Their writings express a disillusionment with the work of architectural modernists, which they have sometimes tied to the large corporate/governmental organizations that commissioned those buildings. Vieyra's book is a less carefully thought-out product of the same vision. In the wake of the "failure" of both modern architecture and of the modern corporate state to fulfill their humanist promises, this is an attempt to find capitalism with a human face in the roadside architecture of the recent past.

The enterprise raises some important questions about semiotic qualities of buildings and their role in roadside merchandising and about the influence of public action on commercial design and the landscape of the strip. In short, the place of the strip in modern American life



Natchez, Miss.

is at issue here. Despite acknowledgment of the work of the Philadelphia architects, Vieyra recognizes few of these questions and confronts none satisfactorily. Declaring "the premise that 'symbols dominate spaces'" to be the "solid theoretical foundation" of this book, the author has chosen to bypass a chronological treatment in favor of a structure that

groups gas stations into four categories: the fantastic, the respectable, the domestic and "the 'functional.'" (No indication is given why the latter requires quotation marks while none of the others does.)

This scheme is fine, but the categories are based upon a visual appraisal of the stations' form, rather than a careful analysis of their symbolic effect. There is no evidence that any of the many art historical, philosophical, anthropological or linguistic theories of symbols seriously affected Vieyra's thinking. As is common in many treatments of commercial vernacular architecture, the author asserts that these corporate buildings reflect all of us, but doesn't say how or why. Since the only systematic documentary research seems to have been concentrated in the *National Petroleum News*, one must assume that the statement is based on the market myth: the belief that producers respond to consumer demand. Because American enterprise is so diversified and so flexible, there is something for everyone. Therefore, what you get is what you want.

If *Fill 'Er Up* hadn't been described by its author as an architectural history with a theoretical structure, it could be written off as a "nostalgic celebration" of the "carefree joy of the open road that once  
*continued on page 86*



# Strut your stuff.

How do you build an effective sales network? It's easy. Just start with MEROFORM® struts and connectors.

MEROFORM is versatile enough to be

used in almost any display space.

Beautiful enough to do justice to whatever you're selling. And simple enough to show it off, without showing it up.

For more information, contact your local Unistrut Service Center or write the Unistrut Corporation, Wayne, MI. 48184.

**UNISTRUT** Mero Systems | GTE

# Tough

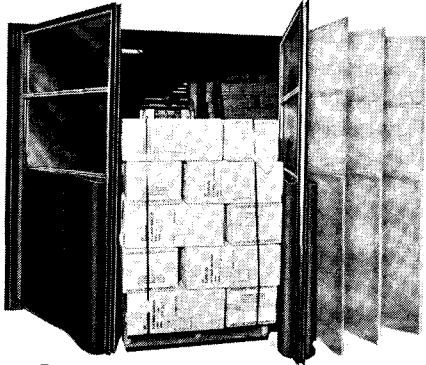

**McGuire Traffic Doors  
Always Come  
Back Swinging**

In Energy  
Conservation...

**Make  
it**

# McGUIRE

**W.B. McGuire Co., Inc.**

The acid test for any traffic door is how well it stands up under actual working conditions, and not by some funny-looking, slow moving, piece of test equipment used under controlled conditions. McGuire traffic doors' reputation for dependability and long life is proven day after day right on the battle line of actual use and abuse. Rugged, heavy-duty construction, shock-absorbing, with dependable V-cam gravity-activated hardware, they swing back time after time. McGuire doors stand up to every new destructive trick that a fork lift operator can come up with.

There's a McGuire traffic door for the ins and outs of every industrial application.

Call or Write For More Information  
**W.B. McGuire Company**  
One Hudson Avenue, Hudson, N.Y. 12534  
Tel: (518) 828-7652

## Books from page 85

seemed the American birthright," as the publisher's blurb described it. Unfortunately, that carefree joy is one of the things responsible for our present economic and energy problems, and nostalgic celebration is perhaps an inappropriate attitude. If, then, we examine this book as the author intended, we find that not only is the theory missing, so is the history. The research is haphazard, and the entire book gives evidence of being thrown together (though handsomely produced). Photographs are introduced without textual explanation, and written descriptions of important buildings are frequently not accompanied by photos. The illustrations are not keyed to the text. The end notes are identified in the appendix by the phrases they document, and their existence is not indicated in the text. It appears that the decision to produce the book was made on the basis of having accumulated 100 pages of material (including a lot of photographs), without regard to any research strategy.

*Fill 'Er Up* should be, albeit unintentionally, effective public relations for an industry currently suffering from a very poor public image. Like Jimmy Stewart's television advertisements for a tire company, Vieyra offers us an image of the giant corporation as downhome folks who work hard for us. *Dell Upton, University of Virginia*

**The Palace or the Poorhouse: The American House as a Cultural Symbol.** Jan Cohn. (Michigan State University Press, \$15.) **The American Home: Architecture and Society, 1815-1915.** David P. Handlin. (Little, Brown & Co., \$20.)

These two books approach the subject of homes in America from the different academic backgrounds of the two authors. Jan Cohn is chairman of the department of English at George Mason University. David P. Handlin has practiced architecture in Italy and England. He is now associate professor of architecture at the Harvard graduate school of design.

Cohn's book starts with a discussion of the first settlements in this country. Shelter was the immediate need, so crude structures went up. From these the communities grew, but any attempt at elegance was frowned upon as a waste of time and labor and a deterrent to community progress. The first settlers needed each other for protection in the wilderness, and communal living was imperative.

Gradually, the more industrious settlers were rewarded with their own land, and the power of private property induced greater productivity. The towns grew and wealthy merchants inhabited them, built large houses and gave rise to a landless

*continued on page 93*

**We started building insulated windows for the energy crisis ten years before there was an energy crisis.**

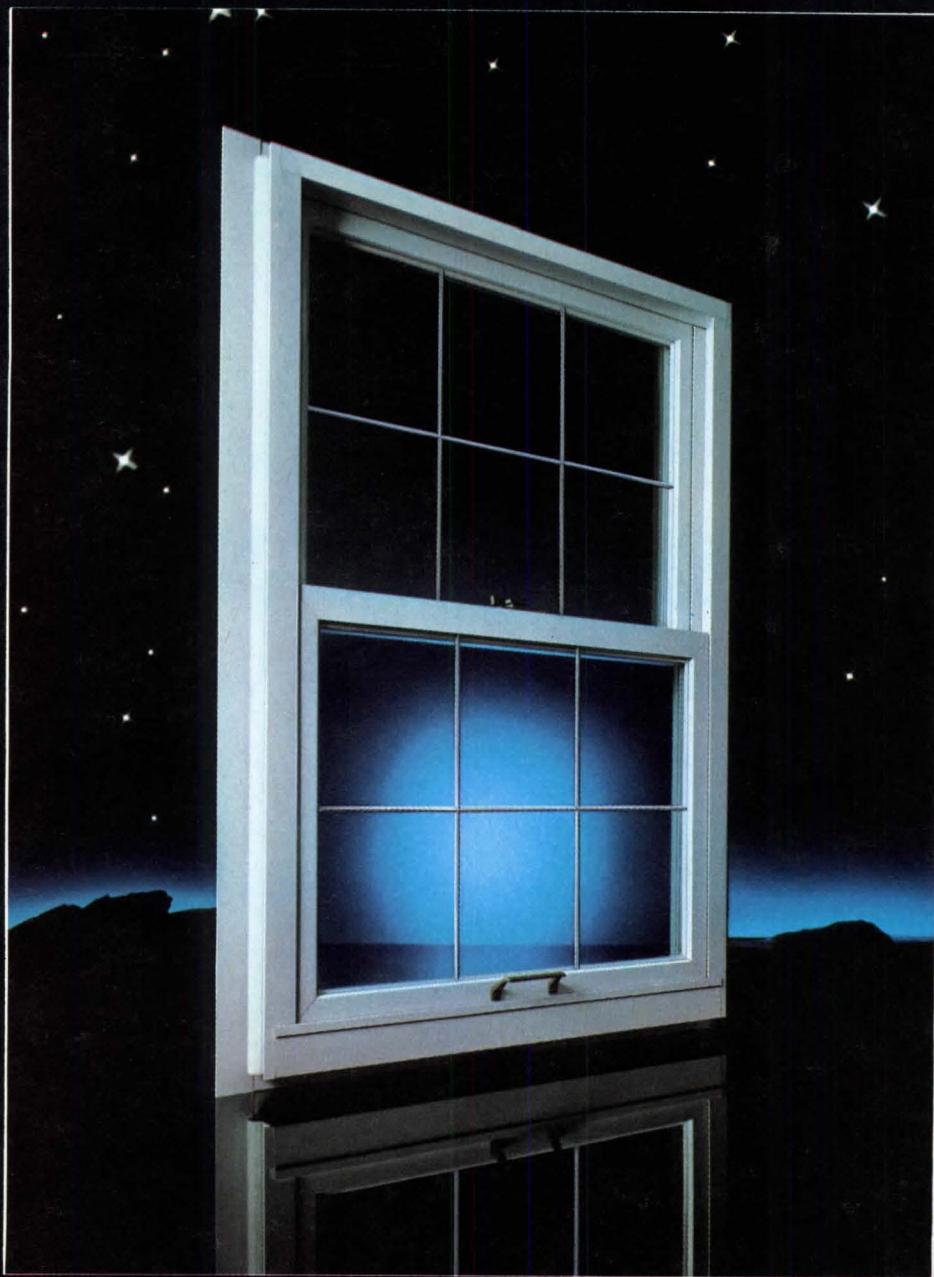

Today, everyone's looking for ways to sell energy saving, especially in windows. And it's no secret that many of today's products were developed yesterday. But when you're building quality housing, you can't afford "johnny-come-lately" products. You want a proven performer, a window with a winning track record.

Like the Alcoa Alaskan™ Insulating Window. The engineers at Alcoa's Technical Center started working on the Alaskan years ago. They designed it with the kind of concern for detail that goes into every new Alcoa™ product. A thermal break to cut heat loss. Twin panes of welded-edge glass for increased

insulation. And double weather stripping to minimize air infiltration.

The result? A window that's proven itself even in the harsh climate above the Arctic Circle. A window that's ready to meet the energy crisis. Today and tomorrow. And a window that you can sell with confidence.

When you're considering energy-saving windows, think of the one with the proven track record—the Alcoa Alaskan.

For more information on the Alaskan Window, and to find out about available sales support, write.

Alcoa Building Products, Inc.,  
Suite 1200, Two Allegheny Center,  
Pittsburgh, PA 15212.

**Alcoa means business, and the Alaskan Window means more business for you.**

**ALCOA  
BUILDING  
PRODUCTS  
INC.**

SUBSIDIARY OF

**ALCOA**

*Circle 51 on information card*

# WOULD YOU RISK TO SAVE A FEW

There are 143 different door manufacturers out there. All eager for your business.

Some promise you "the best door at the lowest price." Others say "quality at a competitive price." Then there's the claim, "we will not be undersold."

Who can an architect really believe?

Hint: Stick with the door people with a solid reputation.

Suggestion: Weyerhaeuser.

Quite frankly, we aren't the only people in the door business with a good background. But we are the only door supplier with seven essential points of difference.

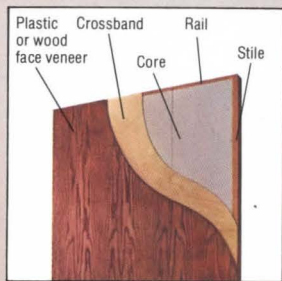

*The quality goes all the way through.*

They run like this:

**1.** Weyerhaeuser has the broadest line of flush wood doors in the world. Interior and exterior. Fire doors rated from 90 minutes to 20 minutes. Sound retardant. X-ray. You name it, we make it.

**2.** Weyerhaeuser fabricates all our own core components. Hollow. Staved. Timblend®. Mineral. We pay as much attention to the part you don't see as the part you do.

**3.** Weyerhaeuser extra touches set us apart as well. Hardwood side edges to match faces. Stiles and rails bonded to the core. Type I fully waterproof glue. Permanent identification with colored dowels for easy verification and reference.

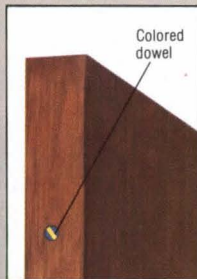

*Our finishing touches make the difference.*



# YOUR REPUTATION DOLLARS A DOOR?

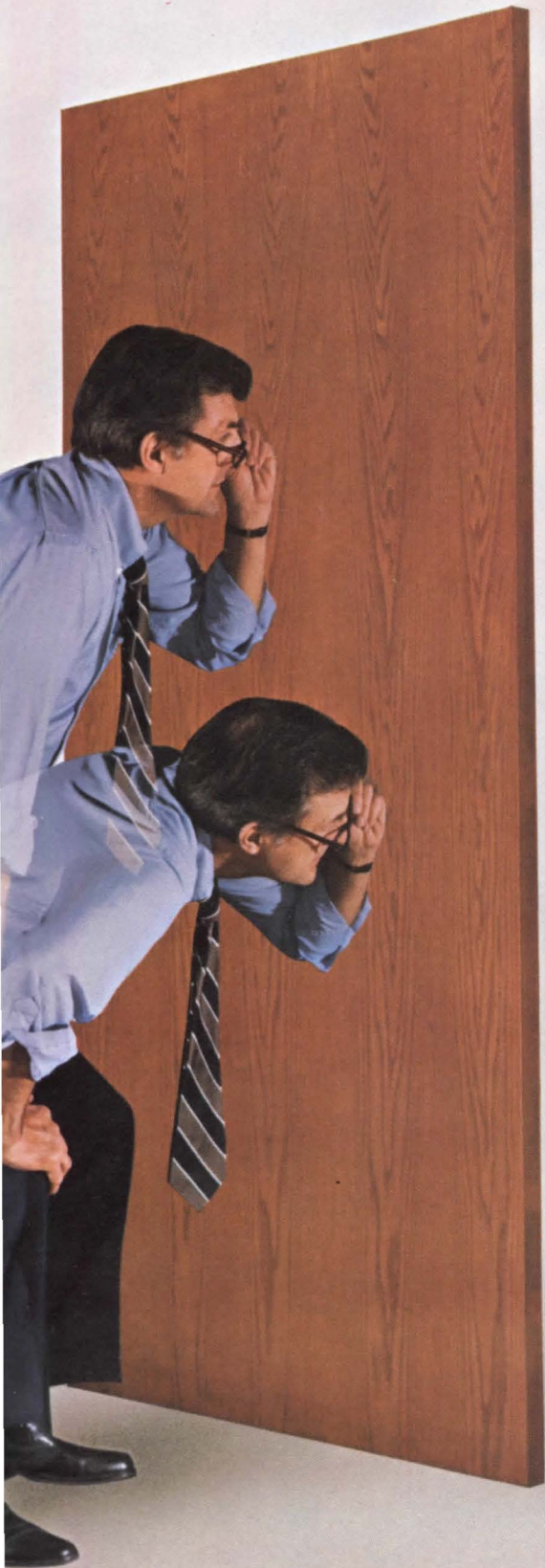

**4.** Our doors are readily available. Many Weyerhaeuser Customer Service Centers across the country carry a local inventory. Or you can order them from our plant in Marshfield, Wisconsin.

**5.** No one beats Weyerhaeuser on choices of faces. Hardwood veneers. Plastic laminate faces. MDO. More than 100 selections. They're all our specialty.



*We have a face to match your plan.*

**6.** The Weyerhaeuser warranty is the toughest in the business. And that's no advertising claim. It's fact. We back you up.

**7.** Finally, we offer a wide range of custom services. Factory finishing. Prefitting. Edge beveling. Cutting for hardware. Decay protection.

Now you might be able to specify a door that's cheaper than Weyerhaeuser. But in no way can that door live up to our 80 years of manufacturing experience, our 7 major points of difference and the Weyerhaeuser reputation.

So the next time *your* reputation goes on the line, think of Weyerhaeuser.

That way, both our good names will have a chance to shine.

For more information, write: Weyerhaeuser, Box B, Tacoma, WA 98401. Or just check Sweets.



**Weyerhaeuser**

*Circle 52 on information card*

# Bobrick is your single source for washroom equipment.

**1.** A *Total Design Concept* in quality stainless steel washroom accessories and laminated plastic toilet compartments.

**2&3.** *Designer Series* washroom accessories including warm-air hand dryers can be color coordinated with laminated plastic toilet compartments.

**4&5.** A full line of high quality hotel bathroom accessories—available in satin, bright polished, or new bronze finishes.

**6.** A complete selection of large capacity waste receptacles for recessed, surface-mounted, and free-standing application.

**7.** Choose from more than 65 dispensers—designed for practically every soap product used today.

**8.** A variety of durable toilet tissue dispensers with many quality features, including spindles that save paper and protect against theft and vandalism.

**9.** For the physically handicapped, specify stainless steel grab bars and patented partition-mounted accessories.

**10.** The only name you need to know in Washroom Equipment. Functional design, trouble-free operation, durability, and ease of maintenance since 1906.

Let us send you our Washroom Planning Guides and Catalogs. Bobrick Architectural Service, Lincoln Building, 60 East 42nd Street, New York, NY 10017. Bobrick products are available internationally.

*Photo No. 1.* TSPS Building, Walnut Creek, California. Architect: Howard Johnson and Associates, San Francisco, California.

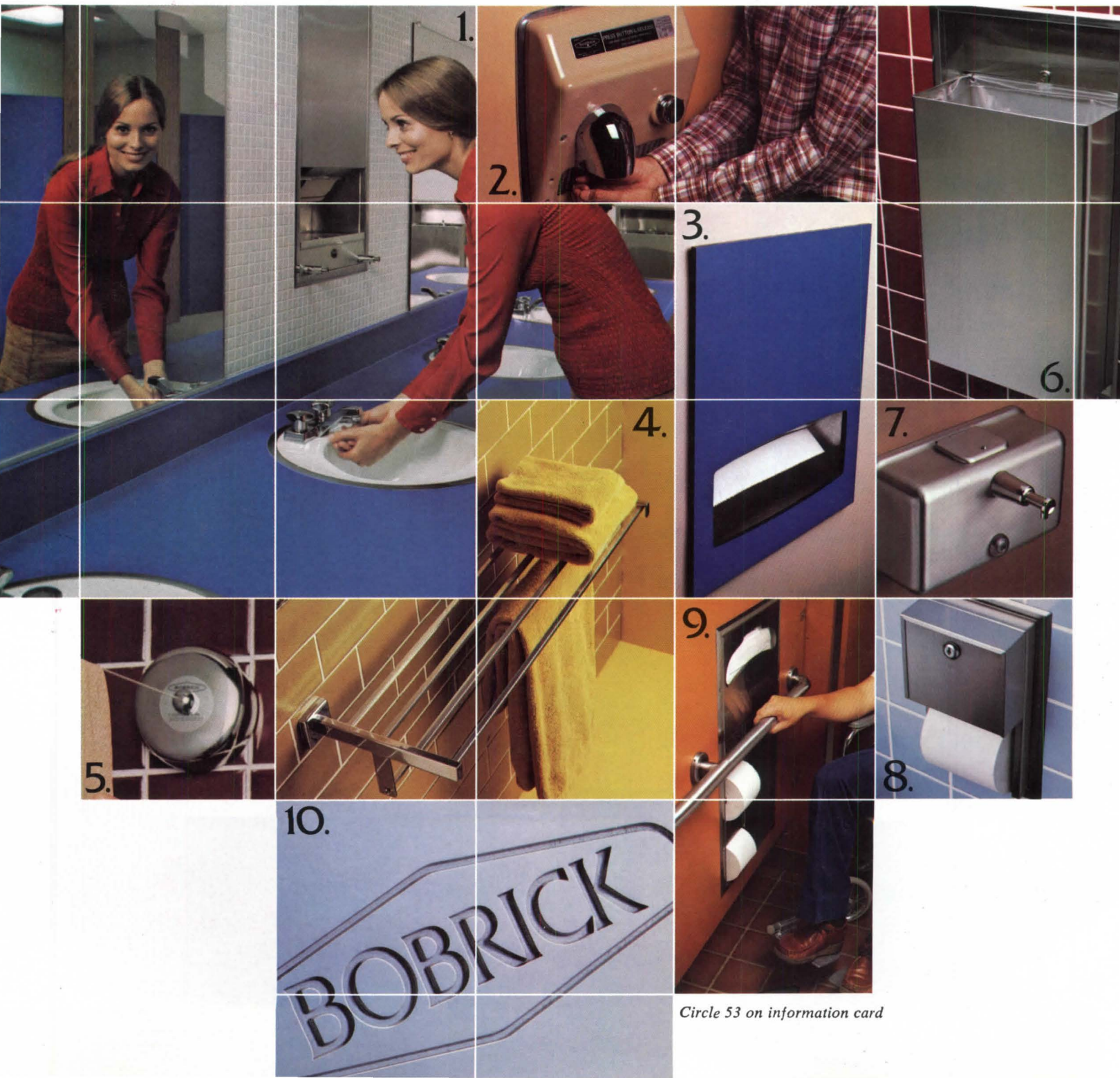

Circle 53 on information card



**Axis 7000**, plush auditorium seating—beam mounted with interchangeable components. Designed specifically for use in council chambers, conference centers, lecture halls, theaters and in any environment where comfortable seating is required.  
Available with single or double armrest concealing optional accessories such as writing tablet and audio equipment.

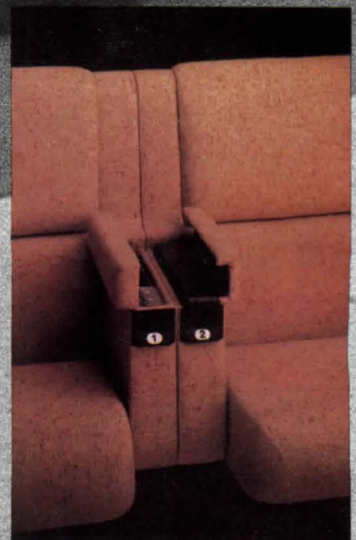
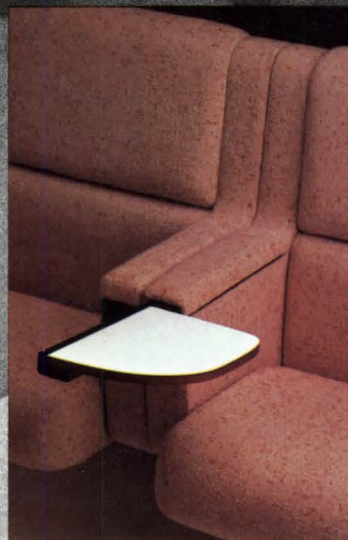
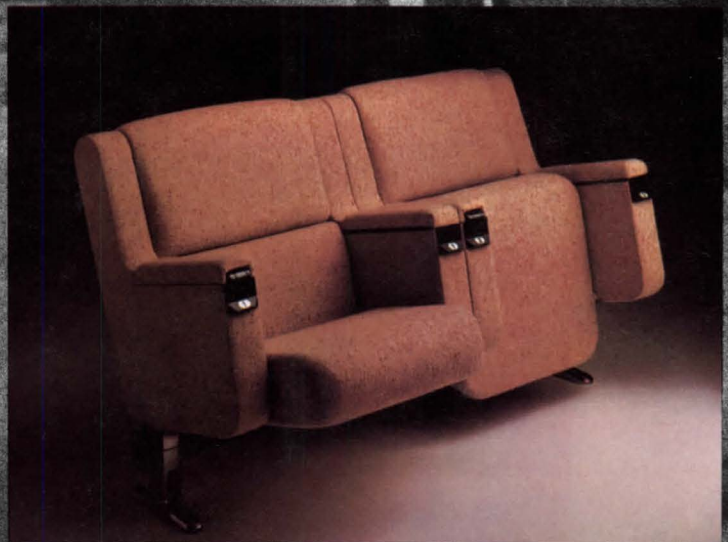

Molded polyurethane  
foam construction by  
**Teflex**

 **CASTELLI**

**Headquarters and showroom**  
950 Third Avenue  
New York, N.Y. 10022  
212/751-2050

**Chicago showroom**  
1150 Merchandise Mart  
Chicago, Ill. 60654  
312/828-0020

**Los Angeles showroom**  
267 Pacific Design Center  
Los Angeles, Ca. 90069  
213/659-8302

*Circle 54 on information card*



Above: Bullock's Department Store in San José, Cal. Note Grinnell Quick Response Sprinklers installed in a sprinkler line suspended from a cable below the fabric roof. Photo courtesy of Virgil R. Carter, Architect, Environmental Planning & Research, Inc.  
 Right above: Grinnell's Model F930 Quick Response Sprinkler.

# The sky's the limit.

## Grinnell® Sprinklers Can Meet the Challenge of Your Most Challenging Designs.

When Bullock's in San Jose, California's Oakridge Mall installed the first fabric roof ever used in a department store, they chose Grinnell sprinklers.

The problem that faced the owners, the architects and the insurance company was how to provide needed sprinkler protection that could respond quickly and effectively to a fire when the sprinkler lines were suspended from cables as much as 17' below the fabric roof.

The roof structure, with its Teflon\* coated fiberglass construction, made conventional pipe hangers impossible. The only practical manner to support the sprinkler system was from the suspension cables which were an integral part of the overall building design.

This innovative design called for an innovative technology, which was met by the use of Grinnell's Model F930 Quick Response Sprinkler. This sprinkler combines the time-tested Duraspeed Sprinkler with an additional heat detection device sensitive to a temperature rate-of-rise of 20°F per second.

The sprinkler's quick-response device attaches in a matter of seconds to any standard Duraspeed soldered-type sprinkler. Thus, standard upright and pendent sprinklers (as well as horizontal sidewall models) were available for use in this overall design.

This unique fast-acting sprinkler, listed by Underwriters Laboratories, proved its capabilities in a test program witnessed by the owner's representatives and representatives of the insurance authorities.

Not only did the sprinkler prove to be effective in the laboratory test, but it also demonstrated the flexibility needed to adapt to the demands of the structure's unconventional roof lines.

When it comes to sprinkler designs from the traditional to the avant-garde, Grinnell has the technology to provide sprinkler protection to match your most demanding design requirements.

For additional information, please write:  
 Grinnell Fire Protection Systems Co., Inc.  
 10 Dorrance St.  
 Providence, R.I. 02903

\*TM DuPont Co.



**GRINNELL**  
 GRINNELL FIRE PROTECTION SYSTEMS COMPANY, INC.  
 Protecting Life and Property Since 1850

Circle 55 on information card



**Books from page 86**

but rich city dweller. Cohn pursues this theme by citing Thoreau and *Walden*, Hawthorne and *The House of Seven Gables* for the effect a house can have on its occupants. With the rise of wealth came the mansions and the contrast of slums. The dream of equality for all gradually became lost in reality, but the American home of the vast middle class survived and strengthened family values and responsibilities.

*The Palace or the Poorhouse* continues with discussions of early architects and social solutions to problems of city tenements and the enormous influx of immigrants to this country. There is further reference to literature as a study of houses. Henry James' work is discussed, with reference to the rich mansions or evil houses as background for his stories. Other novels and authors are introduced, and we come finally to F. Scott Fitzgerald, William Faulkner and John P. Marquand. Cohn has written a short and interesting history of the American house and gives us some insights into the effect our homes have had on our lives.

Handlin, in *The American Home*, has covered a shorter span of time, from 1815 to 1915, but with much greater depth. His long book goes into an infinite amount of detail, covering myriad facts, subjects, people and social problems. He discusses the American home from the viewpoint of the architect, the family, the setting, the construction, housekeeping, financing, and, eventually, we find ourselves faced with early plumbing problems.

Handlin is a scholar and his research is enormous. His approach is architecturally superb. We learn just about everything there is to know about the American home. Like *The Palace or the Poorhouse*, this book gives us literary examples of the effect of a house on its occupants. There is a fine history of the architects of the period and their attempts to solve housing problems. There is, also, a long discussion of labor-saving devices for the home, with some amusing references as to how the housewife would spend her time if freed from the necessity of cleaning. This book will interest architects with its history of a subject that is as old as America, but, probably, never before studied in such specificity. *Elizabeth Class, Washington, D.C.*

**Sixteenth Street Architecture, Volume 1.**  
Sue A. Kohler and Jeffrey R. Carson.  
(U.S. Government Printing Office, no price given.)

You don't have to have ever visited the nation's capital to find this book on Washington's 16th Street to be appealing. All that's required to find it of compelling interest is a curiosity about either American  
*continued on page 95*

## WHAT KEEPS YOUR SALES HOT WHEN THE MARKET COOLS?

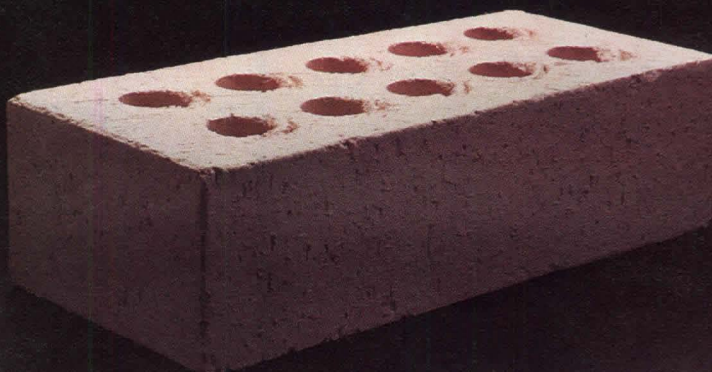

Brick's energy efficiency makes your home a hot seller whatever the prevailing climate in your market. Solid brick walls minimize heat loss in winter, heat gain in summer. So the brick home buyer minimizes utility costs year round. From Maine to Arizona, building with brick means building your sales. Trust Brick.

For hot tips on using brick as a sales-builder, write for Brick Highlights from Brick Institute of America, 1750 Old Meadow Road, McLean, Virginia 22102.



Circle 56 on information card

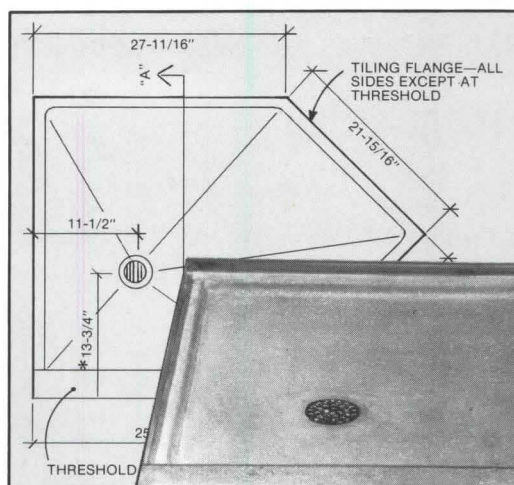

## CUSTOM SHOWER FLOORS

### We'll make you an original.

Enjoy complete freedom of design in hospitals, apartment towers, elderly housing, and dormitories. Custom engineered shower floors of classic Terrazzo meet your specifications, assure quality and offer substantial cost savings compared to on-site construction. One-piece molded floor has integral cast drain, installs direct on the finished floor. No sub-pan is required. Permanently watertight. Natural non-slip finish. Custom colors. • Don't need an original? We have over 16 standard models: square, rectangular, and corner models, and a wheelchair access floor.

# WILLIAMS

STERN-WILLIAMS CO., INC. • P.O. Box 8004, Shawnee Mission, Kansas 66208

Circle 57 on information card

AIA JOURNAL/MID-MAY 1980 93

# Dual-Lite EXCITE™ simply beautiful

Dual-Lite EXCITE is simply the finest exit sign available. It's just what you've been asking for. Superior to cast signs of the past, units are constructed of high impact, injection-molded Lexan®, making them lightweight and permitting the crisp clean lines of modern design. Styled by architects and highly engineered for uniformity of illumination, downlighting, and finish, as well as for durability, Dual-Lite EXCITE will meet your most demanding requirements. Dual-Lite EXCITE has broken the cast aluminum mold with a brand-new concept in exit signs. It's the sign of tomorrow . . . today. Don't settle for less!



The people who know  
emergency lighting best.

**EMERGENCY LIGHTING DIVISION**

Newtown, Connecticut 06470

*Circle 58 on information card*



**Books from page 93**

can architecture or history. It was developed and issued under the auspices of the Commission of Fine Arts, and one assumes from the volume numbering that other publications will follow.

Sixteenth Street stretches for seven miles—from the north point of the District of Columbia line to the White House. It brings to mind residents Daniel Webster, Henry Adams, John Hay, Hamilton Fish, Evalyn Walsh McLean, Gromyko and Dobrynin, and designers James Renwick, Henry Hobson Richardson, John Russell Pope, George Oakley Totten Jr., Warren & Wetmore and Coolidge, Shepley, Bulfinch & Abbott, among others.

After World War I, Washington's leisurely atmosphere changed, says Jeffrey R. Carson in the introduction. Big government caused a surge of building—and noble architecture was torn down for "progress." The changes, he says, were "devastating, historically and architecturally." Among the structures destroyed were the residences of Henry Adams, John Hay and William W. Corcoran.

As well as can be done, this book gives the reader an idea of the grandeur that once was, at the same time mirroring Washington's history. Described in detail is some of the destroyed architecture (and much that still stands), and the many old photographs give meaning to the text. There are histories of the buildings, as well as biographies of the people associated with them, including the architects.

All is not gone, for along the street are  
*continued on page 97*

## WHAT'S THE MOST NATURAL WAY TO SAVE ENERGY?

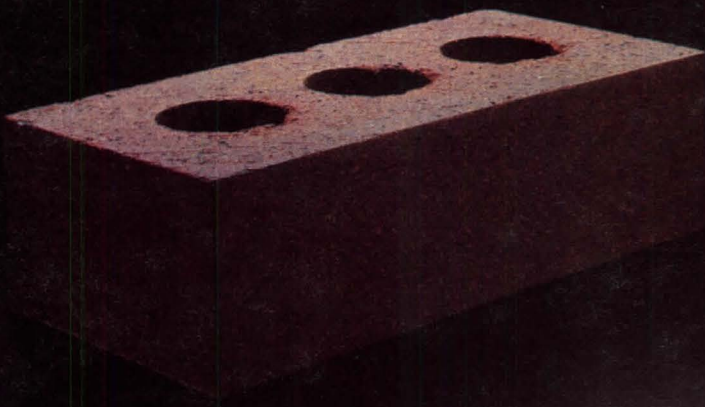

Brick passive solar heating is a natural solution to your problems in today's chilly housing market. In fact, it's almost like giving the home buyer something for nothing. No extra mechanical equipment is needed, just the proper placement of brick to collect the sun's rays to provide free warmth in winter. Because today's home buyers demand energy efficiency, naturally, your passive solar building plans demand brick. Trust Brick.

For more information on the natural choice for energy efficiency, write for Brick Builder Note #16 from Brick Institute of America, 1750 Old Meadow Road, McLean, Virginia 22102.



Circle 59 on information card

# pool lift

makes swimming barrier free

- Simple to install in above and below ground pools
- Low cost installation
- Easy and safe to operate
  - No electricity or hydraulics
- Suitable for new or existing pools
- Rugged, corrosion resistant construction

Send today for details to:

mecanoids

U.S.A.:  
403 Kennedy Blvd., Somerdale, N.J. 08083

HEAD OFFICE:  
5200 Dixie Road, Suite 205, Mississauga, Ontario, Canada L4W 1E4

Telephone: (416) 625-1733  
(Call Collect)

Circle 60 on information card

Beautiful... Permanent...  
Economical... Energy Efficient...



Port Huron Municipal Office Center Building, Port Huron, Michigan / All white material is Cherokee Marble / Arch: Richard C. Cogley / Marble supplied by Genesee Cut Stone & Marble Co., Flint, Michigan

## it's CHEROKEE<sup>®</sup> MARBLE!

Yes, White Cherokee<sup>®</sup> is all of these and much more. In fact, White Cherokee<sup>®</sup> Marble is quite unlike any other marble found anywhere on earth . . . a marble containing myriads of sparkling crystals that reflect the summer heat like diamonds in the sunlight, thereby offering significant savings in energy costs.

White Cherokee<sup>®</sup> Marble is economical in price, versatile in use and flexible in design. It comes in either large panels for cost-effective floor to floor erection, or in smaller weight-saving veneers with our famous Zibell<sup>®</sup> Anchoring System which is designed to reduce building loads by eliminating heavy masonry backup. Think

of the savings this could mean not only in terms of time, but also in overall costs of the structural system.

One of the densest, least absorptive marbles known, White Cherokee<sup>®</sup> is an equal to the finest natural building stones in the world. In fact, when compared to several of the denser granites, White Cherokee<sup>®</sup> Marble proved to be 90% less absorptive, a primary factor in determining not only the durability of a stone, but also how resistant it is to streaks or stains from dirt, rain and drainage water, hand and foot traffic or other atmospheric contaminants. If you want to reduce the maintenance costs of your building, it's

a good "dollars and sense" decision to specify White Cherokee<sup>®</sup> Marble.

It's easy to see that White Cherokee<sup>®</sup> Marble is indeed a uniquely different and superior building stone. It offers energy savings, competitive prices, minimum maintenance, innovative erection systems, exciting new finishes, flexibility in design and deliveries to complement even the most stringent construction schedule.

Yes, White Cherokee<sup>®</sup> is beautiful, permanent, economical and energy efficient . . . but now you know that there is a lot more to the story.



**georgia marble** company

STRUCTURAL DIVISION / Nelson, Georgia 30151 / (404) 735-2591

a jim Walter company

Circle 61 on information card

**Books from page 95**

the embassies of the USSR (planned originally by Mrs. George M. Pullman of Chicago for her daughter and designed by Nathan C. Wyeth), of Italy (designed with Renaissance and baroque architectural elements by Warren & Wetmore), of Mexico (once the home of Franklin MacVeagh, secretary of the Treasury in Taft's cabinet and also designed by Wyeth) and of Spain (built by Mrs. John B. Henderson and designed by her "favorite architect," George Oakley Totten Jr.) There are other standing structures, too, such as the Church of the Holy City (designed by H. Langford Warren, later dean of Harvard's school of architecture) and All Souls Church (its second building, Victorian Gothic in design, whose architect was R. G. Russell; the first church, used for 50 years, was the design of Charles Bulfinch).

The only major thing wrong with the book is that there is no index, but it is hoped that any succeeding volumes will correct the flaw.

**Preservation in American Towns and Cities.** Nathan Weinberg. (Westview Press, \$18.50.)

Nathan Weinberg has provided a good introductory examination of the current practice of historic preservation in the U.S. This illustrated volume defines the preservation movement in general terms: as activities related to saving historically significant buildings and districts from destruction. The author thus embraces not only restoration in the strict sense of the word, but adaptive use of commercial and residential buildings, the creation of historic house museums and districts and the legal and financial mechanisms by which preservation is accomplished. He is also concerned with matters that were at one time tangential to preservation and restoration. Real estate development and speculation, displacement of the indigenous population by preservation activities, transportation planning and its effects on historic districts and innovative preservation programs are all examined.

As a sociologist, Weinberg is in a position unique among preservationists. He examines the preservation process as social phenomena. The process cannot be applied to all situations in the same way; it must change in practice and meaning as it is applied in various contexts. Weinberg views the development of historic house museums and districts in the 1920s and '30s, which was the beginning of serious preservation efforts in this country, as largely a product of the affluent.

A subtle but major shift in emphasis occurred in the 1960s and '70s when preservation expanded beyond saving

*continued on page 98*

## WHAT'S THE MOST ENERGY EFFICIENT BUILDING MATERIAL UNDER THE SUN?



If you've been searching for a little sunshine in today's gloomy economic climate, look no further than brick passive solar housing. In these designs, brick walls and floors serve as solar heat collectors that provide enough free warmth to substantially reduce fuel use. At a time when home buyers are more energy-conscious than ever, there's no more efficient sales-builder than brick. Trust Brick.

For more information on brick passive solar homes, write for Brick Builder Note # 16 from Brick Institute of America, 1750 Old Meadow Road, McLean, Virginia 22102.



Circle 62 on information card

## DRAWINGS at your FINGERTIPS in SECONDS



### KINGFILE

### SOLVES YOUR STORAGE PROBLEMS:

File all your flat materials either **INDIVIDUALLY** using Self-adhesive Suspension Strips—or in **MULTIPLES** employing Metal Hangers with adjustable spring clips and rubber grip pads holding up to 100 sheets. **KINGFILES** store up to 1,000 drawings.

The **KINGFILE** System ideally files multiple-base and overlay sheets—it protects your valuable originals and prints—it permits fast and fatigue-free filing and retrieving of drawings—it saves on valuable floor space—and offers you the lowest filing cost per sheet.

— WRITE FOR DETAILS AND FREE CATALOG —

**H. SCHREIBER COMPANY—Red Lion, Pa. 17356**

Circle 63 on information card

AIA JOURNAL/MID-MAY 1980 97

**Books from page 97**

nationally important buildings and districts, such as Mount Vernon and Savannah's historic core. Areas such as Liverpool Street, a black ghetto of late 19th century vernacular buildings in Pittsburgh, caught the eye of preservationists. The spread of the movement into less important areas created an additional set of concerns and issues. Preservationists were faced with problems of obtaining mortgage funds in redlined areas, of dealing with absentee landlords and the displacement of low-income families through the preservation process as the areas were rehabilitated by young, upwardly mobile professionals. Throughout the book, Weinberg emphasizes the issue of population displacement either explicitly or im-

PLICITLY. It is one of the current problems of the preservation movement that has not been squarely faced—one that tarnishes many otherwise noteworthy preservation efforts.

Weinberg briefly examines the preservation problems and processes in four towns and small cities. One of the most interesting is his study of Annapolis, Md. After tracing the efforts of Historic Annapolis, Inc., from its inception in 1952, he focuses on the problems that have come with success—increased tourism and the resulting demand for tourist facilities and attractions, the inflation of property value in the historic core that has altered the use and character of the area and the concurrent suburban growth that has changed the setting of the town.

Curiously, in his conclusion Weinberg does not concentrate on his observation concerning the problems created by preservation—probably his best contribution to the field. He does, however, neatly summarize the current state of the preservation movement. The book serves as a reminder of the potential that the movement has in helping shape our future environment. *Richard Wagner, Assistant Professor, College of Architecture and Design, Kansas State University.*

**Chicago Ceramics & Glass: An Illustrated History from 1871 to 1933.** Sharon S. Darling. (Chicago Historical Society, \$25.)

Published in connection with an exhibition of the same title, this book focuses on the period between Chicago's great fire and the Century of Progress Exposition, telling a marvelous story of innovations in the decorative arts and architecture. The author says that some of the people responsible for this creativity, such as Frank Lloyd Wright and Louis Sullivan, have become legends, but most of them are either known only to a few specialists or have been forgotten in the passage of time. This copiously illustrated book pays homage to them all.

The first section of the book is devoted to the decorative arts: china painting, art pottery and cut glass. The development of all three, says Darling, paralleled movements in the major urban centers of the U.S., England and the Continent. The styles and techniques traveled to Chicago "with remarkable rapidity," and streams of immigrants brought to Chicago a high degree of artistic skill. The three industries reached their peak by 1929, then went into a decline. "But, in the meantime," says Darling, "numerous designers and artisans had enriched Chicago's private homes and public buildings with the products of their skillful hands and lofty aspirations."

The second half of the book, probably of more interest to architects, concerns those arts closely related to architectural trends—stained glass and terra cotta. In the building boom after the 1871 fire, there was work for the skilled craftsmen who came to the city. Stained glass was used by many architects. Indeed, Darling says that by the time of the Chicago fair of 1893, "colored glass was being used so extensively and in such startling combinations that some concerned glassworkers expressed the fear that the widespread 'abuse of color' would degrade the entire art glass industry."

But the fear was unfounded "when the exquisite stained glass windows and glass mosaics displayed at the World's Columbian Exposition by American glass firms established the supremacy of American

*continued on page 119*



GUME, INC., Hawley & Peterson Architects.

**KALWALL®**

The most highly insulated light transmitting material.  
Saving energy for 25 years.

**KALWALL CORPORATION**

1111 Candia Road, Manchester, NH 03103, 603-627-3861

See Sweet's 8.14/Ka, 7.8/KaL, 13.11a/Ka, 13.2c/Stu.



## **Holophane architectural outdoor lighting.**

### **For your freedom of choice.**

A vote for the new Caribe™ Design Series is a vote for the freedom of choice.

Create the luminaire that will best complement your design theme by coordinating outer geometric shapes and colors, inner refractors and lamps. Then choose from handsome mounting arrangements with square or round poles.

All in all, you can create well over a thousand variations to make each of your projects a unique and very personal statement.

Caribe is quite extraordinary. But esthetic choice isn't the only benefit it offers.

Prismatic refractors provide precise light control. Clean appearance is achieved by a concealed wedge-lock mechanism (patent pending), that eliminates exterior hardware. And rugged construction discourages vandalism.

Find out just how choosy you can be with Caribe. Ask your local Holophane® sales representative to go over all the details with you.



Or contact Jim Dresden, Johns-Manville Sales Corporation, Holophane Division, P.O. Box 5108-AIA-5, Denver, CO 80217. Phone 303/979-1000.



**Johns-Manville**

*Circle 65 on information card*

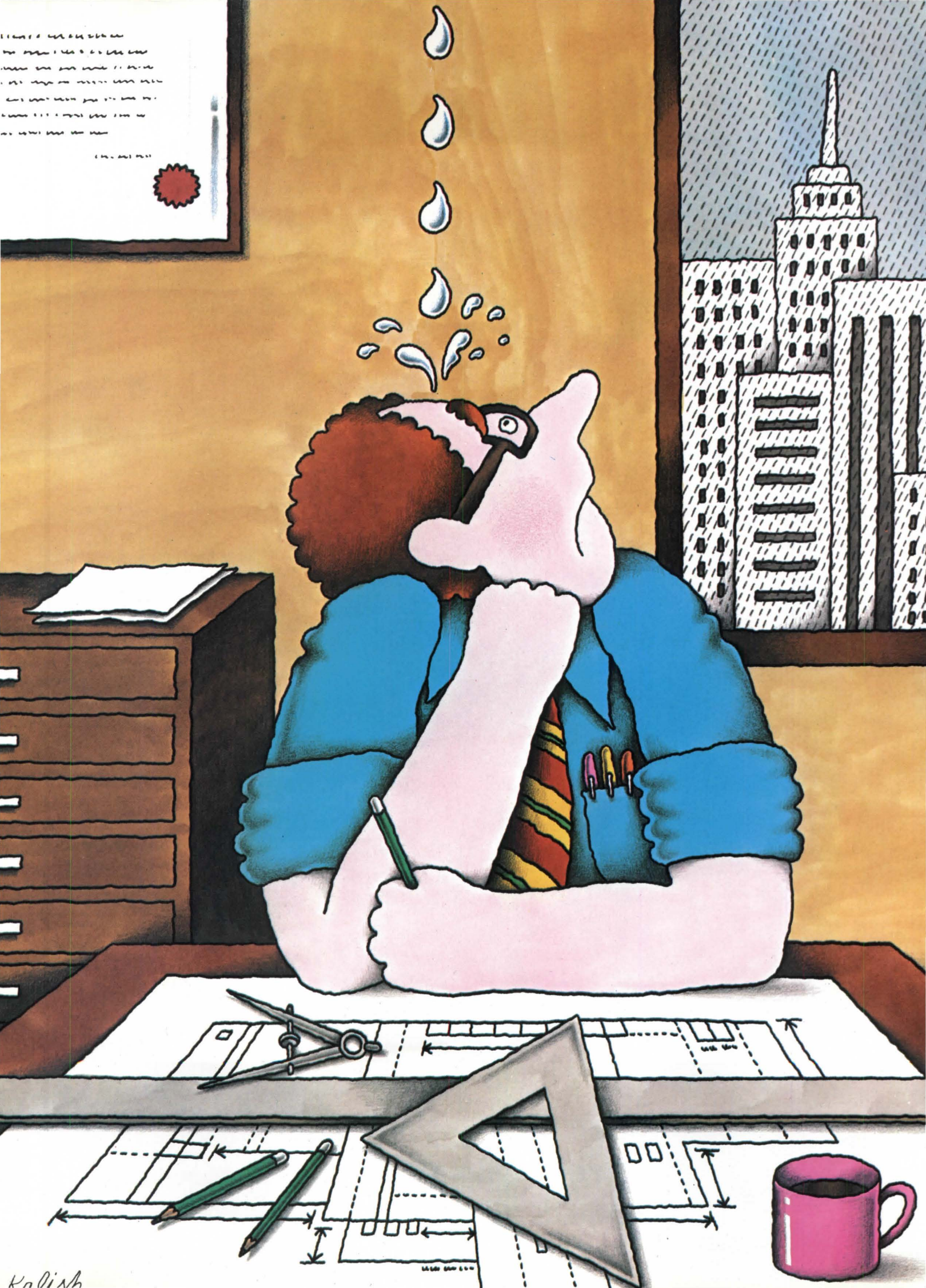

Kalish



# FOR A HUNDRED YEARS, ARCHITECTS HAVE BEEN UNJUSTLY BLAMED FOR LEAKY ROOFS. SO CELOTEX DECIDED TO MAKE THEM NOT SO LEAKY.

---

**Finally, an improved roofing system that is easy to apply properly, so it helps eliminate the major roofing problems.**

---

It seems that as soon as a roof starts leaking, everybody starts looking for the architect.

Celotex knows that architects should not be blamed if a roof is not installed properly.

So we have designed Celo-Glass IV, a special type of fiberglass asphalt mat that makes proper installation easier.

Other fiberglass felts allow hot bitumen to penetrate immediately, making it difficult for workmen to broom properly. Celo-Glass IV has uniformly distributed fibers that permit controlled penetration of the bitumen, which helps assure good interply adhesion. In addition, Celo-Glass IV felts are stronger,

weigh less, lay smoother and resist moisture and rotting better than conventional asphalt felts.

What's more, Celo-Glass IV meets ASTM 2178 Type IV requirements, the most stringent of all. It is approved for all sections of the country.

In short, Celo-Glass IV represents the most problem-free roof that can be designed today. We realize that architects may still get the blame for leaks, should they ever occur, but now you won't be blamed as often.

For more information, contact Peter G. Nazaretian at Celotex Roofing Products Division, P.O. Box 22602, Tampa, Florida 33622. (813) 871-4584.



"Between the world and the weather since 1854."

a JIM Walter company

Circle 66 on information card

**Architect:**  
"To keep this home  
in harmony with its  
wooded surround-  
ings, I wanted the  
natural beauty  
and texture of  
cedar shingles."

Alan Liddle, FAIA



Builder's residence,  
Tacoma, Washington  
Siding: Shakertown 7"  
Colonial Shingle Texture.

**Builder:**  
"I put them up  
the easy way."

Bruce R. Steel, President,  
Crown Pacific Corp.

When your design calls for genuine cedar shingles or shakes, there's one sure—and easy—way to get consistent quality and appearance.

Shakertown Siding. It's made of straight-grain #1 grade western red cedar shingles or shakes, permanently bonded to 8-foot-long plywood backing.

There are no seconds, no grade falldown. And application is always straight and true,

because Shakertown Siding is automatically self-aligning. You get the look you design into the job, every time.

What's more, Shakertown Siding goes up 3 times faster than individual shingles and shakes. No specialized labor or special tools are needed. And, in many cases, no sheathing or stripping. All major uniform codes permit Shakertown Siding to be applied directly to studs,

using only one or two nails per stud. The result: a significant savings in time and labor costs over individually applied shingles or shakes.

Next job, specify Shakertown Siding. It's available in four textures with 7" or 14" exposures, even or staggered butt lines and matching pre-made corner pieces.

Write us for complete product information and specification details.

**Shakertown Siding**



Box 400, Winlock, Washington 98596, Phone (206) 785-3501, In Canada: Bestwood Industries, Ltd., Box 2042, Vancouver, B.C. V6B 3R6

Circle 67 on information card

The Easy Way

# CORIAN®



## CORIAN® is solid value for both builder and buyer.

When you select CORIAN® building products for bath, kitchen or bar, you offer buyers a solid investment in luxurious beauty plus durability and ease of care.

The solid construction of CORIAN is unique. Marble-like patterns and colors run clear through. There's a depth and richness not possible with coated "synthetic marbles" or laminated plastics.

CORIAN is tough enough to take rugged wear without losing its look of elegance. It resists staining. And a little household cleanser does

away with minor surface scratches or cigarette burns.

What's more, craftsmen can work and shape CORIAN as easily as wood, to carry out the most imaginative decorating ideas.

CORIAN comes in one-piece molded tops and bowls for baths, kitchens and bars in a range of styles and sizes. CORIAN sheet for kitchen and bath counter tops, wall wainscoting, bath and shower surrounds, and custom surfaces is also available.

Successful builders find CORIAN appeals to buyers. It's a solid

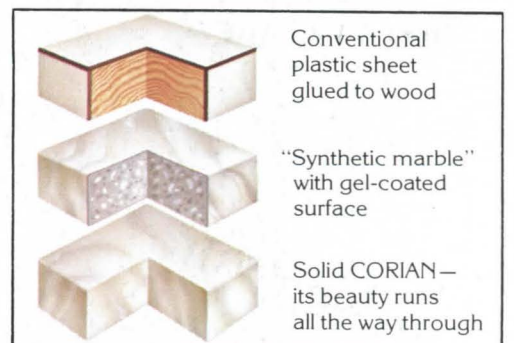

Conventional plastic sheet glued to wood

"Synthetic marble" with gel-coated surface

Solid CORIAN—its beauty runs all the way through

investment in beauty, and adds more in value than in cost. For more information write: DuPont, Room 37939, Wilmington, DE 19898.

Circle 68 on information card



REG. U.S. PAT. & TM. OFF.

# Don't settle for anything less

**USG® Gypsum Ceiling Panels** help you meet special job conditions and close budgets...all without closing out some beautiful options. Such as a distinctive collection of texture-painted and vinyl-clad panels for interior and exterior applications. Or classic plain panels for interior use only.

Inside or out, these versatile ceiling panels do so much more than limited alternatives. They strongly resist abuse, offer easy vinyl-face washability, require little else in the way of maintenance. And you can get USG Gypsum Ceiling Panels for fire-rated applications. Other notable benefits include simple lay-in installation, impact and crack-resistance, as well as USDA approval.

Make the big cost-saving move that won't show it on the finished job. Call your U.S.G. Representative for details on USG Exterior Gypsum Ceiling Panels or USG Interior Gypsum Ceiling Panels in 2x2' or 2x4' sizes. ■ Or write to us at 101 S. Wacker Dr., Chicago, IL 60606, Dept.



Two options:  
Lunar, Vinyl Stipple.  
Wide variety of washable  
vinyl-clad choices.\*

\*Not all patterns,  
available on a  
national basis.

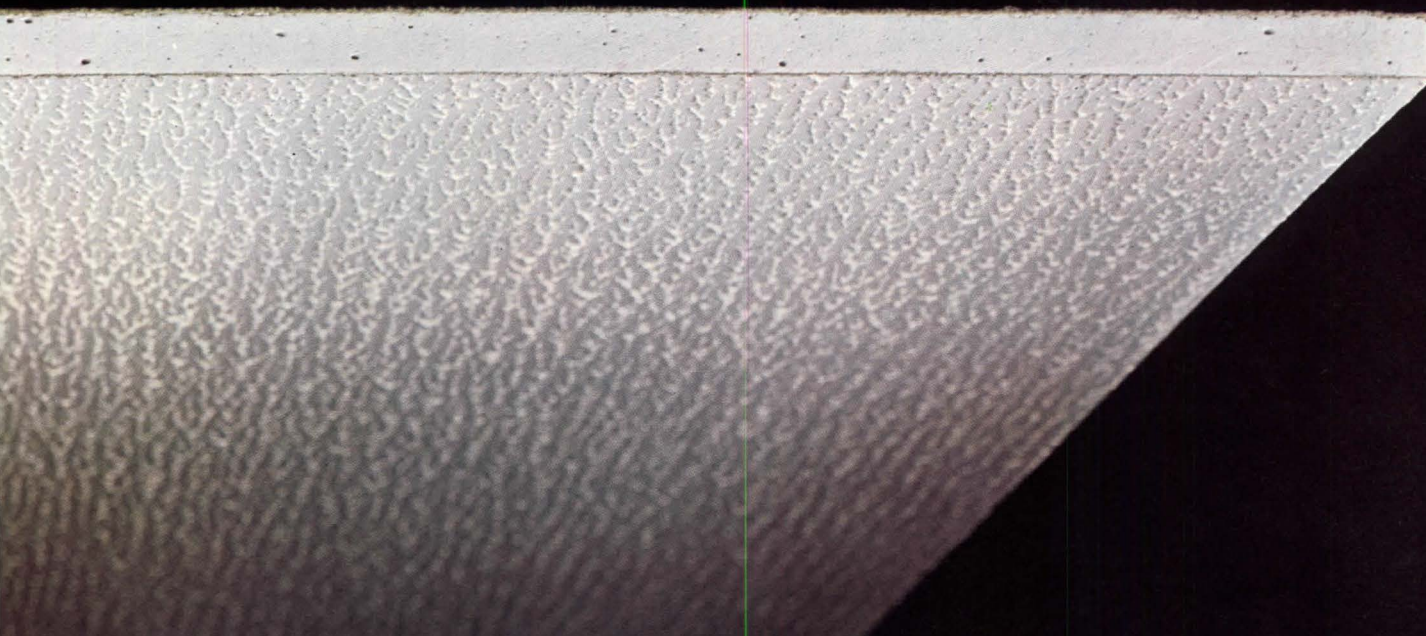

when you can get low-cost, fire resistant ceilings like these.



interior



exterior

**UNITED STATES GYPSUM**   
BUILDING AMERICA

Circle 69 on information card

# A Review of the Year's Books About Architecture

By Mary E. Osman

Which comes first, the book or the trend? Do books really cause architectural change, or do they merely report and/or analyze changes that have already occurred as the result of creative, social, political, technological and other influences?

If one is to believe Barbara Tuchman, author of *A Distant Mirror: The Catastrophic 14th Century* and other commendable works, books are "engines of change." She told a conclave of authors and librarians: "Books are carriers of civilization. Without books, history is silent, literature dumb, science crippled, thought and speculation at a standstill. . . . They are engines of change, windows on the world and (as a poet said) 'light-houses erected in the sea of time.'"

With the intriguing phrase, "engines of change," in mind, it is tempting to speculate, but perhaps foolhardy, on whether any so-called engines of change have been set in motion by recent architectural books. Foolhardy, because change does not occur overnight, of course, and it may take more than a decade of time to determine if a book published in the just-passed year, give or take a few months, will have a lasting impact upon architecture. As Sigfried Giedion observed, it will take until the end of the 20th century to finally evaluate 19th century architecture.

Nonetheless, it is still possible to detect certain trends (or "directions of movement," as the dictionary defines the term) in a review of the hundreds of architectural books published in a year's time.

As in a great deal of recently published literature, there appears to be a searching for "roots" in architecture as well as in other subjects of cultural impact. This seeking, combined with other social factors, is seen in at least two revealed trends in recent architectural books. The search for roots is there, to a degree, in the proliferation of books on historic preservation activity, and it appears to be there also in another spate of books engendered by efforts to re-establish a firm 20th century architectural esthetic. A third trend is revealed in the dozens upon dozens of books published on the subject of energy conservation.

The saving and reuse of older buildings shows a direction of movement, due in part to a yearning for our architectural

past, but also to such social pressures as inflation, the energy crisis, rising interest rates, decline in population growth and rising land and construction costs. Going from the simplicities of grassroots appeal a decade ago to the complexities of a full-blown national movement, aided and abetted by even such an ogre as the Internal Revenue Service, preservation activity has already required architects to diversify their traditional range of services. A recent AIA survey, for example, revealed a 100 percent increase in the past decade in the number of architectural firms undertaking restoration, rehabilitation and adaptive use projects.

An outpouring of books has matched all this activity. Books of recent months include such publications as *Architecture in Context: Fitting New Buildings with Old* (Brent C. Brolin), *Return to the City: How to Restore Old Buildings and Ourselves in America's Historic Urban Neighborhoods* (Richard E. Reed), *How to Recycle Buildings* (Laurence E. Reiner), *Preservation in American Towns and Cities* (Nathan Weinberg), *Moving Historic Buildings* (John O. Curtis) and *Re-creating the Historic House Interior* (William Seale).

There are also the related books that extol past architectural masterpieces, or decry their loss, and books that examine the eclecticism of the past. Among them: *Capital Losses: A Cultural History of Washington's Destroyed Buildings* (James M. Goode), *Splendid Survivors: San Francisco's Downtown Architectural Heritage* (edited by Michael R. Corbett) and *The Egyptian Revival: Its Sources, Monuments and Meaning* (Richard G. Carrott). Something for nearly everyone.

More theoretical in character is a second discernible trend. Recent architectural literature shows that the debate goes on about whether the principles of so-called modern architecture have been overturned in a return to historical forms and symbolism. Ironically, this searching of the past appears to be done in order to find an architectural idiom for our own time, and it appears to be done principally by scholars rather than architectural practitioners.

In the introduction to the recently published *Transformations in Modern Architecture* (Arthur Drexler), a book based on a controversial exhibit by the same title held at the Museum of Modern Art

in New York City last year, the statement is made that "critical discourse has shifted away" from architectural practitioners. The "most instructive commentary," says Drexler, comes from academics, who may or may not be practicing architects. Drexler goes further to say that our judgment of contemporary architecture is hampered by the "overwhelming volume of theory" and also by the "sheer quantity" of buildings published in magazines and books.

One academic commentator, Omer Akin, author of an article on postmodernism in the British magazine *Architectural Design* (vol. 49, no. 8-9, 1979), points to the "confusion" and "considerable disarray" in today's architecture. He believes all this "has been and will continue to be disastrous for young minds in architecture." He is more optimistic about the more mature architect, who will be "better able to sort out the relevant from the irrelevant."

There are many books to help do the sorting. New revised editions of older books that had a considerable influence on current architecture are appearing, including Charles Jencks' *The Language of Post-Modern Architecture*, Robert Venturi's *Contradictions and Complexities in Modern Architecture* and Robert A.M. Stern's *New Directions in American Architecture*.

A few of the recent books on the whys and wherefores of contemporary architecture are *The Language of Architecture: A Contribution to Architectural Theory* (Niels L. Prak), *Architecture and Its Interpretation: A Study of Expressive Systems in Architecture* (Juan Pablo Bonta), *Signs, Symbols and Architecture* (edited by Geoffrey Broadbent, Richard Bunt and Charles Jencks), *The Rationalists: Theory and Design in the Modern Movement* (edited by Dennis Sharp), *Collage City* (Colin Rowe and Fred Koetter) and *The Semiotics of the Built Environment* (Donald Preziosi).

The third discernible trend in recent books on energy reveals in no uncertain terms the crucial matter of rapidly depleting nonrenewable energy sources—and the search for alternatives. In addition to reports by special panels of experts, government documents and monographs by solar energy advocates, there are many practical books for the architectural practitioner.

They range in scope from AIA's own *Energy Planning for Buildings* (Michael M. Sizemore, AIA, Henry O. Clark, AIA, and William S. Ostrander) to *New Inventions in Low Cost Solar Heating* (William S. Shurcliff). Among the many other books are *Energy Conservation: Design Resources Handbook* (Royal Architectural Institute of Canada), *Solar Energy in Buildings* (Charles Chauliaquet, Pierre Bartsbal and Jean-Pierre

Bastellier), *The Architect's Guide to Energy Conservation* (Seymour Jarmul), *Building to Save Energy: Legal and Regulatory Approaches* (Grant P. Thompson), *The Passive Solar Energy Book* (Edward Mazria), *Conservation Through Building Design* (edited by Donald Watson, AIA) and *A Golden Thread: 2500 Years of Solar Architecture and Technology* (Ken Butti and John Perlin).

In addition, there have been recent books to zero in on special energy problems, such as *Protecting Solar Access for Residential Development* (Martin Jaffe and Duncan Erley), *The Energy-Efficient Church* (edited by Douglas R. Hoffman), *Energy-Efficient Community Planning* (James Ridgeway) and *Homes in the Earth* (Larry S. Chalmers, AIA, and Jeremy A. Jones, AIA). There's an energy book for just about everyone.

Not a trend perhaps, but interesting to note, are the many books on architects themselves. Although a knowledgeable architectural editor/publisher has commented that architects don't have heroes any more, there is certainly a raft of books on past heroes. Such publications have investigated the works of Bruce Goff, the Greene brothers, Erik Gunnar Asplund, Alvar Aalto, Aldo Rossi, Louis Kahn, Robert Venturi, Michael Graves, Wells Coates, Philip Johnson, Hans Scharoun, Otto Wagner, Edwin Lutyens, Eliel Saarinen, and on and on.

But in the recent past, surely no single

*Dante, a fresco by Luca Signorelli in the Duomo at Orvieto, Italy.*



architect had as many books written about him as did Frank Lloyd Wright. Some of the books are *Frank Lloyd Wright: His Life and His Architecture* (Robert C. Twombly), *Building with Frank Lloyd Wright: An Illustrated Memoir* (Herbert and Katherine Jacobs), *The Decorative Designs of Frank Lloyd Wright* (David A. Hanks), *Frank Lloyd Wright to 1910: The First Golden Age* (Grant Carpenter Manson), *The Plan for Restoration and Adaptive Use of the Frank Lloyd Wright Home and Studio* (Frank Lloyd Wright Home and Studio Foundation), *Frank Lloyd Wright: A Study in Architectural Content* (Norris Kelly Smith) and *Apprentice to Genius: Years with Frank Lloyd Wright* (Edgar Tafel, AIA).

Beautiful books have been published as well on architectural drawings, an art form that books of recent vintage have reinforced. Among the singularly handsome books (aside from the how-to-learn-to-draw books that often are also visually pleasing) are *The Drawings of Louis Sullivan: A Catalogue of the Frank Lloyd Wright Collection at Avery Architectural Library* (Paul E. Sprague), *Visionary Drawings of Architecture and Planning, 20th Century Through the 1960s* (George R. Collins), *Viennese Architecture, 1860-1930, in Drawings* (edited by Karl and Eva Mang), *The Architect's Eye: American Architectural Drawings from 1799-1978* (Deborah Nevins and Robert A.M. Stern, AIA) and *Architector: The Lodge Books and Sketchbooks of Medieval Architects* (vol. 1, François Boucher).

Architecture is a visual art, and there

have been other beautiful books published recently. Surely a candidate for top honors for 1979 is the three-volume work, *The Plan of St. Gall: A Study of the Architecture and Economy of, and Life in a Paradigmatic Carolingian Monastery* (Walter Horn and Ernest Born). Lavishly illustrated with about 1,000 plans and drawings, the set costs a hefty \$325 (\$750 for the deluxe edition) and won't find its way into many libraries of architects, but it is exemplary in its fine graphic design and will surely go down in the annals of contemporary bookmaking.

In the past year, there have also been all the how-to-do-it books for the architectural practitioner—how to manage a construction project, how to establish a firm, how to carry out effective public relations, how to design an office brochure, how to avoid legal pitfalls. But it is doubtful if such books indicate a trend, nor does the usual plethora of architectural guidebooks and books on what librarians call "architecture by place." Books in these categories are published constantly in any given year and cannot be examined as "engines of change."

In passing, however, the inquisitive may wonder about "nontrends." Except for the "tear sheet" books, compiled from pages of already published magazines, and the many books on "how to design and build your own house" (many, surprisingly, written by architects), where are the basic and comprehensive books on the design of specific building types—research laboratories, transportation terminals and other such structures that exemplify the scientific and technological aspirations of a dynamic American society? Why no book in the English language since 1929 on banking facilities, although money seems to be the generating force of our materialistic age? Another frontier for engines of change might be an in-depth endeavor to find out how the government of a free people should be expressed in the architecture of our time.

It is impossible to tell whether any book published in the past year is an engine of change. If no book of the recent past can claim to have set the course of future architecture, it may not be surprising. Perhaps architectural change is manifested *first* in an actual building. The building itself may be the engine of change. Is it not the architect who sets change in motion rather than those who comment on current "aberrations" and predict future architectural vision?

Returning to Barbara Tuchman's accolade about books, it seems that it is too early to tell whether any book of the past year is an engine of change. But certainly many of them are "windows on the world" as well as "lighthouses erected in a sea of time." Perhaps the engines of change are just in neutral. □

# IF YOU THINK ALUCOBOND™ MATERIAL IS GREAT FLAT OUT, WAIT TILL YOU SEE HOW IT TAKES



The building on the left is an example of what ALUCOBOND material doesn't do.

Namely ripple, buckle, or bulge.

Thanks to this remarkably flat composite of two aluminum sheets and a thermoplastic core, oil-canning has been totally eliminated on Kubota Tractor's streamlined U.S. headquarters in Compton, California.

The building on the right is an example of what ALUCOBOND material does do.

Wrap around corners in sinuously graceful lines.

The incredibly smooth curves and uniform color of this Consolidated Aluminum product help create a beautiful first impression for Trailer Life Publishing Company in Agoura, California.

Available in six siliconized polyester resin colors and four handsome

*When Daniel Dworsky, FAIA, of Daniel L. Dworsky FAIA and Associates, Inc., selected ALUCOBOND material, a key consideration was the easy expansion it permits.*

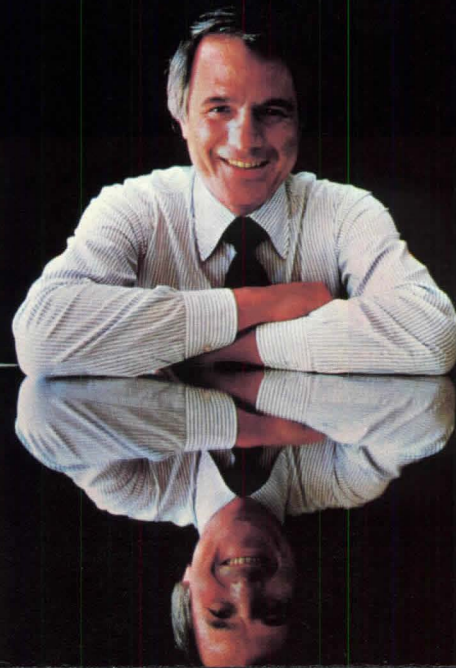



# THE CURVES.

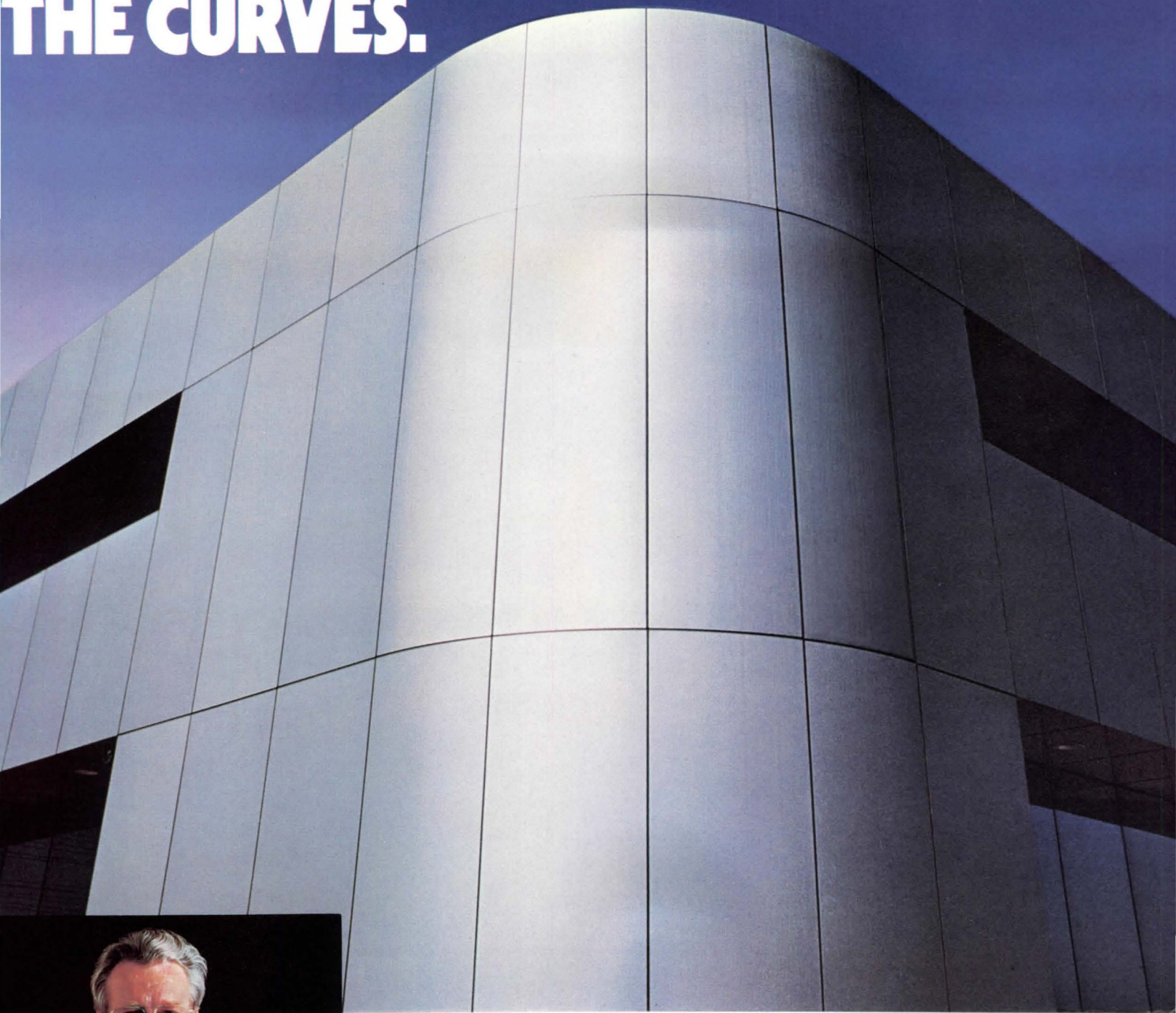

anodized finishes, ALUCOBOND material comes in panel sizes up to 5' X 28' and thicknesses of .118", .157", and .236" (3, 4, and 6 mm).

And its extraordinary adaptability offers architects design possibilities as diverse as their imaginations.

To find out more, call our Marketing Manager, Carla Lane, at (314) 878-6950. She can provide you with samples and

*Jerrold Lomax, AIA, of Lomax-Mills-Architects, shares credit for his creative use of ALUCOBOND material with Project Architect John Rock.*

information on ALUCOBOND material. The innovative product that's smoothing the way for creative architects everywhere.

*Turn page for distributor listing.*



*Circle 70 on information card*

# BOOKLIST

AIA

## INTERIORS

### \*Houses Architects Live In (3-M302)

By Barbara Plumb. Presents brilliantly designed houses and apartments—from modest to lavish, all emphasizing ingenious ways of combining beauty and practicality. All have interiors alive with ideas suitable for adaptation to all types of living situations. The author reviews concerns that determine architects' choices in designing their own environments, and notes how they individually deal with such matters as situation, space, scale, balance, color, light, and all factors involved in creating a home that meets their needs and interests. Hardcover, 168 pages, 168 color illustrations (1977). \$17.95 Non-member, \$16.15 AIA member.

## DESIGN

### \* Pedestrians Only: Planning, Design and Management of Traffic-Free Zones (3-M278)

By Roberto Brambilla and Gianni Longo. This appraisal of traffic-free zoning in 20 European and North American cities provides, for the first time, a comprehensive study of the complex process of eliminating all the noise, pollution, and turmoil from urban spaces. By summarizing and analyzing what has been achieved, the book offers a resource to guide future efforts to make cities more habitable. A compendium of over 70 American pedestrian malls completes the thoroughly researched text. Hardcover, 208 pages, 250 illustrations (1977). \$24.95 Non-member, \$22.45 AIA member.

## ENERGY

### \*Solar Dwelling Design Concepts (3-M311)

Prepared by AIA Research Corporation. This introduction to solar heating and cooling was prepared under contract to the Department of Housing and Urban Development as part of HUD's effort to demonstrate the feasibility of solar technology. A short history of solar applications, description of solar components and full systems, discussion of environmental factors and design concepts, and case studies make up this comprehensive overview of current concepts in solar design. Soft-cover, 146 pages, profusely illustrated (1976). \$5.00 Non-member, \$4.50 AIA member.

## PRACTICE AIDS

### \*Creative Communications For a Successful Design Practice (3-M300)

By Stephen A. Kliment. An invaluable tool for design professionals who want to develop skills and techniques needed to communicate effectively with present and potential clients, the media, and the public. More than a reference, here is a thorough course dealing with everything from letters to the annual report, slide presentations, speeches, press relations, and why and how to write a book. Hardcover, 192 pages, 200 illustrations (1977). \$22.50 Non-member, \$20.25 AIA member.

## GOVERNMENT

### Working in Government: A Profile Study of the Architect as a Public Employee (2-M712)

Prepared by AIA's Architects in Government Committee. The information presented in this report is intended to give the general public a better understanding of the various functions performed by architects in government; to give educators a clearer view of educational needs and opportunities; and government administrators an opportunity to make comparative assessments of architects in various agencies and at various levels of government. Developed from a survey of over 2,000 architects in government conducted in 1976, it provides a comprehensive profile of those persons practicing as architects in the public sector. Softcover, 40 pages (1978). \$5.00 Non-member, \$4.00 AIA member.

## TO ORDER

Order from: Manager, Publications Marketing, 1735 New York Avenue, N.W., Washington, D.C. 20006.

Make checks payable to the American Institute of Architects. District of Columbia residents add 5 percent sales tax.

For first class, air mail, special delivery, air express handling add 20 percent to total amount of order.

Foreign orders must include postage in the amount of 20 percent added to total amount of order. Check or money order must be payable in U.S. dollars.

## WHEN YOU WANT TO USE ALUCOBOND™ MATERIAL, THESE DISTRIBUTORS WILL SMOOTH THE WAY:

### NORTHEAST

Adammetal Supply  
Elizabeth, NJ 07207  
(201) 351-2550

A.O. Stilwell Co., Inc.  
Buffalo, NY 14224  
(716) 828-1415

B.R. Johnson, Inc.  
Syracuse, NY 13057  
(315) 437-1070

Building Specialties  
of Pittsburgh  
Pittsburgh, PA 15209  
(412) 821-5310

Custom Walls and Windows  
Kensington, MD 20795  
(301) 949-6550

Eastern Metal Mill Supply  
Dedham, MA 02026  
(617) 329-1200

The Fox Steel Company  
Orange, CT 06477  
(203) 799-2356

Frank N. Henry, Inc.  
Wilkes-Barre, PA 18703  
(717) 824-4611

Fred Boschan Co., Inc.  
Philadelphia, PA 19127  
(215) 483-8000

Metal Construction  
Services, Inc.  
Baltimore, MD 21218  
(301) 949-6550

### SOUTHEAST

Attaway & Howell Co., Inc.  
Tucker, GA 30084  
(404) 938-7830

Delph-Context, Inc.  
Charlotte, NC 28201  
(704) 376-3671

Demarest Company, Inc.  
Oneco, FL 33558  
(813) 758-3811

Fletcher & Associates  
Birmingham, AL 35203  
(205) 328-0525

J.M. Power Company, Inc.  
Trenton, MI 48183  
(313) 479-2200

John W. McDougall Company  
Nashville, TN 37209  
(615) 383-4036

Penco, Inc.  
Louisville, KY 40204  
(502) 584-1166

W.H. Stovall & Co., Inc.  
Ashland, VA 23005  
(804) 798-1415

### MIDWEST

Casewin, Inc.  
Minneapolis, MN 55416  
(612) 545-1635

Condit Construction Products  
Dayton, OH 45409  
(513) 298-9922

Columbus, OH 43228  
(614) 274-2283  
Cincinnati, OH 45229  
(513) 242-4029

Jones and Brown Co., Inc.  
Addison, IL 60101  
(312) 543-0300

Karl M. Block Co., Inc.  
St. Louis, MO 63144  
(314) 647-8044

Swanson Gentleman Hart, Inc.  
Omaha, NB 68154  
(402) 493-9393

Swanson Gentleman, Inc.  
Des Moines, IA 50309  
(515) 244-0186

### WEST

Associated Specialties Co.  
Salt Lake City, UT 84106  
(801) 487-8501

Elward, Inc.  
Denver, CO 80223  
(303) 936-7201

Payne & Howard, Inc.  
Dallas, TX 75234  
(214) 243-5050

Portland Wire & Iron Works  
Portland, OR 97202  
(503) 234-9731

RPS Architectural Systems\*  
North Hollywood, CA 91605  
(213) 982-5866

*ALUCOBOND is the trademark of Consolidated Aluminum Corporation for its aluminum composite material.*

*Technical information with reference to ALUCOBOND™ material test results can be obtained by writing to Consolidated Aluminum, Attention: Carla Lane. Always consult local building codes before use.*

*\*System design and fabrication for the buildings on the preceding page were by RPS Architectural Systems.*

 **CONSOLIDATED ALUMINUM™**

11960 Westline Industrial Drive  
St. Louis, Missouri 63141

# THERMAL\* DOOR

## Insulated Rolling Door

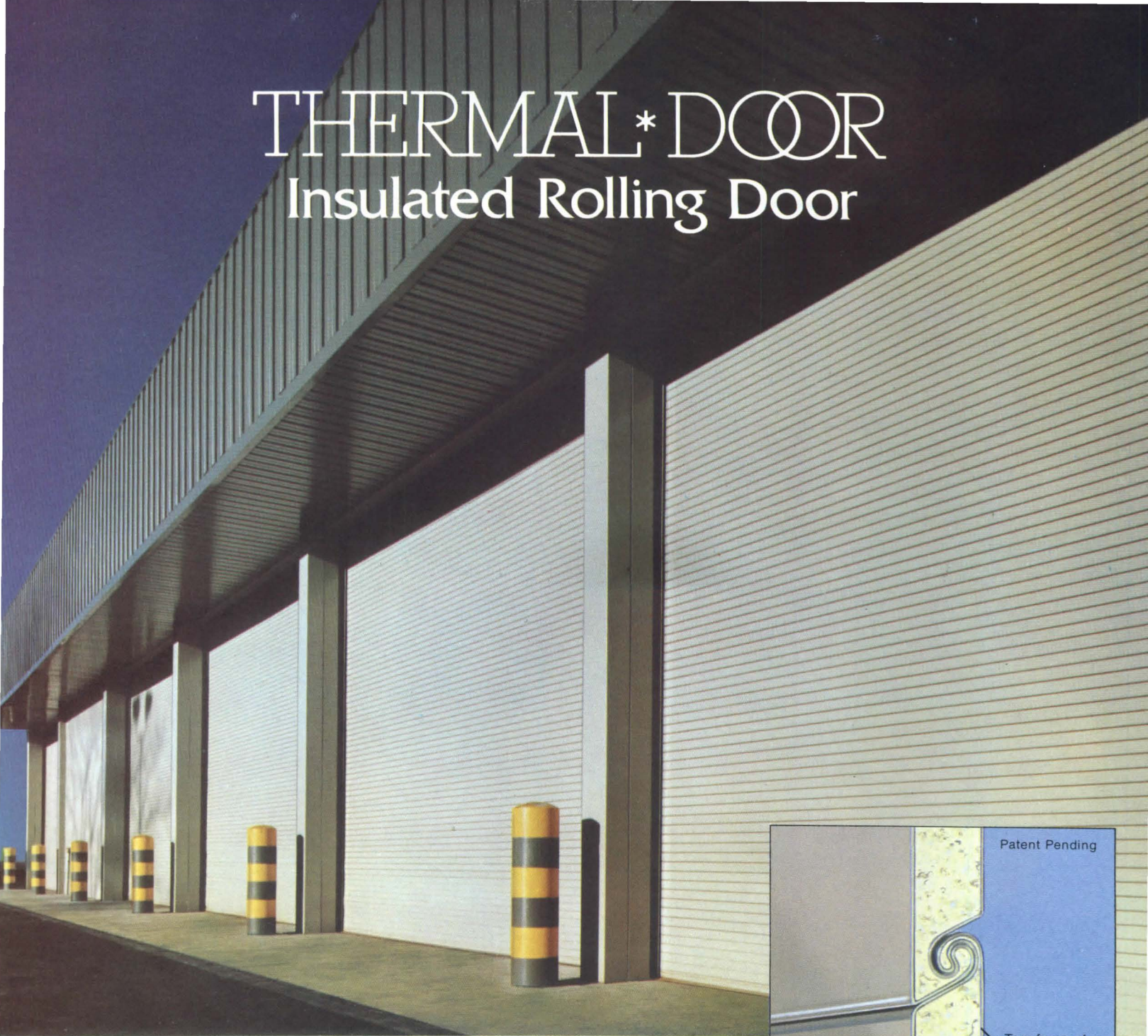

## The Creative Challenge of Today

Design a building that's beautiful and energy efficient. To do it you've got to use every means to conserve energy. That's why Atlas has developed an insulated rolling door with a U-rating of 0.2. "Thermal-door" is designed to meet the challenge of today.

Uniquely constructed, Thermal-door cuts energy waste due to heat flow through and around the door curtain. The door slat is constructed so that polyurethane foam is sandwiched between two faces of 22-gauge galvanized steel. Thermal-door is weather-

stripped on all sides, making it the logical solution for temperature-weather control problems that occur at large door locations. Thermal-door can also be used at interior openings to reduce air flow into air-conditioned areas within your building.

In all, Thermal-door is a thoroughly engineered product from a company committed to meeting the challenges today.

If you'd like to know more about Thermal-door call or write to Atlas Door Corporation (201) 572-5700. Because we're committed.

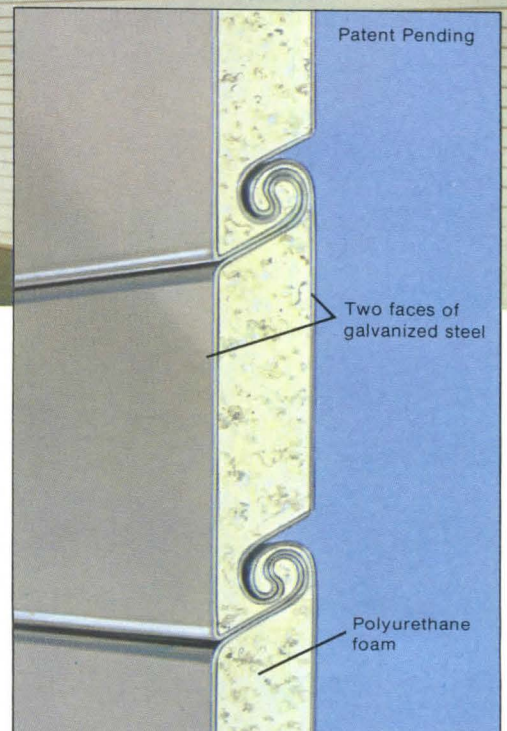

**atlas**

Atlas Door Corp.  
112 Truman Drive  
Edison, N.J. 08817  
201-572-5700

Circle 71 on information card

Meeting the challenge of today...



PATENTED  
RAVNEER LIMIT STOP

# ALL LIVING THINGS SOMETIMES NEED A BREATH OF FRESH AIR.

## **Kawneer Limit Stop Hardware**

To many administrators of buildings where people work, learn or recuperate it has become apparent that a permanently closed window may not be as safe as once thought. The recent history of power failures and "brownouts" are proof that there are times when fresh air is what is really safe. In fact, many life safety codes now specify a ventilation requirement.

## **Introducing The Prudent Alternative**

Kawneer Limit Stop Hardware for vertically pivoted windows is a sensible compromise between the "ultimate" safety of permanently closed windows and the safety of fresh air. Limit Stop Hardware creates a "ventilation position" of four to six inches of window opening. No further. The limit arm restricts further opening, helping minimize the dangers of a fully open window.

The window washing advantages of vertically pivoted windows are not lost with Limit Stop Hardware. A hex key releases the window from its limit arm, allowing the window to be pivoted approximately 175° to a locked washing position. All the advantages of interior window washing, such as reduced labor and elimination of exterior staging, are maintained.

Kawneer Limit Stop Hardware is available exclusively on Kawneer Vertically Pivoted Windows, the same Kawneer windows which offer high performance and ease of operation. For more information, contact your Kawneer representative, or write: Kawneer Architectural Products Information, Dept. C, 1105 N. Front Street, Niles, MI 49120.

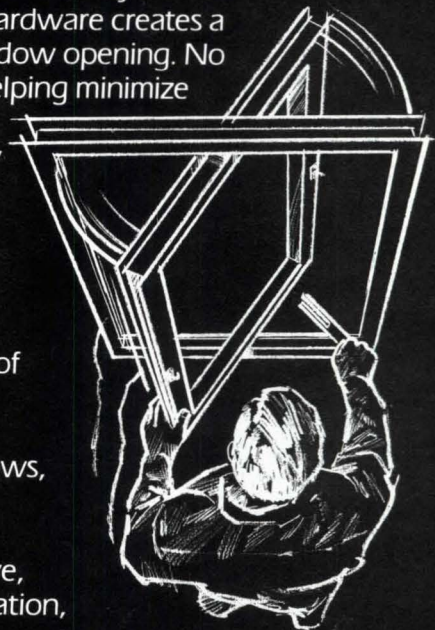

**Kawneer**  
The designer's element

*Circle 72 on information card*

**What would you get  
if you tossed away  
all your ideas about  
what a building  
should be?**

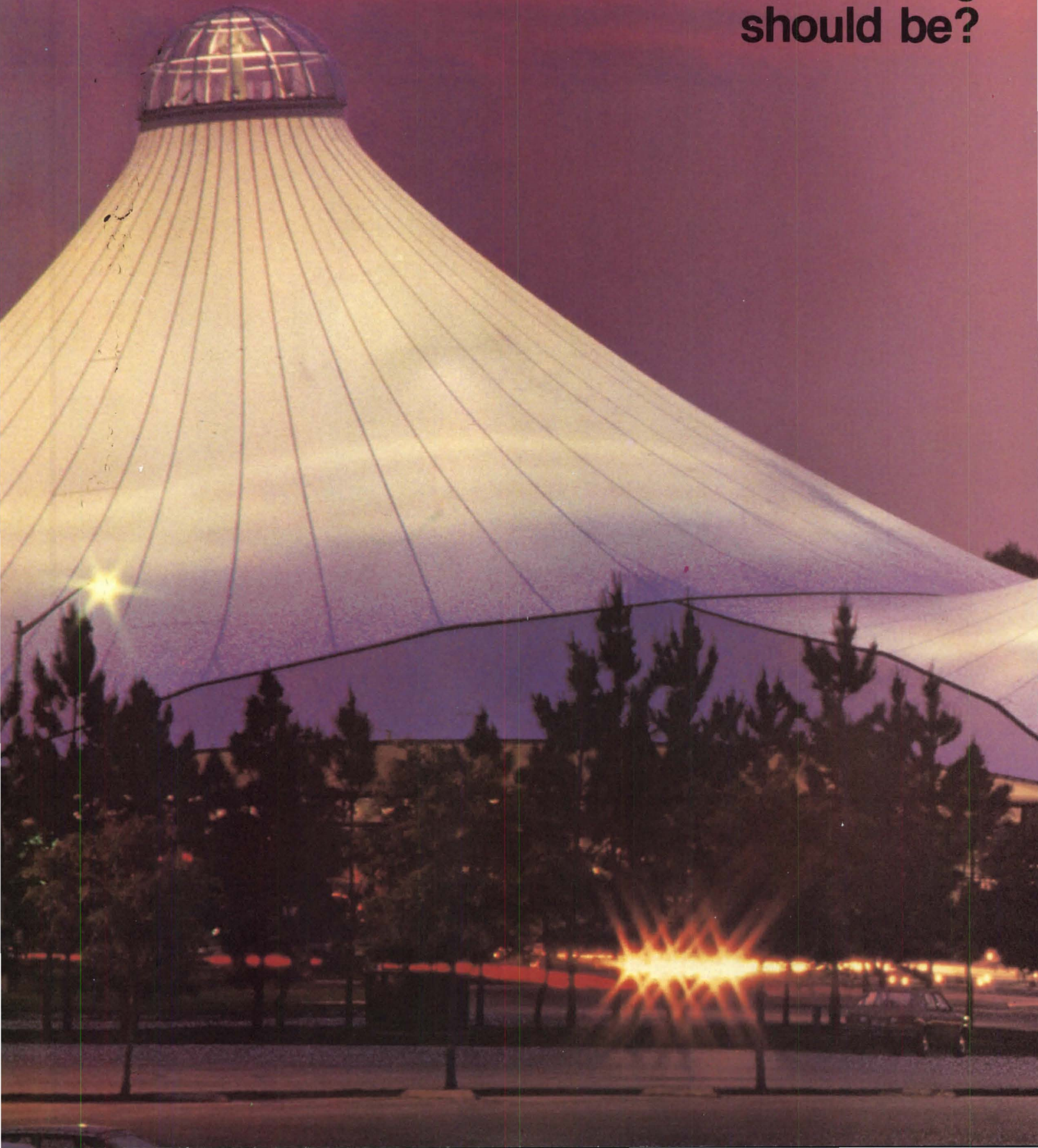

## Permanent fabric architecture from Birdair Structures.

A proven, durable system that offers an exciting alternative to traditional construction methods — and a freedom of design and conceptual versatility never before possible. Not just a wide span roof, but a complete environmental envelope that provides translucency, solar reflectivity, and esthetics. Simply put, a revolution in architectural form.

Florida Festival, a 60,000 square foot shopping and entertainment center at Sea World in Orlando, was fabricated and erected by Birdair Structures. The 90,000

square foot roof is made of SHEERFILL<sup>®</sup>, CHEMFAB's architectural fabric of fiberglass coated with TEFLON\*. With 18% solar transmission, it permits the growth of 40 foot palm trees and other tropical flora. Natural daylight bathes the interior to highlight merchants' products. The high reflectivity of SHEERFILL creates a cooler interior under the hot Florida sun, providing substantial energy savings through greatly reduced air-conditioning requirements.

The design and erection of permanent fabric structures require the specialized skills of a company with the demonstrated ability to help translate vision into reality. Birdair Structures is the pioneer and leader in this field. We invented the technology. Extensive involvement

in virtually every permanent fabric structure built to date makes us uniquely qualified to offer state-of-the-art structural analysis and detailing assistance to the architect. We are the **only** single source that can offer integrated expertise in every phase of fabric structure technology: design, engineering, weaving, coating, fabrication, and erection.

Bring **your** new ideas to us, **Birdair Structures**, a division of CHEMFAB, 2015 Walden Avenue, Buffalo, New York 14225 U.S.A. (716) 684-9500 Telex: 91-353 Cable: Birdair Buffalo.

*Circle 73 on information card*

**BIRDAIR STRUCTURES**  
A DIVISION OF **CHEMFAB**



Architect in Charge of Design and Construction: Basil H. M. Carter, New York, New York  
Architect of Record: Robert Lamb Hart, Robert Lamb Hart Architects, New York, New York  
Engineering Consultants: Geiger-Berger Associates, New York, New York

© SHEERFILL is a registered trademark of CHEMFAB

\* Du Pont's registered trademark for its fluorocarbon resins and film

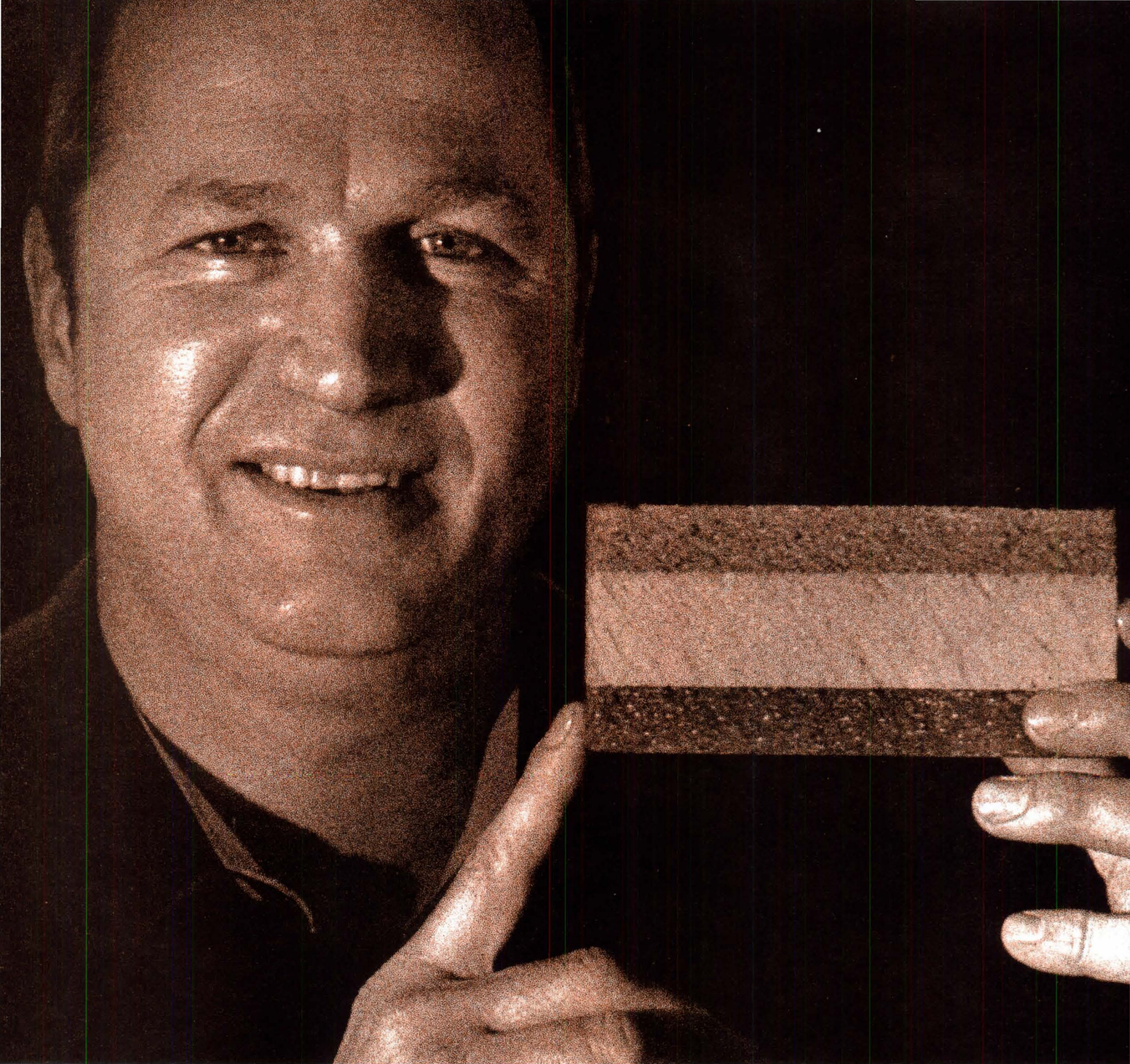

**“If I could say just one thing to architects about Permalite PK Plus® roof insulation, it would be — Relax.”**

Monty Moore  
Pacific-Rainier Roofing Co.  
Seattle, Washington

Relax, because you've specified great insulation and the best platform for a long-lasting, trouble-free BUR — Permalite PK Plus. It's the factory-manufactured platform that's perlite-urethane-perlite chemically bonded together to be stable, dry and economical. Top roofers like Monty Moore trust it to give architects like you a product proven in thousands of installations under all climatic conditions.

If Permalite PK Plus makes as much sense to you as it does to roofers and other architects, then contact us for technical data and free sample.

Grefco, your single source for Permalite® perlite, urethane, perlite-urethane and PK Plus insulation boards. For technical data and free sample write Grefco Inc., Building Products Division, 3450 Wilshire Blvd., Los Angeles, CA 90010.

 GREFCO a subsidiary of  
General Refractories Company

**Permalite®**  
Insulation Board



There's a new era in flooring for all types of buildings. The Access Floor System. Pioneered by Tate for computer rooms, it permits installation of utility services beneath floors for cost, design and maintenance advantages. And now this system is bringing lower construction costs, greater flexibility and design freedom to a variety of installations—including the Wayne State University Health Care Institute described in this magazine. Contact Tate for details.

Tate is the only manufacturer to make its own carpet, specifically designed for access floor panels.

A unique design provides the industry's highest degree of sound absorption.

Available in a variety of hard-surface and carpeted panels to meet specific needs.

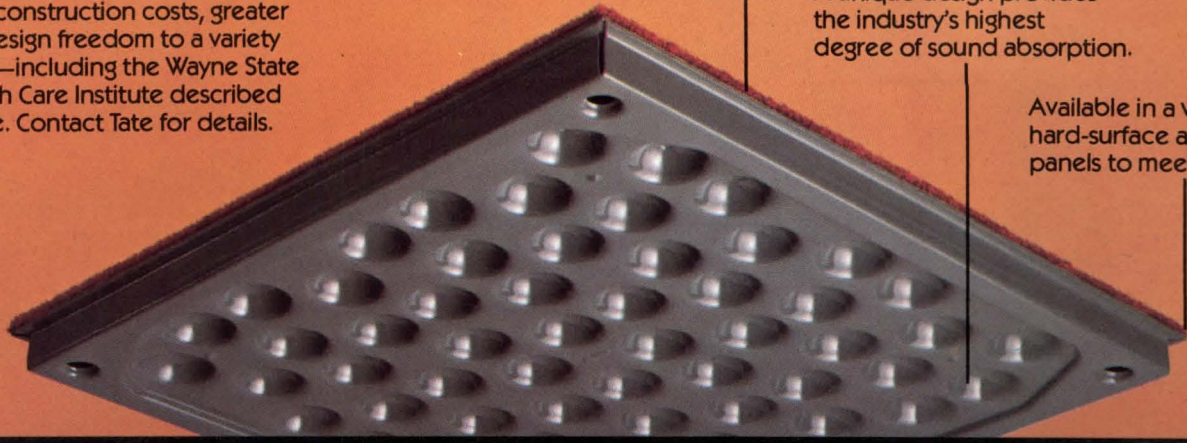

# TATE. WHEN YOU WANT THE PANEL OF EXPERTS IN ACCESS FLOOR SYSTEMS.

# Tate

**THE PANEL OF EXPERTS.**

TATE ARCHITECTURAL PRODUCTS, INC.

7510 MONTEVIDEO ROAD/JESSUP, MD 20794  
301-799-4200 OR TOLL FREE 800-738-5846

*Circle 75 on information card*

# the Young Century

Giants were at work in Chicago; Sullivan, Root, Adler, Perkins, Burnham, the young Wright. And their buildings serve well the society of now.

Among them worked a young Finnish architect, Oscar Rixson, devoted to their concepts of the superbly functional, the purity of architectural line. For them he developed a door control to be concealed in the floor; stronger, more durable than any closer known before, or after.

Rixson closers were specified for almost every major building designed by the leaders of the time. Many still control doors reliably, decade after decade. Yet, just as others further developed the ideas of "The Chicago School," so has the Rixson floor closer been improved, in literally scores of ways. At no time since 1900 has anyone ever made a better, more economical closer than a Rixson.

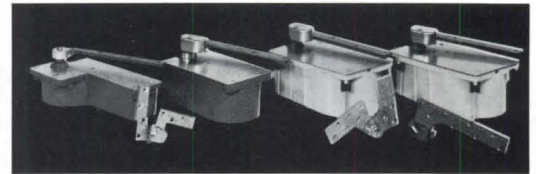

For information on the new generation of Rixson floor closers, contact:

## **RIXSON-FIREMARK**

9100 West Belmont Avenue  
Franklin Park, Illinois 60131  
and Rexdale, Ontario—  
312/671-5670

*Circle 76 on information card*

A DIVISION OF  
**CONRAC**  
CORPORATION

Carson, Pirie, Scott & Co., Chicago  
Louis Sullivan, 1899.



### Books from page 98

glass and stabilized the Chicago art glass market for a decade to come."

Architectural terra cotta came into its own in Chicago with the group of architects that became known as the Chicago school of architecture. They specified that terra cotta be used to sheathe the exterior walls of the tall buildings that were beginning to dominate the Chicago scene, and the material was used on interiors as well for the fireproofing of structural members. Terra cotta seemed the ideal building material because of economy, safety and esthetic considerations. "As Chicago's cityscape attested," says Darling, "terra cotta could be made to assume almost any form, size, color or texture envisioned by an architect or his client."

But the Great Depression had its effect, as did changing architectural styles. By the mid-1930s, the elaborate terra cotta facades had been replaced, and after World War II, Chicago's skyline reflected the influence of the International Style. "Now just over 100 years after the birth of America's terra cotta industry, the large factories have vanished and only a few architects and former employees remain to convey the excitement and recall the activity which characterized terra cotta's finest hours. Yet thousands of structures throughout the city and the Midwest serve as testimony to the significant contributions of architectural terra cotta to the American landscape."

Darling, who is curator of decorative arts at the Chicago Historical Society, has written a book that will interest all who are interested in American art and architecture.

**The Social Life of Small Urban Spaces.** William H. Whyte. (Conservation Foundation, \$9.50 paperbound.)

For those of us who do not have seven or eight years to study the social life of small urban spaces, author William Whyte has taken the time to produce an insightful book on how small open urban spaces work. This profusely illustrated small book draws most of its examples from New York City, although there is a smattering of non-New York open spaces used to illustrate the points. This little book has a feeling of worldliness and common sense that suggests that the findings and conclusions have application almost anywhere in the world where Homo sapiens gathers.

The basic question addressed in the book is: What makes an urban open space successful? Whyte believes that an open space that attracts people who are enjoying themselves constitutes success. Many of the findings seem quite apparent to anyone who has taken the time to think seriously about the behavior of people in public open spaces. The book, however,

neatly pulls together and compresses many years of observations by the author, and thereby provides insights most of us would never evolve on our own.

A good idea of the contents of the book can be gained from the chapter titles. They are: "The Life of Plazas," "Sitting Space," "Sun, Wind, Trees, Water," "Food," "The Street," "The 'Undesirables,'" "Effective Capacity," "Indoor Spaces," "Concourses and Megastructures," "Smaller Cities and Places" and "Triangulation."

As William Reilly, president of the Conservation Foundation, points out in the foreword, many of the findings and conclusions that seem so obvious quite often escape us when we set out to design small urban spaces. For example, spaces

designed to keep out undesirables, pushers, bums and agitators tend to keep out other people as well. The most successful spaces seem to attract people in general and to be relatively free of problems. Sun, trees, water, food and, most of all, places to sit are crucial.

Finally, the particularly intriguing aspect of the book is the author's detailed description of his research methodology, using still and movie cameras. This, I think, would make the book very valuable to first- or second-year design students who are attempting to see and understand how outdoor spaces are actually used. The book is recommended for student, faculty and practitioner alike. *Michael B. Barker, AICP, Administrator, AIA Department of Practice and Design* □

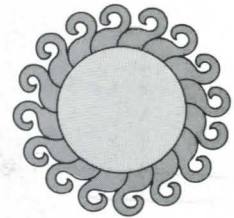

*An ever-changing panorama of natural texture changes as the sun goes around. Truly, the perfect balance between architecture and nature.*

## Natural Buckingham Slate®

**The award-winning 100 WILLIAM STREET building in Manhattan.**

Architects: Davis Brody & Associates and Emery Roth & Sons

Owner-builder: Sylvan Lawrence

Supplier: Domestic Marble & Stone Corporation

Photo: Robert Gray

The fine design of this stately building is well executed in the rich individuality of Buckingham Slate.® Fine grained density, hardness and soundness assure unfading permanence. Natural qualities conserve heating and cooling energy...saving big dollars of fuel costs. Maintenance free durability saves even more long-term dollars. Available in both interior and exterior paneling, flooring and paving. Write or call for information or see our catalogs in Sweet's Architectural Files or B.S.I. Stone Catalog.



**Buckingham-Virginia Slate Corporation**

4110 Fitzhugh Avenue  
Richmond, Virginia 23230  
Telephone: 804/355-4351

Circle 77 on information card



MASTERSPEC 2 comes to you with a 10-year background of proven, successful experience. It preserves the good, solid qualities of MASTERSPEC, but is streamlined for easier use.

MASTERSPEC 2 cuts your specifying time, increases your design time, and lowers your liability exposure. Helps solve people and production problems. MASTERSPEC 2 is updated regularly to keep you up with technology and product changes!

**Adaptable ... In Scope And In Price!**

MASTERSPEC 2 includes a new stand-alone BASIC Version — at the low initial cost of \$395, and a yearly renewal cost of just \$245. Yet, if your practice so requires, it is expandable with two add-on

**\$395**  
\$245 Yearly  
Renewal

options: 1. An abbreviated Short Language Version; and 2. A more detailed Narrowscope Version. BASIC contains approximately 2,000 pages. The Short Language Version is about half that size, and Narrowscope approximately twice the size of BASIC. All versions are also available in automated form.

**Technically Superior**

MASTERSPEC 2 has been written by PSAE's professional specialists, so that it clearly and accurately describes materials, fabrication and installation, as well as citing industry standards. This comprehensive specification system will keep you abreast of the latest innovations in technology, product performance and

Announcing  
the new, affordable specification system

# MASTERSPEC 2

Easily used. Technically superior. Adaptable.

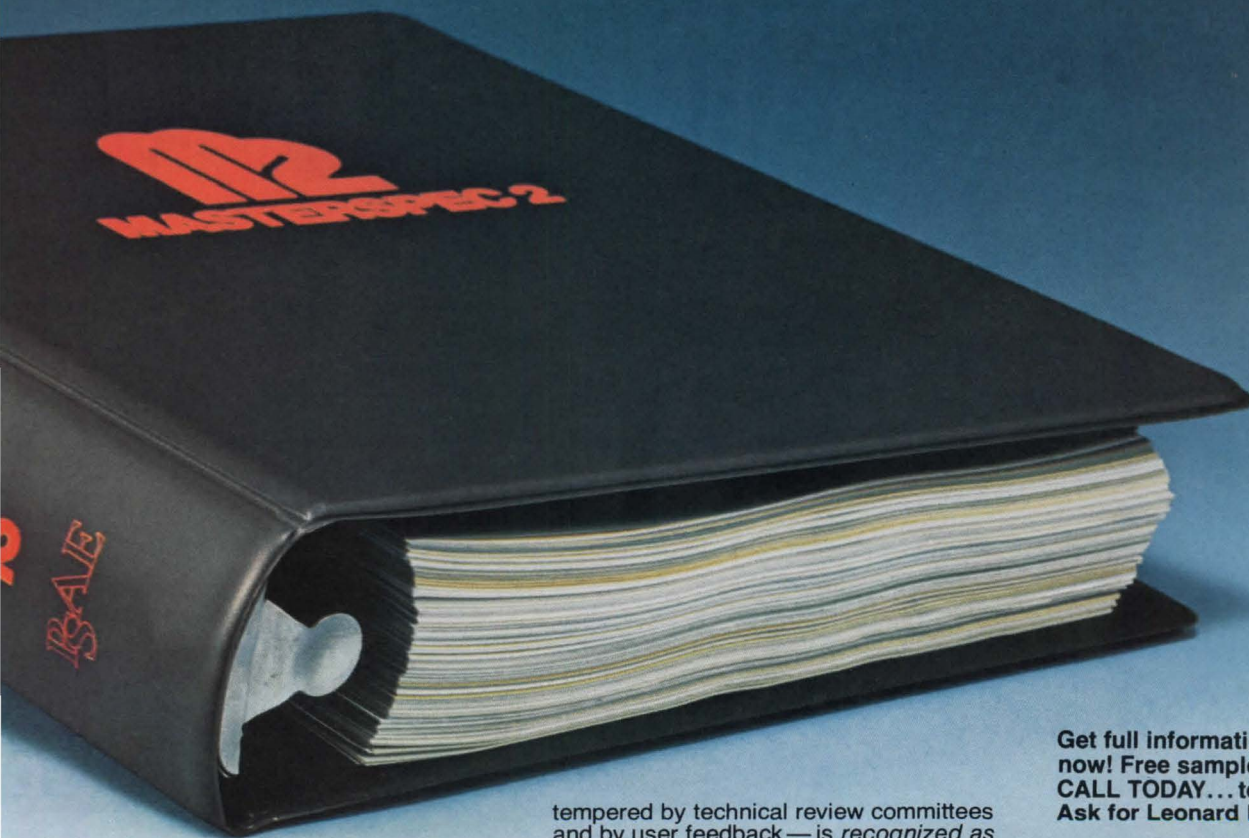

design applications. It separates manufacturers' "sales pitch" from fact. You can be sure that MASTERSPEC 2's language is correct — the system is subject to formal review by the professional societies — AIA, NSPE and ACEC.

#### Use MASTERSPEC 2 With Confidence!

The MASTERSPEC 2 system — forged by PSAE's professional specifiers and

tempered by technical review committees and by user feedback — is *recognized as the standard* of the profession.

MASTERSPEC 2 helps you reduce overlaps, duplications and omissions ... aids in protecting you against liability losses. It's like adding a high-priced specialist to your staff at low-dollar cost! Make MASTERSPEC 2 *your* standard for specifications!

Get full information on MASTERSPEC 2 now! Free samples of text are available. CALL TODAY... toll free! (800) 424-5080. Ask for Leonard Bain, AIA

MASTERSPEC 2 is a product of PSAE

**PSAE** PRODUCTION  
SYSTEMS FOR  
ARCHITECTS &  
ENGINEERS, INC.  
A wholly owned corporation of AIA  
1735 New York Avenue, N.W.  
Washington, D.C. 20006

**M2 MASTERSPEC 2**  
The comprehensive specification system endorsed by the A/E professions.

See MASTERSPEC 2 at: • Booths #321-322 at the AIA Convention, June 1-4, • Booths #66-67, Paper Plane Conference, June 19-20.

Circle 78 on information card

**A concealed sprinkler that goes into the ceiling.  
At a price that won't go through the roof.**



## **The new Unspoiler sprinkler.**

When you choose the new Star® Unspoiler® sprinkler, you get a concealed sprinkler that won't spoil your interior designs. At a price that won't spoil your budget.



You won't find a less expensive concealed sprinkler on the market. There's no need for costly special piping. And you save big on labor costs because the Unspoiler is easy to install.

Best of all, there's no waiting for delivery. We provide same-day shipment on orders accepted by us before 3 p.m.\*

**The looks look good.  
The works work.**

The Unspoiler will fit just about any color scheme. Choose from our standard flat white, chrome, satin chrome and bronze colors. Or order a custom finish to match a special decor.

Star is a name you can rely on for concealed sprinkler systems. Since

inventing the first concealed sprinkler, we've learned a lot about making the best product you can buy.

When you need a fire protection system that looks as good as it works, call (800) 323-4482. Illinois residents call (312) 534-1000. Or write Chemetron Fire Systems, Route #50 & Governors Highway, Monee, Illinois 60449.

\*Subject to conditions beyond Chemetron's control and to limitations of liability provisions as contained in Chemetron's Fire Systems Division's terms and conditions of sale

**CHEMETRON**<sup>TM</sup>

**Fire Systems**

A member company of Allegheny Ludlum Industries

*Circle 79 on information card*

**This is press-on lettering.  
 This is hand lettering.  
 This is mechanical drafting lettering.  
 This is typehouse lettering.  
 This is KroyType™ lettering.\***

\*This is KroyType™ lettering enlarged to 124%.

**Only one can be done quickly and economically  
 with quality right in your own office.  
 It's KroyType lettering.**

**It's a revolutionary technology.** Now anyone in your office can get high quality type instantly with this remarkable system: KroyType™ lettering and the KroyType 80™ Automatic Lettering Machine.

Here's how: Just turn the typedisc to automatically position the letter and push a button. Out comes quality type on transparent tape. Alignment and spacing are always perfect.

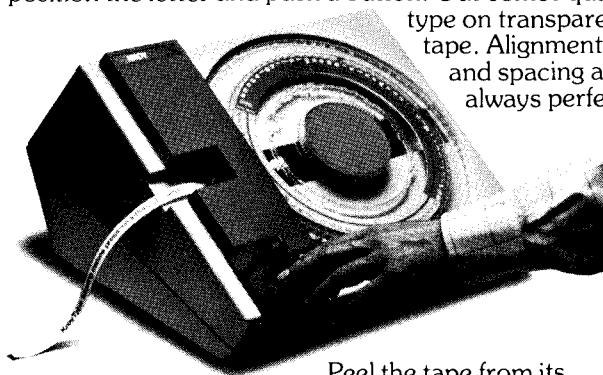

Peel the tape from its backing and position the type wherever you want it. It's that easy!

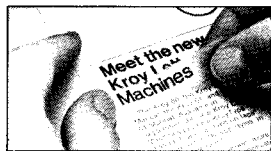

**It's 5 times faster.** If you've ever used press-on lettering, you know how long it takes to complete the job. And then a letter or an entire line can be crooked. Not so with KroyType lettering. All the letters are always in a straight line. Your job can be completed five times faster than press-ons, and at least twice as fast as mechanical drafting lettering. And there's no lost time waiting for an outside typesetter.

**It's economical.** KroyType lettering can cost you less than a nickel a word. And you can expect the KroyType 80 Lettering Machine to pay for itself in a very short period of time. In fact, you can discover the labor savings of businesses everywhere in our free brochure. We'll send it immediately at your request.

Because KroyType lettering will make you look more professional, you can expect to make a better impression. And bring in more business.

**It's professional quality.** Look at the headline of this ad. Compare KroyType lettering with hand lettering or mechanical drafting lettering. There's no contest. Now compare it with press-ons and

commercially set type. Notice how KroyType lettering has this same high quality.

**It's used everywhere.** In our free brochure, you'll see how people all over America are using KroyType lettering.

It's perfect for making presentations more professional, for title blocks on engineering drawings, and for overhead transparencies, easel cards, microfiche and slides.

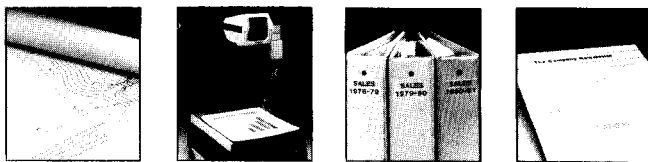

Imagine using it for newsletters and flyers. Office forms, name badges, labeling, file folders, TV storyboards, notebooks, mail bins. Any place you set down words you can use KroyType lettering. Now think of all the things you can do with KroyType lettering.

**19 type faces.** You can choose from 19 type faces in sizes from 8-point to 36-point type. To change type styles in the machine, simply change the typedisc. It's as easy as changing a record on your stereo.

**Free Brochure.** We'll send you a free brochure and a free sample of KroyType lettering. We can also arrange to show you the KroyType Lettering Machine in your office at no obligation. Just dial **Toll Free 1-800-328-1306** or mail the coupon below. We think you'll agree that no matter what professional lettering job you have to do... KroyType lettering makes you look better for about the cost of a good used typewriter.

KroyType™ and KroyType 80™ are trademarks of Kroy Industries Inc.

Mail to: **Kroy Industries Inc.**,  
 1728 Gervais Ave., St. Paul, MN 55109

**KROY**  SEND ME my free brochure and a sample of KroyType lettering.  
 SHOW ME the KroyType 80™ Lettering Machine at no obligation in my own office.

Name \_\_\_\_\_  
 Company \_\_\_\_\_ Title \_\_\_\_\_  
 Address \_\_\_\_\_  
 City \_\_\_\_\_ State \_\_\_\_\_ Zip \_\_\_\_\_  
 Phone \_\_\_\_\_

Circle 80 on information card



## A creative challenge, superbly met.

When the architect finds the solution to a design problem, it's a triumph. At Schinnerer we've been working with architects and engineers in the field of professional liability long enough to appreciate their creativity and expertise — and long enough to be fully aware of the insurance problems they face.

Now we've met a challenge of our own. At a time when the cost of everything else is going up, Continental Casualty Company, one of the CNA insurance companies, has stabilized its rates for a period of at least 27 months (from March, 1978) and added to its Professional Liability Program some new features that can save you money.

One exclusive CNA feature is called the Deductible Credit Plan. It can lower your deductible obligation by as much as 50%, or lower your premium if you select a higher deductible. The Deductible Credit Plan and other new features mean that we can now provide you with the most comprehensive coverage available, at a very reasonable cost.

At Schinnerer and CNA, we're always working to improve our coverage and hold the line on cost. You'll find our latest achievements go a long way toward meeting that challenge. Call your broker and get a quote.

Victor O.  
**Schinnerer**  
& Company, Inc.

*The first is still the best.*

*Program Administrators  
and Underwriting Managers*

5028 Wisconsin Avenue, N.W.  
Washington, D.C. 20016  
Phone: (202) 686-2850

Other offices in:  
New York  
Chicago  
San Francisco

This coverage is underwritten by  
Continental Casualty Company  
*Circle 81 on information card*



## **The Third Annual Review of New American Architecture**

The intent of this special issue remains essentially the same as when it was started: to assemble the best recent work we can find, regardless of whether it has been published elsewhere. Some of the buildings are winners of AIA honor awards, some are not.

We believe that seeing them all in one place can add perspective on the directions of American architecture. Also, doing this review annually allows us to give the buildings a more analytic look than ever is possible in a monthly rush for first publication.

We believe this year's crop of buildings is an unusually interesting and varied one. It includes some major works and some small ones, by large and small offices alike. For example, the media building of the year, the New Harmony Atheneum, is followed by a modest church of great quality in a tiny Alabama town.

In terms of approach, the building analyses are perhaps terser than in the past; partly in the belief that one well chosen and presented picture, while perhaps not worth 1,000 words, can take the place of a great many adjectives. On the other hand, there are more voices involved in discussion of directions than in the predecessor issues. *D.C.*

# A Vision Continued

*Richard Meier's Atheneum, New Harmony, Ind.*  
By Stanley Abercrombie, AIA

Anyone visiting Richard Meier's office in the last couple of years couldn't have missed it: the astonishingly detailed model of his design for the Atheneum in New Harmony, Ind. And anyone seeing it might have been forgiven for wondering: Had Meier finally overstepped his limits as a designer; had his fascination with complex parts overwhelmed his control of the total composition; had his work become overly complicated, overly mannered, overwrought?

Now that the Atheneum is built, these worries can be forgotten. The building is an exhilarating beauty, establishing a new and even higher level of achievement in Meier's work. Here and there it may seem, like the model, to be a bit esthetically muscle-bound, but there is no doubt that it is a superb work of architecture. The features that seemed fussy at one-sixteenth-inch scale are bold and clear at full size; the elaborate interior and exterior circulation system, which might have been suspected of being merely decorative, is seen to be a well-reasoned and fully used accommodation of public movement, and the complexities that might have been overbearing in a tighter context are welcome delights on the building's actual site—a broad, bare field sloping gently down to the wooded banks of the Wabash River.

It is a beautiful site in a fascinating community, and the building's purpose is to inform visitors about the town. It houses a giant model of the original settlement, a number of other exhibits and a theater in which a brief film is shown. At the end of the tour through the building, visitors climb (in good weather) to the roof for a view of the town, then descend a stair and a long ramp to visit a series of the town's restored buildings.

New Harmony was founded in the wilderness in 1814 by the Harmonists, a group of less than a thousand Lutheran Church dissenters from Württemberg, Germany. We all might not have been at home there: The keystones of community life were hard work and celibacy. This life, however, produced an impressive number of sturdily built dormitories, mills and factories, a handsome cruciform brick church and two thousand cultivated acres. In 1825, seeking a location closer to the markets for its goods, the sect sold the entire town and moved to Pennsylvania. But New Harmony's experimentation was not ended; the buyer was the Welsh reformer Robert Owen, who imported a boatload of noted scholars in an attempt to found an "empire of good sense." One of Owen's changes was to convert the Harmonists' church into an Atheneum (a center of learning). Within two years, Owen admitted his experiment a failure, but many of his imported scholars remained, and New Harmony continued to be exceptional. It claims to have produced the first kindergarten, the first trade school, the first free public school system and the first free library. In 1960 Philip Johnson's well-known "roofless church" was built in New Harmony, and later and nearby, the

*A restored 19th century farmhouse is one of the sights that Meier's gleaming new visitors' center explains. Next page, Evelyn Hofer's photo of the complex facade facing the curving banks of the Wabash.*

Evelyn Hofer









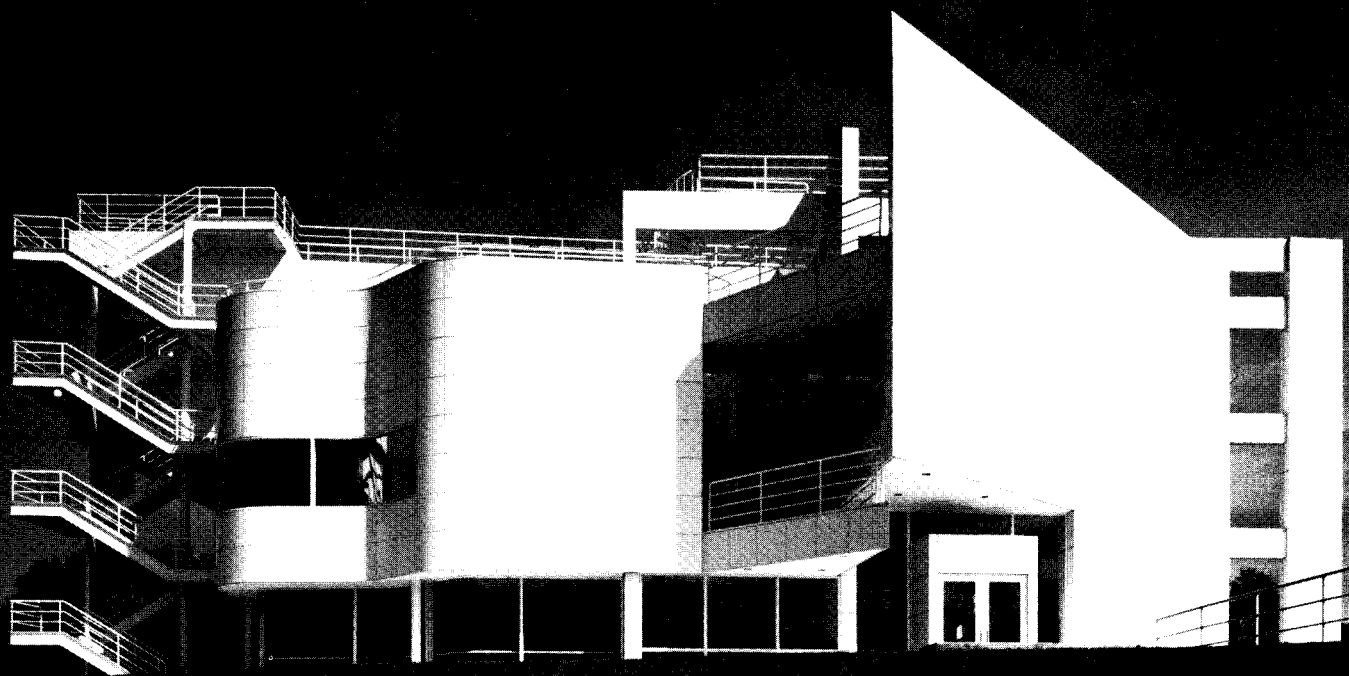

### 'The white is not just white but shiny white.'

Pottery, a little-known Meier building housing a ceramics school, was built.

A distinction of New Harmony's character—in contrast to single-period communities like Williamsburg, Va.—is that it preserves elements from so many stages of its past. The addition of the new Atheneum, a building very clearly of the present, is thus a continuation of tradition, not an intrusion.

Meier's all-white palette is used to great advantage here, the only colored materials allowed being maple strip flooring and some dark gray industrial carpeting. In addition (unlike Meier's all-white houses), there is almost no freestanding furniture (an exception being a conference table and chair group similar to the one Meier designed for his library at the Guggenheim Museum). And, on the exterior, the white is not just white but shiny white, the skin formed from metal panels with a porcelain enamel finish. The result of this whiteness and emptiness is an inspiring lack of clutter, and, here again, there is a remarkable difference between model and building. We are accustomed to seeing architects' models as all-white abstractions, no matter what the intended materials and colors. We are not accustomed to such an effect in a finished building of this size, and the effect is powerful.

The Atheneum's complexity, unprecedented in Meier's work, does not necessarily herald a continued escalation of complexity in that work, for the Atheneum is a specific response to its site and program. But the unprecedented *presence* of the Atheneum does herald a new degree of Meier's confidence as an artist. The Atheneum is at once the best and also the most uncompromisingly Meier-like of all Meier's work so far. □



Evelyn Hofer



*Three exterior views, with the building entrance visible in the top two. At bottom, the long ramp serves as an exit from the building and as the beginning guide for a tour of the restored town beyond.*

Ezra Stoller/ESTO©

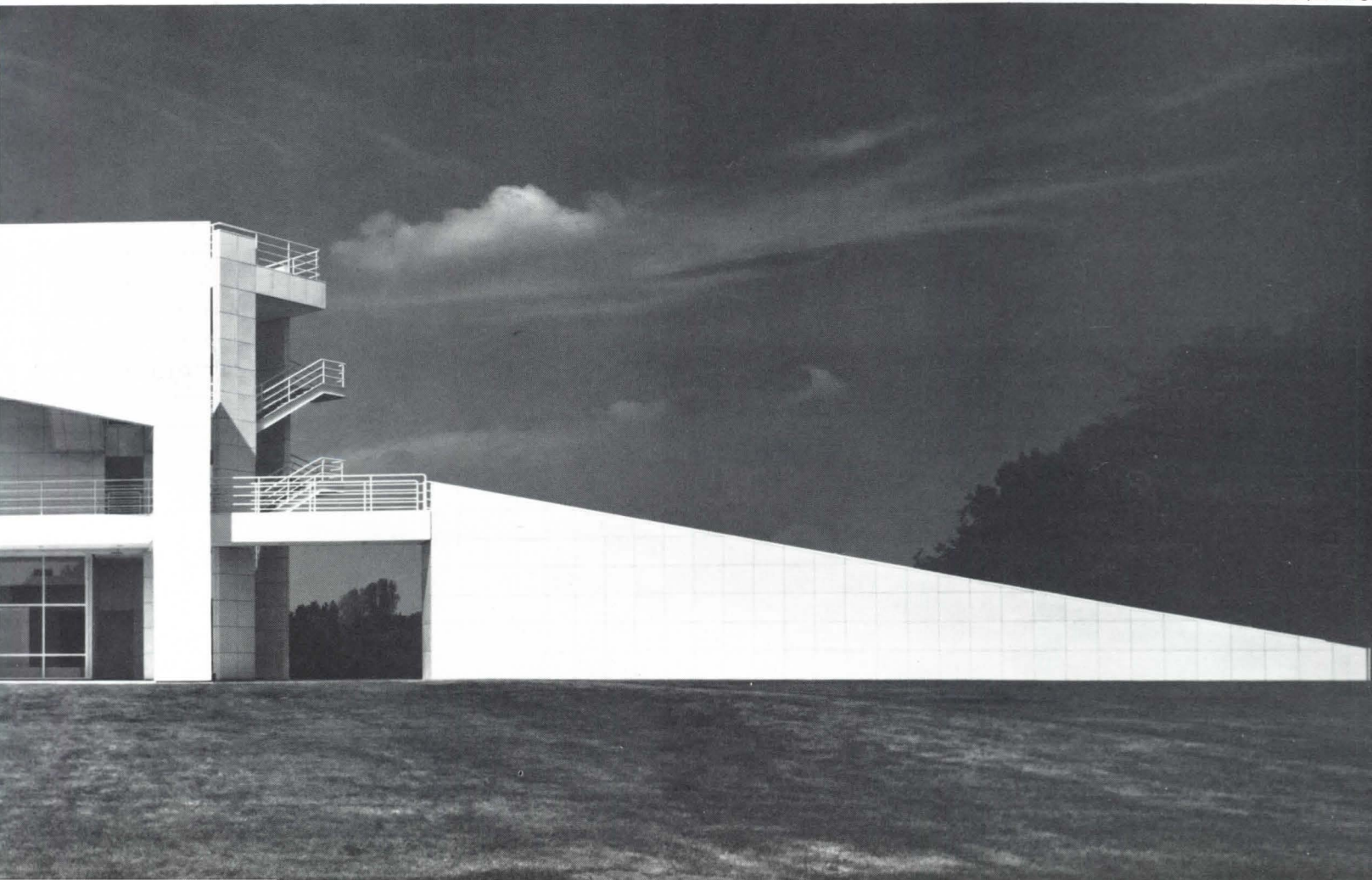

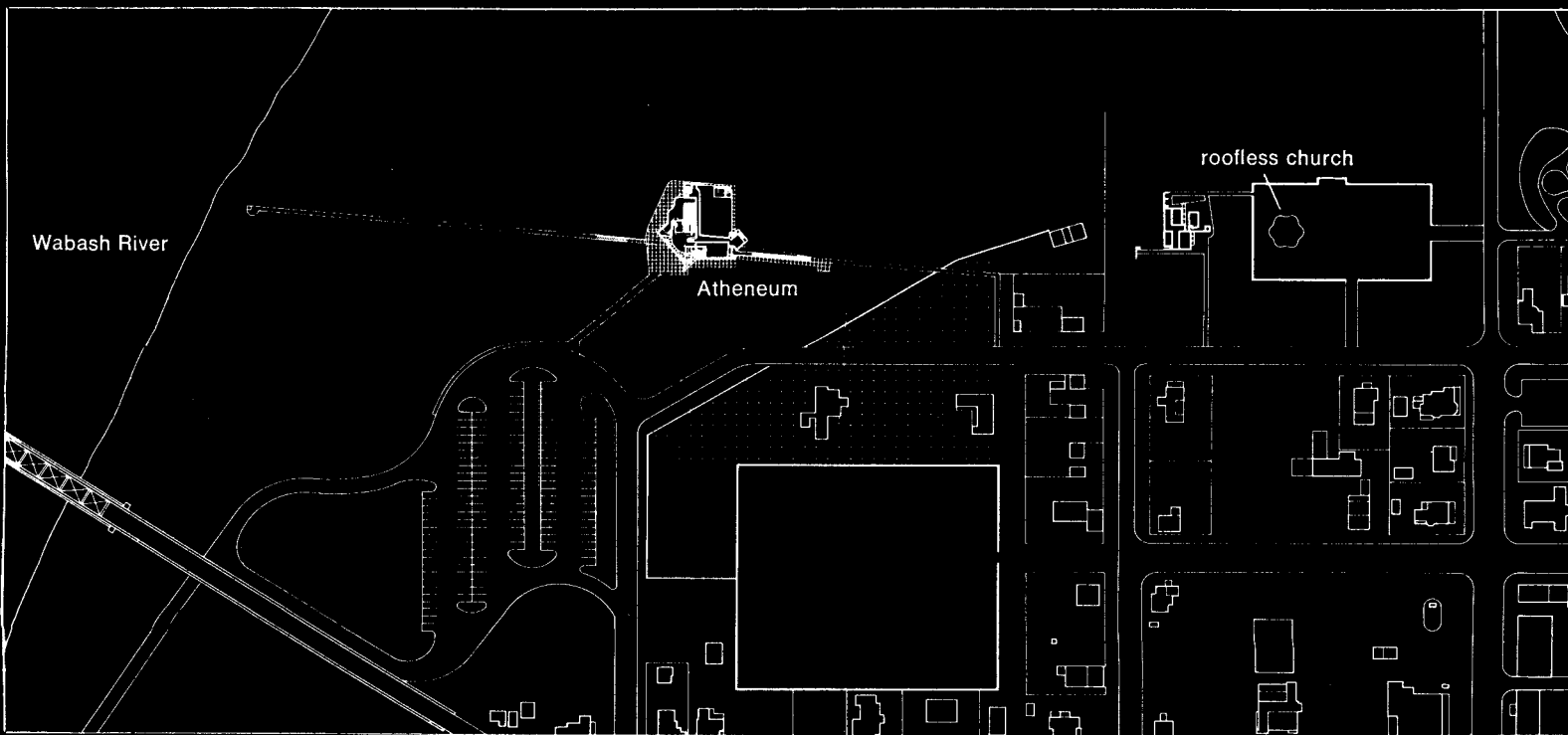
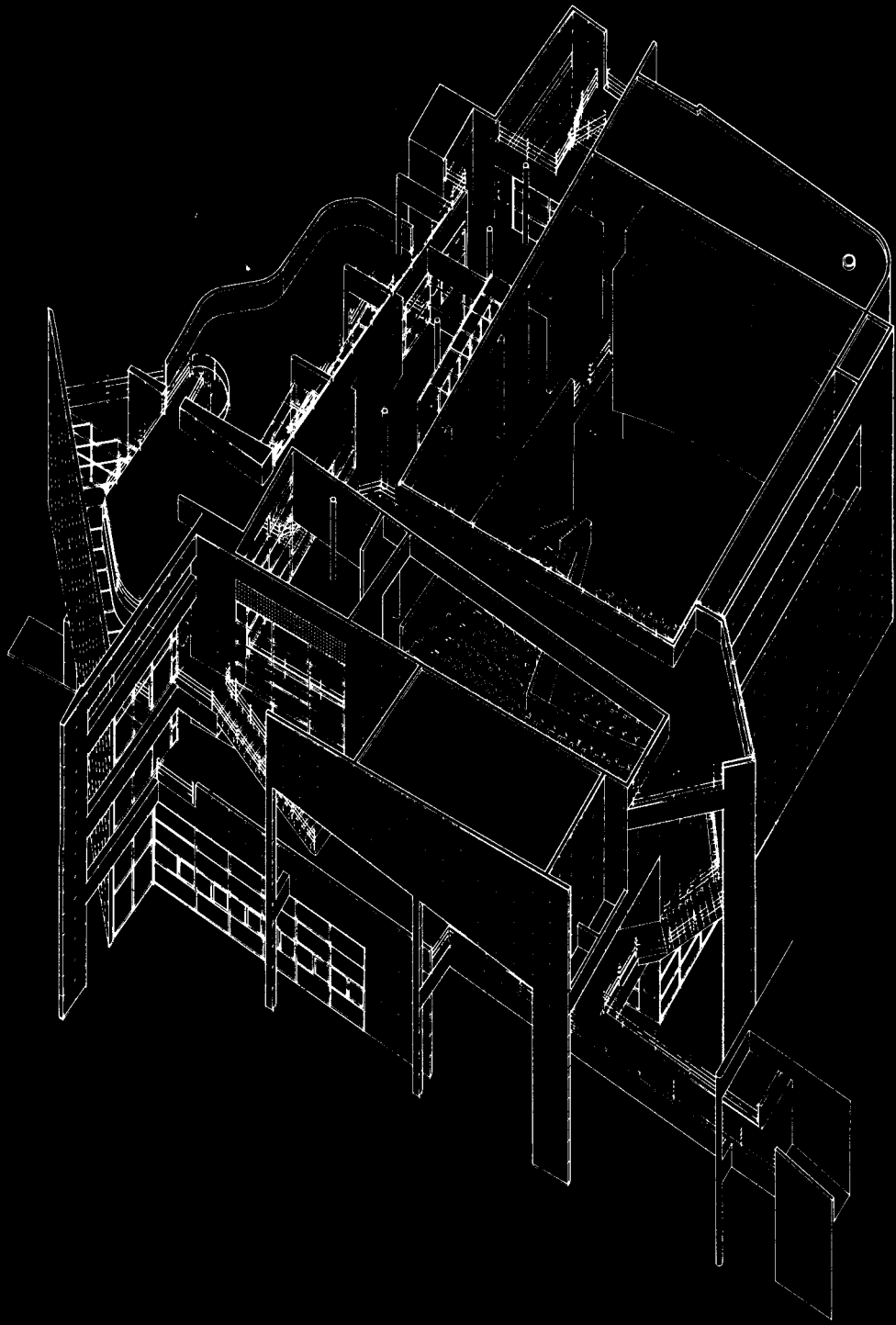



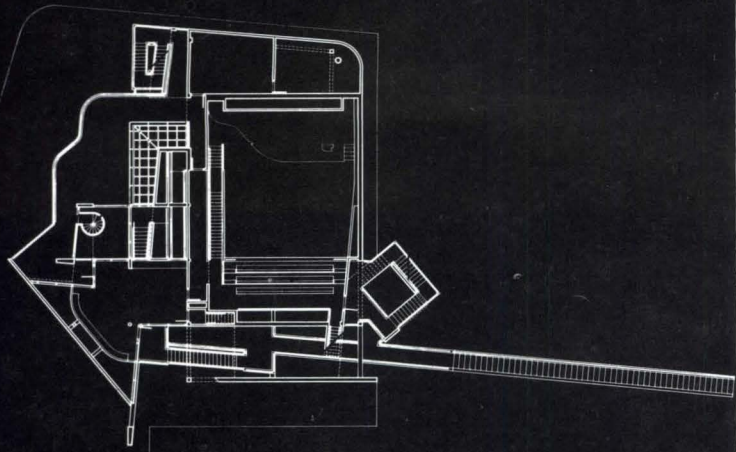

Third Level

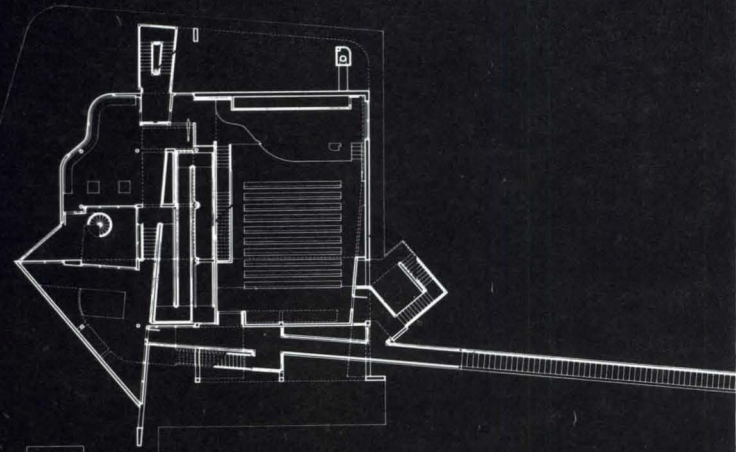

Second Level

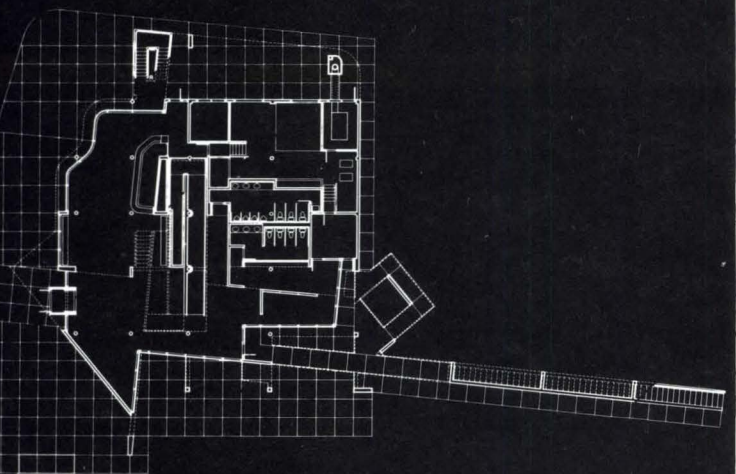

Ground Level

*Axonometric, top left, and second and third floor plans, above, show the sequence of exhibit areas wrapped around the building's largest space, a simple gray and white auditorium. A brief film here ends the visitor's journey through the building; he then climbs to the roof for a view of the town, then descends the stairs and stepped ramp, right, for a closer look.*





Evelyn Hofer

ESTO©/Ezra Stoller



ESTO©/Ezra Stoller



*Left and left below, carpeted ramp climbs from lobby assembly area, its elaborate configuration heightening visitors' anticipation of the tour. The first exhibit seen on the second floor (bottom right, opposite page) is a scale model of the entire town in a large glass vitrine. Below, a low display case, like the glass wall behind it, undulates in response to the curving riverbank beyond.*

Allen Freeman

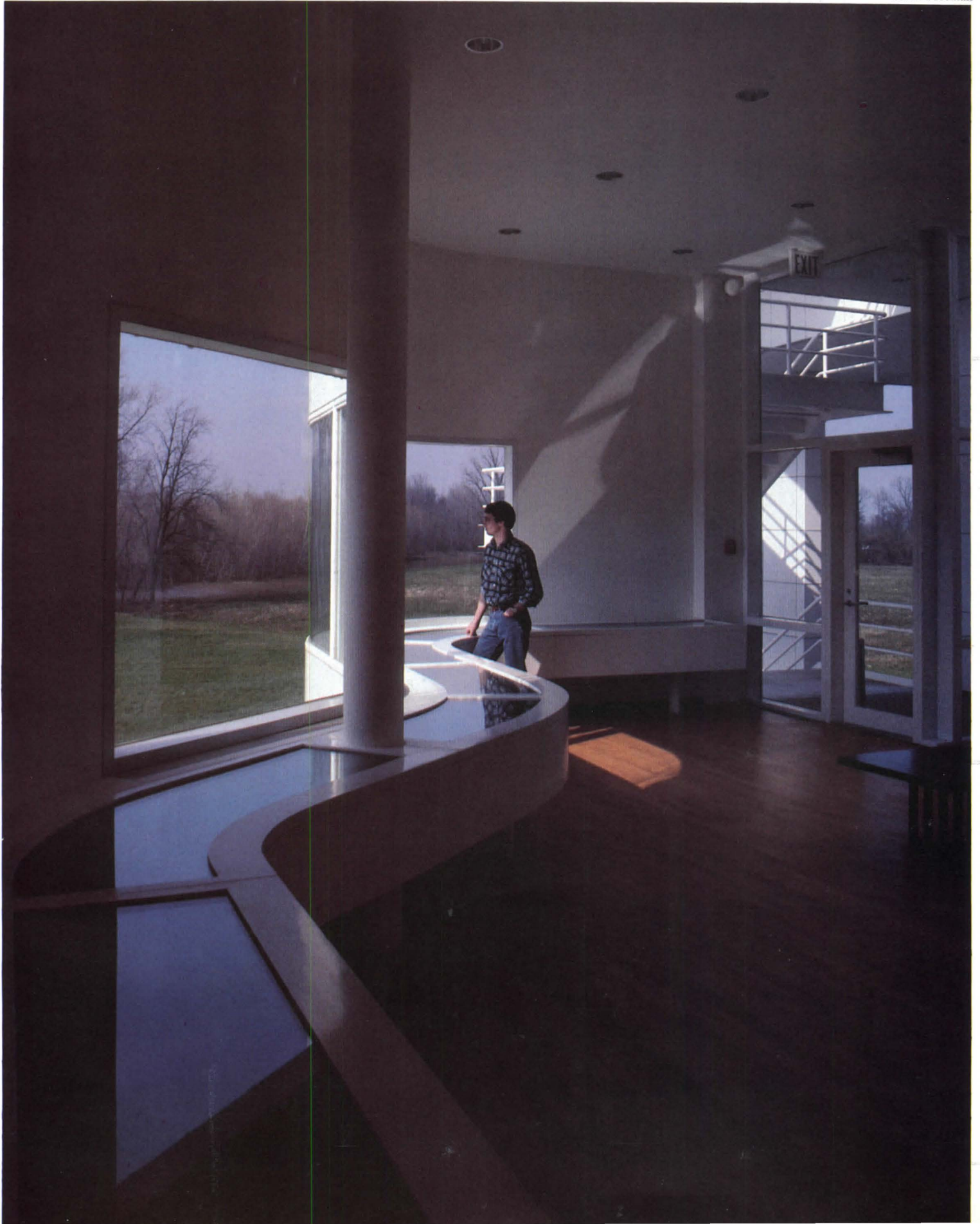

*The end of the tour: an open roof deck with a view of the river. A farther climb reveals a view, on the other side of the building, of the entire town of New Harmony. And, always close at hand, there is the fascinating play of the Atheneum's geometry and its immaculate porcelain surfaces.*







Photographs by Allen Freeman unless otherwise credited.

## Small in Everything But Quality

*Loachapoka, Ala., United Methodist Church, Nicholas D. Davis, AIA. By Allen Freeman*

Loachapoka, Ala., is a picturesque farming community of some 200 scattered dwellings, many of them rambling, steep-gabled Victorian houses set among azaleas and sheltered by pecan trees (above). When one of its five churches, the United Methodist, a tiny 135-year-old Greek revival structure on the road to nearby Auburn, was struck by lightning and fire-damaged, the church leaders asked Professor Nicholas D. Davis, AIA, of Auburn University to design a new one.

Davis at first tried to persuade the congregation to reconstruct the old structure, or at least to salvage materials, but his ideas were strongly opposed by the majority of members. Reconstruction also would have proved financially prohibitive, given the generally unskilled level of local workmanship. Instead, Davis designed an *all-new sanctuary* to seat 120.

After the old church was razed, all that was left on the roadside site was a Sunday school/fellowship building, a 20-year-old brick veneer structure of no distinction that was nevertheless kept for economic reasons. (For one thing, restrooms are not duplicated in the new building.) With its long axis parallel with the adjacent highway, the new sanctuary abuts and effectively screens much of the old.

The new church's wood sheathing echoes the most indigenous and appealing of local structures, the barns and other humble farm buildings. The 45-degree slope of the roof and snorkle-like window that functions as a steeple were derived from the village houses. (A metal roof was originally specified—another allusion to local architecture—but it was substituted by a high-grade asphalt shingle to meet cost restraints.)



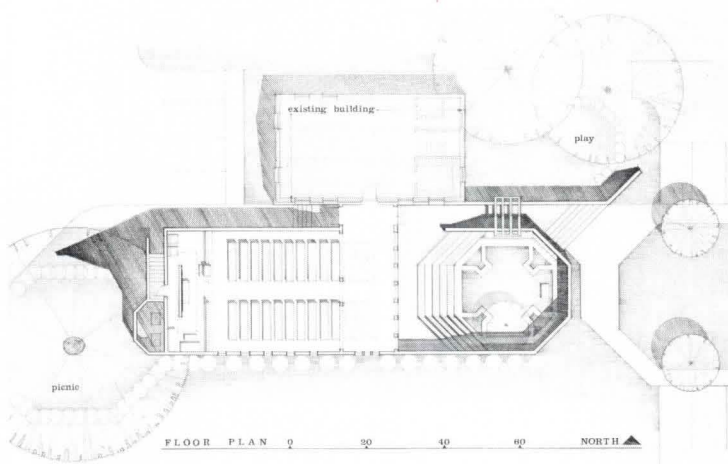

*The octagonal figure, seen in the courtyard (plan above) and narthex window (top), is most prominent as the cross screen (right), which integrates the altar table at its base.*

## A rugged cross in a rough-hewn sanctuary.

Particular attention was given to the entrance, which is pulled to the right side of the east front. It creates a sense of procession, up five steps, then under a tiny pergola through a narrow passage which opens to the first full view of the front and of the enclosed courtyard (still unlandscaped), which steps down to provide outdoor seating for services or Sunday school classes.

Inside the new building, the low narthex is fully open to the high-ceilinged sanctuary. In fact, seats have been placed in this entrance area for the larger-than-anticipated Sunday crowds the new church has helped to draw.

The compelling focus of the small sanctuary is Davis's variation of the Jerusalem cross 10 feet square set on a free-standing screen. The cruciform receives natural light from the high, south-facing window. Raking sun rays are captured during the late-morning hours of worship services and the rich texture of the wood cross is revealed.

The unifying material, inside and out, is Western rough-sawn cedar. In the sanctuary, it contrasts with white-painted gypsum board on walls and ceiling, and the deep brown of its knots is picked up and accented by the cut pile carpet. Lighting is by G-bulbs in industrial pivot holders and fluorescents concealed above horizontal members at the ceiling apex. Seating is pine benches from the old church.

Davis chose an octagonal motif, repeated in windows, courtyard plan and cross screen, as a symbol appropriate to unifying the small congregation. The acceptance of the new sanctuary by practically all the congregants is an indication of Davis's success in interpreting the local idiom. That he provided a handsomely detailed building with a high degree of design integrity for only \$70,000 is remarkable. □







*The wood door handles (at right in top photo) pick up the cross hatch of the octagonal narthex window; the low row of windows mimics the half-oculus above.*





# Exercise in 'Competence and Confidence'

*Roche/Dinkeloo's Helen Bonfils Theater, Denver. By S.A.*

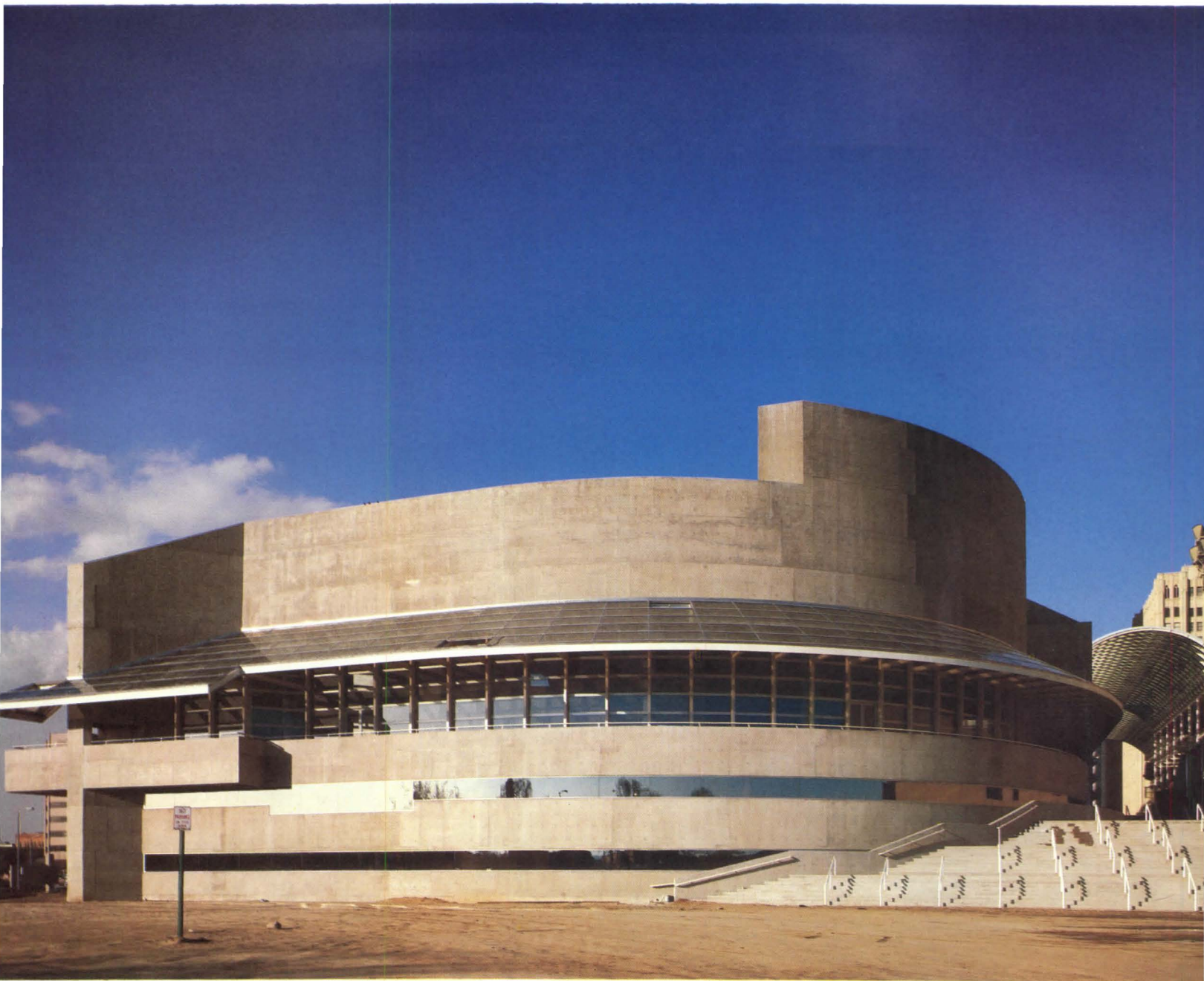

Photographs by Bob Thall unless otherwise credited

At a climactic moment in Orson Welles' "Moby Dick — Rehearsed," one of the productions chosen to open Denver's Helen Bonfils Theater complex this winter, a huge trap gapes open, emitting smoke, white light and fiery red light, and gobbling up Captain Ahab and assorted sailors. This is the mouth of the whale, or the gateway to Hell, or perhaps both, but it is also very surely architecture in the service of theater. And in many ways much less conventional than trapped stages, this complex by Roche/Dinkeloo Associates serves theater beautifully. (A disappointment of "Moby Dick — Rehearsed," for example, is that it plays without intermission, for the lobbies and promenades provided by the architects are powerfully seductive intermission environments.)

The Bonfils building is the newest element of the Denver Center for the Performing Arts, a remarkable four-block super-complex that also includes the 1907 Auditorium Theater, a sports arena, an eight-level parking garage by Muchow Associates and Hardy Holzman Pfeiffer's 1978 Boettcher Hall, home of the Denver Symphony Orchestra. Of the two intersecting streets running through the center, one has been decked over and the other closed to vehicles and roofed with an 80-foot-high

glass vault. Future plans include the extension of the vault to connect with the adjacent Currigan Hall exhibition center, and the vaulted Galleria is soon to be lined with shops and cafés ("Opening mid-1980," some signs promise).

The geometry of the Bonfils, which might seem curious if it were a freestanding structure, is a mixture of curves and angles well calculated to complement its existing neighbors. Its glass skin, much in evidence both inside and out, is detailed with a thick horizontal member between panels (similar to that of Roche/Dinkeloo's United Nations Plaza in New York City), the robust character of this skin being particularly appropriate here, where it is used in conjunction with roughly finished planes of reinforced concrete. Handrails, hanging planters, and other details are similarly direct. But mirrors and mirror-finish metals add theatrical sparkle without fussiness or cuteness, and carpets and fabric-covered wall panels (of fiberglass or gypsum board, depending on the acoustic result needed) are in the most genteel

*Curving concrete wall with window bands of mirror glass below projecting canopy wraps around 730-seat theater, 'The Stage.' Wall terminates in rectangular cantilever, left.*



*Glazed shed dramatizes the building's entrance from the pedestrian level above city's street system. Parking garage (by Muchow Associates) is seen at right in photo above and across page. Great glazed vault covers pedestrian level between some buildings of the group (see site plan); it will be extended in the future to cover other pedestrian areas. This Galleria focuses on the Bonfils complex and, to its left, Hardy Holzman Pfeiffer's earlier Boettcher Hall, home of the Denver Symphony.*

## Past the glazed foyer, two theaters and a cinema.

of colors—pearl gray, dusty rose, deep brown—giving the interiors considerable elegance.

As well as can be judged from its initial productions, the Bonfils complex provides near-perfect facilities for a night at the theater. Indeed, because of the building's skillfully interlocked circulation systems, it provides several fine nights at the theater simultaneously. The building's largest theater ("The Stage"), wrapped by a curving glazed foyer from which the seating area is fed by passageways arranged like a succession of propeller blades, has a maximum capacity of 730 seats, none more than 50 feet from its thrust stage (composed of four separately elevated platforms). The thrust stage can become a proscenium stage; the vomitories can be plugged with additional seating, and several sections of seats are on lifts, so that even the sight line angles can be varied. A seating study prepared by Roche/Dinkeloo shows 15 house plans for "The Stage," based on six different stage configurations, and adds that "many other plans are possible."

A smaller, even more flexible theater ("The Space") holds a maximum of 600 in a pentagonal space with completely movable seating on several levels, and, for special effects, the stages of these two main theaters can be joined by sliding away the sound-proof partition between them. There are also a 260-seat cinema, with its own entrance and box office, a 180-seat "black box" production space ("The Lab") and a number of smaller rehearsal rooms. So steeply raked is the seating of the largest theater that a ring of office space has been located between its entrance level and its stage level.

Gordon Davidson and H. R. Poindexter were theater consultants for the building; Jules Fisher was lighting consultant; R. Lawrence Kirkegaard & Associates were acoustical consultants, and Rudolph deHarak was graphic designer. Roche/Dinkeloo not only designed the Bonfils building but were also master planners for the entire performing arts center. Production drawings for the center's great vault were by Muchow Associates.

Because of the prominence of their architects and because of their locations (confronting each other across a not-yet-vaulted section of the pedestrian mall, with a spectacular mountain view beyond), the new Roche/Dinkeloo building and the two-year-old Hardy Holzman Pfeiffer building will inevitably be compared. The two together offer a textbook-worthy demonstration of the range of architectural styles being practiced today. The older Boettcher Hall is in fact the "newer" in its deliberately provocative appearance and the more adventurous in its auditorium design (the orchestra completely surrounded by the audience). But the "new" look is beginning to be dated. So inured have we become to the sight of exposed HVAC ducts that the ones dominating the Boettcher lobby are no longer excitements, just obstructions. Inside the hall, the frilly gold-banded scallops of the balcony parapets archly mock the vulgarity of those in New York City's Metropolitan Opera, and the ceiling's plaid pattern of bright colors is intentionally jolting. These effects are all good fun, taken as "punk" decor, but they are characterized by an air of impermanence, more suitable for record albums and clothes than for buildings. Much of what seemed fresh about Boettcher in 1978 already gives us the feeling of having stayed too long at the fair.

The Bonfils building, by contrast, is more conservative, closer to mainstream modernism, and far from the cutting edge of any particular fashion. Being in it now (as well as 20 years from now, one expects) is an uncomplicated delight. There is nothing pinched or cheap about the Bonfils, but it gives the impression that money was sensibly spent, concentrated on functional equipment and gracious public areas rather than on elaborate finishes. It is a work of great competence and confidence, and, if it fails to suggest a new stylistic direction, it is a welcome example of architectural quality transcending stylishness. □

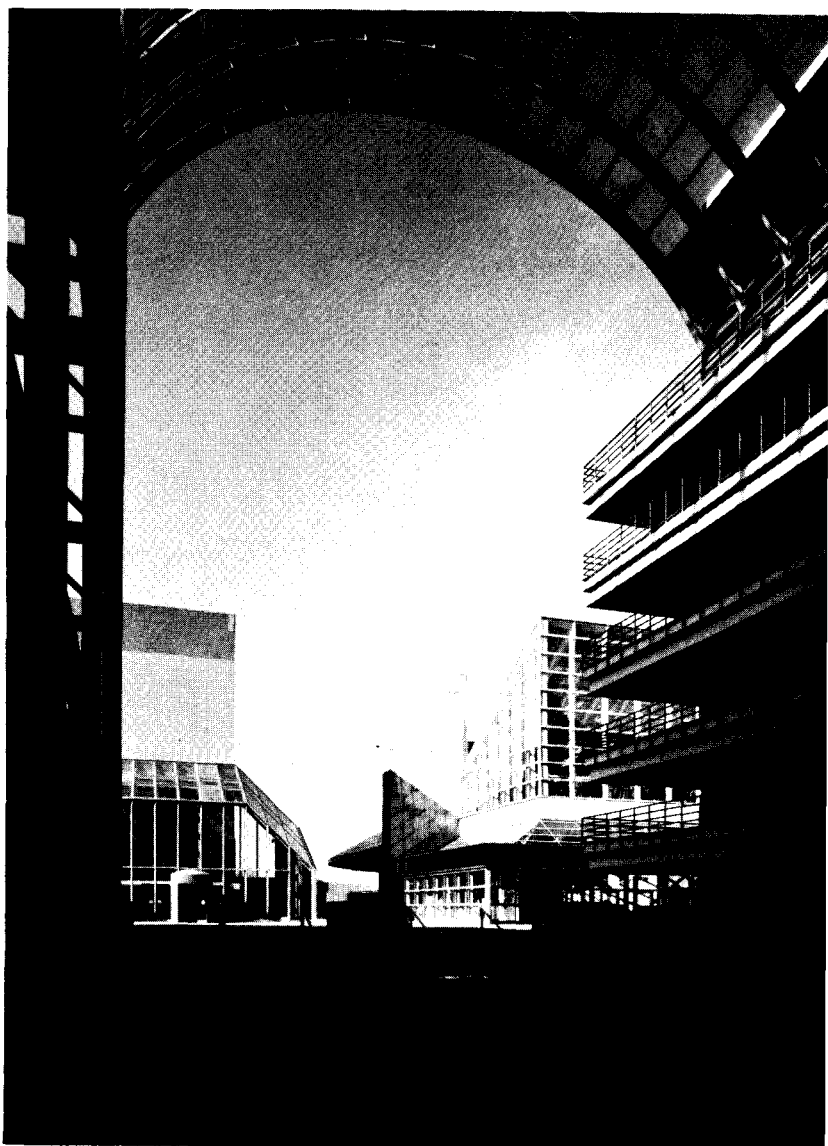
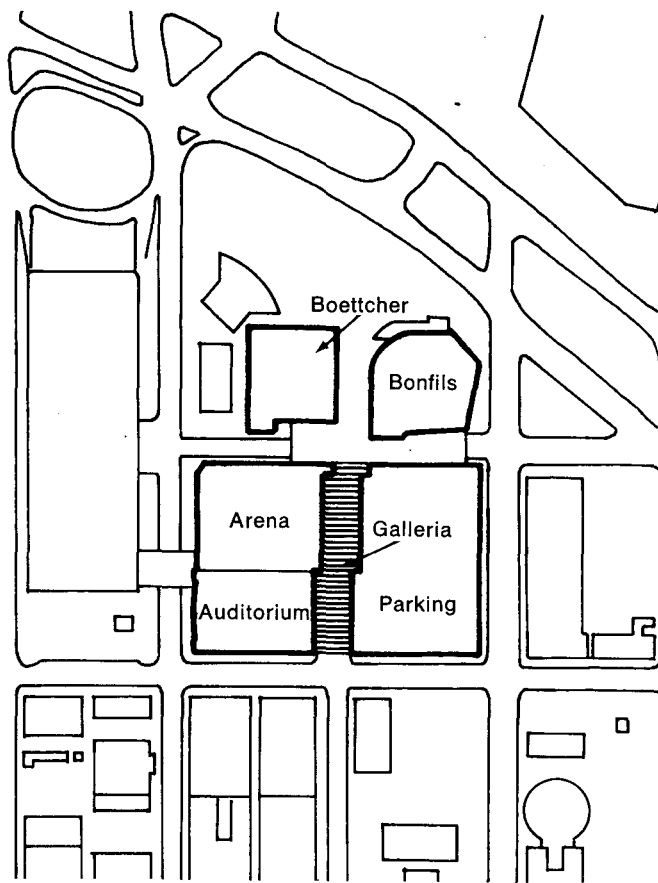

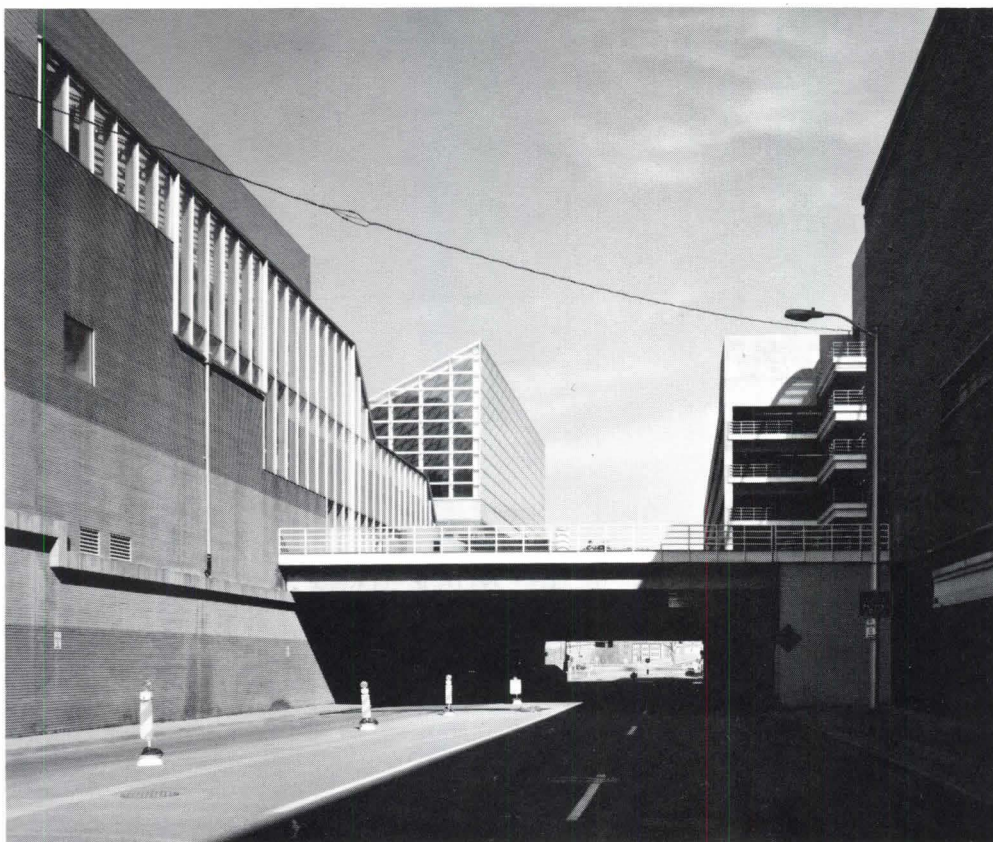
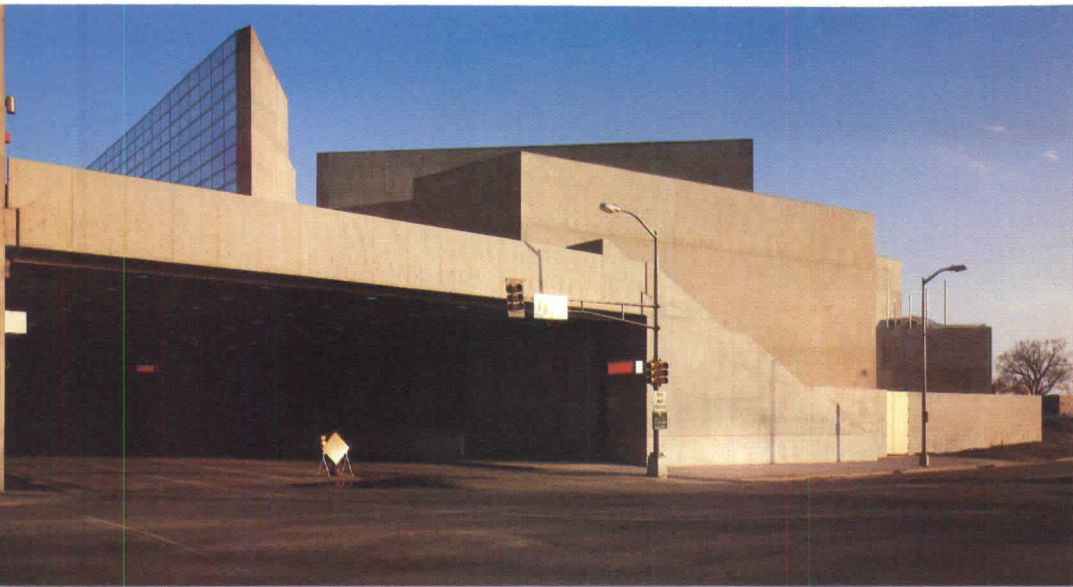

*The Bonfils building's least felicitous aspect is the blank wall, top photo, facing a busy Denver street. Street traffic continues through the tunnel, seen in both photos above, beneath the major pedestrian level. Access to the parking garage, at left of top photo, is from this tunnel. In photo above, Boettcher Hall is left of the tunnel, the older sports arena at right.*

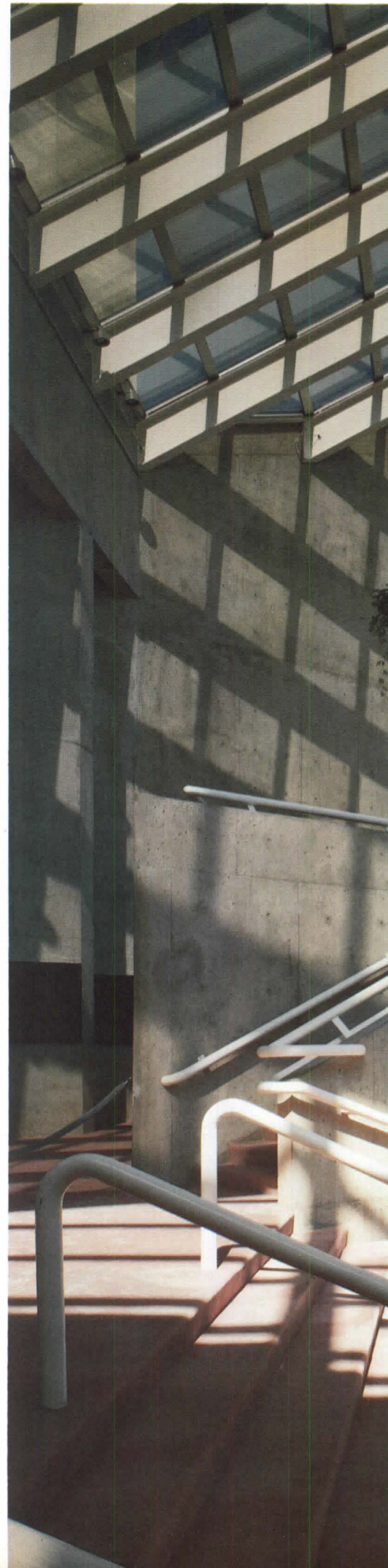





*Left, foyer area under glazed shed. Steps at left lead up to 'The Stage'; stair in the background leads down to 'The Space,' a slightly smaller theater. Lobby seating area, below, looks out on a paved pedestrian level and vaulted Galleria beyond.*







*View from entrance, opposite page, shows box office in white and mirrored materials, other lobby areas in more lush colors. At top of steps, the curving foyer for 'The Stage' theater, left. Stairs, left below, lead down to 'The Space.' Plan shows contrasting shapes of the two largest theaters.*

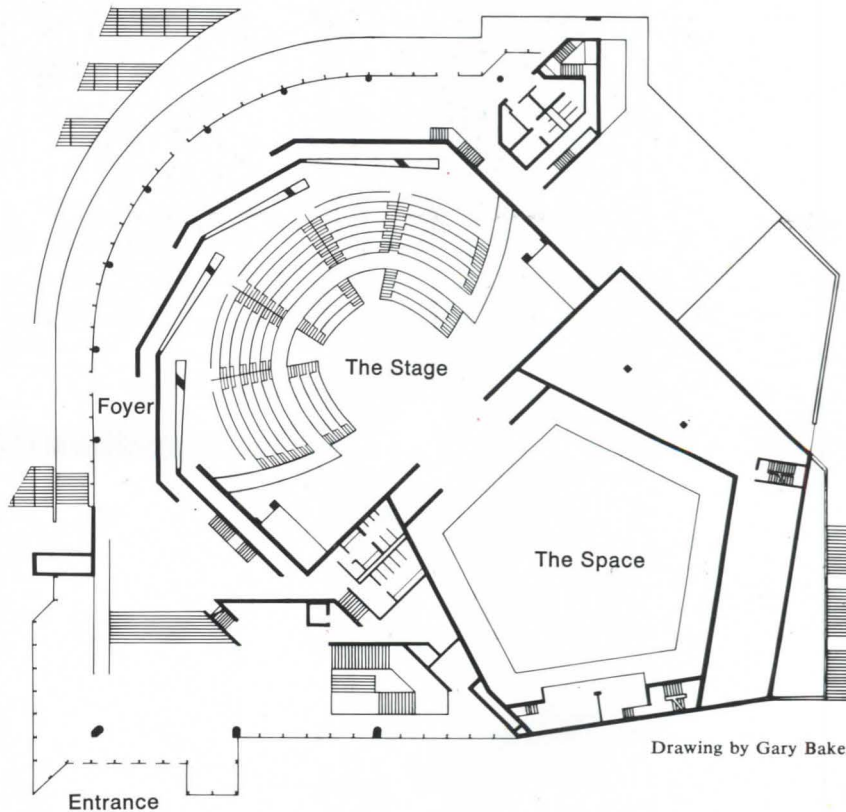

Drawing by Gary Baker

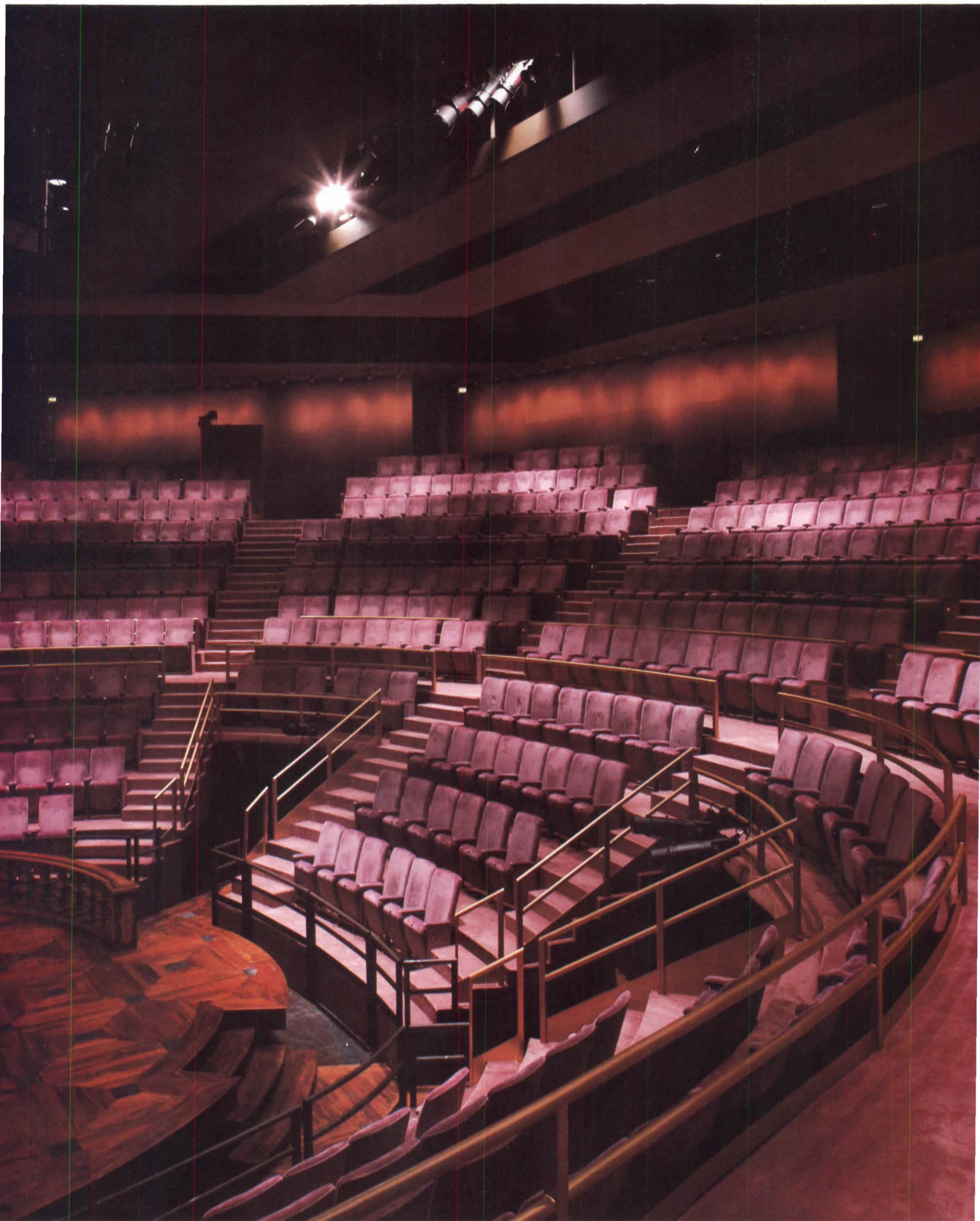

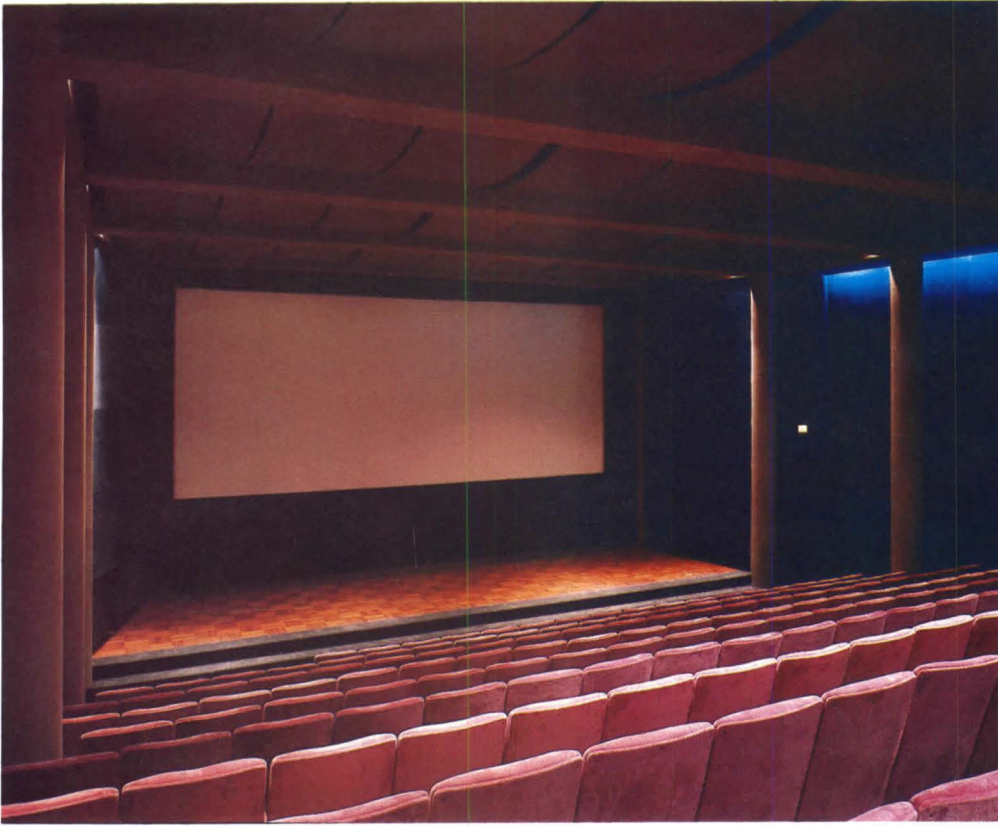

*The three main theaters in the building are: opposite page, 'The Stage'; left, the cinema theater, and, below, 'The Space.' The cinema, located beneath the pedestrian walk between the Bonfils and Boettcher buildings, has its own box office and entrance; its ceiling is of fabric-wrapped acoustic panels in catenary curves. In 'The Space' below, all seating is movable and the stage configuration highly flexible.*

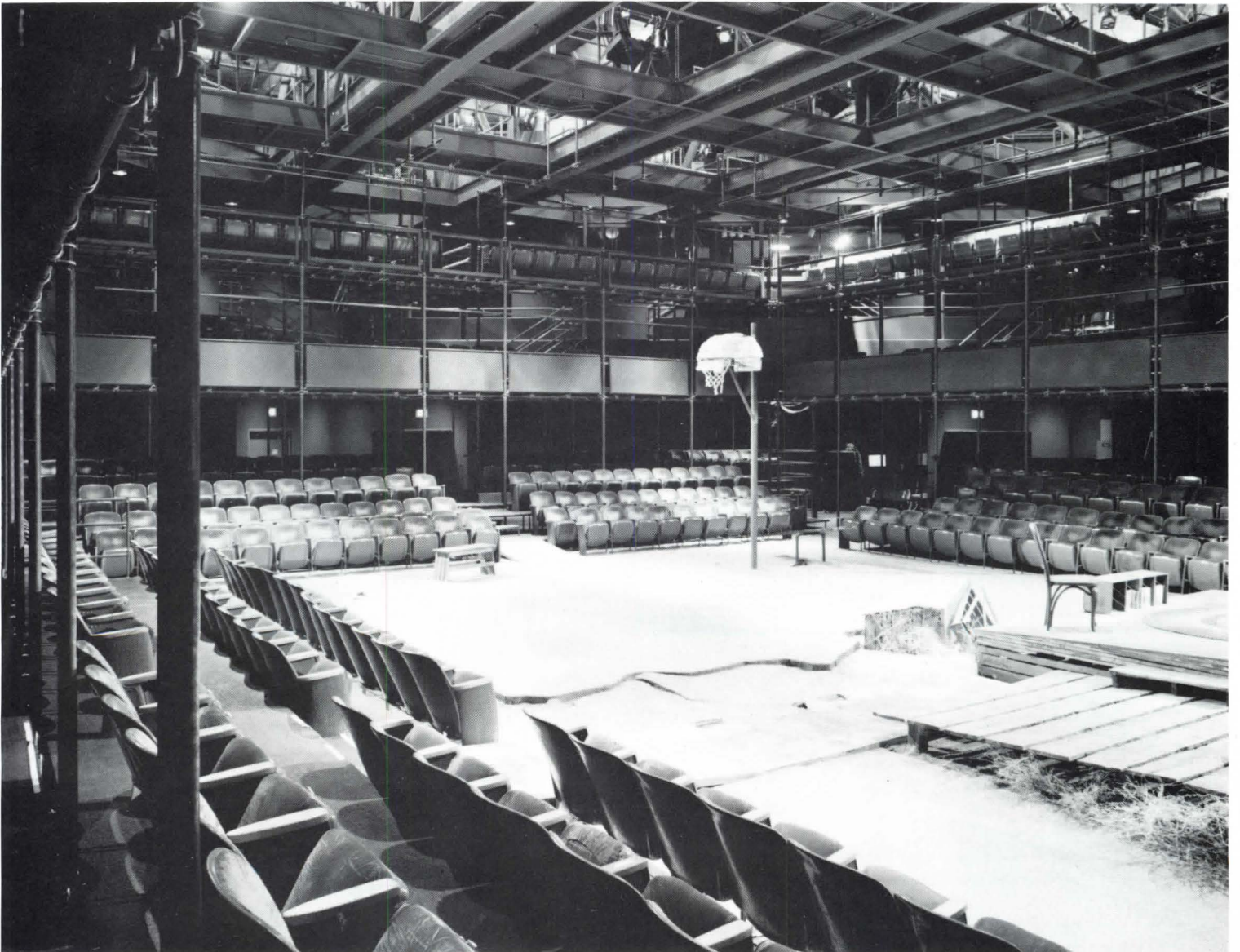

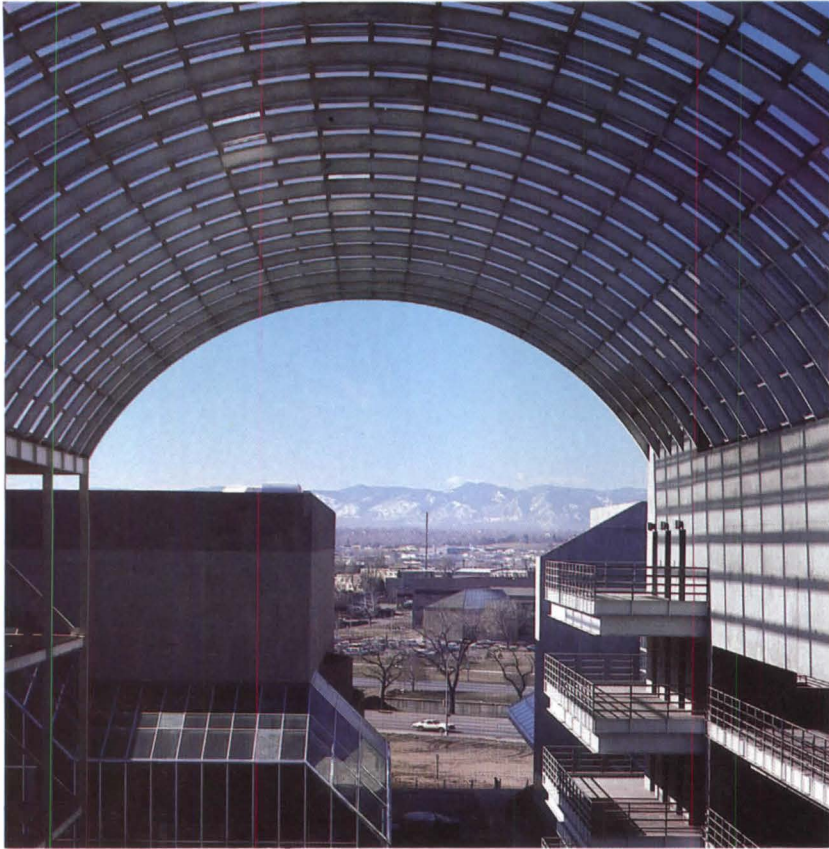

*The Galleria, soon to be a street of shops, enjoys view between Boettcher and Bonfils buildings, of the distant Rockies. Curved wall and canopy of Bonfils building, below, respects Galleria vault and sinuous projections on facing wall of Boettcher.*

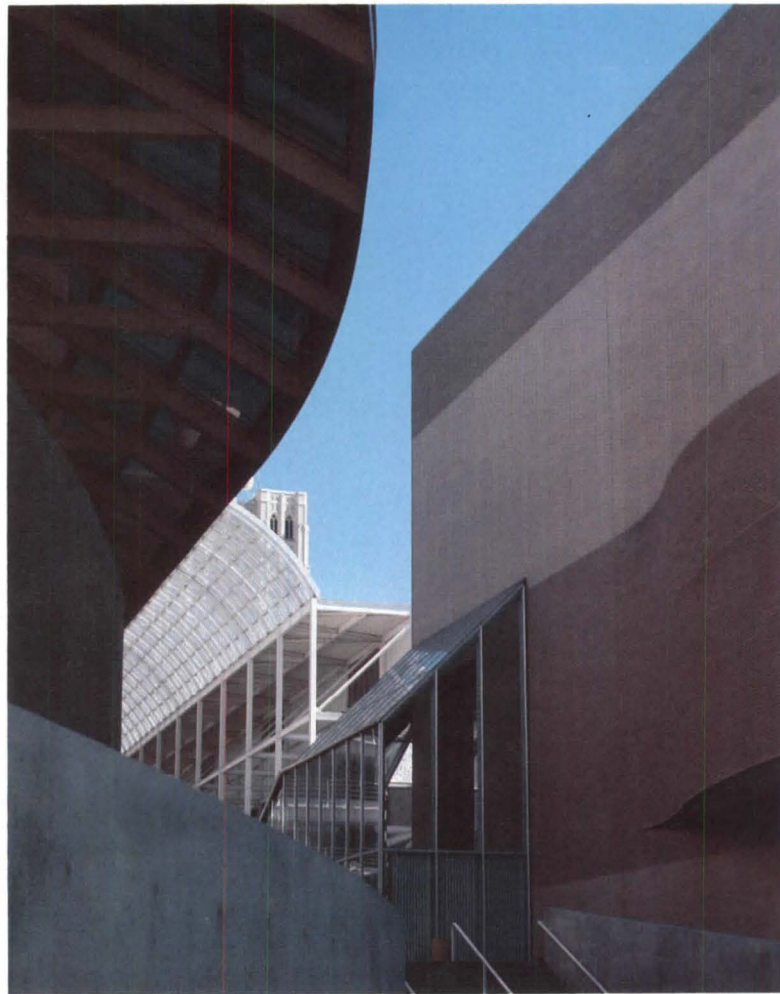

Stanley Abercrombie





# When a Building Becomes a Machine

*Telephone Switching Center, Columbus, Ind.,  
Caudill Rowlett Scott. By S.A.*

When does a building become a machine? Perhaps when the people it was meant to house are replaced by electronic equipment. Such a replacement has largely taken place in Columbus, Ind.'s Telephone Switching Center. (Physical expansion of the building was recently required, but, at the same time, its staff of 15 was reduced to three.)

Caudill Rowlett Scott has responded to this situation with appropriate technology (and with enough skill to win a 1980 AIA honor award). Both old and new wings of the building have been covered with silver reflective glass, most of it opaque, but some of it slightly translucent at the two corner stair towers (built to serve a future expansion). This sealed and heavily insulated facade, combined with a heat wheel system that captures and redistributes heat from the banks of electronic switching equipment, makes the building highly energy efficient.

On a side wall, the mirrored surface is interrupted by three bright blue "portholes" for air intake, and, on a rear wall, by a startling row of color-coded sheet metal stacks. Some of these are for air intake (outside air is circulated through the building whenever temperature and humidity are right), some for smoke exhaust in case of fire, one for expelling heat when an emergency diesel generator is in use, and another simply a dummy awaiting some future need. Even for Columbus, famous for its architectural wonders, this futuristic effect is something different.

And this machine, to use the title of Leo Marx's book on technology and the pastoral ideal, is literally a "machine in the garden." Or soon will be, for the elaborate metal trusses that now give the building's two street-front elevations such a mechanistic look are designed as supports for a future jungle of wisteria vines, already planted and creeping upward. The building as it now stands is therefore only a work in progress, and its completion will be interesting to follow, as leaves and blossoms proliferate, doubled in the reflective surface beyond. The final product promises to be a luxuriant, intriguing, delightful building . . . or machine . . . or vine. □

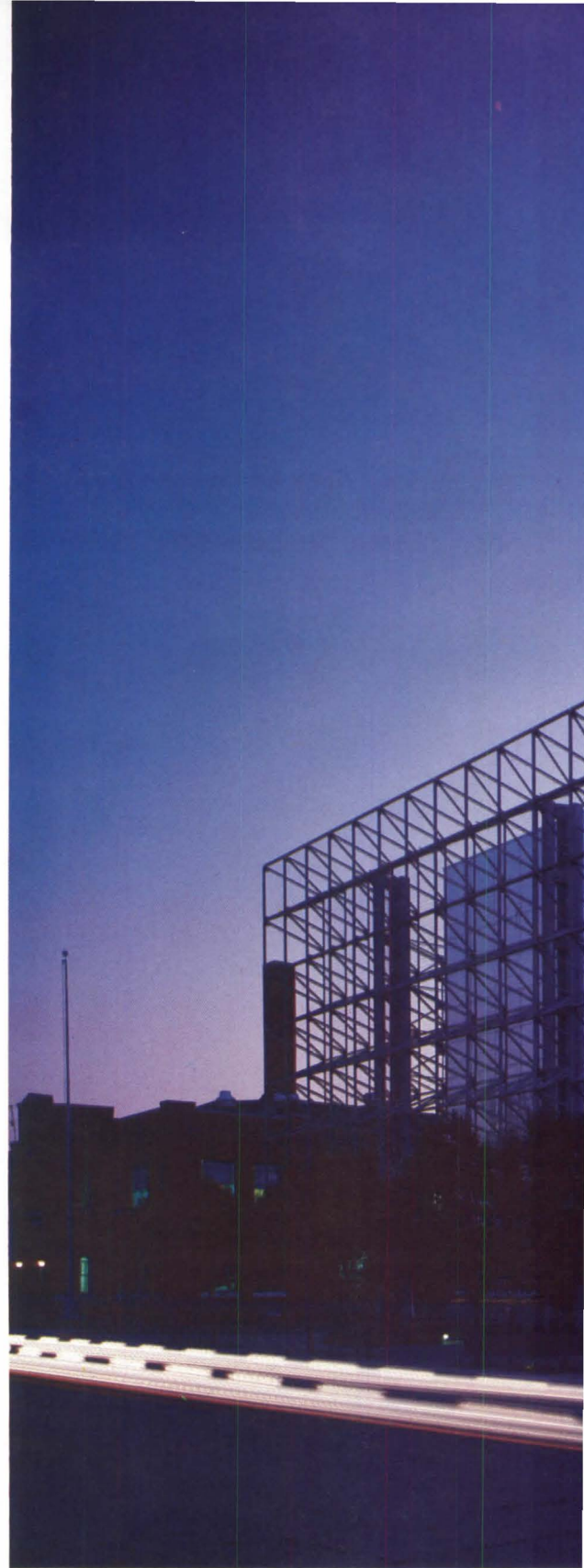

Balthazar Korab

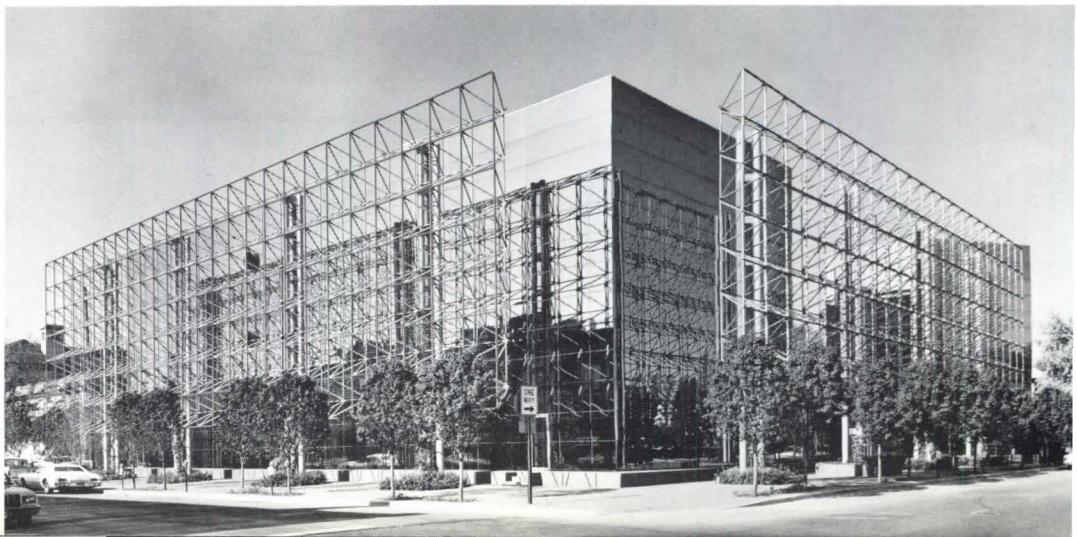





*With human workers largely displaced by electronic equipment, the existing building, left, had become obsolete. It has been covered with reflective glass and is the largest element of a new composition that includes trapezoidal stair towers to serve future expansion. The street facades are in turn shielded by giant trellis structures on which wisteria will grow.*

Balthazar Korab

*Plantings and brick walls and seating platforms are the most prominent elements at street level, below. Actual building forms, as at right, are visually recessive beyond this camouflage. Equipment-filled interiors, below right, are kept dust-free in their newly sealed environment.*

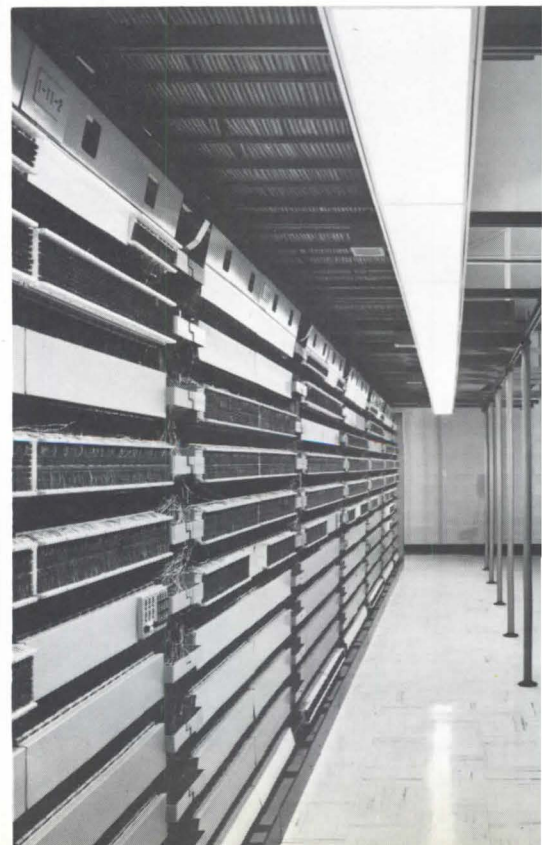
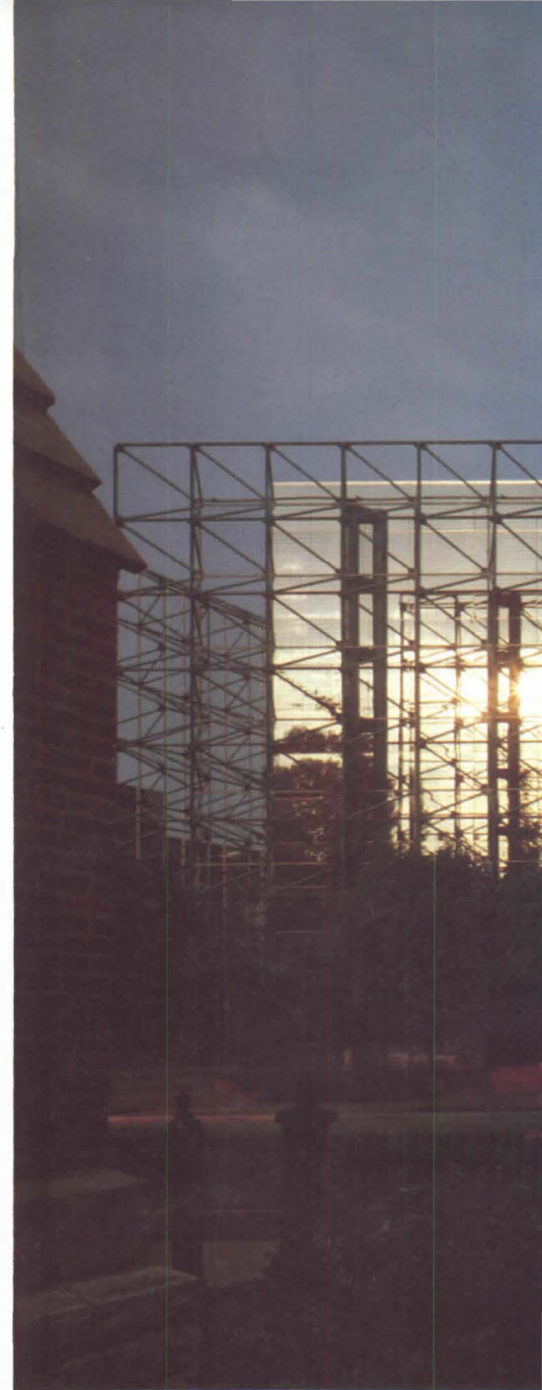

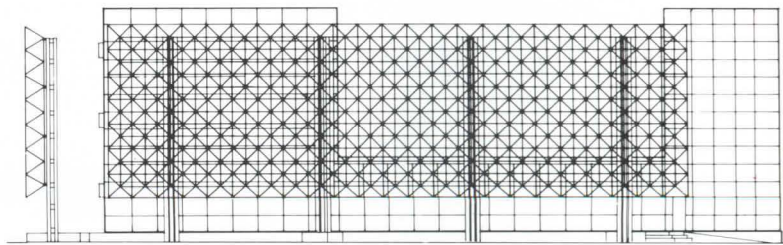
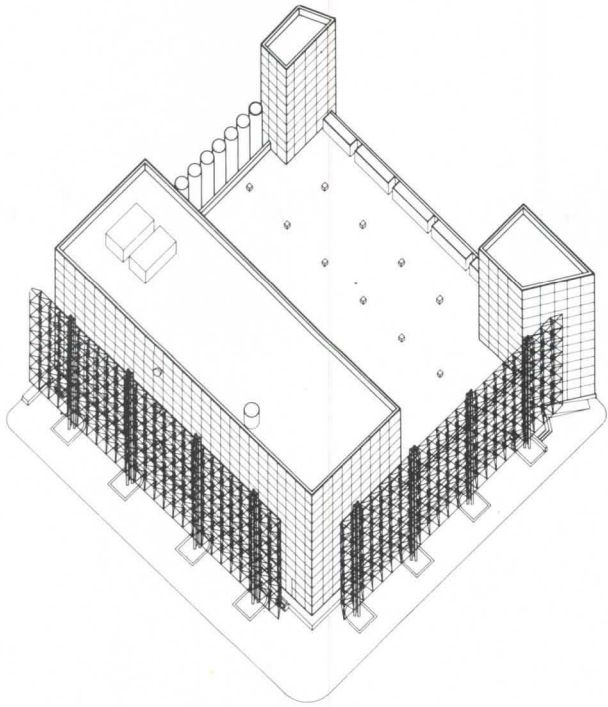
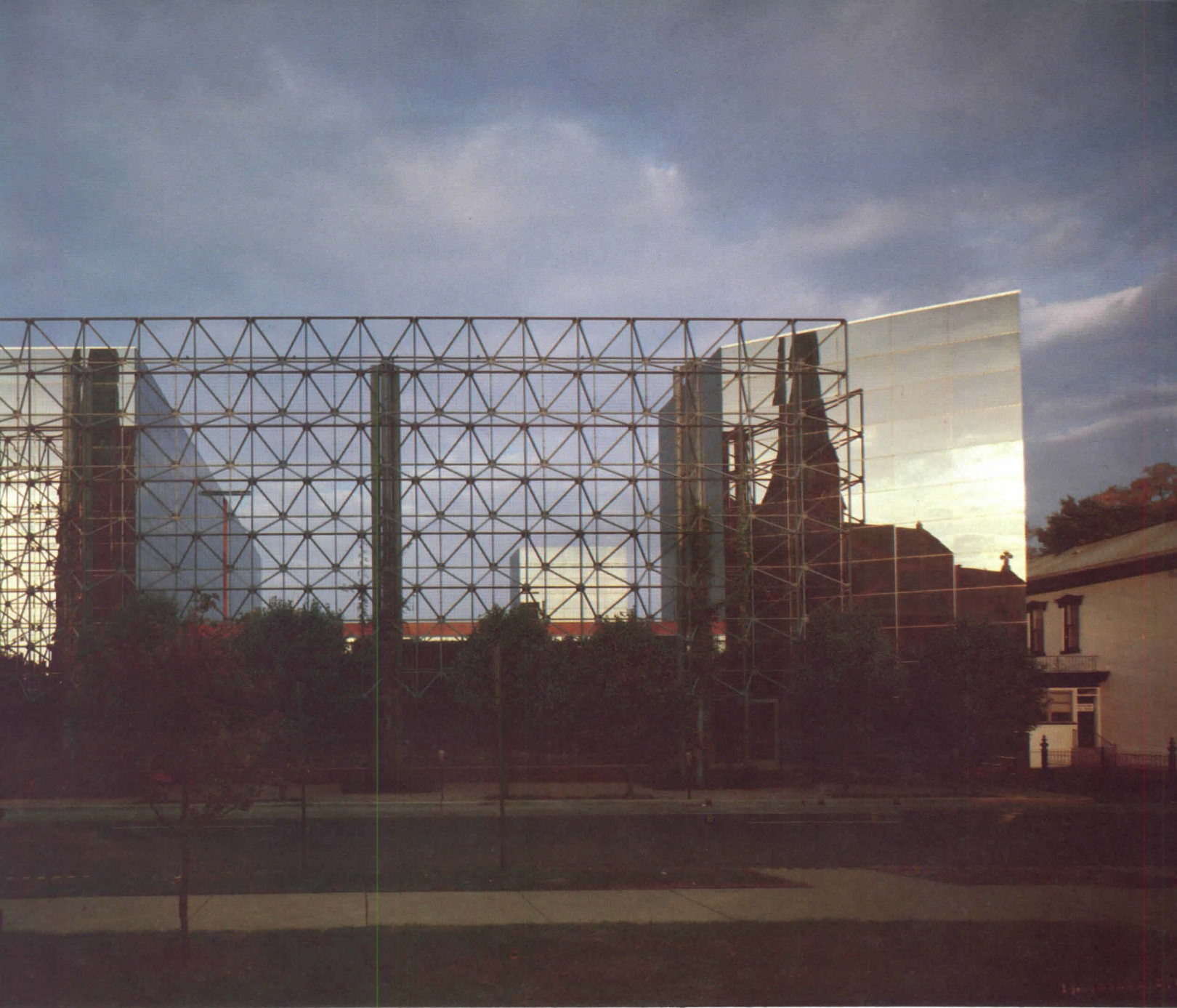

**East Elevation**

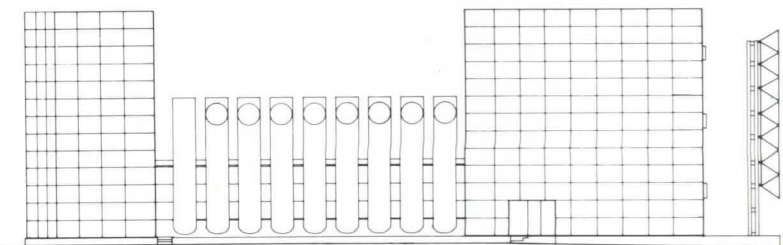

**West Elevation**

*Glass at angled building entrance, below, reflects space between building facade and free-standing trellis structure. Right, along a through-block alley, the glass walls are interrupted by a giant calliope of color-coded air intake and exhaust stacks.*

*Credits: Associated architect: Boots-Smith & Associates. Design principal: Paul A. Kennon Jr., FAIA; project designer: Jay Bauer; project manager: Truitt Garrison, AIA. Client: Indiana Bell Telephone Co. Structural engineer: Robert Crooks. Mechanical and electrical engineers: M & E Engineering Service. Landscape architect: Kiley, Tyndall & Walker. General contractor: Bruns-Gutzwiller, Inc. Completed in 1978.*

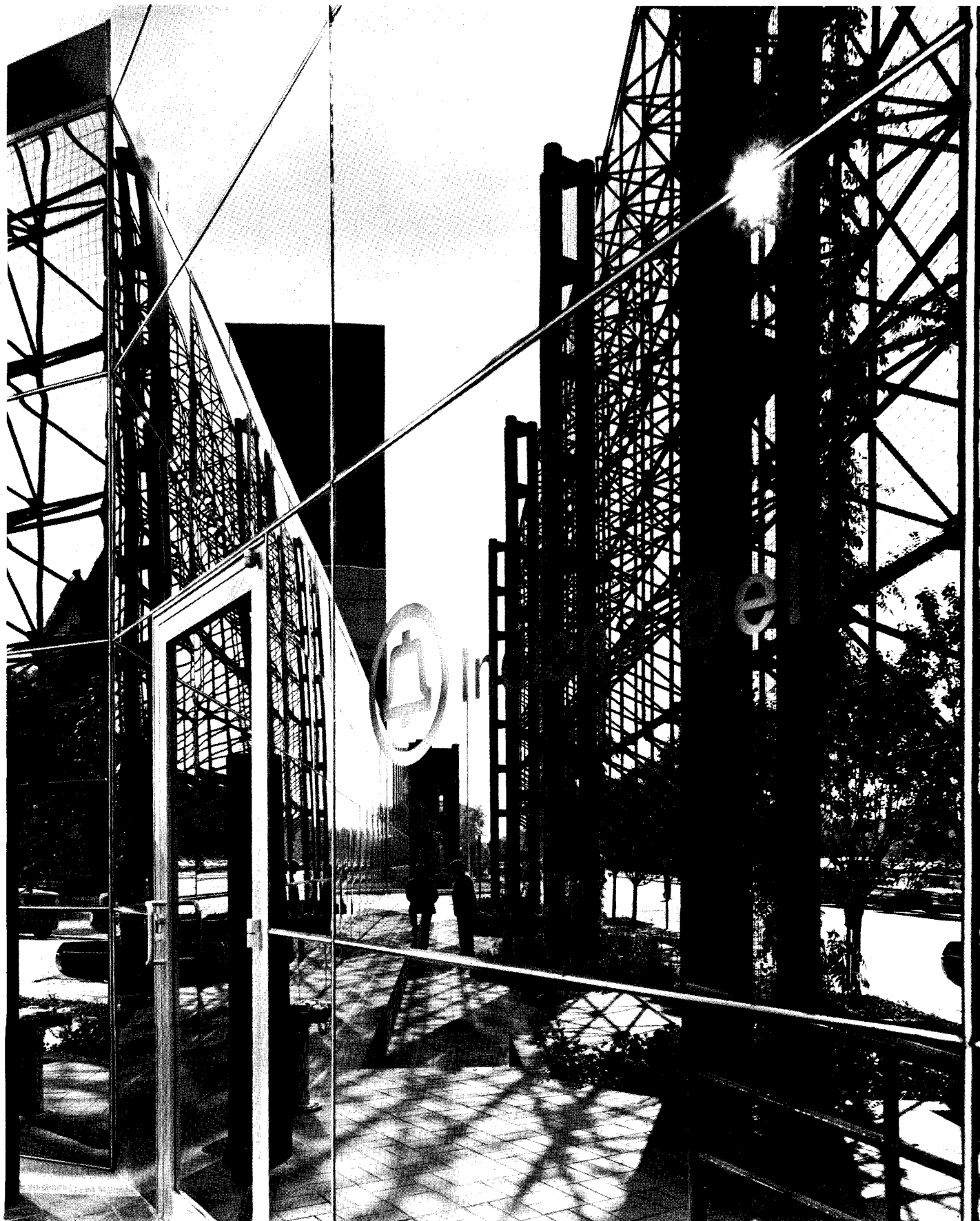

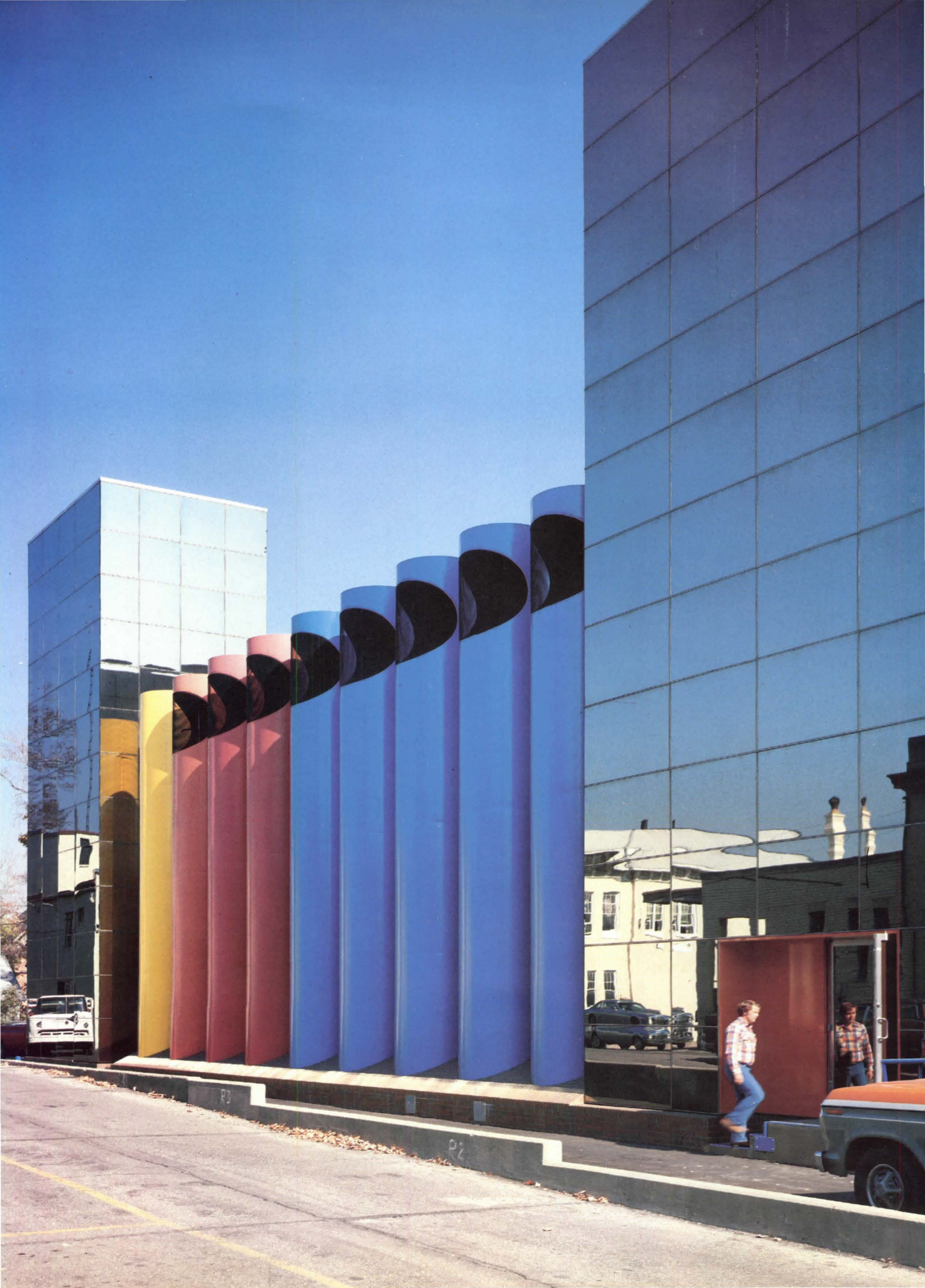



# Federal Contribution to a City's Cohesion

*William Morgan's U.S. Courthouse and Office Building, Fort Lauderdale, Fla. By S.A.*

Fort Lauderdale, Fla., one of the communities that fall between Palm Beach and Miami, is a town of many aspects: the highway strip and its honky-tonk; the downtown beach and its honky-tonk; the uptown beach and its condominiums, each casting an afternoon shadow on its neighbor's pool; Las Olas Boulevard, a street of fancy shops; the beautiful network of inland waterways, bordered by houses, and, perhaps most amorphous of all, the downtown. Just where the downtown was centered has, until recently, been questionable. As someone said of a Pollock painting, "If I had a gun, I wouldn't know where to shoot it."

Now downtown has a heart: a building decently respecting the street grid by being built right out to the property line; a building respecting the climate by providing outdoor space for strolling about, cascading water for pleasure and great overhangs for shade, and a building respecting the community's identity by providing a dignified—in some ways, an almost cornily classical—structure for its federal government offices. In its context of isolated towers, scattered commercial structures and parking lots, this building is a revelation of what downtown Fort Lauderdale might become.

It appears to work well not only for the city but also for the agencies it houses and for their visitors. William Morgan, FAIA, has designed the central courtyard to function as the building's

primary circulation space, thus enlivening the courtyard with movement and also reducing interior corridors to a minimum.

The building houses a wide assortment of federal agencies—the Federal Bureau of Investigation, the Home Loan Bank Board, the U.S. Customs Judge, Occupational Safety and Health Administration, the Small Business Administration, the offices of a congressman, the Department of Labor—that, before construction, were scattered all over town. The local offices of both the Internal Revenue Service and Social Security are here. (As a maintenance man remarked, "We take it away from 'em and give it back to 'em, all in the same building.") Agencies that receive frequent visitors are on lower floors, less popular ones on higher floors. Under all is a level of parking for the building's employees and for those on jury duty.

Although more impressive in concept than in execution (no great sums have been lavished on finishes and details), the building, unlike many government office buildings, has a welcoming character, not a threatening one. Interiors have been brightened by works commissioned under the art-in-architecture program of GSA, and Morgan has knowledgeably manipulated the building forms to capitalize on Florida's strong sun and shadow. In a downtown area that badly needs it, Morgan's building establishes a strong example of urbanity and public amenity. □



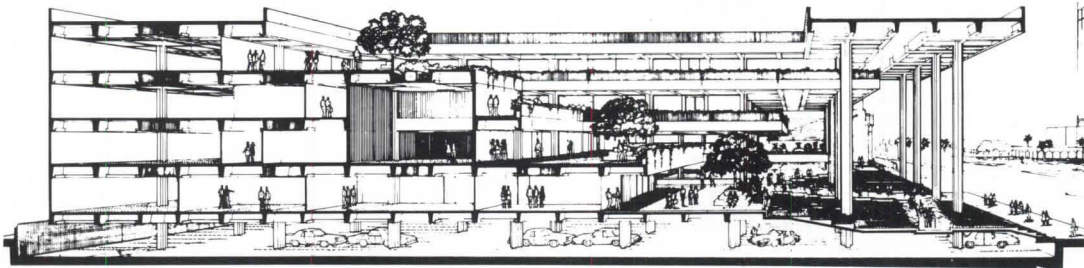

*Four above-grade office and courtroom levels, photo and section at left, are stepped back to provide the open terraces that largely supplant interior corridors. The stepping also creates a major multilevel plaza at the heart of the building. Despite this internal complexity, a powerful building cornice built right to the property line, below, defines a simple overall building form and establishes a new standard for urbane downtown planning in the community.*







Shin Koyama Photography

# Four-Faced Response to Energy Concern

*Ellerbe Associates' Western Life Insurance headquarters, Woodbury, Minn. By Andrea O. Dean*

In many ways the Western Life Insurance headquarters and computer center in Woodbury, Minn., can be seen as a new if still imperfect prototype for commercial buildings. For it pursues its principal goal—energy efficiency and appealing design—by combining modernist notions of form, technique and functionalism with age-old precepts of designing with nature.

The orientation on the southeast corner of the 55-acre site provides views toward a wooded pond and maximizes solar gain. The sun's rays plus heat recaptured from computers and transferred to the building radiation system provides for *all* of the building's heating needs. In addition, underground tanks are used to store surplus heated water and chilled water to supplement airconditioning.

The building is trapezoidal in plan. The windowless, precast east and west elevations appear as sawtoothed bookends framing two utterly different facades. Deep overhangs on each floor act as solar visors on the northwest; on the southeast each floor cantilevers over the one below to shield summer sun yet admit low winter rays. Other energy-saving devices include a solar blind over the entryway glass controlled by the angle of the sun's rays, mirrored plus bronze-tinted glass, thermobreak frames and task lighting built into office furniture.

Offices are open plan to maximize air distribution. To provide a thermal buffer for work spaces and optimum office flexibility, corridors are located along the building's perimeter and the central atrium, which echoes the cantilevered southeast facade. □

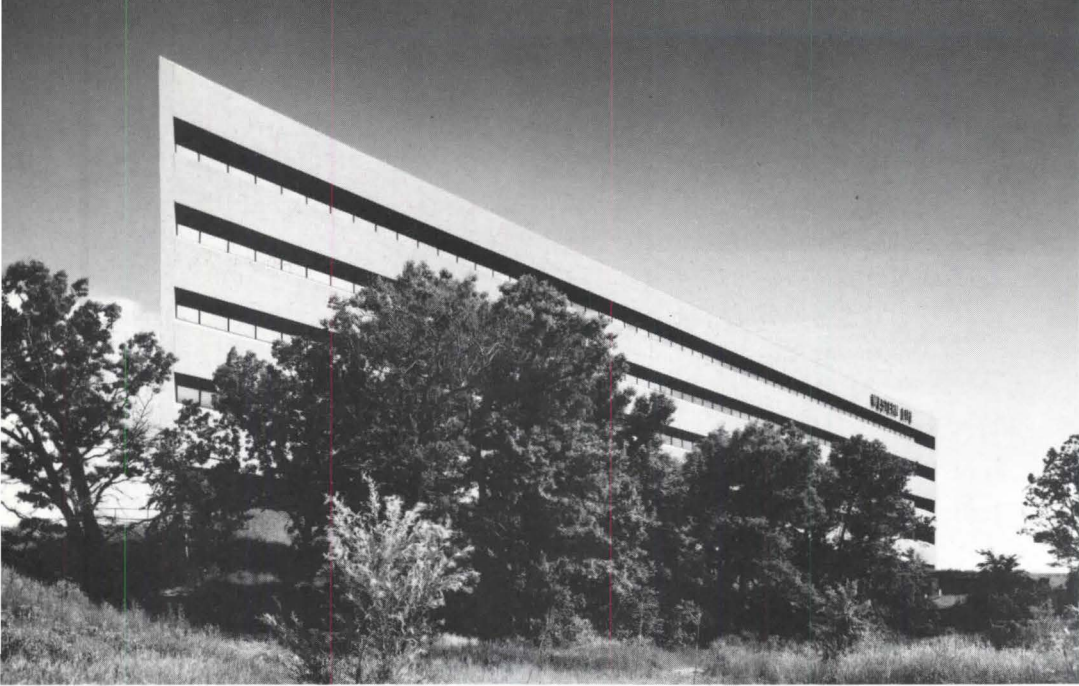

*Windows on the northwest facade (left) are deeply recessed; the floors on the southeast elevation (below) are cantilevered one above the other with a sun louver on the top story and the cantilevers dramatized by an exposed steel structural frame; east facade (bottom right) presents a blank profile; atrium is shown in section, bottom left, and across page.*

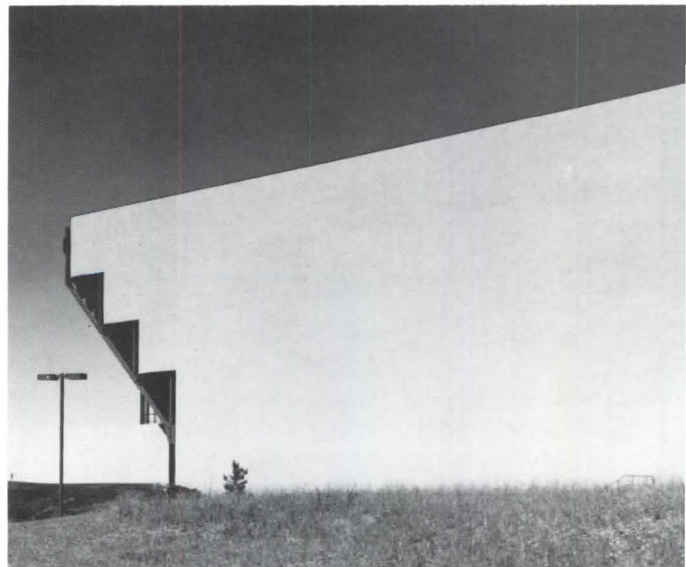





# Of Art, Self-Revelation and Iconoclasm

*A house remade by Frank Gehry in Santa Monica, Calif. By John Pastier*



Photographs by Tim Street-Porter

Frank Lloyd Wright once said that America was tilted in such a way that everything loose eventually rolled into southern California. Living in the land of Kosher burritos, drive-in churches, roller-skate disco, Rent-A-Wreck auto leasing and the Phantom Toenail Painter, its residents have learned to take most things in stride. Environmental calamities are borne as nonchalantly as cultural ones.

There comes a point, however, when enough is enough, and some of Frank Gehry's neighbors are sure that they don't like what he's done to his little pink house in Santa Monica. In fact, as you glance over these pages, you may even be forming similar opinions yourself.

That's understandable. Gehry's unconventional remodeling is a work of architecture that must be seen and wandered through if it is to be understood. Trying to convey its substance through photographs and words is an act of high futility on a par with alchemists' efforts to transmute lead into gold: The exercise may enlighten one who attempts it but will not produce the hoped-for results. People who know it only second hand, even if they are architects, tend to be unenthusiastic or even dislike the house actively. Those who have been through it become believers,

**Mr. Pastier** is a teacher and writer in Los Angeles. His monograph on Cesar Pelli's work will be published in the fall.

because what the house is most about is what the flat photographic medium is least able to convey: tangible space, palpable scale, time, and a multiplicity of possible comparisons and interactions between its elements. Once those qualities have been experienced, there can be no doubt that this is an extraordinarily original and deeply felt house, despite the somewhat self-conscious iconoclasm of its exterior. [The 1980 honor awards jury apparently agreed, making the house a winner in the extended use category—*Ed.*]

It can be approached in several ways: as architecture, as a curiosity, as art, or as psychological revelation. The first three paths are well worn, for this house that defies successful publication has appeared in service magazines, newspaper real estate sections, airline magazines, alternative architectural tabloids and establishment architectural slicks. It has been presented as pure imagery, a West Coast cultural phenomenon, a local controversy involving an artist and his less than artistic neighbors and as an occasion for close architectural analysis. What remains is for someone adept in psychology and fluent in English to examine Gehry's house as a manifestation of nonlinear logic, visual symbolism and the Jungian collective unconscious.

Such an examination cannot take place here, but it is important to temper the architectural discussion with explicit recognition of the essentially emotional nature of this house. Some of

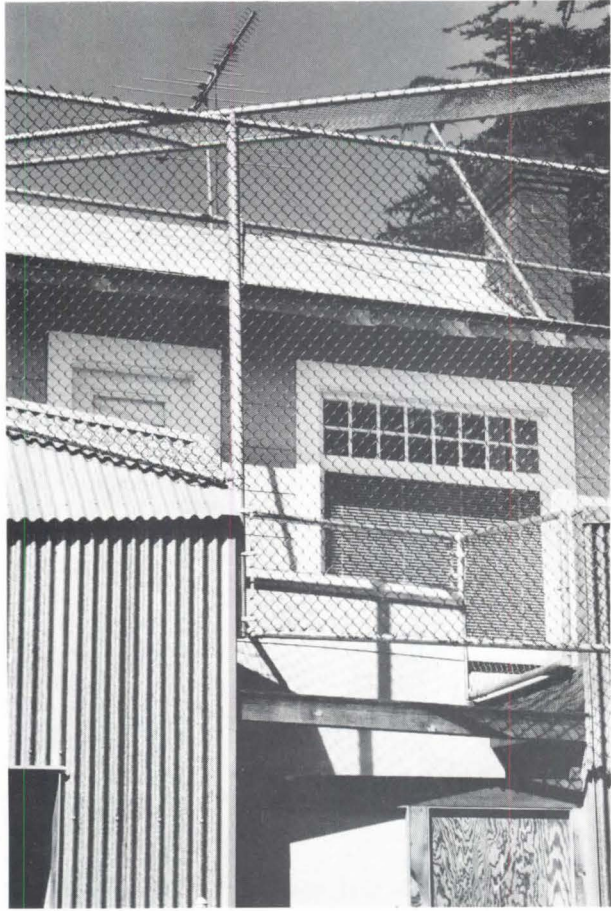
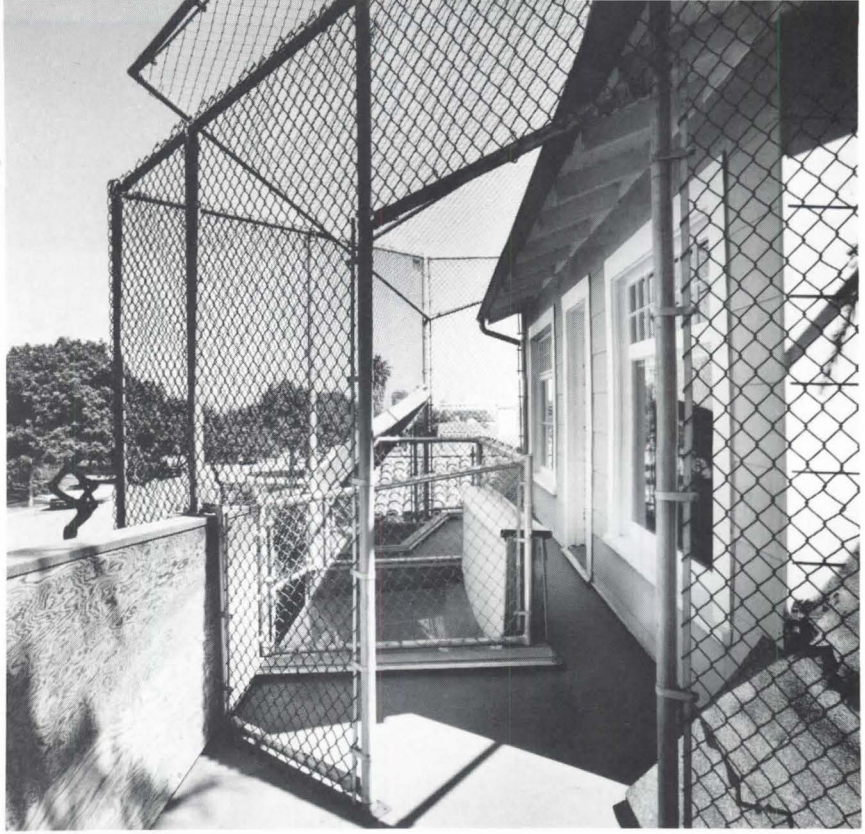
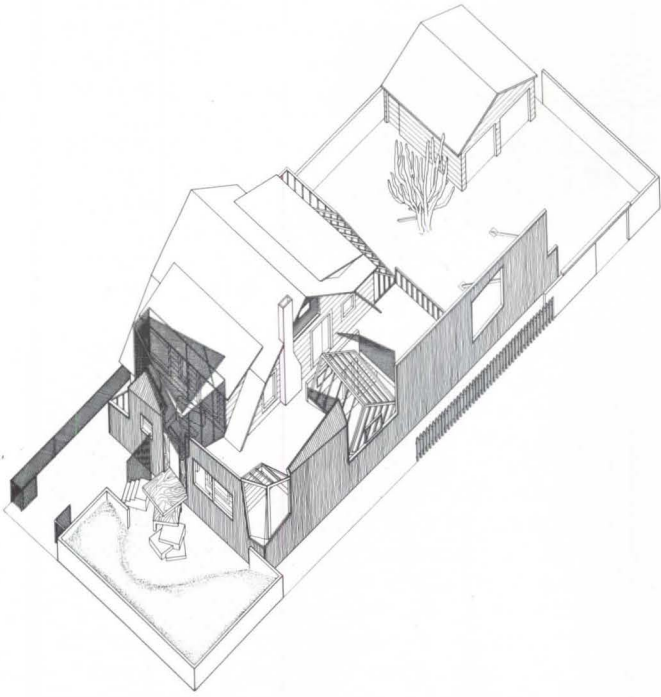

*Wrapped around the existing house is a screen of plywood, aluminum siding, chain link fencing and other miscellany. Near right, the kitchen; far right the living area, with the original windows held in walls stripped to their studs.*



## More affinity to Watts Towers than postmodernism.

Gehry's work has been conventionally disciplined and straightforward, but that is not his characteristic mode of design nor is it the one that stimulates him to his best efforts; if anything, it probably bores him. The ultimate basis of his work is nonverbal and visceral, and even with the advent of postmodernism, those are not qualities that the architectural world has been able to deal with easily. Thus, Gehry's house continues to be discussed as though verbal constructs could always be equated with architectural ones, and as though linear thinking could somehow be applied, after the fact, to a work that evolved without significant reliance on that mechanism.

Frank Gehry's house is a major example of postmodern work, but not one arrived at through normal postmodern methods. Granted, it has one foot in the world of self-conscious and intellectualized architectural revisionism, but the other, the one to which more weight has been shifted, is in the world of intensely committed individual builders such as Simon Rodia, who worked out personal visions such as the Watts Towers intuitively and with their own hands. Many of Gehry's influences have clearly come from West Coast avant-garde art, but he has also absorbed the ethos of those tenacious craftsmen that the Walker Art Center has defined as "naives and visionaries."

Of course Gehry did not rebuild the house himself, but it

looks as though he might have, and the design clearly benefitted from on-site decisions and feedback from the building process. Nor is he a *naif*, not after art studies and an architecture degree from the University of Southern California, a year of city planning at Harvard and more than 20 years of diversified practice. Yet he has somehow managed to preserve, or resuscitate, the untrained artisan's capacity to see ordinary materials as wonderful and to use them in unexpected and poetic ways.

Simon Rodia used beer bottles, crockery and sea shells as cladding for his backyard castle, and Gehry has used chain-link fencing, utility grade plywood and corrugated sheet metal for his. Like the neighbors, the local building departments looked askance at both creations.

But there the similarities end, and a critical difference arises: Rodia's spires, although built on an architectural scale, were sculpture. They provided no shelter from the elements and enclosed no useful space. Gehry's design not only encloses space, but plays with it, distributes it with a generous hand, and makes it the point of the whole effort. It is this focus on space that also distinguishes his house from the work of a group of New York City artists: By taking his house apart as well as putting it together, Gehry has invited comparisons with SITE's disintegrating showrooms for Best Products. Within limits such comparisons are useful, particularly since both parties have ventured into the psychology of the unconscious with their paradoxical



## Incarnation of the houses of children's dreams.

imagery. However, SITE's work is confined to facades and other external elements, while Gehry's exteriors are the lesser part of his accomplishment—the front elevation, in fact, is the one arguably unsuccessful episode in a complicated effort.

Perhaps unintentionally, the emphasis on interior space is a doubly potent metaphor. It represents the essence of shelter, of inhabiting, of the home as a family refuge and a private place. But it goes still further, suggesting that just as there's more to Gehry's house than the exterior meeting a skeptical neighbor's eye, so there may be more to his design than playing with unusual materials and distorted forms. Complex inner space, at least in this case, parallels complex inner meanings.

The house is a pink, asbestos shingled, gambrel roofed "Dutch colonial" affair in a desirable but environmentally nondescript part of northern Santa Monica. "It was just a dumb little house with charm," Gehry explains, "and I became interested in trying to make it more important. I became fascinated with creating a shell around it, one that allowed the old house to exist as an object, and, in a sense, defined the house by only showing parts. . . . It's very surreal, and I am interested in surrealism."

Gehry achieves that surrealism by direct visual reference—his use of diagonals to create illusions of sharp perspective recalls several of de Chirico's paintings—and by displacements such as transforming the old house exterior into an interior wall of the new kitchen and dining room, and then paving the floor of those added spaces with blacktop to represent a driveway that the original house never had. Stripping away some of the old finishes down to the wooden lath, or even the studs and joists, furthers the effect, as does the use of fine-mesh chain link fencing as flooring for a small, almost inaccessible upper walkway leading nowhere. One enters the house through a new door, only to find the old front door two steps beyond. The old windows look out on the new inside of the house, and the line between indoors and out is blurred in a far subtler fashion than ever effected by the old regional standby of sliding glass doors.

The original and added walls are counterposed in such a way that each questions and reassures the other. The new work echoes the old, the old seems to have awaited the new.

This is a splendid place for children—Frank and Berta Gehry have two young sons—for it is a timeless incarnation of all the houses that children have imagined in their dreaming and playing in attics, and even on the first visit it gives one the inexplicable feeling of having been there before. Through his preoccupation with the insides of a house, Gehry has discovered something about the inner mind, and in stripping away old shingles and plaster he has also laid bare part of his soul, and part of ours as well. □

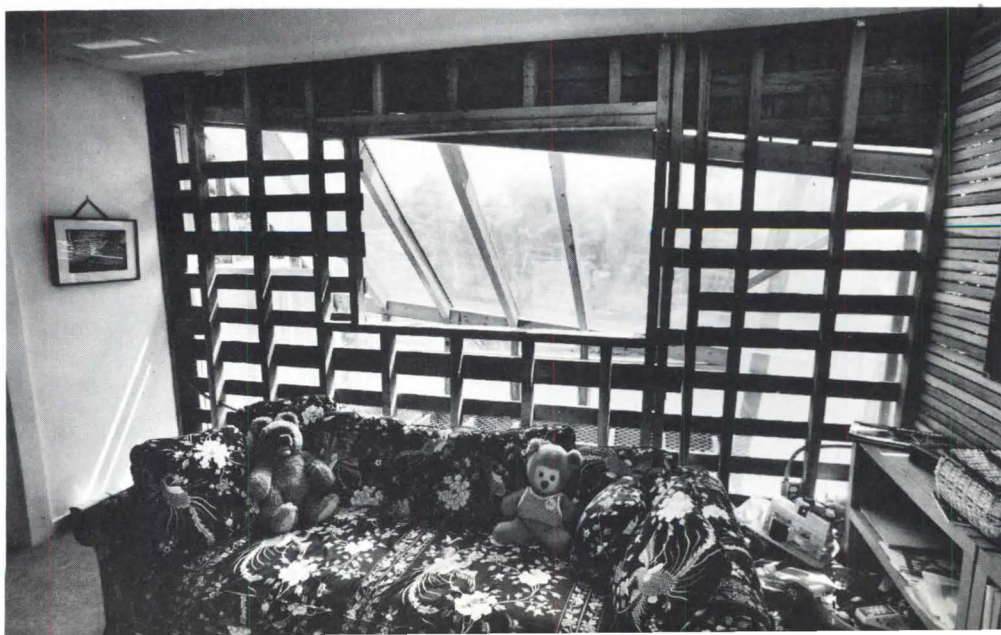





*Above left, the master bedroom on the second level. The fireplace was retained, but the attic above removed. The result is one of the pleasing spatial effects that characterize the experience of the house. Above, another window and stud composition.*

*Credits: Structural engineer: Johnson & Nielsen. Mechanical engineer: Advance Heating & Air-Conditioning. Electrical engineer: Norm Walters Electrical. Landscape architect: Frank O. Gehry, FAIA. General contractor: JSF Co. Completed in 1978.*



# ‘Modularity Without Missionary Fervor’

*The Charles Sieger house, Miami (architect, the owner). By S.A.*

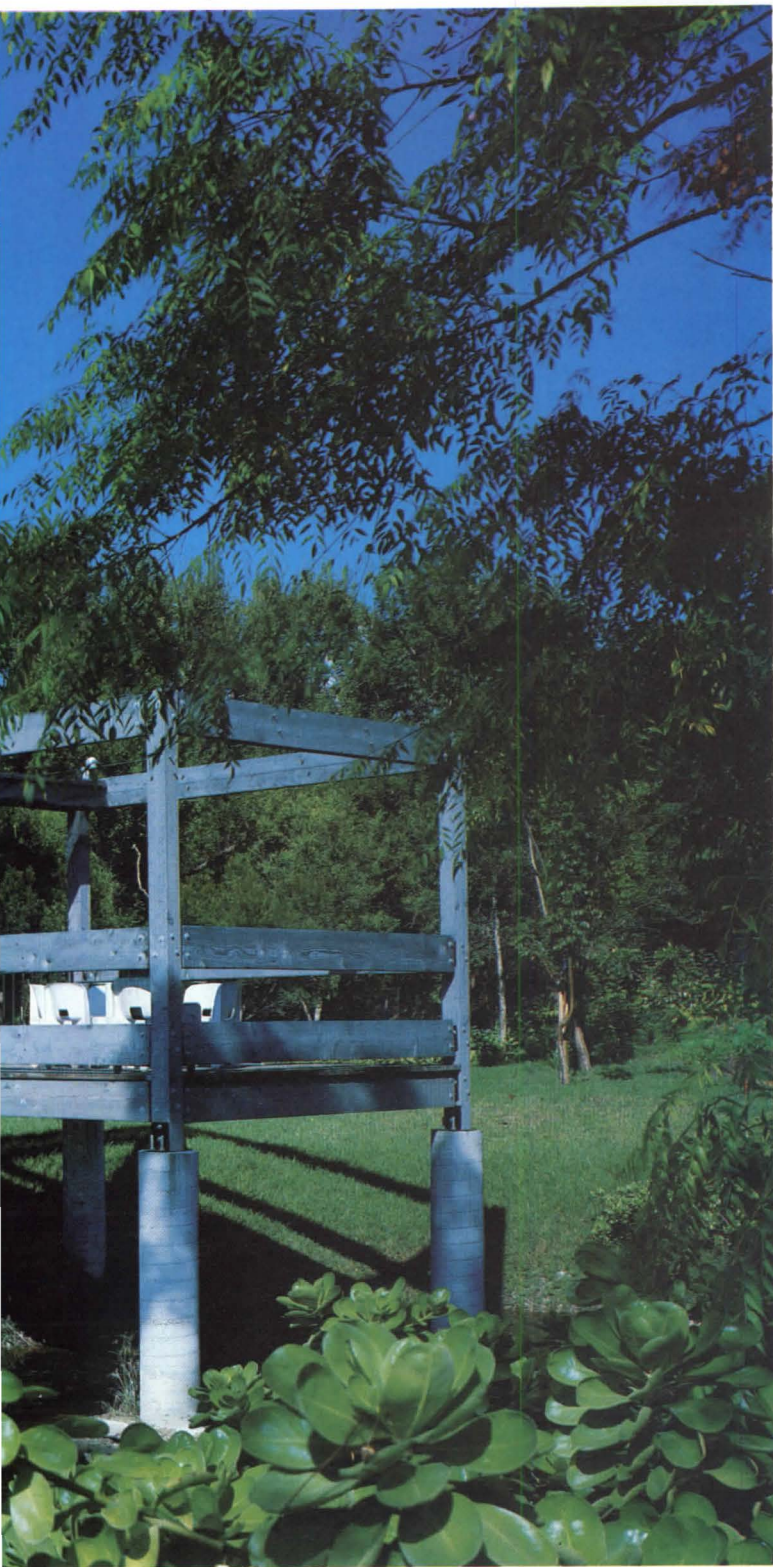

Jeff Roth

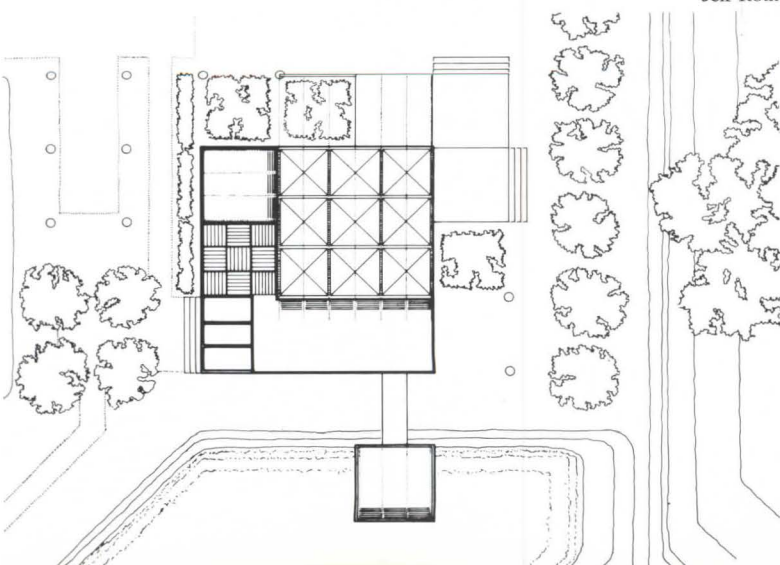

The concept of modular residential construction, part of the postwar dream of cheap, fast industrialized housing, was tried many times, but met the resistance of general inertia, of high cost and of recalcitrant trade unions. Except for some elaborate structures by Moshe Safdie and some very specialized current cases—such as prefabricated hotel rooms being assembled here and shipped intact to the Middle East—such methods are no longer the subject of much attention.

Yet such a modular concept is the basis of a handsome and intelligent new house by Miami architect Charles Sieger, AIA, for his own family. The original house was built just over a year ago, and already the Siegers have added a child's bedroom and playroom unit; further additions—or alterations to the present structure—can be easily accommodated. Building costs, Sieger says, have been in line with conventional construction, but he claims no startling savings.

For this is modularity without the missionary fervor of previous efforts. It is not intended as a panacea for the world's housing problems, but simply as a solution for a particular house. As such, it is a great success, imposing a geometric order and a constructional consistency that give the small structure a rare intellectual content. One can do more here than enjoy pleasant spaces; one can enjoy the manipulation of a predetermined system that produced the spaces.

The basic building grid is 12 feet, 6 inches square, and each of its two floors is tied together in a simple post-and-beam manner with perimeter beams at 6 feet, 8 inches high or at 8 feet high or, sometimes, at both heights. All beams are identical, grooved along their top and bottom edges to receive fixed glass or opaque panels as desired, and drilled at their ends to be bolted into steel flanges that tie them to the corner columns. Any beam can be removed and reused in another position. Bolts can be tightened quickly with impact wrenches, and the whole house frame, Sieger says, was erected by three men in seven days. Under the pine flooring, joist directions are alternated in adjacent bays for increased stability, and wind bracing is provided by occasional shear walls of conventional wood stud construction faced on the exterior with cedar and on the interior with gypsum board. That's all there is to it. Because this structural system provides few hiding places, most plumbing stacks and all air-conditioning ducts are exposed. Each module has its own duct, and these, mercifully, have been painted an unobtrusive flat black.

Within these self-imposed restraints, Sieger has demonstrated an interesting range of possibilities, opening spaces to each other horizontally and vertically and projecting decks and a dining pavilion into the landscape. The double-height living room and part of the master bedroom above are covered with a 25-foot-square of tinted (40 percent reflective) plastic skylights. Between rows of skylights are continuous screened vents to allow the escape of any heat buildup. On uncomfortably sunny days, the skylights can be covered with a canopy of 70 percent shading orchid hothouse screening. The same screening can cover the unenclosed dining pavilion.

Pleasantly complementing the regularity of the house is the exotic contouring of the site. A garbage dump when it was bought, the site has been thoughtfully molded to create a number of lushly planted earth berms that shield views of neighboring houses and a new pond that is positioned to open the site to prevailing southeastern breezes. The house structure, decks and pavilion are all raised above grade on concrete piers for better air circulation and reduced humidity.

The end result is a sequence of pleasant and comfortable rooms within a sequence of ordered units based on a sensible building method. It is a house with all the intellectual satisfactions, but none of the proselytizing, of modular construction. □

*Left above, entrance corner beyond man-made pond. Dining pavilion (at bottom of site plan, left) is over water. Circular piers beyond house will provide footings for future modules.*

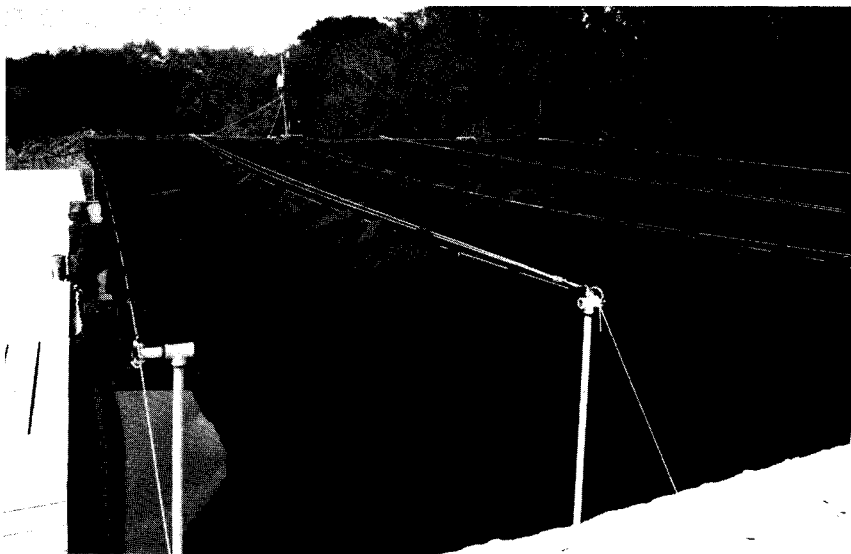

Photographs by Robert Perron

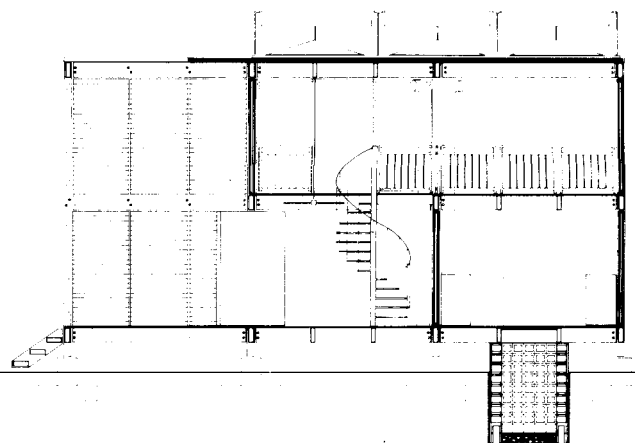
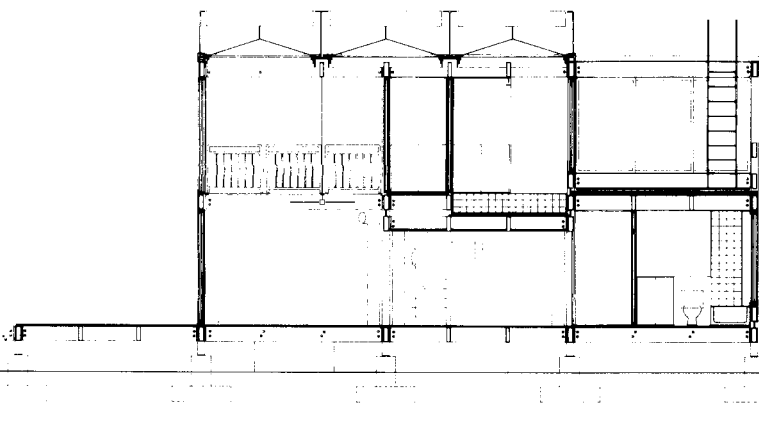



*Top left, rear elevation (with newly added bedroom modules at right) opens to deck. Some exterior bays are filled with cedar-faced stud wall elements that serve as wind-bracing. Two smaller photos show, from interior and from above, the sun screen, adapted from greenhouse use, that can be mechanically drawn*

*over the 25-foot-square skylight. Pit below kitchen, seen in nearer section, is wine cellar built of concrete block. Landing at top of stair leads to bedroom or to studio, above. Simple storage units are also modular and used throughout the house.*

Dan Forer

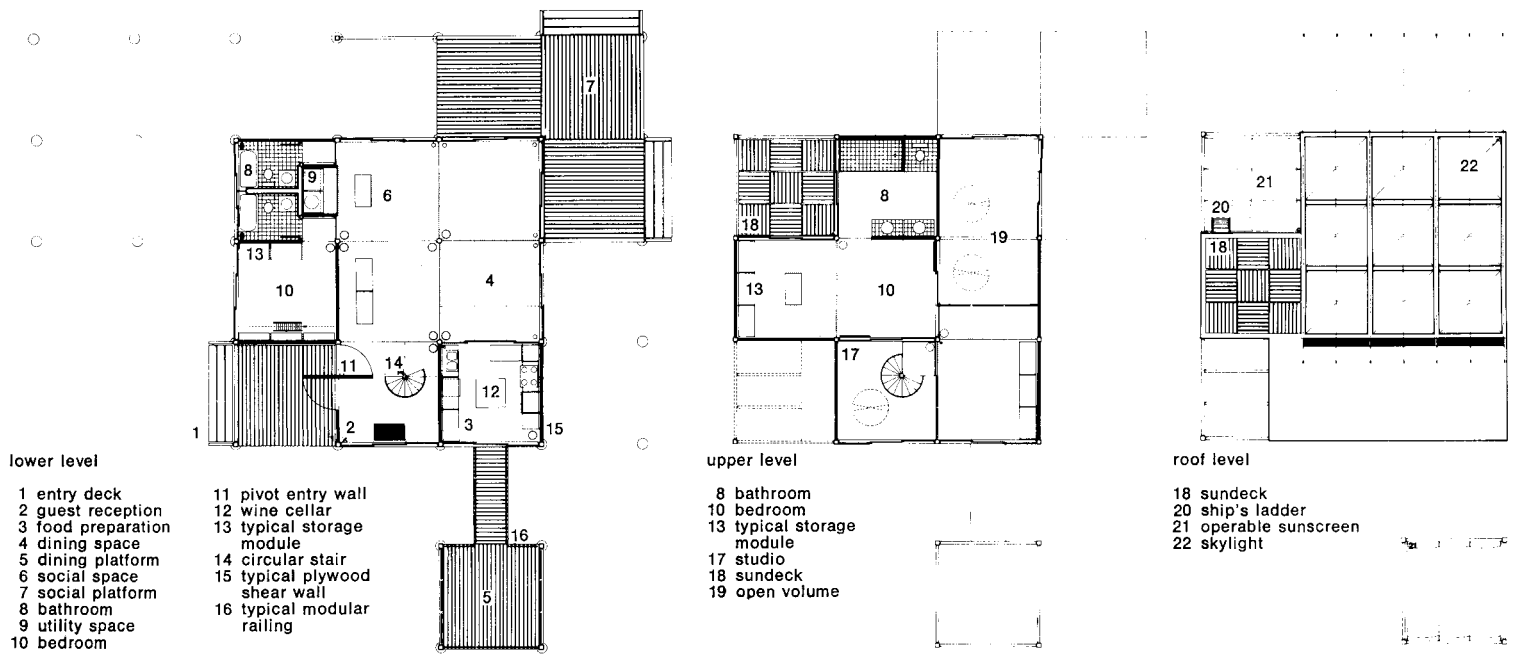

Robert Perron

*Plans show original house, before any extensions. Above, ducts in corners of modules are exposed, painted black. Venetian blinds attached to beams can give visual privacy to bedroom. Right, entrance foyer. Subtle checkerboard results from alternate directions of flooring (and of joists below) for adjacent bays.*







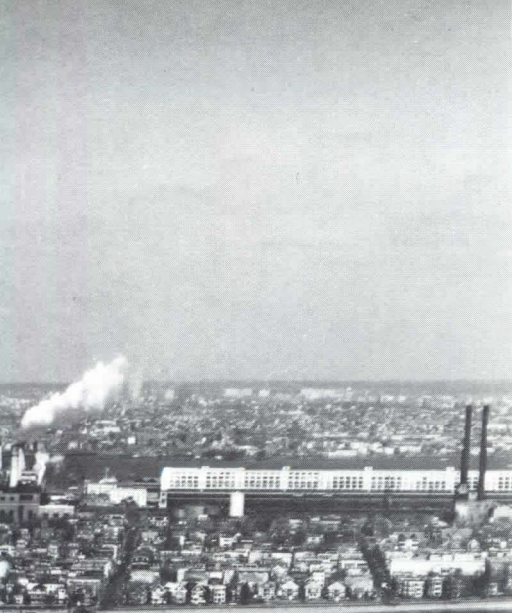

# Complicated Shapes, Moving Experiences

*John Fitzgerald Kennedy Library, Boston*  
*I.M. Pei & Partners. By S.A.*

After a dismaying number of delays and site, program and budget changes (largely because of a feeling among the Harvard Square community that the facility would bring unwelcome numbers of tourists to its initially intended site near the square), the John Fitzgerald Kennedy Library has finally been built on breezy, barren Columbia Point, across the harbor from downtown Boston. It was opened last October, and, like the country's six other Presidential libraries, operates as part of the federal government's National Archives.

From the outside of the building, a visitor is likely to be entertained, but perhaps also a little puzzled, by the variety of assembled geometries: rectangular solids, wedges, cylinders, freestanding planes. What inner forces and requirements have demanded these forms? The answer, one imagines, will be supplied by the interior volumes.

The answer never really comes, but, once inside, the question is forgotten. For one reason, because the variety of geometry is further complicated rather than explained. The cylindrical element—actually distorted into a tear-drop shape—contains no large circular space but a lobby that is square in plan and two lens-shaped auditoriums. There *is* an important circular space, but it happens to be in the center of a square lower level, which happens to be beneath the wedge-shaped element visible above grade. In short, the visitor is to be given no lessons about significant form, but treated to a frolic of geometric combinations and intersections.

A second reason for forgetting to question the shapes is that the building turns our attention so appropriately and so skillfully to its exhibits. Upon entering, we are given a tantalizing balcony view into the building's main space—a soaring volume almost completely glazed—but, once we enter one of the two lens-shaped auditoriums and, after a half-hour film, descend to the lower level exhibition area, our focus is not on architecture, but on John Kennedy—his family, his P.T. boat, his Presidency, his rocking chair, his assassination. Exhibits designed by Chermayeff & Geismar present a rich collection of papers, pennants, costumes, furniture, cartoons, television clips and photographs.

We emerge at last from this avalanche of detailed and often emotionally charged memorabilia into the serene blankness of the building's main space, and the emergence is one of the most refreshing and releasing experiences modern architecture has ever provided. Except for a few plants and a giant American flag high above, the space is unfurnished. It is not a space meant

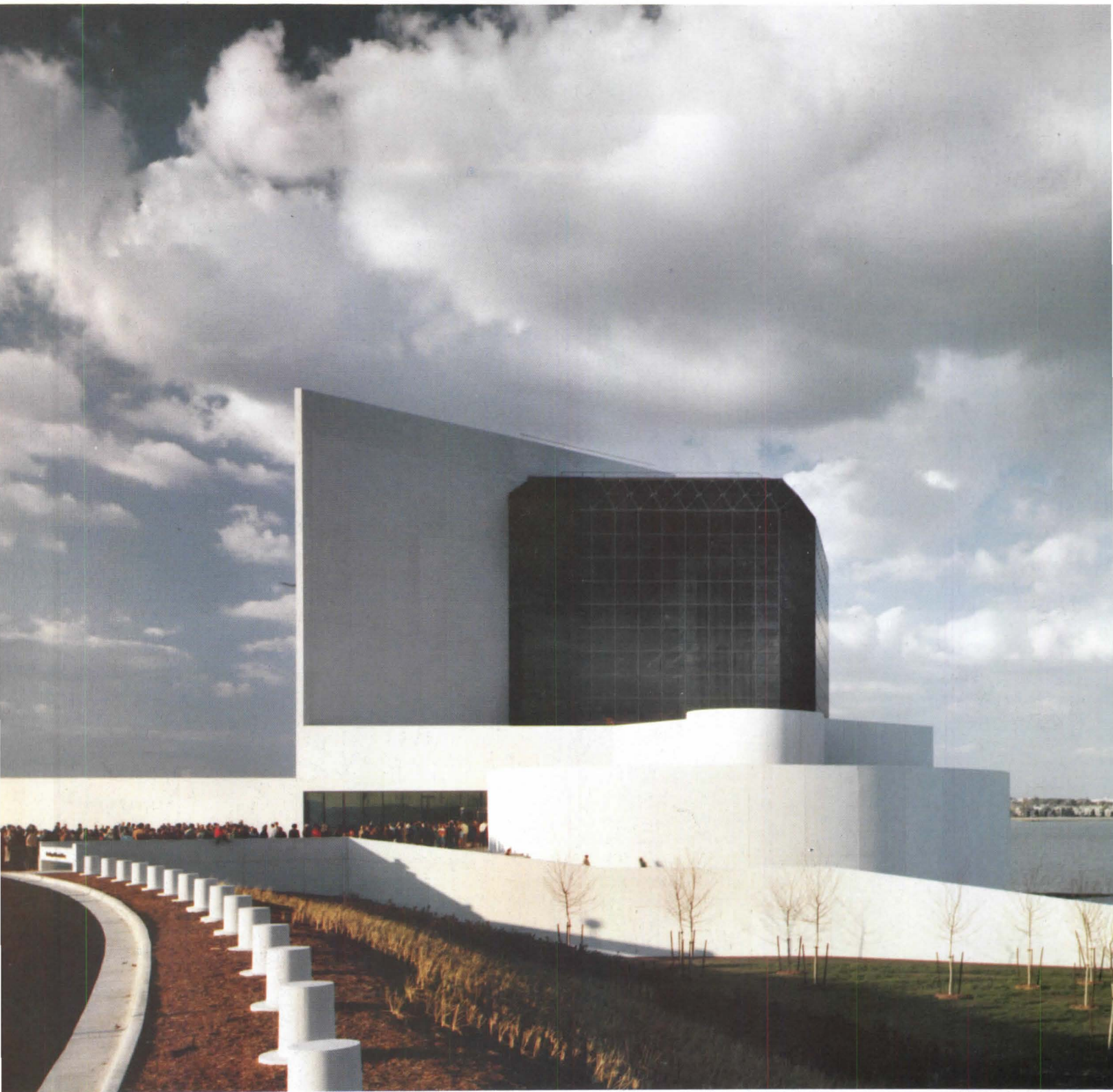

### **Manipulating movement into the glazed room.**

to serve any utilitarian function, nor is it meant to be studied for its own interest as an architectural wonder; it is meant simply to lift our spirits and invite us to a few quiet moments of reflection. Although vacant, the space capitalizes on its view over a contemplation-provoking panorama of water, with the Boston skyline far in the distance. It is a space in which to stay for a while.

Our contemplation finished, we ascend a granite stair within the space, pass through a bustling corridor of telephones, toilets and sales desks, and are returned not just to the lobby looking out to the bus stop and parking lot, but also, unmistakably, to the here and now.

Perhaps if the building were to be considered in the company of the highest level of masterpieces—the Roman Pantheon, say,

or Santa Maria della Consolazione in Todi—we might demand of it less arbitrariness in the shaping of its forms and a more intelligible consonance between its exterior and interior. Even in more comfortable company, we might say that the library lacks the authoritative clarity of Pei's own John Hancock tower, glistening across the water, or the monumental presence of his east wing for the National Gallery of Art.

But what has been done at Columbia Point has been done handsomely. The detailing is elegant and thoughtful, in the Pei tradition, but without ostentation. The general architectural reticence of the exhibition areas, directing our attention to the contents, not the container, is as it should be. And the manipulation of movement through the building, climaxing in the great glazed room, is masterful. The JFK Library provides an experience the visitor will remember with gratitude. □



Nathaniel Lieberman

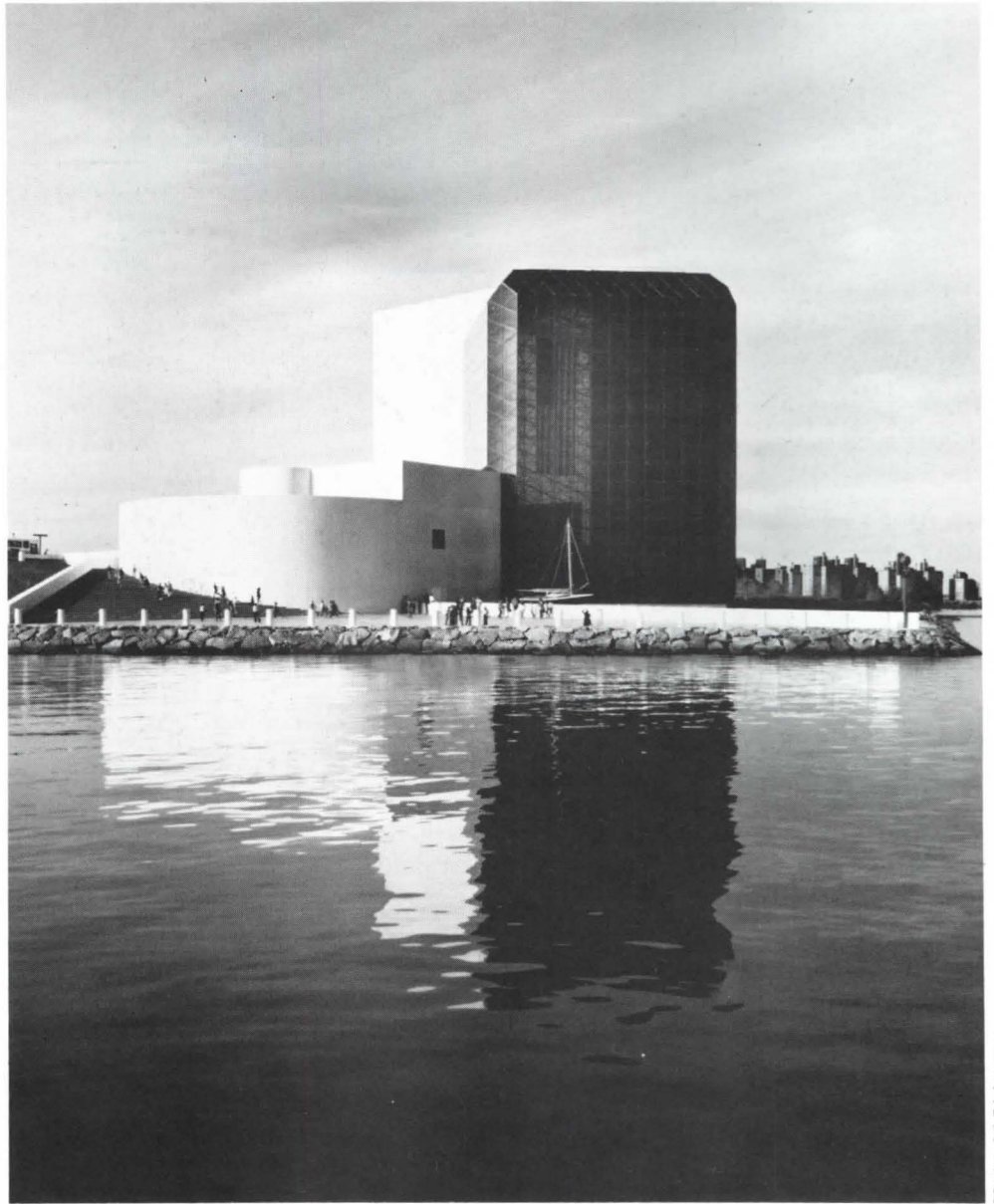

Nathaniel Lieberman

*Three views show the building's close relationship to the waters of Boston Harbor, a relationship particularly appropriate for a memorial to John F. Kennedy. His sailboat 'Victura,' visible in top right photo, is moored on a lawn outside the dark glass prism of the building's main space.*

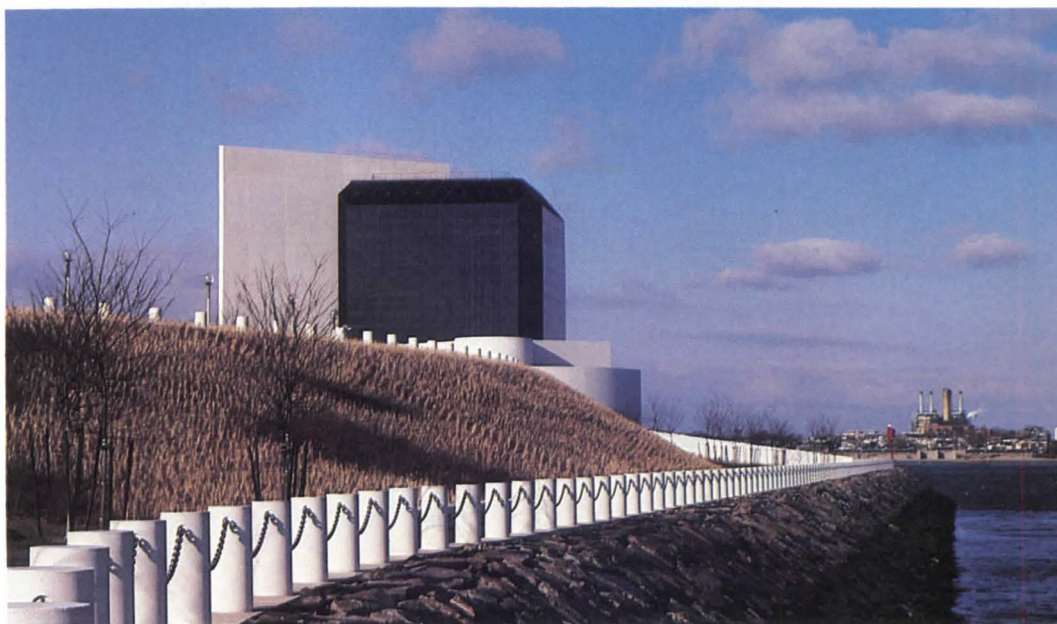

Stanley Abercrombie

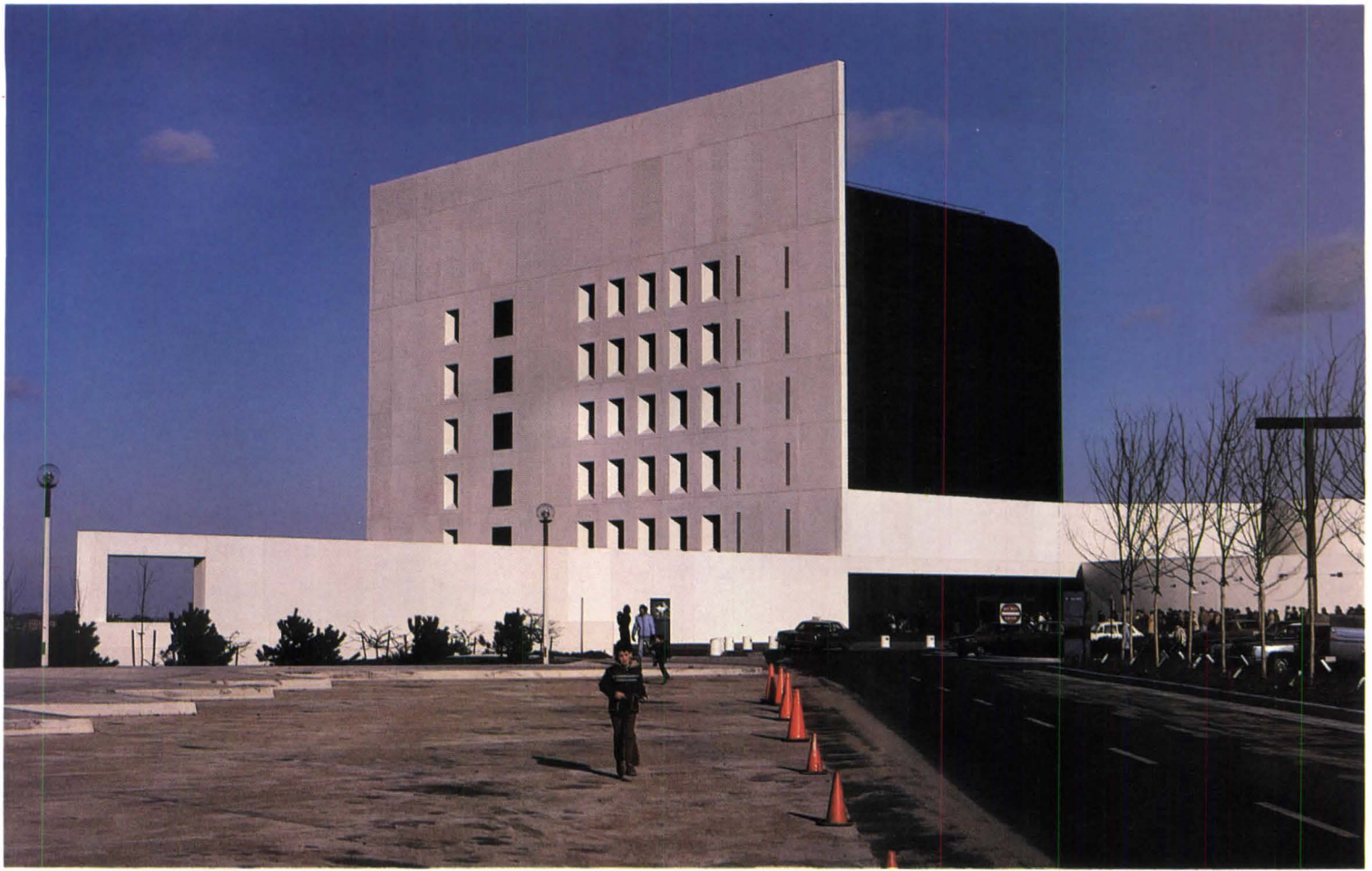

Stanley Abercrombie

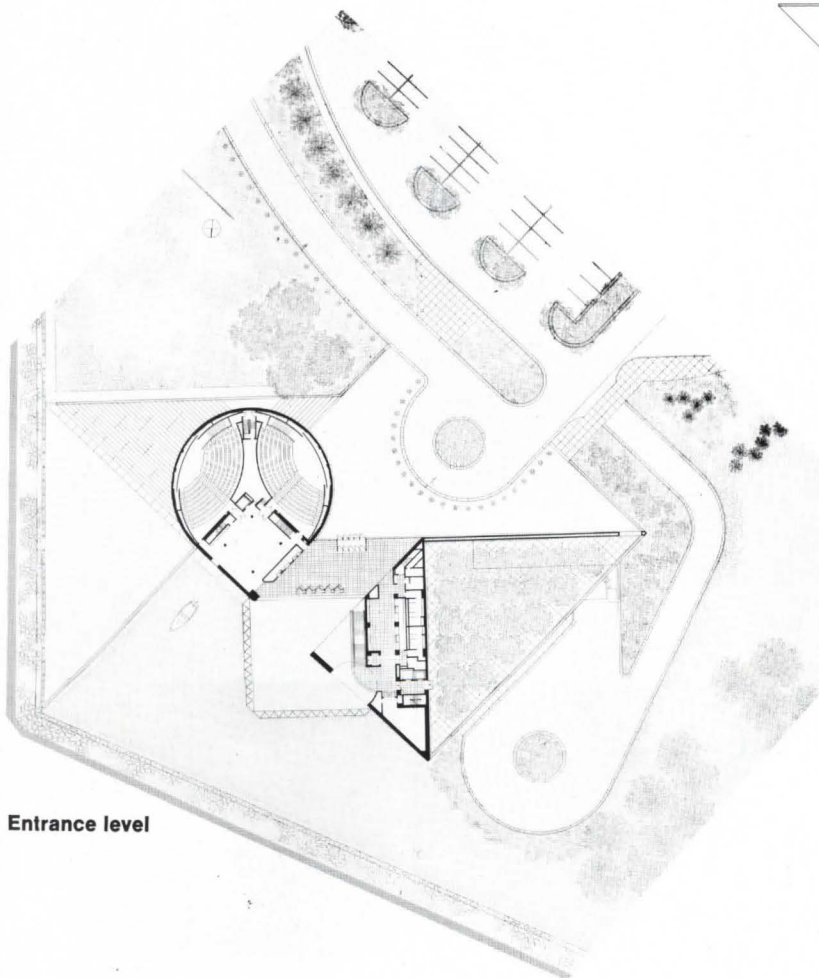

Entrance level

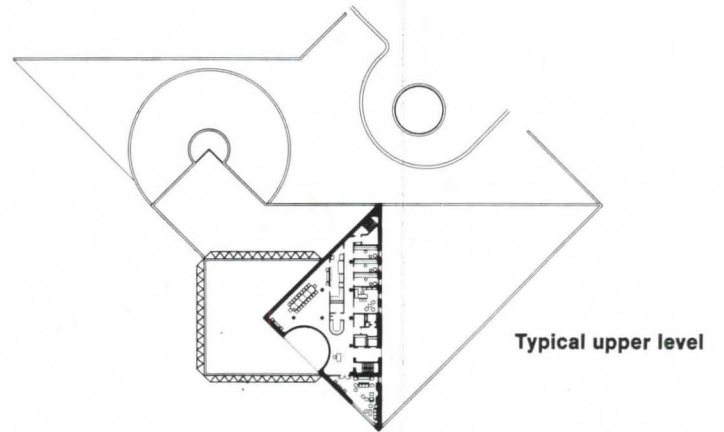

Typical upper level

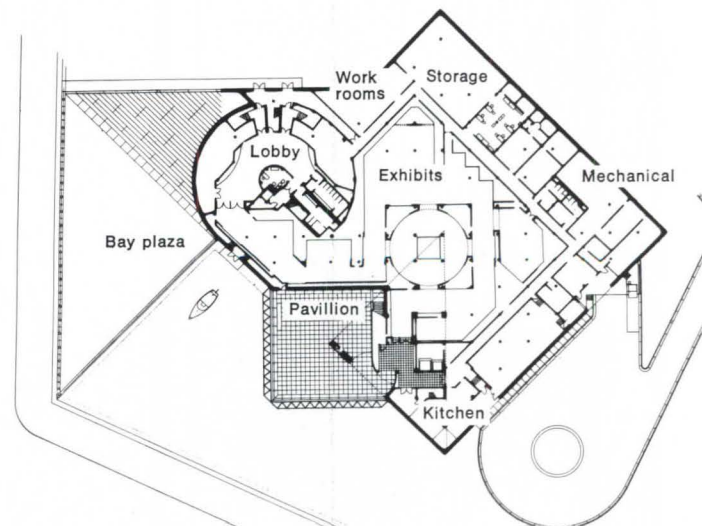

Exhibition level

*A wedge-shaped building element of white concrete, left, holds office and library functions not generally visited by the public. Entrance from parking field is at balcony level; the main exhibition area is largely below grade, covered by an entrance terrace and a triangular planted courtyard set apart by a long concrete wall. The large area for exhibitions is thus architecturally suppressed, allowing the glass pavilion to dominate the composition.*





Photographs by Steve Rosenthal

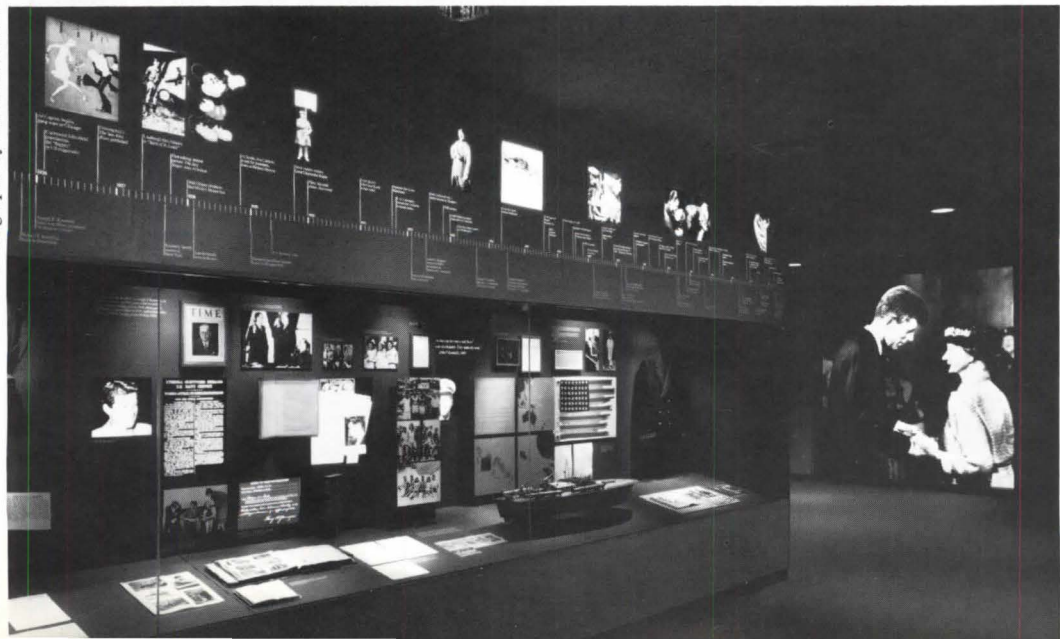



Stanley Abercrombie

*Exhibitions, designed by Chermayeff & Geismar, are divided into sequential sections dealing with different aspects of JFK's career. These sections cluster around a circular central space containing, behind glass, the President's desk and rocking chair from Kennedy's days in the oval office, top left. Time line display, bottom left, presents events of Kennedy's life chronologically; included are the Berlin speech, the Cuban missile crisis, the nuclear test ban treaty, mental retardation and civil rights concerns, economic policies and space exploration. Ship models, above, represent a more personal interest.*

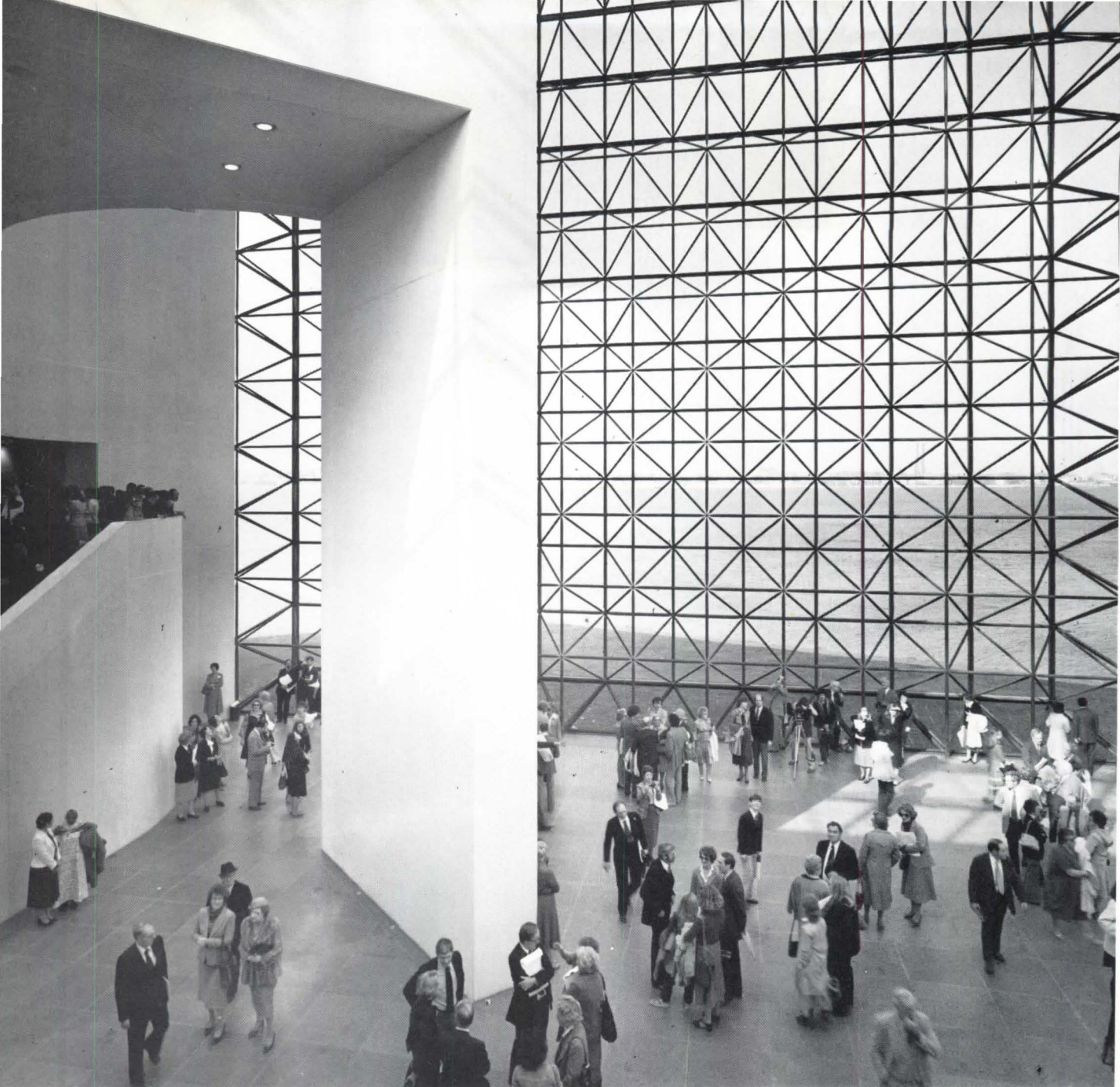

Nathaniel Lieberman

*The building's climactic space, entered after the relatively dark confines of the exhibit area, is this glazed pavilion. The changing perspectives of its space frame members invite upward glances, and there are long views across the water to the Boston skyline. From an apsidal recess, right, windows of the library floors overlook the space. Beneath this apse, above, a stair carries visitors back up to the entrance and exit level. Dominating the space, right, is a great flag.*



Stanley Abercrombie



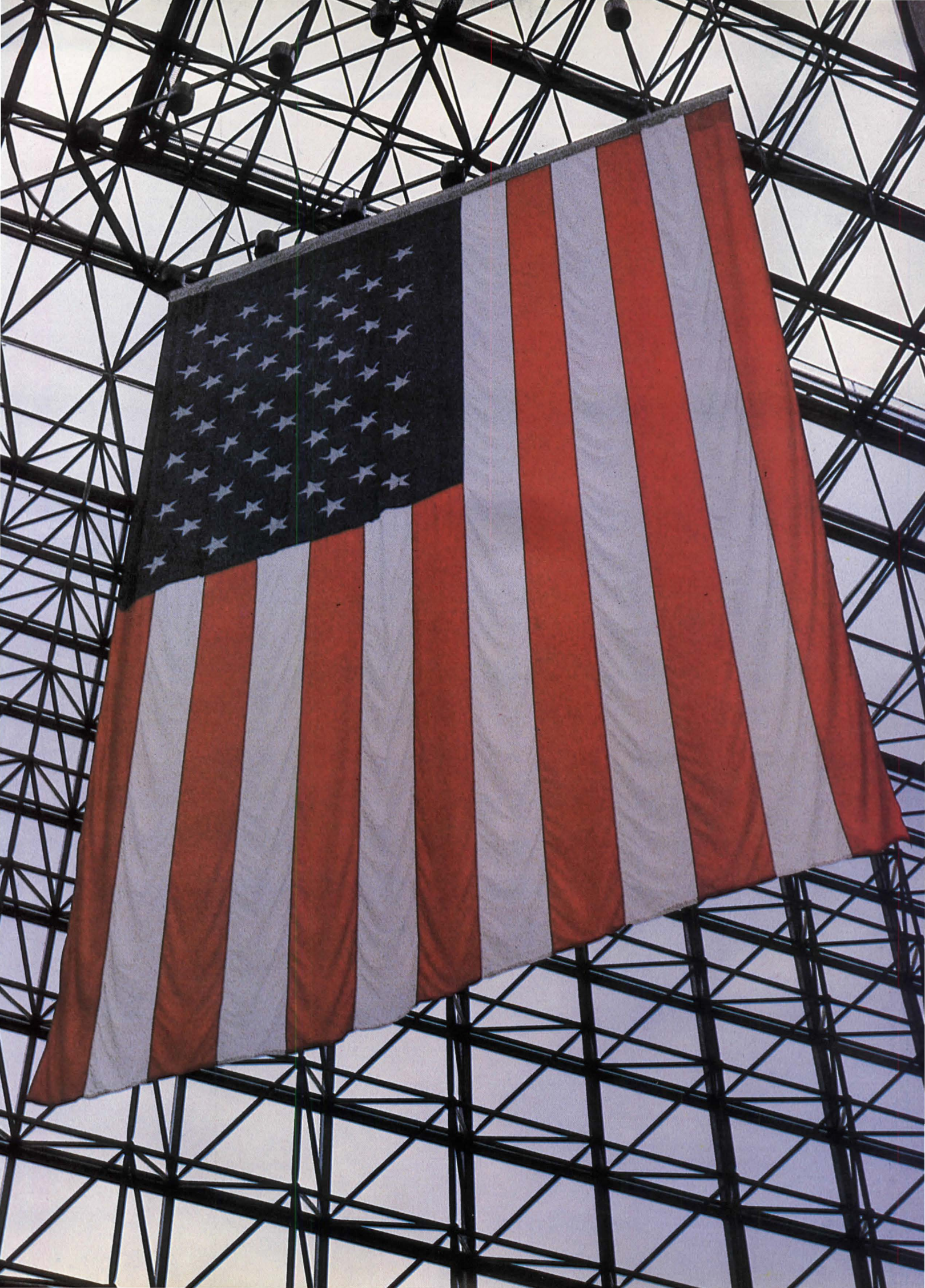

# What's Next?

Since the primary purpose of our annual review of new work is to explore directions in American architecture, it seems appropriate to seek such directions in the minds of architects (and professional observers of architecture) as well as in buildings. So we have done in each of the previous annuals. This year the question asked those surveyed (who were chosen arbitrarily, as before) consisted of the two words above. It was partially amplified in a second question: "Where is architecture heading as the new decade begins?" But it was kept deliberately open and generalized in hope of attracting maximum variety in the responses. This hope was more than realized: The responses are rich in variety and in ideas. We thank all those who responded. We apologize to the few whose responses could not be used because of space limitations.—Ed.

---

## By Reyner Banham

---

American architecture and the general public will, presumably, drift farther apart in the immediately foreseeable '80s. In spite of the apparent populism of the Venturis, or the shingle-revivalists, their styles (like Colin Rowe's Roman revival city planning) derive from the inner anxieties and historical traditions of the profession, not from any very explicit external demands or interests.

All in their various ways are expressions of "intellectual retrenchment," the loss of those old messianic pretensions that fueled the Corb/Gropius generation, the failure of the free-form activism of the late '60s. In other words, the mood of the profession's opinion makers is cowardly, as they cling to their preferred pieces of sanitized and denatured history (even the poor old International Style in some cases) as if to a security blanket or lucky rabbit foot.

All this introspective preoccupation with the private past of architecture may be fine on the psychiatrist's couch, but is incommunicable and irrelevant out there in Real-Life-Land: Try explaining Collage City

### 'Architects had better find out what their act really is, and then get it together.'

or Pacific Design Center to the check-out clerk at your neighborhood Safeway! Now, the arguments for reassembling ancient Rome out of busted utopias or for building a blue glass whale in a residential neighborhood are often very cogent indeed to architects, and highly diverting to long-term professional architecture buffs like myself, but they create a kind of wall of incomprehension between architectural discourse on the one hand and ordinary human conversation on the other.

Obviously, it is possible to persuade some lay folk to buy these arcane messages (otherwise neither Michael Graves nor Peter Eisenman would ever have a client), but not lay folks with urgent needs for a roof over their heads or their commercial enter-

prises. What that means is that the kind of architecture that still dominates most of the magazines will have to be content to be a rich man's plaything once again, or depend upon eccentric advertising budgets, as do the recent works of James Wines or Philip Johnson. That's fine—it's how architecture always used to be, after all—but are there enough rich eccentrics to keep the entire architectural profession off the bread line?

The alternative to mass unemployment, with emaciated figures slumping across their drawing boards as malnutrition overtakes them one by one, would seem to be something that architects have been half promising to do since the middle of the last century in one way and another—to look into their professional skills and accumulated wisdom, not for the comforts of (misconstrued) history but in order to find out what it is they can offer that no other profession or trade can. What is it that architects uniquely do?

Perhaps it will prove true that all they can do, really, is to design public monuments, and are hopeless at housing. But, equally, it may turn out that the one thing they do better than anybody else is to "weld diverse talents into an integrated team." Or have unique skills in organizing zoning appeals. Or can do neat lettering on protest signs. But in a decade where society will have to look for enhanced performance from practically everything and everybody it comprises, architects had better find out what their act really is, and then get it together. I would hate to see the grand old profession wiped out by hypothermia and deficiency diseases, because some of my best friends are still architects! Talk to us—but talk sense!

---

## By Helmut Jahn, AIA

---

Within the current questioning of the premises of the modern movement there is a renewed interest in a wider pursuit of the evolution of the modern style into an attempt for a "new synthesis" where all elements come together again in an integrated architecture.

The last 10 years saw a reliance on "one liners" without interest and attempt for

synthesis with other approaches. Modernism insists on architecture as a systematic solution to technical problems. Late modernism remains within the restricted language of modernism but exaggerates through logic, emphasis on circulation and systems and mannered and complicated use of abstract forms. Postmodernism believes that architecture is a social art that communicates using codes that deal with elitist pursuits of formal language and abstract esthetics, new rationalism and eclecticism.

Though many of these various approaches have shown new solutions to individual pursuits, they fail on the level of a total architecture. Each approach leads to an end in itself and is missing elements that synthesize it.

The new typology now emerging is not of an abstract nature, not of a technological utopia, nor looks back to borrow from history. Its classification can be stated as an appropriate and innovative recomposition of all those elements. Its strength lies in the tensions and transformations it provides between function and form, old and new, nature and technology, abstraction and meaning.

Specifically the work reflects:

- an attempt to extend and continue the modernistic principles of an architecture developed along a functional and technical rationale;
- a response to the increased complexity and variety of everyday environment and life;
- an architecture that has appeal and meaning to which it alludes with appropriate

### 'The new typology now emerging is not of an abstract nature, not of a technological utopia, nor does it look back to borrow from history.'

references and symbolism—familiar forms, products, colors, styles and metaphysical points of view, evoke the intended associations and become the metaphor of the design;

- an increased awareness and response to "place," physical context and larger urban setting;
- a use of history absorbed and recomposed into a creative present—not as orthodox duplication of a historic style;
- the use of technique to support the visual language—not as a means in itself;
- an approach to energy conservation that goes beyond engineering to explore location and form not only to conserve energy, but to provide human comfort and amenity;
- a theory of architecture as a practical art that deals with clients who often do not want architecture altogether and also deals with problems which have escaped the interest and control of the architect.

We deal with these problems and other constraints such as low budgets, an inflationary market, short schedules, changing codes and laws, increased mechanization and new delivery techniques, not by opposing or attempting to change them, but by making them work for our intentions. There is a



*Helmut Jahn's design for the Illinois Center in Chicago, Murphy/Knight, architects.*

constant interaction between an effort to deal with the physical realities of a building and also to deal with theories and ideas for architecture.

"What's next?" is what's always been: an intense investigation of the architectural determinants of form.

### By Brent C. Brolin

It was almost 10 years ago that I had the pleasure of lunching with Margaret Mead. Our discussion touched on the prediction of change and she told me that she had been appointed to a "committee on the year 2000" shortly after President Kennedy's election. The committee's objectives included a sort of reconnaissance of the problems America would be facing at the turn of the next century. Within a few months they realized the impossibility of making even the most general predictions about the year 2000 and changed their name to the committee on the year 1980; shortly thereafter they decided it would be perilous to predict change even 10 years in the future and the committee was disbanded.

On that word of caution let us look at some of the options available to architects in the 1980s.

As modernism's restrictive rules continue to fall away the range of design choices will broaden. We already have more "styles" to choose from than at any time in the past 40 years. But the new openness toward the forbidden architectural past is tentative. Architects are exploring its pleasures cautiously and their treatment of history and ornament is still pretty much tongue-in-cheek. We remain embarrassed by connections to the past and seem unable to use history frankly and directly, without some sort of gimmick.

The timidity will pass, however, and with good fortune the profession will adopt a tolerant view of the past. Recent years have seen respected architects borrowing from the early modern movement without being chastised by their peers. Perhaps in a few years we will be able to draw unself-consciously on all the architectural past without being considered uncreative hacks.

Along with the greater openness to the past has come a different expectation of how an architect's career can evolve. We have all been taught to expect "good" architects to make strong, personal artistic statements. Eero Saarinen, in fact, is the only well-known modernist I can think of who did not

have an easily identifiable personal style—he did not use the same architectural vocabulary in every situation.

Now, instead of pursuing one's own personal style regardless of the context, it is becoming acceptable to create a design that is visually compatible with its surroundings. The refreshing heresy here is that the designer should sacrifice the apparent advancement of his or her personal *oeuvre* for the sake of the architectural ensemble. The idea is not new. Before modernism, truly talented designers like Michelangelo, Scamozzi and Wren had little difficulty relating "new" styles to older ones.

The mere fact that this option exists indicates that the heroic age of the architect/artist may be yielding to a more mature time when designers, confident of their craft, can transcend the narrow, egotistical aim of evolving a personal idiom and consider the broader problem of relating each building to the streetscape in which it will be seen.

Today we teeter on a delicate edge, aware of the need for a greater sense of responsibility to the architectural ensemble but unwilling to abandon the image of the architect who must create his own style. The present period of flexibility—or unsureness—will no doubt be short-lived because, despite their protestations, designers like restrictions. The search for new rules could lead down several paths. There is a danger, for example, that we start paring down the variety of design approaches until we arrive at another "movement," with the codified esthetic aims, the ideological rigidity and the instantly identifiable form-vocabulary which that word implies. Should this happen before our modernist prejudices against the past have faded, the likely consequence would be the creation of yet another "style," coherent within its own ranks but as indifferent to its surroundings as modernism.

We should embrace history and ornament intelligently. The sooner we do, the more likely we are to create a climate in which architects can produce buildings that have genuine affinities to the contexts into which they are placed—no matter how original they may be in other respects. For

### **'A delicate edge: aware of responsibility to the ensemble, but unwilling to abandon personal style.'**

those who think this approach will doom us to monotony, I suggest the following: (1) Look at any number of older European towns whose architecture ranges from Gothic to Art Deco and note the visual harmony that exists within this remarkable stylistic variety. (2) Look at the stultifying monotony that modernism brought on when it "freed" architects from the past.

If this more flexible approach is adopted by enough architects, the gradual rebuilding of our towns and cities could result in refined and compatible urban compositions that could match those of the past for richness, variety and coherence.

This aim is likely to be encouraged by a more interested and informed public. We

are reminded of this daily as nonprofessionals influence the architectural evolution of their neighborhoods through design review boards and other community-based organizations. The increased awareness of laypeople is sure to be viewed by some as an infringement of professional prerogative. Rather than thinking of it that way, try putting the shoe on the other foot. They are not encroaching on our rights. It is we, architects, who usually come from outside the community and invade their territory with buildings with which they will have to live for generations to come.

### By Sim Van der Ryn

"What's next for American architecture?" cannot be answered without asking "what's next for America?" The rest of the century is going to see a transformation as profound as the Industrial/Scientific/Technological Revolution that shaped the West's thought and environment over the past 200 years. The paradigm or world view that led to the great material success of Western culture is losing its power to bring coherence to our experience and to hold us together. The dream of liberation through the satisfaction of constantly rising material wants brought about by a benign science and technology is collapsing. In the physical sense it is collapsing because the cheap stocks of energy required to maintain and expand affluence are running out in our lifetime and in any event could never support an American way of life for more than a fraction of the planet's population. In the cultural sense it is collapsing because the effects of energy addiction breed instability at every level of society from the nuclear family to the planetary family of nations. The separation of person from nature and planet, which is part of the paradigm, provides no spiritual basis or ultimate meaning to our existence.

As a chronic optimist, I believe that we can make the transition and transform our society in a way that will ensure relative peace and stability. The pessimist in me suspects that old beliefs die hard, and that complete societal disintegration may have to precede renewal. Currently, world affairs are dominated by a struggle over the resources to maintain Western energy addiction. Some of us believe the alternative is for Western nations to use their great wealth and remaining stocks of high quality energy to put in place technologies and a way of life that can be sustained by the continuously available "income" of the sun directly, and, more importantly, as it is concentrated by natural systems such as photosynthesis, decomposition, nutrient chains and the hydrological cycle. Comprehensive analysis by Amory Lovins and others shows that the "soft path"

**Mr. Banham**, British author and critic, teaches at the University of California at Santa Cruz. **Mr. Jahn** is director of design at C. F. Murphy & Associates, Chicago. **Mr. Brolin** is the author of *Architecture in Context, Fitting New Buildings with Old*. **Mr. Van der Ryn**, former state architect of California, is with the firm of Van der Ryn & Calthorpe.

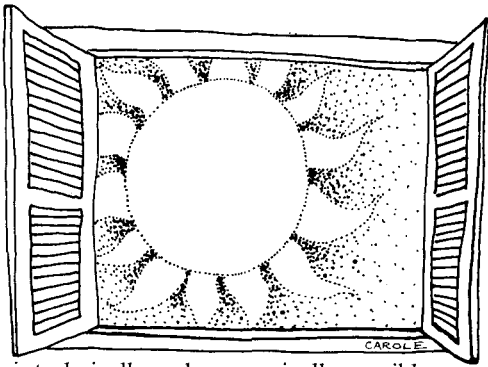

is technically and economically possible, however, it doesn't fit into the still prevailing paradigm of "progress through material growth," or its corollary "strength through exhaustion."

All these trends are reflected in what has happened in architecture. The old paradigm has exhausted and bankrupted itself in almost every area of national life, and architecture is no exception. The vision of the strongest movement of the century, nurtured in the Bauhaus and brought to this country on the eve of World War II, was of a humanizing, liberating architecture made possible by an enlightened technology grounded in democratic process. As powerful and effective as the vision was in the hands of a teacher, organizer, architect such as Gropius, it degenerated into style under the impact of institutional clients who demanded that architects confine themselves to narrow specialist roles and cease to attempt to address or attack the bigger questions. Perhaps only Bucky Fuller keeps the idea alive. In the teaching and work of Louis Kahn architecture did sometimes transcend the modern paradigm producing a true architecture of the spirit and of nature. In the hands of lesser lights, it degenerated into style.

So today we are confronted by an architectural intermission, the stage between the death of one paradigm and the birth of another. True, there are those who dance on stage briefly, one more outrageously insubstantial than the next. Andy Warhol predicted that in the media society we all would be famous for ten minutes. The passing infatuation with the Club of New York, hosted by the dark presence of Philip Johnson, is a sign of the times, a quick blur of colored pencil fragments and rhetoric notable for its vacuous and decadent sophistry.

The rest of the profession grinds away, seemingly oblivious to the stage. The prestigious big firms serve the multinationals. Many major firms over the past five years made it only by exporting the now obsolescent American dream to the newly rich countries of the Middle East. Lesser firms take what they can get.

In the chaos there are hopeful signs. More and more architects seek to maintain their independence and some control over their own work by becoming their own clients, and mastering the worlds of finance, development and politics. Many younger architects have found a niche in the role of traditional master builder, designing and building one small project at a time. These architects are largely responsible for nurturing a pool of traditional crafts and skills that are no longer part of the mechanized American building industry. And most of the significant innovation in renewable energy design

is coming from this network of people who are casting off tired formulas—of bigness—technical specialization and linear, mechanized organization.

What are some aspects of the new paradigm and how is it likely to affect our architectural future? As the technological leverage of systems subsidized by fossil fuels vanishes, engineering and technology will become grounded in ecology and biology, in order to tap into the constantly renewed energy of natural systems. Buildings, habitats, cities will be redesigned to more closely integrate production and consumption of energy, food, water and wastes. Today buildings, cities and environments are still conceived of as simple machines that transform a small portion of a large flow of imported resources and energy into useful products, throwing most away as waste heat and pollution of various kinds. Today's architecture and cities are entropy machines. Architecture and urbanism need to be imagined in their biological context as organisms processing energy, matter and information through many cycles of use. The scale of present service systems—such as energy production and waste treatment—will decrease and be better fitted into the particular ecological character of a location. Buildings will assume multiple functions, integrating some food and energy production as well as processing their own wastes. Living place and work place will be less differentiated. The densities of suburbs will increase and they will become more like communities, while the intense daytime densities of places like Manhattan will become more dispersed. The transition will combine two seemingly opposed but complementary trends. Big government will be increasingly occupied with allocating centralized scarce resources such as oil and coal. There will be a new resurgence of local and regional governments as people look to the local ecosystem to meet needs regionally.

It is too early to tell how the architectural profession will adapt to meet these new realities, or whether in fact it will. Fundamentally, I am talking about a way of look-

**'Architectural form will be derived from entirely unfamiliar determinants. Pioneers are now creating the first models of ecologically based architecture.'**

ing at what we do that goes beyond simple coefficients of performance or energy efficiency. I am talking about architectural form being derived out of an entirely unfamiliar set of determinants. There is a small and growing group of whole system pioneers—some from architecture, some from other disciplines—which is creating the first crude models of an ecologically based architecture. Biologically oriented designers such as John Todd, David Morris, Sean Wellesley Miller, Day Charoudi, Steve Conger, Steve Serfling and Malcolm Wells may be known to some of you, but their work is largely ignored by the architectural media and by the schools of architecture. The seeds are there; let's see if they grow.

**Thomas R. Vreeland Jr., AIA**

What's next? Romantic classicism: An architecture which is geometrically ordered as is Durand's and which can borrow thematic materials freely from wherever it sees fit.

It will be classical because we are tired of the loose informality of "the people's architecture" of the '60s and long for a system of plan organization as the Beaux-Arts had: axes for ordering our plans; apparent symmetry, as in early Wright or late Lutyens, and hierarchies of spaces and of masses. Wagner's St. Leopold's Church looks good to us today, as a church should, while Notre Dame du Haut seems diminished, contorted.

It will be romantic because we are prepared to borrow widely from historical sources very much as turn-of-the-century

**'We have the need to understand the rules of architecture once again.'**

architects did and to use classical forms in less than classical ways. Byzantine, Moorish and secession influences will be blended with the purest modern.

There is a renewed interest in other architectures than our own and in our own earlier history and tradition. Gabriel, Laugier and Ruskin will speak to us once more as we have the need to understand the rules of architecture once again.

There will be a return to ornament because it is a natural form of communication between buildings and users, and to the use of color and pattern on the exterior of buildings. People want to get pleasure again from their buildings. We will return to the images of childhood, of steep-roofed, high-chimneyed cottages and gaily bedecked castles that gave us joy before we learned to rule them out for reasons of morality and rationalism.

There will be emphasis on wall surfaces over skeletal structures—in fact, there already is—and on windows over window walls.

Finally, it is my sincere hope that there will be a return to good craftsmanship in building. There must be an end to gypboard, built-up roofing, cracked concrete and stucco, cyclone fencing and extruded aluminum and a revival of good brick and timber work, of the use of slate and tile, cut stone and good plaster work.

What architects among us best exemplify this program? Isozaki and Hollein, in my opinion.

I may be dreaming, but this is what I hope for as we go into the '80s.

**By Robert Geddes, FAIA**

Architecture evolves. One way in which it evolves is in its relationships with nature. It responds to nature. It learns from nature. It refers to nature. It transforms nature. And, in our present situation, it will itself be transformed by nature reconsidered. There are four aspects of nature that will influence the development of new architecture: (1) nature

as *resource*, the material of architecture; (2) nature as *context*, the setting of architecture; (3) nature as *content*, the commodity of architecture; (4) nature as *image*, the metaphor for architecture.

The contemporary situation is in marked contrast to the early phase of modern architecture following the industrial revolution. Then the resources of nature seemed limitless. Energy and power, exploitation and mechanization were seen as steps toward salvation and were expressed as images of the good. The iconography was taken from the machine, the steamship, the airplane and the dynamo. Now, a fundamental shift in values has occurred. Nature is seen as fragile and limited in resources. It is something to be nurtured, not destroyed by our own acts, including architecture. When nature is thus seen as life-supporting, it is the primary source material for architecture.

Second, nature is the context for architecture, which will mean giving greater emphasis to the Albertian criterion of fitness in architecture. The appropriateness of architecture will be judged by its contextual relations, whether in urban, pastoral or primeval settings. This attitude is already evident in *urban design* and will be increasingly prevalent when the greater awareness of climate, energy and ecosystems leads to a more vivid sense of nature as the setting of life and architecture.

Third, nature is the content of architecture insofar as we all live in tempered envi-

### 'Architecture transforms nature, and will itself be transformed by nature reconsidered as fragile and limited in resources.'

ronments of air, light and sound. Nature as light has always been an important aspect of the experience of architecture and, in an increasingly noisy civilization, nature as sound and silence is also more valued. Because our human bodies are frail and sensitive to the sensory conditions of our environment, the creation of appropriate microclimates will be an even more important aspect of architecture when it is judged in terms of commodity and delight.

Fourth, nature is a source of imagery in architecture. Nature, now seen in a new way, will be expressed in new imagery that



Honoré Daumier, *Les Paysagistes*, 1865.

celebrates it as life-supporting but fragile, stimulating but limited. The imagery of nature will replace the imagery of the machine that has served modern architecture in its early phases. The ornament of the future will be new images of nature. New concepts of the design of landscape—nature transformed by architecture—will emerge. And, in architecture itself, the most powerful image and metaphor will be an idealized nature seen as the edge of the forest, the benign place where the forest and the grassland meet.

### By Nathaniel Owings, FAIA

If you ask me, the architect is barely holding his own against an onrushing, uncontrolled chaotic state. Energy depletion, economic collapse, nuclear proliferation and destruction of most living creatures save man are prime indicators of this condition.

The architect might naturally be expected to provide the pattern and structure of man's society through which some order might be brought out of this chaos. But his influence here is impalpable.

I have here on my desk a little book entitled *Man's Struggle for Shelter in the Urbanized World* by Charles Abrams, published in 1964. Can we architects name an issue to which we should be more responsive? Until this is resolved, the architect's true role as a professional remains unfulfilled.

We find the architect spinning his small set of wheels within his own precious milieu tangentially harnessed to the great millstones of our society whose systems are themselves in the process of self destruction. *Harvard Magazine*, January 1980, addressed these same issues by questioning several professors of different disciplines. The prime concerns were: food, its aching absence for millions of human beings throughout every continent, and species extinction caused by the destruction of natural habitats accelerating to ruinous proportions in the 1980s. A professor of divinity spoke of the long-term redistribution of wealth, while a professor of economics predicted the total reconstruction of the capitalistic system from the shop floor to the board room. No mention was made of either architects or architecture. The planner, professor Peter Rogers, whose overriding concerns involved "cities and regions where the majority of the population lives a marginal existence on the edge of survival," believed that the next decade will be the crucial one in determining whether the 21st century will be worth leaving to our children.

In my own view, the architect's function, to be at all relevant in light of the world's

**Mr. Vreeland** is a principal in the Los Angeles firm of Kamnitzer Cotton Vreeland. **Mr. Geddes**, of Geddes Brecher Qualls Cunningham, is dean of the school of architecture, Princeton University. **Mr. Owings** is a founding partner of Skidmore, Owings & Merrill and a member of the Pennsylvania Avenue Development Corporation board. **Mr. Beeby** is a principal of the Chicago firm Hammond Beeby & Babka Inc.

### 'The architect is barely holding his own against an onrushing, uncontrolled chaotic state. His influence is impalpable.'

problems, is to take a leading role in creating and directing a basic planning process to guide the affairs of man, his shelter and his environment. Yet, I see nothing to indicate that the architect will change his present attitude or philosophy in the foreseeable decades ahead.

With half a century behind me and hopefully a decade or so ahead, and my beloved profession in jeopardy, it seems wise to look back and check out the trends of the last century.

In the July issue of the 1976 AIA JOURNAL, we find a broad spectrum of representative American architecture, all splendid works scattered over the years and the country. Quality, style and taste are represented but seemingly without trend. These enclaves of talented work are generally found surrounded by growing environmental deterioration. Unfortunately, trends are evidenced in the rapidly changing intrusions into the spaces in between—the transportation, the massive housing developments, pollution of air and water and loss of open space. These trends are damaging enough but show every sign of accelerating; therefore the prospects for the next decade are uniformly bleak.

Naturally, the gravity of this crisis is intensified when we bring into focus the 200 million or more people and the two billion acres of land on which they live. Largely leaderless in the areas of land use and land planning, the nation should be turning to the architectural profession for far-sighted directives and technical guidance.

As I see it, there are no options. Either we, as architects, take our place on the front line or the velocity of destructive trends will be totally uncontrollable—and that's when we will find ourselves "on the edge of survival."

### By Thomas H. Beeby

Once upon a time long ago there was a poor draftsman who happened to meet his employer, the Architect. Hoping to interest him, he boasted: "I have a beautiful daughter who is a student and can foresee what will happen next in architecture." The Architect was impressed. "That's an art I like; if your daughter is really as clever as you say, bring her to my office tomorrow and I'll see for myself what she can do."

So when the girl came the next day, the Architect took her to a small room filled with drawings, gave her a drafting board and ordered her to get to work. "You have one night to change this banal project into a piece of avant-garde architecture, but if you fail, your father will be fired and never work again in this city." Then he left the room and locked the door behind him.

The draftsman's daughter had no idea what to do; and after a while she saw there was no escape and burst into tears. Suddenly, the door flew open and a strange little man

with a heavy accent rushed in and asked why she was crying. "I have to transform this ordinary project into the latest thing, and I don't know how."

"What will you give me if I do it for you?" asked the little man.

Since she had no material possessions, she offered him something that was very important to her. "My mind," she replied.

He nodded and sat down at the table, opening a large black book he carried. They worked the whole night, and before morning had transformed the project into a functional building of great perfection.

When the Architect returned at sunrise, he was amazed to see what she had done, so that night he locked her up in a bigger room with a larger project and set her to work a second time. As the poor girl wept, the door flew open and in danced the little man.

"What will you give me if I help you again?"

In desperation, she offered him something

### **'High in the tower of an isolated university library, a strange little man was reading a large black book. . . .'**

that she had always held to be most precious. "My soul," she replied. He nodded, opened his large black book and by morning they had created a perfectly crafted building of high technology.

When the Architect saw the building he was pleased; but being very greedy, he had the largest room in the office filled with drawings. As he slammed the door on the girl, he made a promise. "If you can produce a totally innovative building out of this in one night, I will marry you and make you my partner." ("She is only a draftsman's daughter," he thought, "but we could be rich and famous together.")

As soon as she was alone, the strange little fellow appeared. "What will you give me if I do your work for you this last time?"

"I have nothing left."

"Then promise me your first child if you marry the Architect."

("A lot can happen between now and then," she thought.) In despair, she agreed. The little man opened his large black book and set to work. When all was ready, he vanished; and in the morning, when the Architect found his enormous project transformed into a work of abstract purity, he married the draftsman's daughter and made her his partner.

A year later she gave birth to a miraculous boy with long golden tresses; but by this time she had quite forgotten the strange little man. When he arrived at the office one day to claim the child, the Architectress was terrified and offered him any part of the practice if he would only leave her son. But he insisted: "No, I prefer a living creature to all the practices in the world."

She wept so bitterly that at last he took pity on her. "If in three days you can guess my name, I'll let you keep your son."

She thought all night of all the architects' names she had ever heard, and even sent out a student to comb the library for more.

When the little man came back the next

morning, she called him Alvar, Mies, Corbu and every other name she knew, but he kept repeating, "That's not my name."

The next day she went to the library herself and listed the most unusual names she found: "Maybe Gunnar, Eliel, Serge or Piet?" But he always answered, "That's not my name."

On the third night the student returned with a strange tale: "I couldn't find a single new name, but high in the tower of an isolated university library, I saw a strange little man reading a large black book. Every now and then he'd shout":

"Today I write, tomorrow I build;

With the Architects' child I'll be fulfilled.

No one will know from where I came

Or that SIGFRIED GIEDION is my name."

The Architectress was overjoyed to hear this news, for it came just in time. Soon after the little man arrived and asked her, "Tell me, what is my name?"

"Is your name Louis?"

"No."

"Is your name Frank?"

"No."

"But maybe your name is . . . . Sigfried Giedion?"

The little man was furious and screamed: "The devil told you that! The devil! The devil!" In his anger he tore his large black book into shreds and was never seen again.

---

### *By Fred Bassetti, FAIA*

---

As the '80s begin, let us talk of architecture as buildings. Buildings have character. Buildings are tough, unyielding; they endure.

Architecture was made fashionable in the '70s. It is now discussed over teacups at faculty receptions or at honor award jury sessions, not in terms of structure or function, but for its surface decoration. Between sips of tea or in magazines you will hear words like these: "The flat, lightweight, symbolic ornament eschews pomposity, mixing architectural metaphors and making tongue-in-cheek allusions with great wit. . . . It has a strong and surrealistic imagery."

Architecture (as decoration) is back in the hands of the academy. Some critics do a dainty minuet in front of each arbitrarily elegant facade of what looks like paper structures. It is even out of fashion these days to illustrate designs with perspective drawings—they must now be axonometric.

In contrast to the current magazine fashion, we remember powerful buildings that engaged both heart and mind. We remember the Wainwright and Reliance Buildings, Taliesin West, Nervi's hangars, Kahn's Kimbell Museum. And who can forget Belluschi's Equitable Building that started the whole postwar tidal wave of clearly expressed form and function in tall office buildings? Perhaps all the finest and purest was summed up in Johnson's own house at New Canaan, Conn.

An inspired structural and functional purpose animated these structures. Site layout, plan, cross section—all contributed to a unified, creative whole. And while it's true that few architects were able to reach this level of design achievement, there was general con-



sensus as to method, most agreeing that conditions shape the building, that it was appropriate to use rocks and wood and canvas in the desert, concrete or steel, brick and glass in the city, logs and shingles in the forest.

Today it's another story. As Ada Louise Huxtable said in a recent report to the American Academy of Arts and Sciences: ". . . endless semiology, typologies and half-baked esthetic Marxism . . . small ideas delivered in large words weighed down with exotic and private references, masses of pretentious and glutinous prose."

Pompous architectural language leads to pompous designs and inappropriate buildings. Two examples: for the mentally retarded in the Bronx—a superbly crafted shiny metal wall structure, in its unapproachably high-tech fashion alien and frightening to its users, but rewarded with an AIA honor award. In Wilmette, Ill., for the Baha'i Faith, whose officials asked for an archives building to last 1,000 years—a glass-walled design with plaster or concrete Corinthian columns supporting a stainless steel roof, to be built near the old temple, whose stone or concrete dome seems better acquainted with the millennium.

Even here in Seattle the well-publicized tendency is felt. (Why are architects such sheep?) A couple of blocks from our office a new restaurant opened last January: glass block bar, industrial pipe stair-rails made into a prominent interior feature; hard materials unfriendly to the touch and the eye

### **'The talented architects who have worked the mannerist field will tire of it sooner than will their imitators. We will once again learn the lessons of the past.'**

dominate the space, causing a psychological chill that sends many who enter back out to the sidewalk at once.

Clever and fashionable and witty this work often is to those who read architectural criticism. But, off the printed page, will it endure? Will it prevail in the '80s? I think not. Indeed, I believe the talented architects who have worked this mannerist field will tire of it much sooner than will their imitators.

The new facadism, unrelated to plan or structure or climate, is like a cake made entirely of frosting. I think we will find serious architects once again reading Rudofsky, studying the nonpedigreed buildings that

heed nature, which he has so eloquently documented. Truth has shown itself, without a mask, in vernacular buildings wherever we have cared to look. Truth, as overwhelming beauty, can be found in the alleys of any city; it thrills us with its bold vitality in villages everywhere.

Architects, I think, will leave the circumscribed world of scholastic and eclectic diversions for the bracing adventure of problem solving. They will respond creatively to the demanding structural and material conditions met by those who actually build, as well as to the more elusive and subtle social needs of the public we serve. Serious consideration of such trivialities as a precious house design suited to the unique taste of an architect and his suburban American princess client will pass, except for a minute few who may loll in this indulgence.

Truth is of a tougher strain. We will once again learn simple, powerful lessons of the past, from the walls of Macchu Picchu, the superb ventilated stone granaries of northern Portugal (above left), the forgotten structural and social lessons of Gothic cathedrals. We will take our materials new and old and use them with the same logic, utility and method that led to the many timeless structures admired by both critic and public. There is an untapped wealth of design discovery, creative adventure, simple and solid trustworthy beauty waiting for us all. Our great teachers made gigantic strides with this method but we have scarcely begun. As Rico Lebrun said, "If an artist is to survive his time, he will survive as spokesman, not as entertainer."

### By John Dreyfuss

As the '80s begin, architecture is turning from historicism toward art.

Also, at least in the U.S., architecture is being molded by its existence in a land of plenty that is rapidly becoming a land of shortages.

The International Style that preceded the style of historicism has been pronounced dead by a number of architectural pundits. It's a good thing they're pundits rather than physicians, or they would be sued for malpractice, or murder, or both. And they would lose.

The International Style is old, not dead. Good, if not necessarily innovative architects will be designing good, if not necessarily innovative International Style buildings long after this decade.

While some architects keep alive the aging International Style, a newer generation of architects is bringing to maturity a newer generation of architecture: the eclectic historicism that adapts the best of the past and applies it to today's structures.

A third architectural generation is emerging. It is a generation of art-oriented architects who treat buildings as original works

**Mr. Bassetti** is a principal of the Seattle firm Bassetti Norton Metler Rothschild. **Mr. Dreyfuss** is architectural critic of the *Los Angeles Times*. **Mr. Belle** is a principal in the New York City firm of Beyer Binder Belle.

of art, honoring history, but not mimicking it. This third generation is gaining momentum, and seems sure to continue doing so. Its members often design buildings that are sculptures too. And they love decoration.

But the ornaments they use are not the ornate, extravagant decorations of times past. There is no money for that.

So these architects emphasize ornaments that are almost two dimensional. They are at once embellishments and signboards. As embellishments, they provide esthetic pleasure. As signs, they imply more extensive decoration than what is there. It is a case of what you interpret is what you get.

Besides more decoration in the next decade, architecture is destined for more shortages.

Money will be in short supply. Energy will be too. So will materials. About the only necessary ingredient of architecture likely to be in long supply is architects.

Because of shortages, a possible, unpleasant and fortunately remote prospect lurks beyond the horizon. Instead of ar-

### 'We may be left with the most depressing of architecture. . . . At least it would keep the rain out.'

tistically oriented architecture that works, architects (or, more probably, clients) may cave in before the pressure of existing and impending shortages. Ornament may vanish. In the esthetic sense, design may vanish along with it. We may be left with the most depressing of architecture: plain box upon plain box, providing space and nothing more. At least it would keep the rain out.

The possibility of various shortages bringing us totally plain architecture is a threat, not a certainty. But shortages are sure to create other changes.

Sunshine will be extensively used for space and water heating. Passive solar systems, such as Trombe walls, carefully proportioned overhangs, greenhouses and containers filled with water to collect heat during the day and radiate it at night, will be in greater and greater evidence.

Shortages will compel the development of new life styles, which in turn will elicit new architectural and planning styles. The '80s will include increased construction of multiple use buildings and developments: offices in conjunction with condominiums, apartments, retail outlets and entertainment facilities.

New attention will be paid to relating the cityscape to pedestrians, since decreasing gasoline supplies will create increasing foot traffic in downtown areas. Buildings that would have presented cold concrete or glass to the city walker a few years ago will offer instead arcades, retail stores, restaurants, miniparks and other inviting features.

Many more people will live in much less space. Single family residences will, for the most part, give way to apartments and condominiums. Population densities will increase and the sizes of residences will shrink.

So in the coming decade, people will live closer together in less space with more ar-

chitectural ornamentation than they now enjoy. Cities will become more hospitable to pedestrians and emerging shortages of such things as money, energy and building materials can be a beacon for architectural innovation and growth rather than a harbinger of architectural doldrums and disaster.

### John Belle, AIA

My response to "what's next?" has little to say about the traditional areas of interest and concern for architects—e.g., design, style and theory. I prefer to answer the question through other issues that I feel will be more important aspects of the question. This is not meant to suggest that design is unimportant now or going to be less important in the future.

*A national urban policy:* What's next for architects in the implementation of the Carter Administration's national urban policy? Too general a theme? Pause and consider the following: One of the three major national urban policy tools now funded is the urban development action grant (UDAG) program. UDAG (\$675 million present funding level) is responsible for making the difference between building or not building many worthwhile projects. In my town, New York City, 16 UDAGs helped to bridge the dollar gap and compensated for the extra costs of building projects such as a downtown shopping mall in Brooklyn, the American Stock Exchange at Battery Park City, the conversion of a factory into a shopping mall in the Bronx, the reconstruction of a row of theaters on West 42nd Street and the restoration of the South Street Seaport Museum. Every one of these projects needed architects and engineers and every project would have died on the vine without UDAG help.

With financing and construction costs spiraling, we need every assistance we can get from the federal government. Therefore, let's get busy lobbying for national urban policy and specific programs such as UDAG—but do it as *architects*, emphasizing that these funds can be the difference to bring well-designed and needed additions to our communities.

*The architectural media:* We live in a very well informed society, one of the byproducts of which is a tremendous increase in the general public's knowledge of the built world. Tourism and recreational activities—which will continue to be a major growth industry in the '80s—have spread so people spend lots of their leisure time and dollars visiting cultural attractions. The Vieux Carré in New Orleans, ceremonial Washington, D.C., Main Street in Disney World, colonial Williamsburg, are all *architecture* and receive millions

*continued on page 208*

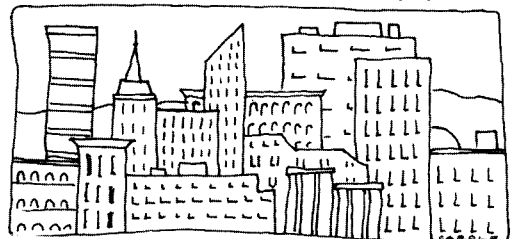



# Three Phenomena

*By Donald Canty*





Larkspur Landing Shopping Center in Marin County, Calif. (left and below), exhibits a complicated kind of regionalism. It is clearly at home in the Bay Area, with its board cladding, weathered look, and even some vaguely Victorian allusions reminiscent of nearby San Francisco. Yet it was designed by a southern California architect, Robert Kupper, AIA, of Leason Pomeroy Associates, who acknowledges the influence of the New England saltbox on the forms. The Flintoft house by Bissell & Wells (bottom) is on Nantucket Island, Mass., and looks it, even to the widow's walk. Yet its saltbox plan has had segments cut from it to take advantage of views and create some interesting angles and movement.

Wayne Thom Associates



# 1. Regionalism

New attention to regionalism is coming from two seemingly contradictory directions. One is postmodernism, whose handmaiden pluralism allows exploration of regional forms. (By definition one cannot be a truly dedicated Miesian and be a regionalist.) Postmodernism's predilection to historicism also helps, since regional forms are apt to be traditional. These influences may be on the surface of things, but they seem real. The second and deeper source of a new respect for regionalism is energy consciousness, whose potential for truly revolutionary impact on architectural thought is only now beginning to be apparent. The key word is particularity. Energy-conscious design responds to *this* situation in *this* place at *this* time; it succeeds or fails in direct consequence of its ability to deal with particular conditions. It must respond to fluctuations at even micro scale. (The particularly energy-conscious Marguerite Villecco, a frequent contributor to these pages, is at the point of dismissing out of hand any claim to architecture on the part of a new building whose four faces are identical.) Replicate the concern with particularity on a larger scale and the result is automatically regionalism.

David Franzen © ESTO



Pedro Martinez

*More tropical forms of regionalism: above, Yaurel elementary school, Arroyo, Puerto Rico, by Jorge del Rio, AIA; near right, Biltmore tennis center, Coral Gables, Fla., by Ferendino, Graf-ton, Spillis, Candela; above right, Lawaetz farm house, St. Croix, U.S. Vir-gin Islands, by TASC Team architects. Far right, the Tennis Ranch near Taos, N.M., by Antoine Predock, AIA, its rugged forms rising as naturally from the desert as those of an ancient Indian pueblo.*



Dan Forer



Katcher Baringer





Hedrich—Blessin

## 2. Replicas

This is to note the emergence of what might be termed hardcore historicism. It goes beyond allusion of past forms to their actual replication. Such has been preached by some theorists such as Allan Greenberg of Princeton, but it is only now beginning to be practiced in a serious way. In some cases, such as the farmhouse on these pages and the apartments overleaf, one's reaction after the shock has worn off can be "why not?" After all, these forms have served these places for a long time, so why discard them? In other cases, such as the office building overleaf, retreat into history has turned to architectural rout. Which may mean that, as with other architectural devices, success in replication of forms from the past may depend a lot on how and why it is done.

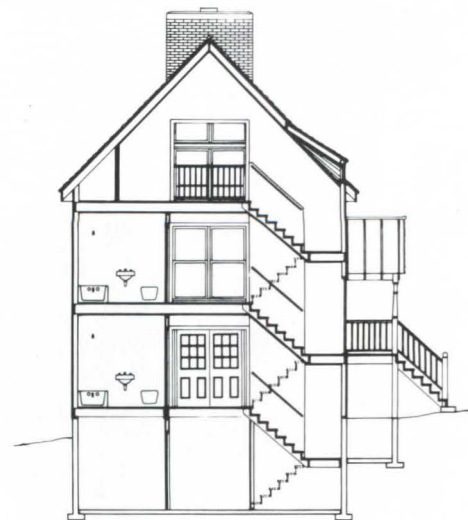

J. P. Cox



*The Beasley farmhouse in Monroe, Wis., replaced an original destroyed by fire. It is not a replica of the first, but it was designed 'to maintain the vernacular of prototype 19th century wood frame buildings of the area,' according to architects Hammond Beeby & Babka. At the Kentucky state horse park in Lexington (right) architects Chrisman, Miller, Wallace took the basic form for 23 new buildings from an existing barn of undetermined age.*



*Victoria Mews (right) cascades cheerfully down San Francisco's Portrero Hill, in form and detail echoing the city of a century ago. Architect: Barovetto, Ruscito & Barovetto. Opryland hotel in Nashville, Tenn. (below), by Earl Swensson Associates, wraps some very contemporary spaces and facilities in facades that veer between historicism and outright replication. Morrison corporate headquarters in Mobile, Ala., by Frederick C. Woods (bottom), displays no such ambiguity. The building seeks to 'express the heritage and solidarity on which the corporation was founded many years ago.'*



Gordon H. Schenck, Jr.



Marc Galassini



Photographs by Karl H. Rieck





Aesthetic Photography

### 3. Multichrome

For some years bright colors have been familiar embellishments on the bones and intestines of buildings. Now they are moving to the skin. Whether more exterior coloration than before is being seen is hard to say, but it can be said that when architects turn to color on the outsides of their buildings they are turning to brighter colors than before. Primary colors, in particular, seem to be gaining in popularity. The bright blooming of the buildings on these pages at about the same time may be a trend's unfolding or may be coincidence but it is indisputably cheerful. *If trend it is, it is a continuation of a reawakening to color in the 1970s, as documented in a special issue of this magazine in October 1978. As pointed out there, the use of vivid color flourished in postwar years and was all but outlawed in the 1960s with the coming to dominance of the modern movement, especially its German branch. It was a return to the "strong prejudice that colored architecture is somehow fine for children, the lower classes or constituents of primitive cultures," the introduction to that issue said. That prejudice began to fade in the 1970s. Whether it will continue to do so, and buildings continue to brighten in the 1980s, shall be seen.*



Aesthetic Photography



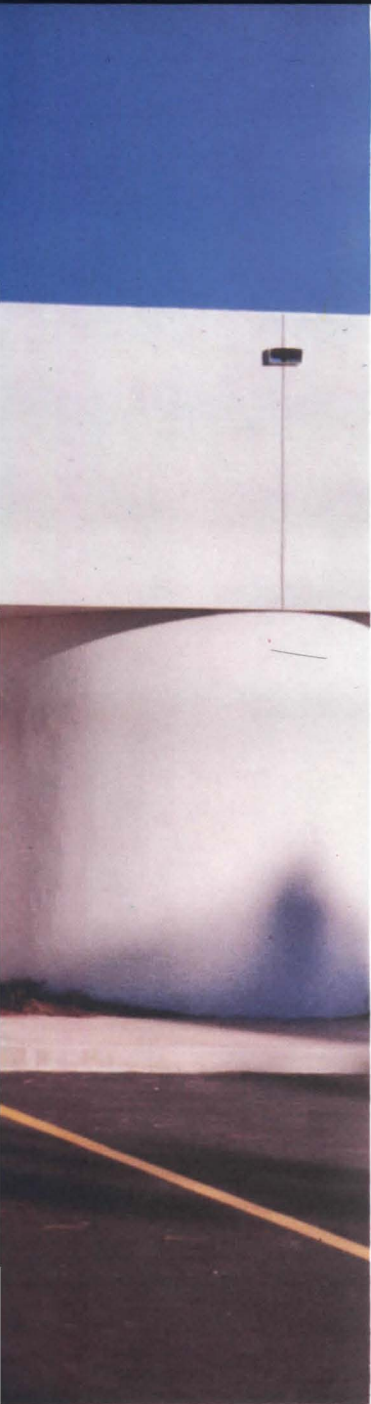

Photographs by M. F. Ross

Left and above, Lincoln Villas community center in Jacksonville, Fla., was designed by architect McDonald & Gustafson to be a 'popular, festive place' in a neighborhood where bright color is common. Right, Edward R. Roybal health center in a mainly Mexican-American neighborhood of Los Angeles is clad in bright tiles 'evoking the exuberance of Mexican art.'

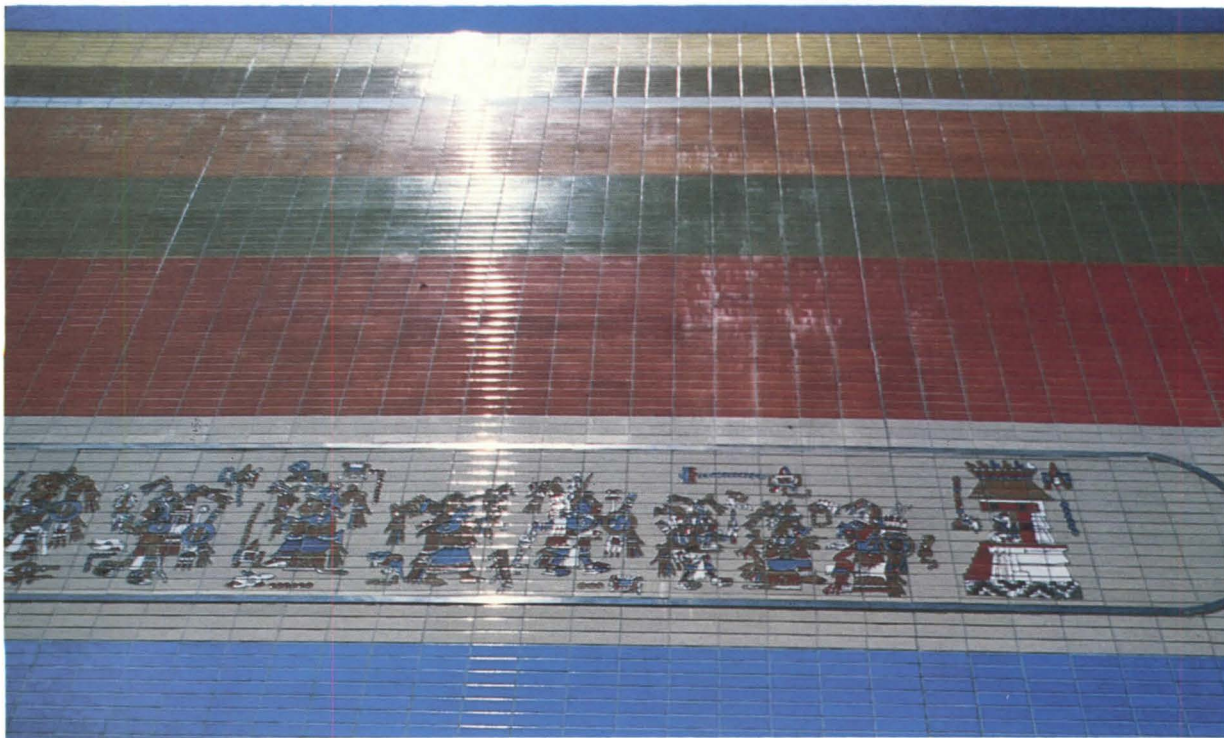

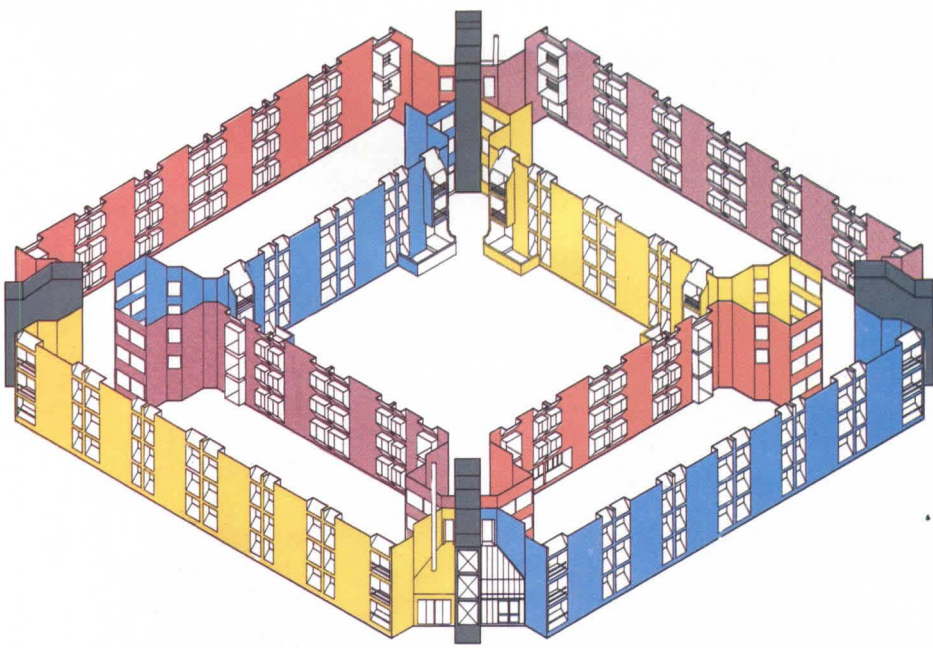

Dan Zimbaldi



Sarah Dennison

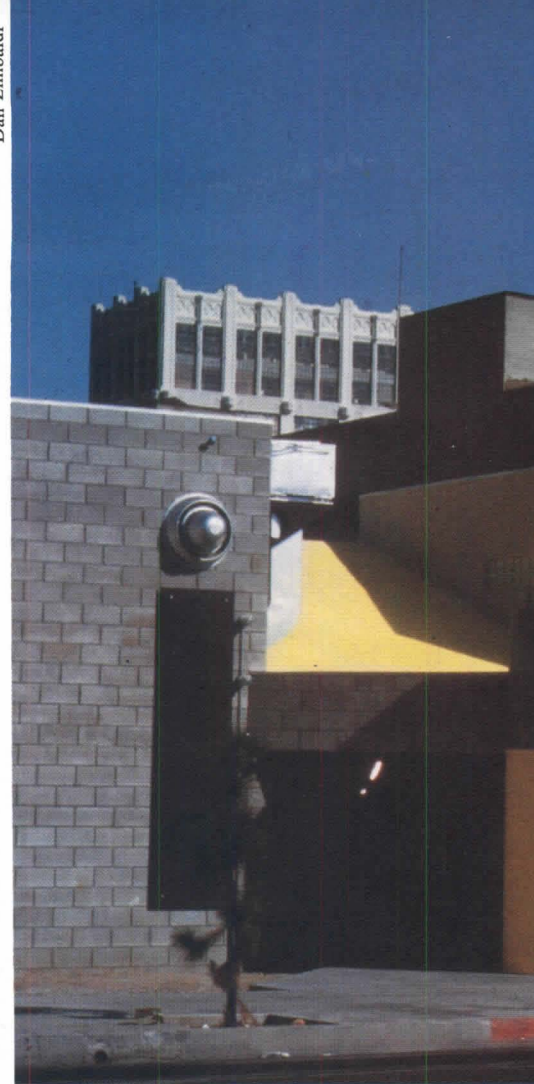

*Pico Union Villa in Los Angeles (left) is housing for the Hispanic elderly. John V. Mutlow, AIA, has given each facade its own bright pastel color, with darker recesses and sunshades. Eric Moss, AIA, and Jim Stafford have used color to relieve what could have been an oppressive (if interestingly organized) facade on this speculative warehouse-office complex in Los Angeles (above). William L. Pereira Associates has made what are essentially garage doors into something like paintings at the auto technology center of Cerritos College, Norwalk, Calif. (right). The firm said the use of bright colors inside and out was meant to 'maintain alertness' and to 'stimulate students and faculty.'*

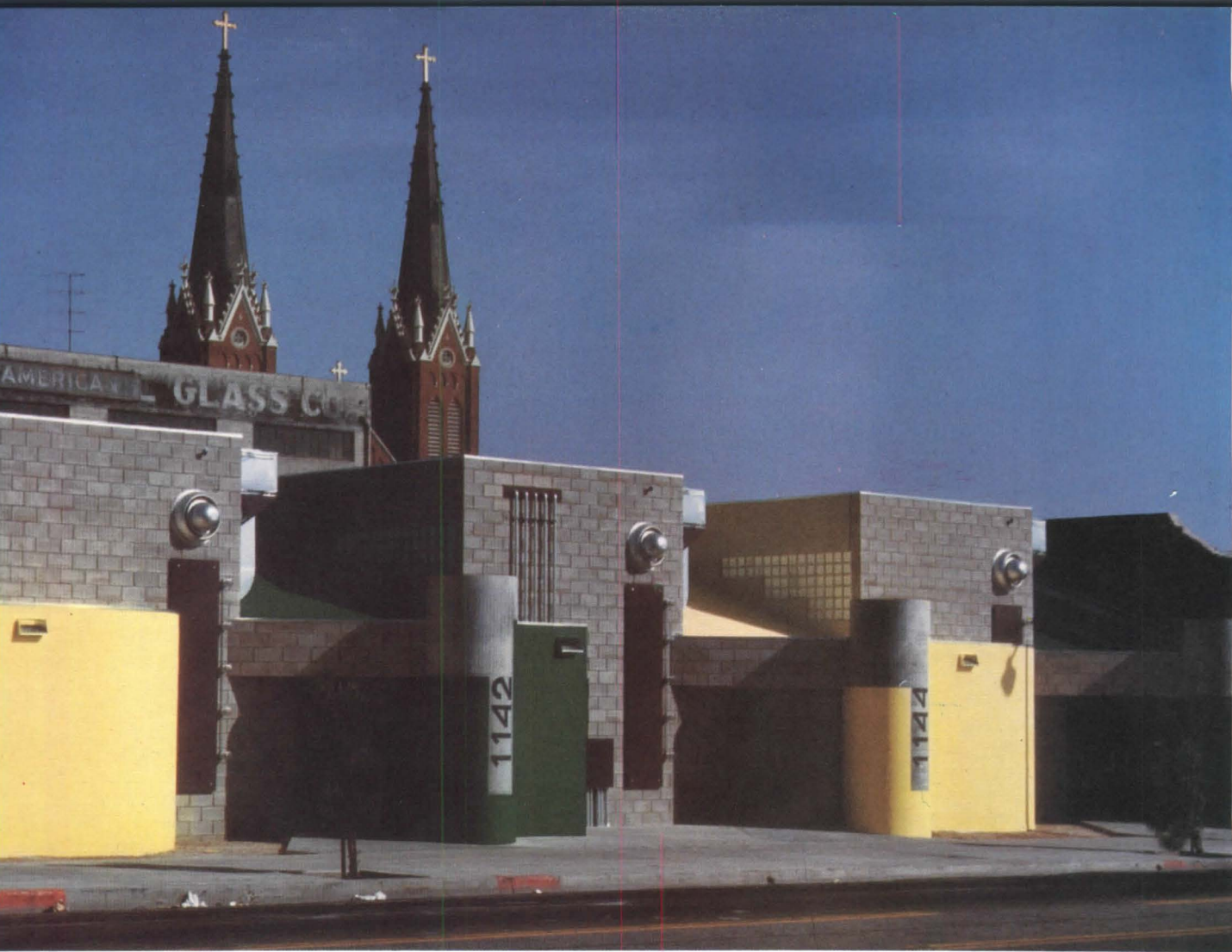

Wayne Thom Associates

# What's Next? *cont.*

of visitors each year. What should be next for the media of our profession—especially the journals and trade magazines—is a conscious campaign aimed at reminding our profession that the mass of ordinary citizens are much more impressed and affected by the impact of *that* built world than they will ever be by the latest corporate headquarters with a funny shaped roof, or the current style of architectural delineation in four shades of pastel pink and puce. It's time *our* media spent more space reminding *us* of the popular built world and how it might influence the work on our drawing boards instead of publishing esoterica.

*Young architects:* Rebuilding the obsolete infrastructure of our cities and recycling existing structures for new uses is going to be their turf. Despite the present fashionable but somewhat shallow attention given to the field of rehabilitation and restoration, the models to be emulated are still held to be the prestige building as an "architectural statement." So, young architects' attitudes and aspirations are distorted and distracted away from the real world by the values of their peers who still dream that they are free of these realities. Coming on the heels of five or six years at architectural school—which is typically staffed by the last of the great romantics, architects who are dreamers of the final design solution—it's going to be hard for young blood to get straightened out.

What's next should be a major effort to ensure that our young architects are exposed to learning the skills of designing within the existing fabric, improving energy performance and life cycle costs, performing design/build services for low budget jobs, efficiently managing people of different capabilities, developing solutions that are respectful of the history of their locations.

It probably all sounds very unheroic, and in a world dominated by the "hot" media event, it's sure to take some of the romance out of architecture. But that's probably what is needed most: a willingness to tackle the gritty problems, to help to clean up the public environment and provide the necessary leadership in the effort to conserve urban and rural resources.

---

## By Juan Pablo Bonta

---

Most architects feel that the energy crisis is the major problem facing us during the '80s. For how long this belief is to stay with us I do not know, but I fear we will continue jumping from one issue into another—be it energy efficiency, urban renewal, user participation or the death of modernism. It is essential that we learn to look at the larger framework within which such problems are only provinces.

The modern masters saw themselves as

the heralds of a new order; they thought that they knew which way society had to go, and felt capable of ushering it into that direction. This belief has been shattered since; but the energy crunch is making us feel again that we have an important role. We may regain a sense of mission, but no sense of direction. Unlike the masters, we have not picked our goals: We are responding to external pressure. This is how things ought to be in a balanced society; but for a generation nurtured in the dream of the architect as leader it is difficult to wake up.

The increasing cost of energy, along with other aspects of a worldwide process of redistribution of wealth, will force us to squeeze funds out of all the other items of the budget.

Faced with such prospects, many will continue to expect technological break-

## **'As expectations and reality fall further apart, fantasy will fill the gap . . . Disney World is only a token.'**

throughs to put us back where we were or better. Such faith may prevent us from responding to scarcity with retrenchment. The gap between perception and reality may grow dangerously.

Due to advances in communication and data processing technology, information is the one resource of which we may expect to have more in the future. Assuming that the consumption of information will not grow as sharply as the ability to distribute it, it follows that a few privileged information sources may tend to dominate the scene. It will be essential for architects and educators (as well as for everybody else) to understand the information market in order to be effective.

Image-designing may be the architect's most influential role in the years to come. With improvements in image dissemination, we are reaching a stage in which the social significance of images exceeds the impact of structures on their site. The next step may well spare us the real problems of building: We may design images of buildings and life styles to be fed into the information distribution systems. Users may then procure the necessary paraphernalia from the market, with little additional architectural services. Architectural endeavors chastized as escapism (Roma Interrotta the second *Chicago Tribune* competition and so on) may in fact be forerunners of this trend. Only one step is needed to legitimize such activities—to coordinate them with an infrastructure capable of providing the appropriate environmental products upon demand.

As expectations and reality fall further

apart, fantasy will fill the gap. Contrary to prevailing architectural philosophies, and very much within the spirit of baroque, materials and buildings will be used illusionistically to suggest worlds other than the real one. The building and entertainment industries (and later, the education system) will merge to provide electronic image and information processing environments. Disney World is only a token of what is to come.

For the last half century architects have alternatively tried the roles of visionary apostle, technocrat, social activist and taste-setter. Our professional identity has become blurred. It is imperative that we find a place for ourselves within the decision making system. Of the old roles, the most likely to survive is that of taste setter, because of its links to image production.

Whatever the identity ultimately adopted, it will entail a greater commitment to the social sciences—not only the traditional ones such as psychology, sociology and anthropology, but to newer branches such as semiotics and general systems theory. The latter is particularly appealing in its promise to unravel the multiple interactions among many complex social and physical systems.

Seen from the perspective of our long-range needs, the skirmishes between post-modernists, late modernists, exmodernists and the like seem rather unsubstantial. This is not to imply, however, that they are void of significance. We should study them to understand the undercurrents of architectural taste in a postindustrial society. We should approach the contemporary architectural scene with the detachment of an anthropologist watching a primitive society: not to take sides, but to identify the rules of operation of the system.

---

## By Thomas Hine

---

The architect in the 1980s has the opportunity to once again assume a civic responsibility. After decades of prosperity the portion of the environment influenced by architects has steadily shrunk and we face times of austerity. Architects are among those to whom society looks for guidance when it is forced to meet its needs as a society, rather than as a huge collection of individuals.

In recent years, architects have discovered the vitality of the shopping strip and the rich symbolism of suburban housing. Since fantasy had long been considered a sin by architects, its sudden respectability has induced an extreme response. Some have reveled in the new freedom, others have self-righteously continued to deny themselves while still others seem convinced it is still a sin, but have indulged nevertheless. But architects cannot compete very well in the environ-

ment of the shopping strip and the distant subdivisions. They may amuse one another, but they can never be as outrageous as real life. Architects may get a chuckle from a classically detailed discount house, but the next minute, some salesman will come up with a "Venetian" geodesic dome. (I received an advertisement for one this morning.)

Architects are left with the collective environment, the major buildings, public and ceremonial spaces that Charles Moore called "the public life." In his famous essay, he said that Californians are not willing to go beyond what they consider to be their private necessities to support what has traditionally been a fundamental task of archi-

### **'The architect has reacquired important responsibilities. The result should be more interesting buildings, and maybe even some beautiful ones.'**

ture—the provision of buildings and spaces that assert a collective identity.

Writing from Philadelphia which, as Moore noted, has an elaborate public life, I look at the relationship between public and private a bit differently. Most Philadelphians live in rather small houses with small yards. Many of the neighborhoods are monotonous. But we have a tradition of providing public squares, pedestrian walks, parks, buildings that make generous civic gestures and lavish festivals. Philadelphians' private domains are so small, they stream from their row houses at the slightest provocation to attend street festivals, dress up in feathers to march up the street as Mummies or cheer on the Phillies or Flyers. That great staircase that Rocky jogged up may discourage many from going to the Art Museum but there is a sense in which most Philadelphians see it as their front porch.

Such collective fantasy is transformed by sheer numbers into a special kind of reality—the kind that makes people willing to fight for where they live.

An austere America will be more like Philadelphia than California. Already, attached housing is predominating in many suburban areas. Big yards mean long commutes, which are becoming less practical in most places. The suburban strips architects enjoy are already archaic, having long since been supplanted by enclosed shopping malls.

In recent years, following the failure of large-scale urban renewal, America has shied away from ambitious projects, much as it has stayed away from foreign involvement after Vietnam. But just as we have begun to understand that we cannot abstain from world affairs, it is also clear that we must sometimes take a comprehensive view of

our surroundings. The lessons of the last decades should encourage architects to carry out this responsibility with modesty and to act in accordance with their newfound respect for the taste of their ancestors and their neighbors.

The bad news about energy has an even more direct effect on architecture, of course. It means that buildings will have to respond to their sites with "solutions" that are neither arbitrary nor standardized.

In short, it gives architects the opportunity to design. The buildings will have to interact with their environment, not deny it. The architect has reacquired some important responsibilities, and he will have to pay greater attention to the effects of what he does. The result should be more interesting buildings, and maybe even some beautiful ones.

It is likely, moreover, that this sensitivity to the environment will interact with a renewed civic sense to produce regional architectures. These will make use of the lessons of the older buildings of their areas, but they need not be self-consciously antiquarian.

Fundamentally, I believe that architecture is about to recover some of the sense of social responsibility it jettisoned along with modernism. Architecture by itself cannot change the world. But it is part of the world, and it is an enduring way in which change is expressed.

---

*By Richard D. Stein, FAIA*

---

Some monumental problems loom. Facing them, understanding them and solving them will determine the changing appearance of our architecture and will shape our philosophies and our teaching institutions. It is possible to list some of these problems and speculate on the directions one must pursue to overcome them.

Shortages of nonrenewable energy on a constantly increasing critical path is an important first influence. It is becoming increasingly understood that when one speaks of energy use in buildings, what is being examined is the entire philosophical basis for designing buildings.

The building must be thought of as the ameliorating membrane between the occupants and the conditions outside. The amount of building, the kind of building can be limited to what is required to permit the admission of what is desirable—light, air movement, heat, the absence of heat (cold)—and the rejection of what is injurious or unwanted—noise, odors, moisture, particles and various chemicals that may be airborne, and so forth. It is becoming apparent to more and more architects, to judge from the new work appearing in some of our architectural magazines at home and abroad, that buildings can be designed to permit the skillful manipulation of environmental conditions. The appearance of these buildings is beginning to suggest that this new area of concern is a liberating rather than a restricting element in the design process.

Here, a word of caution may be in order. As long as these problems are faced as program conditions that require solutions, the forms used will, in themselves, have an ap-

propriateness and a clarity that will be self-evident. (The awnings that shade windows on a south-facing facade are obviously there for their contribution to the comfort conditions in the building.) When and if these same devices are used symbolically, or referentially, they not only lose their meaning, but they destroy the basis for making other significant design decisions. When a *brise-soleil* is introduced only to give plastic interest to a facade rather than to control sunlight, architectural design degenerates into pattern-making.

With diminishing use of private transportation, the growth and increasing density of cities will resume. The patterns will differ from those described earlier, however, and will be more closely related to mass transportation networks of considerable versatility. Here, too, precedents exist. The extension of subway lines in American cities has stimulated speculative apartment development and commercial centers near stations. In some European cities, Stockholm for example, the planning of the subway extension included the planning of new satellite subcenters. This will, or should, affect the kinds of practice and the nature of education and re-education.

In the past five years there has been an explosion in the amount of information that has been uncovered concerning how buildings operate. The patterns of energy use in different kinds of buildings are just beginning to be understood. How windows operate, how buildings breathe, how light is reflected and redirected, what constitutes a pleasant thermal environment, how a building responds to the constantly shifting solar impact are all at thresholds of better understanding. This new information becomes a formidable design tool, and, as noted earlier, if it is not picked up and used by the architects, it will be by some other group.

We have seen the building industry start to shift from materials that are becoming scarce to others that may be momentarily abundant.

### **'It is becoming understood that when one speaks of energy use in buildings, what is being examined is the entire philosophical basis for designing buildings.'**

The situation requires several levels of understanding that affect the design process. First, if each material is used appropriately and only in the quantities required to perform its assigned task, it will go considerably further than it now does. This, in turn, leads to the more elegant use of the material. Second, if we understand the comparative commitment of energy represented by each choice, we will be able to make reasonable choices among alternatives. This is a situa-

**Mr. Bonta** teaches architecture at Ball State University and authored books on Mies' Barcelona Pavilion and on architecture and its interpretation. **Mr. Hine** is architectural critic of the *Philadelphia Inquirer*. **Mr. Stein**, a New York City-based architect, is the author of *Architecture and Energy*.

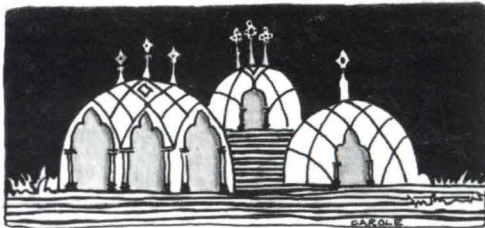

tion that we can expect to become more critical in the years ahead as our own metal and ore extractions become more difficult, our lumber industry becomes less able to satisfy small building requirements, sand and gravel banks become depleted, water supplies diminish and minerals like gypsum are no longer easily available.

And if the problem facing architects seems formidable in terms of our own internal building requirements, it becomes much more awesome if looked at globally. If starvation in Africa and Southeast Asia has been a reality these past years, all logistical problems, including the provision of shelter for a possible two billion increase in population in the next couple of decades, will bring with it an unprecedented requirement for new criteria for what is built where and what materials and services can be assigned.

These are the external realities that will shape our building product in the next decade. They will make the preoccupation with postmodernism inconsequential. I believe, however, that certain underlying attitudes, rather than forms, that were expressed in the '20s and '30s may well be precedents for the new architecture of the '80s.

---

### By Sarah P. Harkness, FAIA

---

Recently, a friend quoted her daughter as saying, "I'm *tired* of being a child of the '60s!" The daughter has been doing those wonderful, alternative, sociological, artistic, small-is-beautiful things that children of the '60s believed in, and doing them exceedingly well. But it's a struggle, and she's lonely.

Did we not listen? Or do we not have the courage to listen? The '60s generation kids grew up with a mushroom cloud hanging over their heads, and then they found that "atoms for peace" was a delusion. They indicated another direction—toward living with nature instead of conquering it—but such a turnabout has to reverse the flywheel of history.

Is this the reason architects have been so slow to catch on? The modern movement began with clarity of purpose and openness to form, but gradually changed to fuzziness of purpose and stylism of form. In the meanwhile, all but unbeknownst to the architectural fashion magazines, there are people (respectable people, too) who are living quite comfortably with only the sun and a woodburning stove to heat their houses. They're enjoying life as never before. In addition, there's been a ground swell of small-scale farming; the poor, the elderly, city dwellers and suburbanites are growing tomatoes in their backyards, on roofs and balconies and in greenhouses. What does that have to do with architecture? A great deal, I would say, unless we think we can exist on a cloud.

I don't know what's next. But I do know what I'd like to see. I don't really care whether the 45-degree angle is replaced by the wiggle, but I'd like to see either one used toward some end other than fashion. I'd like to see an architecture that *makes sense*, and does so gracefully. To make sense could be by far the most exciting thing to do. Who cannot be turned on by *Ralph Knowles'*

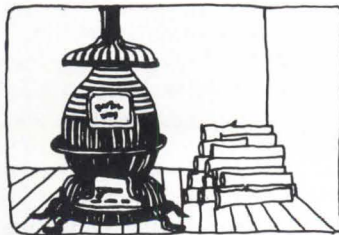

solar envelope concept (AIA JOURNAL, February 1980), which would bring new form and human scale and orientation as well as energy solutions, to cities. As someone at the Moore, Grover & Harper office said, "The more problems you solve, the better the architecture."

The handwriting is on the wall, or at least in every newspaper. "What's Next?" is not as evident as it should be, but it's becoming more so.

---

### By James Pratt, FAIA

---

I am bored with the universalism of the International Style which was for so long a part of the excitement of architecture just after World War II. Then everyone wanted to try out the prefab part or new material, applying it ad infinitum as we went about sealing up and lighting up and attempting to celebrate technology in esthetics. Now I sense a new excitement in expressing the uniqueness of a place.

Recently I heard the following process described for creating an environment: A Texas retailer had his *New York* interiors consultant recommend a *Japanese* working in *Cambridge* to produce an important sculpture for his *Los Angeles* store. This process may produce a marvelous and novel answer, but it is certainly not one growing out of, or part of, a culture of a place. It now seems that buildings should not be universally alike in style, and certainly it makes no sense as a response to energy conservation that environments in North America built at 42 degrees latitude look the same as those built at 35 degrees and even 20 degrees latitude.

The architect is going to be wrestling with four conditions in the '80s: A more sophisticated public; a building dollar stretched to cover yet more equipment and compulsory energy management; shifting economic power bases and economic turbulence, plus the effects of unassimilated knowledge gained from the sciences.

*Sophisticated public:* Our management consultants are telling us that corporate clients are becoming more sophisticated in demanding design and technical prowess. Iowa has passed a recertification law, the AIA is debating compulsory rereading for membership and a few states have passed environmental education laws. All this suggests more knowledgeable clients, requiring us to be better prepared. There is a tendency on the part of clients to see us as specialists in one kind of building design or another. What we had better be sure of is that we do not allow ourselves to be specialized into corners where our generalist contributions are no longer used. A specialist is vulnerable to elimination with change, whereas a generalist is not.

*A stretched building dollar:* I hope our

energy problem will force us away from short-term shoddy materials and craftsmanship, but I am pessimistic. The allocation of building resources is going to go more and more to equipment as we continue to hook our environments up electronically and reduce energy demand. This means that funds allocated to serving traditional values in architecture are going to be even scarcer than now.

*Shifting economy:* With multiple air transport entry points into the U.S., the economic hegemonies of port cities created by ocean transport will give way to more economic power bases, which will come to be reflected in more pluralism in architectural ideas. Houston, closer to Latin America in orientation and latitude, ought to come up with very different architectural answers than New York City. The '80s will further exaggerate the differences between conservator societies in older parts of the country and growing communities in younger places. Economic turbulence has always been the condition under which new design happened, so we may look to some of our young frontiers for fresh design ideas. This could mean that Alaska, Australia and South America may sneak up on us, as Japan has already. It is hoped that the sun belt will flower.

On the other hand, in depressed areas, a different kind of design opportunity may arise: In needy times, suddenly people depend on each other; expressions of community may come back as happened in the CCC days of the depression (whereas booming areas will still tend to be incohesive, and laissez-faire in their resulting individualistic communities). We certainly need a new emphasis on the context of visual design to overcome what Rene Dubos calls our emotional and physical junk heaps of cities.

*Effects of new knowledge:* I am pessimistic about our knowledge of and interest in new information generated by the sciences.

## 'We must not allow ourselves to be specialized into corners where our generalist contributions are not used.'

We architects suddenly have a lot to learn from ethnologists, urban anthropologists and psychologists: how we perceive things, how real people use space, how we live with each other and how we live in nature. The challenge to the generalists among us is to stay up with new knowledge, to know the net impact of its effects, so that we can cover more bases when we synthesize functions into form. We are not trained or psychologically ready to apply in a sophisticated way the nuances of sociology or biology to the environments we make. We have not learned that many of our creations—less dramatic failures than Pruitt-Igoe—do not serve specific humans; we continue to make the same mistakes in shallow programming for abstract prototypes.

Despite the negative harbingers, I am intrigued and heartened with the challenge to create unique environments—each with a sense of place tied strongly to its specific regional and urban context.

---

## By Donald Watson, AIA

---

A decade ago, the facts were known and were published in a report of the AIA energy committee: Energy conservation through building design can save as much energy by 1990 as will then be available from either our domestic oil or gas reserves or from our nuclear plants now on line or projected for construction.

Ten years later, the facts have made this message all the more urgent: Even at an annual fuel cost rise of 15 percent (low by today's trends but unheard of a decade ago), the operating costs for buildings will double every five years. As a result, many buildings being designed and built today will be unaffordable to operate by the end of the century. Because energy costs are also the driving force behind general inflation, we are in a double bind: There is insufficient capital

### **'Dilemma, but also opportunity: Good energy design can be more beautiful because the result is in balance with the specific climatic context and solar geometry.'**

available to invest in energy saving improvements for existing buildings or to allow innovative energy techniques to be incorporated into new designs, even if justified by life cycle costing.

While these facts pose desperate dilemmas, they also offer a unique opportunity. Through energy design, architects can reassert their traditional concerns for humane habitat, revitalized cities and a balance between the natural and the built environment. Energy conservation as a process of restoration is the basis on which to view any project, for an old or new building: restoration both of the site as part of a community environment whose interconnections have been too long ignored and of the design act itself as a creative contribution rather than a destructive burden to the earth's ecological balance.

The architectural drawing style that is currently in vogue emphasizes the dream-like quality of the idea, with artifacts isolated from their context, and with coloring and cloud images that recall the style of surrealist painting seven decades ago. Rather than connecting with reality, this is a vision that separates us from it. Less publicized are the architectural projects through which many designers have increased their confidence to connect with the reality of building and energy. Buildings are being designed that demonstrate that good energy design does not have to cost more than conventional construction, that buildings can be operated with one-fifth or less the amount

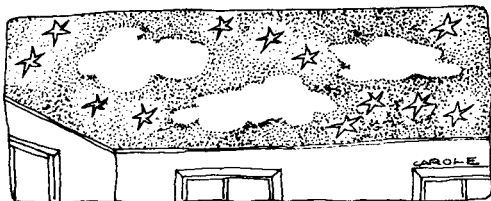

of nonrenewable energy and can be *more* beautiful because the design result is in balance with the specific climatic context and solar geometry of the building and orientation.

Currently, these ideas are not generally acknowledged by the architectural profession. Let us hope that by the end of this decade innumerable examples will have shown them to be irrefutable.

---

## Charles H. Brewer Jr., AIA

---

The lessons we can learn from history which are applicable to the profession of architecture seem clearly to indicate new requirements for public responsibility and should leave the neomodernists leapfrogging toward new territory.

History reminds us that all styles of architecture have three stages of development: the early period, the high period and, finally, the flamboyant, which no longer responds to the needs of society.

One only has to look at the present state of published architecture to see signals of decay.

Michael Thompson's article, "The Architect's Dilemma," in *Design, Methods & Theories*, applied the catastrophe theory to the architectural profession and found public disinclination to be an indication of a "cusp" position on the catastrophic curve. His recommendation was, "Stop trying to get the public to join you and instead join them."

Process, which allows for change and growth, as opposed to methodology, can provide the way to get back in touch with the needs of society and to understand form

### **'Lessons we can learn from history should leave the neomodernists leapfrogging.'**

as a *prelude* to design. The credibility of the architect in the future will be measured by society's willingness to perceive his work as authentic and responsive to public concern, regardless of financial sponsor.

This process of architecture defers the conceptual effort until information is acquired which is very difficult for a designer to comprehend. Consequently, few are inventors, usually many, many more are implementors, once the way has been made clear, and few stay around for the last hurrah.

We need now inventors to again start the process; to relate task to form and form to design. We need architects who recognize

**Mrs. Harkness** is a partner in the Cambridge, Mass., firm The Architects Collaborative and is a former AIA vice president. **Mr. Pratt** is a principal in the Dallas firm of Pratt Box Henderson & Partners. **Mr. Watson** is author of *Designing and Building a Solar House: Your Place in the Sun* and editor of *Energy Conservation Through Building Design*. **Mr. Brewer** is chairman of the department of architecture, Ohio State University. **Mr. Goody** is a principal in the Boston firm Goody, Clancy & Associates, Inc.

the power of all facets of our cultural condition to provoke or determine its form, architects who understand that to design even a simple bus shelter we need to know where the bus is coming from and whom it serves.

In order that architecture might again become a public art, the process of design must be truly inclusive and transdisciplinary, weighing in the balance of decision the traditional physical generators of shape with those that clearly describe what needs to be shaped. Architects now in the last stage of the historic cycle, becoming evermore personal in their design, see this not as an opportunity for discovery of new architectural ideas but as anathema, an expression of confusion, a lack of ability to know "what is right"—long a cornerstone of effective behavior and bravura of the artist. For the public user, however, this may be viewed as an opportunity for participation.

---

## By Marvin E. Goody, FAIA

---

Architecture has always been influenced by a variety of determinants—from local climate to available resources, from social patterns to client preferences. The architect has been called on to be the arbiter of these often conflicting forces and very often expected to evaluate and resolve them almost intuitively.

With the emergence of the institutional and governmental client, this public view of how the architect works has been changing. In the 1980s we face a welter of legislation and officially regulated criteria, strict zoning ordinances, energy budgets, preservation standards, sequential design review procedures, etc., and in most cases a multi-headed client. Community groups and/or ultimate users, funding agencies, local authorities have all become members of the client-team in the government-sponsored project. Private institutions (if not relying on government funds) have also come to recognize the many constituencies their projects serve and have learned to give representation to all on their client-team.

The architect of the '80s will have to deal creatively with the complicated and sometimes conflicting criteria that often result from the complex client. Increasingly, the form and character of the built environment is being dictated by decisions made outside the design office. If the architect, therefore, is to remain a creative force in shaping the building of the future, she/he must play roles other than that of the traditional designer.

Those architects who will write the legislation, design zoning ordinances, conduct design reviews and act as client for major institutions and agencies will have a profound effect on the design quality of the buildings and neighborhoods of the '80s. This new emerging role will be extremely demanding and will require professionals of the highest creativity and integrity.

For those architects who continue in the design offices, I see a new design dialogue (between designer and client) born of the more rational criteria set forth by the "client architect" and leading to design solutions of great beauty.



Balthazar Korab

The Institute's highest design honor this year went to 13 projects out of 412 entered. Seven are new buildings and six old ones put to extended use. The two categories were judged by separate juries.

Each of the new buildings is of a different type. There is a factory, a church, housing for the elderly, a laboratory, an office building, a telephone switching center and a hospital (photo above). This was not intentional, however, according to Frank Tomsick, FAIA, chairman of the jury for new work. The buildings were not judged in categories and "these were the only buildings the jury could agree on."

The winners tilt toward slick and high-tech, but two "recall historic colonial form," in Tomsick's words. Nevertheless, he said, "the same quality of design was represented" in all of the winners.

Siting and "the idea that a project should give something back to its community and its setting" were major considera-

# The 1980 AIA Honor Awards





tions in the minds of the jury, Tomsick said, as was energy consciousness. "Most of the winners were designed by firms located near the projects," he noted. "All are responsive to community needs."

Other members of the jury for new work were Bruce J. Graham, FAIA, Chicago; John Graves, AIA associate member, Berkeley, Calif.; Jane Hastings, FAIA, Seattle; Thomas H. Hodne, AIA, Minneapolis; David V. Maudlin, architectural student, Miami University, Oxford, Ohio, and Donald L. Stull, AIA, Boston.

The extended use jury, according to chairman James L. Nagle, AIA, of Chicago, was disappointed in the quantity of submissions, given the amount of activity in this field around the country. It felt that one reason might be confusion among architects about whether the extended use category covered "restoration, renovation, adaptive reuse, reconstruction, remodeling, recycling," or all of the above. It does indeed cover all.

However, the jury felt that the quality of submissions was high. Fully half survived the jury's first review for further consideration. The projects were weighed on the bases of "both idea and result," Nagle said. "Was the concept sound and how well was it done?"

"The virtue of restraint in restoring existing structures often was set against the architect's new design approach," he noted in his comments.

Other members of the extended use jury were Frances Halsband, AIA, New York City; Jerry Hahn, AIA associate member, Palmer, Alaska; Joseph C. Mancuso, architectural student, Princeton University; Herbert Newman, AIA, New Haven, Conn.; F. Blair Reeves, FAIA, Gainesville, Fla., and Sally Woodbridge, preservationist and architectural historian, Berkeley, Calif. Eleven of the 13 winners are shown on the following pages. The other two are on pages 156 and 169, respectively.

*Mary E. Osman*



Balthazar Korab

## A Hospital Achieves Rare Levels of Design and Amenity

Hospitals are among the building types most unlikely to produce good design. Their technical and program requirements are complex and sacred: When life is at stake, no liberties can be taken for the sake of order or appearance. In other words, form really *has* to follow function, and we all know how limiting *that* can be. A handsome hospital is therefore an especially admirable achievement, and a hospital that is also bright and jolly, as in the present case, is even more rare.



*Cruciform building elements, left, are enlivened with curved forms, air exhaust shafts sheathed in black, office and library areas in yellow. Concrete wedges, right, provide light and air for tunnel.*

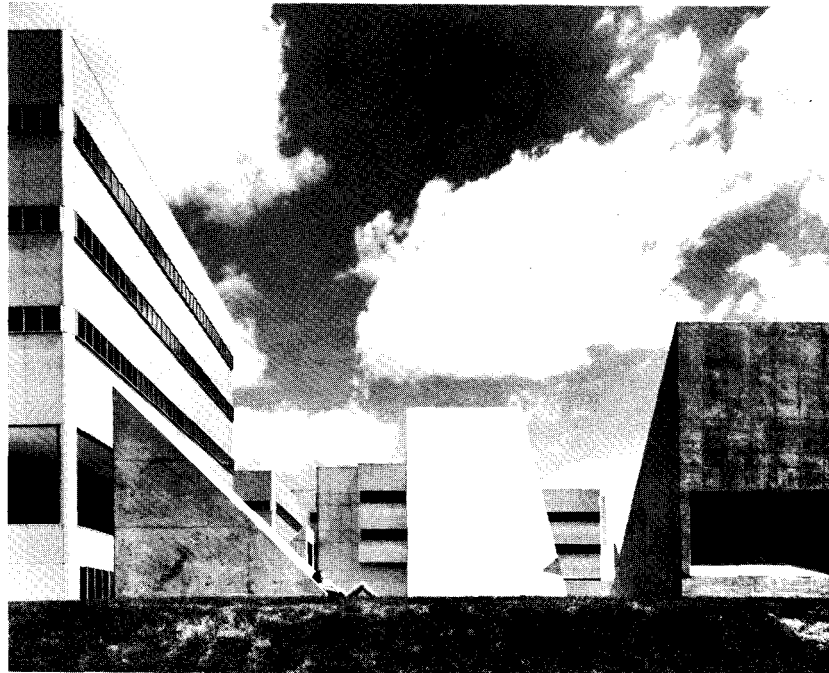
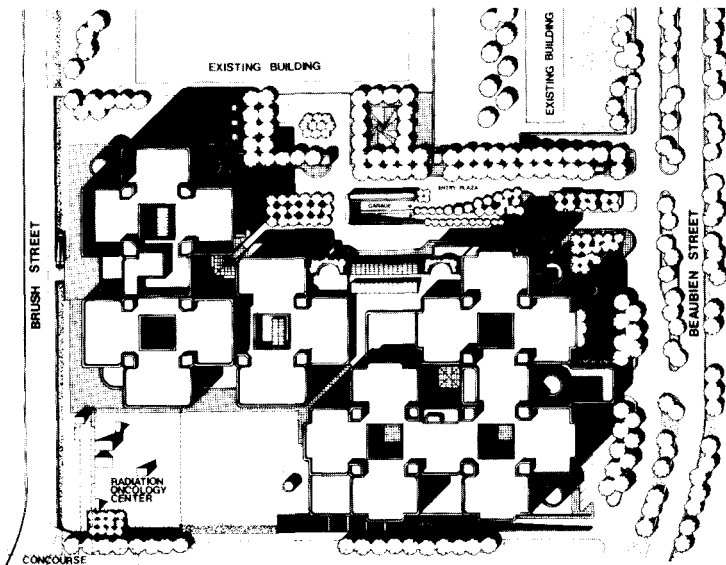

Balthazar Korab

Part of a giant medical center near downtown Detroit, the building is in three parts: the Wayne State University Health Care Institute, an eight-floor wing for teaching and for outpatient clinics; the Detroit Receiving Hospital, a five-floor emergency hospital including a prisoner care unit, an adult burn unit, a coronary care unit and other facilities, and the Detroit Medical Center Concourse, an underground tunnel that ties the new building to several older parts of the medical center. As a further complication, the architects are a collaboration of three firms: William Kessler & Associates, Inc.; the Zeidler Partnership, Ltd., and Giffels Associates, Inc.

The architects have devised a single cruciform building element that works as a basis for all the new construction, and, so far as one can tell at this stage (the clinic wing and tunnel have

been in use for a year; the outpatient wing is not yet fully in use), it will work very well. At the joints between arms of the crosses are shafts of mechanical services sheathed, where they are visible on the exterior, in red-orange porcelain panels. Sheathed in bright yellow panels are half vaults that cover ground floor offices and administration areas and—a particularly pleasant room—the reading area of a medical library.

Where the arms of the crosses touch, they form square light wells, each of which is to house sculpture. One tall well already holds a series of brightly colored dacron ribbons designed by Anne Healy and assembled by sailmakers from Newport, R.I., and another holds a composition of balls on metal rods by Joseph Kinnebrew. These are only part of an ambitious privately supported art program that adds immeasurably to the building's



Balthazar Korab

### **Visual enrichments and a science-fiction tube.**

character; included are graphics by Calder, Matta, Karel Appel, Pierre Alechinsky, Robert Indiana and others.

Also welcome is the fact that a series of concessions—a delicatessen, a branch bank, an optometrist, a travel agency, etc.—is given room on the ground floor to counteract the usual institutional character of a hospital. Bright colors throughout—in seating, in elevator cabs, in niches and cabinetwork covered in plastic laminate—also contribute to this effect.

Such are the uses of adversity (in the right hands) that the complex's most delightful space is its underground tunnel. For most of its length an exemplary science fiction metal tube, it is

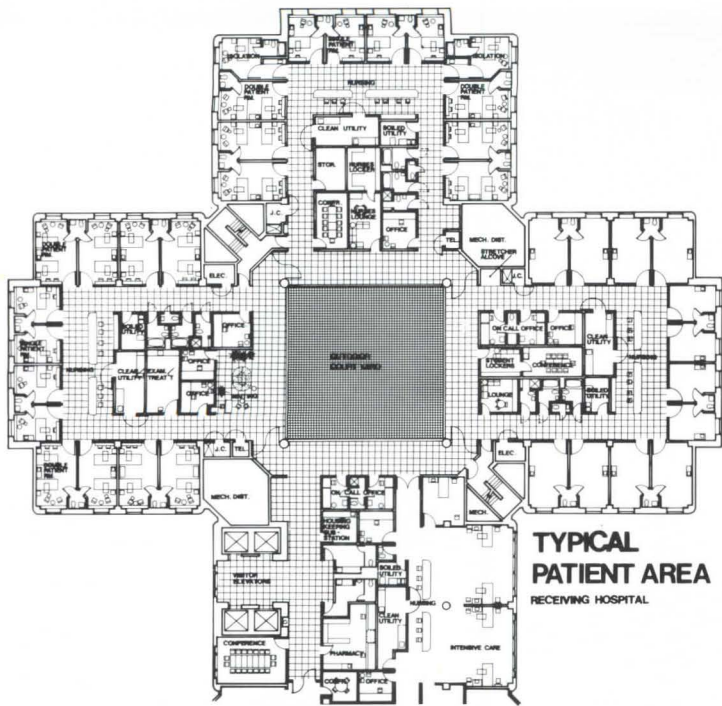

**TYPICAL  
PATIENT AREA**  
RECEIVING HOSPITAL

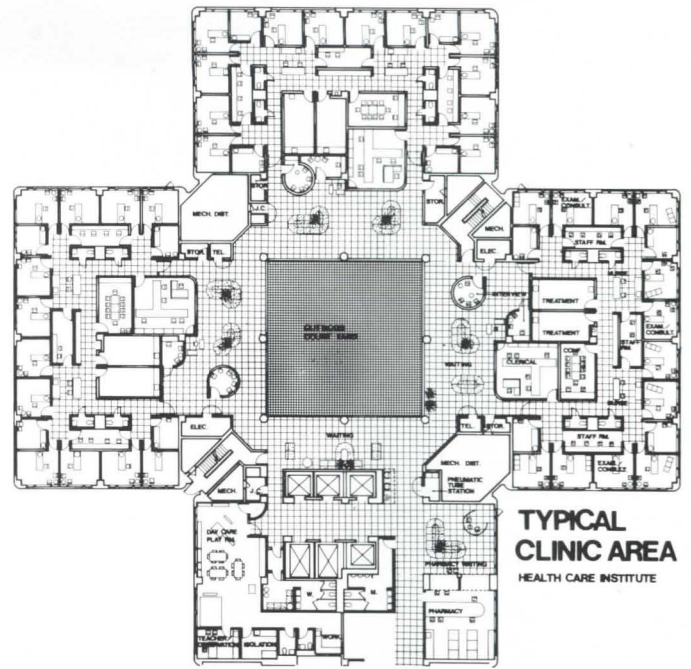

**TYPICAL  
CLINIC AREA**  
HEALTH CARE INSTITUTE



©Timothy Hursley/B. Korab Ltd.

brightened at its intersections by great mirrored periscopes that punctuate the ground above with concrete wedges and that provide the tunnel with unexpected views of the landscape above it.

Although, in its exterior skin of aluminum panels with rounded corners, the building owes something to Richard Meier's Bronx Development Center, the Detroit complex has a powerful repetitive order very much its own, a bold and generally welcome use of color and, for a hospital catering to largely indigent patients, a heartening commitment to quality and pleasure.

Client: Wayne State University (State of Michigan), City of Detroit, Detroit Medical Center Corporation. Landscape architect: Elon Mickels Associates. Construction manager: Turner Construction Co. Completed in 1979. S.A.

*Waiting area for pediatrics section, far left, is designed for appeal to children. Cruciform plan of typical unit, top left, provides good relationship between patient rooms and nurses' station but avoids monotony of long corridors. Underground tunnel, above, connects new buildings to each other and to older parts of the medical center.*



Balthazar Korab

*Within one of the yellow-sheathed tubes, visible in photo on opposite page, is the skylighted reading room of the medical library, above. Right, Anne Healy sculpture of dacron strips brightens an interior courtyard.*

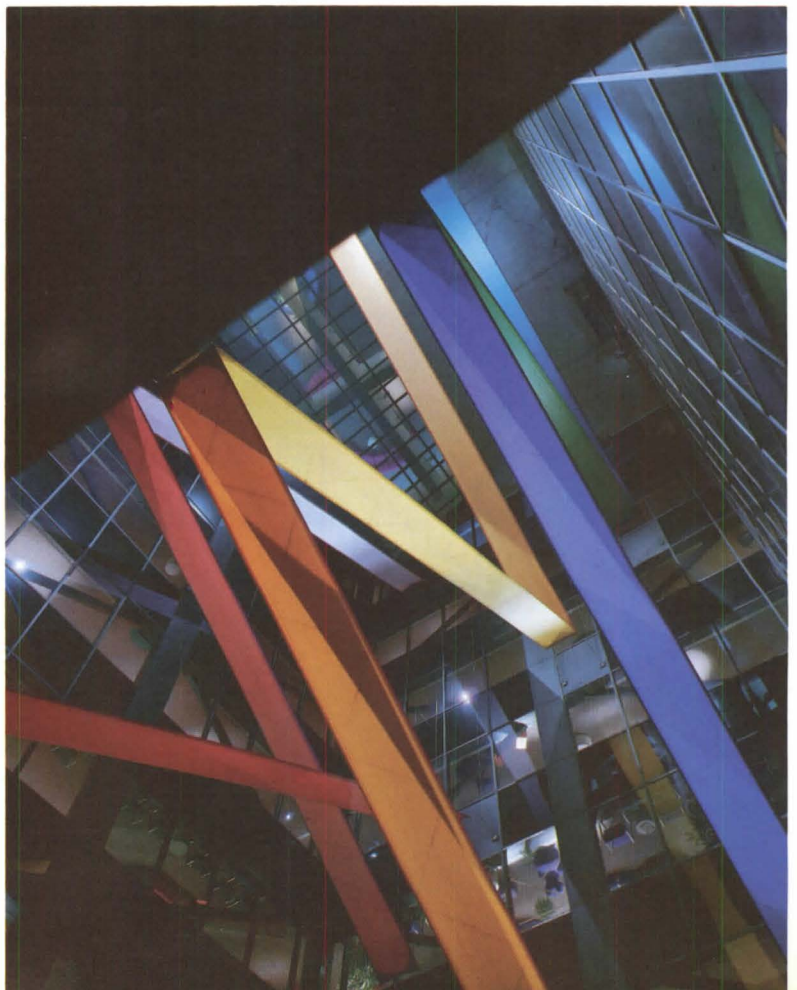

Balthazar Korab





Jon H. Rhind

## 'Calm Excellence' in a Retirement Housing Complex

"If you have to go to a retirement home, this is the place to go," said a jury member about Heaton Court, a housing complex for the elderly in Stockbridge, Mass. Designed by Goody, Clancy & Associates, Inc., of Boston, Heaton Court was praised by the jury for its "delightfully planned courtyard, careful detailing of traditional forms and materials, simple shapes rich in texture" and its subtle integration into the landscape. Located on a site previously occupied by a rambling resort hotel, this low-income, government-subsidized housing for the elderly fits neatly into its small town neighborhood, evoking the character of the once-enjoyed leisure hotel whose remembered amenities include such things as long porches and rocking chairs.

The program called for 50 one-bedroom units, spaces for congregate living and parking facilities. The units and communal facilities are clustered around a courtyard that is linked by continuous porches and galleries, providing covered passages and smooth walking surfaces for its dwellers. All entries, living rooms and dining areas face the porches on the active court side, giving everyone—even the housebound—a view of

this lively area. Bedrooms and baths are on the quieter side, away from the court.

Paths wind uphill from the town center, letting the residents stroll easily and then sit on benches to rest and enjoy the plantings. Parking is provided on the uphill side on a level with the second floor. At this level, bridges connect the porches and galleries, permitting the three-story buildings on the north side to have units that are only one flight up or down. The one-story buildings on the south allow the sun to penetrate the courtyard and open spectacular views of the Berkshire Mountains.

All community facilities are barrier-free, and persons in units for the handicapped feel no separation from the others, although they have proximity to the parking area—and better views. All the units have at least two exposures, creating cross ventilation and eliminating the need for airconditioning. The buildings blend into the landscape, helped by the cedar clapboard siding that is stained in earth tones. The amenities, said the jury, include "raised planters (easy to reach, but not too many to maintain), a vegetable garden (but not a farm) and strolling park-like walks (not just circulation paths)." All combine and add to the "low-key, calm excellence" of Heaton Court.

Client: Stockbridge Housing Authority. Structural engineer: Souza & True. Mechanical and electrical engineers: Reardon & Turner. Landscape architect: Goody, Clancy & Associates, Inc. General contractor: George E. Emerson. Completed in 1978. *M.E.O.*





Clemens Kalischer

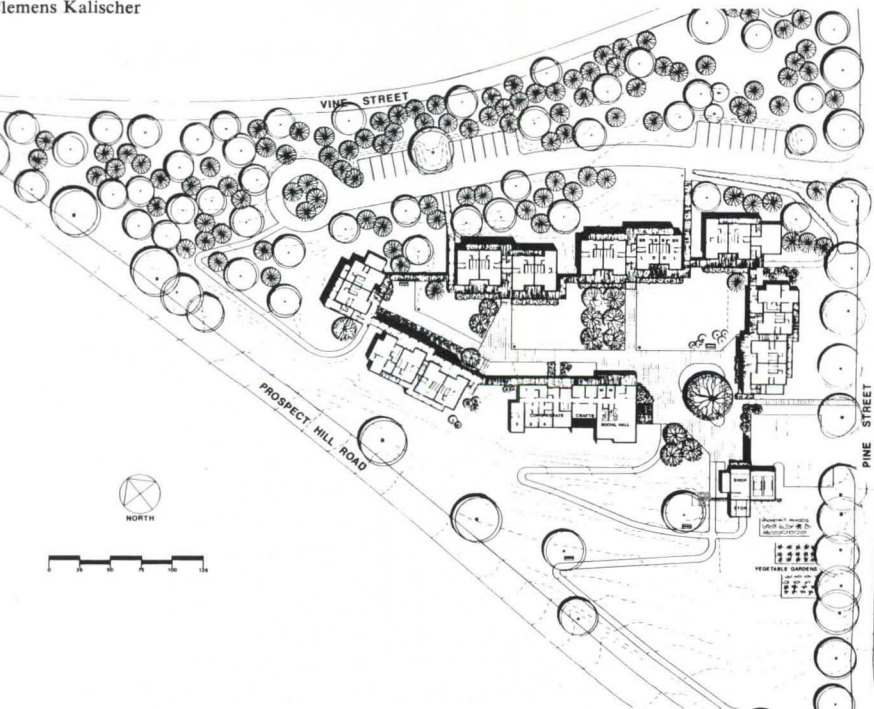

Clemens Kalischer





Clemens Kalischer



Clemens Kalischer

*In form, the sprightly, angular buildings clearly express their New England ancestry. The muted clapboard walls are crisply outlined in white, accentuating the angles.*



Saari & Forr

## Traditional Forms in a Suburban Church Complex

The five gabled-roof buildings of varying volume of the Colonial Church of Edina, Minn., resemble a New England town square. Designed by Hammel Green & Abrahamson, Inc., of St. Paul, Minn., to house a sanctuary, seminar rooms, lounges, offices and a fellowship hall for a nondenominational congregation, the simple forms, says the architect, are "symbolic of a Puritan religious heritage." The congregation, which had outgrown its existing facility, a neo-Georgian structure, wanted a variety of multiuse spaces appropriate for its programs that reach beyond the church into the community, and "colonial" buildings expressive of an architectural and religious past. "The continuity of gable forms, white trim and rich gray mass create the harmony of a perfect village square," the jury said. "Traditional forms and materials are clearly, simply and boldly used." Although the design recalls a long-ago past, the complex "responds to modern energy needs and modern user requirements."

Located on a swampy site within a protected watershed district, previously ignored by developers because the area was

considered too difficult for construction, the complex is conscientious in its preservation of the neighboring wilderness—an attitude viewed by the architect as a "moral as well as a legal necessity."

The buildings, which rest on grade beams and piles, are linked by a canopied colonnade that becomes an enclosed "main street." The street opens onto a central outdoor court whose focus is a bell tower.

Materials and forms, appropriate for the congregation's religious and historic traditions, are highly functional for a region where there is severe climate, often with heavy snows. The many operable, oversized, double-hung windows reduce the scale of the structures, fitting the complex into its residential neighborhood. They are also energy conserving, admitting natural light and ventilating the interiors. Shutters are used to block solar gain. The exteriors are bleached redwood clapboard siding. On the interiors, the exposed posts, beams and trusses give a feeling of warmth and strength. The jury called the design "subtle" in its response to user needs.

Client: Charles A. Geer. Structural engineer: Johnston & Sahlman, Inc. Mechanical and electrical engineers: Hammel Green & Abrahamson, Inc. Landscape architect: Hammel Green & Abrahamson, Inc. General contractor: Kraus-Anderson of Minneapolis, Inc. Completed in 1978. *M.E.O.*

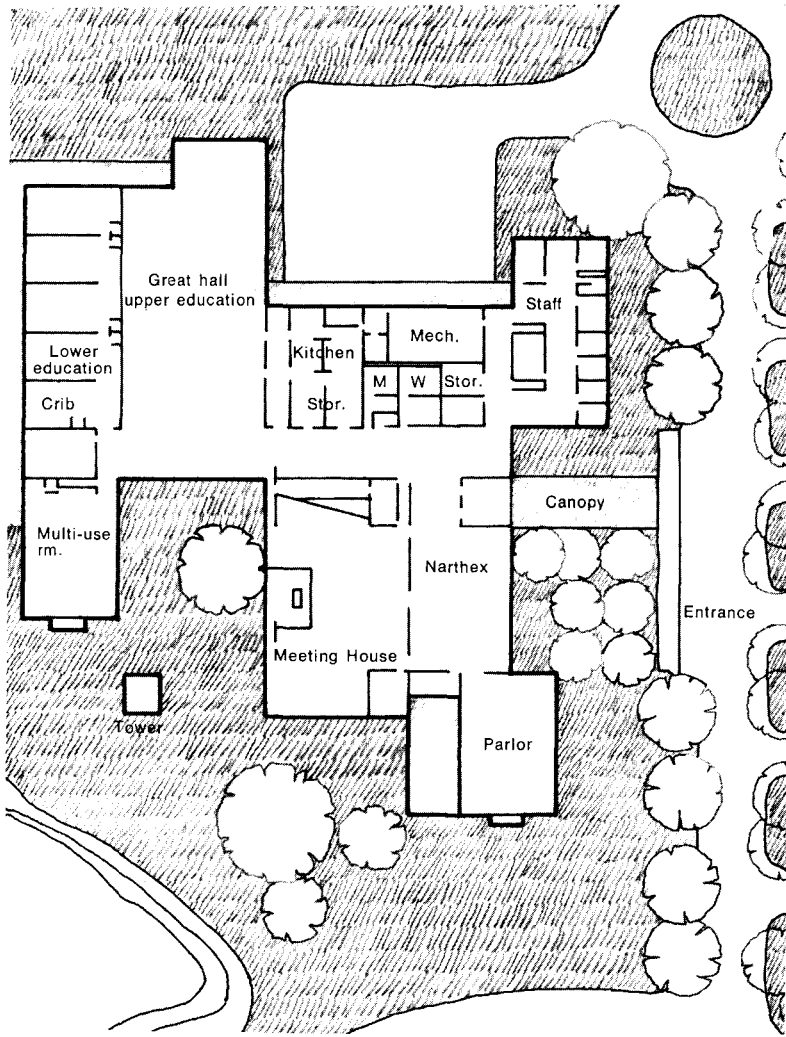

*A New England past is recalled by the simple forms, sloped roofs and wooden construction—as appropriate and functional today as long ago. Multiuse spaces, designed to serve contemporary life and aspirations, are united, yet distinct, allowing many different activities to take place at the same time. The identifying feature of the landscape is the bell tower (bell and spire are planned for future donations). The interior of the sanctuary in its simplicity (across page) is also reminiscent of a Puritan religious heritage.*

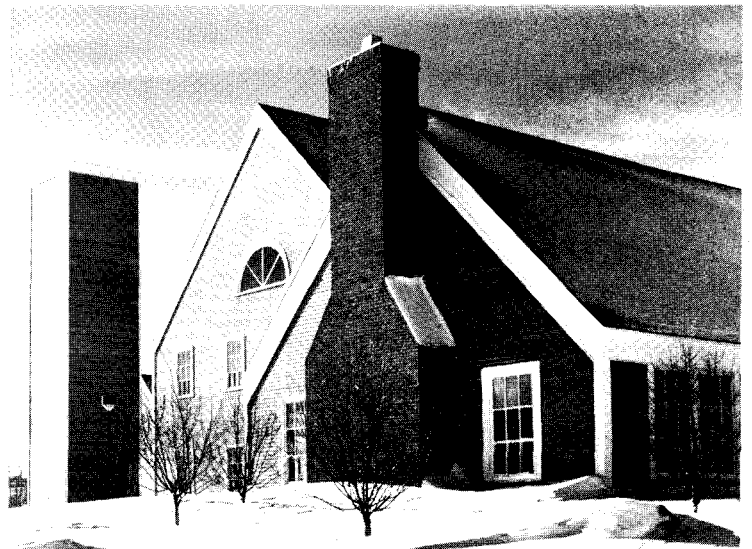

Saari & Forrai

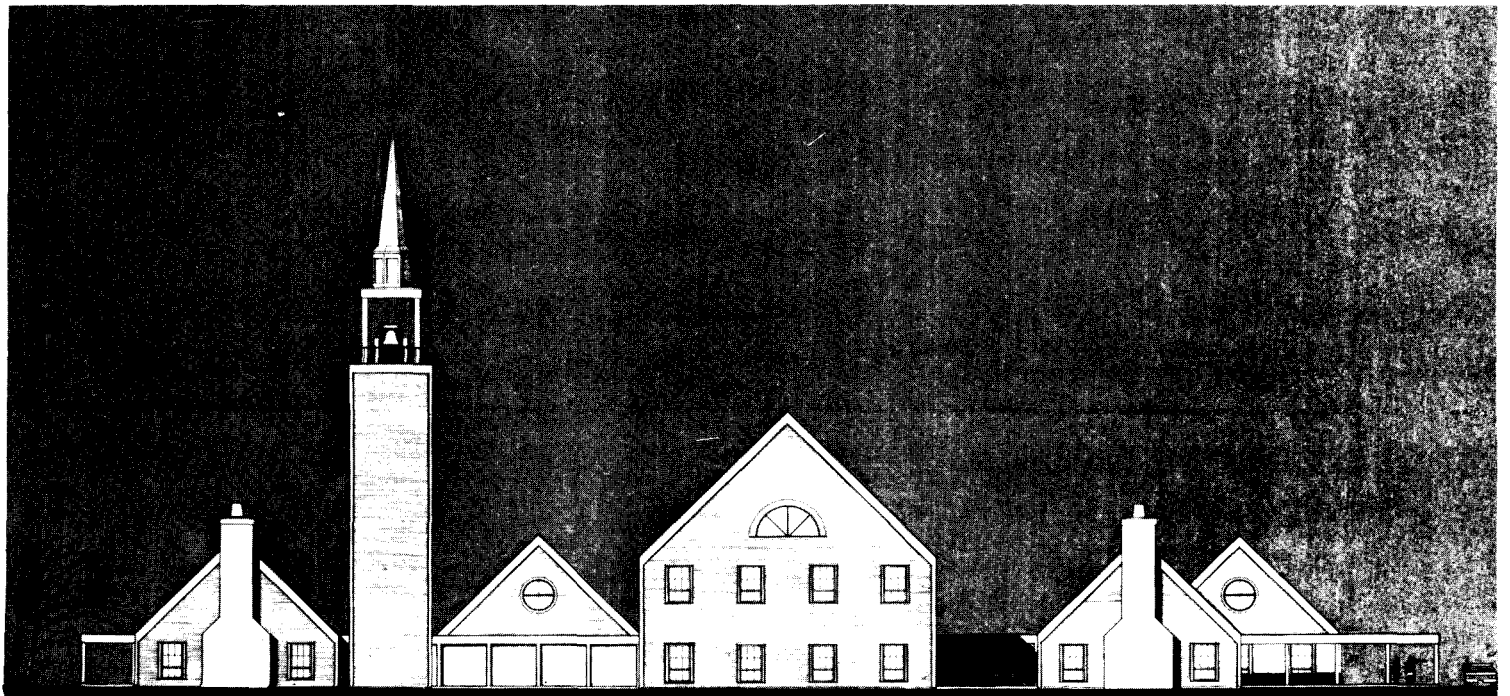



# Strong Forms and Colors And a Central Shaft of Light

The word "factory" usually conjures up thoughts of sweatshops—unattractive places where the environment in which workers spend a good portion of their lives is disregarded. But the multi-use building of Qume Corporation in San Jose, Calif., provides visual order, color, natural light and plantings that are enjoyed by everyone, whether the workplace is in an office or at the assembly line. The building, designed by Hawley & Peterson of Palo Alto, Calif., focuses on a central arcade, with a landscaped atrium lit by a skylight of insulated, translucent panels. Color is provided—and movement ordered—by the exposed and brilliantly painted structural and mechanical systems. No cross bracing nor shear walls are required within the rigid steel frame of the structural system, allowing for interior flexibility. No matter where one turns, said a jury member who visited the building, one sees "strong forms," accented by "strong color." "Crude factory detailing," the jury said, is totally overcome by the use of light, color and plantings.

There are three major divisions of space: 70,000 square feet of office space on two floors; 100,000 square feet in assembly line space, and 55,000 square feet in high bay storage. The two major perpendicular axes of circulation extend from outside to inside, helping make the building and site inseparable. The primary axis, which runs the length of the structure, concludes in an outdoor dining room; the secondary axis, running north and south, links an employee parking area with the main workplace inside. The building answers the client's request that it "reflect a corporate image," have a "strong sense of organization" and that the thousand or more employees have a pleasant working environment.

Design team: John Duvivier, AIA, and Curtis Snyder, AIA; project architect: Wayne Holland; partner-in-charge: Charles A. Peterson, AIA; construction observation: Charles C. Ross, AIA. Client: Qume Corporation. Structural engineer: T. T. Siebert. Mechanical engineer: Practicon Associates. Electrical engineer: George A. Greene Co. Landscape architect: Fong & LaRocca. General contractor: Dickman Construction, Inc. Completed in 1979. *M.E.O.*

Photographs by Jerry Holland

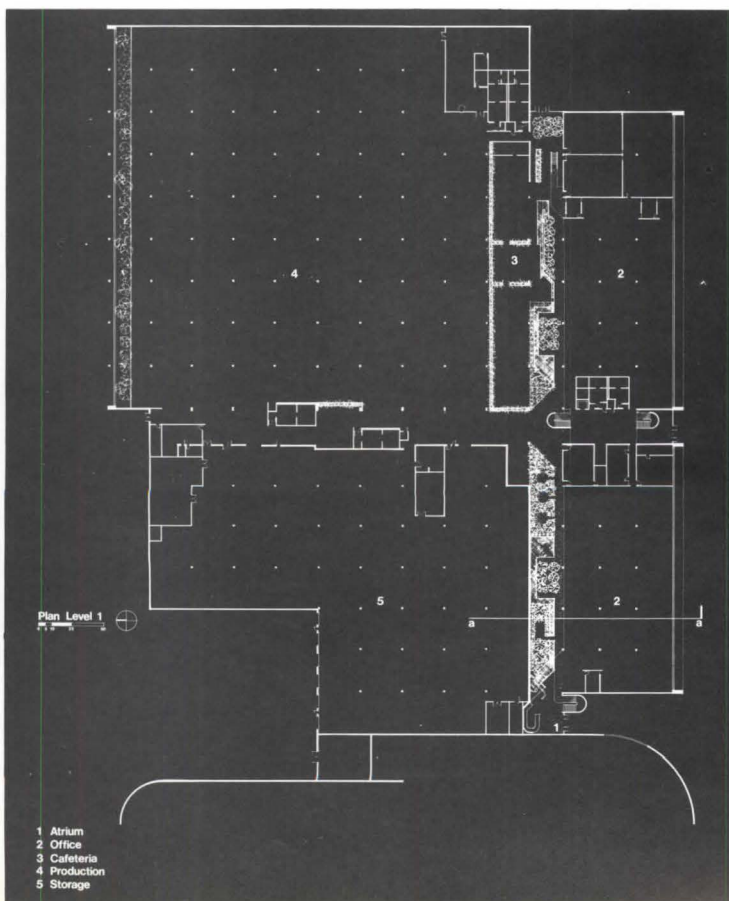







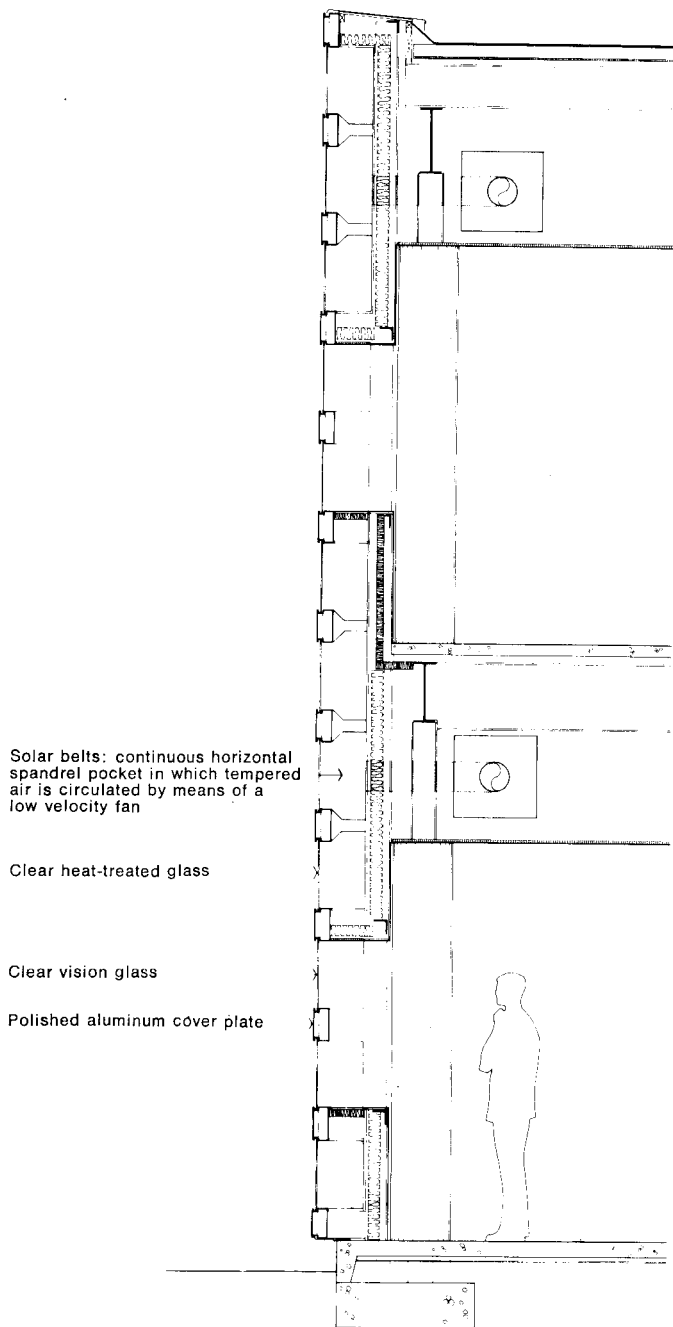

## Clean-Cut Suburban Office Building Girdled in 'Solar Belts'

Designed by Wolf Associates of Charlotte, N.C., as a speculative office building, this crisp, clean-cut steel frame structure, sited on what was once farmland in Charlotte, is now the offices for the Equitable Life Assurance Society's Southern Service Center. The building was designed, constructed and occupied in the surprisingly short time of seven months—and brought in at low cost. The architect says that the "severity of the time and budget restraints required an absolute commitment to the consistent application of building systems and modularity. . . . Each system was scrutinized for economy, availability, speed of construction and its responsiveness to simultaneous construction with other systems."

Program requirements were few: 65,000 square feet of open office space on two levels, an extensive communications network to accommodate a myriad of office machines, two main entrances and a parking area for 350 automobiles. The relationship of the building to its site (no other buildings were there when it was constructed) and the "abstractness" of requirements, the architect says, led to the building's reflection of itself in the "basically

scaleless and totally repetitive character of the taut curtain wall." The curtain wall is composed of alternating bands of clear glass and highly polished aluminum. Two bands of continuous clear glass at each floor allow views from the interior to the outside. The jury called the "slick, brilliant use of glass . . . simple, but innovative."

Even though virtually all the exterior is of single pane glass, the building is energy efficient. What are called "solar belts" are formed by highly insulated pockets behind the glass and aluminum, encircling the building at roof, second level and ground. In winter, solar energy entering the building through the outer skin on the south and west is recirculated through the solar belts to north and east exposures; in summer, conditioned air from the interior spaces is piped through the solar belts before being exhausted from the building. The architect says that projected energy consumption data indicate a maximum four-year payback at current energy rates.

The building demonstrates, the jury said, that "complicated forms and shapes are not necessary to achieve good design; the detailing and materials are as significant to the overall design as is the concept."

Client: Bissell Companies. Structural engineer: King-Hudson Associates. Mechanical engineer: James A. Story & Associates. Electrical engineer: Bullard Associates. General contractor: F. N. Thompson, Inc. Completed in 1977. *M.E.O.*

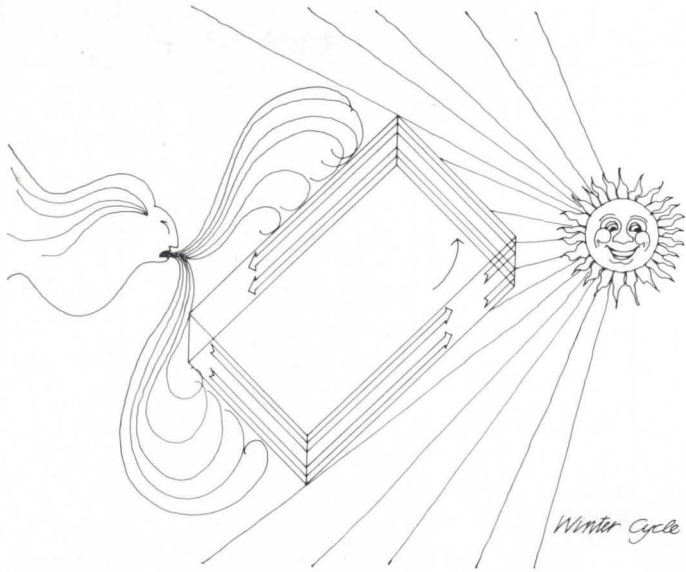

*Sun warmed air is circulated through 'solar belts' to cold winter side of building.*

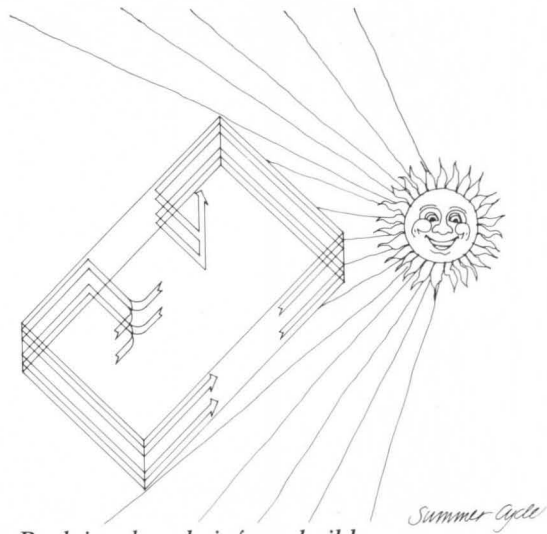

*Reclaimed cool air from building's interior is circulated through 'solar belts' to hot summer side. Sun warmed hot air is exhausted from 'solar belts.'*





James Norris

## Laboratory Designed For Maximum Flexibility

Flexibility is the name of the game in the design of Monsanto's Environmental Health Laboratory, located on 3.9 acres in a St. Louis redevelopment area. Designed by Holabird & Root of Chicago (see Mid-May '79, p. 126), the complete toxicology facility incorporates animal testing areas, incubation laboratories, computer facilities, offices and related spaces. It is flexible in its provision for varied functions involving complex mechanical and electrical systems and in its ability to provide for future independent expansion of either laboratory or mechanical space portions, permitted by the location of the mechanical room at the side of the laboratory facility in a separate sloping element. Built onto this lean-to structure is a solar collector which, among other things, provides hot water to clean animal rooms and cages.

Flexibility is provided as well by the exterior modular curtain wall of insulated metal panels and insulated glass—easy

to install and expand. The glass panels are positioned to let natural light filter into corridor spaces. Interstitial spaces in the two-level building, created by an eight-foot-deep truss, also contribute to flexibility since they allow access to all mechanical, electrical and plumbing systems; when changes are necessary, there will be no interference with spaces either above or below.

The steel trusses are left exposed and painted a deep plum color, and the color differentiations of the mechanical and electrical systems, for safety reasons, also help to brighten the environment. The building was designed with special attention to fitting its surroundings. "Very appropriately, the cooling towers, transformers and the multiple support systems are all housed under the solar collector roof so that the total building and site have a clean urban appearance," the jury said. In contrast with the exposed ducts, trusses and strong interior colors are the building's low-scale, high-style exterior forms and materials, the jury added. The facility, in brief, is a "highly refined solution to a very high-tech, complicated program."

Client: Monsanto Environmental Systems Inc. Structural, mechanical and electrical engineers: Holabird & Root. Landscape architect: Joe Karr Associates. General contractor: Hercules Construction Co. Completed in 1978. *M.E.O.*



## Proud Courts Building Becomes an Arts Center

The opening of Landmark Center in St. Paul, Minn., marked a decade of effort to save the old federal courts building by converting it into a performing and fine arts center and providing office and program space for the St. Paul Council of Arts and Sciences and its member organizations. Designed and constructed by the U.S. Treasury between 1892 and 1902 under the architectural supervision of Willoughby J. Edbrooke and James Knox Taylor, the eclectic composition of French Renaissance and Romanesque elements marked an era of commanding architecture, making the structure one of the finest federal buildings of its time. Occupying a significant place in the urban landscape, the restored building, designed by Perry, Dean, Stahl & Rogers, Inc., of Boston and associated architect Windsor/Faricy Archi-

ects, Inc., of St. Paul, is now a key element in the revitalization of the central business district.

Central to the restoration design is the skylighted courtyard that opens vertically for four stories to an open trellised ceiling, becoming a dramatic interior park surrounded by shops, exhibition cafe and sitting areas. Glass walls in two former attic floors create an enclosed greenhouse, providing an interior garden for the existing fifth floor and newly created space on the sixth floor. Four handsome courtrooms and other spaces on the second, third and fourth floors have been renovated for office space for cultural agencies and to provide facilities for meetings and other community activities. On the second floor is renovated space for art exhibitions. An audiovisual center in the basement, directly below the cortile, is currently under construction, and drawings are being prepared for other uses of space on the fifth and sixth floors. The jury said that it was "concerned" that all the spaces are not yet complete, but found the completed portions so satisfactory that it considered the project worthy of an honor award, calling Landmark Center the "best example of adaptive use"



that was seen in this year's honor award submissions.

Totally new plumbing, HVAC and electrical systems were installed without significantly altering the original design, and the building was made to conform with fire safety standards. Energy efficiency was a major concern in the design process, with the renovation incorporating such features as thermo-glazed and operable windows, insulation of the entire roof area, a power ventilation system at the top of the cortile to assist cooling systems, the use of high efficiency lighting sources and a computer controlled management system for HVAC equipment. The massive walls of the original structure are themselves energy efficient.

Client: Minnesota Landmarks, Inc. Structural engineer: Meyer, Borgman & Johnson, Inc. Mechanical and electrical engineers: Michaud, Cooley, Hallberg, Erickson & Associates. Fire safety and systems application: Fire Pro, Inc. Lighting: William M.C. Lam. Landscape architect: Office of Dan Kiley. Acoustics: Bolt, Beranek & Newman, Inc. General contractor: M.A. Mortenson Co. Completed in 1978. *M.E.O.*



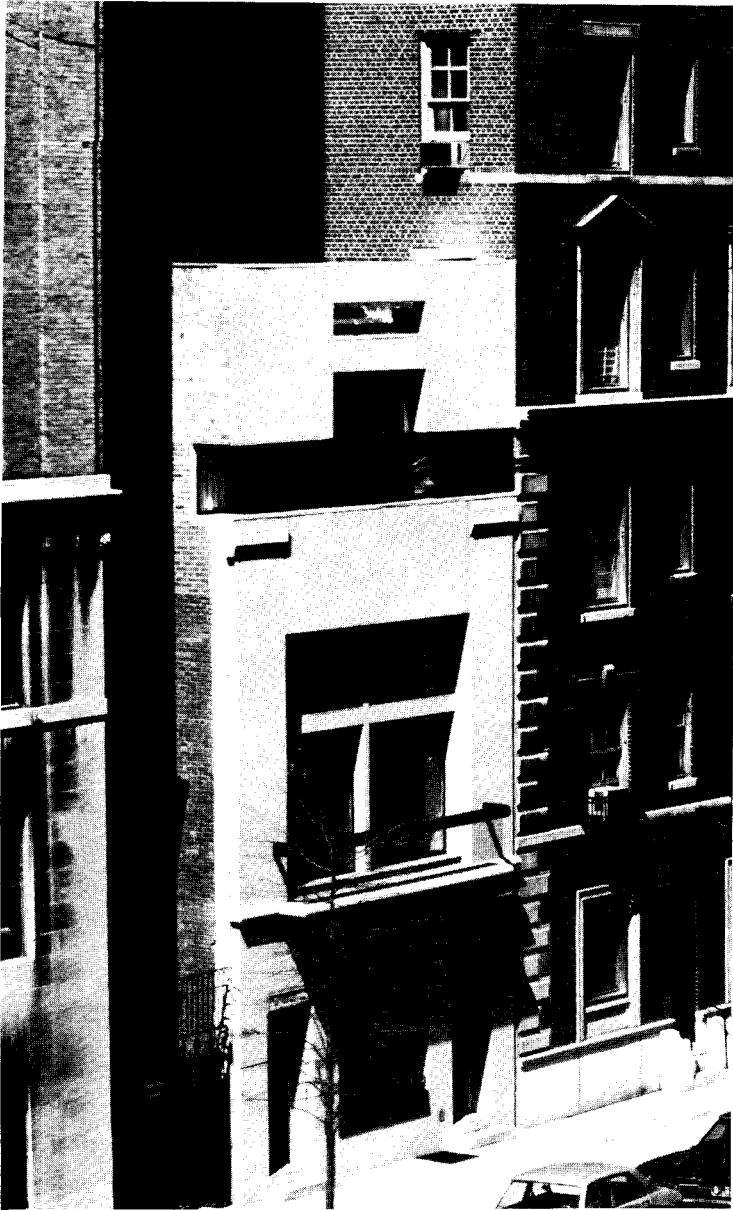

Photographs by Ed Stoecklein

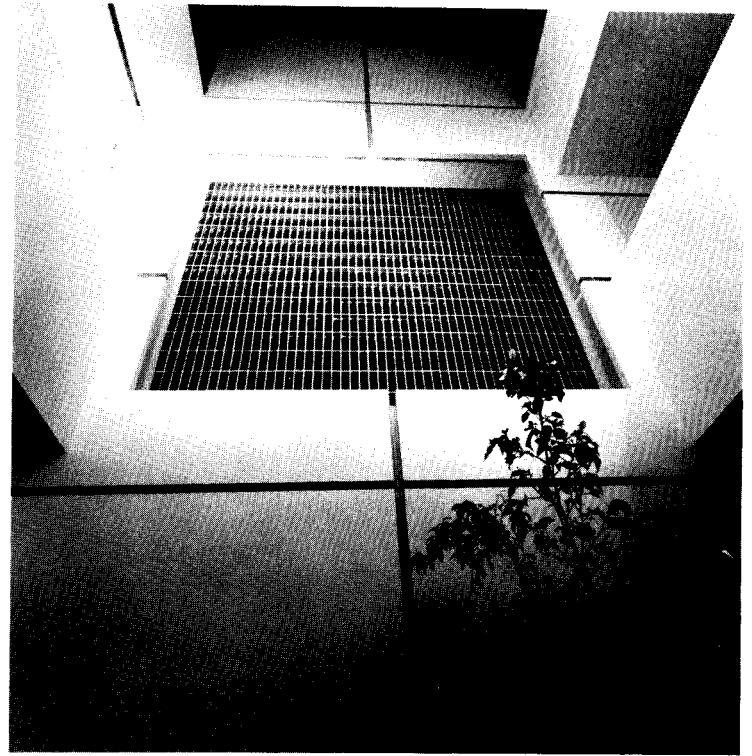

## Manhattan Town House Anchored by an Atrium

Not many single-family town houses remain on New York City's Park Avenue. This one, wedged between apartment blocks, has been radically reconstructed in a design by Robert A. M. Stern and John S. Hagmann. Its facade, while unmistakably new, attempts references to the mildly classical design of its neighbors by its three-part vertical division (recalling base, shaft and capital or the stacked floors of a Renaissance *palazzo*) and by the suggestions of pilasters in its middle section.

Inside, there is considerably less restraint and fewer references to the building's past. Both strong primary colors and more muted tints are used, and there is a virtuoso display of freely curved wall elements. Level changes add further complexities not typical of traditional town houses and link spaces from the entrance hall to the master bedroom suite at the top of the house in what Stern calls a "promenade architecturale." The complex south wall of the building thickens to include fireplace and storage elements and is sliced, punctured and layered in an intentionally ambiguous manner. And, as an architectural anchor around which these varied effects disport themselves, there is a four-floor-high atrium bringing a shaft of light and air through all the main levels. In the rear, a circular stair provides another point of orientation, and an elevator provides further vertical circulation.

Stern, of course, is an ardent proselytizer for what he calls "postmodernism," and he has identified three characteristics of that alleged style—"contextualism" and "allusionism," both of which are detectable on the town house's facade, and "ornamentalism," which is apparent on the interior. The awards jury said that the "facade deals with the language of its neighbors in a unique way," and that "the interior is a bold and personal statement emphasizing form, light, texture, color and circulation."

Structural engineer: Robert Silman & Associates. Mechanical engineer: Atmos Engineering Co., Inc. Lighting: Carroll Cline/INC Consultants Ltd. General contractor: Herbert Construction Co., Inc. Completed in 1975. S.A.





Photographs by Hedrich-Blessing



## Restoring Romanticism To a Los Angeles Hotel

"Modern elegance" combined with "original romanticism" has made a Los Angeles landmark a "much more rewarding environment than it ever was before," said the jury about the restoration of the Biltmore Hotel, initially designed in 1923 by Schultze & Weaver. The restoration architect, Ridgway Ltd. of El Toro, Calif., succeeded by giving the common spaces an "urbane character," while retaining all the elements of architectural and historical value, providing guest rooms that reflect "individual attention and high design," transforming "mundane hotel rooms into a 'luxury liner'" and completely modernizing the physical plant. Major new work on mechanical systems, along with ex-

tensive repairs to existing systems, has resulted in a reduction of more than 33 percent in energy consumption.

The old hotel had fallen on hard times, due to negligence, and was rapidly declining as feasible investment property. As a result of building exterior restoration; modernization of 1,000 guest rooms and suites; provision of a major restaurant, 75,000 square feet of banquet facilities and 100,000 square feet of commercial office space, and extensive modifications of kitchen and other areas, the Biltmore is now able to compete. But its rebirth has done much more. As an example for other restoration projects nearby, it has been instrumental in redirecting the growth patterns of an established downtown business district, proving again the economic viability of historic preservation.

Client: Biltmore Joint Venture. Structural engineer: Brandow & Johnston Associates. Electrical engineer: Ralph E. Phillips, Inc. Graphic design: John Follis & Associates. General contractor: Ridgway Ltd. Completed in 1979. M.E.O.





*Restoration of the exterior (left) included tuck pointing, acid washing of masonry, epoxy injection on terra cotta and repair of wooden double-hung sash. On the interior (below) cast plaster was used for the repair of ornamentation.*





# Bringing Back the Entire Core Of a New England Seaport

The Market Square historic district of Newburyport, Mass., was once the site of that squalor which urban renewal projects of the 1960s sought to strip away, replacing it too often with buildings unsympathetic to an architectural past of intimacy and beauty. Most of the three-story federal structures, built in 1811 as an architectural entity after a devastating fire, were scheduled for the bulldozer, but concerned citizens rallied 'round and engaged the Boston architectural firm of Anderson Notter Finegold Inc. to draw up a plan for the historic district and the entire core area of the town.

The restoration of a two-block area, selected for its proximity to the town's main square and the juxtaposition with other federal structures, required the cooperative efforts of local, state and federal agencies, as well as of consultants and private developers. Market Square now plays a role in making Newburyport a worthy example of early 19th century American seaports. It was called by the jury "one of the few and best examples of district restoration" in the nation. On the basis of the successful restoration project, other New England towns are now re-

evaluating the long-neglected structures in their centers.

The design team placed an emphasis upon intimacy of scale and architectural integrity. Making use of continuous brick facades to preserve the buildings' arrangement, the design team worked out a strategy whereby standards were developed for all exteriors, including sign control, color analysis and detailing of such public spaces as exterior stairways and walkways. A design review process was developed whereby each developer and architect was required to comply with the established standards, with inspections made during the construction phase.

Brick paving in a herringbone pattern is used throughout the area, establishing a visual continuity. Power lines are underground, and the general light is provided by period lamps and other fixtures. Included in the basic elements of the design are granite steps and bollards and wooden benches and trash receptacles. A fountain, formed from granite blocks salvaged from demolished wharf structures, adds an additional touch of beauty. The project, the jury said, overcomes any tendency to be "precious" because of the architect's attention to detail.

Client: City of Newburyport and Newburyport Redevelopment Authority. Structural engineer: Brown, Rona Inc. Traffic consultant: Alan M. Vorhees Associates. Soil consultant: Haley & Aldrich. Landscape architect and civil engineer: Sasaki Associates. General contractor: Walter Reed Corporation. Completed in 1975. *M.E.O.*



Phokion Karas





Photographs by Robert Lautman

## Recreating the Look— And the Spirit—of 1876

The restoration of the Smithsonian Institution's Arts and Industries building on the mall in Washington was a rare combination of historical precision and the evocation of the spirit of a time and its architecture.

Architect Hugh Newell Jacobsen, FAIA, (he shares design credits with the Smithsonian's office of planning and engineering services, engineering and design branch; James M. Murphy, chief, and William Thomas, staff architect) spent countless hours determining the original coloration and detailing of the thoroughly deteriorated 1881 building. The original drawings and specifications were long since gone, so Jacobsen combed the Smithsonian archives for photographs of the building as it was. He arranged them in chronological order and examined them with the aid of a magnifying glass and jeweler's eyepiece to establish such details as the tile pattern of the central rotunda

floor. He prowled the building, chipping away generations of paint in search of the original colors, supplementing his findings with research into the colors in common use at the time.

The occasion for the restoration was the bicentennial. The Arts and Industries building (then called the national museum) was constructed as the first place to house objects from the 1876 centennial exhibition in Philadelphia. When the bicentennial approached, the Smithsonian decided to assemble these objects and many more into a major exhibit in the Arts and Industries building's four soaring galleries, arranged in cruciform configuration around the rotunda. A marvelous collection of objects it is: massive machinery, axes gleaming against velvet, locomotives and ship models. The exhibits and the building—fresh colors gleaming, restored fountain bubbling, festooned with banners and bunting—combine to vividly recreate the exuberance of Victorian America.

Client: Smithsonian Institution. Structural, mechanical and electrical engineers: Smithsonian's engineering and design staff. Landscape architecture: James R. Buckler, horticulturalist; Daniel Kiley, consultant. General contractor: Hercules Construction Co. Completed in 1976. D.C.



*For a time, Arts & Industries gave temporary shelter to the exhibits being assembled for the Air & Space Museum and rockets flanked its spires. Below, the refurbished mall-facing facade. Exterior work was minimal but the interior (right, one of the four exhibit halls) was transformed into an environment from another century.*





U.S. F.R.

# GREAT COMPETITOR: WATER TOWER PLACE

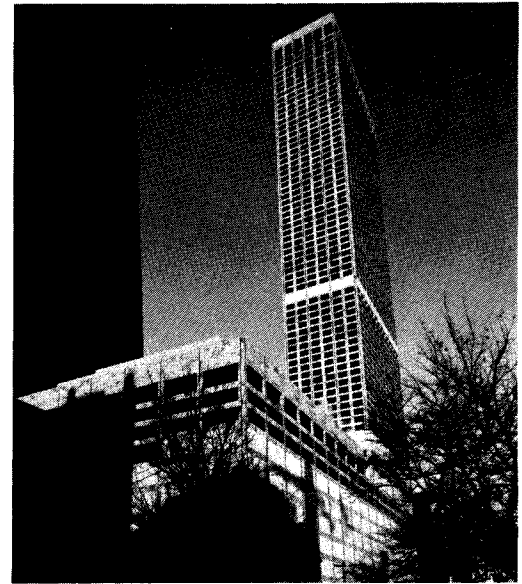

In the contest for profits and prestige on Chicago's "Magnificent Mile," everyone—investors, tenants, architects, shoppers, tourists—recognizes this building as a winner.

**Sheer size is one factor:**

74 floors, three million square feet. Cited as the best of the new high-rise, multi-use buildings, it combines four parking levels, 600,000 square feet of shopping and restaurants, two city-block size office floors, five theaters, 260 condominium units—and the 450-room Ritz-Carlton Hotel.

**It upsets conventional retail wisdom with an eight-level** downtown shopping center. Built around a glittering atrium of glass-enclosed elevators, this first truly vertical shopping mall is also one of Chicago's most popular.

**One of the largest concentrations of plumbing under one roof**—an estimated 68 miles of pipe—results from vast floor area plus a unique mix of functions. The potable water system at Water Tower Place: 100% galvanized steel pipe.



# GREAT COMPETITOR: STEEL PIPE

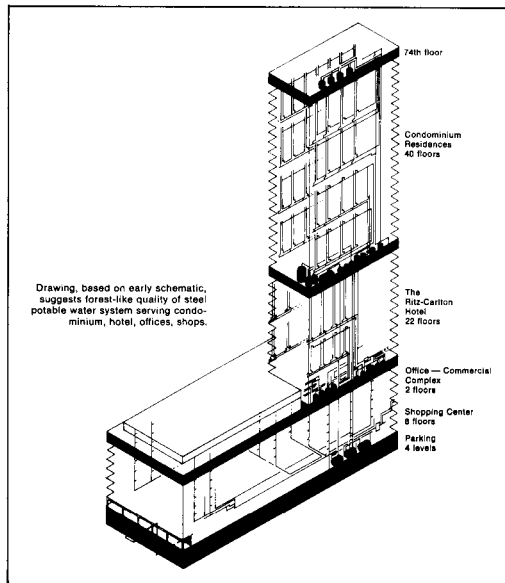

When the time came to specify the pipe for the potable water system, project planners scanned competing materials and agreed *it had to be steel.*

**Steel pipe met Chicago's rigid plumbing code requirements**

—and the project's own demanding criteria—for offices, shopping, condominium and hotel.

**Steel pipe satisfied construction needs.** Its strength, inherent damage resistance helped the plumbing contractor meet accelerated schedules. Local trades greeted steel with total acceptance.

**Steel pipe gave an extra margin of quality** for a demanding, complex job—fewer expansion loops in tight spaces, minimum vibration where quiet is at premium...overall, proven reliability.

"We've simply had no problems with our domestic water system," says chief engineer John Bailey. At Water Tower Place as in other pace-setting buildings, steel pipe outclasses the competition—and goes the distance.

Chances are, *your* next project offers compelling reasons for choosing steel pipe. For more information, write on your letterhead for AISI's new 48-page **Handbook of Steel Pipe**, to **Committee of Steel Pipe Producers, American Iron & Steel Institute, 1000 16th Street, N.W., Washington, D.C. 20036.**



**Credits:**

Architects & Engineers: Loebl, Schlossman & Hackl, Chicago; C. F. Murphy Associates, Chicago (joint venture)  
Architectural Consultant for Commercial Area: Warren Platner Associates, New Haven, Connecticut  
General Contractor: Inland Construction, Inc., Chicago  
Plumbing Contractor: Thomas H. Litvin Company, Chicago

Circle 82 on information card

## News Summary from page 51

M. Costle, administrator of the Environmental Protection Agency, recently told a *New York Times* writer. "Today every schoolchild is taught ecology. Environmental protection is becoming a permanent part of our political value system."

Recent reports on environmental matters suggest some reasons for optimism. For example, the President's Council on Environmental Quality in its last annual report said that the quality of the environment has at last been embedded in the nation's consciousness, and that there is increasing attention given to the precept that no major project should be undertaken without first considering its impact upon the ecosystem.

Over the decade, 25 major metropolitan areas had a sharp decline in the number of "unhealthful" and "very unhealthful" days, the council reported, although in 1977 (the last year for which complete data are available), Los Angeles and New York City had "unhealthful" air more than two out of every three days.

The Environmental Protection Agency said in a "state of the environment" report recently that sulphur dioxide is down 17 percent since 1972; dirt and smoke are down 8 percent, and carbon monoxide is going down at a rate of 7 percent a year. "Overall, the nation's air quality is improving." EPA also reported that ocean dumping dropped 24 percent between 1973 and 1978. All dumping of harmful municipal sewage sludge will be banned by federal law by the end of 1981.

The Council on Environmental Quality's report stresses the matter of water quality, warning that the nation "is still a great distance from the goal of restoring and maintaining the chemical, physical and biological integrity of the nation's water." For example, the council estimates that about 80 percent of the nation's lakes are polluted.

By the end of last September, EPA had made grants of \$24.2 billion to cover the federal share of 17,000 municipal wastewater treatment projects. Today, 11,000 projects, representing \$22.1 billion, are in progress. EPA points with pride to such achievements as the return of the Atlantic salmon on the Penobscot River in Maine, waste recycling in Hawaiian sugar mills and the resurgence of aquatic life in the Savannah River.

It's the matter of "what didn't exist" that continues to worry ecologists. For example, EPA's administrator Costle recently cited a study that showed 700 chemicals in Cincinnati's drinking water, "about 90 percent of which didn't even exist 20 years ago." In a program that opened officially on July 1, 1979, EPA began to review new chemical substances before they are manufactured to evaluate any risks to human health and the en-

vironment. About 400 new chemicals are introduced into the market every year.

Another of the "unknowns" are PCBs, the chemical family that has been linked with many human ills. Last summer, food products in 19 states were reported contaminated by an incidence in Montana. As a result, the Department of Agriculture said in April it would propose a regulation intended to eliminate PCBs from old equipment in food processing plants.

There is also the problem of disposal of hazardous wastes. EPA estimates that anywhere from 1,200 to 2,000 disposal sites may pose significant risks to human health, and that only about 10 percent of hazardous wastes are disposed of in a manner to comply with regulations the agency intends to adopt.

What is required, says EPA, is a "transformation in the way that American industry handles its wastes." They turn up decades later to contaminate water and to seep into homes. EPA recently issued regulations to provide a roadmap of where waste is, where it is going and how it is disposed.

And there are pesticides. A highlight last year was action taken by EPA in a new program designed to encourage the use of a class of pesticides called biologicals. Such pesticides work on the target pests, EPA explains, by means other than poisoning. Biologicals now comprise less than 1 percent of the 35,000 pesticide products marketed in this country, but EPA is authorized to promote the use of biologicals for pest control.

Another environmental problem still to be solved is that of acid rain, which has increased 50-fold over the past 25 years in Eastern U.S.

As EPA notes, "Hard-won gains are always subject to unexpected setbacks. The unresolved problems are many. And the new ones are constantly being uncovered."

## Government: A New Charter for Public Buildings Program

An entirely new legislative charter for GSA's public buildings program was introduced in December by Senator Daniel Patrick Moynihan (D.-N.Y.). It called for the use of limited design competitions on projects costing between \$2.5 million and \$25 million and said that in-house architects should accomplish 25 percent of the design work. This bill in effect replaces an earlier bill, the Architectural Quality Act of 1979 (S461), introduced by Senator Robert Stafford (R.-Vt.), which called for use of design competitions on all federal projects over \$25 million.

*continued on page 250*

# A beautiful, time and money-saving alternative to masonry. And other facing materials.

Faced with stringent budgetary limitations, project architects for the Von Braun Civic Center, Huntsville, Ala., selected a dry-built masonry exterior wall system using Johns-Manville Stonehenge™ architectural panels.

J-M panels not only provided the desired stone-like appearance, but also permitted quick and easy face-fastening to steel studding. As a result, erection time was cut almost 25 percent and costs cut almost one dollar per square foot over conventional masonry. And the job was finished on time and within the budget.

Performance of the wall system has been excellent, resisting high winds, heavy rain and other weather extremes without problems. And the J-M Stonehenge panels have kept their rugged natural stone beauty despite constant exposure to the elements.

When your job calls for lasting beauty that faces up to almost anything, you'll find a J-M wall system that's just right for the job.

For details, consult Sweet's or contact Dave Lucy, Johns-Manville, Ken-Caryl Ranch, Denver, Colorado 80217, AI-2 303-979-1000.



J-M Stonehenge architectural panels cover 70 per cent of the exterior of the Center, providing an attractive, stonelike appearance that will not change due to climate conditions.



The J-M panels were face mounted to steel studding, requiring about 25 per cent less installation time than conventional masonry wall techniques.



## Johns-Manville

Circle 83 on information card

# Johns-Manville Architectural Panels. Chosen for beauty, durability and economy at the Von Braun Civic Center.



The Von Braun Civic Center, a 340,000 square foot, five-unit entertainment, sports and cultural complex in Huntsville, Alabama.  
Architects: Northington, Smith, Kranert & Tomblin & Associates, Jones, Mann and Associates, Dickson and Davis.  
Contractor: Universal Construction Co., Decatur, Alabama.

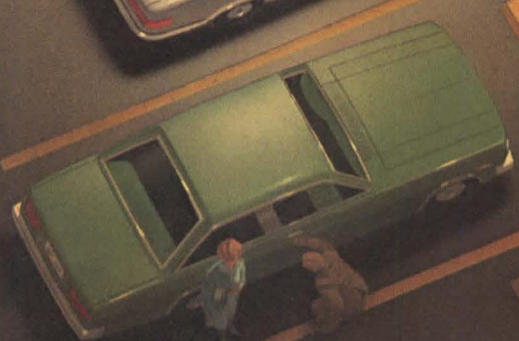

HPS lamp in conventional luminaire gives spotty light.



HPS lamp in new ITT HPS luminaire gives even light.



# ITT invents the HPS luminaire.

It took over 4 years of lighting research, new technology and over \$500,000. But our engineers wouldn't give up.

Now it's here.

The first luminaire ever designed specifically to precisely control and convey HPS light—the energy-efficient light source.

Our HPS luminaire expands the field of optics with space-age research and achieves the optimum match between the HPS lamp, refractor, reflector and housing.

It has a modern rectilinear shape and is quick and easy to install. 70 watt through 400 watt units are available in two different die-cast aluminum housings. The optical assembly is easily accessible from a flush-fitting, one-hand trigger latch.

All electrical components including ballast, capacitor and starting circuit are

mounted to one easy-access Power-Pad® door. The door lifts out for easy service.

The electrical connection works by way of two quick-disconnects between lamp and electrical components, offers quick installation and easy maintenance.

If you're ready for the one luminaire that's totally designed for HPS, or if you need more information, come to the source.

## Computer-matched reflector and refractor.

Unique main beam prism design lifts light to optimum vertical angles, directs excess nadir foot candles to more effective vertical zones. Molded of amazing, new Ryton® plastic, which allows sharp corners, precise contours, withstands extreme heat and cold.

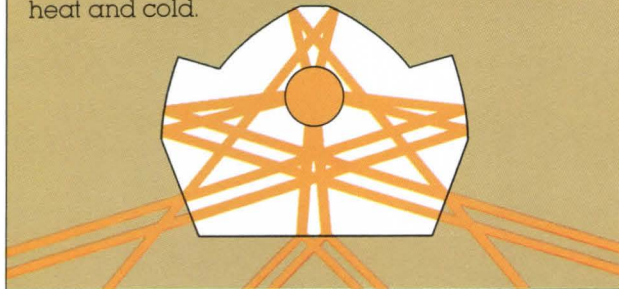

**Before.** Conventional luminaire puts too many raw lumens directly under the luminaire, creating a hot spot, wasting energy and detracting from surface visibility.

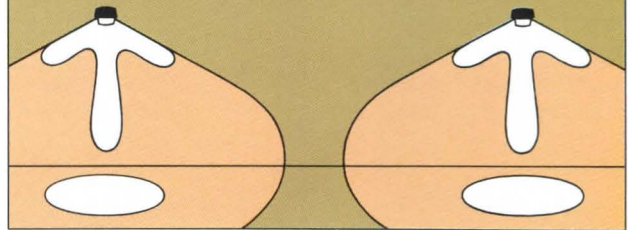

**After.** New ITT HPS luminaire directs a greater percentage of lumens higher and further, spreads light evenly to give excellent surface visibility across a broader area.

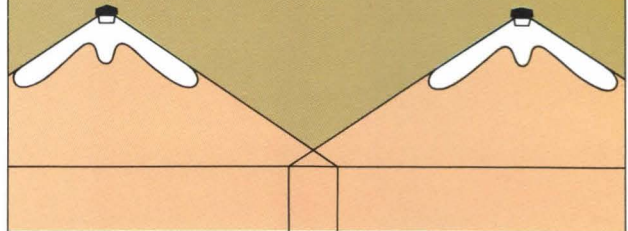

## Good looks, good service.

One of the first housings completely of die-cast aluminum—gives long service free of corrosion—takes a handsome baked-on enamel finish.

ITT Outdoor Lighting,  
Box 100, Dept. A8, Southaven, MS 38671 Phone (601) 342-1545



Please send free  
The New Light Source,  
the complete catalog  
of outdoor lighting.

Name \_\_\_\_\_ Title \_\_\_\_\_

Company Name \_\_\_\_\_

Address \_\_\_\_\_

City \_\_\_\_\_ State \_\_\_\_\_ Zip \_\_\_\_\_

Telephone \_\_\_\_\_

**ITT** OUTDOOR LIGHTING

## News Summary from page 246

The Moynihan bill was recently marked up by the Senate committee on environment and public works. The modified version calls for half of all federal building projects, expected to cost \$5 million or more, to use the competition method for A/E selection. The revision also calls for GSA in-house staff to perform sufficient design tasks to maintain special skills and training, with GSA being allowed to make the decision on just how many projects would be required to achieve this goal. The specific requirement for 25 percent in-house design work was dropped.

Representing the committee on federal procurement of architectural/engineering services at the Senate hearings on the Public Buildings Act of 1979 (Moynihan's bill, S2080), AIA President-Elect R. Randall Vosbeck, FAIA, objected to competitions for every federal project within the cost range, saying that while competitions may be proper for such buildings as monuments and single-function structures, they are not appropriate for more complex buildings. Vosbeck in his testimony also objected to the 25 percent in-house requirement.

The Moynihan bill also requires that GSA submit an annual report of all building activities and a five-year plan for

housing federal agencies. The bill states that within five years of the date of enactment no more than 40 percent of government offices shall be leased, and by 10 years no more than 20 percent.

Placing emphasis on new construction rather than leasing has been advocated by GSA's administrator, Rowland Godfrey Freeman III, and his appointed commissioner of public building services, Albert R. (Mike) Marschall. (Freeman became the 11th administrator of GSA last June, succeeding Jay Solomon.) Although Freeman and Marschall both support adaptive use, they say new construction offers the best long-term benefits for the government and, in turn, the taxpayers.

In his proposed budget for fiscal year 1981, President Carter requested \$101.7 million for new buildings, up from \$87 million in FY '80. The President's budget proposal called for an overall increase of 9 percent for construction expenditures over the FY '80 budget, but the increase would hardly keep pace with the rate of inflation.

In other federal news, Senator Charles McC. Mathias (R.-Md.) recently introduced the Service Liability Self-Insurance Act (S2512), which would "amend the Internal Revenue code to enable design professionals, architects and engineers to set up partial self-insurance funds to

cover service liability. The act would allow design professionals to deduct from gross income money put into a self-insurance fund. The money paid into the fund would be deducted "as a cost of doing business, just like insurance premiums," said Mathias.

The Council on Development Choices for the '80s was recently formed by the Urban Land Institute, with the financial assistance of HUD. The group of elected state and local government officials and leaders from the private development community will examine trends and conditions that affect the built environment, define public policy goal choices "that are consistent with project conditions as well as established public needs" and promote nationwide response. The council's findings and recommendations will be presented to the President's commission on a national agenda for the '80s. Architects among the 35 council members are John C. Portman, FAIA, and Beverly A. Willis, FAIA.

Last summer a federal task force on design recommended that President Carter coordinate the fragmented federal design activities. Each agency now works independently with its own goals, objectives and standards, a situation the task force called "inefficient." Furthermore, said the task force, there is no mandate

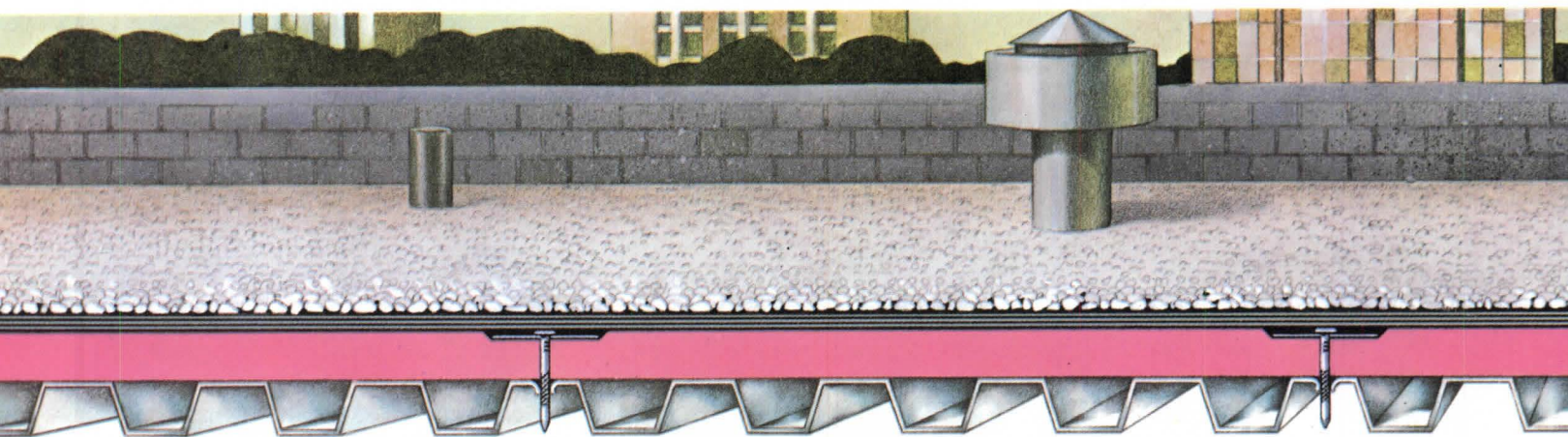

# What the best insulated roof

**The Pink Stuff:** Thermax.<sup>®</sup> It is simply the most efficient roof insulation on the market with a Factory Mutual Class I Fire Rating over steel decks. Thermax provides more insulating efficiency per inch than fibrous glass, composite, perlite or fiberboard roof insulations. Since mechanical fastening is the preferred system of attachment to steel decks, use Insulfast rapid fastening nail/disc system — a pneumatic gun and oxide-coated nails for fast, easy, permanent installation of Thermax to steel decks.

for federal design review, no central information and education resource and lack of overall commitment to design excellence.

The task force called for a clearly defined method to monitor and coordinate design policy, a design management group within each agency, a comprehensive program for design education, design research recognized as a critical factor in the success of the federal design policy and a federal awards design program.

At the state level, 18 states have now adopted A/E procurement laws based on the so-called Brooks bill approach used in federal procurement. This approach recommends that selection be made on the basis of competence and qualifications and was adopted by the American Bar Association as the model procurement code for state and local governments in February 1979. Maryland has a competitive bidding law.

The majority of the 34 states that now have sunset laws require periodic review of their architectural registration boards, and if a board is not recreated by the state legislature, its authority will be terminated. Reviews have been conducted and the need for registration laws has been confirmed in six states, but not always without a strong lobbying effort by local architects and state AIA compo-

nents, sometimes in conjunction with state engineering societies. By 1984, architectural registration laws and boards will be reviewed in 17 states (see May, p. 46). The California Council of Architects/AIA is undergoing an in-depth examination of the state's registration law; in Wisconsin the joint regulatory board of architects and engineers plans to develop its own registration examination; an AIA task force has been established to study all facets of registration, and the National Council of Architectural Registration Boards is surveying architects in its efforts to validate the NCARB examination.

## Cities: Coping with The Familiar Problems as Federal Help Declines

The state of the nation's cities is decidedly mixed. The energy-related return of the middle class continues, but so do poverty, unemployment and fiscal problems of critical proportions. The only safe generalization is that the federal role in determining the cities' fate is declining.

It appears, at this writing, that Congress will cut the \$2.3 billion state share of the general revenue sharing, the \$250

million proposal for countercyclical fiscal assistance and the proposed new business finance programs of the Economic Development Administration. And there is discussion of slashing the community development block grant and urban development action grant programs.

And as part of the President's efforts to slice the budgets of all federal agencies, HUD has been asked to trim \$88 million from the fiscal year 1980 budget and \$176 million from next year's budget. HUD has recommended that the '80 budget cuts come from the community development block grant funds that have been unused. The '81 cuts recommended include a large cut in section 312 rehabilitation funds and cuts from the section 235 home ownership, section 701 comprehensive and community development block grant discretionary fund programs.

A recent survey conducted by the joint economic committee of Congress suggests that many cities are already suffering from the effects of high inflation and a decline in both local and federal revenues. The survey report suggests that cities of all sizes have become increasingly dependent on federal aid, which reached a peak in 1978. Since then, it has been declining and the cities so far have found no sufficient way to compensate for the loss.

*continued on page 252*

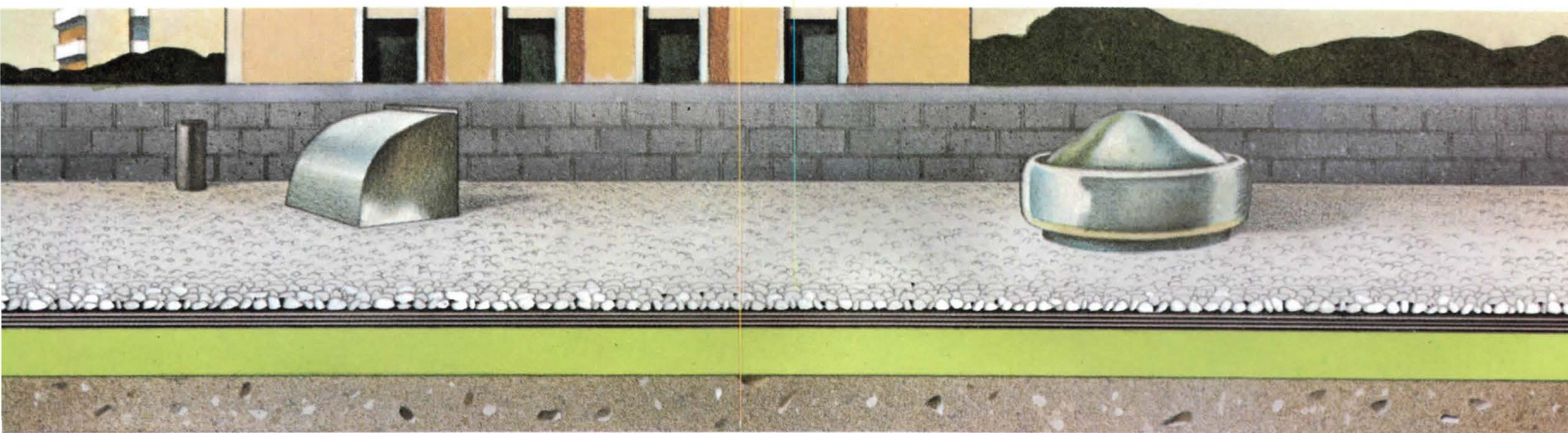

# Roofs are wearing these days.

**The Green Stuff:** Tempchek.<sup>®</sup> It gives you the same high R values as Thermax, and is used on all types of decks, except directly over steel decks. Tempchek is reinforced with glass fibers to give it greater dimensional stability than other urethane foam insulations, so it resists "growth" and ridging. All of which makes Tempchek first choice for any application other than directly over steel. Talk to your Celotex representative about the stuff the best insulated roofs are wearing these days, or call Ed Levin at Celotex, Roofing Products Division: (813) 871-4545.

**Celotex**<sup>®</sup>

"Between the world and the weather since 1854."  
a Jim Walter company

## News Summary from page 251

With the impending federal urban programs' budget cuts, President Carter's pronounced urban policy may have to take a new direction. At a national urban policy conference held in October 1979, Stuart Eizenstat, director of the White House domestic policy staff, indicated that mobilizing private investment in the cities must be the primary goal of the nation's urban policy in the '80s. He added, "The urban policy must have a long-range focus on economic development."

This business/city partnership was recently emphasized by HUD Secretary Moon Landrieu in a House subcommittee hearing on the agency's fiscal year '81 legislative program. "As we look to the future," he said, "we must recognize that a healthy private sector is the key to an effective urban policy." He also told the panel that the nation faces grave housing problems in the '80s, and that low- and moderate-income people are experiencing them most severely.

Meanwhile, there have been some positive results from Carter's urban policy. The first annual report of the urban development action grant program, which is a key element of the policy, says the 236 action grants awarded in fiscal year '79 will result in \$2.9 billion in private investment. That averages out to \$5.95 in private funds for each federal dollar committed.

A decision late in 1979 by Secretary of Transportation Neil Goldschmidt puts into effect one aspect of the urban policy. Goldschmidt turned down a request of the Ohio department of transportation to build a 13.5-mile section of Interstate highway in suburban Dayton. The road would have bypassed the east end of the city's metropolitan area. Goldschmidt said that the proposal threatened to take jobs and businesses away from the inner city.

## Preservation: The Trend Gathers Force, Abetted By a Tight Economy

The number of architectural firms doing restoration, rehabilitation and adaptive use projects increased 100 percent over the past 10 years, according to a survey conducted by the AIA committee on historic resources and the Department of the Interior. This trend is likely to continue in light of high interest rates, high energy costs and high inflation rates coupled with increasing material and land costs.

Recently, the Bureau of Building Marketing Research estimated total U.S. non-residential rehabilitation at \$35.6 billion in '80, compared with \$29.7 billion in '79 and \$19.2 billion in '74. Much of this in-

*continued on page 258*

# Architectural Design Competition

## HELIOS

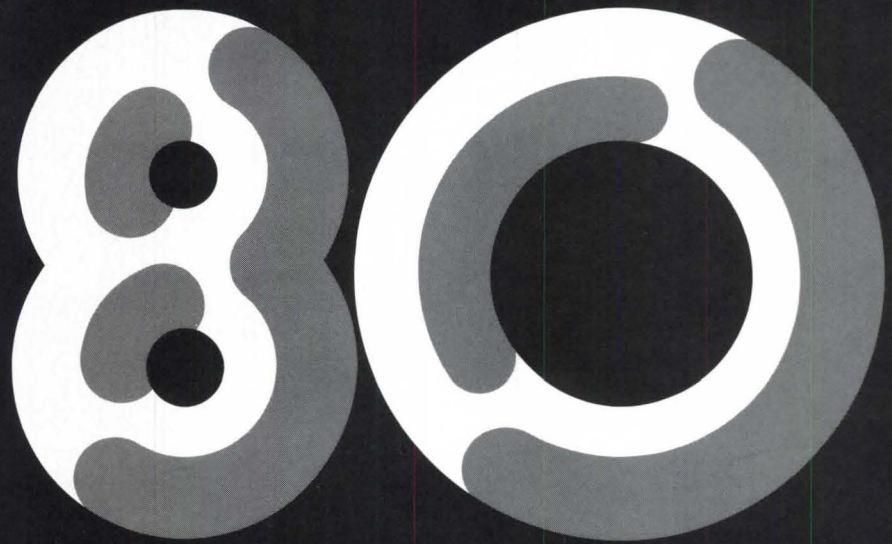

### Sponsored By Helios Tension Products Inc. In Conjunction With Its Affiliate In Japan Taiyo Kogyo Co., Ltd.

Colorful, spectacular tensioned membrane structures are meeting today's needs for lighter, cost efficient buildings. To dramatize the potential for soft shell structures, Helios announces a competition for design of a stage and audience covering-outdoor theater.

**Call for entries.** All U.S. registered AIA members are eligible. Employees of registered architects may enter if the employer signs for the entry and is not also entering the competition. The deadline for entries is October 15, 1980.

Ten awards will be made by a professional jury. Professional Adviser for the competition is Elisabeth Kendall Thompson, FAIA.

<b>First</b>	<b>\$15,000</b>
<b>Second</b>	<b>\$10,000</b>
<b>Third</b>	<b>\$ 7,500</b>
<b>Honorable Mention (7)</b>	<b>\$ 2,500</b>

Entry forms, competition rules, specifications and basic information on tensioned membrane structures are available now. Helios Tension Products, Inc., 1602 Tacoma Way, Redwood City, CA 94063. Telephone: (415) 364-1770.



**HELIOS TENSION PRODUCTS, INC.**  
Soft Shell Structures Division

Circle 86 on information card



# CLOSE HARMONY'



## In Graceful Tension Structures By Helios.

The delicacy and beauty of these tensioned membrane structures is thoroughly practical. In this economical shelter for an outdoor music amphitheater, the natural beauty of the

site is preserved, with only minimal disturbance for footings for structural elements. The smaller white tensioned structure at the Aspen Design Conference in Colorado is even simpler, facilitating its erection and demounting each year.

All these structures, including the festive rest area sunshades, are fabricated of vinyl-coated polyester material held in tension on a steel framework. The result is a lightweight, rigid structure engineered to withstand heavy wind. Though a tensioned membrane structure is in a higher price class than a tent, it offers far greater strength and durability. Compared to alternative structures of wood, steel or masonry, it typically results in important cost savings.

When your imagination calls up sweeping curvilinear shapes or great enclosed space, Helios Tension Products are the people to try your ideas on. We specialize in helping architects



translate their innovative designs into practical reality. Our expertise includes design, engineering, fabrication and erection—a total, comprehensive service unmatched in the U.S.

For more information, or assistance with a specific project, call or write: Dept. R6, Helios Tension Products, Inc., 1602 Tacoma Way, Redwood City, CA 94063. Telephone: (415) 364-1770, Telex 345590

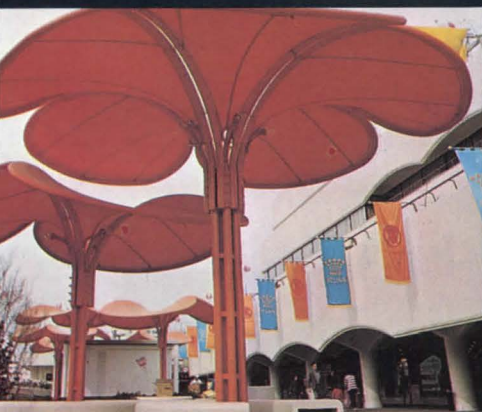

**HELIOS TENSION PRODUCTS, INC.**  
Soft Shell Structures Division



# Knoll Diffrient Seating

Introducing the Diffrient collection. Three compelling benefits make these chairs the next step in the evolution of more productive office seating.

More comfort: 30 years of medical and engineering research define contours so precise they actually engage your body, distribute its weight and properly support it, in any position, to fight fatigue.



More convenience: Niels Diffrient's rational scale of values embraces the discoveries of a career devoted to eliminating stress in aircraft and heavy-equipment seating, e.g., one touch of a convenient fingertip control instantly adjusts you and your chair up or down.

More affordable: Thanks to durable steel shells, efficiently and precisely die-stamped, they cost less to acquire. The patented one-piece upholstery system, which can be replaced in minutes, by anyone, without tools, will keep them cost efficient and productive for as long as you own them. Engineering innovation plus efficient mass production plus traditional Knoll quality add up to marvels of seating value.

Obviously, evolution rewards patience. It also exacts a penalty: as of now, every chair in your office is obsolete. The remedy we propose is simple. Make your office more productive through a process of natural selection. It is as easy as taking the next step.

Knoll International  
The Knoll Building  
655 Madison Avenue  
N.Y., N.Y. 10021

*Circle 87 on information card*



# More architects prefer Cookson Fire Doors

## For Sure-Fire Safety



Cookson Steel Rolling Counter Fire Doors



Cookson Steel Rolling Fire Doors

**Q:** What Steel Roll-up Fire Doors Do You Prefer?\*

<b>A:</b> COOKSON	32%
Mfr. B.	26.8%
Mfr. C.	21.4%
Mfr. D.	14.3%

\*Building Research Bureau—Upward-Acting Door and Grille Study. Non-Residential applications. Free copy of complete study available from The Cookson Company.

Wherever a fire hazard exists, building codes or local fire authorities require fire doors constructed of steel. And for smart, trim appearance, rugged durability and smooth operation, most architects prefer Cookson Counter Fire Doors. For schools, hospitals, cafeterias, pass and ticket windows and the like.

They are available with curtains of galvanized or stainless steel, and provide savings in wall space, positive-control closure speed, and the full utility of standard service doors. All Cookson Fire Doors are approved by Underwriters' Laboratories and Factory Mutuals.

All the advantages of Cookson Standard Steel Rolling Doors are well known for their quality and dependability—backed by the Cookson name and reputation.

So specify Cookson—second to none in Fire Doors. See our catalog in Sweet's (8.7/Co), or write or call for your own free copy. Join the architects who prefer the Cookson label to any other in the industry.

Architects prefer



**Cookson Rolling Doors**  
Best way to close an opening.

700 Pennsylvania Avenue • San Francisco, CA 94107 • (415) 826-4422  
Eastern Plant: 800 Tulip Drive, Gastonia, NC 28052

Circle 88 on information card



## **VISUALLY SIGNIFICANT ROOFS**

. . . a trend of major significance in contemporary architecture—and architects everywhere are finding that Follansbee Terne uniquely incorporates the essential values of form, color and function in such roofs. In this non-traditionally designed mental health center the architects expunged the age-old stigma of such institutions by creating a warm, residential, more home-like atmosphere.

Terne helped to create this welcome departure from the "antiseptic line," for Terne has the important advantage of providing maximum creative latitude at relatively moderate cost. We'll be happy to send you substantiating evidence.

## **FOLLANSBEE**

FOLLANSBEE STEEL CORPORATION • FOLLANSBEE, WEST VIRGINIA

HUNTSVILLE-MADISON HEALTH CENTER • HUNTSVILLE, ALABAMA  
ARCHITECTS: CHARLES McCAULEY & ASSOCIATES, BIRMINGHAM, ALABAMA  
ROD W. WHATLEY, PROJECT DESIGNER  
ROOFER: TIP TOP ROOFING & SHEET METAL, HUNTSVILLE, ALABAMA

*Circle 89 on information card*

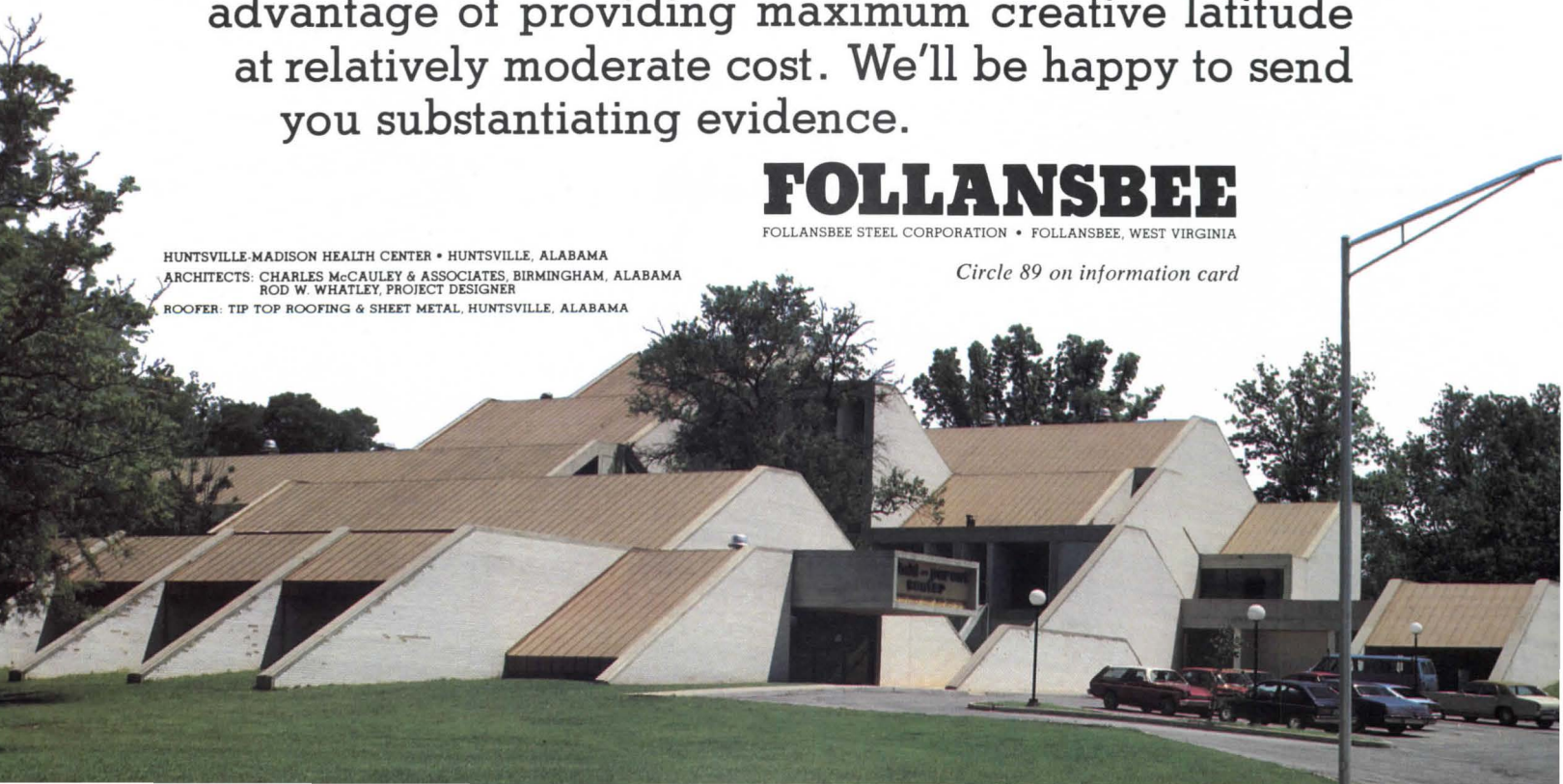

## News Summary from page 252

vestment, says the bureau, was spurred by the Tax Reform Act of 1976, which provides a five-year amortization of rehabilitation costs and accelerated deductions. In addition, a 10 percent investment tax credit is available for renovation of commercial properties older than 20 years.

It appears that during fiscal years '80 and '81, preservation will receive less federal funding than in the recent past. In April, the Carter Administration impounded \$16.5 million of the \$55 million Historic Preservation Fund as part of the attempt to balance the budget. In addition, the Administration revised downward its preservation appropriation request for FY '81 from \$45 million to \$25 million, 55 percent below this year's appropriation. James Biddle, president of the National Trust for Historic Preservation, said, "A reduction of this magnitude will impair ongoing state and National Trust programs, as well as remove a vital stimulus for private sector investment in preservation."

In recent testimony before the House appropriations subcommittee on the Interior Department, Nicholas A. Pappas, AIA, pled for as much funding as possible for the preservation program. Pappas said the Institute "recognizes the need for fiscal responsibility," but that the historic preservation budget "is subject to unduly severe restraints." He mentioned that preservation-related construction activity can generate employment.

The fact that historic preservation of districts in cities creates new jobs and services and new business profit from increased trade and tourism, resulting in a decrease in crime and better housing, was supported in a report, "The Contribution of Historic Preservation to Urban Revitalization," by the Advisory Council on Historic Preservation. Another council report, "Assessing the Energy Conservation Benefits of Historic Preservation," gives a method for measuring energy investment in rehabilitation and new construction.

Three case studies are provided. Formulas show in each instance that rehabilitation saves energy over demolition and new construction.

Meanwhile, both the House and the Senate are reviewing the National Heritage Policy Act of 1979 that will extend the authorization for the historic preservation fund at least five years beyond the 1981 expiration date. It would also strengthen the state historic preservation programs, broaden the range of preservation activities of local governments, organizations and individuals that qualify for funding help, and strengthen federal responsibilities for historic resources.

Testifying on the Heritage Act before

the Senate subcommittee on parks, recreation and renewable resources, Ray K. Parker, AIA, said, "While the Institute is on record in support of the safeguarding of our natural resources, we must emphasize that these efforts must not override our commitment to the preservation of our historically and architecturally significant heritage. . . . Historic preservation is not a luxury and deserves a great deal more priority than the Administration proposal allows." He also said that "documentation" should be recognized "as a basic element of preservation."

In other testimony, Thomas B. Muths, AIA, asked the House committee on interior and insular affairs to amend the National Historic Preservation Act of 1966 to keep historic preservation programs within the Interior Department, but separate from parallel programs of recreation and natural resources. He suggested that architects and architectural historians be made decision makers.

Last year the Advisory Council on Historic Properties amended its regulations that protect properties included in or eligible for inclusion in the National Register of Historic Places. The new regulations, which are binding on all federal agencies, simplify and speed the process of comment when new federal undertakings will affect such properties. And the secretary of the Interior Department set standards for programs under his authority that affect cultural resources listed in or eligible for the National Register of Historic Places. These standards must be used by state historic preservation officers and by the Heritage Conservation and Recreation Service to evaluate grant-assisted proposals, reuse proposals submitted by state and local governments for the transfer of federally owned surplus properties listed on the register, and to determine if a rehabilitation project is certified in accordance with the Tax Reform Act of 1976 and the Revenue Act of 1978.

## The Institute: A Year With a Single Dominant Theme

Ehrman B. Mitchell Jr., FAIA, Institute president in 1979, set as the theme of his year in office "the celebration of architecture." He said that he chose the theme because he wanted the public to focus on "architecture of consequence" and architects to be inspired "to know what it is to do better within their profession." He wanted architects and the public to come together in celebration "because they come together to build."

And the theme was picked up nation-  
*continued on page 320*

# dryvit<sup>®</sup> System Inc. OUTSULATION<sup>™</sup>

## A closer look at a successful retrofit.

The dynamic structural effects achieved in the North Shore Atrium Office Building (shown on facing page) were easily achieved with the Dryvit System.

Pre-formed shapes of Dryvit insulation board were used to form the 3-dimensional sculptured exterior walls. Details below:

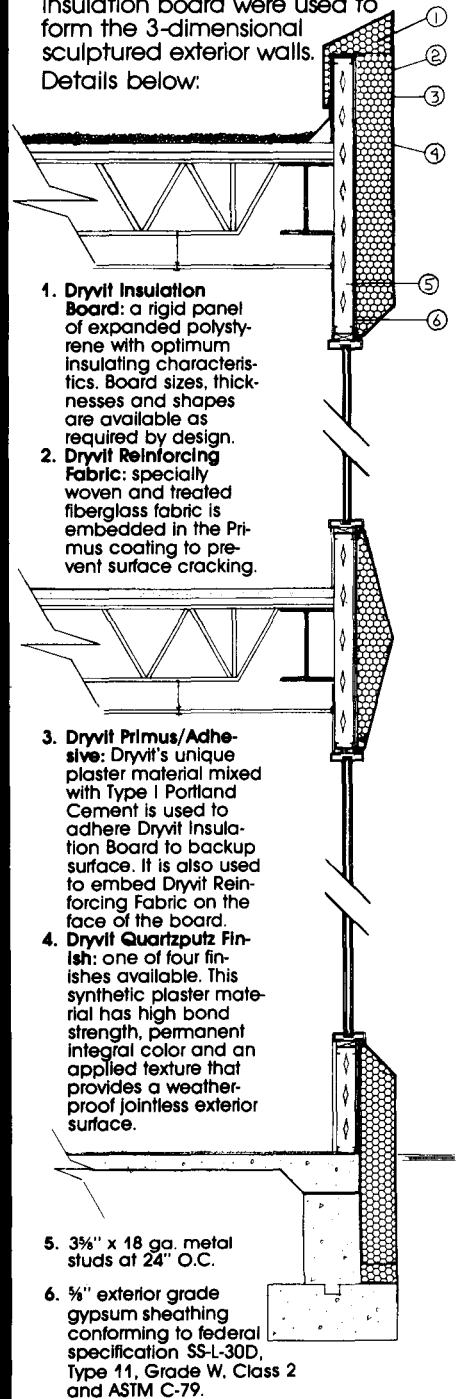

### DRYVIT SYSTEM, INC.

420 Lincoln Avenue, Warwick, RI 02888  
(401) 463-7150  
Plant Locations: Warwick, RI and Tulsa, OK

Circle 90 on information card

In Retrofit,  
energy saving  
can be  
beautiful.



# OUTSULATION™

**Massive insulation placed on exterior walls shaped a new future for this former factory.**

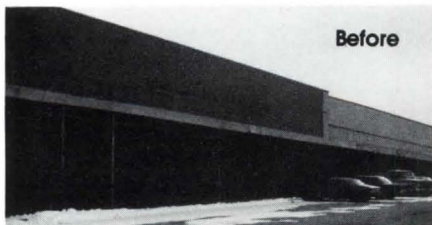

**Before**



**After:** Architect: Peter Elkin, A.I.A., Syosset, N.Y.

Reckson Associates overcame interesting challenges when retrofitting this one-story plant into a luxurious two-story office building.

The existence of 24 ft. ceilings prompted the creation of atrium areas where plants and light make a pleasant backdrop for business. The addition of a sports deck for tenant use became another challenging feature.

Penthouse suites, twin 2-story lobbies, flexible office layouts with total sound control, concealed loading and trash removal bays, offer tenants the kind of luxury only a modern concept can provide.

How to wrap this premium office package in a dramatic contemporary skin was the ultimate challenge. And Dryvit was the choice.

The Dryvit System offers many advantages to the architect and developer. The dynamic structural shapes are factory fabricated. Light in weight, they're easy to work with. And while Dryvit covers, it provides massive insulation. Thermal bridges are sealed. Outside temperatures are equalized, minimizing thermal stress. Permanent energy savings are achieved at a competitive cost.

The Dryvit System works beautifully at the North Shore Atrium Office Building. Let us prove it can work for you. Call or write stating your application: new construction or retrofit.

**dryvit**® SYSTEM, INC.

420 Lincoln Avenue, Warwick, RI 02888 (401) 463-7150 • Plant Locations: Warwick, RI and Tulsa, OK

**Texas Society of Architects.** Alfred C. Glassell Jr. School of Art, Houston; S. I. Morris Associates, Houston (upper right). Facilities include administrative offices, classrooms, studios for printmaking, jewelry, ceramics and sculpture and a library. The classrooms and studios radiate off the large open skylighted gallery. Glass block was used because of its heat insulating qualities, and it has a gray reflective coating. The jury commented, "a fresh use of a new material in a direct urban way." Rick Gardner, photographer.

New campus of the University of Texas at San Antonio; Ford, Powell & Carson, San Antonio (lower right). Located on 600 acres atop a limestone escarpment on the outskirts of San Antonio, the 700,000-square-foot campus was planned for an initial enrollment of 5,000 and an anticipated enrollment of 30,000. The five academic buildings, the library and the administrative offices are organized around a central plaza, which is linked to each of the bordering superblocks by elevated pedestrian streets. Sun control devices—cable-hung wood trellises—are used extensively. Courtyards and skylighted gallerias allow natural light to penetrate through all levels of the buildings. The jury commented, "A handsome expression of building wedded to the site with a solidity of space and color being predominant." Rick Gardner, photographer.

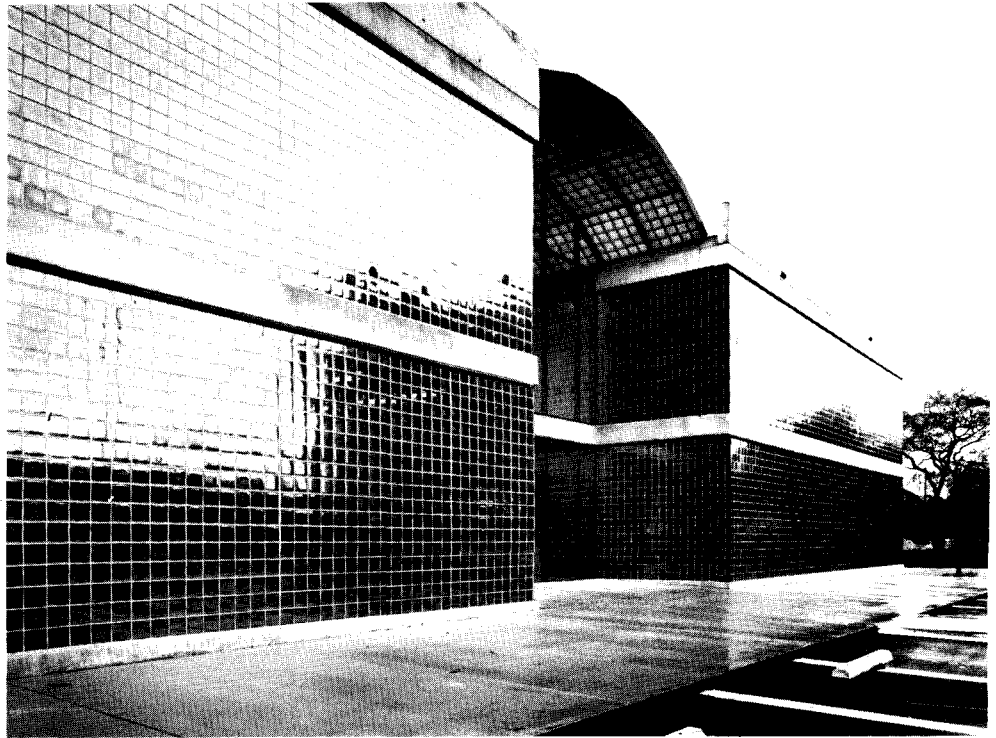



Project: Cafeteria, Educational Testing Service, Princeton, New Jersey

Architect: CUH2A Architecture, Engineering, Planning, Princeton

Lighting: Lite Duct by Peerless, one of the 13 Longlite systems.

Here cast corners and crossings combine with the fixtures to create a polished architectural element. Lite Duct comes in seven different diameters and configurations, in lengths up to 24' in any finish, and adapts to virtually any optical task.



You get more out of a long space if you light it with long fixtures. It's easier, it's cleaner, and, as this ceiling demonstrates so spectacularly, it opens up a whole new world of design. For a catalog of a thousand different Longlite options, write 747-A Bancroft Way, Berkeley CA 94710.

**LONGLITES**  
BY PEERLESS

(415) 845-2760  
Circle 91 on information card

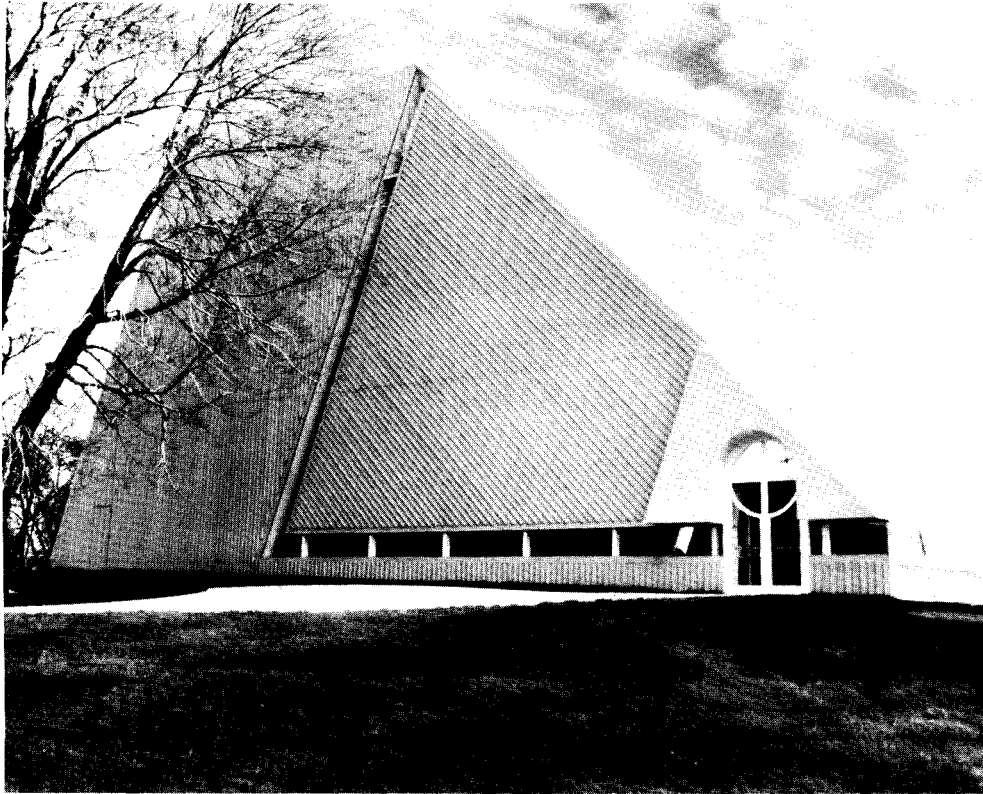

**Michigan Society of Architects.** Calvary Baptist Church, Detroit; Gunnar Birkerts & Associates, Birmingham (left). The simple form is a "superscale" sculpture arising from the landscaped plateau. In the upper room the congregation faces an immense, faceted mirrored wall that is designed to meet liturgical needs and to bring the congregation together visually. The exterior of the church is a yellow-orange ribbed metal skin.

**Minnesota Society.** Gelco Corporation international headquarters, Eden Prairie; Leonard Parker Associates, Inc., Minneapolis (below). The L-shaped building is set into the side of a knoll for energy conservation purposes and for giving all levels of the building a view of the lake and meadowlands below. The stepped-roof configuration provides terraces. Insulating reflective glass is used extensively to create a mirror of the natural setting. The jury commented, "The stepped-form and L-shaped plan minimize the impact upon the landscape and break down the large mass of the building." Balthazar Korab, photographer.



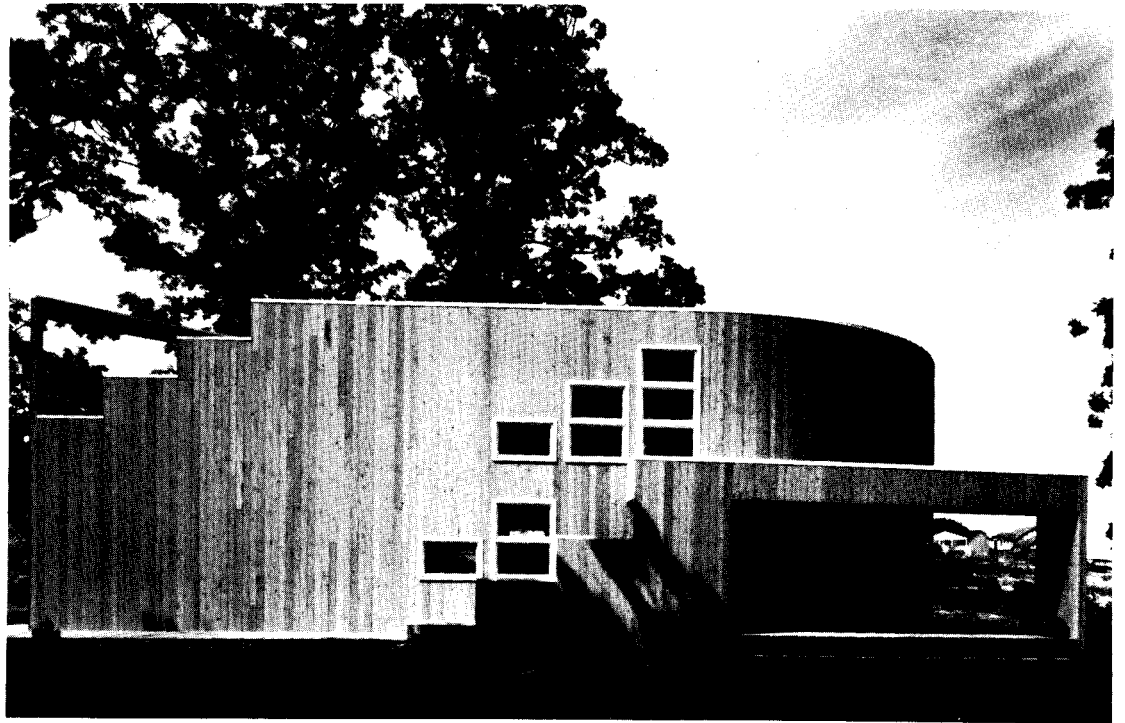

**Chicago Chapter.** The Marion house, Lisle, Ill.; Stanley Tigerman & Associates, Chicago (above). The program requirements were to house a family of three on a one-half acre lot in a suburban subdivision. The house's orientation is south, overlooking a small man-made lake. The architect's solution is a "warping of the binuclear organization" of the International Style. The interior centers around a double height entrance space with a stair design after Michelangelo's Laurentian library. Howard N. Kaplan, photographer.



House on the lake, Glencoe, Ill.; Booth Nagle & Hartray/Ltd., Chicago (above). The house, situated on a bluff overlooking Lake Michigan to the northeast and a ravine to the northwest, is built into a hill, which helps compensate for heat loss through large glass areas. The children's bedrooms and a large playroom are on the lower level; the upper level is a one-bedroom adult living loft space. The jury commented, "It's so technically advanced—and it's such an anachronism in terms of today's architecture. We have to see it as a terrific curatorial effort. It's so sincere; so perfectly done." Philip Turner, photographer.

Residence on a ravine site, Chicago, northern suburb; Michael Gelick Associates, Inc., Chicago (right). The building, oriented with a north/south axis, is set deep into the site to retain existing woods and maintain privacy and provide optimum views of the ravine to the south and west from the principal living spaces. The solution is a three level building block, 32 feet wide and 72 feet long, organized with two adjacent 15-foot bays.





# BASIC BUILD

We're not surprised that people in the building business think of Georgia-Pacific for the basics. Lumber. Plywood. Gypsum board. Because we have all that.

But these days we offer you and your building team even more. Metal products. Roofing. Insulating sheathing.

We are also one of the largest distributors of prefinished wood veneer paneling. And we offer

just about every kind of siding including lumber, hardboard and plywood.

We even have new Teton™ Stain Base™, the first hardboard siding in the industry that stains like real wood right on the job.

There isn't another company today that can offer you as much choice when it comes to building products. Or as much convenience.

Nobody's closer or more able to get your job done better than G-P. We have 163 distribution centers supplying over 25,000 building materials retailers.



# ING BLOCKS.

But before you can take advantage of all we offer, you need to know *what* we offer. So take a minute and order the Georgia-Pacific catalogs that pertain to your business. That way, you'll have good basic information right in front of you.

From the best source in the business — Georgia-Pacific.

**Georgia-Pacific**



Circle 93 on information card

Georgia-Pacific Corporation • Advertising Department  
900 S.W. Fifth Avenue • Portland, OR 97204

I'd like to have your basic information in front of me.

- |                                   |  |                                     |
|-----------------------------------|--|-------------------------------------|
| <input type="checkbox"/> Paneling | <input type="checkbox"/> Siding            | <input type="checkbox"/> Lumber     |
| <input type="checkbox"/> Plywood  | <input type="checkbox"/> Engineering Board | <input type="checkbox"/> Insulation |
| <input type="checkbox"/> Roofing  | <input type="checkbox"/> Metal Products    | <input type="checkbox"/> Gypsum     |

Name \_\_\_\_\_

Title \_\_\_\_\_

Company \_\_\_\_\_

Address \_\_\_\_\_

City \_\_\_\_\_ State \_\_\_\_\_ Zip \_\_\_\_\_

# Vernitron/Better Built

## STERILIZERS WASHERS - DRYERS

**For Hospitals - Central and O.R. Processing,  
Laboratories, Animal Care,  
Research and Production Facilities**

**In Manual or Automatic Systems**

Now, the industry's broadest range of autoclaves, sterilizers, washers, and dryers provides the precise equipment to match your requirements. All are manufactured to exacting performance specifications.

Economy of design, operation, and maintenance adds up to system-wide cost containment. Equipment reliability and minimum service needs shrink downtime. Control accuracy and repeatability boost operator

efficiency. **Most standard replacement parts are available locally, eliminating the cost and clutter of stockpiled spares.** And, professional service is a phone call away.

*The Vernitron/Better Built Company exists to provide the finest quality equipment, customarily matched to our customers' needs, and supported by the highest degree of customer-oriented service.*

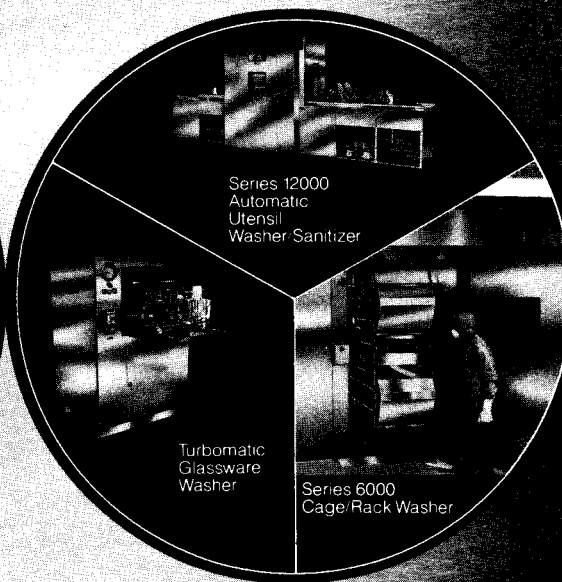
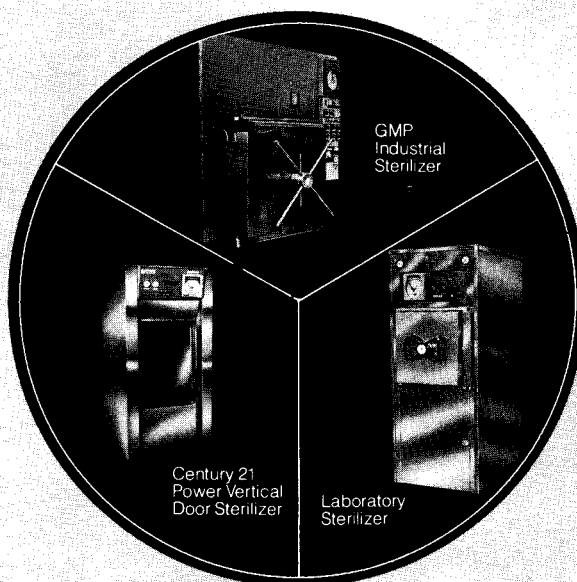

**For more information, write or call today.**

## Vernitron/Better Built

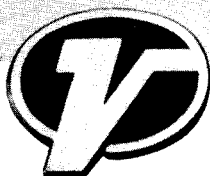

**VERNITRON MEDICAL PRODUCTS**

5 Empire Boulevard, Carlstadt, New Jersey 07072 (201) 641-5500  
TELEX: 13-3345 CABLE: VERNIMED NEWYORK



## 97 years of craftsmanship.

The Heltons of Terre Haute, Indiana. Three generations of craftsmen, and proud of it.

Elza Helton is on the left. He's been laying brick since 1919. Jim, on the right, has been a mason since the late 1940s. Rick is a relative newcomer with five years of journeyman experience on top of his three-year apprenticeship. Every time he lays a brick, Rick brings to the task the accumulated skills, experience and pride of three generations; and every wall he builds reflects those attributes.

Masonry is a unique building system. The inherent quality of the materials—of brick, block, stone, or tile—is one reason. Men like the Heltons are the other.

Their craftsmanship is what gives a masonry wall its beauty, permanence, and durability. Their skill is what makes a masonry wall air-tight, water-tight, sound-resistant and fire-safe. Masonry craftsmen build walls that save money, cut heating and cooling bills, and need virtually no maintenance.

It's a winning combination—the best building materials ever devised, and human skill and pride in using them well.

### **INTERNATIONAL MASONRY INSTITUTE**

(The Bricklayers' International Union and the  
Mason Contractors in the U.S. and Canada)

823 Fifteenth St., N.W.  
Washington, D.C. 20005  
202/783-3908



Circle 95 on information card



**Chicago Chapter.** Rust-Oleum Corporation international headquarters, Vernon Hills, Ill.; C. F. Murphy Associates, Inc., Chicago (left). In order to preserve site area for landscaping, the structure is raised above the 112-car parking area. A circulation axis, with skylight, separates the office space into four flexible modular areas. Bright colors are used to accentuate the exposed mechanical ducts and to emphasize the owner's products. The walls are prefabricated, white enameled aluminum panels. "It starts off as a perfectly straight building," said one jury member, "then you walk in and you find these salamanders all over. It has a terrific sense of procession."

Olson Pavilion/Health Sciences Building, Chicago; Holabird & Root, Chicago (below). The 350,000-square-foot building contains three programs: the dental school with patient operatories, laboratories and lecture rooms; a critical care medical facility for a neighboring hospital, and a cancer research institute with labs and animal care units. The six varying floor heights are connected by four bridges and two tunnels to neighboring buildings. "It's beautifully articulated," said one jury member.

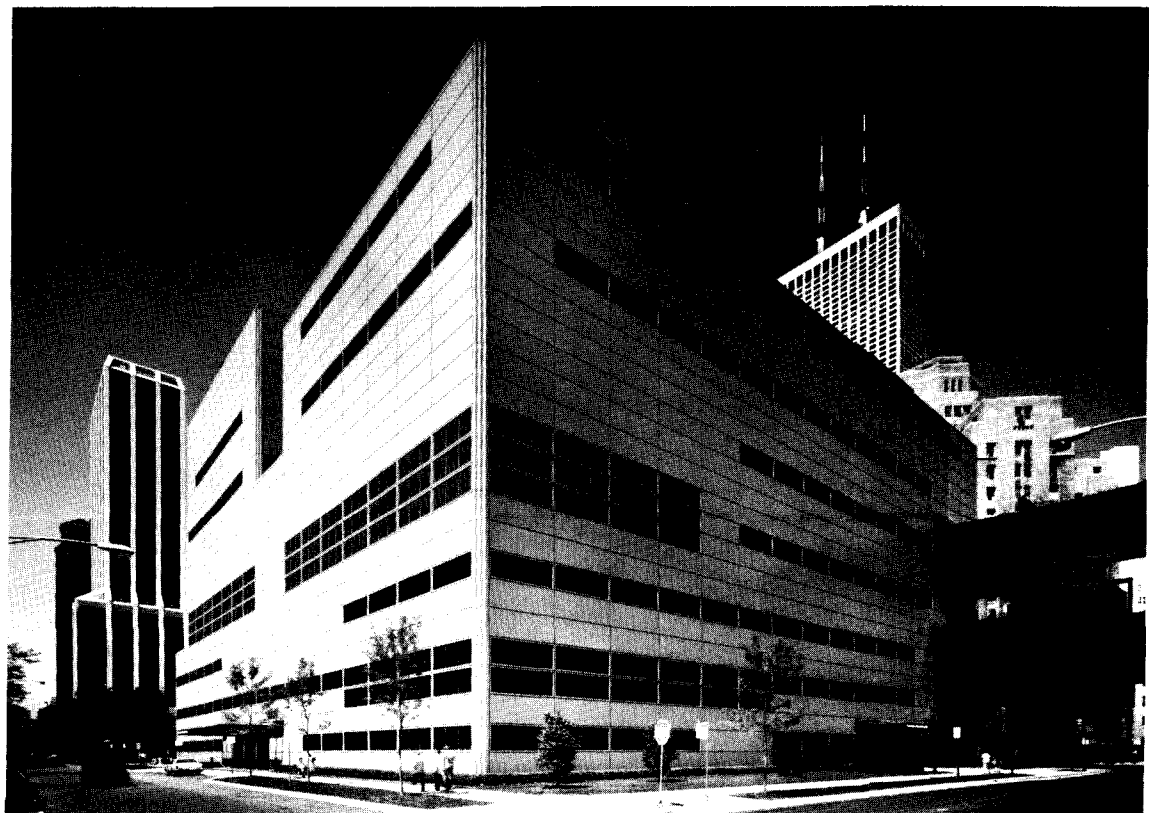



# Steelcraft® distributors can satisfy any taste.

With textured steel, woodgrains, architecturally designed entrance systems, you name it. We know you have a wide variety of needs, so Steelcraft® distributors keep their inventories ready. They have a large stock of standard doors and frames

ready to modify to meet your specific requirements. They're highly trained and skilled, to make certain that you get the precise steel door system you want, when you need it.

Because, your skilled Steelcraft® distributor is a

professional, and then some. In fact, you won't find a better steel door and frame distributor in the business. Or one with a better menu.

For the name of your nearest Steelcraft® Distributor, write 9017 Blue Ash Road, Cincinnati, Ohio 45242.



*Finest name  
in steel doors and  
frames*

**Steelcraft®**  
An American-Standard Company

Circle 96 on information card

# Guardian reflective glass:

1,2

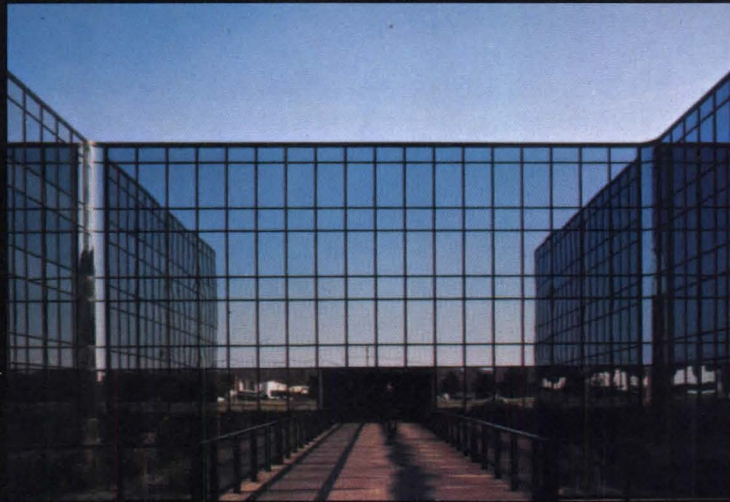

3,4

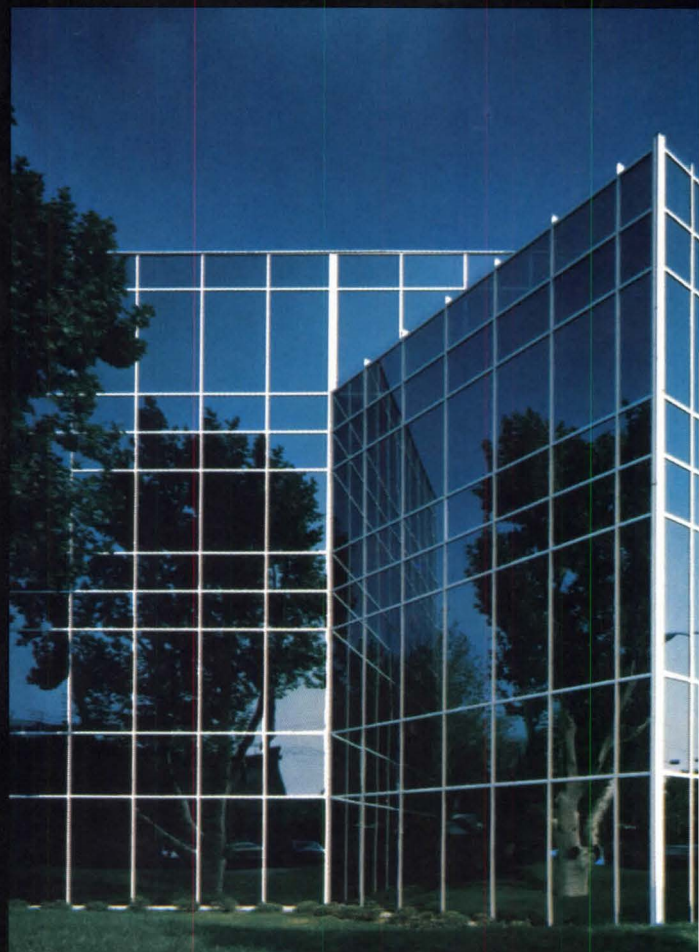
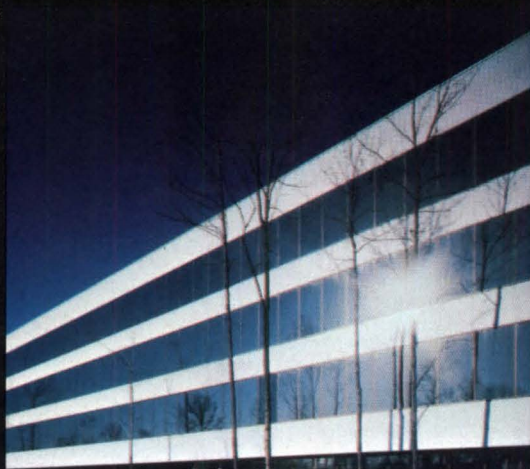

5

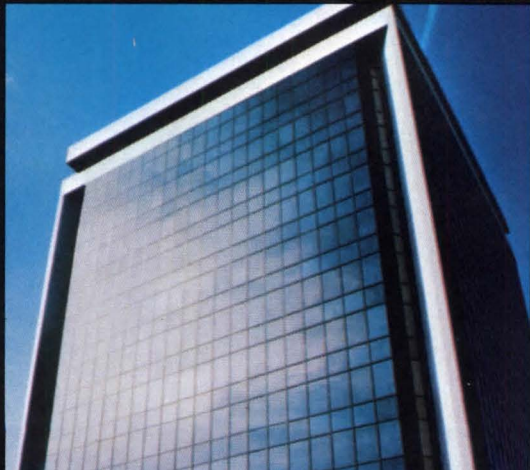

1. Melville Office Plaza  
Melville, Long Island, New York  
Arch: J. Grammas & N. Green  
Glaz. Contr: Levitt Bros.  
SS-8 Silver Reflective

2. 3D International Tower  
Houston, Texas  
Arch: 3D International Inc.  
Glaz. Contr: Cupples Products  
SS-14 Silver Reflective Insulating

3. Bingham Farms Office Bldg.  
Bingham Farms, Michigan  
Arch: Seymour J. Levine  
Glaz. Contr: Benz Glass  
TE-10 Earthtone Reflective

4. Four Seasons Office Building  
Sherman Oaks, California  
Arch: Landau Partnership  
Glaz. Contr: Sitelines  
SS-8 Silver Reflective

5. Fluor Arabia Office Building  
Al Khobar, Saudi Arabia  
Arch: Welton Beckett Assoc.  
Glaz. Contr: Cupples Products  
TE-10 Earthtone Reflective

# See it in Detroit, Los Angeles, New York, Houston, Calgary, Saudi Arabia and in your next building, too.

As you can see, architects both across and outside the United States are specifying Guardian for high-performing reflective glass.

There are good reasons why Guardian is such a fast-growing source. Guardian offers a wide choice of colors and shades. Strong insulating values. And Guardian is a complete manufacturing source—from sand through finished product.

Circle 97 on information card

Best of all, Guardian supports you through completion of the project. You get direct one-source communication on product, pricing and total customer satisfaction. All backed by Guardian Industries, one of the world's fastest-growing corporations.

Learn more about what a growing Guardian means to you. See our catalog—"Glass...in harmony with nature" in Sweet's. Or, for more information, write or call Karl Straky at Guardian's National Commercial Glass Sales Office, Carleton, Michigan 48117. Phone toll-free 1-800-521-9040.



500 5th Avenue Office Bldg.  
Calgary, Alberta, Canada  
Arch: Dale-Chandler-Kennedy  
Glaz. Contr: Zimmcor Co.  
S-B Silver Reflective

6





**Architects Society of Ohio.** Milhoan residence, Worthington; Gene R. Milhoan, AIA, Worthington (above). The garage and studio are separate from the main house, connected by a bridged walkway. The residence is oriented for the view of the Olentangy River valley, with a rounded segment housing the two-story living room. All major spaces have full access

to the sun in the winter and are shaded by trees in the summer. In the winter warm air rises through the building to heat the bedrooms on the top floor.

**YMCA North Branch, Columbus;** Godwin • Böhm • NBBJ, Columbus (below). The first level of the 45,000-square-foot YMCA building is bermed to conserve energy as well as to reduce the

apparent scale, making it more suitable for its suburban neighborhood. The building houses a fieldhouse, 10 racketball courts, exercise rooms, classrooms, lounges and locker rooms with steam, saunas and whirlpool. An indoor swimming pool is yet to be added. ARTOG, photographer.

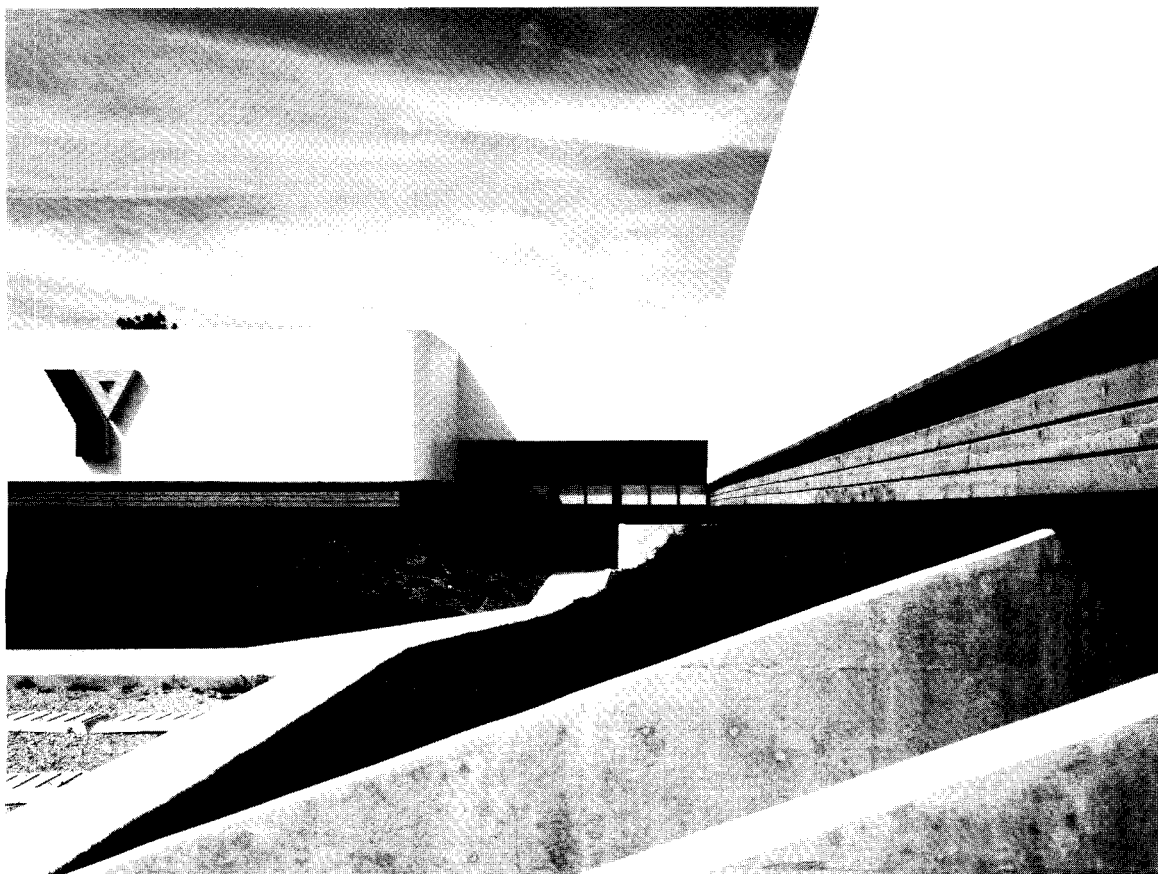

## Introducing the world's only non-stop pencil.

TK-matic advances the lead automatically.

The natural motion of your hand triggers a patented pump-action advance, constantly feeding extra-fine 0.5mm lead to the tip. So instead of stopping again and again to push a button, you keep going.

It's a brilliant system inside a simple, elegant barrel executed in the satin-finished metal shown, or in black with brushed metal accents.

To see this incredible advance in pencils, proceed non-stop to your FaberCastell Dealer. Or write FaberCastell, TK-matic, Box 7099, Newark, NJ 07107.

The non-stop TK-matic. It's a beautiful idea.

**FaberCastell**



# TK-matic<sup>®</sup>

Circle 98 on information card

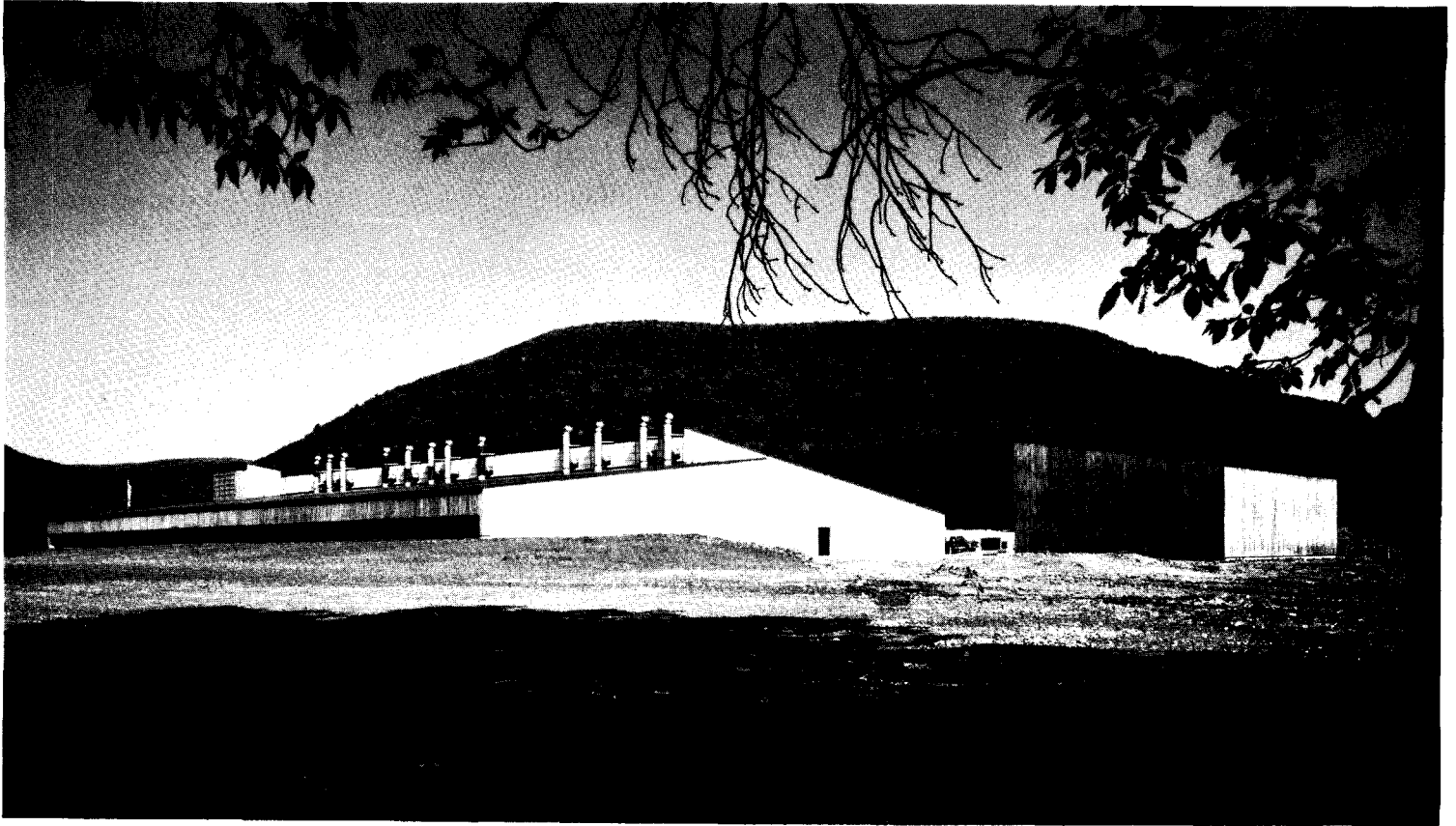

**Architects Society of Ohio.** National Fishery Research and Development Center, Wellsboro, Pa.; Dalton • Dalton • Newport, Cleveland (above). The main spaces of the 3,200-square-meter center are the laboratory spaces and glass-enclosed central circulation spine, from which visitors can view lab work. Well water is used for cooling, and a gravity-operated fresh water system using both

stream and well water provides other water. The structure is of wood post and laminated beams with rough sawn cedar siding. ARTOG, photographer.

Butterfield Senior Center, Cincinnati; Smith-Stevens, Cincinnati (below). The historic Italianate town house, which previously housed all the center's activities, was completely restored. The architects chose passive uses for this building—

lounges, library and small meeting rooms. The new building emulates the proportions, lines and polygonal bay of the historic structure and was purposely held back and kept lower to highlight the older building. More active uses are housed here—dining, dancing, arts and crafts, offices, counseling rooms. Barley-Orner-Makstaller, photographer.



**“After 1,158 days under the searing Arizona sun, Ruf-Sawn 316 looks nearly as good as the day we put it here.”**

—results of a three-year weathering test in Black Canyon Stage, Arizona

When Desert Sunshine Exposure Testing Laboratory began testing Simpson Ruf-Sawn 316 exterior siding for its ability to perform under extreme weather conditions, we were confident that it would do pretty well.

But when the test samples came back for some hardnosed evaluation, even we were surprised.

**Ruf-Sawn 316 looked too good to be true.** For over three years, Ruf-Sawn 316 was subjected to the prolonged heat and ultraviolet radiation of one of the country's severest testing grounds. Black Canyon Stage, located about 35 miles north of Phoenix in the Arizona desert, gets an average of 3,785 sunshine hours a year — substantially more than



New Ruf-Sawn 316

Ruf-Sawn 316 after seven years of exposure

the national average. And, it gets more Langley units of solar radiation (the major cause of paint and surface breakdown) than any other area in the U.S.

Under this kind of torture-test exposure, Ruf-Sawn 316 outperformed our greatest expectations. In appearance retention. Bond adherence. Finish holding ability. And resistance to checking.

In short — Ruf-Sawn 316 proved to withstand the worst kind of weathering in every performance category — day in and day out.

**Compare Ruf-Sawn 316 to its competitors.** In a separate prolonged exposure test started in October of 1972 in Seattle, Wash-



ington, we tested Ruf-Sawn 316 against fir plywood.

As you can see from the actual unretouched photos of the samples being tested, Ruf-Sawn 316 looks remarkably good after more than seven years of testing. Its tough phenolic resin overlay hasn't cracked, split or checked. The paint finish hasn't peeled or blistered. There's no overlay separation.

In contrast, fir plywood shows marked appearance changes. Hairline vertical splits (or “checking”) have appeared all over the surface. And that has caused the paint to fail.

**All the structural advantages of plywood.** Aside from weatherability, Ruf-Sawn 316 offers our cus-

tomers a lot of other advantages. For one thing, paint lasts up to three times longer on the tough overlaid surface than it does on raw wood surfaces. And it takes only about half as much paint to cover a Ruf-Sawn 316 surface.

It's more dimensionally stable than hardboard sidings. It's lightweight, so it's easy to handle. Plus, it doesn't require additional sheathing.

For more information about Ruf-Sawn 316, and Stucco 316, an equally weather-resistant wood siding with an attractive stucco look, write Simpson Timber Company, 900 Fourth Avenue, Seattle, WA 98164.

Ruf-Sawn 316 / Stucco 316  
**Simpson**  
 No other wood siding weathers like it.  
 Circle 99 on information card

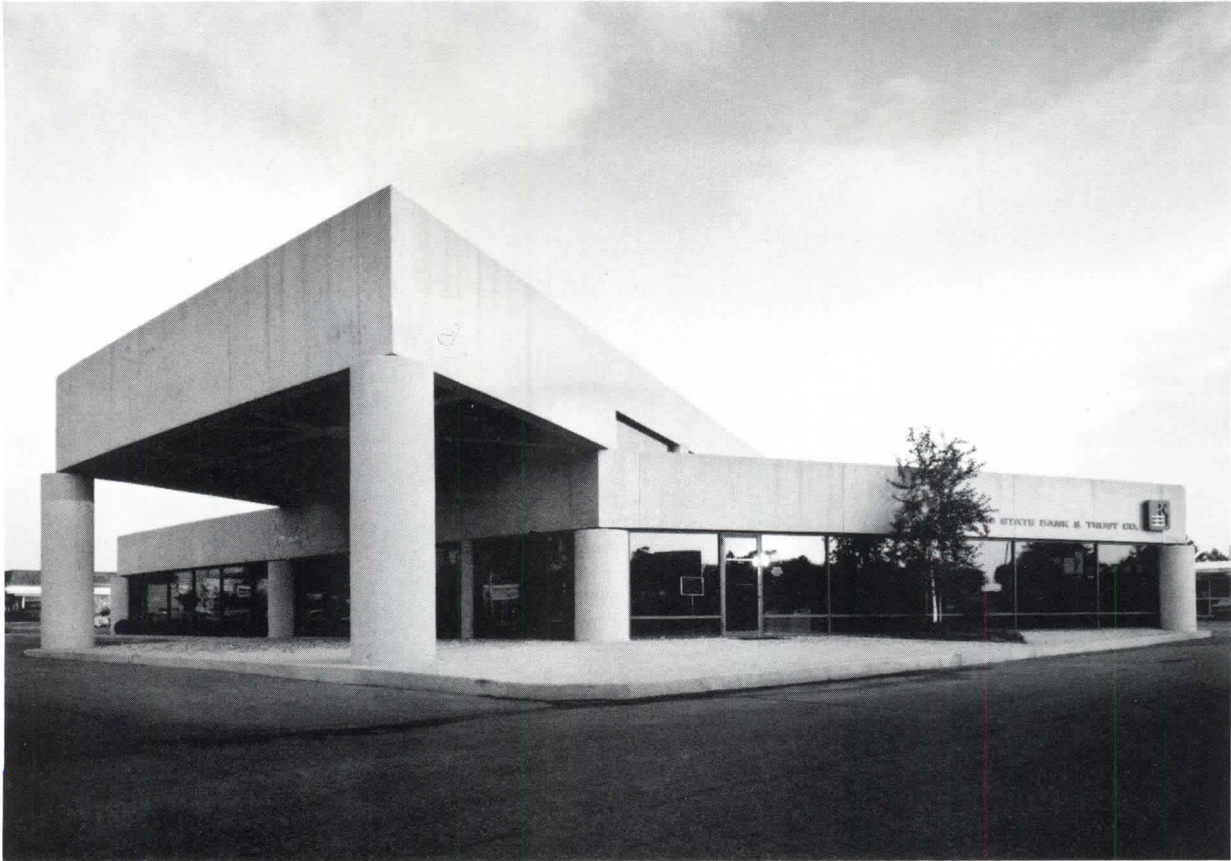

**Kansas Society of Architects.** Kansas State Bank and Trust Co., West Wichita; Robson, Kuhnel & Spangenberg, Wichita (above). The design concept is based on two intersecting parallelogram forms: The lower one contains the banking spaces and the upper form provides roof covering for the building entrance plaza and the drive-up lanes. A clerestory allows natural light to enter the building where the two forms meet. The interior space consists of an open banking area with vault, storage, restrooms and conference-lounge clustered along one side. This windowless side forms a visual barrier from the drive-up lanes and parking lot and shopping center beyond. The other three walls are glass enclosed.

Northwest High School, Wichita; Schaefer & Associates, Wichita (right). The 200,000-square-foot building uses a "town square" concept, with the commons area as the main center of student activity. It serves as a dining facility, study area, gathering place and foyer area for theater use. Two "streets" extend from the commons area, providing circulation to other academic and service areas. A 750-seat theater is adjacent to the commons. The building is of light steel frame construction with masonry exterior walls. Martin Libhart, photographer.





# NO WOOD SELLS ON SITE LIKE NATURAL REDWOOD

It's a fact: Site-scaping with redwood sells your projects — and keeps on selling them for years afterwards — as no chemically treated wood can.

- Redwood's resistance to warping, checking and splitting is natural. So whatever you design and build will *stay* true to form. Chemical treatments cannot make other woods duplicate this performance.

- All-Heart redwood's natural resistance to insects and decay goes all the way through the wood, protecting sawn ends as well as surfaces.

- And no other wood works as easily. Or takes and holds a finish better. Or needs a finish less. Or ages as gracefully as redwood.

No chemically treated wood can look, perform, or sell your projects like redwood. Because that's the way nature designed it.



California Redwood Association • One Lombard Street, San Francisco, California 94111



# REDWOOD

LIVING WITH NATURE

Circle 100 on information card

# PenPly exterior cedar pays dividends by the hour.

PenPly Western Red Cedar Exterior Plywood 303 Siding gives you the real economy of reduced labor costs—while you retain the quality and appeal of cedar siding.

For example, the house pictured here requires only 120 PenPly panels and takes about 91 manhours to cover. Compare that with the 169 manhours it could take to cover an equal area with a piecework siding. That's time, not to mention money, you can't afford to waste.

Buyers also appreciate cedar for its even grain, warm tones, weather resistance and freedom from maintenance. That's why you can afford to step up to cedar and realize a much greater profit when the home is sold.

In order to show you the design and profit possibilities of cedar, PenPly, the leading producer of quality cedar siding, has published a *free brochure*. It contains floor plans to this house, design details and facts.

For more information, contact your wood products distributor, or see Sweet's General Building and Light Residential Files under Siding/Cladding Section (7.6 Pen).

**PenPly**  
Wood Products from I.T.T. Rayonier, Inc.

Circle 101 on information card

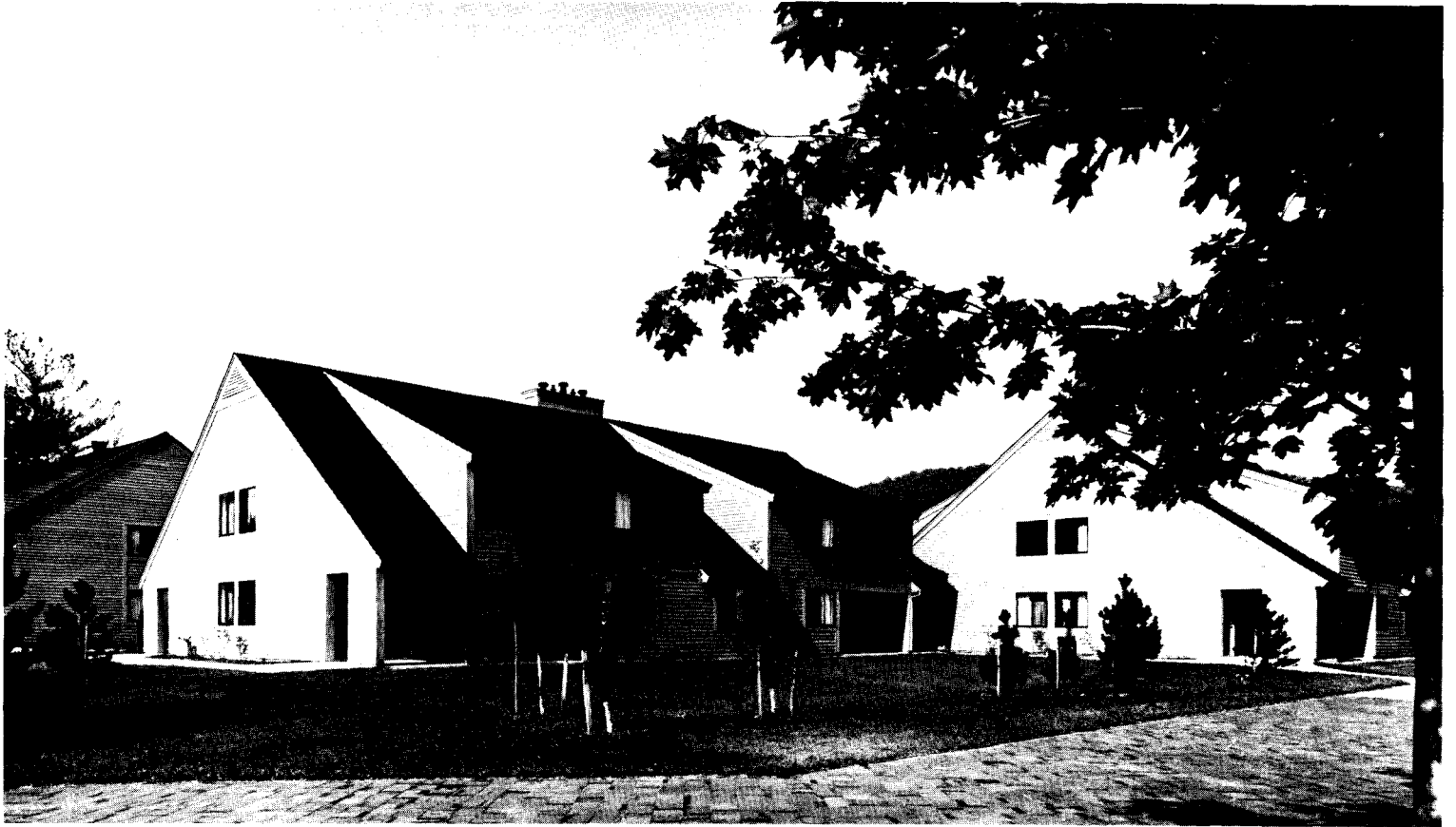

**New York State Association of Architects.** Village Manor Senior Citizen Housing, Painted Post; Schleicher-Soper, Syracuse (above). Sixty-four one- and two-bedroom apartments are housed in eight buildings clustered to create an interior green space. A community building and support facilities are located in a single-story structure joined to the housing units by interior connections and covered walkways. Each unit has a separate exterior entrance, and private balcony or patio. The jury commented, "The architect de-

veloped a clean vernacular design—warm, calm and nicely scaled for the elderly." Rothschild, photographer.

Barn house, Westchester County; Paul Segal Associates, New York City (below). The building is sited on the foundations of a barn that was destroyed by fire. It houses the caretakers/farmers, four cars, two horses and two cows. Garage and stable are on the east side of the stone retaining wall (remaining from the original barn), forming a courtyard between them. The house living area is the ga-

rage's second story. On the high side of the retaining wall the bedrooms, bathrooms and kitchen form an east-facing wing. The hay storage and greenhouse is a glass tower at one end. Structure is wood post and beam. Norman McGrath, photographer.

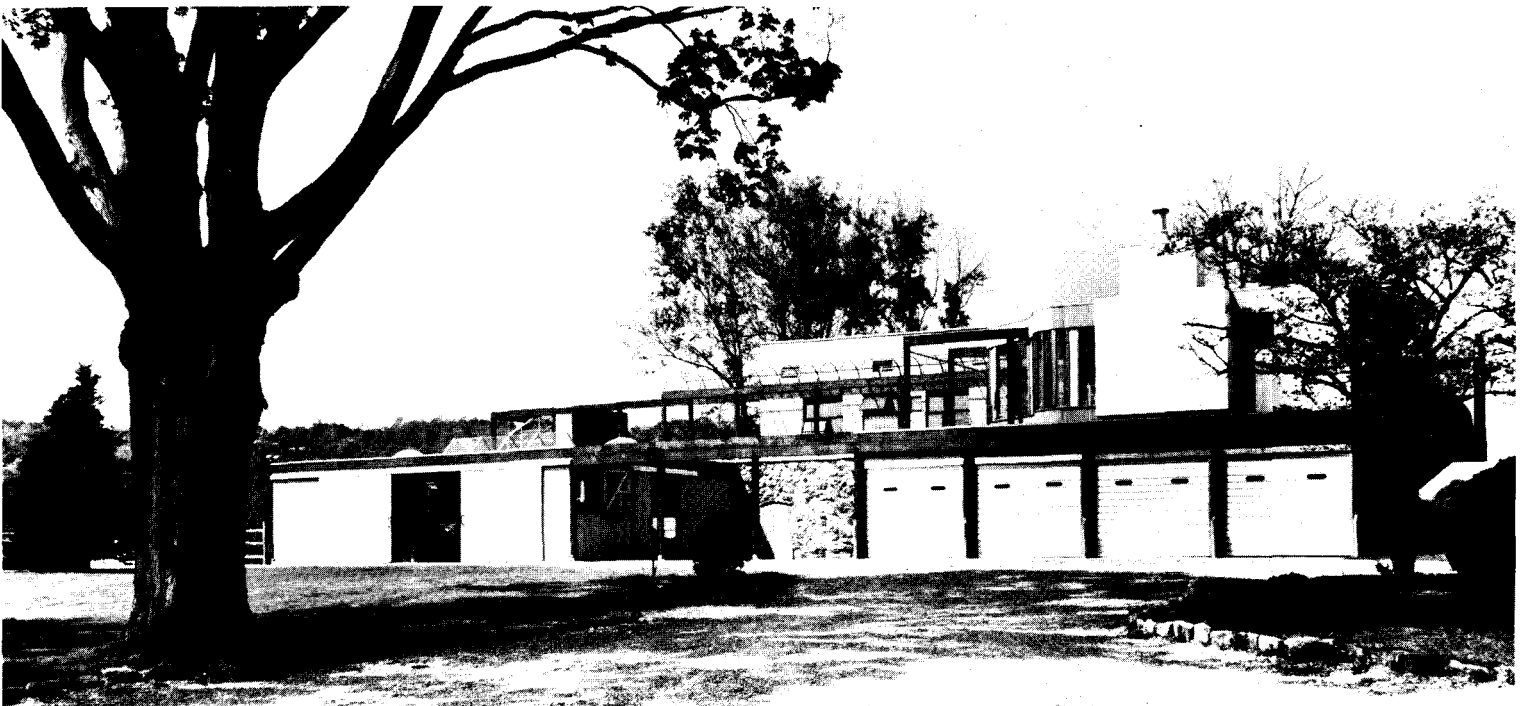

# A 10-acre roof of TEFLON...and air



# fabric coated with supports the load.



An air-supported dome of lightweight Fiberglas® coated with DuPont TEFLON® fluorocarbon resin completely roofs Pontiac Silverdome, home of the Detroit Lions, Detroit Pistons and Detroit Express. The 10-acre area is the largest permanent structure roofed with architectural fabric to date—and the stadium cost far less to build than comparable stadiums using other dome approaches.

Although the roof weighs 200 tons, the spectators inside never notice the slight increase in air pressure that supports it.

Tension structures with steel cables carrying the load, such as this LaVerne College drama lab and campus center, offer an attractive alternative to air-supported structures.



In addition to low construction costs, fabric structures coated with TEFLON offer easy and economical maintenance. The coated fabric resists sunlight, dirt and aging, and rain helps keep it clean because of the non-stick surface of TEFLON.

Fabrics coated with TEFLON have high reflectivity, which helps minimize energy expenditures for cooling in summer. They also provide relatively high solar transmission for natural illumination and can be insulated to minimize heat loss in winter.

Architectural fabric structures are strong. When properly specified, they easily withstand the stresses of wind and snow. And Fiberglas® coated with TEFLON does not support combustion—exhibiting exceptionally low values for flame spread and smoke generation.

## Send for free booklet

Find out more about the advantages of architectural fabrics coated with TEFLON for permanent buildings. For a free 16-page full-color brochure, write: DuPont Company, Room 37051A, Wilmington, DE 19898.



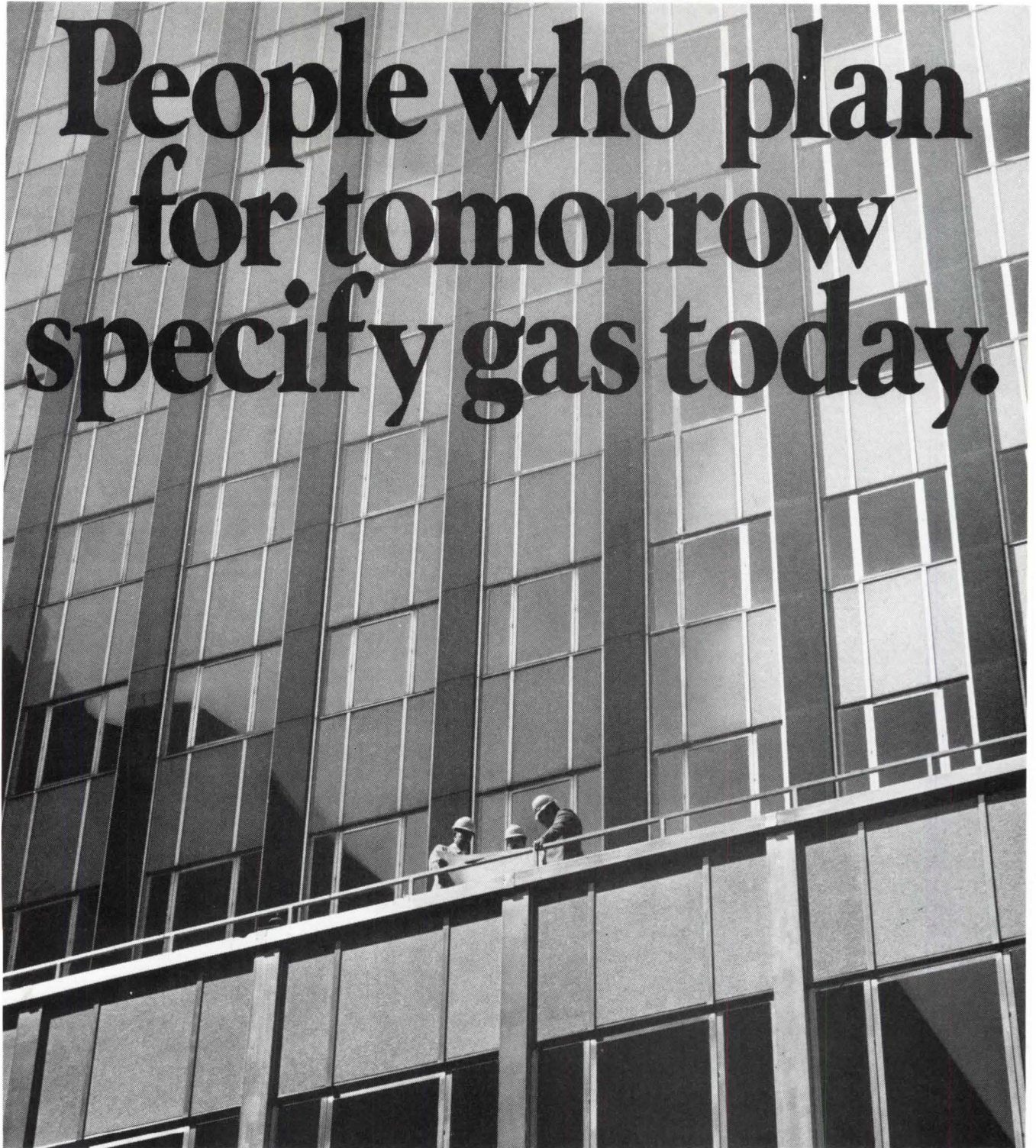

# People who plan for tomorrow specify gas today.

You can count on a dependable supply of gas for the future. Because there's much more gas still underground than we've used so far—enough to last *well into* the next century. And new sources, like gas from coal, will add to the supply. Beyond that, new technologies are expected to provide efficient gas energy for generations.

Good reasons why more and more architects and engineers are specifying gas. And why most gas utilities are accepting new commercial customers.

Gas energy. It's the least expensive energy for space conditioning today, and it will continue to maintain this competitive advantage in the future. **AGA** American Gas Association 

## Gas: The future belongs to the efficient.

# Save up to 70% in space!

**Joy axial fans offer you this big design advantage over conventional centrifugals of equal performance.**

Joy believes air moving systems should be built in, not built around. And the Joy Axivane® fan makes a "built in" system possible. Constructed around the motor, the Axivane fan features in-duct mounting to eliminate duct turns, offsets and plenum boxes.

Result: Smaller equipment rooms. More usable space!

In addition to saving up to 70% in space, the Axivane fan offers these additional benefits:

**UP TO 50% LESS WEIGHT**  
permits reduced structural requirements.

**LOWER INSTALLATION COSTS**  
thanks to a pre-adjusted, self-contained package delivered in one piece for easy, fast installation.

**QUIET OPERATION**  
sound attenuation is much simpler with the higher frequencies of the Axivane fan.

**LOWER OPERATING COSTS**  
due to greater operating efficiencies.

**ADJUSTABLE BLADES**  
provide a wide operating range.

**CONTROLLABLE PITCH IN VAV SYSTEMS**  
for maximum energy savings automatically thru blade pitch control at partial loads.

Yes, you'll have room to spare when you specify Joy Axivane fans. For additional information, contact Joy Manufacturing Company, Air Moving Products, New Philadelphia, Ohio 44663. In Canada: Joy Manufacturing Company Ltd., Alpha Fan Division, Winnipeg, Manitoba.



Save up to 70% in space!



*Offices and plants throughout the world*

**NEW  
PHILADELPHIA  
DIVISION**



Circle 104 on information card

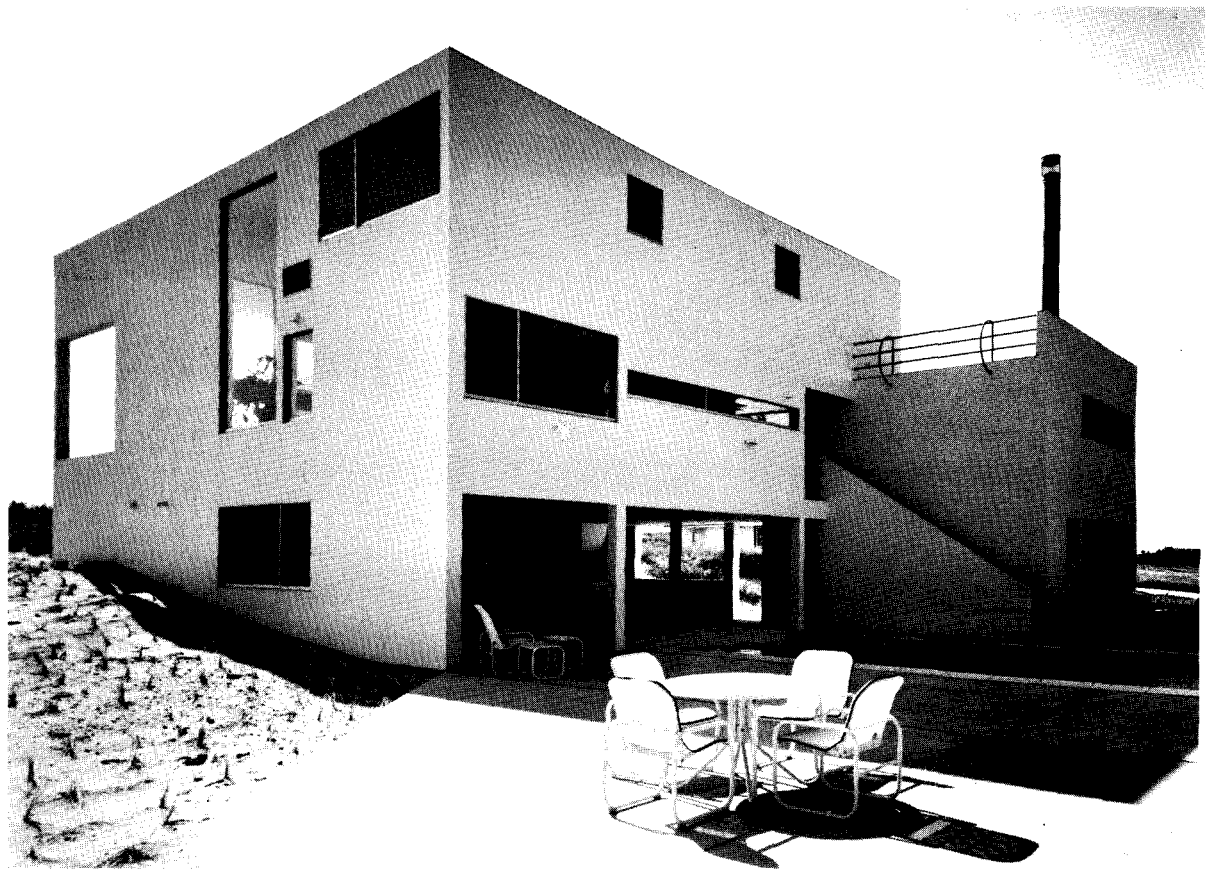

**New York State Association of Architects.** Weitz residence, Quogue; Gwathmey Siegel, New York City (above). The house is located on a sloped ocean dune with view and access to the ocean to the south and view of the inland waterway to the north. There are two separate and self-contained residences with kitchenettes, bathrooms and direct outside access and extensive deck and terrace space. The wood frame house has tongue-in-groove cedar siding and interior walls of laminated sheet rock. "A clean, crisp

design with excellent details and well-done Mondrian cubes," the jury commented. Norman McGrath, photographer.

Benjamin F. Feinberg Library, State University at Plattsburgh; Mitchell/Giurgola, New York City (below). The main entrance of the 133,000-square-foot library has been cut back as a square portico to reflect the front facade of the neighboring student union building. The recessed window wall on the front side emits natural light into the lower level of

the building and offers a view of the outside plaza. The two upper levels contain reading areas intermixed with stacks and larger reading areas on the perimeters of two sides of the building. The only enclosed public spaces on these floors are glass-enclosed reference rooms. The north angle of the library houses the Rockwell Kent Gallery. George Cserna, photographer.

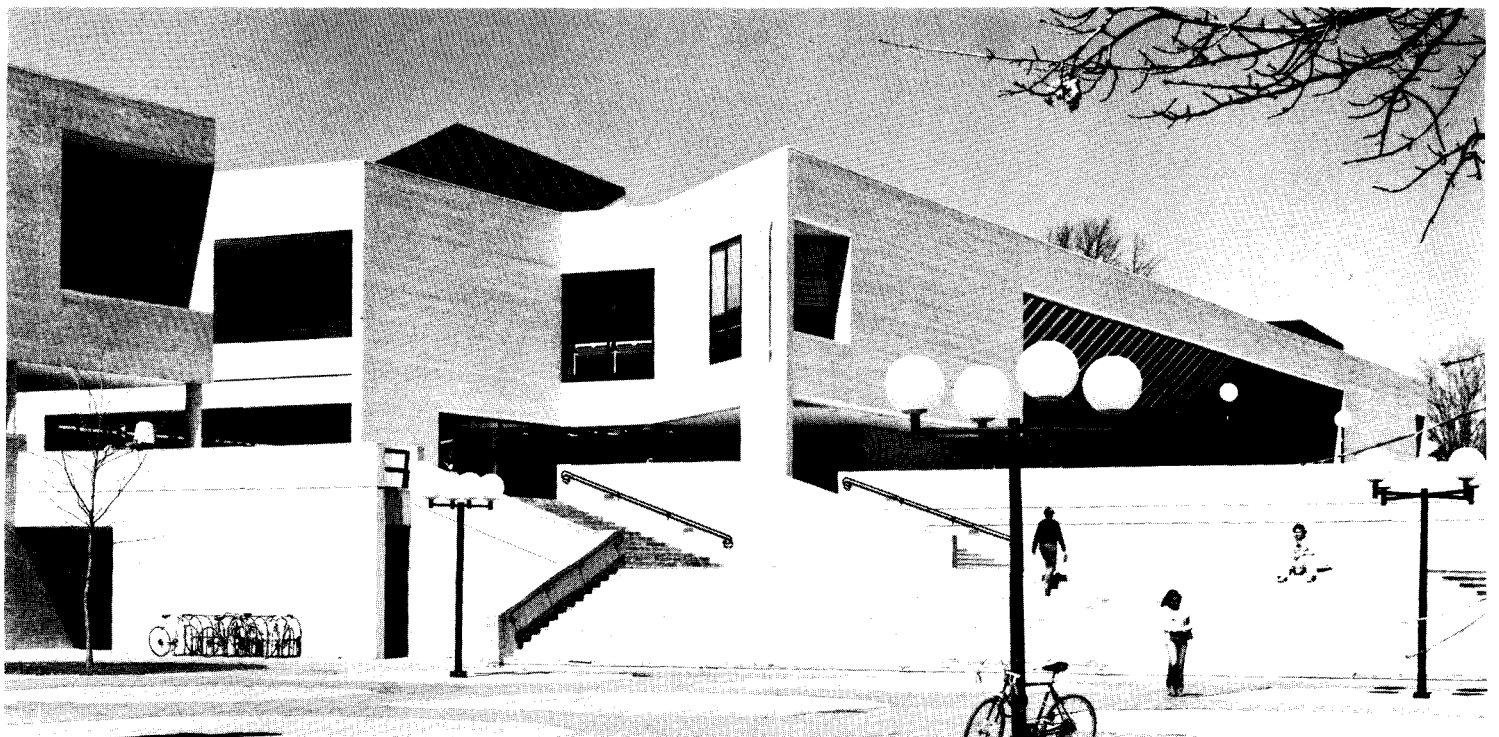





## The most durable floor is the least expensive to own.

PermaGrain® natural wood flooring.

30% less expensive than vinyl.

And terrazzo, quarry tile, nylon carpeting, and conventional wood flooring based on life cycle costs.

500% longer life than even epoxy terrazzo.

Good reasons you might choose PermaGrain.

But the best reason is more obvious: its beauty.

And beauty, cost-effectiveness, and long life is a combination for which PermaGrain is unsurpassed.

For beauty, The American Society of Interior Designers gave PermaGrain its highest award.

Cost-effectiveness is proved. When contract-quality flooring is compared under identical, high traffic conditions and a 20-year life expectancy, PermaGrain can save from 6% to 42% on life cycle costs. At 50 years, PermaGrain's estimated full life expectancy, savings jump to record levels between 21% and 55%. One reason: PermaGrain never needs refinishing.

Maintenance? With PermaGrain, you can forget soap — water — wax. Simply dust mop. And occasionally mist on some cleaner and machine polish to a showcase elegance.

Where does PermaGrain natural wood flooring belong? Everywhere. Just look on this page. Then get a free brochure, comparative life cycle cost analysis, and the name of your nearest PermaGrain representative. Call direct, 215-565-1575, or write PermaGrain Products, Inc., 22 West State Street, Media, PA 19063.

Top: Pearl Ridge Center, Honolulu, HI  
Middle left: Tower National Bank, Lima, OH  
Middle right: Foothill Junior College, Los Altos, CA  
Bottom: Penn Mutual Life Insurance Building, Philadelphia, PA

 **PERMAGRAIN  
PRODUCTS, INC.**

22 West State Street, Media, Pa. 19063  
(215) 565-1575

Circle 105 on information card

# Otis Introduces

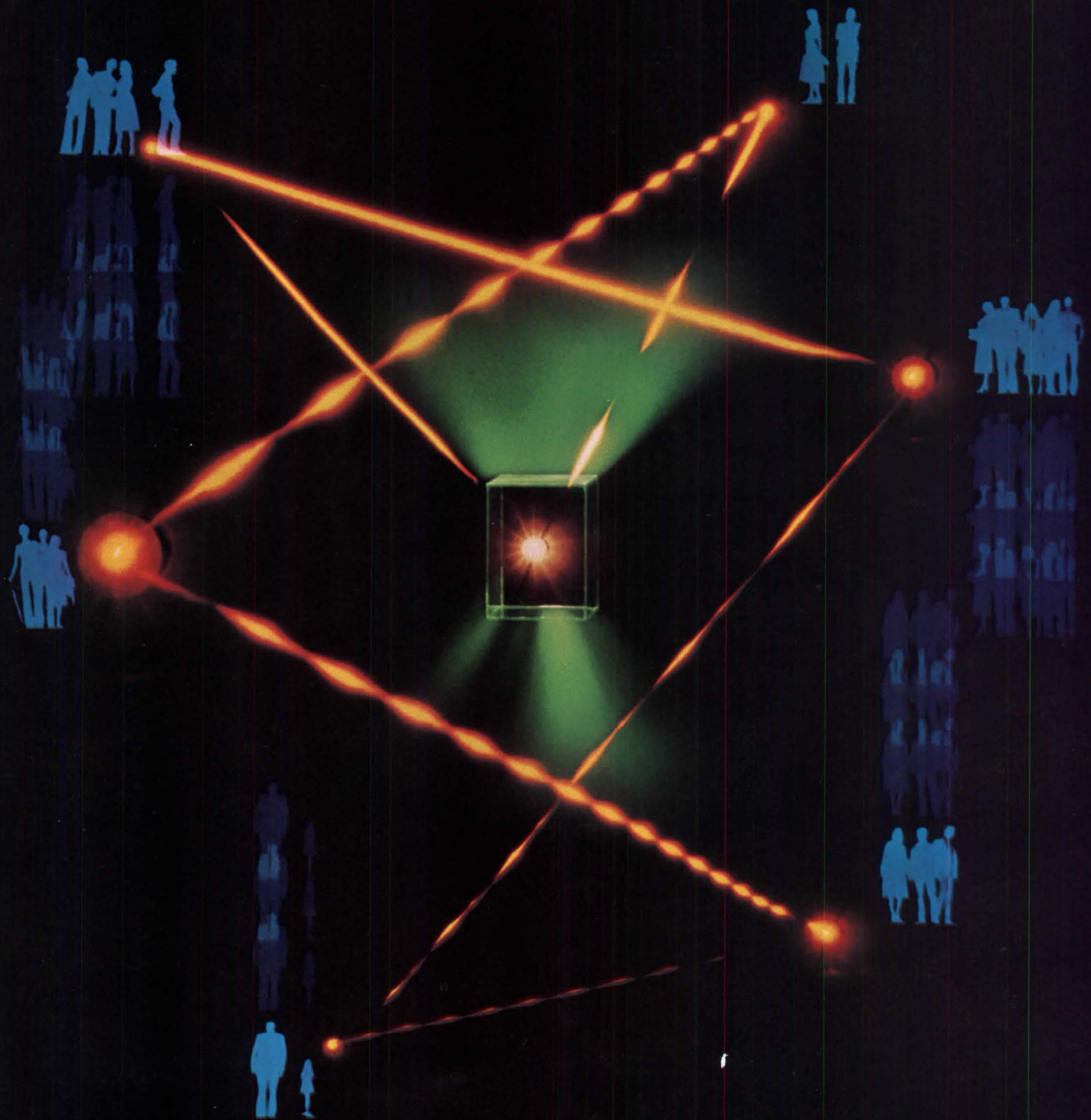

# Elevonic 101...

## A step into the future that saves time, energy and money.

Revolutionary in concept and designed using the latest elevonics\* technology to provide the most economical operation, the new Otis Elevonic 101 microcomputer elevator control system vastly improves passenger travel time, reduces installation and adjustment time, conserves substantial quantities of energy and improves reliability.

### **New Generation Microcomputer**

Otis HR gearless elevator systems, equipped with Elevonic 101 controls, can, for the first time, computer-control every aspect of elevator operation — velocity, position, direction, passenger travel and waiting time, door operation, car assignment in a group, energy usage and system diagnostics. Truly a new generation of elevator control — unmatched by any other system available.

### **Demand-Response Operation**

The Elevonic 101 is unique among elevator control systems. It is the only system that can instantly and precisely react to actual traffic demands all of the time.

It's software based, so it can be easily reprogrammed without replacing expensive hardware if a building's needs change. The result is unequalled performance and passenger convenience and comfort coupled with outstanding operating efficiency.

Average passenger waiting time can be as much as one third less than our best previous equipment.

### **Energy-Saving SCR Drive**

Silicon controlled rectifier (SCR) motor drives use about 30 percent less energy than motor generator sets. They use no power at all when the elevators are at rest. That means improved energy management and lower building operating costs.

### **Precise Floor Landing Stops**

Elevonic 101 eliminates the large electromechanical position selector. A solid state transducer system measures car hoistway position to within 1/32" and provides continuous, dependable leveling accuracy. And, it automatically compensates for building compression.

### **Reduced Installation Time**

The exclusive software-based controls are simulated, tested and adjusted prior to delivery. Total installation and adjustment time can be reduced by as much as 20 percent. And that's not all.

Multiplexing—transmitting several signals simultaneously over a single wire—has reduced traveling cables from an average of three cables, each carrying about 70 wires, to a single cable with about 50 wires, further reducing installation time.

These are only a few of the major improvements that elevonics has enabled us to engineer into our new Otis HR gearless equipment. Others include reduced machine room space, smoother, faster door operation, reduced elevator downtime and additional ways to maximize energy efficiency.

We've given you just part of the Elevonic 101 story. For the full story on the Elevonic 101 control system, call your local Otis office to see how it can save you time, energy and money on your next project.

**\*Elevonics is the science of moving people and products through the use of advanced elevator and microelectronic technology.**



Circle 106 on information card

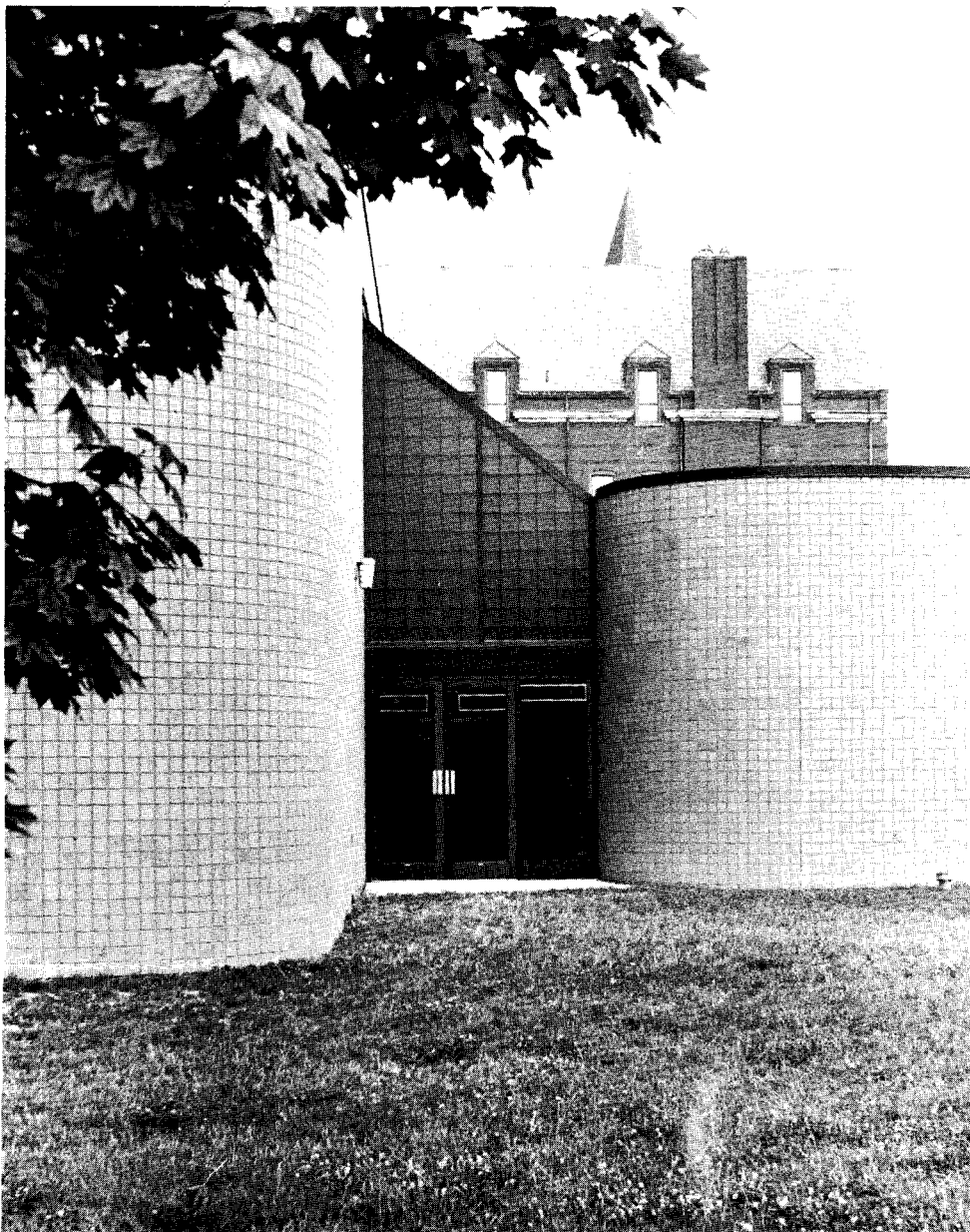

**New York State Association of Architects.** Citibank Satellite Banking Building, various locations throughout New York; Landow & Landow, Commack (above). The client requested a network of unmanned banking buildings to house computerized automated terminals for 24-hour, seven-days-a-week full banking service, in both urban and suburban locations. The client also requested a building that would be expressive of its advanced banking technology, that would be energy efficient and that could be pre-assembled. The architect's solution was two prefab module units (11x22x10.5 feet) that are attached with bolts. A customer enters the lobby by inserting a plastic identification card into an electronic reader that unlocks the entrance door. The lobby contains two check desks and access to the automated teller machines.

**Buffalo—Western New York Chapter,** Elementary Division addition, Mount St. Joseph Academy, Buffalo; Hamilton, Houston & Lownie, Buffalo (left). The 30,000-square-foot, one-story building has classrooms on one side. Adjacent to this is a "cluster" space that functions as an extension of the classrooms. Unassigned multiuse spaces are provided for special programs. All spaces are grouped around a central research and reading area with natural light provided by continuous insulated skylights.

# Steel framing saved more than \$150,000 in four-story retirement complex

Local code restrictions for wood frame construction would have limited Casa de los Amigos in Redondo Beach to only three stories, but four stories were needed to provide the desired 136 living units on the land available for this HUD approved senior citizens' project.

In seeking alternatives, a structure combining steel framing on the first floor with three stories of wood framing above was shown to have many problems. The accepted solution, a design prepared with the help of Inryco engineers, used Inryco/Milcor roll-formed steel stud and joist framing throughout. It solved construction problems and also reduced costs by \$155,470.

## You Get More Than Just Product When You Specify Inryco/Milcor Steel Studs and Joists:

1. Architectural and structural design assistance from our experienced staff.
2. Counsel for owner, designer and contractor based on our longtime involvement in steel frame construction — including an honest appraisal of its suitability for your project.
3. The combination of benefits inherent in our systems: design flexibility . . . construction speed through advance fabrication of framing assemblies . . . thermal energy efficiency . . . capacity to withstand heavy seismic and high wind loads . . . numerous one- and two-hour fire rated assemblies . . . insurance advantages of non-combustible components.

Let us help you increase construction efficiency and reduce costs on your projects. See the information on our steel framing systems in Sweet's: General Building File, section 5.3/In, and Light Construction File, section 5.3/Inr. (Or write for Catalogs 37-1 and 37-2.) Then give us a chance to discuss their application to your projects.

Milcor Division; INRYCO, Inc.; Dept. E-4127 P.O. Box 393; Milwaukee, WI 53201.

## Inryco / Milcor<sup>®</sup> Steel Framing Systems

**Casa de los Amigos**, Redondo Beach, California  
**Architect:** Arthur Hugh Kensler, A.I.A., Los Angeles, CA  
**General Contractor:** J. R. Slaughter Construction Co., Irvine, CA  
**Framing Contractor:** W. C. Froelich, Inc., Buena Park, CA



**Inryco**  
an Inland Steel company

A9-37-1

Circle 107 on information card



Forget everything you ever knew about stacking chairs! Now, the Continuum Chair\* from STOWIDAVIS.

For the first time—fine furniture that stacks and yet is handsomely at home in any area—reception to open office to boardroom!

But don't settle for just this great chair, we have been solving space problems for one hundred years. We do entire office systems. We'd like to do one for you.

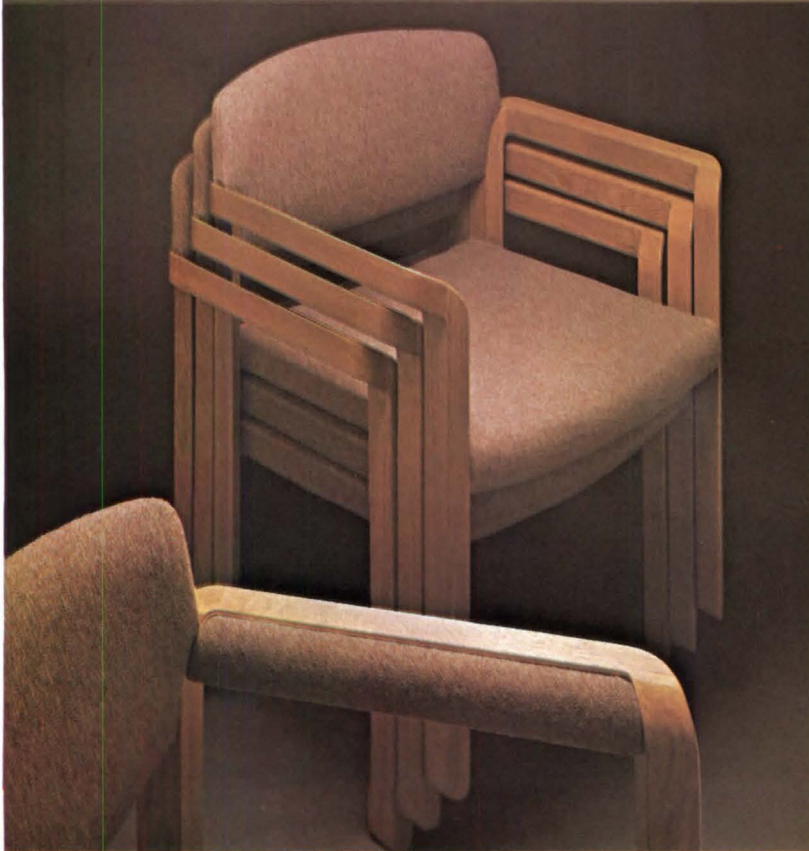

\* Designed by Warren Snodgrass.

Available in white oak or American black walnut.

See the Continuum Chair for yourself. Call us to see one...

SHOWROOMS:

New York City 10022	950 Third Ave.	(212) 688-9410
Chicago 60654	909 Merchandise Mart	(312) 321-0436
Los Angeles 90069	8687 Melrose Ave.	(213) 652-9210
Houston 77019	2 Bering Park	(713) 974-3300
Grand Rapids 49504	25 Summer Ave. N.W.	(616) 456-9681



Celebrating our Centennial year

STOWIDAVIS

Circle 108 on information card



**Connecticut Society of Architects.** Milford Jai Alai Fronton, Milford; Herbert S. Newman Associates, New Haven (top). The 150,000-square-foot facility houses a playing court, 4,800-seat spectator area, cocktail lounges, bars, restaurant, closed circuit television room, betting parlors and administrative offices. The playing court, a 180-foot column-free auditorium spanned by exposed steel trusses, is visible upon entering the building. The jury called the structure "a very big building that celebrates the values

within. It should be playful, and it is." Norman McGrath, photographer.

Apartment building, Hamden; G. Stuart Gray, Hamden (above). The structure is located on what was a vacant lot in an older residential neighborhood, surrounded by one- and two-story wood frame houses. The architect designed the building to be compatible with the smaller houses. Two images were used: one seemingly old to respect the existing street motif and the other new to add modernity to the neighborhood. Two dif-

ferent colors of aluminum siding were used to reinforce the juxtaposition of the two forms. The jury admired the building for the constraint expressed and its respect for the neighborhood: "It shows that you needn't always make a demonstration with an architectural object. One can heed the total environment and still have a quality of design."



Sunpak is on the job right now, putting the sun's inexhaustible energy to work for major industries across the country — including this 9,500 sq. ft. installation at the Jackson, Tennessee, Coca-Cola bottling plant.



# “With Sunpak™, we’ve reduced our natural gas consumption by fifty percent.”

Woods Holloway, Vice President  
Coca-Cola Bottling Works  
Jackson, Tennessee



The natural gas curtailment in 1974 meant serious problems for Woods Holloway. He relied on gas to heat his bottling plant, as well as the water used in the bottle washing operation.

That's why he decided to look for an inexhaustible energy source. And he found it: the sun.

He wanted the most efficient solar energy collector on the market. And he found that, too: the Sunpak solar thermal collector.

It's an evacuated tube system capable of collecting and retaining up to 4 times more

energy than the other systems now available (based on all-day performance).

Since switching to Sunpak, not only has the plant enjoyed a 50% reduction in its natural gas consumption — in the summer, Sunpak delivers up to 100% of the hot water necessary for the bottle washing process.

All this — with no air or water pollution. And no depletion of natural resources.

We'd like to tell you more. Write to us: SUNPAK; Owens-Illinois, Inc.; P.O. Box 1035; Toledo, Ohio 43666. *Today.*

Bonneville Power  
Vancouver, Washington

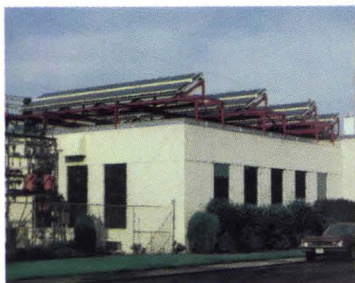

Troy-Miami County Public Library  
Troy, Ohio



Federal Office Building  
Saginaw, Michigan



Yellow Freight  
Miami, Florida

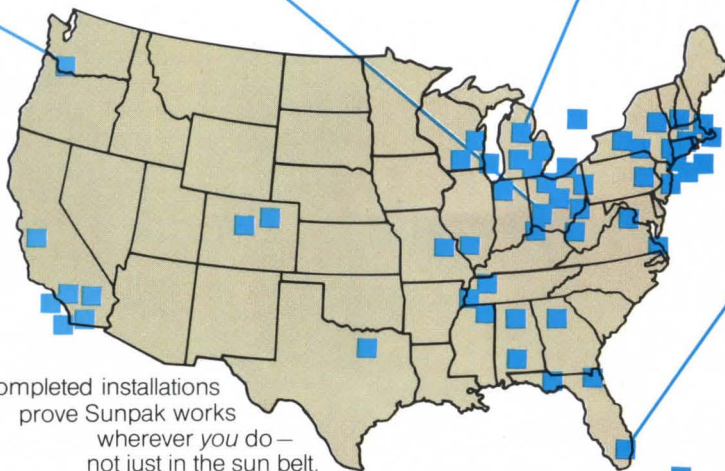

60 completed installations  
prove Sunpak works  
wherever *you* do —  
not just in the sun belt.

# SUNPAK™

Energy Products Group of Owens-Illinois 

Circle 109 on information card

**A glass pipeline to the sun.**

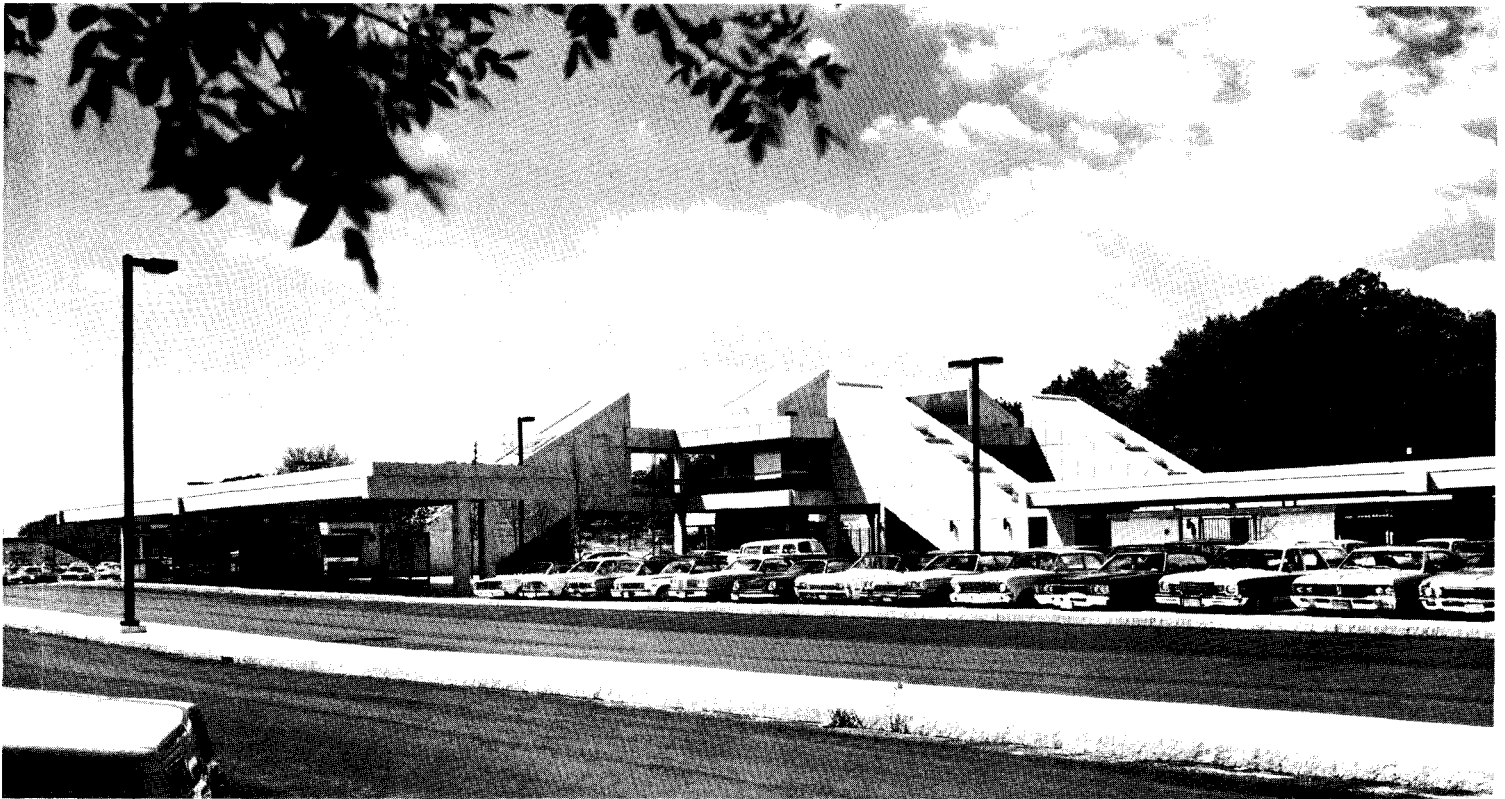

**New England Regional Council.** Oak Grove Rapid Transit Station, Malden, Mass.; Sert, Jackson & Associates, Inc., Cambridge, Mass. (above). A lobby runs over the two surface rapid transit tracks from the parking lot (for 553 cars) to the bus/car dropoff entrance. Escalators and elevators provide access to the overhead lobby. The reinforced concrete structure

has post-tensioned floor and roof beams, prestressed concrete platform and canopies, flameless heat-strengthened glass, porcelain enamel panels, brick paved floors, glazed brick interior walls and sandblasted concrete finish. The jury commented, "It would be hard to imagine a piece of architecture more expressive of the whole system it encloses." Steve Rosenthal, photographer.



Roger Williams Park Zoo, Providence, R.I.; Architects Design Group, Providence (left). By the 1970s many of the existing zoo's facilities had reached a blighted state of disrepair. The architect was hired to completely redesign the existing zoo from a menagerie to a carefully organized series of naturalistic habitats for the animals. New elements—a children's nature center, North American exhibits center and a wetland area—relate to the existing bird house, South American mammal house and concession stand (which are to be restored). On the children's nature center, the jury commented, "The upper parts of these high structures, [two hipped-roof structures] described as tent-like, are handled by the architects in a very imaginative manner wholly sympathetic to the presence of children but without obtrusive cuteness." Foulds-Wilson Studio, photographer.

# You don't have to be "Wired" for Safety



Laminated Safety Glass will do the trick! — without the "caged" look! — without wire! Laminated glass is safe! The glass to PVB adhesion prevents "fall-out" of broken glass.

Laminated glass is distortion-free and is available in a complete line of heat absorbing and reflective products.



**Make it safe! Make it Laminated Glass!**

Get All the facts about Laminated Glass—just send a postcard to:  
**LAMINATORS SAFETY GLASS ASSOCIATION**  
3310 Harrison  
Topeka, Kansas 66611

**LAMINATORS SAFETY  
GLASS ASSOCIATION**



Making Glass that WORKS for You

*Circle 110 on information card*

**In these woods great**



# Ideas grow.



## One of the most comprehensive wallcovering design facilities in the world.

Here, in the historic woodlands of New Hampshire, is the General Tire Design Center... where GENON Vinyl Wallcovering originates. The Design Center is an unequalled resource for wallcovering design and development... with total capabilities ranging from creating new styles to producing richly embossed samples.

You can choose from over 1,000 styles in the GENON collection. Also, the Design Center's superb staff can help you create custom designs. Or show you how new effects can be created from stock GENON patterns. See your GENON distributor or write on your company's letterhead to:

The GTR Wallcovering Company, Division of the General Tire & Rubber Company, C.N.-04850, Trenton, NJ 08650.

**genon**  
vinyl wallcovering



For the wallcovering expertise shown above, contact a GENON distributor listed below.

**KINNEY BROTHERS**  
Oakland, California 94601  
Costa Mesa, California 92626  
Chatsworth, California 91311  
San Francisco, California 94103

**KOMAC PAINT**  
Denver, Colorado 80201

**CONSOLIDATED WALLCOVERINGS**  
Hartford, Connecticut 06114

**GILMAN WALLCOVERINGS**  
Orlando, Florida 32809

**CRESCENT WALLCOVERINGS**  
Atlanta, Georgia 30341

**MIDWEST WALLCOVERINGS, INC.**  
Elk Grove Village, Illinois 60007

**ROSCO INCORPORATED**  
Lenexa, Kansas 66215

**T. M. WALLCOVERINGS**  
Kenner, Louisiana 70126

**POTOMAC WALLCOVERINGS INC.**  
Beltsville, Maryland 20705

**CHARLES BECKER, INC.**  
Lawrence, Massachusetts 01843

**SLATER WALLCOVERINGS, INC.**  
Livonia, Michigan 48150

**FRED G. ANDERSON, INC.**  
Minneapolis, Minnesota 55416

**ROSCO INCORPORATED**  
St. Louis, Missouri 63141

**GENERAL WALLCOVERINGS OF NEW YORK**  
New York, N.Y. 10022

**R. C. SHAHEEN PAINT CO.**  
Rochester, New York 14621

**POTOMAC WALLCOVERINGS, INC.**  
Charlotte, North Carolina 28202

**FASHION WALLCOVERINGS CO.**  
Cleveland, Ohio 44103

**SLATER WALLCOVERINGS, INC.**  
Cincinnati, Ohio 45246

**KINNEY BROTHERS**  
Portland, Oregon 97210

**M. A. BASKIND COMPANY**  
Pittsburgh, Pennsylvania 15206

**WALLDESIGNS**  
Philadelphia, Pennsylvania 19151

**T. M. WALLCOVERINGS**  
Memphis, Tennessee 38118

**ROSCO INCORPORATED**  
Dallas, Texas 75247

**ROSCO INCORPORATED**  
Houston, Texas 77018

**KINNEY BROTHERS**  
Seattle, Washington 98108

**REPUBLIC-DAU PAINT AND WALLPAPER COMPANY**  
Milwaukee, Wisconsin 53210

**Hawaii**  
**KINNEY BROTHERS**  
Honolulu, Hawaii 96813

**Puerto Rico**  
**BUILDING SPECIALTIES CORPORATION**  
Santurce, Puerto Rico 00908

**Canada**  
**MILLS PAINT SALES LTD.**  
Burnaby, B.C. V5E1C5  
Calgary, Alberta T2J3G8  
Edmonton, Alberta T6P3Y6  
Richmond, B.C. V6X2C3  
Winnipeg, Manitoba R3G3L3

**CANADA WALLCOVERINGS**  
Toronto, Ontario M4N2L8

**DENALT WALLCOVERING**  
Div. of DENALT PAINTS LTD.  
Montreal, Quebec H1P1Z1

Circle 111 on information card

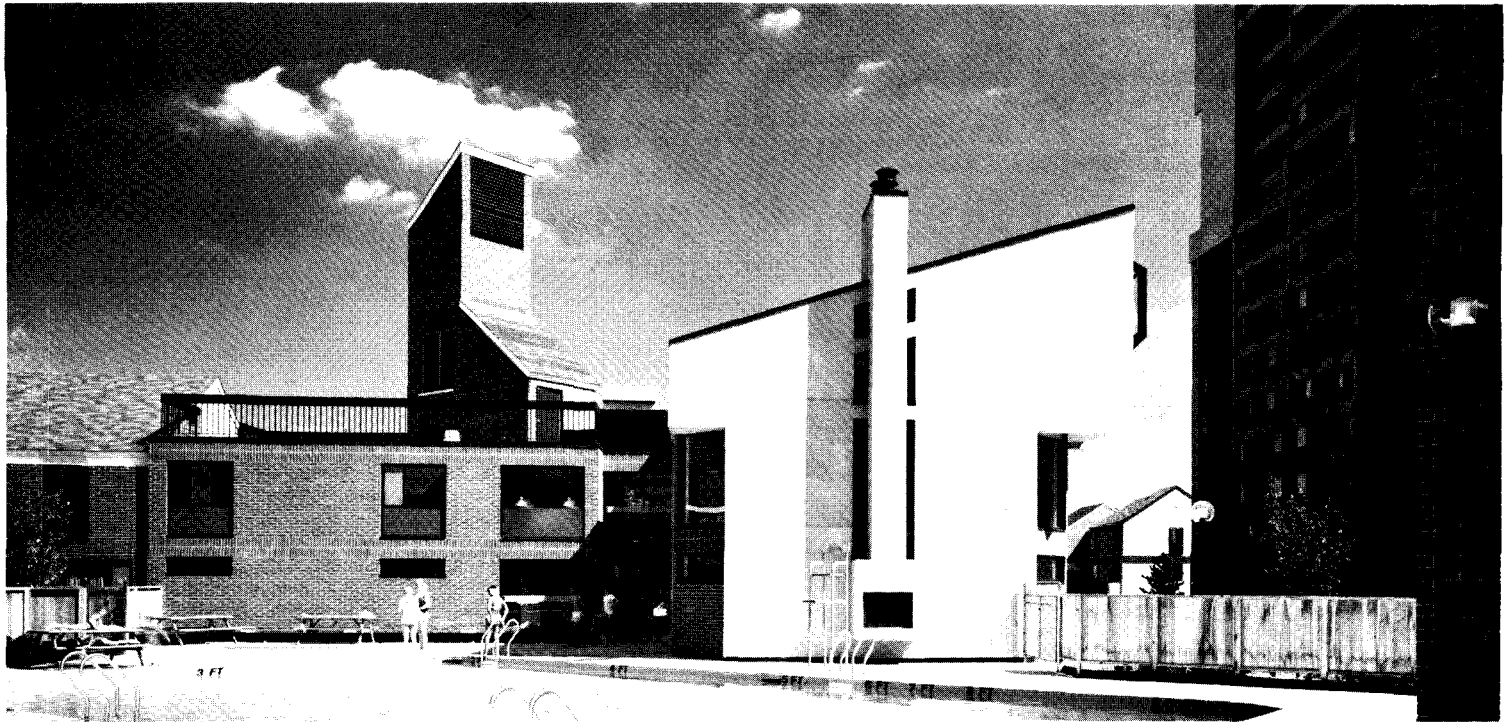

**Boston Society of Architects.** Mission Park, Mission Hill, Boston; John Sharratt Associates, Inc. with Glaser, DeCastro & Vitols Partnership, Boston (above). The 774-unit mixed income housing was developed to stabilize the neighborhood against continuing expansion by area hospitals and universities. The project includes a 28-story highrise; a 78-unit, 8-story midrise for the elderly; two 13-story midrises, town houses and a 1,274-car, three-level underground parking garage. Each housing complex has a swim-

ming pool, tennis and basketball courts, medical offices and a community building. The dwellings are grouped to preserve streets and a sense of neighborhood. "Its relationship to the surrounding neighborhood was judged sympathetic," the jury said, "and the disposition of low, medium and highrise elements within the scheme seemed successful." Steve Rosenthal, photographer.

**New Jersey Society of Architects.** Pegasus Restaurant, the Meadowlands, East Rutherford; Grad Partnership, Newark

(below). The 27,000-square-foot existing building housing the press box and several official booths at the Meadowlands race track was expanded to 100,000 square feet. The building now houses three major dining areas surrounding a central cocktail lounge and two intimate saloons. The exterior of metal and glass was designed in the form of a skylighted porte cochère. Glass elevators carry patrons from the lower lobby to the restaurant facilities.



# Discover It... The Plywood Alternative

New Super 440 Homasote Replaces Plywood,  
Provides Better Insulation & Costs Less!\*



## Carpet Underlayment



It's better than plywood for adding warmth, resiliency and sound reducing qualities when used as carpet underlayment over wood subflooring or concrete above grade. And it costs less.\*

## Sheathing



Its nailable surface and strength make it a superior sheathing that eliminates costly plywood corner bracing. As a sheathing, Super 440 reduces air infiltration better than other sheathing boards and provides double the R value of plywood.

## Ceilings



Its lightweight, choice of textures and range of panel sizes make it more practical than wood for exterior or interior ceilings. Will not splinter or delaminate. And it costs less.\*

## Siding



It makes a handsome, textured exterior siding for Tudor or board and batten construction that takes and holds most finishes better than wood. Available in lengths up to 12 feet and eliminates horizontal joints. And it costs less.\*

Today architects, builders, remodeling specialists and home owners are looking for ways to cut costs without sacrificing building quality. Many have already discovered the unique versatility, improved quality and cost-saving benefits of New Super 440 Homasote Building Board as a superior replacement for plywood in many uses.

In most areas, New Super 440 Homasote can cost less and, unlike wood, is totally free of knots, voids

and splinters. It is nailable, lightweight, yet strong enough to be used as a sheathing without costly corner bracing. Best of all, it provides twice the insulating R value of plywood...and it's totally asbestos free.

New Super 440 Homasote is specifically designed to meet the construction and remodeling needs of today's energy and dollar conscious users of building materials. Send for a free sample now.

Please send a free sample of New SUPER 440 HOMASOTE.

Please have a representative call.

Name \_\_\_\_\_

Company \_\_\_\_\_

Address \_\_\_\_\_

City/State/Zip \_\_\_\_\_

Phone \_\_\_\_\_

**homasote** Company  
B480

Box 7240, West Trenton, NJ 08628  
Founded 1909



**Boston Society of Architects.** Dickson house, New Vernon, N.J.; Crissman & Solomon, Watertown, Mass. (above). The architect designed the house to be "reminiscent of a New England rural vernacular." The first floor consists of an entry/music room, living, dining, screened porch, kitchen and guest bedroom with bath. On the second floor is a study open to the living room below, the master suite and one bedroom with loft. Views are to the south. An apartment is provided over the garage. The jury com-

mented, "Exterior massing and interior spatial manipulation were apparently considered simultaneously, resulting in a striking form on the open landscape, housing dramatic, varied and clearly articulated spaces for living." Steve Rosenthal, photographer.

Jordan Hospital, Plymouth, Mass.; Payette Associates, Inc., Boston (below). The program called for renovation of existing facilities, a new main entry and X-ray department and the addition of 56 beds plus space for an additional 40 beds

and the relocation of the administration staff. The requirement that all new patient rooms be single-bed occupancy led to the "saw tooth" patient floor plan. Solar protection is provided by continuous exterior concrete walls that do not follow the outline of the clusters. Interior spaces are yellow and red, with ceilings painted with bold bright geometric forms. Nick Wheeler, photographer.

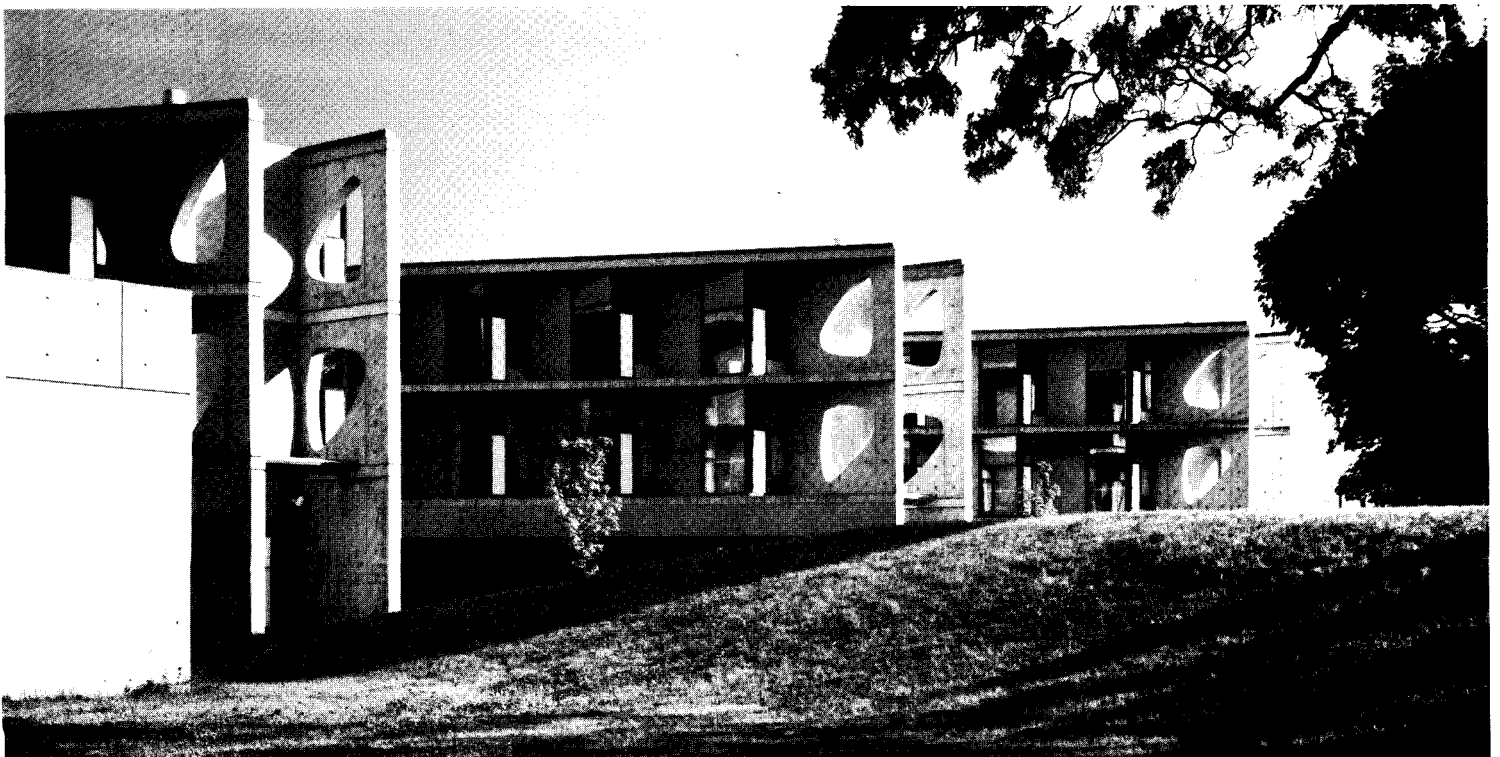



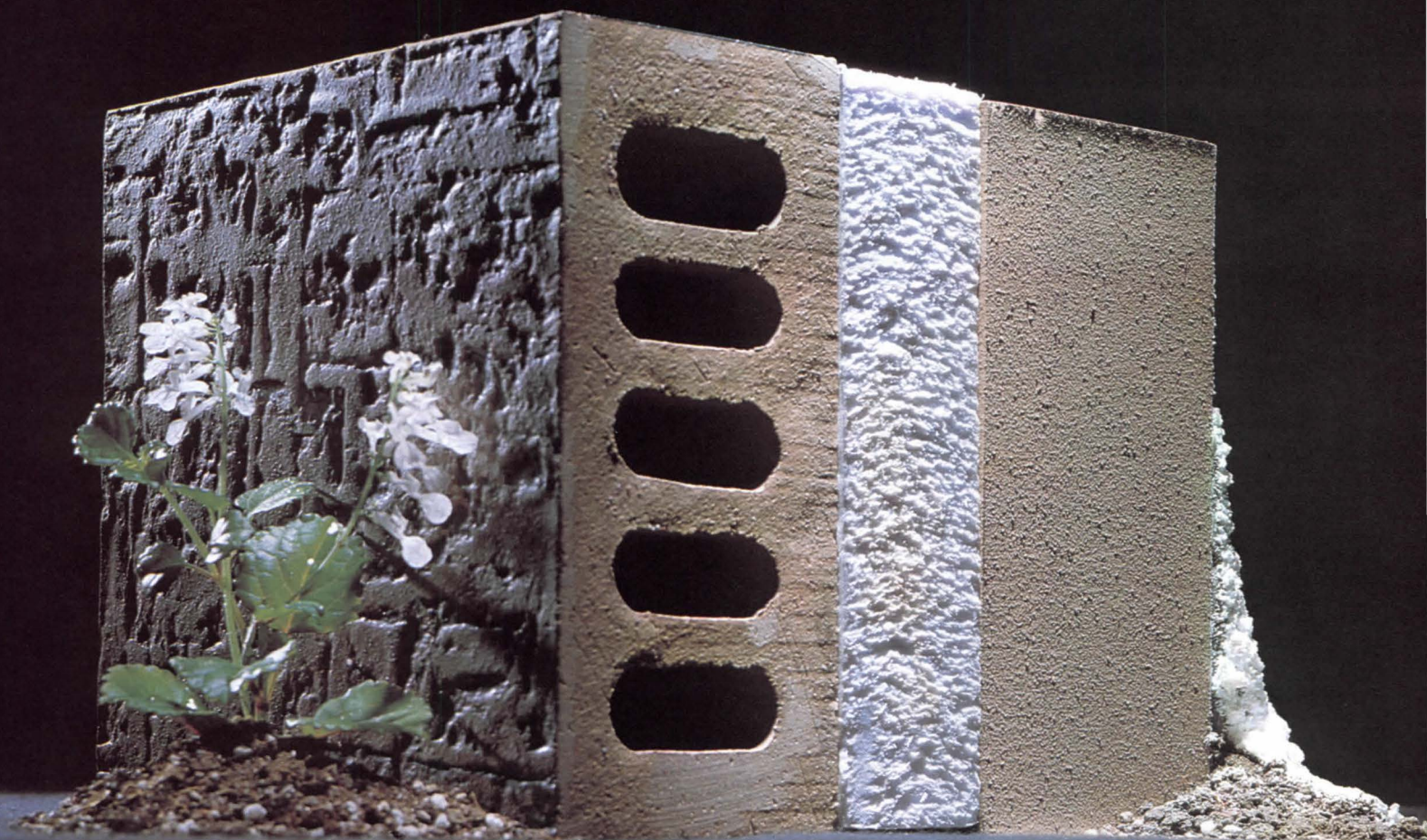

Stark Structural Tile allows for superior climate control designs.  
Its capacity insulation reduces HVAC costs.

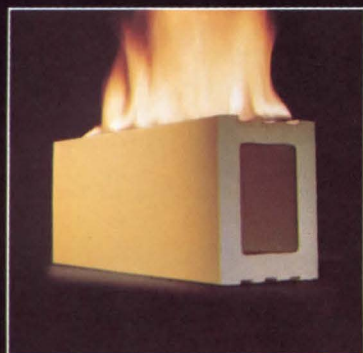

**Fire protection**  
Zero flame spread  
Zero fuel contribution  
Zero smoke density

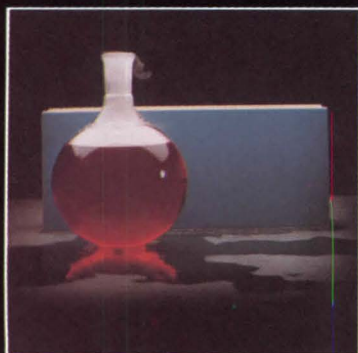

**Impervious surface**  
Fired on hard-as-glass finish



**Sound control**  
STC rating: 46  
NRC rating: .55 to .60



**Stark Ceramics, Inc.**  
P.O. Box 8880  
Canton, OH 44711

Call toll free 1-800-321-0662  
(In Ohio, call collect 216-488-1211)

**Stark Structural Tile is:**  
Glazed Facing Tile  
Acoustical Tile  
Textured Tile  
Textured Acoustical Tile  
... also utility and lustre  
finish utility brick and  
High Brick.

Circle 113 on information card

# THERE'S A BIG DIFFERENCE BETWEEN GAFSTAR AND THE LEADING CONTRACT FLOORING OURS HAS A BIG

It's ironic. When you're about to specify a floor, all you get to see are beautiful new samples. Which gives you absolutely no idea of what the floor will look like when it really counts. In the future.

Unfortunately, that's when your clients' happiness is at stake. Along with your reputation.

That's why with Gafstar® Contractfloor™ sheet vinyl we give you a look at its future, by showing you how well it stood up in the past.

**ANY FLOOR CAN SHINE WHEN  
IT'S NEW. GAFSTAR CONTRACTFLOOR  
SHINES WHEN IT'S OLD.**



In this busy corridor of Brackenridge Hospital in Austin, Texas for example, this Contractfloor took a lot of abuse.

Twenty-four hours a day, for three years, patients' beds rolled over it.

Doctors, nurses and hospital staff hurried back and forth. And visitors paced up and down.

But you can hardly see a trace of wear. It's still a shining example of a beautiful floor.

**TESTS PROVE OUR FLOOR  
STAYS BEAUTIFUL LONGER.**

The key to our beautiful-looking floor is its tough no-wax surface.

But the leading inlaid doesn't even have one. So there's nothing to protect its pattern from the abuse it has to take everyday.

And even though the leading inlaid's wearlayer is thicker, the only gauge that means anything is how it wears.

The Frick-Taber® Abraser Test proved it.

In 6,000 cycles abrasives significantly wore into the pattern of the leading inlaid. While they didn't make a dent in ours.

If that doesn't make an impression on you, imagine those results on the floor.

After years of wear, your clients will still have the same beautiful-looking Contractfloor they started with.



# DIFFERENCE CONTRACFLOOR™ AND ING INLAID. HTER FUTURE.

## A BRIGHT FUTURE WITH VERY LITTLE WORK.

Contracfloor gets off to a beautiful start. With many different designs and colors in widths up to 12-feet. Which means Contracfloor has fewer seams. And it's more flexible than the leading inlaid, so it's not only easier to install, it's faster too. Which makes it beautifully economical as well.

But a beautiful floor isn't worth much, unless it's easy to keep that way. And that's where Contracfloor really shines.

The durable surface is a stain-resistant no-wax. Simple washing and buffing keep it clean and glossy.

Since it's solid and non-porous too, dirt and germs have nowhere to hide. Which means Contracfloor is healthier to be around.

And it's more comfortable to walk on. With a Quiet-Cor® vinyl foam interlayer

Circle 114 on information card



that makes it easy on the feet.

Which all leaves no doubt, for a floor with a brighter tomorrow, you'll want to specify Contracfloor today.

**GAF®** **GAFSTAR®**  
**CONTRACFLOOR™**  
SHEET VINYL

For more information on Contracfloor, refer to Sweet's Catalogue, Industrial Construction/Renovation or General Building, Sec. 9.23 under Resilient Flooring. Or call toll free anytime 800-223-0344.\*  
\*In New York State call 800-522-5250. © 1980 GAF Corp.





**Washington-Metropolitan Chapter.** Private residence, Potomac, Md.; Hartman-Cox, Washington, D.C. (above). The 4,000-square-foot house for a family of four is positioned on a steeply sloping site. The dining, living and sitting rooms create a large living space, open yet separated by the use of terracing. The master bedroom and study are at the top of the sitting area. Atop the entry is a guest room and children's wing. The kitchen is next to the entrance at the top level of the main living areas. A breakfast room juts out from the kitchen. Robert Lautman, photographer.

National Park Service Stable, Washington, D.C.; Hartman-Cox (right). The basic form of the stable is a simple rectangle with a shed roof that is altered to accommodate different internal functions. The building has two types of stalls, hay loft, tack room and lounge. Low-level window space was minimized because of concern over vandalism. Clerestory windows provide additional light and ventilation. Warren Cox, FAIA, photographer.

**North Carolina Chapter.** Flynt beach house, Figure Eight Island; Henry W. Johnston, Wilmington (right). To conserve site vegetation and gain views of the ocean and the sound, the base of the house was reduced (it contains guest parking and a septic tank). A three-story scheme was developed that placed the living areas atop two stories of bedrooms. The entire house was placed at a 45 degree angle to the beach to provide panoramic views and to orient windows to the prevailing southerly breeze. The 2,200-square-foot house is of wood frame with cedar plywood siding, trim and decking. Markatos Photography.



# Don't Compromise Your Wall's Integrity.

Haws Model HWCT6 fountain with cooler is fully recessed, so walls remain smooth and interior lines are uninterrupted. Recess space beneath allows convenient wheelchair access.

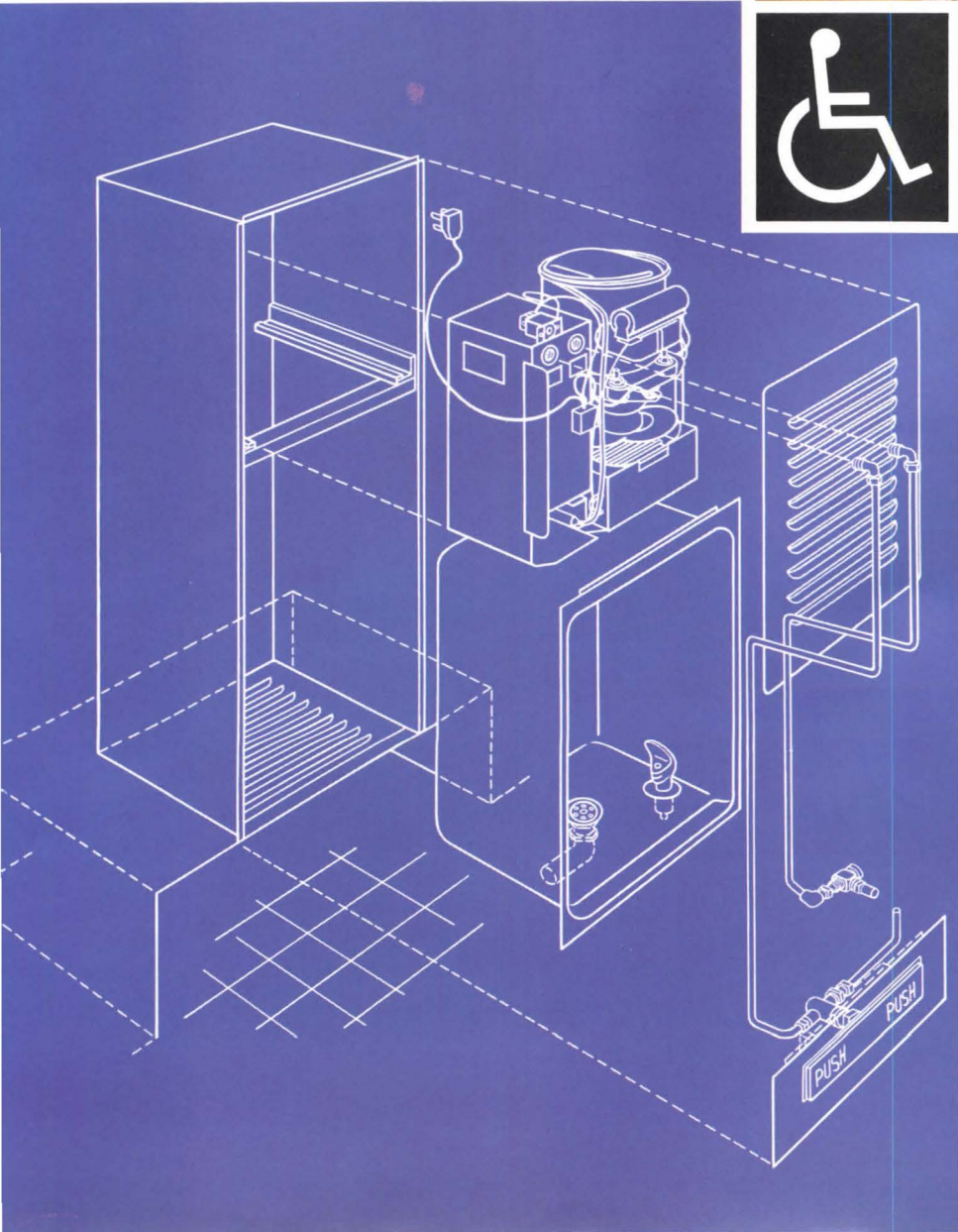
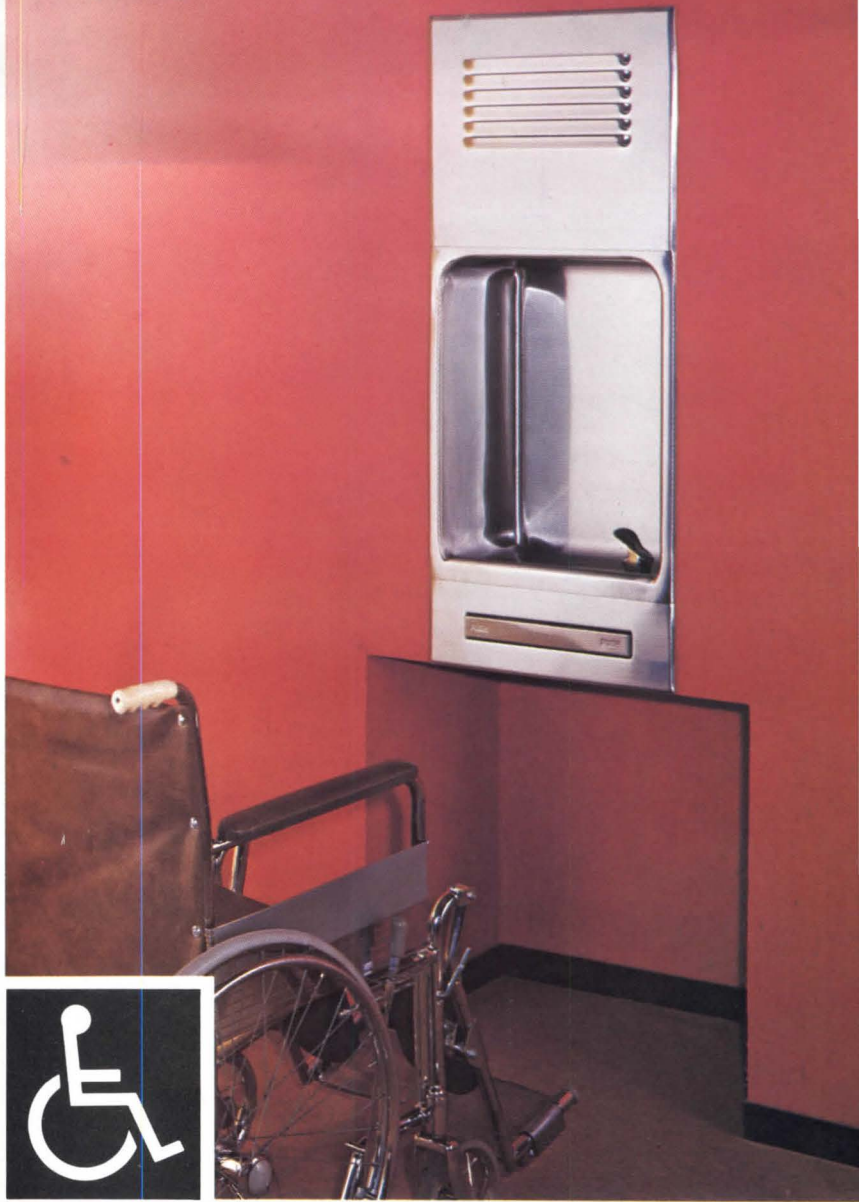

## Sturdy, Easy to Mount.

Steel mounting box is included for convenient installation. 9.5 gph cooler fits simply into place. Features a 17-gauge, satin-brushed finish; polished chrome-plated bubbler; and push-bar valve with automatic stream control.

HAWS DRINKING FAUCET COMPANY  
P.O. Box 1999 • Berkeley, CA 94701



Circle 115 on information card

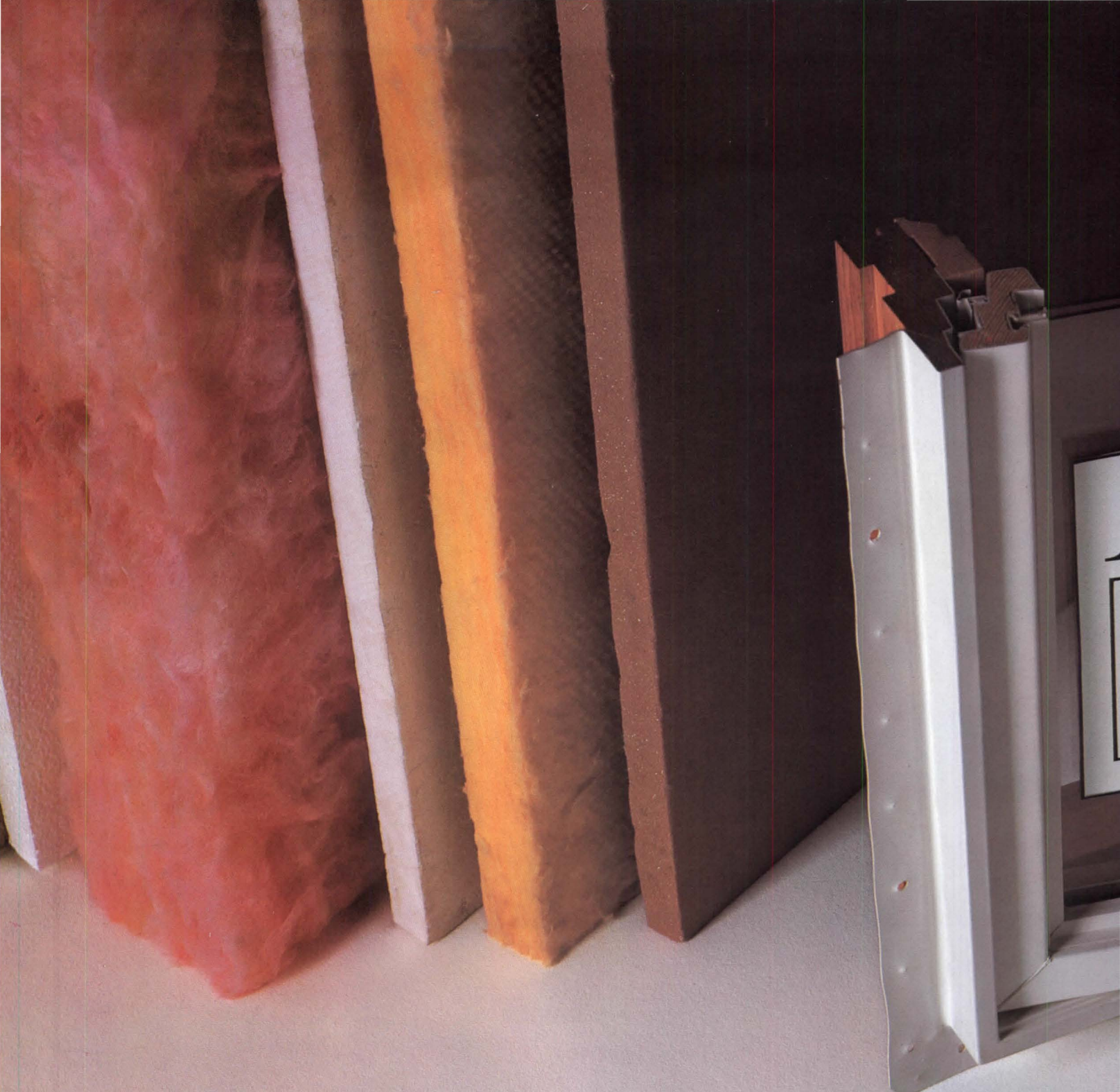

## The more you insulate, the

If you're going to insulate a building to its maximum cost-effectiveness, you ought to include quality windows, too.

Andersen® Perma-Shield® windows, for instance, help insulate where heat loss might otherwise be the greatest—in the window area itself.

Compared to windows that only meet minimum industry air-infiltration standards, Perma-Shield windows allow you to increase the window area without increasing the building's heating and cooling costs.

Low air infiltration is one reason. Andersen's snug-

fitting design is two times more weathertight than industry standards require. The better to keep out drafts and keep in comfort.

Andersen's use of double-pane insulating glass is another reason. It's two times more effective at reducing heat loss conducted through the glass

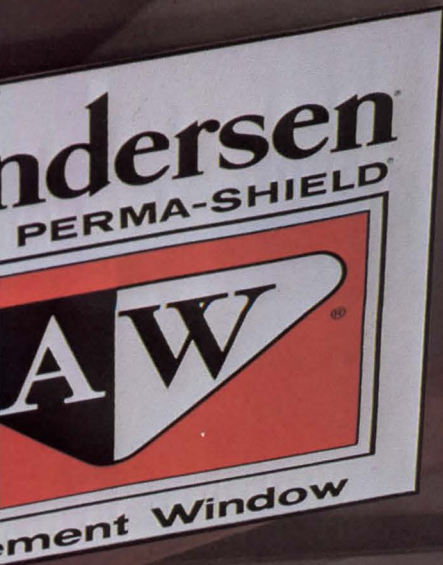

## more you need Andersen.

than old-fashioned single-pane glass.

Add triple glazing and the insulating value of Andersen windows climbs still higher.

And when properly sized, shaded and oriented toward the sun, Andersen windows help save more

energy. In winter, they welcome in the warming sun, and in summer, they open to cooling breezes.

So specify as much insulation as is practical, but insist on quality Andersen Perma-Shield windows and gliding doors, too. See Sweet's file 8.16/An. Or ask your

Andersen distributor to show you the many beautiful ways to insulate with a view. Andersen Corporation, Bayport, MN 55003

The beautiful way to save fuel®

Andersen Windowwalls® 

8120 © Andersen Corporation, Bayport, MN 1978

Circle 116 on information card

# FIRE DETECTION/CONTROL: WHEN THE PROBLEM IS COMPLEX,



## THE SOLUTION IS SIMPLEX.

The problem of fire protection and control can be complicated, especially with the complexity of today's building codes. That's why involved people like you, are increasingly turning to Simplex fire systems for cost effective solutions.

No matter what type of system or system combinations your building requires, Simplex personnel can advise, recommend, offer design assistance and provide what is right for you.

Our reputation and expertise for cost effective time control, life-safety, security, and energy manage-

ment systems stand behind every customer. Additionally, our expertly trained service personnel will periodically test to assure your system operates smoothly and efficiently.

When it comes to your building system requirements, talk to Simplex. We're more than fire protection and control.

Simplex, Simplex Plaza,  
Gardner, MA 01441/(617)632-2500

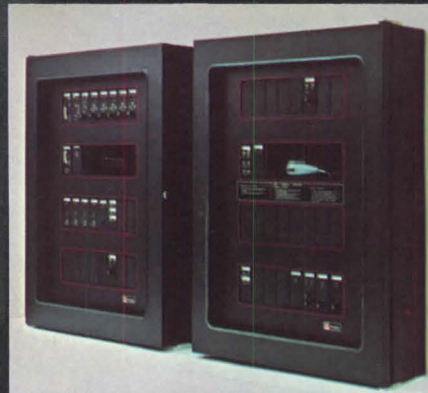

Circle 151 on information card





**Louisiana Architects Association.** David Burrus Boathouse, New Orleans; Lyons & Hudson, New Orleans (left). The architect incorporated the existing frame building into the new design. The two-story glass-enclosed entry area is the main focal point. The roof framing was changed, lending spatial variety and emphasis to the component parts of the building. Major living spaces were rearranged to capitalize on the views to the marina. Frank Lotz Miller, photographer.

**Mississippi Chapter.** Wellons residence, Stockbridge, Ga.; Ronald Murray, AIA, Starkville (right). The house was designed to fit a modest budget and be compact yet suggestive of a much larger and grander structure. The first floor houses a "summer" bedroom and a kitchen that is visually open to the dining room and the two-story living room. On the second floor a "winter" bedroom overlooks the living room and leads to the top floor loft that has a view of a distant lake. The house is oriented on an east-west axis on a wooded, sloping site with views to the north.



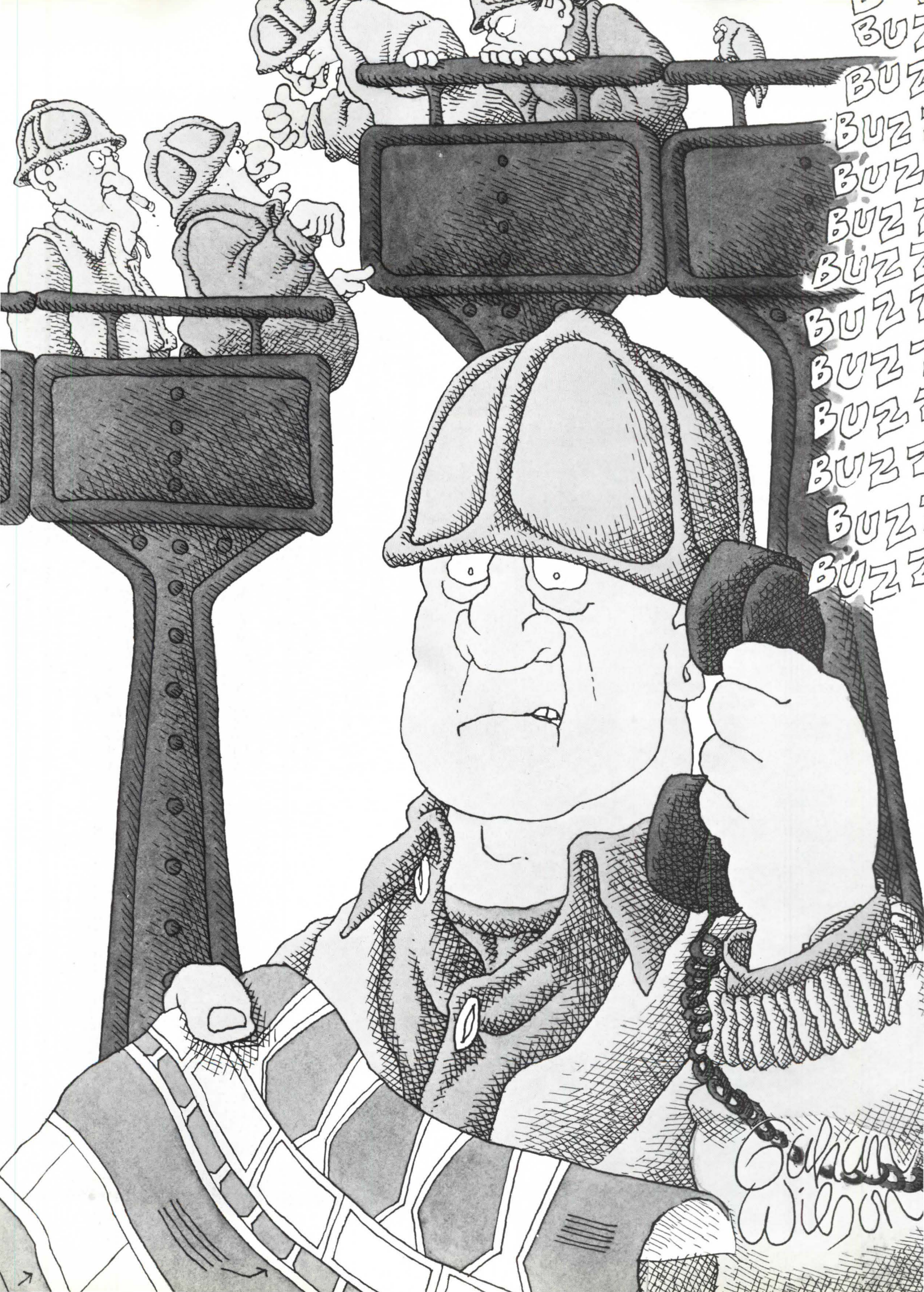

BUZZ  
BUZZ  
BUZZ  
BUZZ  
BUZZ  
BUZZ  
BUZZ  
BUZZ  
BUZZ  
BUZZ  
BUZZ  
BUZZ

Graham  
Wilson

# Is solving problems a problem because you can't be reached?

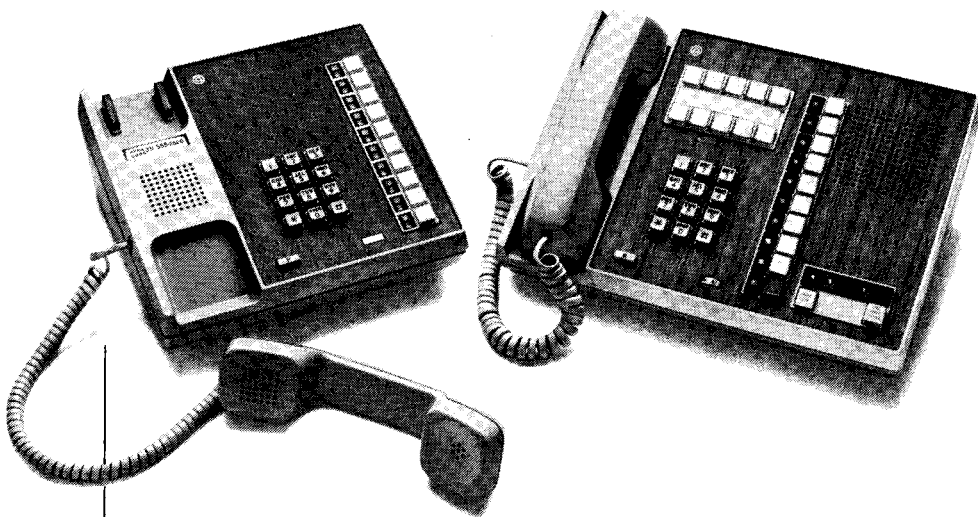

## The Bell System has a way important calls can reach you when your regular lines are busy.

When somebody calls from your job site with a problem, that's no time for all your lines to be busy. You've got to be available.

If you're not, you end up losing valuable time. And that makes it harder for you to make a profit.

What you need is an effective communications system. That's where your local Bell company can help your business.

Both the Com Key\* and Horizon® communications systems by Western Electric feature a personal line that goes directly to your office. It's an open line that can make your business more profitable by keeping you accessible. With it you'll always be assured that important calls get through. This can save you time by enabling you to handle problems efficiently. And whoever you give your private number to will *always* have a way to reach

you—quickly and easily.

Should *you* find the need to make an important call, you'll always find the personal line open.

## Saving time and money

Western Electric Com Key and Horizon systems can help your business in many ways. Suppose you're in the office but away from your desk when an important call comes in. With the paging feature on a Com Key or Horizon communications system, your secretary can call you in almost any part of your office over the paging loudspeakers. No shouting down the hall or wasting time tracking you down.

To stay on top in your business you have to complete your projects on time. And that means using your phone to coordinate job information. That's where conference calling comes in handy. It lets you speak to several people at one time, at the touch of a few buttons. You can consult with your client, an associate, and a contractor at the same time. That saves you time and needless callbacks

because you confirm information quickly and accurately.

## Giving your client the best service

When your client is considering an important proposal, it's essential that he be able to reach you to discuss any details. If you're out of the office when he calls and your secretary has the number where you are, she can call and connect you instantly with the client.

If you're preparing a proposal, you can't waste time running back and forth to your library looking up zoning information. With the Com Key or Horizon system's intercom, you can call your associate or consulting engineer simply by pressing a single button. That way, you can keep right on working—without interruption.

## Tailored to your needs

There are even more ways Western Electric communications systems can make your business more efficient and profitable.

Your local Bell company can tailor a communications system to your needs—no matter what size your business. And they back every system with prompt, dependable, experienced service.

So call your local Bell company today.

You'll end up with more than a better business communications system.

You'll end up with a better business.



Western Electric

\*Trademark of AT&T.



**Tennessee Society of Architects.** Reflection Riding Nature Center, Chattanooga; Franklin Group, Chattanooga (above). The 5,710-square-foot building serves as an environmental education facility, a meeting place for naturalist groups and an administrative center for the park. To house these functions, the building has three separate but connected spaces. The scale and character of the structure is related to the existing nearby houses, barns

and log cabin. Heating and cooling are provided entirely by fly-chaser fans, natural air currents and the shade of existing trees, low air intake vents on the north walls and high exhaust vents on south walls, operable insulated windows and shutters, wood stoves, a stone fireplace and roof overhangs.

**Florida Association of Architects.** State of Florida Regional Service Center, City Parking Facility and Amphitheater, Jack-

sonville; William Morgan Architects, Jacksonville (below). The regional service center provides 200,000 square feet of office space for 900 employees. A public esplanade and amphitheater are created by stepping back each successive level of the building. This also provides an unobstructed view of the St. John's River from each floor. The three-level parking lot is interconnected by continuous ramps. Bob Braun, photographer.

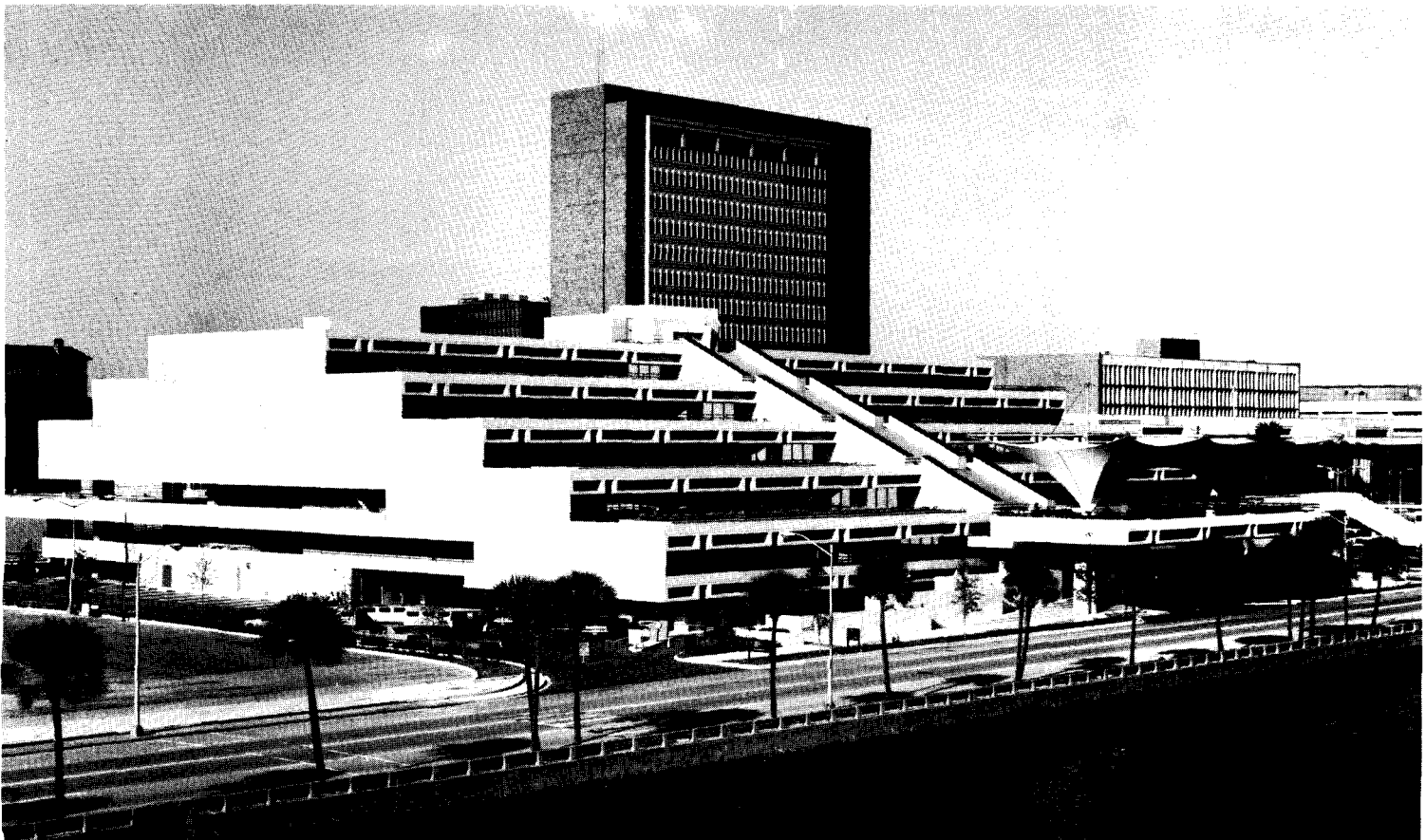

# When the class of **2130** departs we expect this Revere copper roof will still be on campus.

BROOKHAVEN COLLEGE, FARMERS BRANCH—Dallas County, Texas  
Architect—PRATT, BOX, HENDERSON and PARTNERS, Dallas, Texas  
Construction Manager—AVERY MAYS CONSTRUCTION COMPANY, Dallas, Texas  
Sheet Metal Contractor—EVERSOLE COMPANY, Dallas, Texas  
Revere Distributor—STANDARD METALS DIVISION of AZCON CORPORATION,  
Houston, Texas

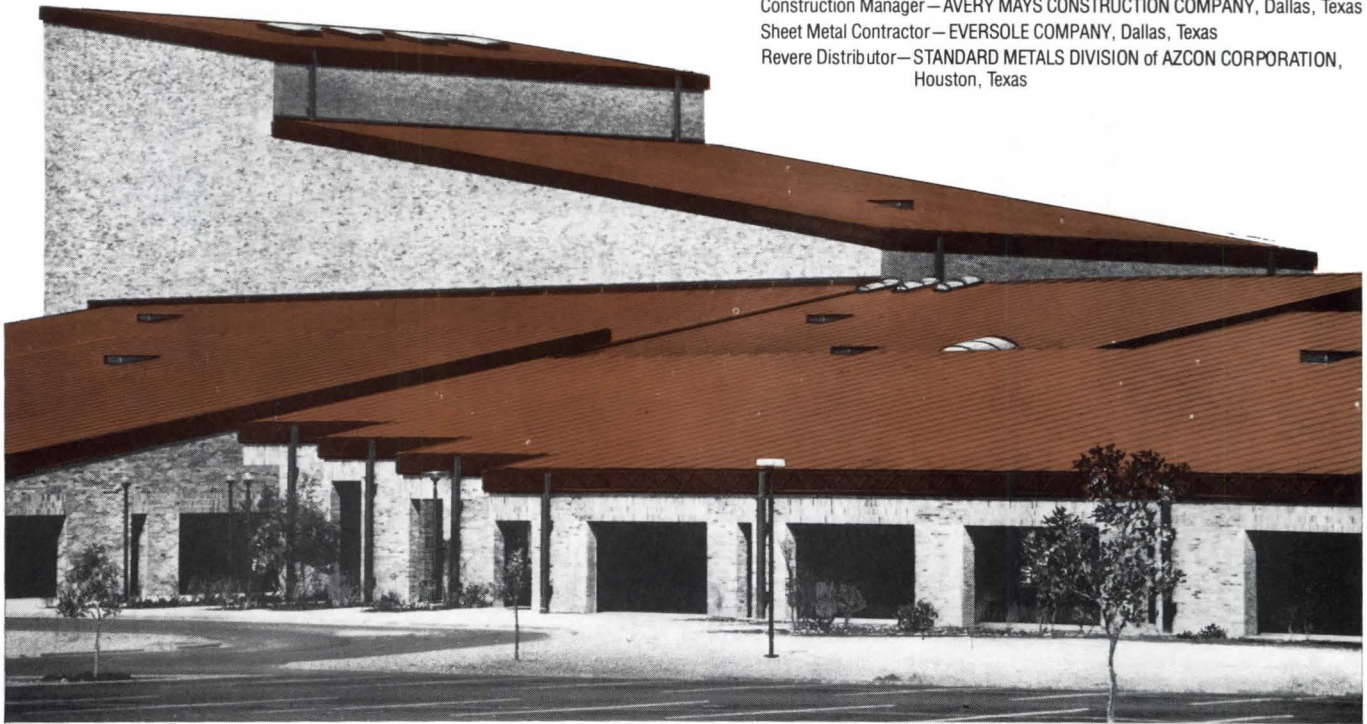

Copper roofs have been known to last for 150 or more years, so the college building shown above should still have its original copper roof in the 22nd century. This enduring quality is one of the reasons so many architects specify copper.

Another reason for "crowning with copper" is the natural warm tone of red metal which complements other building materials. Copper and brick, for example, are a natural, as they are in the building above.

Building owners appreciate the low cost per year of copper because it requires little, if any, maintenance. Another advantage of copper is its ease of installation. Copper can be formed

into any configuration you design and joints are easily soldered.

More than 400,000 pounds of 16 oz. and 20 oz. Revere sheet copper were used on eight buildings at the Brookhaven College. Construction is standing seam over gypsum deck. You can design with freedom and confidence with copper because it lends itself to so many types of construction: horizontal and vertical batten, flat seam and Bermuda style, to name a few.

Revere has a wealth of data on copper for roofing, flashing and other applications which we will gladly share with you. Just drop us a line. Revere Copper and Brass Incorporated, 605 Third Avenue, New York, NY 10016.



# REVERE

Circle 119 on information card

# Are you really into "SYSTEM"

System drafting means selecting the components used in your drafting technique for compatibility and precision performance. It is counting on single-source responsibility for these components. And it is knowing assistance is available for areas of your technique that may need improvement.

With "System" drafting, changes within your present technique are easy. Even easier are transitions from one system to another when you decide "there is a better way".

If the components and quality of your company's drafting products are your responsibility, you should know more about the quality and performance value of the Koh-I-Noor products featured in the following drafting systems.

## The KOH-I-NOOR "RAPIDRAW" System

Direct ink-on-film drafting for precision-perfect engineering drawings and microfilm blowbacks.

**Koh-I-Noor Technical Pens** and precision drawing points for exact line widths. Rapidograph 3065 and Rapidograph SL 3076 Series feature eighteen precision point sizes. Rapidometric 3095 Series features nine metric point sizes in a geometric progression based on the  $\sqrt{2}$  (1.414): matching line widths on microfilm blowbacks is easy. All point sizes for all Technical Pen Series are available in stainless steel, jewel, or tungsten carbide.



**Black India Drawing Inks** formulated to meet specific requirements for drawing on paper or film. The largest single-source selection includes Koh-I-Noor and Pelikan inks for film: Koh-I-Noor Rapid-O-Ink 3072, Koh-I-Noor Rapidraw 3084, and Pelikan "T" 9085 are special formulations to satisfy requirements for drying time, flow, opacity, and adhesion.

**Special Ink-On-Film Erasers** for removal of even the oldest ink lines when drawings need updating. A complete line of Koh-I-Noor and Pelikan erasers — liquid and dry — are available individually and in kit form.

**Rapidraw Drafting Film** with fine-toothed surface for maximum line definition. Virtually indestructible, optimum dimensional stability, unsurpassed storage life.



## The KOH-I-NOOR "KOH-I-LAR" System

Drafting on film with polymer leads. System components include:

- Koh-I-Lar Lead 2200-M; Koh-I-Lar wood-cased Drawing Pencils 1500-M. Each in six degrees, 6H through 3B.
- Koh-I-Noor Lead Holders 5612, 5613 and others.
- Koh-I-Noor Lead Pointers and Sharpeners 992-WC, 25960, 25961, 981, and 983.
- Koh-I-Noor Erasers, including Film Eraser 286 and Eraser Strip 289 with Holder 48.
- Rapidraw Drafting Film, the same virtually indestructible film used for the "Rapidraw" System.



# DRAFTING?

## The KOH-I-NOOR Graphite System

Still the finest quality graphite available anywhere, and it has been since 1790. Matched components for this popular system include:

- Koh-I-Noor Leads 2200 and 2200-I, Koh-I-Noor wood-cased Drawing Pencils 1500 and 1500-T, each in seventeen precision degrees.
- Koh-I-Noor Lead Holders 5611, 5616, 5619-N (0.5mm), 5623 (0.5mm), 5624 (0.3mm) and others.
- Koh-I-Noor and Pelikan Erasers, including Gum Cleaner 204 and Pelikan Special Green 9606-SP2.
- Koh-I-Noor Lead Pointers and Sharpeners including 992-WC, 25960, 25961, 981, and 983.
- Koh-I-Noor Drawing Papers — transparentized vellum and natural tracing bond, both 100% rag.



## The KOH-I-NOOR "RAPIDDRAW" Liquid-Ink Plotting System

The right pen points and the right inks add up to the optimum plotting efficiency for which your plotter was designed.

- **Koh-I-Noor Plotting Points, Pens, and Adaptors.** Ten line widths available. Custom sizes on request. In stainless steel, jewel, and tungsten carbide.
- **Koh-I-Noor and Pelikan Inks** for use on film and paper — among them, Koh-I-Noor "Universal" 3080, Koh-I-Noor 3000-F, 3000-PF and 3084 for film. And Koh-I-Noor 3089 and Pelikan 9065 for paper.
- **Koh-I-Noor Drafting Film and Drawing Papers** in standard and special size sheets, pads, and rolls. Also gridded pads with blue dropout. On request, pre-punched holes for drum plotters.



For in-depth information about Koh-I-Noor matched components for "System" drafting, fill in and return the coupon: Koh-I-Noor Rapidograph, Inc., 100 North Street, Bloomsbury, NJ 08804. In Canada: 1815 Meyerside Drive, Mississauga, Ont. L5T 1B4

**SHOW ME MORE, KOH-I-NOOR!**

Circle 120 on information card

Please have the following FREE brochures sent right away:

- Koh-I-Noor USA-made Technical Pens, K-1071
- Koh-I-Noor & Pelikan Drawing Inks and Selection Chart, K-1072
- Faster and Easier Ink-on-Film Erasures, K-1043
- The "Rapidraw" System for direct ink-on-film drafting, K-913
- Koh-I-Noor Leads, Lead Holders, Pencils, Pointers, and Sharpeners, K-1073
- Koh-I-Noor Drawing Instruments and Sets, K-1075
- Koh-I-Noor "Rapidraw" Liquid-Ink Plotting System, K-1066
- Koh-I-Noor Templates, Scales, Triangles and Other Drawing Aids, K-1074
- Please send me the names of Koh-I-Noor dealers in my area
- Please have a representative call me

NAME (PLEASE PRINT OR TYPE)		TITLE
		( )
COMPANY		PHONE
ADDRESS		
CITY	STATE	ZIP



**Georgia Association.** Greater Cincinnati (Ohio) Airport; Heery & Heery, Atlanta (above). Two new terminal buildings with 19 gates were added, and five gates in the existing terminal were renovated. Instead of locating individual passenger holding rooms near the gates (along the fingers), each airline's holding rooms are combined into one large area. The "fingers" are used by passengers only to reach and leave the planes. There are two ground level roads, rather than a two-level arrival-departure road system. The baggage claim building is located across the ground level road at the edge of the parking lot, connected to the main terminal by a pedestrian bridge. The two terminals stand side by side, and more terminal area can be added in the future. E. Alan McGee Photography, Inc., photographer.

Hickory Hollow Mall, Nashville, Tenn.; Cooper, Carry & Associates, Inc., Atlanta (right). The one-million-square-foot regional shopping mall houses four department stores and mall shops. The client requested a festive atmosphere, reminiscent of a bustling, open air shopping market. Four large courts covered by a steel space frame system rise as much as 50 feet above the lower level floor. Throughout the mall, the space frame is accentuated by natural light through large clerestories. E. Alan McGee Photographer, Inc., photographer.







Right at the start . . .  
**VICRACOUSTIC<sup>®</sup>**  
sound-absorbing systems

From the beginning, plan to increase efficiency . . . minimize absenteeism . . . maximize employee health and morale, with noise-control . . . via Vicracoustic. Seven separate sound-control systems to answer every architectural and function requirement. And without compromising aesthetics because there are more than 100 magnificent Vicrtex<sup>®</sup> vinyl wallcovering patterns in 1700 colors to choose from. Brochure available.

Vicracoustic 80<sup>®</sup>, an unusually lightweight panel system, is especially suitable for height and mass-area installation . . . as in this Conference Room/IDS Tower/Diversified Services Building/Minneapolis/MN.



**L. E. CARPENTER** and Company  A Dayco Company  
170 North Main Street, Wharton, N.J. 07885  
(201) 366-2020/NYC (212) 751-3565  
DISTRIBUTED BY: VICRTEX SALES DIVISION,  
New York, Atlanta, Chicago, Dallas, Los Angeles,  
San Francisco, Boston, Minneapolis, Toronto, Montreal.  
HOWELLS, INC., Salt Lake City  
PAUL RASMUSSEN, INC., Honolulu

# WINNERS BY DESIGN

## Presenting the five winning reinforced concrete structures in the CRSI Design Awards V Program.

This Fifth CRSI Design Awards Program honors an exceptionally diverse group of structures. This variety, ranging from the inspirational to the institutional, reflects the versatility of reinforced concrete itself.

All winners share equally in the Design Awards. There are no specific categories. In addition, for the first time in the Awards Program, the jurists presented a Special Award for energy conservation.

A CRSI Design Awards Program V brochure is now available. It details the structural systems and illustrates design features of all the Award winners. For your copy, write: Concrete Reinforcing Steel Institute. Attention: Victor A. Walther, Jr., Vice President, Marketing and Promotion.

### CRSI Design Awards V Jury

#### Chairman

Ehrman B. Mitchell, Jr., FAIA, National President,  
American Institute of Architects, Washington, D.C.

Fred M. Briggs, AIA, Laguna Beach, CA

Harold Sandberg, President

Alfred Benesch Co., Chicago, IL

Mack Scogin, AIA, Vice President, Design  
Heery and Heery, Architects, Atlanta, GA

Edward M. Cohen, Managing Partner,  
Ammann and Whitney Cons. Engineers, New York, NY

#### A.I.A. Representative

Mrs. Maria F. Murray, Director, Awards Program  
The American Institute of Architects, Washington, D.C.

### Watch for Call for Entries in CRSI Design Awards VI.



CONCRETE REINFORCING STEEL INSTITUTE  
180 North LaSalle Street, Room 2111D, Chicago, IL 60601

For information on Professional Membership Program, write to Vice President, Marketing and Promotion.

### SPECIAL ENERGY CONSERVATION AWARD



#### "Well-ordered intermix of elements."

Douglas County Correctional Center, Omaha, NB.

#### Jury Comments:

"This building says what it is. It uses basic forms in a well-ordered intermix of construction elements—reinforced concrete, masonry and brick. These contribute to a definite warmth so desirable in a correctional facility."

#### Energy Conservation Award.

Solar panels on the roof integrated solar energy into the design in more than just a visual sense. An altogether unique and economical solution to special design problems.

Owner: Douglas County, Omaha, NB

Architect and Structural Engineer: Dana Larson Roubal and Associates, Omaha, NB;  
Phoenix, AR

General Contractor: Charles Vrana and Son Construction Co., Omaha, NB

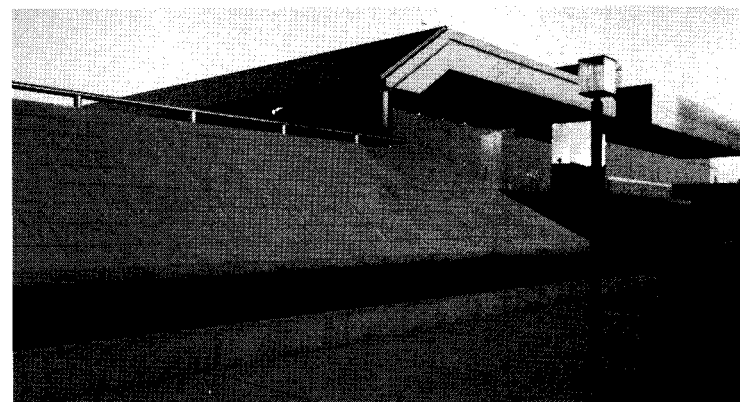

#### "Visual excitement, great flexibility."

Baltimore Convention Center, Baltimore, MD.

#### Jury Comments:

"This building projects a dramatic image of what it is. Extensive use of glass infill permits one to see the people and activity inside the convention center contributing to the visual excitement of the project. A most innovative reinforced concrete framing system frames each of the four major exhibition halls and provides great flexibility for conventions of various sizes. The dominant concrete roof spandrels provide visual strength."

Owner: City of Baltimore.

Architect: Naramore Bain Brady & Johanson, Seattle, WA

Associated Architect: Cochran, Stephenson & Donkervoet, Inc., Baltimore, MD

Structural Engineer: Skilling, Helle, Christiansen, Robertson, Inc., Seattle, WA  
General Contractor: The Whiting-Turner Contracting Company, Baltimore, MD

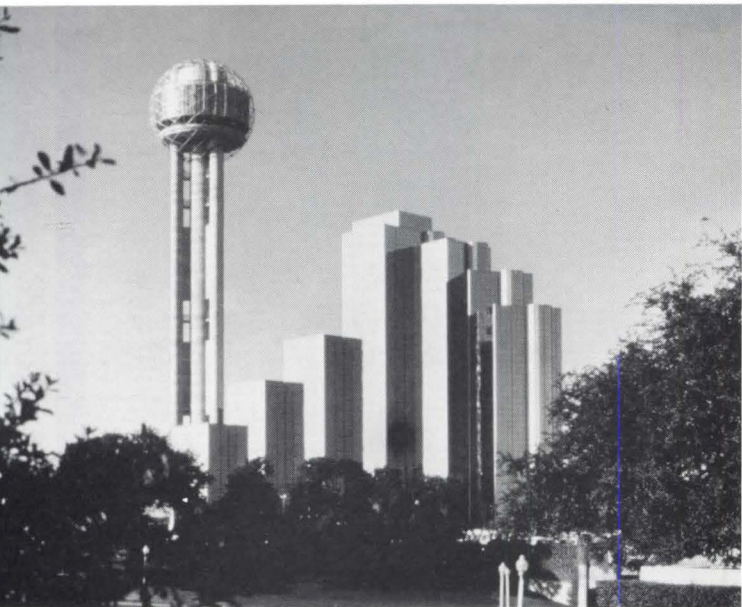

***"Innovative, enthusiastic."***

Reunion Tower, Dallas, TX.

**Jury Comments:**

"A successful solution to a unique structural problem. An innovative structure that capitalizes on modern slip-forming methods to provide both speed and economy. This enthusiastic reinforced concrete structure should have high appeal to the patrons of the observation decks and the revolving restaurant at the top."

Owner: Woodbine Development Co. (subsidiary of Hunt Investment Corp.), Dallas, TX.  
 Architect and Structural Engineer: Welton Becket Associates Architect, Los Angeles, CA.  
 General Contractor: Henry C. Beck, Dallas, TX.



***"Functional, practical, overall economy."***

Mecklenburg County Courthouse, Charlotte, NC.

**Jury Comments:**

"A very functional, practical, and distinguished solution for a government building. Everything is done with a purpose. Reinforced concrete was an excellent example of a very natural material for a high-quality building. The unique glass facade provides visual penetration both in and out of the building. One feels comfortable in this environment. The straightforward design provided overall economy for the client."

Owner: Mecklenburg County, Charlotte, NC.  
 Architect: Wolf Associates Architects, Charlotte, NC.  
 Structural Engineer: King-Hudson Associates, Charlotte, NC.  
 General Contractor: Larke Construction Company, Charlotte, NC.



***"An exciting place to be."***

Chapel of Thanks-Giving Square, Dallas, TX.

**Jury Comments:**

"A fun place for people. A real surprise in a busy, congested downtown area. A multi-leveled, well-ordered, exciting place to be. A tribute to the dedication of open space for use by people."

Owner: Thanks-Giving Square Foundation, Dallas, TX.  
 Architect: Philip Johnson & John Burgee Architects, New York, NY.  
 Structural Engineer: Datum Structures Engineering, Inc., Dallas and Austin, TX.  
 General Contractor: Manhattan Construction Co., Muskogee, OK.

**Circle 122 on information card**

# CANVAS

IS FOR  
THE ARCHITECT WITH  
A LOT OF  
GOOD IDEAS

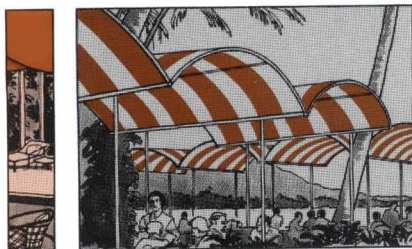

Arches

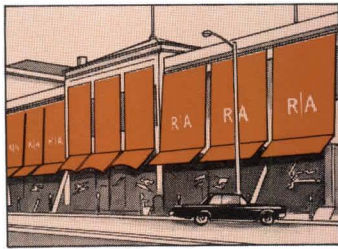

Identification

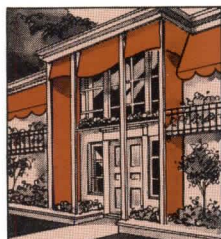

Townhouse Shades

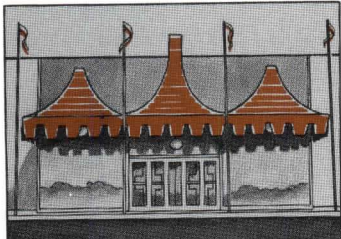

Store Fronts

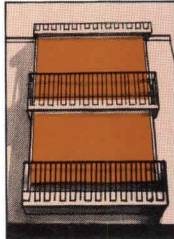

Balconies



Pedestrian Covers

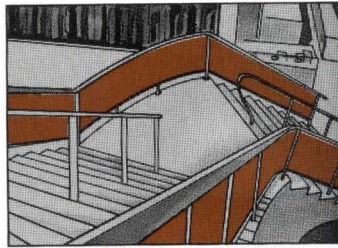

Stair Rails



Sun Decks



Shopping Malls



Canopies

Your nearby canvas artisan has the know-how, fabrics and facilities to help you bring these good ideas to life. He's listed in the yellow pages under "Awnings, Canopies or Canvas Products."

Write us on your company letterhead for a full-color brochure on architectural uses of canvas. Facts on weight, strength, hardware, coatings, energy conservation.



## News Summary from page 258

wide, with Mitchell himself traveling to many of the local celebrations. They varied from AIA's national design conference "Open House: Chicago," which used that city as a laboratory in the illustration of design concepts, to the Florida Association of Architects/AIA organization of eight teams of architects for "talk-fests" on the exploration of design in the state, to the New Mexico Society of Architects/AIA's sponsorship of the architects-in-the-school program for the United Nations' "Year of the Child."

When Charles E. Schwing, FAIA, and other Institute officers and directors were installed in the historic Pension building in Washington, D.C., in December, he said that AIA's programs and services for his year in office would center in transforming the "challenges" of the new decade into "real opportunities for architects and society." Schwing, from Baton Rouge, La., is president of the firm that he established in 1961. He said that the Institute's 1980 budget of \$9.8 million reflects a 6.6 percent increase over the 1979 original income estimate.

In 1979, the Institute supplied more than 1.5 million contracts and forms to members and nonmembers and distributed more than 10,000 books through its publications marketing division. Seventeen new and/or revised documents were completed, including those covering A/E agreements, construction management and interior design. Three new practice publications were developed on facility programming, financial management and project management. The continuing education department produced four new architectural training laboratories and 75 programs offering continuing education units. The department also published eight new SupEdGuides for associate members and intern-architects.

Part of the Institute's program is the recognition of architects and laymen and projects. Nine distinguished foreign architects will become invested as honorary fellows of AIA at the 1980 national convention, nine new honorary members will be inducted and fellowship will be conferred upon 92 members for "notable contributions" to the profession.

In other convention ceremonies, the New York City firm of Edward Larrabee Barnes Associates will be recognized for its consistent production of "distinguished architecture for at least 10 years." AIA's highest design honor will go to 13 projects in its annual honor awards program—to seven new buildings and six old ones put to extended use (see p. 212). And the coveted 25-year award for design of "enduring significance" was captured by New York City's Lever House, designed by Skidmore, Owings & Merrill.

*continued on page 322*

# Hope's reversible series 3000

## The big turn-around in custom heavy steel windows

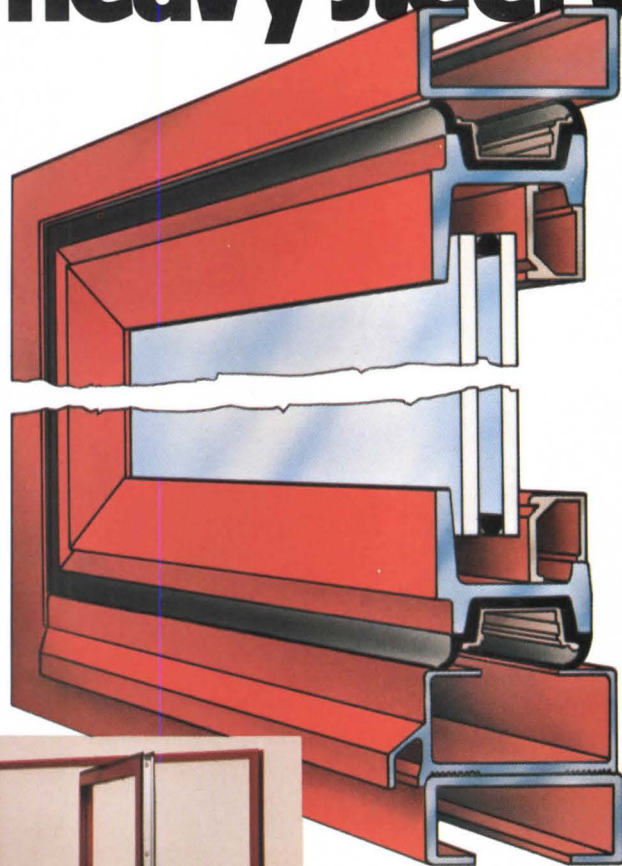

All reversible windows share one obvious advantage. They solve expensive cleaning problems. By 180° rotation, exterior glass surfaces can be safely cleaned from inside the building. But Hope's Series 3000 windows offer other advantages that aren't so apparent. And for a good reason — Hope's believes that strength and operation should never interfere with aesthetics.

Because steel is three times stronger than aluminum, large expanses of glazing can be accommodated without massive framing. This means reversible windows can be designed up to eight feet high and five feet wide, while increasing structural integrity and maintaining graceful sight lines.

Hope's provides two different operating systems — occupant life-safety and custodial. One adds functional good looks, the other can't be seen at all. Of course

every Series 3000 window is fully weather stripped and has a generous glazing space, accepting up to 1" thick insulated glass.

There is one more advantage and it *can* be seen. Hope's unique Ultraclad PVC finish. It is without exception the toughest, most corrosion resistant finish available today.

For more information on the Series 3000 and other custom steel windows, contact the people at Hope's. Steel windows make a building what a building should be. Hope's can make the windows.

**ROBLIN**  
**HOPE'S WINDOWS**

ROBLIN ARCHITECTURAL PRODUCTS COMPANY  
84 Hopkins Avenue • Jamestown, N.Y. 14701 (716) 665-5124

Circle 124 on information card

# Welsbach Stands Unique.

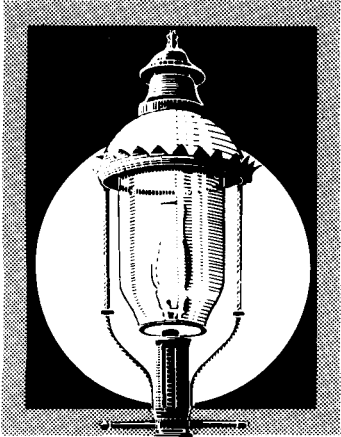

Since 1877

"Just between us and the lamppost, Welsbach has no equal."

"Spoken like a scholar and a gentleman."



Welsbach Lighting, Inc.  
240 Sargent Drive  
New Haven, Conn. 06511  
(203) 789-1710

Circle 125 on information card

## News Summary from page 320

Although the board did not award a gold medal—its highest honor—this year, tribute will be paid in other ways to those who have aided the profession of architecture and related arts. For example, medals will be bestowed upon seven individuals and three organizations in recognition of a diversity of architectural accomplishments. The widow of Leroy M. Campbell, AIA, will receive for him the 1980 Whitney M. Young Jr. citation for "significant contributions" in meeting the profession's responsibility on social issues, and Herbert Epstein, FAIA, will receive the Kemper award, given annually to "one AIA member who has contributed significantly to the Institute and the profession."

And to round out all the recognition for excellence, the 1980 recipient of the AIA/Association of Collegiate Schools of Architecture's award for "outstanding contribution to the field of architectural education" is Serge Ivan Chermayeff.

## Ethics: Considering A Mandatory or Voluntary Statement of Principles

For the past few months, a task force formed in 1979 to study the effects of legal decisions on AIA's ethical code and the related impact upon the Institute's documents, publications and structure has given consideration to the elimination of any potential anticompetitive elements in the code. The question for debate at the annual convention in June is whether a new statement of ethical principles, if adopted, would be mandatory and enforced or voluntarily followed.

Investigations by the task force included a tally at grassroots meetings early in the year which revealed that the membership evidently wants to "go beyond a simple revision of the existing code," but believes that further consideration should be made at the convention regarding whether any proposed new code is enforced or voluntary. Its investigations led the task force to think that among the membership there may be a "strong preference" for a mandatory and enforceable code, but that the "substantial minority in favor of a voluntary code" should be heard. A new code is expected to be presented for adoption by the board at its August meeting, taking convention debate into consideration.

The question of changes in the code arose after a ruling by Judge John F. Sirica on June 25, 1979, in the U.S. Court for the District of Columbia that AIA's former ethical standard prohibiting "supplanting" is in violation of the Sherman Anti-Trust Act. (See Aug. '79, p. 21.)

The supplanting ethic had stated that AIA members should not "attempt to obtain, offer to undertake or accept a commission for which they know another legally qualified individual or firm has been selected or employed" until there is evidence that the agreement had been terminated and written notice given.

The ruling was in the form of a partial summary judgment on the first of six counts of a civil suit brought against AIA and Seymour Auerbach of Washington, D.C., by Aram Mardirosian, also of Washington. The suit arose from an ethical controversy on supplanting between the two architects about the conversion of Washington's Union Station into a national visitors' center, for which Auerbach was the original architect, with Mardirosian eventually replacing him.

Judge Sirica ruled that AIA's supplanting standard "both on its face and as applied" was an "unreasonable . . . and unlawful restraint of trade." In accepting Mardirosian's contention that "censure, or suspension of membership by AIA injures an architect's reputation, standing and ability to obtain projects and other employment," Judge Sirica noted that "membership in AIA is a valuable asset which enhances . . . the ability to compete for and obtain architectural business."

The lower court ruling was based largely on a 1978 Supreme Court decision that the National Society of Professional Engineers had violated antitrust laws in promulgating its ethical standard prohibiting competitive bidding. The court had ruled that the determination of whether an ethical code violated the Sherman Anti-Trust Act should be based solely upon its effect upon competition. In the wake of Judge Sirica's interim order against AIA, NSPE's board dropped the supplanting rule in its ethical standards.

AIA's board in September 1979 also formally repealed the ethic on supplanting (rule 605), effective retroactively to May 1, 1979. Previously, the AIA executive committee had put an emergency "hold" on all cases and prospective complaints involving ethical standard 9 and its successor, rule 605. In December, the board suspended enforcement of any other ethical standards that might be considered anticompetitive by enforcement agencies.

In other matters related to ethics, the past year has revealed that most AIA members support the ruling of the 1978 convention that permitted a three-year experiment whereby AIA members may engage in design-build/construction contracting. The first year report of the task force that is monitoring the experimental period said that only relatively few firms are participating as contractors, but those that are involved "are most supportive" of the concept. □

# NOTHING... That's Something!



Geberit gives you something new and exciting to think about...nothing. No visible tank. No protruding handle. No objectionable noise.

The incredible Geberit Concealed Tank System combines design versatility with built-in dependability. The tank is hidden in the wall, and easily accessible through the handy access cover. Now the bowl can be integrated into the total design concept. Couple this with Geberit's proven reliability, and it's easy to see the unlimited versatility of the Concealed Tank System. The tank is virtually unbreakable, non-aging, non-leaking, frost-proof and insulated. The entire system is backed



by an exclusive 10-year guarantee.

For more than 100 years, Geberit has been the industry's leading innovator throughout Europe. Now we bring this expertise to the architects and designers of America.

We invite you to explore these exciting concepts with us. Call or write for more information. We're certain you'll be pleased with what you see...and with what you don't see.

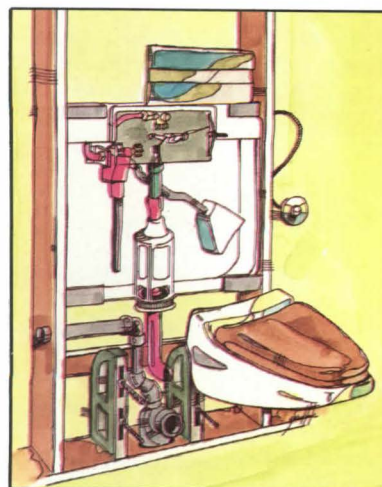

GEBERIT Manufacturing, Inc. • Michigan City, IN. 46360 • (219) 879-4466

Circle 126 on information card

# What's Next? *cont.*

---

*Paul Kennon, FAIA*

---

I think the best of design today is bouncing between the inventive and innovative levels. Perhaps in the 1980s several new fundamentals will emerge.

Architects must recognize the inevitability of change and become part of the process and be responsive to evolving cultural and social issues to avoid becoming anachronistic. We must be creative, not resistant. The decade of the '70s was a period of searching—and researching. People everywhere were looking for meaning. We had, or seemed to have, a luxury of random exploration. In architecture, we uncovered new issues, went

## **'Universal formulas won't hold up in the face of complex, uncertain, diverse situations.'**

down a few blind alleys, opted for numerous "isms" and, in general, started learning to deal with unpredictability.

For whatever reasons, we have now come upon a time in which expression and application must take precedence. The world climate has become increasingly impatient. Solutions are in demand. We will just have to fold exploration into the act of accomplishment. We have a responsibility to promote exploration of design alternatives—to develop new esthetic and symbolic expressions that architecture lacked in the 1960s and '70s. We must begin to apply in earnest what we know and have learned in recent years.

We must for the realities of the 1980s focus on four basic issues:

- *Communication* of intentions and attitudes in our architecture should be made clear by balancing the realities of each project in terms of form, function, economy, time and energy.
- *Uncertainty* is epitomized by the fast changing times, the difficulty of decision making in an unpredictable world where indeterminacy is part of our everyday life.
- *Cultural diversity* is typified by emerging nations that want to industrialize while maintaining their individual cultural heritages. Self-determined environmental appropriate technology is essential to cultural identity and political independence. Each society has both a cultural and technological tradition and new cultural expression and technologies must grow out of this tradition.
- *Responsiveness* to emerging new issues in architecture is essential. Working toward particular and appropriate solutions enables us to be receptive to and creative about new

**Mr. Kennon** is president of Caudill Rowlett Scott, Houston. **Mr. Polshek** is founder of the New York City firm James Polshek & Partners. **Mr. Filler** is editor of *House & Garden* magazine.

issues that emerge in architecture. Responding to and developing new concepts for the forces of the 1980s will produce 1980s forms.

Architecture is traveling along several paths today where there are new values and new sets of architectural principles to be discovered that recognize new technology, new esthetic systems and total human needs. Universal formulas from the 1960s and '70s won't by themselves hold up in the face of complex, uncertain and diverse situations presenting themselves around the world today. We must identify the specifics of each new architectural problem, embrace the realities that surround it and probe new intellectual and esthetic communication in our design as we strive for a significant cultural expression.

New values, plus new concepts, plus creativity, plus new levels of criticism will be the sum of architecture in the 1980s.

In Hugh Prathers' *Notes on Love and Courage*, he says, "There is a time to let things happen and there is a time to make things happen!" I think the 1980s will be time for architects to make things happen!

---

*James Stewart Polshek, FAIA*

---

Architecture is undergoing what I profoundly hope will be no more than an interlude of popularity. The public cant of journalists and the increasing hucksterism within the profession are symptomatic of the trivialization of culture that is part of our time.

There will be a backlash to the personalization and self-aggrandizement that has been the hallmark of so much of the media blitz currently passing for architectural progress. This includes the self-serving arguments that grow up on both sides of the various formal debates regarding pre- and postmodernism.

Architecture must serve and architecture must communicate, and neither responsibility requires sacrificing the *art* of the built work. The politics and social realities brought about by the adoption of new energy systems will not tolerate one-dimensional architects. Coping with daily life will require extraordinary feats of imagination and a degree of self discipline that we are unaccustomed to. Painterly design solutions that excuse the unwillingness of this society to allocate its financial resources to building that serves human needs will not be acceptable. Nostalgic art historical allusions to Hadrian's tomb or the fountains of Rome will not suffice and will not warm the toes or the heart.

If architecture does not begin once more to synthesize art and service by providing solutions to the interconnected esthetic, technological, social and economic problems of the built environment, the next decade will see the behavioral scientists, computer managers, engineers and interior decorators

take over. When that happens, the arguments between mods and postmods will be little more than one-liner jokes.

What must be protected and reinforced is the architect's holistic approach to problem solving. It will be more critical than ever for the architect to be skeptical of the priesthood of specialization without sacrificing his utopian belief in man's ability to control the future. As the professional world at large splits itself into mystics in one camp and superrationalists in the other, it will become truly urgent for us to walk that thin line between art and science that has been our birthright. It is doable if it is discussable. It will be discussable if the increasingly shrill voices of the "art for art's sake" types and the "we must be accountable" types will quiet down long enough to allow those who do not have absolute answers to imperfect questions to assert themselves once more.

---

*By Martin Filler*

---

What is likely to happen and what one would like to see happen are, of course, two totally different things. What is likely to happen during the 1980s? In my opinion we will see:

1. *The continuing dream of the detached single-family house.* Despite skyrocketing real estate values, construction costs, mortgage and interest rates, and every other practical impediment to the rational desire for home ownership, millions of Americans will continue to think of the one-family house sitting on its own plot of land (however small) as the only really desirable housing goal. Of necessity people will continue to live in "mobile homes," "town houses" (the current euphemism for party wall housing, even when built in the sticks) and other more economical forms of shelter. But their eyes will still be trained on the Great American

## **'Architects should realize that, for many Americans, some other way of building is going to have to be found.'**

Dream of a freestanding home of one's own—which, because of economic factors (and the reluctance of most Americans to realize the wastefulness of traditions rooted in dead expectations) will become more of a dream and less of an attainable reality in the '80s.

2. *The rising interest in historic preservation.* Considering the alternatives, more people will prefer to think about fixing up old buildings, both public and private, rather than erecting new ones. The impulse will proceed more from economic imperatives than from altruistic or esthetic ones. Recent studies have shown clear financial benefits to areas that have undergone historic redevelopment renovating. It would be heartening to believe that people might gain enough architectural awareness to reject bad new design in favor of better, older buildings. With luck, the success of such ventures as Boston's Faneuil Hall will lead more developers into efforts heretofore the bailiwick of local preservation groups interested mainly in sav-

*continued on page 326*



## THE DETAILS BEHIND THE DETAILS. A SERIES FROM ACME BRICK.

These details were made possible by the close coordination of architect, engineer, mason contractor and brick manufacturer, achieving a bold new solution, utilizing Engineered Brick Design.

The real beauty of this structural solution is in how it

provides maximum function and design with minimum cost. Walls are not only structural, but also energy conserving, fire resistive, sound insulating, and finished both on the interior and exterior.

The system has integrity. Truthfully employing the properties of the materials. Engineered Brick Design simplified construction procedures on this project, and was more cost efficient than any other system.

Whether you consider cost, flexibility, or beauty, no other system can match the total performance of Acme Brick and Engineered Brick Design. It's the best all-around system choice for your next commission.

For more Engineered Brick Design information, call collect, 817/332-4101, ext. 365. Or write Acme Brick Technical Services, P.O. Box 425, Fort Worth, Texas 76107.

**ACME BRICK. THE BEST ALL-AROUND BUILDING MATERIAL.**

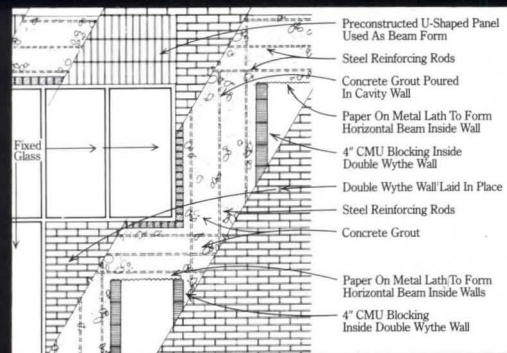

Punched keyhole fenestration within the Acme Brick bearing wall mirror the repetitive shapes of the cantilevered corner elements.

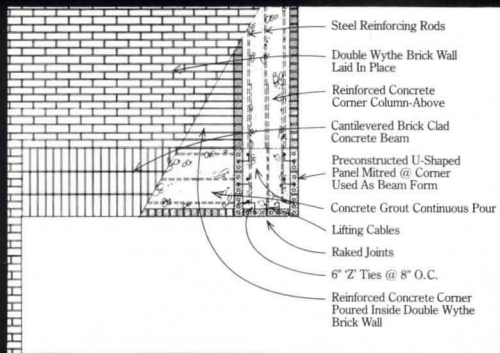

Dramatic cantilevered building corners seem to defy gravity. Made possible by preconstructed Acme Brick panels acting as forms for the internal structure.

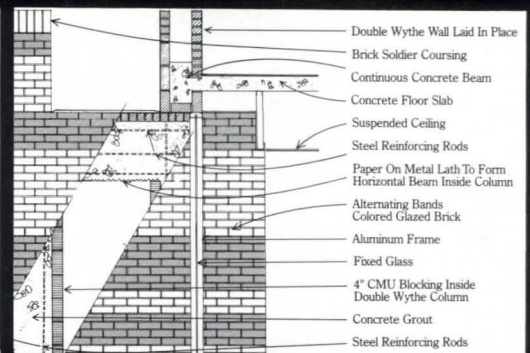

Wing walls of Acme Brick intersect the main form and carry the implied wall mass above. In addition they provide solar shading.



Brookhaven College, Dallas, Texas  
 Owner: The Dallas County Community College District  
 Architect: Pratt, Box, Henderson & Partners, Dallas, Texas  
 Structural Engineer: Datum Structures Engineering, Inc., Dallas, Texas  
 Masonry Contractor: Dee Brown Masonry, Dallas, Texas  
 Construction Manager: Avery Mays, Dallas, Texas

Essays from page 324

ing, and not necessarily integrating, old buildings into a community's life.

3. *The continuing alliance between good architects and developers.* More real estate developers will begin to realize that better design can mean bigger profits. The examples of Frank Gehry for Rouse and Gwathmey Siegel for Evans (among many others), will encourage other large-scale commercial clients to believe in good architecture as a marketable amenity, and thus raise the general design quality of a construction market that has for too long been the province of the cost accountant and the derivative designer.

4. *The rise of alternatives to architecture designed by architects.* Despite the infusions of new talent into the profession at the end of each academic year, the outlook for architecture practiced by architects seems at best circumscribed. The architectural needs of vast numbers of our citizens are not being met under the current limitations of professional practice. The new ways people might begin thinking about—and responding to—these inadequacies are voiced in such books as *The Timeless Way of Building*, *A Pattern Language* and *The Oregon Experiment*. Sponsored by the Center for Environmental Structure at Berkeley, Calif., these books, and the dissatisfactions that encourage them, should put architects across the country on notice that for many Americans, some other way of building is going to have to be found. It remains to be seen, of course, how this message might be brought to the public most in need of hearing it.

What would one like to see happen? I would welcome:

1. *An end to the debates on an architecture of styles.* There is good architecture and there is bad architecture: Ought that not be enough definition for anyone? The fact that we are living in a big, diverse world seems not to have dawned on a great many people, who find it necessary to rail against this architect or that publication for their presumed perversion of the profession. Forget it! Relax! There's enough country out there for all of us to exist.

2. *Stricter zoning and regional planning laws.* The pervasiveness of the strip—and

## 'The pervasiveness of the strip . . . should serve as a warning that this country, after all, has its limits.'

it's now part of virtually every community in America—should serve as a warning that this country, after all, has its limits. The development of our as-yet-undeveloped land in the next 20 years will rather definitively affect the quality of life in this country in the 21st century. If we do not become more aware of the need for thoroughly thought out, well considered strategies for land use—in both city and country—then we will become polarized between the realities of Love Canal, Three Mile Island and Seacaucus, N.J., and the fantasies of Aspen, Hilton Head and the Homestead, where we will escape in order to commune with "nature."

3. *Greater awareness of energy by the design-conscious architect, greater awareness of design by the energy-conscious architect.*

While high-style architects wait around for the development of a photovoltaic cell that will make energy-conscious design more of a "plug-in" affair than it heretofore has been, energy-conscious architects of considerable less design attainment are making hay while the sun shines. Although new critical criteria are being applied to architecture that works well in terms of energy (rather than architecture which looks good in terms of pure design) what will benefit all of us the most is an architecture that combines both. After all, the best indigenous architecture of the U.S.—from the Cape Cod saltbox to the Mississippi plantation house to Wright's prairie house—took climatic (i.e. energy) factors into consideration. Why can't every architect do that now?

4. *Greater public awareness of architecture.* Perhaps the biggest gap in our national cultural life is the lack of general understanding that architecture is our most important—because it is our most public—art form. Opera, ballet, theater, sculpture and paintings are now enjoyed by more Americans than ever before: When will architecture be accorded that status? That will happen once it is taught in primary and secondary schools ("Draw a city of the future that you would like to live in"), when it is seen as an essential part of general education. America is more than its buildings, but its buildings are a great part of America. Start with Independence Hall, the White House, the Alamo and the local courthouse, and it'll be as simple as that.

---

### By Paul Gapp

---

Playing the role of an architectural Nostradamus is a highly risky business, and you could probably get better odds of being right if you went out to the race track. For one thing, many of us are prone to confusing what we would *like* to happen with what is *likely* to happen. For another, we do not always agree on what constitutes "architecture" (hence our habit of looking at a building and making the arcane judgment, "I don't think that's *architecture*").

But perhaps we can avoid wishfulness, and for purposes of crystal balling maybe we can define architecture as the creation of any major one-of-a-kind structure that does not emerge from the Tinkertoy workshops of package builders.

Having gotten that far, perhaps we can also forego all ritualistic discussion of post-modernism, a piece of semantic flapdoodle best left for those salon seminars where people argue about how many draftsmen can dance on the head of a pin.

In the real world, there are only a few things of substance that seem to point toward what we may expect of architecture in the 1980s.

The old constraints of Miesian orthodoxy, of architecture-by-the-numbers, have been pretty well battered down. We are well into

**Mr. Gapp** is architectural critic of the *Chicago Tribune*.

a period of pluralism, experimentation and risk-taking. Almost anything goes, if the client will buy it, and there are signs that more clients are willing to eschew their up-tight conservatism and get into the swing of things.

So far, the most visible manifestations of the Anything Goes Look have been the historic AT&T and PPG posturings of Philip Johnson and the work of sycophants with lesser commissions who tack Corinthian columns onto chic new town houses and favor Palladian windows for fire stations.

I do not regard this as a transient aberration. In fact, I am willing to bet it will trickle down to architecture shops of little reknown and begin showing up in places like Ashtabula, Ohio, and Waterloo, Iowa. The

## 'All this defenestration of pre-1980 dogma . . . suggests a wide-open approach to design that may give our cityscapes diversity, richness, complexity.'

same thing happened with Art Deco 50 years ago, didn't it?

Still, all this defenestration of pre-1980 dogma may lead to something far more substantial than cutesy neoclassical add-ons. It suggests a wide-open approach to design that may solve more problems and give our cityscapes more diversity, richness, complexity and the mass appeal touches of theatricality that enlivened major buildings constructed between two world wars.

The need for an architecture sensitive to user needs and respectful of the existing urban fabric has seldom been greater. Several cities around the nation are preparing to demolish and rebuild large sections of their downtowns with the aid of federal urban development action grants.

This raises the same threats of renewal overkill that wiped out so many neighborhoods in the 1950s and 1960s. It also presents some of the major architectural challenges of our time.

Government itself will continue to be one of our biggest builders in the 1980s. It is a growth industry, particularly at the federal level, and forever in need of more space for its papershufflers and computers. As a client, it will probably be more responsive than the private sector to highly innovative designs for energy conservation, including the use of solar schemes.

Indeed, it is likely that energy saving will play the single most dominant role in the shape and functioning of our buildings in the new decade. Sooner or later, tight enforcement of the new federal energy budget standards will be carried out—after a messy period of balking by state governments responsible for making the program work. Owners will independently demand a higher degree of energy efficiency. Computer pools will be created for small architectural firms faced with new energy budgeting design complexities.

But the demands of energy saving will ultimately be positive in terms of design, be-

*continued on page 331*

# It knows how to save water. Because it "sees" when to flush.



## The Sloan OPTIMA™ **sensor-operated** Automatic Flushing System. No handles. No timer. Flushed by an invisible beam of light.

It's Sloan's great idea for cutting water consumption, while increasing sanitary protection. And the key to it all is the Sloan **OPTIMA** Electronic Sensor.

It "sees" when to flush with an invisible, continuous light beam. When a user approaches the fixture, he reflects the beam back into the **OPTIMA's** scanner. The electronics take over and when the user steps away, the flush valve is tripped by a solenoid.

The **OPTIMA** offers the ultimate in sanitation because the user can't "forget" to flush. And since fixtures flush only when they

are used, precious water is conserved.

The **OPTIMA** is designed for easy, attractive installation. It works with the Sloan Solenoid-Operated Flush Valve that matches your application. This advanced Sloan **OPTIMA** System gives you a trouble-free, water-wise answer to high-volume flushing problems in hospitals, sport complexes, municipal and office buildings, and transportation terminals.

For more information, write for our new brochure.

**Sloan Flush Valves. Anything else is a waste of money.**



**SLOAN VALVE COMPANY**

10500 SEYMOUR FRANKLIN PARK, IL 60131

Circle 128 on information card

# The American Institute of Architects

# Energy Planning for Buildings

Michael M. Sizemore AIA  
Henry Ogden Clark AIA  
William Ostrander PE

Building owners expect their architects and engineers to have the practical knowledge it takes to translate energy theory into a reliable form of practice.

This book, written by two architects and an engineer who have hands-on experience in energy-conscious building design and redesign, does just that. It presents a proven process that design professionals can use (or adapt) to study the present energy performance of a building, uncover opportunities for energy-conscious improvements, evaluate those opportunities, and see to it that they are carried out to the owner's best benefit.

The book describes in detail a manual technique for calculating energy usage and shows in a sample problem how that technique can be applied. This allows the reader to evaluate any energy design solution, including solar assisted alternatives. It also provides a basis for understanding computer-aided energy estimating techniques.

In developing their work, the authors have recognized that non-energy related concerns such as user comfort, environmental impact and visual appearance are as important in an energy-related design as energy performance itself, and they urge designers to iden-

tify these at the outset of a project and to keep them in mind to the end.

An opening chapter offers a look at the basic concerns of energy planning, including such concepts as comfort; illumination and daylighting; the building envelope; heating, ventilating and air-conditioning; and the very concept of energy itself.

Chapter 2 takes up the roles and responsibilities of the team needed to carry a project through to a successful end. Team members discussed include the owner, the architect/engineer, the building users and operators, energy suppliers, product manufacturers and building officials.

Chapter 3, a key part of the book, shows how to study a building's present performance (or, in the case of a new building, analyze a set of building plans) so the energy planner can examine the impact of any proposed changes suggested as a way to greater energy efficiency.

Chapter 4 pinpoints those opportunities, describing the best way of identifying them. The following Chapter 5 then shows how best to narrow the list of possibilities to those that make the most sense in terms of cost, time, payback and technical feasibility. Two

levels of evaluation are given—"quick" and "detailed."

Chapter 6 shows what is needed to carry out the recommendations stemming from the evaluation, and offers much sound advice to the energy planner and owner for monitoring the results and maintaining the renewed building at a peak of performance.

This chapter is followed by a sample problem which illustrates the procedural steps presented in the various chapters.

Finally, an appendix includes discussions on system response and cost benefit analysis.

There is also a glossary and a practical reference list.

ENERGY PLANNING FOR BUILDINGS fills a serious need for a practical, process-oriented book which energy planners can use, and owners can refer to, as they embark on a new building project or go about redesigning an existing one for greater energy efficiency.

156 pages, 120 charts and illustrations.

\$40 AIA Members  
\$44 Others

## The American Institute of Architects

Yes, I would like \_\_\_\_\_ copy (copies) of ENERGY PLANNING FOR BUILDINGS (#4M-720)

Enclosed is my check for \_\_\_\_\_

Mail to: Manager, AIA Publications Marketing  
1735 New York Avenue, N.W.  
Washington, DC 20006

NAME \_\_\_\_\_

FIRM \_\_\_\_\_

ADDRESS \_\_\_\_\_

CITY, STATE, ZIP \_\_\_\_\_

IDENTIFY AIA MEMBER \_\_\_\_\_

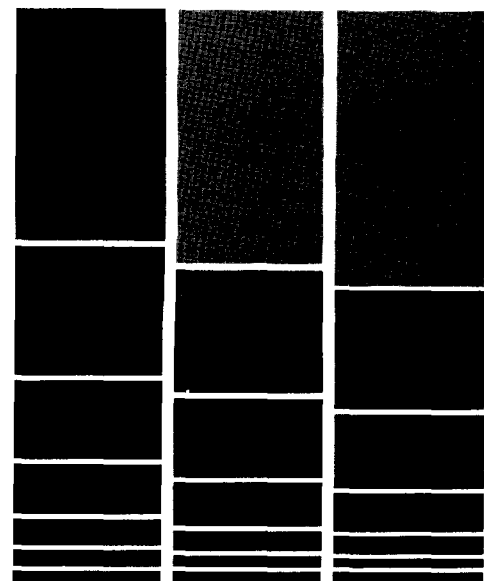

The Offenburg stacking chair is suited for hotels, restaurants and highly trafficked areas where seating is exposed to severe use. This series includes modular benches, stadium seats, chairs, tables and lounges, all from synthetic coated steel.

OFFENBURG  
Design: Heinz Wirth

# Kroin

 ARCHITECTURAL COMPLEMENTS

Post Office Box 168, Lincoln, Massachusetts 01773  
617 259 0129



Circle 129 on information card

# Meisel. Your answer to custom photomurals!

Your design calls for original photography and you have the negatives and transparencies on hand.

Good, we'll put them into our special enlargers and produce the finest color prints and murals available anywhere, beautifully hand-finished as only Meisel does it!

You want a giant Scanamural?

Okay, we're a 3M dealer and we can handle your Scanamurals, too.

We also offer black-and-white and sepia toned prints and murals. We make backlighted transparencies. And we have developed special techniques to put a print on nearly any surface you specify.

Don't worry about mounting. Our experienced people will mount your murals on panels or, preferably, right on the wall. And there is a five-year warranty on our installations.

But what if you don't have your negatives and transparencies?

No problem. You can choose from our Special Collections or our Masters Library of 5000 Images. Or we can recommend top photographers who will create images that are uniquely yours. We really can solve almost any photographic problem!

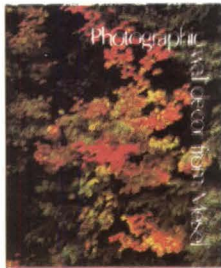

So try us! We're the world's largest custom color lab and we have worked for many well known designers, including Alan Ferry Design Group, Gensler and Associates, 3D/Newhaus+Taylor and H.O.K. Their clients range from the U.S. Government to the nation's largest corporations.

Now, we've added top-flight representatives to help us serve you even better. Check the list in the column at the right of this ad and call the one nearest you.

Or, for literature and information, write Meisel Photographic Design Division, P.O. Box 222002, Dallas, TX 75222.



**MEISEL**  
PHOTOGRAPHIC DESIGN DIVISION



Hyatt Regency Hotel, Indianapolis — National Parks Collection of eight murals.



A 9x27-foot mural for Omega Optical, Dallas.

One of the 16 9x22-foot murals for Pennzoil's national headquarters.



## Call your Meisel Representatives

### North Central Region

Milo Bloch & Associates  
415 N. La Salle  
Chicago IL 60610  
(312) 644-0847

Milo Bloch & Associates  
20 W. 9th Street  
Kansas City MO 64105  
(816) 421-1282

William Krager & Associates  
P.O. Box 8755  
Detroit MI 48224  
(313) 885-8558

Sam Sarat & Associates  
P.O. Box 2301, Loop Station  
Minneapolis MN 55402  
(612) 825-1988

### Northwest Region

The Williams Group  
1120 W. Blaine  
Seattle, WA 98119  
(206) 284-9190

Paulette Green  
505 Colorado Gulch  
Missoula MT 59801  
(406) 728-9136

### Northeast Region

Stanley M. Schlesinger Assoc.  
214 Hill House  
Huntingdon Valley PA 19006  
(215) 947-4835

Erik Norup  
450 E. 63rd St.  
New York NY 10021  
(212) 752-3448

Edward J. McKearney Co., Inc.  
51 Sleeper Street  
Boston MA 02210  
(617) 482-1862

### South Central Region

Glenn Hennings & Associates  
P.O. Box 58103  
World Trade Center  
Dallas TX 75258  
(214) 651-1556

### Southeast Region

John Wall  
1480 Oconee Pass  
Atlanta GA 30319  
(404) 458-1424

Price/Carnahan & Associates  
3091 Maple Dr. NE, Suite 310  
Atlanta GA 30305  
(404) 233-4030

Design Services Bureau  
96 NE 40th St.  
Miami FL 33137  
(305) 576-1031

### Southwest Region

C. J. Welch, Inc.  
8807 Beverly Blvd.  
Los Angeles CA 90048  
(213) 274-0671

Galleria Design Center  
101 Kansas St., Suite 208  
San Francisco CA 94143  
(415) 864-1700

### West Central Region

CDA  
901 Wazee St.  
Denver CO 80204  
(303) 573-6616

CDA  
307 West 200 South, Suite 2003  
Salt Lake City UT 84101  
(801) 521-5332

### Essays from page 326

cause they will force architects into modes of problem solving that go beyond the present bounds of dry orthodoxy. Regional vernacular architecture will become more prominent because of climatic variables. And we will reinvent everything from the openable window to the awning.

Accompanying all this will be an increasing upsurge of renovation, recycling and adaptive use of buildings in the name of preservation, economy and the market's demand for the interesting and colorful ambience of older structures.

There are no detectable signs that architecture of the 1980s will shake down into anything approaching a single new dominant school. Some perceive today's architecture as a confused and turbulent groping for new directions. And while this is correct to a degree, it does not necessarily follow that some new ultimate truth will be discovered to succeed the obsolete rationales of the International Style. We may be stuck with a decade or more of shifting, pluralistic design that defies the labeling so dear to art historians. But is that really so bad?

### Harry C. Wolf III, FAIA

The decade of the '80s has been described as a time of limits, a realization of finiteness. The energy supply will not become more plentiful nor less expensive. Inflation will continue, making money more expensive and less available.

An age of scarcity demands that we husband our resources, expending them with care to produce a quality of result. Economy

### 'The survivors of these tough times will quickly realize that previous solutions will turn out neither safe nor conservative.'

of capital is equal to economy of means which, in turn, means producing buildings that are less capital-intensive and more thought-intensive. Richer results mean better, not more. Architects will be asked to do the same, or more, with less and to do that—to balance the scales—they will use intellect and imagination.

On the other hand, they may not be asked since, in lean times, a natural conservatism arises and one instinctively does that which is safe and proven, tried and true.

I suspect that the survivors of these tough times, the architects, developers, lenders and financial institutions, will quickly realize that solutions which proved tried and true for a previous era will turn out to be neither safe nor conservative. The fact is that the '80s will be a time when the tried and true don't get the job done. If the race does, indeed, go to the swift, then the quick will soon see that the key ingredient is soundness of principle not repetition of product. The only way to balance that "more with less" scale is with ideas. It's a distinction between acting conservatively and acting conventionally. Creativity will be at a premium, now more than ever before.

And what a wonderful time to respond! Issues will be increasingly complex and often without precedent. Seminal thinking will be highly valued and, as architects seek to produce a richness of spirit, the tensions between modernism and postmodernism will provide a flowering of both. The recycling of resources and the focus that brings on the rebuilding of cities combined with the awareness and approval of the past suggested by the advent of postmodernism, bodes well for the shift from object architecture to contextual architecture with the city as an object of design. It's going to be a challenging and exciting decade.

### Robert B. Marquis, FAIA

To me architecture is a social art. (It is not, as some practitioners seem to think, painting or sculpture, even though it deals with many of the same elements.) It is the art of providing spaces for society's needs.

As such it reflects the dominant forces and ideas of its time and culture. If you will, it is the servant of society's institutions. As Kenneth Clark wrote in his book *Civilization*: "If I had to say which was telling the truth about society, the speeches by a minister of housing or the actual buildings put up in his time, I should believe the building."

The modern movement, the revolution that freed us from eclecticism, optimistically and idealistically rejected the notion that architecture reflects its society and instead led us to believe that through design we could change our society. This led us to believe that architecture would be an instrument of social change. In general, however, the modern movement failed to produce the better environment, the more humane work places, the garden cities, the sunny, livable housing for the poor. Those things were in the hands of the politicians, bankers, realtors, entrepreneurs—beyond the control of the architects.

The modern movement rejected the old eclectic, classical rules and substituted its own: functionalism, structural honesty, economy of materials and the celebration of industrial technology. In the hands of masters, the new rules produced some marvelous buildings. In the hands of the average practitioner, modern architecture most often produced buildings that were sterile and devoid of meaning to the user.

If architecture in the past 50 years has failed to fulfill social promises and satisfy social needs, it is not surprising that we are now in the midst of an antimodern revolution. If architecture reflects society, is it any wonder that in a confused and complex post-Vietnam, post-Watergate world, when old values and virtues are being constantly challenged, our architectural thinking is also confused? Is it not to be expected that previously agreed upon principles and rules governing most modern architecture are considered by many to be invalid? What was once considered the mainstream of archi-

*continued on page 337*

**Mr. Wolf** is founder of Wolf Associates Ltd., Charlotte, N.C. **Mr. Marquis** is founder of the San Francisco firm Marquis Associates.

BOSTON • CHICAGO • DALLAS • HOUSTON • LOS ANGELES • PHILADELPHIA • MIAMI • SEATTLE • TORONTO • VANCOUVER • CALGARY • SYDNEY, AUSTRALIA • PARIS

NO LIMIT TO  
CARPET  
DESIGN AT

# EDWARD FIELDS

232 EAST 59TH STREET • NEW YORK, N.Y. 10022 • 212-759-2200

**A PURE WOOL CORPORATE FANTASY COVERING 12,500 SQUARE FEET \*  
FROM THE MAGIC NEEDLES OF EDWARD FIELDS**

Interior Designer: PLM Inc., Kim Furstenwerth, Partner-in-charge  
Photographer: Alexandre Georges  
\*Data: "Seville" velvet textured  
Seamless custom-colored wool  
carpet for industry  
"Persian Garden" custom wool area rug



Circle 131 on information card





**It's happening at American-Standard.**

Take a look at the stunning Ellisse suite. A first! European dash in design and color styling. Putting its unmistakable mark on an entire, integrated bathroom suite: lavatory, toilet, bidet and bathing pool. American-Standard brings the bathroom together in a new concept of sophistication. And take a look at Tahiti. A subtle, new color for subdued drama in decorating.

There's more excitement! Three new whirlpool baths, a soaking bath with whirlpool, and an enormous 20' deep whirlpool bath for two. All accentuated by the newest luxury of American-Standard Dualux fittings. Backed by the American-Standard reputation for quality.

We're saying to every one of your customers: "Take a look at American-Standard." And they are!

# America's bathrooms are coming to life!

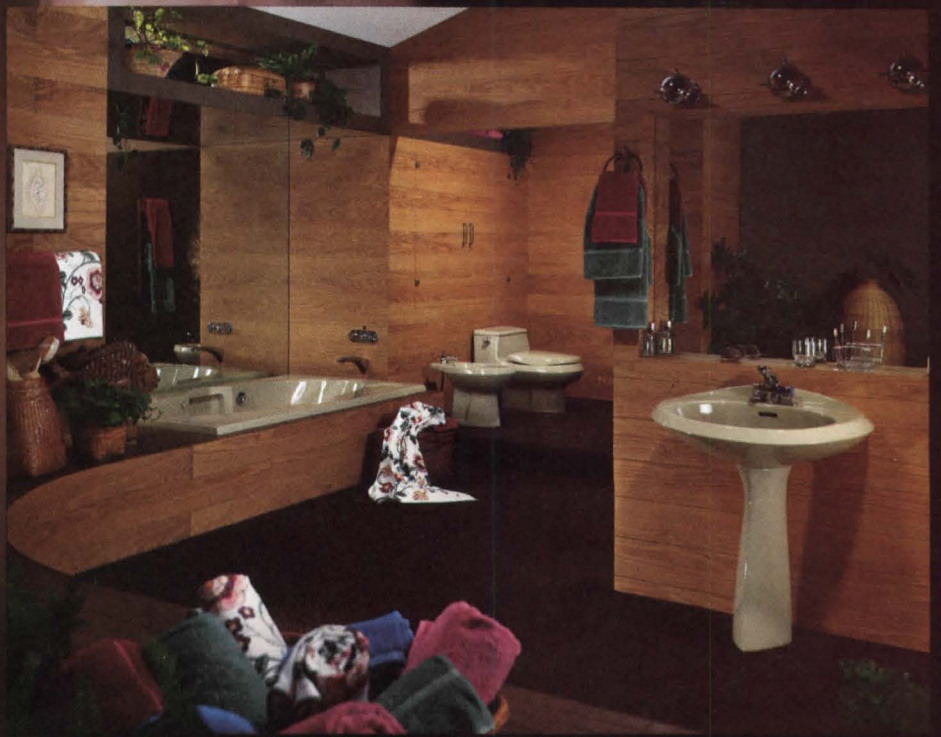

**e AMERICAN-STANDARD**

World's leading name in plumbing fixtures and fittings.

Circle 132 on information card

# Award winning buildings include Bilco products.

## No surprise.

## Bilco quality helps make every building a "winner."



The Bilco Company, Dept. AJ-50  
New Haven, Connecticut 06505

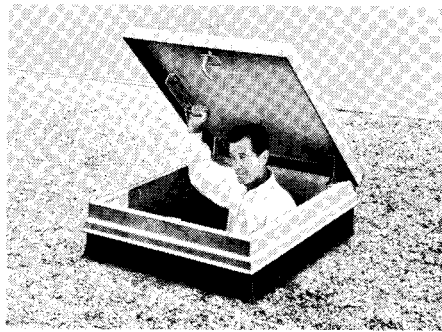

### Roof Scuttle

Standard sizes in steel or aluminum for safe, convenient ladder access to the roof. Features floating cover action, automatic lock-open with operating handle for one-hand closing. Weathertight. Also standard sizes for ship stairs or normal stairs, as well as special sizes to order.

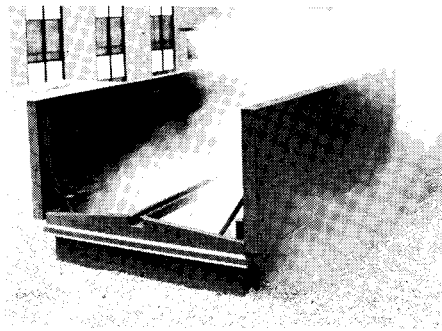

### Automatic Fire Vent

Designed and built for complete reliability and long service. Insulated and gasketed for weathertightness. Exclusive Bilco Thermolatch™ mechanism is activated by fusible link or, when specified, by electrical signal from smoke detector or other emergency device. Sixteen standard sizes and types with UL and FM labels. Special sizes available.



### Ceiling Access Door

Two sizes in choice of all steel or steel frame with aluminum door. Typical sturdy Bilco construction. Available in either upward-opening or downward-opening types. Spring lifting levers assist in opening and closing. When specified, provision can be made for application of acoustical tile by others.

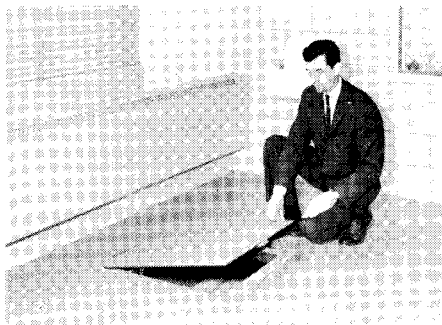

### Floor Door

Single and double leaf designs for every interior floor access requirement. Built-in torsion rods for easy operation of the steel or aluminum plate doors. Models with diamond pattern surface or to receive carpet or composition floor covering. Available in eight standard sizes and in special sizes.

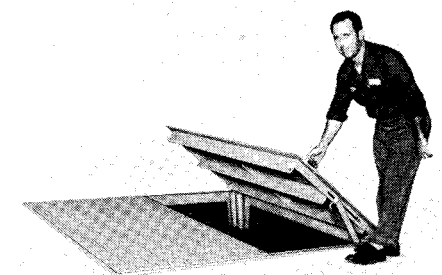

### Vault, Pit or Sidewalk Door

Watertight doors in single or double leaf design, rugged steel or aluminum plate construction. Eight standard sizes or special sizes to order. Tubular compression spring operators afford smooth, easy operation.

Circle 133 on information card

Add an 8th wonder to your world:

**VEREL**® Casement  
Collection VIII  
MODACRYLIC FIBER



The Egyptians closed space in. Cohama Specifier opens space up. With our Space Planners' Casement Collection VIII, styled with a blend of Verel® modacrylic fiber for inherent and permanent flame resistance, you design openness as part of any room decor with the light, airy look that begins with window treatments.

Ask your Cohama Specifier sales representative about adding an eighth wonder to your world... our Verel® Casement Collection VIII. Be sure to see it at NEOCON XII, Space 910-A.

COHAMA **CS** SPECIFIER  
CONTRACT FABRICS

295 Fifth Avenue, New York, N.Y. 10016 • 212-564-6000  
UNITED MERCHANTS AND MANUFACTURERS, INC.

®Verel is Eastman's trademark for its modacrylic fiber

*Circle 134 on information card*



## Good accommodations.

Trus Joist Corporation's structural systems accommodate a wide and demanding range of design criteria, both conventional and innovative.

From our six product lines and 51 profiles, Ramada Inns selected open web TJJ joists for the Inn at Grand Island, Nebraska, and all-wood I joists for the Inn at Breezewood, Pennsylvania.

If our standard joists do not accommodate your needs, discuss your ideas with one of our 180

technical representatives.

You'll find they're not just order-takers—they're skilled specialists, able to contribute and advise at every phase of the project. They stay with your job from start to finish and help bring it in on time and within budget.

Both Trus Joist systems and Trus Joist people are very accommodating.



Wood Technology Leader for 20 years.

**TRUS JOIST CORPORATION**  
P.O. Box 60-J • Boise, Idaho 83707 • (208) 375-4450

COMPLIMENTARY COPY of our 94-page technical support manual will be delivered by a Trus Joist representative on request. Please write on your company letterhead to the address below.

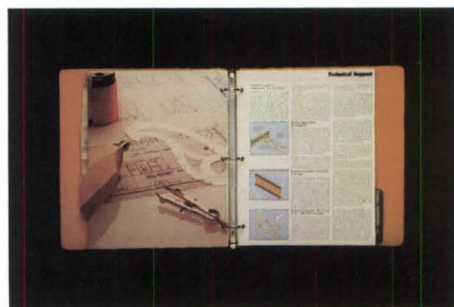

Circle 135 on information card

*Essays from page 331*

tectural thought has broken up into a thousand streams.

I am too much of an optimist to believe in the virtue of the present pluralism, that the state of confusion, the lack of a rational, consistent approach to design will persist. In fact, I believe the thousand streams will reconverge. This belief does not stem from wishful thinking but rather from the premise that enormously strong and pervasive forces are at work in our society and a belief that if architecture indeed serves and reflects its time, it will be forced to respond to it.

The forces whose gravity are not yet fully recognized by society or its architects are: the scarcity of nonrenewable resources in general and energy consumption in particular; worldwide inflation; the widening chasm between the haves and have-nots. There are those among us who believe that technology—energy satellites, desalinization, ocean farming, etc.—will master these forces. I do not have great faith in technological panaceas. I believe the response to these forces will not lead to a return of the modern movement per se, but to a set of new universally

**‘What will remain of ‘historicism’ must be meaningful and understandable, not esoteric and whimsical.’**

agreed upon rules that must again govern architectural design.

Climate and orientation will become a strong form determinant that in turn will result in a return to regionalism. Significant user involvement will become a political necessity for most projects. Many of the ideas that have been dramatized in this post-modern period will remain valid although applied more rationally. What will remain of “historicism,” however, must be meaningful and understandable, not esoteric and whimsical. Buildings will be increasingly designed in response to their context, related to the continuity of streets and other buildings, to the grain and scale of the community.

Some of the principles used in past vernacular architecture that respond directly to the needs of daily life and the limitations of modest technology will re-emerge.

Finally, I believe that while architecture serves its culture, it need not cater to the mediocre or worst. We as architects must choose to express the best ideas and aspirations of our society.

---

*By Jerome M. Cooper, FAIA*

---

This past decade has been a period of great experimentation. Stripped of a rather fragile and esoteric rationale, the profusion of forms that has resulted seems to have more attributes of sensational show biz than architecture. In opposition to this, there are those who have steadfastly retained their affection for older and more familiar ideas

**Mr. Cooper** is a principal with the Atlanta firm Cooper Carry & Associates, Inc.

even though the society that led to their formulation no longer exists. Both of these diametrically opposite attitudes have most frequently led to the same results—form without meaning.

With modest exceptions, architects generally create buildings that reflect the values, needs and desires of the society that brings them into being. Because these have been in a state of flux for the past 10-15 years, it is neither unusual nor unexpected that design attitudes should be in a similar state, as has always been the case.

During the late 1930s, no one would have denied that the formalism, ornamentation and grand scale of the architecture of the Beaux-Arts no longer reflected a society that, racked by depression and beset by war,

was steadily becoming less grand, less static and more functionally and technologically exact. The design attitudes and choices that architects began to make were largely influenced by these profound changes in society. A fluid view of space, functional view of form and a desire to relate the building process to the technology of industry, marked the design attitudes of the Bauhaus and International Styles. Though European in origin, they generally reflected the values, needs and desires of contemporaneous use.

Even though many fine individual buildings were done during the late '40s and the '50s and '60s, the shortcomings of design attitudes soon became evident. As architects,

*continued on page 340*

## **Polytite<sup>®</sup> joint sealant . . . seals your building permanently!**



**This unretouched photo shows the results of water getting behind the joint sealant.**

**You can prevent the damage caused by water getting into a building. With Polytite! Used as the primary sealant or as a secondary sealant behind the backer rod and caulk, Polytite sets up an impenetrable barrier that gives permanent, watertight protection that won't fail. It will give years of unmatched service — even in the severest weather extremes.**

**You can put your confidence in Polytite.**

**Write for full technical details on all Polytite systems.**



**Sandell Manufacturing  
Company, Inc.  
324 Rindge Avenue  
Cambridge, MA 02140  
Telephone (617) 491-0540**

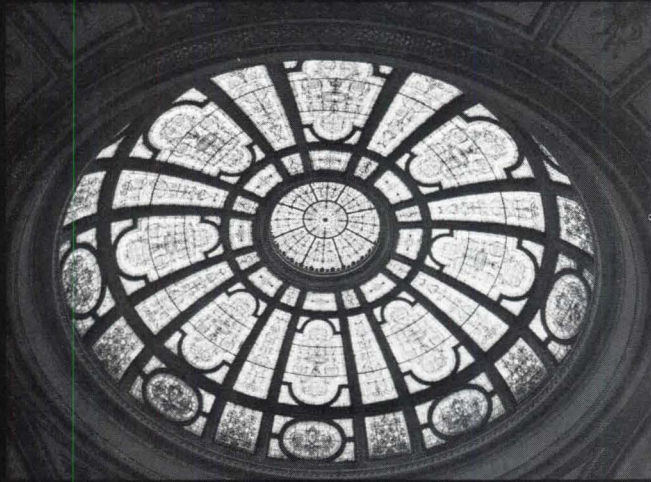

Chicago Library & Cultural Center



Federal Court of Appeals - N.Y.



## Rambusch restoreth what time taketh away.

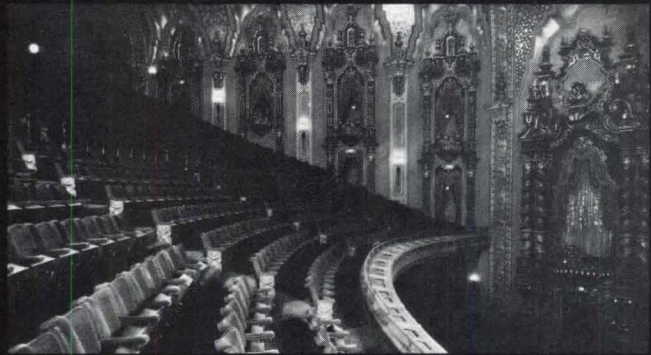

The Ohio Theatre - Columbus

In full accord with the original, Rambusch restores, rebuilds, repaints and enhances...a legislative chamber, a courtroom, a theater, a museum, a bank.

From cleaning and refinishing oak panelling to painstakingly restencilling a Victorian architectural detail. And from designing and fabricating a stained glass window to the efficient relighting of a grand old room. Rambusch creates and recreates the total environment.

In a unique series of art and craft studios, within Rambusch, highly skilled designers and artisans contribute their cumulative expertise to recapture a glory long past.

For further information contact William T. Weber.

stained glass/metal/wood/lighting/painting/refinishing  
consultation/planning/design/fabrication/installation

# RAMBUSCH

40 West 13th Street, New York, N.Y. 10011 (212)675-0400

Circle 137 on information card

## SEDGWICK ELEVATOR

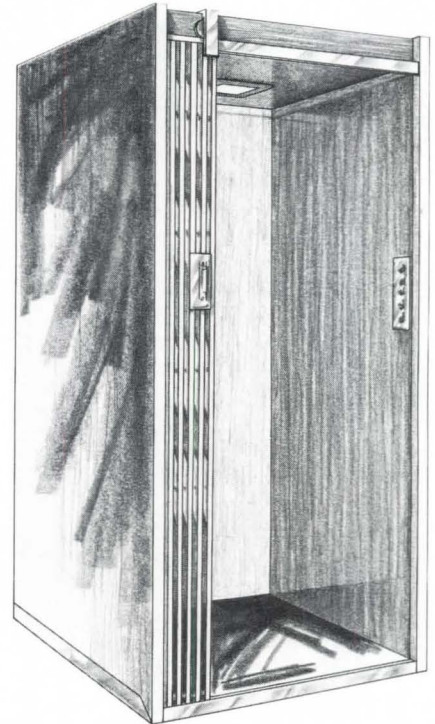

AS INSTALLED IN THE AWARD  
WINNING NEW YORK  
TOWNHOUSE BY:

## SEDGWICK

NATIONALLY RECOGNIZED  
MANUFACTURER OF FINE  
ELEVATORS AND DUMBWAITERS  
FOR OVER THREE QUARTERS  
OF A CENTURY

QUALITY ELEVATORS, DUMB-  
WAITERS AND DUMBWAITER  
DOORS COMPETITIVELY PRICED

## Sedgwick

MACHINE WORKS, INC.

P. O. BOX 630

POUGHKEEPSIE, N. Y. 12602

FOR ALL YOUR ELEVATOR AND  
DUMBWAITER REQUIREMENTS  
CONTACT YOUR SEDGWICK REP.  
OR DIAL (914) 454-5400

Circle 138 on information card

**your building...  
appealing  
...or just  
peeling?**

**ColorKlad**®

It's mystifying...even today the majority of metal roofing, fascia, gravel stop and coping projects still specify: "GALVANIZED SHEET STEEL...FIELD OR SHOP PAINTED..."

You know what happens when painted galvanized is used. Every two to five years, attractive buildings end up looking like the one above: peeling, chipping, cracking and fading. Result? The project must then be scraped and repainted. Up go expenses, well above original costs.

But there is an alternative.

For the same initial cost, an original or replacement installation of **COLORKLAD** eliminates expensive repainting problems. It is a versatile **PREFINISHED** flat sheet architectural metal with a 20-year written warranty **AGAINST** peeling, chalking, fading and cracking.

Nine architectural colors, available in two textures, offer total design flexibility and maximum value for the dollar.

**FOR THE "FIVE YEAR PEEL," CHOOSE PAINTED GALVANIZED...  
FOR THE "TWENTY YEAR APPEAL," CHOOSE COLORKLAD!**

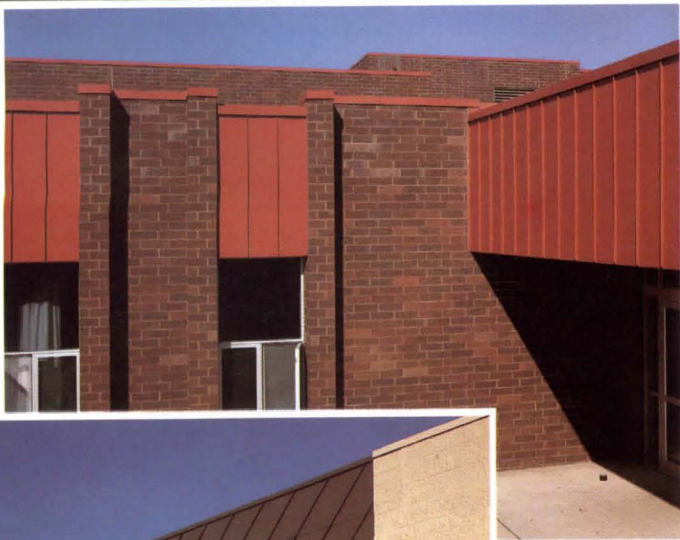

**Vincent**

**BRASS & ALUMINUM CO.**

Building Products Division

P.O. Box 360, Minneapolis, Minnesota 55440

MINNESOTA ONLY 800-552-1202

NATIONWIDE 800-328-7722

See our  
Catalog in  
Sweet's

SEND FOR OUR NEW **COLORKLAD** BROCHURE  
AND FREE COLOR SAMPLES TODAY!

AIA-5-80

Name \_\_\_\_\_

Title \_\_\_\_\_

Company \_\_\_\_\_

Address \_\_\_\_\_

City \_\_\_\_\_ State \_\_\_\_\_ Zip \_\_\_\_\_

Circle 139 on information card

Essays from page 337

often designing for other architects and architectural critics, we had tended to create spaces and forms that were handsome, well designed and impressive as testimony to the power and affluence of the entities that had brought them into being. But by the late 1960s, it had become evident that the rigid logic and the functional and technological exactitude of the Bauhaus and International Styles were leading to a comparatively anonymous environment. It became further evident that these attitudes no longer reflected a steady societal trend toward less structure, less order and rebellion against government and its institutions.

It is largely as a part of this unrest that the experimentation of the 1970s took place. The results of these experiments are usually enervating and occasionally provocative. They seem to concentrate more on style than substance, and only casually do they address the profound changes that are occurring in our society. Once again a situation has developed in which we, as archi-

### 'Architects tend to design more for other architects or architectural critics than for the individual.'

itects, tend to design more for other architects or architectural critics than for the individual. Oftentimes, the results are barely more than stage set design; and the effects are often only illusion and sensationalism.

If we can divest ourselves of our current desire for sensationalism, cast aside the design affectations of the past, address changed values, needs and desires of society forthrightly, then a new "architecture of humanism" may once again be at hand. Unlike the architecture of humanism of the renaissance, the new design attitudes will have more modest goals, seeking to relate the individual to his environment. The relationship between building technology and industry is too firmly rooted in our society for the capricious recreation of historical forms to

be viewed as anything other than affectation. Carried to a logical conclusion, our cities would look more like Disney World than the humane and enjoyable environment for which we all strive. While Shakespeare's "all the world's a stage" may be true, it does not necessarily follow that its surface should be covered with stage sets. As architects, we are better than that and our society requires our best.

### By John F. Hartray Jr., FAIA

I have hopes for the future, but no basis for predictions. The condition of the economy is without precedent in the U.S. and history offers no examples of societies that had a similar array of problems combined with our material and human resources.

My hopes for architecture hinge on our ability to redefine design so that the central interest of our profession can be brought to bear on the needs and concerns of society.

There are a number of interesting challenges to be faced. Shortages in capital, materials and energy may force a return to a truly decentralized economy, reinforcing the tendency toward regionalism which to date has been supported only by a romantic reaction to our perceived national uniformity. The demographic shift to an older population will affect a broad range of issues, from the minimum property standards to metropolitan settlement patterns. A more labor intensive economy could bring with it the opportunity for the return of craftsmanship. Even the proliferation of architectural students could hold great promise if they are equipped to survive and prosper in a turbulent economic environment.

What we currently call design has little or no relevance in facing these issues.

For two generations we were constrained by esthetic theories that kept us ignorant of history and prevented us even from seeing much of what was being built around us. During the period of enthrallment, we

**Mr. Hartray** is with the Chicago firm Nagle, Hartray & Associates, Ltd.

built some very good buildings and advanced the technology of construction. Any new achievement must be based upon a continuation, not a denial, of this work.

The recent expansion of our perception that has been loosely named postmodernism has not brought forth a new style. It has merely allowed us to see what the unorthodox minority has been up to while we were preoccupied with the Cartesian structures and curtain walls.

It includes the continuation of almost all of the historic styles for clients who read forms for meaning, the development of highly personal styles derived from a romantic view of nature, work founded on the handcrafts and finally the architecture of suburbia and the commercial strip. None of this is new. It has always been there.

Our reaction has been to try on all the costumes in the trunk. Those of us with es-

### 'Young practitioners have been driven further in pursuit of shocking juxtapositions.'

tablished reputations have found that we can create a stir by bold acts of inconsistency. The AT&T design would not have been newsworthy had it been proposed by Morris Lapidus. Younger practitioners without established reputation have been driven further in their pursuit of shocking and humorous juxtapositions of form and context.

None of this goes further than schematics. The designs are really not intended to be built. Those that are become embarrassments. We are really dealing with indoor in-jokes.

There is nothing immoral about any of this except that it is being mistaken for architecture and taken seriously in schools and in the press. Our attention is again being diverted from reality; our critical faculties are concentrated on narrow abstractions; our serious efforts are deprived of theoretical support. The revolution has come full cycle. This time without producing anything.

There is hope. The laughter is subsiding. Soon we may yawn and resume work. □

# SOUNDBLOX<sup>®</sup>

Sound-Absorbing Structural Masonry Units

**CONTROL NOISE**

Patented

See Sweet's General Building (Architectural) or Industrial Construction Files (9:1/Pr) or Spec-Data, or phone us collect.  
Nationwide availability... made near your jobsite!

 **The Proudfoot Company, Inc.** ACOUSTICAL PRODUCTS P.O. BOX 9, GREENWICH, CONNECTICUT 06830 A/C 203 869-9031



Blinds on sunny east side are lowering automatically in response to programmed and/or electric eye control. Blinds on south side will be lowered from their concealed storage pockets later in the day. In winter, the controls can be set to close Blinds after dark to hold in building heat.

## Exterior Solar Control Blinds by Nichols-Homeshield

# Save more than they cost

### Control Energy Costs

The energy efficient key to solar control is to keep the sun from striking the glass on your building. Reflective or tinted glazing, interior drapes and blinds, all allow interior heat build-up which must be counterbalanced by the mechanical AC system.

### Minimize Capital Expense—Lower Operating Costs

Nichols-Homeshield Exterior Solar Control Blinds have a shading coefficient of 0.17. They keep the sun from striking the glass and minimize capital expenses by allowing smaller AC systems and less interior lighting. And they provide long range utility savings by reducing energy consumption.

In addition, expensive multiple glazing may be eliminated along with drapes, interior blinds, and the permanent shading systems which never allow your building to take off its "dark glasses". When retracted, Nichols-Homeshield Blinds allow an unobstructed view and added light levels on overcast days.

### Immediate to Eight Year Payback

Depending on geographic location and the local cost of energy, projected payback may be immediate, or may take any amount of time up to eight years.

### New Construction or Retrofit

With Nichols-Homeshield Exterior Solar Control Blinds, you can choose either to accept or to reject the sun. And you can choose them for your next new building, or as a retrofit installation on an existing energy-hungry building.

See us in Sweet's 10.24/Ni or call or write:

## Architectural Products

Nichols-Homeshield, Inc.  
1000 Harvester Road  
West Chicago, IL 60185  
(312) 231-5600

An  Company

Circle 141 on information card

# WE FIT IN

## STAINLESS STEEL UNDER COUNTER LAB REFRIGERATORS AND FREEZERS

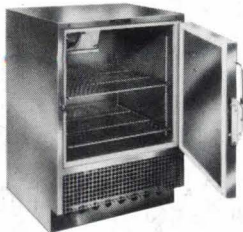

**UC-5-BC** refrigerator has a blower coil cooling system with automatic off-cycle defrosting and condensate evaporator in condensing unit compartment. Two adjustable stainless steel shelves are provided.

**UC-5-F-BC** freezer is equipped with automatic timer electric defrost. Capacity—5.4 cu. ft. (155 ltr.)

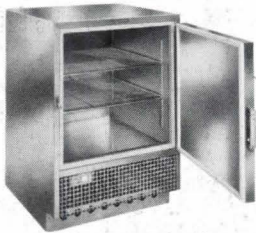

**UC-5-CW\*** refrigerator with cold wall cooling system is equipped with push-button defrost, automatic reset and condensate evaporator. Capacity—5.4 cu. ft. (155 ltr.)

**UC-5-F-CW\*** freezer is equipped with manual hot gas defrost. Capacity—4.6 cu. ft. (130 ltr.)

**UC-5-CW-E** refrigerator has the same interior features as the UC-5-CW but modified to make it *totally explosion-proof*. Capacity—4.9 cu. ft. (140 ltr.)

\*With explosion proof interior only.

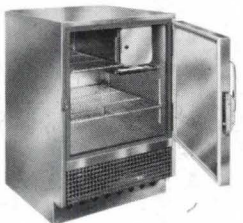

**UC-5** features a two-tray ice cube cooling system with manual defrost and stainless steel defrost water tray. The cooler section has two adjustable stainless steel shelves. The entire UC-5 series features polyurethane insulated thin wall construction and air-tight neoprene thermo-break door seals. Capacity—5.4 cu. ft. (155 ltr.)

Jewett also manufactures a complete line of blood bank, biological, and pharmaceutical refrigerators and freezers as well as morgue refrigerators and autopsy equipment for world wide distribution through its sales and service organizations in over 100 countries.



Refer to Sweet's Catalog 11.20/Je for quick reference.

Circle 142 on information card

### Plastic Honeycomb Panels.

NorCore panels combine light weight, rigidity and the workability of wood. Lamination materials available are: ABS, Plexiglas, Polystyrene, Formica, PVC, Uvex, aluminum, steel and Fiberglas, all of which can be applied in a wide range of thicknesses and are available in a variety of colors. (Norfield Corporation, Danbury, Conn. Circle 196 on information card.)

### Thermal Storage System.

Energy Bank, a residential thermal storage system, is designed to utilize electric energy during the most economical periods of the day, such as "off peak" times. The system can replace conventional gas or oil fired boilers and can be used with baseboard radiation, warm air or fan coil installations. (MEGATHERM, East Providence, R.I. Circle 195 on information card.)

### Beveled Glass.

Beveled one-fourth and one-half-inch thick clear glass is cut by hand, set in patterns and joined by lead comes. The lead comes also serve as a temporary frame. (Beveled Glass Industries, Los Angeles. Circle 194 on information card.)

### Composite Wall Paneling.

Petrarch is a slate composite containing a high percentage of stone granules, bonded with resin and reinforced with glass fiber. The materials are cast in a mold formed from natural slate and pressed into panels five-sixteenth and seven-sixteenth inches thick. They are available in a variety of slate and decorative colors and textures. (Prismo Universal Corporation, Parsippany, N.J. Circle 193 on information card.)

### Outdoor Wall Light.

Perimaliter was designed for maximum spacing between fixtures using HID lamps. It has a prismatic polycarbonate lens, aluminum reflector, heavy gauge aluminum ballast compartment cover and is finished in bronze lektrocote. (Harvey Hubbell, Inc., Christiansburg, Va. Circle 187 on information card.)

### Electric Space Heater.

The compact portable heater is designed for small rooms. No plumbing is needed. Electricity heats a sealed water-antifreeze solution, and a fan distributes the heat. (Inthertherm Inc., St. Louis. Circle 192 on information card.)

### Ceiling Tiles.

The Gallery, a system of 2x2-foot lay-in tegular ceilings, is available in 12 matte finished colors keyed to contemporary

continued on page 346

# FROM CHENEY

# STANDING SEAM PANELS: NEW

Now Cheney gives you another design choice. Introducing Cheney Standing Seam Panels to compliment our complete line of Fascia and Batten panels.

Cheney's unique one piece panel design, with automatic expansion joints and simple concealed fastening, eliminates the unnecessary material installation costs of special tools, snap-ons, hold down clips, etc. Saves time and money.

Available in factory prefabricated heights up to 16'-0" in two standard designs. Heights above 16' and special spacing available on special order. A choice of two lower edge treatments—J-channel or J-clips.

Write or call for complete information.

No. 71

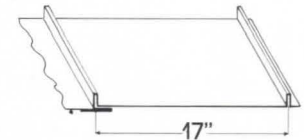

No. 91

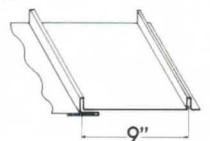

A company in touch with your needs.

## CHENEY

FLASHING COMPANY

ESTABLISHED 1928  
623 Prospect Street  
P.O. Box 818  
Trenton, N.J. 08605  
Phone 609-394-8175

Circle 143 on information card

With System 3 Universal Alarm Control, detecting fire at its earliest stages is just the beginning. It also monitors doors, elevators, fans and sprinkler systems. Supervises alarm signals. Reacts to manual alarms. And combines with other building systems including security and equipment functions. With or without supervised Voice Alarm control.

But perhaps the most exciting thing about System 3 is its modular design which lets you take advantage of any or all of these functions depending on your precise needs. This total flexibility means you won't have to settle for less than you need—or pay for more than you want. And if you expand your facility in the future, you won't have to pull out the whole system and start from scratch. Expanding your existing System 3 will be a simple and economical matter.

System 3 is Pyrotronics' response to your need for protection beyond detection—at a cost that makes sense. It's just what you'd expect from the world leader. For full details, contact Harry Lein, Pyrotronics, A Division of Baker Industries, Inc., 8 Ridgedale Avenue, Cedar Knolls, New Jersey 07927. (201) 267-1300.

**Pyrotronics**

PROTECTION  
SYSTEMS



637

**System 3—an  
economical  
system that  
detects fire  
and controls  
all response functions.**

**That's protection  
beyond detection:**

**That's Pyrotronics.**

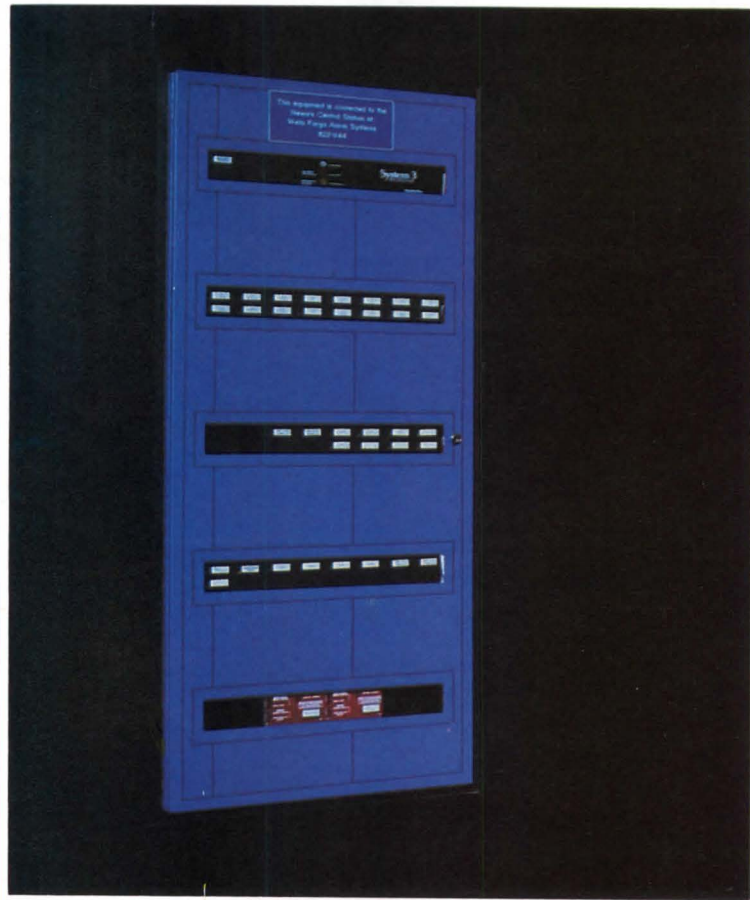

Circle 144 on information card

# CUPPLES PRODUCTS

## Custom Curtain Wall

### **I. M. Pei & Partners**

Dallas Center

### **Hellmuth, Obata & Kassabaum, Inc.**

National Air & Space Museum

### **3D/International**

Seafirst Fifth Avenue Plaza

### **Harry Weese & Associates**

200 South Wacker

### **Edward Durell Stone & Associates**

### **The Perkins & Will Corp.**

Standard Oil Building

### **Skidmore, Owings & Merrill**

Sears Tower

### **C.F. Murphy Associates, Inc.**

Xerox

### **Minoru Yamasaki & Associates**

### **Emery Roth & Sons**

The World Trade Center

### **Philip Johnson & John Burgee**

### **S.I. Morris Associates**

Pennzoil Place

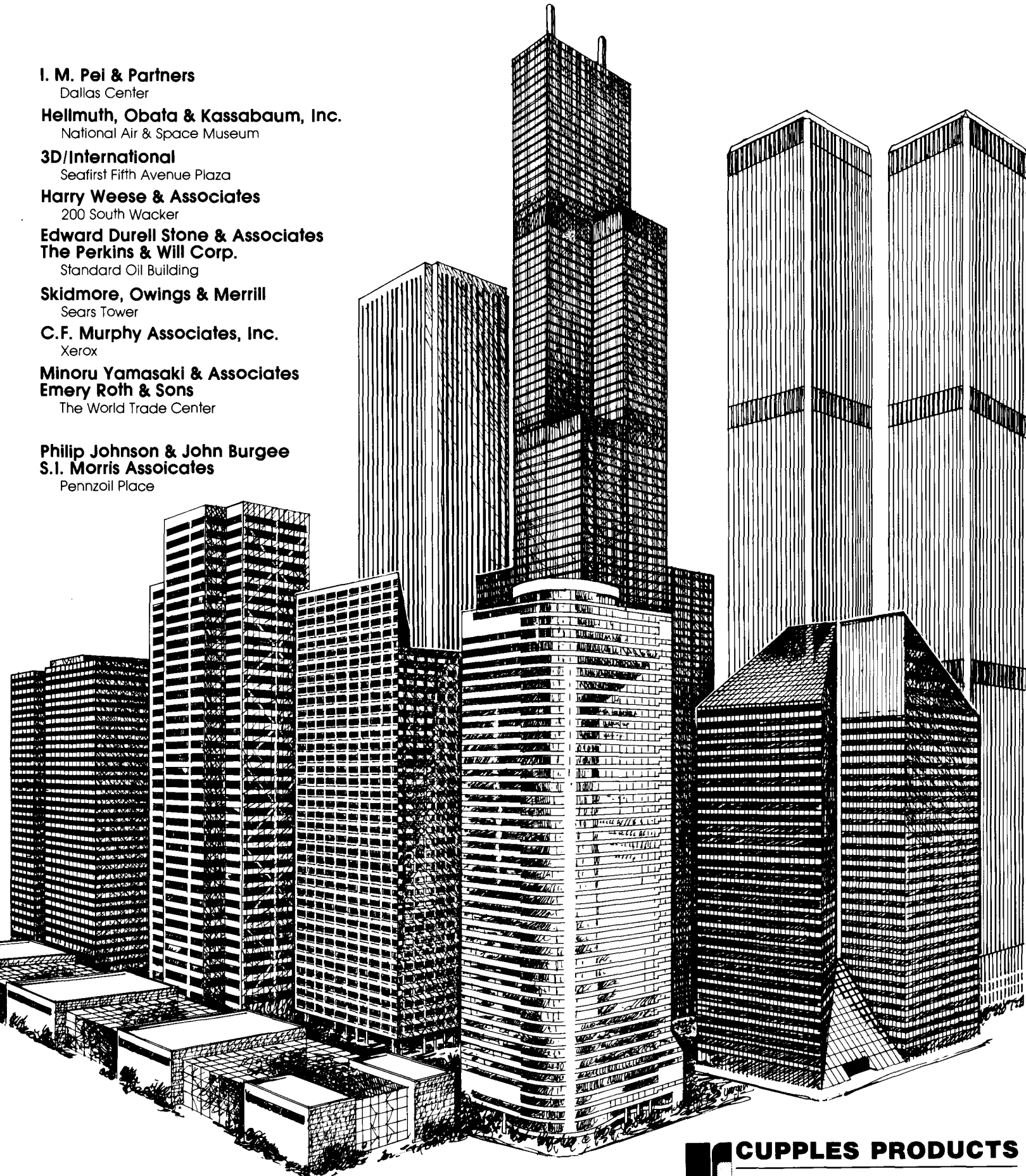

**CUPPLES PRODUCTS**  
DIVISION OF H. H. ROBERTSON COMPANY

2650 SOUTH HANLEY RD., ST. LOUIS, MISSOURI 63144  
(314) 781-6729, TWX # 1-910-761-1197 (CUPPLESPRC STL)

Circle 145 on information card

**Vecta Contract  
Ginkgo Biloba Tables.**  
Uniquely designed  
cast aluminum base,  
beautifully polished  
or coated in 16  
Thermoset colors,  
6 table-top shapes,  
37 standard sizes.  
Veneers and laminates.  
With solid wood, vinyl  
or self edge, 2" or 1 1/4"  
thick. Carefully scaled  
and designed by  
Gunter Eberle for  
today's architecture.



# Vecta Contract

SUBSIDIARY STEELCASE INC.

Call toll-free for literature:  
800-447-4700;  
in Illinois,  
800-322-4400.  
Vecta Contract, Inc.,  
740 W. Mockingbird Lane,  
Dallas, Texas 75247.  
Ginkgo and Ginkgo Biloba are  
trademarks of Vecta Contract®  
patents pending.

*Circle 146 on information card*

When Designing a New  
or Renovating an Old  
**SWIMMING POOL**

**SPECIFY  
PARAGON  
QUALITY  
EQUIPMENT**

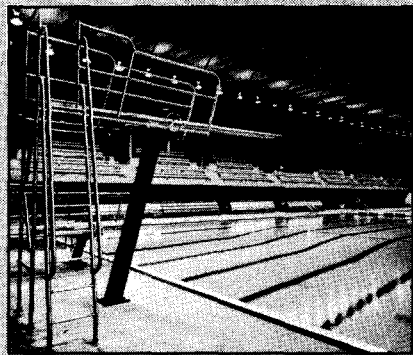
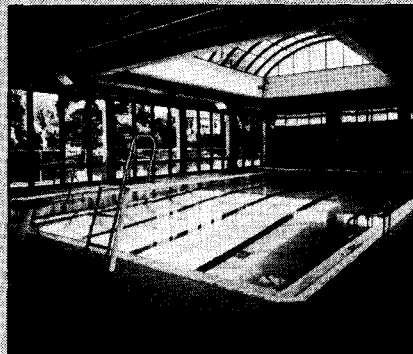

For Detailed Literature or  
Design Assistance Call:



**KDI Paragon**

12 Paulding St., Pleasantville, N.Y. 10570

914/769-6221

See Us in Sweets Under 13.4b/KD

Circle 147 on information card

**Products from page 342**

office furnishings. The color is an integral part of the vinyl film, rather than being painted on the tile. (Armstrong Cork Co., Lancaster, Pa. Circle 190 on information card.)

**Art Deco Reproductions.**

Starrgazers are fiberglass or reinforced plaster art deco and art moderne decorative furnishings reproductions. Twenty-one styles are available as statues, lamps, table pedestals, vases, wall reliefs and wall scones. (Steve Starr Studios, Chicago. Circle 189 on information card.)

**Joist Hanger.**

Type-24 U-Grips are designed to carry a load of 55 pounds per square foot for a span up to 10 feet, 11 inches. Made from 18 gauge zinc coated steel, they can be used for short-span roof and ceiling joists, space frames and in other applications. (TECO, Washington, D.C. Circle 179 on information card.)

**Roofing Shingles.**

Triple "A" shingles are metric-sized (336x1,000 millimeters). Weatherproofing asphalt covers a fiberglass mat and ceramic-coated granules are embedded in the asphalt. (Reynolds Aluminum Building Products Co., Stratford, Conn. Circle 183 on information card.)

**Solar Hot Water System.**

Sun-Pride features Sun-Aid solar collectors and Tube-In-Strip copper absorber plate. The liquid carrying tubes are an integral part of the copper sheet. Hot water tanks are available in four sizes from 66 to 120 gallons. (Revere Solar and Architectural Products, Inc., Rome, N.Y. Circle 171 on information card.)

**Line Drawing Electronic Typewriter.**

No Problem Line Drawing Smart Disc allows a typist to draw and edit lines on the No Problem electronic typewriter's TV-like screen. (Lanier Business Products, Inc., Atlanta. Circle 188 on information card.)

**Faucets.**

Deck mounted, single control mixing valves designed by Arne Jacobsen are available with double swivel or fixed spouts. Both are offered in 10 epoxy colors, polished chrome and brass. (Architectural Complements, Lincoln, Mass. Circle 191 on information card.)

**Hardwood Paneling.**

Solid hardwood paneling is available in four American hardwoods: oak, walnut and cherry (one-half-inch thick) and butternut (three-eighths-inch thick). V-grooves are created when the panels are butted together. Panels come in

**FROM THE  
AIA  
BOOKSHELF**

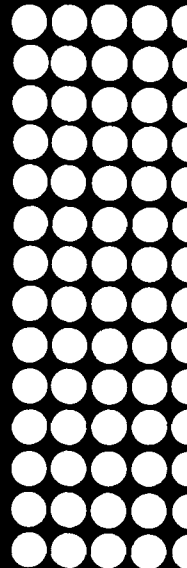
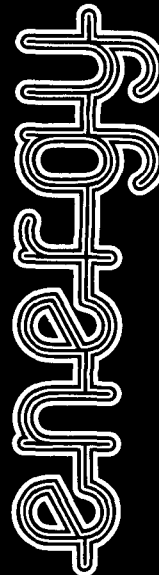
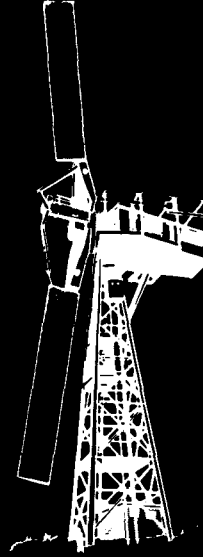

**\*Earth Sheltered Housing Design: Guidelines, Examples, and References (3M381)**

By The Underground Space Center, University of Minnesota. This manual is the first comprehensive work on underground housing design. The earth sheltered homes presented attractively insulated from wind and chill by the utilization of low cost natural resources and energy-saving systems such as layers of soil insulation and passive solar heat. It introduces the basic considerations of earth sheltered design and presents detailed layouts and photographs of existing houses, built in both warm and cold climates. Detailed appendices offer precise information on financing, building codes, product information and bibliography. Hardcover, pages, 300 illustrations (1978). \$17.95. Paperback edition (3M381P) \$9.95.

**\*Passive Solar Energy Book: Expanded Professional Edition (3M399)**

By Edward Mazria. Concentrating on single-family homes, this comprehensive book contains information that will be invaluable to the serious solar designer. Chapters include rules of thumb for choosing a solar system; 13 exclusive appendices containing a precise set of tools for predicting a building's performance; five transparent sun charts locate the sun's position at any time during any month, for most U.S. and Canadian locations; computerized analysis of solar heat specific gravity, and thermal conductivity of 160 solids, liquids. Heavily illustrated, including charts and diagrams. Hardcover, 548 pages (1979). \$24.95.

**TO ORDER** Order from Manager, AIA Publications Marketing, 1735 New York Avenue, N.W., Washington, D.C. 20006.

Make checks payable to The American Institute of Architects, District of Columbia residents add 5 percent sales tax.

For first class, air mail, special delivery, air express handling add 20 percent to total amount of order.

Foreign orders must include postage in the amount of 10 percent added to total amount of order. Check or money order must be payable in U.S. dollars.

widths of four, five and six feet and lengths up to eight feet. (Graser Lumber Co., Franklin Park, Ill. Circle 197 on information card.)

#### **Drawing Table.**

Bieffe BF-5 is tilted and raised with a one-level control. Made in Italy, the "high-tech" style table can be used at the minimum height of 30.5 inches or the maximum height of 41 inches. It accepts boards up to 38x48 inches. (Sam Flax, New York City. Circle 182 on information card.)

#### **Antistatic Floor Mats.**

Compu-Mat floor mats and runners are designed to provide localized protection of electronic systems and equipment from static electricity. The mats are made from nylon containing carbon-infused monofilament and are foam backed. (United Technical Products, Inc., Westwood, Mass. Circle 178 on information card.)

#### **Energy Meter.**

ThermoFlow Energy Meter is an infrared radiometer that measures heat loss in Btus. The meter can be hand-held and has a digital display indicating Btus. (Linear Corporation, Ingelwood, Calif. Circle 176 on information card.)

#### **Open Office System.**

Space Management I is designed to meet the office space needs of smaller companies. Components of the system include overhead storage compartments, shelves, file bins, tackboards, work surfaces, acoustical panels, free-standing desks and tables. (Trendway Corporation, Holland, Mich. Circle 198 on information card.)

#### **Rubber Roof System.**

The SMI Rubber Roof Energy System consists of a thick layer of waterproof EPDM sheet rubber that is bonded to a tapered insulation board. (SYenergy Methods, Inc., Cranston, R.I. Circle 167 on information card.)

#### **Fire Detector.**

DC-1, a photoelectric/ionization fire detector, has two chamber detection methods. Upon activation of either detection chamber, the alarm circuit is activated and locked in. (Pyrotronics, Cedar Knolls, N.J. Circle 177 on information card.)

#### **Wood Paneling.**

Middleton Place, a maple veneered plywood paneling, features a grooving pattern with a look of inlaid wood. The double grooves are spaced 16 inches

apart. It comes in 4x8-foot sheets, one-fourth-inch thick, in several warm wood tones. (Georgia-Pacific Corporation, Portland, Ore. Circle 181 on information card.)

#### **Roof, Wall System.**

Klip-Rib panels can be "clipped" together with no penetration of the panels or battens or sidelap crimping required. The panels have a Zinalume finish. (ASC Pacific, Inc., Tacoma, Wash. Circle 166 on information card.)

#### **Industrial Air Filter.**

Rustproof, corrosion-resistant aluminum air filter can handle velocities from 150 to 900 feet per minute. The passage of air through the filter is controlled by a scientifically staggered pattern of dust-trapping adhesive-coated baffles. (Research Products Corporation, Madison, Wis. Circle 174 on information card.)

#### **Coated Moldings.**

Sanbars are coated with an epoxy matrix and fine or regular aggregates. Standard panel sizes are 4 x 8, 4 x 10 and 4 x 12 feet and are available in 10 colors and several textures. (Sanspray Corporation, Santa Clara, Calif. Circle 173 on information card.) □

## **Fisher Skylights, Inc.**

IS PROUD TO BE A PART OF  
THE A.I.A. BUILDING OF  
THE YEAR. . . . .

THE ATHENEUM  
NEW HARMONY, INDIANA

**FISHER**  
SKYLIGHTS, INC.

50 SNAKE HILL ROAD  
WEST NYACK, NEW YORK 10994  
914-358-9000; N.Y.C. #212-295-2821  
SEE SWEETS FILE 7.8 Fi

specify **Rauland** with confidence

the name respected by the professionals in

## **Sound & Communications**



**advanced internal communications:** Systems designed for schools, nursing homes, dormitories, retirement homes, hospitals... telephone and intercom systems for any commercial or industrial application.

**professional sound reinforcement:** Systems with patented equalization for churches, auditoriums, stadiums; multi-mike systems with "Voice-Entree" for conference and court rooms; paging and sound systems for industry.



**ASK FOR DETAILS:** An Authorized Rauland Communications—Sound Specialist in your area is ready to provide complete technical data for your consideration and use. Write today or use the reader service card.

**RAULAND-BORG CORPORATION**

3535 W. Addison St., Dept. M., Chicago, Ill. 60618 • 312-267-1300

# ADVERTISERS

**Michael J. Hanley**

Publisher

**Michael M. Wood**

National Sales Director

**George L. Dant**

Manager, Production and Business

1735 New York Ave. N.W.

Washington, D.C. 20006

(202) 785-7300

**Lisa Hoke**

Director of Operations

**Suzanne Maggi**

Administrative Assistant

**ADVERTISING SALES OFFICE**

**Washington, D.C.** (202) 785-7271

Michael M. Wood

1735 New York Ave. N.W.

Washington, D.C. 20006

**New York** (201) 729-4937

Thomas R Crow

46 Main Street

Sparta, N.J. 07871

**New England/New York State**

(617) 632-8185

Robert L. Tagen

87 State Road West

Westminster, Massachusetts 01473

**Chicago** (312) 887-1171

Robert M. Brown

201 E. Ogden Avenue

Hinsdale, Illinois 60521

**St. Louis** (314) 569-3210

Richard D. Grater

1466 Summerhaven

St. Louis, Missouri 63141

**San Francisco** (415) 348-8222

Jules E. Thompson

1290 Howard Avenue #303

Burlingame, California 94010

Acme Brick Company .....	325	Chemfab/Birdair Structures Div. . .	114-115
<i>Phillip Poole Associates</i>		<i>Woodward, Askey, Eggers &amp; Schaffer</i>	
Alcoa .....	30	Cheney Flashing Co. ....	342
<i>Creamer, Inc.</i>		<i>MR Associates</i>	
Alcoa Building Products .....	87	Cohama Specifier .....	335
<i>Creamer, Inc.</i>		<i>Mel Richman, Inc.</i>	
Allegheny Ludlum/Chemetron .....	122	Columbia Lighting .....	73
<i>Marsteller, Inc.</i>		Concrete Reinforcing Steel Inst. . .	318-319
Allied Chemical .....	43	<i>Marsteller, Inc.</i>	
<i>Bryant Press, Inc.</i>		Congoleum Corp. ....	24
Alma Desk Co. ....	36	<i>Grey Advertising</i>	
<i>Long, Haymes &amp; Carr</i>		Consolidated Aluminum	
Amarlite .....	57	Corp. ....	108-109, 110
<i>Cargill, Wilson &amp; Acree</i>		<i>Weitzman &amp; Associates</i>	
American Air Filter .....	84	Cookson Company .....	256
<i>Doe-Anderson Adv. Agency</i>		<i>George E. Church Adv.</i>	
American Canvas Institute .....	320	Cupples .....	344
<i>W. N. Gates Co.</i>		<i>Holtgrewe Assoc.</i>	
American Gas Assoc. ....	282	Dover Corp. Elevator Div. ....	12
<i>J. Walter Thompson</i>		<i>Caldwell, Bartlett, Wood</i>	
American Iron & Steel Pipe		Dow Chemical .....	46-47
Committee .....	244-245	<i>Campbell-Mithun</i>	
<i>Hill and Knowlton</i>		Dryvit System, Inc. ....	258-259
American Olean Tile .....	9	<i>Fren/Hanaway</i>	
<i>Lewis &amp; Gilman</i>		Dual-Lite .....	94
American Standard .....	333	DuPont (Corian) .....	103
<i>Keller Crescent Co.</i>		<i>N. W. Ayer ABH Int'l.</i>	
Andersen Corp. ....	306-307	DuPont Teflon (Arch. Fabrics) ..	280-281
<i>Campbell-Mithun</i>		<i>N. W. Ayer ABH Int'l.</i>	
Armstrong Cork Company ..	Cov. 2 - Pg. 1	Edward Fields .....	332
<i>Marsteller, Inc.</i>		Epic Metals .....	54
Atlas Door Corp. ....	111	Faber Castell Corp. ....	273
<i>American Ad Group</i>		<i>Wills Grant Mkt. Communications</i>	
Better Built/Vernitron .....	266	Fisher Skylights .....	347
<i>Alden Advertising</i>		Follansbee Steel Corp. ....	257
Bilco Co. ....	334	<i>Group Marketing &amp; Communications</i>	
<i>McLaughlin, Delvecchio &amp; Casey</i>		Ford Glass Div. ....	21
Bobrick Washroom Equipment .....	90	<i>Wells, Rich, Greene</i>	
<i>Forrester, Wilcox &amp; Assoc.</i>		Formica .....	18
Brick Institute of America .....	93, 95, 97	<i>Fahgren &amp; Ferriss</i>	
<i>Henry J. Kaufman &amp; Assoc.</i>		Forms & Surfaces .....	14
Buckingham Virginia Slate .....	119	<i>Sherrill Broudy Assoc.</i>	
<i>Riddick Advertising</i>		GAF Corporation .....	302-303
Cabot, Samuel, Inc. ....	37	<i>Scali, McCabe, Sloves</i>	
<i>Donald W. Gardner Adv.</i>		Geberit Mfg. Inc. ....	323
California Redwood Assoc. ....	277	<i>Michaeljay Communications</i>	
<i>Foote, Cone &amp; Belding/Honig</i>		General Electric (Lexan) .....	2
Carpenter, L. E. Co. ....	317	<i>Quinn &amp; Johnson, Inc.</i>	
<i>The Siesel Co.</i>		General Electric (Silicone) .....	40-41
Castelli Furniture .....	91	<i>Ross Roy N.Y./Compton, Inc.</i>	
<i>C. A. Advertising</i>		General Tire & Chemical Co. ....	296-297
Ceco Corporation .....	49	<i>D'Arcy-MacManus &amp; Masius</i>	
<i>Fensholt, Inc.</i>		Georgia Marble Company .....	96
Celotex		<i>Corporate Communications &amp; Marketing</i>	
Corporation .....	16-17, 100-101, 250-251	Georgia-Pacific Corp. ....	264-265
<i>Mike Sloan Advertising</i>		<i>McCann-Erickson</i>	
		G. F. Business Equipment .....	25
		Grefco (Permalite) .....	116
		<i>Boylhart, Lovett &amp; Dean</i>	



Grinnell Sprinkler Systems . . . . .	92	Libbey-Owens-Ford (LOF) . . . . .	50	Schreiber, H. Company . . . . .	97
<i>Hutchins/ Y &amp; R</i>		<i>Campbell-Ewald Co.</i>		Sedgewick . . . . .	338
Guardian Glass . . . . .	270-271	Marathon (Bali) . . . . .	63	Shakertown Siding . . . . .	102
<i>Baker, Abbs &amp; Klepinger</i>		<i>Glenn, Bozell &amp; Jacobs</i>		<i>Gerber, Meyers, Wolf &amp; Kilgore</i>	
Haws Drinking Faucet Co. . . . .	305	McGuire Co. . . . .	86	Shand, Morahan Company . . . . .	6
<i>Mandabach &amp; Simms/ Pacific</i>		<i>R. T. Blass, Inc.</i>		<i>Hakanson &amp; Associates</i>	
Helios Tension Products . . . . .	252-253	Mecanoids, Inc. . . . .	95	Shaw-Walker . . . . .	26
<i>Hisata Design Assoc.</i>		Meisel Photochrome Corp. . . . .	330-331	<i>Williams Marketing Service</i>	
Homasote Company . . . . .	299	<i>Hoffman Advertising</i>		Simplex Time Recorder . . . . .	308
<i>Gillespie</i>		Nichols Homeshield . . . . .	341	<i>McKinney/ New England</i>	
Hopes Windows . . . . .	321	<i>Ken MacCowan</i>		Simpson Timber Co. . . . .	275
<i>Moog Advertising</i>		Nucor (Vulcraft) . . . . .	74-75	<i>Kraft Smith</i>	
Howmet Aluminum Corp. . . . .	4-5	<i>Faller, Klenk &amp; Quinlan</i>		Sloan Valve Co. . . . .	327
<i>Crume &amp; Associates</i>		Olympic Stain . . . . .	Cov. 4	<i>Young &amp; Rubican</i>	
Inryco, Inc. . . . .	289	<i>Kraft Smith</i>		Stark Ceramics . . . . .	301
<i>Melrose Advertising</i>		Otis Elevator Co. . . . .	286-287	<i>Ira Thomas Assoc.</i>	
Integrated Ceilings . . . . .	19	<i>Poppe Tyson</i>		Steelcraft . . . . .	269
International Masonry Inst. . . . .	267	Owens-Corning (Energy Awards) . .	10-11	<i>Fahlgren &amp; Ferriss</i>	
<i>Henry J. Kaufman &amp; Assoc.</i>		<i>Oglivy &amp; Mather</i>		Stendig International . . . . .	33
ITT Outdoor Lighting . . . . .	248-249	Owens-Corning (Ceiling Systems) . .	22-23	<i>Allisam Productions</i>	
<i>John Malmo Advertising</i>		<i>Oglivy &amp; Mather</i>		Stern-Williams . . . . .	93
Jewett Refrigerator Co. . . . .	342	Owens-Corning (Fabric Structures) . .	52-53	<i>Ad Mar Co.</i>	
<i>Bowman, Block, Fatin &amp; Cook</i>		<i>Oglivy &amp; Mather</i>		Stow-Davis . . . . .	290
Johns-Manville . . . . .		Owens-Corning (Sound Dividers) . . .	45	<i>Norman, Navan, Moore &amp; Baird</i>	
(Building Systems Div.) . . . . .	246-247	<i>Oglivy &amp; Mather</i>		Tate Architectural Co. . . . .	117
<i>Broyles, Allebaugh &amp; Davis</i>		Owens-Illinois (Sunpak) . . . . .	292-293	<i>Adler-Schwartz Graphics</i>	
Johns-Manville (Holophane Div.) . . .	99	<i>Howard Swink Advertising</i>		TrusJoist Corp. . . . .	336
<i>Broyles, Allebaugh &amp; Davis</i>		Peerless Electric Co. . . . .	261	<i>David W. Evans, Inc.</i>	
Joy Manufacturing . . . . .	283	<i>Hayes, Davidson, Inc.</i>		Unistrut/GTE-Sylvania (Mero Systems) .	83
<i>Covey &amp; Koons</i>		Pen Ply . . . . .	278	<i>Doyle, Dane, Bernbach</i>	
Kalwall Corporation . . . . .	98	<i>Soderberg, Thompson, MacEwan</i>		Unistrut/GTE-Sylvania (Meroform) . .	85
<i>Synerjenn Advertising</i>		Permagrain Products . . . . .	285	<i>Doyle, Dane, Bernbach</i>	
Kawneer Architectural Products . . .	112-113	<i>Aitkin-Kynett</i>		Unistrut/GTE-Sylvania (Moduspan) . .	81
<i>Garrison, Jasper, Rose &amp; Co.</i>		PPG Industries (Glass) . . . . .	76-77	<i>Doyle, Dane, Bernbach</i>	
KDI Paragon . . . . .	346	<i>Ketchum, MacLeod &amp; Grove</i>		United Sheet Metal . . . . .	13
<i>Lloyd S. Howard Assoc.</i>		Proudfoot Company . . . . .	340	<i>Bannerman Industrial Advertisers</i>	
Kim Lighting . . . . .	61	<i>Harrison House</i>		United States Gypsum . . 7, 38, 79, 104-105	
<i>Kim Advertising</i>		PSAE (Masterspec) . . . . .	120-121	<i>Marstrat, Inc.</i>	
Knoll International . . . . .	254-255	<i>Clarkson Associates</i>		United States Steel Corp. . . . .	34-35
<i>Abramson/ Himelfarb</i>		Pyrotronics . . . . .	343	<i>Compton Advertising</i>	
KOH-I-NOOR Rapidgraph . . . . .	314-315	<i>Keyes, Martin &amp; Co.</i>		U.S. Ceramic Tile . . . . .	31
<i>KR Advertising</i>		Rambusch . . . . .	338	<i>Covey &amp; Koons</i>	
Kohler Company . . . . .	42	<i>Johns/ Presser Corp.</i>		Vecta Contract . . . . .	345
<i>Campbell-Mithun</i>		Rauland-Borg Corp. . . . .	347	Vernitron/Better Built . . . . .	266
Koppers Company . . . . .	65-70	<i>George Brodsky Advertising</i>		<i>Alden Advertising</i>	
<i>The Advertising Center</i>		Republic Steel Corp. . . . .	48	Vincent Brass & Aluminum . . . . .	339
Kroin . . . . .	329	<i>Meldrum and Fewsmith</i>		<i>Coulter &amp; Associates</i>	
<i>Architectural Complements</i>		Revere Copper and Brass Inc. . . . .	313	Welsbach Lighting . . . . .	322
Kroy Industries . . . . .	123	<i>Kornhauser &amp; Celene</i>		<i>Langler: Mason</i>	
<i>Grey Advertising</i>		Rixson-Firemark . . . . .	118	Western Electric Co. . . . .	310-311
Laminators Safety Glass Assoc. . . . .	295	<i>Motivation Dynamics</i>		<i>Foote, Cone &amp; Belding</i>	
<i>Clif Furgurson Adv.</i>		Robertson, H. H. . . . .	28-29	Westinghouse/ Arch'l Systems Div. . .	58-59
LCN Closers . . . . .	60	<i>Creamer, Inc.</i>		<i>Marsteller</i>	
<i>Alex T. Franz</i>		R-Way Furniture Co. . . . .	350	Weyerhaeuser Company . . . . .	88-89
Levolor Lorentzen . . . . .	Cov. 3	<i>R-Way Advertising</i>		<i>Cole &amp; Weber</i>	
<i>Muller, Jordan, Weiss</i>		Sandell Mfg. Co. . . . .	337		
		<i>Tower Advertising</i>			
		Schinnerer, Victor O. & Co. . . . .	124		
		<i>Govatos/ Dunn</i>			

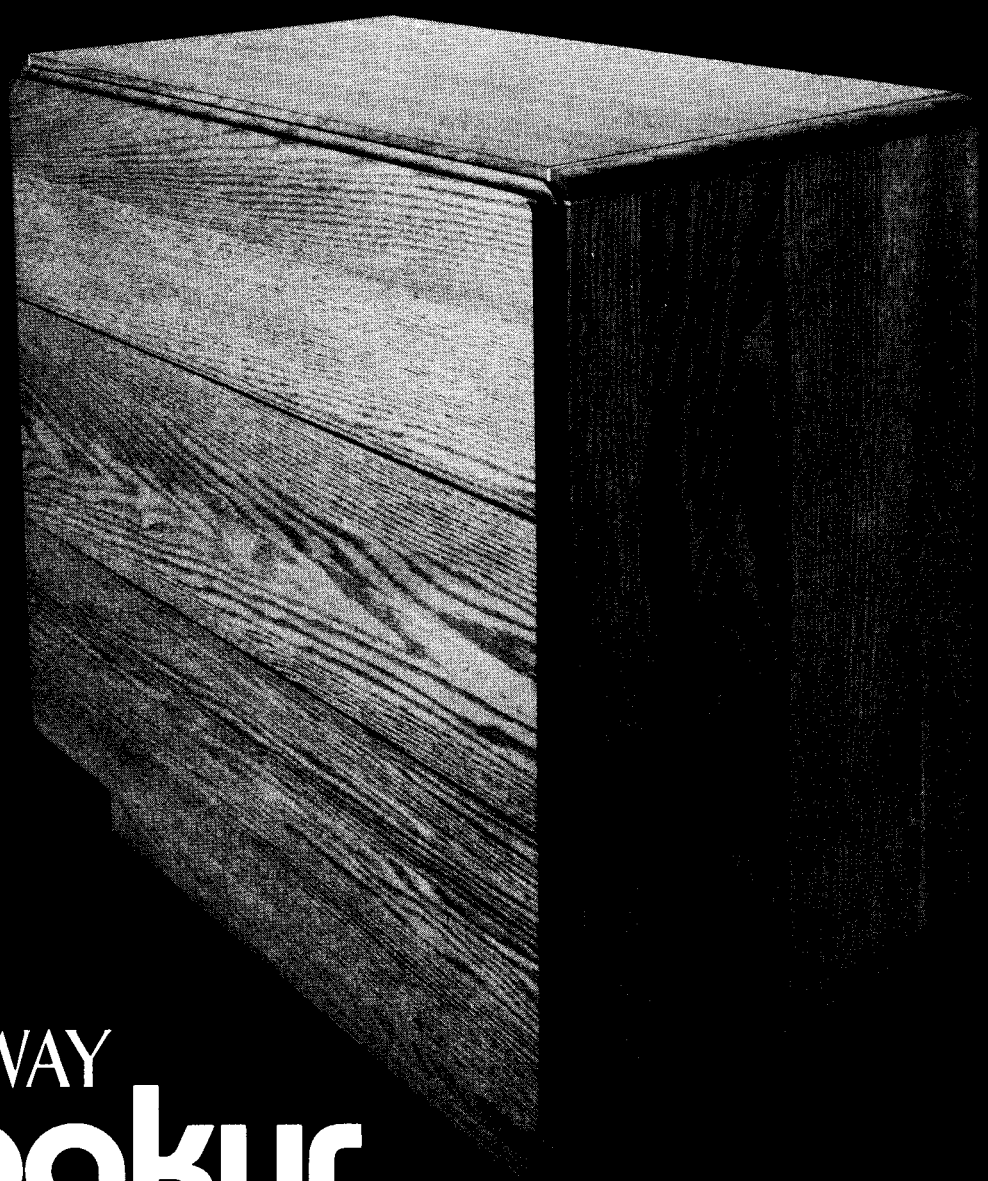

# R-WAY oakur collection

The Oakur Collection, a contemporary grouping of solid red oak, features a durable conversion finish and high pressure plastic laminated tops. Other features are rounded corners, extruded aluminum trim, and plastic surfaced drawer bottoms. The Oakur Collection offers a complete line of beds, desks, dressers, and chests for contract use.

For more information, write R-Way or visit one of our showrooms in New York, Chicago, Atlanta, Dallas and Minneapolis.

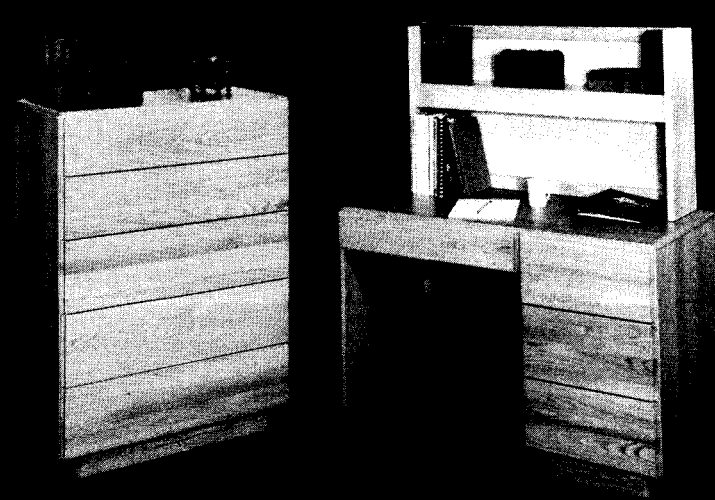

R-Way Furniture Co. Sheboygan, Wisconsin 53081 phone (414) 457-4833

*Circle 150 on information card*

Galaxy Sun Controllers

Riviera Blinds



## We challenge you to find a sun control system this beautiful.

Levolor has come up with a glare-and-temperature control system for large expanses of glass that dramatizes your original design instead of detracting from it. Overhead, Levolor Galaxy™ Sun Controller blinds redirect the sun's rays, for minimum glare, maximum summer cooling, maximum winter warmth. Used with Riviera™ blinds by Levolor at the window, as shown here, you have a total sun control system that

is a visual plus, easy to install and engineered with Levolor technological standards—the highest. A system that can be operated automatically or manually. The beautiful answer to odd-shaped, hard-to-reach special glazing situations. Our Levolor architectural consultant can answer your specific questions. Write for information: Levolor Lorentzen, Inc.,

720 Monroe Street,  
Hoboken, N.J. 07030.

**LEVOLOR®**

Sun Controller Systems.  
A product of Levolor Lorentzen, Inc.

Circle 185 on information card



# Beauty that's more than skin deep.



Architect: Wendell Lovett, FAIA, Seattle, Washington

Enhance and protect the natural beauty of wood with Olympic Oil Stain. Olympic *penetrates* wood to protect from within. Rich linseed oil and micro-milled pigments soak down into the fibers, giving wood a deep, uniform finish that stays beautiful no matter how wet or how dry the weather gets.

For additional information, consult your 1979 Sweet's Catalog. Or write Olympic: Dept. P, P.O. Box 1497, Bellevue, WA 98009.

**Penetrates to  
protect wood  
beautifully.**



Circle 186 on information card