

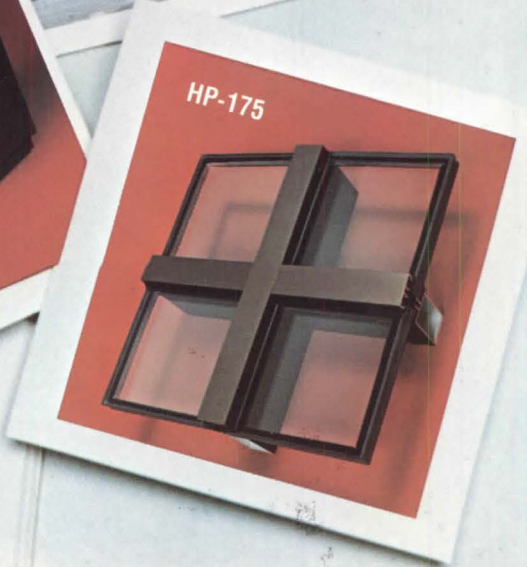

Howmet's ideas and imagination



Specifications

PART II — PRODUCTS

- 2.1 CURTAINWALL: HP-175 Series as manufactured by Howmet Aluminum Corp.,
- 2.2 VENTILATORS: Revolv-O-Vent as manufactured by Howmet Aluminum Corp.,

made saving energy beautiful.

Remodeling the First Alabama Bank in Montgomery presented several challenges. Not only did it need an easily installed, modern exterior, but increased energy efficiency for the 70 year old structure was also a major goal.

That's why Howmet's Architectural Products Division was called in early.

Their answer was Howmet's HP-175 Aluminum Thermal Wall System. HP-175 is the only system combining two important design features. First, it is completely thermally isolated since interior components are protected from heat and cold transfer by non-reversible, non-conductive injection molded clips. Additionally, HP-175 has a continuous, patented P.V.C. water diverter in horizontals to prevent water infiltration.

Howmet also brought a breath of fresh air to the project with Revolv-o-vent. Designed to glaze in like glass, this unique aluminum ventilator system lets employees totally control the amount of fresh air flow. The vent stays open at any position without latches or fasteners. When closed, Revolv-o-vent's fin-seal weathering material assures a tight, thermally efficient seal.

Both Howmet products were installed with virtually no interruption to the bank's normal routine.

In remodeling or new construction, Howmet meets customers' unique needs with custom-tailored solutions. Call us at (214-563-2624) and see.

HOWMET ALUMINUM CORPORATION

 A Member of the Pechiney Ugine Kuhlmann Group
ARCHITECTURAL PRODUCTS DIVISION
P. O. Box 629 • Terrell, TX 75160 • (214) 563-2624

Where Ideas and Imagination Are Only The Beginning

Circle 1 on information card

Columbia **supertube**!

Fluorescent lighting that goes up,...
over... down... or around corners...
wherever you want it!



Columbia Operation
GTE Products Corporation
T.A. Box 2787
Spokane, WA 99220

GTE

**Specification
Lighting**

2 AIA JOURNAL/JUNE 1980

Columbia Lighting's versatile aluminum **supertube** brings flexibility and sparkling colors to architectural lighting. They may be suspended from ceilings or bracket mounted on walls in standard or custom sizes to fit your job. Lamp openings are symmetrically centered and each fixture retains its own "turnability" . . . you can aim it. For more information contact your Columbia agent or write us; we have answers to lighting questions you've yet to ask.

Circle 2 on information card

CONTENTS

The American Institute of Architects

Officers

Charles E. Schwing, FAIA, *President*
R. Randall Vosbeck, FAIA, *First Vice President*
Gerald L. Clark, FAIA, *Vice President*
Anna M. Halpin, FAIA, *Vice President*
Thomas H. Teasdale, FAIA, *Vice President*
Robert M. Lawrence, FAIA, *Secretary*
J. W. Barnes, FAIA, *Treasurer*
David Olan Meeker Jr., FAIA, *Executive Vice President*

Directors (Year indicates expiration of term)

William Blurock, FAIA ('82), *California*
James C. Dodd, AIA ('81), *California*
Donald L. Hardison, FAIA ('80), *California*
Harry W. Harmon, FAIA ('80), *California*
R. Bruce Patty, FAIA ('82), *Central States*
Henry W. Schirmer, AIA ('81), *Central States*
P. Whitney Webb, AIA ('82), *East Central States*
Ellis W. Bullock Jr., AIA ('81), *Florida/Caribbean*
E. H. McDowell, FAIA ('81), *Florida/Caribbean*
Gaines B. Hall, AIA ('81), *Gulf States*
Ray K. Parker, AIA ('80), *Gulf States*
Raymond C. Ovresat, FAIA ('81), *Illinois*
Paul D. Bowers Jr., AIA ('80), *Michigan*
David A. Holtz, AIA ('80), *Middle Atlantic*
James R. Nelson, AIA ('81), *Middle Atlantic*
John Avery Carter, AIA ('82), *New England*
George M. Notter Jr., FAIA ('80), *New England*
Harold D. Glucksman, AIA ('80), *New Jersey*
Joseph Monticciolo, AIA ('82), *New York*
William A. Rose Jr., AIA ('81), *New York*
Leroy Bean, AIA ('82), *North Central States*
Edwin B. Crittenden, FAIA ('81), *Northwest*
William H. Trogdon, FAIA ('80), *Northwest*
Robert Gramann, AIA ('82), *Ohio*
Derek Martin, AIA ('81), *Pennsylvania*
John A. Busby Jr., FAIA ('82), *South Atlantic*
Michael D. Newman, AIA ('80), *South Atlantic*
William Caudill, FAIA ('82), *Texas*
Theodore S. Maffitt Jr., FAIA ('81), *Texas*
Pat Y. Spillman, FAIA ('81), *Texas*
Thomas B. Muths, AIA ('82), *Western Mountain*
John B. Rogers, FAIA ('81), *Western Mountain*
Robert B. Pease, Hon. AIA, *ex officio, Public Director*
Richard Martini, *ex officio, President, ASC/AIA*
Ann Stacy, Hon. AIA, *ex officio, Chairwoman, Council of Architectural Component Executives*

Headquarters

David Olan Meeker Jr., FAIA, *Executive Vice President*
James A. Scheeler, FAIA, *Group Executive, Program and Services Management*
Alan B. Stover, AIA *Acting General Counsel*
James A. Schuping, *Assistant Secretary*
William G. Wolverton, Hon. AIA, *Assistant Treasurer/Controller*
Michael B. Barker, AICP, *Administrator, Practice and Design*
Francis X. Brown, *Administrator, Conventions*
Muriel Campaglia, *Administrator, Public Relations*
James E. Ellison, AIA, *Administrator, Education and Professional Development*
David S. Godfrey, *Administrator, Publications*
Arnold J. Prima Jr., AIA, *Administrator, Government Affairs*
David Olan Meeker Jr., FAIA, *President, AIA Corporation*
Jeanne Butler Hodges, *President, AIA Foundation*
Charles R. Ince Jr., *President, AIA Research Corporation*
John H. Schruben, FAIA, *President, Production Systems for Architects and Engineers, Inc.*

- 30 **The Haunting Art of Luis Barragán**
He is winner of the 1980 Pritzker Prize, richest in architecture. By Nora Richter
- 33 **In Earthquakes, Failure Can Follow Form**
Exploring the relationship between building configuration and seismic behavior. By Christopher Arnold
- 42 **The Seismic Legend of the Imperial Hotel**
How did it really fare in the Tokyo earthquake of 1923, and why? By Robert King Reitherman
- 48 **The Turning Point in Mr. Wright's Career**
A case that it was his Princeton lectures of exactly a half-century ago. By Frederick Gutheim, Hon. AIA
- 50 **Cooper-Hewitt's 'Spectacular Spaces'**
Drawings, from the 16th century to today, at the Smithsonian's national museum of design. By Stanley Abercrombie, AIA
- 56 **MOMA's Architectural Mystery Tour**
The catalog to 'Transformations' helps reveal its intentions, but only a bit. By Reyner Banham
- 58 **Energy Conservation Capital of the Nation**
A remarkable series of planning laws gives Davis, Calif., a claim to the title. By Sally B. Woodbridge

6	Events and Letters	62	Books
11	News	80	Advertisers

Cover: Photograph by Armando Salas Portugal of Luis Barragán's own house, Tacubaya, Mexico.

The AIA JOURNAL, publication number: ISSN0001-1471, official magazine of The American Institute of Architects, is published 14 times yearly at 1735 New York Ave. N.W., Washington, D.C. 20006. **Subscriptions:** for those who are, by title, architects, architectural employees and to those in architectural education (faculty, schools and students), and to libraries, building construction trade associations and building products manufacturers: base rate \$12 a year in the U.S., its possessions and Canada. For all others: \$18 a year in the U.S., its possessions and Canada; other countries to those who are by title, architects: \$18 a year. All others outside the U.S., its possessions and Canada: \$30 a year. Single copies, \$2.50 each. Publisher reserves the right to refuse unqualified subscriptions. For subscriptions: write Circulation Department; for change of address: send Circulation Department both old and new addresses; allow six weeks. Quotations on reprints of articles available. Microfilm copies available from University Microfilm, 300 N. Zeeb Road, Ann Arbor, Mich. 48106. Referenced in *The Architectural Index, Architectural Periodicals Index, Art Index, Avery Index to Architectural Periodicals*. Second class postage paid at Washington, D.C., and additional mailing offices. © 1980 by The American Institute of Architects. Opinions expressed by the editors and contributors are not necessarily those of AIA. VOL. 69, NO. 7.

When Hewlett-Packard selects you to supply building systems

It started with a building in Cupertino, California. Hewlett-Packard combined Vulcraft's computer designed steel joists and joist girders with a fast-track construction schedule, and helped shave two months off the construction time of the building.

This shaved the costs. Not just because the lightweight nature of steel joists and joist girders makes them easier and faster to erect than other, heavier systems. But also because supporting columns can be placed further apart. And foundation size can be decreased.

All of which makes the Vulcraft system more economical than a traditionally fabricated structural steel system. Simply because it's lighter. And faster.

So much faster, that buildings like those constructed for Hewlett-Packard can be delivered to the

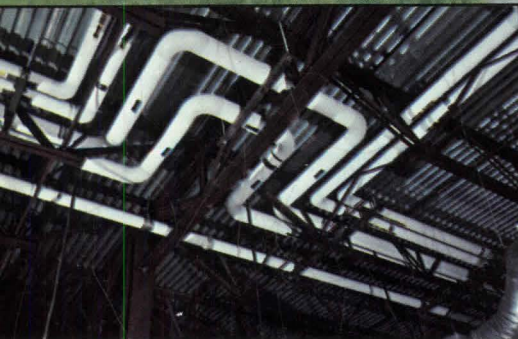

Because electrical and mechanical systems can pass through the open web of the joists and joist girders, installation goes quicker. And changes can be made more easily when needed.



The high strength to weight of steel joists and joist girders can provide increased clear span areas, because supporting columns can be spaced further apart.



Although the Hewlett-Packard buildings using the Vulcraft system have basically the same structural design, the exterior features vary.

They expect results. They got them from Vulcraft, all six times.

...ner as much as two months ear-
...r than if a traditional structural
...stem were used. And the Vulcraft
...stem has since been used in five
...ore Hewlett-Packard buildings: a
...cond in Cupertino; two in Corval-
...Oregon; one in Boise; and one in
...n Diego.

The Vulcraft system can work
just as well for you. To learn how,
contact your local Vulcraft represen-
tative for your Joist and Joist Girder
Specification Guide. Or write
Vulcraft, P.O. Box 17656, Charlotte,
North Carolina 28211. (See Sweet's
5.2/Vu.) Or call 704/366-7000.

We have the know-how. And we
have five plants located around the
country to make sure your deliveries
are on time. So your building can be
ahead of its time.

VULCRAFT

A Division of Nucor Corporation



The Hewlett-Packard facility in Cupertino, California, the first of six to use the Vulcraft system.



The efficiency of Vulcraft's standardized column
connections speeds up steel erections and saves costs.

The versatility of designing with Vulcraft steel
joists and joist girders helps meet complex design
requirements like this unusual eight foot
interstitial floor space.

Vulcraft joists and joist girders can be designed
to easily accommodate all lighting, heating, air
conditioning, wiring, duct and pipe requirements.

Circle 3 on information card

EVENTS

June 29-July 1: Joint Development Marketplace, Capital Hilton Hotel, Washington, D.C. Contact: Urban Land Institute, 1200 18th St. N.W., Washington, D.C. 20036.

July 1: Call for papers, abstract deadline, for presentation at the International Energy Management & Facilities Improvement Show, to be held Nov. 18-22 in Chicago. Contact: Program Director, Expo Management, Apparel Center, Suite 1048, Chicago, Ill. 60654, (312) 329-1284.

July 6-11: Lighting for Interior Designers and Architects Seminar, University of Colorado at Boulder.

July 14-18: Solar Design Short Course, Oakland, Calif. (Repeat courses: Aug. 11-15, Washington, D.C.; Sept. 22-26, Santa Fe, N.M.) Contact: Conferences Group, Solar Energy Research Institute, 1617 Cole Boulevard, Golden, Colo. 80401.

July 17-20: North Carolina Chapter/AIA summer meeting, Wrightsville, N.C.

July 19: Expo '80: Solar and Wind, Jordan College, Cedar Springs, Mich.

July 19-25: Management of Design and Planning Firms Seminar, Harvard University, Cambridge, Mass. (3.0 CEUs approved by AIA.)

July 23-30: Women's School of Planning and Architecture, Hood College, Frederick, Md. Contact: WSPA, 2015 Erdman Ave., Baltimore, Md. 21218.

July 24-26: Stanford Conference on Design, Stanford University.

July 26-31: Energy + Design Summer Institute, Massachusetts Institute of Technology, Cambridge, Mass., sponsored by the Association of Collegiate Schools of Architecture and the Energy Department. Contact: ACSA, 1735 New York Ave. N.W., Washington, D.C. 20006.

July 28-Aug. 1: Principles of Construction Specifications Writing Course, University of Wisconsin, Madison.

July 31-Aug. 1: Construction Cost Estimating and Bidding Seminar, University of Maryland, College Park.

Aug. 1: Deadline for entries, 1980 Prestressed Concrete Institute awards program. Contact: PCI, 20 N. Wacker Drive, Chicago, Ill. 60606.

Aug. 10-15: Building Economics Conference, New England College, Henniker, N.H., sponsored by the Engineering Foundation. Contact: EF, 345 E. 47th St., New York, N.Y. 10017.

Aug. 19-21: Codes and Standards Conference, San Francisco. Contact: American Society of Mechanical Engineers, 345 E. 47th St., New York, N.Y. 10017.

Aug. 19-21: Solar Energy Conference, San Francisco. Contact: American Society of Mechanical Engineers, 345 E. 47th St., New York, N.Y. 10017.

Aug. 20-24: American Society of Inter-

rior Designers annual conference, New York Hilton Hotel, New York City. Contact: ASID, 730 Fifth Ave., New York, N.Y. 10019.

LETTERS

Where Are the Geniuses?: It is a telling commentary on our current architectural times when Guild House in Philadelphia (Feb., p. 38) and other comparable "postmodern" structures are rocketed into the stratosphere, become Meccas for students and even quasi-seriously are compared with favor to masterpieces of former eras.

Are Messrs. Miller, Scully, et al., really to be believed? Where is there to be found, in these waning years of the millennium, architects who have the depth, the genius and sweep of a Frank Lloyd Wright or a Corbu, who can help define the multiple necessities and demands of the 2000s?

*George Conklin, AIA
New Haven, Conn.*

Information Requested: I am writing a book to be entitled *Great New England Churches*, to be published in the fall. It will include contemporary as well as historic churches. Would any reader with examples of interesting churches in Maine and New Hampshire please let me know?

*Robert H. Mutrux, AIA
386 Ridgefield Road
Wilton, Conn. 06897*

Going to 'Lengths' Against Metrics: "I shall not change my measures for all the metrics in China," my wife of 50 years said when I mentioned that AIA was forming a metric board to prepare us for metric acceptance in five years (MEMO, no. 582).

A member of our church is a mechanical engineer who wears a button with "Metrics Now" on it. He is president of such a society in our silicon Santa Clara Valley. His company wants to sell, or is selling, metric-made parts to metric nations. There is, of course, no law against this, but I believe it is unconstitutional to restrict me—us—the building industry—to metric measurements. I am against "Metrics Now" because it will slow us down and raise the prices of all our products. Added inflation!

I've asked around for a consensus, and I have discovered that our greengrocer will not change his pound scales. And an Air Force colonel told me to ask, "Why should our planes be designed in metrics?" (So they'll be easier for the enemy to copy?)

My proposal is simple: that we quietly set up anti-Metrics Now committees in all AIA chapters and simply call them metric committees. When our building friends ask about them, we explain frankly that they are really anti, and we are looking

for the Metric Now nuts.

When I was at Nela Park designing and inventing for the General Electric lamp department, I was asked how long we should make fluorescent lamps. My answer was easy: "Fit them to our building module of four feet." They did, and we have them as they are today. I doubt very much that GE will change over to metric lengths without a fight. GE would have to make both lengths for years in order to furnish both the old buildings and the new metric ones.

My wife wants to know why I can get so serious about something that I know is wacky for the building industry, which never will become 100 percent metric.

*Charles T. Masterson, AIA
Sunnyvale, Calif.*

A Challenge to AIA Components: Last fall, the JOURNAL published a letter I wrote in which I suggested that AIA's chapters help restore Frank Lloyd Wright's Unity Temple in Oak Park, Ill., by donating \$225 per chapter. My thoughts were inspired by an article in the June 1979 issue (p. 32) on restoration efforts.

It is with great pride that I report that the little "desert" chapter of Las Vegas/AIA has sent Unity Temple's Restoration Foundation a check in the amount of \$225.

I would like to reiterate our challenge to other AIA chapters. Send your contributions to Unity Temple, Restoration Foundation, P.O. Box 785, Oak Park, Ill. 60303. *Harry E. Campbell, AIA
Las Vegas*

Corrections: The Mid-Atlantic Center, Hot Springs, Ark., which was honored in the American Institute of Steel Construction awards program, was a joint venture by Stuck Frier Lane Scott Beisner Inc., Little Rock, Ark., and E. Verner Johnson & Associates, Inc., Boston (see April, p. 30).

The Fine Arts Building at the University of Hawaii at Manoa was miscredited in the May issue (p. 62). The architects were Group 70, design consultants, and Group Architects Collaborative, Inc.

It should have been noted in the May issue that the article "Architecture and Consumerism" by Harold C. Fleming, Hon. AIA, was originally commissioned by the Texas Society of Architects as part of its "Texas Tomorrow" program.

Clarification: The client for Monsanto's Environmental Health Laboratory, which won a 1980 AIA honor award (see Mid-May, p. 231), was incorrectly noted on the awards submission form as Monsanto Environmental Systems, Inc. Although the laboratory is operated under the sponsorship of Monsanto's department of medicine and environmental health, the owner is the Monsanto Co.



Owens-Corning sound dividers. Designed so your design gets noticed. Not ours.

We don't expect people at work to appreciate the classic lines of our sound divider system.

They may not notice the handsome fabric covering. Or how beautifully the dividers fit together.

They may never see the electrical raceway hidden in the base or the shelf-hanging capability.

And they can't possibly know that their privacy comes from our special sound-absorbent Fiberglas* core inside each panel.

What they will notice is what really matters: the total landscape you've created.

For a free sound divider catalog, color selector, and booklet, "Speech Privacy in the Open Office," write A.J.S. Meeks, Owens-Corning Fiberglas Corporation, Fiberglas Tower, Toledo, Ohio 43659.

*T.M. Reg. O.-C.F. © O.-C.F. Corp. 1978

OWENS/CORNING
FIBERGLAS
TRADEMARK



Double dribble.

Keeping the water off the roof. And off the floor.

That's the name of the game.

And the reason why it pays to specify Johns-Manville—the first name in lasting built-up roof protection.

With J-M, you get expertise based on over 120 years of solving roofing problems. You get quality that's consistently tops throughout a complete

line of roofing products, components and systems. Plus technical assistance from America's most experienced team of roofing specialists. And a degree of roof guarantee coverage that tops any in the industry.

Score with the built-up roof that offers real protection. For details, consult Sweet's. Or contact George Constantin, Johns-Manville, Ken-Caryl Ranch, Denver, Colorado 80217, 303/979-1000.

**Keeping the water out.
That's what this business is all about.**



Johns-Manville

Circle 5 on information card

DOVER ELEVATORS

serve two triangles on a square in Nashville.

A broad pedestrian walkway slices diagonally through a square in downtown Nashville, leaving space for a pair of distinctive triangular-shaped buildings. One building is the 20-story corporate headquarters for Commerce Union Bank—Tennessee Valley Bancorp; the other, the 12-story, 350-room Radisson Plaza Hotel. The complex is well served by a total of 18 Dover Traction and Oilraulic® Elevators: 11 in the bank building, 7 in the hotel. For more information on Dover Elevators, write Dover Corporation, Elevator Division, Dept. G, P. O. Box 2177, **DOVER**® Memphis, Tennessee 38101.

The elevator innovators.

One Commerce Place and Radisson Plaza Hotel, Nashville, Tenn.

Developer: Carter & Associates, Atlanta

Architects: Thompson, Ventulett, Stainback & Associates, Inc., Atlanta

General Contractor, One Commerce Place: Ira H. Hardin Co., Atlanta

General Contractor, Radisson Plaza Hotel: Paces Construction Co., Inc., Nashville
(A subsidiary of the Ira H. Hardin Co.)
Dover Elevators installed by Nashville Machine Co., Inc.

Energy

AIA Attacks Proposal to Delay Building Performance Standards

AIA last month launched a public campaign against legislation pending in Congress that would delay implementation of the building energy performance standards (BEPS) for three years. Delaying BEPS, AIA claimed in a full page advertisement in the *Washington Post*, would be tantamount to Congress's taking "a giant step backward on energy conservation," and would mean a loss of more than \$4.3 billion in missed energy-saving opportunities. The Institute supports implementation of BEPS by August 1981, one year after the anticipated promulgation as originally mandated by Congress.

An amendment calling for the three-year delay was added to a housing authorization bill. The amendment was introduced by Senator Jake Garn (R.-Utah) and Representative Thomas Ashley (D.-Ohio) in subcommittees of the Senate and House banking committees. The housing authorization bill was passed by both committees with virtually no discussion of the BEPS amendment and to the surprise of many congressmen who have long supported BEPS.

The Institute hoped to generate enough public support to have the amendment killed when the full Senate and House

consider the housing authorization bill, at this writing anticipated in mid-June. AIA called on 22 organizations, who have expressed support for the Institute's position, to form a lobbying coalition. Support has been expressed by such groups as the American Planning Association, the National Rural Electric Cooperative Association, the Consumer Energy Council, Common Cause, the Conservation Foundation, the National League of Cities and the National Urban League.

Through letters explaining the situation, AIA also has sought the support of congressmen, governors, mayors, national and state energy department officials, other government officials, architects working in the government, AIA component executives, AIA past presidents and AIA honorary members.

AIA has called for a two-year phased-in implementation period for BEPS, during which time "needed improvements can be made, workable standards produced and technical and administrative capacity established." During the two years, both building performance and component standards could be used, with the latter eventually eased out.

The delay provision is backed by the American Consulting Engineers Council and the National Association of Home Builders. While ACEC supports a performance approach to energy-conscious building design, it believes that the one-year implementation requirement is "much too ambitious and should be relaxed to permit additional time for states and local governments to take appropriate action," an ACEC spokesman said at the BEPS hearings.

The National Association of Home Builders has publicly condemned BEPS as unnecessarily increasing the cost of a new home. NAHB estimates the increase at \$1,000 per building.

At the public hearings on BEPS, other groups requested a delay in implementation, including the American Society of

Heating, Refrigerating and Air Conditioning Engineers, the National Society of Professional Engineers and the National Council on State Building Codes and Standards.

The *Washington Post* advertisement (May 21) was placed to further engender public and congressional support. In it AIA maintained that "further delay [of BEPS] will accelerate the adoption of narrow, prescriptive standards. By endorsing one method or material over another, such standards thwart innovation and creativity. Moreover, they freeze technology at a time when nothing is more certain than technological change."

The loss in energy saving opportunities, as stated in the *Post* advertisement, would be \$660 million a year for potential new home buyers, \$595 million a year for owners of new commercial buildings and \$192 million in potential energy savings in new schools, hospitals and public buildings.

Quick implementation of BEPS, AIA maintains, is not just an issue for architects, but for consumers as well: "BEPS will encourage competition within the building industry to maximize energy savings for consumers. At a time when consumers routinely find performance ratings of automobiles expressed in miles per gallon, home buyers have a right to expect a reliable projection of home energy performance—stated in BTUs—as they ponder the largest purchase of their lifetime. BEPS will provide such a 'sticker' rating.

Energy Policy Urgency Stressed At Political Platform Hearings

Testifying for AIA at recent hearings of the Democratic and Republican platform committees, R. Randall Vosbeck, FAIA (AIA's first vice president), and David Olan Meeker Jr., FAIA (AIA's executive vice president), said that "possibly the most important leadership challenge before the entire nation is to establish a comprehensive national energy policy" based upon energy efficiency and conservation. They called upon the major political parties to provide such leadership.

Vosbeck and Meeker contended that

continued on page 12

Energy	
<i>BEPS delay opposed</i>	above
<i>DOE 'failures' charged</i>	12
<i>States' foot-dragging deplored</i>	12
<i>'Design Energy' awards</i>	16
<i>'Energy House' winners</i>	19
Government	
<i>Selection codes for two more states</i>	21
<i>Court upholds access ruling</i>	21
<i>Preservation of minority sites</i>	22
The Institute	
<i>New metric conversion guide</i>	22
<i>Financial practice aid</i>	25
<i>Flood research project</i>	25
Awards	
<i>RIBA honors James Stirling</i>	27
<i>Savannah's GSA project</i>	27

Energy from page 11

alternative sources of energy are currently a relatively minor national policy consideration, that improved energy efficiency is largely ignored and that long-term national energy initiatives are only now finding widespread policy discussion. Meanwhile, they continued, the U.S. imports nearly half of its oil which, they say, has exacerbated domestic inflation, unemployment, urban deterioration and other serious economic dislocations.

They pointed to the 1979 annual report of the President's Council on Environmental Quality, which stated that the U.S. can survive and even prosper on about 30 to 40 percent less energy than is now used, through more energy efficient consumer goods, improved building construction, more energy efficient automobiles and waste heat recovery systems. They also pointed to AIA studies that conclude that improving the design of new buildings and modifying older ones can cut current U.S. energy use by 20 percent.

"Government policies designed to reduce energy demand," Vosbeck and Meeker said, "must deal with the basic character of each energy system, and offer a combination of economic incentives and restrictions, carefully balanced to bring about efficiency modifications in the U.S. energy consumption."

For the built environment, AIA recommended that:

- buildings utilize the most efficient system for heating, cooling and ventilation;
- the siting of buildings take advantage of natural light, ventilation and other passive solar design elements;
- financial support, research and development be devoted to decentralized solar facilities intended for commercial, industrial and residential structures.
- loans, grants and other incentive programs be developed to stimulate building design and retrofit modifications, especially passive solar design;
- federal financial support and incentives be made available for energy efficient design and modification of all buildings;
- phased implementation of the building energy performance standards begin immediately to encourage the design and construction of energy efficient buildings;
- federal educational assistance be given to colleges and universities to establish educational training in the areas of energy efficient technologies and design;
- government agency insurance and loan offices establish energy-conscious program requirements demanding improved energy performance standards in federally assisted properties.

Concerning transportation, Vosbeck and Meeker called for incentives to urban transportation system designers and manufacturers to improve energy effi-

ciency in mass transportation systems. For the industrial sector, they called for incentives for energy efficient retrofits of plants and equipment and for accelerated depreciation for a percent of the capital costs of energy efficient building components or retrofits.

Common Cause Sues Agencies, Charges Energy Policy Failures

Common Cause, the self-styled "citizens' lobby," has sued President Carter, the Department of Energy and the Office of Federal Procurement Policy for their alleged failure to develop and implement energy conservation plans as required by law. Common Cause states that "nine of the 18 largest energy-using federal agencies increased their energy consumption in buildings from 1975 to 1978" and that "10 of the largest 18 agencies, including DOE, have increased their overall energy consumption" in the same period.

In one of three separate lawsuits filed in the U.S. District Court, Common Cause contends that DOE has failed to develop a comprehensive 10-year conservation plan for all federal buildings as required by the Energy Policy and Conservation Act of 1975. Common Cause alleges that the plan, if implemented, would reduce energy consumption in federal buildings by at least 31 million barrels of oil per year for an annual savings of more than \$900 million. DOE's inaction in this matter has been criticized by both the General Accounting Office and Congress.

A second lawsuit charges that President Carter and the Office of Federal Procurement Policy have failed to implement federal law that requires the President to develop mandatory standards for conservation in procurement policies. According to the lawsuit, President Carter has only asked OFPP to "encourage" energy conservation in procurement policies, and OFPP has taken "minimal action." Common Cause charges that "federal agencies lack conservation procedures to follow when buying property or services."

A third suit contends that DOE has failed to comply with mandates to establish conservation measures for federal transportation and to evaluate the results. DOE's failure, says the lawsuit, "is particularly serious as over half of the government's energy consumption is used for transportation." Although DOE has issued proposed rules on energy conservation, Common Cause argues that DOE has failed to impose procedures and goals for cutting energy use.

Common Cause quotes DOE as stating that the federal government is the nation's largest energy user: The government "directly consumes an amount of petroleum, electricity, gas and coal equiv-

alent to about 282 million barrels of oil a year, about 2 percent of the national consumption. An additional 4 to 7 percent of national consumption is used by the federal government in support of government procurement of goods and services. About 45 percent of the direct federal energy use is in buildings and facilities and 55 percent is used to operate transportation equipment."

Common Cause Senior Vice President Fred Wertheimer says, "Although Congress has directed the federal government to take the lead in energy conservation, the government is not meeting this mandate. A government that calls on its citizens to conserve energy must provide leadership by doing so itself."

DOE's Energy Goals for States Held Unlikely to Be Achieved

"It is highly unlikely that states will achieve their estimated goals for reducing energy consumption in new buildings," says the General Accounting Office in a recent report to Congress. And, further, unless the Department of Energy "expedites" its plans for the implementation of building energy performance standards (BEPS), working closely with states and local jurisdictions to assure compliance, this program's consistent and effective implementation will be delayed. "If the states cannot properly certify compliance with BEPS, future federal action, including the possible use of sanctions, may become necessary to assure full and uniform implementation of BEPS."

The report deplores the delays by individual states to enforce thermal efficiency standards under DOE's state energy conservation program. Many states, says GAO, did not meet the target date of Jan. 1, 1978, to implement the standards. These delays, according to GAO estimates, could reduce the projected 1980 energy savings by the equivalent of about 46,000 barrels of oil per day.

Only 41 states had adopted some type of thermal efficiency standards by September 1979. To be eligible for federal assistance, each state's plan had to contain, among other things, mandatory thermal efficiency standards and insulation requirements for all new and renovated nonfederal buildings. The states projected that the total planned 1980 energy savings brought about by implementation of the standards would be about 134,000 barrels of oil per day. But delays, says GAO, will cause a reduction in the projected savings by about 34 percent.

After a state had passed enabling legislation, it had up to a year or longer to revise model building codes and to train

continued on page 16



INSIST ON THE WORLD'S MOST PROTECTED ROOF.

Today's most effective and cost-efficient roof system depends on the unique properties of STYROFOAM* brand insulation. It's the most ideally suited insulation for use on top of a roofing membrane. The high moisture resistance, compressive strength and insulating effectiveness of STYROFOAM shield roof membranes from temperature extremes, protect them against physical abuse, and reduce expensive energy loss.

The Protected Membrane Roof (PMR) was pioneered by The Dow Chemical Company and represents a major breakthrough in roofing technology. Because of the superior performance of STYROFOAM brand insulation in roofing applications, building owners can experience

substantial long-term savings due to both decreased maintenance and energy costs.

Before you build, evaluate your roofing alternatives. Let your Dow Representative explain the financial benefits of the PMR system. He has data to support STYROFOAM brand insulation's superior insulating effectiveness and long-term proven performance. You'll see why roof systems incorporating STYROFOAM brand insulation are so widely specified by architects and contractors throughout America, and the world.

Write for more information. The Dow Chemical Company, Dept. F57, STYROFOAM Brand Insulation, Midland, MI 48640.

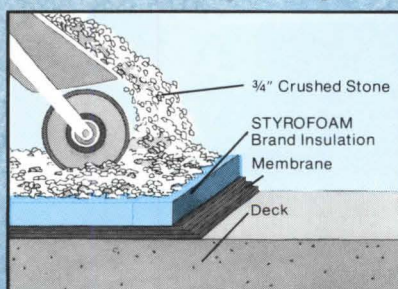

The Proven Answer



*Trademark of The Dow Chemical Company

WARNING: STYROFOAM brand insulation is combustible and should be properly installed. For roofing applications it should be provided with an adequate protection. For specific instructions see Dow literature available from your supplier or from Dow.

Circle 6 on information card

IF YOU THINK ALUCOBOND™ MATERIAL IS GREAT FLAT OUT, WAIT TILL YOU SEE HOW IT TAKES



The building on the left is an example of what ALUCOBOND material doesn't do.

Namely ripple, buckle, or bulge.

Thanks to this remarkably flat composite of two aluminum sheets and a thermoplastic core, oil-canning has been totally eliminated on Kubota Tractor's streamlined U.S. headquarters in Compton, California.

The building on the right is an example of what ALUCOBOND material does do.

Wrap around corners in sinuously graceful lines.

The incredibly smooth curves and uniform color of this Consolidated Aluminum product help create a beautiful first impression for Trailer Life Publishing Company in Agoura, California.

Available in six siliconized polyester resin colors and four handsome

When Daniel Dworsky, FAIA, of Daniel L. Dworsky FAIA and Associates, Inc., selected ALUCOBOND material, a key consideration was the easy expansion it permits.

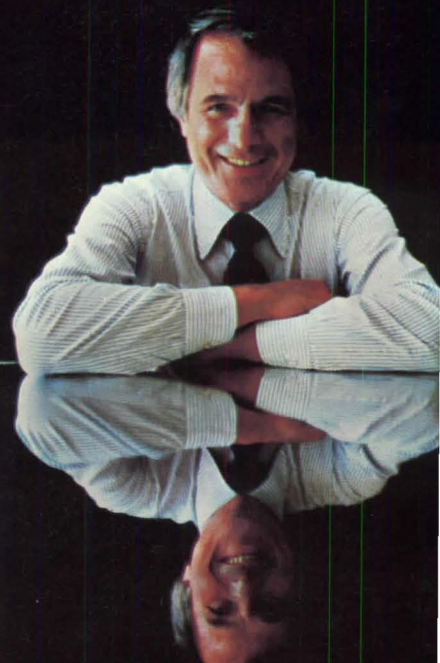

THE CURVES.

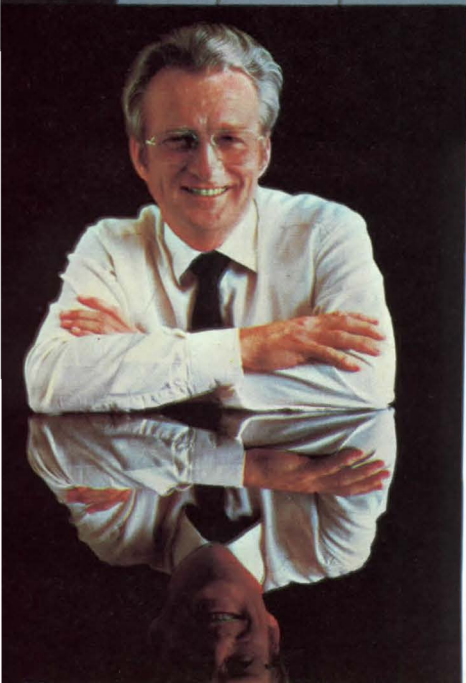

anodized finishes, ALUCOBOND material comes in panel sizes up to 5' X 28' and thicknesses of .118", .157", and .236" (3, 4, and 6 mm).

And its extraordinary adaptability offers architects design possibilities as diverse as their imaginations.

To find out more, call our Marketing Manager, Carla Lane, at (314) 878-6950. She can provide you with samples and

Jerrold Lomax, AIA, of Lomax-Mills-Architects, shares credit for his creative use of ALUCOBOND material with Project Architect John Rock.

information on ALUCOBOND material. The innovative product that's smoothing the way for creative architects everywhere.

Turn page for distributor listing.



Circle 7 on information card

Energy from page 12

builders and inspectors before the new standards were applied to new building design. This delay, along with construction lead time, ranging up to 24 months and more for many commercial buildings, means that "little, if any, of the planned energy savings will be achieved in 1980," GAO says.

GAO also criticizes DOE's inconsistency in determining whether a state has complied with the thermal efficiency standards mandated by the law. For example, in 14 of the 41 states to have adopted some type of thermal efficiency standards by September 1979, standards were not established for all building categories, were not mandatory for all new construction and were not mandatory in all jurisdictions.

The report explains that state laws generally hold local governments responsible for the enforcement of energy-related building standards. Such local authority existed in nine of 12 states reviewed in depth by GAO. Only one state, however, had monitored the enforcement of the standards. And neither DOE nor officials in the remaining 11 states had determined whether the standards had been implemented or how they could be implemented. In some local jurisdictions, officials were not even aware that the standards existed.

Overall, GAO says, it is concerned that "DOE's determination of state compliance with program requirements was not totally consistent with the law or its own regulations." But, says GAO, a "closely coordinated cooperative relationship with the states is essential to the success of the nation's energy conservation efforts." GAO recommends that DOE reassess the manner in which it determines if a state is in compliance with program requirements. GAO also suggests DOE continue to work with the states even if the statutory authorization for the state energy conservation program expires.

BEPS, says GAO, will be significantly more difficult to comply with than the thermal efficiency building standards. Therefore, DOE should expedite its ongoing activities in preparation for BEPS by developing methods for assessing the energy performance equivalency of building standards currently in use. Also, DOE should develop model building codes that will meet BEPS requirements, as well as training programs for architects, builders and inspectors, says GAO, while at the same time continuing its efforts to assist states in adopting and implementing thermal efficiency standards.

GAO concludes: "In our view, DOE should work jointly with the states in effectively monitoring local jurisdictions'

building standard implementation activities, particularly in those states which lack building standard enforcement authority. This would allow states to obtain the information necessary to properly certify whether compliance with BEPS is to be accomplished."

Pennsylvania, Rensselaer Students Win ACSA Awards

First place winners and recipients of checks in the amount of \$2,000 are Robert Nalls of the University of Pennsylvania and Scott Barton of Rensselaer Polytechnic Institute for entries submitted in a competition called "Design + Energy," sponsored by the Association of Collegiate Schools of Architecture and funded by the Department of Energy and the Brick Institute of America. More than 2,220 students from 80 schools participated in the competition which had two categories: an international house for university students and "open" submissions. Nalls won first place for an international house and Barton won in the open submissions category. Both problem options required the application of passive solar energy systems, energy conservation and use of brick masonry.

In the international house category, *continued on page 19*

WHEN YOU WANT TO USE ALUCOBOND™ MATERIAL, THESE DISTRIBUTORS WILL SMOOTH THE WAY:

NORTHEAST

Adammetal Supply
Elizabeth, NJ 07207
(201) 351-2550

A.O. Stilwell Co., Inc.
Buffalo, NY 14224
(716) 828-1415

B.R. Johnson, Inc.
Syracuse, NY 13057
(315) 437-1070

Building Specialties
of Pittsburgh
Pittsburgh, PA 15209
(412) 821-5310

Custom Walls and Windows
Kensington, MD 20795
(301) 949-6550

Eastern Metal Mill Supply
Dedham, MA 02026
(617) 329-1200

The Fox Steel Company
Orange, CT 06477
(203) 799-2356

Frank N. Henry, Inc.
Wilkes-Barre, PA 18703
(717) 824-4611

Fred Boschan Co., Inc.
Philadelphia, PA 19127
(215) 483-8000

Metal Construction
Services, Inc.
Baltimore, MD 21218
(301) 949-6550

SOUTHEAST

Attaway & Howell Co., Inc.
Tucker, GA 30084
(404) 938-7830

Delph-Context, Inc.
Charlotte, NC 28201
(704) 376-3671

Demarest Company, Inc.
Oneco, FL 33558
(813) 758-3811

Fletcher & Associates
Birmingham, AL 35203
(205) 328-0525

J.M. Power Company, Inc.
Trenton, MI 48183
(313) 479-2200

John W. McDougall Company
Nashville, TN 37209
(615) 383-4036

Penco, Inc.
Louisville, KY 40204
(502) 584-1166

W.H. Stovall & Co., Inc.
Ashland, VA 23005
(804) 798-1415

MIDWEST

Casewin, Inc.
Minneapolis, MN 55416
(612) 545-1635

Condit Construction Products
Dayton, OH 45409
(513) 298-9922
Columbus, OH 43228
(614) 274-2283
Cincinnati, OH 45229
(513) 242-4029

Jones and Brown Co., Inc.
Addison, IL 60101
(312) 543-0300

Karl M. Block Co., Inc.
St. Louis, MO 63144
(314) 647-8044

Swanson Gentleman Hart, Inc.
Omaha, NB 68154
(402) 493-9393

Swanson Gentleman, Inc.
Des Moines, IA 50309
(515) 244-0186

WEST

Associated Specialties Co.
Salt Lake City, UT 84106
(801) 487-8501

Elward, Inc.
Denver, CO 80223
(303) 936-7201

Payne & Howard, Inc.
Dallas, TX 75234
(214) 243-5050

Portland Wire & Iron Works
Portland, OR 97202
(503) 234-9731

RPS Architectural Systems*
North Hollywood, CA 91605
(213) 982-5866

ALUCOBOND is the trademark of Consolidated Aluminum Corporation for its aluminum composite material.

Technical information with reference to ALUCOBOND™ material test results can be obtained by writing to Consolidated Aluminum, Attention: Carla Lane. Always consult local building codes before use.

**System design and fabrication for the buildings on the preceding page were by RPS Architectural Systems.*

 **CONSOLIDATED ALUMINUM™**

11960 Westline Industrial Drive
St. Louis, Missouri 63141

EPICORE[®] Composite Floor System is NOT Ordinary!

Because of EPICORE'S **Unique Design** it is compatible with steel or concrete framing. The EPICORE Composite Floor System is equally effective in steel framed, reinforced concrete, reinforced masonry, or precast concrete structures. This improves performance and lowers initial and life-cycle costs.

EPICORE **Load Capacity** can't be equalled. Official tests established that EPICORE slabs can support more than twice their rated capacity.

This **Same Unique Design** gives EPICORE the ability to surpass all other 1½, 2 or 3-inch deck in U. L. **Fire Ratings**. Without the need for spray-on fireproofing, a much more desirable appearance is created.

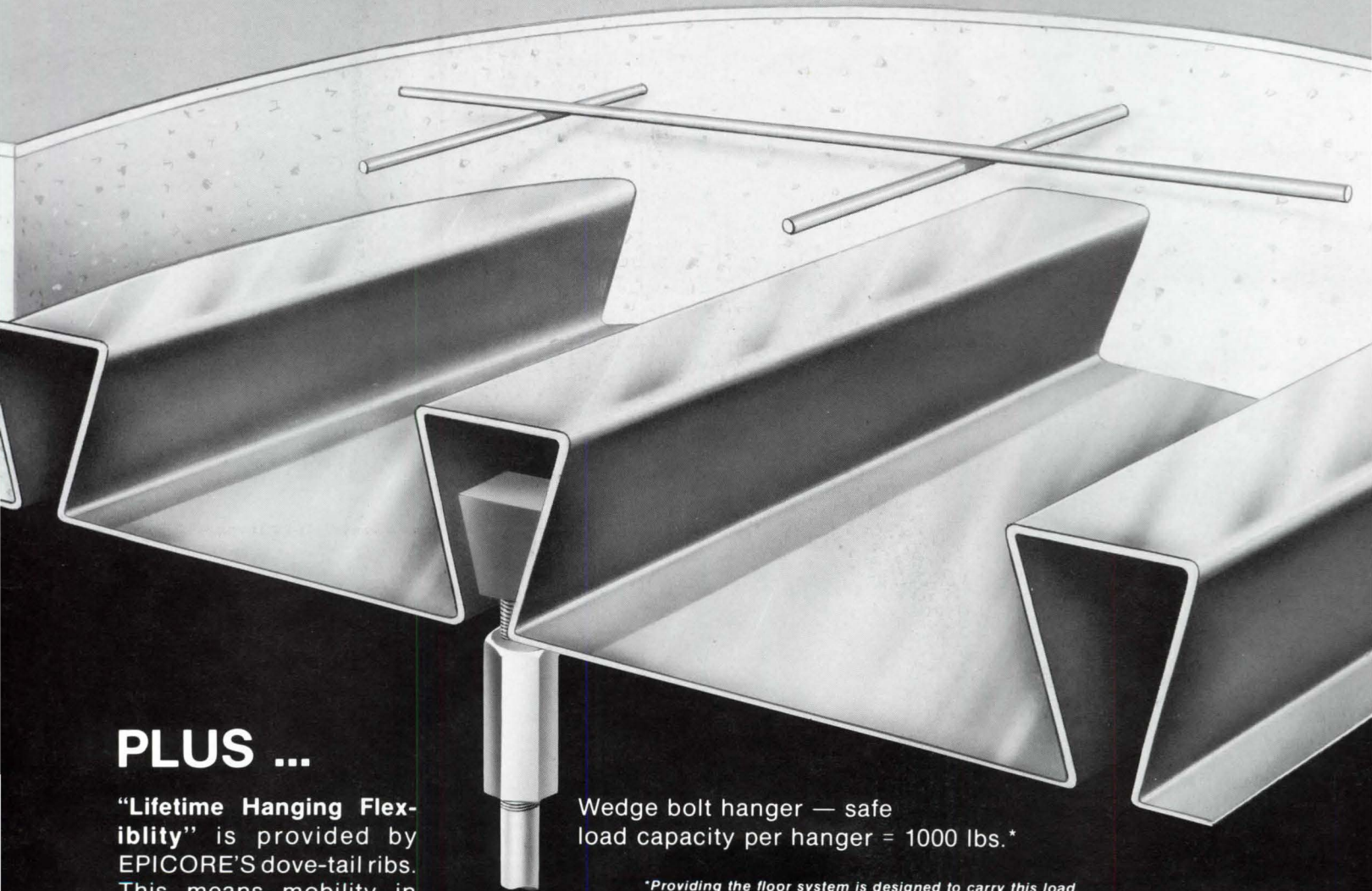

PLUS ...

"Lifetime Hanging Flexibility" is provided by EPICORE'S dove-tail ribs. This means mobility in hanging pipes, suspending ceilings, installing mechanical or electrical equipment — anytime — even after occupancy.

Wedge bolt hanger — safe load capacity per hanger = 1000 lbs.*

**Providing the floor system is designed to carry this load.*

With Dependable Service and Delivery to Equal ... YOU Should Specify EPICORE!

Full details on EPICORE'S capabilities are available by contacting Bob Ault, Vice-President of Engineering or Frank Sauk, Sr. Vice-President of Sales. Circle 8 on information card

EPIC
METALS CORPORATION
Eleven Talbot Avenue
Rankin (Pittsburgh), Pa. 15104
(412) 351-3913

Introducing Sunglas® Reflective, it blocks up to 65% of the sun's heat.

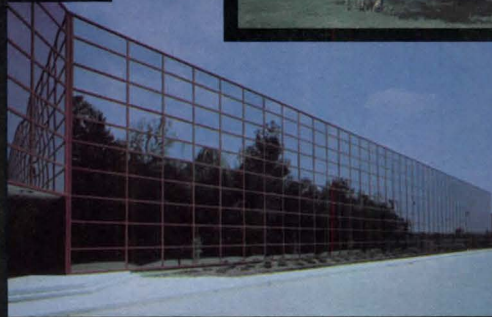
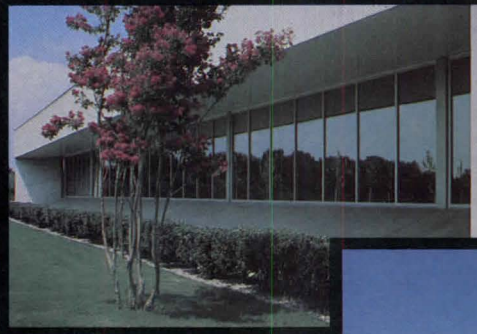
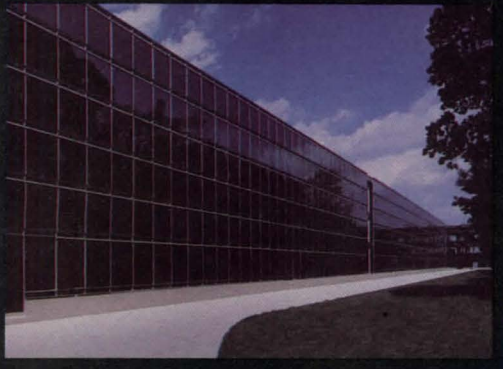

New Sunglas Reflective blocks the heat to help reduce the high cost of air conditioning.

Installing Sunglas Reflective can, over the lifetime of your building, amount to a saving of thousands of dollars. Because it blocks up to 65% of the sun's heat, it can aid in cutting air-conditioning operating costs and may allow for the use of smaller air-conditioning units.

A new concept — blocks the heat. Yet lets in the daylight.

While Sunglas blocks the sun's heat, it lets in more daylight than most other reflective glass products. This means reduced solar heat load while permitting the use of natural daylight for illumination — this

unique property presents another big saving potential. It also helps minimize hot spots so room temperatures remain more uniform and comfortable.

Ford Sunglas Reflective for a natural color view of the outdoors.

Sunglas Reflective lets in the beauty of the outdoors without noticeably affecting its natural color. The neutral silver coating reflects the surrounding outside environment and provides a full-color view of colors throughout the day.

New Computer Program shows you how to S.A.V.E.

Ford's new computerized S.A.V.E. program (Systems to Analyze Value and Energy) can help you determine your solar glass requirements and savings quickly. Find out more about the S.A.V.E. program and Sunglas Reflective so you can take the heat off you and your budget. Sunglas Reflective is available now and it can be

cut, tempered and fabricated locally. You'll find that choosing Ford Sunglas Reflective will be a nice reflection on you.

Sunglas Reflective is backed by Ford experience and a 10-year warranty.

Before we ever marketed Sunglas Reflective, we field-tested more than 2,000,000 square feet of it. The result? When the heat was on, Sunglas Reflective performed very coolly. For more information, send for our detailed product information kit including all the specifics of our warranty by writing: Ford Glass Division, 300 Renaissance Center, P.O. Box 43343, Detroit, Michigan 48243, or call toll free 1-800-521-6346.

 **GLASS DIVISION**

Circle 9 on information card

Energy from page 16

second place was won by James Rasche, University of Minnesota, and third place by Bill Cheeseman, Oklahoma State University. Honorable mentions went to Mustafa Abadan, Cornell University; Kasem Arayanimitskul, University of Michigan; Theodore Haug, University of Illinois at Urbana, and John Posch, New Jersey Institute of Technology. Second place in the open submissions category was given to Robert Vanney, University of Minnesota, and third place to Allen Brown, Oklahoma State University. Honorable mentions were won by David Bowers and by Stephen Kimak, both of New Jersey Institute of Technology. In addition to cash prizes for the students, representative schools also received prizes to encourage future efforts in energy and design education.

Jurors were John H. Burgee, FAIA; Fred Dubin; Paul Goldberger, critic for the *New York Times*; George E. Hartman Jr., FAIA; Richard G. Stein, FAIA, and Robert Fredericks, International House, New York City.

Passive Solar Competition

An awards program to recognize "excellence in passive solar design" has been announced by the International Solar Energy Society, American section, passive systems division. The program, in which the Solar Energy Research Institute will cooperate, will be held in conjunction with the fifth national passive solar conference on Oct. 19-26, at the University of Massachusetts at Amherst. Awards will be given in two categories: single and multifamily residential and commercial buildings and solar redesign of existing structures.

Entries will be accepted for both built and unbuilt projects, although submissions for unbuilt work must reflect an intention or commitment to build. The entries will be judged during the conference by representatives of the architectural, engineering and building communities on the basis of their passive solar attributes and esthetic merits. Economic feasibility will be an additional factor.

Deadline for registration for the awards program is July 1; deadline for submission of entries is Aug. 1. For information, write or telephone: Design Awards, Passive Solar 1980, Box 778, Brattleboro, Vt. 05301; (802) 254-4221.

Energy House Design Awards

Richard C. Bernstein of the University of Colorado at Denver and Ricki B. Fisher of Louisiana State University tied for the first prize in the "Energy House of the '80s" design competition. Sponsored by

continued on page 21

Architectural Design Competition

HELIOS

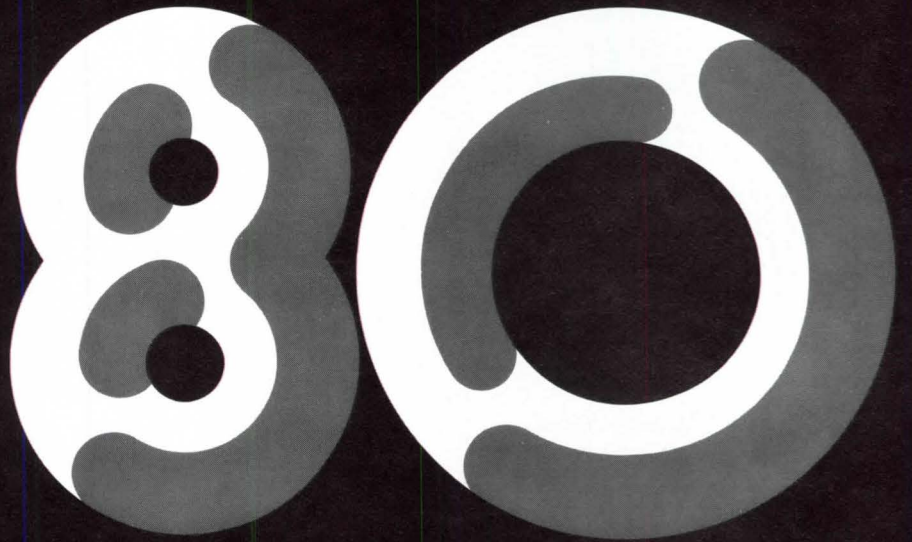

**Sponsored By Helios
Tension Products Inc.
In Conjunction With
Its Affiliate In Japan
Taiyo Kogyo Co., Ltd.**

Colorful, spectacular tensioned membrane structures are meeting today's needs for lighter, cost efficient buildings. To dramatize the potential for soft shell structures, Helios announces a competition for design of a stage and audience covering - outdoor theater.

Call for entries . U.S. licensed architects and professional employees of licensed architects are eligible. The deadline for entries is October 15, 1980.

Ten awards will be made by a professional jury. Professional

Adviser for the competition is Elisabeth Kendall Thompson, FAIA.

First	\$15,000
Second	\$10,000
Third	\$ 7,500
Honorable Mention (7)	\$ 2,500

Entry forms, competition rules, specifications and basic information on tensioned membrane structures are available now. When requesting information, please provide the registration number under which an entry submission would be made. Helios Tension Products, Inc., 1602 Tacoma Way, Redwood City, CA 94063. Telephone: (415) 364-1770.



HELIOS TENSION PRODUCTS, INC.
TAIYO KOGYO CO., LTD.
Soft Shell Structures Division



Paneline™ from Kawneer.

A panic exit device doesn't have to get in the way of design. New Paneline from Kawneer blends into the lines of the entrance. It truly is a concealed exit device. Only the unlocking action tells you it's a panic device.

Paneline doesn't get in the way of people either. In any situation, it opens quickly when pressure is applied to any part of the push panel which protrudes only 1" from the door. And it is closely fitted around the perimeter so fingers or little hands can't get caught. (In the "dogged open" position, the panel actually looks more like a simple push plate.) The almost-flush design of Paneline makes the push panel difficult to jam by chaining or blocking but still provides added security because there's no crash bar for intruders to hook with wires. In addition, a wrap-around pull handle guards the lock cylinder on the outside.

The Paneline exit device is an ideal way to meet life safety codes and build in extra security without sacrificing style. It is available on Kawneer standard series 190, 350 and 500 entrances. And the optional matching panels for vestibule doors, and fixed rails for sidelights, and center lights, allow design continuity to be maintained throughout the entrance area.

If you're looking for a panic device that doesn't get in the way of your design, look no further. Kawneer Paneline makes it easy.

THE PANIC EXIT DEVICE THAT DOESN'T GET IN THE WAY.

PUSH

PUSH

PUSH

For more information, contact:
Kawneer Product Information
Department C
1105 North Front Street
Niles, Michigan 49120

Kawneer
The designer's element
Circle 11 on information card

Energy from page 19

the Association of Student Chapters/AIA and New England Techbuilt, the competition was for a single-family residence that included the "maximum practical passive solar techniques available today" and had the capability to incorporate a partial active solar system.

Bernstein's design called for passive entrapment of heat in two south-facing greenhouses. The heat would be stored in rock beds to be circulated in ducts throughout the house. Radiant heat would be given off by the thermal concrete and quarry tile floors that cover the rock beds. Active solar collector panels and a 100-gallon water tank would heat all domestic hot water.

Fisher's design incorporates a pre-manufactured, prefinished core, consisting of two stacking units which contain bathrooms, kitchen, laundry room, fireplace, hot water storage and preheater, air handling equipment and heat recovery ducts. A greenhouse would be used for passive heat collection with a rock stor-

age bed. Heat generated by washer, dryer, oven, range and fireplace would be recovered and recirculated.

Bernstein and Fisher will split the first and second prizes, each receiving \$3,500. New England Techbuilt intends to construct both houses.

Third prize was awarded to Rob Fender of Arizona State University. Honorable mentions were awarded to Richard N. Faber, California State Polytechnic University at Pomona; Scott A. Johnston, University of Wisconsin—Milwaukee; Greg Markling, University of Arizona; Ronald W. Robinette, University of Arizona, and Randall P. Stout, University of Tennessee. More than 230 entries were submitted.

Jury members were Hugh Newell Jacobsen, FAIA; Carl Koch, FAIA; John R. Kupferer, executive vice president of the National Association of Home Manufacturers; Peter C. Mutty, president of New England Techbuilt, and Daniel Faoro, student from the University of Illinois, Chicago Circle campus.

• The Illinois legislature is considering a procurement code based on competitive bidding, which is opposed by the Illinois Council of Architects/AIA and the Illinois Capital Development Board.

• Indiana will be considering a competitive bidding system this year.

• North Carolina and Nevada are conducting reviews of their design and construction procedures.

• In response to testimony by Maryland architects and Maryland Society of Architects/AIA executive director Ron Ryner, the legislature will undertake a study of the competitive bidding system this summer to determine if price as a factor is preventing quality and innovative design in state work.

Government

Utah, Virginia Are the Latest To Adopt A/E Selection Codes

The adoption of state A/E procurement laws by Virginia and Utah brings the number of states with selection codes to 19. More states are likely to follow this year as state legislatures consider the American Bar Association's model procurement code.

In February 1979, the ABA house of delegates unanimously approved a model procurement code that recommends selection procedures for all services required by state and local governments. The code recommends selection of A/Es according to the so-called Brooks bill approach used in federal government, which is based on competence and qualifications. AIA supports this approach. Of the 19 states with procurement codes, 18 are patterned on the Brooks bill; Maryland has a competitive bidding law.

Utah adopted the ABA model code. The new Virginia law was enacted after a year's study of various selection methods. The law, although based on the Brooks bill, calls for competitive negotiation procedures to select "the most qualified and competent consultants at fair and reasonable rates." The Virginia Society of Architects/AIA opposed the legislation, expressing doubts that it would achieve the objective of lowering construction costs and speeding the delivery process. The

society was successful, however, in having incorporated in the law a so-called sunset clause requiring review in three years.

Other activities on the state A/E procurement front follow:

- The state of New Jersey has adopted competitive bidding procedures for the selection of design professionals. This is not a selection law; the selection of A/Es is by administrative ruling. The process is being implemented after a one-year test and over strong objections by architects and engineers in the state.
- In Massachusetts, an administrative ruling has also called for selection of A/Es by competitive bidding, which contrasts with the state's A/E procurement statute that is based on the Brooks bill approach. This discrepancy will be studied by the legislature and the selection law may be amended to include competitive bidding.
- The Wisconsin division of facilities management set up administrative rules for A/E selection based on competence.
- After a threat of competitive bidding last year and confusion over conflicting statements by state officials, Alabama architects and engineers and the state have worked out a process placing the selection of A/Es in the hands of user agencies.

Women's Firms Sought by EPA To Build Wastewater Plants

The Environmental Protection Agency plans to allocate a "greater portion" of its multibillion-dollar wastewater treatment plant construction funds to businesses owned by women. The funds are provided to architects, engineers and contractors for planning, designing and building municipal facilities. The construction grants program is authorized under the Clean Water Act of 1972 for sewage treatment to eliminate pollutant discharges into the nation's lakes and streams.

Since 1972, according to John McGuire, administrator of EPA region five, headquartered in Chicago, more than \$28 billion "was obligated in construction grants throughout the country, including \$3.9 billion in fiscal year 1979. . . . So far in fiscal year 1980, about \$300 million has been obligated."

The proposed women's business enterprise policy is scheduled to take effect Oct. 1, with public comment accepted until July 1. Guidelines are being written to include the number of women-owned businesses that should become participants in the construction grants program, McGuire says. Firms that are 51 percent owned and operated by women who could be eligible for construction grants are asked to notify EPA. Contact: Joan Arnold, Office of the Deputy Administrator, A101, Environmental Protection Agency, 401 MSt. S.W., Washington, D.C. 20460, or telephone (202) 755-0540.

Court Upholds Access Ruling

The Department of Transportation's ruling that all federally funded public transportation be accessible to the handicapped has been upheld in a recent court decision. The regulation was questioned in a lawsuit brought by the American Public Transit Association (APTA) against the department.

continued on page 22

Government from page 21

DOT's 504 regulation is based on non-discrimination under federal grants and programs law. The law states that no handicapped individual should be denied access to any program receiving federal financial assistance or conducted by a federal agency.

APTA charged that the regulations should be declared invalid and should not be implemented. The four major contentions in the suit were that the regulations:

- are illegal and go beyond statutory authority;
- are defective because DOT did not consider all relevant issues, options and comments during the rulemaking process;
- are "arbitrary and capricious" because they fail to recognize limitations on available technology, that they will cost more to implement but supply fewer benefits to disabled persons than alternative approaches and that they do not take into consideration differences in local conditions;
- failed to fully consider their environmental impacts.

Ruling in favor of DOT, the U.S. District Court for the District of Columbia said that there were ample authorities outside the 504 regulations on which to base the department's policy. The only point upheld by the court was the lack of an environmental impact assessment. DOT has until September to produce such a report.

APTA pointed out that DOT ruled in 1976 that local governments had the ability to determine the services to provide accessibility. These could include such approaches as dial-a-ride or public/private solutions. However, the Department of Health, Education and Welfare subsequently decreed that the 504 regulation applied to every public transit vehicle and system. DOT followed HEW's lead.

Public transit agencies, says APTA, are concerned by the economic effects of this regulation. APTA estimates that in 1979 dollars it will cost \$3 billion to \$11 billion to equip transit rail systems with handicapped facilities; the cost to buses is estimated at \$15,000 per bus. APTA is appealing the court decision.

Groups representing the rights of handicapped citizens say that the handicapped should have full accessibility to all public transit facilities. The congressional budget office is studying the cost and effectiveness of the current DOT strategy. It is likely that the issue will be reviewed by Congress.

The National Center for a Barrier-Free Environment says that the "decision is important for all facets of Title V regulations, since it expands interpretation of the rights of disabled persons beyond a single statutory regulation."

Preservation Funds Granted For Minority Historic Sites

The Heritage Conservation and Recreation Service of the Interior Department has awarded \$2 million to support the preservation of historic resources associated with the nation's minorities, native Americans and ethnic populations—the largest single expenditure of preservation funds for historic properties associated with minority groups.

The Institute

Guide Seeks Metric Conversion With Dimensional Coordination

Coupling of metric conversion in the construction industry with dimensional coordination is proposed in a new book that is the joint effort of an AIA task force, the American National Metric Council and the National Bureau of Standards' center for building technology. The book, entitled *The AIA Metric Building and Construction Guide*, edited by Susan Braybrooke, has been published by John Wiley & Sons, New York City.

The guide proposes a "rational, voluntary process for conversion to the metric system," says Robert T. Packard, AIA, deputy administrator, department of practice and design, at Institute headquarters. "The concept of dimensional coordination is essential to a successful conversion to the metric system by the construction industry." AIA's metric guide is based upon this principle, in accordance with Institute policy on metric conversion.

"This country has successfully applied the four-inch basic module concept to design and sizing of many products," Packard says. "Conversion to metric includes support for a 100-millimeter module for construction as a comparable basic module, which will allow manufacturers to select rational product sizes."

The American National Metric Council's construction industry coordinating committee has established a plan for conversion to the metric system that is discussed in the book. Jan. 1, 1985, has been made the target date for conversion to the metric system by the construction industry.

The committee says that "planning for metric conversion was undertaken with the expectation that the change to metric (SI) units will occur sooner or later, and that an unplanned reaction would create considerable difficulties compared with a planned program of change in which all

"This use of discretionary funds demonstrates my commitment to the historic resources reflecting the ethnic and cultural diversity of the American people," said Interior Secretary Cecil D. Andrus. "This diversity is unique in world history and must be preserved."

Among the projects to be awarded funds are the Martin Luther King Jr. national historic landmark district in Atlanta; Camino de las Misiones in El Paso County, Tex., and Hickory Ground in Wetumpka, Ala.

benefits have been identified so that they can be pursued." Among the major benefits to the construction industry, according to the committee, are improved productivity; better cost estimating; reductions in waste and lower building cost; improved export potential for American products, equipment and design services; preservation of American technological leadership in design, and the use of metric conversion "as an opportunity for review of traditional practices, product lines or processes."

The timetable established by the council for conversion to the metric system will be the basis of a national symposium, "Metric Conversion in the Building Industry," to be held in Chicago on Dec. 2-3, sponsored by the National Institute of Building Sciences.

Packard, who has been AIA's editor of the 7th edition of *Architectural Graphic Standards*, to be published by Wiley, says that early in the process of revising that publication it was discovered that there was virtually nothing in book form in this country on the subject of metric conversion by the building industry.

The AIA Metric Building and Construction Guide, intended to fill that gap, examines the fundamentals of the international metric system of units (SI) and how SIs relate to the practice of architecture, engineering and surveying, architectural and engineering drawings and anthropometric data. It also contains conversion tables.

In the preface to the guide, Braybrooke acknowledges that "for those involved in the construction industry the change to metric will be a profound one," but she says there are tremendous advantages in the system's intrinsic logic and coherence.

continued on page 25

Announcing
the new, affordable specification system
MASTERSPEC 2
Easily used. Technically superior. Adaptable.



MASTERSPEC 2 comes to you with a 10-year background of proven, successful experience. It preserves the good, solid qualities of MASTERSPEC, but is streamlined for easier use. MASTERSPEC 2 cuts your specifying time, increases your design time, and lowers your liability exposure. Helps solve people and production problems. MASTERSPEC 2 is updated regularly to keep you up with technology and product changes!

Adaptable ... In Scope And In Price!

MASTERSPEC 2 includes a new stand-alone BASIC version — at the low initial cost of \$395, and a yearly renewal cost of just \$250. Yet, if your practice so requires, it

is expandable with two add-on options: 1. An abbreviated Short Language Version; and 2. A more detailed Narrowscope Version. BASIC contains approximately 2,000 pages. The Short Language Version is about half that size, and Narrowscope approximately twice the size of BASIC. All versions are also available in automated form.

\$395
\$250 Yearly
Renewal

Technically Superior

MASTERSPEC 2 has been written by PSAE's professional specialists, so that it clearly and accurately describes materials, fabrication and installation, as well as citing industry standards. This comprehensive specification system will keep you abreast of the latest innovations in technology, product performance and design applications. It separates manufacturers' "sales pitch" from fact.

You can be sure that MASTERSPEC 2's language is correct — the system is subject to formal review by the professional societies — AIA, NSPE and ACEC.

Use MASTERSPEC 2 With Confidence!

The MASTERSPEC 2 system — forged by PSAE's professional specifiers and tempered by technical review committees and by user feedback — is recognized as the standard of the profession. Make MASTERSPEC 2 your standard for specifications!

Get full information on MASTERSPEC 2 now!
Free samples of text are available.
CALL TODAY ... toll free! (800) 424-5080
Ask for Leonard Bain, AIA

MASTERSPEC 2 is a product of PSAE
PSAE PRODUCTION SYSTEMS FOR ARCHITECTS & ENGINEERS, INC.
A wholly owned corporation of AIA
1735 New York Avenue, N.W.
Washington, D.C. 20006

M2 MASTERSPEC 2
The comprehensive specification system endorsed by the A/E professions.

See MASTERSPEC 2 at:

• Booths #321-322 at the AIA Convention, June 1-4, • Booths #66-67, Paper Plane Conference, June 19-20.

Circle 12 on information card

Meisel. Your answer to custom photomurals!

Your design calls for original photography and you have the negatives and transparencies on hand.

Good, we'll put them into our special enlargers and produce the finest color prints and murals available anywhere, beautifully hand-finished as only Meisel does it!

You want a giant Scanamural?

Okay, we're a 3M dealer and we can handle your Scanamurals, too.

We also offer black-and-white and sepia toned prints and murals. We make backlighted transparencies. And we have developed special techniques to put a print on nearly any surface you specify.

Don't worry about mounting. Our experienced people will mount your murals on panels or, preferably, right on the wall. And there is a five-year warranty on our installations.

But what if you don't have your negatives and transparencies?

No problem. You can choose from our Special Collections or our Masters Library of 5000 Images. Or we can recommend top photographers who will create images that are uniquely yours. We really can solve almost any photographic problem!

So try us! We're the world's largest custom color lab and we have worked for many well known designers, including Alan Ferry Design Group, Gensler and Associates, 3D/Newhaus+Taylor and H.O.K. Their clients range from the U.S. Government to the nation's largest corporations.

Now, we've added top-flight representatives to help us serve you even better. Check the list in the column at the right of this ad and call the one nearest you.

Or, for literature and information, write Meisel Photographic Design Division, P.O. Box 222002, Dallas, TX 75222.

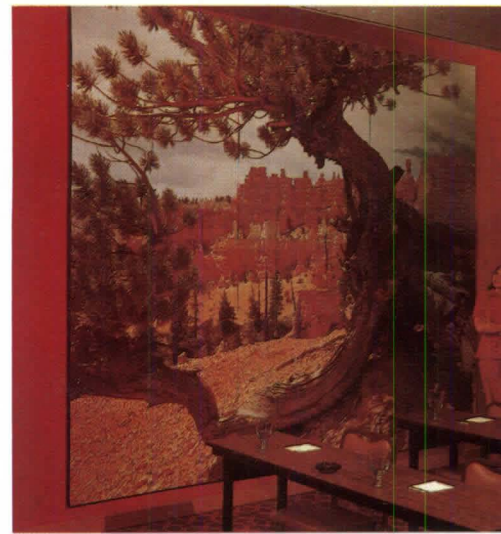
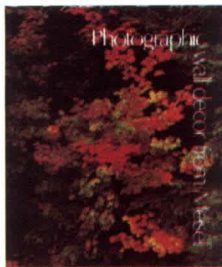

Hyatt Regency Hotel, Indianapolis — National Parks Collection of eight murals.



A 9x27-foot mural for Omega Optical, Dallas.

MEISEL
PHOTOGRAPHIC DESIGN DIVISION

One of the 16 9x22-foot murals for Pennzoil's national headquarters.



Call your Meisel Representatives

North Central Region

Milo Bloch & Associates
415 N. La Salle
Chicago IL 60610
(312) 644-0847

Milo Bloch & Associates
20 W. 9th Street
Kansas City MO 64105
(816) 421-1282

William Krager & Associates
P.O. Box 8755
Detroit MI 48224
(313) 885-8558

Sam Sarat & Associates
P.O. Box 2301, Loop Station
Minneapolis MN 55402
(612) 825-1988

Northwest Region

The Williams Group
1120 W. Blaine
Seattle, WA 98119
(206) 284-9190

Paulette Green
505 Colorado Gulch
Missoula MT 59801
(406) 728-9136

Northeast Region

Stanley M. Schlesinger Assoc.
214 Hill House
Huntingdon Valley PA 19006
(215) 947-4835

Erik Norup
450 E. 63rd St.
New York NY 10021
(212) 752-3448

Edward J. McKearney Co., Inc.
51 Sleeper Street
Boston MA 02210
(617) 482-1862

South Central Region

Glenn Hennings & Associates
P.O. Box 58103
World Trade Center
Dallas TX 75258
(214) 651-1556

Southeast Region

John Wall
1480 Oconee Pass
Atlanta GA 30319
(404) 458-1424

Price/Carnahan & Associates
3091 Maple Dr. NE, Suite 310
Atlanta GA 30305
(404) 233-4030

Design Services Bureau
96 NE 40th St.
Miami FL 33137
(305) 576-1031

Southwest Region

C. J. Welch, Inc.
8807 Beverly Blvd.
Los Angeles CA 90048
(213) 274-0671

Galleria Design Center
101 Kansas St., Suite 208
San Francisco CA 91403
(415) 864-1700

West Central Region

CDA
901 Wazee St.
Denver CO 80204
(303) 573-6616

CDA
307 West 200 South, Suite 2003
Salt Lake City UT 84101
(801) 521-5332

The Institute from page 22

To some people, however, "contemplation of the change itself" is "a horrifying proposition which they would rather ignore, hiding their heads in the sand until it is forced upon them. Because many architects undoubtedly share this feeling, AIA and John Wiley have collaborated to produce this book." The guide, she says, is a "reliable, essential and accessible primer of information in a form that architects will actually be able to read and use."

The guide is available from AIA's department of publications marketing. The price for a hardbound copy is \$19.50 for nonmembers; \$13.50 for AIA members. A paperbound book is priced at \$14.50 for nonmembers and \$7.20 for members.

New Practice Aid Deals With Profitability, Solvency

Scheduled for publication this month is a new practice aid prepared under the aegis of AIA's financial management committee. Entitled *Financial Management for Architects: A Guide to Understanding, Planning and Controlling the Firm's Finances*, the book is by Robert Mattox, AIA. It is aimed at helping architectural firms solve their two most important financial concerns: profitability and solvency.

Called an "umbrella" in a coordinated set of financial management aids, the new book provides an overview of financial management, complementing other AIA documents and services that give detailed assistance in understanding and applying financial principles.

The book is organized into nine chapters, the first of which introduces financial management as based upon an "understanding of what is to be managed, developing a plan of action and subsequently organizing, coordinating, controlling and evaluating the actions." Chapters follow on the fundamentals of finance, planning profit for the firm, planning profit for projects, agreements for professional services, cash management, financial reports and analysis, staffing and ownership. A glossary of terms and a bibliography are provided.

Aimed especially at helping small and medium-sized firms, *Financial Management for Architects* standardizes terminology, making it compatible with practices of the modern business world. It is written for concerned practitioners without formal training in finance and for those with minimal experience.

The book replaces three documents prepared in 1968 and 1969 by Case & Co., and one prepared in 1970 with the assistance of Arthur Andersen & Co. The Institute's practice division is also in the process of updating AIA's financial man-

agement system's compensation guidelines and standardized accounting books to conform with the new book's terminology, thus completing the Institute's entire financial management system.

Financial Management for Architects (2M724) will be available from AIA's department of publications marketing at the price of \$22 for AIA members and \$27.50 for nonmembers.

Flood Control Research Project

Traditionally, efforts to mitigate flood damage have been predominantly site-oriented. Architects have been limited to the design of a building for a specific land parcel and, generally, have not been involved in aspects of the natural hydrologic system. Today, however, there are many interacting decisions that affect both site and building. The full array of interfacing issues will be examined by the AIA Research Corporation, under a grant from the Federal Insurance Administration, in a research project that is intended to help alleviate the rise of annual costs due to flooding. AIA/RC will survey and analyze flood issues, examine relevant case studies and generate design strategies to ease flood damage.

The research will develop guidelines that focus on various concepts and techniques for adjustment to flood hazards. Among the techniques already in use to control floods are such things as dams and levees, elevated buildings, water-tight enclosures and land use management. These and other matters will be studied in the comprehensive research project in order to give architects a knowledge of the characteristics of both the natural hydrologic system and the built environment and of the interfaces between them.

137 Receive Scholarships And Will Share \$178,700

Awards from \$500 to \$2,500 have been made under the AIA/AIA Foundation scholarship program to 135 persons in either of the last two years of an accredited first professional degree program in the year in which the scholarship funds will be used. Also, scholarships went to two persons pursuing study beyond the first professional degree.

In the 1980 program a total of \$178,700 was available for scholarship grants. Some of the funds come from donors in the building industry, including Blumcraft of Pittsburgh; Knoll International, Inc.; National Association of Brick Distributors; Johns-Manville, and PPG Industries Foundation. The amount of each individual scholarship award is based upon the student's academic ability

continued on page 27

PPG OFFERS A STUNNING ALTERNATIVE TO THE DRAB SLAB.

Discover a spectacular exterior wall treatment that puts new designs on all that it surrounds. Discover PPG's Solarcool® Spandrelite® wall cladding.

In addition to dramatic beauty, Solarcool Spandrelite wall cladding offers outstanding performance capabilities. In new or existing applications. And at a cost that's lower than the expected exterior wall treatments: masonry, aluminum, stone and polished stainless steel.

An advanced structural silicone glazing system with the mullions inside can make Solarcool Spandrelite wall cladding appear seamless.

You're free to choose glass types and thicknesses previously unimagined.

And Solarcool Spandrelite works as an energy-efficient opaque curtain wall or a window area. Can even hang in front of insulation.

Since 1965, PPG has led the world in creative application of structural

silicone glazing systems. And began to build more "oohs" and "aahs" into buildings.

Find out more. See Sweet's 8.26/Pp. Or write Environmental Glass Sales, PPG Industries, Inc., One Gateway Center, Pittsburgh, Pa. 15222.

PPG: a Concern for the Future

Circle 14 on information card



Architect: Robert Bridges Associates, New York

The Institute from page 25

and an assessment of financial need.

The scholarship committee, whose 1980 chairman was Jean Young, AIA, also had as its members Richard Dozier, AIA; Devon Carlson, FAIA; Don King, AIA, and student Margie Miller. The committee reviewed a total of 301 completed applications. In making its decisions, the committee relied heavily upon four basic factors: the student's statement of purpose, a dean or administrative head's supportive comments, the student's academic and financial needs.

In the event that there are cancellations, alternative recipients will receive scholarships.

New at AIA Headquarters

William Cameron Tucker, AIA, has been appointed director of professional development programs (formerly continuing education programs) at Institute headquarters. He previously was program director/senior planner for the office of community development, Montgomery County, Md.; program administrator/planner consultant to the municipal planning office, District of Columbia; associated with the firm of Harry Weese & Associates, and assistant professor at Antioch College's environmental design department. He earned an architecture degree from the University of Texas.

John Wilson-Jeronimo, who was president of the Association of Student Chapters/AIA in 1978 and more recently an urban designer for the city of Annapolis, Md., is now the Institute's administrator of component affairs. He holds graduate degrees in architecture and in urban design from the University of Miami.

Evan M. Dudnik has been made director of the government liaison program at AIA. He was associated for two and a half years with the AIA/Research Corporation.

Stephanie C. Byrnes has been appointed AIA librarian. She joined the Institute as assistant librarian in 1977. She is a graduate of Smith College and holds a master's degree in library science from the University of Maryland.

Telephone Change June 27

Effective June 27, AIA's main centrex telephone number is (202) 626-7300. The new "hot line" number is 626-5954. Other new numbers are AIA JOURNAL editor: 626-7477; AIA JOURNAL publisher: 626-7470; component information: 626-7451; education and professional development: 626-7348; government affairs: 626-7375; executive offices: 626-7312; library: 626-7493; practice and design: 626-7360; public relations: 626-7460; publications: 626-7332.

Awards

RIBA Honors James Stirling With Its Annual Gold Medal

British architect James Stirling, Hon. FAIA, is the 1980 recipient of the royal gold medal for architecture presented by the Royal Institute of British Architects. The award is conferred annually on a "distinguished architect or group of architects, for work of high merit, or on some distinguished person or persons whose work has promoted either directly or indirectly the advancement of architecture."

Stirling's early work was influenced by the industrial buildings of Liverpool where he was reared and studied. In 1956, he formed a partnership with James Gowan. One of their major projects was the engineering building at Leicester University. In 1963, Stirling worked independently designing buildings for Queens College, Oxford University, the history library at Cambridge University and the Olivetti training school at Haslemere. During the late '60s, he worked on larger scale projects at Runcorn New Town and St. Andrews University.

In 1971, Stirling formed his current partnership with Michael Wilford. During the '70s, many commissions came from outside England. U.S. works completed in the '70s include 15 luxury houses in New York City; extension of the school of architecture building, Rice University, Houston, and the addition to the Fogg Museum, Harvard University, Cambridge, Mass.

N.C. State Student Is Winner

Gary R. King of North Carolina State University is first prize winner (\$1,000) of the Architectural Woodwork Institute's 1980 national students awards program. Second place honors (and a prize of \$750) went to Brent Thaetta of the University of Idaho. Three special com-

mendations for designs to incorporate "unique features" went to Augustine Hill of the University of Manitoba, Richard C. Carpenter of the Fashion Institute of Technology and Frankie Earl of Auburn University.

This year's program, which was co-sponsored by the American Banking Association, required the students to provide specifications and interior plans for a hypothetical suburban bank branch office. Judged at AIA headquarters in Washington, D.C., the awards program had as jurors Marvin B. Affirme, president of Space Design Group, New York City; Jerrily R. Kress, AIA, Washington, D.C., and Fred Underwood Jr., AIA, Decatur, Ala.

Stevens & Wilkinson, Jacobsen Awarded Savannah GSA Project

The Atlanta firm of Stevens & Wilkinson, with Hugh Newell Jacobsen, FAIA, of Washington, D.C., has been selected by GSA as the winner of a level three competition for the design of a proposed federal office complex on Telfair Square in Savannah, Ga. Runners-up in the competition were Jova, Daniels & Busby, Atlanta, with the Lominack Partnership, Savannah, and the joint venture of Thompson, Ventulett, Stainback & Associates and J. W. Robinson & Associates, both of Atlanta.

The winning design proposal, estimated to cost \$15.23 million to construct, will provide about 173,000 square feet of office space and a 90,000-square-foot parking facility, to house 12 federal agencies now scattered over the city. The proposal (drawing below) calls for three separate buildings, two facing Telfair

continued on page 72



More power to you.



Tempo 3 delivers. It's the open office system designed to manage the electronics explosion. Easily. Effectively.

Real Capacity. Our unique design offers four raceways in each panel base—room for up to sixteen 25-pair cables and six 20-amp circuits.

True Flexibility. Our modular wiring makes rearranging easy. Order pre-wired outlets on one or both sides, in the base or at desk height. And outlets can be added anytime.

So don't get caught with your power down. Let us show you *all* the advantages of Tempo 3. Call your Shaw-Walker representative. Or write Shaw-Walker, 935 Division Street, Muskegon, Michigan 49443.



SHAW | WALKER

Welcome Back, Mr. Wright —Again

Two articles in this issue deal with Frank Lloyd Wright. He also dominated the April issue and will make another appearance in July. We are not alone.

There is a widespread flowering of interest in this most American of masters. Not that his reputation needed revival. But in postwar decades the lessons of his words and work were neither widely taught nor heeded.

This latest “comeback” probably has something to do with the revived respectability of ornament and experimentation with form that is so much a part of the current scene. Mr. Wright and some of today’s most publicized practitioners have in common a certain native audaciousness.

There are many places at which they part company, of course. One of them has to do with historicism. This is what he had to say about it in the Princeton lectures, a point of prior Wrightian renaissance that is the subject of one of the two articles on him on following pages:

“Not so long ago no building, great or small, high or low, dignified and costly or cheap and vile, was complete without a Cornice of some sort. You may see accredited cornices still hanging on and well out over the busy streets in any American City for no good purpose whatsoever . . . really for no purpose at all. But to the elect no building looked like a building unless it had the brackets, modillions, and ‘fancy’ fixings of this ornamental and ornamented pseudo-classic ‘feature.’ Cornices were even more significantly insignificant than it is the habit of many of the main features of our buildings to be. The Cornice was an attitude, the ornamental gesture that gave to the provincial American structure the element of hallowed ‘culture.’ That was all the significance Cornices ever had—the worship of a

hypocritical theocratic ‘culture.’ Usually built up above the room and projecting well out beyond it, hanging out from the top of the wall, they had nothing in reason to do with construction—but there the Cornice had to be. It was, somehow, become ‘manner’—something like lifting our hat to the ladies or, in extreme cases, like the ‘leg’ an acrobat makes as he kisses his hand to the audience after doing his ‘turn.’ The Cornice, in doing our ‘turn,’ became our commonplace concession to respectable ‘Form,’ thanks again to the Italians thus beset—and disturbed in their well earned Architectural slumber.

“But, have you all noticed a change up there where the eye leaves our buildings for the sky—the ‘sky-line,’ architects call it? Observe! More sky! The Cornice has gone. Gone, we may hope, to join the procession of foolish ‘concessions’ and vain professions that passed earlier. Gone to join the ‘corner-tower,’ the ‘hoop-skirt,’ the ‘bustle’ and the ‘cupola.’

“Like them—gone! This shady-shabby architectural feature of our middle distance, the ‘seventies,’ ‘eighties’ and ‘nineties,’ has been relegated to that mysterious scrapheap supposedly reposing in the back-yard of oblivion. Look for a Cornice in vain anywhere on America’s new buildings high or low, cheap or costly, public or private. . . .

“Shall we see the stagey, empty frown of the Cornice glooming against the sky again? Has this cultured relic served its theatrical ‘turn’ or are appearances for the moment *too* good to be true? Periodic ‘revivals’ have enabled our esthetic crimes to live so many lives that one may never be sure. But since we’ve learned to do without this particular ‘hangover’ in this land of free progress and are getting used to bareheaded buildings, find the additional light agreeable, the money saved extremely useful, and as, especially, we are for ‘safety first,’ we are probably safe from the perennial Renaissance for some years to come. At any rate for the moment ‘the glory that was Greece, the grandeur that was Rome,’ ours by way of Italy, may cease turning in ancient and honorable graves. O Palladio! Vitruvius! Vignola!—be comforted—the twentieth century gives back to you your shrouds!”
D.C.



Photographs by Armando Salas Portugal

The Haunting Art of Luis Barragán

He is winner of the 1980 Pritzker Prize, richest in architecture. By Nora Richter



Mexican artist-architect Luis Barragán is the 1980 winner of the international Pritzker Prize. Established in 1979 and sponsored by the Hyatt Foundation, the prize is granted to a "living architect or architectural group whose work demonstrates those qualities of talent, vision and commitment which have produced significant contributions to humanity and the environment through architecture."

In presenting the award, Jay A. Pritzker, president of the Hyatt Foundation, said, "We are honoring Luis Barragán for his commitment to architecture as a sublime act of poetic imagination. He has created gardens, plazas and fountains of haunting beauty—metaphysical landscapes. A stoical acceptance of solitude as man's fate permeates his work."

Emilio Ambasz, former curator of design of the Museum of Modern Art, wrote of Barragán in his book *The Architecture of Luis Barragán* (Museum of Modern Art: 1976): "In the de Chirico-like settings he creates, the wall is both the supreme entity and the inhabitant of a larger metaphysical landscape, a screen for revealing the hidden colors of Mexico's almost white sun and a shield for suggesting never seen presences. . . . While

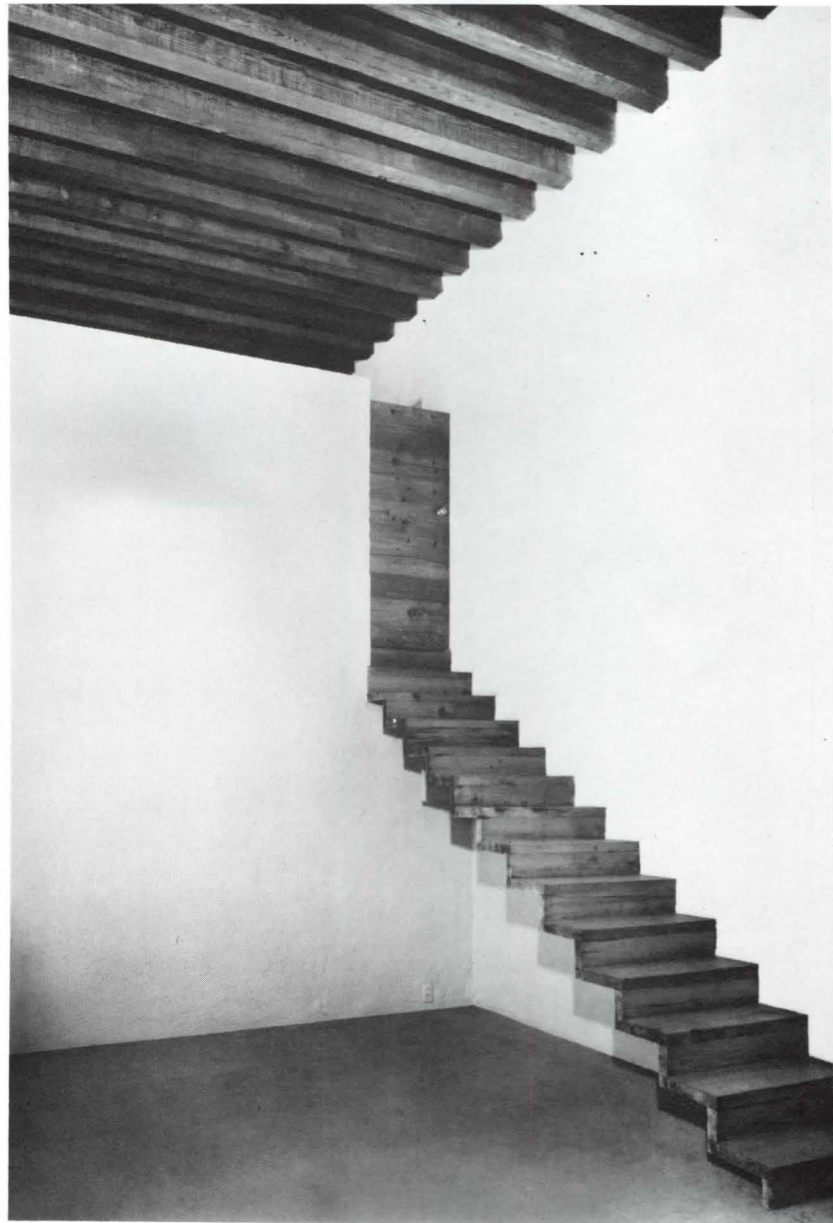

Left, a courtyard of San Cristobal, a suburban residence built in 1968. Horses' stables are beyond the pink wall at left; the main house is to the right; grooms enter the courtyard between the parallel purple walls. Above, in Barragán's 1947 house for himself, a stair of cantilevered pine boards.

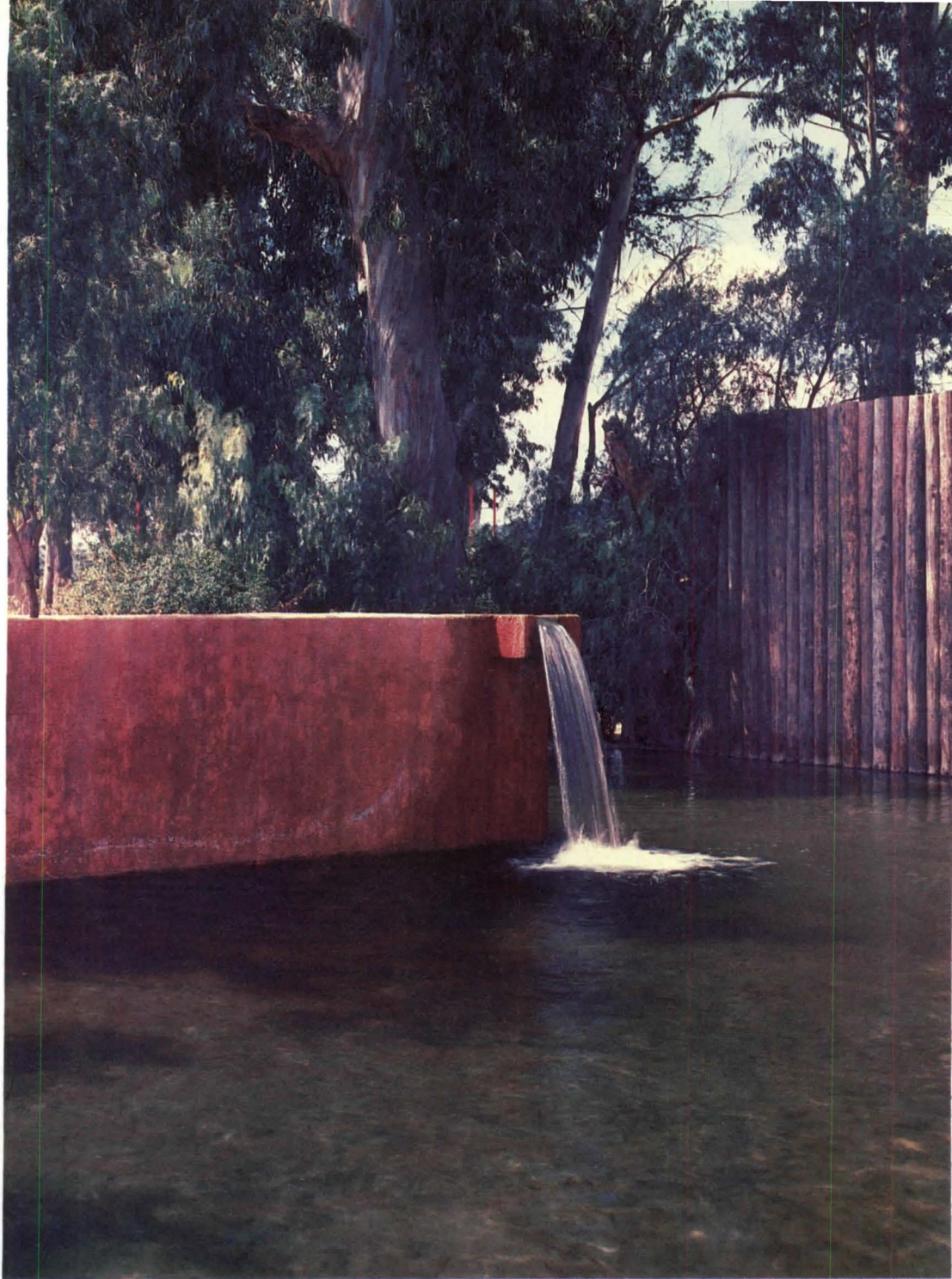

Two views of Barragán's Las Arboledas residential development near Mexico City, where water is a serene presence among the eucalyptuses.

his approach is classical and atemporal, the elements of his architecture are deeply rooted in his country's cultural and religious traditions. It is through the haunting beauty of his hieratic constructions that we have come to conceive of the passions of Mexico's architecture."

Some of Barragán's well-known works are the gardens at El Pedregal, his home in Mexico City, the Chapel for the Capuchinas Sacramentarias del purísimo Corazón de María, the Towers of Satellite City, Las Arboledas and Los Clubes residential subdivisions and the stable, pools and house of San Cristobal.

Jury members for the Pritzker award were J. Carter Brown, director of the National Gallery of Art, Washington, D.C.; Kenneth Clark (Lord Clark of Saltwood), art historian; Arata Isozaki, Japanese architect and critic; J. Irwin Miller, head of the Cummins Engine Co., Inc., Columbus, Ind.; Cesar Pelli, FAIA, dean of the Yale University school of architecture, and Philip Johnson, FAIA, the 1979 Pritzker Prize recipient. Barragán was awarded \$100,000 and a bronze cast of a Henry Moore sculpture. □

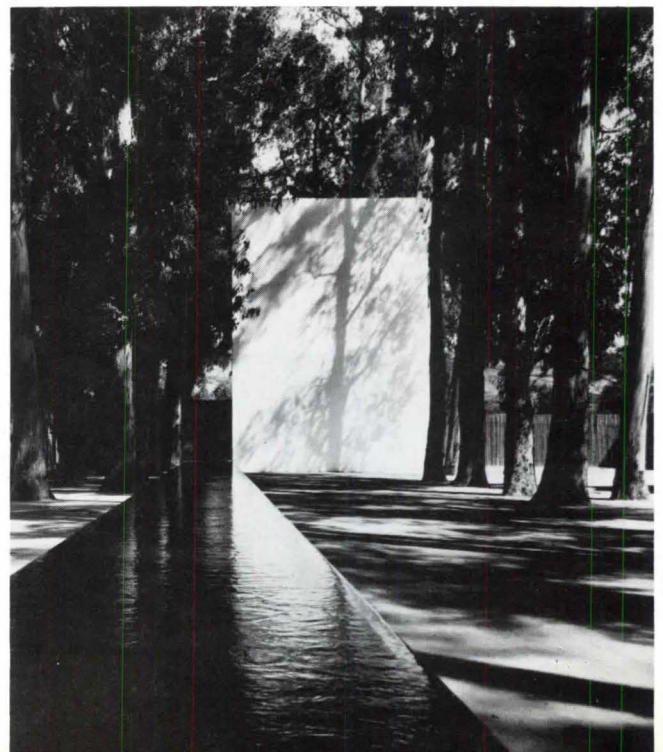

In Earthquakes, Failure Can Follow Form

The relationship between building configuration and seismic behavior. By Christopher Arnold

The idea has long been accepted by engineers that a building's configuration—its size and shape and that of its component elements—has a significant effect on its behavior in earthquakes. Since configuration is essentially an architectural response to solving the building requirements, it follows that there is a direct relationship between architectural design and seismic resistance. However, many architects treat design for seismic resistance as something added to the design, by the engineer, rather than regarding it as an intrinsic part of the initial design phase.

Many engineers, in turn, live a schizophrenic existence. Among themselves they complain about the architect's ignorance of the impact of configuration but at the same time make a good business out of assuring architects that their mysterious engineering skills will allow the most eccentric design both to conform to the seismic building code and stand firm against the less quantifiable wrath of God. In fact, the relationship between engineering and architectural design is delicate, closely interwoven and technically sensitive, and purely engineering concepts—as might govern in the design of a structure such as a suspension bridge—are constantly modified and even vitiated by architectural requirements.

Though a considerable body of information exists as to the influence of configuration, it tends to exist either as comments in research papers directed toward larger issues or as part of the informal lore of practicing structural engineers. This information rarely reaches the practicing architect, or reaches him in a form that emphasizes design restriction rather than developing the understanding out of which the capable designer creates innovative solutions.

Architectural configuration, then, is important for seismic design in two basic ways: One is that configuration influences, or even determines, the kinds of resistance systems that can be used, and the extent to which they will, in the broadest sense, be effective. The second way is our hypothesis that many failures of engineering detail that result in severe damage or collapse

originate as failures of configuration. The configuration of the building either as a whole or in detail is such that seismic forces place intolerable stress on some structural member or connection and it fails.

This is not to suggest that configuration is primary, and detailed engineering design and construction techniques secondary or of no consequence: They are obviously all related as contributors to the safety and efficiency of the building. But it does mean that the designer's first ideas on configuration are very important, because at a very conceptual stage, perhaps even before there is any engineering discussion, he is making decisions of great significance to later engineering analysis and detail design.

Although configuration is normally defined as building size and shape, our concept includes the nature, size and location of the structural elements, vertical, horizontal and lateral, and includes the nature, size and location of nonstructural elements that may affect structural performance. This extended definition of configuration is necessary because of the intricate relationship for seismic performance among these three groups of elements of configuration. In this, our definition extends beyond the idea of building form, which tends to limit itself to overall shape: the nature of the building as a sculptural mass.

Configuration, and the formal elements that create it, originate in the building program, which can be summarized as a description of the activities that are housed in the building—the services, furniture and equipment they need, the space that they demand, combined with environmental requirements for the occupant and image requirements for the building owners. Activities produce a demand for certain settings and kinds of space division, connected by a circulation pattern; the combinations of activity spaces and circulation lead to certain dimensions and finally into a building configuration. But there are other determinants of configuration that sometimes may dominate—such things as site, geology, climate, size, geometry, urban design requirements and architectural stylistic concerns. Many engineers would argue that this last is the only requirement; they are hard pressed to identify any rational determinants of the designs that they work on. The final configuration choice is the result of a decision process which, by some means, balances these varying requirements and influences, and resolves conflicts into a single result.

Mr. Arnold is president of Building Systems Development, Inc., San Francisco. This article is based on part of a study sponsored by the National Science Foundation. The author acknowledges the help of Eric Elsesser, structural engineering consultant; Dr. Fred Krimgold of NSF; Robert Reitherman, research assistant, and Dianne Whitaker, graphics.

"IRREGULAR STRUCTURES OR FRAMING SYSTEMS" (SEAOC)

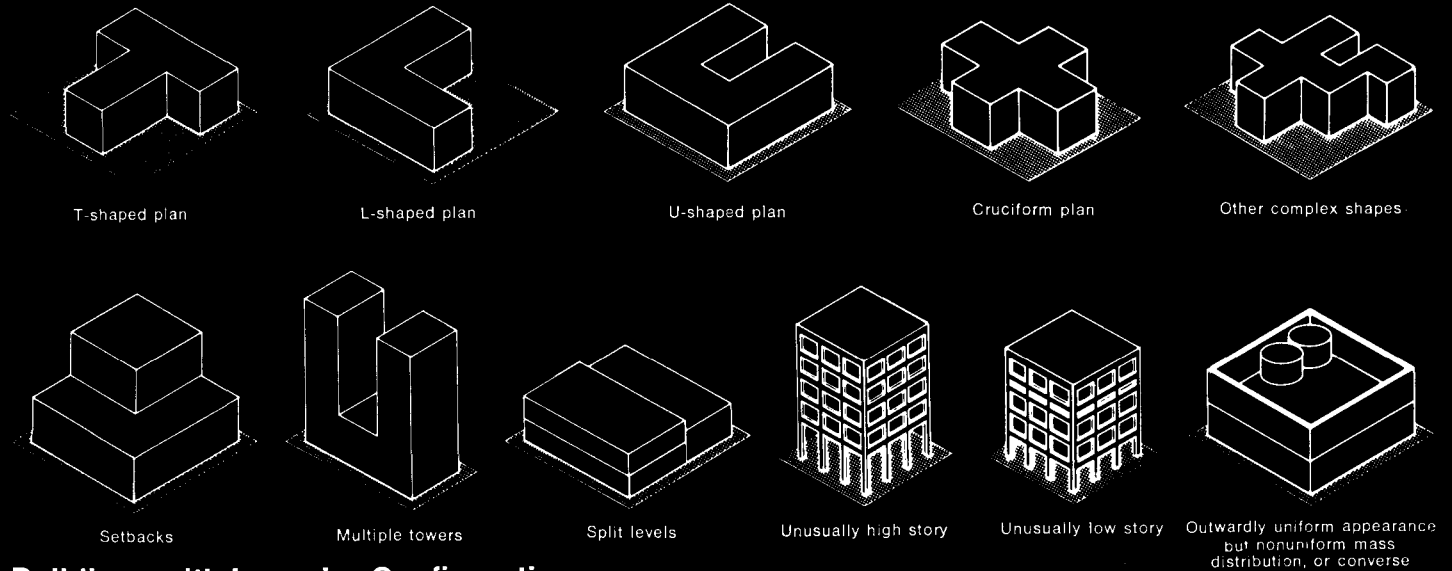

Buildings with Irregular Configuration

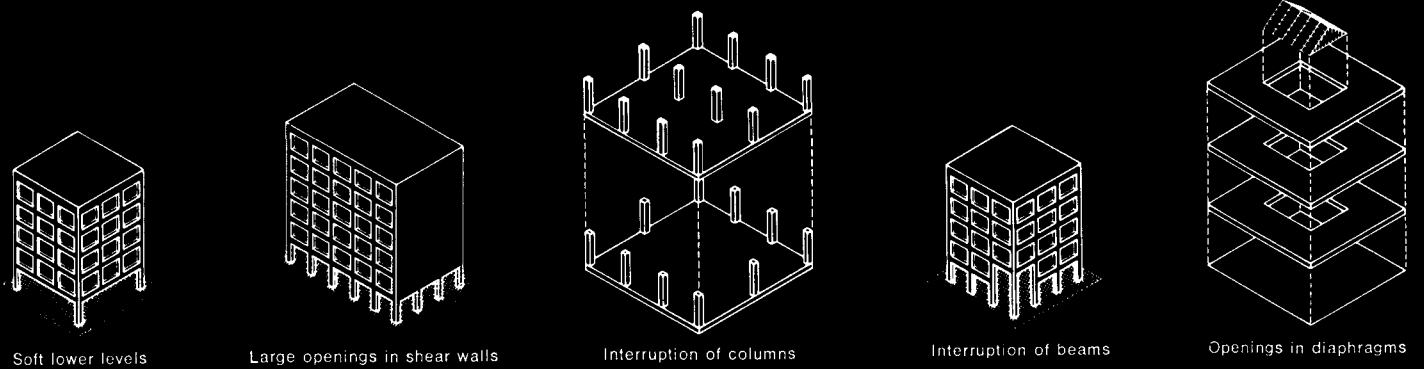

Buildings with Abrupt Changes in Lateral Resistance

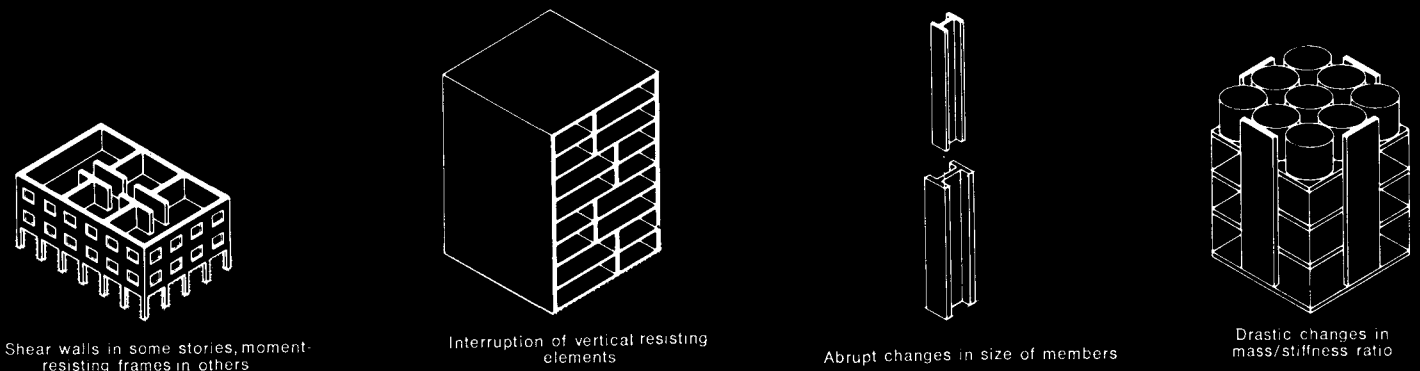

Buildings with Abrupt Changes in Lateral Stiffness

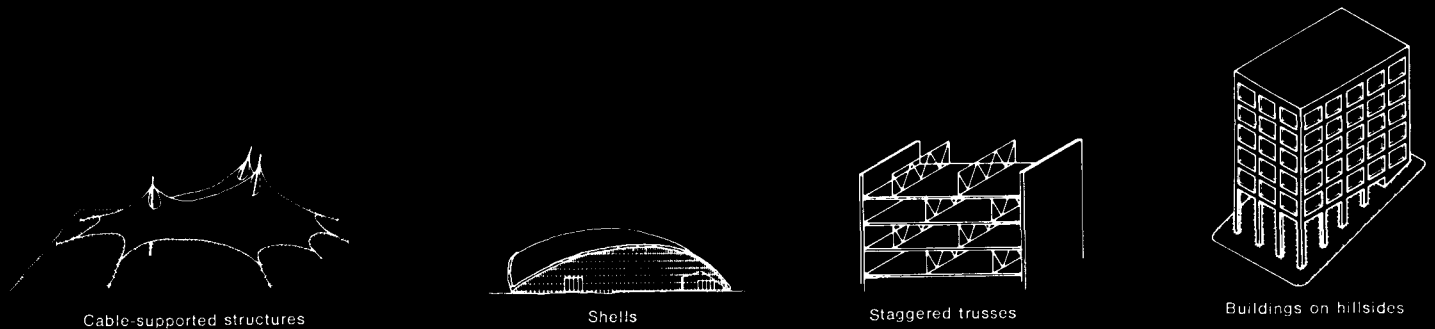

Unusual or Novel Structural Features

In spite of a long recognition of the importance of configuration, it was not dealt with at all in U.S. codes until the 1973 edition of the Uniform Building Code. Now the issue is treated only with a general caveat. If the subject is important, why is this so? And to what extent can the designer feel confident that if, assured by the engineer that his design is in accord with the code, critical configuration issues are thereby addressed?

Configuration has been found too difficult to codify—to reduce to the relatively simple set of prescriptive rules that is our typical code format. This difficulty is explained in the commentary portion of the "Structural Engineers Association of California (SEAOC), Recommended Lateral Force Requirements and Commentary (1975)": "Due to the infinite variation of irregularities (in configuration) that can exist, the impracticality of establishing definite parameters and rational rules for the application of this section are readily apparent. These minimum standards have, in general, been written for uniform buildings and conditions. The subsequent application of these minimum standards to unusual buildings or conditions has, in many instances, led to an unrealistic evaluation."

The importance of this last sentence cannot be overemphasized. In the SEAOC commentary (which is not reprinted in the code and hence will be unfamiliar to many architects) are listed more than 20 specific types of "irregular structures or framing systems" as examples of designs that should use dynamic analysis rather than the equivalent static force method. These are illustrated in figure 1 in a graphic interpretation of the SEAOC list. It is clear that bare adherence to the code will not ensure that the influence of configuration has been addressed. The equivalent static force computation methods specified in the code, by which estimated seismic forces are derived from design principles, are specifically related to regular buildings and do not apply to all those irregular forms defined above.

The percentage of buildings in seismic areas that fall into one of these irregular categories is difficult to estimate. However, one

disturbing recent design trend is for highly irregular shapes to originate in the Eastern U.S. and migrate unmodified to the seismic regions of the West.

It is useful for the designer to acquire an intuitive sense of the way seismic forces affect a building and its resistance systems. The term intuitive suggests knowledge which is based on theoretical understanding so well absorbed that knowledge becomes feeling; this generally occurs as the result of experience. The architect may neither be in a position nor wish to acquire the depth of theoretical understanding and experience that is necessary for the engineer, but it is worth attempting to transfer the feeling for structural forces because, once acquired, this feeling acts as an almost unconscious guide to the designer.

Before considering these issues in more detail we should look at the ways in which the building reacts to the dynamic or moving forces of ground motion. The complexity of this reaction can be compared to the simplicity of the building response to the static force of gravity. If a 100-pound weight is set on a floor, there is no way that the structure can avoid carrying that precise weight down to the foundation. Regardless of structural design or the floor material, the imposed load remains at 100 pounds and it will impose that load continuously for as long as it remains in position.

But because earthquakes exert rapidly fluctuating dynamic loads, we cannot begin to determine seismic forces unless we know a building's dynamic characteristics: its geometry, mass, stiffness and strength. And even with this knowledge the sequence of events and the interaction of different elements of the building under dynamic loads are so complex that the exact nature of seismic forces must always be subject to great uncertainty. This complexity should be remembered when visualizing the lateral forces on a building configuration which are generally modeled by diagrams such as figures 2 and 3.

This kind of diagram originates in the form of the typical seismic design analysis, in which earthquake forces are separately applied to each of the main axes

of the building. To choose to consider only two axes is rational in the case of a rectangle. For a circle, all axes are the same; for complicated shapes, the building might have to be looked at along several axes. The basic concept is that since earthquake forces may come from any direction, the application of forces perpendicular to the major axes of walls or frames usually simulates the two worst cases. If ground motion and its corresponding forces occur diagonally, then the walls or frames along both axes can participate in its resistance and the forces in each will be correspondingly reduced. Hence consideration of forces along each axis in turn results in a computation of worst case situations. It is important to emphasize that in actuality earthquake forces and their determination are much more complex than our diagram would indicate.

Ground motion is random, and the main direction of emphasis will only be axial by chance. In any event, total ground motion will always include nonaxial components. So a better diagram for visualizing configuration reaction to ground motion might be figure 4.

A building is not a homogeneous block, but an assembly of parts. Each part receives forces from adjoining parts through joints, horizontally and vertically. At the scale of a steel section or of wood blocks, the behavior of the T-plan/section is quite different from that of the full-size building. In the homogeneous section, the top flange of the T provides useful resistance along the axis of the leg of the T. For the full-size building, the overall T shape contributes nothing in the way of useful resistance. On the contrary, as we shall see, the wings of the T give rise to torsion and incompatible deformations (5).

Because the building is not a homogeneous block, in a larger building the ground motion will affect parts of the building at times that are different enough to be significant, and may automatically induce torsion or incompatible movement even in a geometrically symmetrical building (6).

The building, being made of parts and connections, will have different localized strengths and

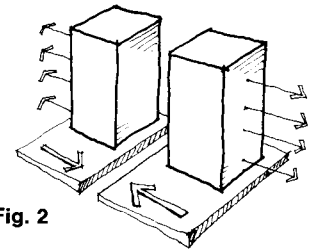

Fig. 2

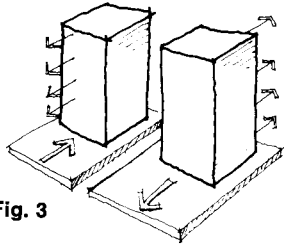

Fig. 3

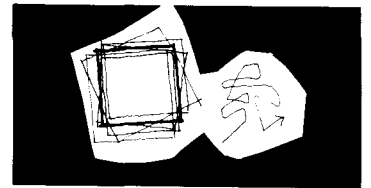

Fig. 4

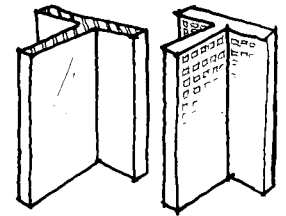

Fig. 5

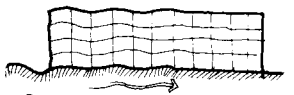

Fig. 6

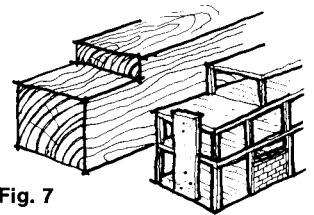

Fig. 7

stiffnesses — some calculated, some inadvertent—caused by the interaction of nonstructural elements or configuration influence. This further removes its behavior from that of a homogeneous material (7).

Most architects have acquired a good sense of vertical forces. One way of attempting to transfer a feeling for the way in which lateral forces work is to imagine them as vertical forces, rotated 90 degrees. The discussion that follows uses this technique in the attempt to transfer the sense of the effects of seismic forces and the way we resist them.

In designing to resist seismic forces, the structural engineer uses a quite small vocabulary of components and systems. Rigid frames, shear walls, braced

frames and diaphragms represent the four basic resistance systems by which we ensure that structures can resist potential lateral forces (8).

Shear walls are really vertical cantilever beams, resisting through their strength and stiffness. Bracing acts in the same way, though the system is generally less stiff. Rigid frames rely on very strong joints between columns and beams. The system is generally much more flexible than walls or braced frames, but is very efficient structurally. In really tall buildings, the flexibility will give occupants an exciting ride in a major earthquake, for deflection may approach four feet at the top of a 50-story building.

The vertical elements are connected by horizontal diaphragms that transfer loads through the building to the vertical resistant elements, which in turn transfer the loads back to the ground through the foundation. Diaphragms are horizontal beams; their edges are designed as collectors that act like the flanges of an I-beam. Rotate the diaphragm 90 degrees and its action becomes obvious (9). Any architect knows that you should not cut a notch in the flange of an I-beam; in the same way, notches should not be cut in diaphragms, but often holes for elevators, stairs or mechanical ducts are made in critical locations of diaphragms (10). Remember also that the edges of a diaphragm may act both as compression and tension flanges as the seismic forces vibrate.

Figure 11 shows a building with shear walls at its end. Inertial forces caused by ground motion are created in the building, causing the floor diaphragms to move (toward the right in the upper illustration). This is resisted by the shear walls. The dynamic nature of the quake will cause a reversal of these forces, and a vibration sequence for a number of seconds, depending on the nature and size of the quake. If the building is rotated (bottom illustration), it is clear that the shear walls are acting as cantilever girders supporting beams represented by the floor diaphragm.

Figure 12 shows above a short and a long cantilever beam, between them supporting a load of

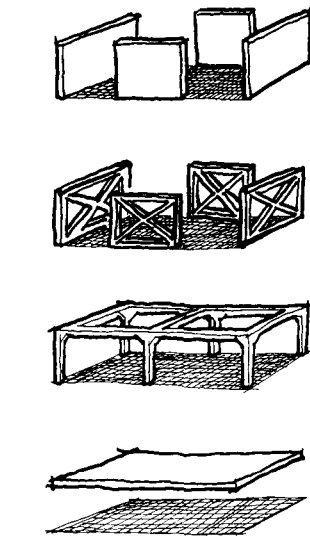

Fig. 8

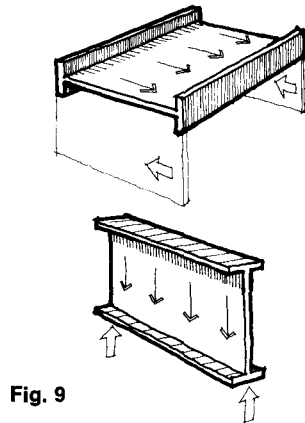

Fig. 9

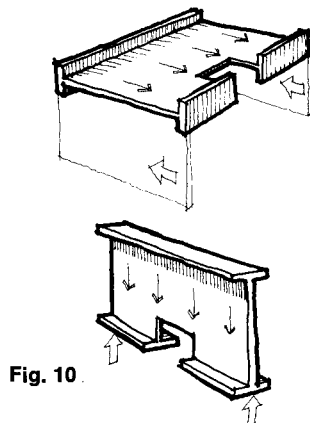

Fig. 10

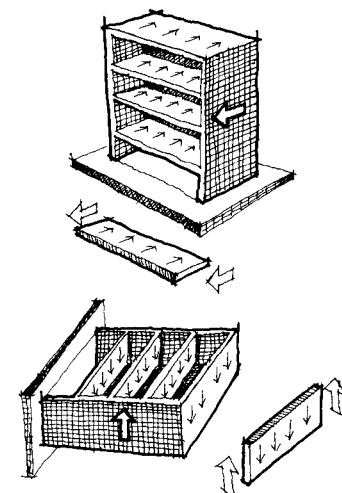

Fig. 11

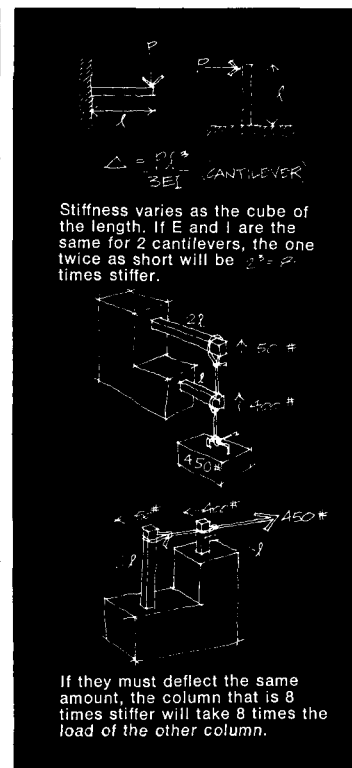

Fig. 12

450 pounds. Our knowledge of mechanics tells us that this load will be distributed in such a way that the short stiff beam will carry eight times the load of the longer flexible beam. This is entirely a characteristic of the geometry of the beam. If this assembly is rotated, we have a frequent condition in first floor columns of buildings. Architectural or site considerations, as shown in the small sketches, may create this condition. When the ground shakes, the short stiff columns will bear the brunt of the forces and will fail if not designed in recognition of this fact. Sometimes the forces may be so great that it is not possible to make the structural detail resist the forces.

Torsion forces are created when the building rotates about its center of rigidity. This occurs when the center of rigidity of the building is eccentric to the center of gravity. In the first illustration of figure 13, the block has a symmetrical resistance system against the lateral force: In a building (second) this might be a diaphragm connected to two equally resistant shear walls. No torsion. But in the third drawing the center of gravity of the block is eccentric to the one support and the lateral force causes rotation. The building equivalent (fourth) might be a building with a strong shear wall at one

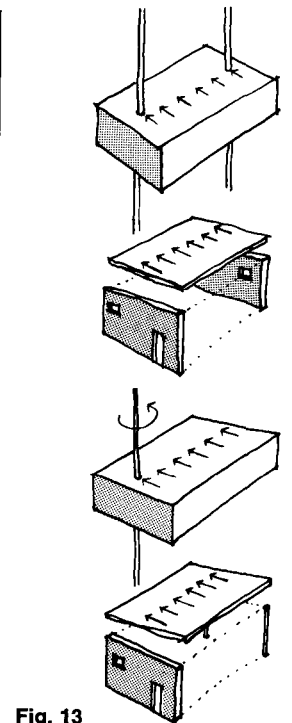

Fig. 13

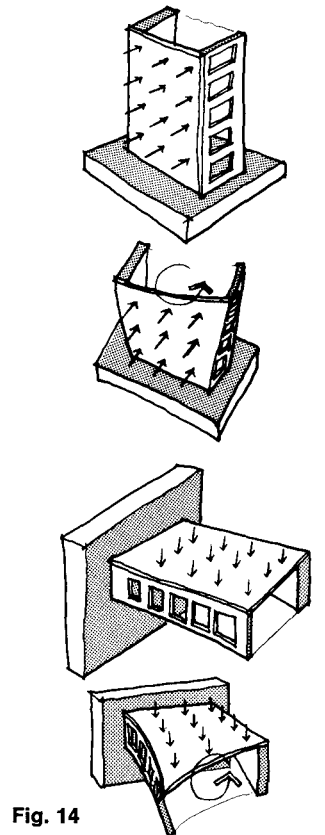

Fig. 14

end, and a weak frame at the other. Figure 14 (top) shows a portion of a building with this condition. As the lateral force enters it, the building tends to twist. Rotating it 90 degrees and *imagining* that this structure cantilevers from a wall, it is easy to sense what is going to happen. These torsional forces are difficult to calculate, and they may be very great.

L-shaped buildings are very prone to incur torsional forces.

Figure 15 (top drawing) shows an L-shaped building in which the hinge of the L acts like a stiff shear wall of the structure in figure 14, so that the lateral forces tend to make the weak end rotate and create torsion. Rotate the building 90 degrees (second) and it is clear what is happening. One solution is to disconnect the two wings (third) and each building will act as a simple rectangle; the forces then are much easier to predict and compute. The rotated illustration (bottom) begins to suggest the kind of resistance systems necessary. Of course if the earthquake strikes from another direction, then the roles of the two sections of the building will reverse.

Buildings with wings have a notch, at the re-entrant corner. An identical situation also occurs in buildings with a setback, which are vertical L-shaped buildings (figure 16, top). The notch is a weak point, because there is heavy force concentration at this location. Why this is so is easy to feel if the building is rotated and becomes a cantilever structure. If it is made out of a homogeneous material, it will fail at the notch when an overload is applied. Even though the building is not homogeneous, the stress concentration will occur and will affect whatever material is in that location.

These notes on seismic design concepts indicate an approach to the understanding of seismic design. The items shown represent issues that are particularly relevant to the study of configuration and seismic design, and these themes will recur in the following listing of configuration problems.

A number of problem areas in which configuration is a major issue can be identified. There are two types: One type involves problems intrinsic to the geometry of the overall configuration of the building and is an aspect of the form of the building as a whole. The second type involves problems that relate to the nature, size and location of the resistant elements within the form. It should be noted that these problems are not mutually exclusive. On the contrary, they can be combined with one another, to the overall detriment of the seismic design.

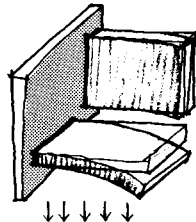
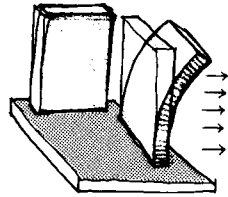
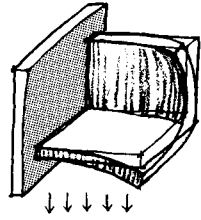
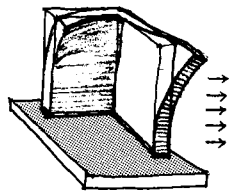

Fig. 15

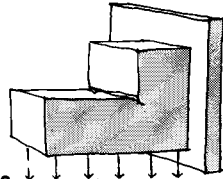
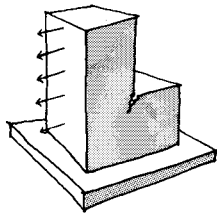

Fig. 16

The presence of these problems does not necessarily mean that the building is unsafe. It simply indicates the need for wariness as the seismic design proceeds, and recognition that, depending on the extent to which the problem is present in a gross form, special design steps may be necessary to ensure good building performance.

Some of these problems may be intrinsic to other building determinants — of urban design, program or esthetic intent—and hence cannot be avoided. But we believe that an understanding by the architect of the nature of the problem will make the seismic design more effective and lessen the detrimental effects. Often such understanding will enable

the designer to achieve the desired configuration effect without detriment to the seismic design through modifications that are of great seismic significance but of little architectural moment.

Five problems due to general building form can be identified. Three of them will be only briefly mentioned. Extreme height/width ratios can create large overturning forces. Extreme plan areas can result in the building having trouble responding as one unit to earth motion, and may also result in the buildup of large diaphragm forces. Extreme elevation length may result in the buildup of large shear forces. Historically these conditions have caused damage, but have not resulted in the most destructive failures.

Setbacks produce a stress concentration at the notch. They also produce a large shear force that must be transferred through the diaphragm at the transition (17). The narrow tower, set back from a broad base, is a common building form, particularly for hospitals, hotels and offices, in which the broad base is often used as a parking garage. Engineer S. B. Barnes has discussed this type of structure:

"The tower usually has a moment resisting frame with no shear walls. The large base structure usually involves basement stories which obviously must have basement walls which have almost infinite rigidities as compared to the more flexible frame which carries through under the tower. At the transition level then we need an especially heavy diaphragm to transfer lateral forces from the tower area to these perimeter basement walls, and special attention must be given to strut-tie connections at this level."

Re-entrant corners and complex forms is a huge family of forms, including L, T, U shapes and their combinations. Curved forms and courtyard forms are also included. The re-entrant corner acts as a notch, producing a stress concentration; the form also tends to induce torsion since the free ends of the wings are less stiff than the connected ends (18).

The stress concentration at the hinge produces high diaphragm forces, particularly if the wings are long, but building circulation

requirements always tend to place the elevator and staircase core at this location, so that often the diaphragm is perforated at the location where it needs maximum integrity (19). The so-

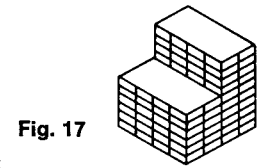

Fig. 17

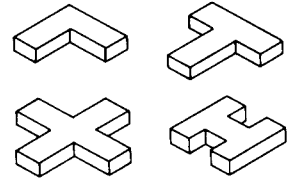

Fig. 18

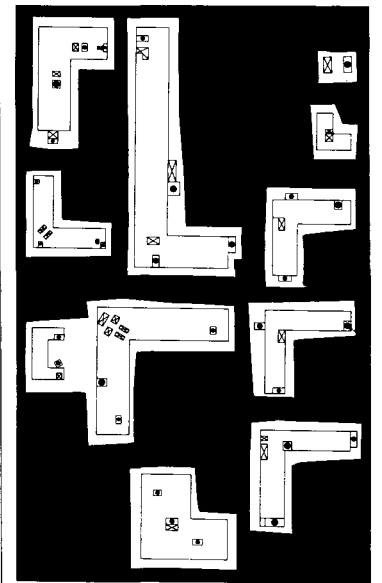

Fig. 19

lution is to separate the building into simple forms, taking care to allow adequate separation to obviate pounding. Other solutions, dependent on the size and proportion of the building, are to enclose the building in a shear-wall box or to provide a stiff box at the point of convergence of the wings. Stress concentration at the notch can be relieved by an architectural splay that allows a triangulated horizontal framing structure.

"Soft story" is a major class of problems that relates to the size, nature and location of resisting elements. In its commonest form, this is created by a programmatic requirement for a high first floor. The result is an abrupt change of stiffness at the transition from long flexible columns to the stiff superstructure, and a concentration of stress at the transition. The soft story may occur at an upper floor, but the shear forces

reduce on the upper floors, so the condition is not so serious (20). Sometimes, also, in the effort to achieve an open first floor, vertical supports are reduced, so that there are larger spans at the second floor level. Hanson and Degenkolb in *Earthquakes* comment on the soft story as follows:

"There is a strong architectural tendency throughout the world to have an open first floor—to place the building on 'stilts' as it were. . . . It cannot be emphasized too strongly that current earthquake code requirements are not based on this type of dynamic stiffness distribution, and potentially a great amount of trouble should be expected where these buildings are built to minimum shocks. The damage to many buildings in Caracas gives ample warning as to what lies ahead on the West Coast of the U.S."

A special case of the soft story is that of the discontinuous shear wall. When shear walls do not line up in plan from one floor to the next, forces cannot flow directly down through the wall from roof to foundation (21). The resulting indirect load path

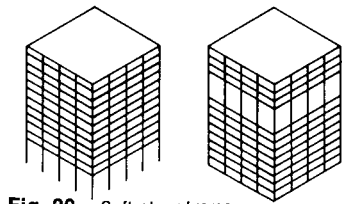

Fig. 20 Soft story frame

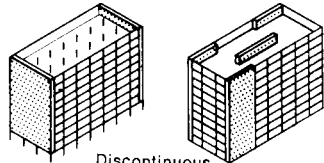

Fig. 21 Discontinuous shear wall

can result in serious overstressing since the shear walls are the main vertical resistant elements of the building and will be very highly stressed.

Often the discontinuous shear wall condition represents a special but common case of the soft first-story problem. The requirements for an open first floor result in the elimination of the shear wall at that level, and its replacement by a frame. It should be emphasized, once more, that the loads will be greatest at first-floor level, and removal of the shear wall at this location in effect removes its rea-

son for existence, for it cannot transmit the floor shear to the foundation. Thus the discontinuous shear wall that stops at the second floor represents a "worst case" of the soft first-floor condition.

The damage to the Olive View Hospital in the San Fernando, Calif., earthquake of 1971 provides unusually clear examples of soft story failures. The building also represents a classic case of discontinuous shear wall. The general vertical configuration of the main building was a soft two-story layer of rigid frames on which was supported a four-story (five counting the penthouse) shear wall-plus-frame structure (22). The severe damage occurred in the soft story portion, which is generally to be expected. The upper stories moved as a unit, and moved so much that the columns at ground level could not accommodate such a huge displacement between their bases and tops and hence failed. The largest amount by which a column was left permanently out of plumb was two and a half feet (photograph 23).

A discontinuity in vertical stiffness and strength leads to a concentration of stresses and damage, and the story that must hold up all the rest of the stories in a building should be the last, rather than the first, component to sacrifice.

Though it is not as widely known, the stair towers at Olive View also show a clear example of a soft first-story failure. The nature of this failure is not obvious because the towers (and the main building) have a second floor that extends out to form a plaza. Thus, in photographs the towers appear to have a first floor at grade level, and the main building appears to have a single soft story rather than two (23). These seven-story towers were independent structures (22a) and proved incapable of standing up on their own. Three overturned completely and the fourth leaned outward 10 degrees. The six upper stories were rigidly braced with ample solid reinforced concrete walls, but the bottom soft story was composed of six reinforced concrete columns, which failed. The exception was the north tower, whose walls came down to the foundation directly

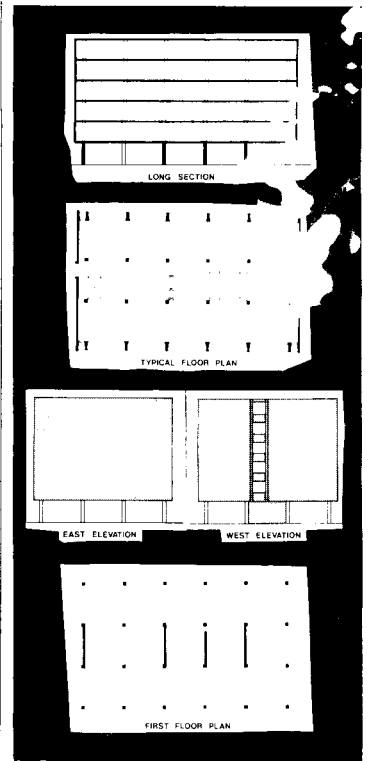

Fig. 24

without any discontinuity; this was the only tower that remained standing. Obviously, none of the towers was adequately built to prevent overturning, since the 10-degree out-of-plumb of the north tower might easily be called "failure," but it is clear that this flaw was compounded into total collapse only where the soft story was present.

While one may attribute the proximate cause of these stair tower failures to the detailed design of the reinforced concrete columns that failed (such as the inadequacy of their ties) and to the extreme ground motion, it is clear that the configuration factor was responsible for setting up this over-stress situation. No matter how well the reinforcing is designed, a more reliable general solution would have been to eliminate the discontinuity created by the termination of the shear walls.

The behavior of the Imperial County Services Building, El Centro, Calif., in the Imperial Valley earthquake of 1979 provides a textbook example of the effects of a discontinuous shear wall type of soft first story on seismic resistance. The building is a six-story reinforced concrete structure (24) built in 1969. In the relatively mild earthquake in which only a few of the poorest unreinforced masonry buildings suffered structural damage, this

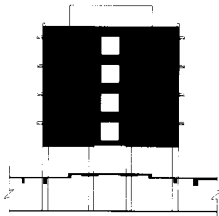

Fig. 22

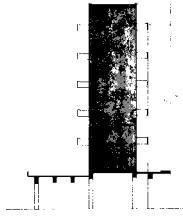

Fig. 22a

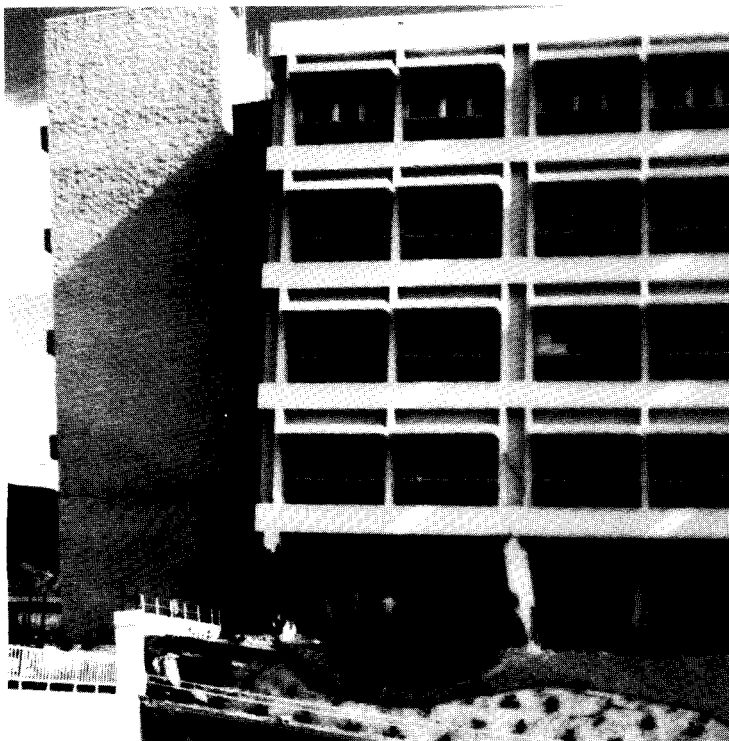

Fig. 23



Fig. 25

building suffered a major structural failure, resulting in column fracture and shortening, by compression, at one end (the east) of the building. The origin of this failure lies in the discontinuous shear wall at this end of the building (25). The fact that the failure originated in the configur-

ation is made clear by the architectural difference between the east and west ends. The difference in location of the ground floor shear walls was sufficient to create a major behavioral difference in response to rotational forces on the large end shear walls (26).

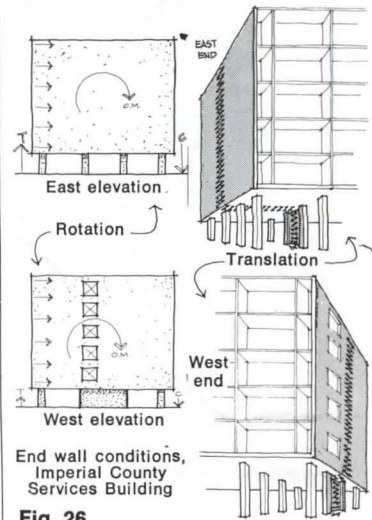

Fig. 26

The 1978 earthquake in Sendai, Japan, provides other examples of soft first-floor failures, such as the Obisan building, a rigid box supported on four columns (27).

Solutions to the problem of the soft story start with its elimination: to avoid the discontinuity through architectural design. If for programmatic or compelling image reasons this is not possible, the next step is to investigate means of reducing the discontinuity by other design means, such as by increasing the number of columns or adding bracing. Alternately, a high first floor may be attained but dynamic discontinuity eliminated by introducing a vertical super bay in which the main structure

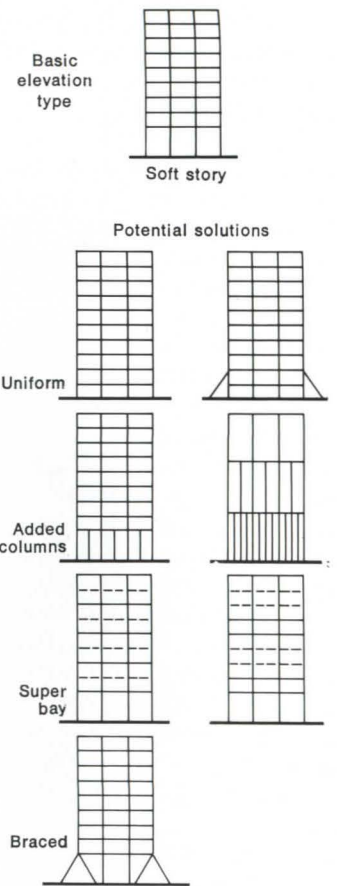

Fig. 28

has uniformity of stiffness throughout its height and additional lighter floors are inserted in such a way as to have as little effect as possible on the characteristics of the main structure (28). The solution to the discontinuous shear wall condition is, unequivocally, to avoid it.



Fig. 27

Variations in column stiffness are created when columns of varying length or of varying architectural design form the supporting structure. Often a sloping site will result in a variation in first-floor column length; sometimes columns are deliberately exposed freestanding to two or three stories in length for architectural effect (29).

The seismic forces will seek out and concentrate on the stiff elements with the result that these may receive a disproportionate share of the loads and may fail. Two particular instances are worth comment. It is a common architectural design approach to place a narrow, wide window between columns to provide high level, or clerestory lighting. Its structural effect is counterintuitive, because the short column looks stronger than its neighbor. In fact its strength is the same, but it will receive far more load.

The other instance of note is that often the same kind of condition is created by an infill wall which, if of masonry, will greatly stiffen the panel and leave a short stiff column, with the same detrimental result. Such an infill may be done without the struc-

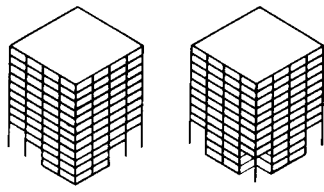

Fig. 29

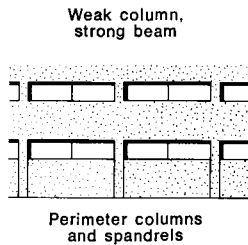

Fig. 30

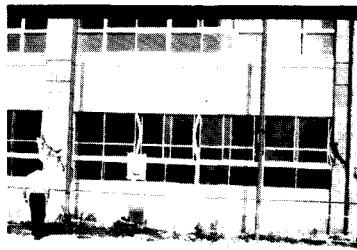

Fig. 31

tural engineer's knowledge, either as an architectural element or even as a later remodeling activity. The solution is carefully to equalize the stiffness of all columns. If long columns are required for architectural effect,

they can be braced to reduce their effective length. If infill walls are required, they must be detached from the columns so that inadvertent stiffening does not occur.

With weak columns and strong beams, a stiff (generally very short) column is rigidly attached or braced by a deep stiff beam or wall that acts as a beam. The characteristic condition is that of a deep concrete exterior spandrel between widely spaced brittle columns (30). As a result, shear forces seek out the stiff columns and subject them to extreme stress. Often the condition is accompanied by conditions of unequal stiffness, as noted above, and so a small number of columns will be subject to extreme shear.

This is a well understood phenomenon, but the conditions for its occurrence continue to be designed. Many instances of failure through this condition were observed in schools and other buildings in Sendai in the June 1978 earthquake. Photograph 31 shows this school very close to total collapse. The solution is to avoid deep structural spandrels, and to design nonstructural spandrels in such a way that they are

detached from adjoining columns and cannot act to stiffen them.

Variations in perimeter strength and stiffness occur in buildings in which there is wide variation in facade structure and materials between the elevations of the building. The reason for this variation is often programmatic. Two common examples are the store, with a glass front and solid side and end walls, and the fire station, with large vehicle openings at one facade and solid walls on the others. This kind of design and construction is extremely common in commercial structures, often of great size and mass, which by their economic nature tend to be inexpensive buildings designed to minimum code standards.

Because of the large discrepancy in mass and stiffness between solid and open facades, seismic forces create torsion; the forces may be very great. A classic instance of this kind of effect is that of the J.C. Penney building (32) in Anchorage in the 1964 Alaska earthquake. The building was so badly damaged by torsional forces that it had to be demolished. Three people were killed. The store was a five-

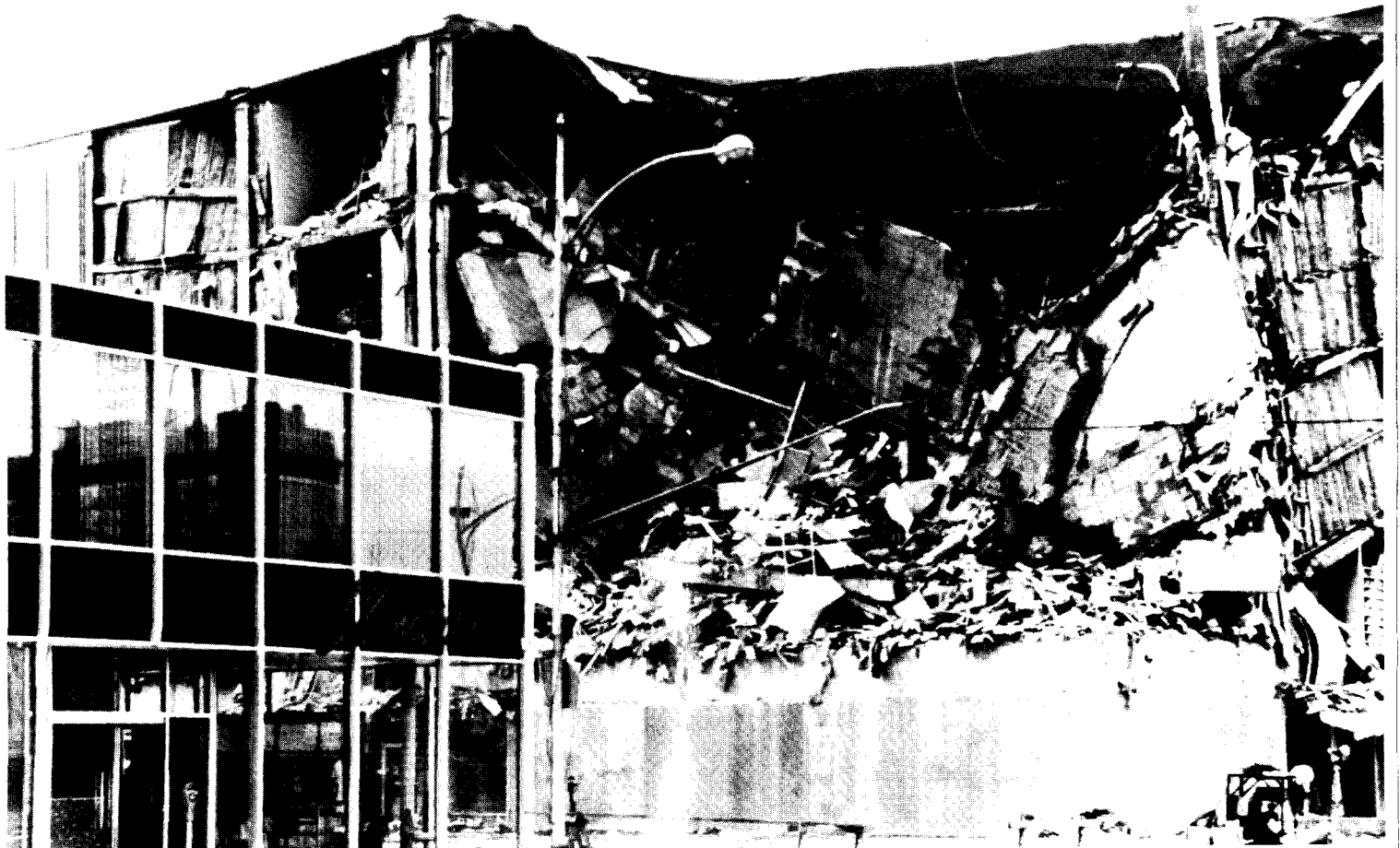

Fig. 32

story building of reinforced concrete construction. The exterior wall was a combination of poured-in-place and concrete block walls and precast concrete nonstructural panels which were heavy but unable to take large stresses.

In the first story there were shear walls on all facades, but in the upper stories the north wall was structurally open with large quantities of shear wall on the other three facades. These major discrepancies in strength and stiffness produced large torsional forces that the building was unable to resist (33).

The solution is to equalize the strength and stiffness of the facades dynamically. This is not difficult to do, while still maintaining the desired architectural treatment. If the entire structure is designed as a frame, lightweight cladding can be transparent (glass) or opaque to suit the program requirements while maintaining the uniformity of resistance.

Since the building core is often designed as a major resisting ele-

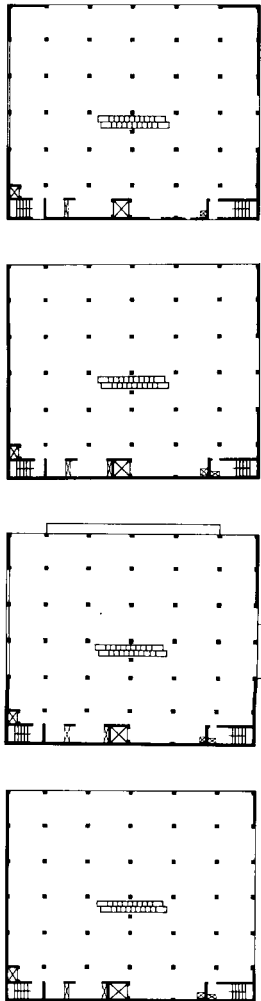

Fig. 33

ment, with great strength and stiffness, its location is critical. If the core is located asymmetrical in an otherwise symmetrical structure, the result is to make the entire structure dynamically asymmetrical and to induce torsion. This condition is called "false symmetry" because superficially the building appears symmetrical although dynamically it is not (34).

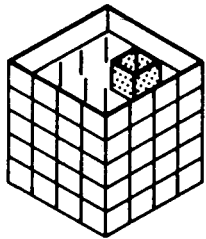

Fig. 34 False symmetry

Experience has shown that this condition creates major torsional problems. Furthermore, that relatively small design differences between multiple cores in a building may be enough to induce significant torsion. Collapse in 1964 of the Four Seasons Hotel in Anchorage is generally attributed, among other factors, to the asymmetrical placement and differing design details of the two cores.

The core location has a major impact on the planning and circulation system of the building, and it is unrealistic to insist that cores be located based solely on seismic requirements. That being the case, the solution is to recognize the dynamic conditions that will apply and design the entire resistance system of the building to counteract detrimental tendencies as far as possible. As part of this strategy, it may prove wise not to use the cores as a major resistant element at all; it should be remembered that a core is basically a hole in the diaphragm (which brings its own problems), and the enclosing walls do not necessarily have to be heavy structural walls.

This list of problems is not exhaustive, but is intended to clarify and organize their identification and analysis. We have not discussed holes in shear walls and diaphragms, which are configuration problems. The problem of pounding may be a consequence of the solution of the configuration of an L-shape or large plan building, in which inadequate separation is provided

at the seismic joint.

One final direction. When seismic design and configuration are taken seriously, there are some architectural consequences that, rather than being restrictive (don't do L-shaped buildings, don't do soft first floors, etc.), may suggest the possibility of an interesting positive approach to design. This might be called a "new regionalism" in design. It seems right that when you design a building in California or Japan, it might look rather different from a building elsewhere where seismic requirements differ (35, 36, 37).

There is a good history of the expression of lateral force elements in buildings—not seismic forces, for the ideas of design for seismic forces had to await modern analytical methods. But the expression of lateral force resistance in a Gothic cathedral is an important part of the imagery of that building type.

In fact, traditional designers substituted for analytical methods a sound intuitive sense of building behavior. One of the ef-

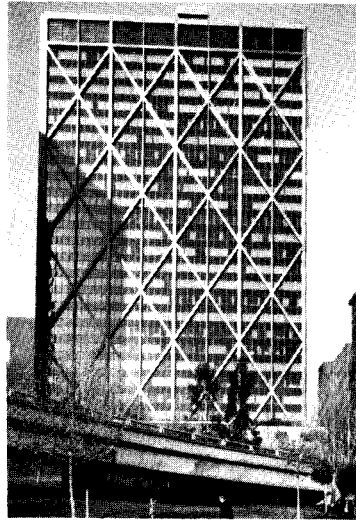

Fig. 35

fects of our split between engineers and architects is that the form giver may rely on the engineer's analysis and lose an intuitive sense of the forces acting on the building. It is also true that with traditional buildings in earthquake country, configuration was the first line of defense, for materials and construction methods did not exist that make today's homogeneous and ductile structures possible. This is the major explanation for why some historic structures, which fall far short of meeting seismic codes, have survived earthquakes, often repeatedly. It also reinforces the notion that for the buildings we design the seismic influence of configuration is worth our while to try to understand. □



Fig. 36

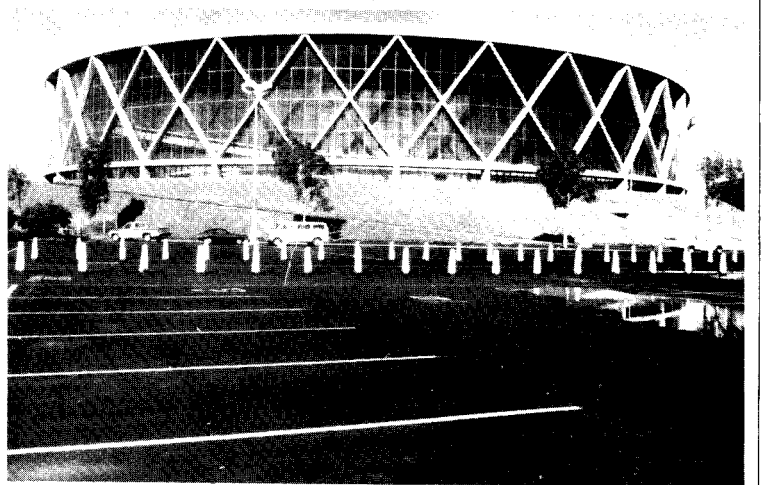

Fig. 37



The Seismic Legend of the

How did it really fare in the Tokyo earthquake of 1923



Photographs by RETORIA/Yukio Futagawa

Imperial Hotel

by Robert King Reitherman

"HOTEL STANDS UNDAMAGED AS MONUMENT OF YOUR GENIUS.
HUNDREDS OF HOMELESS PROVIDED BY PERFECTLY MAINTAINED
SERVICE. CONGRATULATIONS.
OKURA"

This dramatic radio telegram from Tokyo by Baron Okura, the key financial promoter of the just completed Imperial Hotel, was the first word to reach the U.S. concerning the Sept. 1, 1923, Great Kanto earthquake: The Imperial Hotel earthquake legend had just sprung to life full grown. As Finis Farr, one of Wright's biographers, has noted, "The publication of this message in the newspapers was the start of the widely believed and printed myth that the Imperial Hotel was the only building in Tokyo to withstand the earthquake. This, however, was far from the truth."

If one were to choose the building whose performance in the 1923 earthquake, or perhaps any earthquake, had the greatest influence on architectural historians and journalists and therefore the mass audience, it would no doubt be the Imperial Hotel. But if one were to look at the structural performance that was most noted and discussed among engineers, or to single out the examples that had the greatest effect on both the development of the state-of-the-art of seismic design and on the evolution of the modern aseismic building code, then the Tokyo buildings designed by Dr. Tachu Naito would be the obvious choice.

The family tree of our contemporary seismic state-of-the-art can be traced back through Naito (and Suyehiro, Sano, Imamura, Omori, Milne and others in Japan) and to Italy and elsewhere in the latter half of the 19th century, but Wright is not part of this lineage. The Imperial Hotel case stands outside this evolutionary history.

How well did the building perform? The Imperial Hotel experienced some nonstructural and structural damage in the 1923 earthquake: The dining room floor bulged and required cutting and shimming of concrete columns to relevel it, and fans, kitchen equipment, lights, partitions and other similar non-structural items were damaged. The insurance companies' damage rating system used a five-point scale. The Imperial Hotel was listed in the category of second-best performance, or light damage. There were other large buildings that were rated in the first category. The Tokyo building inspection department's estimates, which included fire as well as earthquake damage, list about 19 percent of the city's brick buildings in the undamaged category, and a little over 20 percent of the steel and reinforced concrete buildings in this category.

Typical, second-hand contemporary press accounts that the building "withstood the earth stresses far better than other large buildings in Tokyo" were thus in error, and the recently made statement that "Frank Lloyd Wright's finest hour was when his Imperial Hotel in Tokyo stood while others fell" might be more accurately rephrased to say "while *some* others fell (and while some others performed better)." The map of intensity, or ground shaking severity, prepared immediately after the earthquake by A. Imamura, one of Japan's foremost seismologists of the day, placed the Imperial Hotel in the second most intense category out of four levels of shaking. A good deal of Tokyo was within this category or the highest level of intensity.

Tokyo's main train station, according to contemporary reports, performed better; it was nearly in the same estimated

Mr. Reitherman is a research associate with Building Systems Development, Inc., San Francisco. This article was adapted by the author from his paper submitted to the seventh World Conference on Earthquake Engineering.

A monolithic mass on a flexible cushion.

ground shaking severity zone and was of comparable size. While these basic facts may not be surprising to Japanese readers, there is a considerable amount of misconception in other countries. The building's structural performance, under these circumstances, might be termed good, but not outstanding. If foundation settlement had not occurred (and it is differential settlement which the contemporary reports blame for the structural damage to concrete columns and floors) the building would apparently have performed quite well.

As was the case in San Francisco's 1906 earthquake, most of the damage was caused by the subsequent fire that swept Tokyo and Yokohama, rather than the earthquake itself. In this sense the fact that the Imperial Hotel survived the fire, which was partly due to nonflammable construction, partly its location across the street from a park, and partly due to the use of water from its pool, is more significant than its earthquake performance. In 1945 the hotel was not so fortunate: A fire started by an American bombing raid partially destroyed one wing.

Many people have heard that the building's foundation system somehow isolated the building from the earthquake's vibrations, and that this was responsible for good performance. The foundation system was certainly quite novel: Nine-inch diameter tapering concrete piles only eight feet long were set about every two feet along the length of the walls, in pairs or threes side by side. According to Wright, who supervised his own boring and pile-testing program, about eight feet of soft surface soil (nicknamed "cheese") overlaid about 75 feet of softer alluvium, and ground water extended to within about two feet of the surface. (Recent borings in the area show a pattern of 50 to 60 feet of alluvium overburden covering gravel and sand.)

Wright theorized that "because of the wave movements, deep foundations like long piles would oscillate and rock the structure. . . . That mud seemed a merciful provision—a good cushion to relieve the terrible shocks. Why not float the building upon it?—a battleship floats on salt water." Julius Hoto, the project's Japanese structural engineer, agreed. "These piles, tying the heavy superstructure of the taller buildings to the solid earth below, transmitted the full intensity of shocks."

Hoto's and Wright's attraction to the idea of a "monolithic mass resting on a soft flexible cushion" is perhaps not itself theoretically invalid, but it does lead to the related problems of providing adequate vertical support to prevent settlement and of making an entire building truly act monolithically. The "soft story" concept as applied to soil materials is as dubious and problematic as its application to the ground story of a building. It is likely that the underlying mud, rather than being a "merciful provision—a good cushion," was rather an amplifier of the ground motion.

However, at the same time that it would have increased the amplitude, it would have affected the frequency content of the motions, filtering out the short frequencies and transmitting a predominantly long period motion to the surface. (It is difficult for a deep layer of soft soil to vibrate rapidly, while its natural tendency in an earthquake is to vibrate in a way that observers typically compare to the rocking or rolling motion of being in a small boat.)

The Imperial Hotel was demolished in 1968, amid worldwide but ineffectual protests. Probably the prime reason for the economic obsolescence of the hotel was its lowrise, low density design and its high-priced, central Tokyo location. A reporter also noted that the owners, the Inumarus, had cited the fact that "the structure was impossible to repair, and was slowly sinking into the mud." The central seven-story portion of the complex settled two feet in the earthquake. From 1955-1965 it sank five inches. Total settlement at the rear of the central section in the 45-year life of the structure was three feet, eight inches. Settlement was definitely a major problem.

In the opinion of Richard Bradshaw of Los Angeles, structural engineer, "When one sifts through the 'waiter carrying trays,' 'the earth waves,' 'cheese foundation,' etc., one finds that what the man did was drive piles. It's as simple as that . . . [another] misconception is that the choice of foundations [very shallow piles] was even a wise one." Although there is much to learn about soil/structure interaction and local geological effects, at this point it appears likely that the design feature which Wright and others have primarily credited with the success of the Imperial Hotel's 1923 performance, the short pile foundation system, was in fact the probable primary cause of the damage experienced in 1923 from the earthquake and in subsequent years due to ongoing settlement. Taller buildings in Tokyo, which used deep pile foundations (and which probably tuned in more to the ground motion due to their greater height, and hence longer period of vibration) suffered less damage, indicating that the usual foundation design method was a sound approach.

Bradshaw passed harsh judgment on the building's foundation system: "The writer will stand hat in hand, respectfully at attention while architects eulogize Frank Lloyd Wright as an architect . . . but when they make extravagant engineering claims for him, I feel I must speak out. . . . Engineers, and I mean the good ones, not the $WL^2/8$ type, look elsewhere than to F.L.W. for leadership engineering. I have found from experience that I am howling into the wind when I criticize the great man in any way whatsoever. India has its sacred cows and we have Frank Lloyd Wright." Bradshaw was writing in 1961, and now the "sacred cow" comment seems anachronistic to the point that one must be careful that our contemporary revisionist impulses in regard to the modern masters does not bias us in the other direction.

The analogy of the waiter's tray was also emphasized by Wright in his subsequent explanations for the way the building withstood the earthquake. Wright stated: ". . . a construction was needed where floors would not be carried between walls, because subterranean disturbances might move the walls and drop the floors. Why not then carry the floors as a waiter carries his tray on upraised arm and fingers at the center—balancing

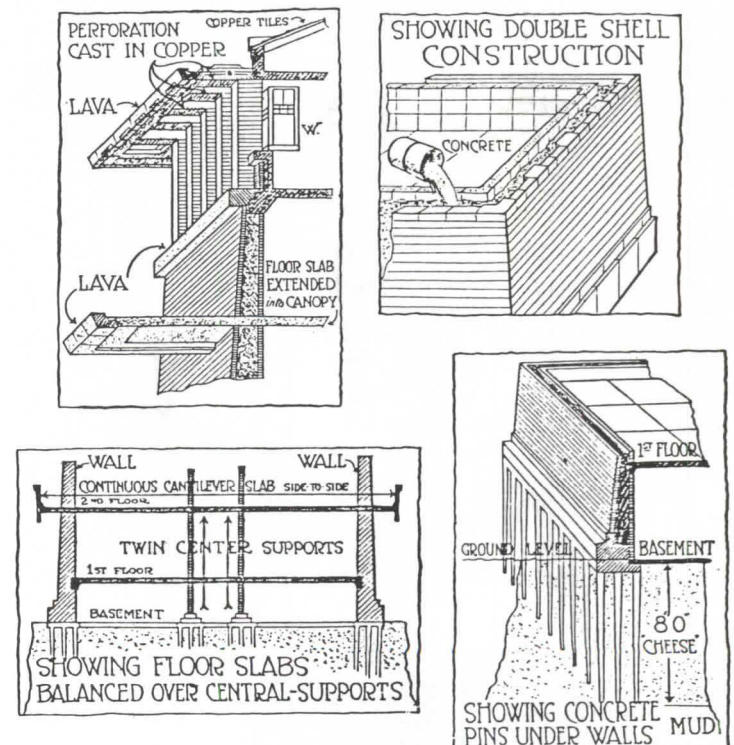

Second level floor slabs (top left) were cantilevered past bearing walls. The 'waiter's tray' concept (bottom left) placed double-loaded corridor between twin center supports. The foundation system (lower right) was nine-inch diameter tapering piles two feet apart. Walls were concrete sandwiched between brick.



the load? All supports centered under the floor slabs like that instead of resting the slabs on the walls at their edges as is usually the case? This meant the cantilever, as I had found by now. . . .”

Floors spanned transversely over a pair of columns in the middle, which straddled the double-loaded corridor, and the floors were supported by bearing walls at the exterior. Floors cantilevered past the walls to form balconies at the second level. (Hoto thought that the Imperial Hotel’s cantilever design appeared “new by virtue of the originality of architectural design,” not by its structural behavior.) It appears now that Wright was addressing a major recurring problem in masonry design: how to connect floors to walls. Wright’s reasoning that extending the slabs continuously *over* the wall, rather than “leaving them to grasp at the sides of walls,” is at least theoretically valid, but this leaves unanswered several practical issues concerning chords, wall-floor shear transfer and bond beam function.

John Milne, an English scientist who helped introduce European science into Japanese academia in the late 1800s, described turn-of-the-century Japanese buildings with wood roofs that “floated” upon their masonry walls to allow for seismic movement rather than functioning as diaphragms. This ap-

proach, however, the “waiter’s tray,” has been universally rejected by mainstream seismic design since then, and the principle of tying the floors, walls and other parts together has become one of the most basic seismic axioms.

The bearing walls were composed of an exterior wythe of solid bricks, an interior wythe of hollow patterned bricks and a solidly filled cavity of concrete. The bricks were to be of a color and type not previously manufactured in Japan. A Japanese ceramics expert was involved in the research and development phase, and a brief flurry of gang warfare between rival contractors—including an assault on the kiln itself—accompanied the production phase. This was one of the costly complications which led to a break between Wright and the project sponsors before the building was completed.

Was the concrete reinforced? In a letter to John Freeman in 1931, Wright specifically said that there was no steel reinforcement in the concrete. According to Hoto, the walls were built by “layering up an outer and inner shell of brick, filling in between, as the work progressed, with concrete and laying reinforcing steel into this concrete, thus making exceedingly strong monolithic walls.” It is symptomatic of this building’s story that there are conflicting reports concerning such a basic

Double bearing walls tapering toward the top.

point. As Shinjiro Kirishiki noted in his attempted reconstruction of the general history of the building at the time of its demolition, "several points still remain vague." The more one examines the story of the Imperial Hotel, the more vague and contradictory the historical record becomes.

Another little-known controversy awaiting resolution concerns R. M. Schindler, who managed Wright's Los Angeles office while Wright was in Japan. Schindler later wrote to Wright that "the structural features which hold the Imperial Hotel together were incorporated only after overcoming your strenuous resistance." (Wright, in turn, said that Schindler should not take personal credit for any design work done by the L.A. office and that Schindler was a World War I draft evader.)

There is even some confusion in the literature concerning the year in which the earthquake occurred. A minor earthquake occurred in 1922 while the building was still under construction, and Wright stated that measurements showed absolutely no foundation settling or other damage. Although Wright did not later confuse this earthquake with the great 1923 occurrence, others have, such as Vincent Scully in his reference to "the great earthquake of 1922." While there was no damage in the minor earthquake, there was significant damage in the large one, and hence inaccuracy in reference to the two events has tended to obscure the facts surrounding the building's actual performance.

As to the significance of the filled-cavity bearing wall construction, whether reinforced or not, Glen Berg, a University of Michigan engineering professor, has concluded that "... a construction feature that received less comment [than the short pile foundation] from the architect but which seems to me to have been a greater contributor to the success of the structure, was the exterior wall construction. The walls consisted of a double shell of brick, each shell just a single brick in thickness, but with the void space between them carefully filled with poured concrete. In principle this is not greatly different from the filled-cavity masonry walls required in California schools today." Wright also wrote that because the lava stone used as trim was "so easily worked I could hollow it out and use it for forms into which the concrete slabs, cantilevers or walls were cast and the steel reinforcement be tied into the material from beneath and all cast solidly together with the concrete. Wherever there was a chance for a flaked off piece, copper was used in connection with it to insure it." Since the Imperial Hotel was perhaps the most profusely ornamented masonry building in Tokyo, the good performance of appendages is notable. Reportedly only two pieces of garden sculpture fell.

Hoto, the structural engineer, stated that although he designed the reinforced concrete slabs and transverse frames for Wright in conformance with the code then in effect in Chicago, Wright told him "that, in building, my computations were disregarded and that much lighter sections were everywhere substituted, making in effect a design which eliminates all the strength usually provided for the live loads. In this connection, the writer would like to comment that this reduction was entirely logical. . . ." Since early code provisions dealing with reinforced concrete design for vertical loads were sometimes unduly conservative, Hoto may have been right concerning the prudence of Wright's downward adjustment of his calculations, especially since the construction supervision was apparently quite thorough. It makes the story of the Imperial Hotel even more surprising, however, since the architect disregarded his structural engineer's calculations for concrete member design, used an innovative foundation system and otherwise took responsibility for the building's structure.

The Imperial Hotel illustrates both strengths and weaknesses of the strong-willed master designer or master builder approach to architecture. Contemporary team design has obvious ad-

vantages, but perhaps it is not generally recognized that it too has weaknesses: Often the team approach leads to merely "satisfactory" or "unobjectionable" compromises rather than to superior innovative solutions derived from a strong-minded adherence to first principles. The Imperial Hotel illustrates both sides of this issue simultaneously.

The vertical arrangement of the building's exterior is an interesting example of the complementary interaction of architecture and engineering. Wright wrote, "The outside walls were spread wide, thick and heavy at the base, growing thinner and lighter toward the top. Whereas Tokyo buildings were all top-heavy, the center of gravity was kept low against the swinging quake movements and the wall slopes were made an esthetic feature of the design." The walls were perforated with small windows in the first two stories, while the more abundant openings in the third story reduced the material and turned the walls into closely spaced piers.

In general, seismic loads achieve their maximum value at the base of the building and diminish upward, resembling the relatively smooth downwardly increasing distribution of gravity loads. (In taller structures, significant exceptions to this generalization can occur.) Hence an esthetic that reflects this load distribution in the distribution of material has an advantage. One of the greatest single earthquake problems in post-World War II buildings is their lack of ground story resistance (the "soft story" problem), which is often induced by the fact that our recent architecture has been guided by a style that has attempted to visually dissociate rather than root the building to the ground.

The point that Wright stressed most in his published writings and interviews, after the foundation and the "waiter's tray," was what he called flexibility. However, again there is a tendency to misunderstand the facts.

Wright wrote that "we solved the problem of the menace of the quake by concluding that rigidity couldn't be the answer, and that flexibility and resiliency must be the answer. . . . Why fight the quake? Why not sympathize with it and outwit it?" When Wright advocated "flexibility," he wasn't actually taking the opposite side of the debate from Tachu Naito, who was the prime spokesman for the "rigidity" argument in the '20s and '30s. Wright's method of creating a "flexible structure instead of a foolish rigid one" was to "divide the buildings into parts. Where the parts were necessarily more than 60 feet long, joint these parts, clear through floors, walls, footings, and all, and manage the joints in the design," he wrote. He called the result a "jointed monolith." What is immediately apparent today is that this was an early and thorough use of the seismic separation joint, though this seems not to have been subsequently appreciated. Thus the 500-foot-long wings did not have to try to act like 500-foot-long structures. The complex plan (from a seismic viewpoint), with eight major and at least four minor re-entrant corners, was thus merely a concatenation of simple, symmetrical, small rectangles, mostly three stories (plus basement) tall, about 35x60 feet in plan. The height/depth ratio of the component structures was close to one, and the shear walls of the perimeter, along with the rigid diaphragms and with some rigidity added by the interior columns and numerous longitudinal and transverse partitions, must have created a stiff, rather than "flexible" structure, in the usual seismic use of the word. The fundamental periods were probably less than one-quarter second. Wright's use of lightweight copper sheet rather than the traditional Japanese tile lightened the roof by a factor of about 10. The use of a light roof further reduced the period of the structure. (Wright had another purpose in mind: "Roof tiles of Japanese buildings have murdered countless thousands of Japanese in upheavals, so a light hand-worked copper roof was planned. Why kill more?") The stiffness probably decreased the amount of nonstructural damage, and also probably decreased the dynamic response of the building to the ground mo-

continued on page 70

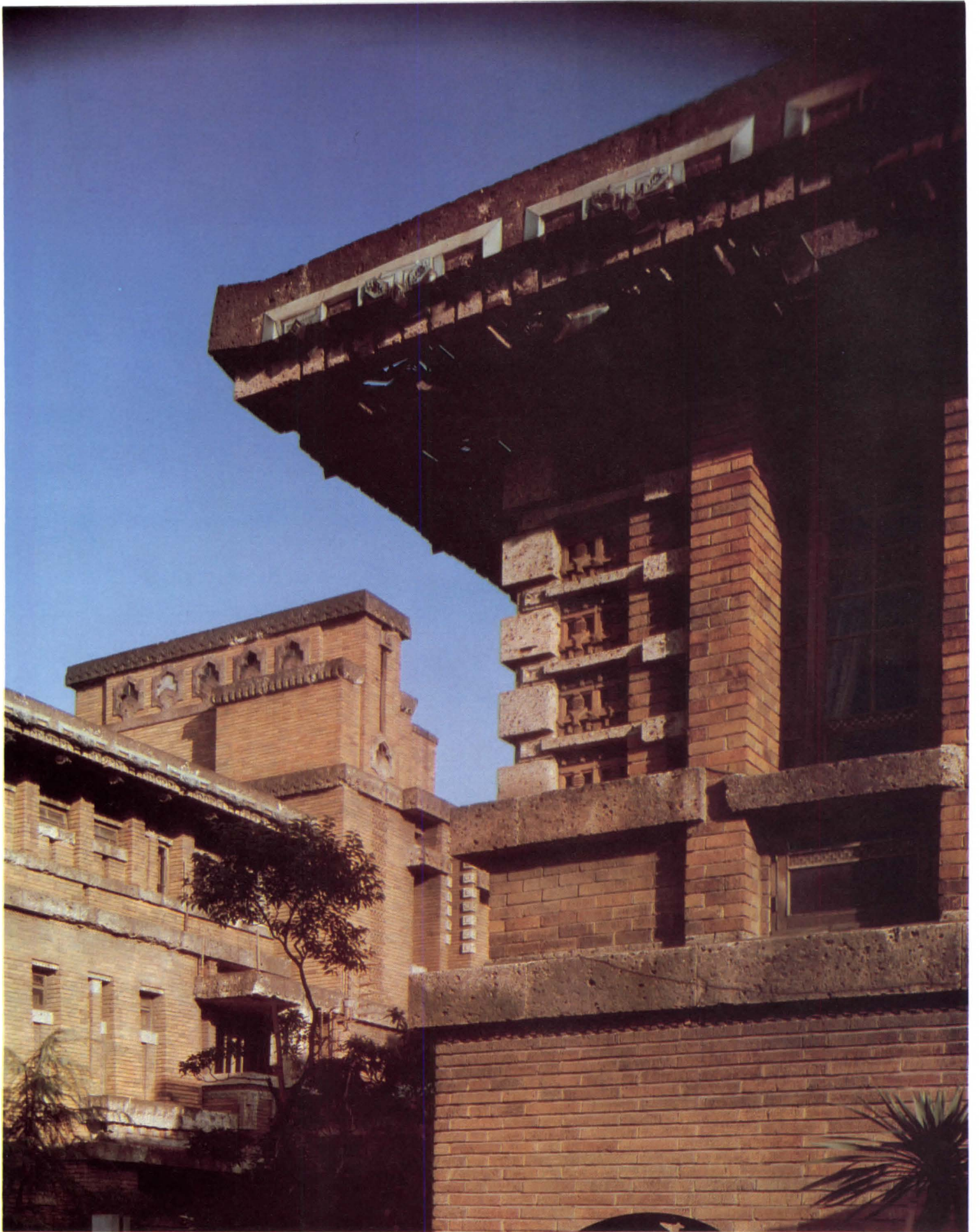

The Turning Point in Mr. Wright's Career

A case that it was his Princeton lectures of exactly a half-century ago. By Frederick Gutheim, Hon. AIA

At Taliesin in the winter of 1930 icicles as thick as your thigh hung from the eaves. The only heat came from the hearth. The bankrupt Frank Lloyd Wright corporation had once again just beaten its creditors from the door but there still loomed the threat of a sheriff's sale of Wright's personal property—his Japanese prints, Chinese sculptures, as well as his library, drawings and professional papers. The potatoes-and-cabbage odor of rural poverty hung over the Wright household and its five draftsmen.

Not the great Depression but the collapse of Wright's personal fortunes and professional career was responsible for this situation. Only two of the architect's buildings had been brought to completion in the previous five years. The most recent casualty was the enormous San-Marcos-in-the-Desert resort complex whose lasting effect was the introduction of Wright to then-undiscovered Arizona. (He was to return there in 1937 on doctor's orders to seek a milder winter climate.) The project for a New York City skyscraper, St. Mark's-in-the-Bouwerie, later to surface as the Price Tower in Oklahoma, was tottering to extinction. Extravagant conceptions like those for the Doheny Ranch survived only in crayoned drawings of hillside houses and houseboat dwellings recalling the Vale of Kashmir. An entire phase of Wright's career in southern California, marked by the experiments in concrete block design in the Barnsdall, Millard and other houses, had passed without significant continuity.

Perhaps worst of all, the architect's reputation was in eclipse. His celebrated Prairie School period (1889-1909), the years of the Oak Park studio, was far in the past. Only the series of professional articles in *Architectural Record*, whose collective title, "In the Cause of Architecture" seemed a melancholy echo of crusades long gone, marked a professional reputation once bathed in oceans of newspaper ink.

At this lowest point in Wright's career, at the age of 60 years, there arrived at Taliesin the invitation to give the Kahn Lectures at Princeton University. Sponsored not by that university's still embryonic school of architecture but by the department of art and archaeology, then headed by C. Baldwin Smith, the origin of this invitation and the records of the event itself have been found preserved in the department's basement. The 50th anniversary of this event is viewed as significant as it marks a decisive turning point in Wright's professional career. A commemorative conference at Princeton on May 16 further explored the meaning of the 1930 lectures today.

The choice of Wright to give the Kahn Lectures (financed by Otto Kahn, a cultural titan of the 1920s and frequent benefactor of Princeton art programs) has always been somewhat mysterious. Professor Robert Clark has established that he was not the first choice. That was J. J. P. Oud, the Dutch exponent of modernism, who accepted but withdrew almost immediately for personal reasons. Just how Wright was perceived as the harbinger of those ideas of modern architecture that Princeton was thought to need in 1930 is still not clear. But once settled upon, it was a comfortable relationship, and Wright remained a loyal, indeed a fervent, Princetonian.

In 1930, the architectural battle lines were not yet drawn between the U.S. and Europe but were drawn between East and West. Like the other progressive architects of Chicago and farther west, Wright looked upon New York and the monied East with a combination of love and hate, but most of all as a place to prove oneself. Princeton was a stronghold in this eastern citadel, and it challenged Wright's powers.

After the thrill of recognition had calmed at Taliesin and work on the preparation of the lectures had begun, the enterprises began to grow and multiply. In spite of his assertion that "I am hungry for work, not honors," Wright welcomed the opportunity for additional lectures. What eventuated was a tour that commenced at the University of Oregon, whose architecture school was directed by Walter Willcox, like Wright an alumnus of the Chicago office of Adler & Sullivan. It continued to Seattle. Then came the Princeton lectures. Two lectures in Denver; five in New York City; a lecture in Philadelphia and more lectures in Madison, Wis., Minneapolis and Chicago completed the circuit. Together, this burst of activity started by the Princeton invitation after such a long eclipse was sensational evidence of a renewed interest in Wright. The publication of many of these lectures reinforced their impact at a time when the idleness of many architects during the Depression years and the growing awareness of Le Corbusier, the Bauhaus and other worldwide impulses was producing a mood of re-evaluation in architectural circles. It is too much to assert that America was rediscovering the Frank Lloyd Wright Europe had known since the publication of the Wasmuth portfolio in 1910 and the special issue of the Dutch Journal *Wendingen* in 1925, but it is a provocative reflection. Wright himself was certainly aware of these currents as his references to them in the Princeton lectures demonstrate.

If the Princeton lectures thus marked a critical turning point in Wright's career, both personal and professional, they need to be seen in the larger context of changing American architecture.

While the publication of the Princeton lectures brought Wright to the notice of many who did not hear his words, the lectures transformed Wright into a platform virtuoso. They led to an immediate career he described as that of a "journeyman preacher." Wright's own evaluation of this experience, not too long after the event, is worth quoting: ". . . to a week of preaching in New York City (at the New School) to earn the only fees anywhere in sight at that bad time of my life. This began to look like recognition at home."

Yet, he was anything but at ease on the platform. The informal, chatty style he later achieved had not yet matured. He apologized for his speaking style, and his practice of reading lectures he rationalized in these words: "To treat a subject adequately with best thought where real issues are at stake, a well studied written discourse that may be read will always be best."

But he was also well aware that it was the young who "paid me thousands of dollars to talk to them." And it was from this experience that, as Arthur Holden viewed it, Wright became aware of his influence over youth, and thus in his mind was born the idea of a career as educator. He was reaching forward to a new period in which he could exercise his talent as a mentor of the young. This was ultimately to take form as the Taliesin Fellowship.

If conventionally defined, Wright would have despised the designation of educator. (He probably would have rejected it however defined.) Henry Klumb has observed, "Wright cared nothing about education. He thought and spoke out of vision and intuition and gave concrete examples of the beautiful. He wanted to create the environment in which man could develop into human beings true to themselves and nature. His idea of association with him was to obtain from the sources of his inner being that which filled his life in a manner satisfying to him; and having obtained this, he maintained that 'man should create out of self that which gives meaning and content to life.'"

Mr. Gutheim is chairman of the Washington, D.C., consulting firm of Gutheim, Seelig & Erickson.

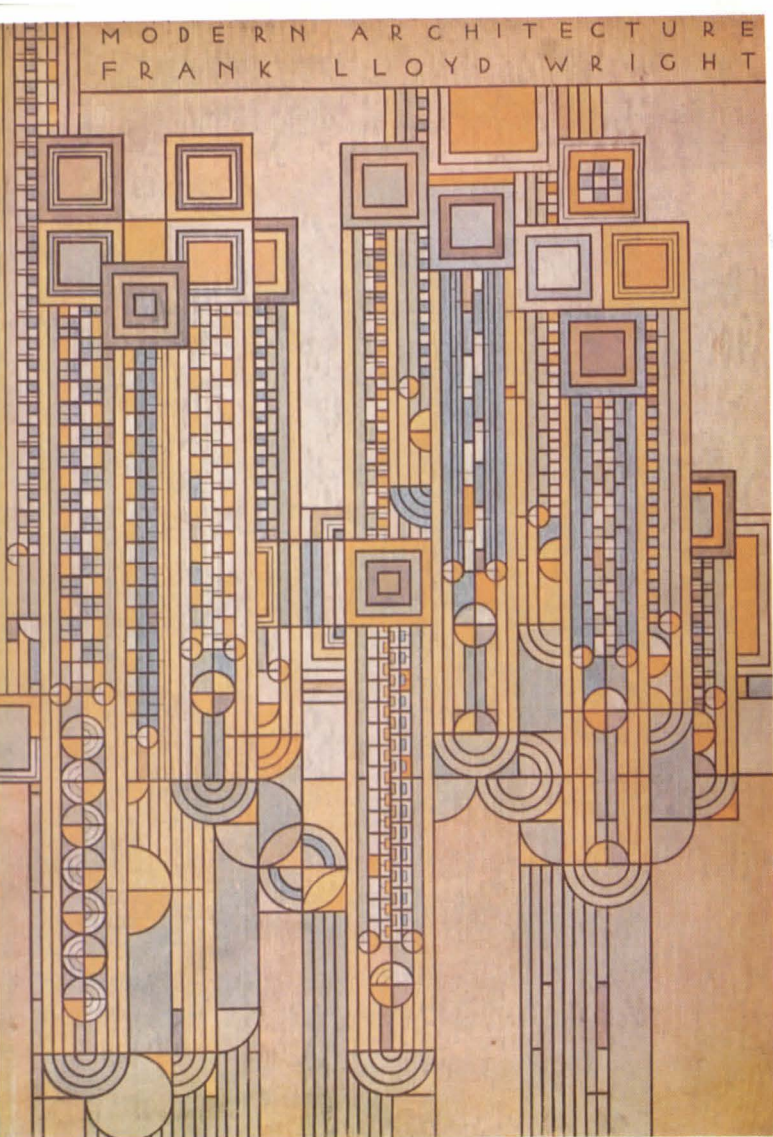

The lectures were published in 1932 by the Princeton University Press, which later let them go out of print. The cover (above) was in the geometric style much favored by Wright then and was the work of Henry Klumb.

Of the several hundred students who passed through the Taliesin Fellowship in the last 30 years of Wright's life, only Edgar Tafel has provided much descriptive detail. His recollection, *Apprentice to Genius*, offers the best portrait of Wright as well as the most detailed description of this experiment in architectural education. Stimulated by his experiences at Princeton and other architectural schools which he visited as a lecturer and whose graduates he received at Taliesin, Wright restructured his professional office into a new type of educational institution. In its communal aspects Wright looked back to the nearby Hillside Home School conducted by his aunts, with its roots in the progressive education movement. The Oak Park studio was another fruitful source of experience, and it must be remembered that Wright had earlier described it as "a little university." Certainly his own experiences in Adler & Sullivan's office, where Sullivan's career at the Ecole des Beaux-Arts appears to have been the source of his concept of professional discipline, was also available.

Wright found in his apprentices a disciplined extension of his own talent. It is an oversimplification to describe the education as one of imitation, but undoubtedly "do it like the Master" was the rule and originality was not encouraged. Yet despite the common assertion that no great architects were produced here, an astonishingly large number of original designers did emerge and went on to successful practices elsewhere. Alden Dow, Aaron Green, John Howe, Henry Klumb, Edgar Tafel are only some of a much longer list of Taliesin alumni.

The Princeton lectures also had a more immediate impact on

Wright's professional fortunes. Lecturing and writing created the public personality that drew increasing attention in the mass media—in the daily press, in such popular magazines as *Time* and *House Beautiful*. He appeared increasingly on radio, television and in films. The *Autobiography*, published in the same year as the Princeton lectures, reinforced his public aura. And, of course, the continuing appearances at lectures—at ever higher fees. The increasing popularity of his books, their familiar ideas adroitly packaged and editorially recycled in the 1950s by Ben Raeburn at Horizon Press, became an important activity, as were the numerous exhibitions in the Museum of Modern Art and other institutions. Even the American Institute of Architects, which had been cuffed about on numerous occasions by Wright, who described its leaders as "old men afraid to go out without their rubbers," got on the bandwagon and gave him its Gold Medal.

The last 30 years of Wright's career were characterized by these lineaments of a national celebrity. Responsive to these new conditions, Wright began to design small houses. On the model of the well-described Herbert Jacobs house, these began to generate their own circles of fame. Supervising the construction of scores of these "Usonian" houses and, increasingly, contributing to their design, was an important function of the Taliesin Fellowship and this type of building soon began to exhibit characteristics of standardization.

I remember coming into Wright's studio office early one morning when he was opening his mail. Throwing one of the arriving letters across the table, he remarked, "That's the kind of letter I like to get." It was from a faculty wife in an Illinois college asking if Wright would design a house for her and describing in detail the proposed site. As I returned the letter, Wright called to his secretary, "Gene! Send this woman the plans for the museum house." It was a building designed for the garden of the Museum of Modern Art. I began to laugh. "You're a fine one," I said, "preaching about building 'from the ground up' and now you are going to build a house on a site you have never seen." "So what," he grumbled, "It ought to be built."

Robert Twombly has not unfairly remarked that "Wright's career was the search for a perfect house." Low cost houses, prefabricated houses, entire housing communities were a continuing preoccupation, but only after his widely publicized houses at bargain prices in *Life* and other magazines during the postwar housing shortage did he build them in quantity.

Another characteristic of his practice after 1930 was the number of large buildings that were strongly oriented to their publicity value. The first of these was the administration building and research tower for Johnson Wax and the Herbert Johnson house, Wingspread, at Racine, Wis. But others with aspirations to the headlines were the buildings for Florida Southern College, the Price Tower in Oklahoma and probably the Marin County center. While buildings of this type can be found as far back as the Larkin building—the first monuments of the advertising empire of soap—I believe it is a valid contrast between Wright's work before and after 1930.

The years after 1930 also saw him enter into a different kind of architectural practice. The Taliesin Fellowship was an educational institution, but it rapidly developed into a corporate form of architectural practice. Again, in the Princeton lectures can be seen Wright's educational philosophy and the institutional form it was taking. Although much thought about by him, and expressing his deepest feelings at the age of 60, it is difficult to believe that he foresaw what the fellowship would become or that it would change and dominate his life.

Only since Elizabeth Kassler has commenced her investigation of the Taliesin Fellows—now estimated to number upward of 600—has this aspect of Wright's career become more clearly significant, and the possibility of additional information concerning his practice since 1932 appeared. But the beginning of this phase was clearly at Princeton 50 years ago. □



Cooper-Hewitt's 'Spectacular Spaces'

When Lisa Taylor, director of the Cooper-Hewitt Museum, and Gerhard Bott, head of Cologne, Germany's Wallraf-Richartz Museum, met some time ago, they planned an exchange of exhibitions. It was an obviously good idea: The Wallraf-Richartz owns 7,000 drawings from the collection of Jakob Ignaz Hittorff, the Cologne-born architect of many of Paris' best-known buildings and spaces (including the Gare du Nord and the Place de la Concorde) and the modern discoverer of the polychromy of Greek architecture; and the Cooper-Hewitt, the Smithsonian Institution's national museum of design, owns a stupendous collection of 30,000 drawings, half of them on architectural subjects. The Hittorff show will be coming to this country soon; meanwhile the Cooper-Hewitt show, selected and organized by drawings and prints curator Elaine Evans Dee, has traveled to Cologne and back and is on display until early this month at

the Cooper-Hewitt Museum in New York City (the former Carnegie mansion, restored by architect Hardy Holzman Pfeiffer).

The show of 110 drawings is called "Spectacular Spaces." (In Cologne it was mysteriously called "The Idea and Claim of Architecture," but "Spectacular Spaces" suits it to a T.) The earliest item included is a 16th century French drawing of a chateau built near Senlis; the most recent are a partly classicized house facade by young California architect Thomas Gordon Smith and one of the now ubiquitous Fargo-Moorhead Cultural Bridge renderings by Michael Graves. In between are elaborate baroque concoctions by the prolific Bibiena family, restrained doorway studies by Filippo Juvarra, a lush cartouche by Francesco Guardi, landscapes with ruins by Charles-Louis Clérisseau and lyrical ink washes by Giuseppe Barberi. There are Hector

Left, Charles-François Hutin's 'Gate to the "Temple of Hymen,"' a pavilion erected in Paris' Place Dauphin in 1745 to celebrate the marriage of the dauphin (son of Louis XV) and Marie-Theresa of Spain. Top, below, Whitney Warren's 1897 pencil drawing with black and white ink for the facade of the New York Public Library. Bottom, an early 19th century wash drawing by Alessandro Sanquirico for a Gothic stage set.

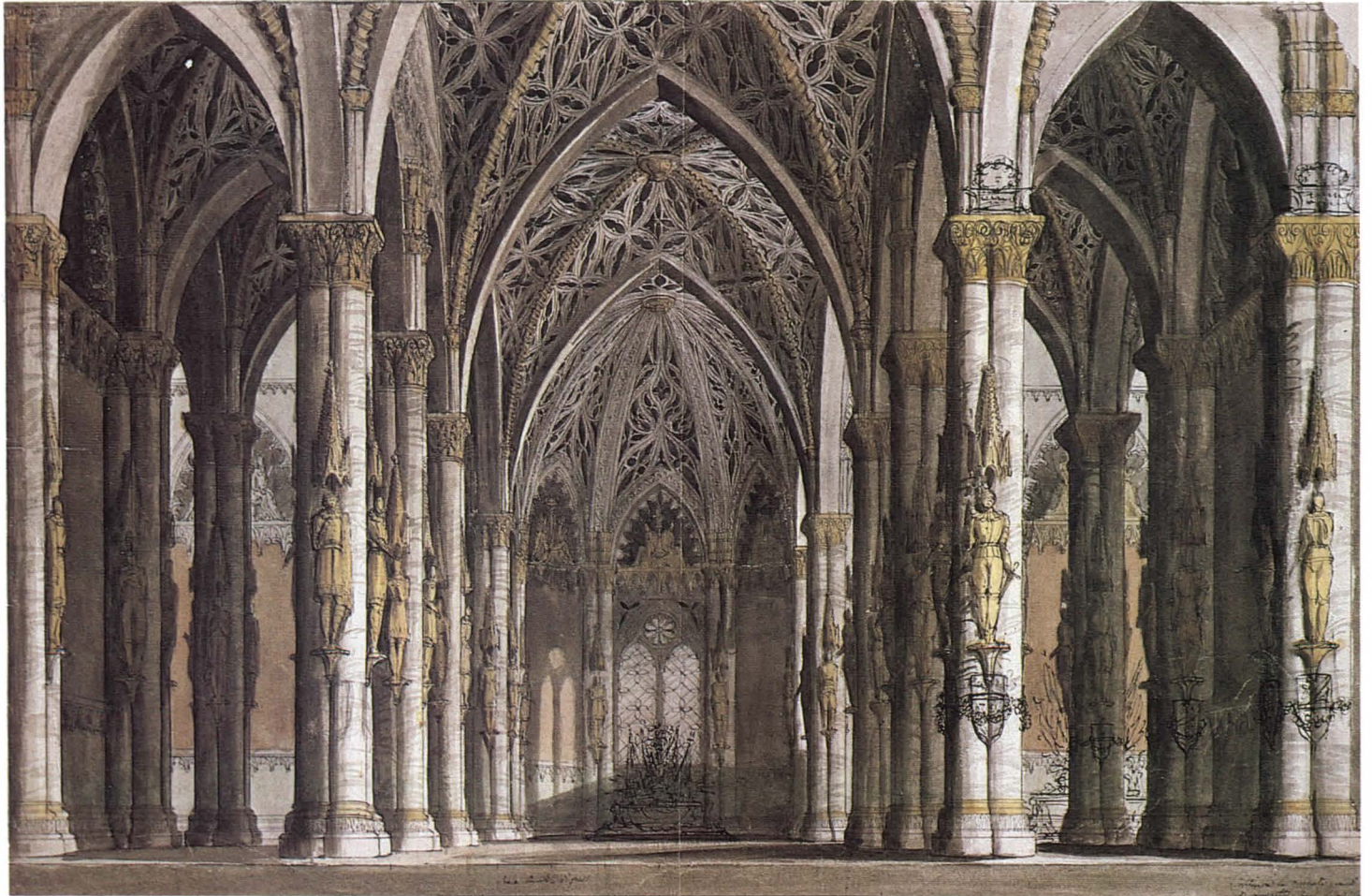
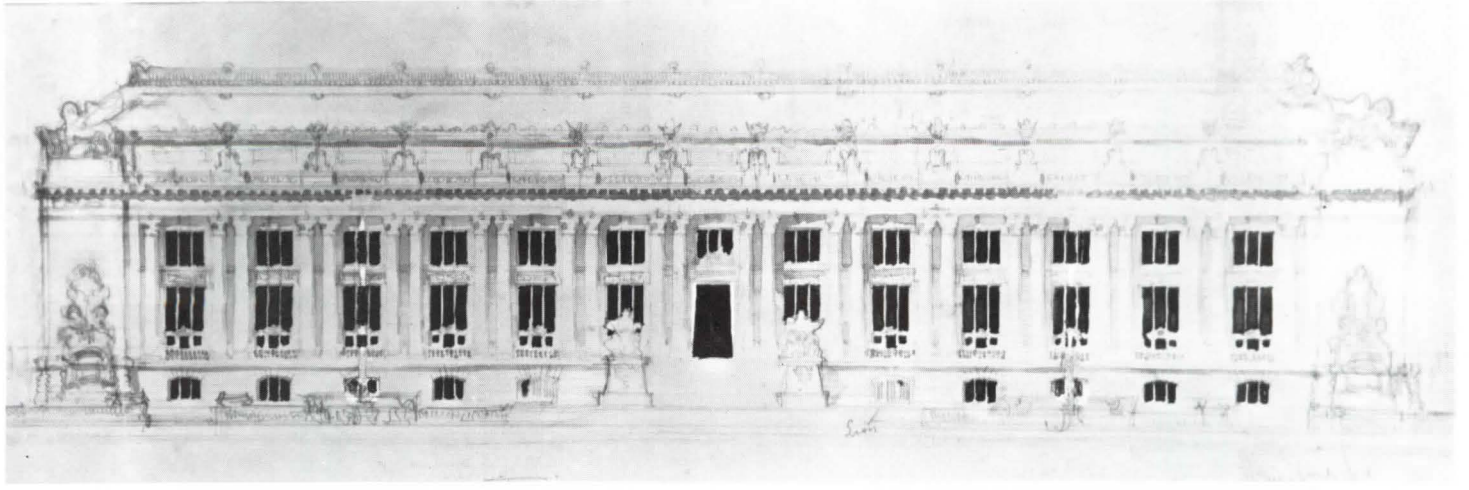

Guimard drawings from 1900-1905, American Beaux-Arts work by Whitney Warren and Ely Jacques Kahn and the powerful zoning studies and simplified renderings of Hugh Ferriss. Some of these are drawings for actual buildings; some are for monuments, memorials or temporary displays; some are stage set designs, and some—probably most of them—are the purest fantasy.

“Designing architecture means creating an illusion,” curator Dee claims in her introduction to the show’s catalog. “Faced with the challenge of enclosing a space to make a room, or a series of spaces to make a building, or all the varieties of spaces in between and beyond like gardens, arches, amphitheaters, city squares and streets, architects have looked upon space as something to manipulate.” From the Cooper-Hewitt’s own selection, we show here a few of those manipulations. They remind us of the power and grace that various rendering techniques can possess, and they tease us, amuse us and perhaps even inspire us with their created illusions. *Stanley Abercrombie, AIA*

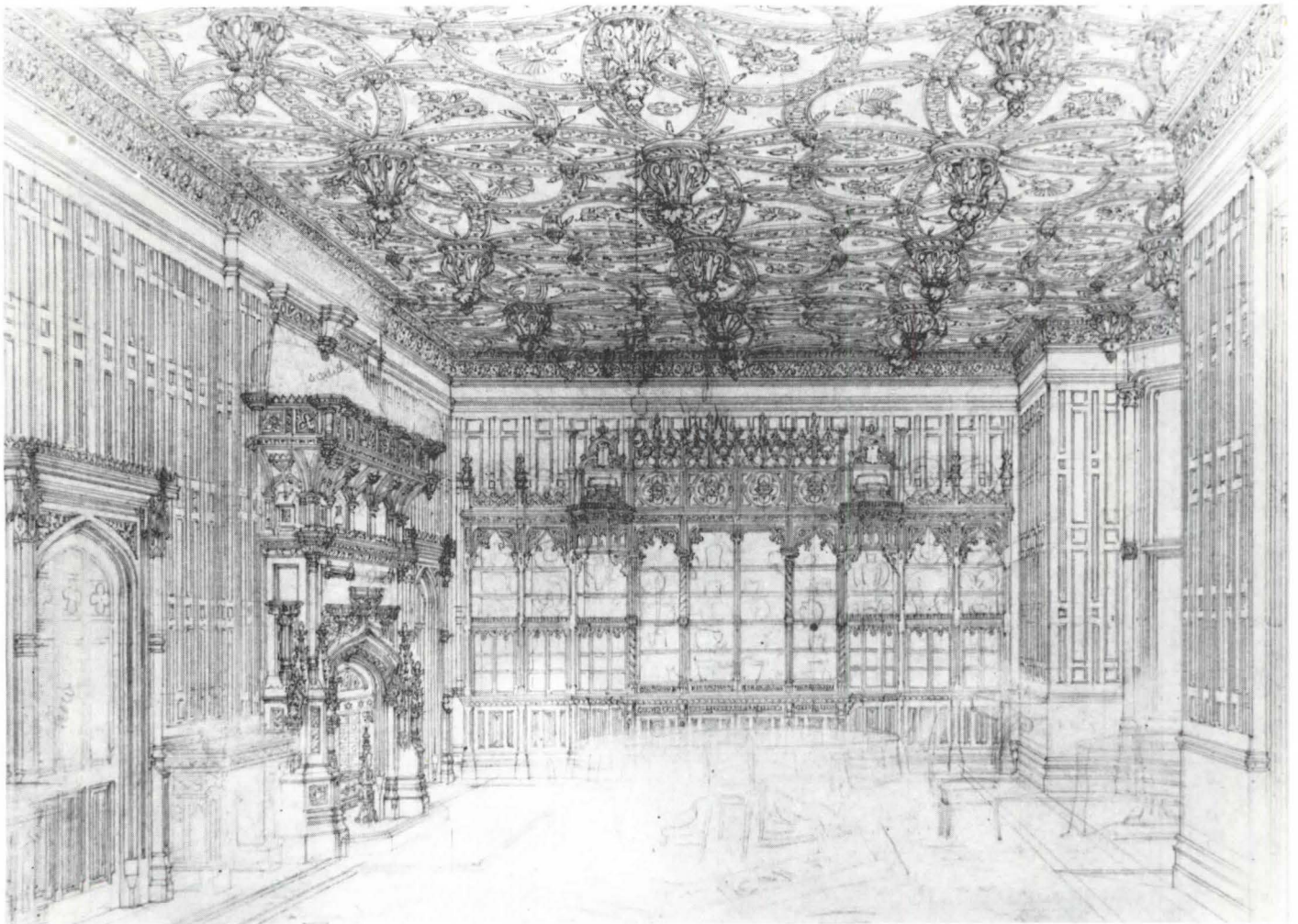



Left, an anonymous pencil drawing, dated about 1875, of the dining room of a Gothic country house. Above, an ink, pencil and watercolor drawing by Frederick Crace (English, 1779-1859) of a Chinese pavilion. Below, Hector Guimard's 1904 ink and pencil elevation study for his Castel d'Orgeval, Paris.

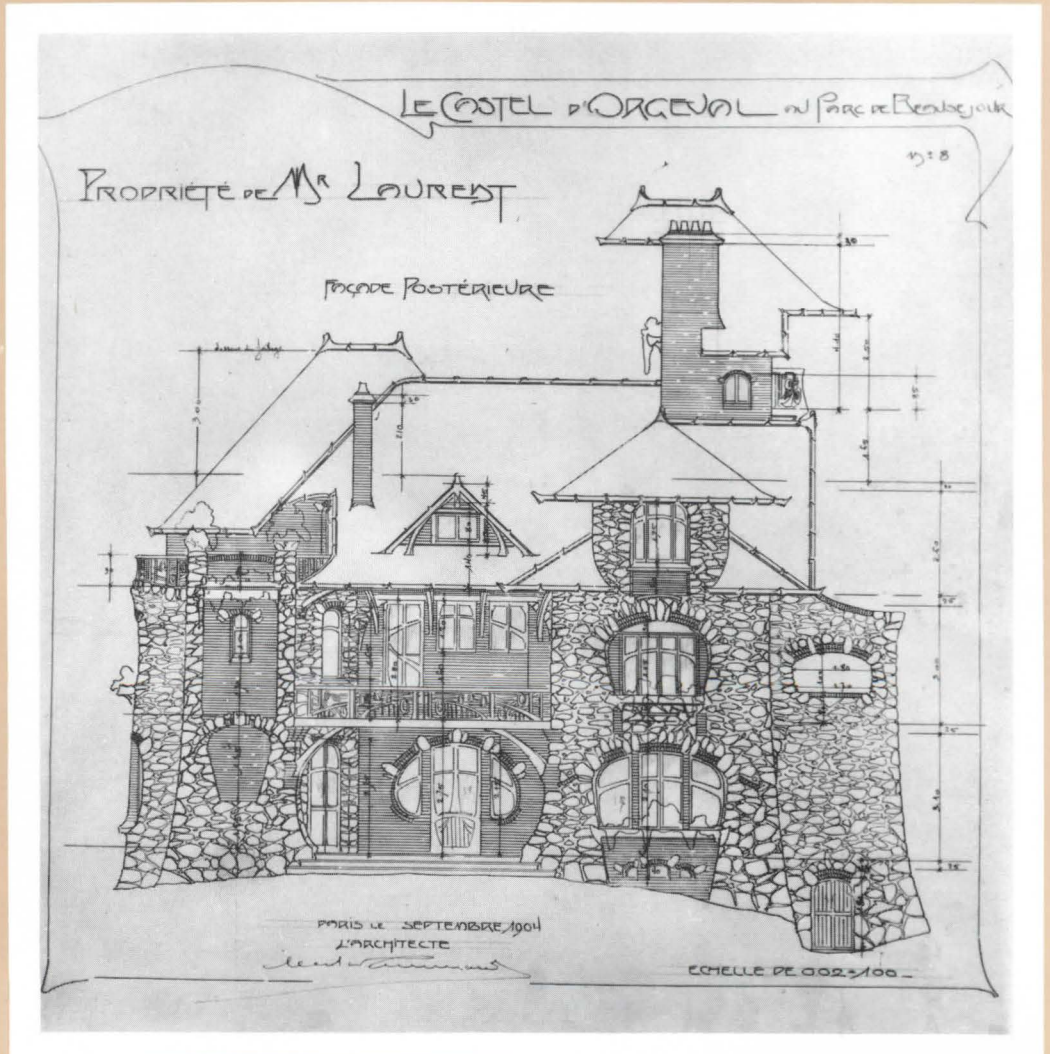

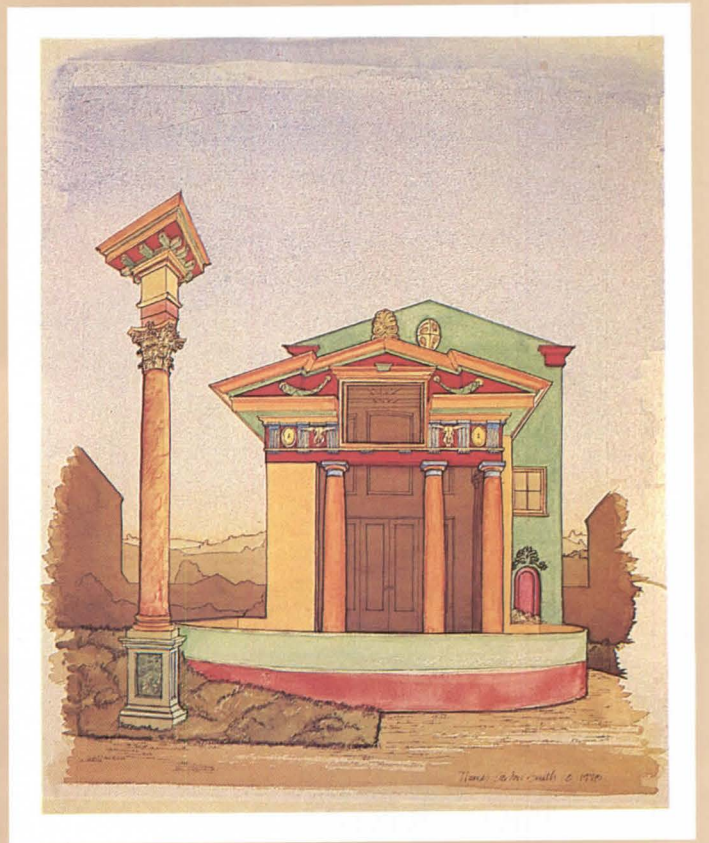
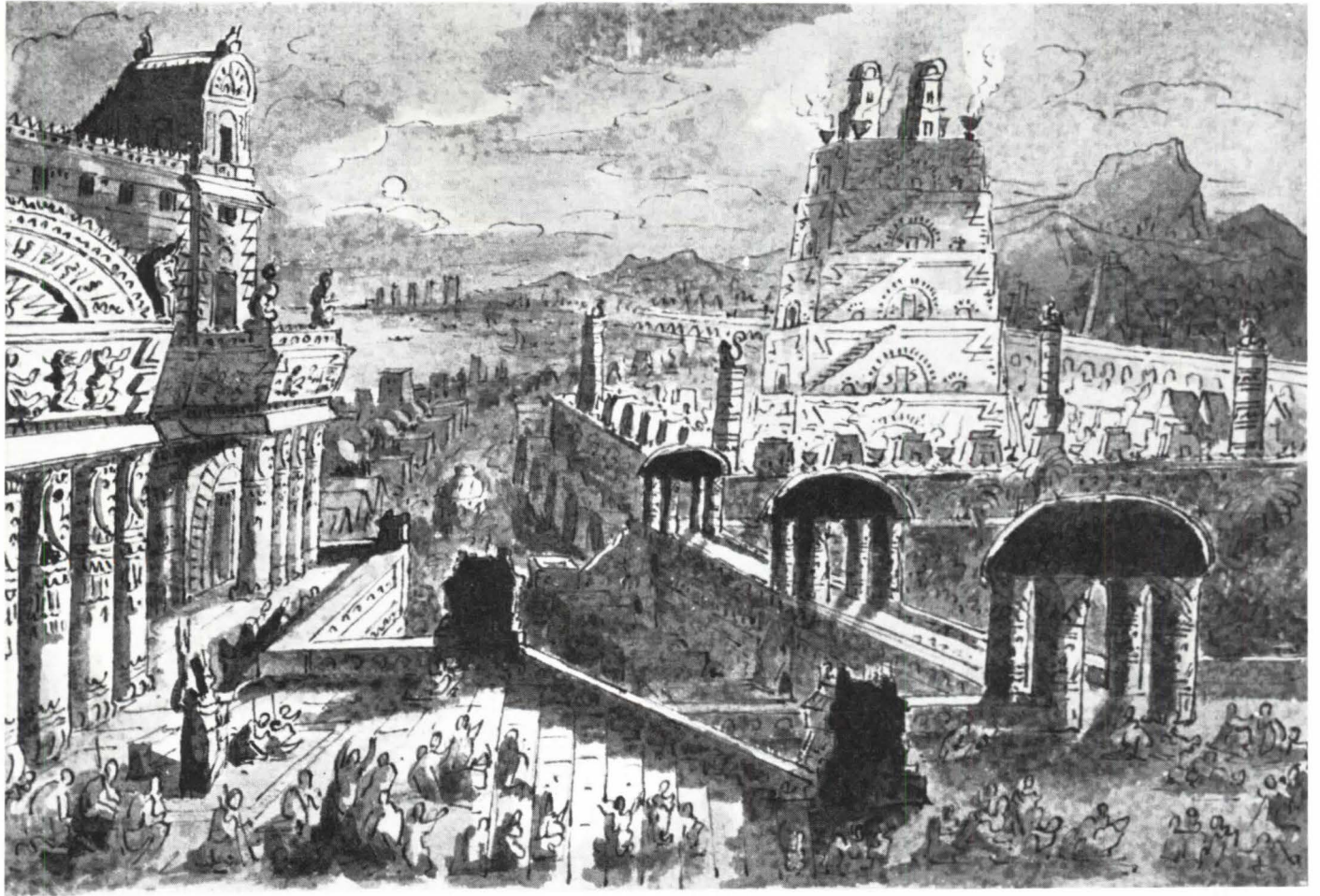

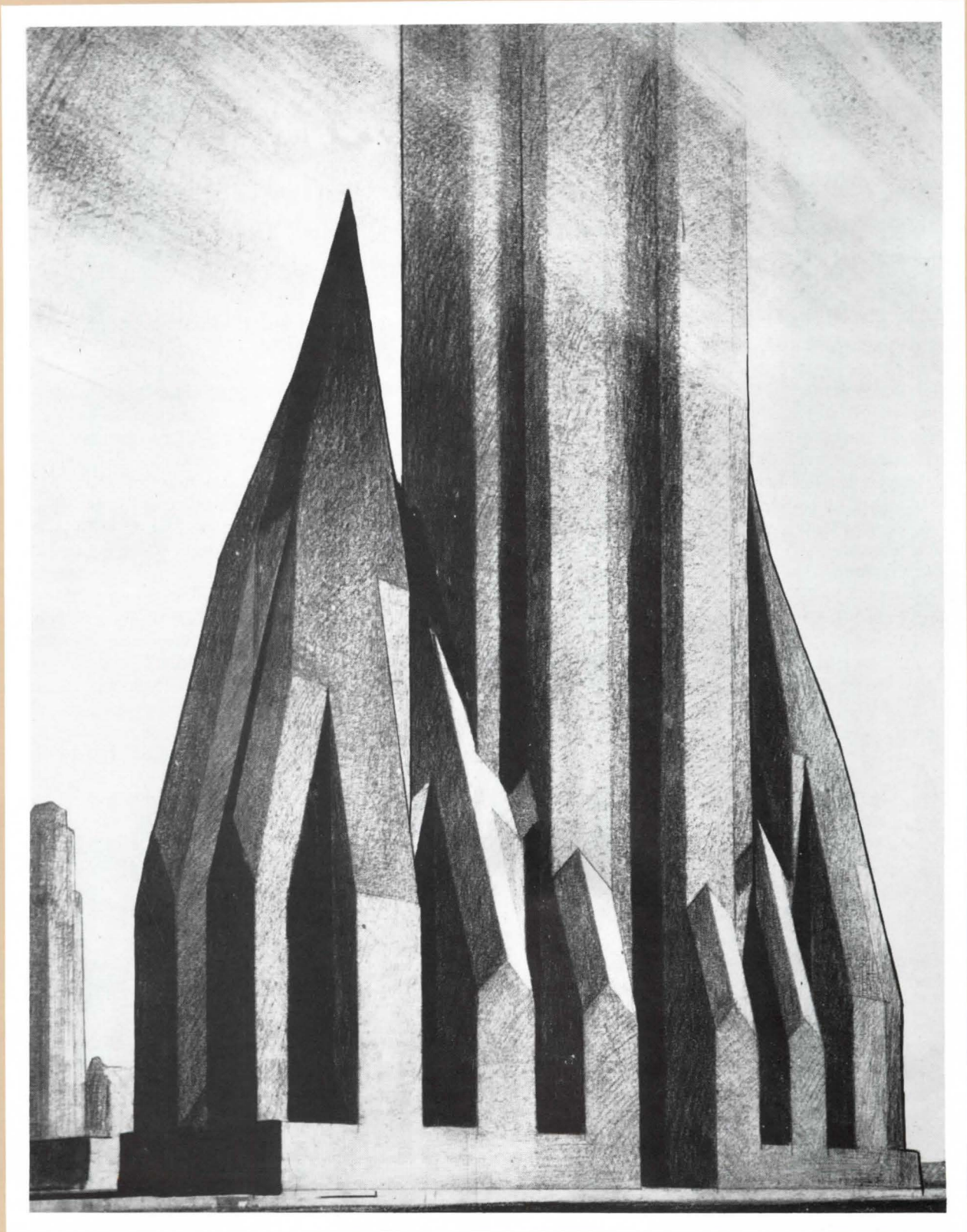

Opposite page, top, a fanciful view of Montezuma's Palace, Mexico, by a successor of the 19th century Bolognese Antonio Basoli. Left, Thomas Gordon Smith's 1978 ink and watercolor 'Mathews Street House, Perspective View at Dawn.' Above, 'Study for the Maximum Mass Permitted by the 1916 New York Zoning Law, Stage 3,' a black crayon drawing by Hugh Ferriss.

MOMA's Architectural Mystery Tour

The catalog to 'Transformations' helps reveal its intentions, but only a bit. By Reyner Banham

Arthur Drexler's large and lavish exhibition at the Museum of Modern Art in the winter of 1979, under the promising title of "Transformations in Modern Architecture," was preceded by allegations of politicking and log-rolling (why had John Hejduk been cut out, after being invited to submit?) that promised a lively and stimulating exhibit. When it opened, however, the general response (apart from the columns of one or two prominent critics who dare not admit they have no idea what is going on) was one of genuine bafflement. It was an interesting show, at least in parts, said the consensus, but what was it all about? It seemed to have even less of a didactic message or programmatic theme than Bob Venturi's *Complexity and Contradiction*. Was it just a vast stamp-collection of buildings that Arthur took a fancy to? Was the very heavy representation of glass-skinned structures due to pressure from his main sponsors, Pittsburgh Plate Glass? (Interestingly, and uncharitably, no one suggested that he might have gone to PPG Industries Foundation because there were going to be a lot of glass buildings in the show, and they therefore sounded like appropriate sponsors.)

"Anyhow," said one and all, sagely, "let's wait until the catalog comes out and see what he has to say, right?" Well, barely a year after the show closed, here's the catalog, almost as large and lavish as the show itself, and with a front cover that looks uncannily like that of the paperback edition of *Star Trek*. And are we any wiser? The answer, I think, is "a bit." One can read the text and digest the illustrations at one's own speed and in greater comfort than under exhibition gallery conditions, and one can draw one's own conclusions—which will be almost as many as there are readers, for Drexler still refuses to come to a point or a conclusion. What one now sees, very clearly from the last two paragraphs of the introduction, is that this not coming to a point is programmatic—it may even be what the show was all about. "Whatever its excesses or deficiencies," says Drexler, "modernism has valued buildings as artefacts that are well made and do what is required of them. In that sense it has been against interpretation, preferring the self-evident fitness of things."

Now, there's a switch! MOMA exhibitions in the field of architecture and design had always been interpretive, didactic, propagandist. This one was not; it was supposed to rely on self-evident qualities such as fitness. That kind of approach has worked before—remember Ed Ruscha's books of filling stations, apartment blocks, parking lots, presented cold, full-face, with identifying captions and no commentary or value judgments? Enormously effective—but chiefly because most of the artefacts were completely new to us and had not been interpreted, whereas practically every building in this show is an old friend and comes to us trailing banners of interpretation, be it by Peter Eisenman, Charles Jencks, myself, Peter Cook, Alan Colquhoun, Allan Temko, Philip Johnson, Ada Louise, Edgar Kaufmann, Oscar Newman—or even Arthur Drexler! In any case, the very title of the show is a commentary, an interpreta-

tion, which bids us see how modern architecture has been transformed, and thus requires us to compare building with building (how else can we know there has been transformation without, as it were, "before and after" pictures), and comparison can be the most destructive, or illuminating, of all forms of interpretation.

Skip it, then. The show was a muddle, but a rich one, and so is the catalog. Its prime virtue seems to be, in retrospect, that it called back to mind quite a number of really good architects and excellent buildings that everyone was just about to forget—Gottfried Bohm, for instance, and his stunning city hall at Bensberg; Bob Geddes' police station in Philadelphia; the Ahlséns' PUB department store in Stockholm; Ernest Kump's Foothill College campus; Bernard Pfau's Dusseldorf playhouse; Carlo Scarpa's stores and showrooms everywhere, or even—are you ready for this?—Luigi Moretti's Watergate apartments in Washington, D.C., which were very interesting architecture before they got conscripted into the great tragi-comedy of the 1970s.

But then, having thanked Arthur Drexler for reminding us of these self-evident artefacts, we have to ask, for instance, how there could be nothing by Bakema or van Eyck? How such well-made and serviceable artefacts as the Kitt's Peak solar telescope or the Stanford linear accelerator facility got left out. And what *did* happen to John Hejduk? □



Mr. Banham, prolific British author and critic, teaches at the University of California at Santa Cruz.

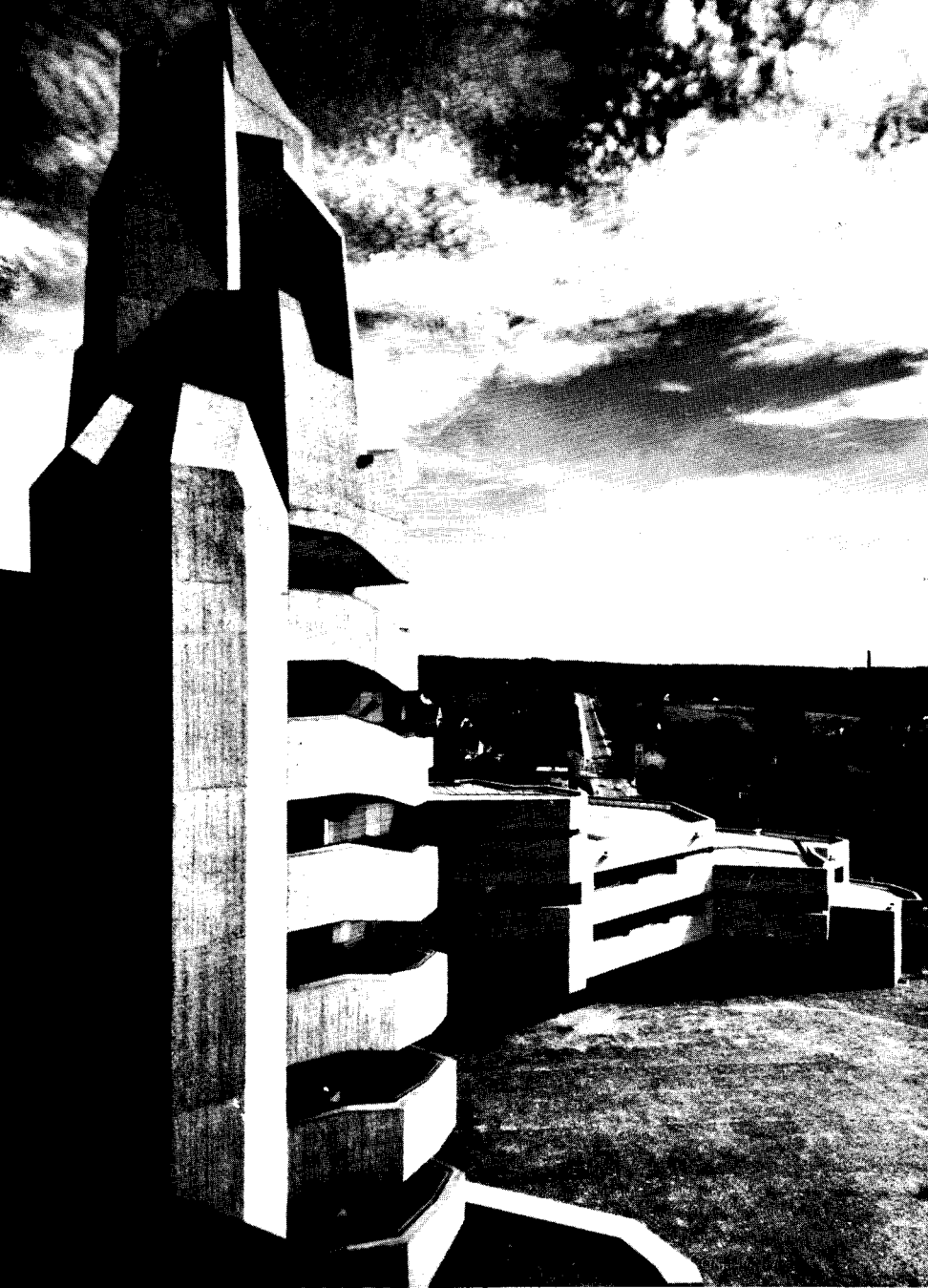

Photograph courtesy of The Museum of Modern Art



Photograph courtesy of The Museum of Modern Art



A sampling from the 'Transformations' exhibition: the Ahlséns' PUB department store, Stockholm (facing page); Gottfried Bohm's city hall at Bensberg, Germany (above left); Foothill College, Los Altos Hills, Calif., by Ernest J. Kump and Masten & Hurd (left), and Luigi W. Moretti's Watergate complex in Washington, D.C. (above).

Karl H. Riek



Chad Ankele

The Nation's Energy Conservation Capital

Remarkable planning laws give Davis, Calif., a claim to the title. By Sally B. Woodbridge

Davis, a central California university city within commuting distance of the state capital of Sacramento, has become a showcase for the effectiveness of mandatory energy conservation programs. In this community of 36,500, planning policies deal with everything from lot size and orientation, street widths, a bicycle circulation system, reduced paving and increased tree shading to the protection of solar rights and support for the humble clothesline. Policies are enforced largely through design review of planned unit developments, not zoning. And planning is integrated with an energy conservation building code and directed at the broader issues of community control through a housing priority program. At a time when the energy field is characterized by fits and starts, Davis's orderly progress over the past decade is astonishing.

Seen from the air, the University of California campus dominates the town center, with recent off-street shopping malls and office complexes just to the east in blocks parallel to the older commercial streets. These continue both the low profile and the

low-key design of the older buildings. In the adjacent residential areas, rows of mature street trees help to homogenize the one- and two-story houses into a satisfying, small town streetscape. Beyond this circle, Davis is recent residential construction whose ripple of rooftops ends abruptly in green fields of farm land.

The new construction is mostly attributable to university and governmental growth. University enrollment is 18,000 and its staff 13,000, so it is no surprise that education accounts for more than half of the city's employment. The rest is largely white collar, with a substantial number of commuter residents employed by the state in the Sacramento area.

In the early 1970s, Davis's projected 1990 population was 90,000, an alarming prospect for those who prized its small town character. Two foreseen effects were the weakening of Davis's lively citizen participation in town government and the loss of the prime farm land that was the original reason for its existence. To ward off this disquieting future, about a dozen students got together to study land use, growth control and energy conservation. They called themselves the Greater Davis Research Group. (In Davis, unlike politically fractured Berkeley, there has been consistent respect and support for the university.)

Ms. Woodbridge is a writer and architectural historian in Berkeley, Calif.

In the spring of 1972, a coalition formed by a member of the group won a majority in a city council election. This victory of environmental concerns over development-oriented interests proved decisive. After the Greater Davis Group disbanded, several members formed the Low Energy Research Group, funded by the university and the city, to work on an energy conservation ordinance. This was a more concentrated effort to meld research with the environmentalist philosophy in a way that would lead to political action. Two faculty members—an architect and an engineer—served as consultants. In the summer of 1974 the group published *A Strategy for Energy Conservation: Proposed Energy Conservation and Utilization Ordinance for the City of Davis, California*. The stated purpose of the report was: “. . . to examine some aspects of how houses and neighborhoods in Davis operate, how they consume energy, how they can be made to consume less, and how they can be made more self-sufficient so that they can serve their inhabitants better.”

Research focused on household management practices and the effect of architectural design and orientation on electricity and natural gas consumption in existing apartments and houses. Next the report dealt with the incorporation of passive solar features in conventional housing where active collectors could later be added. The authors wanted first to encourage simple and inexpensive energy conserving improvements. They argued that the energy consumed both by space heating and cooling and household appliances could be halved without inconvenience.

The report also suggested ways to implement the proposed ordinance, improve the city’s circulation systems and promote the use of alternative transportation modes, mainly bicycling. (The last effort has been successful. In Davis now there are two bicycles per adult, and bike lanes and routes make it easier in many cases to bike than to drive.)

Since practicality was crucial to the proposal’s incorporation into the existing code—and hence to the encouragement of innovation—the consultants paid careful attention to the proposed building standards. For a variety of reasons, including problems of equitable treatment for existing housing and the economic complexities of commercial and industrial buildings, the standards were directed to passive design of new construction in the residential field. Not only was this the dominant kind

of local construction, it typically included the most energy-hungry appliances of all, large airconditioners. Furthermore the building permit process offered an existing mechanism for enforcing compliance with the new code. Psychologically, success in new housing would help the retrofitting of older homes. The emphasis on passive measures resulted from the higher cost of active systems and the need for technical skills as opposed to the easy fit of passive features with conventional building practices.

In the fall of 1974, when the strategy was presented to the city planning commission, the design review commission and the city council, there was general approval. Final acceptance was deferred to the building board of appeals made up of engineers, architects, developers, builders and the fire chief. Builders predictably opposed the ordinance, arguing that the industry was already over-regulated, that the code would result in increased cost at the market level as well as an exodus of builders from Davis, that restricting the design options of architects and builders would lead to unattractive housing and diminished appeal, that passive measures would not be as effective as predicted if they depend on manually adjusting screens and shading devices and that the imminence of a state code canceled the need for a local code.

Anxiety over the implications of change and a general ignorance of passive solar design powered much of the builders’ opposition. On a more subtle level, the countercultural values, the inexperience and youthfulness of the principal consultants did not bolster their credibility with the development sector. Compromise was difficult to achieve but the political clout gained by the environmentalists in the 1972 election prevailed.

After publication of the *Strategy for Energy Conservation*, the group got more funds from the university and the city, plus a HUD grant for \$86,000, all of which led to completion, adoption and implementation of the ordinance and planning policies. The money also made possible the construction of two houses incorporating passive solar design.

The solar step was, for local builders, the most significant of the several components of the city’s extensive growth management program—limits and controls on new residential construction. The city adopted a “housing development program” whose objectives were elaborations of the concerns of the original stu-



Sally Woodbridge

County bicycle lane (left) borders a highway at the Village Homes subdivision, seen from the air on facing page. There, bike paths cut through greenbelt commons between rows of houses.

A contemporary version of the Radburn idea.

dent research group: orderly residential growth, protection of surrounding prime farm land, housing and services for the university faculty, students and staff, good housing for those with moderate, low and fixed incomes, and environmentally sound development patterns. An annual needs survey resulted in an annual housing allocation encompassed in an overall three-year projection. By identifying housing needs in each of the city's planning areas and basing the allocations thereon, the city hoped to achieve a uniform mix of housing types across the city, healthy social interaction and stable property values.

The housing development review board uses an index of factors such as the number of units approved and actually constructed in prior years, the availability of utilities and public services and the objectives of the general plan along with those of the program itself and the annual survey to rate all proposed planned unit developments. In practice, it has become obvious that builders earn points for design innovation in energy conservation. Those who go beyond the basic code provisions stand a far better chance of getting allocations than those who don't.

In general, this code mandates south orientation (157.5 degrees to 202.5), light exterior colors for walls and roofs (Munsell rating of 6 to 10), minimum six-inch insulation, R-19, and R-11 batt insulation. Exterior glazing is limited to 12.5 percent of the floor area with credits given for double-paned windows and various kinds of shading and screening. Unshaded glazing is limited to 1.5 percent of the floor area. Winter and summer standards are based on "design days," with the winter day, Dec. 21, having a 24-hour average outside temperature of 45 degrees and the summer day with a range, specified by hour, from 59 degrees at night to 100 degrees at midday. These standards reflected the Davis microclimate with its brief, often sharply cold winters and long, dry and hot summers. The winter performance standard states that the total day's heat loss shall not exceed 120 BTUs per square foot of floor area; the summer stan-

dard decrees a gain of not more than 40 BTUs per square foot.

Permit application measures that reduce engineering procedures to relatively simple formulas have mitigated the code's complexity for the builder; increasing familiarity with the code has also reduced the paper work. There are two options. The first is prescriptive and requires designers and builders to show that windows meet the minimum shading requirements and that the plans are in compliance with other rules and minimum criteria. Most construction, particularly tract housing, has followed this path. The second path was intended to encourage innovative design. If a designer could prove, through heat loss and gain calculations, that deviations from the code requirements increased energy saving, the standards could be set aside. This second option is time consuming and has been little used.

Since its enactment, the code has not produced the dire effects that some of its opponents predicted. Housing costs have not increased significantly. Cost increases—excluding that of insulation, which is also required by the current state code—range from \$50 to \$1,000 per house, depending on type, orientation and energy conserving features installed. More than 90 percent of all new lots in Davis are oriented north-south, and compliance with code orientation criteria has cost little.

Naturally, there is an abundance of opinion about the effectiveness of the code. The work and testimonies of two active developers, Michael Corbett and John Whitcombe, are representative of the present range of ideas and experience in Davis.

Corbett is the builder/developer of Village Homes, a 70-acre subdivision on the western edge of Davis. In 1970, he and others formed a cooperative to design a self-sufficient community. When the co-op disbanded two years later, Corbett continued on his own, acquiring land and looking for financing. After encountering stone-wall opposition from banks, other lending institutions and the Federal Housing Administration because of his unconventional ideas on energy conservation and community planning, Corbett shifted emphasis for the initial, 38-unit phase of the project to more traditional design. Active solar systems



Photographs by Sally Woodbridge

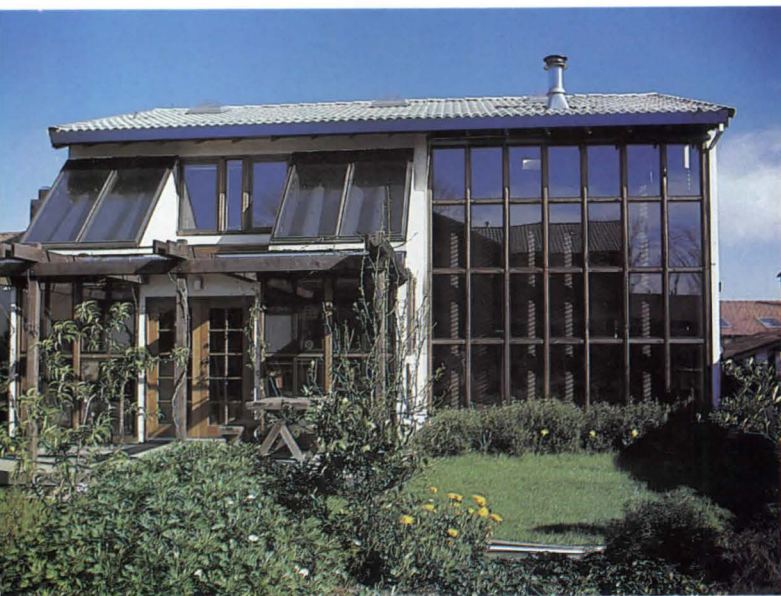

Two passive solar houses in Village Homes, one (lower photo) with a water wall of metal culverts. Greenway (facing page) has gravel drainage course and narrow, curving bicycle path.

were deleted because banks would not approve their inclusion in speculative housing. (Most of these first units have since added solar hot water and space heating.) Finally, in the fall of 1975, Corbett was able to proceed with the help of a \$200,000 construction loan from a local bank. At this writing, 150 houses out of a projected 217 have been built, plus 26 apartments.

The philosophy behind Village Homes echoes that of Lewis Mumford and Paul Goodman. Goals include a strong sense of community through involvement in a homeowners' association. In plan, Village Homes is a descendant of Radburn, N.J. Common areas or greenbelts, controlled by eight families who in many cases were involved in their design and construction, are the basic community units. Work parties have involved the larger community in building retaining walls, bridges, play areas and a community building and pool. There are two community play fields—the only expanses of greensward—and a generous belt of community farm land partially in vineyards. Cul-de-sacs are eight to 12 feet narrower than through streets and punctuated by parking bays. Lot sizes have been reduced and street-side front yards planted as private gardens. Between the house rows, greenbelts with narrow bike paths give a casual, rural look intensified by the lack of manicured lawns and foundation plant-

ing. Instead, there are raised beds with vegetables and communal, sand-filled fire pits for outdoor cooking. Gravel-bedded drainage courses meander through the greenbelts. In the rainy season they receive the run-off water that in conventional developments goes immediately into an underground system. Village Homes stands in vivid contrast to adjacent developments with their welter of streets, driveways and randomly parked cars.

Stylistically, Village Homes is hardly radical. Passive solar elements include light colored stucco walls, tiled shed and gable roofs, broad overhangs and minimal glazing except on the south side where the roof is often extended in the form of a vine-draped trellis. The Spanish colonial California house of the 1920s is recalled. Roof solar collectors and the few wood facade houses don't disrupt a general vernacular look.

There are several types of passive solar designs in Village Homes. There are also one-story, simple-format houses that rely on roof collectors, south wall glazing and thermal storage in a tiled, concrete floor slab; several kinds of skylit and clerestory houses, and so-called water-wall houses that use standard metal culverts, painted black, filled with water and sealed, set in a bank along the south-facing walls for thermal mass.

Corbett is more interested in new solar features than in other design refinements. But when house sizes range from 800 to 2,500 square feet and modesty is a social virtue, the benefits of architectural refinement are not so clear as the costs.

Not everyone in Davis views energy conserving design as an integral part of social reform. John Whitcombe, president of Tandem Properties and a principal partner in Trident Energy Systems, is building for those whose interest in saving energy does not extend to changing their living habits.

When the energy regulations were taking shape, Whitcombe served on a housing subcommittee and was responsible for the incorporation of a small-builder incentive into the housing priority program. Under this rule, those awarded allocations have to sell 20 percent of their lots to other builders. The motive was simply to keep a reasonable number of builders in town and avoid a monopoly situation. But Whitcombe objects in principle to the housing allocation because it results in marketing at the city council, not the consumer, level. This objection is shared by many Davis builders.

Tandem Properties' latest completed project is Suntree, an eight-acre, 95-unit, middle income apartment complex of which 60 units are Section 8 or low income housing. The two-, three- and four-bedroom apartments have an active solar system developed for architects and builders who don't want to worry about the behavior patterns of their clients. Two water tanks, three feet in diameter, with a heat exchanger, one for domestic use and one for space heating and cooling, are housed in the garage or a service shed attached to the house. They are connected to roof-mounted solar collectors and plastic piping imbedded in the concrete floor slab. Backup units, small flash heaters, are integral with the system.

Since Davis's housing allocation for the next two years is only 260 units, Whitcombe and other large-scale builders who have been working outside Davis will have to continue to disperse their activities. Their experience should increasingly spread the innovations developed in Davis.

The state of the art of energy-oriented design, in Davis as elsewhere, is hard to assess. Whether active or passive, the systems generally in use rely heavily on slab-on-grade construction, a practice that loses its efficiency in multiple-story buildings and on uneven sites that are not easily graded. Because of the generally flat sites and the availability of undeveloped land, the problems of orientation that afflict urban areas have not been addressed. Moreover, the cooling problem is more intractable than the heating problem. And cooling is what Davis needs most. Yet there seems to be enough momentum and sufficient belief locally in the Davis style of living to continue the community's record of energy innovation. □

BOOKS

'Englishness' Explored From Three Perspectives

The English House. Hermann Muthesius. Edited with an introduction by Dennis Sharp. (Rizzoli, \$75.) **Suffolk Houses: A Study of Domestic Architecture.** Eric Sandon. (Barron Publishing, 5 Church St., Woodbridge, Suffolk, England, \$39.50.) **Georgian London.** Third edition. John Summerson. (MIT Press, \$17.50.)

Das englische Haus was first published in Berlin in 1904. This remarkable and in some ways revolutionary book had a strong impact on the early modern movement in Germany, starting with the pre-1914 Werkbund in which Hermann Muthesius played a prominent role, and later influenced Peter Behrens, Hugo Häring and Hans Scharoun. It is ironic that only now—75 years after Muthesius' death—is the book available in an English translation, the language of the architecture it celebrates.

In a preface provided by Julius Posener we are told that the reason the book was not published sooner in the English language was that styles changed. The best work of Muthesius' heroes—Norman Shaw, William Morris, Philip Webb, C. F. A. Voysey and a young rising star, Charles Rennie Mackintosh—was done in 1870-1900. Early in the new century they were eclipsed, first by "banker's Gothic" and then by the International Style. At last, three quarters of a century later, Posener concludes that we might be ready to look at what Muthesius really had to say. If we are ready, then this new edition of Muthesius' masterpiece is an event of considerable architectural importance. It rebuts the recent obituaries of the International Style by reminding us of the roots of the modern movement, in a basic and persuasive document hitherto virtually unavailable except to German-speaking scholars.

Muthesius was an architect who was appointed cultural attache to the German Embassy in London in 1896. His official researches produced technical reports on railroads, energy and industrial buildings. But his passion was the English house, and in pursuit of this passion, he was indefatigable and thorough.

His approach is organic, contextual and antistyle. "When we consider the architecture of the past," he wrote, "we too

often forget that side by side with fine architects—the architecture practiced since the Renaissance by cultivated architects usually on buildings of some pretension—there was always a great deal of building with which architects had nothing to do. The work was the responsibility of master-masons who belonged to the guilds and represented local tradition . . . (handing) on their craftsmanship from generation to generation.

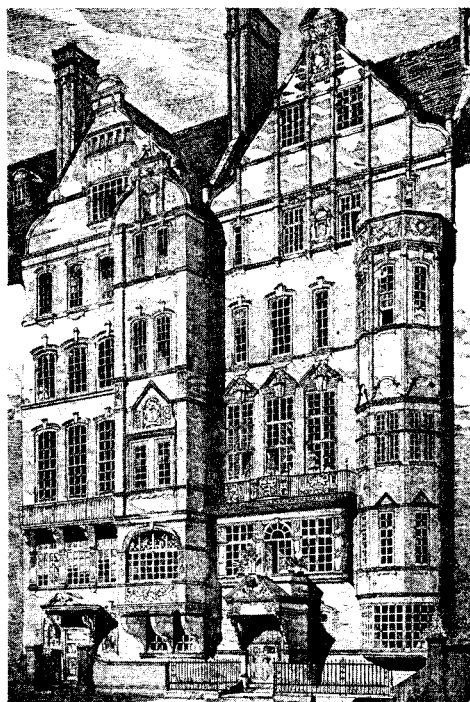

Cadogan Square houses, Norman Shaw.

"It was England's achievement—and it cannot be rated highly enough—to have been the first to find an escape from this dilemma. . . . The escape consisted in the architects recovering the traditions of the old master-masons, abandoning any suggestion of fine architecture and beginning to build simply and rationally like the old guild masons."

Muthesius is refreshingly direct. He is not seduced, as were almost all of his contemporaries, by fake images, whether medieval or classical. He sees each house as an interrelationship of functions, people and spaces. "The house is a mirror of the personal culture of those who live in it." And just as the house plan expresses the family's interpersonal relationships, the site plan, according to Muthesius, is an articulation of the family's relationship with the physical environment and the social and cultural world.

The country house emerges as an organic expression of man in landscape. And the way each house is sited in the landscape, the way its interior spaces relate to the vagaries of meadows and woodlands or outcroppings of rock, is the key to its form and materials. Similarly, the city house (whether it is one of Norman Shaw's great London houses or W. H. Lever's Port Sunlight—in which Muthesius discovered to his delight in 1898 that "every house, down to the smallest, has a bath"), has the relationship of interior plan to street and block, providing themes for its form and material that are carried through to the ultimate detail.

Muthesius writes like an architectural sleuth. The white stucco, slate and horizontality of a Voysey house in the Lake District echoes at once the surface of the lake and the eroded hill forms surrounding it, while the plan shape of the house shields an internal court from prevailing winds and driving rain.

The importance of Muthesius in the early years of the modern movement is made strikingly clear by this book. With a directness that is nothing short of extraordinary, given his period and background, he cuts through the cobwebs of stylistic posturing and eclecticism enshrouding architecture at the turn of the century. From this book, which includes all of the photographs and drawings of the original edition—including the marvelous sections on furniture, plumbing equipment and the rest—it is easy to see what an impact Muthesius had. It is only a small step from Voysey to Mies' Barcelona Pavilion via Muthesius.

And now when once again the capacity of architects to express our contemporary culture directly and organically is threatened by layers of fashionable eclecticism, Muthesius is like the air of a cool, clear day in spring.

Coincidences are seldom accidental. It is more than Englishness that make Muthesius, Summerson and Sandon's East Anglican vernacular architecture relevant to us in the U.S. today. Eric Sandon's *Suffolk Houses*, the product, one suspects, of years of singleminded and devoted research, is a vertical slice of more than a thousand years of local architectural history. East Anglia, of which Suffolk is part, is that area of England northeast of London in which Constable painted rain-laden landscapes, a low-lying marshy

coastal region laced with streams, curving country roads, ponds and nestling hamlets. Here in this gentle, scholarly book which Sandon and his wife have beautifully illustrated with photographs and drawings, he has revealed the mainsprings of local building through the centuries to be in "commoditie, firmnes and delight" derived from local materials and ways of life.

The same essential message is written urban by John Summerson. Sir John is without doubt the most urbane and wittiest of contemporary architectural historians, and this new edition of *Georgian London* is a particularly appropriate contribution to our present-day debates. He shows, as Muthesius and Sandon do in their own ways, that the forces which shape design are not primarily style, but politics—in the case of *Georgian London*, the cut-throat economics of the marketplace, the ambition and cheeseparing of developers and the jealousy of architects in quest of recognition. Sir John lays it all bare. From the seething situations he recreates in pages as precise as a surgeon's scalpel, we see the quiet squares of the London we know today grow as precarious developments in open fields, fraught with maneuvers, squabbles and occasional bankruptcies. And Muthesius' point is again driven home that the overdrive of architectural and urban design forms is not in fashionable imagery, but in context. Your scalpel is uncomfortably close to the heart, Sir John! *David Lewis, FAIA*

Design: Purpose, Form and Meaning.

John F. Pile. (University of Massachusetts Press, \$20.)

The key to the text is found in this book's title, in which Pile reveals the breadth of his intent. The message is reinforced in the foreword where he promises a "general theory of design, broad enough and logical enough to give us hope that the chaos of the physical circumstances of modern life is neither inevitable nor inescapable." And again in the introductory chapter: "It is the purpose of this book to make a critical study of . . . modern design activity and try to identify those design directions that are constructive and those that are, on balance, harmful to the realistic purposes of human life."

Pile's purpose is thus made clear, and readers who have wrestled with this hybrid discipline born of creativity out of craft are given reason to hope that it will at last be forced to yield its mysteries.

It is not.

Pile is an accomplished writer, but the book he has written is not what he led us to expect. In fact, if length is any indication, it is apparent that his real interest lies not in the analysis of modern design activity or in the formulation and application of a broad and logical theory, but

rather in an introspective apperception of the essence of design. To this end, he explores, in Trilling-like phrases, the phenomena of nature; lauds the rational evolution of form in vernacular design and the equally rational products of the 19th century engineer. He delivers an exceptionally lucid analysis of function and functionalism; discusses the nature of materials, and then relates design to both art and esthetics, finessing the question of taste by substituting Sir Henry Wotton's "delight" for Vitruvius's "beauty." This section of the book is so successful that one wishes Pile had rewritten the foreword and introduction so that these first five chapters could have appeared as an internally consistent monograph, in the manner of the works of Norberg-Schulz.

Whatever one wishes, the book does not end here. Of the four remaining chapters, two are largely pictorial. The others, while in general thoughtfully composed, do not form the promised critical study of modern design activity, although they do present a general theory of design based on the true cost, or life cost, of objects and systems. Some of the conclusions are lamentably glib—for example, that the use of carpets in schoolrooms "tends to promote quiet and constructive behavior." There is an almost obligatory section on design method. It is in the brief and final chapter, which deals with the further evolution of design, that Pile re-

turns to what appears to be his strength: the expression of a personal esthetic.

Indeed, this is a largely personal book. A glance at the bibliography shows it to be heavily weighted toward works published prior to 1970. The latest original publication date is 1972. The text also shows a bias toward modernism in its stricter, Bauhausian, internationalist sense. It does not seem to extend fully to what we euphemistically term our own postmodern days. The architects most commonly cited as examples are Le Corbusier, Mies and Aalto. More contemporary designers (however defined) are rarely given more than passing mention.

From this evidence, one is led to assume that Pile's esthetic consciousness was formed by the masters of the recent past, and that he has decreased susceptibility to current trends which may prove inconsequential in the evolving history of design. He also shows himself to be a purist in that he appears to ally himself with those who seek logic in an illogical world, those who assume that if only the principles be made clear, the millenium of nonobsolescing, energy efficient products of sensitively selected materials will occur. (This era has apparently arrived in Sweden, at the—perhaps small—cost of limiting choice to approved articles, colors and forms.)

The shortcomings of Pile's work are *continued on page 64*

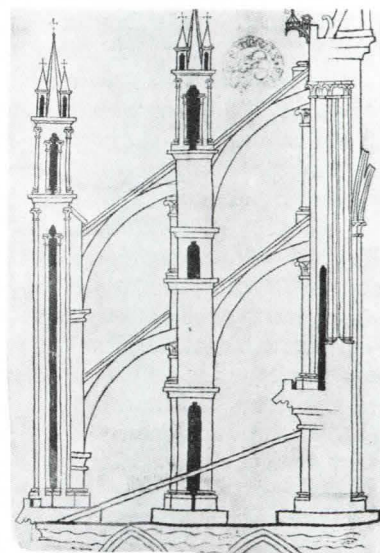
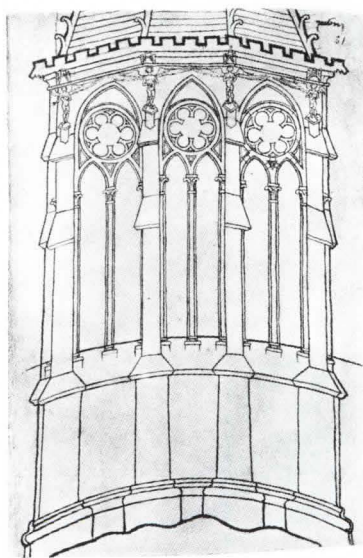

Architector: The Lodge Books and Sketchbooks of Medieval Architects. Vol. 1.

François Boucher. (Abaris Books, Inc., 24 W. 40th St., New York, N.Y. 10018). The first volume in a projected series on the personal sketchbooks of medieval architects, this book reproduces, with commentary by Boucher, the lodge book of Villard de Honnecourt (entries dating from about 1215 to 1233); the Frankfurt lodge books of "Master WB," a mason for Abelin Jörg in Stuttgart (entries begun about 1560 and completed in 1572), and the leaf pattern book of Hans Boeblinger (completed probably in 1435). These sketchbooks, Boucher says, are a "remarkable source of information on medieval architectural theory and methods of construction." Above are sketches by Villard of an elevation of a choir chapel and of choir buttresses at Reims Cathedral, which Boucher calls the "most forceful architectural design of the 13th century."

Books from page 63

largely self-inflicted. He leads us to expect a certain kind of information, and then supplies another, tangential to the first. The reader may experience the disappointment that arises when an easy answer is promised but not delivered. If this be the case, it is beneficial to recall George Nelson's perception, appearing in his 1957 *Problems of Design*, that "it is not possible to grasp the expression of a principle if you are concerned only with finding formulas to follow and tricks to copy." Nelson is not one of the designers or authors cited in Pile's book, but his words are valuable nonetheless. The indirection of this book prompts us to make our own analysis of the nature of design, and to applaud its author for his thought-provoking presentation. *Reed Benhamou, Assistant Professor, Department of Creative Arts, Purdue University*

Gold Was the Mortar: The Economics of Cathedral Building. Henry Kraus. (Routledge & Kegan Paul, \$30.)

The author of this book has an interesting history. He became a scholar of the medieval period and has lived in Europe since 1956. Before that, he served the United Automobile Workers, started its national paper and was involved in the labor strife of the 1930s. To go from social problems of manufacturing automobiles to the economics of cathedral building, Kraus has traveled a long and scholarly path, publishing his findings on the art and architecture of Europe along the way.

Kraus discusses the construction of eight cathedrals in relation to the financing of their building, and the hurdles, or in some cases the clear and relatively fast track, in finishing the job. Not surprisingly, the buildings rose in direct proportion to the money made available for construction costs. In medieval times, the government grants for buildings came from the rulers of the land in the form of donations which would reflect the glory of God and King in juxtaposition. Wars tended to deter building and certainly one that lasted 100 years had a cease and desist effect, especially when it was coupled with outbreaks of Black Death, which by educated guesses decimated half the population of the Western world, including most of the artists and artisans employed in the construction of great churches. But, in spite of all this chaos, those huge edifices rose.

Kraus tells us some interesting reasons for the troubles faced that preclude war and the disaster of the Black Death as the principal causes of the delay. York and Canterbury were in dispute constantly in a battle for individual supremacy. In Toulouse, cathedral building coincided with the period of the Albigensian heresy,

which resulted in expropriation and execution of wealthy merchants. Lyon made younger sons of nobles canons of the cathedral and then suffered a lack of enthusiasm by its churchmen for cathedral building, since they were preoccupied with increasing their own fortunes. The snobbery of the cathedral chapter of Lyon irritated the wealthy burghers who, as a result, contributed very little to the cathedral's building.

Poitiers, that Romanesque city, remained so from lack of building funds. The taxes exacted by Henry II in his wars to preserve his hold over half of France did little for cathedral building. Subsequent victory by the French resulted in confiscation of much of the conquered land and impoverishment of its people, resulting in the preservation of some remarkable Romanesque structures.

The cost of the Crusades of 1248 and 1270 are collated by the author, humorously, and perhaps not intentionally so. A knight's salary for one year would have paid for one stained glass lancet. The annual wages of 10 chevaliters would have paid for the work of 12 sculptors. By the time the Crusade of 1270 left France, 500,000 livres departed with it, a sum that would have built a dozen great cathedrals. Different strokes for different folks. Kraus would have preferred cathedrals. Paris, Amiens, Rouen and Strasbourg cathedrals were built with relative ease. There was money available in these cities to get the job done and wars were elsewhere.

The book has interesting things to say. It is not long (191 pages) and contains some aids for the reader's understanding of medieval life. The glossary and notes are adjuncts to the easily read text. *Elizabeth Class, Washington, D.C.*

The Cape May Handbook. Carolyn Pitts, Michael Fish, Hugh J. McCauley, AIA, Trina Vaux. (Athenaeum, 219 S. Sixth St., Philadelphia, Pa. 19106, \$5.)

Cape May, N.J., possesses one of the largest collections of late 19th century frame buildings remaining in the country. Its more than 600 structures are a veri-

table textbook of vernacular American architecture, ranging from Gothic revival through Queen Anne and shingle style to Georgian, Spanish and Tudor period revivals. This handbook contains descriptions and photographs and drawings of all of the styles.

Although the book is directed principally to owners of historic buildings in Cape May to help them in restoration, it contains much helpful advice on restoration in general. There are suggestions about things to consider and mistakes to avoid, things to take into account when an old house is bought or to check in one already owned, how to take advantage of new tax laws, how to apply for preservation loans, how to get a building permit. Much of this information can be used in any situation. There is also a commendable glossary and a bibliography.

How Big and Still Beautiful? Macro-Engineering Revisited. Edited by Frank P. Davidson, C. Lawrence Meador and Robert Salkeld. (Published by Westview Press for the American Association for the Advancement of Science, \$28.50.)

The word "revisited" in the title of this provocative book refers to the first book published on macro-engineering, *Macro-Engineering and the Infrastructure of Tomorrow* (1978). Both volumes are based on papers given at symposia held at annual meetings of the American Association for the Advancement of Science.

The first volume, Frank P. Davidson explains, stressed the ubiquity of large-scale infrastructure projects and the need to understand their impacts. The second "sets out, more aggressively, to shed multidisciplinary light on the presuppositions, the semantics, the issues and the psychological, economic and political implications of humanity's awesome power to engineer the future of the planet."

Davidson says in an overview of macro-engineering that introduces the book that the nation, at this moment, faces a two-fold challenge. First, we must, by the concerted effort of all sectors of society, make

continued on page 66

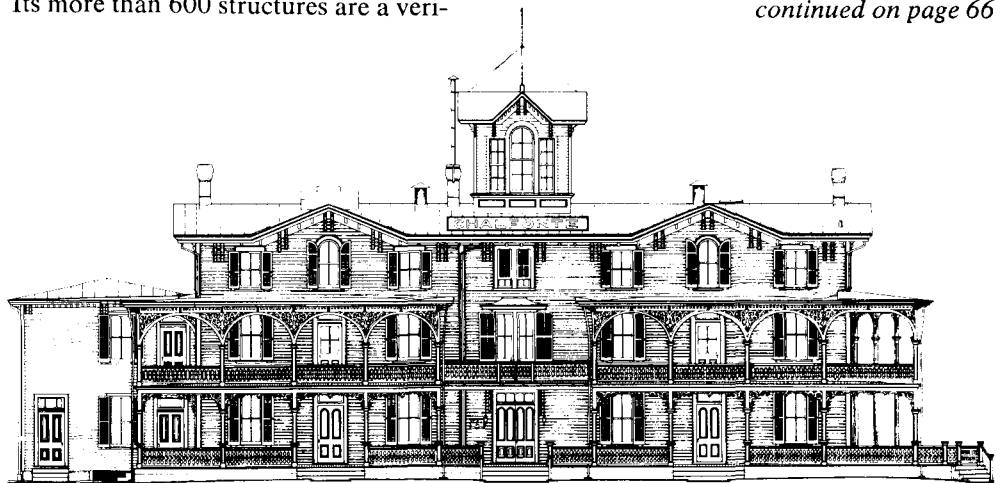



After: Salmon River Central School, Fort Covington, NY
 Architect: Cappuccilli-Bell Architects, A.I.A.
 Contractor: Tracey Trombley Construction Company
 Structural Engineer: John P. Stopen

This Formawall retrofit improved U-values from 0.88 to 0.10.

At the Salmon River Central School, Fort Covington, New York, Robertson's Formawall panels are helping to save an estimated 17,500 gallons of fuel a year.*

Cappuccilli-Bell Architects worked closely with Robertson to cover large sections of the school's 1956 aluminum and glass curtainwall with 20,000 square feet of Formawall insulated panels.

Why they chose Formawall. Formawall's U-value—as low as 0.065—was one major reason. But its crisp appearance and the proven durability of its Durasil finish were also important.

In addition, the erection of Formawall over the existing curtainwall allowed classes to proceed without interruption and provided an improved U-value by leaving the older curtainwall system intact.

Let Formawall work for you. Whether you're planning a retrofit or an entirely new project, Formawall can provide the insulation, beauty and durability you need. It's available with Durasil, Versacor, Vitralume porcelain enamel or other finishes.

For information about a free computerized cost-analysis of retrofit options for your building, including pay-back estimates based on fuel savings, write: H. H. Robertson Company, Department J-6, 400 Holiday Drive, Pittsburgh, PA 15220.

*Based on typical (as of March 25, 1980) fuel costs of \$0.87/gallon, annual estimated savings today are \$15,225.00. (Fuel savings estimates and U-value measurements by Cappuccilli-Bell.)
 Formawall, Durasil, Versacor and Vitralume are registered trademarks.

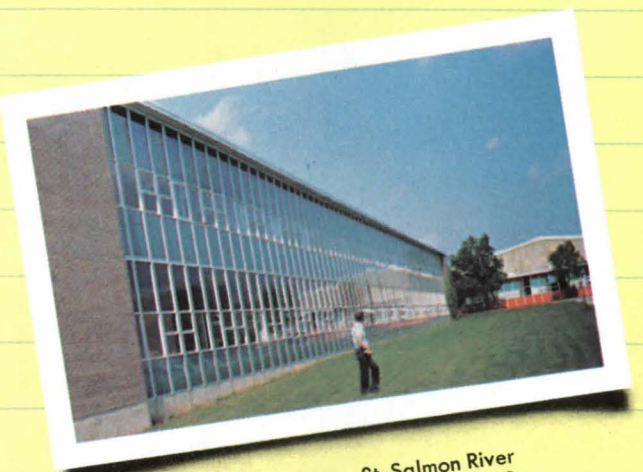

Before: Prior to Formawall retrofit, Salmon River School had a 1.10 U-value for glass and a 0.20 U-value for wall panels. (Photo by Dennis Spina, Cappuccilli-Bell.)

Robertson

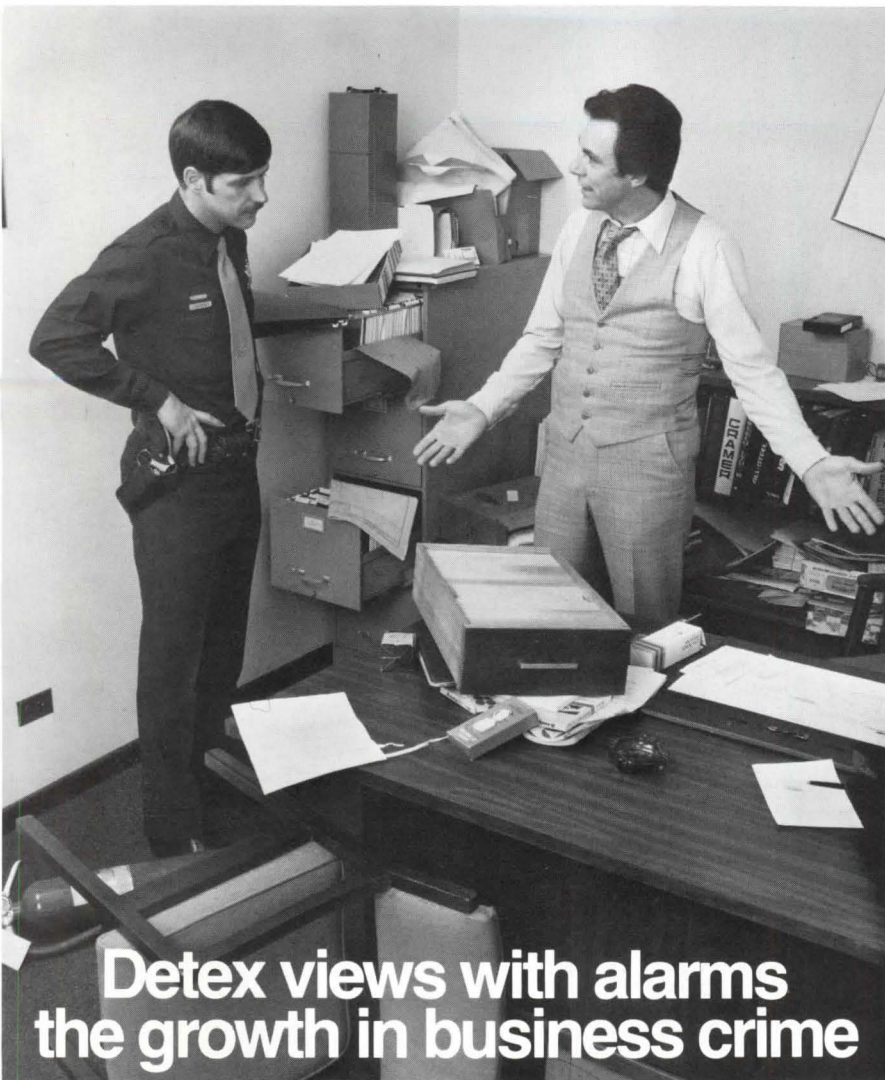

Detex views with alarms the growth in business crime

Up sharply and climbing. Latest statistics paint a sad picture of the recent rise in business crime. What's sadder still, much of it was preventable with alarm-equipped deterrent devices by Detex. Restricting entry to authorized persons. Discouraging intrusion. Preventing misuse of exits. Detex does it all. Our security hardware products

keep outsiders out and personnel in their places. They're rugged, reliable, reasonably priced devices, combinable into systems to protect an area, a floor, an entire building. Our full-line brochure gives you all the basics. Or, for comprehensive specs and installation data, write on your letterhead for our catalog.

DETEX
 DETERS

4147 Ravenswood Ave., Chicago, IL 60613 Telex: 206268 DETEX CGO

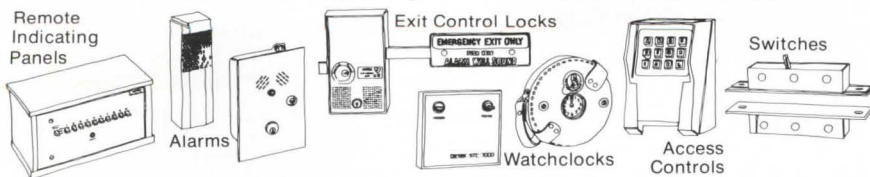

Books from page 64

good the national slippage in productivity and competitiveness. Second, we have to demonstrate that "our technological capacities can be directed, wisely and effectively, on behalf of human needs and aspirations." To do so requires more than analytical models. "We must look for such creative and adaptive energies as implied by Buckminster Fuller's familiar quest for a 'comprehensive, anticipatory design science,' and we must seek out the reinforcing medicines of integrity, persistence and a sense of public service."

In one of the papers, William J. Jones, a research associate at the energy laboratory at the Massachusetts Institute of Technology, says that a project may be defined as macro-engineering if it entails government spending or involvement because of the magnitude of investment requirements, extent of environmental impact and time span for completion; if it uses exhaustible natural resources; if it affects large numbers of the population; if it requires substantial participation from state and/or foreign governments, and if it obligates the government to monitor and control the products, in the event that the private sector fails to do so.

The papers are divided into two major parts: those that evaluate the impacts of gigantic projects and those that discuss cases in point on land and sea and in aerospace. Papers in part 1 consider the financing, management and control of gigantic mixed-economy enterprises; the policy, planning and control of such undertakings, and the values, psychology and decision process involved. Papers that examine specific macro-engineering projects cover such topics as maritime cities of the future and solar power satellites.

Perhaps John A. Seeger, associate professor of business administration at Northeastern University, sums up what the book is all about: "In our society, bigness is a fact of life. It will not and cannot simply go away because it makes some of us uncomfortable. . . . How we use it will make the difference, and how we control it will govern how we use it. . . . It must be possible to make the big, beautiful."

The Place of Art in the World of Architecture. Donald W. Thalacker. (Chelsea House in association with R. R. Bowker Co., \$35.)

"One hears a babel of voices expressing pride, bafflement, irritation. Yet one senses that public art is gathering new momentum daily and receiving such significant acceptance that neither party politics nor economic recession nor our serious energy and environmental problems can reverse the trend," says Sam Hunter, professor at Princeton University, in the introduction to this book, which is a comprehensive and entertaining account of

continued on page 68

**“You don't have to be
the biggest to be insured
by the best.”**

“Shand, Morahan?”

“Shand, Morahan.”



It's the growing consensus of the leading architectural and engineering firms in the land: the E&O program available through Shand, Morahan & Company is about the best coverage you can have, at a most competitive premium rate. That's why so many of the ENR top 500 design and construction firms are choosing our insurance.

But your firm doesn't have to be among the biggest to enjoy the best in Architects and Engineers Professional Liability insurance. Shand, Morahan also extends its uniformly excellent claims-made program and unmatched standard of service to more and more medium and smaller-sized firms as well. These firms enjoy the same experience and attention that only the nation's foremost source for professional liability insurance can provide.

If your present Architects and Engineers Liability policy or premium might benefit from an analysis and comparison with ours, we welcome your insurance broker's inquiry. Whether you're among the biggest, or just want the best.

**SM Shand, Morahan
& Company, Inc.**

One American Plaza, Evanston IL 60201

Circle 19 on information card

ENERGY QUESTION:

How do you design a building that slashes energy costs and looks great?

ENLIGHTENED ANSWER:

Create a stylish reinforced concrete building that helps reduce energy use by 50%.

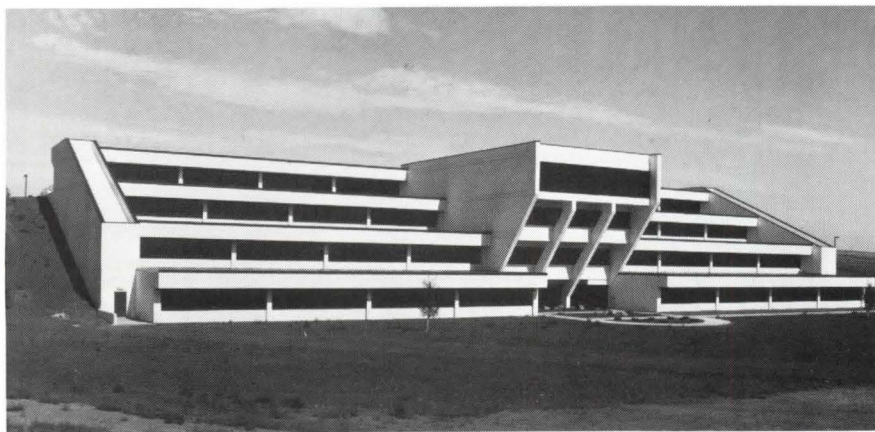

The headquarters building for Basin Electric Power Cooperative in Bismarck, N.D., has become a landmark because of its imaginative styling. But the beauty of its reinforced concrete design is more than skin deep.

The building's energy requirements are about one-half those of a comparably-sized conventional building. The designers nestled the building into a hillside, so that all but one story is shielded from chilling northwest winds. All four stories on the southeast elevation are warmed by winter sun passing through the windows. Higher-angled rays from the summer sun are blocked by overhangs.

This passive solar design, along with heat pumps, allows the accumulation of enough heat to make supplemental heating unnecessary—even at sustained low temperatures in the range of -4°F .

A prominent feature of the building is a center section that gets

progressively larger on the higher floors. This section contains executive offices and board room and space for elevators and stairwells.

Besides its obvious contribution to energy conservation by moderating the effects of outside temperature variations, reinforced concrete also was chosen for its built-in fire resistance. Concrete also is monolithic and less susceptible to below-grade expansions and contraction. Finally, the economy possible with Grade 60 reinforcing steel contributed to the success of the project.

Reinforced concrete delivers fast, money-saving answers to the question of energy conservation. Write for Bulletin 7903.

ARCHITECT: **Ritterbush Associates, Bismarck, N.D.**
STRUCTURAL CONSULTANT: **Loos & Traeholt, Bismarck, N.D.**
GENERAL CONTRACTOR: **Froeschle Sons, Inc., Bismarck, N.D.**
OWNER: **Basin Electric Power Cooperative, Bismarck, N.D.**

CONCRETE REINFORCING STEEL INSTITUTE 
180 North LaSalle Street, Room 2111
Chicago, Illinois 60601

THE ANSWER'S IN REINFORCED CONCRETE.

For information on Professional Membership Program, write to Director of Marketing.

Books from page 66

public art projects sponsored by the U.S. government.

Donald Thalacker, director of GSA's art-in-architecture program, in 220 pages filled with black and white and color photographs tells about how the public art program has fared, and, as Hunter says, "all these trying tales have had happy endings." And this in view of the fact that the "American capacity for demagoguery, and our deep mistrust of educated values, remain appalling facts of public life."

Thalacker describes how the artists were commissioned, what their aims were in their artworks, how the art was fabricated and installed, how the public reacted. He includes comments from the artists—many of whom ask to bring artists into the architectural planning early in the building stage.

It is interesting to read of the public comment about art that, at first, may be incomprehensible. For example, James Surls' "Seaflower," a sculpture 17 feet high and 28 feet long designed for a federal building in New Bedford, Mass., was debated in the local press and called such things as a "frightened caterpillar" and a "crippled sea urchin." But another reader of the paper saw value in the controversy about the art: "I may be weird but I think that sculpture . . . is just great. I think of it as the burr in the pants of our city."

The public art has been a "burr" for American citizens as a whole, establishing, as Hunter says, a "common ground of values and experiences, liberating art from the cloistered museums and placing it in the public realm of shared purposes."

Earthquake Engineering and Hazards Reduction in China. Edited by Paul C. Jennings. (National Academy of Sciences, \$11.50.)

This book is a report of a trip by representatives of the National Academy of Sciences, the National Academy of Engineering and the Institute of Medicine to China in 1978 to study the reduction of earthquakes and hazards in that country. The papers center on five major themes: the organization of earthquake engineering in China, earthquake engineering research and practice, a report of the Tangshan earthquake in 1976 and the Sungpan-Pingwu earthquakes of August in that year. The photographs that accompany the two last named sections are mind-boggling—buckled rail lines, ground collapses, destroyed buildings and bridges. The book will be helpful for engineers and seismologists. Of particular interest is the report on the Sungpan-Pingwu earthquakes, notable because Chinese seismologists predicted the two main aftershocks and gave the members of the team a detailed account of how the predictions evolved. □

Build high, wide and handsome with Clayburn brick

Clayburn brick opens the door to an infinite number of design possibilities. Special shapes are available which can perform many design functions, such as sharply angled walls and curving surfaces.

And with the revolutionary Clayburn *Giant** brick system, you can achieve remarkably fast, economical construction while still enjoying the rich warmth and beauty of fired clay brick. Throughout the west, single wythe, load bearing walls of Clayburn *Giant* brick are performing beautifully. Your inquiries are invited.



CLAYBURN*

* TM of Clayburn Industries Ltd.

Head office and plant at Abbotsford, B.C. Canada
Sales offices in Abbotsford, Calgary, Edmonton,
Vancouver, Salt Lake City and Seattle.

Dealers throughout the West.

Circle 21 on information card



Imperial Hotel from page 46

tion which, as discussed earlier, could probably be characterized as long period or low frequency.

Mechanical/electrical riser elements hung free of the structure in vertical shafts, and runs were laid in covered concrete trenches in the basement rather than buried. "Earthquakes had always torn piping and wiring apart where laid in the structure and had flooded or charged the building," Wright wrote. Lead pipes were used and pipe turns were accommodated with sweeping curves rather than small radius right angle bends. "Thus any disturbance might flex and rattle but not break the pipes or wiring." Except for the underwriting industry's concern with the seismic aspects of fire sprinkler plumbing design dating from the '40s, Wright's serious attention to this architectural/engineering problem remained a rare example in American practice up until at least the 1964 Alaska earthquake (and thorough examination of the nonstructural problem remains the exception, not the rule even today, especially on the part of architects).

The reflecting pool in the entrance court, which stored roof-collected rain water, was planned as an emergency water supply, according to Wright, and it was used for bucket brigades following the earthquake when the conflagration swept Tokyo and Yokohama. Fires reached to the very edge of the Imperial Hotel grounds on three sides, but it was not damaged. Windows were wetted down as the fire approached the vicinity. The pool had an everyday esthetic role to play as well. In fact, since Wright often used a pool in an entrance court, as in the case of the Coonley house of 1912, one might argue that the pool would have been part of the design even if it had no emergency function to fulfill. Questions relating to the construction itself are unclear, and questions of motivation are even more opaque, hence no speculation will be offered on the question of how much different the building would have been had it been designed for Illinois rather than Japan.

It should be briefly noted that this same building was a forerunner in the development of radiant heating, forced air ventilation and indirect lighting, and even though there is thus a long list of interesting seismic and nonseismic technical innovations involved in the story of the Imperial Hotel, it achieved fame and landmark status primarily on the basis of its esthetic character. While Louis Sullivan's contemporary writings on the Imperial Hotel contain some factual inaccuracies (such as overstating the building's size by 50 percent), he was quite perceptive in calling the work "thought-built." Although Wright's accounts sometimes sacrifice engineering accuracy to poetic license, his statement that "the plans were made so that all architectural features were practical necessities" is more than simply self-publicizing rhetoric. Whether practicalities are antecedently considered and then used to determine the esthetic aspects or whether practicalities are fitted into design concepts is perhaps of minor significance. The important question is whether the two sets of concerns are thoroughly integrated.

Some of the innovative seismic design aspects for which the building is known, such as the foundation system and "waiter's tray" floor system, may now seem flawed, while other features never given much attention at the time or subsequently are now state-of-the-art: the use of seismic separation joints, structural/nonstructural interaction, multihazard design to protect against fire as well as earthquake, filled-cavity bearing wall construction, appendage anchorage, vertical mass and resistance proportions. It is generally true that a great building, upon closer inspection, is great for a variety of reasons, and perhaps it is also true that upon closer inspection the particular facts are almost never as simple as they at first appeared.

As Finis Farr has noted, "Such a commanding personality gave myth-makers plenty to work with, and the absurd legends that came to surround Wright might almost make one forget that the facts were even more extraordinary." □

Principles to build on.

What do buildings do? How do they work? In answering these questions, Edward Allen describes the basic functions every building—from grass hut to skyscraper—must perform, and shows the various ways structure and systems interact to meet ecological challenges and satisfy human needs. Free of technical formulas or prepackaged solutions, "this is a book that needed to be written.... a distinctive contribution to the literature of building."

—Albert G. H. Dietz,
Professor Emeritus, M.I.T.

of related interest...

By Christopher Alexander et al.

THE TIMELESS WAY
OF BUILDING \$27.50

A PATTERN LANGUAGE: Towns
Buildings, Construction \$39.50

THE OREGON EXPERIMENT \$17.95



OXFORD
UNIVERSITY PRESS

200 Madison Avenue, New York, N.Y. 10016

Edward Allen HOW BUILDINGS WORK

The Natural Order of Architecture

With 300 line drawings, 8½ x 11 format, \$19.95





With Howmet's new aluminum interior door frame your construction problems are ancient history. Unlike hollow metal frames, Howmet's lightweight, one-piece aluminum frame installs easily while the walls are going up.

Once installed, it's durable enough to last a lifetime. And since it never needs repainting you can say good-bye to maintenance headaches.

Choose from two models — ceiling height and ceiling height or less. Each comes ready to install in our standard bronze paint finish. Other finishes are available on special order. Matching sidelite material is also readily available. Both the frame and sidelites are fully demountable.

For more information, contact Bobby Hall or Jimmy Parker at (501) 234-4260. Learn how you can have a bright future with Howmet door frames.

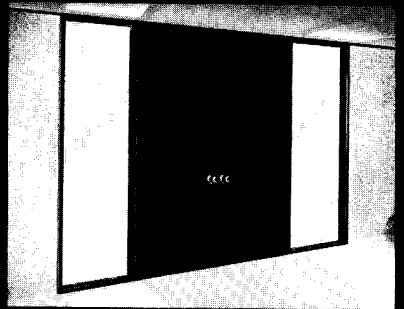

HOWMET ALUMINUM CORPORATION

 A Member of
The Pechiney Ugine Kuhlmann Group
SPECIALTY PRODUCTS DIVISION

P.O. Box 40 • Magnolia, Ark. 71753

**Where Ideas and Imagination
Are Only The Beginning**

Howmet takes the door frame out of the stone age.

Circle 23 on information card

"A bold vision.

"It breaks new ground on most fronts.

Oscar Newman's outlook cuts against the grain, quarrels with conventional wisdom... An imaginative urban planner, he wants his colleagues to review how we house ourselves. Sketching designs that can turn dwellings into homes, he challenges the general reader too."—John K. Roth, *Los Angeles Times*.

"Will be widely discussed..."

Newman rejects the concept of 'interest communities' which transcend neighborhoods and proposes the 'community of interest' based on several controversial yet well-defended concepts such as racial and economic quotas and rejecting mix of ages and lifestyles, among others."—*Library Journal*.

"Crucial to all of us.

Oscar Newman addresses the issue of the social balance of urban communities...Deserves serious attention and is certainly controversial!"—Caroline Seebom, *New York Times Book Review*.

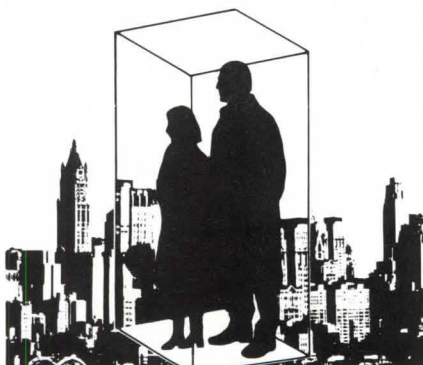

COMMUNITY OF INTEREST BY OSCAR NEWMAN
author of DEFENSIBLE SPACE

\$14.95 at booksellers
ANCHOR PRESS/DOUBLEDAY

Awards from page 27

Square and the other York Street, which are conceived as one unit in order to retain the architectural scale of the neighborhood and the dominance of Telfair Square.

According to the design proposal, one of the three multistory office buildings will be wrapped around an elevated interior parking garage. An underground passageway will connect the buildings. A landscaped plaza will permit public access to the complex, with a 20-foot *allée* also connecting the buildings both physically and visually.

According to GSA regional administrator Wesley Johnson, the selected design "is in keeping with the historical traditions of Savannah and complements the surrounding structures" in scale, color and fenestration. John Hayes, executive director of the Historic Savannah Foundation, said that the foundation favored the selected proposal "because it followed the original city plan" of Savannah.

Florida Architects Eligible For University Competition

A competition for the design and the methodology to deliver the design on time (June 15, 1982) and budget (\$4.5 million) of an architectural facility for Florida A and M University has been announced.

The competitors are being asked to be "as ingenious about delivering the design as the design itself," said Forrest Wilson, AIA, competition adviser. In addition, the design/design delivery system of this building will be "seriously" considered by the sponsors, the state university system of Florida, as a possible prototype for awarding future university building facility commissions.

Because of the competition's unique design/design delivery provisions, a proposal has been submitted to the National Endowment for the Arts for a matching funds grant to be used to document and disseminate competition information.

The competition is open to all architects registered in Florida prior to Sept. 1, 1980. Five finalists and three alternatives will be selected in early August. The finalists will each be awarded \$3,000 to develop their solutions to be presented to a jury on Sept. 26.

Jury members will include John Harkness, FAIA; Forrest Kelley, AIA; Porter Driscoll, AIA; Laurin Askew, AIA, and Richard Chalmers, AIA, plus two to be selected.

For more information, contact Forrest Wilson, AIA, Professional Adviser, School of Architecture, Florida A and M University, Tallahassee, Fla. 32307, (904) 599-3244.

David Bishop, Rochester
Max W. Bisson, Owensboro, Ky.
John Paul Ehrig, Clearwater, Fla.
W. Henry Fey, Kirkland, Wash.
Craig Haaren, Rumson, N.J.
Myron E. Jensen, Cozad, Neb.
W. C. Keenan Jr., New Orleans
C. F. McAlpine Jr., Fort Lauderdale, Fla.
Kenneth B. Norton, Bronxville, N.Y.
Steve K. Parsons, Dallas
Sol Rosenthal, FAIA, New Orleans
J. Davidson Stephen, New York City

Marvin E. Goody, FAIA: A principal in the Boston firm of Goody, Clancy & Associates, Inc. (winner of an AIA 1980 honor award for Heaton Court, Stockbridge, Mass., see Mid-May, p. 220), Mr. Goody died on May 18 while sailing in Padanarum Harbor. He was 51.

The recipient of a bachelor of architecture degree from the University of Pennsylvania, a master of architecture degree from the Massachusetts Institute of Technology and a master of city planning degree from Yale University, Mr. Goody taught at Yale and came to Boston 25 years ago to teach architectural design at MIT. At MIT, he helped develop the staggered truss system in use in highrise buildings throughout the world.

He was chairman of the Boston Art Commission at the time of his death. He was also a former director and commissioner of education and research of the Boston Society of Architects/AIA, former vice president of the Boston Architectural Center and former chairman of the Massachusetts Board of Registration of Architects.

Edward J. Mathews, AIA: After training as a draftsman under Bertram Grosvenor Goodhue, Mr. Mathews studied at Yale University's school of art and architecture, where he later taught for two years. Prior to World War II, he was employed as a designer by the architects of Rockefeller Center in Manhattan. An associate in the firm of McKim, Meade & White, he joined the New York City offices of Skidmore, Owings & Merrill in 1950, two years later becoming a general partner. In 1965, he formed his own New York City firm. He died on March 28 at the age of 77.

Mr. Mathews, who helped create New York's city planning commission, had charge of studies in the 1950s for the rehabilitation of lower Manhattan for the Downtown Association and participated in the development of the Chase Manhattan Bank and plaza in the financial district. He served on AIA's committee on urban design for seven years, and was its chairman for five years.

Briefs on page 76

PenPly exterior cedar pays dividends by the hour.

PenPly Western Red Cedar Exterior Plywood 303 Siding gives you the real economy of reduced labor costs—while you retain the quality and appeal of cedar siding.

For example, the house pictured here requires only 120 PenPly panels and takes about 91 manhours to cover. Compare that with the 169 manhours it could take to cover an equal area with a piecemeal siding. That's time, not to mention money, you can't afford to waste.

Buyers also appreciate cedar for its even grain, warm tones, weather resistance and freedom from maintenance. That's why you can afford to step up to cedar and realize a much greater profit when the home is sold.

In order to show you the design and profit possibilities of cedar, PenPly, the leading producer of quality cedar siding, has published a *free brochure*. It contains floor plans to this house, design details and facts.

For more information, contact your wood products distributor, or see Sweet's General Building and Light Residential Files under Siding/Cladding Section (7.6 Pen).

PenPly
Wood Products from I.T.T. Rayonier, Inc.

Circle 25 on information card

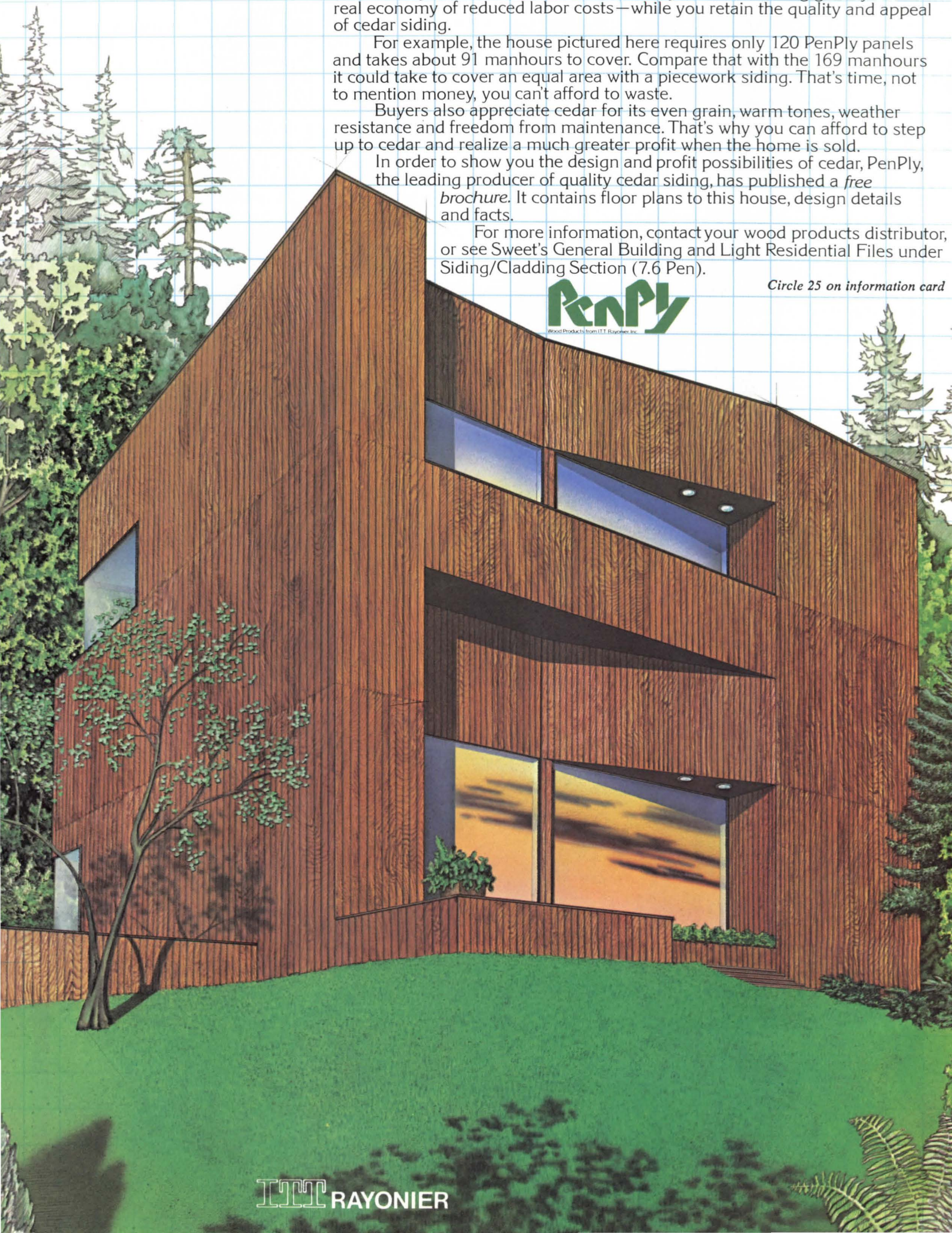

FICTION?

Don't be fooled. The ad below implies that America's best-selling polystyrene insulation is a poor substitute for extruded foam board.

Styrofoam BRAND INSUL

**YOU SPECIFIED IT.
BE SURE YOU GET IT.**

There's only one STYROFOAM® brand insulation and The Dow Chemical Company stands squarely behind it. STYROFOAM, with thirty years of proven performance, keeps on delivering consistent energy savings for the life of a building.

Don't confuse STYROFOAM brand insulation with porous foam products made with today's throw-away technology, like molded foam cups and picnic coolers. This whole category of disposable foam products is made an entirely different way.



One product made with this same short-life, throw-away technology is "beadboard" insulation. Ever had a foam cup leak in your hand?

That's exactly how these porous imitations can work in buildings. Think about it next time you specify insulation.

STYROFOAM brand insulation keeps the wet out. Moisture absorption is the most common cause of thermal resistance deterioration in perimeter, sidewall and roof insulation. Since water is a good conductor of heat, soggy insulation robs a building of the

energy it's supposed to be saving. The unique closed cell structure of STYROFOAM repels water and retains R-value.

STYROFOAM brand insulation also meets many of the toughest building codes for demanding applications, like below grade. Because when moisture gets in and freezes, porous imitations can crumble—along with their insulation value. STYROFOAM will continue to perform long after other materials fail.

Accept no substitutes. Specify STYROFOAM brand insulation and make sure it's actually

applied. Then you can be confident that you and your clients have invested in the proven answer for energy savings from frostline to skyline.

For more information, write:
The Dow Chemical Company, STYROFOAM Brand Insulation, Dept. A00, Midland, MI 48644

The Proven Answer



® Trademark of The Dow Chemical Company

WARNING: STYROFOAM brand insulation is a combustible and should be properly installed. A system brand interior finish should be used in commercial construction. For proper application, STYROFOAM brand insulation should be provided with an adequate protection. For specific instructions see data literature available from your supplier or from Dow.

FACT.

Look at the record. EPS polystyrene insulation board outsells extruded polystyrene foam by about 2 to 1. Here's why:

Modern expanded polystyrene (EPS) insulation board gives you much more R-value for your money than extruded foam board. But that's just the beginning. Considering all its advantages, you can easily see why EPS is the better answer!

More cost efficient. EPS board products supply about 35 units of "R" (resistance to heat loss or gain) per dollar of product cost. Compare that to about 20 R's for Styrofoam.[®]

If you need R's from rigid board products, and must meet the budget, there's only one way to go: Readily and locally available EPS. Look at the numbers!

Reliable R-value life. The fine, air-stabilized cellular structure of EPS assures steady, long-term retention of R-value. From the day of installation through the entire life of the building.

Low porosity. Excellent resistance to moisture also contributes to the consistently high R-value of EPS. It offers high infiltration resistance... zero capillarity... non-settling stability... joint-tight resiliency... and is non-corrosive.

With EPS you get proper cold side breathing without costly venting. Proven below grade performance over 25 years. Advanced EPS technology offers plus-value economy from frost line to roof line... on

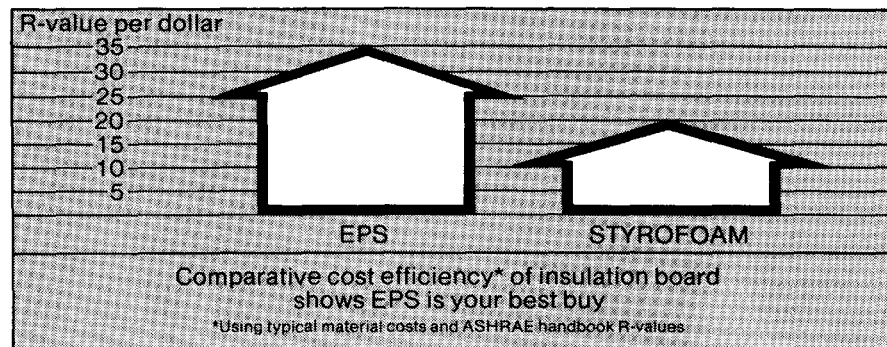

residential, commercial, educational and industrial buildings.

Accept no substitutes. EPS is available in types, sizes and thicknesses tailored to meet design requirements from building product suppliers across the country. Friction fit widths for furring and studs. 48" width and wall height lengths for

vertical sheathing applications. Foil skins for added strength and extra R's. Density selection to meet load conditions. Composites and tapers for roof jobs.

Write us for all the facts and the names of 150 EPS insulation producers. There's one in your area.

EPS: The Better Answer!

EPS should not be exposed to ignition sources during storage, installation and use. Consult your supplier for application recommendations and limitations. Illustrations shown herein make no attempt to show specific details mandated by codes and standards.



BASF Wyandotte Corporation
Styropor Division
Wyandotte, Michigan 48192



Circle 26 on information card

BRIEFS

The American Subcontractors Association has elected its first woman president: Norma Mann of the Mann Steel Co. in Dallas. She will assume office on July 1.

The American Academy in Rome has awarded mid-career fellowships in architecture to Thomas L. Bosworth, FAIA, University of Washington; Euine Fay Jones, FAIA, University of Arkansas; John Quinn Lawson, AIA, University of Pennsylvania, and Werner Seligmann, Syracuse University.

The 1980 "Build/America" awards for construction excellence, sponsored by the Associated General Contractors of America and Motorola, Inc., have been presented to: Mardian Construction Co. of Phoenix, for the construction of Terminal Module Three at Phoenix's Sky Harbor Airport; Dravo Engineers & Constructors, Pittsburgh, for the conversion of an underground salt mine in Louisiana to a crude oil storage facility, and to John Luther & Sons, Rochester, for reconstruction of the Olympic bobsled run in Lake Placid, N.Y.

Jason L. Seley, a sculptor, will become dean of the college of architecture, art

and planning, Cornell University, in July, succeeding Kermit C. Parsons, AIA, who has been dean since 1971. Seley served five-years as art department chairman.

Of the 255,000 black students in colleges and universities, 0.2 percent were enrolled in architectural programs in 1976, according to a study made last year by the National Advisory Committee on Black Higher Education. There were 10.7 percent in business and management, 2.4 percent in engineering, 1.5 percent in the biological sciences, 0.5 percent in physical sciences, 0.3 percent in agriculture and 83.6 percent in all other fields.

Senior faculty positions in architecture and town planning are open at the Israel Institute of Technology in Haifa. Contact: Dean, Faculty of Architecture and Town Planning, Technion City, Haifa 32000, Israel.

The late Richard J. Neutra's home in the Silverlake area of Los Angeles has been given to California Polytechnic State University at Pomona by the architect's widow Dione Neutra. Known as the "research house," the structure was built in 1932, and will be occupied by Mrs. Neutra until such time as the house becomes the sole property, along with endowment

for its upkeep, of the Cal Poly Kellogg Unit Foundation, Inc. It will be used primarily by the university's school of environmental design faculty and students.

"The Summer Academy in Architecture," a six-weeks course for high school students interested in architectural careers, will be held at the University of Texas at Austin's school of architecture on July 13-Aug. 22. Contact: Summer Academy, Box 7908, University of Texas at Austin, Austin, Tex. 78712, (512) 471-1922.

E. James Gambaro, FAIA, of New York City has been re-elected to his third term as second vice president of the National Sculpture Society. Serving on the society's council are C. Dale Badgeley, AIA, Ferdinand Eiseman, AIA, and Edwin Thatcher, AIA.

The Associated General Contractors of America has installed Ival R. Cianchette of Pittsfield, Maine, as its 1980 president.

Richard Llewelyn-Davies, Hon. FAIA, of England, has been invited to take up residence at Princeton University's Institute of Advanced Studies as the principal visitor for the 1980 fall semester. He is the first architect ever to be accorded this honor. *Products on page 78*

HAWS drinking fountain has wheelchair access



With ample knee space from three sides for easy approach and a self-closing feather-touch push-bar valve for easy operation, this compact wall-mounted Haws drinking fountain may be reached with a minimum of positioning and hand movement. Model 1107 in #4 stainless steel satin finish or Model 1107B in stainless steel Sienna Bronze finish readily meet the requirements of Public Law 90.480 which mandates handicapped-accessible facilities in new and some existing public buildings. A remote chiller with grille is available at extra cost. For complete information, contact Haws Drinking Faucet Co., P.O. Box 1999, Berkeley, CA 94701.

Haws
DRINKING FOUNTAINS

How to get everything you need to know about ceramic tile.

Your American Olean sales representative is highly qualified to help you.

He can assist you in specifying the proper ceramic tile for a job.

Answer any technical questions you might have. Even suggest new and

imaginative ways to use our tile. To see our broad, beautiful line, send for our 1980 product catalog. Our help and the catalog are yours for the asking.

American Olean Tile Company
2769 Cannon Avenue, Lansdale, PA 19446.

Have your sales representative call. Send me your new catalog.

Name _____ Company _____

Address _____

City _____

State _____ Zip _____

Telephone _____

American Olean Tile
A National Gypsum Company

Introducing StarShield™ The Ultimate Roof System.

Ultimate watertightness.

The StarShield system's advanced design makes it virtually impossible for leaks to occur. Seams are approximately 3" above the panel surface to minimize contact with standing water, melting snow and ice.

The use of sliding clips eliminates through-fasteners at panel sidelaps and allows the panels to "float". This means the end of leaks caused by elongation of fastener holes due to panel expansion and contraction.

Increased thermal efficiency.

The StarShield panel clips also help reduce energy costs by providing a 1" clearance between the roof panels and purlins. This minimizes heat loss due to compressed insulation.

StarShield panels with 4" batt insulation can provide a tested U factor of .0742 (Btu/Hr. Ft² °F). This is almost twice as efficient as metal roof panels fastened directly to purlins on 6" fastener spacings.

Ultimate durability.

StarShield roof systems are constructed of long-lasting 24 gauge steel for years of worry free protection. Their transverse ribs are designed to prevent oil-can popping, flutter and damage caused by roof traffic.

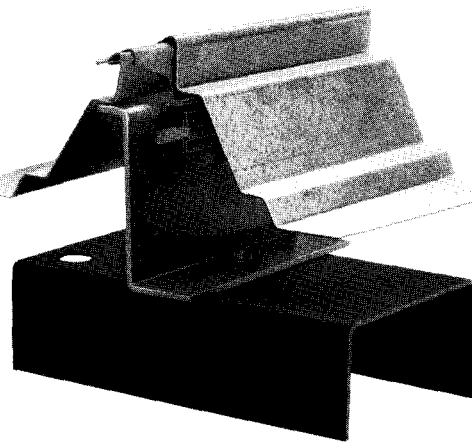

Specially-designed clips, which attach securely to purlins with only one screw, allow the roof panels to expand and contract with temperature variations. A 1" clearance between the roof panels and purlins is provided to minimize heat loss due to compressed insulation.

Streamlined construction saves time and money.

StarShield roofs are a builder's best friend. Owners like them too, because of the reduced on-site labor costs.

StarShield clips and interlocking panel edges permit the entire roof to be installed prior to seaming. This gives the builder flexibility in scheduling people and equipment, plus it gets your building under roof faster.

Panel seaming is also greatly simplified. Sidelap sealant is factory-applied,

assuring a continuous, watertight seal.

And, the StarShield seaming machine requires no special scaffolding at the eave or ridge. A hand crimping tool is provided to start the seaming process.

The interlocking panel design also eliminates "false" seaming, which is possible with other standing seam roof systems.

Self-aligning components, self-drilling fasteners and factory-notched panel ends further speed the installation of your StarShield roof system.

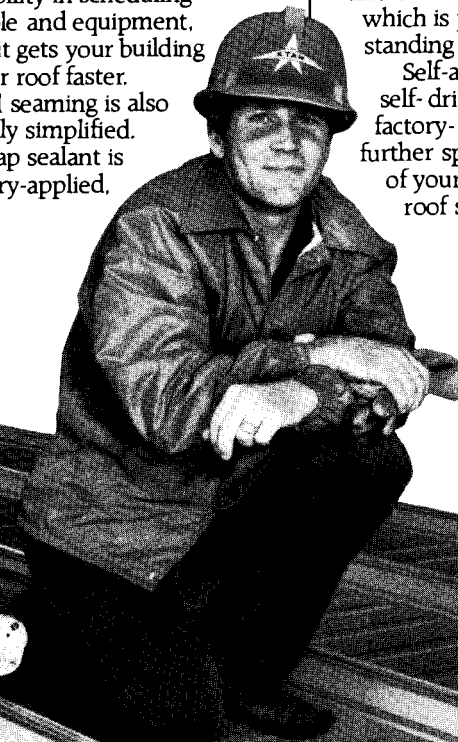

The high speed motorized seaming machine requires no special scaffolding at the eave or ridge.

For new or existing buildings.

StarShield roof systems offer great flexibility of application. They're equally at home in new or retrofit installations. The only requirement is that you have a surface on which to fasten the clips. Bar joists, wood framing, even decking will suffice. The StarShield clip is die-punched in three places to satisfy virtually all fastening situations. StarShield roofs can even be installed directly over existing roofs in some cases. The 1" standoff feature allows extra insulation to be placed between the old and new roof surfaces.

Ultimate appearance.

The classic appearance of a standing seam roof is further enhanced by the StarShield system's absence of exposed fasteners along the panel sidelaps. Accessories such as facades, gutters, vents and roof jacks are designed to complement the system, not detract from it.

Call today for more information.

Your Star Builder has full details for specifying StarShield roof systems on your next building project. Let us help put you in touch with him today.

Call toll-free 800-654-3921.
In Oklahoma call collect 405-636-2548.
Or write Star Manufacturing Company,
Box 94910, Oklahoma City, OK 73143.

STAR 
**BUILDING
SYSTEMS**

PRODUCTS

Stain and Wood Preservative.

Weather Screen, a linseed oil-based, water repellent stain, contains two wood preservatives: TBTO to guard against wood rot and decay and FOLPET to prevent mildew growth. It is available in 10 semitransparent colors. (Olympic Stain, Bellevue, Wash. Circle 199 on information card.)

Energy Efficient Doors.

Energy Guard Doors feature one-and-three-eighths inch thick insulating wood panels and one-half inch panel tapers. The doors are available in fir and hemlock. (Nicolai Co., Los Angeles. Circle 198 on information card.)

Mortar and Sealer for Brick, Stone.

Adhesive Mortar is designed to bond decorative brick/stone and structural building surfaces. Brick and Stone Sealer can be used on decorative stone surfaces. (Contech Brands, Minneapolis. Circle 196 on information card.)

Wood Folding Doors.

Wood FolDoor features Dual-Durometer hinges and bonded vinyl wood grains. The hinges are of rigid and flexible fused vinyl. Vinyl wood grains are bonded to

wood panels, core panels are half-inch thick wood, tracks are 16 gauge steel and trolleys are ball-bearing. Panels are available in 5, 6, and 8 inch widths. (Holcomb & Hoke Manufacturing Co., Inc., Indianapolis. Circle 197 on information card.)

Color Aerial Slides.

Approximately 2,000 color aerial slides are available covering such topics as architecture, pollution sources, transportation facilities. (Landslides, Boston. Circle 181 on information card.)

Roofing Membrane.

Flexhide is plasticized and formulated with ultra-violet inhibitors, antioxidants and fungicides. It is available in 34, 45 and 50 millimeters thickness. (USM Weather-Shield Systems Co., Stanhope, N.J. Circle 195 on information card.)

Furring Channels.

Zinc-coated steel drywall furring channels are available in seven-eighths and 1.5-inch depths with wide serrated faces. The channels come in 12-foot lengths and other lengths on special order. (Allied Structural Industries, Detroit. Circle 194 on information card.)

Wood Frame Chairs.

Continuum chairs are available in three

variations: full panel arm, upholstered pad/wood open arm and rhomboid leg cross section with softly radiused arm-leg joint. They are designed for conference, guest and stacking use. The chairs measure 24x23x30.5 inches and are available in solid white oak or American black walnut. (Stow/Davis, Grand Rapids, Mich. Circle 193 on information card.)

Electronic Clock Thermostat.

The Model 6000 series thermostat displays both actual and desired temperature. The temperature can be automatically changed four times every 24 hours. (RapidCircuit Corporation, Brooklyn, N.Y. Circle 192 on information card.)

Flexible Pew Chairs.

Flexible Chairs are designed to fit together easily and rapidly. They can be used individually or in traditional row formation. They are made of oak with the seats and back upholstered over pliable, soft foam. (Garnett Church Furniture & Manufacturing Co., Garnett, Kan. Circle 191 on information card.)

Filing System, Light Table.

System One is a filing system designed to hold all types of sheet graphics and drawings on one rack for easy retrieval and replacement. The Huey Light Table

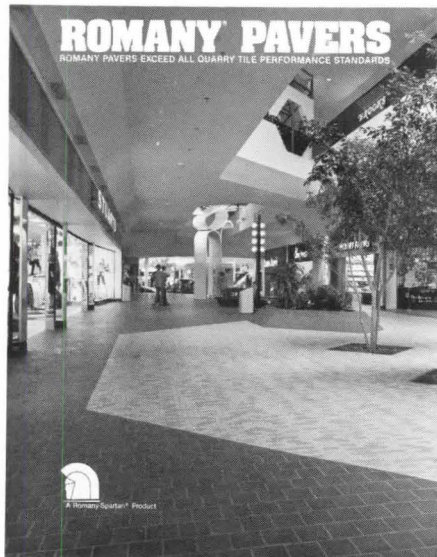

**Before
you
specify
quarry
tile
send for
this free
booklet.**

Learn how Romany® Pavers exceed the recommended A 137.1 standard grade specifications for quarry tile in this free, illustrated, fact-filled booklet.

Made with a slimmer profile (3/8" thick) than standard quarry tile, Romany Pavers excel in strength and beauty. They exceed A 137.1 standards for bond strength, warpage, wedging, water absorption, breaking strength, abrasive hardness and facial dimensions.

Write for free test data brochure, which also includes color illustrations of the complete product line. United States Ceramic Tile Company.

**United States
Ceramic Tile
Company**
Subsidiary of
**Spartek
Inc.**

1375 Raff Road S.W.
Canton, Ohio 44711

COMMISSIONER ON HERITAGE AND URBAN DESIGN

This is a new position responsible for the management of the office of Heritage and Urban Design, a newly created division in the Department of Public Safety, City of St. Louis.

Responsibilities will include the supervision of a four person professional staff, the designation and regulation of historic districts and landmarks in the City of St. Louis.

The minimum qualifications are a Bachelor's degree in Architecture, Architectural Engineering, Urban and Regional Planning, Civil Engineering, Architectural History, Preservation or a closely related field and five years of progressively responsible related experience of which three years must have been in preservation and/or historic landmark planning and development.

This is a professional career position covered under the City of St. Louis Civil Service System. The annual salary is \$25,000 with an excellent fringe benefit package including the use of a car.

Interested persons should submit resume to Mr. Patrick Martocci, Department of Personnel, City of St. Louis, Room 235 Municipal Courts Building, 1320 Market Street, St. Louis, Missouri 63103.

Application deadline is August 15, 1980.

An Equal Opportunity Employer

maintains a continuous light at all points of the table and has 180-degree movement. (Huey Co., Franklin Park, Ill. Circle 190 on information card.)

Square Distribution Lighting.

Lobay 11 Luminaire has an aluminum reflector with white baked, high reflectance enamel on the interior. The injection-molded acrylic Quadrature lens, which has the appearance of four separate quadrants joined together at the center, produces wide, square distribution lighting. (Holophane Division, Johns-Manville, Denver. Circle 176 on information card.)

Steel Doors.

Doors may be custom-ordered in galvanized, embossed, textured, painted or stainless steel. The steel is continuously bonded to a polystyrene foam core. Skin thicknesses are 14, 16, 18 or 20 gauge. (Industrial Metal Products Co., New Brunswick, N.J. Circle 175 on information card.)

Solar Tracker

Suntracker-Concentrator consists of three or more parabolically curved, stainless troughs linked together to a control system. The troughs are operated by optical sensors which instruct them to face the sun and move with its path. Solar radiation is concentrated on and absorbed by the black coating of the tube. (Natural Energy Jersey Ltd., Jersey, British Isles. Circle 185 on information card.)

Aluminum Ceiling Systems.

Daempa systems, introduced more than 30 years ago in Europe, are now available in the U.S. The light-weight aluminum linear panels snap in place and come in 100 colors. They are available in custom-cut lengths. (Levolor Lorentzen Inc., Hoboken, N.J. Circle 184 on information card.)

Energy Recovery System.

Rapid Payback Unit is designed for general ventilation applications with exhaust temperatures to 125 degrees Fahrenheit, airflows to 10,000 cubic-feet-per-minute and a total static pressure of three inches. (United Air Specialists, Cincinnati. Circle 180 on information card.)

Computer Control System.

The Direct Digital Control system applies individual microcomputers to the components of the building's energy systems. Each microcomputer can analyze input data and draw on information in its memory bank to direct the operation of the system components to which it is assigned. (Computer Controls Corporation, Wilmington, Mass. Circle 186 on information card.) □

Don't let water make its mark!

Joint sealant problems such as this are eliminated for the life of your building by Polytite-B when used as a backer for caulking.

Sandell's patented Polytite-B is a resilient, open-cell polyurethane foam strip. It is saturated with liquid sealant compound, and coated on one face with a release agent that acts as a bondbreaker for caulk.

Use Polytite-B with backer rod and caulking for a truly-safe system.

Polytite[®]

the protection you
should insist upon

Sandell Manufacturing Company, Inc.

324 Rindge Avenue
Cambridge, Mass. 02140
Telephone (617) 491-0540

Circle 32 on information card

This untouched photo shows the results of water getting behind the joint sealant.

ADVERTISERS

Michael J. Hanley

Publisher

Michael M. Wood

National Sales Director

George L. Dant

Manager, Production and Business

1735 New York Ave. N.W.

Washington, D.C. 20006

(202) 785-7300

Lisa Hoke

Director of Operations

Suzanne Maggi

Administrative Assistant

ADVERTISING SALES OFFICE

Washington, D.C. (202) 785-7271

Michael M. Wood

1735 New York Ave. N.W.

Washington, D.C. 20006

New York (201) 729-4937

Thomas R Crow

46 Main Street

Sparta, N.J. 07871

New England/New York State

(617) 632-8185

Robert L. Tagen

87 State Road West

Westminster, Massachusetts 01473

Chicago (312) 887-1171

Robert M. Brown

201 E. Ogden Avenue

Hinsdale, Illinois 60521

St. Louis (314) 569-3210

Richard D. Grater

1466 Summerhaven

St. Louis, Missouri 63141

San Francisco (415) 348-8222

Jules E. Thompson

1290 Howard Avenue #303

Burlingame, California 94010

American Olean Tile	76	Owens-Corning Fiberglas Corp.	7
<i>Lewis & Gilman</i>		<i>Ogilvy & Mather</i>	
BASF (Wyandotte)	74-75	Oxford University Press	70
<i>Meldrum & Fewsmith</i>		<i>Franklin Spier</i>	
Chem-Fab (Birdair)	cov. 3	Pen Ply	73
<i>Woodward, Askey, Eggers & Schaffer</i>		<i>Solderberg, Thompson, MacEwan</i>	
City of St. Louis	78	PPG Industries (Glass)	26
Clayburn Industries	69	<i>Ketchum, MacLeod & Grove</i>	
<i>Baker Lovick</i>		PSAE (Masterspec)	23
Columbia Lighting	2	<i>Clarkson Associates</i>	
Concrete Reinforcing Steel Inst.	68	Robertson, H.H.	65
<i>Marsteller, Inc.</i>		<i>Creamer, Inc.</i>	
Consolidated Aluminum	14-15-16	Sandell Manufacturing Co.	79
<i>Weitzman Dym & Associates</i>		<i>Tower Advertising</i>	
Detex Corporation	66	Shand, Morahan Co.	67
<i>Zylke Affiliates</i>		<i>Hakanson & Associates</i>	
Doubleday & Co.	72	Shaw-Walker	28
<i>Franklin Spier</i>		<i>Williams Marketing Service</i>	
Dover Corp., Elevator Div.	10	Star Manufacturing Co.	77
<i>Caldwell, Bartlett, Wood</i>		<i>Akerman & McQueen Advertising</i>	
Dow Chemical Co.	13	United States Ceramic Tile	78
<i>Campbell-Miithun</i>		<i>Covey & Koons</i>	
Epic Metals Corp.	17		
Ford Glass Div.	18		
<i>Wells, Rich, Greene</i>			
Haws Drinking Faucet Co.	76		
<i>Mandabach & Simms/Pacific</i>			
Helios Tension Products	19		
<i>Hisata Design Associates</i>			
Howmet Aluminum Corp. . . cov. 2, pg. 1			
<i>Crume & Associates</i>			
Howmet Specialty Products	71		
<i>Kerrs, Chapman, Bua & Norsworthy</i>			
Johns-Manville (Bldg. Systems Div.) 8-9			
<i>Broyles, Allebaugh & Davis</i>			
Kawneer Architectural Products	20		
<i>Garrison, Jasper, Rose & Co.</i>			
Meisel Photochrome Corp.	24-25		
<i>Hoffman Agency</i>			
Nucor (Vulcraft)	4-5		
<i>Faller, Klenk & Qlinlan</i>			
Olympic Stain	cov. 4		
<i>Kraft Smith</i>			

What would you get
if you tossed away
all your ideas about
what a building
should be?

**Permanent fabric architecture
from Birdair Structures.**

More than just wide span roofs. Complete environmental envelopes that provide translucency, solar reflectivity and esthetics. Proven, durable systems that offer exciting alternatives to traditional construction methods — and a freedom of design and conceptual versatility never before possible. Simply put, a revolution in architectural form.

Like Florida Festival, the new shopping and entertainment center at Sea World of Florida in Orlando. The innovative 90,000 square foot roof was fabricated and erected by Birdair Structures and is made of SHEERFILL[®], CHEMFAB's architectural fabric coated with TEFLON*.

Birdair Structures is the pioneer and leader in permanent fabric architecture. We invented the technology. Extensive involvement in virtually every permanent fabric structure to date makes us uniquely qualified to offer state-of-the-art structural analysis and detailing assistance to the architect. We are the **only** single source that can offer integrated expertise in every phase of fabric structure technology: design, engineering, weaving, coating, fabrication and erection.

Bring your new ideas to us, **Birdair Structures**, a division of CHEMFAB, 2015 Walden Avenue, Buffalo, New York 14225 U.S.A. (716) 684-9500 Telex: 91-353 Cable: Birdair Buffalo.

BIRDAIR STRUCTURES
A DIVISION OF **CHEMFAB**

Circle 33 on information card

Architect in Charge of Design and Construction:
Basil H. M. Carter, New York, New York
Architect of Record:
Robert Lamb Hart, New York, New York
Engineering Consultants:
Geiger-Berger Associates, New York, New York

* SHEERFILL is a registered trademark of CHEMFAB.

* Du Pont's registered trademark for its fluorocarbon resins and films.

Beauty that's more than skin deep.



Architect: Wendell Lovett, FAIA, Seattle, Washington

Enhance and protect the natural beauty of wood with Olympic Oil Stain. Olympic *penetrates* wood to protect from within. Rich linseed oil and micro-milled pigments soak down into the fibers, giving wood a deep, uniform finish that stays beautiful no matter how wet or how dry the weather gets.

For additional information, consult your 1979 Sweet's Catalog. Or write Olympic: Dept. P, P.O. Box 1497, Bellevue, WA 98009.

**Penetrates to
protect wood
beautifully.**



Circle 34 on information card