

ALABAMA



Once you know Howmet, you'll forget all about what's-its-name.

When it comes to architectural aluminum, most people automatically think of the "big name" in the industry. But just because a company's well known doesn't mean it's the only alternative.

In fact, Howmet has more to offer than anyone around. And even though we're growing every day, we'll never be too big to give you one-on-one service in design, engineering, products and delivery.

What's more, we have as many aluminum systems as anybody. More than most. They include innovative thermal wall systems, thermal store fronts and entrances, ventilating systems, wall facing panels, thermal sliding glass doors, bath enclosures, ceiling grid systems, interior door frames, aluminum seating products and more.

We also have an award winning staff with the expertise to help you design with existing systems or create new ones. And you can count on 100% of their involvement, follow-up and prompt responsiveness.

If you haven't been getting these things with your present supplier, call Howmet. We're one of the few companies around with total integration from production of primary ingot to completed design.

The point is, you have an alternative. One with the kind of dedication to service and products that'll make you forget all about that other company.

For more information, call (214) 563-2624. Or write to Howmet Aluminum Corporation, Architectural Products Division, P.O. Box 629, Terrell, Texas 75160.



HOWMET ALUMINUM CORPORATION

A member of the Pechiney Ugine Kuhlmann Group.

Warehouse/Plant locations: Washington, D.C.; Dallas, TX; Atlanta, GA; Houston, TX; San Jose, CA.

Howmet. The name to remember.

Circle 1 on information card

Columbia supertube!

Fluorescent lighting that goes up, ...
over... down... or around corners...
wherever you want it!

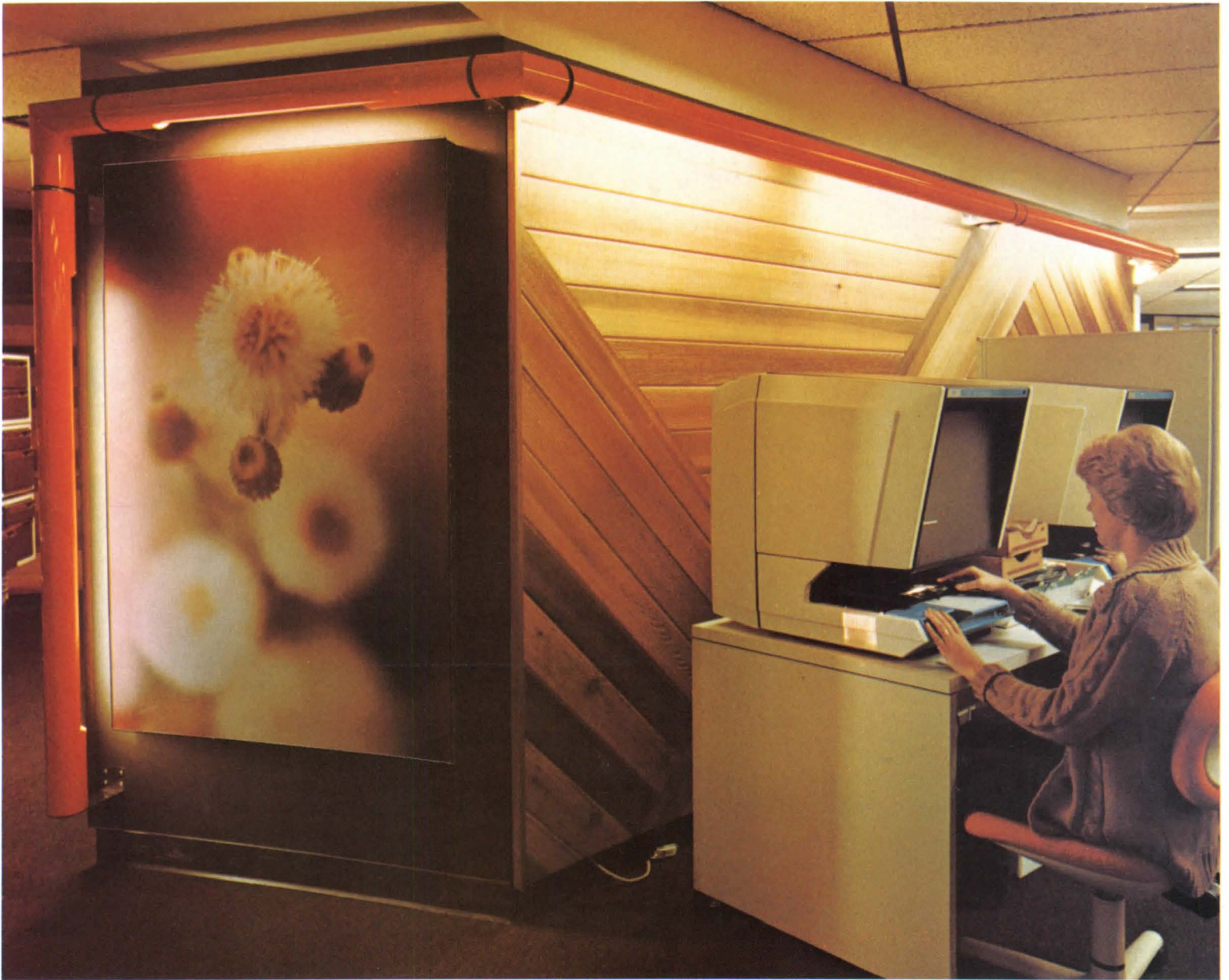

Columbia Operation
GTE Products Corporation
T.A. Box 2787
Spokane, WA 99220

GTE | **Specification
Lighting**

Columbia Lighting's versatile aluminum supertube brings flexibility and sparkling colors to architectural lighting. They may be suspended from ceilings or bracket mounted on walls in standard or custom sizes to fit your job. Lamp openings are symmetrically centered and each fixture retains its own "turnability" . . . you can aim it. For more information contact your Columbia agent or write us; we have answers to lighting questions you've yet to ask.

Circle 2 on information card

Glass Block for the 80's

...design with confidence

Beautiful and versatile glass block have exceptional insulating and energy conserving capabilities.



Glass block encourages exciting window, wall and partition designs . . . from soft and subtle to bold and striking . . . from serpentine shapes to curved or straight panels. With glass block, the taste and skill of the architect or designer are utilized to the fullest.

With glass block you control the transmission of light from the outside or from room-to-room. Light may be directed, diffused, reduced or reflected . . . translucence or transparency varied. Natural and artificial light may be employed dramatically or subtly to produce interesting environments. Add a sense of space or create a point of interest . . . design with confidence.



Glass block are made by fusing two halves of pressed glass together. This creates a partial vacuum which gives glass block the insulating value of a 12-inch thick concrete wall (U-value 0.56, R-value 1.79).

Because of this insulating value, heating and air conditioning equipment with reduced capacities may be specified and future energy requirements lowered. Glass block can help to conserve energy . . . design with confidence.

We want you to design with confidence. For more information on Glass Block for the 80's, contact Pittsburgh Corning Corp., Marketing Department AI1080, 800 Presque Isle Drive, Pittsburgh, PA 15239, Telephone (412) 327-6100.

Pittsburgh Corning's commitment to the 80's

The beauty and energy conservation of glass block have led to a renewed interest by architects and building owners. To meet and encourage this interest, Pittsburgh Corning has undertaken a major modernization of its glass block manufacturing facilities. This modernization, which will be completed in mid-1981, will not affect the availability of glass block for your current or future projects.

Pittsburgh Corning is pleased to announce that Solar Reflective glass block will again be available upon completion of this modernization.

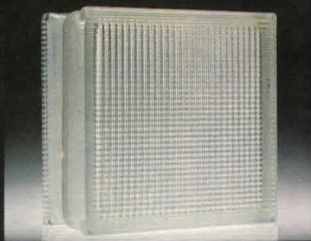

▲ **ESSEX® Glass Block**
Diffuses and disperses light uniformly. Pattern is pressed into the inner and outer faces. Available with a fibrous glass insert to control brightness, glare, solar heat gain and light transmission.

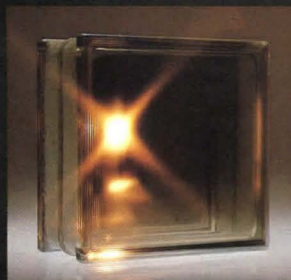

◀ **SOLAR REFLECTIVE Glass Block** (Available mid-1981)
Maximum energy conservation. VUE® block pattern with highly reflective, thermally bonded, oxide surface coating which reduces solar heat gain and transmitted light.

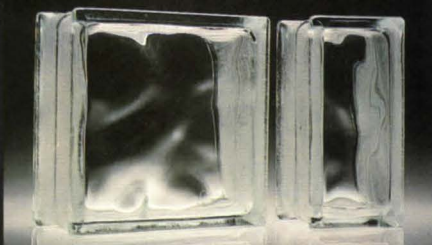

DECORA® Glass Block ▲
Pattern pressed into inner faces, smooth outer faces. Maximum light transmission and brightness. Available with a fibrous glass insert to control brightness, glare, solar heat gain and light transmission.



VISTABRIK® Solid Glass
Smooth outer surfaces. Solid glass offers excellent light transmission and maximum protection from forcible entry.



VUE® and ARGUS® Glass Block
◀ **VUE®** provides maximum visibility and light transmission, inner and outer faces are smooth.
ARGUS® has rounded flutes at right angles on inner faces. Maximum light transmission and brightness. **ARGUS®** ▼

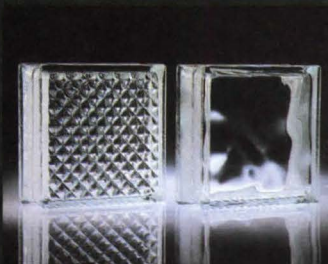
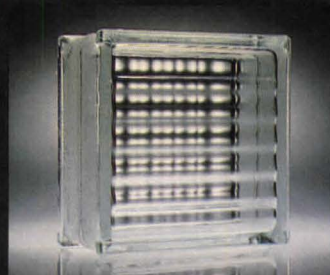

THINLINE glass block, 3/8-inch thick, are available in **DELPHI™** and **DECORA®** patterns. **DELPHI™** has smooth outer faces with a multiple, triangular pattern on the inner faces which produce a prismatic effect. Good light transmission and excellent privacy.



PITTSBURGH
pc®
CORNING

DOVER ELEVATORS Cover North America.

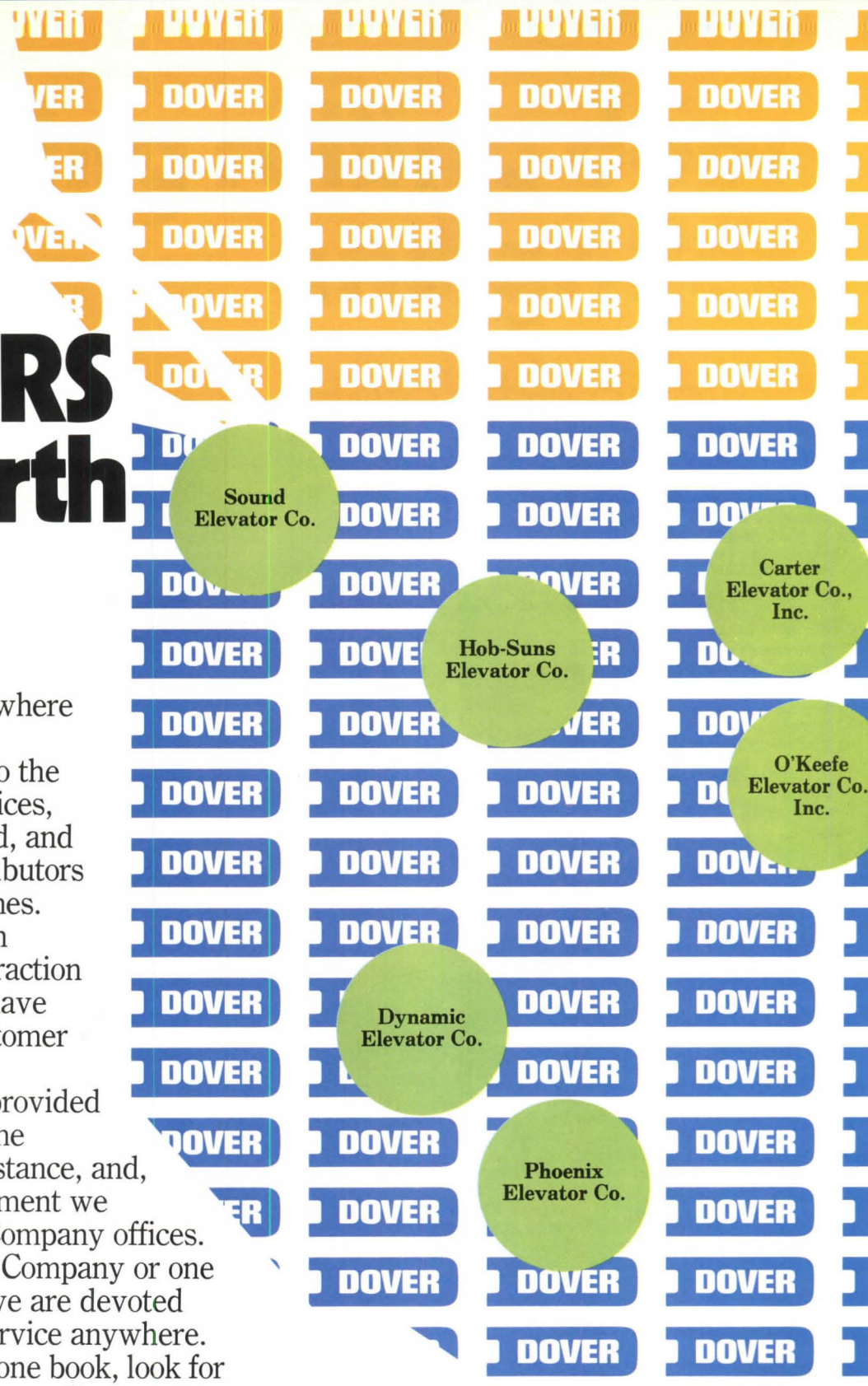

Sound Elevator Co.

Carter Elevator Co., Inc.

Hob-Suns Elevator Co.

O'Keefe Elevator Co., Inc.

Dynamic Elevator Co.

Phoenix Elevator Co.

Hawaiian Pacific Elevator Corp.

You'll find Dover Elevators everywhere you look.

That's because, in addition to the 122 Dover Elevator Company offices, Dover elevators are sold, installed, and serviced by 24 independent distributors who operate under their own names.

These distributors have been handling Dover Oildraulic® and traction elevators for many years. They have built valuable reputations for customer service unequalled in their areas.

The Dover distributors are provided the same factory training, the same constantly updated technical assistance, and, of course, the same quality equipment we produce for our Dover Elevator Company offices.

Whether it's Dover Elevator Company or one of our independent distributors, we are devoted to giving you the best elevator service anywhere. If you can't find Dover in your phone book, look for one of our distributors. Or write Dover Corporation, Elevator Division, Marketing Service, Dept. 662, P.O. Box 2177, Memphis, TN 38101.

DOVER[®]
The elevator innovators.



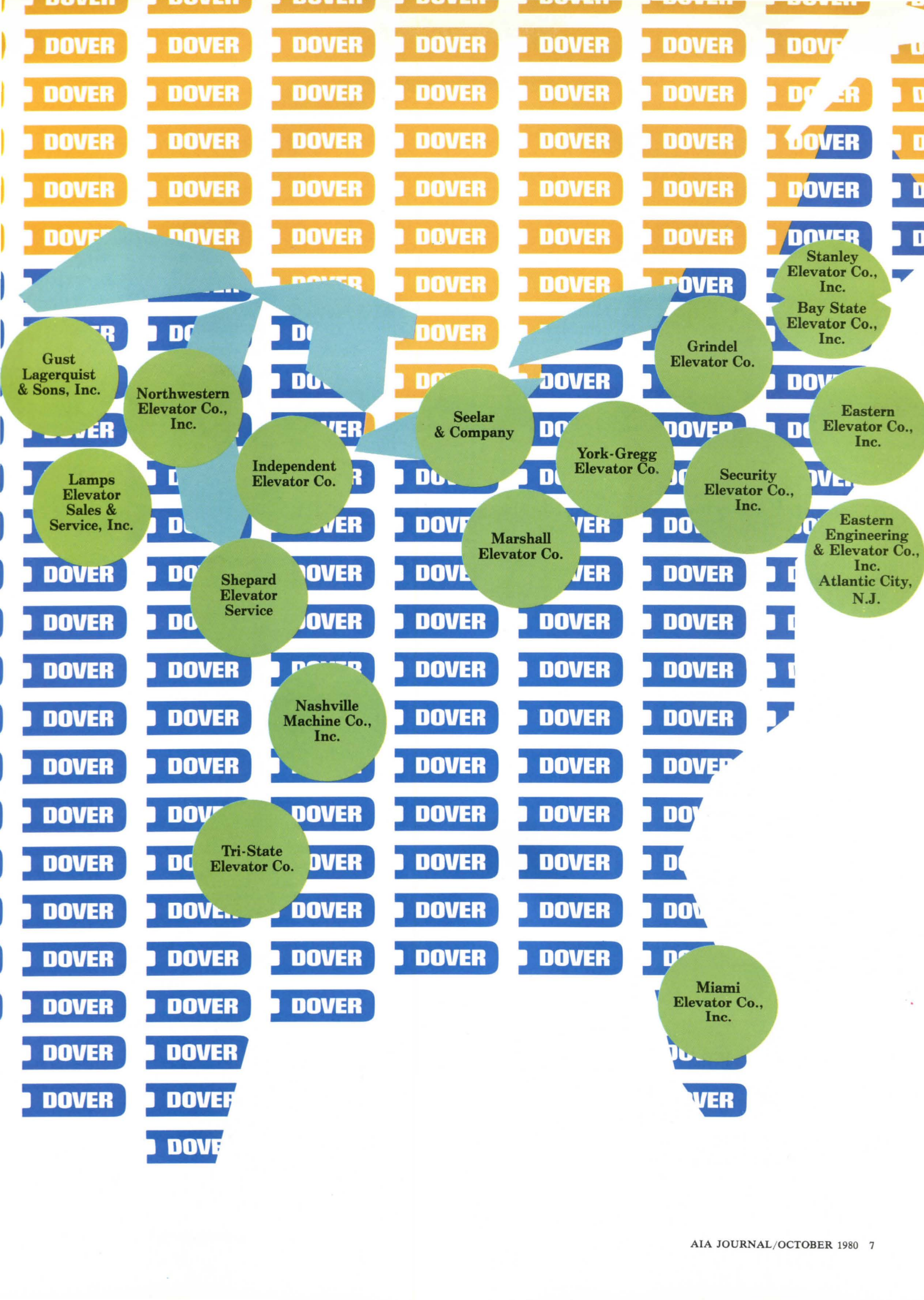

Gust Lagerquist & Sons, Inc.

Northwestern Elevator Co., Inc.

Lamps Elevator Sales & Service, Inc.

Independent Elevator Co.

Shepard Elevator Service

Nashville Machine Co., Inc.

Tri-State Elevator Co.

Seelar & Company

Marshall Elevator Co.

York-Gregg Elevator Co.

Grindel Elevator Co.

Security Elevator Co., Inc.

Stanley Elevator Co., Inc.
Bay State Elevator Co., Inc.

Eastern Elevator Co., Inc.

Eastern Engineering & Elevator Co., Inc.
Atlantic City, N.J.

Miami Elevator Co., Inc.

EVENTS

Oct. 27-29: Conference on fire and safety design for the handicapped, Howard University, Washington, D.C., organized by the AIA Research Corporation and the National Task Force on Life Safety and the Handicapped and sponsored by the National Bureau of Standards. Contact: Earle Kennett, AIA/RC, (202) 626-7500.

Oct. 30: Entries deadline, Building Stone Institute's awards program. Contact: BSI, 420 Lexington Ave., New York, N.Y. 10170.

Nov. 4-8: Clinic for Marketing Coordinators in Design Firms, Philadelphia. Contact: The Coxe Group, Inc., 1900 Chestnut Building, Philadelphia, Pa. 19103.

Nov. 5-8: Texas Society of Architects/AIA annual meeting, Dallas.

Nov. 6: Seminar on Short Cuts for Selected Common Problems in Reinforced Concrete Design, Minneapolis. (Repeat seminars: Nov. 12, Fort Lauderdale, Fla.; Nov. 14, Jacksonville, Fla.; Dec. 10, Washington, D.C.; Dec. 12, Cincinnati.) Contact: Concrete Reinforcing Steel Institute, 180 N. La Salle St., Chicago, Ill. 60601.

Nov. 6: Housing Rehab/Energy Conservation Conference, New Haven, sponsored by Tri-State Regional Planning Commission and Connecticut Department of Housing. Contact: John Miller, (203) 787-8372.

Nov. 6-7: Construction Claims Seminar, American University, Washington, D.C.

Nov. 6-7: Construction Contracts and Specifications Institute, University of Wisconsin, Madison.

Nov. 6-7: Energy Auditing Seminar, New York Sheraton Hotel, New York City. (Repeat seminar: Dec. 8-9, Walt Disney World, Orlando, Fla.) Contact: Association of Energy Engineers, 4025 Pleasantdale Road, Suite 340, Atlanta, Ga. 30340.

Nov. 6-7: Workshop for Land Analysis, Georgia Center for Continuing Education, Athens. Contact: Jack Hannula, School of Environmental Design, University of Georgia, Athens, Ga. 30602.

Nov. 6-7: Building Seismic Safety Council annual meeting, Hyatt Regency, Memphis. Contact: William G. Kirkland, BSSC, 1015 15th St., Suite 700, Washington, D.C. 20005.

Nov. 13-14: AIA practice management committee open meeting on managing a practice in a recession, DeSoto Hotel, Savannah, Ga. Contact: William Hooper, AIA, Institute Headquarters, (202) 626-7458.

Nov. 17-18: Conference on Computer Energy Programs for Buildings (workshop on Nov. 19-20), University of Wisconsin, Madison.

Nov. 17-20: Coastal Zone '80 national symposium, Hollywood, Fla. Contact:

Dallas Miner, Department of Commerce, Office of Coastal Zone Management, 3300 Whitehaven St. N.W., Washington, D.C. 20235.

Nov. 17-21: Seminar on roofing technology, San Francisco. Contact: Roofing Industry Educational Institute, 6851 S. Holly Circle, Suite 250, Englewood, Colo. 80112.

Nov. 18: Conference to explore problems faced by managers of consulting firms, Host International Hotel, Houston. Contact: Lowell V. Getz, Professional Services Management Association, Rice Center, 9 Greenway Plaza, Suite 1900, Houston, Tex. 77046.

Nov. 18-20: International Energy Management and Facilities Improvement Show, Merchandise Mart, Chicago. Contact: Expo Management, Inc., Apparel Center, Suite 1048, Chicago, Ill. 60654.

Nov. 22-25: American Society of Landscape Architects annual meeting and exhibit, Fairmont Hotel, Denver. Contact: ASLA, 1900 M St. N.W., Suite 750, Washington, D.C. 20036.

Nov. 25-30: International Furniture Show, National Exhibition Centre, Birmingham, England. Contact: BFM Exhibitions Ltd., 30 Harcourt St., London W1H 2AA, England.

Dec. 1: Entries deadline, plywood design awards program. Contact: American Plywood Association, Box 11700, Tacoma, Wash. 98411.

May 17-22, 1981: AIA convention, Minneapolis.

LETTERS

Sailing, Sailing: The AIA JOURNAL is superb, but, more to the point, I have read with great pleasure the editorial in the August issue (p. 31). I have taken its advice with somewhat different results from what was drawn (Mr. Franzen's drawing is below). *Ulrich Franzen, FAIA*
New York City



The Office Environment: I recently had the pleasure of reading the article "Workplaces: The Open Office Revisited" by Andrea O. Dean in the July issue (p. 50). I was impressed by the study that went into the writing of the article and its thorough coverage of the subject. Being currently employed in an interior design office, I was suddenly made aware of how much philosophy and psychology, to say nothing of technology, went into the work

I was taking for granted.

It does concern me, however, that only the employees of large business and legal firms are considered so important that psychologists, behavioral scientists, manufacturers' associations and other think-type tanks make continuing studies to determine what percentage of open planning, what height partitions, what temperature ranges, what lighting and noise levels, what seating comfort will make for optimum productivity. No time or expense is spared to achieve this result.

Meanwhile, the creators of this environment—architectural designers and draftsmen—are haphazardly scattered around disorganized loft spaces or are jammed up like sardines in high-rent, box-like offices, with little more tools than they have been using for the past 100 years—somewhat like the threadbare tailors who wove silk and gold robes for ancient royalty. No computer terminals, video screens, intercoms, oak desks, fabric-covered walls or high-style coffee and lunchrooms for the designers and draftsmen. And, surely, no high salaries to compensate for outdated working conditions.

The architectural profession is missing the boat, and it is surely enough to deplete future architectural offices as young people take off for law schools, scientific academies and multinational corporations to enjoy the luxuries of the 20th century. Architects have convinced themselves that they enjoy creating this luxurious environment since they seem to be forbidden its utilization.

Edmond Pachner, AIA
Kensington, Md.

Barrier-Free Design: The National Center for a Barrier Free Environment is a private, nonprofit organization dedicated to ensuring that the physical environment is accessible to, and usable by, handicapped persons. [AIA is a founding member.] As part of its expansion of programs and services, the center is developing a network of consultants who can provide assistance with accessibility projects, and is seeking the participation of architects and other design professionals having specialized knowledge of any aspect of barrier-free design. Members of this network will provide technical assistance to individuals and organizations concerned with the physical access requirements of barrier-free design projects.

If any architect is interested in being a participant in the network, please send your name and address to: Network, National Center for a Barrier Free Environment, Suite 1006, 1140 Connecticut Ave. N.W., Washington, D.C. 20036.

Maureen A. Beavers
NCBFE, Washington, D.C.
Letters continued on page 40

EDUCATIONAL



A Spectacular Rain/Sun Shelter By Helios.

Conference Structure, Aspen, Colorado



The logic of this tensioned membrane structure is as exciting as its appearance. A canopy over a school yard play area, it provides shelter for outdoor activities in almost any weather. The attractive "upside-down" design allows rain water runoff through the support columns.

The shelter is fabricated of vinyl-coated polyester material held in tension on a steel framework. The result is a lightweight, rigid structure engineered to withstand heavy wind loading. Though it is in a higher priced class than a tent, a tensioned membrane structure offers far greater strength and durability. Compared to alternate structures of wood, steel or masonry, it typically results in important cost savings.

When your imagination calls up great roofed-over spaces or rhythmic curvilinear shapes, Helios Tension Products are the people to try your ideas on. We specialize in helping architects translate their innovative designs into *practical reality*. Our expertise includes design, engineering, fabrication and erection—a total comprehensive service unmatched in the U.S.

For more information, or help with a specific project, call or write:
Dept. P3, Helios Tension Products, Inc.
1602 Tacoma Way, Redwood City, CA
94063 Telephone: (415) 364-1770,
Telex 345590



HELIOS TENSION PRODUCTS, INC.
Soft Shell Structures Division

Circle 5 on information card

VULCRAFT HELPED RAISE



The expansion of the Sharpstown Center added 89 new shops. The addition of a second level to an existing facility is a first for the shopping center industry.

THE ROOF IN HOUSTON.



Throughout the entire five-month period, no store ever stopped operating because of the remodeling.

When the Sharpstown Shopping Center in Houston decided on a \$25 million expansion, they also decided on Vulcraft steel joists and roof deck.

Not only did Vulcraft have the best price for the job, but we were able to provide the best delivery. And because the construction schedule called for considerable sequencing, dependable delivery was imperative.

Since the remodeling of the Sharpstown Center involved the construction of a second level over the existing mall, Vulcraft's lightweight steel joists were ideal for the job. They minimized the weight load on the existing structure, and were easy to handle in a confined area. Compared to alternative systems, they could be erected faster and with lighter weight equipment.

And to top it off, Vulcraft is the only manufacturer of both steel joists and steel decking. So we were able to offer the convenience and economy of supplying both for the Sharpstown Center.



Vulcraft steel joists and roof deck played an important role in the innovative expansion of Sharpstown.

As the largest joist producer in the country, we've been involved in more shopping center remodelings than any other company in the joist business. So if you're into this type of business, give us a call. We'll help you raise the roof, add a wing or remodel anything that stands still.

More information is readily available from your local Vulcraft representative, or by writing P.O. Box 220646, Charlotte, North Carolina, 28222, for our steel deck and joist catalogs. You can also call us at (704) 366-7000 or see Sweet's 5.2/Vu and 5.5/Vu.

P.O. Box F-2, Florence, SC 29502 803/662-0381
P.O. Box 169, Fort Payne, AL 35967 205/845-2460
P.O. Box 186, Grapeland, TX 75844 713/687-4665
P.O. Box 59, Norfolk, NE 68701 402/371-0020
P.O. Box 1000, St. Joe, IN 46785 219/337-5411

VULCRAFT

A Division of Nucor Corporation.

Circle 6 on information card

Announcing the U.S.G. ceilings program planned for your future.

Ready
when
you are.



We're making a major investment in our capabilities to meet the demand for ACOUSTONE®, AURATONE®, and USG® gypsum ceilings. We're acting now to boost production to be ready for your increased future demand.

At the same time, we're accelerating the creation of beautiful new tiles and panels with innovative colors and patterns. Our engineers are developing new features to add to appearance and performance, simplify installation and provide needed accessibility.

A program of this magnitude takes time to implement so we are phasing in the elements as market conditions indicate your needs. And we will be telling you about it every step of the way.

With a broad selection of products in every price category, it's practical for you to specify a U.S.G. sound control ceiling for all your projects. Our goal is to see that you get the best-looking, best-performing ceilings it is possible to make, delivered in the best possible time to keep your project always right on time.

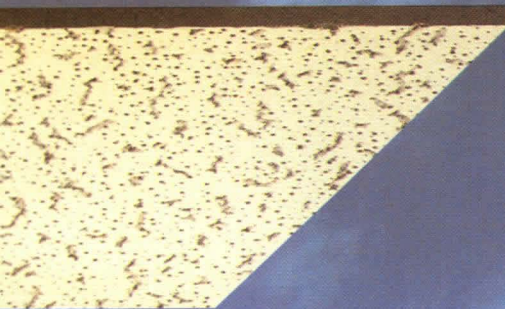

Auratone Panels and tiles

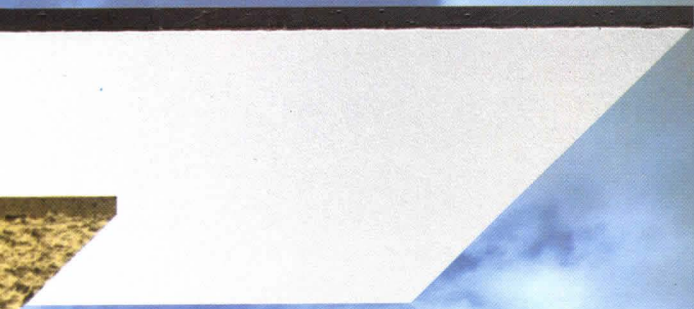

USG Gypsum Panels

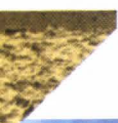

Acoustone Panels and Tiles

Left, Acoustone Yellow Frosted ceiling.

Right, Acoustone "F" Fissured pattern ceiling.
Tougaloo College Collection, Mississippi Museum of Art.



Fancy, fissured and
fire-rated!

AURATONE[®] Ceiling Panels and Tiles

Excellent sound attenuation and good sound absorption distinguish these water-felted, mineral-fiber panels and tiles. Four attractive patterns with easily maintained finish or special plastic coating to resist severe soiling. Available with up to 3-hr. fire-rated designs. ■ For complete details, see your U.S.G. Representative or write to Sound Control Products, 101 S. Wacker Drive, Chicago, Ill. 60606. Dept. AJ1080B

UNITED STATES GYPSUM //
BUILDING AMERICA

Circle 8 on information card

Practice from page 13

Visual Arts Study Center Opens In Second East Building Triangle

The Center for Advanced Study in the Visual Arts (CASVA), housed in one of the two triangles that make up the widely publicized east building of the National Gallery of Art in Washington, D.C., quietly opened its doors last month. Modeled on the Institute for Advanced Studies at Princeton University, CASVA hopes to become America's national center for postdoctoral studies in art and architectural history, eventually welcoming 12 fellows each year, who will pursue their own work in the history of art, architecture, urban design, plus theory and anthropology as they deal with physical form. The fellows will be selected by a standing committee of the center's advisory board. This year, only four have been selected, one of whom, Dora Crouch, is an architectural historian.

CASVA's dean is Henry Millon, formerly a professor of architectural history at the Massachusetts Institute of Technology and then director of the American Academy in Rome, 1974-77. He explains, "You might have comparable resources at Harvard or Columbia in terms of libraries. What exists nowhere else is the support system we want to provide." What he hopes to create at CASVA is an international community of scholars who share similar interests, participate in scholarly lectures, symposia, colloquia and seminars and can benefit from the considerable resources available to them in the nation's capital, including the National Archives

and the Archives for American Art. Quips Millon, "The whole pompous nature of this town relative to itself and to America makes it the likely place for a national institute of this sort." His hope is to be able in the future to provide communal housing for CASVA's fellows together with their counterparts at the Woodrow Wilson Center, Library of Congress, Folger Library and Dumbarton Oaks.

The completion of CASVA's fourth floor spaces in the east building awaited Dean Millon's arrival. He explains, "I wanted everything that was put in here to be consonant with the general theme of the building, rather than shoe-horning rectangular shapes into rhomboid spaces. I was also very interested in having the infill system separate from the support system." The oddly angled results are striking. The six-story interior courtyard, surrounded with offices on two sides and glass enclosed stacks on the third, serves, in Millon's words, "as a unifying element, somewhat like the hole at Lou Kahn's library at Exeter. You always have a sense of where you are in the building." You also always have a very precise sense of where you are in relation to the building's exhibition spaces and the federal city beyond. *Andrea O. Dean*

Rome Prize Fellowship Deadline

Nov. 15 is the deadline for the receipt of all application material for the American Academy in Rome's national awards for the Rome prize fellowships in the arts and humanities. Included are several fellowships in architecture that provide a year's residence at the academy in Rome, a monthly stipend, travel and working supplies allowances, a bedroom and studio and two meals a day.

In addition to the one-year fellowships for recent graduates, the academy offers four six-month midcareer fellowships by the National Endowment for the Arts, with financial arrangements similar to the one-year fellowships.

Contact: American Academy in Rome, 41 E. 65th St., New York, N.Y. 10021.

Concrete Design Student Awards

Michael Otavka, a student at the California Polytechnic University in Pomona, is first place winner in the fifth annual architectural precast concrete student design awards program, sponsored by the Prestressed Concrete Institute and the Canadian Prestressed Concrete Institute. He will receive a \$2,000 cash award, and his school will receive a \$500 award.

The second place winner in the program is Michael O. Winters of the University of Colorado. He will receive a \$500 award, with an additional \$250 award for his school. *Practice continued on page 21*



Allen Freeman

A beautiful, time and money-saving alternative to masonry. And other facing materials.

Faced with stringent budgetary limitations, project architects for the Von Braun Civic Center, Huntsville, Ala., selected a dry-built masonry exterior wall system using Johns-Manville Stonehenge™ architectural panels.

J-M panels not only provided the desired stone-like appearance, but also permitted quick and easy face-fastening to steel studding. As a result erection time was cut almost 25 percent and costs cut almost one dollar per square foot over conventional masonry. And the job was finished on time and within the budget.

Performance of the wall system has been excellent, resisting high winds, heavy rain and other weather extremes without problems. And the J-M Stonehenge panels have kept their rugged natural stone beauty despite constant exposure to the elements.

When your job calls for lasting beauty that faces up to almost anything, you'll find a J-M wall system that's just right for the job.

For details, consult Sweet's or contact Dave Lucy, Johns-Manville, Ken-Caryl Ranch, Denver, Colorado 80217, AIA-10 303-979-1000.



J-M Stonehenge architectural panels cover 70 per cent of the exterior of the Center, providing an attractive, stonelike appearance that will not change due to climate conditions.



The J-M panels were face mounted to steel studding, requiring about 25 per cent less installation time than conventional masonry wall techniques.



Johns-Manville

Johns-Manville Architectural Panels. Chosen for beauty, durability and economy at the Von Braun Civic Center.



CONCERT HALL

The Von Braun Civic Center, a 340,000 square foot, five-unit entertainment, sports and cultural complex in Huntsville, Alabama.

Architects: Northington, Smith, Kranert & Tomblin & Associates, Jones, Mann and Associates, Dickson and Davis.
Contractor: Universal Construction Co., Decatur, Alabama

LOOKS



Architect: Loeffler/Johnson and Associates,
Pittsburgh, PA
Contractor: Crump, Inc., Pittsburgh, PA

ARE EVERYTHING.

PPG SOLARCOOL® SPANDRELITE® GLASS FASHIONS A SPECTACULAR IMAGE.

Specify a wall cladding of extraordinary beauty. One that takes instant command of a landscape. Rivets attention. And draws people in.

That's what PPG

Solarcool Spandrelite can do. Plus, it reduces building costs, especially when compared to ordinary wall treatments like masonry, aluminum, stone and polished stainless steel.

Better still, it reflects heat. Which saves energy.

And you can use it in new or retrofit applications: over existing facades, in front of insulation or as an opaque curtain wall.

PPG makes a broad range of

problem-solving, energy-efficient glass, from single-glazed Solarcool® to double-glazed Solarban® Twindow® units. All in a variety of colors and reflective capacities.

One is ideal for the project you're working on now.

Want to learn more? See Sweet's 8.26 P/p. And write to Environmental Glass Sales, PPG Industries, Inc., One Gateway Center, Pittsburgh, PA 15222.

PPG: a Concern
for the Future



Circle 10 on information card

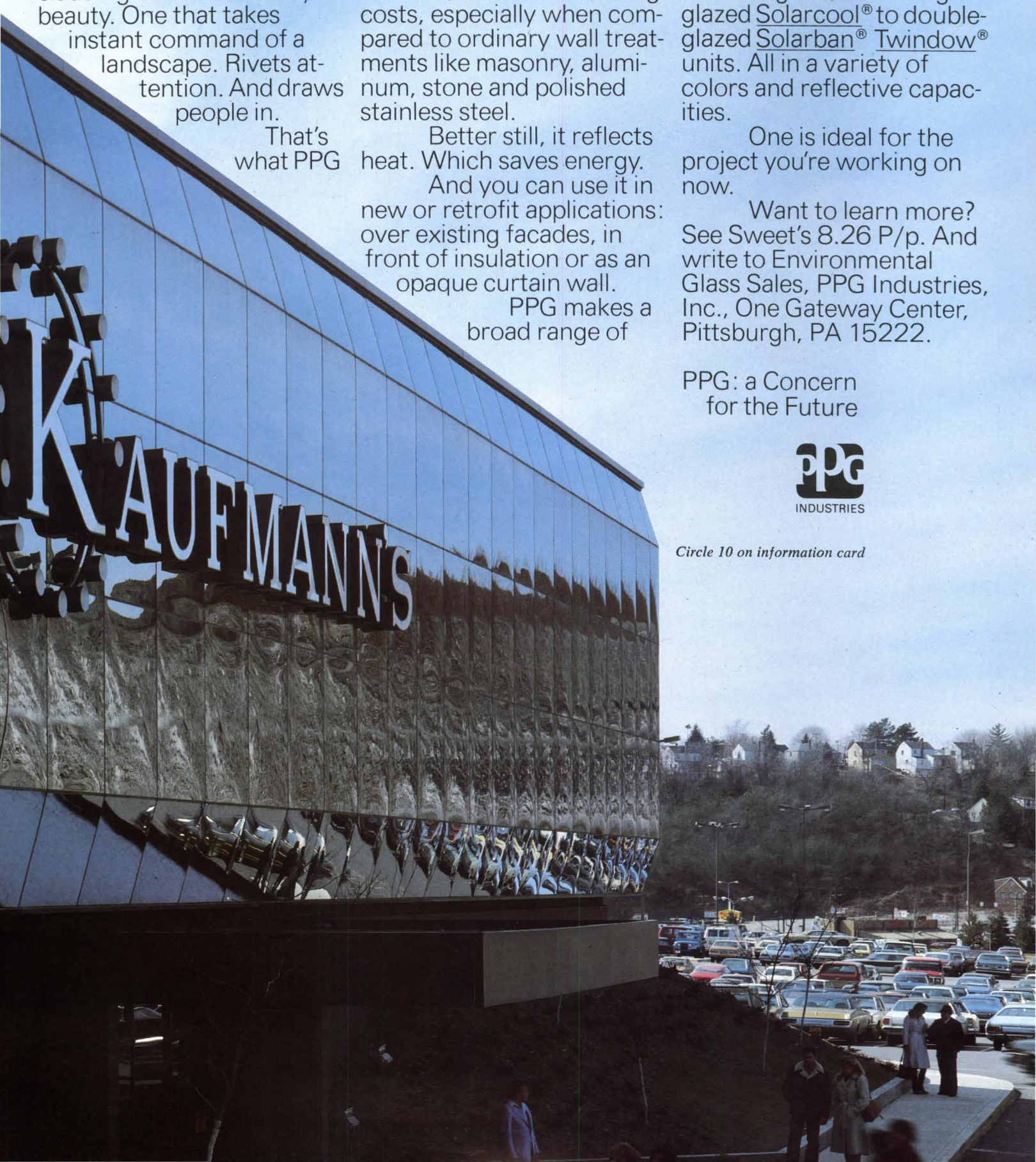

EPICORE[®] Composite Floor System is NOT Ordinary!

Because of EPICORE'S **Unique Design** it is compatible with steel or concrete framing. The EPICORE Composite Floor System is equally effective in steel framed, reinforced concrete, reinforced masonry, or precast concrete structures. This improves performance and lowers initial and life-cycle costs.

EPICORE **Load Capacity** can't be equalled. Official tests established that EPICORE slabs can support more than twice their rated capacity.

This **Same Unique Design** gives EPICORE the ability to surpass all other 1½, 2 or 3-inch deck in U. L. **Fire Ratings**. Without the need for spray-on fireproofing, a much more desirable appearance is created.

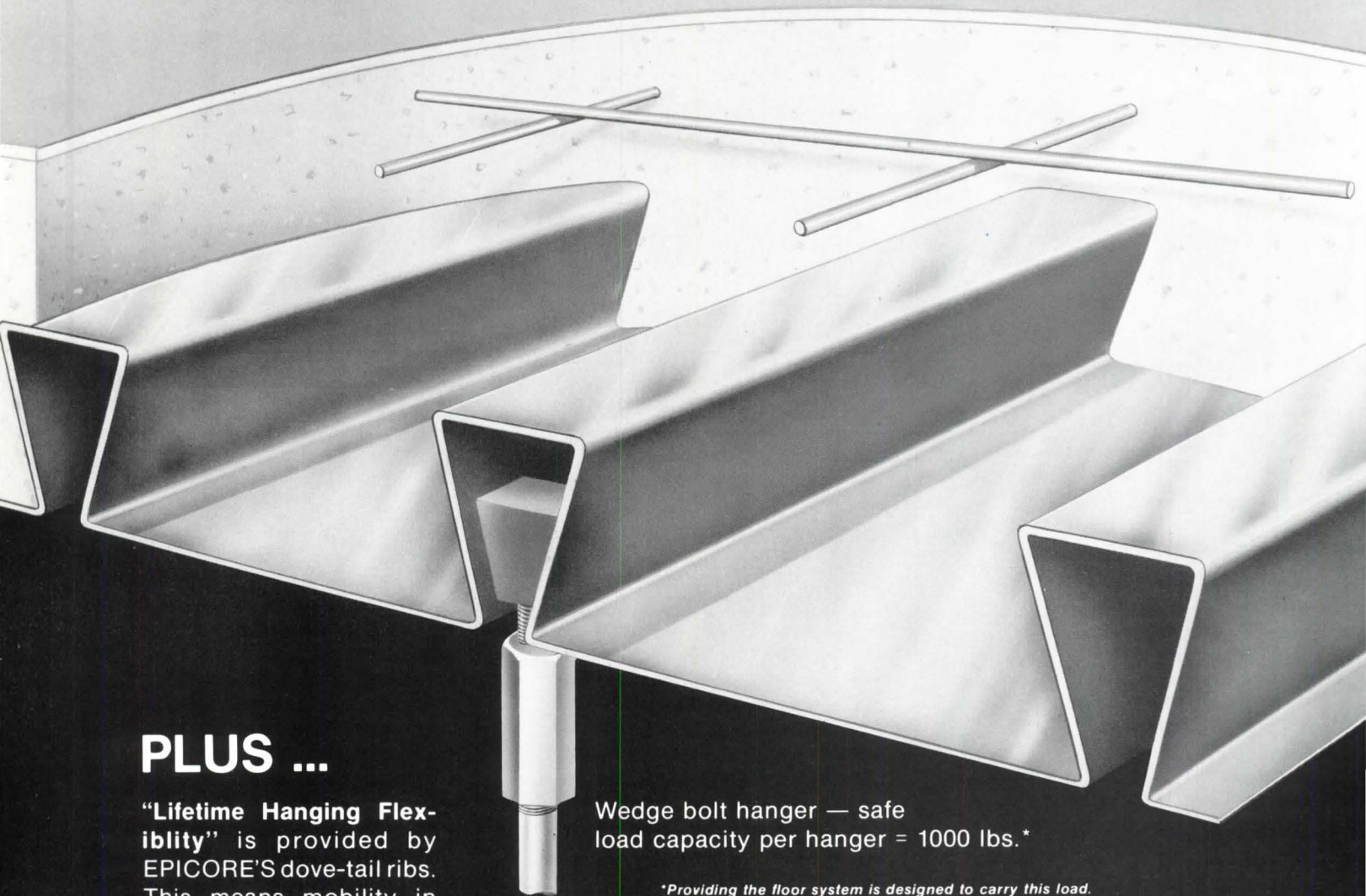

PLUS ...

"**Lifetime Hanging Flexibility**" is provided by EPICORE'S dove-tail ribs. This means mobility in hanging pipes, suspending ceilings, installing mechanical or electrical equipment — anytime — even after occupancy.

Wedge bolt hanger — safe load capacity per hanger = 1000 lbs.*

**Providing the floor system is designed to carry this load.*

With Dependable Service and Delivery to Equal ... YOU Should Specify EPICORE!

Full details on EPICORE'S capabilities are available by contacting Bob Ault, Vice-President of Engineering or Frank Sauk, Sr. Vice-President of Sales. Circle 11 on information card

EPIC
METALS CORPORATION
Eleven Talbot Avenue
Rankin (Pittsburgh), Pa. 15104
(412) 351-3913

Court Overturns Designation Of Virginia Historic District

The first legal case in which a national historic landmark designation has been attacked resulted in U.S. District Judge Robert R. Merhige Jr. in Richmond, Va., overruling the landmark status of the Historic Green Springs District. The 14,000-acre site was designated as a historic district by the Interior Department in 1974. The judge also invalidated preservation easements given to Interior by a number of property owners in the district.

The court challenge came when a vermiculite mining company sued the Secretary of the Interior, the Keeper of the National Register of Historic Places and the Virginia state historic preservation officer. The judge's action, says *Preservation News*, published by the National Trust for Historic Preservation, "opens the way to massive strip mining for vermiculite, a mineral used as a soil conditioner and in insulation and kitty litter."

Judge Merhige ruled that Interior had not established rules, criteria and procedures for the historic landmarks program, and ordered Interior to develop standards and to establish procedures that would call for public hearings in landmark designations. He further directed that Interior determine whether a "district" can be included under the term "site," as used in the Historic Sites Act of 1935, under which the landmarks program was established.

The judge said that he was "troubled" at Interior's "assertion that a single 'district' the size of Manhattan can be a historic 'site' in spite of the absence of any significant commemorative events or historic person associated with it." He stated in his opinion that Interior's historian "was able to find records of only a few Revolutionary War or Civil War skirmishes that took place in or near the district."

Historic Green Springs, Inc., a local preservation group, says that the decision will probably be appealed, but at this writing, the Interior Department had not yet made a decision regarding an appeal.

National Building Code Entente

Delegates to the annual meeting of the National Conference of States on Building Codes and Standards (NCSBCS) in Scottsdale, Ariz., last month unanimously passed a resolution that invites the boards of the Building Officials and Code Administrators, International, Inc., the International Conference of Building Officials and the Southern Building Code Congress, International, Inc., to join with NCSBCS as "equal, participating, con-

structive partners" in achieving nationwide uniformity in model building codes using a mutually agreeable combination of consensus procedures.

The resolution also says that NCSBCS, a nonprofit corporation composed of delegates appointed by state governors, would reconsider its endeavors to update the National Building Code (NBC) if the three model building code organizations made a firm commitment to NCSBCS by Nov. 30 or another mutually agreeable date.

Last spring when NCSBCS assumed responsibility for NBC from the American Insurance Association, it said the code would be revised by the consensus process. Among those to voice objections was the Council of American Building Officials, the coordinator of activities of the three major building code organizations, saying that "no real benefits" for NBC's revision had been identified.

Justice Department Sues ACEC On Voluntary Ethical Guidelines

The Justice Department has brought suit against the American Consulting Engineers Council for three provisions in its professional conduct guidelines which warn against the pitfalls of its members' acceptance of contingent contracts, provision of free services except to charitable or church institutions and participation in design competitions unless competing firms are compensated. ACEC calls the

Institute

Board Moves to Establish an AIA 'Political Action Committee'

At its meeting in Halifax, Nova Scotia, in August, AIA's board of directors approved in principle the establishment of an AIA political action committee (AIA/PAC) and directed that steps be taken to organize the committee, subject to final board approval in December.

AIA/PAC would "aid in the election of congressional candidates who have demonstrated their interest in and commitment to the advancement of the architectural profession and its goals, by contributing money to their campaigns." Presidential, state and local campaigns would not be involved, nor would contributions go to lobbying for the passage of legislation.

The voluntary, nonpartisan, nonprofit, unincorporated AIA/PAC would receive administrative assistance from the Institute. AIA/PAC would be governed by a

suit "tantamount to the government's repainting or resurfacing a bridge 45 days before it is to be replaced by a better structure." Everett Thompson, president of ACEC, says that "on four occasions" Justice officials were informed that the voluntary guidelines, "which had never been enforced" by ACEC, were due to be submitted for replacement to its board at its meeting this month.

According to ACEC, the guideline on contingency fees "sought to prevent conflicts of interest as might occur when a consulting engineer agrees to analyze and determine a project's feasibility at no cost so long as he or she is assured of payment if the project goes forward."

The provision regarding free services was intended "to protect smaller firms from losing ground to large firms which could afford to obtain a business foothold by initially offering free advice," says ACEC. The guideline against participation in design competitions except where competing firms are compensated was developed, says ACEC, "to protect firms submitting innovative and creative ideas that were later incorporated by others into the developed project."

Thompson says that the guidelines to be considered this month by ACEC's board of directors are the result of work with such professional organizations as the American Society of Civil Engineers and the National Society of Professional Engineers as "a step toward a uniform code for all professional engineers."

13-member board of trustees consisting of eight members of the Institute's executive committee, plus five members selected by the AIA board who would serve staggered three-year terms. AIA/PAC's board of trustees would elect officers, appoint committees, determine policy in the distribution of funds and authorize the contributions actually made.

Funds would be solicited from AIA members only, as required by law. Administrative controls would be established to ensure that all contributions would be made by individuals, since corporate contributions are prohibited by law. Other controls would be initiated to ensure that AIA/PAC funds would be kept separate from those of the Institute.

In other action, the AIA board acted in accordance with the vote of delegates

continued on page 22

Institute from page 21

at the 1980 Cincinnati convention in formally approving the repeal of AIA's mandatory code of ethics and professional conduct (see July, p. 11). It is anticipated that a voluntary statement of ethical principles, now being prepared by the legal decision impact task force, will be approved by the board at its December meeting. Meanwhile, the board passed a motion that calls for the Institute's former code of ethics to be regarded as a guideline by AIA members until such time when a new voluntary ethical statement is adopted.

Among other actions, the board:

- Reaffirmed its priority commitment to the energy professional development master plan, whose overall objectives are the development of AIA member skills and knowledge to make them leaders in the energy field, to make energy-consciousness an integral part of the design process and to aid the public and clients alike in their perception of architects as leaders in the field of energy conservation (see July, p. 21). A motion passed which waives a rule of the board concerning transfers from the general reserve fund, authorizing the withdrawal of up to \$70,000 in 1980 to support the development and implementation of the program, with income derived in future years from the

program paid back to reserves.

- Ratified a convention resolution on the re-evaluation of Institute purposes (A-1), and passed a motion that waives a rule of the board in order to authorize \$10,000 from general funds for the establishment of a five-member task force, which will present an interim report to the 1981 convention. The resolution passed at the convention in 1980 calls for the board to "organize a broadly based national dialogue to discuss and redefine the proper role, purpose and character" of AIA, with cooperation from Institute components.

- Ratified resolution A-2, which concerns the preparation of an amendment to the bylaws to provide for associate member representation on the board of directors, as well as resolution K-1, which expresses AIA's concern for the national crisis in housing and suggests actions for its amelioration.

- Defeated convention resolution T-1, that the National Science Foundation or other appropriate organizations be encouraged to investigate the problems involved in the decommissioning of nuclear power plants.

- Adopted a proposed formula, effective immediately, for the determination of the allocation of directors among the regions of the Institute. The board cannot exceed

32 directors and had reapportionment not been made, there would have been 33. The approved formula to determine the number of directors calls for one director for 625 to 1,562 members; two directors for 1,563 to 2,812 members; three directors for 2,813 to 4,062 members, and four directors for 4,063 to 5,312 members, with one additional director for each increment of 1,250 members. The bylaws provide that directors be allowed to complete terms of office regardless of reapportionment.

- Adopted a revised public policy statement on flood plain construction (formerly entitled environment, water resources), which calls for AIA members to become locally involved in the development of wise flood plain management regulations and practices and for federal agencies to provide data to architects to enable them to alert their clients to flood hazards.

- Adopted a revised public policy statement on the Tallgrass Prairie Reserve and Park in Kansas and Oklahoma "to ensure that this important area of the national and historic heritage be preserved for future generations."

- Adopted a revised policy statement on surface mining, which, among other things, endorses "citizen and professional

continued on page 24

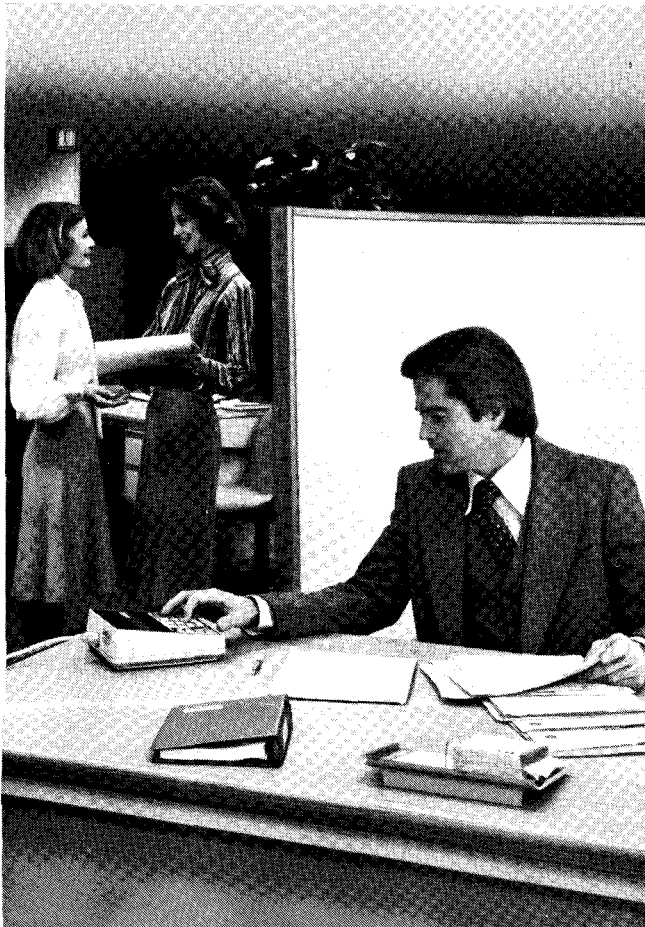

With Dukane sound masking, the office can be open . . . the discussion is closed.

Open offices are wise investments. They dramatically increase usable floor space and reduce maintenance, heating and cooling costs. Even employee efficiency is increased.

Dukane sound masking makes the open office even more practical. These electronic systems help achieve a higher degree of speech privacy in a busy office. The system works by preoccupying the ear, yet goes unnoticed, itself.

Dukane has over 50 years experience with sound systems. We can custom design a sound masking system suited for the acoustical conditions in your open office.

Attach your business card to this ad and send for information today.



DUKANE
DUKANE CORPORATION
COMMUNICATION SYSTEMS DIVISION
ST. CHARLES, ILLINOIS 60174 312/584-2300

Perhaps the most important new door closer since 1900:

THE RIXSON *Heritage*

Model 2000-I (Interior)
Model 2000-E (Exterior)

**Superb door control.
More durable, reliable and
versatile than any other closer not
imbedded in a concrete floor.**

STRONGEST SURFACE CLOSER EVER OFFERED

Assures life cycle economy...
reduced maintenance...
long term reliability.

- Exclusive one-piece cast iron closer body... cold rolled steel arm... heavy gauge, welded steel cover.
- Exceptional hydraulic capacity and oversized piston, with brass needle valves.

SUPERIOR, EXTREMELY RELIABLE CONTROL

Easy to open, guaranteed to close; protects hardware, door, frame and passersby.

- Unique field-adjustable backcheck system for degree—pre-set at 75° but easily adjusted from 65° to full door opening, regardless of arm application.
- Independent, fully adjustable latch and stroke valves.

EXCELLENT, TIMELESS APPEARANCE

Adaptable to any architectural design or environment. Steel cover and arm readily accept all painted and plated finishes.

- Aesthetically proportioned total closer cover.

- Unique straight arm further enhances appearance.

UNEQUALED VERSATILITY/ SPECIFICATION SIMPLICITY

Remarkable capabilities of two basic models (identical in appearance) assure proper, uniform selection, with uncommon ease.

- Model 2000 I (interior): Narrow stile, narrow projection model to complement quality aesthetics in virtually all interior applications. With on-site "power conversion" feature to modify closing force for unusual conditions. Available for parallel arm or top jamb mounting.
- Model 2000 E (exterior): A rugged, equally attractive model with narrow profile, suitable for exterior use and particularly demanding interior applications. "Power conversion" feature allows modification of closing forces on-site. Available for parallel arm or top jamb mounting.

RIXSON-FIREMARK

A DIVISION OF
CONRAC
CORPORATION

9100 West Belmont Avenue
Franklin Park, Illinois 60131
and Rexdale, Ontario—
312/671-5670

Circle 13 on information card

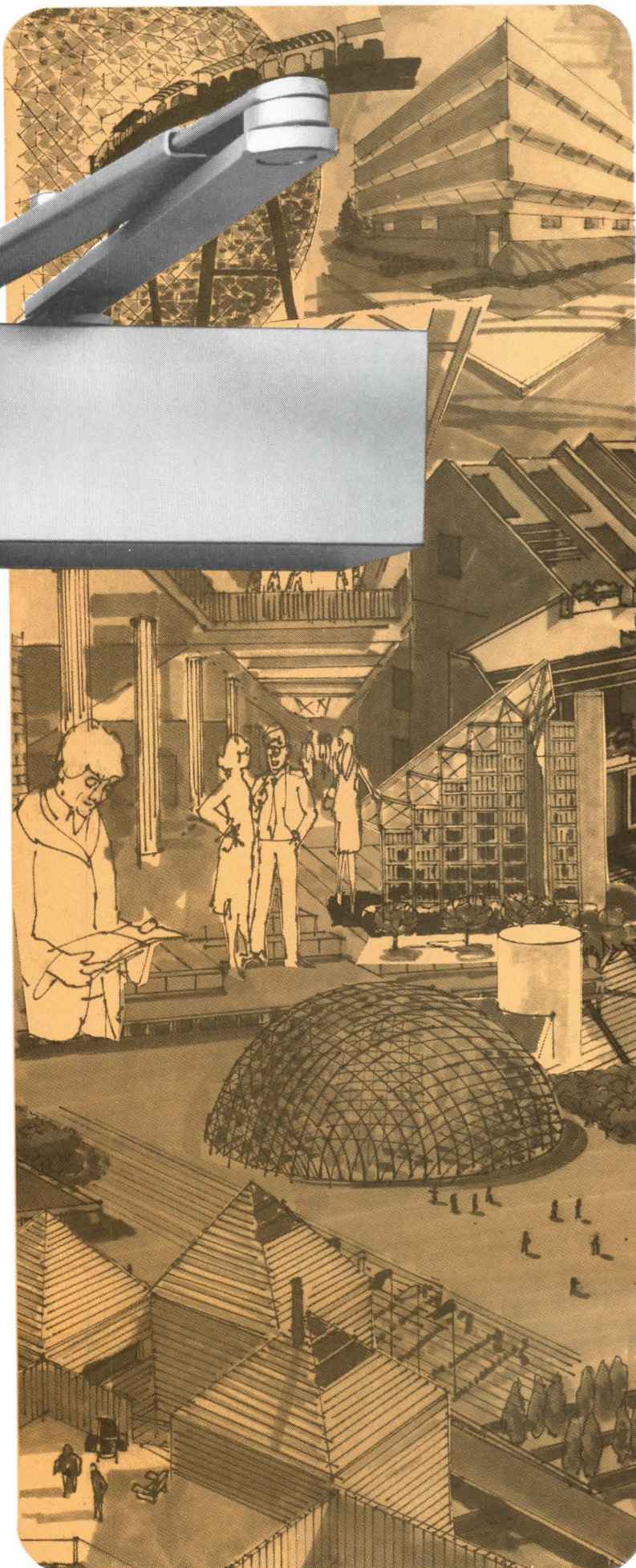

Institute from page 22

participation in the process of implementation of laws related to surface mining control and reclamation," stresses the vigorous enforcement of federal standards and gives support to comprehensive land use planning on federal lands "especially as it relates to preservation of the natural environment as well as to planned coal production measures."

- Adopted a revised policy statement on a barrier-free environment in support of the concept "that handicapped individuals should be afforded the means to participate in society to the fullest extent that they are able through the development of supporting systems, the elimination of physical barriers and the improvement of attitudes of the handicapped and the nonhandicapped public."
- Adopted a revised policy statement on seismic education and research, which says that AIA "encourages improved education and research activities on the effects of seismic hazards to buildings and their components."

Board Passes New Set of Policy Statements on Registration

At its August meeting, AIA's board of directors heard the report of the registration law advisory task force (chaired by William C. Muchow, FAIA) on its recommended Institute policies for shaping legislative guidelines to aid states in drafting registration laws. The board passed the following policy statements recommended by this task force:

- Exemptions from architectural registration: Although registration laws do not require that certain building types be designed by architects, it is AIA's contention that such exemptions should be limited to private, owner-occupied structures. The policy says that AIA "opposes blanket occupational exemptions from registration laws, and believes that any exemptions based on occupational or professional status should be limited in a manner to ensure adequate or equivalent protection of the public health, safety and welfare."
- Interrelationship of architecture and engineering: In the belief that there are "significant differences between architecture and engineering," AIA supports the concept "that architects and engineers *should only practice* the other discipline to the extent that it is incidental to their own practices," and that often both architectural and engineering services are required on a project.
- Uniform architectural registration criteria: AIA supports criteria that establish "a minimum standard of entry into the architectural profession and allow for reciprocal registration."

- Accreditation: Support is given to a national program of accreditation for architectural education programs. The current process "should be evaluated in terms of its reliance for entry into the profession," giving consideration to such factors as the program's ability to develop skills and the knowledge and judgment required for practice beyond initial licensing.
 - Maintenance of competence: All licensed architects, AIA believes, should maintain a minimum level of competence, and the Institute gives support to the concept of lifelong education, advocating voluntary continuing education programs of excellence.
 - Composition of registration boards: AIA supports registration boards that include both public and architect members, with the majority registered, resident architects. The public members should have an interest in and a familiarity with the profession and the construction industry.
 - Enforcement of licensing: The "vigorous enforcement of architectural licensing laws by states" is advocated, and it is further recommended that penalties be assessed for practice by nonregistrants and also for incompetent practice by registrants. Registration laws should be authorized to investigate complaints, to revoke or suspend licenses, to hold administrative hearings to ensure due process, to initiate actions for injunctions and to prefer civil or criminal charges in the name of the state.
 - Rules of conduct: AIA supports the adoption of rules of conduct by architectural registration boards in order to establish "common standards governing the relationship between registrants and the public, and the enforcement of such rules by the registration boards."
- In related recommendations and positions, which are an outgrowth of the investigation of architectural registration, AIA's board approved policy statements on the following:
- Responsibility to consumers: AIA and its components should assume "significant additional responsibility" in such areas as the education of consumers on the nature of architectural services, the strengthening of continuing education programs and the creation of better environments for the disadvantaged and others with special needs.
 - Responsibility of firms to candidates for registration: Architectural firms should make commitments to provide candidates for architectural licensing with experiences that will strengthen the candidates' skills, knowledge and judgment.
 - National Council of Architectural Registration Boards monitoring: In acknowledgment of NCARB's "increasingly important role" in the determination of skills, knowledge and abilities required to practice architecture and in other areas

related to licensing, AIA believes that it has a responsibility to its members to review and comment on NCARB policies and activities "in the formative stages of development. AIA should continuously monitor and take positions on the major issues being discussed by NCARB."

Four additional policy statements will be considered by the board at its December meeting.

Liability Coverage of Six Insurance Companies Compared

AIA will release this month a survey comparing professional liability coverage offered by six insurance companies. The survey, conducted during May and June under the direction of the architects liability committee, was spurred by what was seen as the need for the architect "to reconcile" insurance coverage needed with the amount bought.

The introduction to the survey states: "The past five years have seen drastic changes in the marketplace for professional liability insurance. These changes go far beyond the mere discussion of premium rate structures. They include new and varied exclusions, different types of project insurance and new legal interpretations which leave the architect potentially more vulnerable than ever."

Respondents to the survey were Victor O. Schinnerer & Co. (underwriting manager for Continental Casualty Co.), Design Professional Insurance Corporation, Thomas Sheehan Inc. (manager for Imperial Casualty & Indemnity Co.), PCM Intermediaries Ltd. (underwriting manager for International Insurance and International Surplus Lines Co.), INAX, (underwriters for Insurance Co. of North America) and Illinois R. B. Jones (managing broker for Lloyd's of London).

The companies were asked 30 questions. Highlights of the survey follow.

Insurance for specific projects is offered by Continental Casualty Co., Imperial Casualty & Indemnity Co., International Supply Lines Co. and Lloyd's of London provided that the architect has basic liability coverage with the company. Design Professional Insurance Corporation provides insurance for medium- and large-sized projects and INAX offers coverage for projects with more than \$1 million in gross fee billings.

In the case of settlements, all of the companies except International Surplus Lines require the consent of the insured. If the insured refuses to consent to any settlement recommended by the company, the company's liability will be limited to the amount that could have been settled for. Some companies also add cost and expenses they have incurred.

continued on page 29

Guess whose beehive is buzzing the busiest for total source contract fabrics?

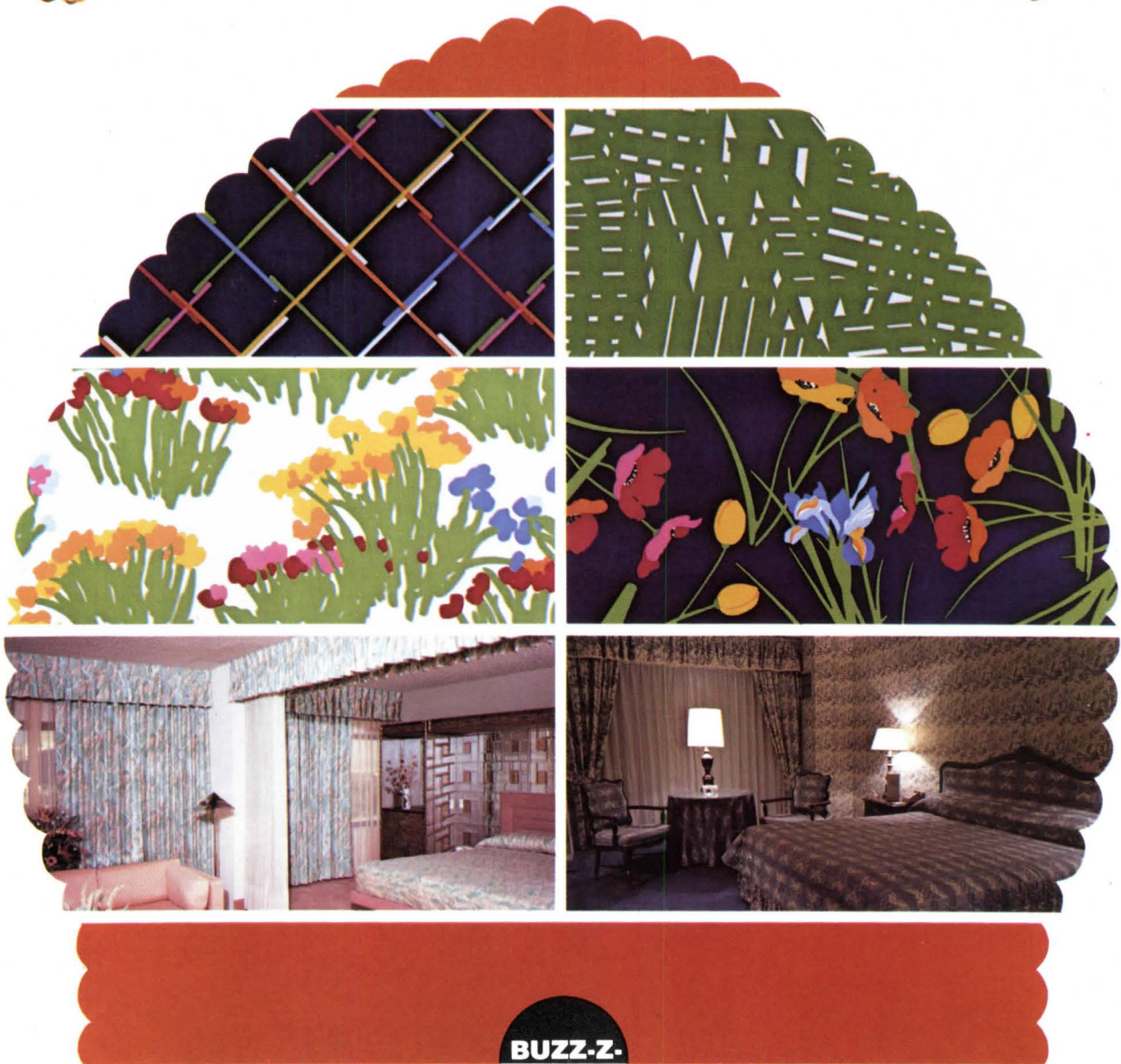

BUZZ-Z-

More and more of the country's finest specifiers are calling on Cohama Specifier for total-source contract fabric services. In fact, you're seeing many of our best works in many of their best projects. Wherever drapery, bedspreads, upholstery and wallcovering are specified in the country's finest hotels/motels, offices and institutions.

Now the Cohama Specifier bee has more sting than ever. Innovative designs. New colorways. New Introductions, including the latest Bob Van Allen collection. "Snap Shots." Prints. Wovens. Solid coordinates. A staff that's not satisfied to only answer specifying questions, but eager to anticipate specifier needs.

The Cohama Specifier bee will never be content to sit on his honey. He'll always keep buzzing. For you.

WE WELCOME YOU TO SPACE 2603
INTERNATIONAL HOTEL/MOTEL SHOW
NOV. 9-12, NEW YORK CITY COLISEUM

COHAMA SPECIFIER
CONTRACT FABRICS

200 Madison Ave., New York, N.Y. 10016 • 212/561-8680
UNITED MERCHANTS AND MANUFACTURERS, INC.

Circle 14 on information card

Lone Star

The glass-sheathed Hyatt Regency Hotel and its companion Reunion Tower are fast becoming the landmarks of Dallas.

The 1,000-room hotel is completely curtained in LOF Vari-Tran[®] silver-coated glass windows and spandrels that mirror the 50-story tower and its Vari-Tran-glassed geodesic dome top.



Special features within the complex include the hotel's 18-story glass-roofed atrium and 6-story glass wall that give hotel guests spectacular views of Reunion Tower and its surrounding parks. And glass-enclosed elevators that rise within the atrium, pop through the roof and ascend in a mirror glass shaft to the upper floors.

Circle 15 on information card

Equally impressive, this glass is energy efficient as well as beautiful. The Vari-Tran glass helps control heat gain and glare while it admits plenty of natural daylight. So air conditioning and artificial lighting expenses can be reduced. Combined with the matching Vari-Tran spandrels, it increases the buildings' visual impact, eliminates corrosion worries, improves employee morale, boosts civic pride and delights hotel guests.

If you'd like to learn how glass can help improve your performance and cut clients' energy bills, send \$1.00 for our definitive 43-page study "Predicting Daylight as Interior Illumination." Libbey-Owens-Ford Company, 811 Madison Ave., Toledo, Ohio 43695.



LOF Glass

A Libbey-Owens-Ford Company

superstar.



Don't Compromise Your Wall's Integrity.

Haws Model HWCT6 fountain with cooler is fully recessed, so walls remain smooth and interior lines are uninterrupted. Recess space beneath allows convenient wheelchair access.

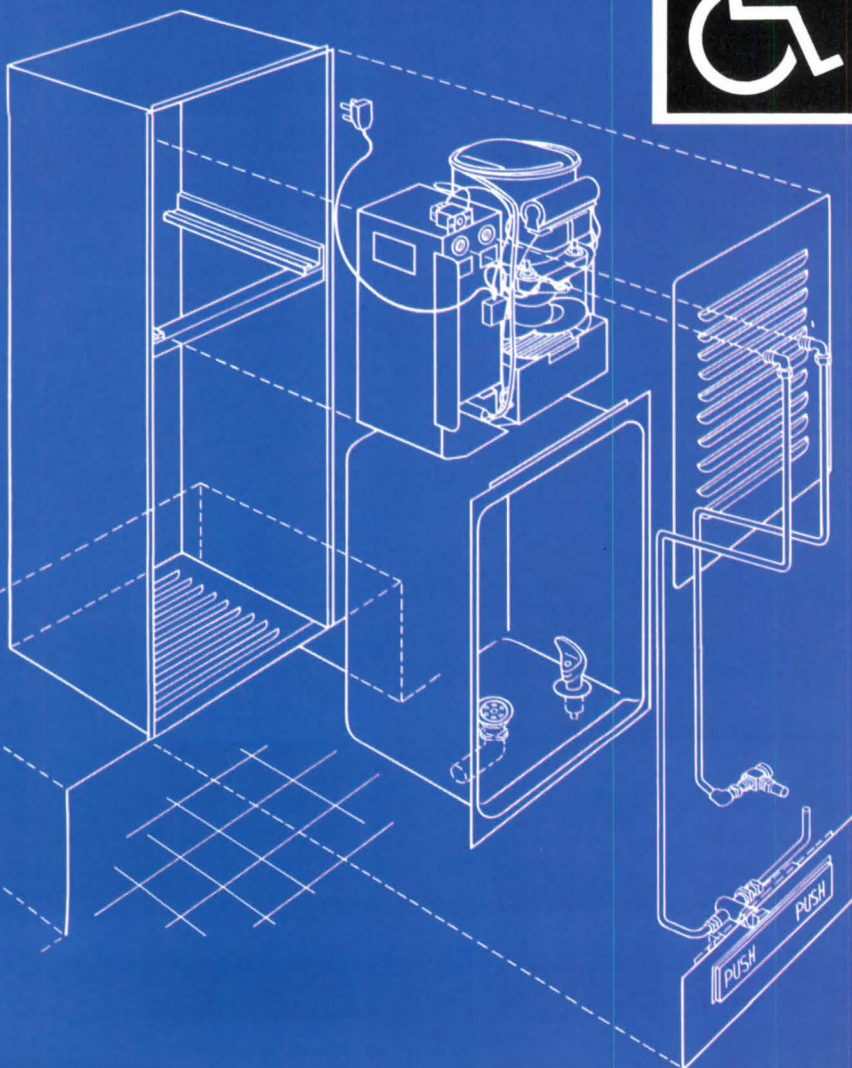

Sturdy, Easy to Mount.

Steel mounting box is included for convenient installation. 9.5 gph cooler fits simply into place. Features a 17-gauge, satin-brushed finish; polished chrome-plated bubbler; and push-bar valve with automatic stream control.

HAWS DRINKING FAUCET COMPANY
P.O. Box 1999 • Berkeley, CA 94701

Haws

Circle 16 on information card

Institute from page 24

Defense costs are included in the limit of liability by Continental Casualty Co., but the deductible does not apply. Defense costs are outside the limits of liability but are included in the deductible in coverage offered by the other companies.

The right to appoint counsel to defend an insured is reserved by PCM Intermediaries Ltd. and Illinois R. B. Jones; the others also reserve the right to appoint counsel but are open to suggestions from the insured.

The companies were also asked under which of the following nontraditional forms of practice would the company insure a design professional: designer as prime contractor, builder as prime contractor, joint venture, design-develop, turnkey (when the design professional owns the land and provides the construction financing for a project that he has contracted to sell upon completion to a specific client for the client's purpose). PCM Intermediaries Ltd. offers coverage for none of these. Coverage for the designer as prime contractor is offered by

Imperial Casualty & Indemnity Co. and Lloyd's of London. For builder acting as prime contractor and subcontracting the design responsibility, coverage is available from Imperial Casualty and the Insurance Co. of North America; a conditional coverage is offered by Continental Casualty Co., Design Professional Insurance Corporation and Lloyd's of London. For a joint venture, coverage is offered as an option by Imperial Casualty. Design-develop coverage is available from Continental Casualty Co.; conditionally by Design Professional Insurance Corporation, and as an option by Imperial Casualty. For turnkey contractual relationships, Insurance Co. of North America offers coverage, Continental Casualty Co. conditionally offers coverage and Imperial Casualty and Lloyd's of London offer optional endorsements.

The companies were also asked where coverage is offered, if a loss prevention program is available, what the minimum and maximum deductibles and limits of liability are and what factors influence the amount of the premium, among others.

thermal, wind, nuclear fusion, alcohol syntheses and biomass, to provide the next generation of energy sources."

For the development of renewable resources, Anderson supports the creation of a solar bank to provide home improvement loans and mortgages to finance the purchase and installation of approved solar energy systems; tax incentives for residential use of alternative energy sources, and expanded federally-sponsored research for solar and other alternative technologies.

As for other energy sources, the Democrats call for increased use of coal, which the party regards as "our nation's greatest energy resource." Emphasis is also placed on development of synthetic fuels, while being sensitive to environmental and water concerns. And as renewable energy sources and alternative fuels become available in the future, the Democrats call for the retirement of nuclear plants in an orderly fashion.

Republicans believe "that in order to address our energy problem we must maximize our domestic energy production capability." The party supports continued development of synthetic fuels, with limited government support; decontrol of the price at the well head of oil and gas; research, development and demonstration of the breeder reactor.

Anderson supports accelerated development of a synthetic fuels industry, but he maintains that the federal role in the synthetic fuels program must be carefully circumscribed. On nuclear fission, Anderson "feels that while there are problems which must be resolved, it would be premature to impose a moratorium on existing plant construction."

The top priority in the Democratic platform's urban policy is a strong jobs policy "which supports productive employment of the people in the public sector and encourages employment in the private sector by attracting and strengthening business in cities." The platform calls for public works programs to help rebuild cities' infrastructure; incentives for energy conservation; national economic policies intended to maintain growth in our economy and reduce the inflation rate; a five-year extension of the local government revenue sharing program, and renewed efforts to consolidate existing grants-in-aid programs in order to provide state and local governments greater flexibility.

The Republican urban policy, as stated in its platform, revolves around its economic program which will create a climate in which "American cities can once again produce, build and grow." A Republican Administration, says the platform, "will cut taxes, increase incentives to save, restore sound money and stimulate capital

continued on page 32

Government

How the Three Platforms Treat Issues of Concern to Profession

The political platforms of the Democrats, Republicans and John Anderson make no mention of architecture but do discuss issues of interest to the profession, such as energy, urban affairs and the environment. Following is a brief comparison of their positions on these issues.

The Democrats give conservation the highest priority in their energy program. The platform calls for the establishment of a massive residential energy conservation grants program and special incentives for use of renewable energy resources in homes, such as passive and solar energy systems. Only the Democrats mention and embrace implementation of building energy performance standards (BEPS) to "encourage the design and construction of energy efficient buildings." In addition they say, BEPS "should apply to all new construction and should begin with federal government buildings."

Republicans see conservation as playing "a vital role in the consideration and formulation of national energy policy," but "reject the position of the Democrats which is to conserve through government fiat." While calling for cost-effective incentives to achieve energy efficiency and conservation, the Republicans believe that "every BTU of genuine energy 'waste' in our economy would rapidly disappear if

we immediately and completely dismantle all remaining energy price controls and subsidies."

Anderson urges a "renewed look at conservation in all its varied forms." And while he favors a "liberalization of the existing tax credits for residential insulation and weatherization," he cautions that "we cannot permit a wave of consumer demand to overwhelm the existing supply of home insulation services and thereby escalate insulation costs to unacceptable levels."

Concerning solar and renewable energy sources, the Democrats set a goal of having solar energy account for 20 percent of our total energy use by the year 2000. The platform calls for a greater share of federal funds for basic solar research, for the development of renewable energy resources and nuclear fusion research and development.

The Republicans maintain that coal, gas, oil and nuclear fission are the potential energy sources for the short term, and "renewable resources must be brought significantly on line to replace conventional sources" in the long term. . . . "We believe the government must continue supporting productive research to speed the development of renewable energy technologies, including solar energy, geo-



PAT. 4,080,758
MAXIMUM-LIMIT STOP

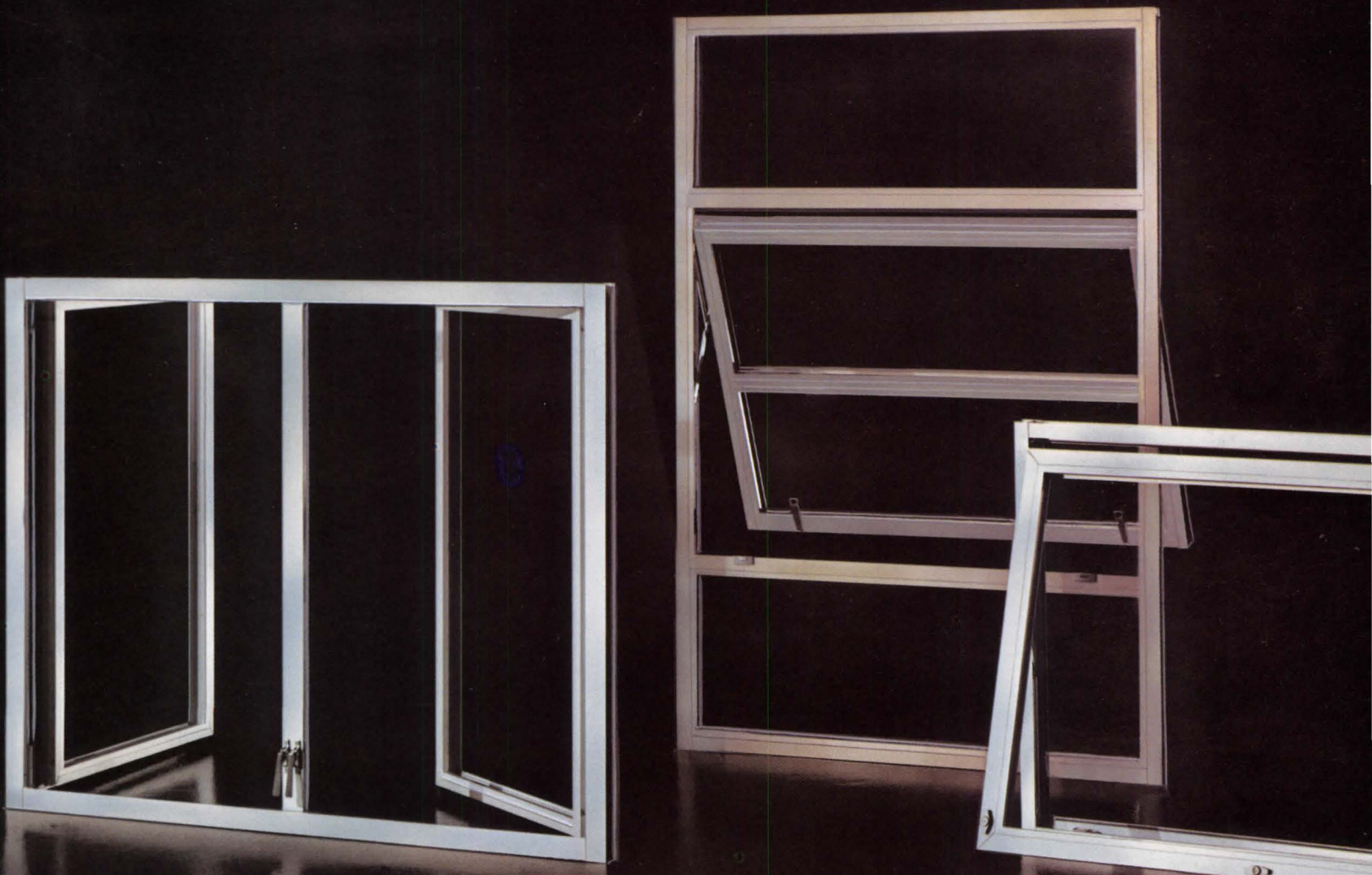

THE ADDED DIMENSION IN THERMAL WINDOW DESIGN: CHOICE.

A wide range of thermal windows that help designers see all the possibilities.

Today's thermal windows from Kawneer are the products of design experience that goes back to 1906. Our thermal research has been conducted for almost two generations. Kawneer thermal windows are designed to efficiently complement recent advances in glazing techniques, maintaining the Kawneer reputation of efficiency and structural soundness. But now, Kawneer broadens the view of designers by providing a complete line of thermal windows that fit beautifully in practically any application.

Kawneer thermal windows feature Isolock[®], a unique thermal break design which not only physically separates the inner and outer aluminum members, but also minimizes potential window framing failure and the resulting glass breakage. Windows with Isolock significantly reduce window framing heat transfer and condensation. These abilities help lower energy costs and prevent condensation water damage.

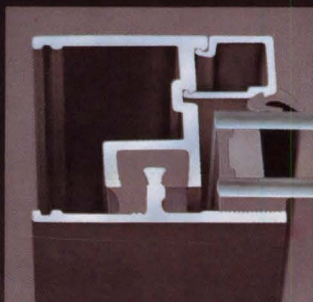

Kawneer Sealair[®] Thermal Windows include: Vertically and horizontally pivoted windows, casement, projected, and fixed, as well as top hinge and drop head windows. Sound and light control can be provided with thermally-broken 3" windows.

Sealair Window Systems from Kawneer are available in a complete line of 2 1/4" and 3" aluminum thermal windows that can add a new dimension to your overall design. In addition, custom thermal window fabrication is also available. So, when you're looking for thermal efficiency and maximum selection, Kawneer has what you need. The choice is yours.

For more information, contact your Kawneer representative and ask for our new brochure, Kawneer Sealair Aluminum Windows. Or write: Kawneer Product Information, Department C, 1105 N. Front Street, Niles, MI 49120

Kawneer
The designer's element

Circle 17 on information card

DOLLARS-AND-CENTS QUESTION:

What's the best choice for economical construction of a multi-building business park?

QUICK-AND-EASY ANSWER:

Tilt-up reinforced concrete for low construction costs and individualized design.



Westbelt Business Park, Columbus, Ohio, was started in 1976 as a joint venture of Vantage Companies and The Prudential Insurance Company of America.

To ensure the commercial success of the park, the owners sought a fast construction method that would result in quick occupancy. They also wanted to make each building distinctively suited to individual tenants' needs.

The answer: tilt-up reinforced concrete. With this proven low-cost technique, large concrete panels are cast horizontally on the ground with Grade 60 reinforcing steel and then tilted into vertical position. Hence, buildings go up faster, and tenants take occupancy sooner.

To date, the developers have constructed twenty tilt-up warehouse and office buildings in the Westbelt Business Park. Various unique surface treatments—

exposed aggregate, ribbed relief, colors—were easily incorporated into the concrete during casting.

When built in 1978, construction costs were in the \$7.50-\$8.50 range per square foot for basic warehouse facilities. Other buildings in the park ranged in costs from \$10 to \$20 per square foot. Since 1978, costs for new tilt-up buildings have increased at a rate far less than the national inflation rate.

Besides economy, tilt-up concrete delivers all of reinforced concrete's benefits: excellent fire resistance, low maintenance, favorable thermal properties, easy expansion capabilities, security, and more. In fact, for today's business parks, tilt-up concrete answers all the questions—beautifully. Write for Bulletin 7902.

DEVELOPER: **Vantages Companies, Columbus, Ohio**

ARCHITECT: **Edwin D. Wagers, A.I.A. (All Projects)**

CONCRETE REINFORCING STEEL INSTITUTE 
180 North LaSalle Street, Room 2111
Chicago, Illinois 60601

THE ANSWER'S IN REINFORCED CONCRETE

For information on Professional Membership Program, write to Director of Marketing.

Government from page 29

investment to create jobs, which will in turn help revitalize neighborhoods and cities." A Republican Administration will also encourage cities to undertake neighborhood revitalization programs in cooperation with local interests; replace the categorical aid programs with block grant or revenue sharing programs and, where appropriate, transfer the programs, along with the tax sources to pay for them, back to the state and local governments.

Anderson calls for "changes in federal urban policy aimed at facilitating local self-reliance and initiative and restoring America's cities to their rightful position as vital centers of community and culture." He calls for extension of the block grant and revenue sharing programs; for programs to develop increased city revenue bases, to upgrade the quality of city service infrastructure, to attract commerce and industry and to encourage job training and employment opportunities.

On the environment, the Democrats advocate a continuation of existing environmental policies, while "striving to ensure that environmental regulations cost no more than necessary and are streamlined to eliminate waste, duplication and delay."

The Republicans believe that a healthy environment is "essential to the present and future well-being of our people and to sustainable national growth." The platform stresses that it is "imperative that environmental laws and regulations be reviewed and, where necessary, reformed to ensure that the benefits achieved justify the costs imposed."

Anderson maintains that "as compelling as the looming energy crisis is, we simply cannot automatically relax clean air, clean water and other pollution standards. . . . Our progress in this area must not be slowed."

Feds Foiled Again in Efforts To Contain D. C. Area Towers

The most recent effort by the federal government to prevent developers from constructing still more highrises across the Potomac River from Washington, D.C., comes from the National Capital Planning Commission. The commission voted unanimously at a recent meeting to urge denial of HUD support for a proposed apartment building in Arlington, Va., because it would "intrude visually . . . on the monumental core of the nation's capital." The commission said that the 24-story building should be reduced in height by 50 feet, or five stories.

After the meeting of the planning commission, a HUD official said that the developer of the apartment building had requested federal mortgage insurance and

rent subsidy for 20 percent of the building's proposed 374 units. He said HUD would ask the developer to reduce the building's height before federal support would be given.

The commission also voted unanimously to urge the county board and its planning commission not to approve any structure higher than 60 feet in the county courthouse area. A highrise office building is proposed to be built opposite the courthouse on a ridge overlooking Washington.

The county board, however, later defied the commission's appeal and approved construction of a 14-story office building on a site two blocks from the courthouse. The commission had told the board that the structure would mar the skyline of Washington. A member of the board said that the action was justified because it would improve the county's tax base. He said that federal officials are "not willing to compensate us for the tax loss if we conform to the height loss."

Although Arlington County has a maximum height limit of 16 stories for hotels and apartment buildings and 12 stories for commercial structures, county officials have regularly waived the restrictions. They call the federal government's objections "meddling in local matters," and point to the fact that last year the Department of the Interior and the planning commission lost a suit brought against developers of four highrises in Rosslyn, Va., when a U.S. district judge ruled that the highrises would not detract from "the average visitor's view of the memorials, monuments and parks in our nation's capital." The judge said the government had failed to prove that "the visual intrusion complained of is, in fact, a public nuisance," as the government contended. (See April '79, p. 26.)

An Arlington County planning official told a newspaper reporter that another government move could come from GSA if the agency linked its leasing practices to height limitations. Currently, GSA leases space in Arlington for 24,000 federal government employees. Some of the controversial highrise office buildings were constructed specifically for rental to the government.

Community Development Grants Achieve Energy Conservation

Although Congress did not mandate energy conservation in its statutory language which established HUD's community development block grant (CDBG) program, many of the 6,600 communities that have been reached in CDBG's six years have taken what HUD calls "imaginative initiatives . . . to address a diverse array of energy problems." A recent HUD report entitled "Block Grant Energy Con-

continued on page 35

ARCHITECT: PROBLEM: SOLUTION:

Jova/Daniels/Busby

Design a church interior that conveys a powerful sense of warmth and peace yet is as economical to maintain as it is inspirational for worship.

Brick

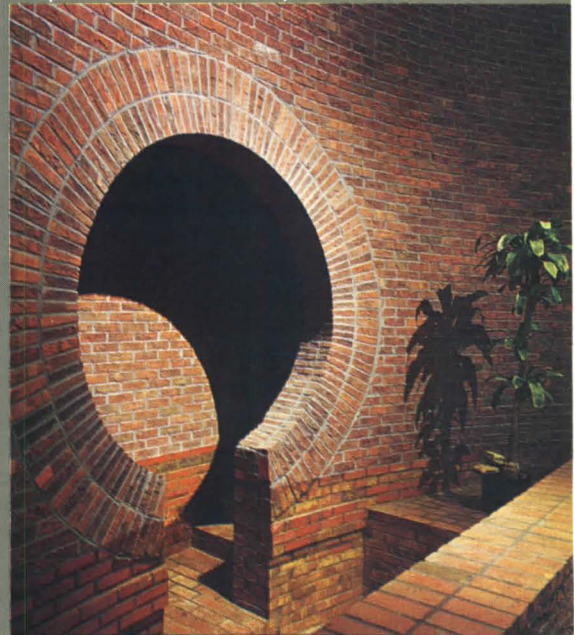

For more information about the design of the First Christian Church of Atlanta, request a free copy of Brick In Architecture, Volume 34, Number 2 from Brick Institute of America, 1750 Old Meadow Road, McLean, Virginia 22101.



Circle 18 on information card

STOP WASTING ENERGY!

Control POOL ROOM Humidity

Finally! A sensible way to control Pool Room Humidity while reducing operating costs.

DESERT AIRE DOES IT ALL!

- Reduces Operating Costs Up to 75%
- Controls Damaging Humidity while Heating Pool Room
- Saves Money
- Uses No Gas or Oil
- Models to Suit All Needs

Don't throw Money Out the Window!



DESERT AIRE CORP.

Dept. DA 2
5633 W. Florist
Milwaukee, WI 53218
1-414-462-4143

**“You don't have to be
the biggest to be insured
by the best.”**

“Shand, Morahan?”

“Shand, Morahan.”



It's the growing consensus of the leading architectural and engineering firms in the land: the E&O program available through Shand, Morahan & Company is about the best coverage you can have, at a most competitive premium rate. That's why so many of the ENR top 500 design and construction firms are choosing our insurance.

But your firm doesn't have to be among the biggest to enjoy the best in Architects and Engineers Professional Liability insurance. Shand, Morahan also extends its uniformly excellent claims-made program and unmatched standard of service to more and more medium and smaller-sized firms as well. These firms enjoy the same experience and attention that only the nation's foremost source for professional liability insurance can provide.

If your present Architects and Engineers Liability policy or premium might benefit from an analysis and comparison with ours, we welcome your insurance broker's inquiry. Whether you're among the biggest, or just want the best.

**SM Shand, Morahan
& Company, Inc.**

One American Plaza, Evanston IL 60201

Circle 21 on information card

Government from page 33

ervation" tells what 10 of the communities have done to anticipate the future prices of energy in their project designs and financing.

The actual numbers of all CDBG recipients to implement similar or separate energy projects have not been calculated, HUD says. The cited examples were not selected "in any deliberate or systematic fashion," but were called to HUD's attention by community leaders in a three-weeks span before the report was written.

Four of the projects described demonstrate, HUD says, that "solar heating and cooling is now available as a viable, cost effective alternative to oil and fossil fuels for low- and moderate-income housing and public facilities." One of the projects concerns passive solar space heating design in the construction of a new community center in Spokane, Wash., which helped make the center self-supporting after construction. The condition of self-support was laid down by the city council before it would release CDBG funds to build the much-needed center for a neighborhood of low- and moderate-income, single-parent families.

The report also tells the story of a project in Hutchinson, Kan., where block grant funds were used to defray the costs of aerial thermography in a neighborhood energy audit on a block by block basis to determine which buildings are currently energy efficient and which are not. The thermograms are being used to help the city weatherize lower-income housing.

Another story concerns the Village of Soldiers Grove, Wis., which received disaster assistance under CDBG to relocate its business district away from the flood plain of the Kickapoo River. The village board has ruled that every building at the new downtown site must be equipped with solar energy and be at least 50 percent energy self-sufficient.

Endowment Announces Awards

The National Endowment for the Arts recently announced the awarding of more than \$1.6 million in fiscal year 1980 to support "creativity and innovation" in the fields of architecture, landscape architecture, urban design and industrial, graphic, interior and fashion design. Projects in the design demonstration category vary from an \$8,000 grant to Historic Savannah (Ga.) Foundation, Inc., for support of a design competition to develop guidelines for infill construction on vacant lots in the city's Victorian district to a \$60,000 grant to the Film Art Fund/Anthology Film Archives, Inc., in New York City to assist in planning for the conversion of the old Second Avenue courthouse into the organization's new headquarters.

continued on page 37

ARCHITECT: Brooks Borg and Skiles	PROBLEM: Design an office building that will display low operating and maintenance costs and meet stringent energy conservation guidelines.	SOLUTION: Brick
---	---	---------------------------

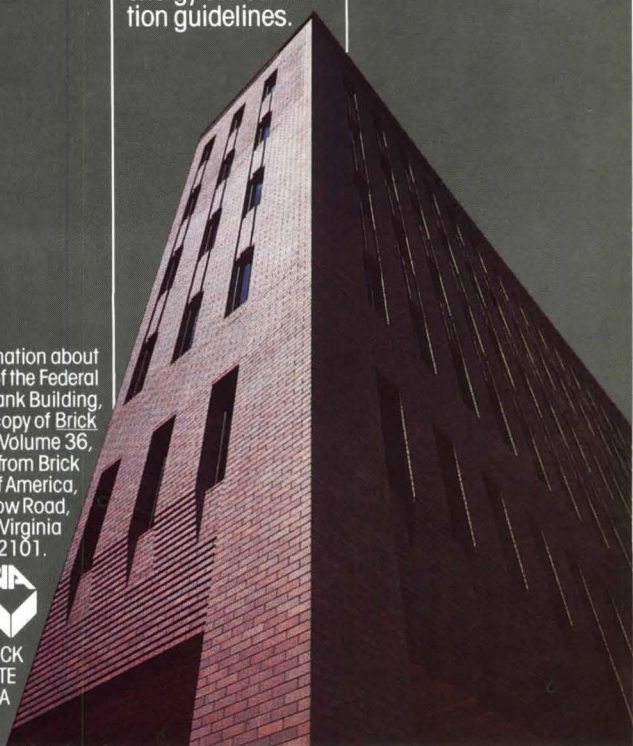

For more information about the design of the Federal Home Loan Bank Building, request a free copy of *Brick In Architecture*, Volume 36, Number 6 from Brick Institute of America, 1750 Old Meadow Road, McLean, Virginia 22101.



BRICK INSTITUTE OF AMERICA

Circle 22 on information card

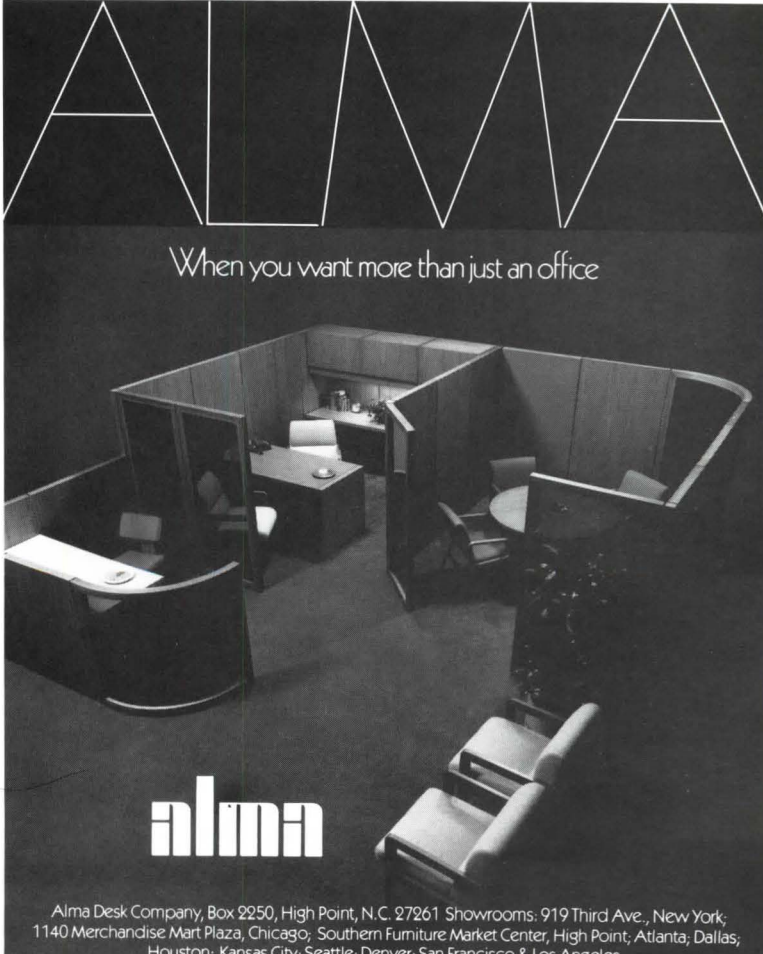

When you want more than just an office



Alma Desk Company, Box 2250, High Point, N.C. 27261 Showrooms: 919 Third Ave., New York; 1140 Merchandise Mart Plaza, Chicago; Southern Furniture Market Center, High Point; Atlanta, Dallas, Houston; Kansas City, Seattle, Denver, San Francisco & Los Angeles.

Circle 23 on information card

Total Performance



Sunglas® Reflective. Less heat. More daylight. Low cost.

Sunglas® Reflective by Ford blocks up to 65% of the sun's heat, while letting in over 40% more natural daylight than the closest competitor, at a cost that's surprisingly low.

The next time you specify reflective glass, specify the total performance of Sunglas® Reflective.

For more information call:
1-800-521-6346.



GLASS DIVISION

Government from page 35

In the design communication category, grants were made to 41 organizations, among them \$20,000 to the Architectural History Foundation, Inc., in New York City to support the publication of 73 sketchbooks by Le Corbusier. Grants were also made in the design exploration/research category, among them an award of \$31,745 to the Massachusetts Institute of Technology for the preparation of four case studies about energy-conscious design for use in professional schools and continuing education programs.

Also, design fellowships were given, with Charles A. Blessing, FAIA, of Detroit and Robert B. Marquis, FAIA, of San Francisco among the recipients of senior level sabbatical fellowships. Individual project fellowship awards were made to persons to pursue fields of study. Among the recipients of such awards were Andrew F. Euston, AIA, of Washington, D.C., and Benjamin H. Evans, AIA, of Blacksburg, Va.

In a category called general services to the field, grants were made to such institutions as Harvard University's graduate school of design for a program in career discovery for precollege students and to the University of Texas at Austin to support its summer academy in architecture for high school students.

Housing for Elderly, Disabled

HUD recently announced the reservation of more than \$687 million to finance more than 17,900 housing units for the elderly and the disabled. The funds will be used to finance new construction and the substantial rehabilitation of existing structures in 45 states and Puerto Rico.

Authorized under HUD's section 202, the funding will go to 324 nonprofit sponsoring organizations, of which 53 are minority sponsors. Sponsors may borrow from HUD up to 100 percent of the total development costs, to be repaid over a 40-year period at an interest rate based on the average rate paid by the Treasury in its borrowing activities.

HUD will require sponsors to scatter the housing units throughout their communities rather than concentrating them in single neighborhoods, "in an effort to normalize living environments for disabled people."

The program is designed primarily for low- and moderate-income people, but the occupants of the housing are expected to have a wide range of incomes, including some occupants who will need no financial assistance. Under HUD's rental assistance program, subsidies will be available to those who need help in paying their rent. Eligible families pay no more than 25 percent of their incomes.

Briefs on page 114

ARCHITECT: PROBLEM: SOLUTION:

Caudill Rowlett Scott

Design a university arts center that makes a boldly contemporary architectural statement yet blends gracefully with the traditional buildings that make up the remainder of the campus.

Brick

For more information about the design of Wake Forest University's Fine Arts Center, request a free copy of *Brick in Architecture*, Volume 36, Number 1 from Brick Institute of America, 1750 Old Meadow Road, McLean, Virginia 22101.

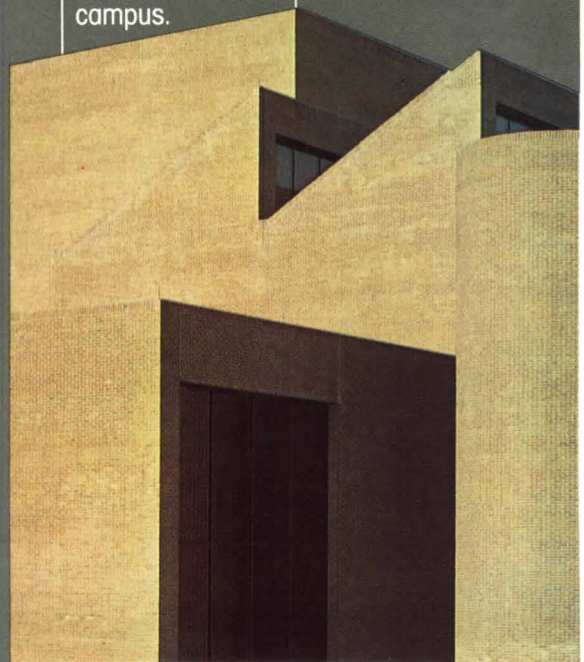

Circle 25 on information card

Building ideas.

"The history of modern architecture," writes Kenneth Frampton, "is as much about consciousness and polemical intent as it is about buildings themselves." Examining the important movements, schools, and individuals from Louis Sullivan to Buckminster Fuller, Art Deco to New Brutalism, Frampton defines the social, political, and aesthetic forces that shape the architecture of our recent past—and of our future.

MODERN ARCHITECTURE A Critical History Kenneth Frampton

With nearly 300 illustrations,
\$17.95 cloth, \$9.95 paperback.

THE WORLD OF ART

At your bookstore, or send your check to:

OXFORD UNIVERSITY PRESS

Box 900-80-006 ■ 200 Madison Avenue, New York, N.Y. 10016

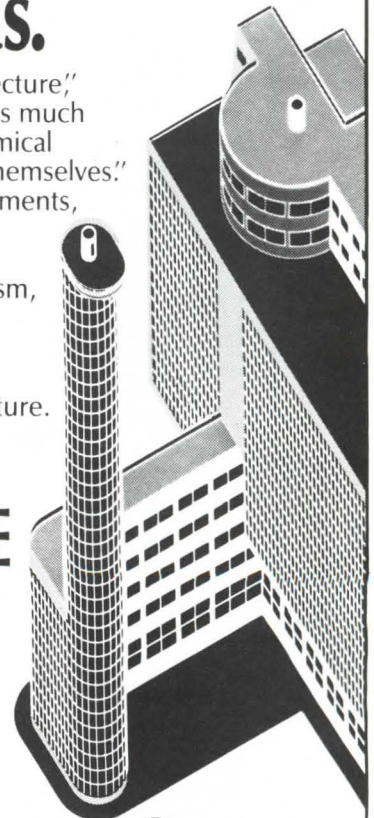

Circle 26 on information card

**What would you get
if you tossed away
all your ideas about
what a building
should be?**

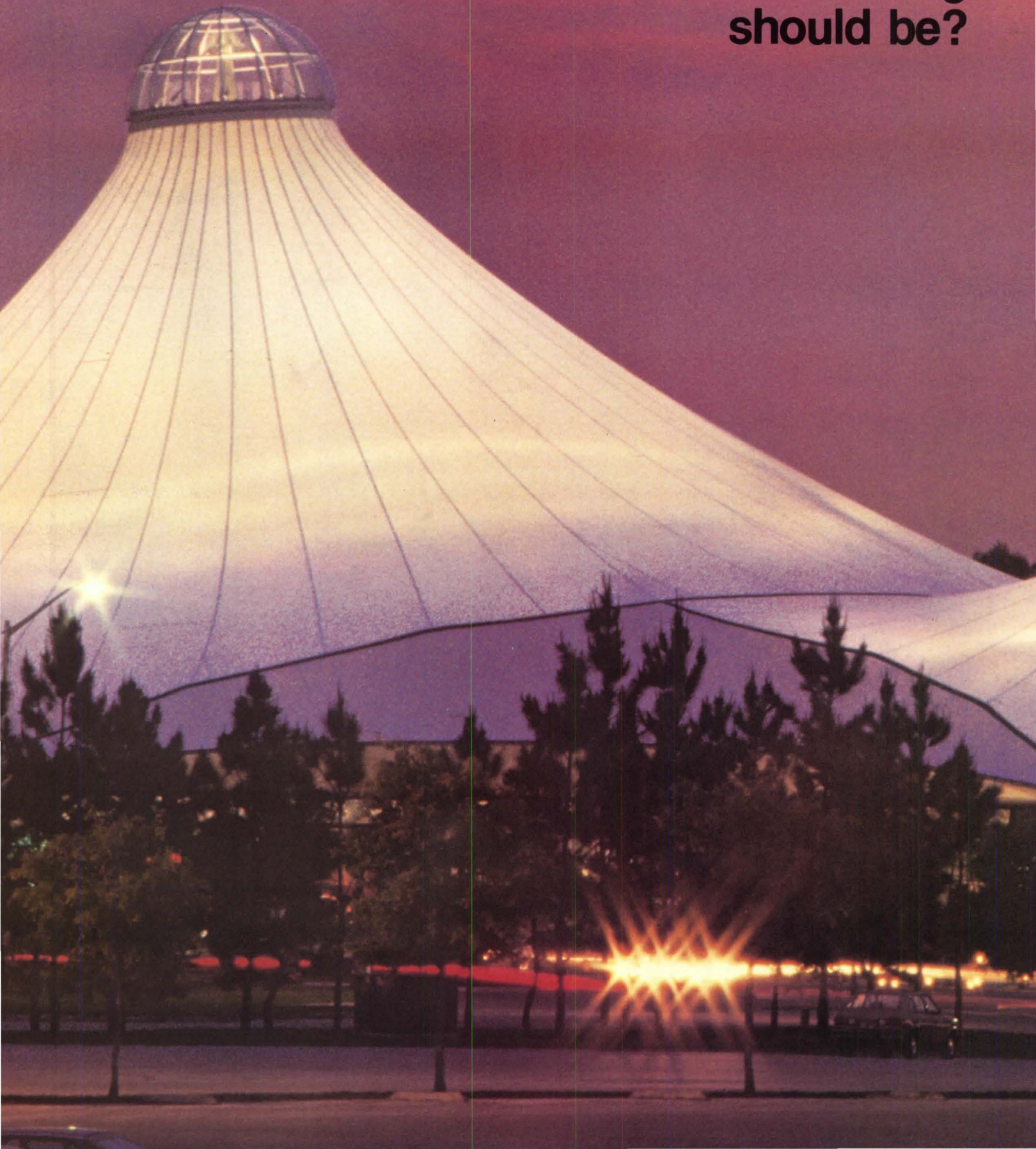

Permanent fabric architecture from Birdair Structures.

A proven, durable system that offers an exciting alternative to traditional construction methods — and a freedom of design and conceptual versatility never before possible. Not just a wide span roof, but a complete environmental envelope that provides translucency, solar reflectivity, and esthetics. Simply put, a revolution in architectural form.

Florida Festival, a 60,000 square foot shopping and entertainment center at Sea World in Orlando, was fabricated and erected by Birdair Structures. The 90,000

square foot roof is made of SHEERFILL[®], CHEMFAB's architectural fabric of fiberglass coated with TEFLON*. With 18% solar transmission, it permits the growth of 40 foot palm trees and other tropical flora. Natural daylight bathes the interior to highlight merchants' products. The high reflectivity of SHEERFILL creates a cooler interior under the hot Florida sun, providing substantial energy savings through greatly reduced air-conditioning requirements.

The design and erection of permanent fabric structures require the specialized skills of a company with the demonstrated ability to help translate vision into reality. Birdair Structures is the pioneer and leader in this field. We invented the technology. Extensive involvement

in virtually every permanent fabric structure built to date makes us uniquely qualified to offer state-of-the-art structural analysis and detailing assistance to the architect. We are the **only** single source that can offer integrated expertise in every phase of fabric structure technology: design, engineering, weaving, coating, fabrication, and erection.

Bring **your** new ideas to us, **Birdair Structures**, a division of CHEMFAB, 2015 Walden Avenue, Buffalo, New York 14225 U.S.A. (716) 684-9500 Telex: 91-353 Cable: Birdair Buffalo.

Circle 27 on information card

BIRDAIR STRUCTURES
A DIVISION OF **CHEMFAB**



© SHEERFILL is a registered trademark of CHEMFAB

* Du Pont's registered trademark for its fluorocarbon resins and film

In Defense of 'Our Self-Educated Minority'

Don't file away the August JOURNAL without pausing to note, and perhaps mourn, the fall of yet another species to the advance of civilization. The decision of the state licensing boards to deny certification to self-educated architects will surely shut off the trickle of unusual and highly motivated people who have circumvented college in entering the profession (p. 11).

I'm sorry to see this happen. Our self-educated minority has historically provided the profession with a valuable source of diversity and, in many cases, saved it by its unorthodox vision when the demands of history exceeded the capacity of the established educational system.

Brunelleschi, a patriotic Florentine, gave up his amateur standing as a building committee member when his architects were unable to complete an Italian cathedral without reverting to French or German motifs. Jefferson entered the profession to invent a style suitable for a form of government that had not been considered in the academies of his day.

Paxton, Sullivan, Burnham, Wright, Mies and Fuller were all able to respond to changing social and economic conditions because their vision cut through the accepted scholastic certainties of their times. One might argue that a formal architectural education would not have hurt them, but from their own accounts few of them would agree.

To our credit we have usually accepted and sometimes have welcomed these gifted mavericks. We have acknowledged their accomplishments and shared their glory.

The fact that the profession has often had to accept outsiders in response to change should not be taken as evidence of the failure of academic architectural education. The times do not always change, and the institutions that sponsor our profession and its educational system are generally committed to resist change with all the means at their disposal. Architecture is intended to be conservative art. Revolutionaries cannot afford it. But even if we can rely on the academies to do an adequate job during periods of stability, there may be other reasons for keeping alternate paths into the profession open.

Respect for precedent might have led us to recognize that apprenticeship has been the only method of training architects for most of the profession's history and that formal academic training, except in France, is a relatively new experiment. The period during which our schools have multiplied and prospered has not been marked by a noticeable improvement in the quality of the built environment, and,

while it is grossly unfair to place the blame for our predicament entirely on the schools, it is reasonable to assume that they may share some responsibility.

Beyond this we might consider that architects, like other people, become receptive to ideas at unpredictable times and in unorthodox sequences. For some individuals, work at the construction site may be a necessary prerequisite to design. Others may want to read Dickens before Eisenman. Some youngsters at 20 find protracted theoretical speculation as tedious as I do at 50.

The self-educated architects I have known and worked with did not seem to be too different from the rest of us, except that they invariably were realists. This usually manifested itself in a clear prose style. They also seemed to share an unusually strong sense of responsibility to the profession which they had worked so hard to enter. All were committed to education as a lifetime enterprise.

It is hard to understand what the government has against them. As far as I know, they were never connected with scandalous architectural failures. No public outcry was ever heard asking that the practice of architecture be restricted to college graduates. The public and that small minority within it that constitutes our clients only ask for competent and sometimes inspired performance mixed with a little public vision and altruism of the kind they have gotten from Wright and Burnham.

There was no demand for this change from the profession. I believe that the AIA board was overwhelmingly opposed to the degree requirement the last time it discussed the issue. The schools did not ask for a monopoly on entrance to the profession. They knew that the next step is regulation and participation by the government in the development of curriculum. (When we get our official questionnaires about what we think we need to know in order to practice, we must respond that, next to Masterspec, the essays of Colin Rowe are our most important aids. This may not be entirely true for all of us, but at least it will tip the statistics in the direction of diversity.)

Everything considered, the only beneficiaries of the degree requirement are the government agencies that have finally pushed it through. It will end their search for a college equivalency examination that all college graduates can pass. It will delegate responsibility for certifying professional competence to the schools, who presumably need a full-blown conflict of interest to help them mature. It will remove a disturbing source of complexity and so make the profession easier to keep track of.

With everyone going to school in lock-step, graduating to a uniformly structured

internship and entering a period of practice punctuated with accredited continuing education classes, the registration business will be entering its golden age. All that is missing is a final multiple-choice examination to be filled out on our deathbeds, proving that we eventually learned everything we needed to know.

I am not convinced that the newly pruned profession has as happy a future as its regulators. It will be difficult to maintain the confidence of the public if the next generation of architectural innovators has to practice under an assumed name.

John F. Hartray Jr., FAIA
Chicago

Construction Management Controversy: In the mid-August issue (p. 46) the statement is made in a report on the Joint Conference on Construction Management that "AGC [the Associated General Contractors of America] maintains that architect should not practice construction management."

This statement is incorrect. AGC fully supports the statement adopted by the joint conference in 1975, a portion of which states: "From a practical standpoint, an effective CM organization is likely to be a multidiscipline organization. However, CM is an appropriate function for construction contractors, as well as architectural or engineering firm or divisions thereof, so long as said organization or division in fact has CM capabilities." (These capabilities were described earlier in the statement.)

What AGC *does* maintain is that it is a conflict of interest for an architect to design a project and to also serve as the construction manager on the same project, in effect evaluating and criticizing his own work.

Campbell L. Reed, Director
Building Division, AGC
Washington, D.C.

AIA holds the position, as the article stated, that a conflict of interest does not arise if an architect acts as both designer and construction manager. There is no conflict of interest so long as the architect does not become contractor, buying labor or materials, and does not accept profit from their purchase. The architect comes in conflict with those interests only when he represents two individuals with competing interests or when he acquires a competing personal interest, which is not the case when an architect acts for the primary benefit of a client in one capacity as agent.

As both an agent and a licensed professional, the architect is required to make judgments in the best interests of the client, AIA maintains, and the client is protected by law from the architect's acting unobjectively in the performance of design or construction management. Ed.

M2 MASTERSPEC 2

Specification System helps you turn THIS

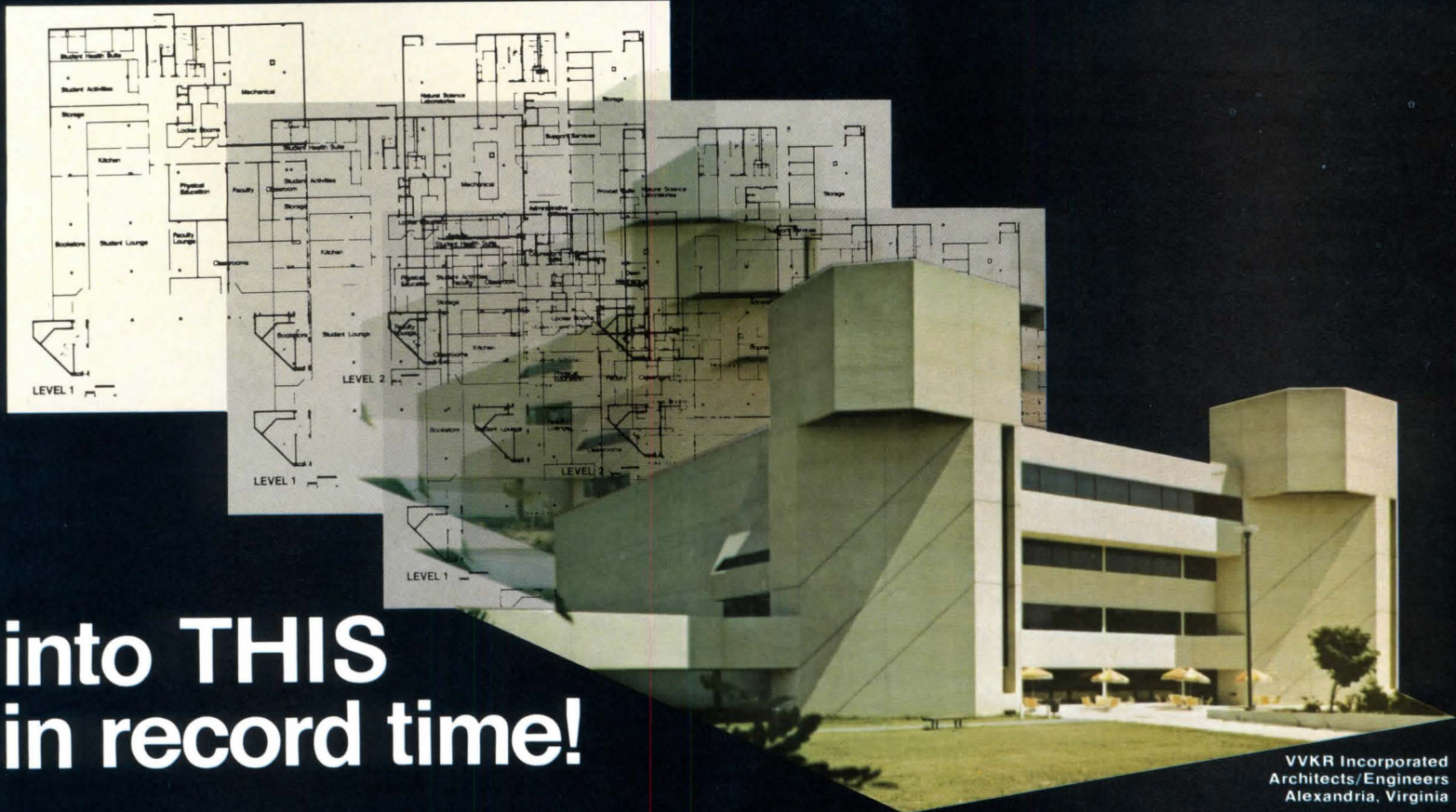

into THIS in record time!

You know that specs are usually written at the last minute. Sometimes the night before. When deadlines are tight. And pressure on you and your staff escalates.

MASTERSPEC 2 System can relieve that pressure and reduce costly errors—it is the most affordable, easiest-to-read, most complete specification system available anywhere.

Properly used, MASTERSPEC 2 saves you up to 50% in technical labor. MASTERSPEC 2 helps make product and technology choices because it is the **ONLY** specification system that names products and manufacturers, along with generic requirements.

The MASTERSPEC 2 system provides the items that should be included in your specs—separates the roles of drawings and specs, thereby saving you from overlaps, duplications and omissions. And MASTERSPEC 2 helps prevent liability losses by reducing the "sole authorship" aspect of your specs.

MASTERSPEC 2 is the technically superior system—researched, written

and updated every 90 days by recognized professionals.

This new system's BASIC version is all 8 out of 10 architectural offices will ever need. With the initial subscription priced at only \$395 a year and yearly renewals at \$245, it is easily affordable. If your practice requires it, there are add-on options available. You subscribe to what you need when you need it.

Let the MASTERSPEC 2 system assist you in translating your finest designs into competent, easy-to-understand construction documents—in record time. Your professional name and practice deserve the best—the MASTERSPEC 2 system. Call or write today.

**For complete information
CALL 800/424-5080 TOLL FREE
Ask for Leonard Bain, AIA. You will
receive a free brochure, samples of text
and other information.**

MASTERSPEC 2 is a product of P_SAE

P_SAE PRODUCTION
SYSTEMS FOR
ARCHITECTS &
ENGINEERS, INC.
A wholly owned corporation of AIA

1735 New York Avenue, N.W. Washington, D.C. 20006

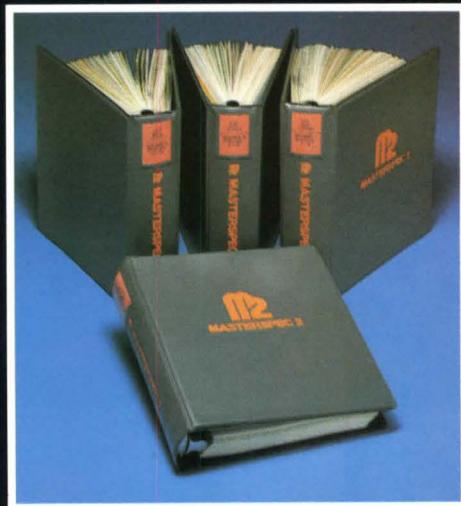

M2 MASTERSPEC 2

The comprehensive specification system endorsed by A/E professions

Circle 28 on information card



SEALS OUT WATER, LOCKS IN "R"

STYROFOAM* brand insulation seals out the moisture that steals R-value. Tests prove that STYROFOAM, when exposed to moisture and freeze-thaw cycling, retains over 90% of its original R-value.†

Moisture absorption is a cause of thermal resistance deterioration in below grade, sidewall and roof insulation. STYROFOAM, with thirty years of proven performance, repels water and retains R-value from frostline to skyline. That's because it's made by an exclusive *extrusion* process, resulting in a unique closed-cell structure. This makes STYROFOAM ideal for building insulation applications.

STYROFOAM brand insulation also meets

many of the tough new building codes for the most demanding applications, like below grade. There, locked into freeze-thaw cycles for the life of the building, STYROFOAM stands up to brutal punishment, repels moisture and seals in R-value.

Accept no substitutes. Specify STYROFOAM brand insulation, made only by The Dow Chemical Company. And make sure it's what is actually applied. Then you can be confident that you and your client have invested in the proven answer for energy savings, from frostline to skyline.

For more information, write:
The Dow Chemical Company, STYROFOAM Brand Insulation, Dept. K57, Midland, MI 48640.

The Proven Answer



*Trademark of The Dow Chemical Company

†Laboratory and Field Investigations to Moisture Absorption and its Effect on Thermal Performance of Various Insulations. Pub. ASTM-STP660, 1978.

WARNING: STYROFOAM brand insulation is combustible and should be properly installed. A gypsum board interior finish should be used in commercial construction. For roofing application STYROFOAM brand insulation should be provided with an adequate protection. For specific instructions see Dow literature available from your supplier or from Dow.

© 1980 The Dow Chemical Company
0-082

Circle 29 on information card



TRICKS OF THE TRADE, EXPLAINED.

To be a blinding success, just use your imagination. And the Blind Imagination of Bali one-inch blinds.

When you specify Bali, you'll be giving your building a more uniform appearance. With none of the visual distractions so common with drapes.

That's only our outside story.

Our inside story is this: Bali Blinds do a better job controlling light than other types of window coverings. That saves energy. Even when they're wide open, Bali Blinds still work at 25% efficiency.

Bali saves time, too. Because when it's time to move walls as office arrangements change, inside and recessed or pocket-mount blinds don't have to be moved.

But there's one thing Bali won't leave to your imagination. That's our specifications.

Bali Blinds have been specified in a simple

CSI format to permit ready reference for procurement packages.

And we'll make these specs available to you, for you to write your requirements around them.

So, if you want to be a blinding success in business, build around Bali. And use the coupon below for a copy of our brochure, *The Tricks of the Trade*.

BALI BLINDS

©1978, Marathon Carey-McFall Company, Loyalsock Avenue, Montoursville, Pennsylvania 17754. Division of Marathon Manufacturing Company.

Show me *The Tricks of the Trade*, free.

Name _____

Company _____

Address _____

City _____ State _____ Zip _____

Telephone _____

 **BALI BLINDS**
BALI IS BLIND IMAGINATION.

Circle 30 on information card

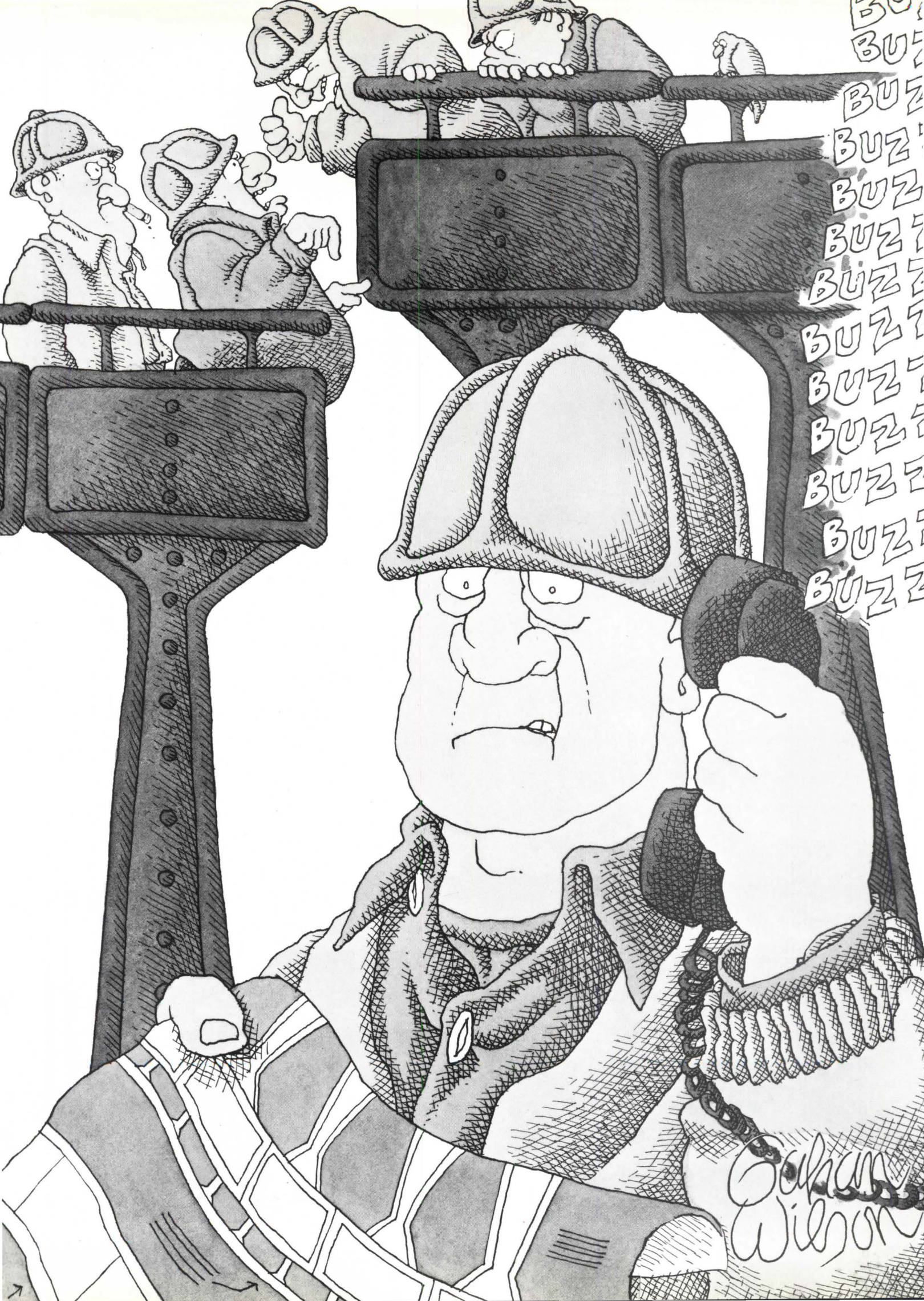

BUZZ
BUZZ
BUZZ
BUZZ
BUZZ
BUZZ
BUZZ
BUZZ
BUZZ
BUZZ
BUZZ
BUZZ

Graham
Wilson

Is solving problems a problem because you can't be reached?



The Bell System has a way important calls can reach you when your regular lines are busy.

When somebody calls from your job site with a problem, that's no time for all your lines to be busy. You've got to be available.

If you're not, you end up losing valuable time. And that makes it harder for you to make a profit.

What you need is an effective communications system. That's where your local Bell company can help your business.

Both the Com Key* and Horizon® communications systems by Western Electric feature a personal line that goes directly to your office. It's an open line that can make your business more profitable by keeping you accessible. With it you'll always be assured that important calls get through. This can save you time by enabling you to handle problems efficiently. And whoever you give your private number to will *always* have a way to reach

you—quickly and easily.

Should *you* find the need to make an important call, you'll always find the personal line open.

Saving time and money

Western Electric Com Key and Horizon systems can help your business in many ways. Suppose you're in the office but away from your desk when an important call comes in. With the paging feature on a Com Key or Horizon communications system, your secretary can call you in almost any part of your office over the paging loudspeakers. No shouting down the hall or wasting time tracking you down.

To stay on top in your business you have to complete your projects on time. And that means using your phone to coordinate job information. That's where conference calling[†] comes in handy. It lets you speak to several people at one time, at the touch of a few buttons. You can consult with your client, an associate, and a contractor at the same time. That saves you time and needless callbacks

because you confirm information quickly and accurately.

Giving your client the best service

When your client is considering an important proposal, it's essential that he be able to reach you to discuss any details. If you're out of the office when he calls and your secretary has the number where you are, she can call and connect you instantly with the client.

If you're preparing a proposal, you can't waste time running back and forth to your library looking up zoning information. With the Com Key or Horizon system's intercom, you can call your associate or consulting engineer simply by pressing a single button. That way, you can keep right on working—without interruption.

Tailored to your needs

There are even more ways Western Electric communications systems can make your business more efficient and profitable.

Your local Bell company can tailor a communications system to your needs—no matter what size your business. And they back every system with prompt, dependable, experienced service.

So call your local Bell company today.

You'll end up with more than a better business communications system.

You'll end up with a better business.



*Trademark of AT&T.

[†]Note: Voice quality may decrease depending upon the distance between conferees and the number of persons on the conference call.

Western Electric

Ceco can put together a door package for your entire project.



*the high
performance
door
people*

Ceco has what it takes to outfit your entire project: thousands of high performance steel door and frame combinations. Plus a complete selection of builders' hardware.

Rugged, attractive Ceco doors are designed to install fast — and last. It's been that way for 30 years.

What's more, there is a Ceco door package to fit every functional and esthetic need. Our Colorstyle finishes are available in a wide spectrum of colors. And Ceco doors meet all nationally recognized performance standards for hospitals, schools, hotels, industrial plants and institutional buildings of all kinds.

Where do you get them? Anywhere in the U.S. With 18 Ceco warehouses coast-to-coast and over 200 stocking distributors, you can get what you want, when you need it, wherever you are.

Whether you need high performance fire doors, added building security or the complete steel door, frame and hardware package, your Ceco high performance door specialist is a good man to know. See us in Sweet's, call us or one of our distributors — we're in the Yellow Pages under "Doors," or contact The Ceco Corporation, 1400 Kensington Road, Oak Brook, IL 60521.



"The door people"™

Circle 32 on information card

Structure

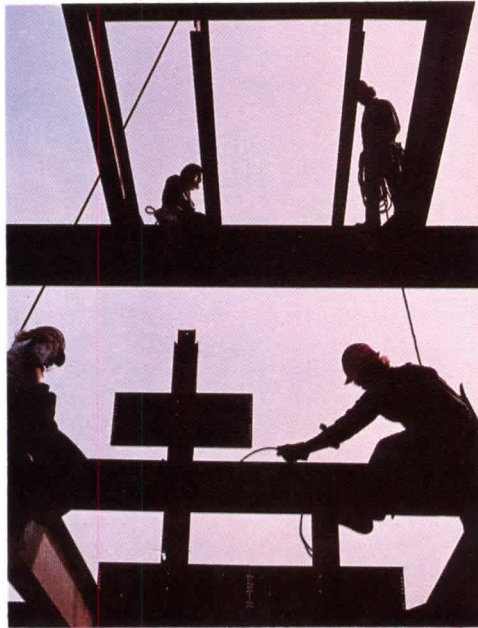

At 2:35 P.M. on May 4, 1973, Sears Tower in Chicago rose higher than the dual towers of the World Trade Center in New York. Sears was topped out on May 4 of that year at 1,454 feet. The World Trade Center had been topped out in December 1970 at 1,350 feet.

Thus, the title of the world's tallest building had changed hands twice in three years after remaining with the Empire State Building for more than three decades.

In those days the quest in structural design was for superlatives: biggest, strongest, longest—and, sometimes, most expressive. It sounds quite archaic in this era of resource scarcity and the conservation ethic.

How is structural design responding to this ethic? Is structural expression being discarded along with other tenets of modernism? How does structure fare as form giver in the hands of the architects of allusion and symbol?

This issue does not attempt to answer such questions with finality. What it does attempt to do is to stimulate thought about these and other questions—thought about structure in architecture. Like last year's issue on daylight it also attempts to bridge between issues of technology and issues of form. *D.C.*

Structure and Perception

By Ralph Knowles and Marguerite Villecco

Under primitive circumstances, it was necessary for humans to understand more than a consistent arrangement of parts comprising the environment. They looked for structural relationships in which there were clear differences among parts, suggesting directionality in the world. Our perceptions of structure become critical in this context and inextricably linked to our larger sense of orientation. The perceptual, as well as the physical, elements of structure define our image of the environment and therefore lie within the realm of design as an expression of intent.

This intent may vary. Even when building form is differentiated, it frequently has little to do with the way its elements are piled up. If we want a building that is large on top and small on the bottom, technology will provide the means, but possibly deny a correlation between those means and the resultant forms.

It is now possible to make forms that represent any degree of stability we like. Such correlation between form and stability is learned empirically.

It is the concern with legibility, orientation and balance that suggests the consideration of structure from a perceptual as well as a physical viewpoint. One is led to compare the concepts of objective, or physical, balance with perceptual, or apparent, balance. The two may be quite different.

What structures appear to do can sometimes be different from what they actually do. The potential difference between truth and appearance, fact and phenomenon, can be intentional or not depending on artistic values and can be used as a basis for weighing architectural differences among buildings. These relationships can be explored at four levels.

1. Structure. This first level is conceptual. As a phenomenon, structure is the property of directional relation, or the resolution of directional forces to ground (although structural elements may also resolve thermal, acoustical and other forces, as well as wind, seismic and gravity forces). To structure means to recognize by organization the incremental change of some condition or state, to relate one state or condition to another one. The major issue here is physical stability. The relevant question is, are forces balanced or not?

2. Construction. The second level for considering structures is physical. It is based on particular demonstrations of a structural concept. Construction is the developmental recognition of community need and ability if the building is to be built at all. The major issues here are economic and technological. The

Mr. Knowles is a professor of architecture at the University of Southern California. He is a recipient of the AIA medal for research, author of *Energy and Form* and author of *Sun, Rhythm and Form*, to be published by MIT Press in summer of 1981.

Ms. Villecco is a consultant to the design arts program of the National Endowment for the Arts. She was consulting editor for the September 1979 *AIA Journal* on daylight design and for this issue on structure. Formerly, she was a senior research associate of the AIA Research Corporation, a senior editor of *Architecture Plus* and *Architectural Forum*.

relevant question is, are physical resources used without avoidable waste?

3. Image. The third level for examining structures is perceptual. Image in buildings is the artistic expression of concept and real development pressures. The major issues here are esthetic and functional. The relevant question is, does artistic expression support, interfere with or act neutrally with regard to structural function?

4. Meaning. This last level contemplates the metaphysical properties of structure. Meaning here reflects our perception of the designer's intent, rather than an historical accumulation of knowledge. The major issues here are philosophical and ethical. The relevant question is, how does the design proclamation of meaning relate to societal values, by congruence or by contrast?

The esthetic breakpoint for design decisions is, of course, that between construction and image. An architect cannot make a decision for constructional instability, cannot make a decision to design a building that will fail structurally. But an architect can decide for the image of instability or the expression of reality by choosing an image of verity (unity with the structural concept); illusion (discontinuity with reality), or parody (purposeful deception). These choices are part of a set of decisions and values that lead to esthetic development.

There are three levels at which we can consider the objective with the perceived resolution of structural forces. In the first category, continuity, structures do what they appear to do. Most primitive buildings tend to fall in this category because obviously stable forms evolve directly by the hand-processing of material.

In the second category, discontinuity, structures cannot do what they appear to do. Many buildings that separate the structural frame from the building envelope or skin fall into this category because the resolution of forces is no longer apparent, especially when the skin is placed outside the frame. A paneled glass form cannot transfer structural loads to ground in spite of its apparent stability.

In the third category, dissolution, are structures that appear as if they cannot do what in fact they do. Unlike the first two categories in which the perceptual resolution of structural forces is not necessarily self-conscious, buildings in this category must usually exhibit a seeming lack of stability. They seek attention and create suspense by apparently violating our intuitions about stability.

The first table considers exclusively vertical forces and selects building images that most clearly express differences in their perceptual resolution. Buildings are not constructed to exclusively resolve one directional force, but, for purposes of analysis, our discussion will isolate those design strategies.

In the first column, vertical forces are carried to ground through bearing walls in a Southwestern adobe building. The

	Continuity	Discontinuity	Dissolution
Structure			
Construction			
Image			
Meaning	Verity	Illusion	Parody

I. Structural resolution of vertical forces

translation from structural diagram to bearing wall construction to the solid and stable walls of the finished building is continuous and hardly needs interpretation even for the unindoctrinated. There is a unity of conception at all levels. The term verity is used to express meaning in the obvious facts of the expression, not necessarily a superiority or higher moral value.

In the second column, vertical forces are carried to ground through a framework of columns and beams in a modern commercial building. The translation from structural diagram to constructional frame is continuous, but the next step that adds a curtain wall is perceptually discontinuous. There is no way to visually transfer vertical forces to ground. The structural relationship between the glass box and the columns that transfer its apparent bulk to ground is an illusion.

In the third column, vertical forces are carried to ground through a framework of columns, beams and diagonal bracing that transfers laterally to ground from a cantilever. As in the other two cases, the translation from structural diagram to constructional frame is continuous. But the designer of this building has apparently chosen to dissolve or to disintegrate the building's formal whole, communicating by structural dissolution. The structural and constructional continuity has been purposely broken. The building's final image is a parody of structure. The image is based on nonsensical stability, or apparent instability—a choice made for other than structural reasons.

The second table considers exclusively horizontal forces and purposely selects building images that best express differences in their perceptual resolution. In the first column, horizontal forces are transferred to ground through large-scale diagonal braces. Since these braces are made part of the building's skin, the translation from construction to image is continuous and perceptually unambiguous. The designer's intentions with regard to structure are clear and verifiable. The building's image is its structure and its meaning, verity.

In the second column, another highrise building that transfers horizontal loads either through a stiff frame or through some sort of internal bracing has been clad with a skin that is all glass. There is no way to visually transfer the horizontal forces of wind and earthquake from the apparently rigid glass box into the ground. The stability of the glass box is an illusion.

In the third column, a skewed park arcade transfers horizontal loads directly into the ground on one side, while being open through tilted arches on the other. The constructional section clearly demonstrates a stable relationship that cannot be easily understood when one views the finished colonnade. The designer has purposely broken the continuity between construction and image. The construction must obviously be stable because the arrangement stands. The load is transferred horizontally to ground, but the image is that the splayed columns and vault must

fall sideways. The image is a parody, unstable and evoking sensations that the designer valued in the context of an amusement park setting.

The third table considers the combinations of vertical and horizontal forces and also selects building images that seem to best express differences in their perceptual resolution. In the first column, all vertical and horizontal forces are transferred to ground through stanchions, cables and the fabric of a large circus tent. The resolution of forces is graphic, the image a verity.

In the second column, all forces are transferred through cables to a stiff, vertical core and thence to ground. The finished building, however, offers the illusion that the glass box is sitting on a narrow core or that the cables support a rigid glass cage above the ground.

In the third column, a constructional frame transfers building loads directly to ground. But the building's final image includes a "bearing wall" of brick that supports neither itself nor the building. The building is structurally stable, but the image of the building is a parody of a bearing wall.

This perceptual versus physical concern with structure is part of a continuing dialogue among contemporary architects. Witness these remarks by Cesar Pelli, FAIA, and Michael Graves, FAIA, on the occasion of Philip Johnson's gold medal award.

Pelli: "The moment we separate container from support, we leave behind all the expressions of gravity and most of the things that we use as code now, like door or entrance or top that are really nothing but attitudes as to how to express gravity. And now we don't have to."

Graves: "Buildings do have bottoms and tops. If one's palette is so thin as to only discuss the geometry of architecture, as we leave out the things that are germane to the culture of architecture, and we leave out the window, and we leave out the gravity, and we leave out the front door, you can't get in!"

We do get into architecture by our perceptions. We cannot know the intent of the designer when we use a building. We can only speculate on the verity of its message and respond to its image.

The image of continuity presented by the historic building's bearing wall naturally invokes a sense of stability and security. The illusion of a glass skyscraper's translucent support may be intellectually fascinating, but remote from our sense of permanence and stability. The parody of stability represented by structures that fool us by standing when they apparently cannot stand, create suspense and excitement, although our attention may be as short as it is sharp.

Our perception of structure is its own reality. The conscious tuning of structural image to our perceptions, for whatever effect, constitutes a part of the humanity, richness and potential of design. □

	Continuity	Discontinuity	Dissolution
Structure			
Construction			
Image			
Meaning	Verity	Illusion	Parody

II. Structural resolution of horizontal forces

	Continuity	Discontinuity	Dissolution
Structure			
Construction			
Image			
Meaning	Verity	Illusion	Parody

III. Structural resolution of vertical/horizontal forces

Buildings are supported in a myriad of ways, more now than ever before. Some ways necessarily have a profound effect on building character; some, like well-trained servants, can be effective without even being noticed. Those subtle ones we leave for other times; this month we concentrate on structures contributive to form. We include not only buildings, but also bridges, dams and visionary projects we *can't* even put a name to.

Basically, structures fall—no, let's rephrase that—structures can be divided into two types. First, massive ones, depending on weight for strength, the heavier the better. The adobe construction that closes this issue is an example. In general, the Grand Coulee dam and power plant (1) by the bureau of reclamation, Department of the Interior (Marcel Breuer, FAIA, and Hamilton Smith, FAIA, consulting architects; Thomas Hayes, associate) is another. But only in general, for the 1,100-foot-long concrete wall of the Breuer-Smith design is folded to maximize stiffness, minimize material.

A second broad category of structure, muscular but lean, the lighter the better, is exemplified by most of the other structures we show. In Hellmuth, Obata & Kassabaum's stadium (2) built for the 1980 winter Olympics in Lake Placid, N.Y., exposed trusses of bolted I-beams provide a column-free interior. Engineer was Jack D. Gillum & Associates.

Within the same broad category of minimalism, but using quite different means, are the light forms of a tent structure by Frei Otto (3), seen here in the garden of New York City's Museum of Modern Art. Wolf Von Eckardt of the *Washington Post* was reminded of "garden parties with good champagne," and said of the tent that "we may see a whole city under shelters like that." Such visions at urban scale have taken many forms, including the space frame schemes of French planner Yona Friedman, coming close to realization in the 853-foot-square space frame (4) covering an exhibition hall in Sao Paulo, Brazil.

Prestressed concrete forms can also take graceful, minimal shapes, as in the Old Miramar Road overcrossing, San Diego (5). California's highways division is architect, engineer and owner.

Other built reminders of urban design schemes include the domes of triangular aluminum panels spanning 122-foot diameter clarifiers at a wastewater treatment plant in Franklin, N.H. (6). Design is by Conservatek, Inc., Conroe, Tex.

Still with us, of course, and still useful, are humbler structural traditions. For a new resort hotel at Trengganu, Malaysia, for example (7), Honolulu architects Wimberly, Whisenand, Allison, Tong & Goo have employed typical Malaysian wood roof framing.

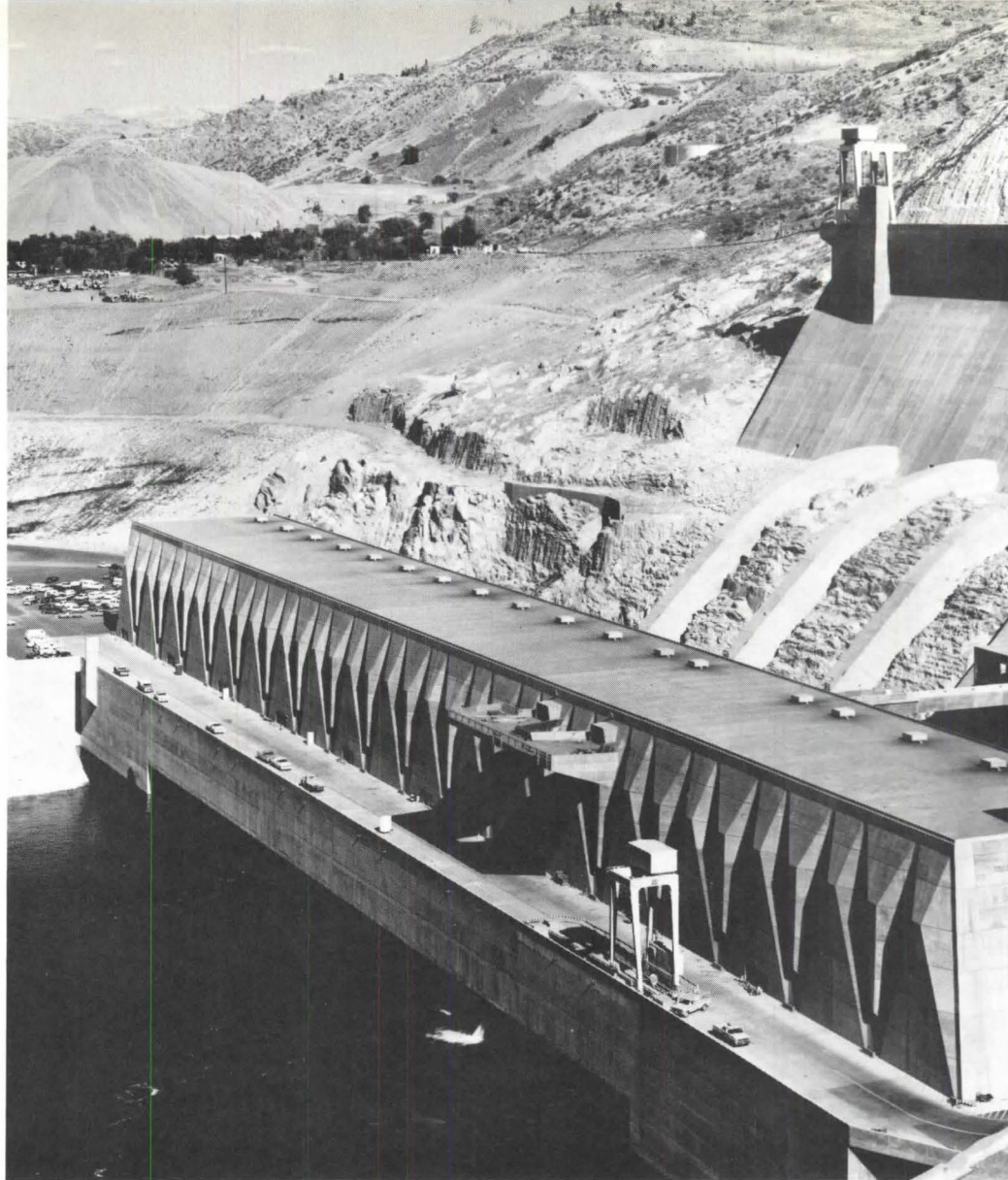

1

Structure and Form

By Stanley Abercrombie, AIA

6



Henry N



Shin Koyama



George Cserna



Courtesy, Museum of Modern

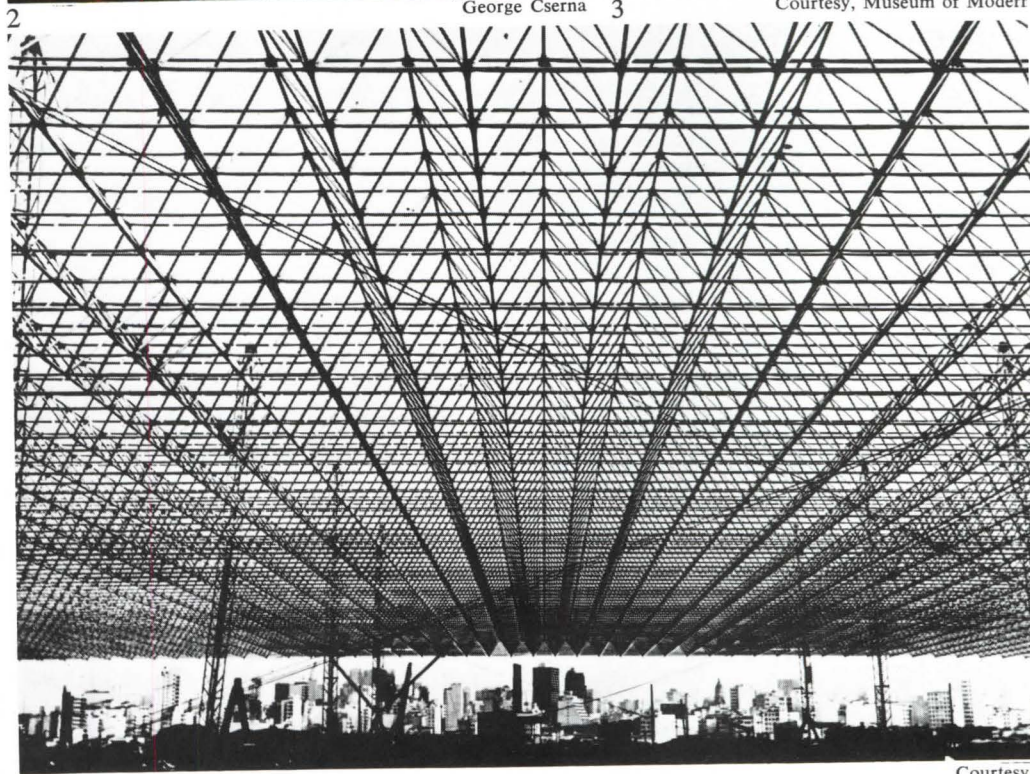

Courtesy



Vierendeel trusses are structural forms particularly popular with architects, for their lack of diagonal members makes them adaptable to many uses. Recent applications include pedestrian bridges in Syracuse (1) designed by Schleicher-Soper; John P. Stopen was structural engineer.

Composite wood and steel construction is also commonplace, but is not often applied to long span structures. The Kibbie stadium (2) at the University of Idaho, shown here as construction began, was built of open web arches with top and bottom chords of laminated wood. Architect was Cline Smull Hamill Quintieri Associates of Boise.

Increasingly, such athletic facilities are being roofed with fabric. One at the University of Florida (3) combines a central air-supported section surrounded by a tensile-structure skirt. Moore, May & Harrington was the architect, Geiger-Berger the engineer.

More commonplace structures include concrete retaining walls, given a new twist by the International Engineering Co. of Denver in a wall along the Vail Pass highway (4): Each unit is precast in a parabolic segment for added strength.

But of all structural types, perhaps the most visually spectacular is the suspension bridge. A recent example is Arvid Grant & Associates' half-mile-long Pasco-Kennewick bridge (5) over the Columbia River in Washington State. Not surprisingly, such structures have been adapted for buildings as well. An early example was Pier Luigi Nervi's 1962 paper mill in Mantua, its suspended roof spanning 535 feet; another was Finnish architect Aarno Ruusuvuori's 1966 printing plant in the new town of Tapiola. Perhaps the most recent is Skidmore Owings & Merrill's dining hall (6) for Baxter Laboratories near Chicago. Although the hall has a floor area of 45,000 square feet, it is kept column-free except for the two masts from which the roof is hung. Additional cables inside the hall protect the roof from upward flutter. SOM's own Fazlur Khan was the engineer, Bruce Graham, FAIA, the partner in charge of design.

Some structures are visually striking even though they are never meant to be seen. For example, the 100-foot diameter manifold (7) of the Aluminum Co. of Canada's Chute-des-Passes powerhouse, seen here just before being flooded with water on its way to the turbines.

Even apparent whimsy can have structural logic. The zigzag pattern of the above ground section of the trans-Alaska pipeline (8) is calculated to allow for expansion and contraction during temperature changes; pairs of rubber "bumpers" keep the pipeline in place while still allowing some freedom of movement.



1 William Rothschild

Dave Alfis

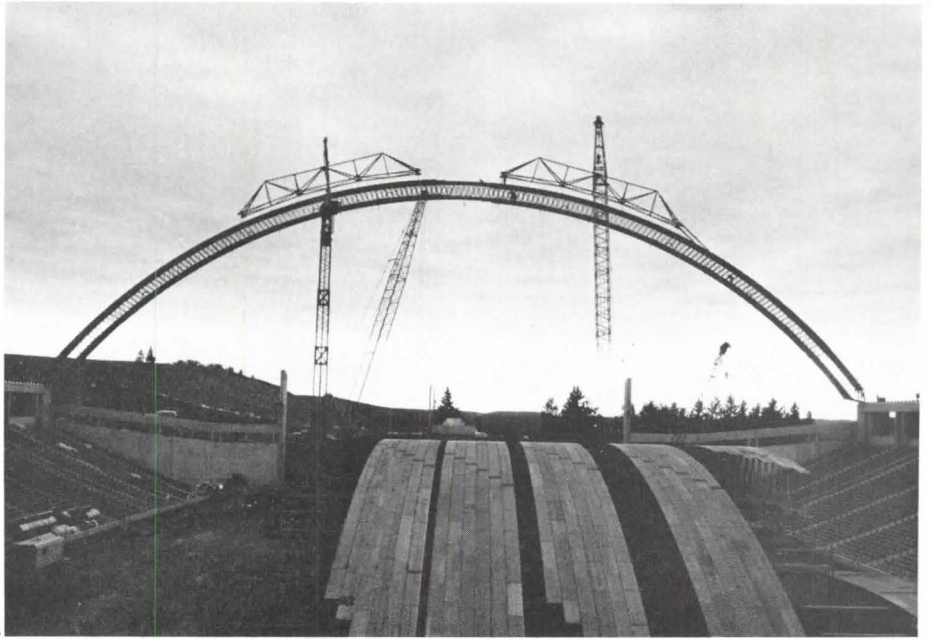

Courtesy, Owens-Corning Fiberglas



Courtesy, Alcan



5 Courtesy, American Society of Civil Engineers

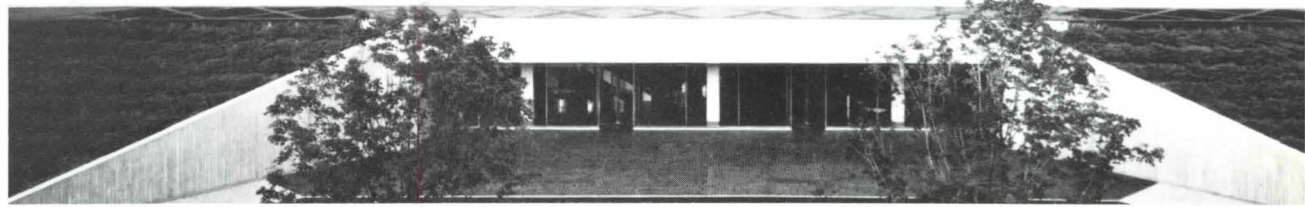
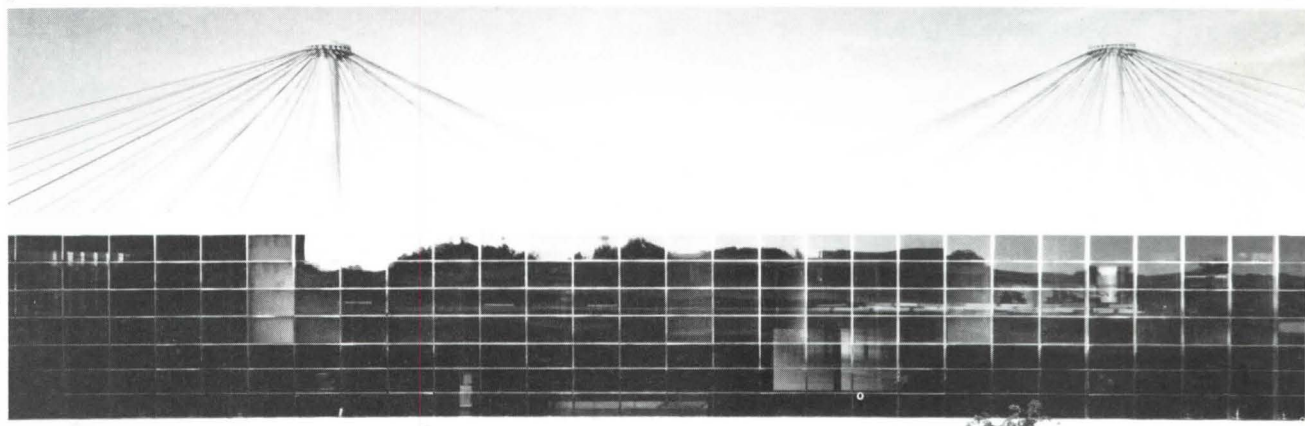

6 7 8 Howard N. Kaplan © HNK Architectural Photography

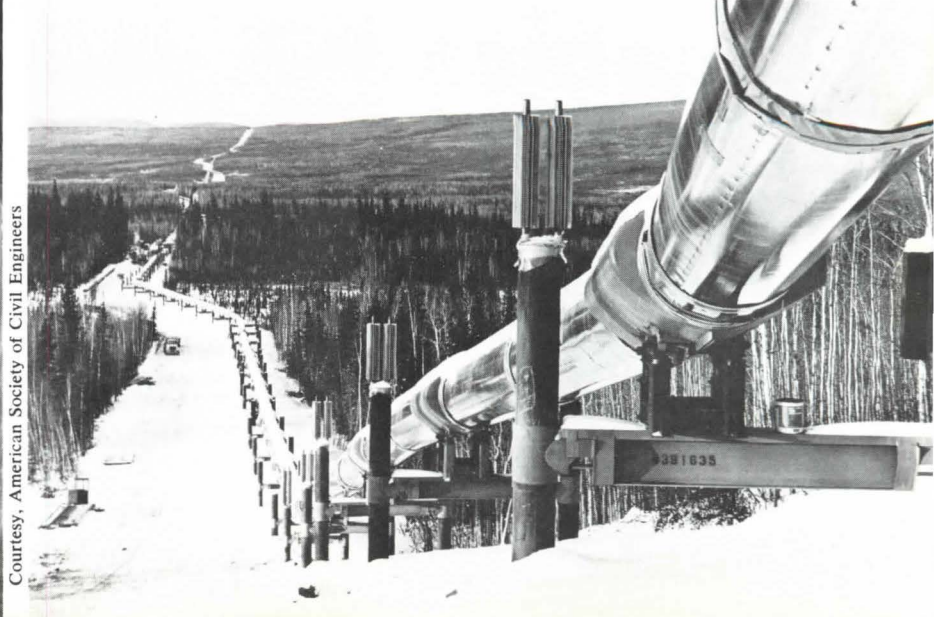

4 Courtesy, American Society of Civil Engineers

Courtesy, American Society of Civil Engineers

Begun as a summer project for Pratt Institute students in 1977, designed by architect Vittorio Giorgini, this 105-foot-long structure (aerial view, 1, and detail, 2) is nearing completion in upstate New York. It is being built of ferrocement, a thin-shell technique pioneered by Pier Luigi Nervi and used by Giorgini as early as 1959 in a Florence, Italy, art gallery. When funds are found to continue the work, a mortar of cement, sand and water will be pressed into the wire mesh, which acts as finely distributed reinforcing; the temporary wooden supports can then be removed. The project is also an experiment in what Giorgini calls "compound shell beams"—that is, the structure is strengthened not by adding thickness but by adding curvature; thus its shape.



1 Angelo Gainpiccolo

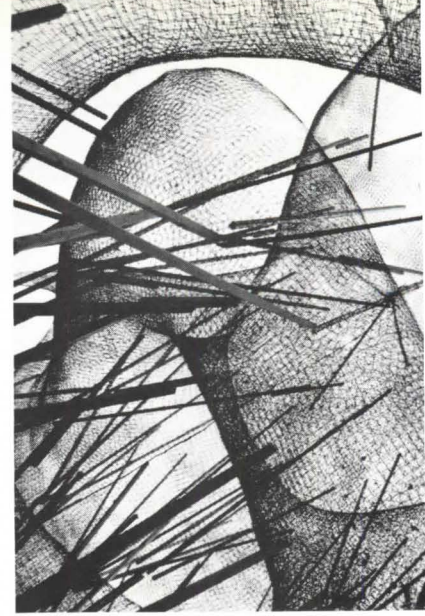

Angelo Gainpiccolo

Also underway, on a tremendous scale, is Skidmore Owings & Merrill's Haj terminal in Jeddah (3). When finished in 1982, 5.5 million square feet of fabric in 210 tent-like units will shield 105 acres from the Saudi sun. Geiger Berger Associates was a consultant in early stages of the design. Simpler tent forms also continue to be useful and graceful, such as (4) the "Parawing" model of lightweight, waterproof nylon by the Moss Tent Works of Camden, Me. It is made in 12-foot and 19-foot versions.

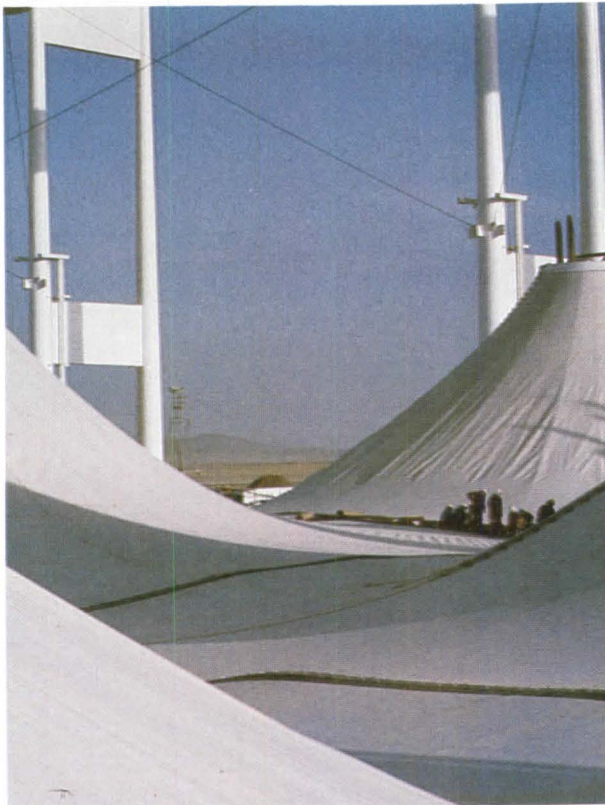

Courtesy, Owens-Corning Fiberglas

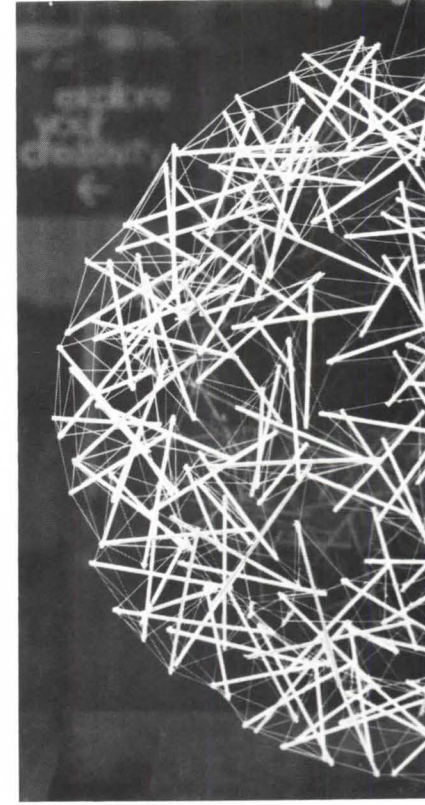

3

Since 1964, when he described such a possibility to a regional AIA convention in Biloxi, Miss., Buckminster Fuller, FAIA, has been investigating the use of large geodesic spheres. The "Stars Sphere" (5), he thinks, will be buoyant enough, when equipped with a sealed inner envelope of solar-heated air, to float in the atmosphere. A study model was completed in 1979, and the Franklin Research Institute is considering the use of such a sphere a mile in diameter as a high-altitude astrophysical laboratory.

Seen here before being encased in mirror glass (6) is the structure of Johnson/Burgee's "crystal cathedral" for the Garden Grove Community Church near Los Angeles. Its continuous space frame of pipe members in triangular sections is 420 feet long. Structural engineer was Severud-Perrone-Sturm-Bandel.

The progressive reduction of structural mass—from mounds of stone, adobe and concrete to space frames, air-supported shells and floating spheres—may have its ultimate conclusion in a project by Peter Goering and B. Elkin of Toronto. They are studying the possibilities of weather-tight enclosure based not on the use of any solid, static materials, but on the dynamic circulation of air "curtains" (7). One of the intriguing aspects of such a structure would be its invisibility. Another would be its instantaneous appearance and disappearance: If circulating fans were switched off, the structure would suddenly cease to exist. □

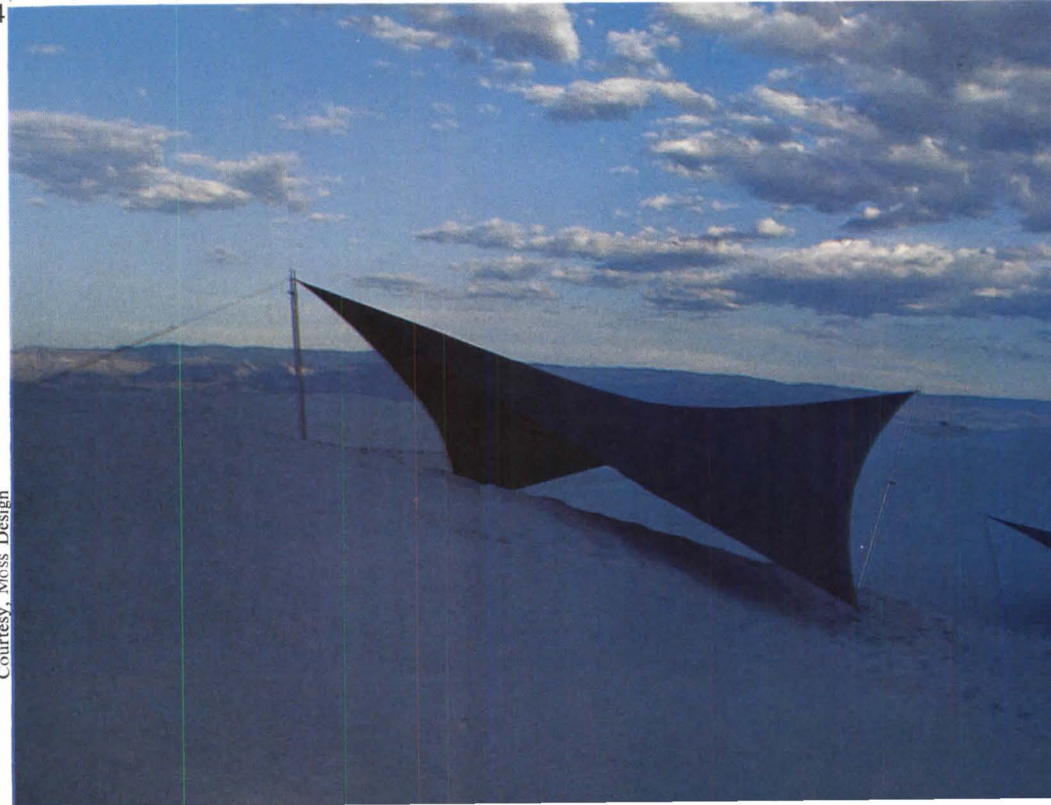

Courtesy, Moss Design

4



2

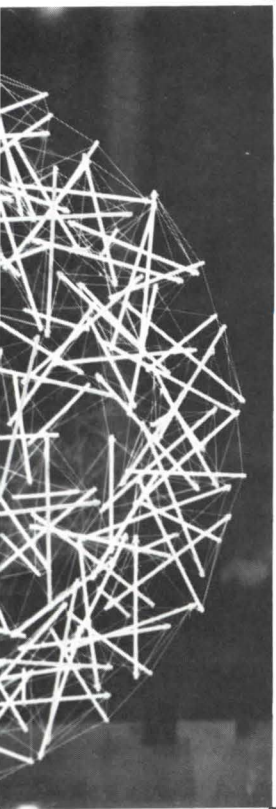

5

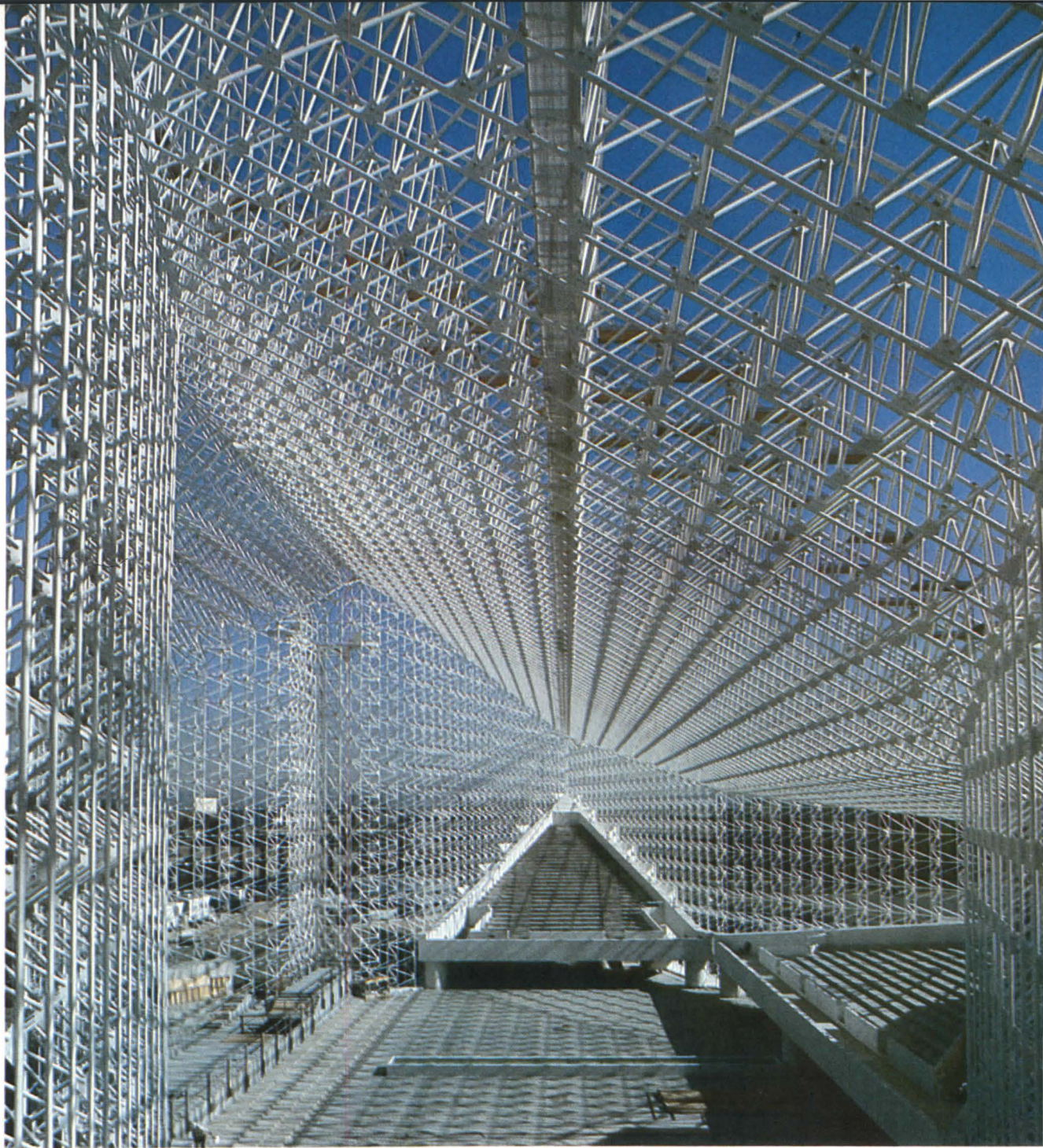

James Caccavo

7

6

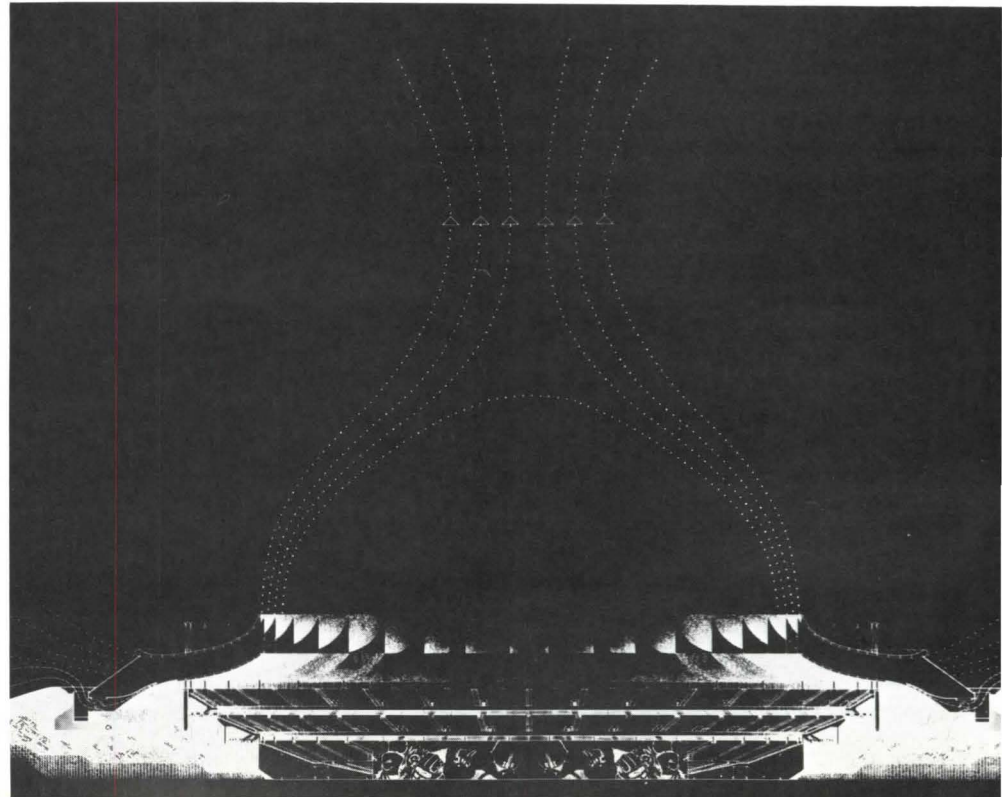

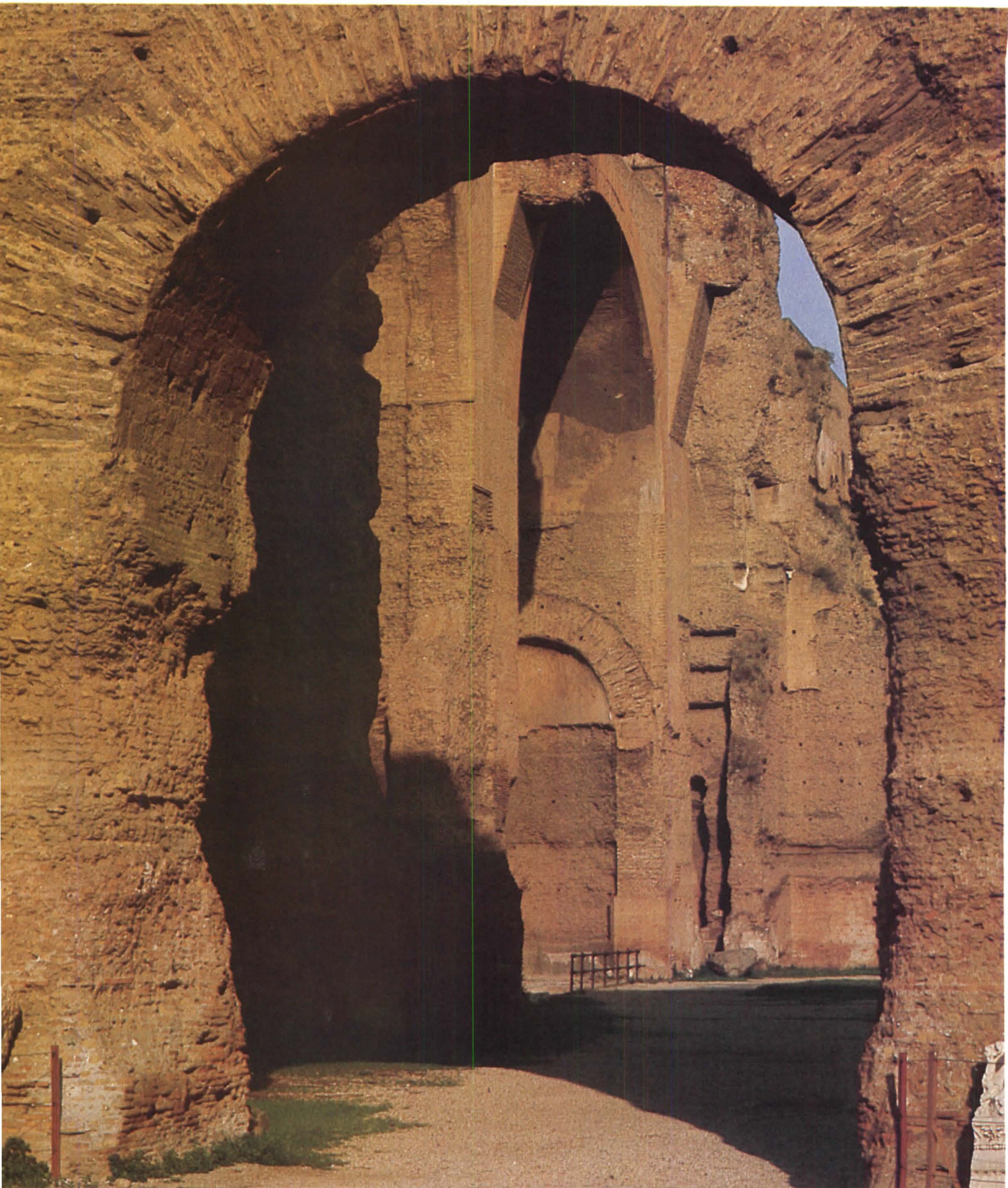

Robert L. Vann

Structure and Intuition

By Peter McCleary

"I believe you could exterminate the French at a blow and re-settle the country with Tartars, and within two generations discover, to your astonishment, that the national characteristics were back at norm. . . . Yes, human beings are expressions of their landscape, but in order to touch the secret springs of a national essence, you need a few moments of quiet with yourself . . . if you sit quite still in the landscape-diviner's pose—why, the whole rhythm of ancient Egypt rises up from the damp cold sand. You can hear its very pulse tick. Nothing is strange to you at such moments. Underneath the purely superficial aspects of apparent change the old tide-lines remain." So wrote Lawrence Durrell in his 1960 essay on "Landscape and Character."

A few of the "tide-lines" of structures in architecture can be found on an examination of a geological map of France. Coutances cathedral (1218-91), which was built at the same time as Rheims (1211-90) and Amiens (1220-88), is situated in a region of very hard precambrian sedimentary rocks, and metamorphic granitoidites, both surrounded by granite. The severity (or simplicity, if you will) of the expression of structure, sculpture and ornament in Coutances is a direct response to the local material. The contrast with the "articulation" to be found in Rheims and Amiens is in no small part due to their being located near rivers with their recent deposits and surrounded by superior cretaceous sedimentary rocks. If it is true that, in the Middle Ages, the cost of stone equalled the cost of transporting it 12 miles from the quarry to the site, then the expediency of using the local stone is obvious.

Then, as now, the prestige building was allowed not to answer to the logic of location. Much of the stonework for the Norman cathedral at Canterbury was prepared at the quarries of Caen, Normandy. A history of the use of building stones in Washington, D.C., indicates that as the nation's capital has grown more prestigious, it has cast its net farther to quarry its stone—traveling as far as Italy to obtain Carrara and Travertine marble. To complete or end this "internationalism" one might build a dome, albeit a small one, in Washington, with rocks transported from the moon.

In attempting to discover those "tide lines" that show "what we are," it has been suggested that severity of architectural expression indicates a sober culture and that, similarly, there is a correlation between flamboyant cultures and their architecture. No one doubts that it is difficult to eke out a life in locations where igneous rocks are near the surface, but such correlations between culture and architecture are often interpretations of a small part of the architectural context, and are misleading.

Mr. McCleary, trained as an engineer, is chairman of the department of architecture at the University of Pennsylvania.

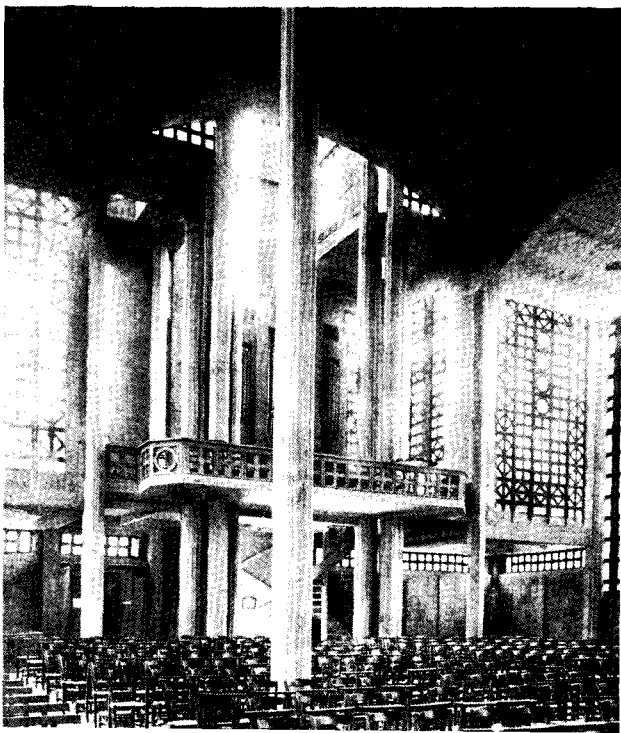

In most observations about architecture, there is a "yes" and a "no." "Yes," there is a strong relationship between architectural character and location and materials. "No," the implications of that relationship should not be carried too far. That relationship which endures is man's knowledge of the nature of the local materials and his understanding of the working of those materials. The loudest "yes" has to be in agreement with the belief that man's "fundamental activity is one of productive interchange with nature."

Our studies of the U.S. show that, at the grossest scale, the mid-Atlantic is a region of mainly brick and steel (steel, since one moves iron ore to the coal and not vice versa); the West Coast of concrete (Japanese steel notwithstanding) the Northwest of wood, etc. For each of these materials, the size and form of the manufactured and/or fabricated element shows less variety each year. Clay, for example, is rarely to be found as rammed clay (pisé) or sun-dried brick. Will the cost of firing kiln-dried brick force a return, in part, to the earlier forms? Where is the Roman brick that led to the wall of opus incertum, reticulatum or testaceum? Replaced by concrete? Where is the broad, flat, catalan tile used by the Gustavino family which led to the shell and vault-like surfaces of the boveda tabicada, solera, tabique de pandarete, etc.? Have so-called economies of scale reduced the possibilities that are inherent in the material?

Clay and its brick derivatives can lead to an architecture of wall, and with courage and intuition to an architecture of vault and even shell. Today, brick is seen more and more as a skin, and, even then, without ornament. There is no one who would dare to emulate the brick elliptical barrel vault of 120-foot height and 83-foot span of Ctesiphon (A.D. 531-579) or the Baths of Caracalla (A.D. 211-217). The formula, which includes capital, labor and energy, perhaps prohibits such structural effort with brick in today's world.

Were the economic resources available, it is unlikely that an architect and a builder could be found now with the knowledge and skill to complete such a vision. Today, we have one brick, with minor variations, that can be used in perhaps two ways. The limitation is not in the material but in the calculations and in the desire of the culture.

It was said that the Gothic cathedral was not limited, but inspired, by stone. Today, the opposite is apparently true. Brick need not lead to a wall or a skin, it insists only on compression. Only drying and compression must be answered to; the expression drawn from it is as multivariate as the cultures using it.

What is revealed in a study of location and architecture is that most architects have been sufficiently expedient to use the local building materials; but what was not obvious at first glance was that any material has not only limitations, but also the possibility of being fabricated into a great variety of shapes and sizes. Further, these fabricated elements imply or suggest a shape or form for the whole ranging from the arcuated (and later surface) structure, to trabeated (and later skeletal) structure. The limitation in the use and nature of the local material reveals an essence of the place. That essence of the place is not hidden but is revealed to every architect. What are hidden are the possibilities of the material and its forms. The untapping, revealing or "bringing into unconcealedness" of those possibilities inherent within the place is the major task for the architect; at least for those architects who answer to an architecture of immanences. It has been suggested by Martin Heidegger that truth is concerned with the ratio of "gathered presences" (or what is revealed) to what is concealed by a context.

Of course, the material has no will to act alone. Its limitations and possibilities are revealed through use. Unfortunately, architects lack the wherewithal for experimentation and make more use of interpretation. How many interpretations are there as to

Left, Auguste Perret's 1924 church of Notre Dame du Raincy. Facing page, the third century Baths of Caracalla.

A widening gap between designing and building.

the nature of exposed reinforced concrete? Auguste Perret has seen it as cut, or cast, stone in the elevations to his apartment building in the rue Raynourd in Paris. The stair between first and second floors of the Public Works Ministry takes that form of reinforced concrete seen much later by Pier Luigi Nervi and Ove Arup, and as stone again, in the mysterious fluted columns of the same building. In ancient Mesopotamia, the wall surfaces were decorated and made more durable with the insertion, into the soft mud plaster, of long pointed cones of terra cotta—the treatment of Perret's apartment building in the rue Franklin is in that lineage. In many other buildings, he investigates several other possibilities for reinforced concrete. Perhaps at the Church of Notre Dame du Raincy, he has revealed not only the limitations but also the truth of the possibilities. Reinforced concrete as column, as wall, as screen, as beam, as slab, as vault, as shell, and all ranging from an expression of ashlar masonry to mud. It is as expression, and not as size, that the possibilities are revealed, and this church is unsurpassed in the synthesis of material and structure.

Were reinforced concrete to be precast rather than poured in place, then the form might be remarkably different. Is the form of reinforced concrete a direct response to the limits set by its formwork, be it wood, plastic or steel? Wood and its rider, the carpenter, lead to thinking of skeletal frameworks, and in an earlier era to the trabeated or post and beam system. The engineering mind seems to favor skeletal structures, e.g., post and beam, and portal frame, whereas the architectural mind seems to favor surface construction, e.g., wall, arch and pier, vault, etc.—the Gothic versus the Romanesque? R. Morandi and T. Y. Lin in their use of skeletal reinforced concrete have an engineer's perception. Candela and Saarinen have an architect's perception of surfaces in reinforced concrete. Is that also true of Maillart and Torroja? Present day architecture of reinforced concrete in Japan reminds us of their wood tradition (precasting notwithstanding). There is a carpentry of reinforced concrete and not the difference between architect and engineer. It is an intuition of the skeletal.

Between the extremes of surface and skeletal structures, there lie the multiribbed surface investigations of Nervi. It is an expression in response to the lack of giant cranes, precluding weighty elements, and to a culture which is capital saving and labor intensive, etc. It has its precedents in English Gothic vaulting that begins as surfaces, then adds ribs at the folds, then ribs on the surfaces between folds, then ribs for the ease of construction, and finally to the use of ribs that served neither a logic of construction nor that of structural isostatics. In studying the surface, Nervi concludes with the skeletal. His development can be contrasted with that of Arnold of Westphalia (15th century) who begins with the skeletal, i.e., rib and panel Gothic vaulting, and concludes with the surface, e.g., multifolded plates.

Who, today, is the master of the expression of either extreme of surface or skeletal structures in reinforced concrete? Perhaps we have moved toward the use and expression of other materials and their forms, or, more likely, it is not considered to be an issue worthy of debate or pursuit. If one continues to build single-family houses or other lowrise buildings, or study the logic of urban formal tissue or study the vernacular of either the local crafts or mass culture, then the question is moot. In the present architectural culture, structure makes no insistence for attention. When the span is large or the building is high, then the flow of forces insists to be recognized. Neither houses nor cities accentuate the stress due to weight. Between the size of the house and that of the tower or the bridge lie the buildings on which most architects focus their attention. At that in-between scale, whether or not structure is expressed, is a function of the architect's personal morality of form.

The search for originality, not for an expression of structural

intuition, is the current mood. Even knowing that "what was original in the morning is copied the same evening," many present luminaries continue to cast light on only themselves—leaving principle in the dark. Lacking originality, there is an obedience to, and not a listening to, the precedent. As William Blake wrote.

"we are led to believe in a lie
when we see with, not through the eye".

To paraphrase P. Valery: Only a strong intuition will serve as a compass in the wilderness of current practice and the morass of current theories. What is needed in the study of the relationship between structure and architecture is not a set of precedents, but an intuition of intuitions. At one time the self-weight of structures was much greater than the applied loads. This fact led to many and particular shapes and forms—the arch, the vault and the dome in masonry; and for the small span and short height, trabeation in stone. Today, when the applied, or live, loading is of the same order as the self-weight, we cannot depend on our "seeing" of the precedents. Tomorrow, when the loading and the use that is yet to be applied will become the major determinant of form, then our precedents will be most inappropriate. What is the shape of structures for wind, movement, change? The fact that tent structures, pneumatics, etc., have yet to find an adequate architectural expression is in no small part due to our dependency on precedents and languages rather than on intuition and principle.

Intuition and principle do not lead to uniformity of expression. A study of the Gothic vaulting of France, England and Central Europe will reveal that each country had a quite different structural intuition. All three peoples had to solve the structural problem of the flat diagonal groin and the problem of the construction of the whole cross-vault. The development of French vaulting indicates a preference for domical vaulting, and hence surface structure, which fact is related to their tradition of

Below, Pier Luigi Nervi's reflected ceiling plan for his 1950 casino at Ostia, and dome of his 1960 sports palace, Rome. Right, Henri Labrouste's Bibliothèque Nationale, Paris, 1854-75.

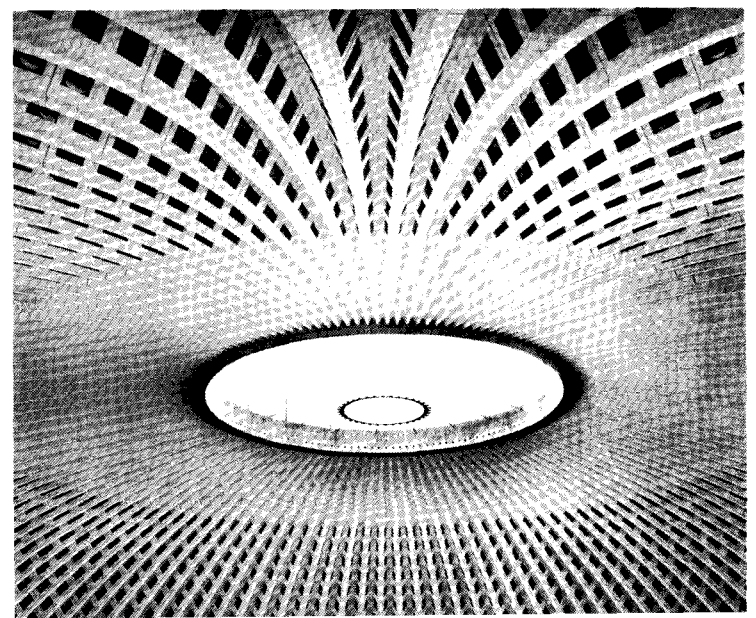
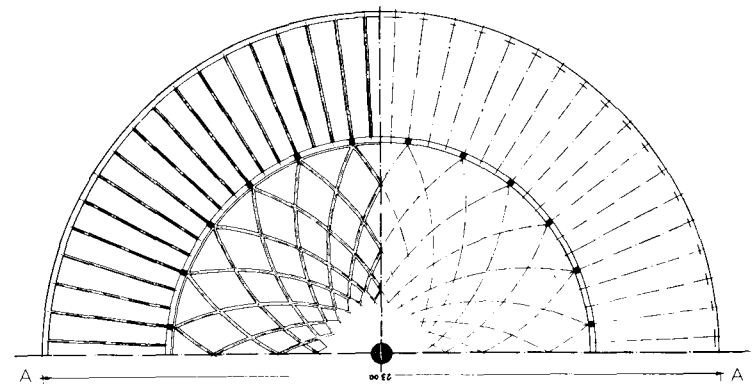



working in masonry. English vaulting shows a development toward multiribbed vaulting that is a response to the act of construction and to having a strong tradition in carpentry, and hence in skeletal structure. Central European vaulting takes several directions, but uniquely develops the multifaceted folded plate surfaces. Were the Catalonians, with their tile, to have responded to the problem, then one might expect another result, the outcome of another intuition.

Another issue concerns the facades of cathedrals which are most usually constructed using a geometry of interlocking triangles, i.e., *ad triangulatum*, or interlocking rectangles, i.e., *ad quadratum*. Compare the French with German preference on this issue. Robert LeRicolais' concept of structure is derived from a homogeneous partition of space and a preference for even numbers of faces, edges and vertices in the elements. My own intuition leads to a heterogeneous location of elements in space and a preference for odd-sided figures. Of course, homogeneous and even belong together as does heterogeneous and odd. They are different intuitions that answer to the same principles.

Since the era of stone, and prior to entering that of organic

materials, we have experienced two centuries with iron and steel. Until the middle of the 18th century, cast iron and not wrought iron or steel was the most readily available and its expression was that of cast stone. Cast-iron columns replete with fluting and "ordered" capitals—as Perret's early reinforced concrete columns. Cast-iron columns replacing wood columns that had copied stone columns that, in turn, it is said, had copied wood columns. As is often the case in the building industry, new materials and their fabricated elements replace or "substitute" for the old materials and elements whose performances are found inadequate. As is also often the case, the form of the new copies the form of the old. Arch bridges in stone are replaced by arch bridges in cast iron. Banded barrel vaults in stone are replaced by banded barrel vaults in cast iron, i.e., Labrouste's library of St. Geneviève, Paris (1838-1850). The details of Labrouste's arches clearly indicate "casting" and the joints differentiate for us what was made off-site from that which was connected on-site. The availability of cheap puddled wrought iron separates his first library from his design for the national library (1874-75). In this later building, the arches, which combine to support and

continued on page 119

Structural Digest

Sam Chan, coordinator of engineering and chairman of academic affairs at Louisiana State University, estimated earlier this year that the number of technical articles published annually about structural engineering is now 2,340,000 and rising. Obviously, with the best will in the world, we have not been able to examine more than a fraction of those written in the last few years, although eliminating the ones that were beyond our comprehension did narrow the field considerably. The following digest therefore makes no claim at being thorough. We merely present, in varying degrees of abbreviation, a number of recently published articles (and some unpublished ones) that we thought our readers would find informative. Some of them, such as the concluding text by Paul Weidlinger, are general, dealing with total effects of technology on our cities; most of them are more specific, dealing with particular structural developments and research; none of them, as abridged or paraphrased here, is dependent on mathematics. *Stanley Abercrombie, AIA*

The Effects of Scale

By Myron Goldsmith, FAIA, general partner in the firm of Skidmore, Owings & Merrill, Chicago. This paper is excerpted from an address to the national convention of the American Society of Civil Engineers.

In the 17th century, the prevailing opinion on the relation of size to structure was expressed by Sagredo in the *Dialogues Concerning Two New Sciences* written by Galileo in 1638: "If a large machine be constructed in such a way that its parts bear to one another the same ratios as in a smaller one and if the smaller is sufficiently strong for its purpose, I do not see why the larger is not."

Galileo refuted this proposition by saying that the size of an organism or artifact has a decisive influence on its structure and its function. He proved his theory with the utmost possible clearness, and with a great wealth of illustration drawn from animate and inanimate structures. He said: "You can plainly see the impossibility of increasing the size of structures to vast dimensions either in art or in nature, likewise the impossibility of building ships, palaces or temples of enormous size in such a way that their oars, yard-

Goldsmith acknowledges the following references for information included in this excerpt: Clark, W. C., and Kingston, J. C.; *The Skyscraper: A Study in the Economic Height of Modern Office Buildings*, New York City, 1930; Galilei, Galileo, *Dialogues Concerning Two New Sciences*, Henry Crew and Alfonse De Salvio, translators, Chicago, 1914; Ketchum, Milo S., *Structural Engineering Handbook*, New York City, 1924; Steinmann, David B., "The World's Most Notable Bridges," *Engineering News-Record*, Dec. 9, 1948; Thompson, Sir D'Arcy Wentworth, *On Growth and Form*, Cambridge, England, 1948.

beams, iron-bolts and in short all their parts can hold together; nor can nature produce trees of extraordinary size because their branches would break down under their own weight; so also it would be impossible to build up the bony structures of men, horses or other animals so as to hold together and perform their normal function if these animals were to be increased enormously in height, for this increase in height can be accomplished only by employing a material which is harder and stronger than usual, or by enlarging the size of bones thus changing their shape until the form and appearance of the animals suggest a monstrosity.

"To illustrate briefly I have sketched a bone whose natural length has been increased three times and whose thickness has been multiplied until, for a correspondingly large animal, it would perform the same function which the smaller bone performs for its small animal. From these figures . . . you can see how out of proportion the large bone appears. Clearly then if one wishes to maintain in a great giant the same proportion of limb as that found in an ordinary man, he must either find a harder and stronger material for making the bones or he must admit a diminution of strength."

In this remarkable work Galileo formulates the idea of an ultimate size for structures. He says: "Among heavy prisms or cylinders of similar figure there is one and only one which under the stress of its own weight lies just on the limit between breaking and not breaking so that every larger one is unable to carry the load of its own weight and breaks while every smaller one is able to withstand some additional force tending to break it."

The principles dealing with the effects of magnitude, laid down by Galileo, have

since been extended and elaborated in many fields, such as biology, mathematics, philosophy and engineering. Sir D'Arcy Wentworth Thompson in his work *On Growth and Form* cites many examples from these fields. He says: "We learn in elementary mechanics the simple case of two similar beams supported at both ends and carrying no other weight than their own. Within the limits of their elasticity they tend to be deflected, or to sag downwards, in proportion to the squares of their linear dimensions; if a match stick be two inches and a similar be six feet (or 36 times as long), the latter will sag under its own weight thirteen hundred times as much as the other. To counteract this tendency, as the size of an animal increases the limbs tend to become thicker and shorter and the whole skeleton bulkier and heavier; bones make up some 8 percent of the body of mouse or wren, 13 or 14 percent of goose or dog and 17 or 18 percent of the body of a man. Elephant and hippopotamus have grown clumsy as well as big, and the elk is of necessity less graceful than the gazelle. It is of high interest, on the other hand, to observe how little the skeletal proportions differ in a little porpoise and a great whale, even in the limbs and limb bones; for the whole influence of gravity has become negligible, or nearly so, in both of these."

Concerning limitations on height, Thompson observes that the tall tree tends to bend under its own weight and mentions how Greenhill showed that a British Columbian pine tree 221 feet high and 21 inches in diameter at the base could not have grown beyond 300 feet, the very limitation on growth for trees anticipated by Galileo. Analogies to the tapering pine tree are to be found in

116-story concrete buildings designed by R. L. Hodgkison, with advisers M. Goldsmith, F. Khan, D. Sharpe.

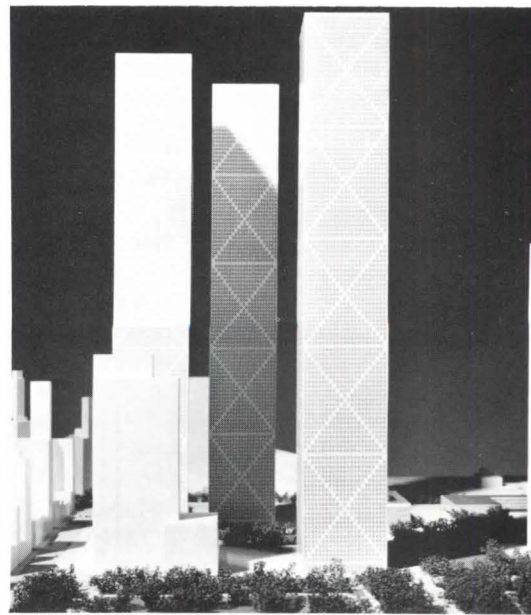

Hedrich—Blessing

Smeaton's lighthouse and the Eiffel Tower whose profiles follow a logarithmic curve so that the structural strength is uniform throughout their height.

In 1947, after studying *On Growth and Form*, I became convinced that different scales required different structures. A study was made of how these principles are found to be applicable to modern engineering structures. The first study shows a comparison of the spans of dif-

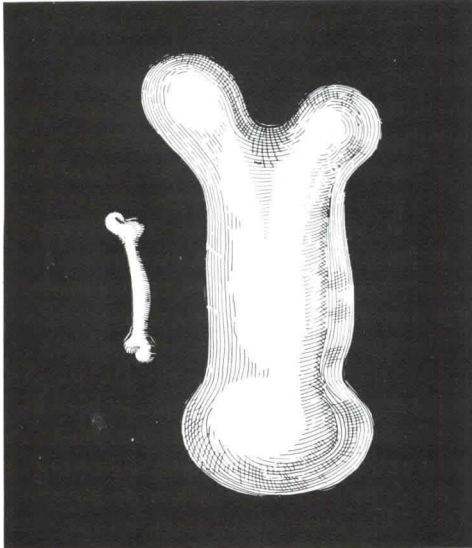

Galileo's normal and oversized bones.

ferent types of bridge structures. Each type has an upper and lower limit. The longest plate girder span is 860 feet, while the simple truss has been used up to spans of 720 feet and continuous truss has been carried to a span of 1,000 feet. Thereafter the span increases rapidly, the arch spanning 1,600 feet, the cantilever bridge 1,800 feet, and finally the suspension bridge reaching a present maximum of 4,200 feet with predictable limits in the region of 10,000 feet. So it is seen that at certain limits the structural system has to be changed. The reason for the upper limit of structural systems becomes clear by comparing the weights of railroad bridges of different spans. It is seen that a 150-foot span structure weighs 400,000 pounds, whereas a 600-foot structure weighs 4,500,000 pounds, thus representing an increase of four times in span and 11 times in weight. The curve of a graph shows that after 600 feet the increments of weight increase rapidly for every increase in span, and it can be expected that the maximum span for this type of construction will be reached not far beyond 700 feet. The steel skeleton of multistory buildings exhibits a similar behavior. An eight-story building requires 10 pounds of steel per square foot, while a 100-story building requires 30 pounds.

In summing up, it can be said that every structure has a maximum and minimum size. For example, in the bridge structures there is a region between 400 and 700

feet where now one and then another type is used, but above 2,000 feet the suspension system reigns supreme, while below 400 feet the suspension bridge is reaching a minimum efficiency. An optimum size may be found somewhere between these extremes, and its exact determination will be at its point of maximum efficiency.

Masonry structures are at their greatest efficiency in low buildings where the thickness of wall required for protection against the elements is sufficiently strong to carry the floors and roof. The maximum height of masonry office structures was reached in the 16-story Monadnock Building, built in Chicago in 1891 by Burnham & Root. It has walls six feet thick at the base, decreasing gradually through the upper stories to 30 inches. The internal columns are of cast iron; the external walls are of masonry acting as bearing walls and stabilizing the structure by their mass.

A reinforced concrete skeleton is a monolithic structure in which all the vertical loads are carried by means of columns, while the horizontal loads are resisted by the columns stiffened by the beams and girders. It is characteristic of this structural type, of which the Promontory Apartment Building, built in Chicago in 1948 by Mies van der Rohe, is a good example, that the thickness of the floor construction may remain constant for every story, whereas the columns and girders must increase in the lower stories due to the increase of vertical and horizontal loads. The skeleton type permits great flexibility in internal planning, since the vertical members are relatively small and isolated; but the increasing size of the principle members in

the lower stories of tall buildings tends to interfere with the use and flexibility of the interior space and, as a consequence, the practical limit on height for this structural type has been about 25 stories.

The limitations inherent in the pure concrete frame were rapidly overcome by the introduction of a whole new series of concrete structures: the frame and shear wall combination; the concrete tube (where the exterior resists lateral forces), and various combinations of these. This clarification came about through the work of Fazlur Khan during the '50s and '60s. One project showing this development of the concrete tube is the Chestnut De Witt Apartment Building, designed by Skidmore, Owings & Merrill with Bruce Graham, FAIA (design partner), Myron Goldsmith, FAIA (senior designer) and Fazlur Khan (chief structural engineer). Another such project is the 166-story, braced tube office building designed as a master's thesis at Illinois Institute of Technology in 1968 by Robert C. Hodgkinson with Myron Goldsmith, Fazlur Khan and David Sharpe as main advisers.

Simultaneously, there was a similar development of steel structures for tall buildings, also by Fazlur Khan. He identified the heights at which various structural systems in steel were economical. The proliferation of new structures has led to a corresponding development in the architectural expression of these structures, as diverse as in the Sears Tower and the John Hancock Building (see p. 68).

We see that it is impossible to examine anything in depth without an understanding of the scale factor. The realities of scale exist in all aspects of construction and life. The right means to the right

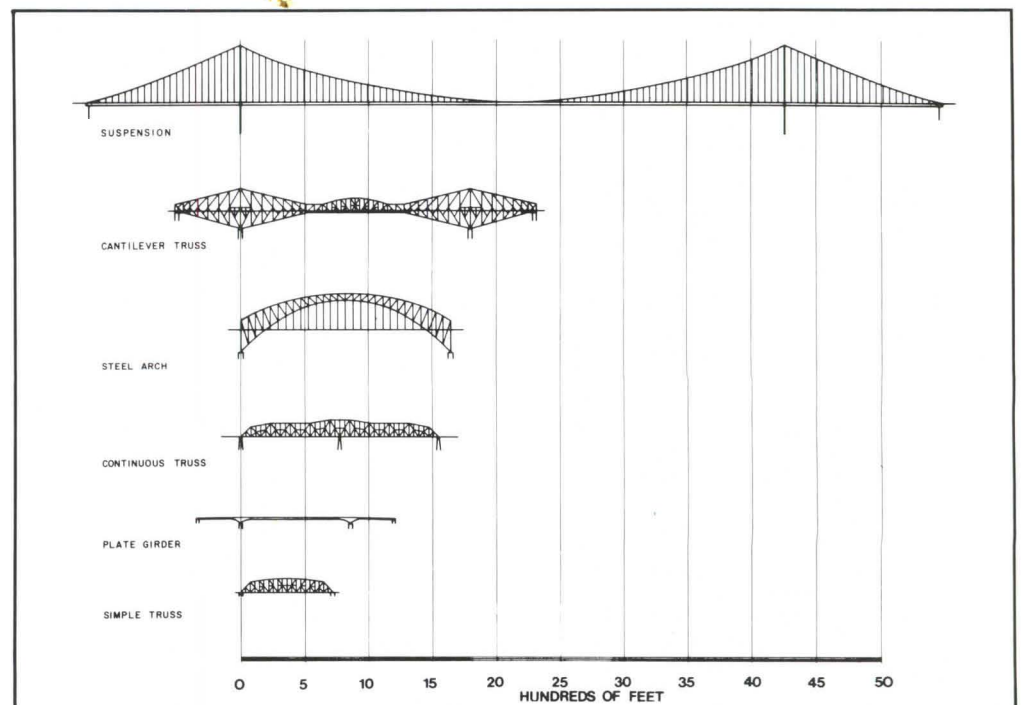

Spans of different types of bridge structure.

ends must be found; in other words, the means must be in scale with the ends and a philosophical base is needed when judging the aspects of structure, scale and architecture, and our relation to it.

Several major conclusions can be drawn on the subject of structure and scale:

1. Every structural type, whether an organism or artifact, has a maximum and minimum size.
 2. In the tall building there are two limitations on height: One is structural and the other functional.
 3. When a certain magnitude has been reached in a building, the structural and other systems must be changed.
 4. A new structural system gives the possibility of a new esthetic expression.
 5. Size and scale have important implications environmentally and functionally.
- Engineering for efficiency is not the last and only determinant; it is possible to make a choice from several efficient schemes because of architectural, esthetic and environmental reasons. The human needs must give the directions.

Dynamic Loads

By H. S. Ward (school of engineering science, Plymouth Polytechnic, England). Excerpted from *Shock & Vibration Digest*, August 1977.

In the past only a few engineers have had to confront the difficulties associated with predicting the action of dynamic loads on buildings. Nevertheless, a significant amount of pertinent information exists in the technical literature, stretching back over a period of at least 50 years. This review is mainly concerned with some of this earlier work. A number of factors suggest that engineers will be now and in the future more involved with structural dynamic problems.

The sources of some of the dynamic loads that act on buildings are summarized in the illustration, which refers to land-based structures. It can be seen that both man-made and naturally occurring dynamic disturbances occur. The effect of earthquakes has perhaps received the most attention in the past. Economic pressures and disturbing social developments, however, might make other loads of prime concern in the future. Economic pressures are producing a situation in which structures are becoming both lighter and larger—and thus more susceptible to the action of such loads as wind. Anarchy is frequently manifested in attempts to destroy buildings.

The so-called energy crisis sparked a dramatic increase worldwide in the search for offshore fuel reserves. The exploration of the North Sea revealed shortcomings in our knowledge of this

hostile environment. It can be argued that, if the problems of a growing world population are to be contained, the demand on engineers to design a wider range of structures for use in the sea will increase. A prerequisite for these developments is a better understanding of the action on structures of wave loads; tidal, turbidity, and ocean currents, and icebergs, as well as such environmental factors as corrosion.

Nuclear explosions are being considered as a way to excavate large quantities of soil. Such use of nuclear power has resulted in the removal of some data from classified-secret files of defense organizations. Theoretical methods for predicting ground motion levels and frequency content produced by underground nuclear explosions are not yet well established.

The Suffield Research Establishment in Alberta, Canada, carries out much of the serious work in the Western world on large conventional explosions. The results are probably of limited interest to civil engineers, however. More useful results have been obtained from the study of quarry blasts of controlled explosions, in which interest has centered on the vibration levels that produce damage to buildings.

Construction activity and vehicular traffic also cause dynamic disturbances of buildings. In the case of traffic vibrations, the riding surface of the road has the greatest influence on the level of the ground motion that is generated. It is of interest that dynamic loads are not always a source of nuisance, as exemplified by piling data. The sonic pile driver

creates less disturbance when producing a resonant driving force in the pile-ground system than do conventional systems.

Airborne disturbances include wind and those resulting from explosions. Sonic booms are another form of dynamic loading that might become significant to the civil and structural engineer. Other types of dynamic loading of structures include thermal loads due to temperature variations and fire, impacts and the action of ocean waves, currents and wind.

Daily and seasonal variations of temperature can generate significant movements in large structures. These movements, like those associated with ground settlement or steady-state wind pressure, take place slowly and can be measured in years. The effects would usually be considered to be static loading effects; they are included in this review because the resultant movements can be measured only with advanced instrumentation derived from dynamic test methods. An important design problem in temperature movements involves multistory buildings—exterior and interior columns can be subjected to temperature differences in excess of 100 degrees F. Most of the work on this problem has been carried out by structural engineers responsible for designing the tallest buildings in North America.

Fire loads constitute a dynamic loading, insofar as the temperature increases that occur can be measured in minutes. Observations have shown that a wide range of fire loads can occur, depending upon the type of building and its con-

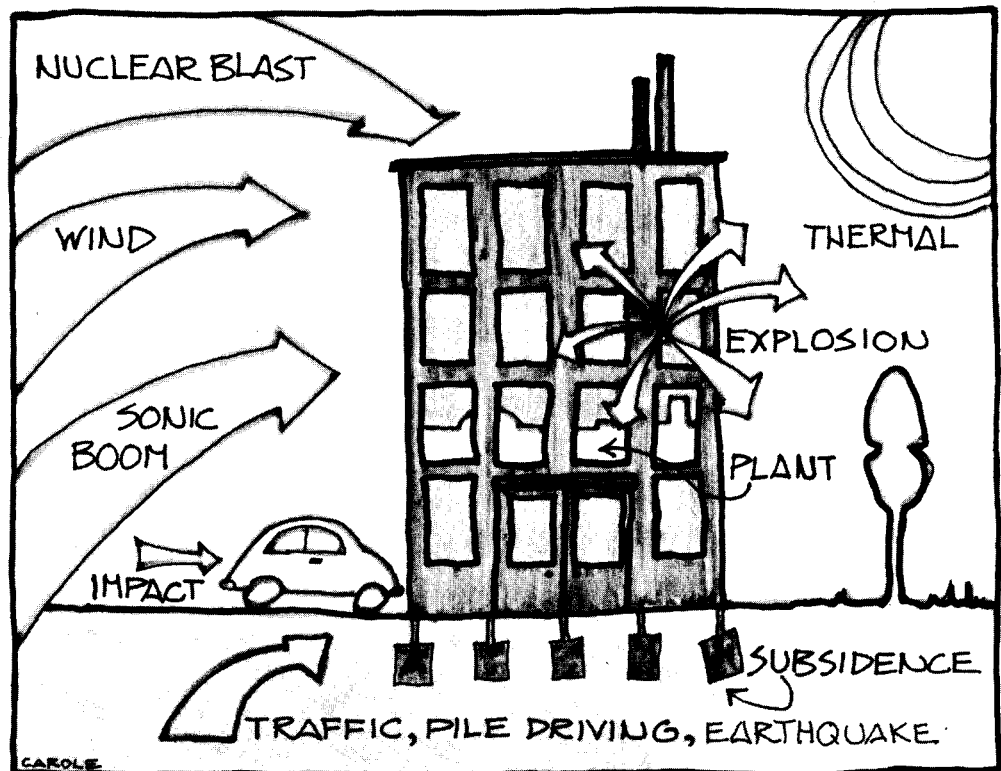

Sources of dynamic disturbances for land-based structures.



tents. These factors complicate the selection of appropriate fire resistance for any structural component. Survey data from disastrous events can provide useful information about the real loads that develop in structures.

One reason for the lack of useful data pertaining to structural dynamics of structures is that too few engineers are familiar with modern instrumentation. Many experiments involving dynamic loading have been prompted by the devastating effects of earthquakes on tall buildings. The laser is gaining in importance as a tool for measuring large slowly varying movements.

The influence of dynamic forces on structures did not arouse widespread interest until recently. Economic pressures and technical developments are changing this position, however, and as structures become lighter and safety factors are lowered, problems that arise must be dealt with properly. Far more experimental work must be performed to obtain data on both the characteristics of the forces and the movements they produce in existing buildings. Proper understanding of this information would allow designers to approach the design of new buildings with greater confidence.

Progressive Collapse

Since 1968, when a kitchen explosion on the 18th floor of an English apartment block ripped out an exterior wall panel and caused the subsequent collapse of all the floors below, "progressive collapse" has been a frequently used term and a matter of general concern. A symposium on the subject was held in Boston in 1975 at the annual convention of the American Concrete Institute, and a summary of papers presented at that symposium was printed in the September 1979 issue of the ACI Journal. Another summary of recent thinking on the subject, excerpted

here, is "Approaches for Design Against Progressive Collapse," by Bruce Ellingwood and E. V. Leyendecker (both research structural engineers of the center for building technology, National Bureau of Standards), published as paper 13610 in the Journal of the Structural Division of the American Society of Civil Engineers.

A progressive collapse is a chain reaction of failures following damage to a relatively small portion of a structure. The resulting structural damage characteristically is out of proportion to the damage which initiated the collapse. This type of failure represents a significant percentage of the total number of structural collapses recorded in the U.S. and Canada both during and after construction in recent years. There is evidence that the progressive type of collapse can occur in all types of construction. Traditional steel and reinforced concrete frame construction have frequently performed quite well after sustaining local damage because their redundancy, continuity and inelastic load carrying capacity (of both structural and nonstructural elements) permit redistribution of forces around the damaged volume. However, there is evidence that certain other construction types, such as precast panel and unreinforced masonry structures, require special attention in order for this necessary residual strength to be developed.

In recognition of this, a number of European countries and Canada have incorporated progressive collapse provisions in their building codes. Also, the American National Standards Institute committee on building code requirements for minimum design loads has recently appointed a group to study possible standard provisions. These typically consist of a general statement of required structural performance and often contain a set of load factors for checking designs. However, such criteria in the past have tended to be based, in large part, on subjective judgment, and have frequently been criticized for the possible economic penalties that they may impose on certain types of structures.

When an extreme load event occurs, a limited amount of structural damage is generally accepted as inevitable by standards-writing authorities. This is a necessary consequence of the balancing of safety and economy in the development of design standards. Although buildings are routinely designed to resist transient wind and earthquake loads, infrequently one of these will occur that is of sufficient magnitude to cause a certain amount of structural damage. Moreover, there are those loads that may not be currently considered in design because of their low probability of occurrence relative to com-

mon structural design loads, but that may precipitate catastrophic structural failure if they occur. These so-called abnormal loads are highly random in magnitude and incidence.

The primary objective of designing damage tolerance into structures is to minimize the loss of life that might otherwise occur in the event of local failure and to permit the safe egress of the occupants from the damaged structure. With these points in mind, it is suggested that damage tolerance be determined by assuming that the primary structural elements, defined as major load-carrying

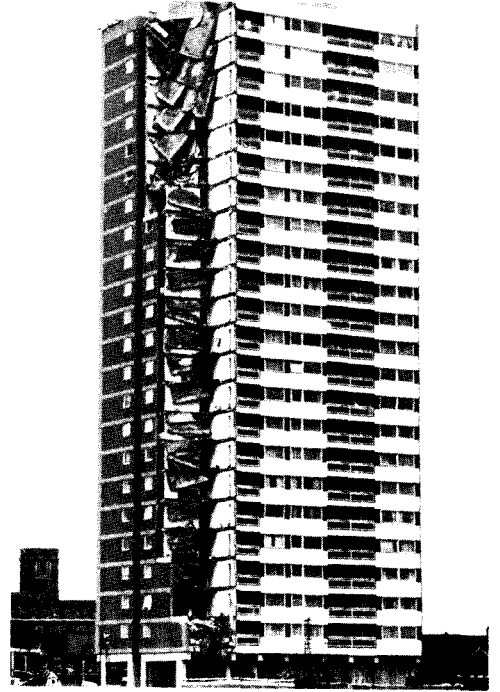

beams, floor slabs between supports, columns and bearing wall panels, are incapable of carrying load, one element at a time, and evaluating the resulting structural behavior. Damage should be confined to the story above and below the unit assumed to be the focal point of the extreme loading event. In the horizontal plane, damage should not extend outside an area greater than 750 square feet or 15 percent of the floor area. These recommendations are similar to those used in Denmark, the United Kingdom and Sweden.

Types of Structural Failure

By D. I. Blockley, University of Bristol, England. From the Proceedings of the Institute of Civil Engineers, London, February 1977.

Basic types of structural failure were classified in this paper. Two dozen major structural failures were compared, and the accidents were ranked in the order of their apparent inevitability. Human errors of one type or another proved to be the dominant reasons for the failures con-

sidered. The paper presented a simplified form of a proposed procedure for predicting the likelihood of structural accidents.

Wind Tunnel Studies

By Alan G. Davenport, Nicholas Isyumov and David Surry, all of the Boundary Layer Wind Tunnel Laboratory, faculty of engineering science, University of Western Ontario, Canada. Excerpted from a paper presented to the American Society of Civil Engineers in Boston in 1979.

Traditionally, wind tunnel model studies of wind engineering problems have been confined to trouble-shooting potentially unacceptable behavior, such as the aerodynamic instability of long span bridges, or the evaluation of extreme behavior of structures for particular design speeds. While this use has continued, the role of wind tunnel simulations, in recent years, has been expanded to become an integral part of the design process. There are at least three reasons for this: first, the constant trend to innovation in both structural design and in architectural shape—both tend to put some buildings and structures outside conventional codified experience; second, the availability of more penetrating analytical methods coupled with powerful computer techniques which tend to remove any fat from the structural system, and third, the recognition that the rational application of more precise structural design inevitably must be accompanied by a refinement in the definition of the structural loading. This is often beyond the capability of the most modern code definitions, even for conventional structures.

The evolution of structural design is obviously a significant factor in the current role of the wind tunnel as a design tool; however, the underlying reason for the increased importance of the wind loading is to be found in the growing significance of the dynamic component of the wind-induced response. Technological changes over the past few decades have led to far more efficient use of materials. The result has been a trend toward more slender and flexible structures with markedly lower mass and structural damping. All of these trends have tended to increase the sensitivity of modern structures to dynamic excitation. The wind, which is gusty by nature, has found these a more vulnerable breed of structures.

Generally, wind tunnel studies become effective or even essential components of the design process in situations where one or several of the components of the wind loading chain fall significantly outside existing experience, or where wind is the dominant loading and even modest im-

provements translate into significant economic benefits. The range of structures for which wind tunnel studies can play an effective role is broad. Each type of structure is associated with a different set of potential problem areas; each with different features by which situations warranting special attention can be recognized.

In all cases, additional aerodynamic problems can be introduced by unusual topography, close proximity to nearby structures and unusual aerodynamic cross sections. In many cases, significant wind loading problems may be evident which are not explicitly recognized by many current code specifications. Some of these special concerns are:

1. the occurrence of unbalanced wind loads. The latter type of loading, largely ignored by most codes, can lead to significant torsional loads for buildings, and overturning and stress reversals in special roof structures.
2. the action of forces in several directions. Typically, in the case of buildings it is important to consider the simultaneous occurrence of forces in both the along-wind and across-wind directions, together with torsion.
3. the recognition that wind loading often occurs in conjunction with other environmental effects. Notably, the joint occurrence of wind and ice accretion loads becomes important for transmission lines and slender tower structures.

The types of models used in wind tunnel studies are either rigid or flexible. A rigid model study requires only the additional condition that similarity of the

model to boundary layer dimensions is maintained. It is typically used to define environmental winds, local surface pressures and overall forces.

While wind tunnel studies are often prompted by uncertainties associated with specific aspects of existing code approaches, it is important to recognize that the scope of such studies is potentially far beyond the role of providing assurance in the context of existing design methods. Taken to its full potential, a wind-tunnel-based study provides a consistent alternative design procedure which can recognize many of the subtleties of the wind/structure interaction and which can be tailor-made to focus on particular aspects or structural behavior. For instance, wind tunnel studies clearly demonstrate that buildings are not simply loaded normal to their faces, but also experience lateral and torsional loads acting simultaneously. This occurs for all wind directions, even those along lines of symmetry, due to the significant dynamic components of the wind induced loads. Few codes recognize unbalanced load effects, not to mention the simultaneity of the loads along several directions.

It is important to recognize that in most situations the structural response is sensitive to wind direction. Wind tunnel studies can effectively define this sensitivity. Improved predictions of full-scale behavior result if the directional sensitivity of the aerodynamic behavior and that of the local wind climate are jointly taken into account.

A detailed evaluation of cladding loads



Model structures for testing in a wind tunnel.

can lead to a more effective tailoring of glass design to reflect a building's environment and to potentially provide significant overall economies. The state-of-the-art is such that the same on-line techniques, mentioned above, are available to provide a better understanding of the behavior of glass under unsteady loading in order to establish the most relevant loading criteria for design purposes. All particular design studies naturally add to the store of knowledge from which future codes can be derived. Such work has begun for cladding loads of tall buildings. Even in relatively routine situations, it is interesting to note that traditionally accepted concepts are not always valid. For instance, many codes suggest that the suction loads acting on cladding increase with height and are more severe near edges of buildings. In fact, it is not uncommon to find the largest suctions near the base of a building and toward the center of particular building faces.

Advantages of wind-tunnel-based design studies have been discussed above. However, there are also some limitations and practical difficulties. To complete this general perspective on the role of wind tunnels, these are briefly examined from the following two viewpoints: (1) the implied costs and inherent difficulties of the implementation of this approach; and (2) the inherent uncertainties involved.

Regarding the first point, undoubtedly the inclusion of wind tunnel studies in the design process introduces additional costs and adds a further dimension to the overall design process. While the costs of such studies vary with scope and extent of involvement in the design process, the direct costs are relatively modest. The costs of a wind tunnel design study carried out to define the facade wind loads for a tall building is typically less than 0.5 percent of the glazing and cladding costs. In many cases this cost is offset by economic benefits derived from a closer tailoring of the design. While wind tunnel design studies can generally be cost effective, this is not attained without some effort on the part of the designer. The level of sophistication of the entire process is relatively high and optimum effectiveness is only realized with a proper level of awareness and flexibility of design method. In the context of the previous discussions, the increased sophistication of the wind tunnel study also puts pressure on improving the other links of the design chain.

Concerning the second point above, direct comparisons between wind tunnel and full-scale data provide the most important bench mark for the evaluation of uncertainties. Such comparisons can be made at several levels. Comparisons can be made of the basic aerodynamic data, as obtained from rigid models, at particular wind speeds and directions. Possible

data include point pressures, overall aerodynamic forces and various measurements of the flow itself. Another level of comparison is the aeroelastic response of particular structures. Comparisons of aeroelastic response measurements in model and full-scale are somewhat clouded by uncertainties in the full-scale structural properties. Full-scale parameters, such as the damping and stiffness properties of the structure, usually are not precisely known. This can contribute as much to the uncertainty in the extrapolation of model results to full-scale as the inaccuracies inherent to the basic modeling. The inherent variability of the full-scale wind further complicates all model to full-scale comparisons and hence they must invariably be made on a statistical basis.

While the methodologies and required data bases have improved significantly, the prediction of the speed and directional characteristics of the wind still forms the largest single source of uncertainty of the entire process.

A commonly asked question is when is it necessary or advantageous to undertake a detailed wind load study. In some instances codes indicate partial answers to this question by recommending taller and more slender structures to be studied for dynamic effects—either analytically or through wind tunnel investigations. However, complete and definite answers may not be possible to state. There are a number of features which singly or together suggest their desirability. These features are indicated by affirmative answers to the following questions.

Is the wind load dominant in design? Is the structure strategically important? Is the wind climate unusually severe? Is the site unusually exposed? Is the structure unusually light, tall, slender or flexible? Are the damping and frequency low? Is the center of structural stiffness eccentric? Is the torsional resistance low? Does the structure possess slender exposed members? Is the shape unusual? Is the glass and cladding design vulnerable to wind? Are there large isolated buildings upwind?

The above answers will indicate wind sensitivity. In some instances economy may dictate and justification may be sought for reducing the wind loading. Such situations may arise when the structure is unusually well sheltered from the wind or the structure unusually robust.

This paper has attempted to indicate how wind tunnels may be used as part of the design process to improve the understanding of wind action and lead to more effective design against wind. The techniques for carrying out the tests are improving steadily in their ability to supply answers as well as in their costs and the time taken.

Tuned Mass Dampers

By Robert J. McNamara, principal, Gillum-Colaco consulting structural engineers, Cambridge, Mass. Abstracted from paper 13200 published in the September 1977 Journal of the Structural Division of the American Society of Civil Engineers.

The response of a highrise building to external dynamic forces created by the wind is dependent on wind intensity, surrounding environment, building size, shape, mass, stiffness and amount of energy dissipation available in the system. Only recently has this last factor, the energy dissipation system, received much attention.

Recently, attempts have been made to increase the damping in building systems and thereby reduce structural response. The World Trade Center in New York City was one of the first major buildings



Hugh Stubbins & Associates

to utilize an added energy dissipative system in an effort to reduce structural motions induced by wind, although the concept of a tuned mass damper as an added energy absorbing system dates back to 1909. Much work in vibration analysis has been related to the use of tuned mass dampers (or vibration absorbers) in mechanical engineering systems. The Centerpoint Tower in Sydney, Australia, is one of the first applications of a large-scale tuned mass damper in a building; in that system, the tower's water tank was incorporated into the design of the tuned mass damper to reduce wind-induced motions. A 400-ton tuned mass damper has been built at the top of Citicorp Center (photo above) to reduce expected motions induced by wind, and it has also been studied for reduction of earthquake response.

This paper reviews the tuned mass damper as an energy absorbing system to reduce wind-induced structural response of buildings in the elastic range of behavior. Experimental results from wind tunnel models with and without a tuned mass damper are presented. Practical design considerations are examined.

Fabric Structures

By Lora E. Spiller, Chemical Fabrics Corporation, North Bennington, Vt. Excerpted from a talk at the ninth annual International Dome Symposium held in March 1980 in Winooski, Vt.

Societies throughout history have lived and worked in tents, which had the advantages of light weight and mobility. In this century, fabric structures began to find wider uses as warehouses, military radomes and protective coverings for swimming pools and tennis courts. By the late 1950s, these structures had begun to

Partly inflated, a 6.5 acre air-supported fabric roof, a Syracuse University stadium.



capture the imagination of a small group of architects and engineers who foresaw fabric structures as workable alternatives to conventional roofing systems for wide-span applications.

Walter Bird, without doubt the father of the fabric structure industry, began searching in the early 1940s for the right combination of design and materials that would make permanent fabric structures a reality.

Early models of fabric structures were usually bubble-shaped, like the first air-supported military radome that Bird built in 1948. Since then, Birdair Structures, the company he founded in 1956, has designed and fabricated thousands of structures.

By the late 1960s, things had begun to change. There was a growing chorus of appeals for better materials that could meet criteria for larger commercial applications: long life, weatherability, esthetic appeal and physical strength.

The structure that seems to have served as the final necessary catalyst for action appeared at the 1970 World's Fair in Osaka, Japan. David Geiger of Geiger-Berger, New York City, with architects Davis Brody & Associates, designed and engineered a fabric structure with major architectural innovation. The U.S. pavilion was a huge, *low-profile* structure that covered a large area in a graceful flow of

shapes. However, the fabric used, a woven glass fiber coated with vinyl, was only a temporary roof; like earlier fabric covers, it could not permanently withstand the ravages of weather.

Industry responded to the challenge of finding better materials. DuPont, Owens-Corning Fiberglas, J. P. Stevens, Chemfab and Birdair mounted a cooperative research effort that led to the development of permanent architectural fabrics.

In 1973, only seven years ago, the first permanent fabric structure was completed at LaVerne College, LaVerne, Calif., designed by John Shaver Associates. Since 1973 there have been fabric structures built all over the U.S. and overseas—stadiums, malls, department stores, student activity centers. The largest project to date, now well underway, is Skidmore, Owings & Merrill's Haj Terminal facility for the new Jeddah airport in Saudi Arabia. Its fabric roof will cover an unprecedented 105 acres. And, in a few years, perhaps even the Jeddah project will seem small.

Latticed Structures

By Donald R. Sherman. Originally published as paper 12581 in the November 1976 issue of the Journal of the Structural Division of the American Society of Civil Engineers.

A comprehensive review of practice current in 1976 regarding the whole family of shell-like structures composed of networks of elements in the form of grids, domes, hyperbolic paraboloids and other

shapes. The review provided a general overview of all the important aspects of latticed structures and emphasized the characteristics common to all types. The report began with a background history of such structures, illustrated by existing structures. In addition to general descriptions, tables are included that catalog methods of analysis and stability determination for such structures and show where they are applicable. References are made to an extensive bibliography for further information on specific types of latticed structures.

Stressed Skin Structures

By E. R. Bryan, professor of structural engineering, University of Safford, England. Excerpted from the September 1976 issue of The Structural Engineer (London).

Although it is widely appreciated that a building is stiffened when cladding (roofs, walls and floors) is added to its framework, this effect is often disregarded in structural design. Consequently, actual stresses and deflections in clad frames are generally quite different from the calculated values. Whether or not a building is designed for this effect, interaction between frame and cladding will always profoundly affect structural behavior. If the effect is disregarded, it must not be imagined that the resulting design is always conservative since, because the cladding is so stiff, it usually attracts a great deal of load to itself and so may well be overstressed. How much better it

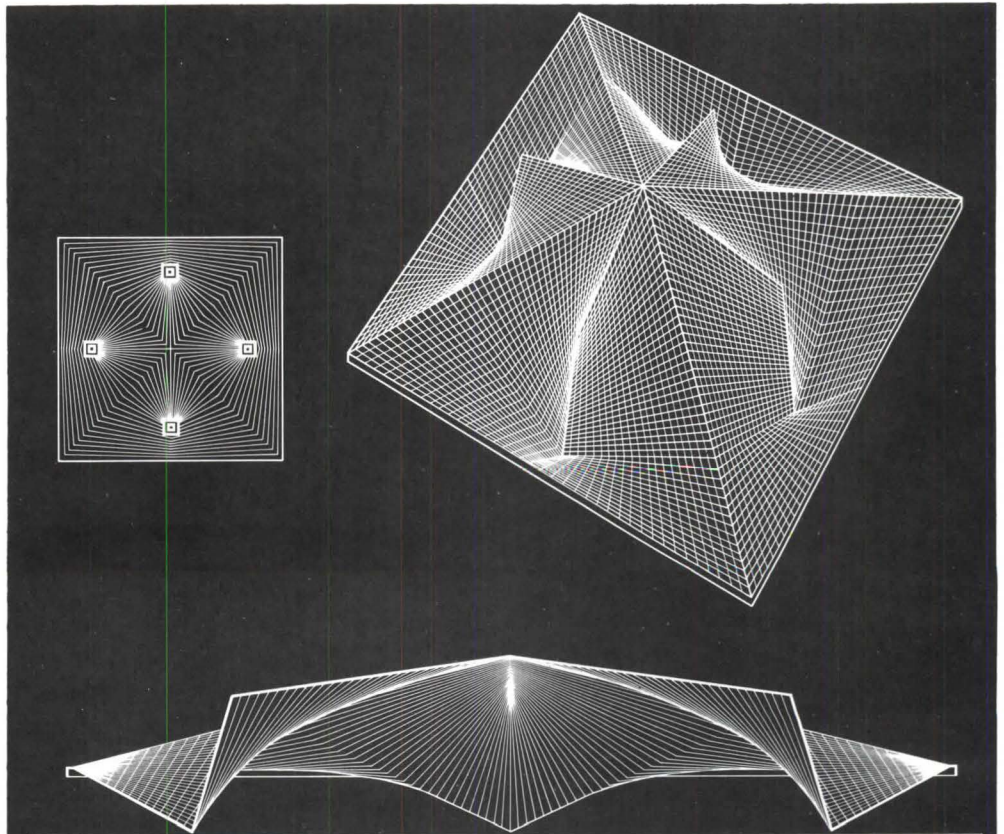

Courtesy, Student Publication of the School of Design, North Carolina State

is, therefore, to allow for the effect of the cladding logically and safely so that the calculations will predict the actual behavior of the building. At the same time, substantial economies may be made in the design of the building frames. This concept, called "stressed skin design," has been widely used in the design of aircraft, cars, ships and trains, as well as in buildings.

Bryan's report outlines methods of analysis of stressed skin structures, summarizes the position of several countries' building codes, as of 1976, concerning such design methods and describes several buildings designed by such methods, particularly schools, libraries and other public buildings that have used the roof deck as a stressed skin element.

Light Frame Structures

By S. K. Suddarth (Purdue University), W. L. Galligan (U.S. Forest Products Laboratory) and H. M. Montrey (the Weyerhaeuser Co.) Excerpted from *Construction Specifier*, December 1977.

Price and structural quality in light-frame buildings can be quite unrelated, particularly in the residential market. The buyers of homes cannot measure and so cannot appreciate levels of structural quality. If the engineering quality cannot be sufficiently identified so that its value can be reflected in price, it cannot participate in the profit margin. Structural performance beyond the mandates of codes, the requirements of mortgage lenders or the estimated future values of reputation cannot be rewarded.

Have we progressed enough in our present age of science to bring structural quality into the light and measure it? Perhaps we have. Much hope lies with combined application of the sciences of mathematical statistics, engineering and economics. One hears terms these days that indicate movement in the right direction—"limit states," "reliability engineering," "service life expectancy" and "life cycle costs." These are being spoken by quantitative people, professionals who deal in numbers. The objective is one of appraising the construction, its materials, its construction process and possible service conditions—all in numerical terms that tell how well the building is expected to perform during its lifetime.

The problem is defined and the need is clear: Develop realistic measures of quality and apply them to long-term economic evaluation. Solution requires that the factors that define building performance be dissected by mathematics to describe their variability; then the set of all factors be reassembled analytically to arrive at a numerical appraisal of the structural reliability.

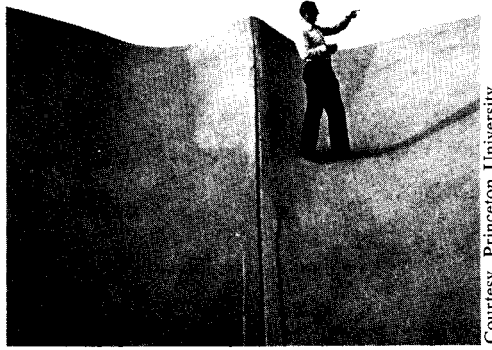

Courtesy, Princeton University

Heinz Isler on the concrete shell roof of his Heimberg tennis center, 1979.

The field of structural engineering already contains a viable activity in probabilistic engineering with a substantial literature base as evidenced by recognized activity within the American Society of Civil Engineers. Scientific interests are now evident in studies at the U.S. Forest Products Laboratory, the Canadian Forest Products Laboratories, Purdue University, Washington State University and in other research organizations involved with wood construction. Efforts so far, however, to apply probabilistic notions to wood structures are attempting to "feel the elephant."

A new look in light-frame engineering is on the way. The question now is whether the advantages can be anticipated by the essential elements of the building community—can coordinated support be mustered for goal setting in a realistic and effective time frame?

The Art of Heinz Isler

By David P. Billington, school of architecture and school of engineering and applied science, Princeton University.

Billington has organized for Princeton's art museum a series of exhibits on the bridges of Robert Maillart, the bridges of Christian Menn (a follower of Maillart), St. Louis' Eads Bridge and other subjects. The most recent, seen there last spring, was on the thin-shell work of Heinz Isler. The show was supported by the Ciba-Geigy Corporation and by the National Endowment for the Humanities, the National Endowment for the Arts and Princeton's school of engineering and applied science. The following is an excerpt from Billington's text for the catalog:

Isler's philosophy is that every structure should be seen first as a whole and only afterward as parts. The prevailing academic attitude toward the study of structures has been analytic in the sense that a structure is cut up into parts, which are then analyzed with highly mathe-

tical means. This approach leads to an emphasis on forms that can be well analyzed, leaving out completely those forms for which no mathematical analysis exists; it also omits esthetic judgments even on those analyzable forms. Pierre Lardy's teaching at the Federal Technical Institute in Zurich tended to reverse that analytical approach and to describe overall form before attempting to analyze it or before seeing it as parts. One reason physical models appealed to Lardy was that they provided a means to study forms for which no mathematical analysis was available.

Thus what Isler, Menn and many others got from Lardy was a strong emphasis on models as a means of expanding design possibilities, on esthetics as a primary design objective and on overall form having precedence over analysis of parts.

Three types of designers work with three-dimensional forms: the engineer, the architect and the sculptor. Each professional must consider three different sorts of criteria in making a form. These are scientific criteria, social ones and symbolic ones. The first essentially comes down to making structures with a minimum of materials and yet with enough resistance to loads and environment so that they will last. This efficiency-endurance analysis is arbitrated by the concern for safety. The social criteria comprise mainly analyses of costs as compared to the usefulness of the forms by society; such cost-benefit analyses are set in the context of politics. Finally, the third criteria, the symbolic, consist of studies in appearance and how that can be achieved within whatever constraints the scientific and social criteria permit; this is the esthetic-ethical basis upon which the individual designer builds his work.

For the structural artist the forms arise out of scientific studies, while for the architect they come from studies of use. Bridge engineers like Maillart and Menn started with relatively simple criteria for use and developed subtle forms to achieve minimum materials with the lowest possible cost. That they shaped these forms with appearance in mind makes them artists. Engineers for long-span roofs like Isler and Nervi also started with relatively simple criteria for use and also developed subtle forms based on minimum materials and cost. It is their success in expressing visually these scientific and social goals that makes them structural artists.

Concrete as a material tends to crack. The thin-shell solution is a structure made as thin as practical, which is at the same time mainly in compression. The designer best satisfies the goal of achieving structural soundness and a pleasing form by making a form that is doubly curved (a dome as opposed to a cylinder) and that

continued on page 94

Evaluation: Trussed Tube Towering Over Chicago

'A building that works, like Mayor Daley's city used to be.' By Andrea O. Dean



Ezra Stoller © ESTO

When it was built in the late '60s, the John Hancock Building attracted attention mainly for its monumental scale and appearance, both products of its structure. The tapered and trussed, blunt, black blockbuster, elegantly detailed and stripped to essentials, was then the tallest building in Chicago. It remains the world's largest mixed use complex in which apartments are layered over offices.

Big John, as it is called in Chicago, is a stack of 700 apartments (with commissary, restaurants, a pool, track, observatory and other "amenities") atop 810,000 square feet of offices on 30 floors, above a seven-story garage, over six floors of commercial space. Perched on this upended parcel, wrapped in X-shaped diagonal bands, are two horn-like antennae, 359 feet high, for TV, radio and microwave transmission.

All this was made possible by a then-novel structure—essentially a trussed steel tube—which allowed the Hancock to rise 100 floors at a per square foot cost no higher than for a 30-story building. Architect Skidmore, Owings & Merrill of Chicago never repeated the system for the same reason that such a singular image as the Eiffel Tower was never reproduced. But SOM did use the principles created for the Hancock to develop a structural vocabulary that spawned a new generation of giants, including the Sears Tower in Chicago and a mixed use complex scheduled for completion in spring of 1983 two blocks north of the Hancock.

Hancock's visual image was intended to project the "gutsy, masculine, industrial tradition of Chicago where structure is of the essence," in the words of chief designer Bruce Graham, FAIA. Inside and out, the building embodies a machine-made environment, standardized, technically perfected and super-rational. It relates to nature primarily as something to be looked at, and from afar at that, in the form of open spaces and spectacular views. Removed also from the hustle and aggravations of city life, the building has been compared to a space capsule or ocean liner. (Structurally, it is, in fact, a bridge standing on end.) Inside, it is an insulated, tidy, quietly elegant and tranquil city floating above the noises, social disharmonies, human drama and discourse of everyday urban life.

Big John is the largest real estate investment ever made by the giant, 108-year-old insurance company, John Hancock Mutual Life, and its structure and form grew out of economic and use requirements. Location dictated that the building include apartments and commercial space, rather than just offices as does the Hancock in Boston. The neighborhood on Chicago's North Michigan Avenue was, and remains, an elegant shopping and residential area. Chicagoans, more than any other U.S. urban dwellers except New Yorkers, have embraced highrise living to the point of being willing to pay more for greater height and the ever-more spectacular views. Before Hancock's success proved otherwise, however, the neighborhood, remote from the Loop and good transportation, seemed unsuited for large-scale office development.

The original scheme called for two 700-foot towers, side by side, one for offices, the other for residential use. This would have left apartment dwellers peering at views of adjacent offices, and being peered at. Although placing apartments above offices in a single building was considered impracticable at the time, it would provide residents with unobstructed views and privacy, and Graham wanted to try it. The obstacle was cost. For with traditional structural methods, the higher a building, the higher its cost per square foot. As SOM-Chicago's engineering partner



Hedrich—Blessing

Fazlur Khan puts it, "It was an economic problem at first. Bruce said, 'If you create a structure, we'll make architecture out of it.'" Kahn, the first engineer ever to be made a partner of the Skidmore firm, devised a diagonally trussed steel tube, essentially a bearing wall structure and, together with Graham, transformed it into architecture.

It was a very simple concept, says Khan, of "trying to employ exterior structure to develop the entire strength and stiffness of the building, which would eliminate traditional barriers to great height." No interior bracing for wind would be required and the vertical load alone could be the determining factor for the amount of steel required. The diagonals would act as inclined columns, carrying the compression and the loads, the entire tube acting as a wall rather than a wind bracer. Since the diagonals would remain in compression throughout, Khan explains, they could simply be butted one against the other, without a lot of tension welding. "The entire building would be represented in terms of strength and stiffness at the joints; whatever was inside would be free as in a low, bearing wall building." The system devised by Khan would require only 29.7 pounds of steel per square foot as contrasted with the usual 45 to 50 pounds for a traditional frame highrise.

Sway at the top and omnipresent structure.

The core would support only itself and a portion of the floor load. Floor-to-ceiling heights could be flexible, except that a slab would be needed at points where diagonals and vertical members meet. This would allow the architects to insert four apartment floors for every three of office space where higher ceilings were required. Tapering the building would give long spans for office spaces, shorter ones for apartments. It would also reduce the effect of wind pressure at upper reaches of the building, where gusts are strongest, since there would be less "sail area."

The steel structure would also allow elevator shafts to be discontinuous and rentable space to be grabbed where they were dropped. Says Graham, "If you have a very big building, you have to look at everything, including transportation, in a new way." An express elevator would go from ground level to the apartment "skylobby" on the 44th floor, from which a local elevator would take over. This had the dual advantage of requiring less core space for elevators on lower levels and providing tighter security for apartments.

Once the basic principles and materials—steel, tinted glass, duranodic aluminum cladding—were selected, computers worked out the details, and wind tunnel tests were made to ensure that the structure would withstand wind and rainstorms far more severe than any Chicago had ever experienced. Among the numerous experiments that Khan performed before construction was one to measure how the building's motion would be perceived at upper stories. Interestingly, he found that people did not feel building movement until wind speeds reached 65 mph, regardless of their psychological state or physical position—supine, seated or standing. His tests showed that with 100 mph winds, movement would become "strongly perceptible, but still not disturbing." When the wind blows 40 mph, the building sways only three inches at its top.

Finally, the complicated job of constructing the huge building began. For putting in its foundation caissons, the most powerful drilling rig in the world, so it was advertised, was built (5 million inch-pounds torque). At least one of the 57 bedrock shafts went 191 feet, the deepest sunk until then in Chicago. More than 42,000 tons of structural steel and 2.5 million pounds of duranodic aluminum went into the frame.

Yet, the Hancock doesn't look grossly out of scale, except when viewed from the southwest corner (North Michigan and Chestnut Street), where two sides of the 260x160-foot rectangle are in full view next to its much smaller neighbors. Even here, however, the taper of the form helps reduce the feeling of bulk, as does the fact that the building is set back from North Michigan. (It occupies only 50 percent of its site.) The "Xs" formed by intersecting diagonals, which diminish in size as they soar, tend to exaggerate perspective, making the building appear to zoom upward all the faster and higher, or descend with a great rush, depending upon how you perceive it. The steel structure is set on a travertine base with separate, setback entrances for each of the building's distinct functions. This reduces the bulk at street level.

The Hancock's sunken plaza on North Michigan, lined by service-type commercial spaces, is probably its least successful space. About the size of the plaza at Rockefeller Center in New York City, it was planned as an ice rink in winter—but the compressor unit was underdesigned and the ice kept melting—and reflecting pool in summer—which wasn't very practical either with winds blowing dirt and debris. The corner of Delaware and North Michigan is probably the windiest in the windy city, an inevitable effect of Hancock's great height. According to Khan, nothing short of enclosing the space with an arcade would still the gusts.

Today, the plaza is paved with dark granite; there is some landscaping and a small number of concrete benches. Visitors are scant, for it is unshaded and hot in summer, cold in winter

and devoid of attractions all year around. For the last, SOM holds management of the commercial spaces responsible. Originally, Bergdorf Goodman had contracted to lease most of the commercial spaces in Hancock. They had, in fact, been designed for Bergdorf and, according to Graham, the retailer had planned to line the plaza with boutiques and restaurants, and enliven it with fashion shows and other activities. But Bergdorf pulled out during construction, was replaced by Bonwit Teller plus an assortment of service-oriented enterprises, and the plaza remains lifeless.

Unlike the plaza, which is a simple but unusable space, Hancock's complex ground floor layout turns out to be workable, well planned. On the west or main facade is the entrance to offices, from which escalators ascend to a mezzanine lobby with elevator banks plus the large U-shaped spaces of the Upper Avenue Bank. The apartment lobby is entered from the north where express elevators shoot up to the 44th floor skylobby. Autos enter the building on the east, elevators to the rooftop restaurant are on the west. Bonwit has entrances and display windows on three sides of the building. The store is broken into smallish spaces, which the retailer employs to its advantage as boutique-like sales areas. Bonwit occupies space on floors one, three and four, which appear to the shopper to be one, two and three, because they are so marked in elevators—a harmless deception.

Graham describes the interior public spaces as "not very special. Everything is very simple and understated." In fact, Hancock's interiors are quite special precisely for their simple design, attention to details and pleasing, quiet colors. Most important, perhaps, the scale is comfortable. Says Graham, "Human scale is a Chicago phenomenon. Mies, Sullivan, Burnham—all tended to be responsive to middle class America. That's who we're talking to, not to pomposity, financial genius and all that. It's a more real world here than in New York, which is much more abstract, so the buildings become abstract."

This sense of the concrete and comprehensible is underscored by use of the building's structure as primary esthetic element inside and out. Says Graham, "I had always thought that the Eiffel Tower was a marvelous structure to look through. You were aware that you were up in the air, because the structure was around you. I had a predilection for the diagonal from the start." Khan speaks of the diagonal as "contributing to the sculptural elegance of the spaces within. The diagonal members in windows give spaces an unusual sculptural effect. The two intersecting diagonals looked at from inside the second floor office lobby as well as the apartment lobby on the 44th floor are particular examples of the structural esthetics of this frame as perceived from within." The diagonals are, indeed, singularly elegant design elements in the two double height lobbies. But in



Photographs by Ezra Stoller © ESTO

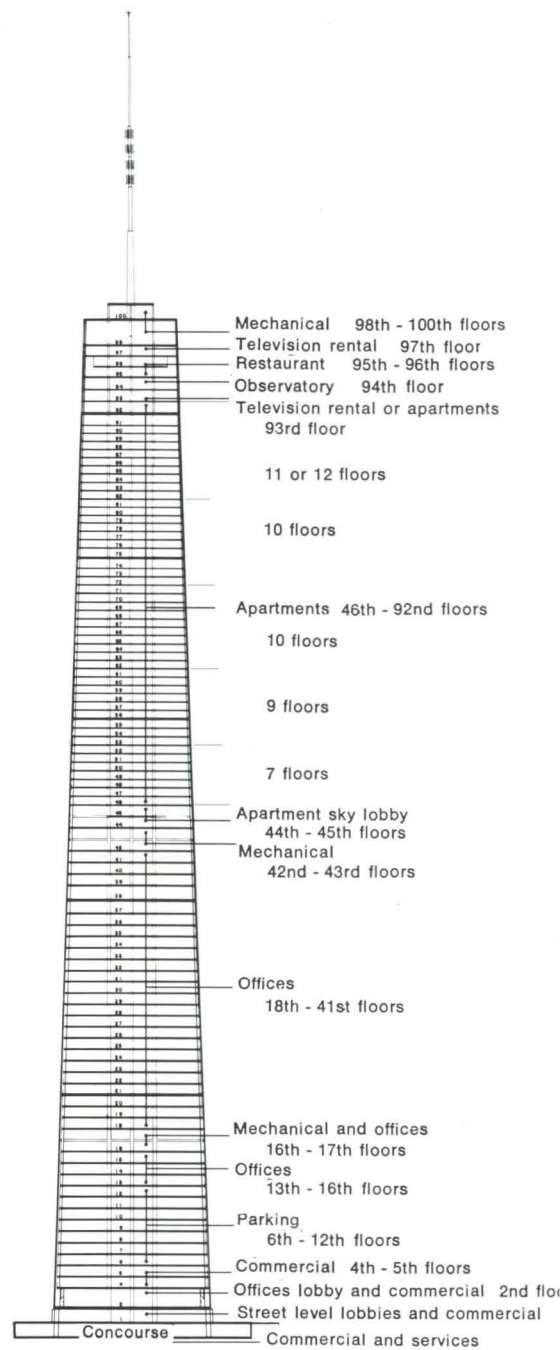

On the 44th floor, with splendid views of the city below, are such 'amenities' as the swimming pool (facing page) and the sky-lobby (left) with soaring diagonals. Street level entrances are scaled to blend with the neighborhood, and a seven-story spiral ramp acts as counterpoint for the steel/glass building (above left).

Ambivalence about Big John's size and muscle.

single-story spaces they tend to look squat and awkward. They also block light.

Some announcements for available apartments, in fact, advertise "no diagonals." In bedrooms, they do create comfortable nooks; in living areas, they have been variously mirrored, papered, paneled, made into bookcases, used as dark sculptural objects against light walls or light sculptural objects against dark walls. Graham maintains that residents cherish the diagonals as symbols of the building; in the main, however, people do not seem to feel strongly about them one way or the other.

The apartment floors go through five changes of layout, adjusting to diminishing area. Most of the smaller units are concentrated on lower, deeper floors, leaving higher stories with more window space for larger apartments, which need it. All units sell quickly despite horrendous prices, mainly because of the building's incomparable convenience and views. Complaints from residents are few and minor: the swooshing noise and puffs of wind produced in elevator cores by stack action on windy days, the nuisance of having to take three elevators to get home from the garage. The double elevator system from ground to apartments seemingly disturbs no one. Residents take for granted the short ride that transports them to the skylobby where they pick up mail, shop for food and pick up dry-cleaning before going home. Because of the Hancock's convenience and convenient location, close to 30 percent of residents have sold their cars—10 percent work and live in the building.

Mildred Hall, coauthor with her husband Edward T. Hall of numerous books on architecture, including *The Hidden Dimension*, lived at the Hancock on three different occasions. She says that at first she heartily disliked the building on principle, objecting to its scale, feeling it was "the ugliest building ever built and had changed the skyline of Chicago and the immediate neighborhood by dwarfing superior buildings." She now regards it as an almost perfect place to live in the middle of a big city.

She covers most of the points made by others who live at the Hancock: "I only wish there were buildings like this in every city. You can do everything in it—your banking, Xeroxing, shopping. Almost every service you need is right there. If you worked at it, you could certainly find a doctor and dentist in the building. In that godawful climate, who wants to go out? I only wish more architects would provide all these amenities and face the fact that women work and don't want to be marching to nine places on their way home, running around looking for a laundromat—all that. The only problem is that we were above the 60th floor and had to call the doorman to ask what the

weather was. We were often in the clouds, with no sense of the outdoors.

"Not only is Chicago a terrible climate, but it isn't the safest place in the world to be wandering about, either. Security at Hancock is excellent, not only because of the elevator system, but because of the doorman, who immediately knew who belonged to the building. The acoustic privacy is extraordinary. Both Ned and I worked at home. The woman next to us had an organ and, let me tell you, if you can have a neighbor with an organ and not be driven bananas, that's good acoustics. There are thousands of people in that building, yet you're never aware of the hordes, and that's the secret of high density. Density is not a dirty word; it has to be planned for, and they did. My only real complaint about the interior of the building is that they forgot to put in mail drops."

Rumors have it that at the upper floors the Hancock's sway makes chandeliers swing and water in sinks slush about as in a boat in heavy seas. In fact, the building's very slight sway is not mentioned as troubling. Perhaps disconcerting, but still not troubling, is that on windy days the building's structure makes creaking noises like those heard from the rigging of large ships.

Although designed before anyone thought of conserving energy, the all-electric building is far less wasteful than might be supposed. Windows are double glazed and do not go from floor to ceiling. In offices, especially, the ratio of floor space to glass is relatively high, and windows have recently been covered with a Mylar-type film to reduce solar gain. Remarkably little heating is required in apartments, since the offices generate heat, which flows upward.

As William Waddell, who now works as an engineer for Watertower Place, says of the Hancock, "It's a building that works. It's like Mayor Daley's city used to be."

Another attraction of living and working at the Hancock is the superb shopping on North Michigan Avenue, much of which Hancock's very existence has attracted. The building's residents are affluent, and most of its 4,000 office workers are managers and professionals who also have money to spend for shopping. The building also holds a fascination for Japanese businesses (Mitsubishi has offices there) and tourists, who pack the 94th floor observatory and the Hancock's restaurants. Several retailers, among them I. Magnin, have moved to North Michigan and, of course, Hancock's success as a mixed-use building spawned Watertower Place, Big John's esthetically inferior neighbor on the south. Watertower's site belonged to the life insurance company. Hence the setback of its tower—to leave views from Hancock's apartments unimpeded.

There is little doubt that the Hancock building drastically

The black, antenna-topped Hancock dominates the skyline (right, in view to the south), including, directly south, Watertower Place. The building's tapered form and diagonals (facing page) exaggerate perspective and, thereby, its upward swoop.





BUNWIT TELLER JOHN HANCOCK CENTER BUNWIT TELLER BUNWIT TELLER

Photographs by Ezra Stoller © ESTO

altered both Chicago's skyline and the neighborhood on North Michigan Avenue. A common reaction to Big John's outsized image, scale and concept is ambivalence. Sculptor Claes Oldenburg has compared it with "The Statue of Death" by Lorado Taft in Chicago's Graceland Cemetery. The statue, wrote Oldenburg, "has a shape like the Hancock building, and the Hancock building resembles the black slab against which the sculpture stands." He calls the building "a highly funereal structure," likes it, but feels "resentful of its scale." A young man who works in the Hancock puts it this way: "I think it's very attractive, but sometimes I look at this big, black building and I think it's like a big blackhead, a big sign of power—very evil."

The structural principles employed for the Hancock were used, without the diagonals, first at the Sears Tower, where nine steel tubes of different heights are bundled together into one building. They will be further developed in SOM's newest addition to Chicago, another huge, mixed use complex called One Magnificent Mile, to rise on a site two blocks north of the Han-

cock. It will be a triad of hexagonal reinforced concrete tubes of varying heights, once again bundled as a single structure, whose tallest tower will be 58 stories. Says Khan, "Sears established that the bundled tube is a vocabulary, not a system, as at Hancock. We have extended it, made it more flexible. We can now let the tube happen on the basis of program and site; it has become a moldable shape."

As Paul Gapp of the *Chicago Tribune* wrote recently, with Hancock and One Magnificent Mile, Skidmore, Owings & Merrill has "dealt with the problem of bigness as well as anyone could expect. Acknowledging this fact of life can only aggravate our sense of foreboding about bigness eventually taking over. . . . We are the envy of many large cities where *nobody* lives downtown. But we pay a high price for this. As the big drives out the small, we lose many of the amenities and qualities of the urban fabric that make people want to live downtown in the first place. Have we perhaps reached, or even passed, the critical point of diminishing returns?" □

Evaluation: Composition of Cubes in Tokyo

An intended prototype of prefabrication remains one of a kind. By Hiroshi Watanabe

During the Osaka exposition of 1970, a developer named Yuzo Watanabe discovered a pavilion called the Takara Beautillion with capsules lodged in a jungle gym of steel pipes, the brainchild of architect Kisho Kurokawa.

Then 36, Kurokawa had launched the metabolist movement with Kiyonori Kikutake, Noboru Kawazoe and others a decade before. The Osaka exposition was the turning point in his career and the occasion of his elevation to public figure status. He designed not only the Beautillion but the IHI Toshiba pavilion and the theme pavilion's capsule as well. The future, it seemed, had arrived with Kurokawa as midwife.

The developer too was not one to be left behind. After practicing law for five years, Watanabe was "fired with the ambition to build an office building during the turbulent postwar period." His first venture in real estate proved a failure, but as the history of the company quickly informs us, "the lessons he learned then in the spirit of scientific and rational study and the effective application of capital became the basis for today's Nakagin." When postwar reconstruction was virtually completed and land became more difficult to acquire, the company hit upon the idea of using air rights; "We'll buy your sky" was its slogan.

Developer met architect, and the concept of a capsule apartment and office building was born. Each capsule in the cooperative building would be a compact space, rationally organized and equipped with up-to-date gadgetry, where a businessman could closet himself—that was about the size of it—and get some real work done, away from all distracting influences. It would also be a convenient home away from home for those from outside Tokyo. (Kurokawa quipped to critic Charles Jencks that the capsules with their round windows were meant to suggest Japanese bird cages for out-of-town businessmen and bachelors "with their birds.") Nakagin Inc. happened to have a 4,750-square-foot property in the Ginza area of Tokyo, and the choice locale and the high visibility any structure there would enjoy made it ideal for the site. Construction began in April 1971 and at the end of March the following year the Nakagin Capsule Tower Building was completed. Nakagin itself took possession of the office space on the first two floors. The building received wide coverage in the media, including television. The price of a capsule 8.2 feet wide, 13.1 feet long and 8.2 feet high was \$12,300 to \$14,600 at the exchange rate then. This came to an expensive \$115 to \$136 per square foot, but all the capsules had been sold by the time the building was completed. (Some owners apparently bought them as investment; for two or three years afterwards, they were being resold for twice the original cost. Even today they may fetch \$26,000 each.)

The building has one basement floor. Above ground stand *two towers 11 and 13 stories high* from which the capsules are cantilevered. The building is made up basically of three parts: the main structure, which includes stairs and elevator shafts; the capsules, which were assembled to nearly 90 percent completion at a factory in Shiga prefecture and then brought to the site,

Mr. Watanabe has a private architectural practice in Tokyo. He was a correspondent for *Architecture Plus*, and contributed to this magazine's special issue on Japanese architecture last November.

and the mechanical room and prefabricated units for piping.

The main structure is steel and reinforced concrete rigid frame. For the sake of economy and to be able to use the stairs as quickly as possible during construction, the floors and the walls around the elevator shafts were made of precast concrete. For the foundation two types were considered but, for reasons of scale and economy, the decision was made to spread the foundation laterally to balance the structure. Although it is possible to go from tower to tower at every third floor, the pair is structurally tied only at the base; shear walls run the length of the basement.

The piping was assembled in racks three stories high and attached to the main structure. Each rack contains water supply and return, hot water, airconditioning supply and return and drain pipes. These were attached to the capsules by means of flexible tubes. Both for this work and for future repairs, a part of the capsule floor was made openable. (Capsule owners complain about having the flooring disturbed every time something goes wrong with the pipes.)

The capsules are welded trusses of light gauge steel. Each side of the truss was assembled with a jig, and then a three-dimensional jig was used in welding all sides together. (The factory in

Capsules were attached to frame from bottom to top. Special fanlike blinds (below) were designed for the circular windows.

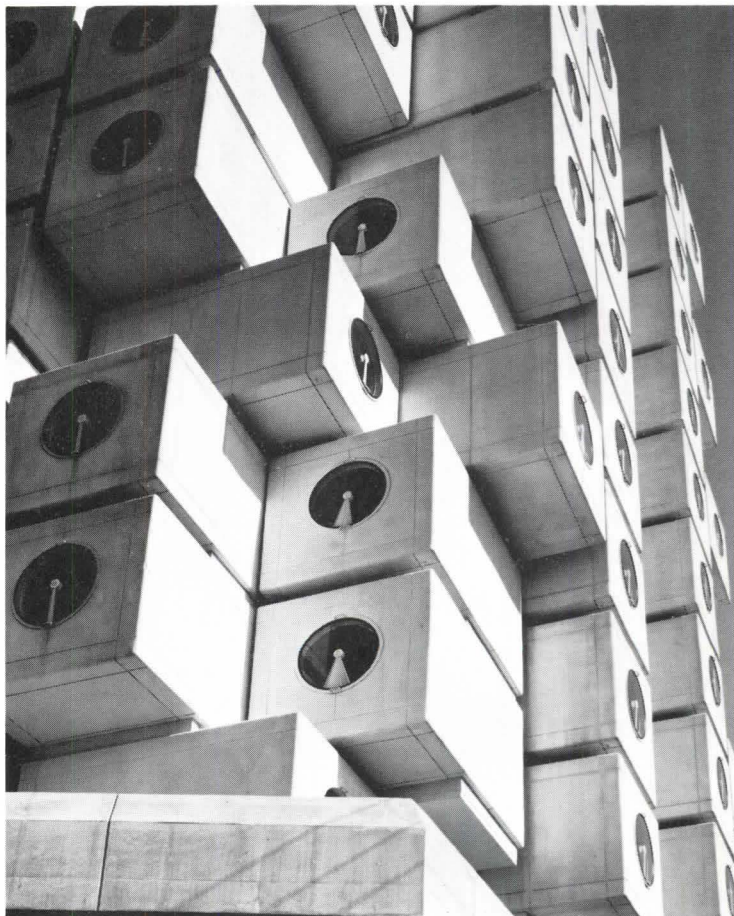



Photographs by Tomio Ohashi

Shiga normally manufactures trains.) The exterior is made from .048-inch thick bonderized steel sheet panels, sized approximately 3.9x7.5 feet for handling by a single person. The corners could not be pressed because the number made it uneconomical, and so much of the work was done by hand. For fire protection and heat insulation, the main structural members were sprayed with more than 1.8 inches of asbestos and the exterior panels with over 1.2 inches. The bathroom is of single-body reinforced plastic construction. There is one fixed, steel sash window, 4.3 feet in diameter. (To permit entry by firemen, a few windows were made openable.)

Because the small size made it difficult for more than one person to work on a unit at a time, the architect wanted to have the individual parts manufactured at other places and to simply assemble them at the factory, but a great deal of wet construction and conventional work was nevertheless necessary.

Each capsule is attached at its top and bottom to the main

structure. In fastening units, work proceeded from the lowest story to the highest. This and the fact that not much space exists between capsules meant that there was little working area for attaching the bottom joints. It was decided therefore to let these simply restrict lateral movement. Mortar was poured into brackets projecting from the main structure; into these were lowered short pegs connected to the bottom of the capsule. Four high-tension bolts attached from within the capsule by means of a torque wrench constitute the upper joints. For fireproofing and durability, the joints were wrapped in lightweight concrete.

A capsule may have a door on the long or the short side, and a window similarly on the long or short side. The door of a capsule may be "right-handed" or "left-handed." There are, in all, eight types of capsules structurally, two types of structural joints, four types of piping structure, eight types of interior finish and two types of bathrooms. The permutations are therefore considerable; with only 140 units, not all the possible types were

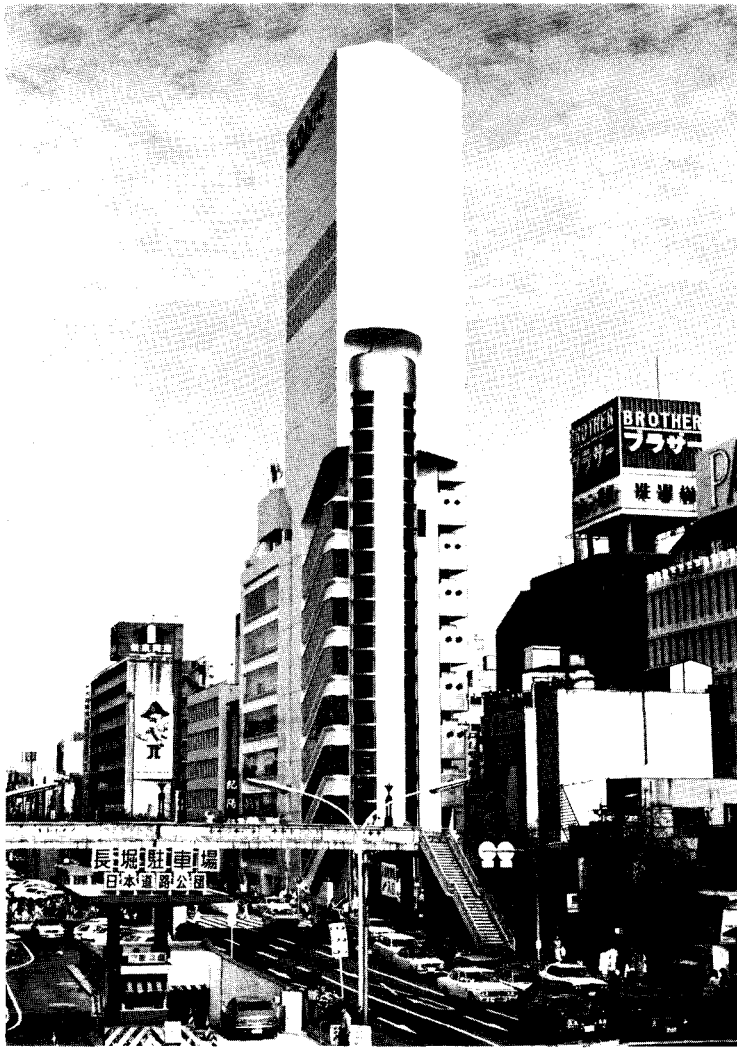

A still theoretical possibility of replacement.

used, but the variety does seem to belie the claim of mass production potential.

Owners were given a choice of colors, interior finish and some appliances. A bed, storage cabinets, bathroom, color television set, clock, refrigerator and airconditioner were standard equipment. A stereo, tape deck, air cleaner, sink, table light and desk calculator were optional. Linen and cleaning service, the use of a copier and the services of a front desk on the first floor were also available.

There was speculation that mass production would bring significant lowering of cost and heady talk of shipping capsules overseas to foreign developers.

Eight years and several oil crises later, the view is not so optimistic. Nakagin Inc. went back to dealing in conventional apartments, and they lose money every year maintaining the Capsule Building. (They do not mind that too much, apparently, since it still serves as their widely recognized corporate symbol.) Kurokawa subsequently used capsules in only three projects: a small house (1973), the Sony Tower in Osaka (1976) and the National Ethnology Museum (1977). The foreign deals never materialized, and, needless to say, the dream of mass production remains a dream. Now working with big institutional clients, he designs solid, imposing structures, odd for a man who once advocated a dynamic concept of urbanism. Even before his buildings in proper metabolist fashion had metamorphosed, the man had.

Of the 140 capsules, some are not being used or are used only infrequently. About 35 persons actually stay overnight regularly, and the rest use the capsules only during the day. Among those who use them as offices are accountants and travel agents.

Nakagin Inc. is finding that combining hotel, apartment and office functions can lead to difficulties. The building must be kept open at all hours and someone is at the front desk *all night*. There is a security problem; since some capsules are used as offices, people must be allowed to come and go as they please, although in other apartment buildings of any pretension, entry is restricted. Rising fuel costs are also a problem, and the building has recently stopped supplying hot water during the night. The owners are billed separately and directly by the telephone and electric companies, but fuel and water bills are footed by the building as a whole. Each owner pays a maintenance fee of about \$75 per month. This may not seem like much, but when considered in terms of the capsule area, 100 square feet, it is high.

These are problems that arise not so much out of the architecture as out of the original program and merchandizing scheme. There are, however, matters that have to do with the building itself. Considering the amount of traffic in the area, the exterior paint has stood up well, but the time obviously has come for a recoating. Not a small amount of the high estimated cost is for the involved scaffolding required by the building's peculiar facade.

The capsules themselves have been the source of complaints. The space being small, cigarette smoke and water vapor from the shower often activate the fire alarm, and the smoke sensors are now being replaced by heat sensors. Many of the folding fan-like window screens made of Japanese rice paper have been torn, and few owners are in a hurry to have these custom-made features replaced. Conventional curtains have gone up in many units.

Complaints, of course, are voiced that the capsules are cramped. Inside, the unit is approximately 7.5 feet wide, 12.5 feet long and 6.9 feet high. One must be blessed with a certain amount of inner tranquility or resignation to spend the whole day, not to mention the night, there. Without the airconditioning, the room with its one fixed window would soon become intolerable. It is questionable if such a total dependence on the mechanical system is a good idea. Should the system ever break down in midsummer, the birds in their cages are likely to be broilers.

If there was anything consistent in the diverse oeuvre of the metabolists (and the proto-metabolists like Tange) in the '60s, it was the expression of incompleteness and the possibility of change. The theme pavilion that Tange created for Expo in 1970, with all the gadgetry and capsules nestled under and inside a giant space frame megastructure, was prefigured by the Sky House that Kikutake designed in 1958, in which mechanical devices were meant to be exchanged in the future for newer models and in which a child's bedroom was to be slung underneath the basic structure. In 1971, therefore, Kurokawa almost *had* to make his capsules replaceable in order to maintain his credibility as a metabolist.

Any capsule is supposed to be replaceable "theoretically," without disturbing the others. There are three things that might, however, stand in the way: money, other owners and the architect's own design.

The construction cost for each capsule was \$4,500. Today, it is estimated that a similar capsule would cost three times that. There would then be the perhaps heavier cost of actually removing and attaching capsules. Legal problems may enter in because of the other owners. Strictly speaking, each owner has the right to his capsule and can replace his own if he so chooses. Any such proceeding, however, would probably need general approval. Considering how much trouble Nakagin Inc. is having getting an O.K. for pipe repairs, the obstacles to this much more serious undertaking seem insurmountable.

Across page, the completed tower. Above left, Kurokawa's Sony Tower, in which the capsules were used only as toilets. Right, the fully outfitted Nakagin capsule.

In many of the metabolist projects, the asymmetry and the purposely unfilled gaps that suggested buildings in the process of growth are so artfully designed that one suspects any real metamorphosis of the building would be esthetically detrimental and unwelcomed. The gaps in Tange's well-known building in Yamanashi—with its huge round columns and spanning office spaces—in fact have been filled in to a great extent, and the composition is as a result far less dynamic. The picturesque irregularity with which the Nakagin capsules are attached was achieved not without much calculation, evident in the elevator and stair connection; for 50 percent of the units, one has to walk up or down after taking the elevator. The way the units interlock cannot but hinder any operation to replace one of them without disturbing the others, despite Kurokawa's assurance. The appearance of replaceability, therefore, was at least as important as the fact.

One wonders if there was not a price paid for leaving open even that remote "theoretical possibility" of replacement. The capsules themselves are solidly built and watertight, yet the joints between the capsules and the main structure may be vulnerable. Water reportedly has seeped in through the joints into the corridor during heavy rains. Ironically, the first things to be replaced may prove to be not the units themselves but features of their connection to the towers.

The dream was to mass produce the capsules, but a large market would be necessary. The level of consumer sophistication in Japan has risen considerably in the last 10 years, and even the Japanese, accustomed to living in "rabbit hutches," as some observers described Japanese housing, would balk at the cramped capsules as a general housing solution. The truth is that the capsules provide an answer for only very special situations. When asked if he saw any influence that the capsules have had on the Japanese scene, a man at Nakagin thought for a moment and then replied, "Yes, in the prevalence of package construction site offices that are easily transported from one place to another." The architect himself apparently acknowledges the special character of capsules. In subsequent designs, they play only modest, auxiliary roles. In the Sony Tower, they house toilets.

Built on a choice site that made even its restricted spaces commercially viable, for a client that wanted a different corporate image, and in the wake of the Osaka exposition, that celebration of technology and an expanding economy, Nakagin was special in almost every sense. The ambitious hope of metabolic renewal and mass production has surely been dashed by subsequent events, if not by the design's own conflicting character. □

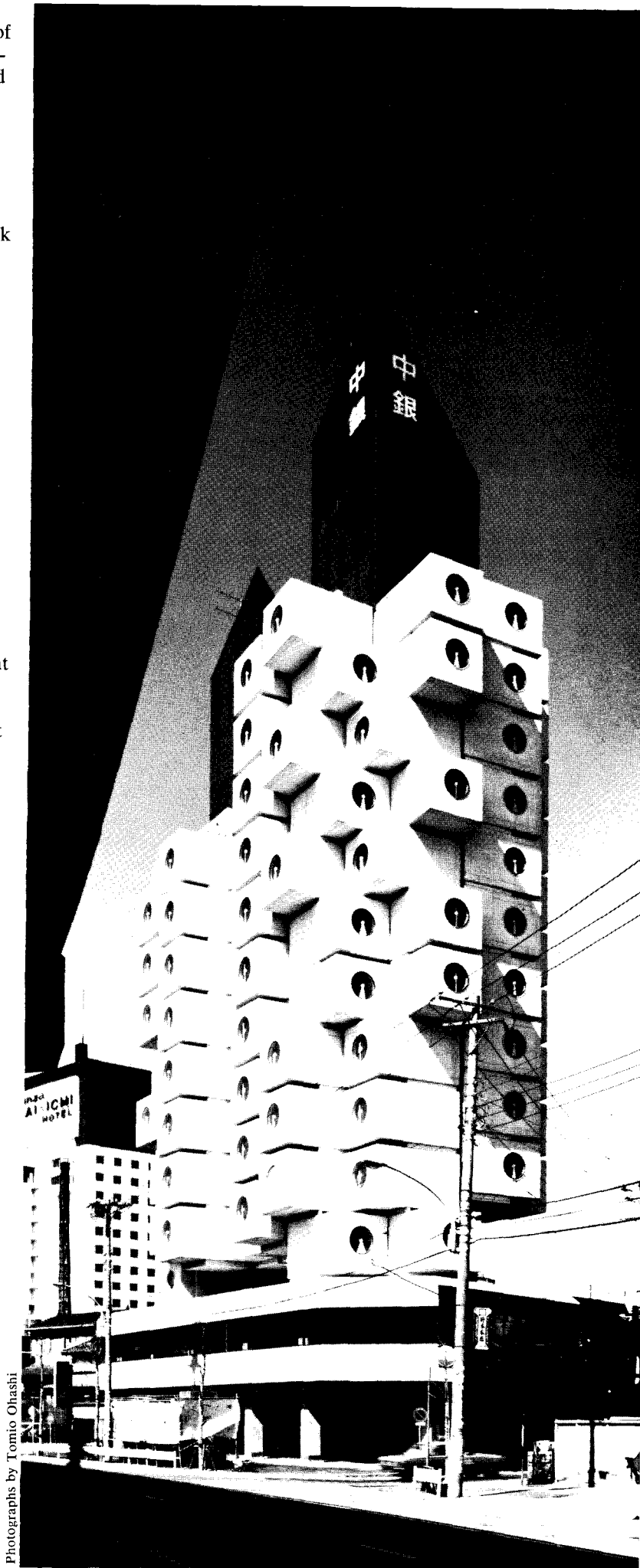
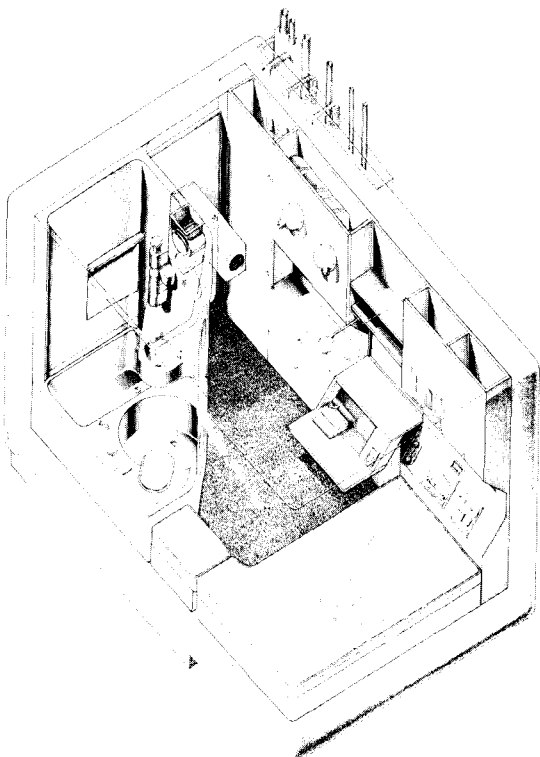

Photographs by Tomio Ohashi





Evaluation: New Mexico's Marvelous Mud

Poor in some ways, adobe is rich in formal and thermal properties. By Gerald Allen

Sun-dried mud bricks are common to most of the semi-arid regions of the world, and in Spanish these are known as *adobes*. The same word has migrated into English, since many parts of what is now the American Southwest were once an isolated and almost unimaginably far-flung region of the Mexican arm of the Spanish empire, and since there is an extensive mud-brick architecture there—particularly in New Mexico and its part of the Rio Grande valley, which stretches from the southern end of the Rocky Mountains down to El Paso, and from there along the Mexican border to the Gulf. The region was sparsely populated and desperately poor, colonized by the Spanish for religious much more than for economic purposes. Initially this demography was very significant to the development of an adobe architecture, since adobe is by just about every reasonable standard—except, as we shall see, for two—a poor material with limited strength, limited durability and limited capacity to be rendered into complex or even regular shapes.

By far the most thorough discussion of New Mexico's historical adobe architecture is Yale art historian George Kubler's *The Religious Architecture of New Mexico* (University of New Mexico Press), a really admirable work now 40 years old, and with an elaborate scholarly apparatus. Kubler points out that although clay, gypsum, limestone, other building stones and wood are abundant in New Mexico, buildings using bricks, lime mortar, stone or wood are rare there until the 19th century, simply because of the inhospitality of the land itself, which required the full efforts of the small population for mere survival. Thus both manpower and time were lacking for the development of more sophisticated building techniques.

Adobe architecture in New Mexico has been created in several different historical phases, two of which still flourish. The native Indian population used adobes during the precolonial epoch, and the Spanish adopted them for their purposes during the colonial epoch which began in the late 16th century. In the territorial epoch, which began in the middle of the 19th century, when New Mexico became a part of the U.S., a third cultural

Mr. Allen works in New York City with Peter Gluck & Associates and also teaches design at the Yale school of architecture. He is coauthor of *The Place of Houses* and *Dimensions: Space, Shape & Scale in Architecture* and author of a new book on the work of Charles Moore, FAIA, to be published this fall.

Photographs by David Muench

Adobe and fieldstone in an ancient pueblo.

tradition was added to the other two already there, and as the population increased, adobe building declined, almost as proof of the point that if resources were available to allow an alternative, the alternative would be chosen.

However, at the beginning of the 20th century an adobe revival—both in terms of retrieving historic structures from oblivion and designing new ones—began to be achieved by a group of people of whom the Santa Fe architect John Gaw Meem, FAIA, was perhaps the most prominent. These enthusiasts, interestingly, were often Americans from the East Coast, and often they were of Anglo-Saxon heritage as well.

More recently still, of course, adobes have swung into the orbits of another group of enthusiasts, the energy conservationists, and this development constitutes the most recent phase of the historical sequence.

Whatever purposes they were used for, adobes have traditionally been made of mud mixed with straw or manure, which helps bond them together, and dried in wooden frames in the sun. These are then laid up using a mortar of similar composition. In the past, foundations were either nonexistent or made of buried logs or rocks. For taller buildings the walls, at least at the bottom, were thick—more than three feet. Sometimes buttresses were added to check the tendency of the structure to bend outward at the top, and sometimes logs were embedded between adobe courses to provide wanted strength and tension and therefore to check the tendencies of the wall both to slump and to crack.

Walls of very old adobe buildings are markedly battered; in many other old adobes, however, they are not, and it is not clear whether the battering, when it occurs, was designed for structural purposes or whether it is the result of poor maintenance and the progressive erosion of the walls from top to bottom.

At the roof level, logs known as *vigas* were laid between opposite walls, and sometimes the ends of the logs were allowed to project beyond the outside wall surfaces, just as they often are today. The spaces between logs on the roof itself were spanned either by boards or by small pieces of split timbers, known as *latillas*. Dirt was then spread over these, and that was that, except that parapets were always included above the roof, perhaps to help prevent the dirt from blowing away. The entire building was plastered with mud, which sometimes had to be renewed annually.

One of the handsomest collections of old adobe buildings in New Mexico is the Acoma pueblo, which incidentally is also the

subject of an episode in Willa Cather's book, *Death Comes for the Archbishop*, the fictionalized account of the life of Jean Baptiste Lamy, a Frenchman who became the first bishop, then archbishop of Santa Fe, and who helped preside over the modernization and Americanization of New Mexico in the second half of the 19th century. Acoma stands on a remarkable acropolis-like site above the desert west of Albuquerque, and it has one of the grandest, and also one of the simplest, of the adobe churches, San Estevan, which was originally built, according to George Kubler, sometime before 1644. Acoma is also slightly unusual in that pieces of fieldstone are used along with adobe construction, sometimes as an outside facing.

In 20th century New Mexico, current practice has varied the adobe tradition somewhat. More durable concrete block stem walls resting on continuous reinforced concrete footing are now used until the wall surfaces above grade. The size of adobes has been standardized to 10x14 inches by four inches thick, and they are now often "stabilized" against erosion by a petrochemical additive. Lime mortar is sometimes used between adobe bricks, and often reinforcing is made of steel wire or mesh between courses. A reinforced concrete bond beam is almost always added just below the roof, and, of course, modern built-up roofing is always used. Nearly always now, too, stucco rather than mud is used for the external plaster.

Most of the poor qualities of adobe as a structural material are obvious and have in any case already been noted. It does, however, have two very remarkable qualities, each of which has been in sequence important to its two most recent phases of development in the 20th century. The first is that it produces a quasi-plastic building mass that is in fact simple, smooth, somewhat irregular and gently rounded at its edges and corners. In effect, the result is monolithic, abstract, primitive and romantic. Thus, in the earlier part of the 20th century—and even today—adobe strokes the imaginary fires of architects, painters, photographers and sculptors who are interested in its almost modernistic purity. At the same time, it does exactly the same thing for those who are interested in the re-creation (or creation) of a half-imagined path.

The second remarkable quality of adobe, significant to its most recent, energy-conscious phase of development, is that, although it is quite poor as an insulator, it has high specific heat, which means that it has the ability slowly to absorb and slowly to re-radiate great quantities of heat, just like the dirt from which it is made. This fact has several consequences. One is that adobe serves as a temperature stabilizer, helping to average out daily and even seasonal variations and making buildings that

Sketch at right, typical adobe construction. Note thickness of walls. Photos, detail and street, Acoma pueblo, New Mexico. Previous page, the church of San Estevan, Acoma.

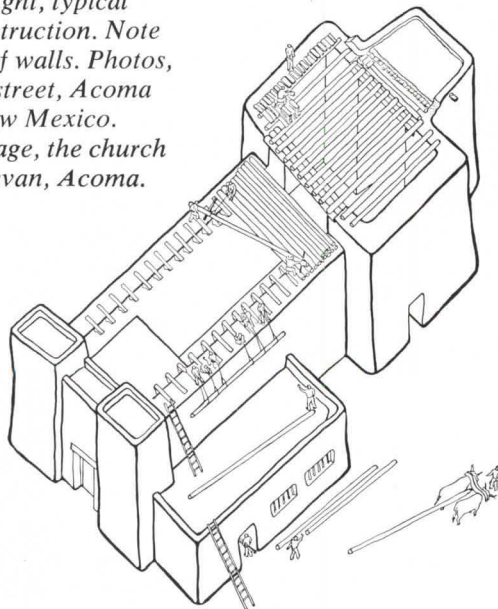



Photographs by David Muench

are, as almost everyone has noted for a very long time, cool in the day and warm at night, warm in the winter and cool in summer. Another consequence is that, if an adobe building can be designed to emit quantities of solar radiation into its interior in the winter and exclude them in the summer, then the necessity for mechanical environmental control systems is reduced.

These consequences are quite simple in principle, but slightly more complex when put into service. One problem is that for an adobe building to be really energy efficient it must be insulated. This is now standardly done by nailing two or more inches of rigid insulation on the outside of the wall, then plastering stucco over that. This works well, allowing heat on the inside to be absorbed by the adobes, but finally not to pass to the outside. However, the sheets of nailed-on rigid insulation at least partially destroy the plastic qualities of the exterior, or cause them to have to be faked, thus obviating one of the points of using adobe in the first place.

Another fairly common practice, at least for south-facing walls, is not to insulate them at all and to assume that more heat will be absorbed from the sun and radiated to the inside than will be lost by re-radiation from the inside back to the outside. Another method recently attempted by my own office was to make a cavity wall of two 10-inch courses of adobe with a four-inch cavity filled with plastic beads. This allowed the adobe surface to be maintained both inside and out, and it also produced a very thick wall, which we liked, but it had to be abandoned in the end because of cost.

Another energy related problem with adobe, which can be very simply put, is that gas and electricity are still almost ridicu-

lously inexpensive in New Mexico, and so the purely economic incentive to curb their use is not great. Another question involves style. Passive solar adobe houses nowadays are often so laden with formal gewgaws and contraptions that they look more like paleo-spaceships than houses, and it is certainly at least arguable that it is as important to human welfare for a house to look like a house as it is for it to conserve energy.

What do all of these things, ancient and modern, say about adobe as a structural material? One thing is obvious since it has already been said: Adobe is on the whole a mean material, but it nevertheless has a memorable visual quality and an important thermal one. What is perhaps even more interesting is what the history of adobe architecture has to say about structure itself. Architects are, after all, used to thinking of structure as the system that physically holds buildings up, and the previous essays in this issue show how rich that realm can be. So it may also be worth pointing out that structure also involves conceptual structures which bind a work of architecture into an imaginative whole. In its native, precolonial phase, adobes were used to create a primitive urban architecture; in their colonial phase, they were used to structure a fusion of primitive tradition with 17th century European religious principles and architectural memories, resulting in a series of buildings that are unique on the face on the earth. In the 20th century, they have been used as the framework for old-fashioned romance and old-fashioned (and new-fashioned) purities. More recently, they have helped give form to a newer dream that the human race be no longer profligate, and that it restore the balance between its needs and the world's resources. □





Across the

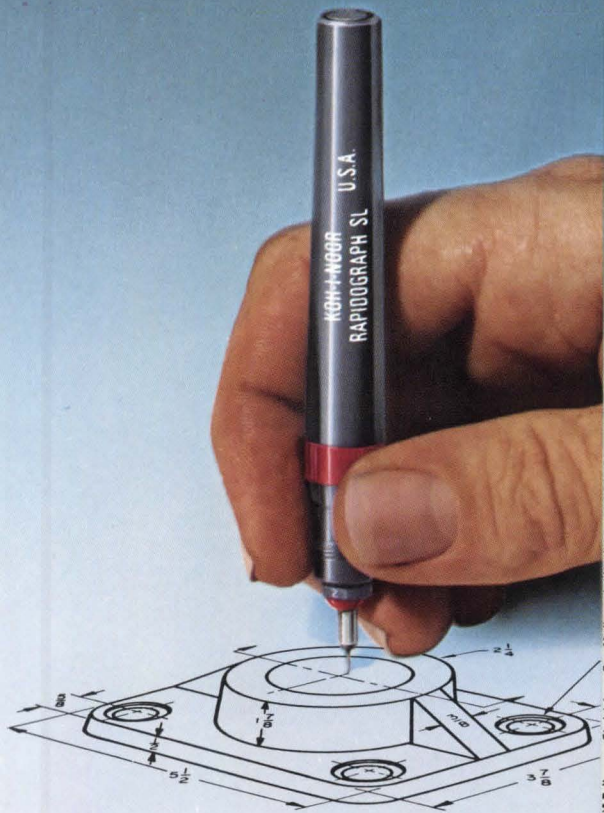

MACHINE DESIGN



ELECTRONICS



AEROSPACE

more drawings are made with a **KOH-I-NOOR**

...and with good reasons! Rapidograph is the registered tradename of the original technical pen, introduced by Koh-I-Noor in 1954. The patented nib design uses a flow-control breather channel and weighted cleansing wire to provide the proper balance of air entry and ink flow for precision line width and consistent density. The remarkably successful patented dry, double seal cap keeps ink fluid for instant startup throughout the entire pen system during storage for weeks, even months at a

time. The widest range of point sizes includes the broadest and finest line widths available, in Stainless Steel, Jewel or Tungsten Carbide.

All Rapidograph technology is USA-based. If you have questions about how your technical pens really function, or problems about your present drafting techniques or materials, you can consult with our "better-ideas" oriented Research & Development Technicians: Toll free 800-631-7646; collect, or from New Jersey 201-479-4124.

*In the U.S.A. and Canada.

board...

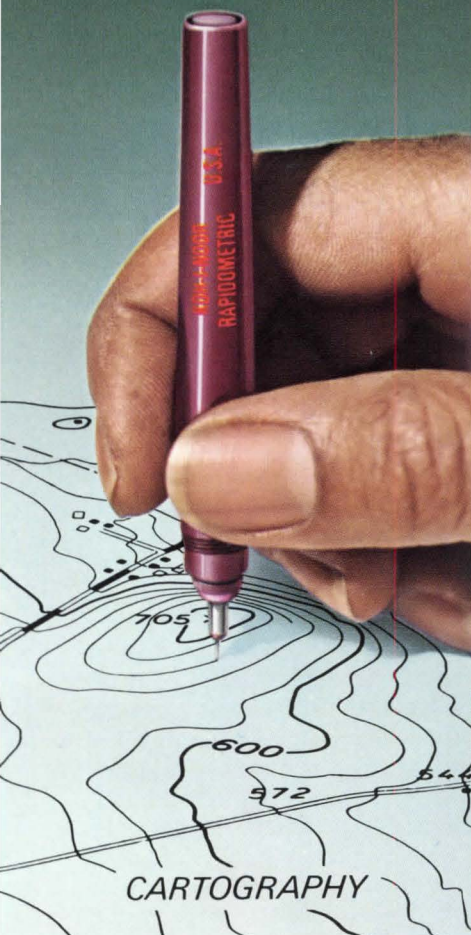

CARTOGRAPHY

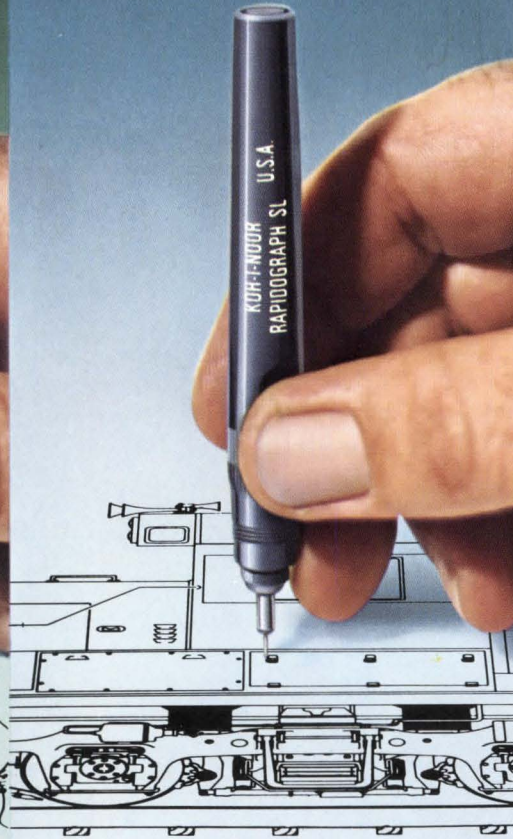

TRANSPORTATION



CONSTRUCTION

APIDOGRAPH® than any other technical pen!*

KOH-I-NOOR RAPIDOGRAPH, INC.
 100 North St., Bloomsbury, NJ 08804
 In Canada:
 1815 Meyerside Dr.
 Mississauga, Ont. L5T 1B4



Show me more, KOH-I-NOOR!

Please have the following FREE brochures sent right away.

- Koh-I-Noor USA-made Technical Pens, K-1071
- Koh-I-Noor Drawing Instruments and Sets, K-1075
- Koh-I-Noor lead Holders, Pencils, Pointers Sharpeners, K-1073
- Koh-I-Noor & Pelikan Drawing Inks and Selection Chart, K-1072
- Koh-I-Noor Templates, Scales, Triangles Other Drawing Aids, K-1074
- Please send me the names of Koh-I-Noor dealers in my area.
- Please have a Koh-I-Noor representative call me. AIA-10-80



NAME _____ TITLE _____

COMPANY _____

ADDRESS _____

CITY _____ STATE _____ ZIP _____

BOOKS

The Theme of Structure From Varying Viewpoints

Tensile Architecture. Philip Drew. (Westview Press, \$35.)

At a time when postmodernism is still running its course, we can truly be enchanted by this book. The lightness and shape of these space enclosures give importance to space itself, and thus to the essential element of architecture. Though architects are essentially not engineers and rarely structural inventors, they are not sculptors either. Mass and form are significant only in their own relationship to and expression of space. In architecture that means, of course, that space is always related to human function. Hence, there is no need to be self-conscious about the architectural nature of tensile structures. As Buckminster Fuller, FAIA, is celebrated today as the poet of technology, so must Frei Otto be recognized as another such poet.

What makes this volume particularly valuable is the detailed and rich history of traditional tensile architecture in the large first chapter. Tents and their variants, including teepees and kbitkas, were traditional in all nomadic cultures, and it is fascinating to follow their development in all their forms through the ages. The Arabic tent has proven to be perhaps the most durable system that the contemporary traveler can still observe. The circus tent prevails to our day as a remnant of the medieval urban tent forms.

The second chapter gives a brief review of the direct precursor of modern tensile structures—the suspension bridge, which to this day offers most elegant solutions.

Philip Drew devoted a previous book specifically to Frei Otto's work, but the book under review broadens the information on tensile architecture in the third chapter. There are now enough good examples of modern structures that shelter by means of elegant and lightweight tent roofs to convince us of their value and continued use. This book gives a splendid collection of examples, from Otto's Montreal pavilion via the Munich exhibition structures to many other exhibition membrane pavilions. Such tension structures as the Dulles International Airport, the Aspen music tent, the Yale skating rink and Tange's Olympic arenas, to name a few, are discussed and illustrated. A revised edition of this book could add Skid-

more, Owings & Merrill's vast air terminal structure at Jeddah in west central Saudi Arabia and other new tent structures in hot climates. While most tensile architecture seems to flourish in climates where shadow and ventilation are most important, more and more architects are venturing into the design of permanent and completely enclosed buildings with lightweight suspension roofs for our latitudes.

Tensile architecture, as a result of highly sophisticated modern technology, is well rooted in the creations of older and more primitive civilizations. It is not only the elegance of form, but also the economy in use of materials that appeals

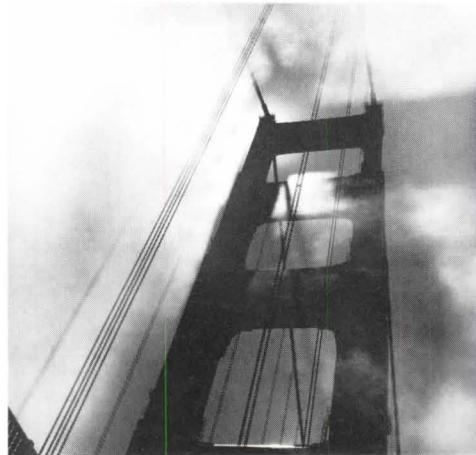

Gene Anthony/Black Star

in our situation where doing the most with the least is becoming a matter of survival, transcending the usual primacy of market economy. But tensile architecture reveals as well the need for basing modern design upon traditions to be nourished not only by the knowledge of Western architectural history, but also by the history of all other traditions. We will then more easily understand that the technology of our time must relate to the wisdom of its precursors.

Drew's book, therefore, provides a wonderful learning experience and much visual delight. *H. H. Waechter, AIA*

Structure in Nature Is a Strategy for Design. Peter Pearce. (MIT Press, \$45 hardbound, \$12.50 paperback.)

Until our own era, nature was probably the most consistently exploited source of inspiration for the artist and designer. While imitation of natural forms is currently out of favor with the so-called cognoscenti, other uses are still permitted—such as that by one of today's better known industrial designers, here namedless, who astonished his graduate students

by assigning them to transpose plant seed delivery systems to prototypes for antipersonnel weapons as part of his Department of Defense funded research. In this book Peter Pearce manages to break with the traditional approach to natural design without turning it to seemingly unnatural ends. Inspired not by nature's outward forms but by its internal structure, he postulates (and proves, if 40 highly magnified photographs suffice to do so) that the polygon is the basic building block of nature; and, by extrapolation, that adapting this form to environmental structure will result in configurations that are naturally space and energy efficient.

The book, recently reissued in paperback, continues Pearce's exploration of the polygon that he began in 1958 when a student at Chicago's Institute of Design. In 1965, he further developed his theory with the support of a grant from the Graham Foundation; and in 1970, the polygon became the founding module of Synestructics, a company eventually to be "fully engaged in the business of producing architectural systems," but which is now producing prototypes of those systems as children's toys and playground equipment. The polygon is also the subject of Pearce's second book, *Polyhedra Primer*, written with Susan Pearce.

Structure in Nature is in large part a complex, and complexly phrased, explanation of the properties of polygons and polyhedra. Pearce's preface states that "readers without mathematical backgrounds should be able to follow the development of the subject"; and his organization of the material is eminently logical. Still, it should be remembered that he has had 22 years with which to familiarize himself with the material. Readers who shelved their solid geometry texts the day before yesterday may wish to prep for this work by playing with Synestructics toys and by studying the less abstruse *Polyhedra Primer*. Even so, they may feel themselves caught between a rhombicuboctahedron and a hard place.

The abstruse geometry may be one reason the book has yet to hit its target audience of architects and designers. Another may be that Pearce is apparently interested only in structural and architectural applications. The principles illustrated can be readily adapted by artists and designers to produce graphics, fabric, tile, sculpture, products and packaging; but

continued on page 88

BEYOND BASICS

For 30 years Spectra-Glaze® units have provided bottom line basics for initial and life cycle savings. Build and finish glazed walls with one operation, one trade. One unit, thru the wall, both sides exposed. Facing available on both sides for additional economy. Cores easily accommodate utilities, reinforcing, insulation. Block mass means less energy cost, more evenly controlled temperatures. Excellent sound transmission loss. High fire ratings, low insurance costs.

But Spectra-Glaze® units go beyond basic economies, with design flexibility and proven performance, interior and exterior. Choose plain, sculptured, or scored faces. 72 colors. The factory applied facing is integral—will not come off. It is permanent, resistant to marring, scarring and impact. And for years to come, the sanitary, satin finish is easy to clean and virtually maintenance free. Ask to see the new 12 minute audio-visual presentation. Fact-filled. Current. Helpful.

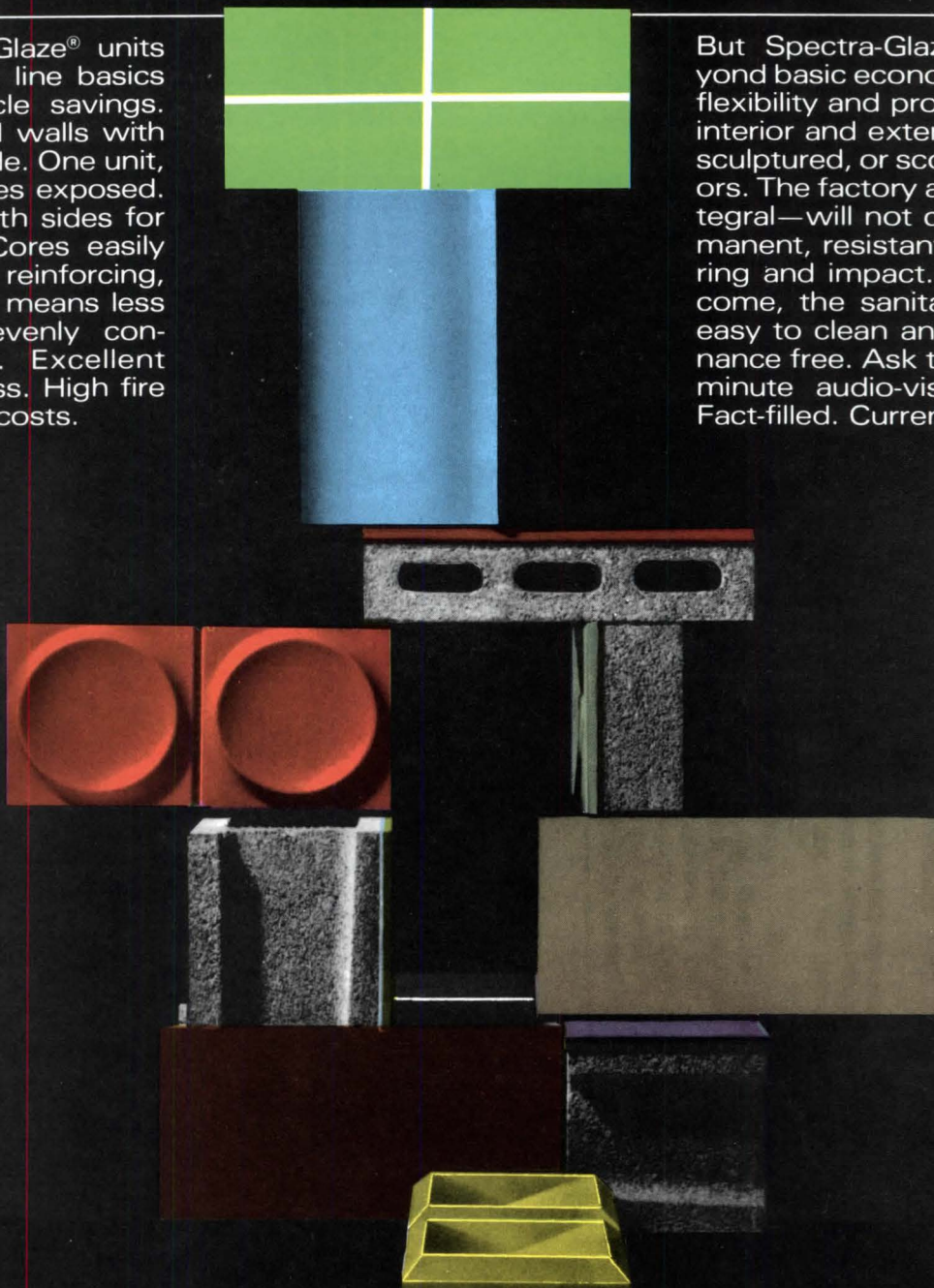

KEEP THE COST OF WALLS WITHIN BUDGET . . . AND STILL ENJOY DESIGN FLEXIBILITY PLUS PROVEN PERFORMANCE

© Reg. U.S. Pat. Off.,
Canada & other countries by
THE BURNS & RUSSELL CO.

Spectra-Glaze® II

PRE-FACED GLAZED MASONRY UNITS

Box 6063, Balto., MD 21231.
301/837-0720.
4.4/Bu in Sweet's

Circle 34 on information card

Books from page 86

these uses are not mentioned. By omission, Pearce implies that these applications are not "design"; and by emphasis, he seems to say that the creation of environmental structure is the designer's only worthwhile concern.

Another impediment may be Pearce's underlying philosophy. It is not a simplistic "because nature uses polygons, we should use polygons to be in harmony with nature," although conversations with

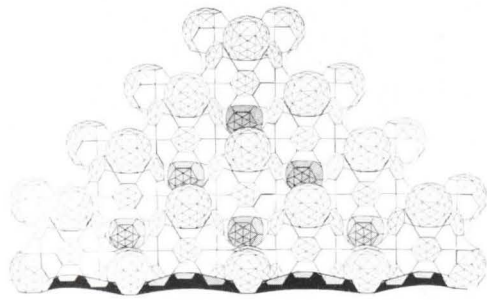

A 20-story building assembled from more than 500 identical saddle hexagon modules.

designers may reveal that this is taken to be the message. Pearce extols the polygon not so much because it is "natural," but because it allows the creation of the widest variety of triangulated, efficient structures with the fewest components: "If a building system can be considered analogous to a molecular structure which is highly responsive to varied actions of force, it may offer the real possibility of generating building forms responsive to the human needs and natural requirements of diversity, adaptation, change and the conservative use of natural resources."

Basic to this argument is Pearce's contention that "diversity of form can enhance man's relationship to his environment." This is not an opinion unique to Pearce, of course. Many of today's architects and designers, perhaps chief among them Buckminster Fuller, FAIA, and Moshe Safdie, are seeking to educate the public to non-orthogonal form. The masses continue to clutch the box to their esthetic bosom. While the barrow, the teepee and the igloo testify to some willingness to experiment with shape, the great mass of building that has occurred since man moved out of the cave has been based on the 90-degree angle. It is quite possible that this is due to more than "the dogma of habit and bias," as Pearce would have it.

Certainly the model structures he includes in his last section raise questions about the practicality of non-rectilinear layout. Polyhedral spaces are most effective when allowed free interpenetration, but this effectiveness is primarily visual. (He admits that the models are "impressionistic" and that "function was only approximately defined," an apparent tri-

umph of form over substance.) They suffer when made to accommodate "the human needs and natural requirements" of storage, display, privacy and readily available furnishings. Designers might have it otherwise, but there is no evidence that the mass of humanity is eager to embrace diversity, and there is a good deal of evidence to the contrary.

To date, implementation of Pearce's system seems to have foundered on the twin shoals of a conservative public esthetic and pervasive technical difficulties. Actual use has been primarily restricted to the Synstructics toys (which can also serve as architectural models) and to the Curved Space System permanently installed in the Brooklyn Children's Museum. Pearce's honest recital of the problems involved in this installation, ranging from molding the panels to computing the loads they would have to tolerate, indicates that while the technological difficulties are not insurmountable, they are considerable. To the designer and architect, both the forms and the principles that en-

gender them are interesting experiments. It remains to be seen whether their ultimate users will find them so advantageous as to finance their final development. Reed Benhamou, Assistant Professor, Department of Creative Arts, Purdue University

Analysis of Structures: An Integration of Classical and Modern Methods. Harry H. West. (Wiley, \$25.95.)

"If we suppose that the first structure was a tree that conveniently fell across a chasm and was subsequently used as a bridge, then since that meager and accidental beginning, humans have indeed advanced in their ability to design and build structures. When the structures of humans began to reflect their ability to conceive and design them as well as to construct them, structural engineering was born, and it has grown in sophistication as it has endeavored to meet the demands of humanity for increasingly useful, convenient and esthetic structures,"

continued on page 90

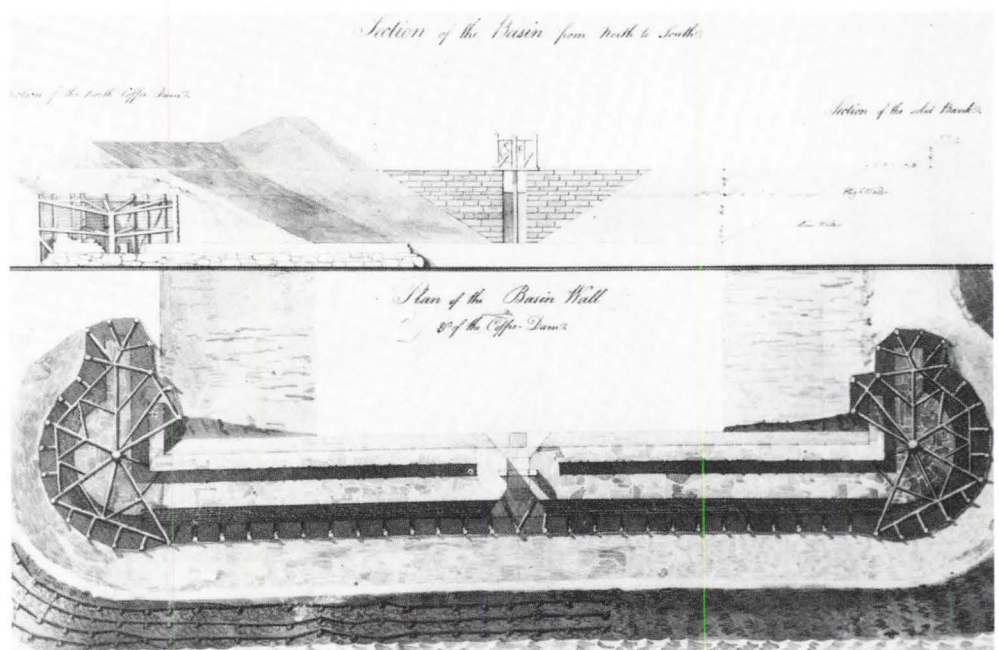

The Engineering Drawings of Benjamin Henry Latrobe. Edited with an introductory essay by Darwin H. Stapleton. (Published for the Maryland Historical Society by Yale University Press, \$62.50.) Benjamin Henry Latrobe is remembered as this country's first professional architect, but he was also a founder of the engineering profession. He often signed his plans with the word "Engineer." This book, which is the first detailed treatment of his engineering projects, is a major contribution to the study of early American technology. "Engineering as practiced by Benjamin Henry Latrobe was a complex profession," the editor says. "It was scientific in its general concepts of topography, geology and hydrology; it was mechanical, involving pumps, pile drivers, industrial machinery and steam engines; it was precise, requiring surveying, detailed cartography and fine drawings; and it was managerial, including the organization and supervision of those who carried out Latrobe's design." Here are provided drawings that testify to Latrobe's contributions to transportation, waterworks, river control, surveying and industrial development. Each drawing is carefully and technically annotated. Above is a drawing for the Philadelphia Waterworks, "Section of the Basin from North to South; Plan of the Basin Wall & the Coffre-Dam." Stapleton calls it "one of the most exquisite of the surviving Latrobe drawings." Latrobe broke with traditional rendering to show different views of a structure within the same drawing, Stapleton points out.

“WE THINK THE CHOICE OF BRICK WAS THE OBVIOUS SOLUTION.”

H. Duane Jarvis, AIA, Principal in Charge
Jarvis Putty Jarvis, Inc., Dallas, Texas

“Brick is a recognized quality material appropriate for a public building such as a government center. And in the case of Collin County, proved to be cost effective since it also served as a structural component.

“We tried to be sensitive to the high cost of energy; and the use of brick, in our opinion, was a good

material choice. The thermal lag property of brick, due to its mass, contributes to long-term energy savings. Brick also was adaptable to forms consistent with the design, which helped shade the glass areas — another energy savings.

“With regard to aesthetics, brick provided the appearance of dignity and quality, which we were trying to achieve.

“We wanted to avoid materials which were faddish or temporary. Brick has stood the test of time for centuries, and was the ideal material to keep this job within our budget. For the Collin County project, we think the choice of brick was the obvious solution.”

The bold dynamics of Engineered Brick Design work hand in hand with new advances in structural brick technology, and can cut costs significantly by simplifying construction procedures.

Acme Brick and Engineered Brick Design can be the best all-around system choice for your next project.

For more details about brick technology call Acme Brick collect, 817-332-4101, ext. 365. Or write Acme Brick Technical Services, P.O. Box 425, Fort Worth, Texas 76107.

ACME BRICK. THE BEST ALL-AROUND BUILDING MATERIAL.

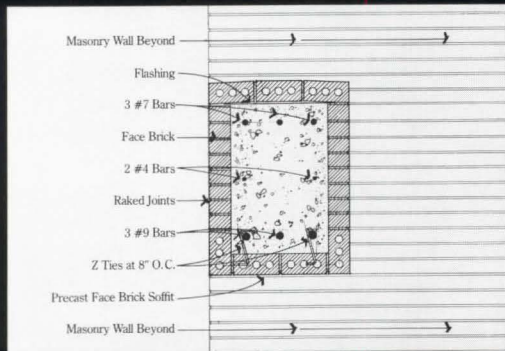

The handrails were constructed by forming U-shaped brick channels. Reinforcing steel was then set in the channels which were filled with concrete. The top surface was finished with Acme Brick.

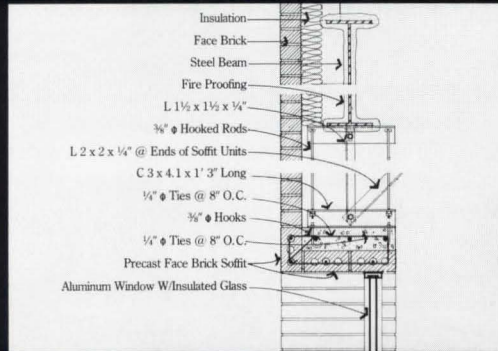

Acme Brick was attached to the structural steel truss to form a return and to frame the recessed opening of the glass area.

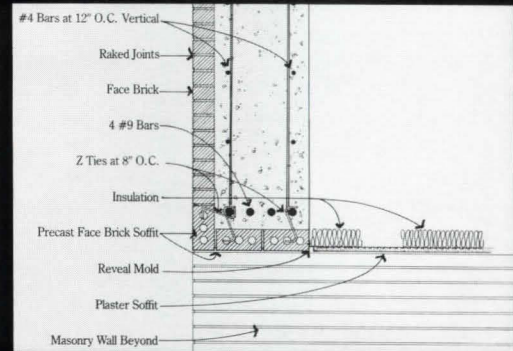

The poured in place spandrel beam was formed on two sides by Acme Brick which serve as the exterior finished wall and the soffit. The brick thickness was included in the structural calculations.



Collin County Courthouse and Jail, McKinney, Texas
Owner: Collin County, Texas
Architect: Jarvis Putty Jarvis, Inc., Dallas, Texas
Structural Engineer: Datum Structures Engineering, Inc., Dallas, Texas
Masonry and General Contractor: Howard U. Freeman Incorporated, Irving, Texas

Books from page 88

says the author. This book, which is intended for engineering students, integrates classical approaches to structural analysis with the more modern approaches that take into account increased use of the digital computer. The author explains that classical formulations are first presented and used to illustrate fundamental concepts of analysis, and then, after "sufficient generalization," modern matrix methods are given.

The book is divided into four parts, the first of which gives an orientation to structural analysis and provides the fundamental concepts. The second part concerns statically determinate structures; the third, statically indeterminate structures. Fully generalized matrix methods are given in the fourth part. The author, who is associated with Pennsylvania State University, says that his aim has been to develop a "strong teaching textbook. It is fundamental in nature, and no effort has been made to include all that can be written on structural analysis." His primary purpose is to provide students with a tool for the integration of fundamental concepts.

Unbuilding. David Macaulay. (Houghton Mifflin, \$9.95.)

David Macaulay, who has given younger readers such handsome books as *Cathedral*, *City* and *Pyramid*, now turns his fertile mind and facile pen to what would be involved in "unbuilding" New York City's Empire State Building. He fantasizes that a Saudi Arabian outfit, led by American-reared Prince Ali, decides to buy the Empire State for its new headquarters in the Arabian desert, dismantling the structure and shipping it to its new site. Despite the generous offer to give the Empire State's site to the city as a park, with the building's mooring mast (which couldn't leave the country because it was a designated historic landmark) completely re-erected as the park's central feature and the basement and sub-basement converted into art galleries, New Yorkers resist all offers until the prince decides to give oil on a regular basis to taxicabs and buses and, as a gesture of goodwill, to tear down the World Trade Center.

Macaulay follows the Empire State's dismantling step by step, starting with the TV tower and then going floor by floor in the reverse order in which the building was erected. His drawings are a delightful complement to the text. Along the way, the reader learns about the engineering challenge of unbuilding 86 floors of steel, limestone and glass and much about structural problems.

Alas, the ship taking the crates and containers to Saudi Arabia collides with an iceberg anchored off the south Arabian coast to supply the desert with water, and

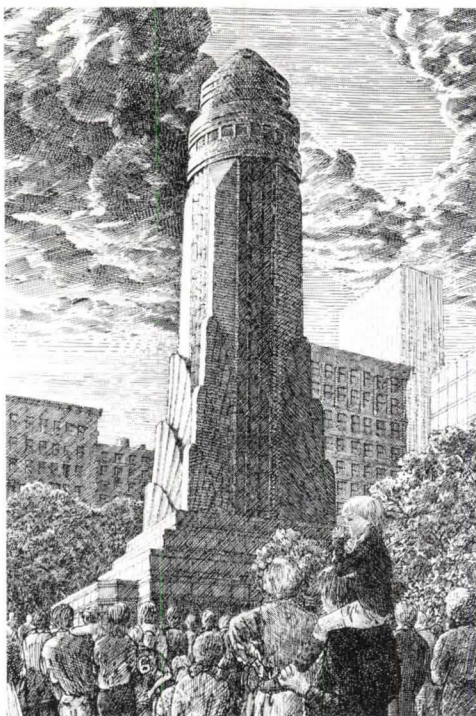

the ship and her cargo are lost. The New Yorkers, when informed of this loss, start over again in the Empire State Park, erecting a new building on the old Empire State's basement and sub-basement (drawing above). The prince, elated at all the fanfare at the park's dedication, flies home, dreaming of a plan to dismantle the Chrysler Building.

Construction and Geotechnical Engineering Using Synthetic Fabrics. Robert M. Koerner and Joseph P. Welsh. (Wiley, no price given.)

This book gives an overview and background of synthetic fibers to establish an understanding of their production, physical properties and generic names and variants. A section follows on construction fabrics—their elements, uses, important properties in construction work, and details of individual construction fibers. Subsequent sections cover the use of fabrics in the separation of materials, as reinforcement, in drainage, in erosion prevention and as forms. A part of the book on impermeable fabrics discusses their use in air-supported and tension structures, water-filled structures and self-sustaining structures. A final section covers current research and development, and gives guidelines on fabric use.

Structures. Daniel L. Schodek. (Prentice-Hall, \$24.95.)

The author explains that this book discusses "in an introductory way the nature of the invariant physical principles that underlie the behavior of structures under load," but its primary purpose is not to address analytical techniques, but to "more generally explore their role in the design of structures in a building context."

There are three principal sections in the book, the first providing an introduction to structures and their use in buildings, reviewing the fundamental principles of mechanics and providing a discussion of structural analysis and design. Part two is devoted to the major structural elements used in the building context, including trusses, beams, columns, rigid frames, plate and grid structures, membrane structures and shell structures. The final part, on the principles of structural design, considers, among other things, structural grids and patterns, and connections.

There are 13 appendices to supplement the text, and the book is filled with diagrams and other illustrative materials. The author, who is thorough in his approach, is a professor at Harvard University.

Pile Foundation Analysis and Design. H. G. Poulos and E. H. Davis. (Wiley, \$32.50.)

Although the use of piles dates back to prehistoric lake villages, say the authors of this book, it was the late 19th century before there was a first attempt at a theoretical assessment of the capacity of a pile. In more recent years, studies have been published that predict the behavior of piles and their interaction with the embedding soil, and many "excellent" textbooks on the practical aspects of pile foundations have appeared. In this book, the authors do not attempt to duplicate this information. Their aim is to give a theoretical approach to the prediction of pile deformation and load capacity and to present parametric solutions; to demonstrate how such solutions can be used for design purposes, and to review the applicability of such approaches to practical problems.

The first chapter gives the general principles of pile engineering. Sections follow on the behavior of piles under vertical loads and under lateral loading; on piled rafts, and on piles subjected to vertical or lateral soil movements. The final section concerns such topics as the buckling of slender piles, dynamic load on piles and pile load tests.

The authors are associated with the University of Sydney, Australia. The book is a part of Wiley's series in geotechnical engineering.

Design of Wood Structures. Donald E. Breyer. (McGraw-Hill, \$27.50)

This book's organization generally follows the subjects encountered in actual design, going from vertical and lateral design loads to connection design. Among other topics, consideration is given to the behavior of structures under load, structural glue-laminated timber, horizontal diaphragms and anchorage. □

ACID RAIN

An architectural crisis. **Versacor: Robertson's response.**

International in scope. Acid precipitation has become an architectural crisis of international proportions. And it's a crisis that directly affects your buildings, wherever they may be.

Last year alone, three international conferences addressed the problem. A recent *Scientific American* article reported: "On an annual basis, rain and snow over large regions of the world are now from five to 30 times more acid than unpolluted rain. The rain of individual storms can be from several hundred to several thousand times more acid than expected."

What causes acid rain? Airborne sulfur and nitrogen pollutants (from automobiles, smelters, and power plants, among others), often traveling hundreds of miles before combin-

ing with water vapor to form an acid solution, can fall unpredictably—perhaps on your latest building site.



In many areas, fish are already dying from the effects of acid rain.

The end of the non-corrosive building environment.

The fact is, almost every location—rural or urban, commercial as well as industrial—is now subject to ever-increasing corrosive attack from acid rain.

Already stone, masonry, automotive finishes, and single-layer metal wall finishes are proving inadequate—in fact, even the timeless beauty of the Taj Mahal in India is beginning to deteriorate. It's for this kind

of world that Robertson created Versacor® **Versacor—beauty that's proven itself in acid rain.**

Robertson saw the necessity for a special product to meet the specific problems of metal walls and roofs in Scandinavia, where acid rain had already begun corroding buildings in the 1950s. Versacor was initially tested there and has outperformed every other paint system in over 10 years of exposure.

Now the Versacor multi-layer protective coating system, with its unique epoxy base coat, is available in the U.S. Versacor has been proven superior to competitive finishes in a battery of independent laboratory tests—especially the Kesternich test, an accurate predictor of resistance to actual acid rain

conditions.

Available in flat wall and profiled shapes, Versacor can meet your most demanding aesthetic criteria for all kinds of buildings. And that's essential—because all kinds of buildings now face the long-term challenge of acid rain.

For more information about Versacor, write to H.H. Robertson Company, Department J-10, 400 Holiday Drive, Pittsburgh, PA 15220.



Robertson

Circle 36 on information card



Electrical Energy Views
from The National Electrical
Contractors Association
Volume IV, Number 3

Energy audits. A smart way to save energy and improve productivity.

No matter what your facility — manufacturing plant, warehouse, office building, retail store, etc. — energy conservation can be a useful tool in cutting energy expenses, lessening wear on equipment, and improving performance. It can also help reduce our dependence on foreign oil. But to be effective, conservation activities must be well planned.

Any plan designed to conserve energy used in buildings must include: a commitment from top management to make the investment required to initiate and maintain the energy conservation program, the execution of a comprehensive energy audit, creation of a plan of action including budgeting and scheduling according to priorities adopted, and follow-through to ensure the necessary actions are implemented.

At the heart of this four-step approach is a detailed energy audit. Energy audits can be divided into two basic procedures — a building survey which analyzes energy use and identifies energy conservation opportunities (ECOs), and a report that describes the various ECOs including estimates of the initial expense involved (if any) and the potential energy and dollar savings. Building surveys can consist of a building walk-through or a more detailed procedure. Walk-through audits can identify only those ECOs that are visually obvious. Most substantial

energy savings can be identified only through more thorough investigation.

A detailed energy audit may require participation by representatives of the utilities involved and design professionals such as an architect, mechanical engineer, and electrical engineer. Any one of these professionals can serve as an auditing team leader. In many situations, an ideal team leader would be a qualified electrical contractor with total energy management experience. In fact, if your building is served by a professional electrical contractor, he is the first person you should call to begin planning an energy audit. For he is likely to be aware of the personnel available in your area and can mobilize the best qualified team.

With today's drastic increases in energy costs and the steadily rising costs of capital equipment, an energy efficiency audit can play a major role in cutting your overhead and improving productivity.

Of course, the audit will serve no useful purpose unless the proper actions are taken once it is completed. To this end, the electrical contractor and his contact in the building should develop a comprehensive report of problems discovered and recommendations for top management. The report may cover such topics as: production scheduling inefficiencies which drive up power demand costs; areas of improper voltage which can cause overheated circuits and burned-out motors; motors that are too small to effectively handle their loads; hidden production losses due to underutilization of equipment; power trends that tell you circuits in certain areas of your facility need to be heaved up; load imbalances that can be alleviated by shifting equipment wiring; the number and locations of low-power factors; the source of line voltage transients; on/off sequences that create unnecessary demand charges; poor lighting that reduces productivity and wastes energy.

It may not be possible to act on all recommendations immediately, but remember that the cost of energy inefficiency and the steps needed to remedy it will continue to rise rapidly. The sooner you take appropriate actions the more money you will save in the long run.

Energy audits can play an important role in our nation's efforts to conserve energy and improve productivity. If you'd like more information on how an energy audit should be conducted write the National Electrical Contractors Association

at the address listed below. Ask for "Building Energy Audits", Index No. 302527.

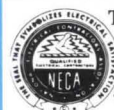
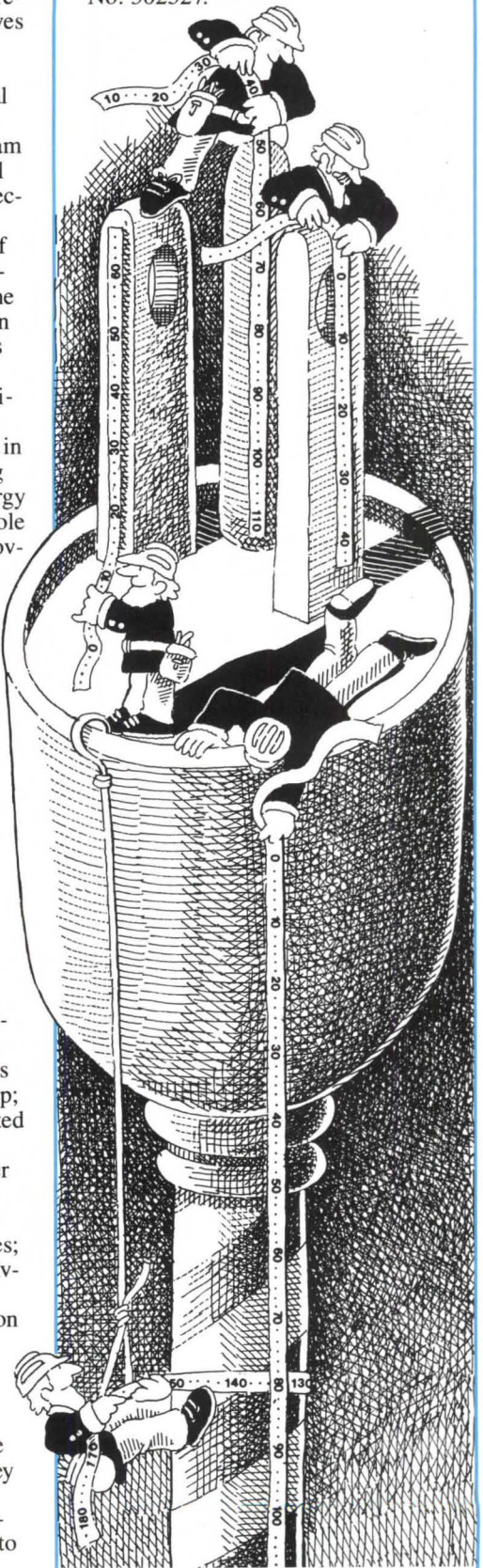

**THE NATIONAL ELECTRICAL
CONTRACTORS ASSOCIATION**
Department A1-100
7315 Wisconsin Avenue
Washington, D.C. 20014



The best passive solar heating system under the moon.

Thanks to the unique thermal performance of masonry, it's possible to use the sun's heat to warm buildings at night.

Masonry, because of its mass or weight, absorbs heat more slowly and holds it longer than any other building material. In passive solar heating systems, masonry walls and floors collect and store the sun's heat during the day. Then, because of masonry's thermal conductivity, the stored heat is slowly radiated back into the interior at night, providing enough free warmth to substantially reduce mechanical heating requirements.

The natural energy efficiency of masonry materials—brick, concrete block, stone—is enhanced by the skill with which masonry craftsmen use them. Every wall masons build is carefully hand-fitted to reduce air infiltration and heat loss.

What's more, masonry walls and floors designed to function as elements of a passive solar heating system can serve many purposes—structural, decorative, enclosure—and they don't occupy extra living space. Masonry enables building designers to meet the demand for energy efficiency without compromising on aesthetics.

Masonry—the most beautiful building material under the sun. And the best passive solar heating system under the moon. Doesn't your next building deserve masonry?

If you'd like to know more about passive solar masonry buildings, write to the International Masonry Institute, 823 15th Street, Northwest, Washington, D.C. 20005.

INTERNATIONAL MASONRY INSTITUTE

(The Bricklayers' International Union and the Mason Contractors in the U.S. and Canada)



Circle 38 on information card

Digest from page 67

has a minimum of sharp changes in thickness, in curvature or in boundaries. This is best achieved when the roof, its edges and its supports are fully integrated into a single form.

But integrated forms are only practical if the costs for building them are competitive and if the results are of high quality. Isler's forms are so carefully shaped that there is no cracking of the concrete and hence no leaking, even though no roofing is applied to the concrete.

Along with integration of elements and competitive costs, the symbolic or visual esthetics of a structure are an essential part of Isler's designs, which are characterized by extreme thinness, bare texture and vivid contrast to the setting. These are the expressive features of concrete thin shells and Isler has carried them at least as far as any other designer.

The fact that these works result from a design process of experiment and precision and a construction process of economy and control is just what permits Isler to express his own personal vision of structural art. As he develops his forms, the ideals of integration and competition are always present but, above all, the idea of esthetics remains primary, as it did for his teacher Lardy, as it did for Maillart, and as it does for Menn. Isler's forms are not the automatic result of some formula or of some experimental process: Even though they are highly rational, they are modified and shaped to satisfy the three basic criteria—scientific, social and symbolic—as well as is possible today.

Response to Bridge Design

By Colin O'Connor, professor of civil engineering, University of Queensland, Australia; Michael D. Burgess, department of transport and work, Darwin, Australia; Michael J. Egan, student, University of Queensland, and John L. Olsen, senior planning officer, coordinator general's department, Queensland. Excerpted from paper 15107 in the January 1980 issue of the Journal of the Structural Division of the American Society of Civil Engineers.

The paper described results of four surveys of Australian public opinion on the appearance of existing bridges. The first survey was conducted in 1971, the others in 1978, and there were approximately a thousand respondents for each survey. Bridge names and locations were not given to the respondents. Although most of the bridges compared are in Australia, the last three are in New York, in Newcastle-on-Tyne, England, and near Schiers, Switzerland.

The earliest survey used only photographs; one of the more recent surveys substituted drawings to see if the results

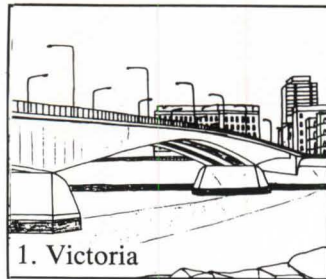

1. Victoria

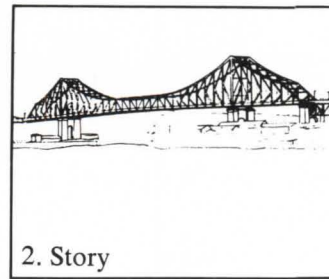

2. Story

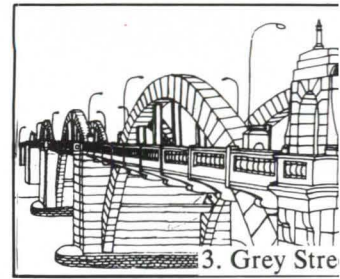

3. Grey Street

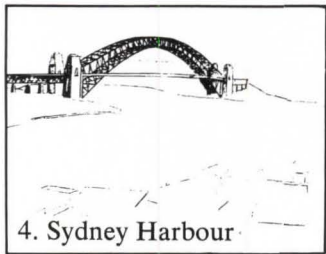

4. Sydney Harbour

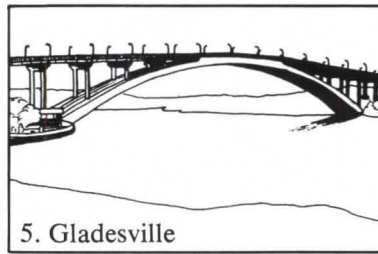

5. Gladesville

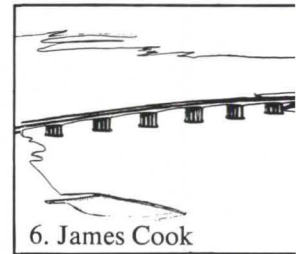

6. James Cook

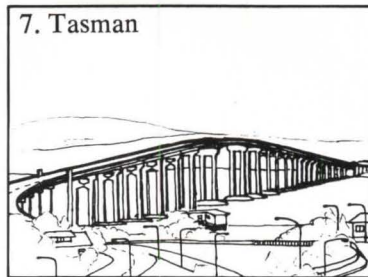

7. Tasman

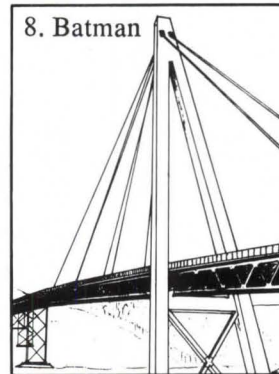

8. Batman

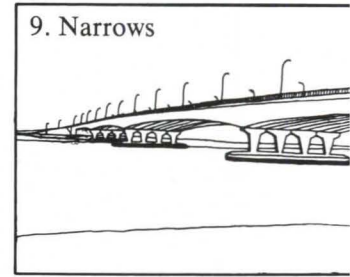

9. Narrows



10. Verrazano Narrows

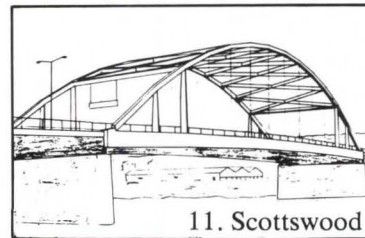

11. Scottswood

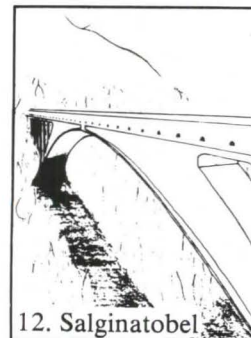

12. Salginatobel

would differ, and another recent one compared results based on photographs of bridges in silhouette with those based on photographs taken at dramatic angles. When the drawings shown here were used, the bridge with the greatest overall popularity was number 1, the Victoria Bridge, Brisbane; the second was number 10, the Verrazano Narrows Bridge, New York, and the third was number 4, the Sydney Harbour Bridge, Sydney; least popular was number 11, the Scottswood Bridge in Newcastle-on-Tyne.

Conclusions based on all four surveys included:

- Public opinion about the appearance of bridges can be reliably sampled by questionnaire.
- Repeated surveys in 1971 and 1978 indicated no significant changes in taste during the period.
- Simple sketches can be used to obtain results comparable to those obtained from photographs (although the most popular bridge, based on the photographic survey, was number 9, the Narrows Bridge in Perth, which ranked fourth in the sketch survey).

- There are marked differences of opinion between silhouette and angle views of the same bridges.
- Men have some preference for slender, more daring structures with simple profiles, while women seem to prefer bridges with greater solidity, sometimes with ornamentation.

Live Loads Survey

By Charles G. Culver, disaster research program coordinator, center for building technology, National Bureau of Standards. Abstracted from paper 12615 published in the December 1976 issue of the Journal of the Structural Division of the American Society of Civil Engineers.

The design of safe, economical structures requires consideration of both loading and resistance. Although considerable information exists relative to structural resistance and the behavior of building components and loads resulting from winds, earthquakes and wave forces, only limited data exist for fire loads (weight of

continued on page 96



Turn down the "Volume" with Laminated Glass...

—sh—sh—sh—make it whisper-quiet with LAMINATED sound control glass. It's the economical way to MINIMIZE unwanted noise — and still have your desired visibility and easy maintenance. No costly framing devices are required.

Laminated sound control glass is a safety glazing material that is also available in Solar Control assemblies. Make it quieter! Make it LAMINATED glass!

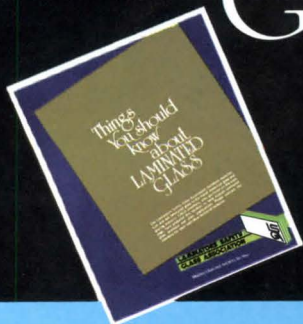

Send for FREE Booklet

Get All the facts about Laminated Glass—just send a postcard to:
LAMINATORS SAFETY GLASS ASSOCIATION
3310 Harrison
Topeka, Kansas 66611

**LAMINATORS SAFETY
GLASS ASSOCIATION**

Making Glass that WORKS for You

Circle 39 on information card



Digest from page 94

combustible contents) and live loads resulting from the intended use of a structure.

Culver's paper presents the results of a survey of 23 office buildings located throughout the U.S. The buildings ranged in height from two to 49 stories, and both government and private buildings were included. Factors considered in relationship to live loads were building height, building age, geographic location, room use and room size. Some of the conclusions of the study were:

- The magnitude of the loads in rooms of office buildings is not affected by geographic location, building height or building age.
- There does not appear to be any significant difference between loads in government and private office buildings.
- The magnitude of room live loads is related to the use of the room. Libraries, file rooms and storage rooms were the most heavily loaded. In general, the mean room live load appears to decrease as the area of the room increases, but further study is required to establish the influence of area on load magnitude.
- There is a definite tendency for loads in offices to be concentrated around the perimeters of rooms.



Mechanical Aspects

By Tseng-Yao Sun, principal, Hayakawa Associates, Los Angeles. Abstracted from paper 1447 in the March 1979 issue of the Journal of the Structural Division of the American Society of Civil Engineers.

In a building design team, mutual understanding among architects, structural engineers and mechanical engineers plays a crucial role. Too often, the mechanical engineer has little interest in the building's structural system, and the structural

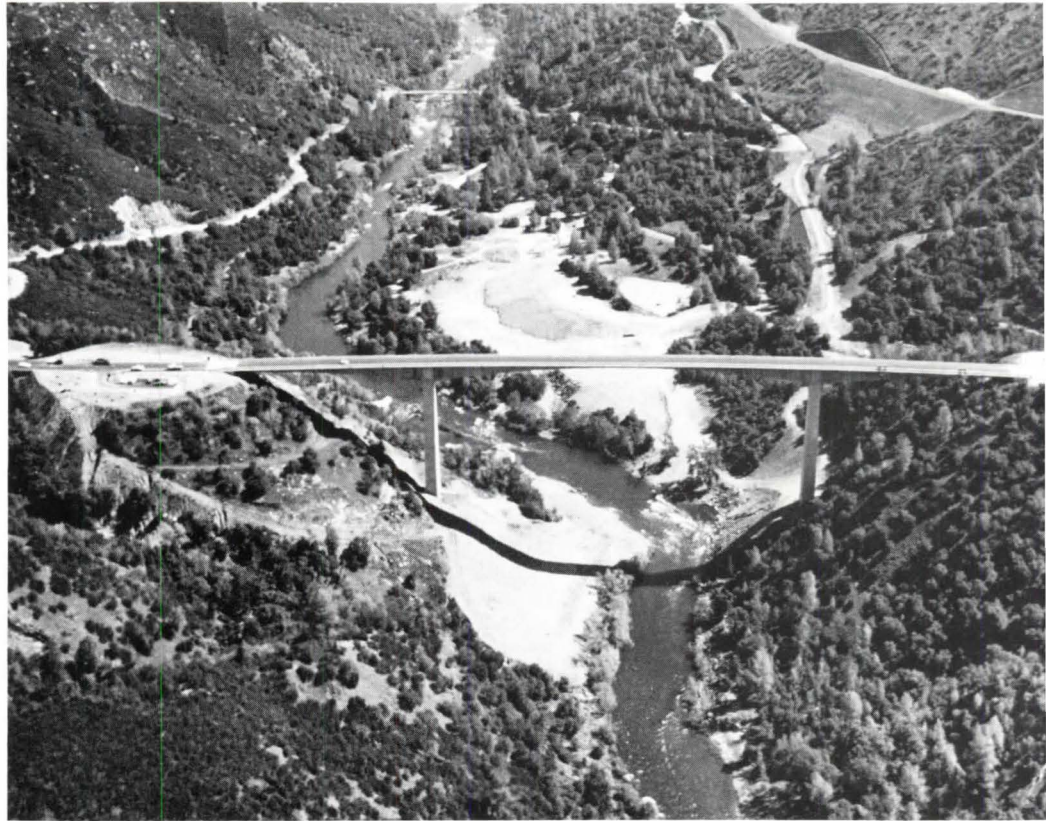

The Parrotts Ferry bridge over the Stanislaus River in California. Its span of 640 feet is the world's longest in lightweight concrete.

engineers feel the same toward the building's mechanical system. Sun's paper examines the mechanical aspects of the building design process that may be of interest to structural engineers, the possibilities for integrating mechanical and structural systems and the roles of mechanical and structural engineers in the systems approach to design. In particular, the paper considers the virtues and the potential pitfalls of the interstitial design concept. The Veterans Administration hospital in Loma Linda, Calif., completed in 1977, is used to illustrate interstitial design.

Structural Honesty

By Henry J. Cowan, head of the department of architectural science at the University of Sydney, past president of the Building Science Forum of Australia and author of several books, including *Architectural Structures, Science and Building* and *An Historical Outline of Architectural Science*. Excerpted from *Architecture Australia*, March 1980.

Many people believe that correctly designed structures are automatically beautiful. Long-span bridges generally have a simple geometric form which is often pleasing. Moreover, the designers of these difficult and expensive structures are leaders in their profession, and eminent people in any field of endeavor usually have good taste. The result is not, however, achieved automatically.

Structural honesty was not, as far as I am aware, considered by the masterbuilders of the ancient world and the Middle Ages, notwithstanding 19th century statements to the contrary. Features of Gothic architecture, which were presumably of structural origin, such as the ribs of a cross vault, proliferated in late Gothic churches. From the structural point of view this is a degeneration of an originally rational architecture, yet these vaults are among the most artistic in Gothic construction.

In the renaissance and the baroque structural honesty was rarely considered. The objective was to produce the desired architectural form, and the structure often bore little resemblance to that form. One of the best-known examples is Sir Christopher Wren's use of a brick cone, which is visible neither from the inside nor from the outside, to support the dome of St. Paul's. The actual dome was formed by a timber truss resting on the structural brick cone. Wren's solution was criticized during the neo-Gothic era and again in the 1950s as structurally dishonest. I regard it as a brilliant solution to a difficult structural problem. Wren could have built a double masonry dome, as Michelangelo had done for St. Peter's, but that would have cost much more. The dome of St. Paul's is the lightest masonry dome per unit area prior to the 19th century—that is, it is a remarkable structural achievement.

The concept of structural honesty has
continued on page 98

**"ASK ME
ABOUT WOOD
SHINGLES"**

**"ASK ME
ABOUT ELK
PRESTIQUE"**



	ELK PRESTIQUE	WOOD SHINGLES
Handsome wood look	<i>yes</i>	<i>no</i>
Class "A" fire rating from U.L.	<i>yes</i>	<i>no</i>
Warranty	<i>30 years</i>	<i>none</i>
Rot, Warp & Curl	<i>won't</i>	<i>will</i>

I see a lot of wood shingle roofs in my line of work. I have to admit, they look terrific. Only thing...they've got one big problem. Fire! And why live with a fire hazard over your head?



For the handsome, random look of wood...without the fire hazard...I specify Elk Prestique™ laminated fiberglass shingles for the homes I design. Elk costs a lot less, too.

DEMAND ELK PRESTIQUE LAMINATED FIBERGLASS SHINGLES!

Circle 40 on information card

Write today for free sample of one of world's best roof insulations:

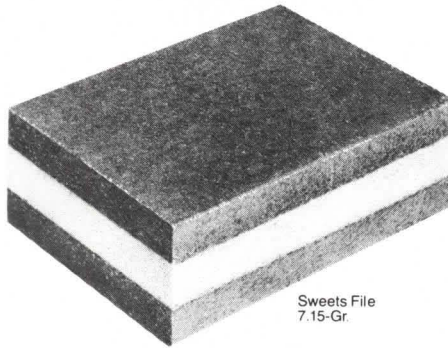

Sweets File
7.15-Gr.

Permalite® Pk® Plus perlite/urethane/perlite 3-part composite roof insulation

Specify it when you want long-life insulation having a "C" value of .10 or better for industrial/commercial roofs.

•Permalite Pk Plus is a true sandwich board. The top and bottom perlite layers maintain the efficiency of the polyurethane core by protecting it from the effects of high rooftop temperature changes. The top perlite layer also protects the core from hot asphalt during membrane application. And both perlite layers contribute to the dimensional stability of the insulation panel and help dissipate both heat and moisture during application. SEND FOR FREE SAMPLE.

Permalite®

GREFCO, Inc. / Building Products Division
GENERAL OFFICE: 3450 Wilshire Blvd.,
Los Angeles, CA 90010
SALES OFFICE: 2905 Butterfield Road,
Oak Brook, IL 60521 (312) 654-4500

 A subsidiary of General Refractories Company

Circle 41 on information card

Digest from page 96

rarely, if ever, been introduced into the design of bridges. It acquired architectural significance only in the 18th century when it provided a rational basis for the revivals of classical and Gothic architecture.

The concept again received attention in the 1940s, '50s and '60s. It was responsible for the creation of some superb architecture in which structural form, competently used, became a means of architectural expression. It also produced some costly aberrations. In spite of its outstanding success as sculpture on a grand scale, the Sydney Opera House is in the latter category. Eero Saarinen, one of the judges of the competition, in a television interview after the judging, described the structure as a thin shell. This was the basis on which the original cost estimate was made, which was eventually exceeded by more than 1,000 percent. It soon became clear that discontinuities at the boundaries of Jorn Utzon's forms produced huge bending moments, and that the "shell" would have to be very thick. Sir Ove Arup, the consulting structural engineer, stated that a "three-dimensional steel skeletal framework" was considered, but not pursued, apparently because of Utzon's insistence on structural honesty. The concrete "shell" cannot, in fact, be seen either from the outside or the inside, except in a few places where it contributes nothing.

Moshe Safdie's apartment complex built for the Montreal International Exposition in 1967 would have been far more economical if it had been less "honest." Safdie conceived the complex as a series of boxes stacked on top of one another so that the roof of one unit formed an outdoor living space for a unit at a higher level. The concept is admirable, but it is not dependent on the use of precast units. The same result could have been achieved at a much lower cost if the boxes had been built by conventional site-cast reinforced concrete construction instead of precasting the entire box.

Ludwig Mies van der Rohe was fascinated by the impression of lightness created by the exposed frame. His most famous detail is the corner on Alumni Memorial Hall of the Illinois Institute of Technology, which has been praised by Sir Leslie Martin and by Lord Llewellyn-Davies as the logical solution of the problem of the corner in a steel frame building. In fact, the steel frame had to be cast in concrete for fire protection, and the steel sections shown are not part of the structural frame but a nonstructural veneer. It is a matter of opinion whether the steel frame is a thing of beauty that should be expressed visually even though fire regulations forbid showing the real frame.

Cable Supported Shapes

By Horst Berger, principal, Geiger Berger Associates, New York. The following is excerpted from Bulletin 62 of the International Association for Shell and Spatial Structures, Madrid.

People on the move have used lightweight tensile structures in the form of tents for many thousands of years, the oldest—made of branches and animal skins—going 20,000 to 30,000 years back. Medieval armies had tents of impressive size and shape. The large circus tent is one of the more recent applications.

The development of high strength cables, structural synthetic fabrics and sophisticated engineering concepts and methods open opportunities for many very exciting new applications. The low profile cable supported air structure is proving to be without competition in the area of very large spans.

The main obstacle to a similar breakthrough in self-supported tensile structures (without air support) is the difficulty of their design. Shape and prestress must be determined with great accuracy which can only be achieved economically by mathematical methods with the help of computers.

Conventional structures derive their stability largely from gravity and rigidity. Lightweight tensile structures are made of materials which have negligible weight and rigidity, such as high strength cables and structural fabrics. Therefore gravity and rigidity are not available as a means of achieving stability. Air supported tensile structures introduce air pressure as a pseudo-gravity. If shaped to be in equilibrium with the internal air pressure, they can be put under sufficient tension to achieve stability. Self-supported tensile structures (without air support) obtain their required stability differently.

A single cable will take on a completely different shape for each different arrangement of loads. Single cables are therefore not suitable for structures with varying load cases, since they would not be stable and could fail due to dynamic action, which was demonstrated very dramatically in the failure of the Tacoma bridge. In order to achieve a stable cable structure, the cables have to be arranged in a network of intersecting cables which satisfies certain basic requirements at each node. Under prestress only, with no external force acting on the node (since dead load is negligible), the requirement for equilibrium is that *any two intersecting cables must be of opposite curvature*. This is the first principle of design for self-supporting lightweight tensile structures.

Superimposed loads such as wind and snow will add an external force at each

continued on page 100



Nailing into our clear wood paneling would be like putting a moustache on the Mona Lisa.

The Profilewood Paneling System is dedicated to the idea that beautiful wood should stay that way.

It shouldn't be subjected to wood injury. Nail holes. Or hammer dents.

Nor should it split, gap or twist.

That's why our special clip system of application was devised in Europe to eliminate nailing through our fine quality wood.

Instead, Profilewood is specially grooved to go up with galvanized clips that are nailed or stapled to furring strips.

In some cases, it can also be glued up. The Profilewood Paneling System

even protects the wood after it goes up. The clip system allows the wood to move so it doesn't resist the natural effects of expansion and contraction.

Made only of the finest clear grain hemlock, fir, cedar, redwood and Sitka spruce, no other paneling in the U.S. looks this good.

But then no other paneling in the U.S. goes up this way.

For more information please write Ostermann & Scheiwe U.S.A., P.O. Box 26, Spanaway, WA 98387.



Ostermann & Scheiwe USA^{INC.}



Profilewood is available in random lengths of 3' to 20'.

PROFILEWOOD
PANELING SYSTEM

Circle 42 on information card

Digest from page 98

node of a cable network, adding tension in one direction of the network and decreasing tension in the other. In order to remain stable, the initial prestress must be larger than the reduction in tension so that the cable does not go slack. *Therefore the prestress in the cable network must have such a level that all cables remain in tension under superimposed loads.* This is the second principle.

There are two basic shapes that will satisfy the requirements of the first principle, the hyperbolic paraboloid (shaped like a saddle, with its curves in opposite directions) and the more common radial tent. The choice of overall configuration of a cable network will further depend on the support conditions. Any self-supporting tensile structure requires upper supports, lower supports and outer supports. The supports can be linear (beams, arches, rings, catenary cables) or points (masts, poles, A-frames). In a true tensile structure, compression members must be minimized. This tends to lead toward point supports for the upper and outer supports and catenaries for the lower supports and edges.

In a well-designed structure, the supports are arranged in a closed system; this means that internal forces are equilibrated as close to their origin as possible. For large span structures this is essential for their economy.

The best method of design is one that has the prestress forces as input and the shape as output. The method developed by the author is based exactly on this procedure. A computer program has been developed that finds the exact geometry of the cable network satisfying the equilibrium of internal forces at each node of a system. The computer generates pictures showing the resultant configurations. This method can be applied to an almost unlimited number of shapes. By adding units, by turning alternate modules upside down, by varying the plan shape and the edge configuration, many different structures can be designed.

Response to Motion

By A. W. Irwin, department of civil engineering, Heriot-Watt University, Edinburgh. Excerpted from the September 1978 issue of *The Structural Engineer* (London).

Clients, consultants, observers and users often express concern when perceptible motions of buildings, bridges, offshore and other fixed structures occur. Nausea, sickness and alarm caused by whole body motion of human beings have been known for a very long time. Regarding land travel, constant frequency motion was introduced relatively recently with the advent of railway systems on which the swaying of constant frequency trains often causes mild travel sickness. Prior to this, transport on land was mostly by horse drawn vehicles which stopped at short intervals and had speed variations sufficiently changeable to avoid sustained motion at any given frequency, and motion induced sickness was only occasionally experienced by the passengers. Seasickness, which is generally of a more intense nature, has been experienced for thousands of years, but perhaps the most intense form of motion induced sickness, to which human beings have been introduced only within the last 70 years, is air sickness. In contrast to these situations, where vibrations causing discomfort to people are studied and innovations devised to reduce acceleration levels to within the comfort range, there are other situations such as at fairgrounds to which people often travel some distance and pay to be subjected to motions which in the travel situation they would declare highly undesirable.

These forms of motion, whether unwanted and causing motion sickness or sought after for pleasure, are all transmitted to human beings from recognizable dynamic sources, the vibrations of which can generally be readily understood and accepted to a degree by average persons. On the other hand, civil structures are

traditionally of a static form, and people do not readily accept perceptible motions of buildings, bridges or other fixed installations that they have to use. Problems associated with the dynamic behavior of such structures are generally of recent origin.

Until about a century ago, bridges, except for minor structures and a few isolated examples, consisted of short, rigid, simply supported spans, which do not readily respond dynamically to wind, wave or traffic induced forces. Buildings were not generally tall enough to generate interest in their dynamic behavior, apart, that is, from a few lighthouses, watchtowers and castles whose construction was generally of a massive form that prohibited perceptible structural movements unless acted upon by a major earthquake. Until recently, tall residential and office blocks generally had rigid structures with stiff infills between loadbearing elements, providing another generation of unresponsive buildings.

In contrast to these unresponsive structures, more modern buildings have tended to be formed from slender sections, for reasons of economy of space, foundation requirements, material outlay, speed of erection and elegance. These much lighter buildings are more responsive to dynamic forces than their predecessors. Similarly, during the last century rapid developments in bridge construction and the economic necessity of developing bridge technology to span large distances have led to long span lightweight structures for wheeled traffic and to slender footbridges that can also vibrate noticeably with normal traffic and environmental forces.

Although most people prefer that structures used by human beings should provide an apparently stationary environment, in many instances they are prepared to tolerate some degree of motion. Much work has been carried out in the field of motion sickness of human beings in land, sea and air transport and the occurrence of vibration induced nerve and blood vessel diseases, such as "white finger" disease caused by the vibration of hand-held tools. But only recently has any great interest been shown in the effects of whole body motion of people in structures. Engineers have generally concentrated on structural stresses, deflections and fatigue regarding the dynamic response of civil structures. Many engineers view the addition of design parameters for human comfort and reactions to structural motion as a nuisance and of only minor importance. In some cases, the owners, designers and operators are reluctant to divulge useful data they had acquired on human response to motion of their structures, even though the data could hardly be classified for any security

continued on page 104

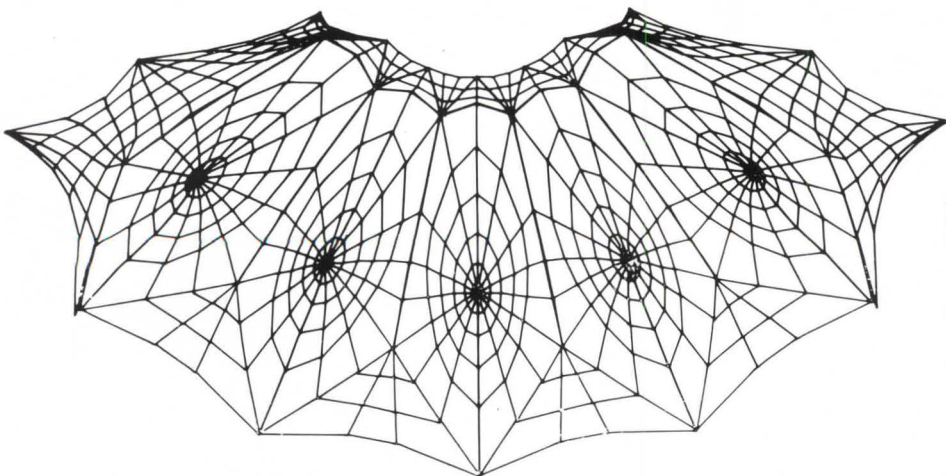

Architect: William Morgan, FAIA

Computer drawing of a cable supported roof for a proposed amphitheater in Florida.



The sky's the limit.

Grinnell® Sprinklers Can Meet the Challenge of Your Most Challenging Designs.

When Bullock's in San Jose, California's Oakridge Mall installed the first fabric roof ever used in a department store, they chose Grinnell sprinklers.

The problem that faced the owners, the architects and the insurance company was how to provide needed sprinkler protection that could respond quickly and effectively to a fire when the sprinkler lines were suspended from cables as much as 17' below the fabric roof.

The fiberglass fabric roof coated with TEFLON® made conventional pipe hangers impossible. The only practical manner to support the sprinkler system was from the suspension cables which were an integral part of the overall building design.

This innovative design called for an innovative technology, which was met by the use of Grinnell's Model F931 Quick Response attachment. This sprinkler combines the time-tested Duraspeed Sprinkler with an additional heat detection device sensitive to a temperature rate of rise at 20°F per second.

The Quick Response device attaches in a matter of seconds to a Duraspeed solder-type sprinkler. Thus, standard pendent sprinklers as well as horizontal sidewall models were available for use in this overall design.

This unique fast-acting sprinkler attachment, listed by Underwriters Laboratories, proved its capabilities in a test program witnessed by the owner's representatives and representatives of the insurance authorities.

Not only did the sprinkler attachment prove to be effective in the laboratory test, but it also demonstrated the flexibility needed to adapt to the demands of the structure's unconventional roof lines.

When it comes to sprinkler designs from the traditional to the avant-garde, Grinnell has the technology to provide sprinkler protection to match your most demanding design requirements.

For additional information, please write:
Grinnell Fire Protection Systems Co., Inc.
10 Dorrance St.
Providence, R.I. 02903

®TEFLON® is Du Pont's registered trademark for its fluorocarbon resin and film.



Above: Bullock's Department Store in San José, Cal. Note Grinnell Quick Response Sprinklers installed in a sprinkler line suspended from a cable below the fabric roof. Photo courtesy of Virgil R. Carter, Architect, Environmental Planning & Research, Inc.

Right above: Grinnell's Model F931 Quick Response Sprinkler.
Circle 43 on information card



GRINNELL
GRINNELL FIRE PROTECTION SYSTEMS COMPANY, INC.
Protecting Life and Property Since 1850

NEW NAME, SAME AIM.

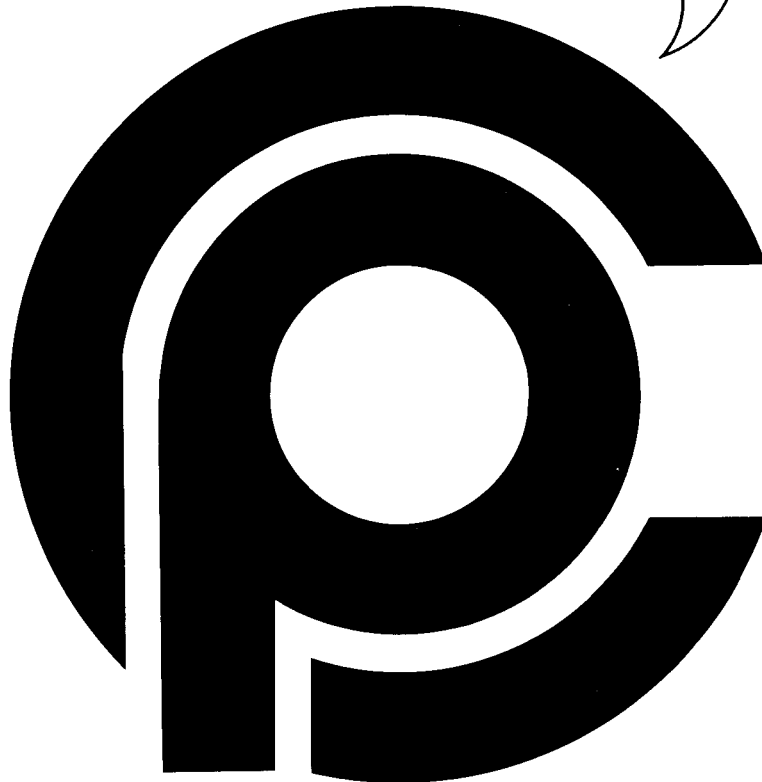

The Producers' Council is now the **Construction Products Manufacturers Council, Inc.** After 60 years, we've solved our identity crisis with a new, more definitive, better-fitting name. A name that more precisely identifies us as an association of manufacturers of products for building construction.

We'll keep our logo. And our function: To serve our membership with timely information about developments in the construction industry, and to maintain good working and idea-exchanging relationships with other professional and trade groups in the industry.

To find out what's new besides our name, write the Construction Products Manufacturers Council, 1600 Wilson Boulevard, Arlington, Virginia 22209.



**CONSTRUCTION PRODUCTS
MANUFACTURERS COUNCIL**

Introducing the StarTherm™ Energy Efficiency Analysis!

It won't cost you a penny, and it could save your clients thousands.

StarTherm insulated roof and wall systems are so remarkably energy efficient we think they'll out-perform almost any conventional construction materials. And we're willing to prove it with a free StarTherm Energy Efficiency Analysis.

Just give us the location and specifications of your proposed building project and your Star Builder will ask our computer to determine the energy savings you could realize with a StarTherm building of the same size. The results can be dramatic.

The StarTherm system's remarkable insulating properties will significantly reduce operating and maintenance costs, which account for about 50% of the total life cycle costs of any building. (The rest is initial construction and finance costs, plus improvements or building additions.)

You'll find it pays impressive dividends to build with StarTherm insulated panels.

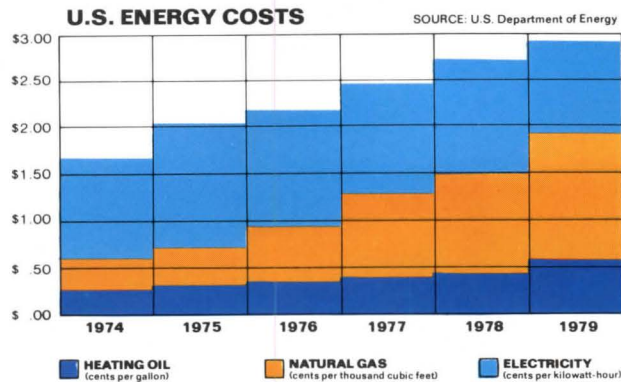

\$1,839 Annual Savings in Chicago.

In one example, the computer compared a 100' wide by 150' long by 20' high structure with 4" normal density blanket insulation in the roof and 12" core-filled concrete block walls, with a building of the same size equipped with StarTherm roof and wall panels.

Our energy savings calculations were based on heating loads only. We told the computer that our example buildings were located in Chicago, and we specified that each building had two 3x7' walk doors, two 10x10' insulated overhead doors and two 3x6' thermal pane windows. We assumed gas heating at \$3.50 MCF.

The results?

The StarTherm building consumed 68% less energy than the conventional building, resulting in an annual dollar savings of at least \$1,839. And when you consider the current rapid inflation in energy costs, this savings will be even more significant to the building owner 20 years from now.

Remarkable but not surprising.

StarTherm insulated panels offer some of the lowest U factors money can buy: 0.043 for roofs, an even lower 0.040 for walls. They have no through fasteners or compressed insulation points. Joints form a positive energy tight seal, and, according to ASTM-E-283 testing procedures, allow no detectable air infiltration.

Tax incentives. Reduced maintenance costs. Even lower insurance premiums.

The StarTherm system's low thermal transmission properties might qualify your structure for energy-related tax incentives.

Additional savings will occur through reduced maintenance costs. And our Class 1 low fire hazard rating and UL 30, 60, and 90 wind uplift ratings could lower insurance premiums. So over the life of your building StarTherm panels really pay off.

Ask for your energy efficiency analysis today.

Your Star Builder wants to help you design the building your client will thank you for—both today and in the future.

So ask for your free energy efficiency analysis today.

Call toll-free 800-654-3921. In Oklahoma call collect 405-636-2548. Or write Star Manufacturing Company, Box 94910, Oklahoma City, OK 73143.

STAR BUILDING SYSTEMS

Circle 44 on information card



MARBLSTAL[®]



WE CAN AFFORD TO BE SPECIFIC ABOUT MARBLSTAL.

Because all it takes is a list of advantages to show you what a natural choice Marblstal is for dressing room and toilet partitions, even shower stalls.

Marblstal is prefabricated. It's available in standard sizes (complete with hardware), from stock. Or we can custom fabricate to your exact specifications.

Marblstal is economical. It resists scratching and the absorption of moisture, odors and contaminants. And that means a long, long life cycle and exceptionally low maintenance and cleaning costs.

Marblstal is versatile. You can find it in many new and remodeled industrial, commercial, recreational, educational and medical buildings.

Marblstal is truly beautiful. After all, it is magnificent Georgia crystalline marble and available in several unique varieties. Add to that your choice of the standard birch veneer door or attractive alternatives in metal or plastic and you can see why Marblstal is so compatible with so many design and color schemes.

Think about it. In terms of cost efficiency, durability and just plain good looks, can you really afford not to find out more about Marblstal? All it takes is a call. Our number is (404) 735-2591.

What could be more natural than Georgia Marble?[®]

 **georgia marble** company
Structural Division, Nelson, Georgia 30151

a Jim Walter company

Digest from page 100

or economic reason. The many aspects of motion that affect human beings should be analyzed so that guides suggesting magnitudes of motion that should prove acceptable to those using the structures can be compiled, amended and extended.

There are many ways in which motion can be either exaggerated or obscured from those subjected to it. For instance, people who are more sensitive to vibration can serve to trigger perception of motion in others. Noise cues such as occur when high wind acts on poorly insulated buildings cannot only increase awareness of building motion by occupants but can also greatly reduce the level of motion that they find acceptable. There are several examples where identical structures were built in the same locality, the first few being well clad and acoustically insulated but later structures being poorly insulated against sound.

Subsonic sound generated by traffic movements adjacent to buildings or the flow of air in ducts can induce the sensation of motion in people, often to the extent that users of structures that only vibrate to a very limited extent but that are subject to waves of subsonic sound often complain about structural motions that they are certain are of a high level.

The frequency of occurrence of particular events can exaggerate motion since those regularly subjected to the vibration can generally perceive it more readily than those new to the experience. In some instances acclimitization takes place, but in other circumstances repetition of an event reduces the acceptable level. People long accustomed to living in some forms of lowrise buildings, such as two-story flexible frame wood houses, are sometimes prepared to accept magnitudes of motion that cause alarm to other people. On the other hand, occupants of tall buildings do not seem to learn to accept magnitudes of motion that initially caused them alarm, and, generally, the more frequently such motion occurs the more objectionable it becomes.

Sometimes combinations of factors, such as adverse effects on services due to building motion, can cause alarm to occupants of structures. An extreme example of this was wind induced lateral sway in a poorly joined multistory box-type structure that resulted in the wires being pulled from the backs of electrical sockets in the upper stories of the building. Also, a person's health can determine the levels of motion acceptable.

The probable motion of a planned structure can be found by structural dynamics, using the structure stiffness and mass, the wind or wave spectra or the actual dynamic force input to the structure, the structure shape, aspect and roughness

continued on page 108



13 good reasons to specify Azrock Floors.

Azrock Floors stand up to every-day wear, year in and year out — like the Thru-Onyx pattern. It's a non-asbestos tile with all the proven beauty, durability, low cost, and easy maintenance of Azrock vinyl composition tile. For more good reasons to specify Azrock Floors for your next store or shopping center project, call toll-free 800-228-2222 (in Nebraska, 800-642-9642), or write Azrock Floor Products, Dept. 412A, P.O. Box 34030, San Antonio, Texas 78233.



The name
to specify
in resilient floors.

Circle 51 on information card

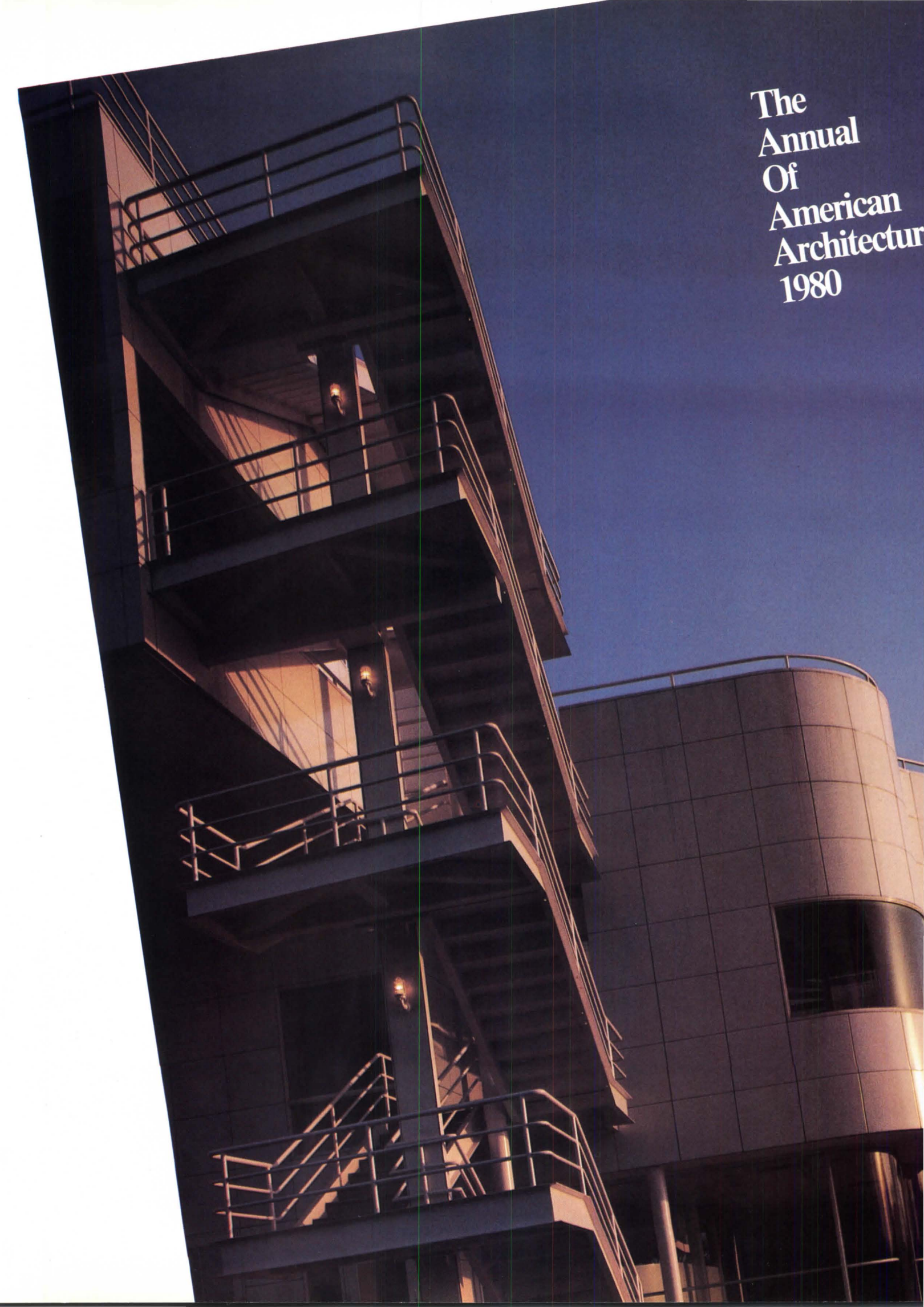
The image shows a modern architectural structure. On the left, a tall, dark, angular tower features a prominent external staircase with metal railings. The staircase is illuminated from within, casting a warm glow. To the right, a curved, cylindrical section of the building is visible, also with a metallic finish. The sky is a clear, deep blue. The overall composition is dynamic, with strong geometric lines and a play of light and shadow.

The
Annual
Of
American
Architecture
1980

The Annual of American Architecture 1980

Here, for the first time, is the only publication in permanent form which brings together the most significant recent buildings in American architecture

Three years ago, the AIA JOURNAL published its first annual review of new American architecture. Until then, anyone wanting to keep up with the best of what was being built in America and chart directions in architectural design had two basic choices: read at least the three major American architectural magazines regularly, and perhaps some foreign ones as well; read book-length collections of buildings, usually of single types (houses, factories, etc.), not all of which were anywhere near new.

The JOURNAL's review brought together for the first time a representative sampling of new buildings of all types between a single set of covers; together with observations of prominent architects, critics and historians in architectural design.

The Annual of American Architecture 1980 puts the JOURNAL's annual review between hardcovers for the first time. This beautifully illustrated, four-color book is designed for both the lay and professional reader—a handsome addition to the home or office library. Why not buy extra copies for those friends who "have everything." They won't have this—yet.

To order, simply fill out the coupon below and send in, with your check payable to AIA.

Please send _____ copies of The Annual of American Architecture 1980
(#2M725) @ _____ \$19.95 non-member price
_____ \$16.00 AIA member price

All orders must be prepaid. District of Columbia residents add 5% sales tax. Foreign orders must be paid in U.S. dollars and include postage in the amount of 20% added to dollar amount of order. Total enclosed \$_____.

Send to: Director/Publication Sales
The American Institute of Architects
1735 New York Avenue, N.W.
Washington, D.C. 20006

FIRM _____

ATTENTION _____

ADDRESS _____

CITY, STATE, ZIP _____

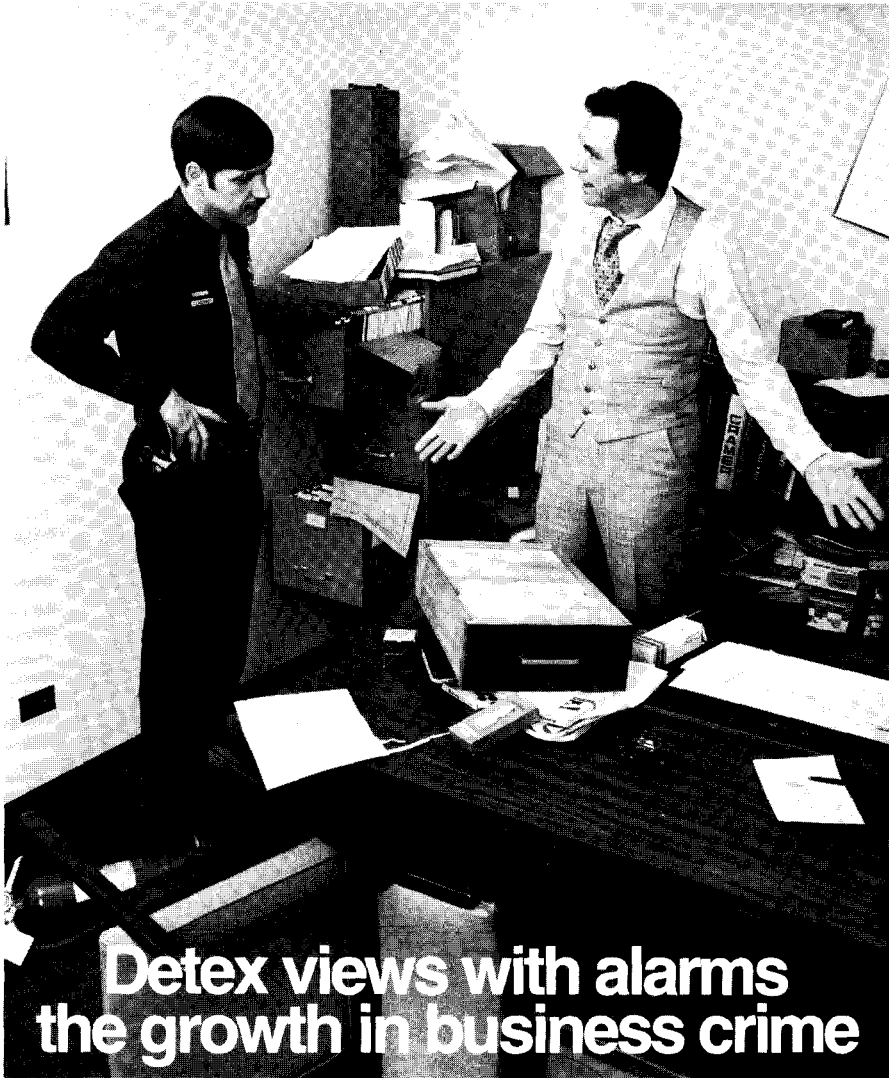

Detex views with alarms the growth in business crime

Up sharply and climbing. Latest statistics paint a sad picture of the recent rise in business crime. What's sadder still, much of it was preventable with alarm-equipped deterrent devices by Detex.

Restricting entry to authorized persons. Discouraging intrusion. Preventing misuse of exits. Detex does it all. Our security hardware products

keep outsiders out and personnel in their places. They're rugged, reliable, reasonably priced devices, combinable into systems to protect an area, a floor, an entire building.

Our full-line brochure gives you all the basics. Or, for comprehensive specs and installation data, write on your letterhead for our catalog.



DETEX

DETERS



4147 Ravenswood Ave., Chicago, IL 60613 Telex: 206268 DETEX CGO

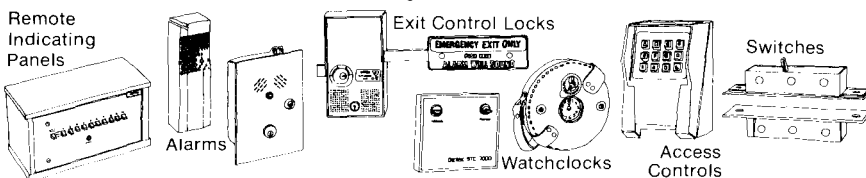

Digest from page 104

and, in the case of external environmental forces, appropriate topographical data.

Wind tunnel and wave tank studies employing aerodynamic and hydrodynamic models can also be used to assess the likely motion of structures. For structures that are large in comparison to surrounding objects, the calculation of probable storm induced motion is simpler than for cases where a number of large structures are built close together.

Where unacceptable levels of structural motion exist or are expected, a number of solutions of varying degrees of complexity can be employed. One form of solution is to increase the structural rigidity (and, thereby, the fundamental natural frequency) by judicious addition of stiffening elements of small mass in comparison to the existing structure. Thus raising the frequency of motion and, in some cases, reducing the magnitude of acceleration can often eliminate the motion problem, but care must be taken at low frequencies, since the acceptable level of acceleration falls with increasing frequency in this range.

The straight addition of mass to reduce the frequency of motion is generally not an efficient means of reducing problems of overall vibration of structures, a more efficient means being the addition of either ring dampers on slender towers or tuned mass dampers (see page 65) that are designed to negate significant dynamic components of horizontal motion of tall buildings.

For ground motion input, foundation isolation of various forms has been tried, and, in some cases, a degree of success has been achieved, but additional problems can arise from dynamic force actions applied above functional level.

In conclusion, the study shows that, although a large body of data has been gathered about human response to structural motion, much work still remains to be done, especially on problems arising from low frequency motion.

Urban Technology

By Paul Weidlinger, structural engineer. This text is excerpted from a lecture given at Columbia University in 1979.

Urban technology has been described as a collection of structures and systems which constitute our urban environment. Many of these systems—like telephone service, water supply and sanitary sewers—work quite well and we are reasonably satisfied with them. But when I think of urban technology, what comes immediately to mind are the things that do *not* work. I think inevitably of potholes, of power blackouts, of rubbish-strewn

continued on page 110

From sunup to sundown

JOY™ controllible pitch fans automatically supply VAV systems with just the right amount of air to meet changing air conditioning requirements and save you power costs.



In response to changes in humidity, temperature or static pressure the blade angle changes automatically

while the fan is operating. Air volume flow is changed in seconds to meet system needs.

AXIVANE® fans use less power than any other conventional method of volume control. They are truly energy efficient.

For energy savings data contact Joy Manufacturing Company, Air Moving Products, New Philadelphia, Ohio 44663.

Offices and plants throughout the world

**NEW
PHILADELPHIA
DIVISION**



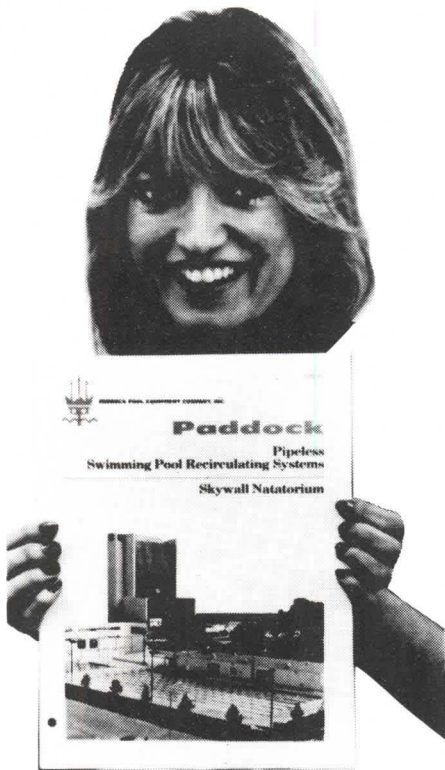

The answer to all your swimming pool questions.

New construction or rehabilitation... filtering systems to pool enclosures... manual or fully automated operation... whatever your question, you'll find the answers in our new 16 page, full color brochure. Write, call, or send reply card today — we'll send your brochure out by return mail.

Paddock®
Pool Equipment Co., Inc.
P.O. Box 511
Rock Hill, S.C. 29730
803-324-1111

Circle 49 on information card

Digest from page 108

streets. I think also about things which are missing: subways that are fast, cheap and safe, or a pleasant environment. Each of you could probably extend this list of complaints indefinitely. When you hear such a litany, it is likely to be followed with: "When we can put a man on the moon, why can't we . . . ?" Here you can interject any one of the urban desiderata.

Whenever we have a social problem, we tend to turn to the technologists for imaginative solutions. This is what is referred to, in policy research circles and among political scientists, as "the technological fix." This so-called technological fix is what I'd like to discuss, to explore whether it is applicable to our urban problems, and to consider the constraints.

Take, for example, the energy shortage. One nontechnological solution that has been suggested is conservation. If we made a serious effort, we could probably reduce our energy demands by 20 or 30 percent. Another approach, which is sometimes called alternative technology (in the jargon, it is referred to as AT for "appropriate technology"), or "soft" technology, proposes solutions such as the use of woodburning stoves, or solar energy, or bicycles to replace "hard" (capital-intensive) technology. On the other side of the energy debate are people who advocate advanced technology, who make proposals regarding exploration for natural gas, shale oil recovery, coal conversion, nuclear fission or fusion.

I am sure you realize that I am oversimplifying the distinction, but it is a valid one in terms of urban problems. Those who advocate nontechnical solutions to some of our technological problems in the city will propose approaches through planning, through zoning or labor-intensive manufacture. Finally, they will propose the 3 Rs: reconstruction, recycling and rehabilitation. There are many other valid suggestions of this type, but I am sure that even the most fervent advocates of nontechnological solutions will agree that hard technology cannot be eliminated from the city. I also think that there is no constituency in the inner city for nontechnological approaches. To put it bluntly, city dwellers are not really convinced that a brick in the toilet tank will save us from future water shortages. You probably gather from these remarks that I myself am not convinced that the nontechnological, or soft technology, solutions will solve our problems. But, unfortunately, neither am I convinced that massive public works projects offer an automatic cure.

Let me remind you that this is a new problem for us, because the civil engi-

neers of a few generations ago didn't have any such worries. That was the era when the Suez and Panama canals were constructed; the water supply systems were installed; railroads, streetcars and subway systems were built to take care of mass transport; the Empire State Building and the Eiffel Tower were put up. All of these structures were objects of pride that could be characterized with superlatives: biggest, longest, strongest, fastest. When I ask myself how these feats were accomplished and managed so well, I can think of four reasons. First, the problems were clearcut and the goals well-defined. Second, the social benefits were very clearly perceived. Third, such large projects were relatively few in number—sufficiently few that a small number of brilliant individuals could address themselves to the problems successfully. Finally, because the engineering projects of that era were unprecedented the criteria of success or of acceptability were less stringent than they would be today. What was common to many of those large-scale undertakings which incorporated imaginative new concepts and designs was that the same people who conceived them also worked out the scientific problems posed and then went on to solve the logistical dilemmas involved in the actual construction.

Now, looking at contemporary technology, we find the picture quite different. Some of the great accomplishments of a century ago seem almost trivial to us. Such things can be and are done today by ordinary, not brilliant, people; and they are done with an expenditure of effort in design, analysis and construction that is frequently an order of magnitude less than what was required just a few generations ago. In fact, what is notable about present-day problems of advanced technology is that the underlying scientific methods are usually available in the published literature. In effect, the situation is now reversed: In the past, the problem was posed and we looked for a scientific solution; today, we have a plethora of possible solutions and our task is to match them to our problem.

Given this optimistic description of our current state of technology, why is it that technology in the city doesn't seem to work? Why doesn't the airconditioning work in the new city buses? Why are the subway cars increasingly noisy? Why do windows blow out of new skyscrapers? It wouldn't be difficult to give detailed technical explanations for these failures, but I personally believe the problem does not lie with technology. A naïve belief in the omnipotence of technology ignores the very real social and economic costs of technological solutions. Furthermore, we must be aware that large undertakings in today's world require a public consensus.

continued on page 112

Steel Joist Construction— why you can still look at it as your most economical way to build.

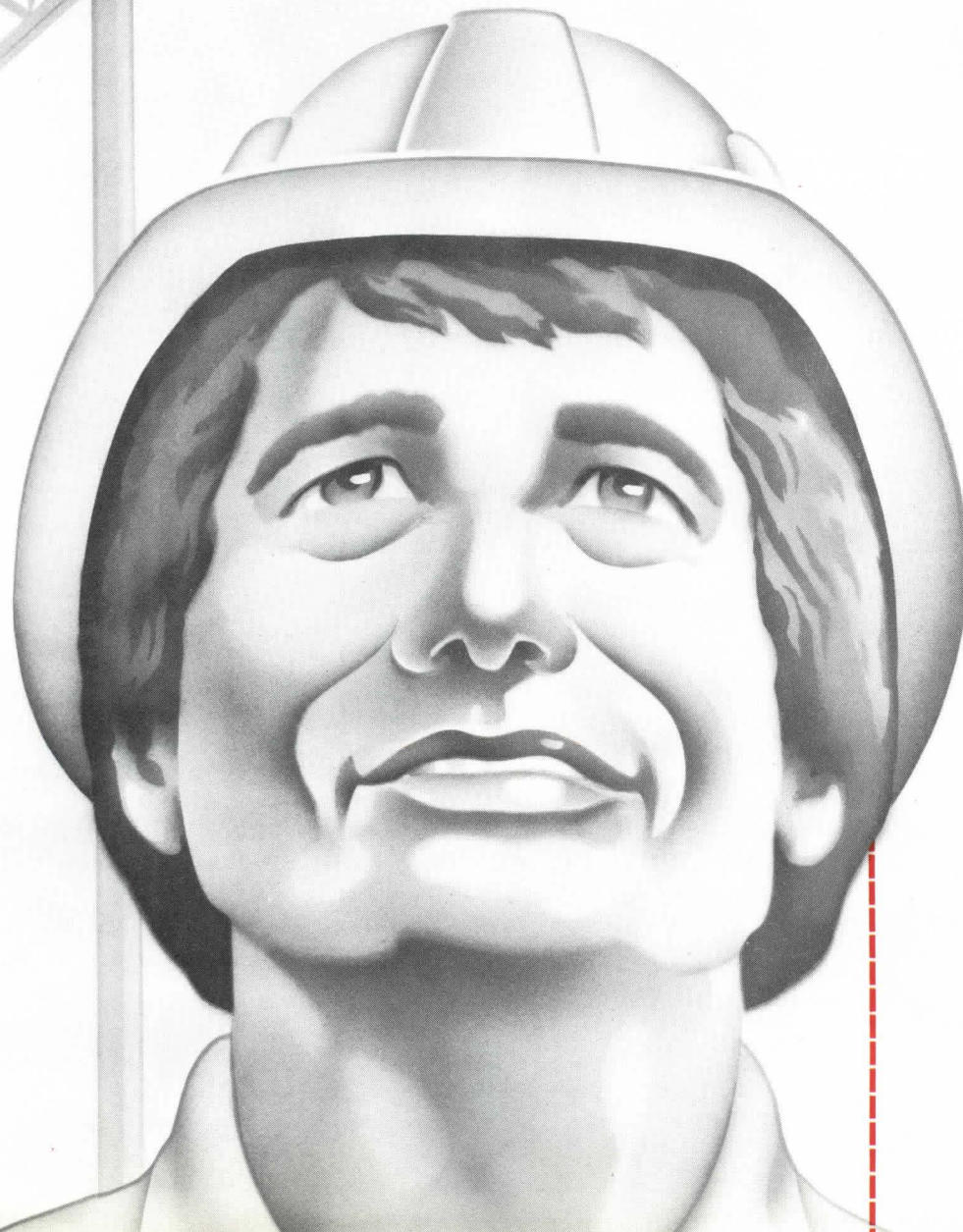

- Steel joists can save on your labor costs by speeding up construction.
- More square feet covered per day— with a system of joist girders and joists. (Fastest way to get a roof on.)
- Steel joists let you install duct work, wiring and pipes simultaneously.
- Steel joists eliminate the time and expense of erecting temporary flooring and working platforms.
- Steel joists are made with modern, high-strength steels, allowing you to use less steel to meet structural strength requirements.

Free! FIRST EDITION

Combined Specs, Load Tables and Weight Tables for steel joists and joist girders.

79011

Steel Joist Institute
Room 204-B
1703 Parham Road
Richmond, VA 23229

Please send me your latest copy of Specs, Loads and Weight Tables.



Name _____

Title _____

Firm _____

Address _____

City _____ State _____ Zip _____

Circle 50 on information card

WITH CHENEY

VENTILATE

Cheney continuous soffit vent is an attractive and economical system that provides 23% of open air space per square inch. Can be used with all Cheney Soffit Panels in matching colors.

Send for brochure showing design and installation procedures.

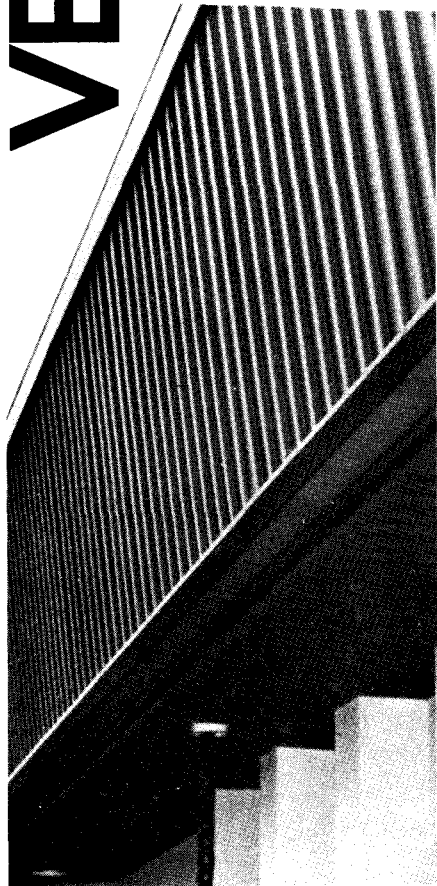

A company in touch with your needs.

CHENEY FLASHING COMPANY

ESTABLISHED 1928
623 Prospect Street
P.O. Box 818
Trenton, N.J. 08605
Phone 609-394-8175

Circle 51 on information card

Digest from page 110

And for a consensus to exist, one must be able to agree on priorities, to understand tradeoffs.

Historically, technological innovations have been accompanied by unpredictable social effects, making consensus not only difficult but frequently illusory. I therefore believe that if we want to introduce advanced technology we must also introduce equally advanced and innovative processes of decision making.

As long as this process consists of an unstructured debate among ill-informed parties, the technologists will be able to say: You tell us what you want, and we will do it. This seems to be an important unresolved issue.

A second, less obvious, issue is the mismatch between the quantity and complexity of our urban problems and the quantity and competence of the professionals on hand to deal with them. This is an assertion that I cannot support with any statistics, but it derives from a strong impression gained by personal experience. It reminds me of a Malthusian phenomenon, with technological problems growing exponentially while the number of people who can solve them grows only linearly. In engineering and technology, however, we have obtained significant help—just in the nick of time—from computer technology. Computer technology produces solutions very rapidly but it does not guarantee brilliant solutions. In fact, we can ordinarily expect only mediocre solutions and occasional failures. Our perception of this fact is especially strong because our criteria of success have become extremely stringent, necessarily so. The fabric of the urban environment is so fragile that any malfunction can have very serious and dramatic consequences, as witness the aftermath of 1978's blackout in New York City. We must therefore apply very high standards before we accept any new technology or consider it a success. This, I would remind you, is a relatively new phenomenon.

After this recitation, it would be presumptuous of me to offer you solutions. But I can at least suggest some thoughts that are the result of prolonged and frequent confrontation with these problems.

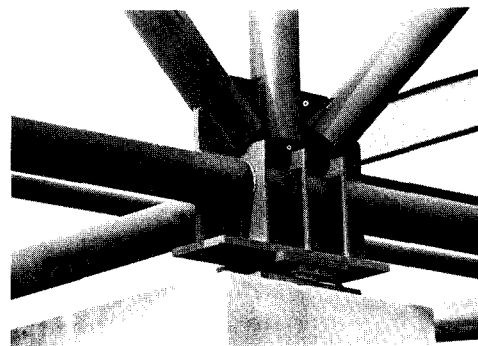

A stopgap measure would be to recognize our limitations and to adjust our expectations accordingly. A permanent solution, on the other hand, poses a formidable challenge to members of the academic community both in their role as researchers of scientific problems and as educators. We must somehow find a way to convince the best and the brightest of our students and professionals to turn their attention to problems of urban technology. We may have to rethink our curricula in engineering schools and to raise the level of competence and creativity of future professionals as well as to increase their numbers.

But even if the schools of engineering were to succeed in this very difficult undertaking, we would still be faced with the inadequacy of our political decision making in respect to technological issues. Again, the best place to explore this is in the university, where ideas have to be developed, debated and even experimented with. Perhaps the first step should be to work out some formalized, institutionalized procedure to reach, if not first-order, at least second-order agreements; that is, to agree what it is we disagree on, to agree on the facts and on the agenda for the debate. Anyone who has worked on conflict-resolution is aware how difficult even that step can be, but it is most urgent in this context.

If I have strayed somewhat from my area of expertise, I have done so in the hope of being able to show you that those of us deeply involved in these issues in our professional lives are aware of the limitations of our tools. On a more optimistic note, I am convinced that many of the perceived problems of the city are actually ephemeral. More specifically, I believe the problems are soluble because there already exists an excellent urban technology—not on the moon, and not in any one place on this planet, but scattered in a number of cities around the world. A component may be found in Chicago, another in London, or Paris, or Moscow or even New York. Furthermore, every one of the complaints that I enumerated at the start does not crop up in every one of the cities I have just named: Some have good subways, some have good surface transportation and so on. The problems are solved technologically, so the question becomes one of how we use the technological solutions. In the long run, these problems will be solved, either with us or without us, in the context of the much broader political problems of our world. And they will be solved somehow in the next 50 to 100 years, or else we won't have either the problems or the cities themselves. In the meantime, I console myself with the fact that (as the Chinese curse has it) we are living in interesting times. □

What is a deductible credit plan?

The Deductible Credit Plan is a new and exclusive feature of the CNA Architects' and Engineers' Professional Liability Insurance Program that could save you from 10% to 50% of your deductible obligation at the time of a claim. Or you can use your deductible credit to lower your premium without having to buy a higher deductible! And, best of all, for qualified insureds, it's a standard feature of our policy — no extra charge!

Sound like a good deal? It is.

And it's available with the CNA Architects' and Engineers' Professional Liability Insurance Program.

Call your broker for details.

Victor O.
Schinnerer
& Company, Inc.

Program Administrators & Underwriting Managers
Commended by AIA and NSPE for its members since 1957.

The first is still the best

5028 Wisconsin Ave., N.W.
Washington, D.C. 20016
(202) 686-2850

40 Wall Street
New York, N.Y. 10005
(212) 344-1000

55 E. Jackson Boulevard
Chicago, Illinois 60604
(312) 939-1202

595 Market Street
San Francisco, California 94105
(415) 495-3444

The Deductible Credit Plan is subject to approval by state regulatory authorities and may not yet be available in some areas.

Ivor Ash, La Canada, Calif.
 H. J. Reed Barrett, La Jolla, Calif.
 William A. Bowden Jr., Birmingham, Ala.
 Chester A. Brown, Winter Park, Fla.
 Harold Carver, Arvada, Colo.
 Frank R. DeLuca, Marblehead, Mass.
 Harold Gimeno, Santa Ana, Calif.
 B. R. Hardman, Richmond, Calif.
 Clarence O. Jahn, Green Bay, Wis.
 Charles O. Matcham, FAIA, Pasadena, Calif.
 Raymond E. Meyn, Kansas City, Kan.
 George Brian Mitchell, Birmingham, Ala.
 John W. Powers Jr., Birmingham, Ala.
 Albert Simons, FAIA, Charleston, S.C.
 George Sprinkle, FAIA, Phoenix
 Austin Van Dusen, Seattle
 George L. White, Alexandria, Va.

Albert M. Goedde, AIA: A member of AIA's board of directors in 1963, representing the Illinois region, Mr. Goedde also served as president of the Southern Illinois Chapter/AIA. He died on Aug. 18 at the age of 67. Mr. Goedde headed the firm of Albert M. Goedde & Associates in Belleville, Ill., participating in the design of many of the area's institutional and industrial buildings, including schools, libraries, churches and hospitals.

Bill N. Lacy, FAIA, president of the Cooper Union for the Advancement of Science and Art in New York City, has been named program chairman for the 31st International Design Conference in Aspen, Colo., to be held June 14-19, 1981.

William A. Cox Jr. of Norfolk, Va., has been installed as president of the National Society of Professional Engineers.

A master's degree in historic preservation is now offered by the University of Oregon's school of architecture and allied arts.

J. Armand Burgun, AIA, of New York City has been elected chairman of the board of directors of the National Fire Protection Association.

"Insulation Manual: Homes, Apartments" gives architects and others information on the proper installation, use, economics and benefits of insulation as well as energy-saving techniques for wood-frame buildings. Prepared by the NAHB Research Foundation (National Association of Home Builders), it is available for \$10

from the Mineral Insulation Manufacturers Association, 382 Springfield Ave., Summit, N.J. 07901.

The Walker Art Center in Minneapolis has begun its three-year internship program in graphic design. Applications for internships beginning September 1981 will be accepted through April 1981. For information, write: Design Fellowship, Walker Art Center, Vineland Place, Minneapolis, Minn. 55403.

Robert M. Warner, former director of the Bentley historical library, University of Michigan, has been installed as the sixth archivist of the U.S.

Roger T. Carrillo of the firm of Bradley & McChesney, San Antonio, Tex., won second place in the eighth annual William Van Alen international awards program, sponsored by the National Institute for Architectural Education. The award-winning project was for an audiovisual center for the Louvre in Paris.

The National Fire Protection Association has published 20 new and revised safety standards. The three new ones are: Standard Fire Protection Symbols for Architectural and Engineering Drawings

continued on page 116



Before you specify quarry tile send for this free booklet.

Learn how Romany® Pavers exceed the recommended A 137.1 standard grade specifications for quarry tile in this free, illustrated, fact-filled booklet.

Made with a slimmer profile (3/8" thick) than standard quarry tile, Romany Pavers excel in strength and beauty. They exceed A 137.1 standards for bond strength, warpage, wedging, water absorption, breaking strength, abrasive hardness and facial dimensions.

Write for free test data brochure, which also includes color illustrations of the complete product line. United States Ceramic Tile Company.



1375 Raff Road S.W.
 Canton, Ohio 44711

Questions About Your Subscription

To insure fast service on inquiries concerning your *AIA JOURNAL* subscription, please include the address label from the most recent issue received.

ATTACH LABEL HERE

Change of Address

Eight weeks' notice required for change of address. Include address label from most recent issue and new address information in space provided below.

NEW SUBSCRIPTION

Please check here if you wish subscription rate information.

Name _____
 Address _____
 City _____
 State _____ Zip _____

MAIL TO:

AIA JOURNAL
 Circulation Dept.
 1735 New York Ave., N.W.
 Washington, D.C. 20006

TWO GREAT COMPETITORS: WATER TOWER PLACE

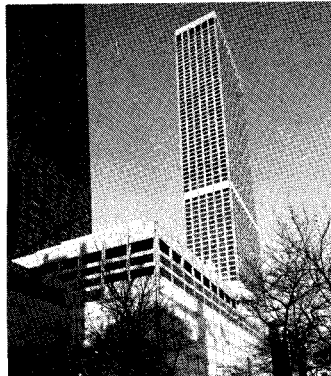

In the contest for profits and prestige on Chicago's "Magnificent Mile," everyone—investors, tenants, architects, shoppers, tourists—recognizes this building as a winner.

Sheer size is one factor:

74 floors, three million square feet. Cited as the best of the new high-rise, multi-use buildings, it combines four parking levels, 600,000 square feet of shopping and restaurants, two city-block size office floors, five theaters, 260 condominium units—and the 450-room Ritz-Carlton Hotel.

It upsets conventional retail wisdom with an eight-level

downtown shopping center. Built around a glittering atrium of glass-enclosed elevators, this first truly vertical shopping mall is also one of Chicago's most popular.

One of the largest concentrations of plumbing under one

roof—an estimated 68 miles of pipe—results from vast floor area plus a unique mix of functions. The potable water system at Water Tower Place: 100% galvanized steel pipe.

STEEL PIPE

When the time came to specify the pipe for the potable water system, project planners scanned competing materials and agreed *it had to be steel.*

Steel pipe met Chicago's rigid plumbing code requirements

—and the project's own demanding criteria—for offices, shopping, condominium and hotel.

Steel pipe satisfied construction needs. Its strength, inherent damage resistance helped the plumbing contractor meet accelerated schedules. Local trades greeted steel with total acceptance.

Steel pipe gave an extra margin of quality for a demanding, complex job—fewer expansion loops in tight spaces, minimum vibration where quiet is at premium...overall, proven reliability.

"We've simply had no problems with our domestic water sys-

Credits:

Architects & Engineers: Loeb, Schlossman & Hackl, Chicago; C. F. Murphy Associates, Chicago (joint venture); Architectural Consultant for Commercial Area: Warren Platner Associates, New Haven, Connecticut; General Contractor: Inland Construction, Inc., Chicago; Plumbing Contractor: Thomas H. Litvin Company, Chicago.

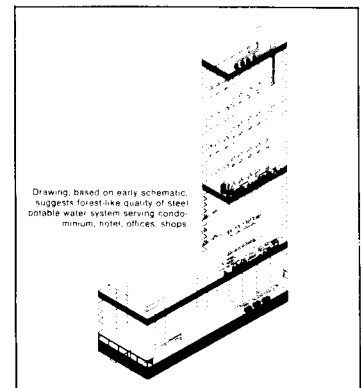

tem," says chief engineer John Bailey. At Water Tower Place as in other pace-setting buildings, steel pipe outclasses the competition—and goes the distance.

Chances are, *your* next project offers compelling reasons for choosing steel pipe. For more information, write on your letterhead for AISI's new 48-page **Handbook of Steel Pipe**, to **Committee of Steel Pipe Producers, American Iron & Steel Institute, 1000 16th Street, N.W., Washington, D.C. 20036.**



Circle 54 on information card



A POST YOU CAN LEAN ON



Pick your post and lighting fixtures from the greatest variety of nostalgics ever to grace the American scene. Wherever you gaze, wherever light enhances man's outlook, Welsbach stands unique.

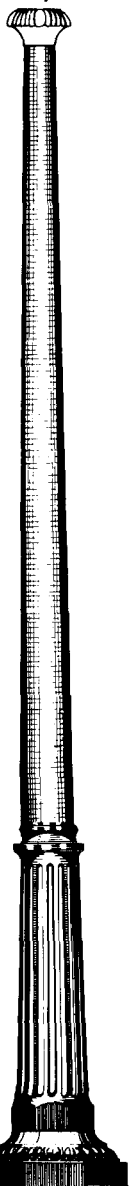

The Essex

WELSBACH LIGHTING, INC.
240 Sargent Drive
New Haven, Conn. 06511
(203) 789-1710

Circle 55 on information card

Briefs from page 114

(NFPA 172); Standard Fire Protection Symbols for Risk Analysis Diagrams (NFPA 174), and Standards on Aircraft Maintenance (NFPA 410). The 17 other documents have been revised completely. Contact: NFPA, 470 Atlantic Ave., Boston, Mass. 02210.

“Rehabilitation of Historic Buildings: An Annotated Bibliography,” edited by Frederec Ellsworth Kleyle, lists publications readily available on the recycling of industrial, commercial and residential buildings. It is available for \$2.25 from the U.S. Government Printing Office, Washington, D.C. 20402 (No. 024-016-00130-3).

Candidates may now apply for the 1981/82 Kate Neal Kinley memorial fellowship, which yields \$3,500 to help defray expenses for advanced study in architecture, art or music in the U.S. or abroad. Applications are due by April 15, 1981. Contact: Dean J. H. McKenzie, Kinley Fellowship Committee, College of Fine and Applied Arts, 110 Architecture Building, University of Illinois at Urbana-Champaign, Urbana, Ill. 61801.

“Housing: Process and Physical Form” is the title of the proceedings of seminar three in the series “Architectural Transformations in the Islamic World,” held in Jakarta, Indonesia, in 1979. The seminars were sponsored by the Aga Khan award for architecture. The report contains papers on issues in housing, professional and user roles, background to housing in Islam and comments and discussions. For information, write: Seminar Three, Aga Khan Award for Architecture, University City Science Center, 3624 Science Center, Philadelphia, Pa. 19104.

An international symposium on indoor pollution will be held in the fall of 1981 under the sponsorship of Harvard University’s energy and environmental policy center. Papers are solicited. Contact: Joan Curhan, Energy and Environmental Policy Center, John F. Kennedy School of Government, Harvard University, Cambridge, Mass. 02138.

Rex Whitaker Allen, FAIA, of San Francisco, president of the Institute in 1969/70, has been elected vice president of the Northern region of the Pan American Federation of Architectural Associations. The region encompasses the U.S., Canada and Mexico.

Thomas Hsieh, AIA, of San Francisco is one of three persons appointed by President Carter to the President’s Commission on Executive Exchange. □

PRODUCTS

Wallcovering.

Four natural-fiber wallcoverings feature cotton, silk, wool, jute and other imported fibers. All exceed class “A” fire specifications. (Importex, Louisville, Ky. Circle 197 on information card.)

Lighting Track System.

LSI track system, made of anodized satin aluminum with reinforced GE Lexan fittings, is available in 4-, 8- and 12-foot lengths, with in-between sizes easily produced by field-cutting. Several mounts are offered and track lengths can be coupled at any angle between straight and 90 degrees. (Lighting Services Inc, New York City. Circle 193 on information card.)

Recording Hygrometer.

Class 61 relative humidity and temperature recorders are designed for environmentally sensitive operations such as computer and manufacturing facilities, archives and museums. Disposable fiber-tip cartridge pens inscribe relative humidity, or relative humidity and temperature, on a circular chart. (Honeywell Inc., Process Control Division, Fort Washington, Pa. Circle 192 on information card.)

Water Coolers.

Series of Oasis water fountains with seamless stainless steel cabinets and rounded edges for safety includes a model featuring barrier-free design with a “soft-touch” lever on each side upon which light pressure activates water flow. (Ebco Manufacturing Co., Columbus, Ohio. Circle 191 on information card.)

Window Insulation.

Heat Mirror transparent insulation transmits 80 to 90 percent of visible light, while reflecting longer-wavelength radiant heat back inside a building in winter and outside in summer. Consisting of a microthin coating applied to polyester film, it can be used in windows, skylights and greenhouses for passive solar heating. If used between two panes of glass as a center layer, it has an R-value of 4.3. (Southwall Corporation, Palo Alto, Calif. Circle 194 on information card.)

Suspended Ceiling.

A metal pipe grid connects colorful cotton canvas panels in this system designed for informal commercial applications. (Integrated Ceilings, Inc., Los Angeles. Circle 185 on information card.)

Under-Carpet Wiring System.

Versa-Trak flat-conductor cable system is designed for open offices, banks and industry. Insulated conductors are laminated in a polyester envelope and sand-

continued on page 118

Before the mail arrives... Kwik-File's Mailroom Planning Service happens.

Kwik-File has used its organizational and design expertise to solve mailroom problems for several of the country's leading corporations. Now that expertise is available as a planning resource for architects and contract designers.

Mailroom design involves a lot more than just ordering the furniture. There are flow patterns to consider, sorting systems, timing of delivery schedules, and a lot more. Kwik-File has found that efficient mailroom design can contribute to the all-important bottom line, and that's where the Mailflow Systems Mailroom Planning Service comes in.

The Planning Service is based on a review of design parameters from hundreds of mailrooms both new construction and remodelings. It permits

architects and contract designers to establish a dialogue with Kwik-File mailroom analysts leading to a detailed plan, suggested flow patterns, furniture schedule—even photographs of the proposed mailroom built with scale models.

For your copy of the Mailflow Systems Mailroom Planning Service Kit, call Roger Howe at Kwik File's toll-free number 800/328-5711, or write him at the address below.

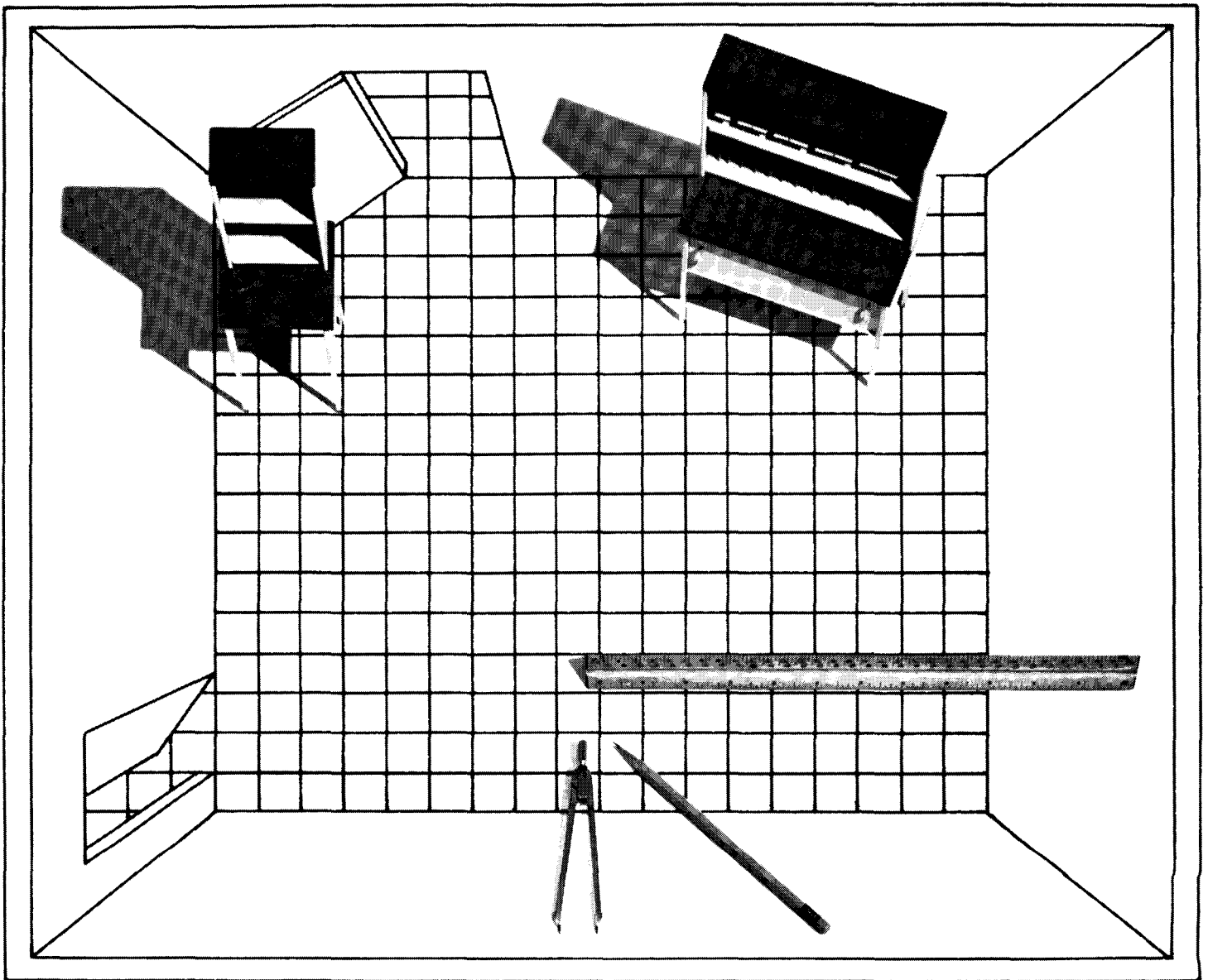

KWIK-FILE

700 Colorado Avenue, Golden Valley, MN 55416

Products from page 116

wiched between a grounded protective metal shield and a moisture/abrasion-resistant polyester bottom film. The cable can be covered with standard carpet squares. Several designs of floor pedestals for outlets are available. (Thomas & Betts Corporation, Raritan, N.J. Circle 186 on information card.)

Vanity.

Commercial restroom cabinet integrates accessories—paper towel dispenser, towel disposal and soap dispenser—into a vanity top that can accommodate wheelchairs. Formica top is available in a variety of colors and patterns. (Ampco Products, Inc., Hialeah, Fla. Circle 188 on information card.)

Vinyl Suede Fabric.

Striped vinyl suede fabric for wall-coverings or upholstery is flame-rated, 54 inches wide and available in 25 color combinations. (J. M. Lynne Co., Inc., Hauppauge, N.Y. Circle 183 on information card.)

Tile.

Imported unglazed ceramic tile for use indoors and out is available in four colors: red, flashed red, burnt umber and Sahara flashed. Serie Copper line of glazed tiles

has a layer of copper powder fused during firing, creating an incandescent effect. (Hastings Tile & Il Bagno Collection, Lake Success, N.Y. Circle 184 on information card.)

Pressure-Treated Wood.

Sunwood is a reddish-brown pressure-treated wood that is resistant to termite and fungus damage. A special colorant is combined with the water-borne preservatives used in the traditional green treatment, producing the earthtone effect. (Osmose Wood Preserving Co., Buffalo, N.Y. Circle 179 on information card.)

Floor Lamp.

Sabra contemporary designed lamp is a 5-inch diameter column. Changing the height of the column (can be varied from 44 inches to 54 inches) allows different amounts of light through the luminous frosted glass midsection. (Koch + Lowy, Inc., Long Island City, N.Y. Circle 181 on information card.)

Planter.

Floor planter of aluminum alloy is corrosion-resistant and available in polished and satin finishes. Inside surface is Teflon. Measures 17x18 inches. (Architectural Supplements Inc., New York City. Circle 180 on information card.)

Word Processing.

Execupak time-management system is a software-based addition to the Micom 2001 word processor. It keeps agendas, presents status reports of projects and organizes and stores incoming mail. Other systems introduced for executives are a text editor, a math software package and the Miconet high-speed electronic communications system. Micom Co., Dallas. Circle 182 on information card.)

Wraparound Fluorescent Lenses.

Prismawrap lenses are manufactured from clear acrylic. The 6100-A model has an upright prismatic component and a bottom transverse and longitudinal prism design for lighting corridors and aisles up to 10 feet wide. The prismatic array of the 7100-A and the 7400-A models provides a widespread light distribution, obscures lamp images and masks dark lamp ends for a clean luminaire appearance. (Johns-Manville Corporation, Denver. Circle 196 on information card.)

Woven Oak Shutters.

Wovoak insulated shutters are prehung in a 2- or 2.5-inch deep oak box, designed to seal to the wall, surrounding the trim and window opening. (FTR-Wovoak, Boulder, Colo. Circle 170 on information card.) □

MUSSON

DISC-O-TILE™ Safety rubber flooring &
DISC-O-TRED™
Safety stair treads

No.
788

The unique raised circular disc design allows drainage, easy cleaning. Durable, stain-resistant, fire-retardant (Meets ASTM-E84 Flame Spread Rating of 25 or less); non-tacking and non-slip. Ideal for shopping malls, airport terminals, schools, hospitals, heavy traffic areas. TILES are 24" sq. TREDs ¼" thick, standard lengths. COLORS: Brick Red, Brown, Gray, Sand, Blue, Black.

Meets ASTM-E84 flame
spread rating of 25 or less

No.
787



For Free Brochure & Samples, write:

THE R. C. MUSSON RUBBER CO.

1310 East Archwood Akron, Ohio 44306 Ph: 216/773-7651

UNIVERSITY OF MISSOURI—COLUMBIA invites applicants for the position of DIRECTOR OF FACILITIES MANAGEMENT

The Director of Facilities Management will be responsible for the planning and coordination of all renovation, rehabilitation and improvements of campus facilities and grounds including coordination with Central Administration of contract work. The Director will also be responsible for the administration of facilities funds and the development of the legislative request for capital funding for the preservation and improvement of physical facilities.

The University of Missouri—Columbia was founded in 1839 and is the oldest state University west of the Mississippi River. There are 172 buildings with a gross square footage of 7,238,534 square feet serving 17 Schools and Colleges within the University. The Columbia campus has approximately 24,000 students and 5,000 employees. Columbia is located an equal distance (120 miles) between Kansas City and St. Louis and is within easy reach of lakes and hunting grounds in the Ozark foothills.

Successful applicant will have an Architect license, Master's degree in Engineering, Architecture or a planning related area and six to eight years of experience in physical planning, preferably including experience in higher education.

Submit resume and salary requirements prior to November 1, 1980 to:

Dr. Ria C. Frijters
Vice Chancellor for Administrative Services
University of Missouri—Columbia
309 Hitt Street
Columbia, Missouri 65211

AN AFFIRMATIVE ACTION/EQUAL OPPORTUNITY EMPLOYER

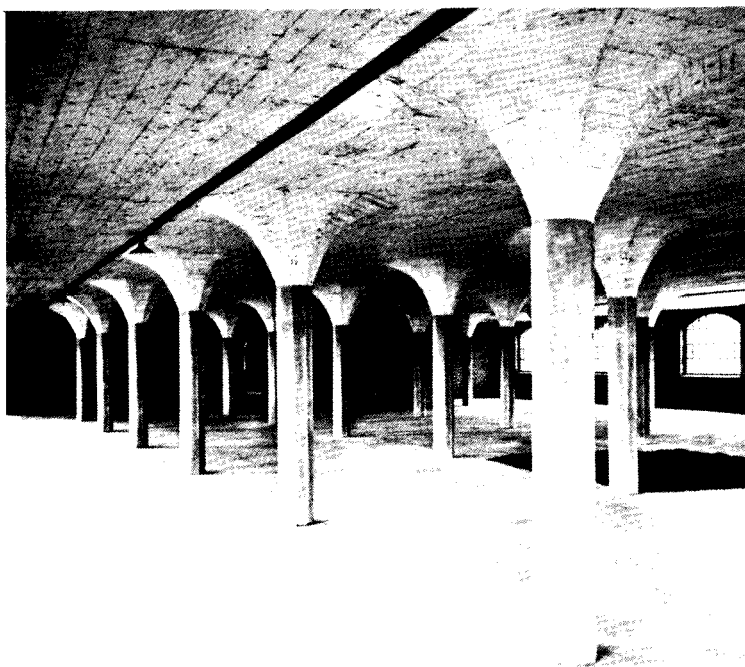
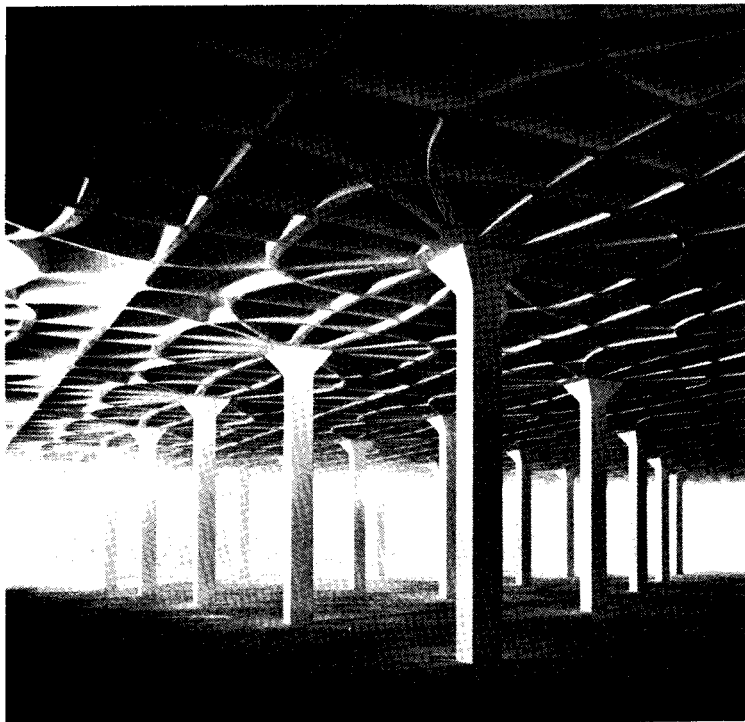

Upper photo, the Gatti wool mill in Rome by Pier Luigi Nervi, 1953. Lower photo, a warehouse in Zurich by Robert Maillart, 1910. From 'Structures Implicit and Explicit,' published by the University of Pennsylvania graduate school of fine arts.

before of the separation of metal structures into tension and compression members which, in joining, demand the support of a labor intensive economy. Here, we have accepted to be capital intensive and labor-saving and continue to accept the shape of that manufactured product from the factory that demands the least of labor for fabrication and assembly. The care with which Mies van der Rohe sought for the expression of the steel column suggests a European attitude—it is labor intensive and material saving.

The question has to be raised as to whether the structural intuition of one culture should be transferred to another culture. While focusing on the transfer of technologies, we have not studied the influence of the transfer of ideas, and here, of intuitions. What, and where, is the source of the structural intuition of Arup, Candela, Gaudi, Khan, Komendant, LeRicolais, Maillart, Mies, Nervi, Otto, Torroja, et al.? The logic of physics insists that experiments be replicable throughout the world. The "scientia" or theoretical roots of architectural structures is not equivalent to the "scientia" of physics. In the absence of an intuition of intuitions, it might be appropriate to begin a study of a "science" of intuitions.

The architect, today, has a new intuition as to the limits and possibilities of the material world—at least that aspect of it to be used in building. No longer do we have an understanding of an architecture of stone, of wood, of steel, etc. That understanding discussed the nature of those materials, their limits and their possibilities. The characteristics sought today are those of performance. As we have moved toward specifying the heat, sound, light, durability, changeability, etc., of the elements which define our spaces, so we have removed ourselves from the materials themselves. As we remove ourselves from the materials, we remove ourselves from the forms they can take and hence from the development of any structural intuition. Thus, we find the dominant expression becomes that of skeletal frame (hidden, to be sure) on which we apply skins, and composite skins, capable of the specified performance. Assuming the day will come when any specification can be met with a special synthetic skin (appropriately structured), there remains a danger for architecture and that danger is the end of the primacy of praxis in architecture; praxis being the dialectic, or dialogue, between theory and practice in which theory informs practice and practice informs theory. The tendency toward an architecture of performance specification has already widened the gap between designing and building. As the pragmatics of architecture leave the total formula, then we see an increased interest in semantics, or meanings, and syntactics, or languages; and a decreased interest in structural intuition. As new materials and their concomitant structural form come into existence, then perhaps intuition will become less useful and less valid as the science of building begins to dominate. The traditional role of the architect to find the delicate balance between art and science might lead not to art and science, but art or science. The relationship among the past, present and future will be less clear.

We accept, in part, that the pragmatics of building in the past are less than useful today, thus invalidating our intuition of structure and construction as an art and a science. For some odd reason we cling to the importance of the meanings and the languages of architecture from the past. The source of this schism can be the result of the separation between the designer and the designed thing, i.e., the architect and the building. Without building, there can be no intuition of building and hence no intuition of structure and construction. Structuring, like building, is not only a means-end problem but also, as architecture, it is inextricably linked with its designer and its culture. □

Intuition from page 59

define the domes, have a completely different expression. The parts are clearly rolled or hammered and riveted together. The manufacturing process and the new engineering expertise are evident. The ornamentation comes from the geometry of the parts and there is no cast foliage as in St. Geneviève. The column remains cast iron, fluted and with an Ionic capital—or, one might say, it remains inhibited by the tradition of stone. However, a new expression and a new structuring is made possible and is realized by Labrouste.

For a period, the American and the French structural intuitions in iron seem parallel. Perhaps the engineers, for that short period, freed the architects from the precedent. Here in the U.S., the engineers were more empirical than their theoretical counterparts in France. In the absence of an aerospace industry, many of the great engineering minds addressed themselves to bridges and buildings. Today, Europe, with a limited aerospace industry, can still attract good minds to the engineering of buildings and bridges. France continues the tradition from Polonceau and

ADVERTISERS

Michael J. Hanley
 Publisher
Michael M. Wood
 National Sales Director
George I. Dant
 Manager, Production and Business
 1735 New York Ave. N.W.
 Washington, D.C. 20006
 (202) 626-7484
Lisa Hoke
 Director of Operations
Suzanne Maggi
 Administrative Assistant

ADVERTISING SALES OFFICES

Washington, D.C. (202) 626-7471

Michael M. Wood
 1735 New York Ave. N.W.
 Washington, D.C. 20006

New York (201) 729-4937

Thomas R Crow
 46 Main Street
 Sparta, N.J. 07871

New England/New York State

(617) 632-8185
 Robert L. Tagen
 87 State Road West
 Westminster, Massachusetts 01473

Chicago (312) 887-1171

Robert M. Brown
 201 E. Ogden Avenue
 Hinsdale, Illinois 60521

St. Louis (314) 569-3210

Richard D. Grater
 1466 Summerhaven
 St. Louis, Missouri 63141

San Francisco (415) 348-8222

Jules E. Thompson
 1290 Howard Avenue #303
 Burlingame, California 94010

Acme Brick Company	89	Joy Manufacturing	109
<i>Phillip Poole Associates</i>		<i>Covey & Koons</i>	
Alma Desk Company	35	Kawneer Architectural Products . . .	30-31
<i>Long, Haymes & Carr</i>		<i>Garrison, Jasper, Rose & Co.</i>	
American Iron & Steel Pipe		Koh-I-Noor Rapidograph, Inc. . . .	84-85
Committee	115	<i>KR Advertising</i>	
<i>Hill and Knowlton</i>		Kwik-File	117
Azrock Floor Products	105	<i>Nelson & Visel, Inc.</i>	
<i>Glenn, Bozell & Jacobs</i>		Laminators Safety Glass Assoc. . . .	95
Brick Institute of America	33, 35, 37	<i>Clif Ferguson Adv.</i>	
<i>Henry J. Kaufman & Assoc.</i>		Libbey-Owens-Ford (LOF)	26-27
Burns & Russell Co.	87	<i>Campbell-Ewald Co.</i>	
<i>Marc Smith Company</i>		Marathon (Bali)	43
Ceco Corporation	46	<i>Glenn, Bozell & Jacobs</i>	
<i>Fensholt, Inc.</i>		Musson Rubber Co.	118
Chemfab/Birdair Structures Div. . .	38-39	<i>Richard Blocher Adv.</i>	
<i>Woodard Askey Eggers & Schaffer</i>		Nat'l. Electrical Contractors Assoc. .	92
Cheney Flashing Co.	112	<i>Vansant Dugdale</i>	
<i>MR Associates</i>		Nucor (Vulcraft)	10-11
Cohama Specifier	25	<i>Faller, Klenk & Quinlan</i>	
<i>Mel Richmond, Inc.</i>		Olympic Stain	Cov. 4
Columbia Lighting, Inc.	1	<i>Kraft Smith</i>	
Concrete Reinforcing Steel Inst. . . .	32	Ostermann & Scheiwe	99
<i>Marsteller</i>		<i>Sharp, Hartwig & Vladimir</i>	
Cookson Company	4	Oxford University Press	37
<i>George E. Church Advertising</i>		<i>Franklin Spier</i>	
Desert Aire Corporation	33	Paddock of California	110
<i>Arrow—Advertising</i>		<i>Halpin Williams & Assoc.</i>	
Detex Corporation	108	Pen Ply	12
<i>Zylke Affiliates</i>		<i>Soderberg, Thompson, MacEwan</i>	
Dover Corp., Elevator Div.	6-7	Pittsburgh Corning Corp.	2-3
<i>Caldwell, Bartlett, Wood</i>		<i>David J. Westhead Co., Inc.</i>	
Dow Chemical Co.	42	PPG Industries (Glass)	18-19
<i>Campbell-Mithun</i>		<i>Ketchum, MacLeod & Grove</i>	
Dukane Corporation	22	PSAE (Masterspec)	41
<i>E. R. Hollingsworth & Associates</i>		<i>Clarkson Associates</i>	
Edison Electric Institute	32A-32F	Rixson-Firemark	23
<i>N. W. Ayer</i>		<i>Motivation Dynamics</i>	
Elk Roofing	97	Robertson, H. H.	91
<i>Reed, Melnichek, Gentry & Assoc.</i>		<i>Creamer, Inc.</i>	
Epic Metals Corp.	20	Schinnerer, Victor O. & Co.	113
Ford Glass Div.	36	<i>Gavotos/Dunn</i>	
<i>Wells, Rich, Greene</i>		Shand, Morahan Company	34
Georgia Marble Company	104	<i>Hakanson & Associates</i>	
<i>Corporate Communications &</i>		Star Mfg. Co.	103
<i>Marketing</i>		<i>Akerman & McQueen Advertising</i>	
Grefco (Permalite)	98	Steel Joist Institute	111
<i>Boylhart, Lovett & Dean</i>		<i>Batz, Hodgson, Neuwoehner</i>	
Grinnell Sprinkler System	101	United States Ceramic Tile	114
<i>Hutchin/Y&R</i>		<i>Covey & Koons</i>	
Haws Drinking Faucet Co.	28	United States Gypsum	14-15
<i>Mandabach & Simms/Pacific</i>		<i>Marstrat, Inc.</i>	
Helios Tension Products	9	University of Missouri-Columbia . .	118
<i>Hisata Design Associates</i>		Welsbach Lighting	116
Howmet Aluminum Corp.	Cov. 2	<i>Langler: Mason</i>	
<i>Crume & Associates</i>		Western Electric Co.	44-45
International Masonry Inst.	93	<i>Foote, Cone & Belding</i>	
<i>Henry J. Kaufman & Assoc.</i>		Westinghouse Elevator Co.	Cov. 3
Johns-Manville (Bldg. Systems		<i>Marsteller, Inc.</i>	
Division)	16-17		
<i>Broyles, Allebaugh & Davis</i>			

CROWD PLEASER.

**Moving people in style. Saving energy.
That's the Westinghouse Moduline 100[®] escalator.**

Pleasing big crowds is the specialty of the Park Place Casino Hotel in Atlantic City. And of the Westinghouse Moduline 100 escalator.

Customers were impressed with the dynamic looks of this "Stairway to the Stars" and its spectacular 90-foot glass balustrade.

Hotel managers liked its ability to move a lot of people quickly. Efficiently. And the quick, trouble-free installation meant the

Bally Corporation, owner of this showplace, could open for business sooner. And win in the big race for new business in the "new Las Vegas."

But like building owners and operators all across America, Bally will also be pleased with the substantial energy savings these escalators provide.

Independent tests showed the Moduline 100 saved 30% over conventional escalators going up

and a whopping 59% going down with only five passengers. And with more people the savings were even greater.

How does Westinghouse do it?

With a unique one-design concept. Modular units, each with a separate motor and drive, can be interconnected. So you can span a vertical rise to almost limitless height. Separate, parallel, criss-cross or even stacked arrangements are possible. And the compact design reduces the need for

massive machine rooms. Building space opens up. That's real design freedom!

To find out more about these people-pleasing people-movers write: Westinghouse Elevator Company, Dept. 802, 21 Bleeker Street, Millburn NJ 07041.

Circle 59 on information card



**Westinghouse
Elevator Company**

**The technical leader
in people-moving systems.**



Beauty that's more than skin deep.



Architect: Wendell Lovett, FAIA, Seattle, Washington

Enhance and protect the natural beauty of wood with Olympic Oil Stain. Olympic *penetrates* wood to protect from within. Rich linseed oil and micro-milled pigments soak down into the fibers, giving wood a deep, uniform finish that stays beautiful no matter how wet or how dry the weather gets.

For additional information, consult your 1979 Sweet's Catalog. Or write Olympic: Dept. P, P.O. Box 1497, Bellevue, WA 98009.

**Penetrates to
protect wood
beautifully.**



Circle 60 on information card