

Playboy would never settle for anything that wasn't beautifully built.

Playboy's new hotel and casino in Atlantic City is one of the most spectacular buildings on the boardwalk.

It combines unusual shapes and materials to create many interesting aesthetic and functional design variations. For that, we congratulate the architect.

But sophisticated design requires equally sophisticated aluminum system engineering and fabrication. And that's where Howmet shines.

Because at Howmet, we believe that just about any design requirement can be met with aluminum. No matter how complex.

And that philosophy is reflected in the Playboy building with features like complex mitered corners, bay windows that provide

a continuous site line around the entire building, unique octagonal skywalks and the innovative use of several sloped wall systems.

Fabricating aluminum systems for creative commercial architecture is a big order. But at Howmet, we have the resources, expertise and commitment to handle just about any shape in the book. Even Playboy's.

For more information call (214) 563-2624. Or write to Howmet, Architectural Products Division, P.O. Box 629, Terrell, Texas 75160.

Circle 1 on information card

HOWMET
ALUMINUM
CORPORATION

A Member of The Pechiney Ugine Kuhlmann Group

Howmet. The name to remember.





©1981 Howmet.
PLAYBOY and RABBIT HEAD Design
are Trademarks of Playboy Enterprises Inc.



Our newest wood eggcrate ceiling systems are both functional and beautiful, and offer Class I Fire Rating, a concealed suspension system, a variety of cell sizes and louver thicknesses, and a selection of light colored woods. Our Quick Ship Program in standard woods and finishes assures delivery when you need it.
Forms & Surfaces Box 5215 Santa Barbara, CA 93108 (805) 969-4767 969-5033

FORMS + SURFACES

Circle 2 on information

CONTENTS

The American Institute of Architects

Officers

R. Randall Vosbeck, FAIA, *President*
Robert M. Lawrence, FAIA, *First Vice President*
Robert Broshar, FAIA, *Vice President*
George M. Notter Jr., FAIA, *Vice President*
Ray K. Parker, AIA, *Vice President*
Harry W. Harmon, FAIA, *Secretary*
J. W. Barnes, FAIA, *Treasurer*
David Olan Meeker Jr., FAIA, *Executive Vice President*

Directors (Year indicates expiration of term)

George A. Bissell, FAIA ('83), *California*
William Blurock, FAIA ('82), *California*
James C. Dodd, AIA ('81), *California*
J. Peter Winkelstein, FAIA ('83), *California*
R. Bruce Patty, FAIA ('82), *Central States*
Henry W. Schirmer, AIA ('81), *Central States*
P. Whitney Webb, AIA ('82), *East Central States*
Ellis W. Bullock Jr., AIA ('81), *Florida/Caribbean*
E. H. McDowell, FAIA ('81), *Florida/Caribbean*
William H. Beaty, AIA ('83), *Gulf States*
Gaines B. Hall, AIA ('81), *Gulf States*
Raymond C. Ovresat, FAIA ('81), *Illinois*
John W. Jickling, FAIA ('83), *Michigan*
Theodore F. Mariani, AIA ('83), *Middle Atlantic*
James R. Nelson, AIA ('81), *Middle Atlantic*
John Avery Carter, AIA ('82), *New England*
Robert J. von Dohlen, AIA ('83), *New England*
Romeo Aybar, AIA ('83), *New Jersey*
Joseph Monticciolo, AIA ('82), *New York*
William A. Rose Jr., AIA ('81), *New York*
Leroy Bean, AIA ('82), *North Central States*
Edwin B. Crittenden, FAIA ('81), *Northwest*
David A. Pugh, FAIA ('83), *Northwest*
Robert Gramann, AIA ('82), *Ohio*
Derek Martin, AIA ('81), *Pennsylvania*
John A. Busby Jr., FAIA ('82), *South Atlantic*
Richard A. McGinty, AIA ('83), *South Atlantic*
William Caudill, FAIA ('82), *Texas*
Theodore S. Maffitt Jr., FAIA ('81), *Texas*
Pat Y. Spillman, FAIA ('81), *Texas*
Thomas B. Muths, AIA ('82), *Western Mountain*
John B. Rogers, FAIA ('81), *Western Mountain*
Robert B. Pease, Hon. AIA, *ex officio, Public Director*
William J. Plimpton, *ex officio, President, ASC/AIA*
Ann Stacy, Hon. AIA, *ex officio, Chairwoman, Council of Architectural Component Executives*

Headquarters

David Olan Meeker Jr., FAIA, *Executive Vice President*
James A. Scheeler, FAIA, *Group Executive, Program and Services Management*
Alan B. Stover, AIA, *General Counsel*
James A. Schuping, *Assistant Secretary*
William G. Wolverton, Hon. AIA, *Assistant Treasurer/Controller*
Michael B. Barker, AICP, *Administrator, Design*
Francis X. Brown, *Administrator, Conventions/Conferences/Special Events*
Muriel Campaglia, *Administrator, Public Relations*
James E. Ellison, AIA, *Administrator, Education and Professional Development*
David S. Godfrey, *Administrator, Publications*
Robert T. Packard, AIA, *Administrator, Practice*
Ronald Panciera, *Administrator/Assistant Controller*
Arnold J. Prima Jr., AIA, *Administrator, Government Affairs*
Arnold J. Prima Jr., AIA, *Acting Administrator, Member/Component Affairs*
David Olan Meeker Jr., FAIA, *President, AIA Corporation*
Jeanne Butler Hodges, *President, AIA Foundation*
Charles R. Ince Jr., *President, AIA Research Corporation*
John H. Schruben, FAIA, *President, Production Systems for Architects and Engineers, Inc.*

Urban Canada

- 38 **Toronto**
A sophisticated city of mix—and of the future?
By Stanley Abercrombie, AIA
- 50 **Montreal**
A city with a unique past begins to protect it.
By Andrea O. Dean
- 60 **Vancouver**
The explosive young giant of the Canadian West.
By Donald Canty
-
- 72 **Tom Wolfe's Fantasy Bauhaus**
What's Watts Tower doing in that zigguratium?
By George Nelson

6	Events & Letters	80	Furnishings
13	News	91	Annual Index
72	Books	96	Advertisers

Cover: Photograph by Allen Freeman. An abstract detail of the Royal Bank Plaza, Toronto, by Webb Zerafa Menkes Housden (see page 38).

Donald Canty, Editor; **Carole Palmer**, Art Director; **Suzy Thomas**, Associate Art Director; **Stanley Abercrombie, AIA**, Senior Editor, Architecture; **Mary E. Osman, Hon. AIA**, Senior Editor, Books; **Andrea O. Dean**, Senior Editor, Articles; **Allen Freeman**, Managing Editor; **Nora Richter Greer**, Associate Editor; **Lynn Nesmith**, Editorial Assistant; **Michael J. Hanley**, Publisher; **Michael M. Wood**, Director of Marketing; **Jesse Sims**, Production and Business Manager; **Terry L. Peck**, Circulation Manager; **David S. Godfrey**, General Manager.

The AIA JOURNAL, publication number: ISSN0001-1479, official magazine of The American Institute of Architects, is published 14 times yearly at 1735 New York Ave. N.W., Washington, D.C. 20006. **Subscriptions:** for those who are, by title, architects, architectural employees and to those in architectural education (faculty, schools and students), and to libraries, building construction trade associations and building products manufacturers: base rate \$24 a year in the U.S., its possessions and Canada. For all others: \$30 a year in the U.S., its possessions and Canada. All others outside the U.S., its possessions and Canada: \$40 a year. Single copies, \$3 each. Publisher reserves the right to refuse unqualified subscriptions. For subscriptions: write Circulation Department; for change of address: send Circulation Department both old and new addresses; allow eight weeks. Quotations on reprints of articles available. Microfilm copies available from University Microfilm, 300 N. Zeeb Road, Ann Arbor, Mich. 48106. Referenced in *The Architectural Index, Architectural Periodicals Index, Art Index, Avery Index to Architectural Periodicals*. Second class postage paid at Washington, D.C., and additional mailing offices. © 1981 by The American Institute of Architects. Opinions expressed by the editors and contributors are not necessarily those of AIA. VOL. 70, NO. 14.

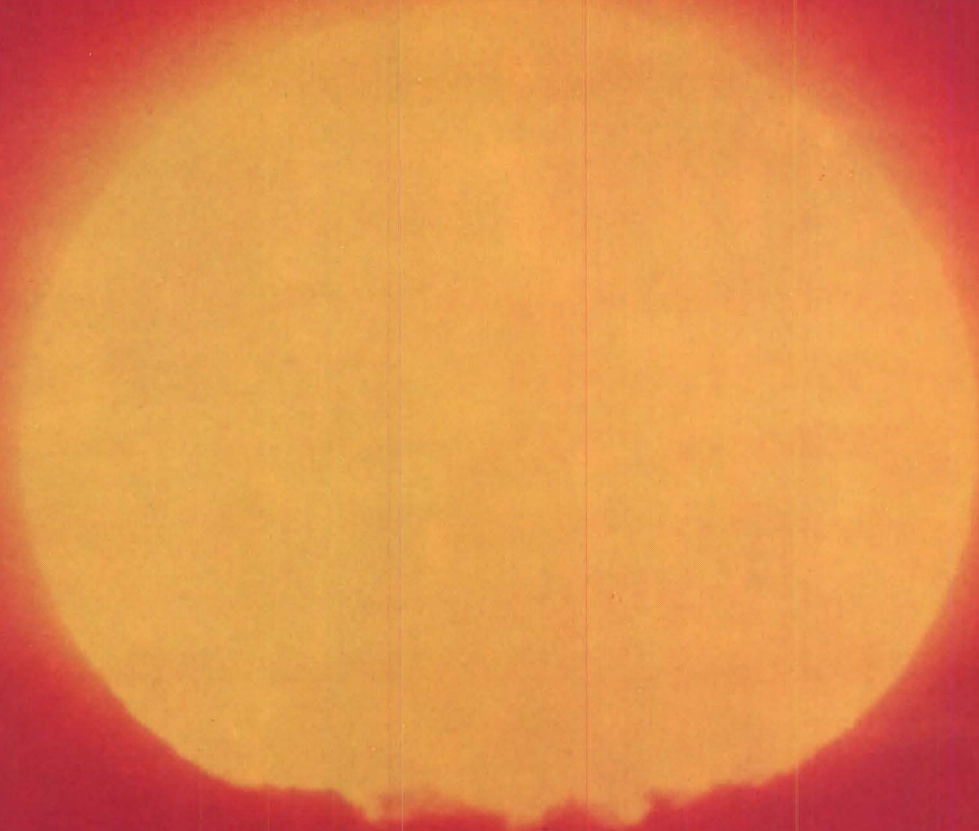

Cryotherm Treated blinds reduce solar heat gain by 55% (12% more effective than conventional blinds).

You've always known that window blinds are energy efficient. They keep out undesirable solar radiation in the summer, let in and retain valuable solar radiation in

the winter, while diffusing sunlight to provide glare-free illumination all year.

And now there's something new in blinds. The Cryotherm Treated Riviera™ Blind by Levolor. An innovation in window treatments that makes blinds more energy-efficient than they've ever been before.

Cryotherm is a mirror-like metallic finish that is more than just

beautiful. Its sleek surface promotes direct reflection of the entire solar energy spectrum—including infrared heat—and allows individually adjustable heat control with glare-free comfort. A definite asset in today's glass-faced buildings.

Exactly how effective is this new treatment in reducing heat gain? We asked the Stevens Institute of Technology to find out. Their find-

Detailed information about the use of these blinds in both summer and winter environments is available. Please write: Levolor Lorentzen, Inc., 1280 Wall Street West, Lyndhurst, New Jersey, 07071

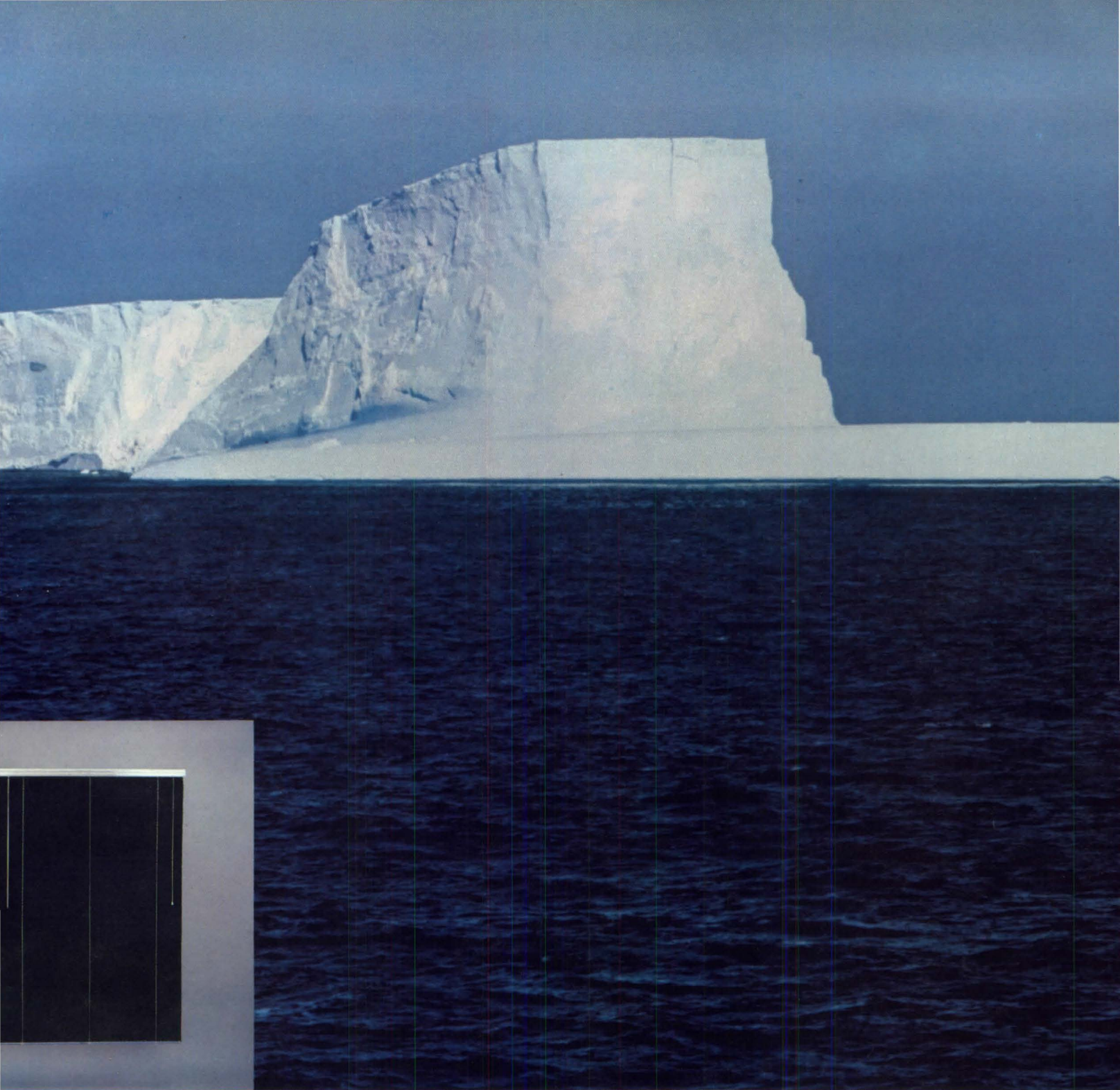

ings in the accompanying chart reveal that the Cryotherm Treated blind reduced solar heat gain 12% more effectively than white blinds. Even more when the treated blind is compared to darker blinds.

But Cryotherm is only one side of the story. These blinds reverse to a dark, heat absorbing color on the other side, reducing energy costs in winter, too.

Heat loads and energy savings		
Finish of blind	Total heat loads (Btu/hr.)	% Savings
No blind (clear glass)	16,086	Base
White finish blind in closed position (clear glass)	8,176*	49%
Cryotherm Treated [†] blind in closed position (clear glass)	7,282*	55%

Chart represents data for a typical summer day (August 21) for south-facing windows on a building located at 40° N latitude. Temperatures are 95° F outside and 75° F inside at 12 noon.

*The 894 Btu difference represents a 12% savings.
†No. 89 Brite.

CRYOTHERM™ TREATED LEVOLOR® BLINDS.

Circle 3 on information card

EVENTS

Jan. 7-8: AIA Energy in Design: Practice Workshop, Detroit. Contact: Brenda Henderson at Institute headquarters.

Jan. 11-12: Preservation Tax Incentives Conference, Portland, Ore. (Repeat conferences Jan. 18-19, San Antonio; Feb. 1-2, Boston; Feb. 15-16, San Francisco; Feb. 19-20, Los Angeles; Mar. 1-2, Atlanta; Mar. 8-9, New York City; Mar. 22-23, Chicago.) Contact: Education Services/Tax Conferences, National Trust for Historic Preservation, 1785 Massachusetts Ave. N.W., Washington, D.C. 20036.

Jan. 11-12: Workshop on Energy Aspects of Residential Design and Construction, University of Wisconsin, Madison.

Jan. 18-22: Seventh Annual Value Management/Engineering Seminar-Workshop, University of Wisconsin, Madison.

Jan. 19-21: Introduction to Program/Project Management Workshop, Crystal City Holiday Inn, Washington, D.C. Contact: Planning & Control Institute, 201 E. 25th St., New York, N.Y. 10010.

Jan. 21-22: AIA Energy in Design: Process Workshop, Arlington, Tex. (Repeat workshops Jan. 22-23, Washington, D.C.; Jan. 29-30, Providence, R.I., and Birmingham, Ala.) Contact: Brenda Henderson at Institute headquarters.

Jan. 22-24: International Conference on Barrier-Free Design, United Nations Headquarters, New York City. Contact: Sherry Barndollar, Landscape Architecture Foundation, 1717 N St. N.W., Washington, D.C. 20036.

Jan. 22-25: National Association of Home Builders Annual Convention and Exposition, Las Vegas. Contact: NAHB, 15th and M Streets N.W., Washington, D.C. 20005.

Feb. 5: Project Management and Profitability Workshop, University of Wisconsin, Milwaukee.

Feb. 18-Mar. 2: Third Annual Solar Tour of Israel. Contact: Linda Bouwkamp, Tour Director, Jordan College, 360 W. Pine St., Cedar Springs, Mich. 49319.

June 6-9: AIA National Convention, Honolulu, Hawaii.

LETTERS

Bidding for Work: Architects today face a serious threat: the imposition of the bidding system on our profession. Because some states have been guilty of political favoritism in awarding commissions, public officials in Massachusetts, Maryland and New Jersey have adopted the bidding process as the only equitable method of assigning projects to architects *as well as saving money on A/E fees.*

This procedure, which is now spreading from the state level into county and local agencies as well as into the private sector, invites professionals to respond to public

advertisements by submitting qualifications. These submittals are screened by a committee that "long lists" firms that in its opinion are most qualified. Those selected are then interviewed by the committee, which then short lists three firms that are then *privileged* to submit bids. The lowest bidder receives the commission.

We now find ourselves competing for commissions by bidding against each other much as contractors compete, except that when a contractor bids, he has a complete set of plans and specifications that define the scope of the work. The bid is based upon sub-bids that are subject to change and to pressure when the contractor "buys out the job" *after* he has been awarded the contract.

In most cases architects are given only a brief description of the project, i.e., a medium security 400-bed correctional institution on a 25-acre site—no survey, no borings, no interaction with the using agency, no subsurface data, etc.

Recent results of bidding in New Jersey are appalling. In one instance, a firm has left better than \$300,000 "on the table"—the difference between the low and second lowest bidders. Low bids for three recent projects ranged from 3.3 percent to 4.4 percent. But most recently, a 300,000-square-foot building project was won with a low bid of 2.87 percent of the stated construction cost of \$21 million. For this sum of \$602,700, the architects are to: (1) prepare the program to suit the user's needs; (2) develop the site improvements; (3) prepare the contract documents suitable for bid by five prime contractors; (4) prepare furniture layouts and work stations for the entire building; (5) check shop drawings; (6) provide the services of a field representative for two years, in addition to the normal periodic inspection by the home office and consultants; (7) be prepared to deal with bidders who automatically low bid and hope to recoup on extras and delays.

Since bidding by A/Es is a relatively new practice, the savings in fees to the client will remain unknown for at least two years, when the construction is complete. Then those well-intentioned officials who think they are saving money will be shocked by the final cost of a project for which the extras will make the A/E fee savings seem miniscule.

Bernard J. Grad, FAIA
Newark, N.J.

Photo Contest: In appreciation of the art of photography, I would like to thank the JOURNAL for sponsoring such a fine photo contest (September issue). Photography is another form of creative expression that I and many other architects enjoy. I encourage you to continue this superb competition. Richard R. Bergmann, AIA
New Canaan, Conn.

Congratulations on the September issue. I know that the photo contest will become an even greater event in the years to come, for photography remains a large part of the never-ending study of architecture. What better way to make a statement than with a single photograph instead of countless pages of writing?

But more important was the parallelism implied in the series of photographs. First, that the professional photographers' pictures were not necessarily the better ones. Second, that many of the amateurs' pictures had more original approaches and themes. This ties in directly with architecture: Many amateurs today are designing better work than some of the so-labeled "professionals."

David J. Della Torre
Weston, Ontario, Canada

Corrections: Our September review of the first volume of Le Corbusier's *Sketchbooks* (p. 67) should have stated that the series is a joint publication of MIT Press and The Architectural History Foundation. The National Endowment for the Arts and the National Endowment for the Humanities provided funds supporting the books' production.

A review of *Earthquake Protection of Essential Building Equipment* in the October issue (p. 96) contained some minor errors. The author, Gary L. McGavin, belongs to the Earthquake Engineering Research Institute; he works in Riverside, Calif., and he works for the firm of Ruhnau • Evans • Ruhnau Associates.

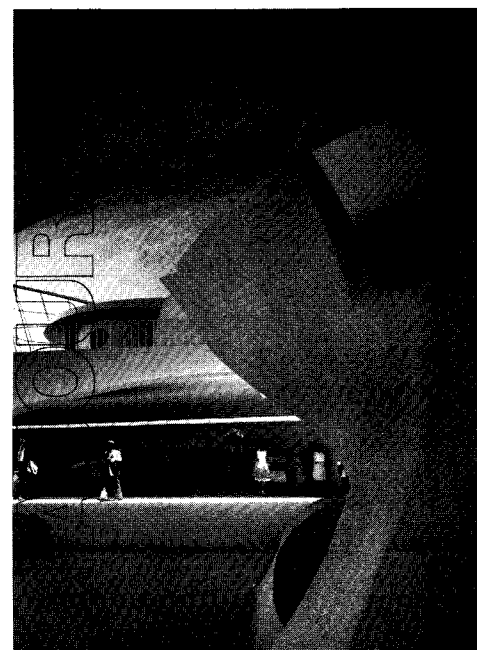

Editor's note: The striking photograph of Eero Saarinen's TWA terminal at Kennedy airport that was the JOURNAL's November cover was credited incorrectly. It was taken by Ezra Stoller, who has our sincere apologies.

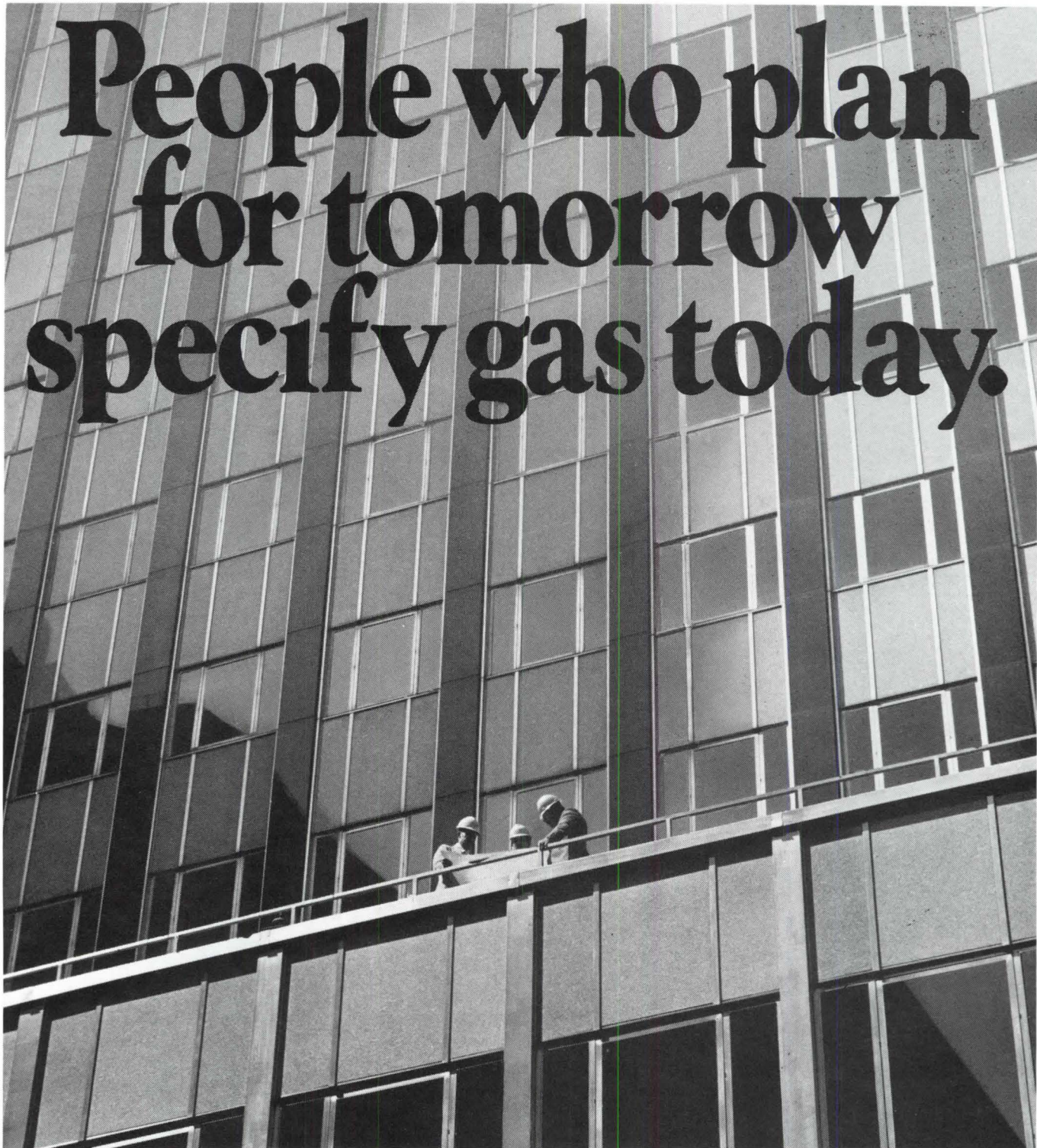

People who plan for tomorrow specify gas today.

You can count on a dependable supply of gas for the future. Because there's much more gas still underground than we've used so far—enough to last well into the next century. And new sources, like gas from coal, will add to the supply. Beyond that, new technologies are expected to provide efficient gas energy for generations.

Good reasons why more and more architects and engineers are specifying gas. And why most gas utilities are accepting new commercial customers.

Gas energy. It's the least expensive energy for space conditioning today, and it will continue to maintain this competitive advantage in the future. **AGA** American Gas Association 

Gas: The future belongs to the efficient.

The thirteen-story Marina Del Sol condominiums in Corpus Christi used Vulcraft joists and steel deck throughout.



TEXAS-SIZED SAVINGS WITH VULCRAFT JOISTS.

Vulcraft's redesign of the balconies resulted in a significant cost saving.

Even though they were building high-ticket luxury condominiums, the owners didn't want to waste money on construction costs.

So when the Marina Del Sol was being planned in Corpus Christi, Texas, the plan was to save money by building with Vulcraft steel joists rather than poured-in-place concrete. This cut one-third off the construction time, proving once again that Vulcraft joists are a more cost-effective structural system.

And when Vulcraft redesigned the balconies by building added camber into the supporting joists, another significant saving was accomplished.

A critical delivery schedule was required in order to coordinate perfectly with a four-sequence construction schedule. So Vulcraft delivered on time, every time.

Besides steel joists, Vulcraft also supplied steel deck for this thirteen-story showplace by the Gulf. And Vulcraft is the only company in the country that manufactures both steel joists and steel deck. This means you can rely on one source for both. Another plus for working with Vulcraft.

It's said that Texans think big, but when it comes to construction costs, the smart ones think Vulcraft joists.

What about you?

For more information, contact your local Vulcraft representative, or write P.O. Box 220646, Charlotte, North Carolina 28222, for our joist and steel deck catalogs.



You can also call us at 704/366-7000 or see Sweet's 5.2/Vu and 5.5/Vu.

P.O. Box 637, Brigham City, Utah 84302 801/734-9433

P.O. Box F-2, Florence, SC 29502 803/662-0381

P.O. Box 169, Fort Payne, AL 35967 205/845-2460

P.O. Box 186, Grapeland, TX 75844 713/687-4665

P.O. Box 59, Norfolk, NE 68701 402/371-0020

P.O. Box 1000, St. Joe, IN 46785 219/337-5411

VULCRAFT

A Division of Nucor Corporation.

Circle 5 on information card

**“You don't have to be
the biggest to be insured
by the best.”**

“Shand, Morahan?”

“Shand, Morahan.”



It's the growing consensus of the leading architectural and engineering firms in the land: the E&O program available through Shand, Morahan & Company is about the best coverage you can have, at a most competitive premium rate. That's why so many of the ENR top 500 design and construction firms are choosing our insurance.

But your firm doesn't have to be among the biggest to enjoy the best in Architects and Engineers Professional Liability insurance. Shand, Morahan also extends its uniformly excellent claims-made program and unmatched standard of service to more and more medium and smaller-sized firms as well. These firms enjoy the same experience and attention that only the nation's foremost source for professional liability insurance can provide.

If your present Architects and Engineers Liability policy or premium might benefit from an analysis and comparison with ours, we welcome your insurance broker's inquiry. Whether you're among the biggest, or just want the best.

**SM Shand, Morahan
& Company, Inc.**

One American Plaza, Evanston IL 60201



MASTERSPEC 2 puts the latest on products and technology into your hands 4 times each year

Our subscribers tell us that one of the primary advantages of MASTERSPEC 2 Master Specification System is our hundreds of pages of intensively updated information on products and technology that arrives at their offices quarterly.

MASTERSPEC 2 is the best information source you can have working for you.

Our updating, like our text, is researched and written by our permanent staff of recognized professional specialists. It's their full-time job. And, our text and updating are reviewed by standing technical committees of the design professions.

You retain control of your jobs with MASTERSPEC 2's updating.

You know how many hours of raw research it takes to keep current with changes in products and technology. And, we know that most firms just can't spare that kind of staff time. So, what happens is that some firms use old specs and cut and paste. The danger is that they may be using out of date information leading to obsolete specs. You can avoid the troubles obsolete specs can lead to by keeping current with MASTERSPEC 2. With MASTERSPEC 2, you avoid trouble with contractors who may substitute undesirable materials. With MASTERSPEC 2, you avoid trouble with contractors if the job is held up and they demand compensation for

waiting time. With MASTERSPEC 2, you avoid trouble with clients if they find out the specs are obsolete. With MASTERSPEC 2, you avoid trouble with changes in standards and regulations. With MASTERSPEC 2, you avoid other problems such as potential liability losses and diminished professional reputation. MASTERSPEC 2 is the master specification system with the intensive updating that helps you avoid all these problems and keep control of every job!

Plus, MASTERSPEC 2 can save you to up 50% in technical labor!

Your decisions are quicker because MASTERSPEC 2 is the *only* master specification system that names names of products and manufacturers. You'll have no more costly overlaps, duplications and omissions—MASTERSPEC 2 is the system that provides items *that should be included in your specs*—you know it's what you leave out that can cause problems. With MASTERSPEC 2, you

and your people will have more time to do more for your clients, spend more time on design, go after more jobs.

When you subscribe to MASTERSPEC 2's affordable BASIC VERSION you also receive quarterly updates.

Most small firms find that BASIC VERSION is all they need. Some firms like to add our SHORT LANGUAGE VERSION for nominal or outline specs. And, when you have a job with exceptional or custom-designed features, you can subscribe to either *individual sections* or the entire text of our more detailed NARROWSCOPE VERSION. You get *what you need when you need it!* All MASTERSPEC 2 VERSIONS are also available on a variety of diskettes for automation.

So, call or write today for more information on current, affordable MASTERSPEC 2

BASIC VERSION	\$395
SHORT LANGUAGE VERSION	\$95
NARROWSCOPE VERSION	\$830

\$10 a section, minimum order 5 sections

CALL 800/424-5080 TOLL FREE
Ask for Leonard Bain, AIA. You will receive an information package.

MASTERSPEC 2 is a service of PSAE

PSAE Production Systems for Architects & Engineers, Inc.

A wholly owned corporation of AIA
1735 New York Avenue, N.W.
Washington, D.C. 20006

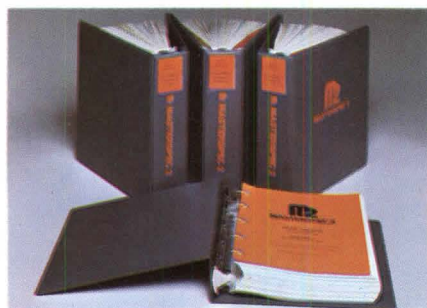

Circle 23 on information card

Lighting design is exciting . . . with Columbia!



Columbia SuperTube!

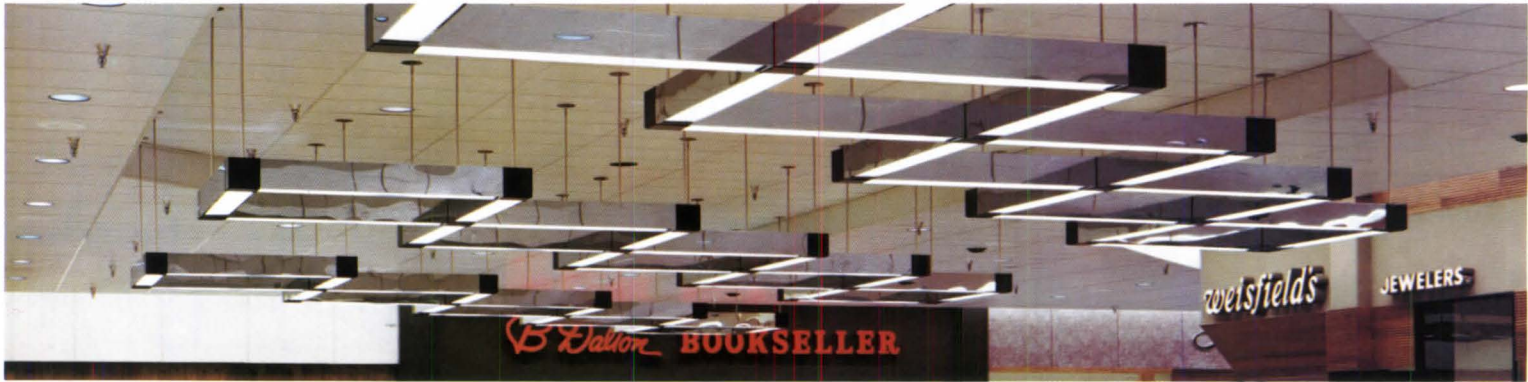

Columbia Form 4!

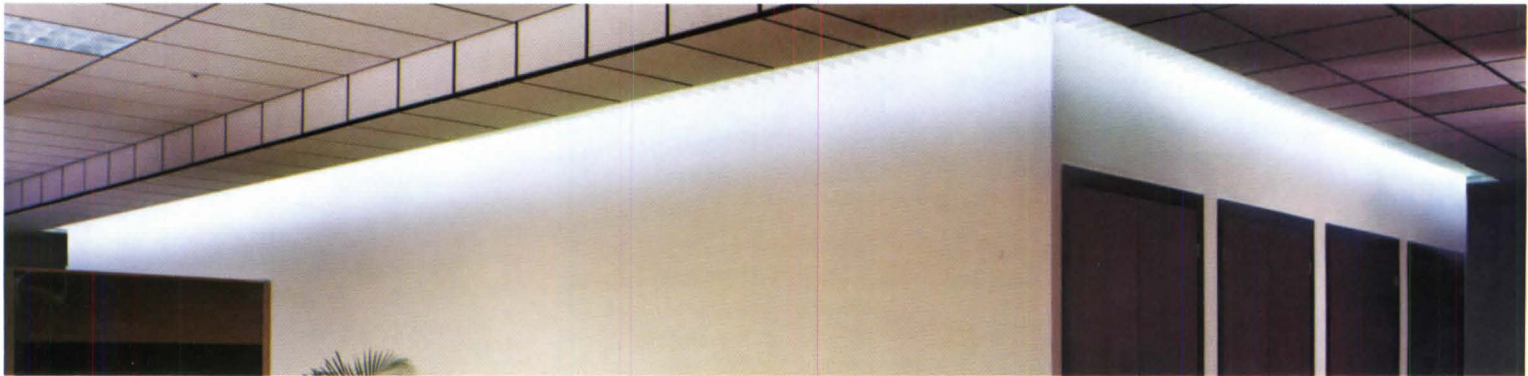

Columbia Accent Lighting!

Fluorescent lighting needn't be restricted to illuminating acres of desks. With Columbia's Designer Lighting series you can wash a wall, accent an architectural feature or differentiate a space. You can suspend the lights, bracket them on walls, conceal them in the ceiling or create attractive patterns. For information contact your local Columbia Agent or write to us.

T.A. Box 2787
Spokane, WA 99220
509/924-7000

USI
A Subsidiary of
U.S. INDUSTRIES, INC.

Columbia
Lighting
Inc

Circle 8 on information card

Survey, Roundtable Explore Use Of Computers in Architecture

A recent survey found that possibly as many as 4,900 of AIA's 10,840 member firms are considering buying their first computer capabilities or adding to their current equipment within the next 12 months.

The firms were asked what computer capabilities are being considered. Their answers indicate that word processing equipment or software is the area of strongest interest. Specification software is the next most anticipated purchase, followed by financial management programs and cost accounting software. Far less anticipated and listed in order of decreasing interest, are purchases in the areas of project management, scheduling, energy audits, structural and mechanical software, library storage, computer graphics and life cycle costing.

Asked their greatest needs regarding computers, the firms' most frequent responses were in the areas of basic computer applications education and in knowledge of software availability.

The survey was conducted by William Hooper, AIA, director of the Institute's practice division. Although the survey sample was small (10 percent of AIA's list of firms) Hooper sees the results as a valid indicator of a trend toward wide computer acceptance and use. And he sees increasing availability as working for the small firms that want to invest.

To advise the Institute on how it might best help architects, and especially the small firms that comprise most of AIA's

membership, make decisions about buying computers and getting the most out of them, a roundtable of architects, consultants and representatives of manufacturers and vendors met at AIA last month. Members of the group were self-selected—they responded to an item in the MEMO—and for the most part are computer "true believers," in the words of Bruce Patty, FAIA, who chaired the roundtable.

Regarding the needs of the profession, there was agreement with the findings of the survey. By consensus, the roundtable found the biggest problem for prospective purchasers is in finding out what is available. The catalogs offered by suppliers are woefully incomplete, and out of date four months after publication, said one architect participant. And there are problems coping with vendors' claims and diverse terminologies, offered another. One possible help in this area is establishing user groups to exchange information about computers, it was suggested.

For those considering their first purchases, two major considerations are closely linked. They are how to get started and how much to initially spend. There is the "top-down" approach, whereby you invest in one of the most sophisticated systems that have graphics and design applications. This means spending at least \$50,000, and probably much more, it was agreed. This is the route many of the larger firms have taken. The other approach, of course, is to start with a small initial investment and expand, and this is probably the only choice for small firms.

The roundtable's consensus was that the easiest way to get architects and engineers to begin to understand and to start using computers is through word processing applications. This probably means an initial investment of \$6,000-\$15,000.

Then, the firm can add other capabilities on line as they are deemed feasible.

Also discussed were the attitudes of architects toward computers, and the group agreed that there is a strong resist-

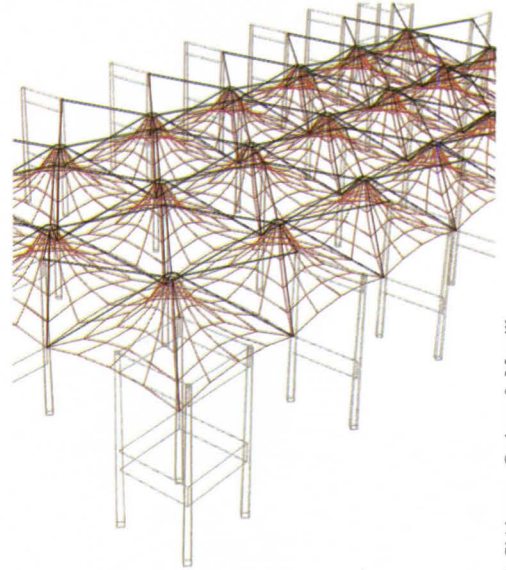

© Skidmore, Owings & Merrill

A computer-aided design by SOM. Survey found relatively minor immediate interest in this type of computer application.

ance to change that is fueled by the difficulty of understanding how they work. One person called it a "black box syndrome," the fear of the unknown, and suggested there is also the "fear of getting sucked into something." Another cited the well-known stories about firms that invested heavily in computer hardware 10 years ago and got burned because of the lack of software at that time. Still another suggested that the problem is with management: "It's the boss that needs to be educated. The kids are ready."

Owens-Corning Names Six Buildings for Energy Awards

Owens-Corning Fiberglas Corporation has presented six awards for "significant contributions" to energy conservation in institutional, industrial, commercial and government buildings in its 10th annual awards program.

The winner in the institutional category is CRS, Inc., Houston, for the University of Florida's Stephen C. O'Connell Student Center, Gainesville (page 16). Completed in December '80, the 246,000-square-foot center's walls and roof are of translucent Teflon-coated glass-fiber fabric. The fabric is stretched over curved concrete support columns on the exterior walls and is held aloft over the main arena's 150,000-

continued on page 16

Practice	
<i>Choosing a computer</i>	(above)
<i>Owens-Corning awards</i>	(right)
<i>Eight buildings receive PCI awards</i>	16
<i>Survey of solar homeowners</i>	21
Institute	
<i>President Lawrence's plans for '82</i>	22
<i>California craftsmen honored</i>	25
<i>AIA scholarships available</i>	25
Government	
<i>Federal A/E procurement policy</i>	25
<i>Affordable housing competition</i>	25

1. **Security Savings**
Glendale, Wisconsin
 CG-8 Gold Reflective Glass
 Owner – Security Savings
 Architect – Torke-Wirth-Pujara,
 Ltd.
 Glazing Contractor – Klein
 Dickert Milwaukee, Inc.

2. **Alpha Tower**
Dallas, Texas
 SS-8 Silver Reflective Glass
 Owner – McFaddin/Kendrick
 Architect – TMHI, Inc.
 Glazing Contractor – Haley-
 Greer, Inc.

3. **Corning Museum**
Corning, New York
 SS-0 Silver Reflective
 Pattern Glass
 Owner – Corning Glass Works
 Architect – Gunner Birkets
 and Associates
 Glazing Contractor – Kirschner
 & Sons

4. **Royal Trust Bank Tower**
West Palm Beach, Florida
 SG-10 Gold Reflective Glass
 Developer – Olympia & York
 Architect – Schwab & Twitty
 Architects, Inc.
 Glazing Contractor – Alumi-
 glass, Inc.

5. **Cadillac Fairview Towers**
Calgary, Alberta (Canada)
 SS-14 Silver Reflective Glass
 Owner – Cadillac Fairview
 Architect – S. Zerafa & Chand
 Kennedy Architectural Group
 Glazing Contractor – Dominion
 Bronze Limited

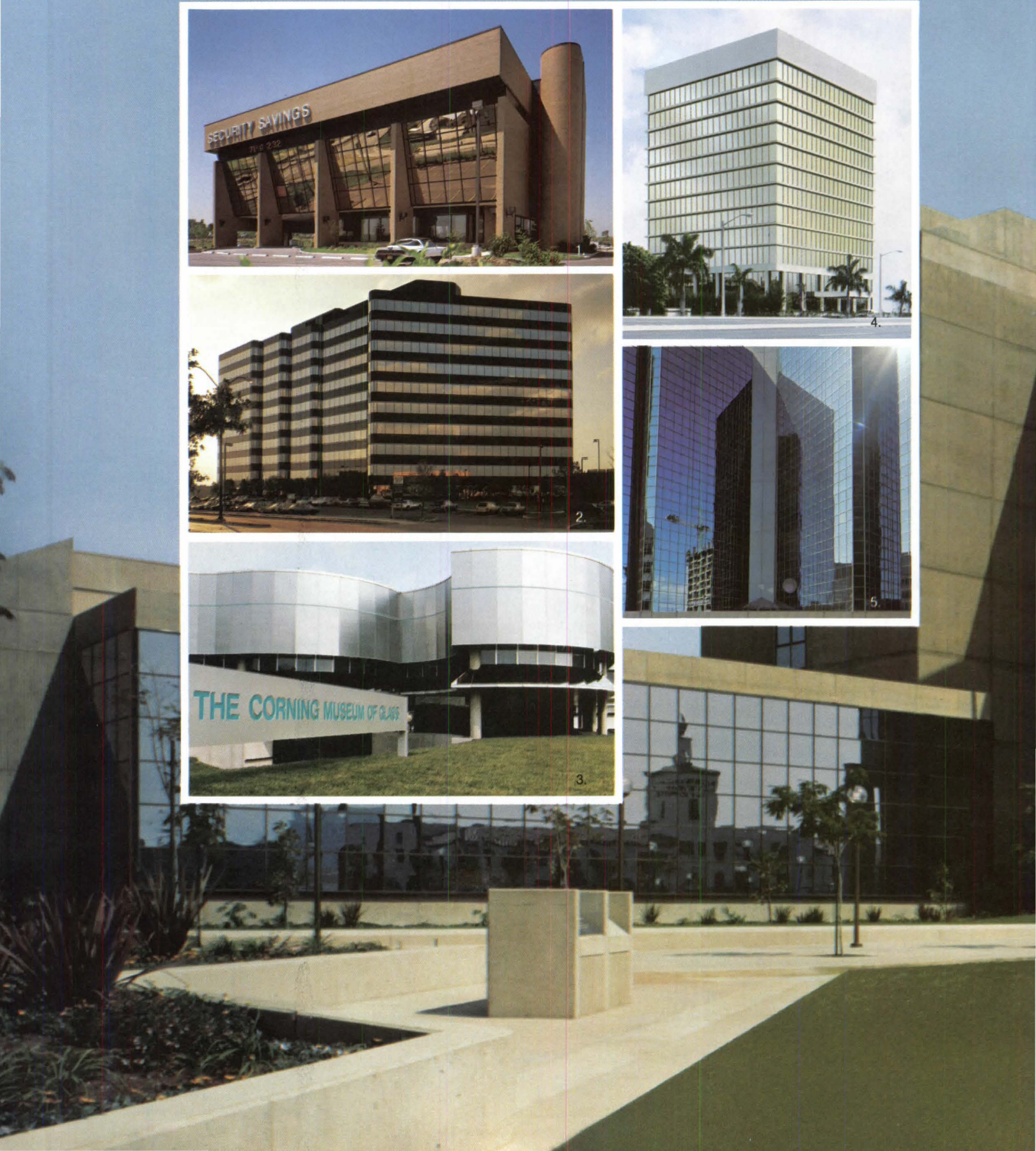

Guardian glass reflects your good judgment.

And Guardian has earned an international reputation for making promises come true.

You're in good company when you choose Guardian high-performing reflective glass. You'll discover what top architects, glass-installers, and building owners across North America already know: Guardian follows through with the quality, fast service, and one-on-one communication you need to get the job done.

You get full support because Guardian controls every phase of the glass manufacturing process from the sand to finished glass. And Guardian offers reflective glass in a wide choice of colors, shades, and insulating values. You get aesthetic beauty and high performance.

Working to keep you satisfied has made Guardian Industries one of the world's fastest growing corporations, with ten manufacturing plants located throughout North America.

Learn more about the advantages of Guardian reflective glass. Check our catalog: "Glass...in harmony with nature" in Sweet's. Then write or call Karl Straky at Guardian's National Commercial Glass Sales Office, Carleton, Michigan 48117. Phone toll-free 1-800-521-9040.



Circle 9 on information card

Anaheim Civic Center
Anaheim, California
SS-8 Silver Reflective Glass
Owner - City of Anaheim
Architect - Dan L. Rowland &
Associates, Inc.
Glazing Contractor - Cottrell
Glass Company

Practice from page 13

square-foot dome by up to four 100 horsepower fans. Because 4 percent of the sunlight is transmitted through the fabric, the need for artificial lighting in the main interior areas is minimal. The fabric reflects 75 percent of the sun's energy, which lowers cooling costs. In addition, the double-layering of the fabric creates an insulating dead air space that helps absorb the excess solar radiation. The total projected energy consumption is 43,700 BTUs per square foot per year.

Cogswell/Hausler Associates, Chapel Hill, N.C., is the winner in the industrial category for the Transit Operations and Maintenance Facility, Chapel Hill. The 15,000-square-foot building has nearly 4,000 square feet of glass-block walls and glazed doors on its southern exposure. Solar heat is stored in the exposed concrete floors, masonry walls and concrete roof deck. In addition, natural light enters through glass-block skylights and eliminates the need for artificial lighting during the day in the maintenance bays, machine shops and service lanes (which comprise 60 percent of the building area). Hot water needs are primarily supplied by two closed-system, fluid-cooled roof collectors. Energy consumption is estimated at 20,000 BTUs per square foot per year.

Walker McGough Foltz Lyerla, Spokane, Wash., is the winner in two categories—institutional design for the Washington/Jefferson Elementary School, Walla Walla, Wash., and commercial design for the Farm Credit Banks building, Spokane. The 70,135-square-foot school will be earth-covered on three sides and on much of the roof. Ninety-five percent of the building's total glass area will be on the southeast exposure, as will most classrooms and other heavily used spaces. The use of nine-foot floor-to-ceiling heights, five-foot-high glass windows and appropriate solar orientation will allow light to enter 15 feet or more into the south-facing rooms during daylight hours. The building will use an estimated 44,000 BTUs per square foot per year.

The 18-story Farm Credit Banks building's relatively narrow floors (65 feet interior dimension), north-south windows and open offices will serve to reduce the need for artificial light during daytime hours. To decrease the cooling load on the south side, glass will be shaded with horizontal and vertical surfaces and the outside edges will be positioned three feet in front of the clear glazing. Including the mechanical and electrical systems, the anticipated annual energy consumption is 40,000 BTUs per square foot per year.

One of the winners in the government design category is Marquis Associates, San Francisco, for the California state Department of Justice office building, Sacramento. Through the use of simple venti-



CRS's O'Connell student center, winner of both Owens-Corning and PCI awards.

lation techniques, natural daylighting and effective mechanical and control systems, the 380,000-square-foot building is expected to use only 38,000 BTUs per square foot per year. In the design, two-story "blocks" are connected by courtyards and a circulation "tree" of wide, building-height corridors. Occurring every 72 feet in the east/west direction, the corridors are covered with clerestory windows, which will provide natural light for both floors and also act as ducts for cooling. Nighttime ventilation will be used to cool the building and reduce daytime heating load.

The other winner in the governmental design category is The Colyer/Freeman Group, San Francisco, for the Antelope Valley California Poppy Reserve visitors' center, Lancaster, Calif. Use of passive solar techniques, temperature moderating thermal mass and a wind electric generating system will allow the energy needs of this 1,950-square-foot, earth-sheltered building to be met with nondepletable resources. Direct solar heat will be gained through the south facing window wall and stored in concrete block walls and floor slabs. An overhang will shade the window against excessive solar gain, and R-5 value window shades will help retain the heat in the winter evenings. In the summer, the building will be cooled at night by ventilation and evaporative cooling. Natural light will enter the building through the south wall and a 30-foot insulated glass clerestory located between the roof and the north wall. The building is expected to use 7,043 BTUs per square foot per year.

Jurors were Ezra D. Ehrenkrantz, FAIA (chairman), Sital Daryanani, John W. Honeycomb, Ralph L. Knowles, FAIA, Robert G. Shibley, Marvin W. Wiley and Erv Bales.

Eight Building Projects Cited By Concrete Institute

A jury of architects and engineers has named nine winners in the buildings category of the 1981 Prestressed Concrete Institute awards program. The winning entries were selected for "esthetic expression, function and economy using precast and prestressed concrete," the jury said.

The winners are:

- Stephen C. O'Connell Center, Gainesville, Fla. (CRS, Houston).
- Security Insurance Group Corporate Headquarters, Farmington, Conn. (Russell Gibson von Dohlen, Farmington, Conn.)
- Miami Free Zone, Miami (Ferendino/Grafton/Spillis/Candela, Coral Gables, Fla.)
- Bellevue Square, Bellevue, Wash. (Charles Kober Associates, Seattle).
- Walter Reed General Hospital, Washington, D.C. (Stone, Marraccini and Patterson and Milton T. Pflueger, San Francisco).
- Five Points Station, Atlanta (Heery International and Finch Alexander Barnes Rothschild Paschal, Atlanta).
- Site 1A/Gregory Bateson Building, Sacramento, Calif. (Office of the State Architect).
- Canadian Imperial Bank of Commerce, Toronto, Ontario, Canada (Shore Tilbe Henschel Irwin Peters, Toronto).
- Metropolitan Toronto Police Station #52, Toronto, Ontario, Canada (Shore Tilbe Henschel Irwin Peters, Toronto).

Library of Congress Exhibits Court House Photographs

An exhibition of 69 photographs from the Seagram County Court House Archives will be on display at the Library of Congress' Thomas Jefferson building until March 15, and the exhibition will travel to other cities through 1983.

The complete Seagram County Court House Archives, a catalogued collection of more than 11,000 photographic negatives, 8,000 reference prints and 2,500 master prints, was presented to the Library of Congress in 1980 by Joseph E. Seagram & Sons, Inc.

To mark the U.S. bicentennial the company, under the direction of architect Phyllis Lambert, commissioned 24 photographers to record more than one-third of the 3,101 U.S. court houses. Many of the photographs appear in *Court House: A Photographic Document*, edited by Richard Pare and published by Horizon Press. (Excerpts of the book are featured in the August '78 AIA JOURNAL.)

Among the 69 court houses in the current exhibition are H. H. Richardson's

continued on page 21

**Introducing A
Working Color System For
The Working Professional**

The Chromatics



**Formica Corporation
Presents The Color Grid™**

The Neutrals

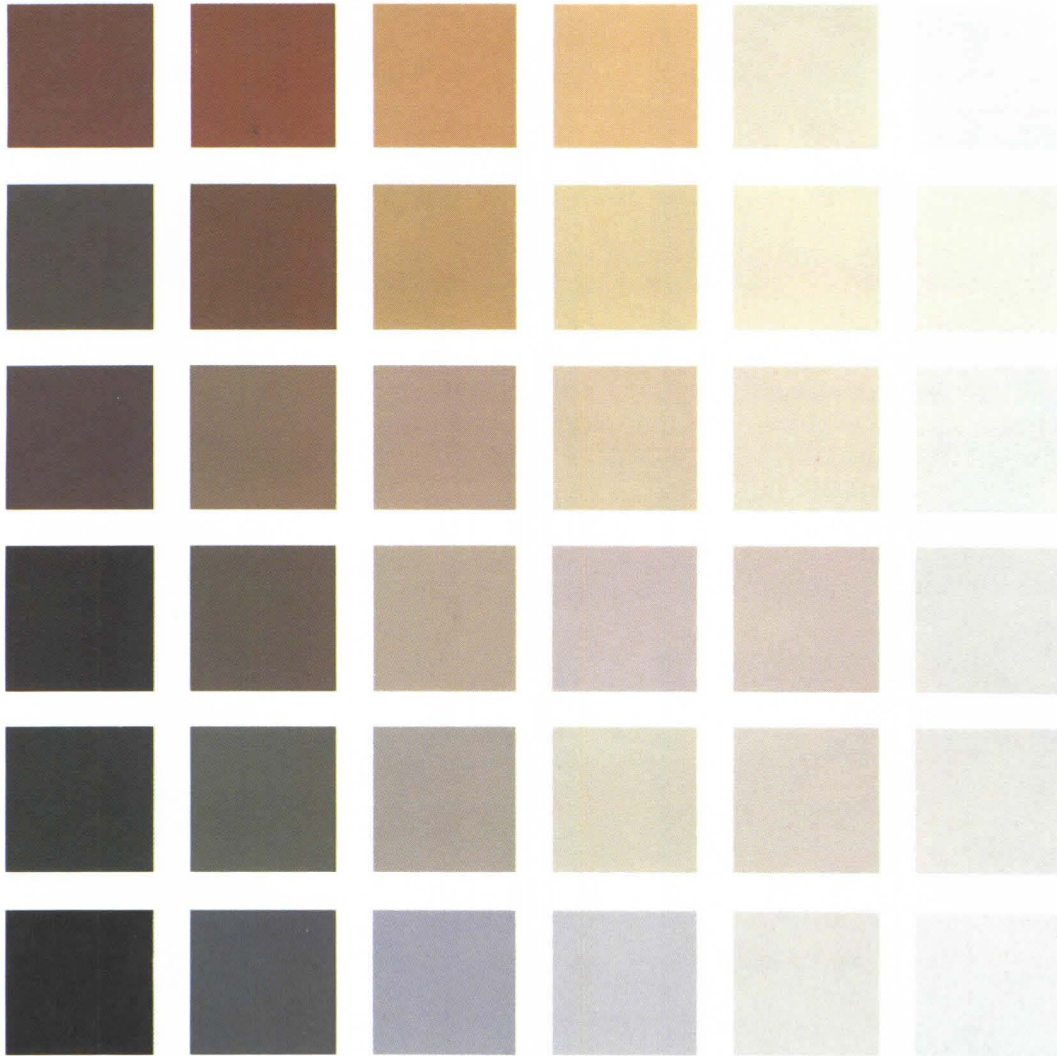

The Color Grid. A solid color system based on solid design thinking. 72 carefully integrated colors arranged in two grids: The Chromatics and The Neutrals.

The Color Grid was developed by our design staff and the distinguished designers and architects of our Design Advisory Board. People who understand color and the needs of professionals making color decisions.

The Color Grid laminates are available in a new finish, "Matte," giving them color depth and clarity. And a new grade that allows greater design flexibility for formed and wrapped applications.

The Color Grid range will be available on a long-term basis for secure specifications.

The Color Grid. At last, a working color system for the working professional.

For more information, contact
Formica Corporation
One Cyanamid Plaza
Wayne, New Jersey 07470



New Outfits New Team

We've just outfitted our Von Duprin 99 exit device with the same handsome touch pad that's on our Von Duprin 33 exit device. And now our 33 sports an end cap that's redesigned to make it field sizeable, just like our 99.

Finally we've made the wide stile 99 and narrow

stile 33 compatible in visual appeal. The same beautiful finishes are available in both devices.

Quality design, rugged construction and non handed versatility make the 99 and 33 dynamic performers on their own.

New outfits make them

play well together.

The Von Duprin 99 and 33 exit devices are now available for teamwork on your next project.

VON DUPRIN

Part of worldwide Ingersoll-Rand

400 W. Maryland
Indianapolis, IN 46225

Circle 12 on information card



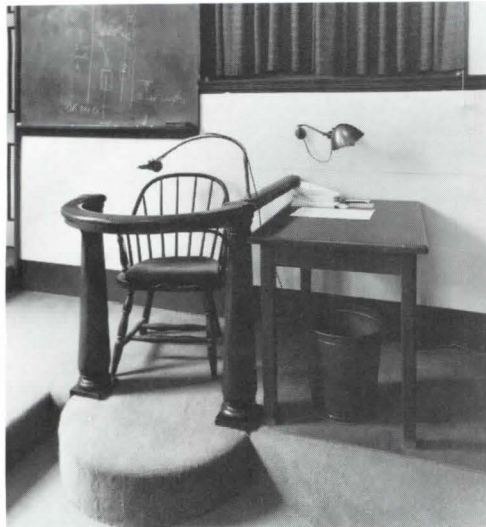

Practice from page 16

Allegheny County Court House and Jail, Pittsburgh (1884-88); Frank Lloyd Wright's Marin County Civic Center, San Rafael, Calif. (1957-69), and Lincoln County Court House, Wisasset, Me., (1824, above).

In addition to the Seagram collection the Library of Congress has published on microfiche over 8,500 photographs of more than 1,900 county court houses, including approximately 1,700 images from collections other than the Seagram County Court House Archives.

Survey of Solar Homeowners Finds Satisfaction with Systems

Owners of houses that incorporate active and passive solar systems are "satisfied" or "very satisfied," concluded a survey whose results were recently released by the Solar Energy Research Institute. And in another survey also recently published by SERI, respondents indicated that solar energy is the most preferred energy source, with energy conservation rated second.

Of the 38,000 homeowners surveyed in the first study, 81 percent had solar collectors to heat water and 26 percent lived in houses with passive solar design. One-third of the owners of active solar systems reported that they have never had any problems with their systems, while 45 percent said they have had minor difficulties that have been solved. Only 3 percent reported chronic problems.

Of the owners with passive solar systems, 43 percent described their systems as "excellent," 32 percent "very good" and only 1 percent reported chronic problems.

Solar homeowners also report reductions in their monthly utility bills. Ten percent report savings of 40 to 50 percent; 19 percent report 20 to 30 percent

savings; 17 percent 10 to 20 percent savings.

In SERI's other survey, personal interviews were conducted with 2,023 homeowners. Of those, 27 percent anticipated harder energy times ahead, while 57 percent thought the situation would improve. (Preference for solar development, the study points out, is also reflected in a national survey conducted by the President's Council on Environmental Quality. In this survey respondents rated solar energy first, energy conservation second, coal third, hydropower fourth, oil and natural gas fifth, synfuels sixth and nuclear energy last.)

The SERI survey found 73 percent of the respondents were too uninformed about solar energy systems to make a decision about using it in their homes. As for the interest in having home audits of energy conservation measures and solar energy measures applicable for their homes, over half of the respondents indicated interest, with 20 percent saying they were "very interested."

The second survey (SERI-SP-513-1209) can be ordered from the U.S. Department of Commerce, National Technical Information Service, 5285 Port Royal Road, Springfield, Va. 22161, for \$6.50 (paper) or \$3.50 (microfiche).

Practice continued on page 22

Repla...form and function in windows of uncompromising quality

Repla responds to innovative design. Every day, we put our 15 years experience on the line for creative architects who won't be inhibited by conventional windows. And we have dozens of successful projects to prove it. This same attitude extends to our complete line of standards. Every Repla window and patio door is a product of extensive research and development. We combine the best features of aluminum, vinyl and redwood with technology that is right for the times.

If you're not getting this kind of performance from your window supplier, perhaps it's time you look into Repla.



482 South Service Road East,
Oakville, Ontario, Canada L6J 2X6.
Ph: 416/844-1271 Telex: 06-982370

Circle 13 on information card

Architect: Phillip H. Carter, Toronto

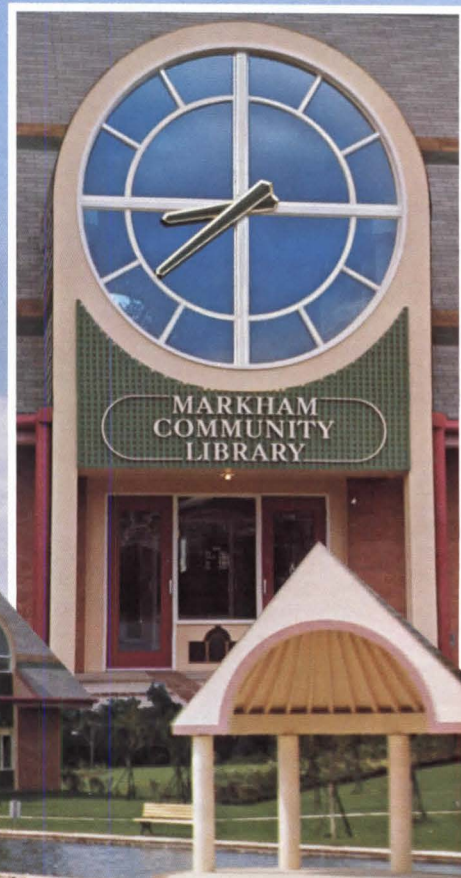

Examination of Solar Projects Finds Need to Tailor Designs

A survey of the performance of 50 Department of Energy solar demonstration projects over two seasons of operation has yielded the conclusion that "careful design attention to energy loads, system configurations and the ways building occupants operate their systems largely determine the extent to which solar energy can meet building energy requirements."

Results of the survey are summarized in DOE's newly published "Guide to Effective Heating and Cooling Practice." Some of the other findings:

- Systems must be designed to operate efficiently during minimum loads as well as peak loads. Otherwise, overheating may result in the summer and lowered performance at other times.
- Some major problems can be avoided by providing as much user automatic control as possible.
- Systems that use heat pumps to draw upon storage as auxiliary energy sources are not always cost effective.
- Sites incorporating heat pumps have demonstrated good performance.

The report, which also contains a glossary of 80 terms relating to the solar field, can be ordered from: U.S. Department of Energy, Technical Information Center, P.O. Box 62, Oak Ridge, Tenn. 37830.



"Transformed Houses," an exhibition documenting the architectural development of single, semidetached and row houses of lower and middle class urban neighborhoods, has opened in New York City and will travel to Baltimore and 18 other cities through May 1984. Photographer and project director for the exhibition Camilo Vergara says, "Transformations made by individual homeowners are a form of urban renewal that generally goes unnoticed. In contrast to the decline that marks many urban neighborhoods, homeowners are showing a strong local desire to preserve their communities." The cities studied for the exhibition included New York City (above), Chicago, Boston, Los Angeles and cities in Indiana, New Jersey, Kentucky, Georgia, Alabama, Maryland and Michigan. The show was organized by the Smithsonian Institution Traveling Exhibition Service.

The Institute

Lawrence's Year as President Is 125th Anniversary of AIA

Next month, AIA begins a year-long celebration of its 125th anniversary. The Institute's new President Robert M. Lawrence, FAIA, sees it as an "unusual opportunity" to reflect on the history of the architectural profession, but also as a time to look at the challenges that architects will face in the future. During his year in office Lawrence also plans to initiate a "vigorous" membership drive, to improve public awareness of architecture and continue to emphasize the energy professional development program.

The anniversary celebration in itself will be aimed at increasing public awareness of architects' roles in the built environment and in architectural design and practice. Lawrence says, "As we celebrate the Institute's 125th year, we are, in a way, on a bridge between two eras. Behind us stands over a century of professional achievement. Now it is up to the current generation of architects to see that

the Institute's past is prologue to an equally creative and successful future."

The biggest event of the year will be an outdoor anniversary reception at Institute headquarters in Washington, D.C., in April. And throughout the year other special events will commemorate the anniversary. Already scheduled is an exhibition on the history of the profession that will include recreations of architects' offices of 1857 and 1892. This will take place at the Octagon from Jan. 14 through Feb. 20.

A look into the future will be prompted by the convention theme, "A Quest in Time," June 6-9 in Honolulu, Hawaii. Among other events, three scientists—B. Gentry Lee, Joseph B. MacInnis and Gerard K. O'Neill—will predict the state of society and environment, and specifically the implications for architectural practice, during the next 5 to 25 years.

The "aggressive" two-year membership drive will be aimed at increasing AIA's

membership from the current 38,000 to 50,000 members. Lawrence calls the membership drive "vital if the Institute is to have the capacity and resources to respond to the needs of the future." The "Energy in Architecture" program will remain high on AIA's agenda, with 75 workshops already scheduled throughout the U.S. in 1982. And there will be continued efforts in developing ongoing liaisons with related professional groups and in attempting to expand opportunities within the Institute and the profession for women and minorities.

One of AIA's biggest problems, according to Lawrence, is public awareness and education. During the year the Institute will work to identify target groups for whom educational programs will be developed. There will be increased emphasis on promoting environmental education in kindergarten through the 12th grade.

As a practitioner with a small firm, Lawrence believes it is essential that such firms improve practice techniques to compete effectively with larger firms. Therefore, emphasis will be placed on developing practice aids designed especially for small firms.

Lawrence is from Oklahoma City,
continued on page 25

The KAD II Koh-I-Noor Auto Draw is electronically controlled to produce rapidly a virtually limitless library of lettering styles, symbols and designs used in engineering, electronic and architectural drawings, as well as the drawings of many other disciplines. Once demonstrated, KAD II requires no special operating skills.

KAD II consists of three components. The PLOTTER, less than four pounds, adapts to almost every drafting machine. It draws with liquid ink in any one of five preprogrammed character heights on most drawing surfaces. Servo motors operate the pen holder to produce faster and better quality characters than can be



provided by any hand lettering device.

The CONTROLLER contains the logic circuitry to operate the Plotter. It drives the Plotter by commands from a standard or custom preprogrammed ELECTRONIC TEMPLATE MODULE (ETM) placed into a receptacle in the front panel. The Controller can be placed on the drawing board, on a roll-away stand, or any other handy location within cable length of the Plotter. ETM's are quickly interchangeable to provide different symbols or lettering styles as required. Each ETM has its own corresponding keyboard overlay indicating its preprogrammed functions. Send the coupon today.

KAD II Auto Draw

The most versatile, electronically controlled lettering and symbol-generating instrument available from today's microprocessor technology!

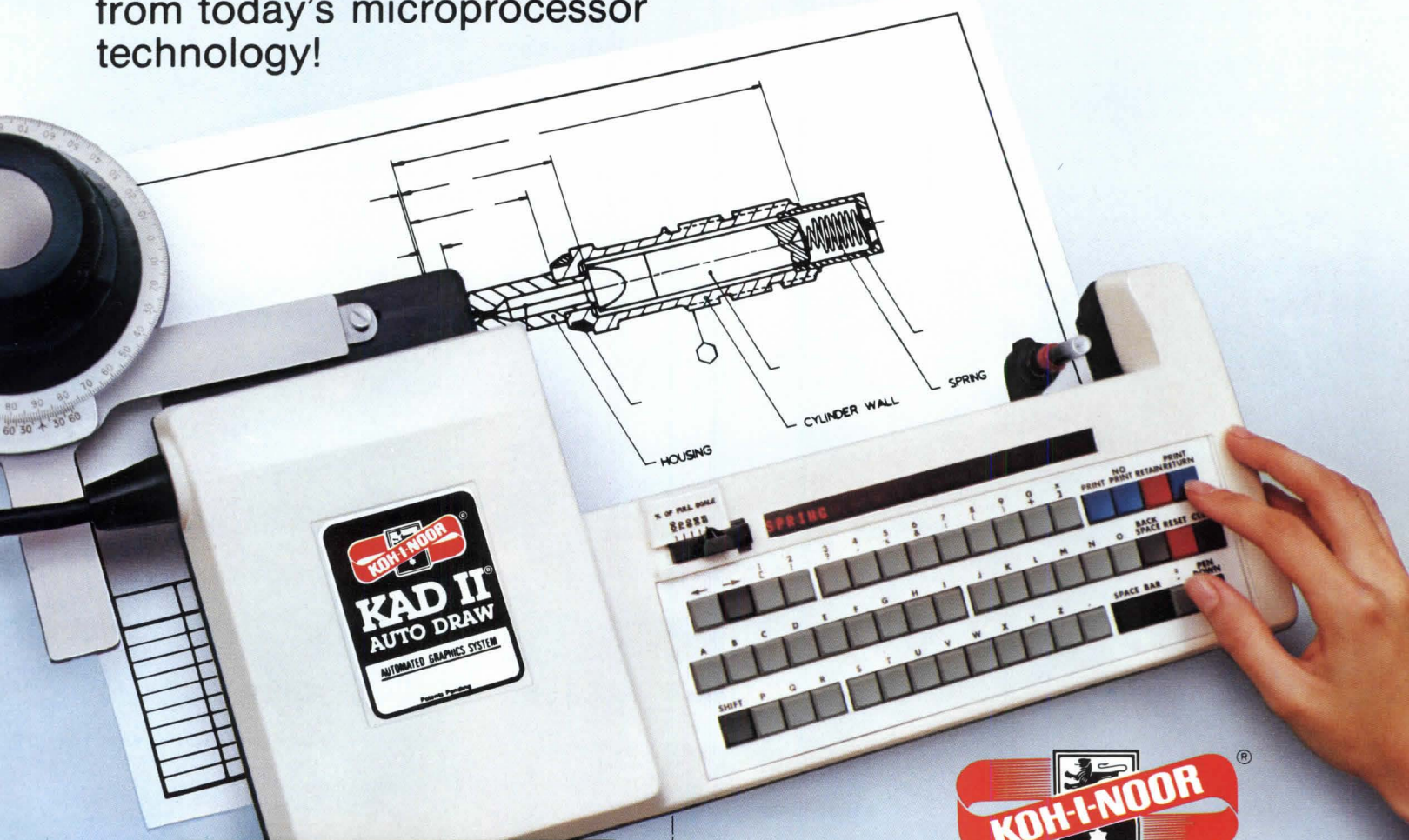

Please send me free descriptive literature for the Koh-I-Noor KAD II.

Name _____ Title _____

Firm _____

Address _____

City _____ State _____ Zip _____

KOH-I-NOOR RAPIDOGRAPH, INC., Bloomsbury, NJ 08804 800-631-7646.
In Canada: 1815 Meyerside Dr., Mississauga, Ont. L5T 1B4 800-268-4961.

AIA-12-81

Two ancient ideas for a new church addition.

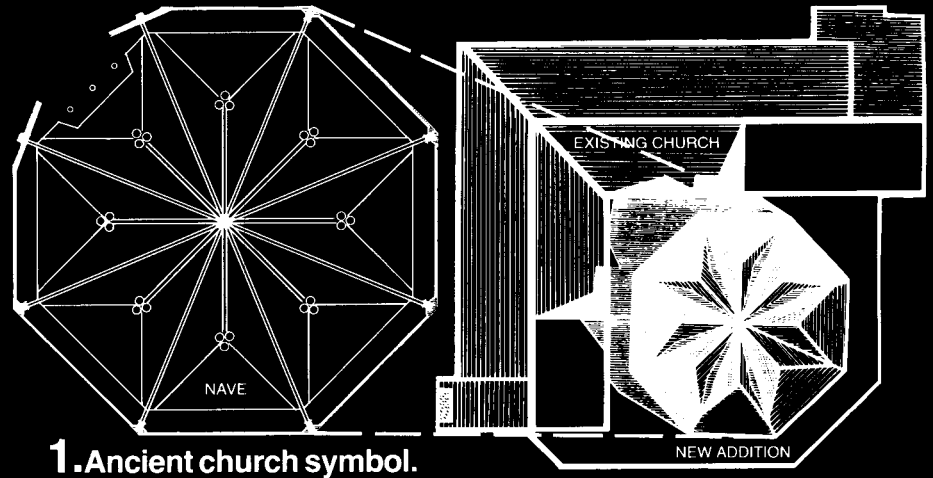

1. Ancient church symbol.

2. Red cedar handsplit shakes.

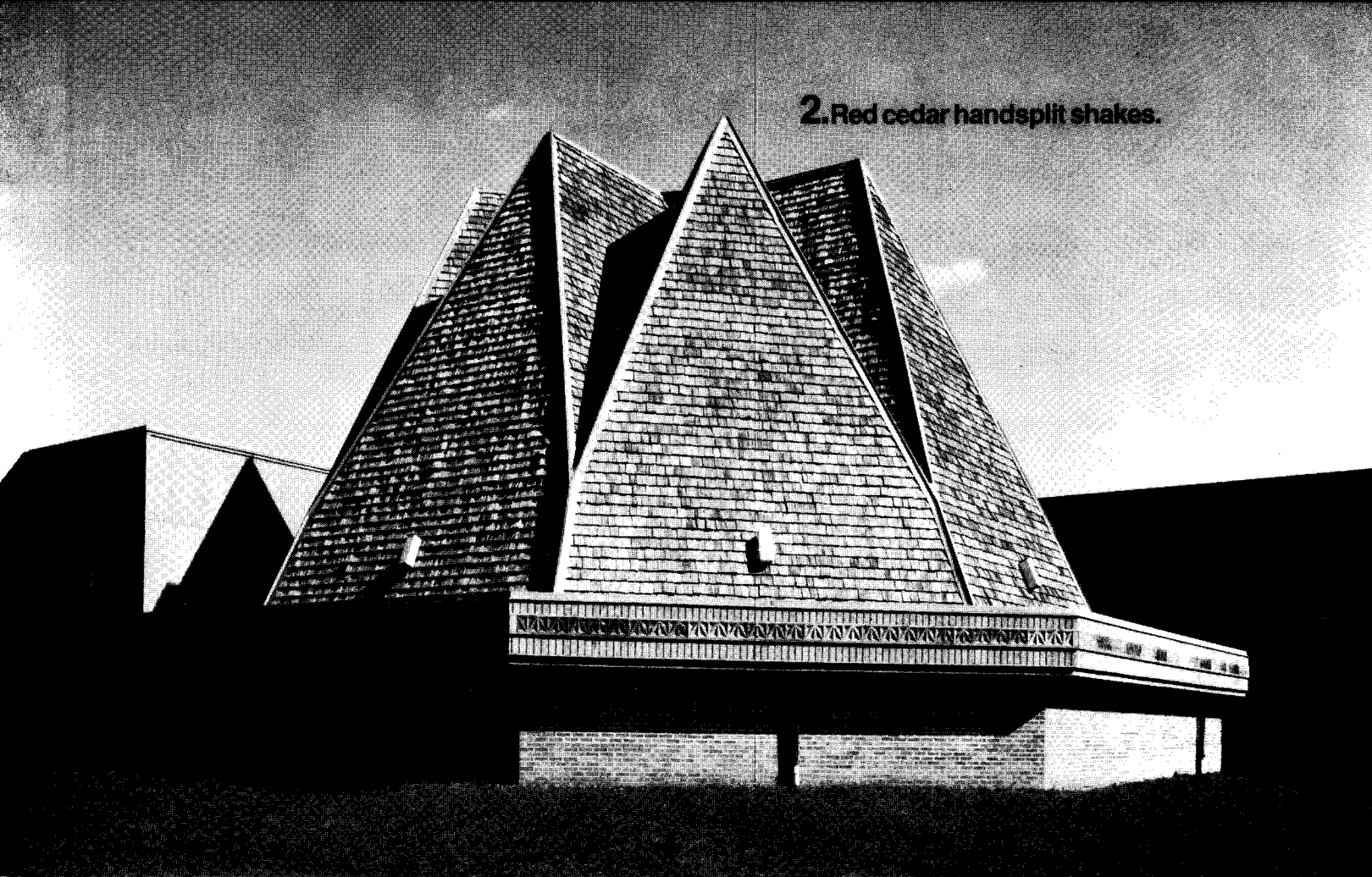

Problem: How to design a 300-seat sanctuary addition and create a totally new look for the Sunnyland Christian Church.

"Our solution was the reviving of an ancient church shape and nesting it into the existing L-shaped building.

"We brought it to life with a radial folded-plate plywood form clad with cedar handsplit shakes.

"The shakes, combined with the rough-sawn plywood, produced the naturally handsome and contemporary statement we were seeking."

— Forest A. Phillips

For our new color brochure "27 New Commercial Ideas in Cedar (and a few old ones)," write Suite 275, 515-116th Avenue N.E., Bellevue, WA. 98004. (In Canada: Suite 1500, 1055 West Hastings Street, Vancouver, B.C. V6E 2H1.



These labels under the bandstick of red cedar shingle and shake bundles are your guarantee of Bureau-graded quality. Insist on them.

Sunnyland Christian Church, Peoria, Illinois
Architects: Phillips/Anderson/Associates

Haida Indian ceremonial house in Old Kasaan. **Cedar. To touch the earth.**

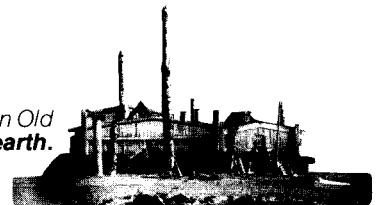

Red Cedar Shingle & Handsplit Shake Bureau

Circle 10 on information card

The Institute from page 22

Okla., and is a partner, along with his father, in the firm Lawrence, Lawrence & Flesher. He is both a registered architect and engineer, having received degrees from Oklahoma State University.

He became involved in Institute activities as an officer and then president of the Oklahoma Chapter/AIA. He has served as chairman of the AIA legal decision impact task force and of the 1976-77 ethics task force and the commission on professional practice, and has served on the board of Production Systems for Architects and Engineers, among others. He has also been an AIA regional director, and secretary and vice president of the Institute.

California Craftsmen Honored

Two skilled artisans are the recipients of the AIA/AFL-CIO craftsmen of the year award for their contribution to the California State Capitol restoration project. The award is given every two years in recognition of "outstanding workmanship and ingenuity displayed by tradesmen."

Michael H. Casey of West Sacramento, Calif., received the award for restoring the parget ceilings and friezes of the California State Capitol to their original 1893 appearance. Karl Mindermann of Sacramento was honored for his restoration of the capitol's copper dome.

The jury cited Casey for his "sculpture talent, artistic sensitivity and masterful control of the plaster medium" and Mindermann for his "mastery of process of crafting," which it called "as impressive as the final product."

Serving on the jury were James M. Harris, FAIA, Tinsley A. Galyean Jr., AIA, and Pascal DiJames, general president and secretary-treasurer of the Tile, Marble, Terrazzo, Finishers and Shopman International Union, AFL-CIO.

Study Aid Available

Applications for AIA/AIA Foundation scholarships for study or research beyond the first professional degree are due Jan. 15 (the deadline for undergraduates is Dec. 15). Awards range from \$200 to \$2,000.

All applicants must be students in or applicants to schools with programs accredited by the National Architectural Accrediting Board or the Royal Architectural Institute of Canada. One application will place a person in competition for any one of the various AIA or AIA Foundation awards. The program assists over 100 students each year.

Candidates for advanced research or study may apply in writing to the assistant director, education programs, at AIA Headquarters.

Government

Some Are Wary of Revisions In Brooks Procurement Approach

The proposed uniform federal procurement system issued recently by the Office of Federal Procurement Policy calls for no change in the way architects and engineers are selected for federal work. However, the architectural and engineering professional organizations fear that the system, once adopted, may lead to the re-examination of the so far rejected idea of procuring A/E services by competitive negotiation.

Currently, architects and engineers are selected on the basis of competence and qualifications with price negotiations undertaken after the selection. This system was established by the 1972 Architect-Engineer Selection Act (PL92-582), widely known as the Brooks bill.

The proposed uniform procurement system calls for "no revision, modification or repeal of the A/E procurement law," says Charles Clark of the Office of Federal Procurement Policy, although that is not stated in the proposal. (A/E selection is only mentioned under one section that lists examples of socio-economic and other requirements that affect government procurement.) What it does do is propose a single, simplified government-wide procurement regulation to "eliminate or clarify" the more than 700 sets of agency regulations that now control federal procurements. Procurement laws, such as the A/E law, would not be initially affected, but could be challenged by later efforts to consolidate the procurement system.

The federal government spends over \$100 billion annually for goods and services, the biggest portion of which goes toward Department of Defense procurements. In 1980, most procurements were over \$10,000 (for a total of \$99.6 billion) with \$1.5 billion for A/E services. The proposed system is to "put federal procurement on a more systematic, professional and business-like basis than it is today, and it has the potential for substantial savings," the Office of Federal Procurement Policy says.

Meanwhile, the Committee on Federal Procurement of Architect-Engineer Services of the American Consulting Engineers Council has expressed concern over a procurement directive that the council said could undermine the Brooks bill approach. The directive, known as Office of Management and Budget circular A-76, requires that agencies must compare the

cost of acquiring goods and services from the private sector with the cost of using federal workers.

ACEC grew concerned when the Department of Energy advertised for price proposals to provide "engineering support services." DOE maintains that this particular procurement was not covered by the Brooks bill because it was not for engineering or architectural services in connection with construction of a public facility, an argument that is in line with recent General Accounting Office decisions. ACEC expressed its "deep concern" that by using the term support services instead of professional technical services DOE will continue to request price submissions from interested firms. ACEC believes that the A/E procurement law should be followed, not the regulation.

Ken Guerken of the Office of Management and Budget agrees. He says the circular applies to A/Es only after a selection has been made and fee negotiations are under way. Costs will be compared to what it would cost government employees to do the same job.

The question of whether price should be included as a factor in procuring A/E services is currently being studied by the Building Research Advisory Board's federal construction council, which is composed of federal agency procurement officials. The council is also examining the effects of the 6 percent fee limitation and of a proposal to reimburse A/Es for the cost of submitting proposals for certain projects. The study, which is to be available in February, is not expected to have a major influence on procurement policy.

Trimming Space, Energy Use To Produce Affordable Housing

In an attempt to do something about the problems brought before the President's commission on housing (following story), the State of California recently held a competition of ideas tailored to help people with incomes from low to average who are being forced out of the housing market.

The California Affordable Housing Competition received over 480 proposals; awarded cash prizes (\$2,500 to \$15,000) to 28 architects, municipal agencies, developers, community organizations and other individuals, and cited 22 proposals

continued on page 29

Now Touch 'n Draw™ puts computer-aided design at your fingertips.

If you're trying to stay ahead in the architectural/design field today, you're facing pressures you've never faced before. Pressures such as skyrocketing production and people costs. More competition. Accelerated design-time schedules and client demands for improved cost controls.

To counter powerful pressures like these, it will take powerful tools, like the computer-aided design and drafting (CADD) systems you've been hearing about. And to do it effectively and economically, it'll take Touch 'n Draw™.

Touch 'n Draw™ makes your people and your practice more productive: with it, you can turn out more design drawings, of uniformly high quality, in less time. Which means Touch 'n Draw™ makes it easy for your business to grow — without adding hard-to-find design and drafting staff.

It's easy to use.

Touch 'n Draw™ is designed for designers — not programmers. That means any of your design and drafting people can work with the system productively after just a few days' training. And in a couple of weeks, they'll be using it like experts.

Through its Touch Control Station™, the system puts computer power right at your fingertips. Commands are selected by touching a "menu" box; the system responds with operator messages, using terms familiar to you. Drawings are entered

graphically from a large digitizing tablet, or numerically from a keyboard.

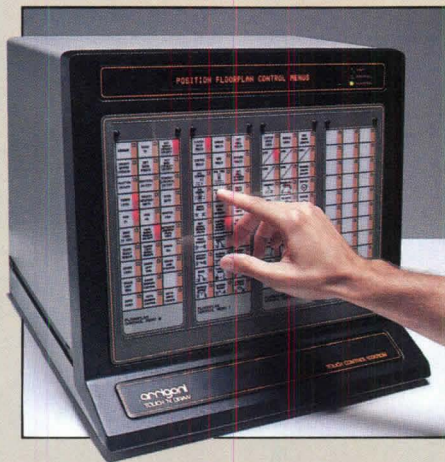

While a drawing is being electronically created on the display screen, it can be changed, moved, or scaled up and down — limited only by your imagination. Once it's complete, the drawing can be automatically produced on a digital plotter in just minutes. Any size drawing is possible: from 8½ by 11 inches up to full "E" size; in multi-color; on paper, vellum or mylar. If changes need to be made to a drawing later on, it can easily be retrieved, modified and quickly reproduced with original quality.

It's easy to integrate.

No matter what your design specialty is, you'll appreciate how quickly Touch 'n Draw™ goes to work in your practice. If you're an architect or design engineer, you'll be able to produce complete sets of working drawings faster than ever before. If you're a facilities

planner or interior designer, you'll be able to deliver comprehensive space plans with project material and cost summaries in record time.

Touch 'n Draw™ fits into your practice easily because it has all the specialized symbols and commands you need. At present, a library of over 1,000 drawing symbols is available, covering all of the specialty areas — electrical, mechanical, landscape, furniture, etc. — required for complete working drawings. And if you should happen to need other symbols or details beyond our standard library, you can easily create your own.

It's easy to afford.

For the cost of a single draftsman, you can now have a Touch 'n Draw™ system. Typically, one system does three to five times the drafting work pos-

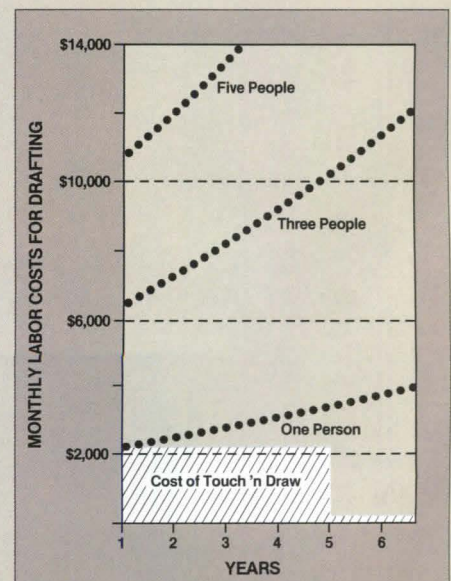



sible manually — and considerably more than that on repetitive tasks. That means now you can add design and drafting power to your office, without adding manpower. And reduce turn-around times dramatically too.

Installing Touch 'n Draw™ won't cost you a bundle either, because it fits in your office without any special wiring, flooring or air conditioning. And since the system's hardware consists of standard computer/peripheral components, oper-

ating costs are less than you might expect.

It's easy to grow with.

No matter how large or small your design workload is, a Touch 'n Draw™ system will be easy to grow with, as your business grows.

To face the challenges of the 80's, design firms like yours will need help from CADD systems. Help that's easy to use, easy to integrate, easy to afford and easy to grow with. And there's

only one CADD system that meets all those criteria: Touch 'n Draw™

Touch 'n Draw™ could be your blueprint for success in the 80's right now. To find out how, contact us today for further information or a demonstration.

TOUCH 'N DRAW™

*Arrigoni Computer Graphics, Inc.
231 O'Conner Drive
San Jose, CA 95128
(408) 286-2350*

Circle 14 on information card

ATLAS THERMAL SERIES— NO OTHER INSULATED ROLLING DOOR MEASURES UP

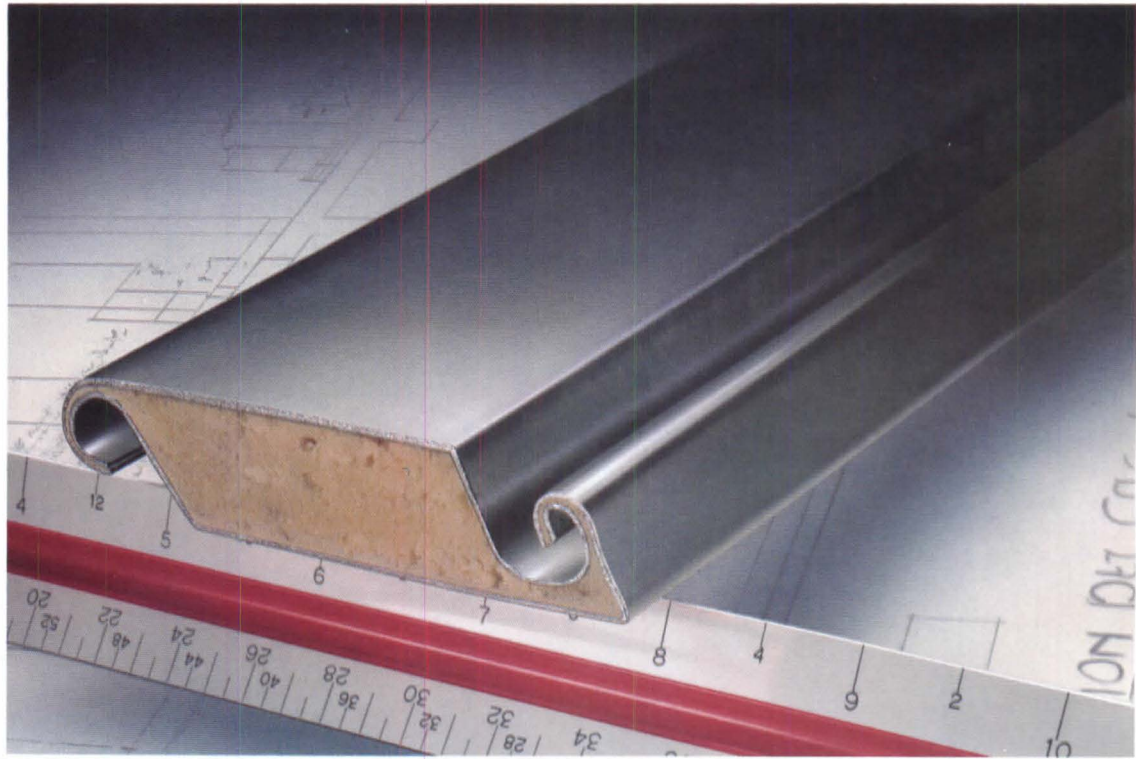

1. "Foamed in Place" Polyurethane

Today the amount of insulation in a door is more important than ever before—but even more important is the way it's put in. That's where nobody measures up to Atlas. And that's why Atlas uses "foamed in place" polyurethane, because solid insulations can't fill effectively. Foamed in insulation reaches in and penetrates filling all the small and hard to get to places. That's the difference, it's effective and fills completely.

2. Superior Slat Design

Inside the curves, where the slat faces interlock, are the hard-

est spots to insulate—in any rolling door. It's here that Atlas makes some unique design modifications that allow them to be filled completely. This effective insulation over the entire length of the slat is a major design achievement, yielding 100% insulation coverage and performance, a real value that no other rolling door measures up to.

3. Bonding, Strength, Highest R

For strength and durability, urethane foam hardens to a solid lightweight plastic that bonds to the metal slats permanently—no falling off, warping, or wearing. It's protected from external damage and weathering by 22 gauge galvanized steel, a tough combination of metal/foam/metal. Urethane foam also has the lowest thermal conductivity (K)

and highest resistance (R) of all common insulators. These unique properties coupled with Atlas technology produce a durable, lightweight, energy barrier that will last for the life of the door.

4. "New" Atlas Options

Two new rolling door options, the Atlas Safety-Stop™, which prevents the door from free falling, and the Atlas VHC™, which extends the useful life of the door, complement a complete line of rolling doors and grilles. Atlas doors are backed by a national network of distributors and in-

stallers. That's because Atlas measures up—all the way.

For more information about Thermal Series rolling doors and these new options contact Atlas at 116 Truman Drive, Edison, N.J. 08817, or call (201) 572-5700.



We're meeting the challenge!

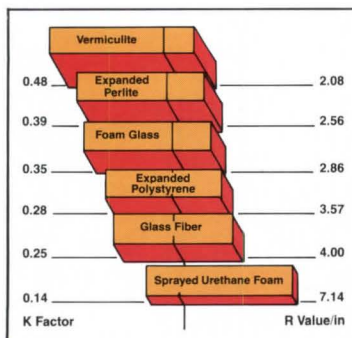
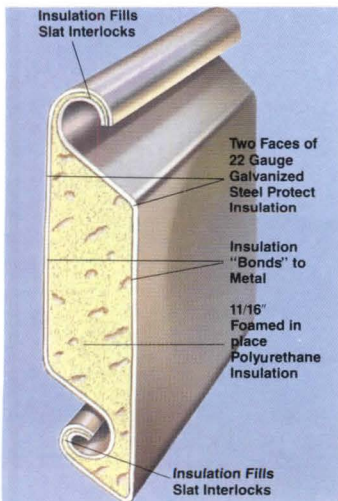

Circle 15 on information card

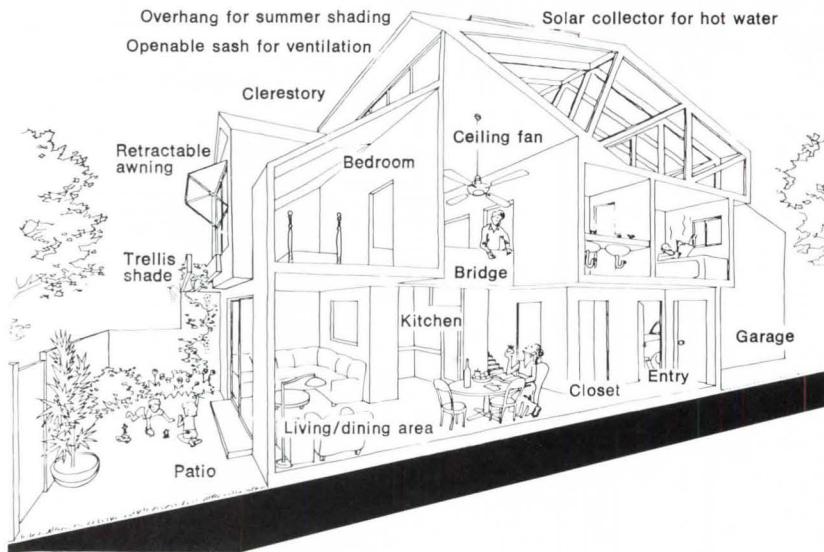

Government from page 25 with honorable mentions. Awards were given in three general categories: projects, including designs and architectural plans; processes to cut the cost of regulations, and an open category called "new possibilities," which included financing options and manufactured housing.

Two ideas common to almost all of the submitted designs were more compact living spaces and better energy usage. Virtually all of the designs claimed some kind of passive solar feature, including creative landscaping, southern orientation and thermal mass collectors. Many also incorporated active solar systems for heating water.

One of the \$15,000 award winners was a privately developed project of 36 town houses (drawing above) for publicly owned land in downtown Sacramento. The designs by SOL•ARC make the most of floor plans of less than 1,000 square feet. The developer, Hoffman Co., claims construction savings through use of a pre-cast foundation post and beam system and prefabricated roof and second-story ceiling trusses. Using landscape design and passive heating and cooling, a monthly energy charge of \$9 per unit is predicted, compared with \$22 for a conventional similar unit. Projected sales price is \$53,950 per unit, compared with \$90,000 for similar projects in the area.

Similar construction savings are projected for a project in Chico, Calif., designed by Kurtzman & Kodama, also a \$15,000 award winner. Savings come from using post-tension slabs in foundation construction and prefabricated truss systems for floors and roofs. Passive solar features include a south-facing living area with a heat-retaining concrete floor and thermosiphon solar water heaters.

Common themes in the processes and new possibilities categories included ways of sharing houses, self-help projects and cutting of government red tape. Examples include:

- utilization of surplus rice straw to man-

ufacture building materials, including sub-flooring, 2x4s, wallboards and cabinets;

- a plan to upgrade a hotel in San Francisco's Chinatown without displacing its low-income residents;
- a proposal to provide inexpensive food and shelter by placing small travel trailers inside unheated greenhouses;
- a program by San Diego County to develop new policies, ordinances and action programs to stimulate mobile home usage;
- a proposal for the state to hold a lottery with a house as the prize and to use the estimated \$43 million to \$500 million in annual proceeds to establish a fund for low interest home loans;
- a plan to speed construction inspection by local governments which would contract with qualified private firms to provide such services;
- a free service, including a comprehensive application and interview process, that matches older people who have partially empty houses with people seeking affordable housing. This program in Santa Clara County, winner of \$15,000, has served more than 1,600 clients since 1977.

The competition was sponsored by the Governor's Office of Appropriate Technology (OAT) and the California Department of Housing and Community Development.

Streamlining Regulations To Promote Affordable Housing

To help alleviate the problem of rising housing costs, local, state and federal governments should review housing-related regulations, Donald J. Hogan, AIA, told the President's commission on housing. By changing excessive or out-of-date rules and by resolving inconsistencies where they exist, "housing can be kept affordable without sacrificing quality," Hogan said.

Representing AIA, Hogan testified that

continued on page 30

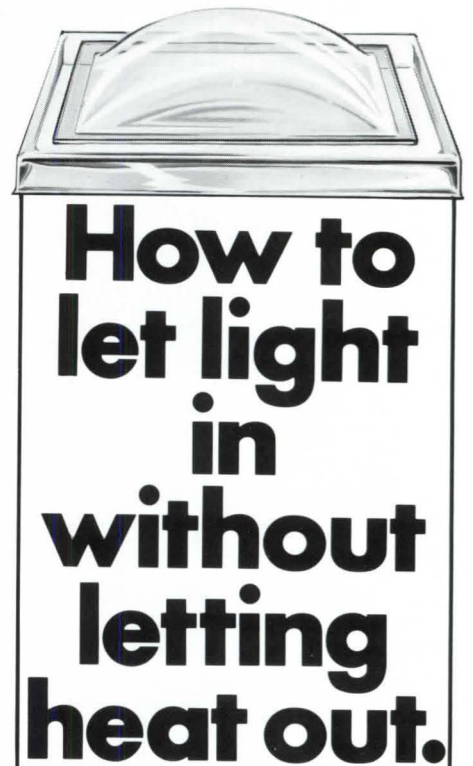

Skylights formed from UVEX® Plastic Sheet can reduce costs by reducing the need for artificial lighting during daylight hours.

While the optical transparency of UVEX Sheet lets light in, its low thermal conductivity keeps heating and cooling losses low.

UVEX Sheet has excellent impact strength and outstanding resistance to weathering. And in many instances, skylights formed from UVEX Sheet can be flashed directly into the roof—eliminating the need for aluminum curbing or support.

For information and the name of the skylight manufacturer nearest you, contact

Eastman Chemical Products, Inc., Plastics Products Division, Kingsport, Tennessee 37662.



Eastman Chemical Products, Inc., a subsidiary of Eastman Kodak Company, Kingsport, Tennessee. UVEX is Eastman's trademark for its plastic sheet. Eastman makes only the plastic sheet used in finished products and therefore makes no warranties with respect to such products.

UVEX®
Plastic Sheet

Circle 16 on information card

“The ENCYCLOPEDIA OF AMERICAN ARCHITECTURE

is a monumental, fascinating, most useful reference work, to be enjoyed by architects and laymen alike.”

Pietro Belluschi
Architect

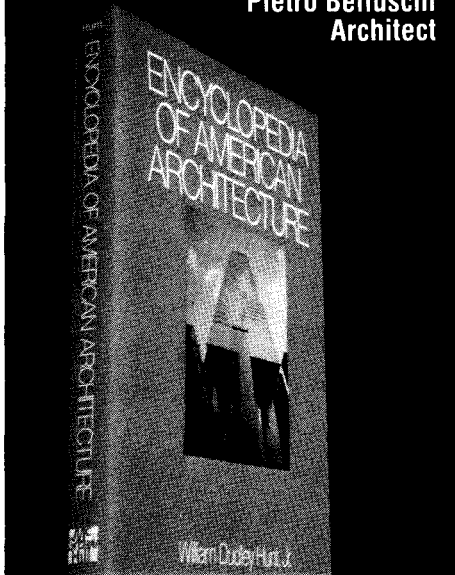

WILLIAM DUDLEY HUNT brings you the full scope and splendor of a magnificent cultural heritage — America's built environment past and present — in over 200 lavishly illustrated articles on its history, practitioners, and styles, building types, structural components, systems, and materials, and today's architectural practice. 612 pages, 576 photographs (26 full-color) and drawings, outside format.

“As might be expected from the author ... this is a work of large scope ... the best and most up to date ... an impressive one-man performance ... fair, calm, and even-handed.”

Frederick Gutheim, Hon., AIA
AIA Journal

At bookstores or direct
from publisher for
15-day Free Examination



McGRAW-HILL BOOK COMPANY
Box 400, Hightstown, NJ 08520

Send me Hunt's ENCYCLOPEDIA OF AMERICAN ARCHITECTURE (031299-0) for 15 days on approval. In that time, I will pay \$39.95, plus tax, postage, and handling, or return the book without further obligation. I understand that if I remit with this order, plus local tax, McGraw-Hill pays all regular postage and handling, and that the same return privilege applies.

Name _____

Address/Apt. _____

City/State/Zip _____

Offer good only in U.S. Order subject to acceptance by McGraw-Hill.

57-J441-4076-3

Circle 17 on information card

Government from page 29

“housing affordability will be a major issue” throughout the '80s. “Unless the U.S. meets the market challenges in housing and improves its housing production, the crushing housing cost increases of the past few years will worsen,” he said. In the near term, he added, we will see an unprecedented demand for housing, unprecedented prices for homes, an unprecedented weakness in the savings and loan industry and a reduced government role in providing housing units.

The commission was established to advise the President and HUD Secretary Samuel R. Pierce Jr. on the development of a national housing policy consistent with the Administration's economic recovery program. Among its primary goals is to review federal housing policies and programs and to assess those factors that contribute to the cost of housing. The commission is chaired by Los Angeles attorney William McKenna and vice-chaired by former HUD Secretary Carla Hill.

Hogan focused his comments on how regulations affect the housing construction market. “Unlike many industries that have had major regulatory acts imposed upon them,” he said, “the building industry suffers from a slowly acquired accumulation of many small pieces of regulatory action, which makes it very difficult to estimate how these regulations add to the cost of a house.” And, he added, “Some form of regulation impinges on every step in the development and construction process, which has caused an increase in the time and cost required to bring housing to the market.”

To help control construction costs, “AIA believes that emphasis must be given to performance standards,” Hogan said, which will allow for more flexibility in the use of materials and types of design. Historically standards that regulate federally financed construction have “literally prescribed the materials and construction techniques that are required for compliance,” he said. “While these standards have upgraded the quality of the nation's housing stock, they also have tended to limit the use of new materials and technology that have the potential to lower construction costs.”

Hogan talked of the “first costs” of housing and suggested ways that regulations could be changed to reduce these costs. In an effort to reduce raw land costs, he called for the elimination of overlapping environmental impact studies; the encouragement of higher density development along major transportation routes and in areas with existing sewer and water services; additions to zoning codes to include the latest planning concepts to allow cluster housing, zero lot line development, mixed use and other innovations

continued on page 32

TOWER

**CONTRACT VINYL
WALL COVERING**

DISTRIBUTOR DIRECTORY

WALLCO

6700 N.W. 77th Court, Miami, Florida 33166
(305) 592-8000
Broward Line: 524-4352 Fla. Wats: 1-800-432-9516
Cable—WALCOINT Telex—803559
5329 West Crenshaw Street, Tampa, Florida 33614
(813) 885-2767
Fla. Wats: 1-800-282-7715
3287 Marjan Drive, Atlanta, Georgia 30340
(404) 455-6100
Ga. Wats: 1-800-282-7203
N.C., S.C., Ala., Tenn., La., Ark., Miss., Fla.
Wats: 1-800-241-7361
803 Pressley Road, Suite 108, Charlotte,
North Carolina 28210 (704) 523-4167
N.C. Wats: 1-800-432-6258
S.C., VA., Wash D.C., M'land Wats: 1-800-438-2986
(809) 753-7474
186 Juan P. Duarte, Hato Rey, Puerto Rico 00925
5800 Jefferson Hwy., Brookhollow Center,
New Orleans, LA. 70123
(504) 733-3318
La. Wats: 1-800-452-8833
Miss., Ark. Ala., Wats: 1-800-535-8855

WALLCO WEST

4704 North 7th Avenue, Phoenix, Arizona 85013
(602) 274-3529 or 274-9112
4870 Nome Street, Montbello Industrial Park,
Denver, Colorado 80239
(303) 373-5060

FRAZEE'S CREATIVE WALLCOVERINGS

6625 Miramar Rd., San Diego, CA 92122
(714) 276-9500
16301 CARMENITA RD. • CERRITOS, CA 90701 • (213)
926-9555
3249 N.W. 29TH AVE. • PORTLAND, OR 97210 • (503)
226-6793
Telephone: CALIF. (800) 352-3889
OREGON (503) 226-6793
WASHINGTON (206) 643-0920
NEVADA (800) 421-3839
HAWAII (213) 926-9555
ALASKA (503) 226-6793

ISGO CORP.

2121 W. 21st Street
Chicago, Illinois 60608
Phone (area 312) 376-2121
1237 Conveyor Lane
Dallas, Texas 75247
Phone (area 214) 634-1313
1334 Atlantic Street
North Kansas City, Missouri 64116
Phone (area 816) 421-5060
5809 Chimney Rock
Houston, Texas 77081
Phone (area 713) 666-3232

WASHINGTON WALLCOVERINGS

5015 New Utrecht Ave.
Brooklyn, N.Y. 11219
Tel. (212) 633-8800

BREWSTER WALLCOVERING CO

288 A Street
Boston, Mass. 00210
Tel. (617) 542-9306 Telex 94-1792

THE BLONDER COMPANIES

3950 Prospect Ave.
Cleveland, Oh. 41115
(216) 431-3560
237 No. 4th St.
Columbus, Oh. 43215
(614) 221-4461
5133 E. 65th St.
Indianapolis, Ind. 46270
(317) 257-1321
21072-21076 Bridge St.
Southfield, Mich. 48075
(313) 358-4730
606 Parkway View Drive
Pittsburgh, Pa. 15205
(412) 787-7550

IN CANADA

General Paint & Wallcoverings
950 Raymur Ave., Vancouver, B.C.
Canada Wallcoverings
3275 Yonge St., Toronto, Ont.
Metro Wallcoverings
66 Orfus Rd., Toronto, Ont.
Novax Wallcoverings
740 Trans Canada, Longueuil, Que.
Reed Wallcoverings
1995 Clark Blvd.
Bramalea, Ont.
Matchless Paints
Sugar Loaf Rd.
St. John's, Newfoundland

TOWER CONTRACT VINYL WALL COVERING

A Collection of textures in deep dimension

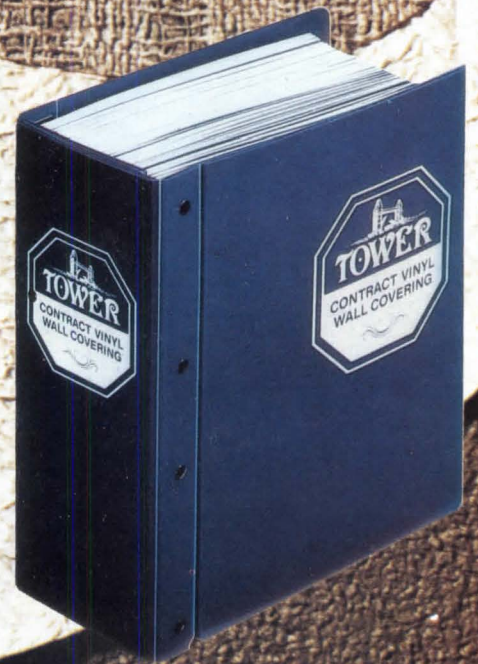

Texture and color as subtle as that of an everlasting bouquet can be found in the 37 patterns of 366 color selections of Tower Contract Vinyl Wallcovering. Featuring textures in deep dimension for fabrics, wood, grass, masonry, leather, etc., Tower Contract Vinyl Wallcoverings can be found in buildings of distinction from coast to coast in the United States and Canada. Consult the distributor directory for catalogue and samples. Material is supplied in 30 yard bolts of 54 inch width. Custom colors and emboss effects are also available.



CANADIAN GENERAL-TOWER LIMITED
(OAKVILLE DIVISION)

Circle 18 on information card

Government from page 30

in an effort to use less land and allow shorter utility runs, and the efficient use of older housing.

Hogan called for the federal government to "take a leadership role in educating and encouraging local and state officials to follow uniform regulations."

Attention must also be given, he said, to prevent scrapping of existing housing stock and to "the regulatory burden that hampers the rehabilitation of housing units. . . . Our experience indicates that many of the existing regulation procedures, especially those at the local and state level, increase the time and carrying costs necessary to complete a project, thus increasing the total cost of the rehabilitation project."

And AIA believes, Hogan said, that "affordable housing must also be energy efficient housing." He called on the federal government to continue its work on determining what are the cost-effective levels of energy conservation in a variety of geographic regions and to disseminate this information to the housing industry.

Aid to Low-Income Families Emphasized by Housing Panel

The President's Commission on Housing in its interim report recommends grants to individual families as the primary federal program for providing decent housing for low-income families. The current system emphasizes grants to builders and owners

under the federal Section 8, Section 202 and public housing assistance programs.

The 25-member commission, which is to recommend options for a national housing policy next April, has concentrated its early efforts on low-income housing assistance and the role of mortgage revenue bonds in financing housing.

Among its other recommendations:

- New housing construction should be added as an eligible activity for community development block grants so that cities can "address housing problems in a more coordinated and comprehensive manner."
- Owners of residential rental structures should also be eligible for the same investment tax credit for rehabilitation expenses that is currently offered to owners of nonresidential buildings (a 15 percent tax credit on rehabilitation expenses for structures 30 to 39 years old and a 20 percent credit for older structures).
- Federal Housing Administration insurance programs for segments of the housing market not adequately served by the private sector should be continued.
- Current regulations or laws that "inadvertently" limit the housing investments of pension funds, insurance companies and other potential major sources of housing capital should be eliminated.

In the next few months, the commission will consider a program of individual accounts that would encourage and assist savings for a down payment by the first-time buyer and other savings incentives to increase available mortgage funds.

A/E Liability Relief Sought

AIA and two professional engineers' societies again have urged Congress to legislate relief for the problems of professional liability.

Institute President R. Randall Vosbeck, FAIA, testified in a Senate subcommittee in favor of a bill that would enable designers to supplement their insurance coverage by setting up service liability trusts with pretax dollars to pay deductibles and uninsured losses as a way to contain escalating premium costs (see April, p. 14). The Senate bill, for which there is a companion in the House, was introduced by Senator Charles Mathias (R.-Md.).

Vosbeck, speaking for AIA, the American Consulting Engineers Council and the National Society of Professional Engineers, said the Mathias bill would help assure that owners and users of buildings would not go uncompensated in the event of a negligent error or omission on the part of a designer. And, he said, the bill can provide "some stability to a volatile professional liability insurance market and to the design firms most affected by the rising cost of insurance."

News continued on page 87

Fairfax Center Design Competition

The Board of Supervisors of Fairfax County, Virginia, is pleased to announce the commencement of the Fairfax Center Design Competition—a two-stage competition for the design of its new governmental and civic complex.

Stage One is open to any firm or team licensed to practice architecture in the United States with a record of gross receipts for professional services of at least \$100,000 per annum during each of the last three years. In the case of teams, the lead firm must fulfill these requirements. At the conclusion of this stage, four finalists will be selected to compete in Stage Two.

In Stage Two, each finalist will receive \$25,000 to develop a preliminary design. An independent design review board will evaluate the submissions and provide the Fairfax County Board of Supervisors with a formal report. The Board of Supervisors will then award the commission for the project at its discretion.

Among the design goals for this project are creative approaches to resource management and housing local government in a manner that is open to and accessible by the public that it serves.

The design review board is composed of five members, comprising three architects, an engineer from the field of energy conservation, and a professional in local government administration:

Chloethiel Woodward Smith, F.A.I.A.
Jacquelin Robertson, F.A.I.A.
Barry Wasserman, F.A.I.A.
Fred Dubin, P.E.
Wayne F. Anderson

Any interested firm meeting the above criteria is invited to request additional information and materials. The deadline for the receipt of Stage One qualifications is 25 January 1982. Please write to:

Professional Advisor
Fairfax Center Design Competition
The Cooper-Lecky Partnership
3203 Grace Street, N.W.
Washington, D.C. 20007

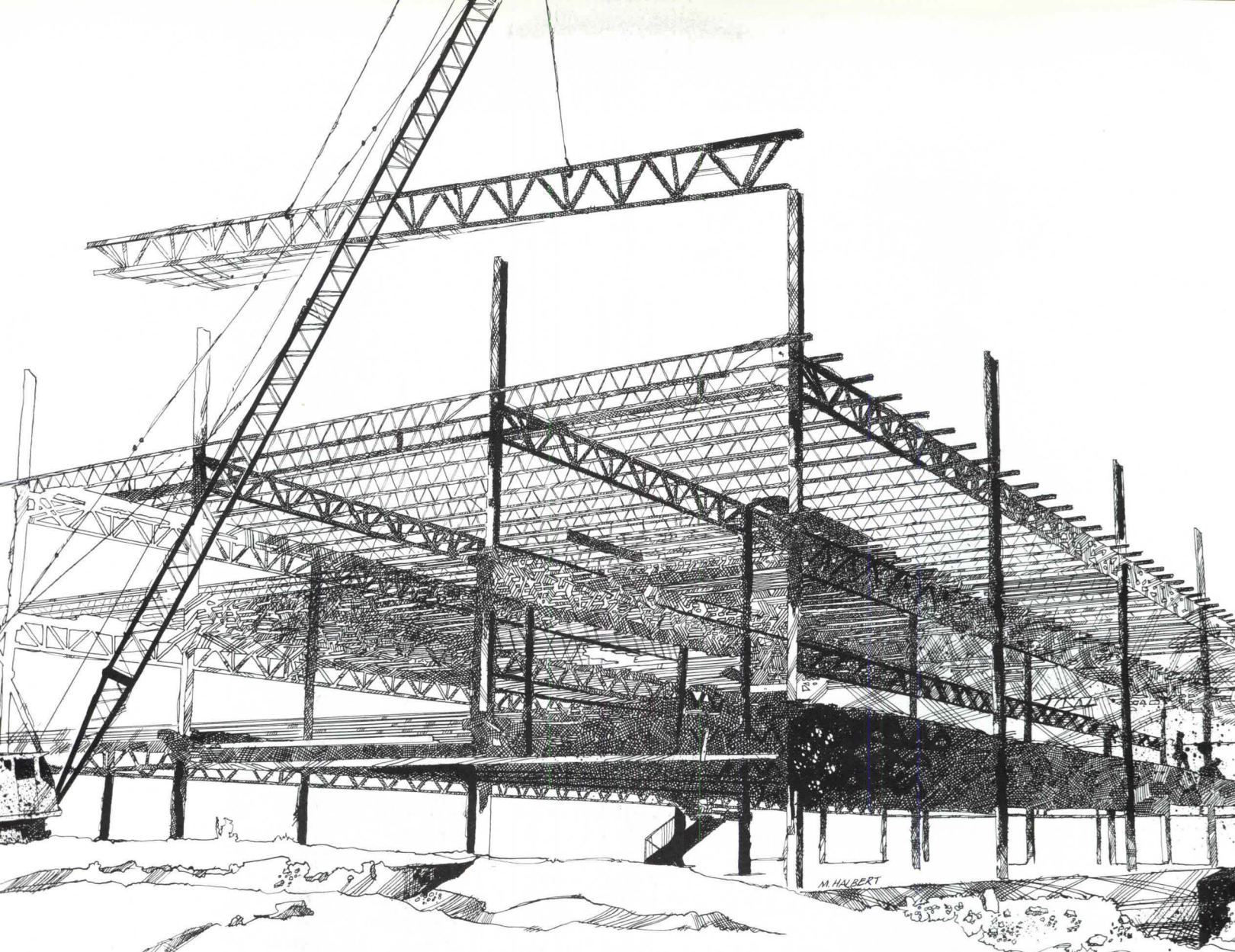

Steel Joist Construction – still the most economical way to reach for the sky.

Steel Joists can:

- Save on labor costs by speeding up construction.
- Cover more square feet per day. A system of joist girders and joists is still the fastest way to put on a roof.
- Eliminate the time and expense of erecting temporary flooring and working platforms.
- Meet structural strength requirements with less steel.

Free latest catalog! Combined Specs, Load Tables and Weight Tables for steel joists and joist girders.

MEMBERS OF THE STEEL JOIST INSTITUTE:

The Berger Steel Co., Inc.
 Carolina Macomber, Inc.
 The Ceco Corporation
 Compujoist Corporation
 De Long's, Inc.
 Gooder-Henrichsen Co., Inc.
 Guille Steel Products Co., Inc.
 John W. Hancock, Jr., Inc.
 Midwestern Joists, Inc.

Nucor Corporation Vulcraft Divisions
 Outten Joist Corporation
 Owen Joist Corporation
 Owen Joist of Florida, Inc.
 Socar Incorporated
 Standard Building Systems, Inc.
 Tex-Ark Joist Company
 Valley Joist, Division of
 Ebsco Industries, Inc.

Steel Joist Institute
 Room 204-B
 1703 Parham Road
 Richmond, VA 23229



Please send me your latest copy of Specs, Load Tables, and Weight Tables.

Name _____

Title _____

Firm _____

Address _____

City _____, State _____

Zip _____

Circle 20 on information card



2" EPS. R = 7.8. 5000 sq. ft.



1" Styrofoam RM. R = 5.0. 3451 sq. ft.



15/16" fibrous glass board. R = 3.8. 3362 sq. ft.



1" urethane foam. R = 6.2. 3095 sq. ft.

ROOF TO ROOF PROOF: YOU GET MORE INSULATION FOR LESS WITH EPS.

Dollar for dollar, you can design more R value into your roofs for less money with EPS (expanded polystyrene) insulation.

Compare for yourself. For the same cost, 2" of EPS covers 49% more area than 1" of Styrofoam RM, 49% more area than 15/16" fibrous glass board, and 62% more than 1" of urethane. And 2" of EPS insulation has a greater R value than any of the other three.

So, the next time somebody recommends an insulation based on a high number of Rs per inch . . . ask about the number of Rs per dollar.

Get more for less with EPS.

MATERIAL	COST/SQ.FT.*	R VALUE	COVERAGE (@ \$1170)
2" EPS	23.4¢	7.8	5000 sq. ft.
1" Styrofoam RM	33.9¢	5.0	3451 sq. ft.
15/16" fibrous glass board	34.8¢	3.8	3362 sq. ft.
1" urethane foam	37.8¢	6.2	3095 sq. ft.

*Estimated average price per square foot based on a random survey of building suppliers conducted by the Bureau of Building Marketing Research, November 1980. Actual costs may vary.

Expanded polystyrene (EPS) insulation is combustible and should not be exposed to flame or other ignition source.

ARCO Chemical Company manufactures DYLITE™ expandable polystyrene.

Sturdy EPS insulation is available in a variety of densities, configurations, and edge treatments to fit just about any need. For the name of your nearest EPS producer and some design ideas using EPS, call the Sweet's Buyline.



ARCO Chemical Company
 Division of AtlanticRichfieldCompany
Intelligent Solutions

AIA JOURNAL

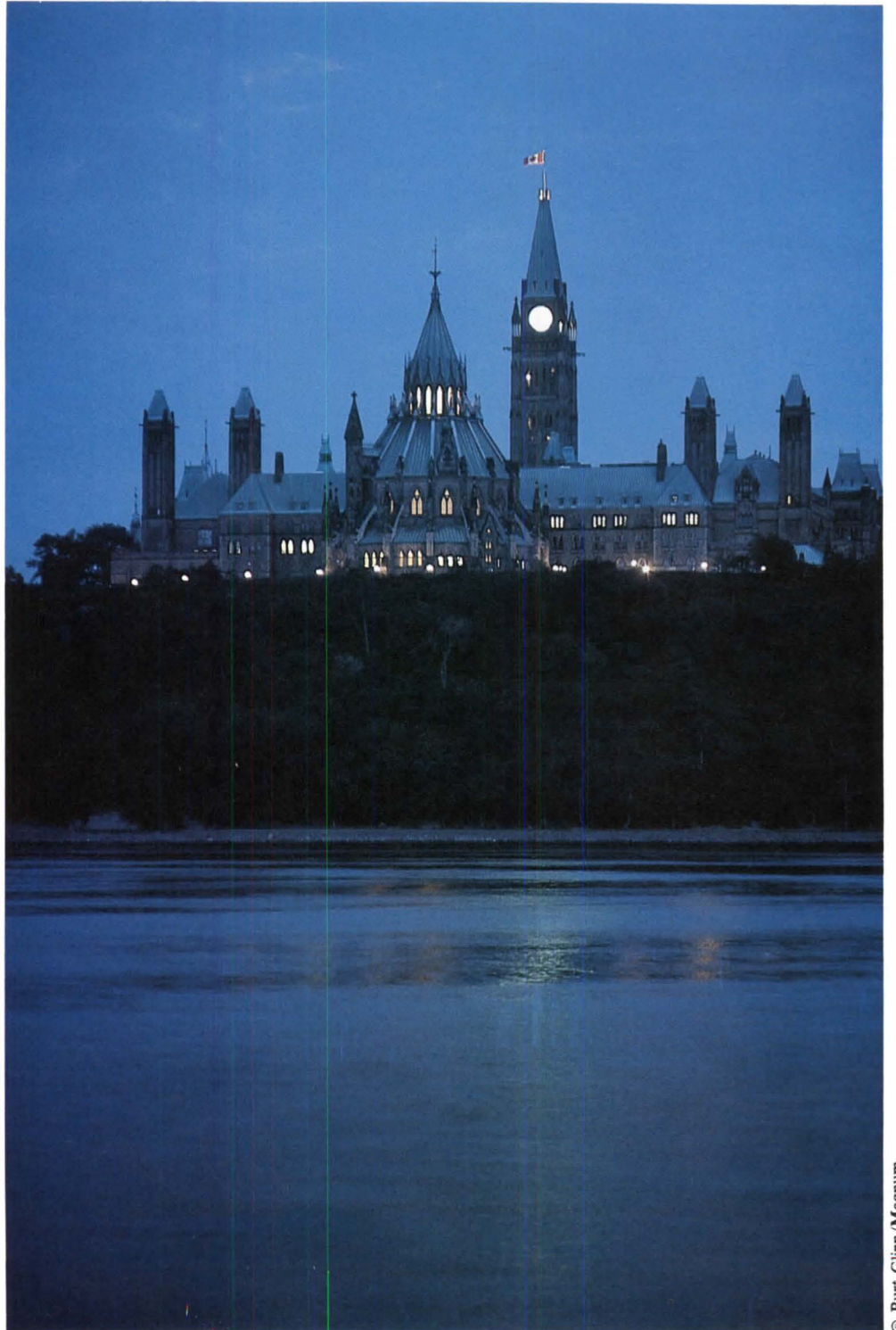

© Burt Glimm/Magnum

Urban Canada

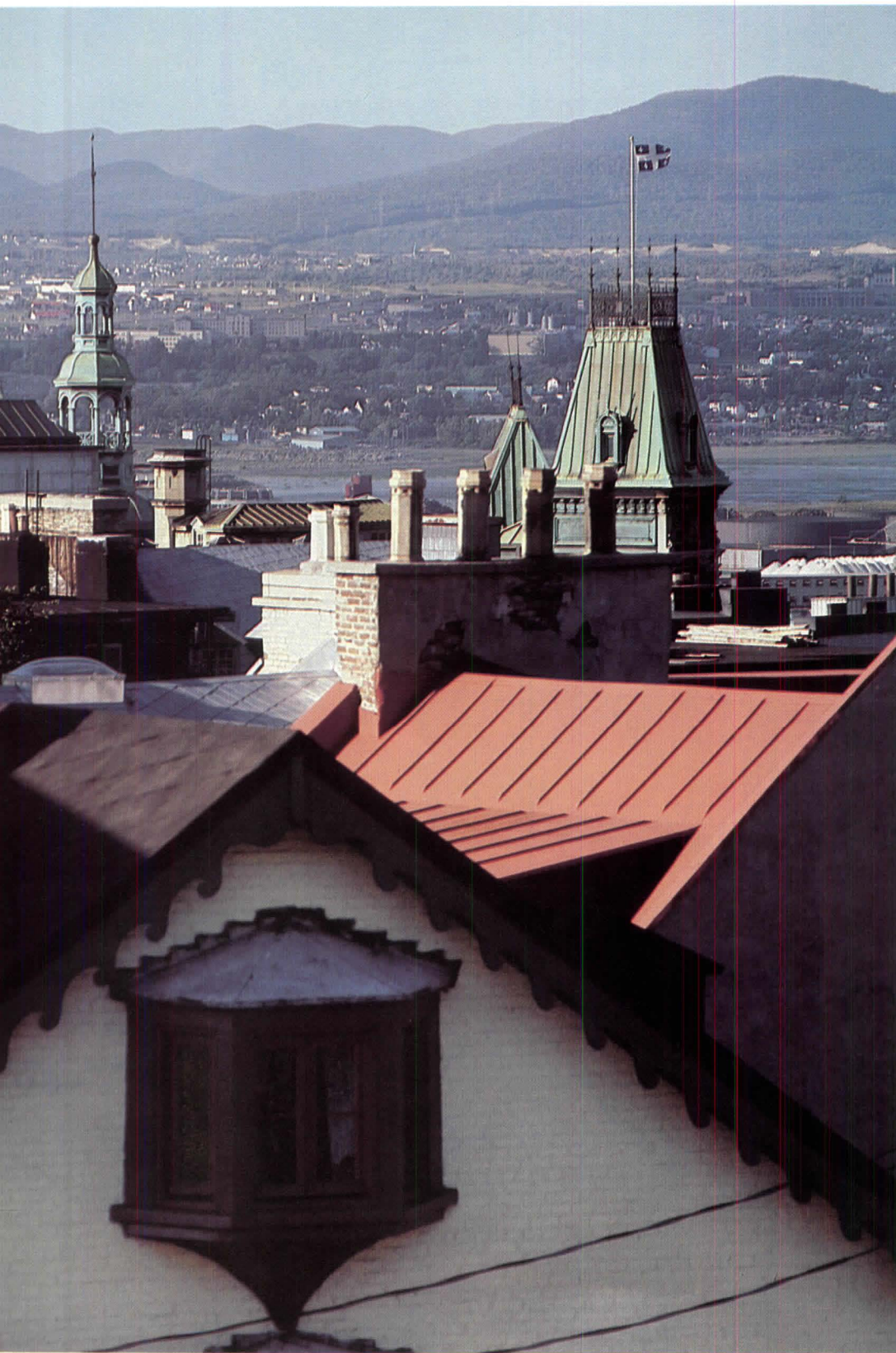

For a magazine to take on an entire nation in a single issue is an awesome, if not presumptuous, task. So we have limited our look at Canada to its urban areas, and decided to focus upon three that represent some of the major strains of Canadian urban development and environment.

It would be even more presumptuous to generalize about Canada and its cities. Like our own, it is a diverse, expansive land. Calgary is at least as different from Quebec City as Houston is from Boston.

There is more of the Old World in Canadian cities than ours. Yet in their vitality, even occasional brashness; their pace; their sometimes careless mixes of people and buildings, and, it must be said, their sprawl, they are essentially North American. Having said this much, we will go on to more specific, and therefore more comfortable, commentary on the cities of Toronto, Montreal and Vancouver. *D.C.*

Left, Old World Quebec; right, New World Calgary; previous page, official Ottawa.

© Michael J. Pettypool/Uniphoto



© Aardvark Aerial Photography (Ltd.), Calgary, Alberta



Toronto

*A sophisticated city of mix—and of the future?
By Stanley Abercrombie, AIA*

Relax. Forget those fears that the city of the future will inevitably be like Houston, for there is a quite delightful alternative: It could be like Toronto. Not that the two cities aren't similar in many ways; Toronto architect Barton Myers points out that they are about equal in population (something over three million), that both, although much earlier in origin, are primarily the products of growth since the Second World War and are therefore essentially new cities and that both are dynamic economic centers. (Part of Houston's current boom, incidentally, is the result of investment by Toronto-based developers, one of them—Cadillac-Fairview—currently responsible for construction covering 75 acres of downtown Houston.)

Quick surveys from airplane windows might even suggest a physical similarity between the two cities, for both are comprised not just of single high-density centers but rather of a whole array of high-density clusters, each of which could serve as the major focus of a smaller city. But this suggestion would be deceptive, for Houston, despite its satellites, has one cluster that is clearly predominant surrounded by what is definitely suburban sprawl. And the airplane views wouldn't have revealed the separation of



uses that exists in Houston (in Myers' words, a "work here, live there" sort of organization) and that is absent to such a striking degree in Toronto.

For Toronto is a city of mix. It seems perfectly fitting that it should be the present home of Jane Jacobs, whose *Death and Life of Great American Cities* opened our eyes in 1961 to the virtues of urban mix. Most apparently, even from our airplane, it is a city of topographical mix, a rolling plane eroded by a network of deep ravines, almost all of which have been left totally green (although an important traffic artery, Don Valley Parkway, has been allowed to cut through one of them), thus effecting a city plan that consists of a typically rigid grid surprisingly and very pleasantly interrupted by fingers of parkland.

It is a city of ethnic and cultural mix. To an older stock of Anglo-Saxons, Italians and others has recently been added an influx of Pakistani and Chinese, and there is a small sprinkling of blacks. Investment money and people managing it have been

arriving from Hong Kong and Germany. There are ethnic neighborhoods, to be sure, and there are many signs catering to French-speaking citizens, but, except for some skirmishes with Caribbean immigrants, there has been no indication that Toronto will suffer anything like either the massive language-based disruptions to its east or the race-based conflicts we have experienced to its south.

Toronto's plan is based on a mixture of transportation types, the subway system, opened in 1954, still being extended and efficiently interlocking with bus and streetcar networks as well as with key parts of the city fabric. (Houston has very ambitious and very welcome plans for a rapid transit system, of course, but it can hope to serve only some of the present city and help shape the future; Toronto has a good head start.) And in Toronto a network of bicycle trails is being planned, and even walking is a frequent possibility.

Toronto is a city of mixed density. Scattered throughout are not just clusters of office towers but also whole areas of highrise construction, some of them residential, cheek by jowl with areas of single-story buildings. The concentrations of density occur

Looking south toward Lake Ontario, above. Right above, the 1890 City Hall by E. J. Lennox seen from the plaza of New City Hall.



'Man-made ridges of highrise construction.'

with most consistency along a central spine that extends northward and inland from Lake Ontario, which forms the city's southern boundary, and they occur at intervals of approximately one and one-half miles, a spacing with its origin in early land concession boundaries and now reinforced by the crossing of major east-west streets and streetcar lines and by stops on the subway lines.

Between these man-made ridges of highrise construction, of course, are valleys of lesser development, and it is this alternation of building sizes that has fostered Toronto's most valuable mix of all: that of building uses. From the bustle of commerce to the lazy, shady streets of residential enclaves is never more than a few blocks, and this city seems to offer an astonishingly great number of opportunities for living near the office, which also turns out to mean living near the shops.

Varied development is not limited to the north-south spine, however. From west to east, along the lake shore and for miles inland, there is a succession of virtually self-sufficient communities, each with its complement of housing, industry and commerce, each with its own personality, and many, but not all, with their own local governments—Etobicoke, North York, Don Mills, The Beaches, Scarborough.

Your architect's ears, perhaps, perked up a bit at the mention of Scarborough, for it was in that eastern section of Toronto that John Andrews' much-publicized building complex for Scarborough College was built in 1965 (in collaboration with Page

& Steele). Before the wonders of Montreal's Expo, before the advent of Arthur Erickson as an international star, the college constituted Canada's initial claim to the first ranks of modern architecture. A valid claim, indeed, for the college still radiates an impression of strength and unimpeachable authority. A less convincing Toronto building of about the same time, but one that also attracted much international publicity, was Viljo Revell's curvaceous, competition-winning New City Hall (designed in collaboration with the Parkin Partnership).

And the most inescapable Toronto landmark of all is the CN communications tower, finished in 1975. How can the world's tallest structure (1,815 feet)—moreover, one that has, apart from an observation level and an (ugh) revolving restaurant, no function to serve other than being tall—how *can* such a structure be clunky? Perhaps only through the efforts of an excessive number of collaborators, in this case the offices of John Andrew & Partners (reportedly after Andrews himself had moved to Australia), Roger Du Toit, Webb Zerafa Menkes Housden and E. R. Baldwin.

Also considerable among Toronto's architecture of a few years ago is a cluster of buildings in the financial district, that most downtown of all the city's downtowns, where the subway lines make their closest approach to the lakefront, then turn back inland. Many of these buildings are connected to each other

A view from the CN tower, above, shows the city's distinct highrise clusters. Above right, Revell's New City Hall of 1965. Right, Andrews' linear superblock for Scarborough College, also built in 1965.

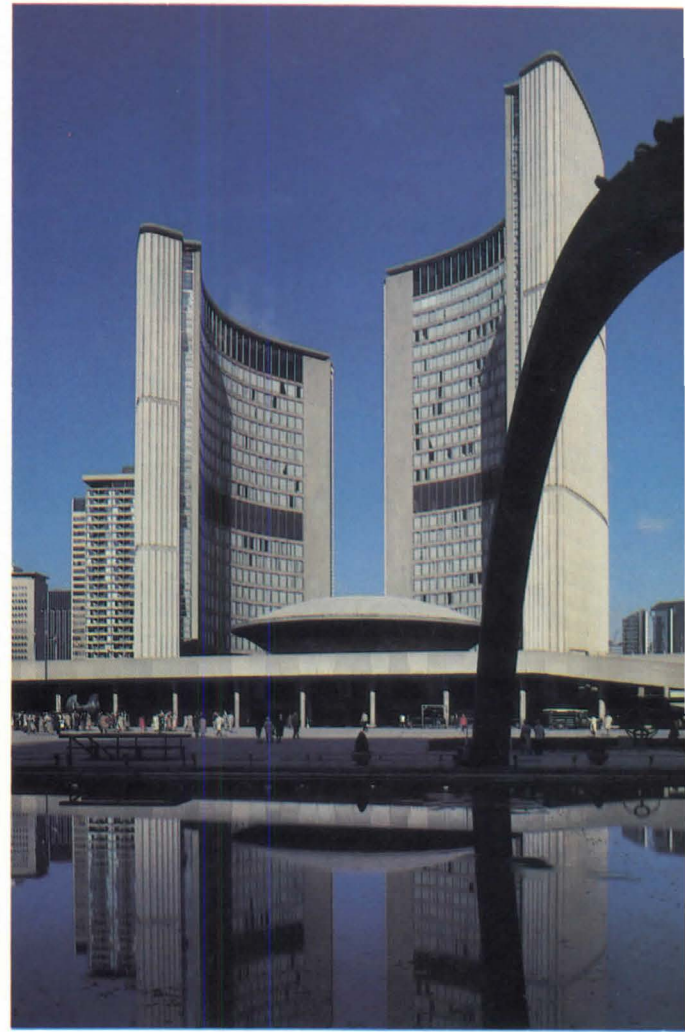



Photographs by Allen Freeman



Monuments to banks and mega-developers.

and to the subway by a maze of attractive, shop-lined, winter-proof underground passages. One above-grade highlight of the group is a 1973 complex for the Commerce Bank by I. M. Pei in collaboration with Page & Steele. It skillfully combines a 57-floor stainless steel sheathed tower, some lower concrete elements and the bank's 1931 headquarters building by Darling & Pearson. Another highlight is the Toronto-Dominion Bank complex, three black painted steel towers by John B. Parkin Associates and Bregman & Hamann with Mies van der Rohe as consultant. The one-story banking pavilion by Mies at the foot of the towers, sumptuously finished with bronze hardware, fine woods and rich marbles, is one of the master's best buildings anywhere.

These, as well as an unexciting Edward Durrell Stone (with Bregman & Hamann) tower for the Bank of Montreal and a rather overexcited Royal Bank Plaza by Webb Zerafa Menkes Housden, are all, you may have noticed, built for banks. Because banks in Canada are not geographically restricted as they are in the U.S., there are only five major banks in the entire country (compared to, say, several dozen in the state of Ohio), but those five are extraordinarily rich and powerful, just the sort of patrons architecture needs. Similarly rich and powerful are Toronto developers, including the billion-dollar Olympia & York Developments Ltd., privately held by the Reichmann family, and Cadillac-Fairview.

But business success and lavish patronage don't necessarily make livable cities. Success, indeed, can be quite destructive of environmental quality, and the happily heterogeneous Toronto of today would probably have been impossible without some

firm and enlightened government intervention. This came in 1972 with the election of David Crombie as mayor. His campaign coordinator (and now Toronto planning and development commissioner) was Stephen G. McLaughlin, a "lapsed architect," as he calls himself, and a determined advocate of planning reform. The new administration had five goals, according to McLaughlin: that people should live downtown; that office development should be decentralized; that existing neighborhoods and old buildings should be left; that new public spaces and parks should be created, and—a more subjective goal—that "buildings should be polite to the street."

Crombie's election on such a platform could have been the signal for a desperate new wave of beat-him-to-the-punch construction but for a rather draconian act by the new mayor in 1973, a two-year moratorium on all building projects taller than 45 feet or larger than 40,000 square feet. Eventually the provincial government of Ontario overturned the Toronto moratorium, but not before it had given Crombie's team a chance to assess its priorities and establish controls for future growth. The post-moratorium situation is that all developments in the city are now a product of negotiation between the private investors and the public sector. The city has no powers for dictating architectural details, McLaughlin points out, but it does make specific de-

Three views of the financial district. Facing page, above, its towers include those by Mies van der Rohe with Parkin Associates and Bregman & Hamann, left in photo, and by I. M. Pei with Page & Steele, right. Reflected in the Pei tower is one by Edward Durrell Stone with Bregman & Hamann. Facing page, below, the Miesian banking pavilion at the heart of the district.



A city shaped by good luck—and controls.

mands about such things as setbacks, massing, relationships of building height to street width and preservation of existing structures, these demands informed by such things as sun and shadow studies at various times of the year and, in the case of tall buildings, wind tunnel tests of downdraft effects at street level. Of even more importance is the city's policy of permitting maximum development only for mixed use projects including housing, with a floor area ratio bonus if 10 percent of the housing units is subsidized.

It is such control, obviously, as well as good luck and general good intentions, that has created today's Toronto. In the case of Cadillac-Fairview's Eaton Center, (designed by the Zeidler Partnership with Bregman & Hamann) comprising office towers, department stores and an immense four-level mall, the city was able to insist on some modifications that enliven the 860-foot-long side facing Yonge Street, the major north-south shopping street, thus mitigating the center's negative effect on the life of the street. Even so, the adjacent blocks of Yonge appear to suffer somewhat from the competition, but it is also true that Eaton Center has brought new life to the downtown area in general. One feature of the complex, for example, is something called Cineplex, an astonishing cluster of 21 movie theaters; if you can't find a movie you want to see in the Cineplex, you just don't like movies.

Special efforts of the reform government were directed at the field of housing construction, with the twin aims of stabilizing existing residential neighborhoods by preventing developers' "block-busting" and subsequent highrise construction and of adding new housing to predominantly commercial areas. This has been effected through the agency of two organizations, the City of Toronto Non-Profit Housing Corporation (called "Cityhome"), controlled by the city council, and the Canada Mortgage and Housing Corporation, part of the federal government. Cityhome's particular concern is for the provision of rental housing for low- and moderate-income households, and it now owns and manages more than 3,000 units, with almost as many more in the planning stage. Cityhome also encourages nonprofit cooperatives, their funding guaranteed by Canada Mortgage and Housing; more than 1,500 units have been created under this program. As ex-Mayor John Sewell explained the program in a speech last year (David Crombie having moved on to the federal parliament in 1978), "Under present legislation Cityhome and the cooperatives borrow money on the open market and receive interest write-downs and other subsidies from the federal and provincial governments; in return, rents are set at the 'low end' of the market—that is, they are quite attractive. These subsidy programs have been crucial to the growth of nonprofit and co-op housing."

The physical forms of these housing efforts are of two very different types: a few very large new developments and innumerable small infill developments in old neighborhoods. Of the large type, the St. Lawrence project is the most dramatic accomplishment, covering 44 acres immediately east of the financial downtown, parallel to the rail yards at the city's southern edge, and occupying the site of former low-density industrial uses, junk yards and storage depots, remnants of an era when rail transportation was dominant. Some adjacent structures, including a 19th century market building still in use, have been retained, and the existing street grid has been extended into the area, thus weaving it into the city fabric. The new housing, much of it already in use, is a mixture of three-floor walk-up row houses and eight-floor elevator buildings; there is also a school and a

Eaton Center, a giant shopping mall between office towers, vitalizes downtown but seems intimidating along Yonge Street, right.

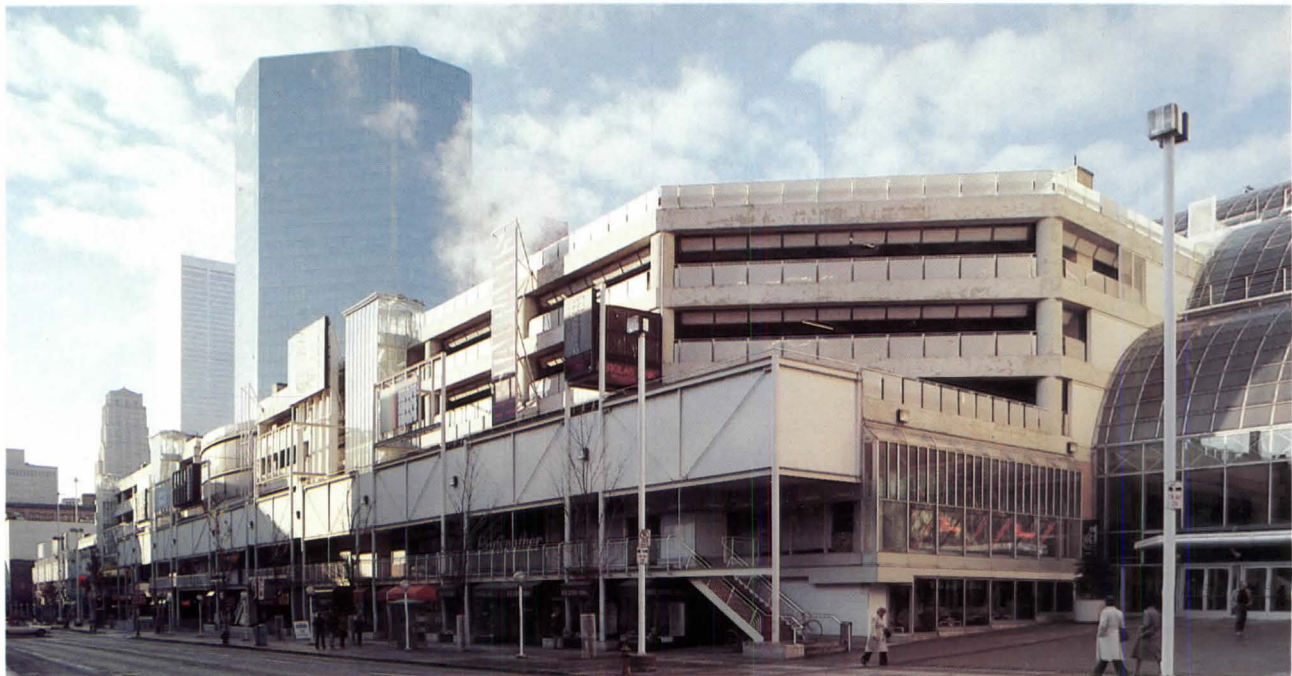

Photographs by Allen Freeman

Allen Freeman



Allen Freeman



Ian Samson

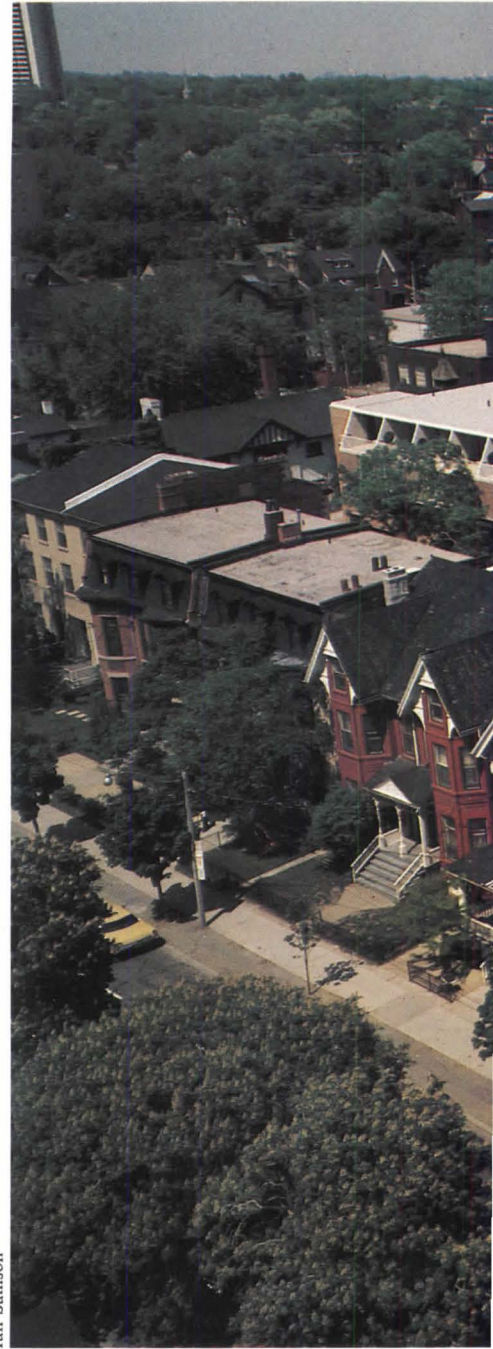

Housing sketched into existing neighborhoods.

complement of retail facilities at street level. When completed, there will be 3,500 new housing units in St. Lawrence. Many different developers and many different architects have been at work here, with a resultant variety of styles, and there is also an admirable variety of housing types—nonprofit rental units, private rental units, cooperatives and condominiums. Thirty percent of these will be built by private investors, 30 percent will be controlled by Cityhome and the remaining 40 percent will be controlled by nonprofit cooperative groups (including those representing the Canadian labor movement and the French, Russian and Czechoslovakian communities). Again, a remarkable mixture, but given some architectural coherence by means of the height restriction, the uniform brick color mandated by the city and a large, linear park running east-west for several blocks through the new development.

But it is the small infill housing developments, some as small as 10 units, that constitute Toronto's most impressive recent architectural accomplishments. Some fine talents have been sensitively at work on the problems of insinuating new construction into existing neighborhoods, including A. J. (Jack) Diamond

and Barton Myers, both in their former partnership, Diamond & Myers, and separately since then. The office of DuBois Plumb & Associates has demonstrated a similar concern with scale, and, in several works in the Yorkville area, including their own offices and the large Hazelton Lanes complex, the office of Webb Zerafa Menkes Housden has ably applied the infill principle to commercial and mixed-use structures.

Toronto's first completed infill scheme and Cityhome's first undertaking was the Dundas/Sherbourne project by Diamond & Myers (Barton Myers, partner in charge). Its real initiators, however, were the neighborhood residents who, in the spring of 1973, reacted strongly against a development plan that had been spawned in the pre-Crombie days. Eighteen 19th century houses were to be demolished and replaced by a 29-story tower; what was demolished instead was the construction fence that had been thrown up around the site. And what was finally built instead

Representative of new housing in the St. Lawrence district is this 1980 block by architect Jerome Markson, top left. At lower left, in the city's mixed-use Yorkville section, two churches that have been converted to boutiques. Above & right, Dundas/Sherbourne, one of the pioneering infill housing schemes by Diamond & Myers.



was a group of 300 new units; the old houses were converted to 74 apartments, and the total density was as great as would have been obtained with the tower construction, yet with a maximum height of six stories. Following this highly successful example have been several more recent infill projects such as the pioneering 150-unit Hydro Block by Diamond & Myers (Jack Diamond, partner in charge), conceived even before Dundas/Sherbourne, finally finished in 1977 and itself a product of considerable political controversy. (Its name derives from the fact that the infill housing supplants a large “block-buster” scheme planned for the site by the local utility company.)

But wait a minute. How is it possible to discuss Toronto at such length without considering what—from the air, at least—seems to be its most striking asset: its relationship to Lake Ontario? Quite simply, because it is possible to spend a very long time in Toronto without any awareness that the lake is there. True, there is a ferry terminal at the foot of Bay Street that provides access to the Toronto Islands, reportedly pleasant warm weather recreation spots, but for the most part the city has been cut off from its waterfront since the middle of the last century by a wide swath of railroad tracks. Rising from the midst of this no-man’s-land, as if to emphasize the area’s desola-



Ian Samson

A very unusual kind of urban showcase.

tion, is the CN tower, the only built relic of a 1968 development scheme called Metro Center. The scheme, since shelved, would have allowed extensive development of 200 acres of land owned by Canada's two major railways, the privately owned Canadian Pacific and the government-owned Canadian National. As Stephen McLaughlin characterized it, Metro Center was "your basic early '60s Harvard grad school inter-modal-nodal rhetoric."

But the end of Metro Center was not the end of plans for the area. On the edge of the water, beyond the tracks, is a handful of new structures, including office buildings and a hotel, and plans for development of the rest of the lakefront are progressing again, the '60s zeal replaced with '80s circumspection. A whole new 90-acre mixed-use development plan, called Harbourfront, championed by the present mayor, Art Eggleton, and under the direction of Howard Cohen, is beginning to come into focus, and it is heartening that one of its first planned increments is not a cluster of new towers but the multiuse rehabilitation of an enormous warehouse structure right on the water.

In addition to its concrete accomplishments and plans, Toronto harbors a perceptible architectural "scene," bolstered by the architecture schools of York University and the University of Toronto, by *Trace*, an attractive year-old quarterly edited by architect George Baird and focusing on old and new Canadian work and by Yorkville's Ballenford Books, one of North America's finest architectural bookshops and galleries.

There are striking new buildings in the city, of course. Still, like Mies, most Toronto architects seem more concerned with being good than with being interesting. As Jack Diamond sees them, Toronto architects in general are "serious, industrious and pragmatic." Macy DuBois of DuBois Plumb, who next May will become president of the Royal Architectural Institute of Canada, compares the state of the art in Toronto with that in the U.S.: "The modest means of many of our clients in Toronto," he says, "drives us to be more inventive with our general schemes and also more inventive in our use of inexpensive materials. We're often forced to dig deeper, and there are therefore frequently fresh results."

Toronto is not, in short, a major showcase for the most lavish, fashionable or shocking stylistic developments. It is a showcase instead for the way in which architectural elements can combine to make a livable urban whole. □





Above, looking east from the St. Lawrence area. At left in the photo is the St. Lawrence Market, an 1898 expansion of what had been built 50 years earlier as Toronto's first city hall. At the center of the photo above and at the left of the photo at left, the 1891 Flatiron building by architect David Roberts; the mural by Derek Bessant on its west wall repeats the fenestration of the adjacent buildings. The Flatiron's restoration was undertaken by developer David Walsh with the advice of Jack Diamond and other architects.

Montreal

A city with a unique past begins to protect it.
By Andrea O. Dean

If Toronto may stand as a portent for the future, Montreal speaks more volubly about the past, a past unique on the North American continent. The city's history was shaped by an uneasy coexistence of "two solitudes," as the French and English speaking Canadians have been called. For more than two centuries, the Anglophones, though a minority, were firmly in control of Montreal and the province of Quebec, and the two groups lived side by side, their relationship confined to an uncomfortable economic interdependency. Now that the Francophones are in power, history has, if anything, strengthened its grip on the present. On the license plate of every vehicle in Quebec are the words, *je me souviens* (I remember).

The Francophones refer to their province as *un etat*, more properly translated as nation than state, except as Louis XIV used the word when declaring *l'état c'est moi*. Moreover, they call themselves Quebeckers, not Canadians or French Canadians. They remain a uniquely homogenous group with a common language, culture and religion and a deep attachment to a medieval French heritage. "With our history," says architect Roger D'Astous, "Quebec can actually consider the rest of Canada as an invasion." Most of its residents are descendants of settlers who came from Brittany more than 300 years ago. From the time of their conquest by the English in 1759 until 1976 when René Levesque and his Parti Québécois were elected to office, the position of Francophones was somewhat similar to that of blacks or Chicanos in the U.S.

All that has changed now with language laws that enforce the use of French for public and official use and limit instruction in English in the schools. As D'Astous explains, "We take it for granted that if you live in Ontario or British Columbia the language of work is the language of the majority. The same principle should apply in Quebec, but until recently it didn't."

The Quebeckers are now masters in their own house and take only "modest and gentle revenge" on the English-speaking minority, as architect Victor Prus puts it. Some Anglophones have left for English-speaking Canada. Most of those who remain have come to terms with their changed situation, and both groups suffer feelings of inferiority: English-speaking Montrealers tend to feel second best to the U.S., on the one hand, to Toronto, on the other; and it is hard not to see an element of "we're okay, after all" in the Francophones' fervent nationalism and obsession with roots. Whatever the divisions between the two groups, though, the history of each is preserved in the bricks and mortar of Montreal, and both are bent on the city's preservation and modernization.

Montreal is one of the oldest, most charming and European-

New Montreal rises west of the French quarter.



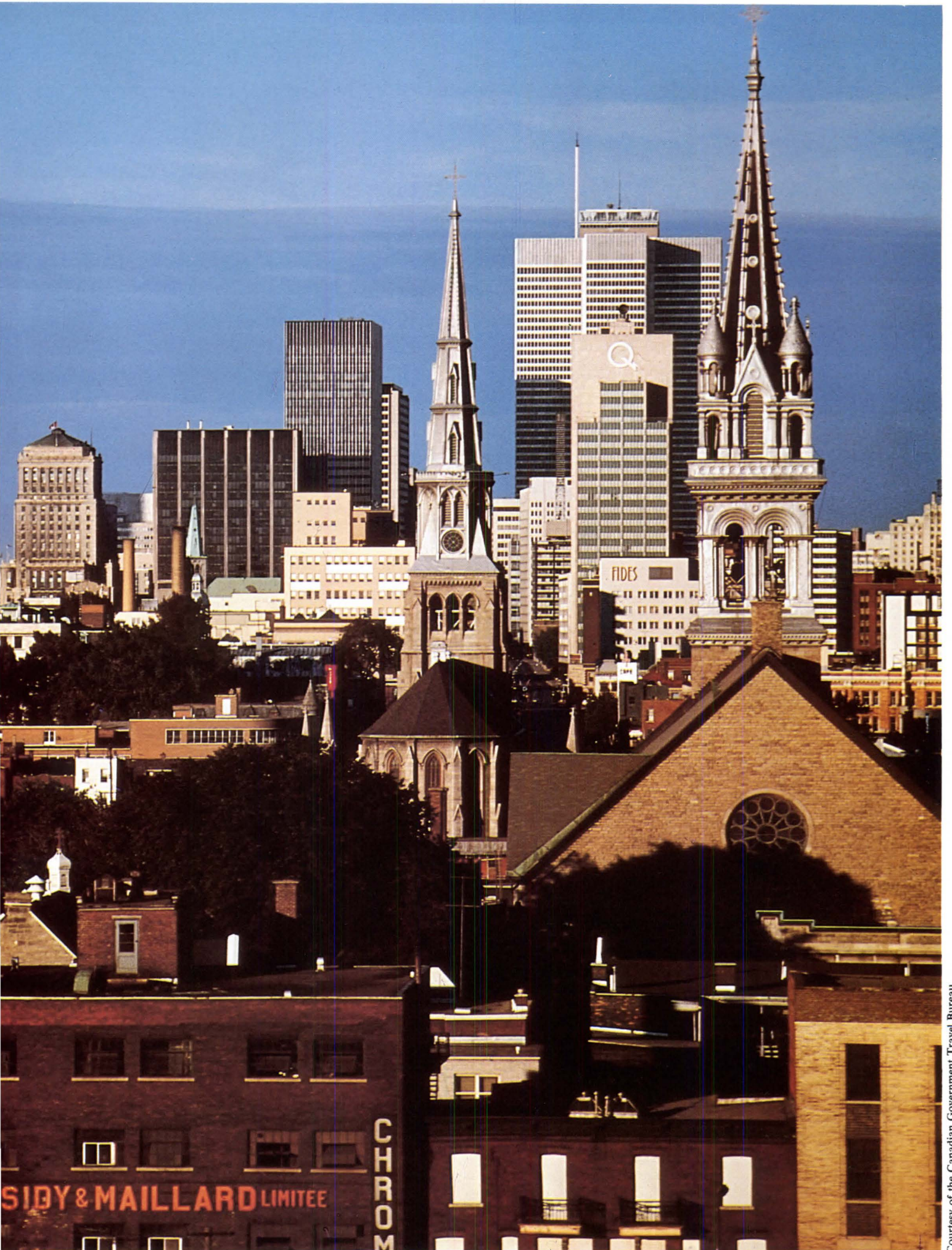

Courtesy of the Canadian Government Travel Bureau

The old city, French and English versions.

seeming of North American cities. At the same time, its giant mixed use developments that plug into a vast underground network make it “21st century and edgy,” as writer and architect Melvin Charney observes. The city is built in terraces on a grid, and in its earliest days was organized in *côtes* (territorial units integrated with the political and economic system of the medieval seigneurie and structured by the parish) and *rangs* (narrow rectangles of land perpendicular to the street). As Charney points out, the influence of the *rang* persists. The street still takes precedence over individual dwellings, whose narrow facades tend to meld into a continuous wall.

After defeat of the French, Montreal rapidly became Anglicized and much of what we call old Montreal is actually English or American-inspired. The few remaining French buildings—massive, square, fortress-like dwellings built with fieldstone and awash in mortar—are found on the southern rim of old Montreal near the river.

In the late 19th century, with the development of the steamship, railways and the telegraph, Montreal rapidly became the economic and industrial hub of Canada, and the need for cheap labor attracted waves of immigrants both from the Quebec countryside and abroad, mainly from Ireland. Among the new arrivals there were also Russian Jews, Italians, Greeks, Chinese and other groups, each of which still retains to some degree its own culture in its own neighborhood.

At first, housing followed employment, but once public transport was introduced the so-called new Montreal grew rapidly beyond the old city, spreading chaotically as far as it could to boundaries created by the river to the south, Mount Royal to the north and the affluent Anglophone township of Westmount to the west. Parks were carved out—there had been no need for them before the industrial revolution—and the summit of Mount Royal was made into an urban green space by Frederick Law Olmsted in 1874-76. Cemeteries were expropriated for squares, as in the case of what is now Place Victoria. The privileged English settled in Mount Royal, Westmount and Outremont in spacious, mostly freestanding houses built in Montreal’s characteristic gray stone during the 19th century and later in brick. Their design was influenced by American Victorian architecture and tended to be less restrained than England’s.

St. Lawrence Main Street separated the English from the French who lived in worker neighborhoods, or *quartiers populaires* in the eastern portions of the city, which still house mostly working class Montrealers. The houses were revolutionary for their use of a shell made of crude plank construction with layering of materials that included air for insulation. Living units are still built one on top of the other and rooms on double-loaded, narrow corridors run from front to back, creating fairly dark and musty living quarters since light reaches only the end spaces. Most characteristic are the outside stairs resembling curling fire escapes that wind up to second and third story entries to give each unit “a number on the street.” The stairs are charming, certainly unique and have the practical advantage of freeing up interior space. But they also tend to block light and make interiors still darker and stuffier than they otherwise would be. Almost every house has a porch and atop it a balcony. Since these houses were “designed to accommodate people who had recently arrived from the country, where porches and verandas were quite common, these features were possibly considered as something necessary,” wrote Jean-Claude Marsan in *Montreal in Evolution*.

Until recently, the French Canadians were controlled not only by poverty but also by the Roman Catholic church. In

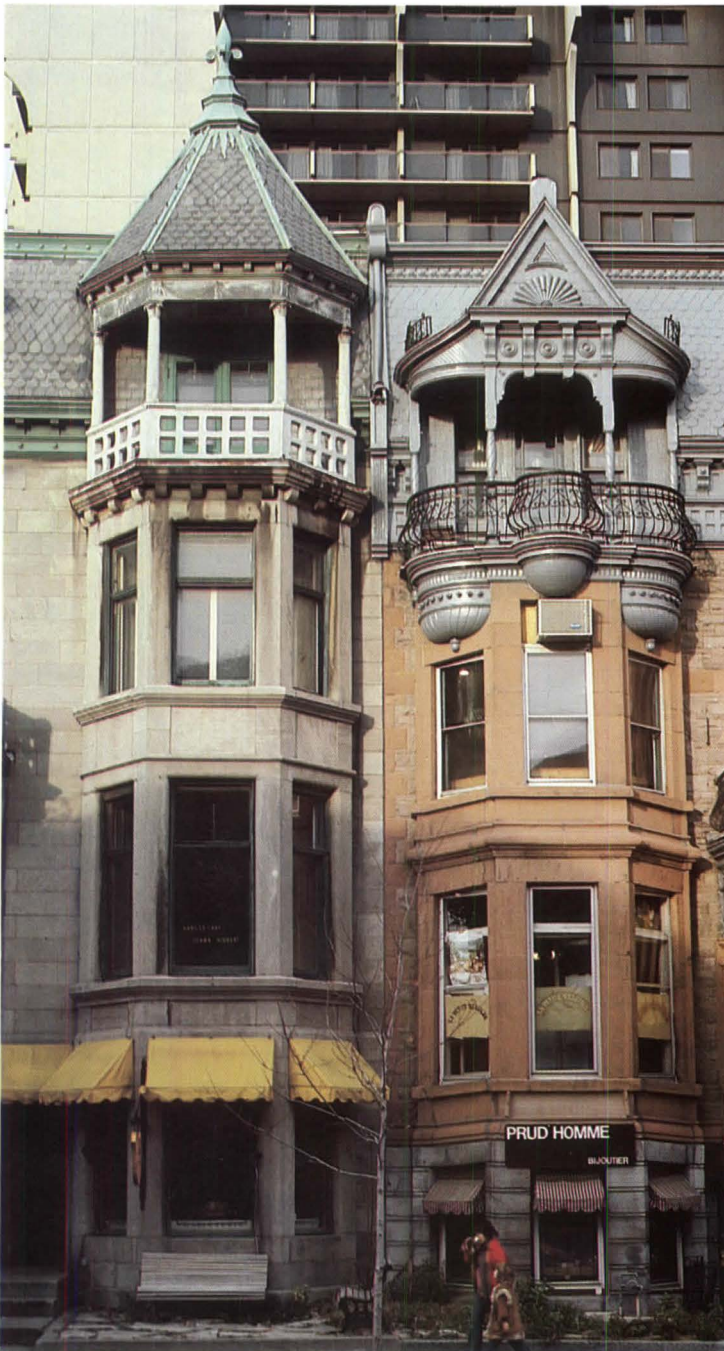

Photographs by Allen Freeman





19th century Montreal, the number of parish churches increased in direct proportion to population density, and Mark Twain said of Quebec's capital that it was the only city he knew where you could not throw a pebble without breaking a church window. Quebec's Quiet Revolution of the 1960s was an effort on the part of Francophones both to loosen the shackles by which the church held them captive and gain economic power. Though the church was shorn of its power by the end of the decade and its schools and other institutions transferred to government control, remnants of the clerical influence over Quebecers remain, especially in a continuing tendency to choose autocratic leaders. "There's this penchant for electing the wonderful man who will fix everything for everyone," says architect Michael Fish, pointing to Mayor Jean Drapeau, in office since 1960, and to Premier René Levesque.

The Quiet Revolution coincided with a period of economic boom and a spurt in building activity that resulted in a series of huge mixed use developments, which differed from those being constructed in other cities by being tied into an extensive and sophisticated underground system for transportation and shopping. Said Peter Blake in 1966, "Few people in Montreal seem

In French-speaking Montreal, modest but lively-looking attached structures are the norm in both commercial and residential areas, across page, above. Below them are typically freestanding and spacious houses in Anglophone Westmount. Above, St. Sulpice (1683) with Notre Dame church (1823-29) in the background.

to realize that they are building the most advanced urban core of our time."

It all began in the mid-'50s with a decision by Donald Gordon, then president of Canadian National Railroads, to develop the railroad's 22 acres of downtown land. He brought in developer William Zeckendorf, who brought in architects I.M. Pei, Harry Cobb and Vincent Ponte to prepare an overall master plan and to design the seven-acre Place Ville Marie, which was to be the fulcrum for the new downtown. At the same time, Mayor Drapeau made the decision to go ahead with a long-discussed subway system.

Place Ville Marie was an enormous risk. At a time when Montreal's annual office space construction came to a mere 300,000 square feet, PVM had a total of 3,071,097. The gamble paid off when the president of the Royal Bank of Canada decided to move his headquarters into PVM. The complex consists of a 48-story, cruciform tower placed off-center on a four-acre plaza with four underground levels totaling 1.2 million square feet of retail and commercial space. Beneath them are two levels of parking and Canadian National's tracks and platforms.

The impact of PVM, completed in 1963, was enormous. With one stroke it moved Montreal's business center westward and prompted a surge of nearby construction. Not long after ground was broken for Pei's tower, two other new projects were announced, the 34-story CIL House and the 43-story Canadian Imperial Bank of Commerce building. Together the three projects created three million additional square feet of office space.



A downtown boom, above and below ground.

Next came Westmount Square by Mies van der Rohe; the 47-story concrete and glass Place Victoria by Moretti and Nervi; the 15-story rough concrete Place Bonaventure by Montreal architect Ray Affleck of ARCOP; the 38-story Hotel Chateau Champlain by Roger D'Astous, and the Place Alexis Nihon by Harold Ship. Vincent Ponte called the new Montreal an "urban miracle" and said it was made possible by "the presence of large reservoirs of downtown real estate, held in single ownership, often by railroads or other corporate entities. These broke the shackles of lot-by-lot piecemeal development."

As Melvin Charney points out, these superblocks represented a clear progression from the suburban shopping mall-like model of PVM to more urban solutions. Like PVM, Westmount Square had an underground podium. At Place Bonaventure, a bulky concrete behemoth, the podium seems to have been moved out of the underground, but passageways remain confusing and turned in on themselves. Place Alexis Nihon combines two towers, a raised podium for parking and low blocks of shops opening to the street. Its detailing is "abominable," as Mark London of Heritage Montreal says, but the complex provides Montreal's biggest interior promenade with its six levels from metro stop to skylit center. The most recent superblock, Complexe Desjardins, is also the city's most urban with its four towers grouped around a galleria that is like a covered street. Begun in 1960, the Complexe was the first giant-scale project undertaken by French Canadians and designed by Francophone architects. By coincidence, it was completed the same year the Levesque government, committed to Quebec's autonomy, was elected. Located several blocks east of PVM, the Complexe Desjardins was also

an attempt to shift the focus of Montreal eastward toward the old city and away from the seat of Anglophone power.

Montreal's mixed use developments are less objectionable than comparable recent efforts in American cities; none is brilliant but all are competent, with exception of Place Alexis Nihon. But it was beneath ground that the most exciting design work was being done.

Montreal's first metro station was opened in 1967. Today, the system extends 30 miles and has 50 stations, and if all goes as expected it will have 68 stations when completed in 1986. Each station is different, with the most talented private practitioners and government architects leaving their signatures. The metro, in Mark London's words, "was the first in North America to be more than a fancy sewer." It was also unique for being a single tunnel system with a platform on each side and for using rubber tires that allow faster stops and starts and quieter locomotion.

The climax of Montreal's burst of energy and confidence in the '60s came with Expo '67. Architect Peter Rose, who was still a student at the time, remembers that "Expo made Montreal seem like the center of the earth. We felt that we had all these resources and hadn't made any of the major errors of other cities. That's why I came back here to practice, full of hope." Since then, Rose has become Quebec's most publicized and criticized postmodernist.

One among Montreal's 50 different metro stations, above left. The 1976 Complexe Desjardins, above right and across page, designed by a Francophone firm for a French Canadian cooperative, is the most advanced step in the evolution of urban complexes that began with Place Ville Marie.





Photographs by Allen Freeman

The 1976 Olympic stadium as it looked this fall, above. Olympic Village, across page, is now rental housing.



A world's fair and an unhelpful Olympics.

The master plan for Expo '67 tied four sites together through a hierarchy of transportation networks, the most important of which was Expo-Express, a train with a capacity of 30,000 passengers per hour. The architecture of the individual components of the exposition grounds was not revolutionary but illustrated then-current trends, the best example of which was the building as envelope as demonstrated in structures erected by the U.S., Germany, Ontario and Quebec. The American contribution was a huge geodesic dome by Buckminster Fuller; acknowledged as the best individual achievement was the tentlike German pavilion by Frei Otto and Rolf Gutbrod.

And then there was Habitat, which brought Moshe Safdie to international attention. Habitat was very much a child of its time, a time that still believed technology could solve urban problems, that was concerned with improving housing and was beginning to free itself of the strictures of the International Style. The cellular, irregular, expandable units of Habitat were regarded by some, at least, as a prototype "building block" for whole neighborhoods. Habitat itself was never expanded but still stands today at the river's edge as a high-priced condominium.

The expansiveness of the time was evident in a municipal plan, drafted in 1967, called "Horizon 2000," which was based on the premise that Montreal's population would reach seven million by the year 2000. But, as Jean Claude Marsan wrote of Expo in 1974, "Far from heralding an exceptional future, it masked the rapidly evolving reality of approaching decline." As ingredients of involution he listed economic recession, unemployment, social problems, the 1970 "October crisis" of separa-

tist terrorism, the collapse of liberal reformism, the national identity crisis, the return of uncertainty and conservatism.

And, he wrote, "The 1976 Olympic Games, by increasing public indebtedness in a catastrophic manner, did nothing to improve the picture." The Olympic stadium, designed by French architect Roger Taillibert, alone cost \$1.6 billion (Canadian), of which the federal and provincial governments have assumed all but \$225 million in debt. By comparison, the metro when finished in 1986 is expected to cost \$1.9 billion, for which the city will receive 60 miles of subway. The stadium was left uncompleted when the money ran out, and is now a weird apparition with steel reinforcing rods protruding from its partial tower, which was to support a retractable roof. Two huge cranes stand by as though simply abandoned. The giant curving concrete form of the stadium has the look of a muscular, prehistoric monster caught in midstride.

The Olympic Village, designed by Quebecer Roger D'Astous, was built to house visiting athletes and has been converted to rental apartments. It was roundly criticized for removing an important piece of parkland from a city already short of green space, for being a copy of a condominium at the Baie des Anges on the French Riviera and for embodying the worst aspects of the modern movement. The complex has almost 1,000 apartments in two giant pyramidal structures that look as though dropped by accident onto the park they occupy. As John Bland, the retired chairman of McGill University's architecture school, says, "The human aspect is missing."

Fortunately, the two Olympic complexes are complete anomalies, given Montreal's current emphasis on context and preservation. The will to preserve what remains of an old city is stronger

Conservation after years of devastation.

in Montreal than in almost any other North American city. In part, this is a reaction to rampant demolition. Montreal's almost nonexistent restrictions on developers made the city a haven for builders at a time when other Canadian cities, especially Toronto, were tightening controls. Since 1967, developers have bought up lots all over the city, torn down tens of thousands of units to save taxes and administrative costs and used the land as revenue-producing parking lots until the time becomes ripe for building. The practice has almost been stopped, but not before removing almost one-third of the old city.

This gave rise to several strong preservation movements and fueled a rush to restoration among French as well as English-speaking Montrealers. Both groups have embraced the cause of preservation as a corollary to preserving a collective cultural identity. Organizations such as Save Montreal and Heritage Montreal (headed by architect Phyllis Lambert, who is also creating a new Center for Contemporary Architecture) aggressively lobby against destruction of buildings, and almost all new structures have an element of conservancy.

Conservation and contextualism are the principal emphases of the two largest projects now underway in Montreal. One is a new headquarters for Aluminum Limited of Canada by ARCOP, which will preserve three town houses and a turn-of-the-century hotel on Sherbrooke Street, and convert their interiors to office space. A four-story, glass-covered galleria with shopping concourse will link the old structures and an adjacent, new seven-story office building.

A convention center being built by the provincial government attempts to heal, or cover over, the wounds of ill-considered demolition and road building, while continuing and strengthening an urban axis begun by the Place des Arts and the Complexe Desjardins in the traditionally Francophone eastern portion of the city. Architect Victor Prus was chosen for the project in a two-stage competition, which has become since 1976 the procedure for A/E selection in major public projects. The convention center will be suspended over a major expressway and kept low to avoid obstructing views of the old city. It will have four different faces, the better to respond to its surroundings.

The most prominent built symbol of the new attitude is the recently completed University of Quebec at Montreal, by Dimitri Dimakopoulos & Partners. Covering three large blocks, the complex incorporates two facades of an old church and respects its finely scaled neighborhood by adhering to a modest height limit and varying in plan from block to block. Like most recent Montreal projects, its buildings are linked through underground concourses that plug into the subway system.

During the last decades, development in Montreal has been cyclical and spurred on more by politics than economics. There was a boom before Expo '68, then a bust, another boom before the Olympics, then again nothing. Currently commercial construction is booming following a moratorium between Levesque's election in '76 and the referendum in '80, which defeated separation of Quebec from the rest of Canada.

The picture of Montreal as lovely lady in decline can be exaggerated, of course. The city remains a conduit for vast quantities of European money being moved to North America, and it is a wonderfully situated city with great charm and old world flavor. It has been spared the depredations of typical frostbelt American cities: Montreal's core is intact and it is safe to walk in at all hours. "It has pretensions," says Victor Prus, "of being a premier international city, but the fact is it doesn't measure up. It should take pride in being a big Montreal instead of pretending to be a small Paris. The intense preoccupation with Quebecker nationalism is a step backward in terms of the development of Western civilization. But, my life has taught me that it is just a matter of time before this is reversed again, and that these cycles are best left to their own development." □



Allen Freeman



Embedded in the new University of Quebec, the facade of an old church, top. Alcan's new headquarters, above, will preserve facades of two 19th century town houses and a hotel. The steel structure of Buckminster Fuller's geodesic dome for Expo '67, across page, remains though its skin went up in flames.



Vancouver

The explosive young giant of the Canadian West.
By Donald Canty

Even a native San Franciscan must gasp at the beauty of this city's surroundings. Projecting out into the Strait of Georgia, it has as a backdrop seemingly endless ranges of exceedingly tall and rugged mountains, some capped with snow even in midsummer.

And even a native San Franciscan is impressed by the youth of this city. It started with a saloon established in 1867 on Burrard Inlet (the body of water in the background of the photo), was made a town named Granville in 1870, became the city of Vancouver in 1886—and was all but destroyed by the fire the same year. The city was quickly rebuilt and its future was assured when the Canadian Pacific Railway made it the western terminus of its line, receiving a grant of 6,000 acres of land in gratitude. The railroad also effectively fixed the location of the downtown core by placing its first station at the foot of Howe Street on the inlet (just past the tallest clump of towers in the photo), following up with a major hotel and opera house which, with construction of a major bank and a post office, engendered a brisk business in sale of its land in the area for commercial purposes.

Shortly after its arrival the railway also began residential development of what came to be called the West End (the clump of towers in the left side of the photo). Soon it became the place where the first families of the growing young city built their mansions. After the turn of the century, apartment buildings began to appear beside the mansions. In 1956, the city lifted the height limit that had prevailed in the area, and the West End exploded into what some claim to be the most densely populated precinct of any city in Canada.

At the same time, the commercial core was moving westward, and from the 1950s to the present it too has exploded in an eruption of ever-taller new office and hotel towers. Many are competent, few are distinguished and the power of these buildings is in their sheer mass rather than design.

They are clustered on a peninsula bounded by the inlet, English Bay (foreground of photo) and False Creek (the narrow band of water extending from English Bay in the right center of the photo). *The whole aspect is Manhattanlike.* So is the depend-

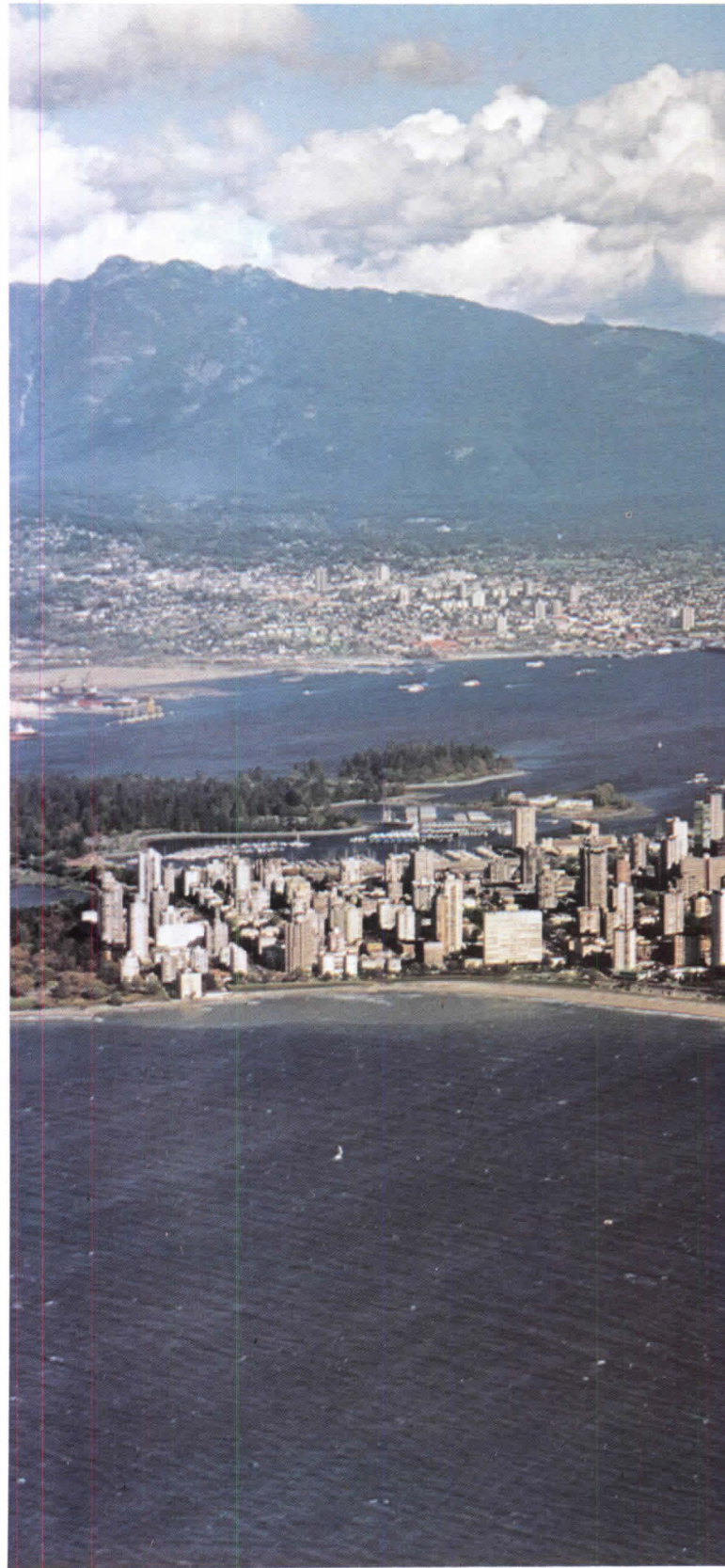

ence of the city upon a few bridges and the single link of land to the east to move a vast and increasing number of vehicles to and from the peninsula each day. They do not move easily.

The concentration of the core is particularly dramatic because of what lies to the south—a seemingly endless carpet of lowrise sprawl on largely flat land. Surprisingly, this Vancouver—which is to say, most of Vancouver—is a city of bungalows with neatly tended gardens, a good deal more like Los Angeles than San Francisco.

Vancouver is again like San Francisco, however, in the diversity of its population. Most notably, the two cities have the larg-



Allen Aerial Photos Ltd.

est concentrations of population of Asian birth or descent in North America, and Vancouver's Chinatown is a large and considerable presence in its core.

Without stretching the comparison, there are other things the two cities share: pleasant climates; booming economies; histories of laissez faire attitudes toward development, and current aversion to the tall and dense products of that history. And, perhaps most pervasively, a quite different social atmosphere from their eastern counterparts: more relaxed, less bound by tradition.

The following pages deal with some current planning and architectural events in Vancouver. Before proceeding to them,

note should be taken of two past accomplishments evidenced in the photo.

One of the city's prime public assets is the beach that sweeps along the south side of English Bay (its right edge in the photo). Once this waterfront was lined with small houses, but early on the city adopted a policy of buying them one by one as they came on the market and replacing them with sand.

And just above the left tip of the peninsula in the photo is the magnificently forested thousand acres of Stanley Park, a reminder of what this whole scene looked like not much more than a century ago.

Urban amenities along a downtown waterway.

False Creek is aptly named, since it is not a creek at all but an inlet that makes downtown and the West End a peninsula, then terminates abruptly to the east just past the forest of towers. Its more than geographical significance was sealed in 1887 when the Canadian Pacific Railway lined the north shore with its yards, stimulating industrial development for a time. Surprisingly soon, however, the area declined and became an industrial slum along a slough, embarrassingly close to the new downtown. Since the late 1960s its revival has been the active concern of the railroad and the city and provincial governments.

First came the railroad, with a 1968 Arthur Erickson scheme for a new-town-in-town of 30,000 on the north shore of the creek above the tracks. Erickson's design called for two huge curving buildings rising as high as 40 stories. The project was lost when citizens and the city government objected to its density, and to the wall that it would create between downtown and the rest of the city to the south, cutting off the cherished water and mountain views. (Erickson and his then-partner Geoffrey Massey responded by buying six acres of the land, designing for it what they called the see-through highrise, a kind of mega-structure punctured with holes. It too was rejected.)

Next came the city with a plan to turn the south shore, which it had acquired from the province, into a model urban housing community mixed in every possible way: by building type and style; by age, family composition and income of residents; by forms of ownership, with condominiums predominating. Thompson, Berwick, Pratt & Partners are coordinating architects, chosen in a limited competition.

So far, some 1,300 units have been built (bottom photo), along with a school, marinas, shops and restaurants, and a third phase of construction is underway. The plan pays sensitive attention to the needs of pedestrians and the relationships of buildings to open space, and of both to the water. The buildings, designed by a variety of architects, are equally varied in quality, but within a range of interesting to pleasant.

The new housing has helped stimulate a great deal of activity on Mount Pleasant, on a ridge just behind it, some rehabilitation and some infill housing. It is a flavorful area with wonderful views and it has gotten very expensive.

It and the False Creek community are separated from each other by railroad tracks and a very busy avenue. The False Creek community, for all of its amenity, suffers keenly from isolation. Some residents complain that it has become ingrown, and the breadth of the resident mix has diminished with an explosive rise in resale prices. It seems more colony than integral part of the city.

A friendly neighbor to the west is Granville Island (foreground, top photo), not really an island but a 38-acre projection of land into False Creek beneath Granville bridge. Here many of the industrial buildings, and even a few surviving industries, were retained. The major uses of the island now are shops, restaurants, small scale arts and crafts activities, and a thriving public market that draws people from the entire metropolitan area.

The planners and designers, Norman Hotson Architects, kept a light touch. Little was done to the existing buildings except for some sophisticated color work, and new ones were consciously designed in an early industrial mode. The whole was drawn together by such simple devices as paving and a continuous, colorful steel runner on timber posts.

The end result is one of Vancouver's principal man-made amenities, at once gritty and urbane, and a resounding success. The only prospective shadow over its future, quite literally, is a new plan for False Creek by the British Columbia provincial government.

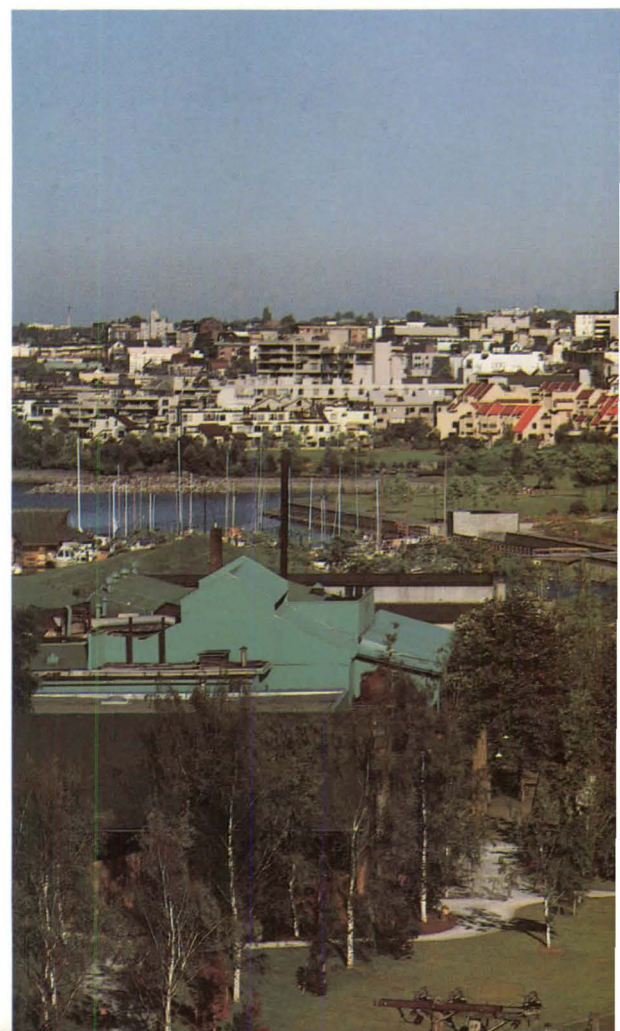
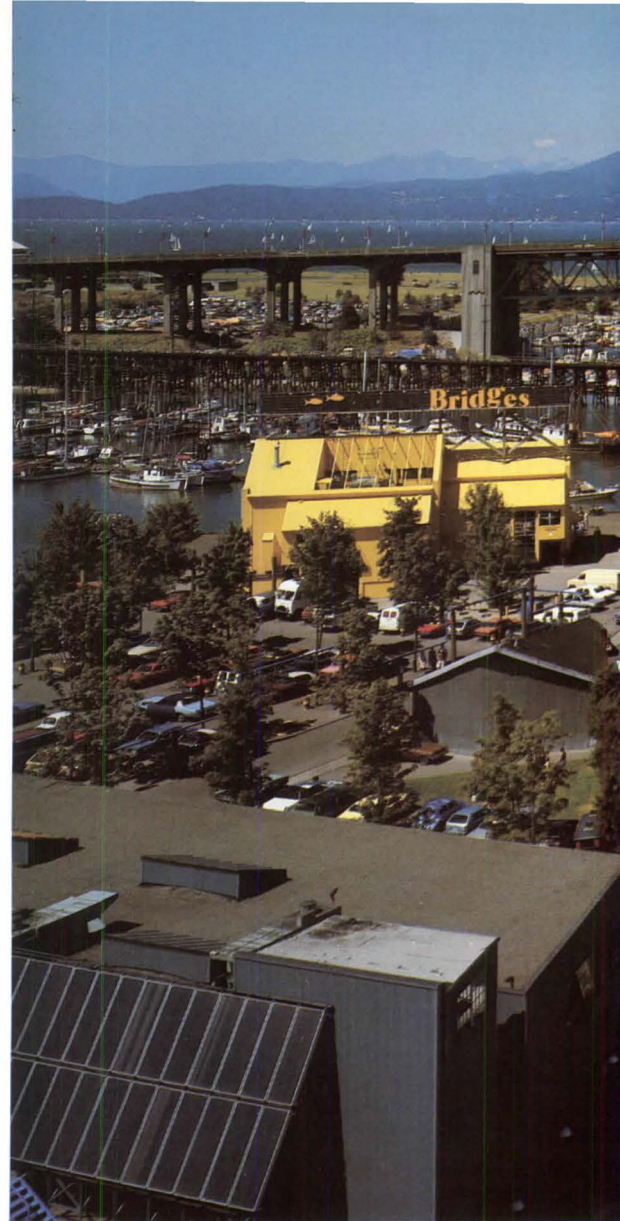



In the aerial photo at right, False Creek is the horizontal band of water in the foreground. B.C. Place would march across its far shore between the bridges to the left and right. Below, the view from Mount Pleasant north with the False Creek South housing in the foreground and the B.C. Place site across the water. Bottom, the opposite view, up thriving Mount Pleasant, unfortunately cut off from False Creek and its housing except for a pedestrian bridge.

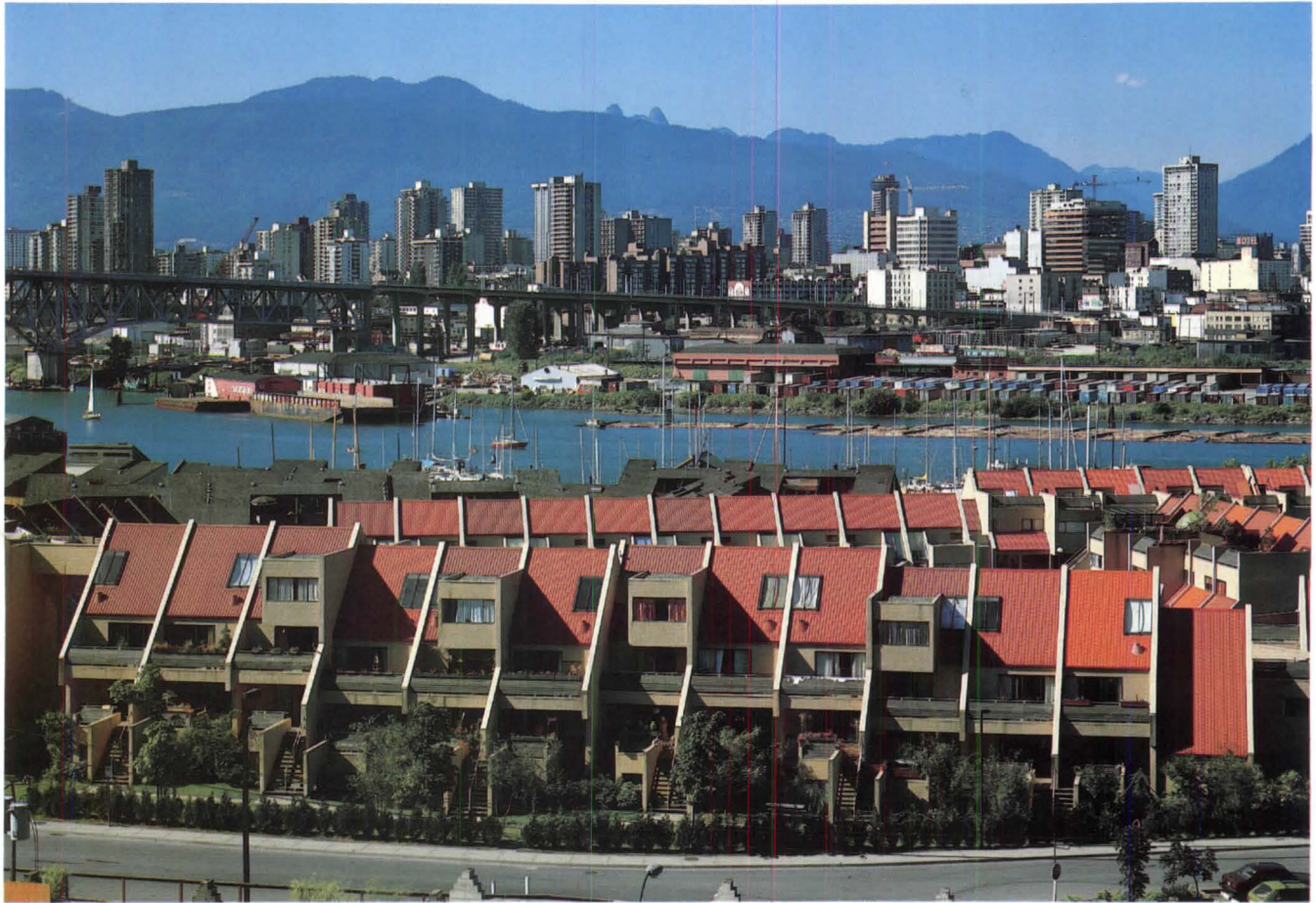

Cervin Robinson



Cervin Robinson



Making big plans—and facing consequences.

As boomtown, Vancouver has no shortage of big plans. Most involve the provincial government and the railroads (or their lands) as well as the city. Currently they include an automated rail rapid transit system, a convention center on the provincial pier extending into Burrard Inlet; a 60,000-seat covered sports stadium, well into construction; Transpo '86, a world's fair with a transportation theme, and, biggest of all, British Columbia Place on the north side of False Creek.

Incorporating the stadium and the Transpo site, B.C. Place would eventually develop 175 acres along the creek at a scale reminiscent of the Canadian Pacific plan of 1968. In fact, B.C. Place is being planned by a crown corporation (a favorite quasi-public development device throughout Canada) whose board of directors includes some of the same people who were involved in the 1968 plan.

The preliminary B.C. Place site plan calls for construction of housing for 20,000 people and some six million square feet of commercial and retail space, plus assorted amenities and perhaps a hospital. In a series of hearings this fall the plan ran into formidable trepidation and/or opposition on the part of both citizens and city officials.

Sources of concern are the impact of the development-cum-

stadium on the already-strained transportation system and, once again, the fear of a new highrise wall in this view-conscious city. Some with regional perspective also wonder if the province is wise in stimulating further intensification of the development of Vancouver's core rather than encouraging it elsewhere. Some form of decentralization already is part of the province's official planning posture.

The provincial government is into B.C. Place in part because of its potential for producing revenues that could be used for core development elsewhere. There have been recent suggestions, however, that it may no longer be in a financial position to engage in such energetic entrepreneurship, partly because of the problems of the forest products industry.

Little of the public controversy over B.C. Place so far has focused on the mixed blessings of density and height. Instead it has turned on the new road system that the B.C. Place corporation has said it needs, first for the stadium and eventually for the full development. City and provincial officials at this writing were in negotiation over this and other issues involved in developing the increasingly valuable land on the north side of seemingly placid False Creek.

At least one observer has suggested that the greatest value of the land may be as open space and recreation, not as a generator of development dollars for entrepreneurs, private or public.

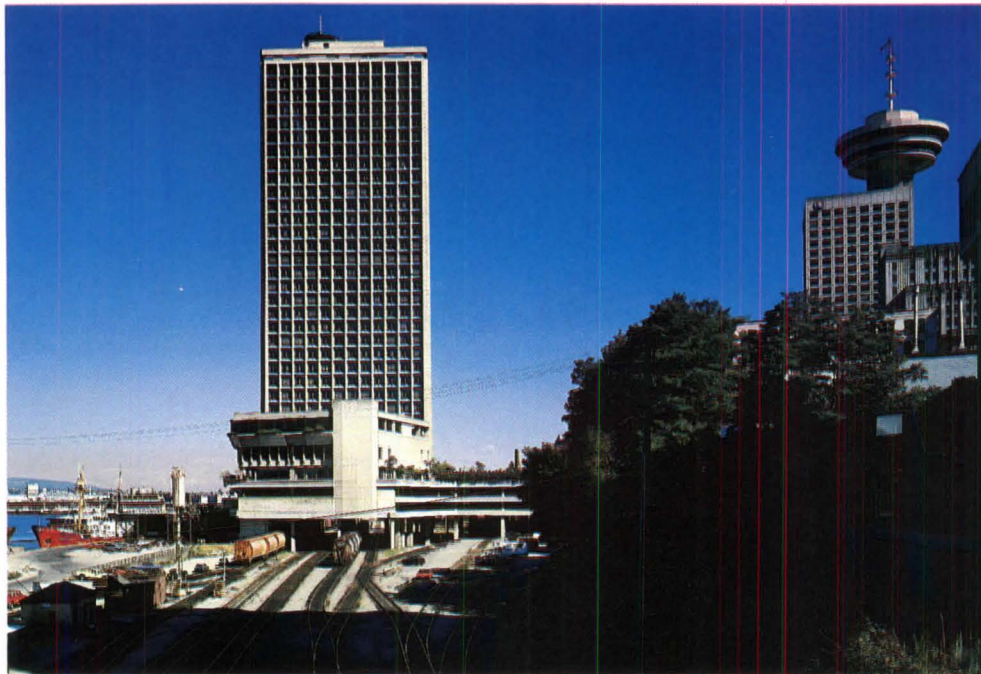
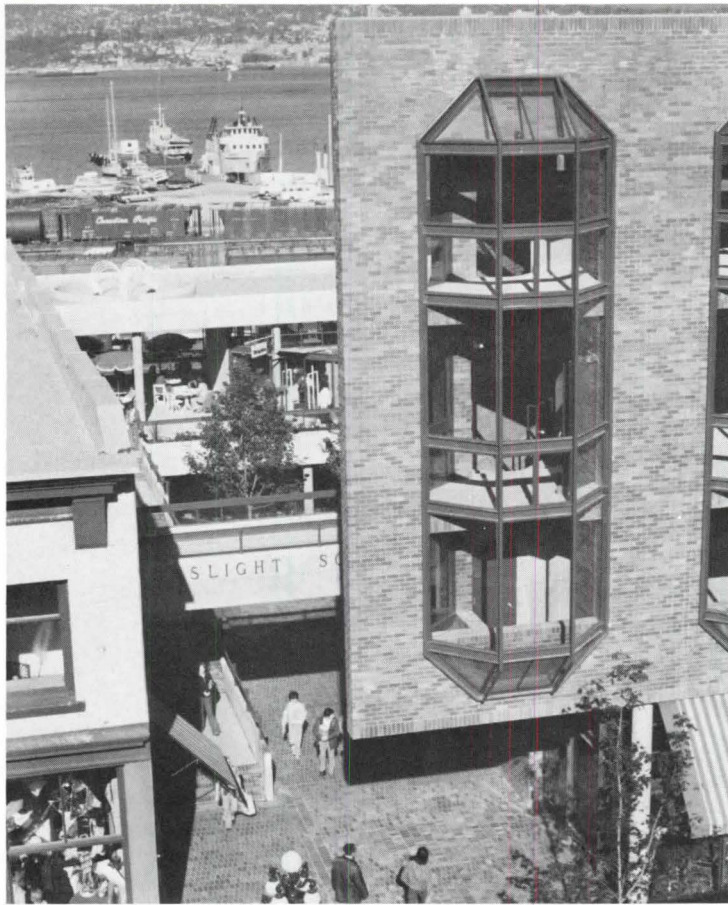

Cervin Robinson

Gaslight Square, top, by Henriquez and Todd is the centerpiece of Gastown, the renewed waterfront neighborhood where Vancouver was born. At one point Canadian Pacific Railway wanted to redevelop the entire area and build highrises reached by platforms across its tracks. Only one was built, Granville Square by Francis Donaldson (above).

A remarkable new spine and focal point.

The province's most recent contribution to Vancouver was a large and remarkably benign one, but it didn't start out to be that way. The provincial government decided in the '70s to consolidate some of its many offices scattered around the city and combine them with a new courthouse. It engaged Arthur Erickson as architect and asked him to design an office tower with the courthouse as its base in the middle of a park. It is said, perhaps apocryphally, that the then premier of the province wanted the two to have a floor for every year of his life. He was then 55.

Midway through design, the premier and his conservative regime were replaced by liberals and, as one observer put it,



Ezra Stoller © ESTO

“the province’s monument to itself became people’s park.” None of the participants can precisely delineate who contributed what to the metamorphosis, but the tower turned into a long low structure that is as much open space as it is building. While it owes something to Kevin Roche’s Oakland, Calif., museum with its plantings and terraced roofs, there is nothing quite like it in North America.

Incorporating the classical old courthouse that was originally scheduled for demolition and is about to become the municipal art gallery, the project, called Robson Square, occupies three full city blocks. The old courthouse, given a new forecourt, is joined beneath the intervening street to the middle block, the juncture passing a skating rink and ending in a sunken plaza

with cafes and other amenities. The middle block contains the provincial offices, but not so you would notice at a casual glance, so covered over are they by pools, waterfalls, plazas, plantings and cascading stairs. This element then bridges the second cross street to the new courthouse, covered over by a huge angular canopy that is a filigree of glass and metal arching seven stories above ground. The muscular end wall of the courthouse is shown above, beneath the canopy.

This unique three-block spine has given downtown Vancouver its largest open space and first real civic focal point. (Shortly after its completion, when the local soccer team unexpectedly won the North American championship, this was the place where cheering thousands greeted their returning heroes.)

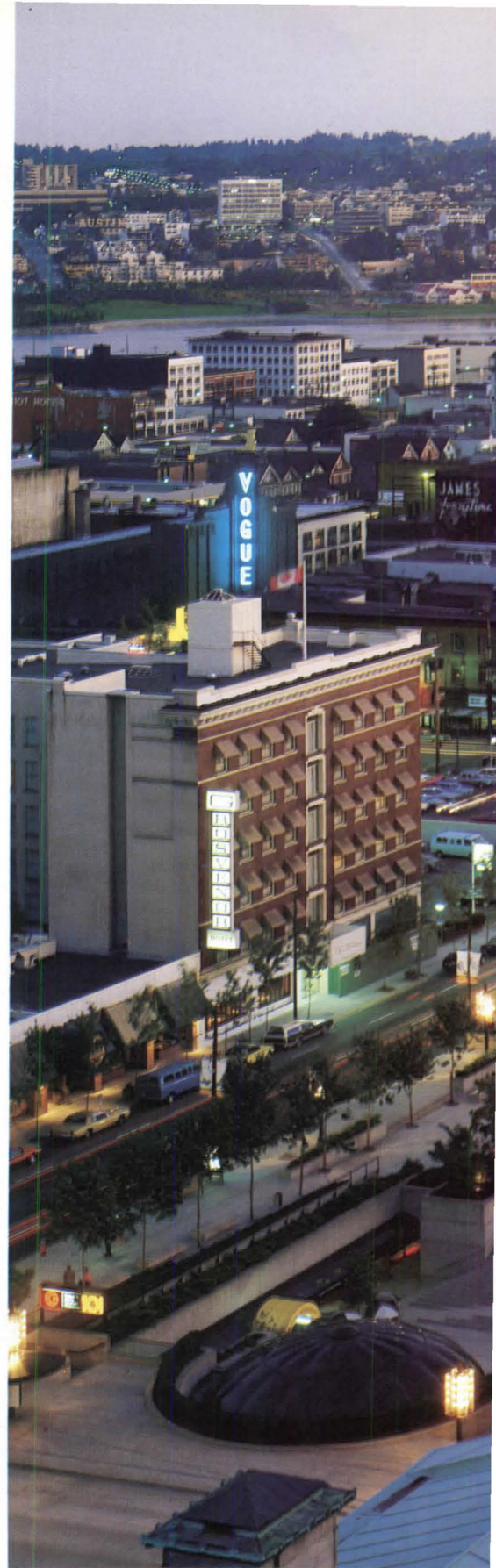

At right, the full sweep with the old courthouse at left foreground, then the terraced-over office block, and finally, under its cocked canopy, the new courthouse. Above, the opposite view from the new courthouse. Below, under the canopy.

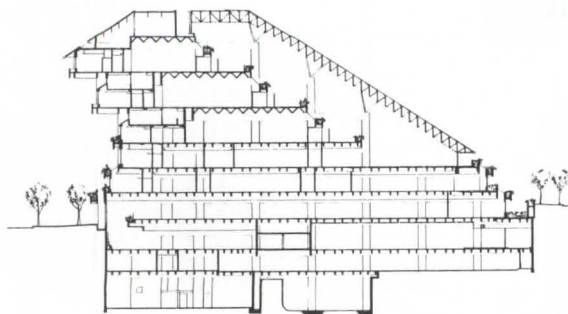
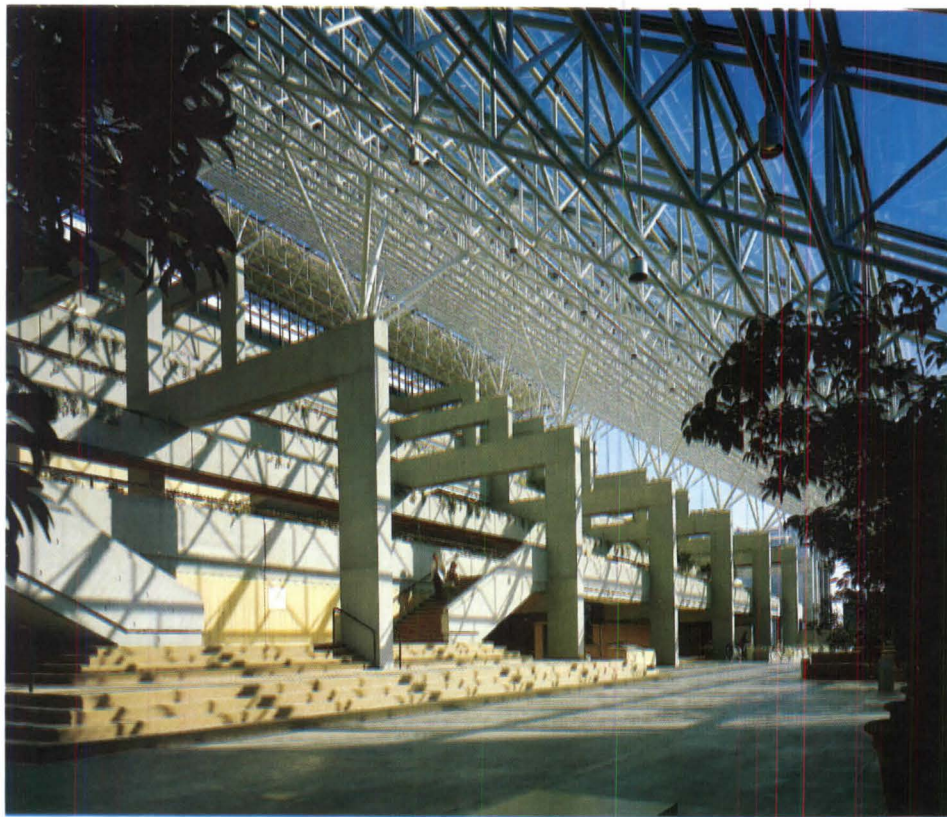

More for the public than their employees.

Robson Square succeeds far better as urban design than its components do as buildings. They have their moments, a notable one being the great space beneath the courtroom canopy (above left) with its dramatic concrete bents. But even here the visitor wonders about lavishing all of this structure on what is essentially a foyer for the courtrooms.

In fact, the ratio of foyer space to working space seems excessive until one sees the section at left, showing just how much of the building area is "backstage" (secure, nonpublic spaces such



Photographs by Ezra Stoller © ESTO

as detention rooms and judges' chambers) and underground. Even so it all seems very lavish, and, despite what Erickson likes to say about the canopy symbolizing the openness of the judicial system, it really has very little to do except imprint his "signature" on the building.

And the office building is considerably more wonderful to walk on than to work in. The office space is entirely underground, underwater or under plaza. Typically the government employees toil in open office landscapes flanked by perimeter corridors, in full view of their supervisors, fellow workers and citizen employers. There are wells and shafts to bring them light,

of course, and some spaces look up to the undersides of pools and out to the backs of waterfalls.

Neither of the new buildings meets the streets with much grace. For all of the lightness of the canopy and pleasantness of landscape above, at ground level the pedestrian encounters mainly harsh concrete walls. (Robson Square thus shares with Robert Venturi's Pennsylvania Avenue plaza in Washington the quality of revealing itself more fully to birds than humans.)

All this having been said, Robson Square remains a considerable contribution to, and an almost perfect symbol of, this delightful, aggressively laid-back city. □

Electric

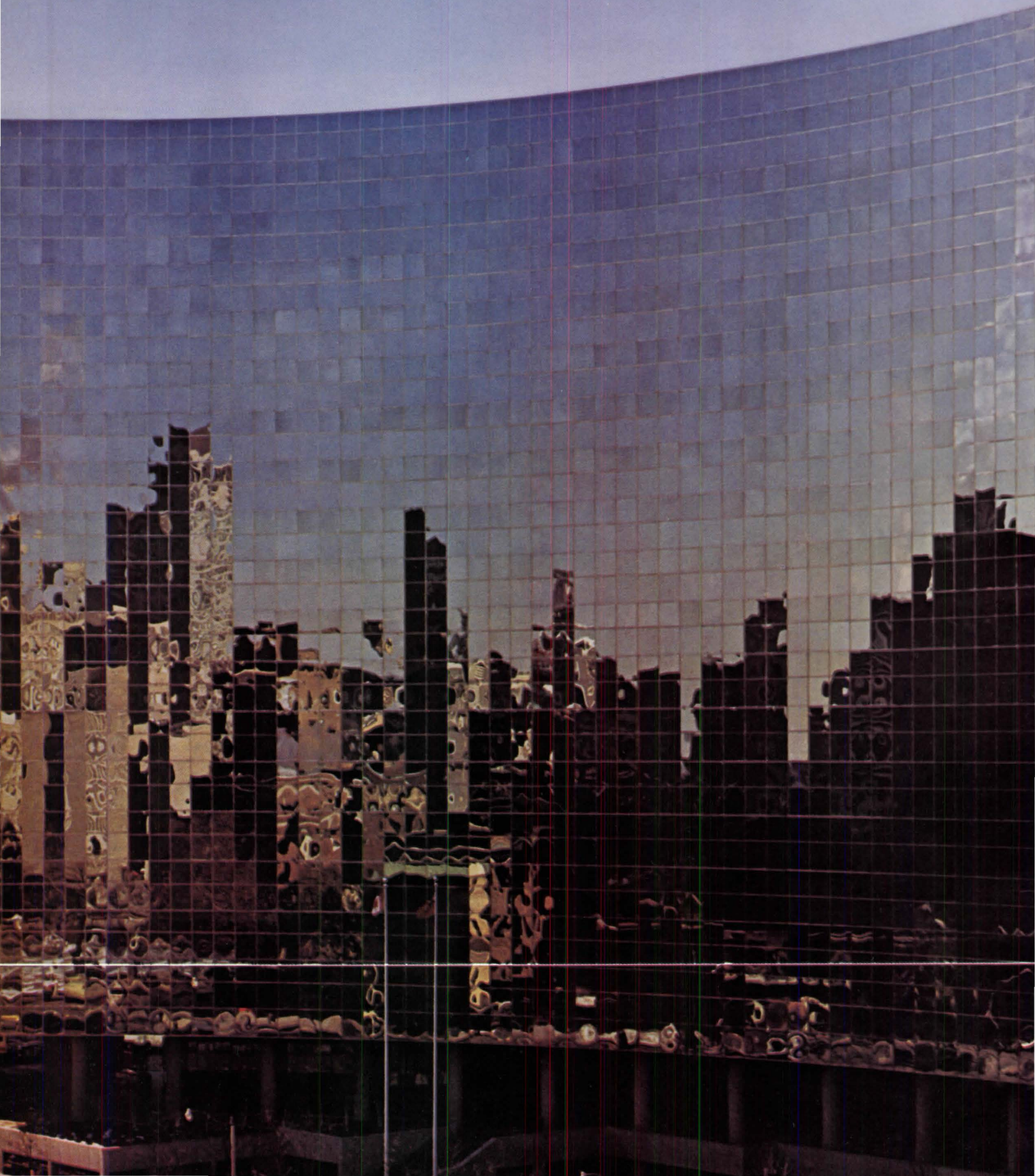

excitement.

The Ontario Hydro Building in Toronto never looks quite the same.

That's because the entire surface of its upper floors is curtained in LOF glass with Vari-Tran[®] coating. The mirrorlike finish of its curvilinear facade reflects constantly changing images of nearby buildings, street traffic and Mother Nature's sky.

Architects everywhere are relying on the unique aesthetics of Vari-Tran glass to add architectural interest and excitement to all sizes and types of building design. It's a cost-conscious, energy-efficient way of making your building dramatically stand out from its neighbors.

But Vari-Tran is much more than beautiful. Ontario Hydro's Vari-Tran 1-114 fabricated into insulating units combines the advantages of heat reflection with insulating glass to make year-round climate control far easier. Air conditioning costs are reduced. The building has no standard heating system. Instead, heat energy generated by lights, office equipment and people is recycled throughout the building to maintain comfort.

If you would like to know more about the beauties of Vari-Tran glass, write to Greg Oehlers, Libbey-Owens-Ford Company, 811 Madison Avenue, P.O. Box 799, Toledo, OH 43695.

Building: Hydro Place, Toronto, Ontario
Owner: Canada Square Corporation
Consulting Architects: K. H. Candy, Chief Architect—Ontario Hydro, and Adamson Assoc., Toronto, Ontario
Architect: K. R. Cooper, Toronto, Ontario
Glazing contractor and fabricator of insulating units: Pilkington Glass Ltd

Circle 22 on information card

LOF Glass

A Libbey-Owens-Ford Company

BOOKS

Tom Wolfe's Fantasy Bauhaus

What's Watts Tower doing in that zigguratrium? By George Nelson

For millennia, people have been depending on buildings—architects if you insist—to keep the rain off their antimacassars, to provide nests and even, from time to time, to repel boarders. Despite the ubiquity of this need, architecture is not what the book business would call a hot item. But now comes Tom Wolfe, everybody's favorite word merchant ever since he began Mau-Mauing those radical chicks, with a new book—on architecture, the jacket says—and there it is, already on the best seller lists.

A reviewer should always approach his assignment with circumspection, a fine old word that means to look around carefully before picking up anything by Tom Wolfe. There are some ecstatic blurbs: "Tom Wolfe rattles the foundations of modern architecture," "Tom Wolfe gives modern architecture a swift kick in the glass," etc., etc.

Powerful blurbs indeed, evoking other, earlier images from a happy childhood: *Tom Swift and his Electric Runabout*, *Tom Swift and his Atomic Airplane*. Days of good cheer and happy anticipation . . . Tom Swift, where are you, friend of my youth? This Tom Wolfe and his Barbecued Bauhaus . . . he doesn't really rattle foundations: an IBM electric attached to a press agent does that.

Anyway.

What we have here is a best seller. It is going like gangbusters. How did the man do it . . . with architecture, yet? That is the question—how? "Best seller" is the *what*. Subject matter takes a back seat when you have a best seller; you might even say that *being* a best seller is the subject matter.

For the "how?," we all realize, an author needs a formidable talent: Dostoyevsky, for instance, created some unforgettable characters, a gift not given to every writer. Wolfe's most conspicuous talent, on the other hand, is character assassination, also a gift not given to every writer. A best seller also requires a story line, a good plot, and it is best to adorn this plot

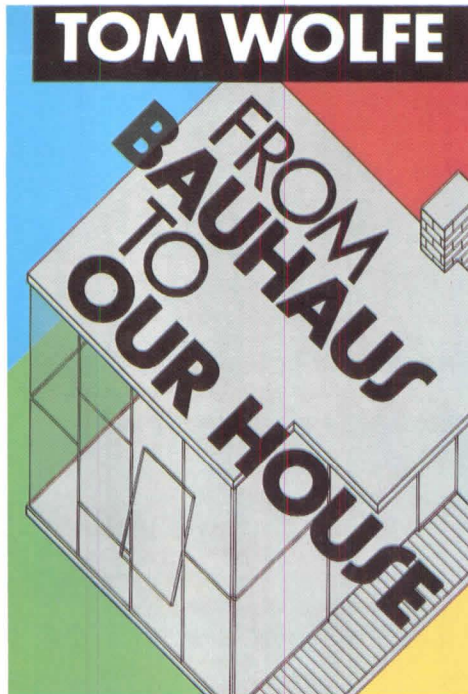

From Bauhaus to Our House. Tom Wolfe. (Farrar, Straus, Giroux, \$10.95.)

with at least one *outrageous proposition* so that the critics will be drawn out of their lairs and write contentious reviews. With luck, these should trigger letters to the editors and more reviews.

It is essential, in any good scam involving a book, that the major reviews be sharply critical, that they go into much earnest detail to show that the reviewer knows more about the subject than the author. In the case of *From Bauhaus to Our House* any reviewer could pass the test. When the unfavorable reviews appear, the author has to find them extremely funny. This establishes the David-Goliath image. He is *grateful* for these reviews: How else can he make clear his shining integrity? Wolfe plays the game better than most.

And just where is this game played? In interviews, of course. You have to set up one hell of a lot of interviews for a best seller. In these sessions it is possible to

hint delicately at rewards to come. In one such interview Wolfe confessed that he had been inundated with invitations from AIA chapters. In a rational world it would be absolutely unthinkable that a literate architect could read this book and actually invite the author to come and say more. The book, which is being passed off as a history of modern architecture, is deliberately mendacious and empty of content. The only reason for discussing it is not the book itself, but the general pollution it brings to the intellectual environment.

The "history" begins in postwar Vienna (post-World War I), where quantities of worker housing were built to meet a desperate need for dwellings. This house was minimal. Europe was in ruins, materials were in short supply; the new housing was "modern," which meant that it lacked the embellishments of prewar housing. There was nothing high-tech about it, obviously; it was simply a response to an exceedingly difficult situation. For Wolfe none of these facts provided what he was looking for, a thesis on which he could hang a lot of razzle-dazzle, something that would make another best seller. So he transformed a distressing reality into the fantasy of a nasty Marxist plot that would ultimately take over American architecture and subvert our most precious values.

One doubts if an ordinary writer, troubled by scruples, perhaps, could have made this fantasy stick, let alone develop it. Wolfe has no trouble at all. Modern architecture infiltrates America and puts up its own monument, the Seagram building on Park Avenue, designed by Mies van der Rohe. "Worker housing," shouts the daring author, "pitched up 38 stories." This is real vintage Wolfe—the catchy metaphor wrapped around a fallacy.

The "story" that emerges from Wolfe's private Vienna is subsequently enriched by a parallel tale about the Bauhaus. This brings in Walter Gropius, its founder. Paul Klee's affectionate name for him, a

continued on page 74

GRINNELL SPRINKLER SYSTEMS GIVE YOUR DESIGNS MORE ELBOW ROOM.

Space limitations imposed by building codes can also impose limits on architectural creativities. But you can broaden those limits by installing a Grinnell Sprinkler System.

When sprinklers are installed throughout a building, many building codes permit up to a 300% increase in floor area—depending upon occupancy, height, and construction — resulting in a correspondingly better utilization of valuable land.

A sprinkler system is a capital investment that allows you other cost-saving design freedoms as well. Increased building height. Greater distance between exits. A wider range of interior finishing materials. Lighter roof framing. Decreased exit widths. Fewer draft stops and less firestopping.

So when you lay out your next building, design in a Grinnell sprinkler system.

It'll help you make more economical use of every construction dollar.

For additional information call your nearest Grinnell district office located in the Yellow Pages, or write: Grinnell Fire Protection Systems Company, Inc., 10 Dorrance Street, Providence, Rhode Island 02903.

Circle 26 on information card



Protecting Life and Property Since 1850.

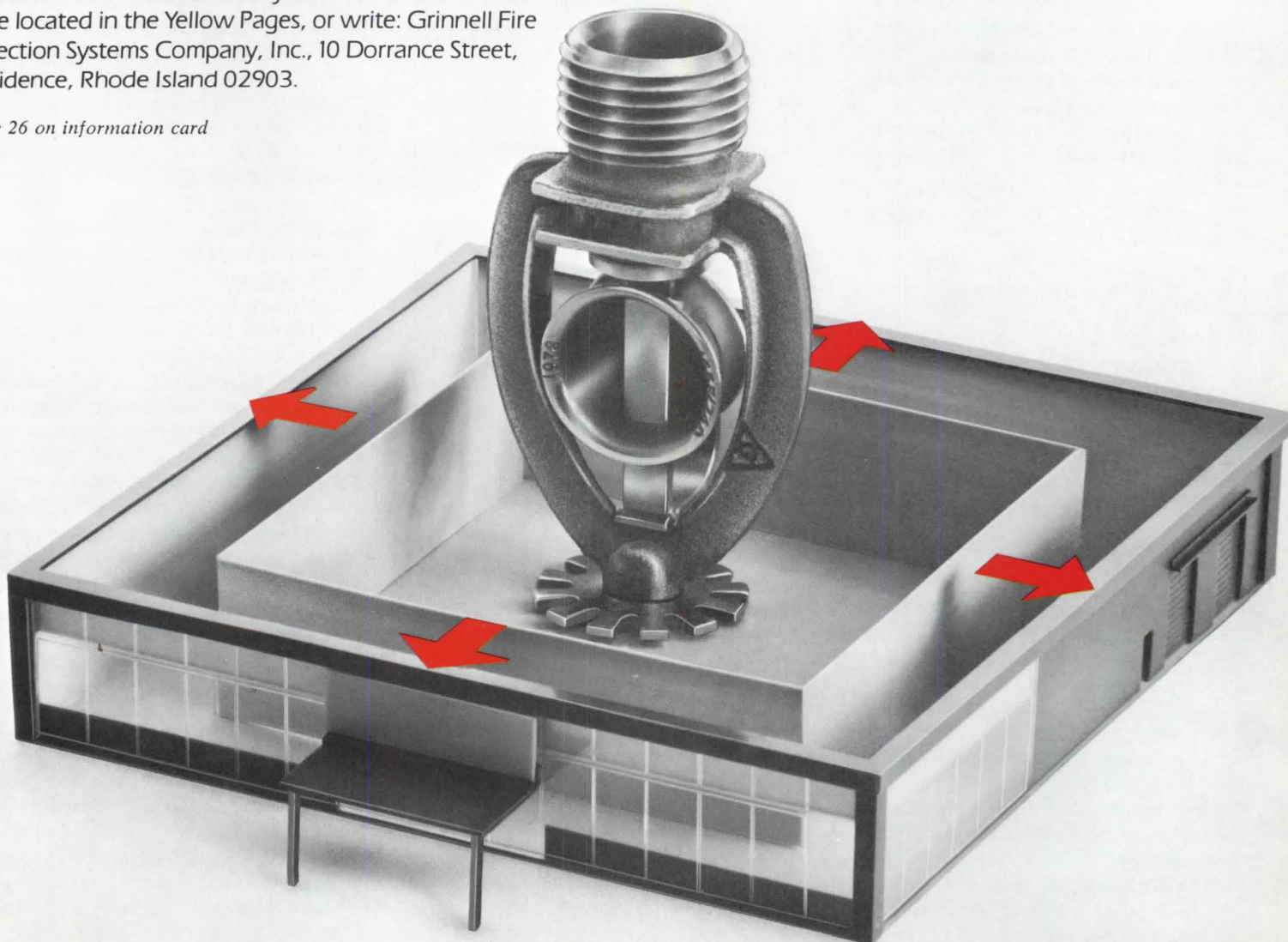

Books from page 72

kind of private joke, "The Silver Prince," becomes a sneer in Wolfe's busy fabrication. But Gropius becomes a kind of obsession for Wolfe, who apparently identifies, on one fantasy level or another, with The Silver Prince. It bothers Wolfe that Gropius did not care for the proletariat—he just "pretended" because it was fashionable. It is intolerable for Wolfe that this man, who carried himself like an aristocrat, was not "strictly speaking" an aristocrat. We even learn that Gropius' father, "while well-to-do, was not of the nobility." What comes out of this posturing snobbery is no further clarification of what Gropius might have been about, but a sudden and massive regurgitation of Wolfe's psychic garbage. In a way, the scene (no credit to the author) is fairly incredible: Germany after the War was shattered, in ruins. Gropius, appalled by the scene in front of him, writes, "This is more than a lost war. A world has come to an end. We must seek a radical solution to our problems." These and similar observations by his contemporaries set a series of events in motion that led, presently, to the founding of the Bauhaus, later to become, in its short life, the most powerful influence in design education of the 20th century.

Wolfe, in the midst of these massive events, hops around complaining that Gropius' father, "strictly speaking," was not of the nobility!!! There are few authors today with Wolfe's skill in giving a real-life scene so powerful an aura of total unreality. But some of us are still around

who were on the scene at the time and are bemused by reading so many "facts" of dubious ancestry.

I met Corbu for the first time in 1932, in Rome. I had started writing for *Pencil Points*, the ancestor of *Progressive Architecture*, and suggested to him that this was his chance to get a full, exclusive article on his works and thoughts in an American architectural publication. At this period little was known in the U.S. about the "modern" European architects. For Corbu, modern architecture and his own career were the same, much in the spirit of Louis XIV's *l'etat, c'est moi*. And what I got, at this first meeting, in the course of several hours, was a unique blend of history, theory and autobiography. Neither then, nor subsequently, did Corbu ever mention Marxist housing in Vienna as a factor in his development. But he spoke at length about light, air, steel, concrete and glass.

In the summer of 1933, I went to Berlin to find Mies. The Bauhaus had been shut down and its building in Dessau had been taken over for the Hitler Youth or something equally creative. He was kindness itself and let me hang around for too much of the afternoon; he talked a lot (for Mies) about architecture. He didn't mention Marxist housing in Vienna either.

In 1927 Mies had been commissioned to set up an international exhibition of housing in Stuttgart, later to become the famous Weissenhofsiedlung, and he invited the leading architects of all Europe to participate. Stuttgart had been literally

pulverized and the piles of rubble everywhere were not to be believed. The very sensible idea they came up with was to build the exhibition as a living neighborhood. I saw it in 1933. The houses that were built for the exhibition were all variations on the theme of simple geometry and flat roofs. Trees and shrubs had been planted, and people were living there. In its surroundings of bombed wasteland, it was a little island of hope. When Wolfe deals with this event and the architects involved he makes it sound like a convention of transvestites. I don't think he likes little islands of hope. Not if they have flat roofs.

Speaking of flat roofs, there is a list, presented with smug satisfaction, of "other American monuments to 1920s Middle European worker housing" that "began falling down of their own accord." These were sports arenas and convention centers with "flat roofs." Just how these facilities became monuments to Middle European housing is never made quite clear, except that "the snow was too much for them." I can see Wolfe in my mind's eye, solemnly explaining why flat roofs can't hold up snow. Those AIA chapters that have succeeded in signing him up have a real treat in store.

A strange character, this manufacturer of best sellers. He doesn't like modern architecture; he doesn't like worker housing (would he prefer it to be on the order of the Breakers in Newport, perhaps?). He doesn't like workers. He doesn't like post-modernists, either, except when he perceives Robert Venturi, say, getting away with something very sneaky, like ideological fence-straddling. He does not like the pollution of our fair land with anything European, and with this delicate touch of chauvinism, he becomes pure redneck, a half-life-size soft plastic replica of the silver-tongued William Jennings Bryan, complete with high collar and high sentiments: "O beautiful for spacious skies, for amber waves of grain, has there ever been another place on earth where so many people of wealth and power have paid for and put up with so much architecture they detested as within thy blessed borders today?"

Interesting question; has there ever, indeed?

There are performances that would make Archie Bunker blush. John Portman, for instance, is promoted to "the Morris Lapidus of today," an accolade that apparently has to do with the fact that both men have been identified with large hotels. However, Wolfe assures us, this elevation in Portman's rank does not make the two men really equal: Lapidus had a "Rimsky Korsakov American approach" while Portman does "Babylonian ziggurat" hotels. Yes, that's what it says: Babylonian ziggurats. They're scarce these

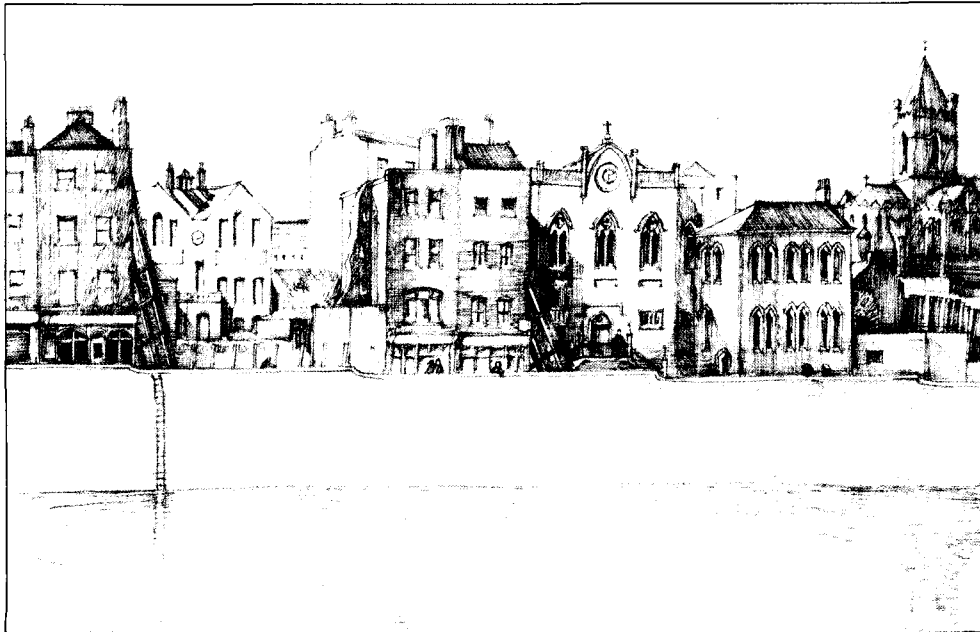

Dublin: Ninety Drawings. Brian Lalor. (Routledge & Kegan Paul, \$14.95.) In the late 1970s when Brian Lalor was preparing the 90 drawings for this book, he says that Dublin's physical fabric resembled a city emerging from the ravages of World War II. Nonetheless, he found beauty, as the pen drawings testify. Laced with the art is Lalore's pungent commentary on the spirit of a noble city and its citizens. He calls the river a fitting theme for the city. It is seen in the drawing of Essex Quay above. At the far right is the Church of Saints Michael and John, built in 1815. Lalore, a former architect, also has produced beautiful books of Jerusalem and Cork, Ireland.

days, but not impossible to find.

My favorite among a truly rich assortment of bloopers is the description of a "Hyatt Atrium Ziggurat" (sic) as "a Watts Tower production with the assistance of mortgage brokers and automatic elevators." All those AIA chapters, impatiently waiting for the Word from on High, could do worse than request a further development of this thought: "Hyatt as Ziggurat," perhaps, or "Ziggurat as Hyatt." Even "What's Watts Tower Doing in That Zigguratium?" might lead to some interesting discussion. Many possibilities suggest themselves. The great advantage of Wolfe in such a role is that knowing absolutely nothing about his subject matter, he would be unlikely to favor one theme rather than another.

As the fancy moves him, since no one could possibly accuse Wolfe of a concern for veracity, he calls himself a social critic or social historian, but in reality he deals in neither history nor criticism. What it seems to be, as far as I can make out, is just gossip. Not neighborly, pass-the-time-of-day gossip, but malicious gossip. Ambiguous gossip, so that many of his victims never realize that they have just been shafted by one of the world's great pros. This, for Wolfe, is one of the supreme pleasures, I would guess: to play out the joke, the more vindictive the better, and have "them" never know.

One wonders what causes all the thrashing around. Obviously, there is a terrible, insatiable need to be noticed. His books are written, more and more, not to say anything, but to attract attention. The addiction, apparently, needs bigger and more frequent fixes.

There was the interview with *People* magazine's Eric Levin. Levin asked "What would you do if you were, say, the architecture czar of America?" The question is a trap, obviously, a ploy by an experienced interviewer trying to get his subject to say something worth printing. One would think that anyone as shrewd as Wolfe would have sidestepped this one without a second's hesitation. But no—the fantasy takes over and our minihero, a complete one-man Light Brigade, charges: "I would say . . . each new building had to be . . . um . . . totally unlike the last building done in its category in the same town . . . and that . . . no basic building design could be repeated within . . . 100 miles. But I'm not here to change the world. . . ."

When Walter Mitty launched into his instant fantasies, their charm was the utterly familiar, human blend of sense and nonsense, and we could laugh with that wonderful old rascal Thurber, knowing that he and we and his creation were all pieces of the same nutty human individual, infinitely diverse, glorious and silly.

continued on page 77

Designed to be Natural

Fibers coarsely woven.
Burlap's candid feel is all its own.
Tranquil strength
in eight colors. Sierra to Oakbuff.

Gold Bond
DURASAN
Vinyl-Surfaced
Gypsum Wall Panels

For our Pattern Selector,
call toll-free 1-800-821-7700, ext. 807.
(In Missouri, call toll-free 1-800-892-7655, ext. 807.)

Gold Bond
Building
Products

Circle 24 on information card

Bilco. The finest in horizontal doors.

When your need is for roof scuttles, floor and pit doors, automatic fire vents — any type of horizontal door — look to the leader. Every Bilco product gives you the design, the quality, the workmanship, and the operation that assures long service and complete satisfaction.

For full information, details and specifications, send for our catalog.

Bilco® DOORS FOR SPECIAL SERVICES

The Bilco Company, Dept. AJ-121, New Haven, Conn. 06505

Circle 25 on information card

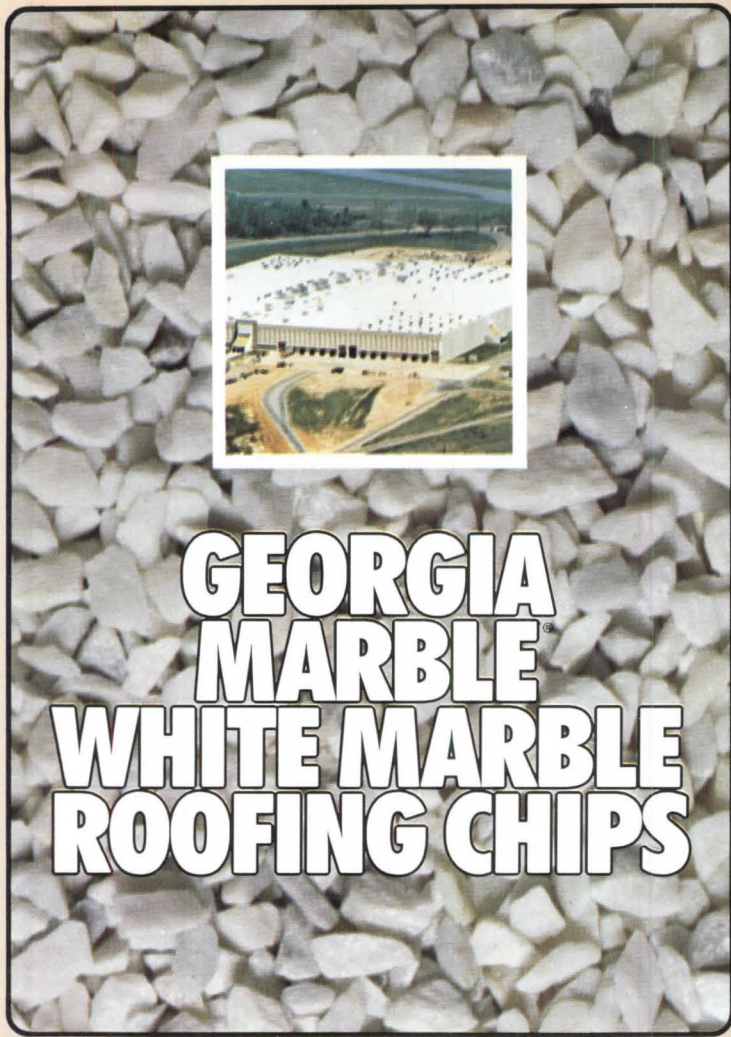

GEORGIA MARBLE WHITE MARBLE ROOFING CHIPS

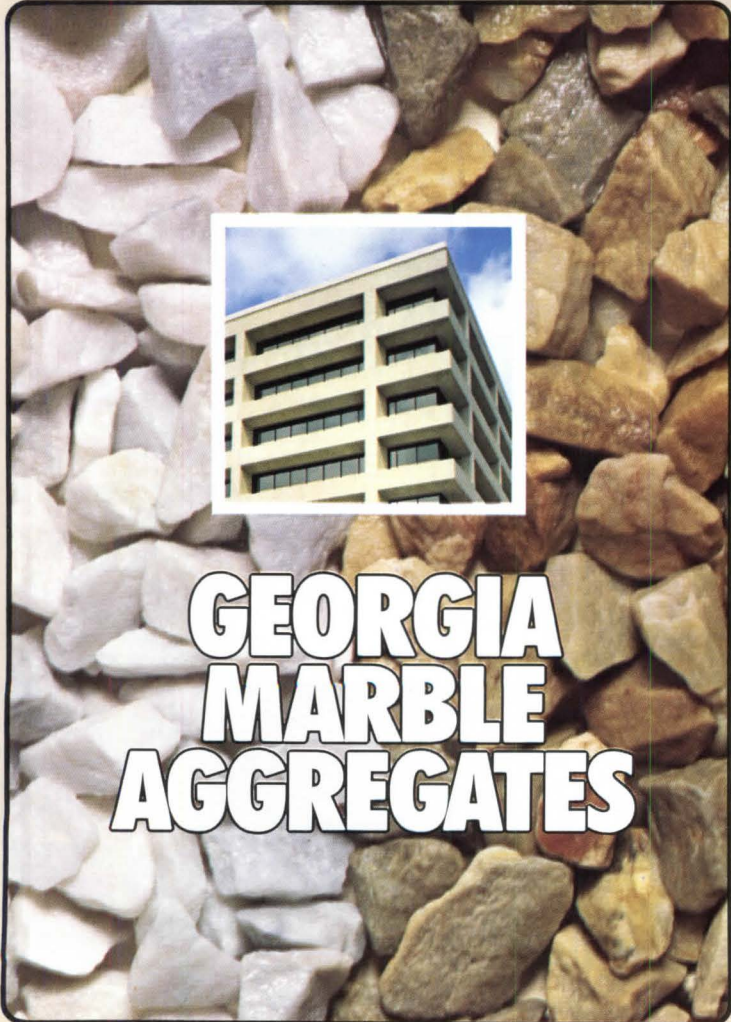

GEORGIA MARBLE AGGREGATES

REDUCE COOLING COSTS AND EXTEND THE LIFE OF THE ROOF.

Because of its high reflectivity, Marble Top[®] white roofing chips has been shown in testing to save as much as 12%* in energy cost when compared to other types of roofing aggregates. The high reflectivity also protects base coating materials from early deterioration caused by excessive heat build-up and extends roof life.

The aesthetic value of a bright, white roof that remains snow white through the years is another positive factor in specifying white marble roofing chips from Georgia Marble.

*Based on The National Bureau of Standards Load Determination (NBSLD) computer program and Miami weather data for 1977 as furnished by the U.S. Weather Bureau.

A NATURAL CHOICE FOR BEAUTIFUL BUILDINGS!

Since 1884, The Georgia Marble Company has supplied marble for many of the nation's architectural masterpieces. Quarried from virtually unlimited reserves in the North Georgia mountains, Georgia Marble[®] aggregates are available in two materials, Georgia White and Florentine Rustic.

GEORGIA WHITE — Beautiful white marble mined, crushed and sized specifically for use as exposed aggregate. Its durability and record of ability to withstand weather staining is outstanding.

FLORENTINE RUSTIC — A beautiful quartzite material. It is one of the hardest and most durable stones known to man.

*For further information contact
The Georgia Marble Company.*

 **georgia marble** company
consumer product sales

2575 Cumberland Parkway, N.W., Atlanta, Georgia 30339 / (404) 432-0111

a Jim Walter company

Circle 6 on information card

Books from page 75

The image we get out of the *People* interview is that of a character as humorless as Adolf Hitler, whose distended ego leads him into a statement of such asininity that it would take days to plumb its depths.

It is normal social behavior—at all times and places—for people to build in certain ways because materials, technology, beliefs, environment, economic constraints, to mention a few, indicate that it makes sense to do so. It is also normal, once such models exist, to try to improve on them. The urge to design, as Harry Bertoia once put it, is just like the urge to go on living. This is how “styles” come into existence. The notion that architecture is a game of hemlines, a play of “alike” and “different,” is not childish; it is moronic, and while it is almost impossible to believe that Wolfe is that ignorant of what is really kindergarten stuff, just that seems to be the case. He could never “rattle the foundations of modern architecture.” He wouldn’t know where to look for them.

In a perceptive essay on the New Journalism and the growing tendency to confuse fact and fiction, John Hersey (*Yale Review*, Autumn 1980) mentions a pair of pieces about *The New Yorker* written by Wolfe in 1965. It was demonstrated at the time, and in great detail, that the articles were made up largely of outright lies. Hersey’s comment was “There seems to be no way to explain the stunningly irresponsible street cruelty of Wolfe’s exercise.” He doesn’t seem to have changed much in the past 16 years. *Bauhaus* contains about as much distortion, falsification, general misinformation and slander as anyone could cram into the pages of a small book.

Bauhaus, for such a slight book, is surprisingly heavy. I think that something happens when the reader becomes aware of what the author is up to: characters like cartoon strip characters, without depth, style or diversity; jokes that suddenly cease being funny as their venomous content becomes apparent; a blatant ignorance of the subject beyond the most elementary listings of names and dates; an unexpected bigotry that manifests itself whenever the question of European influence on American “purity” comes up. This is not a nice book. Even Mme. Gropius, an uncommonly intelligent and personable individual, is pilloried as “the first and foremost of the 20th century’s “Art Widows,” as if there were something unspeakably shameful in a widow’s remarrying within her own class.

It may seem inconsistent that the review of a book so little admired by the reviewer should go on at such length, and so it would be if the book did not illustrate a matter that is very serious indeed. Wolfe is a minor figure in the New Journalism,

continued on page 79

Designed to be Natural

The harmonious grace of the Classic, remaining fresh through time in its serenity. Dover White to Shadow Olive.

Gold Band
DURASAN
Vinyl-Surfaced Gypsum Wall Panels

For our Pattern Selector, call toll-free 1-800-821-7700, ext. 807.
In Missouri, call toll-free 1-800-892-7655, ext. 807.

Gold Band Building Products

Circle 27 on information card

We deliver in hours because a lot can happen overnight.

A lot of unnecessary waiting. And worrying. American Airlines Priority Parcel Service doesn't make you wait overnight. We can deliver your small parcels virtually anywhere in hours. *In hours!* To every part of the continental U.S., Hawaii, Canada, Mexico and the Caribbean. And when you call toll-free (800) 638-7320, we'll even provide door-to-door service any time of the day or night.

So call American for delivery today. And rest easy.

American Airlines Priority Parcel Service

Doing what we do best.

Circle 28 on information card

ENTRY[®]

computer
services news

MCDONNELL DOUGLAS AUTOMATION COMPANY

New MCAUTO systems design buildings four times faster than manual methods.

MCAUTO's Building Design System (BDS) and General Drafting System (GDS)* offer you complete computer-aided graphic project coordination on any type or size of building. That includes automatic interference checking, current 2-D master drawings, plus standardized and stylized computer drafting. As a team these two new systems produce drawings four times faster than by manual methods.

MCAUTO's BDS, a 3-D modeling system for buildings, replaces the traditional design process by creating a building model stored in computer memory. By eliminating tedious manual jobs, BDS enables architects and engineers to spend more time planning, designing and reviewing projects.

BDS provides section, elevation and perspective views, sketch plans, room data and equipment catalogs, quantity measurements, cost estimates, service analyses and automatic interference checking.

MCAUTO's GDS is a versatile drafting system which standardizes 2-D production drawings. It accurately produces working drawings

Circle 29 on information card

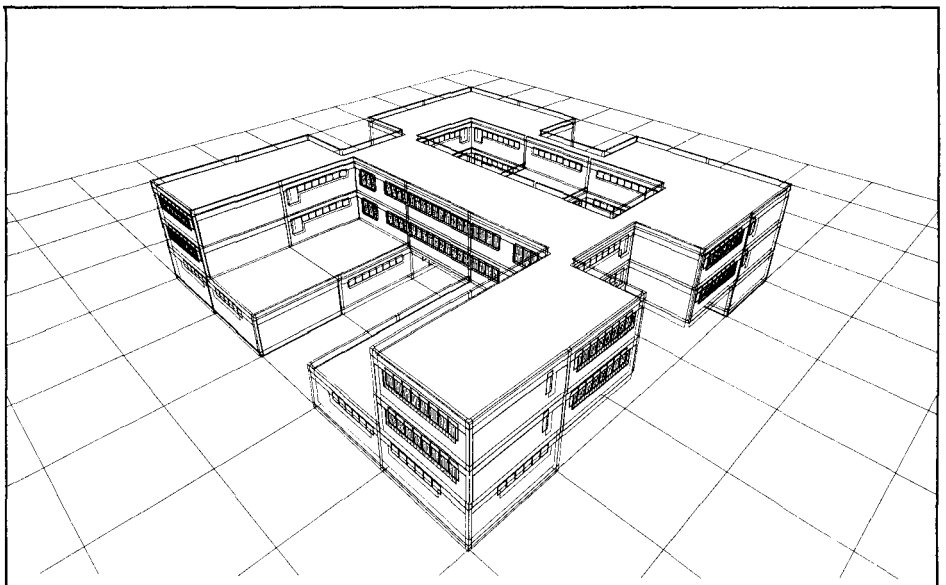

A building design as produced by MCAUTO's BDS. The system automatically suppresses hidden lines to enable the designer to aesthetically evaluate a building's appearance in its early design stages.

of a BDS model. With GDS, you rapidly access standard drawing details. The whole drawing—or any part—can be viewed or plotted or saved for later use.

Together, these two new MCAUTO systems can give you the competitive edge you need in building de-

sign. They offer a new level of design accuracy, standardization, and more time to plan designs and evaluate cost-effectiveness and practicality. For more information about MCAUTO BDS and GDS, call (314) 232-8021. Or mail the coupon.

**W. R. Vickroy, MCAUTO, Dept. KBN-500
Box 516, St. Louis, Mo 63166**

- Please send more information on MCAUTO BDS/GDS.
 Have your representative phone me for an appointment.

Name

Title

Company Name

Phone

Address

City

State

Zip

MCAUTO
MCDONNELL DOUGLAS
Setting the standard in data processing

MCAUTO and ENTRY are registered trademarks of McDonnell Douglas Automation Company.
*Based on software owned and originated at Applied Research of Cambridge, Ltd

Books from page 77

an approach to information that claims the right to mix fact and fiction without warning or explanation. What this kind of writing does is blur the edges of what we perceive as reality. Carried far enough, it erodes the basis for critical judgment, taking confusion to the point where the victim (in our case, an entire society) becomes helpless in distinguishing between reality and fantasy.

I am not suggesting that the New Journalism has this kind of power, but we must worry when we consider the extent to which we now move in an environment saturated with misinformation, whether distortions in advertising ("Come to Marlboro Country," "Let us make a car for you!" etc., ad infinitum), or political pronouncements at high levels. For those concerned with architecture, *From Bauhaus to Our House* is a particularly pertinent sample.

I would guess that what happened with this book and also *The Painted Word* is that Wolfe crossed an invisible line and got out of his depth. I was a Wolfe fan for years and found his excursions into the world of hippies, custom car buffs, miscellaneous small people reaching for status, both illuminating and funny. Gossip goes down well with such subjects; there is little else to do with them anyway. Their unifying quality (always allowing for exceptions) is that they all want to be somebody. An author can make fun of them and nobody minds.

Architects, artists, scientists and such people inhabit a very different region. Its occupants' unifying quality is a desire to do something, and the doing, at its best, is generally pitched at an idealistic level. It does not matter whether the members of this group succeed, or fail trying. There is a dignity in such aspirations that people recognize and respect, and even if the efforts are Quixotic or Utopian, an author cannot safely mock such people without ultimately disgusting his readers.

Architecture is a serious business for these very human reasons, and also because buildings are costly, bulky and heavy; because they have a powerful effect on their users; because enough of them put together make a city, and a city, ultimately, is where civilizations are hatched. It does not help architects, even in their most mediocre efforts to deal with this serious business, if vital ingredients in their work, like responsibility, integrity, a concern for truth—even compassion—are mocked and degraded.

The only possible good I can find in this perverse and corrupting book is that if seen for what it is, a distorting mirror of an enormously complex reality, it might do yeoman service as a text on how brains may be washed and conscience lobotomized. □

Designed to be Natural

Harvest. The natural patterns of grains... vital in their simplicity. Barley, Chamoline, Maize and Chaparral.

Gold Bond
DURASAN
Vinyl-Surfaced Gypsum Wall Panels

For our Pattern Selector, call toll-free 1-800-821-7700, ext. 807.
(In Missouri, call toll-free 1-800-892-7655, ext. 807.)

Gold Bond Building Products

Circle 30 on information card

SPECULAR TILE "Living" Ceiling

HIGHLY POLISHED FLUSH ALUMINUM PANELS HUNG FROM SNAP-IN OR LAY-IN SUSPENSION SYSTEM

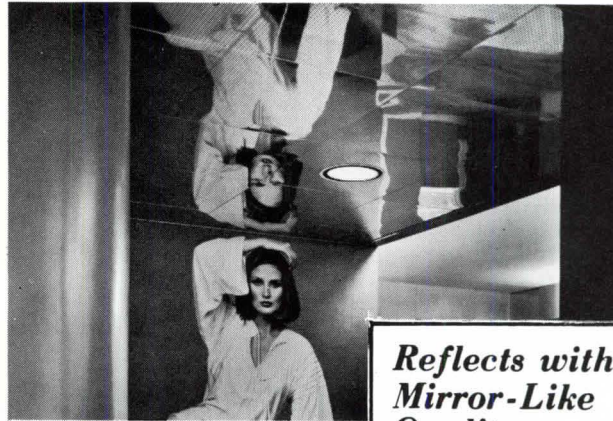

Swirl Showroom, N.Y.C.
Arch: Gwathmey & Siegel, N.Y.C.

UNPERFORATED FOR UTMOST REFLECTING QUALITIES OR PERFORATED FOR ACOUSTICAL CORRECTION Available in gold or silver
Dramatizes Your Lighting Effects

For sizes, finishes or prices, call or write

SIMPLEX CEILING CORP. Refer to SWEET'S CATALOG Section 9.1

SALES OFFICE: 50 HARRISON ST., HOBOKEN, N.J. 07030 • PHONE (212) 349-1890
DIRECT PHONE TO FACTORY: (201) 864-6630

Sales "Reps" needed—Write to Simplex for information

Circle 31 on information card

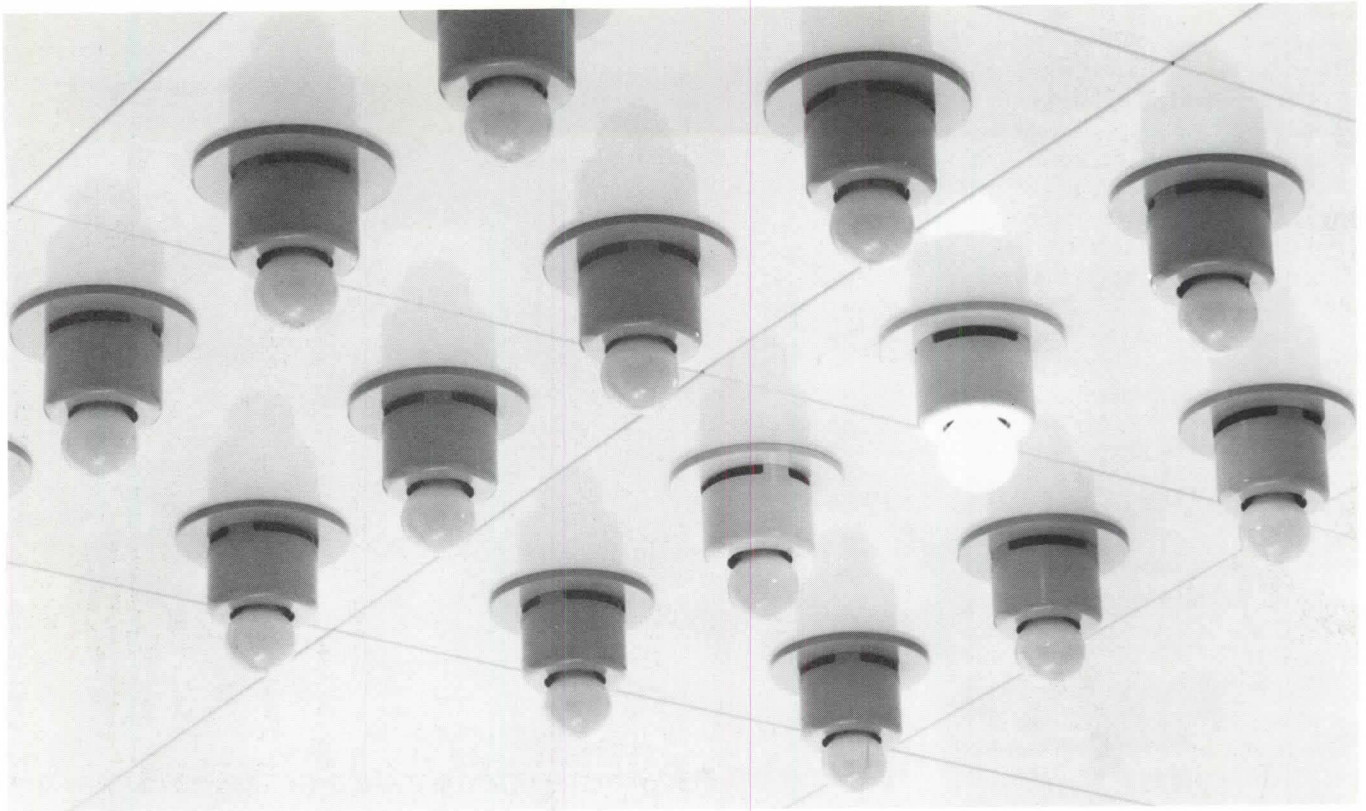

1

Furnishings

*As resources for design
and objects of design. S.A.*

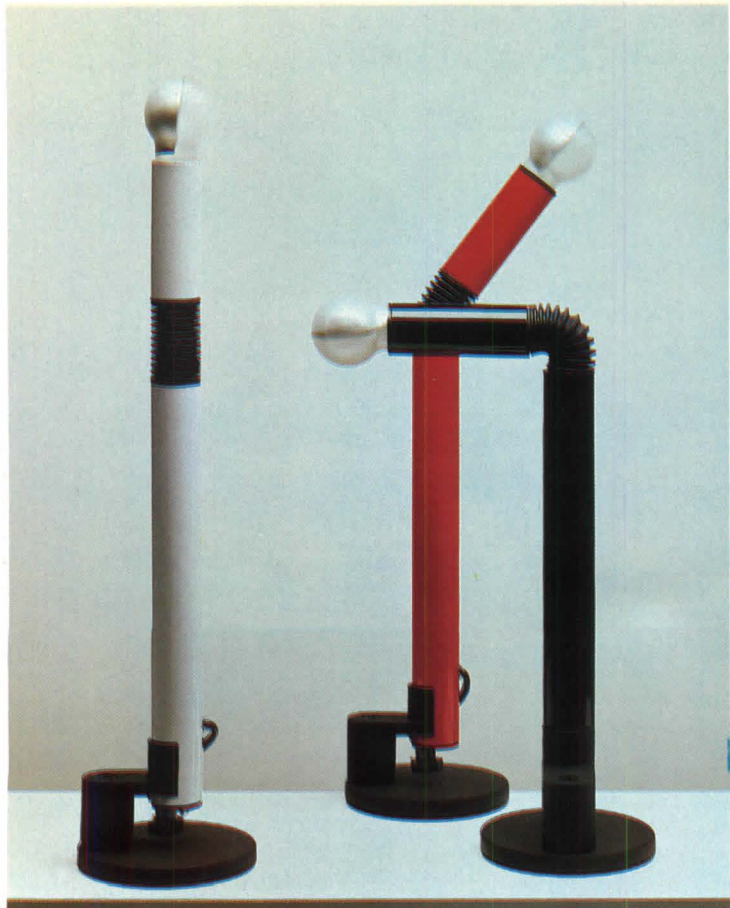
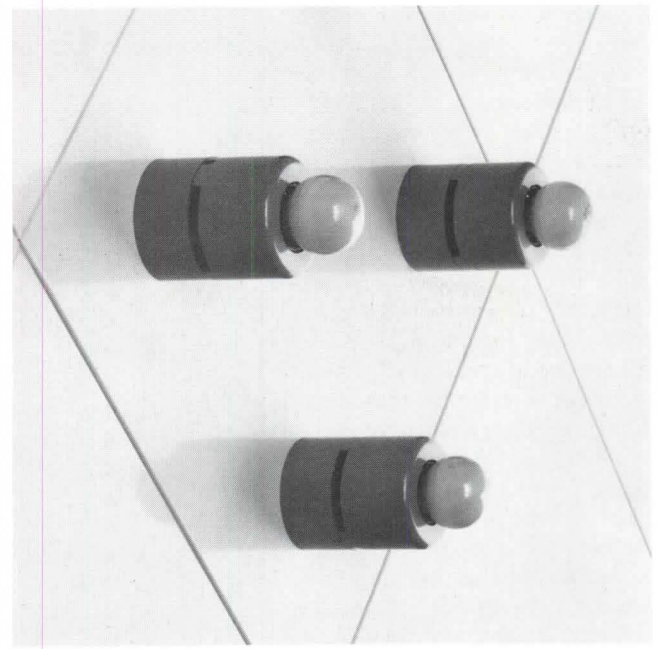

2

Pilo ceiling mounted or wall mounted lighting fixtures (1) are designed by Massimo Rossetti and Alessandro Carmignani for Stilnovo of Milan. There is also a pendant version with conical shades of colored aluminum added. The colors available are white, black, green and yellow. Also from Stilnovo are the Periscopio table lamps (2) designed by D. & C. Aroldi. They have a flexible nylon joint between lengths of rubber coated fiberglass tubing. Bases are standard or clamp-on, and there is a wall mounted version as well.

Folded Cloth #2 is the name of a cotton fabric design (3) by Warren Seelig, part of the *Art Fabric: Mainstream* exhibition and accompanying book by Mildred Constantine and Jack Lenor Larsen. Chairs designed by architect Roald Steen Hansen of Copenhagen (4) are built of oak or ash. Their backrest detail provides resiliency from a single piece of wood. The fully upholstered Enos sofa (5) is a Studio Tecnico A&F design for Art & Form, Turin, Italy.

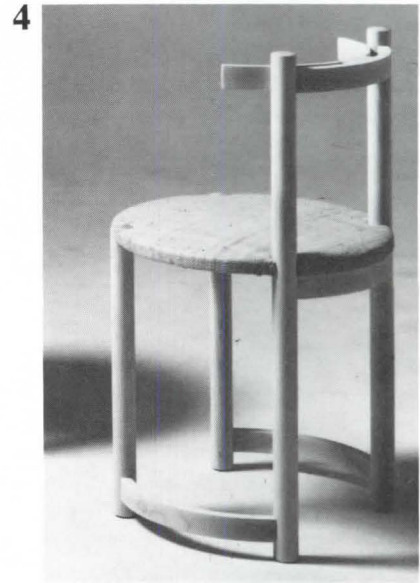
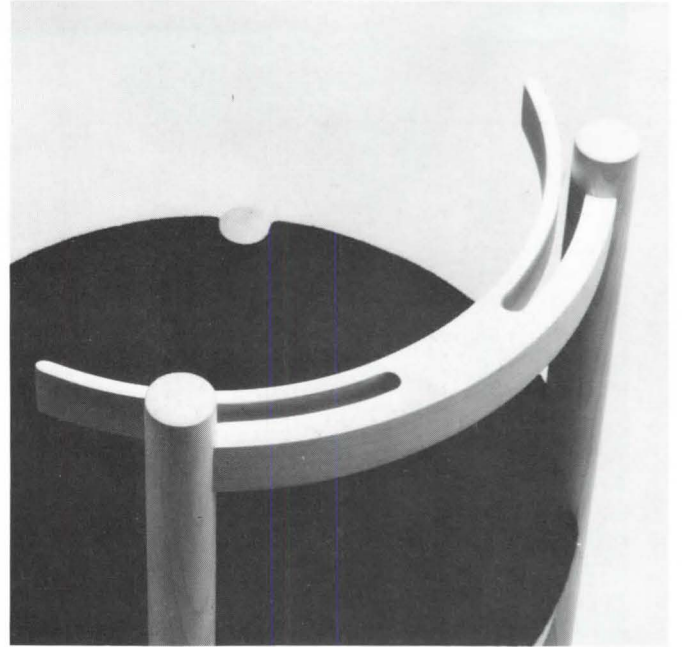
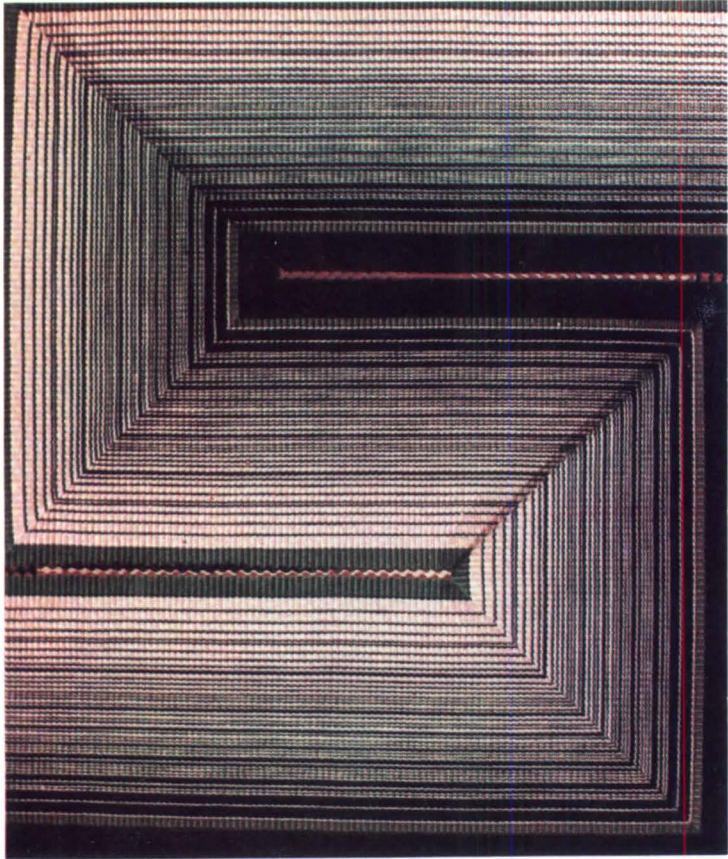

3

4



5



1

The Margarita lounge chair (1) is designed for outdoor use by Herb Saiger for Lee L. Woodard Sons, Inc. Its waterproof stretch fabric is available in more than a dozen colors; its frame in 20 paint finishes. Chaises and matching glass topped side tables are also available. Lumipoches lamps (2) are hung between chrome ceiling hooks and black metal weighted bases and are of fire-proof, removable fabric. They are designed by Christian Germanaz for Verre Lumiere of Paris. Part of the Rabbit multiple seating program from Rudd International is the Rabbit Beam Group (3). The length of the supporting beam and the arrangement of seats and table units attached to the beam are both variable.

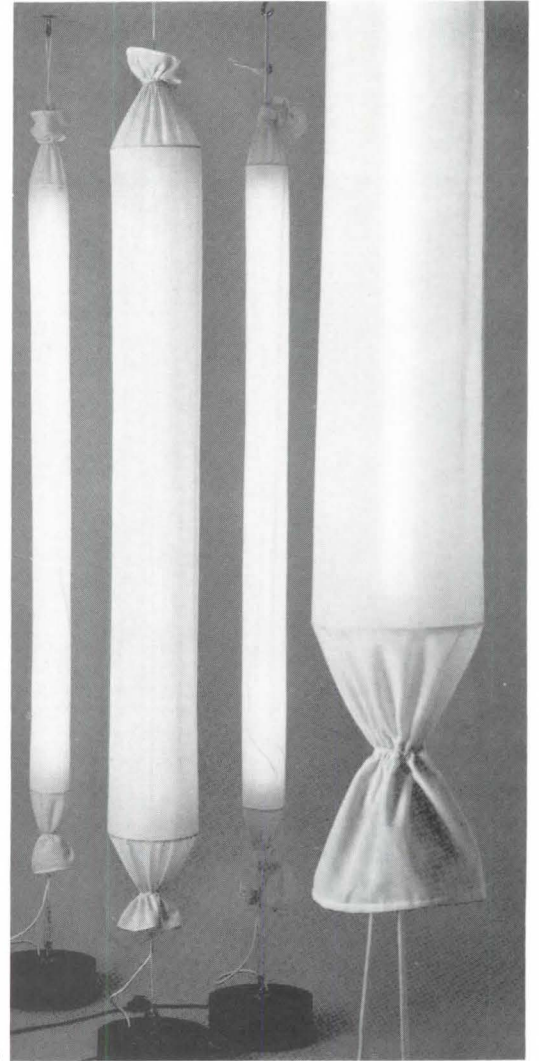

2

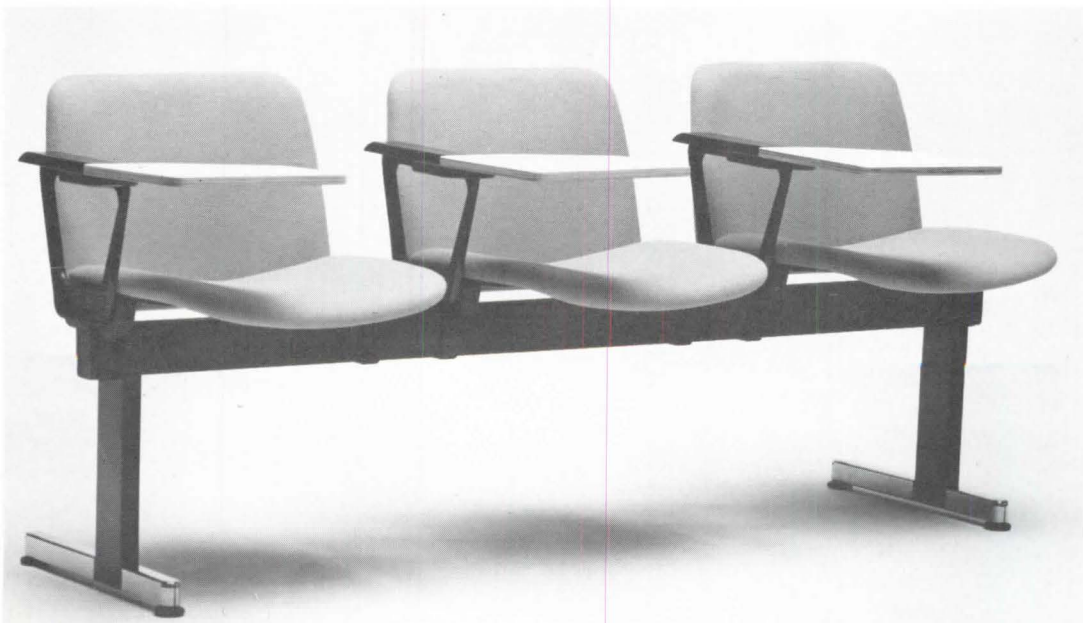

3



The Pavilion sofa (4) is one of 15 new designs by John Saladino for David-Edward Ltd. Its seat and arm panels are sewn in parallel channels, and its dacron filled back pillows, which appear loose, are actually attached to the back. The sofa height (38 inches) is unusually tall, and it is made in either two-seat or three-seat lengths. From Stow/Davis is the Triangle chair (5) designed by Robert De Fuccio. Seats and backs are solid, as shown, caned or upholstered. In addition to the sled base, there are office versions on swivel bases with either casters or glides. All types are available armless or with arms, in oak or in walnut. The Ri-Piego folding wood armchair (6) designed by Paolo Pellion for Art & Form, Turin, has a removable canvas cover and fits inside a canvas storage and carrying bag. There is also a folding table with wood top. □



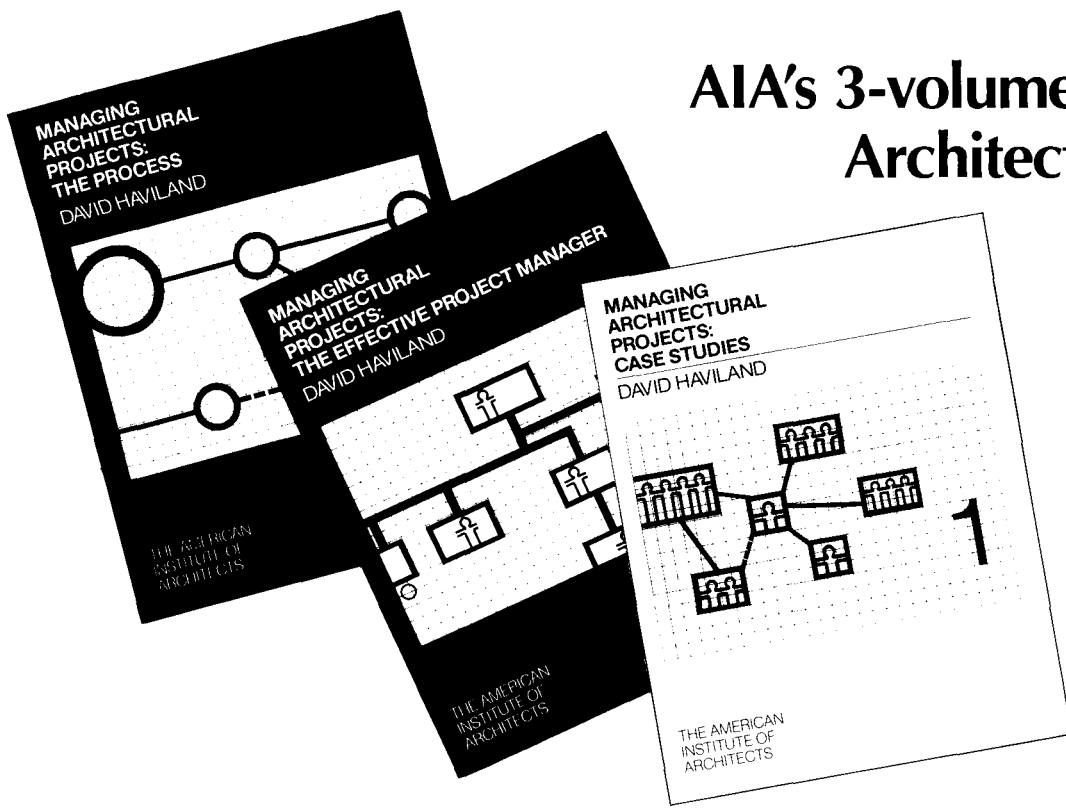

AIA's 3-volume series on Managing Architectural Projects (MAP) shows you the way to hire, train or become an effective project manager.

There are proven ways to approach managing an architectural project, and there are skills and attitudes that the successful project manager must have. The new AIA series, *Managing Architectural Projects (MAP)*, tells you how to implement an effective project management system; how to plan, organize and staff it; and how to gear the system to meet your firm's needs. The MAP series also describes the qualities a good PM should have — and it shows you exactly how these skills can be taught and learned.

The MAP series is must reading for PM's, architects and architecture students. Order these books today, either separately or as a series by simply filling out and mailing in the coupon below.

Managing Architectural Projects: The Process — by David Haviland

This book outlines essential project management activities and shows how you can organize your office for effective project management. It suggests a step-by-step approach: Understanding project management; planning, organizing and staffing; directing; evaluating and implementing the project management system.

1981/112 pp./\$16 members, \$20 non-members #2M727

Managing Architectural Projects: The Effective Project Manager — by David Haviland

This book examines in detail the skills and attitudes that characterize good PM's. It also shows how a firm can hire and further develop PM's.

Contents also include: Fitting the project manager into the architect's office, the principal's role and the bottom line: an effective project management process.

1981/42 pp./\$8 members, \$10 non-members #2M730

Managing Architectural Projects: Case Studies — by David Haviland

Each case study in this volume examines a different architectural firm as the firm takes a project from initial lead to completion. The case studies allow you to view the many dimensions of project management, and to understand how the project management process differs from firm to firm.

(Order separately or as a single volume.)

MAP 3: Complete Set Case Studies — 1981/3 volumes/\$17 members, \$21 non-members #2M732-0

MAP 3: Moreland/Unruh/Smith Case Study — 1981/approx. 36 pp./\$6 members, \$7.50 non-members #2M732-1

MAP 3: Hansen/Lind/Meyer Case Study — 1981/approx. 36 pp./\$6 members, \$7.50 non-members #2M732-2

MAP 3: NBBJ Group Case Study — 1981/approx. 36 pp./\$6 members, \$7.50 non-members #2M732-3

Circle 32 on information card

Please send me the following AIA publications:

Quantity	Members	Non-Members
<input type="checkbox"/> #2M727 MAP 1: The Process	\$16.00 <input type="checkbox"/>	\$20.00 <input type="checkbox"/>
<input type="checkbox"/> #2M730 MAP 2: The Effective Project Manager	8.00 <input type="checkbox"/>	10.00 <input type="checkbox"/>
<input type="checkbox"/> #2M732 MAP 3: Complete Set Case Studies	17.00 <input type="checkbox"/>	21.00 <input type="checkbox"/>
<input type="checkbox"/> # 2M732-1 MAP 3: Moreland/Unruh/Smith Case Study	6.00 <input type="checkbox"/>	7.50 <input type="checkbox"/>
<input type="checkbox"/> #2M732-2 MAP 3: Hansen/Lind/Meyer Case Study	6.00 <input type="checkbox"/>	7.50 <input type="checkbox"/>
<input type="checkbox"/> #2M732-3 MAP 3: NBBJ Group Case Study	6.00 <input type="checkbox"/>	7.50 <input type="checkbox"/>

(District of Columbia residents add 6% sales tax. No charge for postage and handling.)

\$ _____
TOTAL

Name _____

Firm or Institution _____

Shipping Address _____

Attention _____

City _____ State _____ Zip _____

Signature _____

Clip this coupon and mail to: **Publication Sales**
American Institute of Architects
1735 New York Avenue, N.W.
Washington, D.C. 20006

Please enclose full payment.

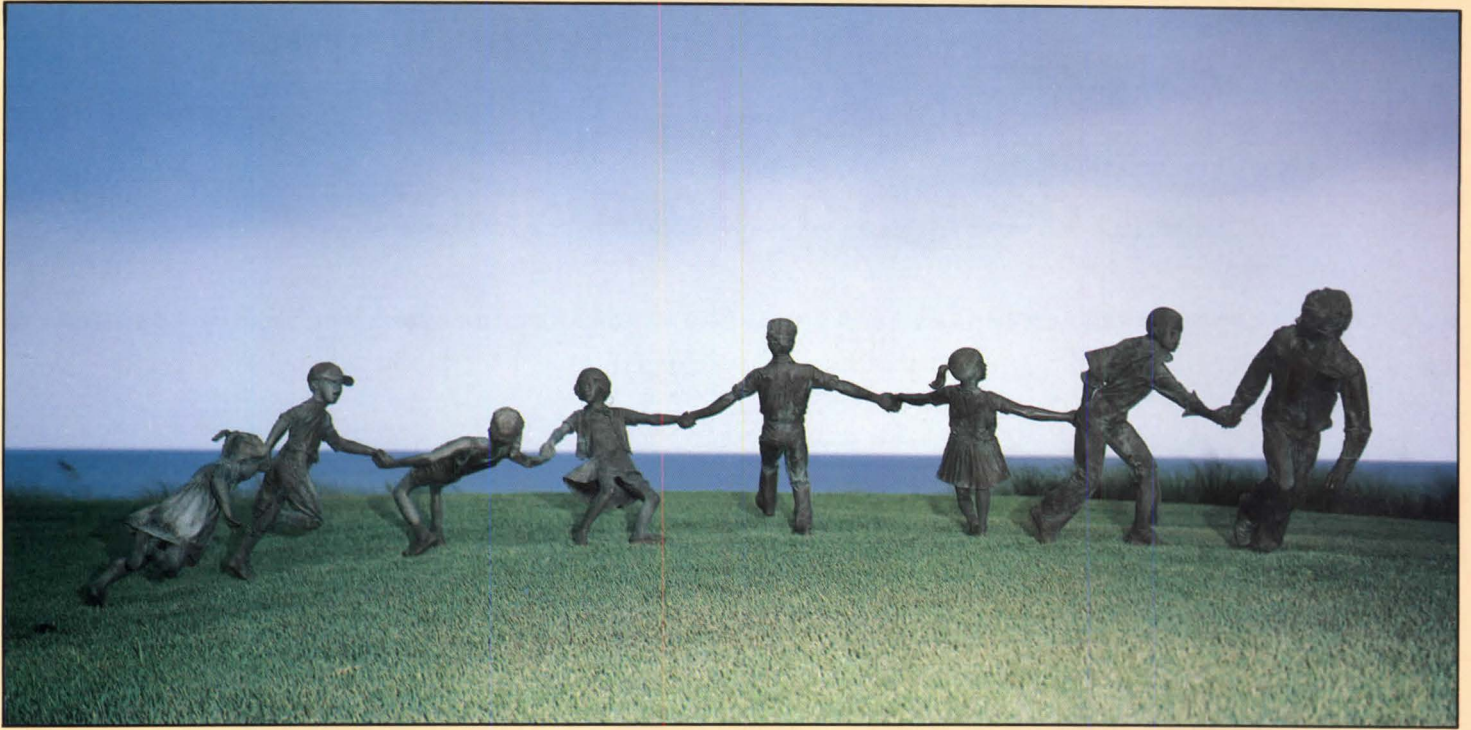

"Crack the Whip"

J. Seward Johnson, Jr.

For information contact:
Sculpture Placement
P.O. BOX 9709
WASHINGTON, D. C. 20016
202-362-9310

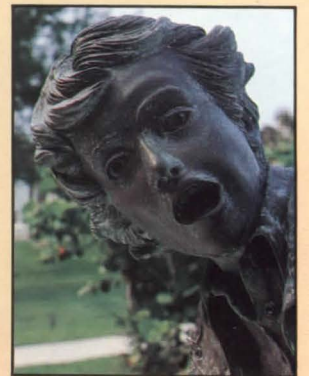
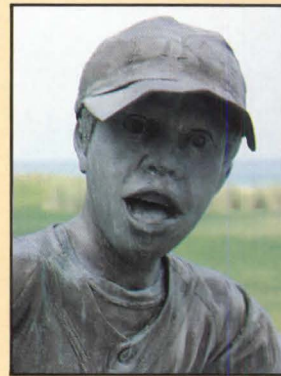

Close up: "Crack the Whip"

Lifesize figures produced in limited editions of seven or less.



"Far Out"



"Lunch Break"

Circle 33 on information card

Make a New Year's Resolution to learn what you're missing in energy-related design opportunities.

"Energy in Architecture" Workshops



- No. 4302c: DETROIT, MICH.
Jan. 7-8 (\$295) Practice
- No. 3104c: KANSAS CITY, MO.
Jan. 8-9 (\$170) Techniques
- No. 3202c: MINNEAPOLIS, MINN.
Jan. 8-9 (\$275) Process
- No. 2205c: DALLAS, TEX.
Jan. 21-22 (\$295) Process
- No. 8104c: RICHMOND, VA.
Jan. 22-23 (\$170) Techniques
- No. 8201c: WASHINGTON, D.C.
Jan. 22-23 (\$290) Process
- No. 6201c: PROVIDENCE, R.I.
Jan. 29-30 (\$295) Process

- No. 5201c: BIRMINGHAM, ALA.
Jan. 29-30 (\$275) Process
- No. 5104c: PALM BEACH (Jupiter),
FLA.
Feb. 5-6 (\$170) Techniques
- No. 1108c: BILLINGS, MONT.
Feb. 12-13 (\$150) Techniques
- No. 5103c: TALLAHASSEE, FLA.
Feb. 19-20 (\$150) Techniques
- No. 6105c: SYRACUSE, N.Y.
Feb. 26-27 (\$170) Techniques
- No. 7103c: CINCINNATI, OHIO
Feb. 26-27 (\$170) Techniques

Please register me for workshop
No. _____
(Indicate your preference by placing an "X" in the box
corresponding to the workshop of your choice and by
placing the appropriate workshop ID number in the space
provided above)

Yes, I want to make a New Year's
Resolution

Please complete this form and return
it with your payment to:
AIA Accounting/Energy
The American Institute of Architects
1735 New York Avenue, N.W.
Washington, D.C. 20006

A registration form is required for each
registrant. This form may be duplicated.

For Office Use Only

Amount Received

Date

Name

Area Code/Telephone Number

Firm/Institution/Organization

Address

City

State

Zip

Check one: AIA Member₁ FAIA₂ Associate Member₃
(AIA Chapter)₄ Chapter Professional Affiliate ASC/AIA₅ Other₆

(Do Not Detach)

Account No. 236-000-000

PRINT NAME (Please repeat from above)

TOTAL AMOUNT ENCLOSED \$ _____

Account No. _____

My check for \$ _____ is enclosed
(Please be sure that the amount is correct;
fees may vary).

Please charge the workshop fee to:
(check one): American Express
 MasterCard Visa

Expiration Date _____

(Signature)

Starting here and now.

It's the time of the year to plan
ahead.

One thing you can definitely plan
on is that the AIA's comprehensive
Energy Professional Development
Program will help you serve your
clients even better this year than you
did last year.

The Institute's program, "Energy
in Architecture," has been developed
with you in mind. In the multilevel
series of three two-day workshops,
you can acquire new information and
new skills—to handle any situation,
from energy-efficient design and
retrofit to external and internal
factors affecting design, from energy
audits to life-cycle cost/benefit
analysis.

We'll supply the program, the
workbook, and the supplemental
materials at a cost far below most
non-AIA seminars and workshops.

Plan ahead. Save time, save
money, save energy.

Energy in Architecture

The American Institute of Architects
1735 New York Avenue
Washington, D.C. 20006

Circle 34 on information card

DEATHS

Albert Mayer, FAIA: A founding partner of Mayer, Whittlesey & Glass in 1935, Mr. Mayer also was a planner and housing consultant for projects worldwide who strongly believed in the ability of city planners to bring order to the urban landscape. He was the master planner for Chandigarh, India, the new town that achieved international renown in the '50s when Le Corbusier was given the commission to design its major public buildings. Along with Lewis Mumford and Henry Wright, Mr. Mayer established the Housing Study Guild, a research organization that in the '30s recommended pioneering types of public housing. Mr. Mayer attended Columbia University and received a degree in civil engineering from MIT in 1919. He died on Oct. 14 at the age of 83.

Mellen Clark Greeley, FAIA: Born in 1880 in Jacksonville, Fla., Mr. Greeley began a career in architecture after the great fire of 1901 destroyed most of downtown Jacksonville. Through the years, he designed numerous buildings, including hospitals, clubs, churches, schools, low-rent housing, warehouses, a post office, office buildings and residences. In 1964 he was awarded the Florida Association/

AIA's gold medal, and in 1968 the Jacksonville Chapter/AIA created the Mellen Greeley craftsmanship award. He died on Sept. 4.

Richard Llewelyn-Davies, Hon. FAIA: The intellectual acumen, energy and the range of his interests made Lord Llewelyn-Davies internationally influential for the past 35 years. An educator and successful practitioner (he headed the London-based international firm of Llewelyn-Davies, Weeks), he made the study of growth, change and indeterminacy in the built environment the core of his work. This was most notably expressed in the master plan for the new city of Milton Keynes north of London. There he adopted a strategic approach to the master plan based on a communications network that gives nearly equal accessibility to all areas of the city.

His firm's architecture has tended toward low-key modernist buildings that coexist in harmony with their environment. The design of the new Stock Exchange in London makes courteous concessions to the old city with its shortcuts and rambling street structure.

The village of Rushbrooke in Suffolk (1957) uses a vocabulary of shed roofs, stucco, light and shadow to marry a modern settlement to a rural environment. By

its plainness, the new addition to London's Tate Gallery focuses attention on the art, much of which is seen in natural light.

Active also in the U.S., he leaves a thriving Houston office (Llewelyn-Davies Sahni) and memories of speeches at Harvard, where he delivered the 1975 Gropius memorial lecture on the relation between science and architecture, and at Philadelphia, where he was the keynote speaker at the 1979 Urban Design Conference, giving his unconventional view of the "neighborhood" as a planning concept. He resided at Princeton's Institute for Advanced Studies in the fall of 1980.

As professor of architecture at the Bartlett school, London University, he instigated valuable interdisciplinary research. As a Labour member of the House of Lords, he was active politically in world affairs. Much of his firm's planning work was in Third World countries.

A realist and a man of some intellectual detachment, he was nonetheless of an optimistic temperament. He believed that there is "a longer, deeper swell in Western culture" that would transcend fads and fashion and ultimately lead architects to find an expression of the spirit of our age. He died Oct. 26 in London. *Susan Braybrooke, Barnegat, N.J.*

Deaths continued on page 88

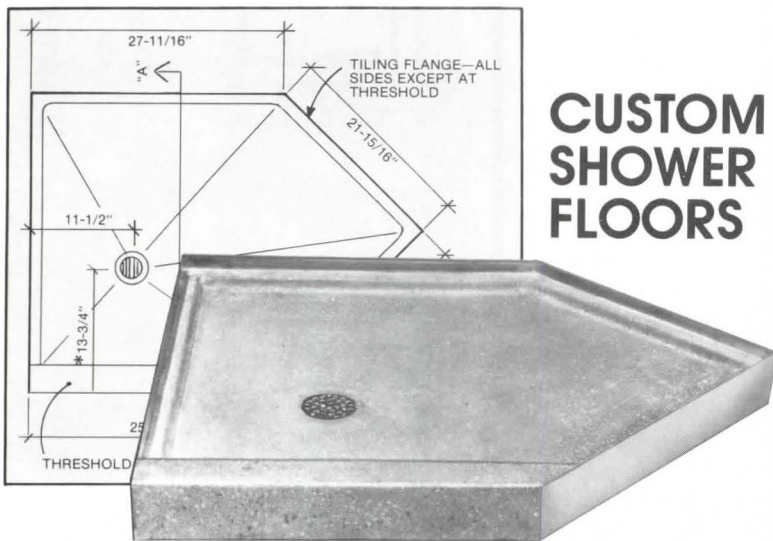

CUSTOM SHOWER FLOORS

We'll make you an original.

Enjoy complete freedom of design in hospitals, apartment towers, elderly housing, and dormitories. Custom engineered shower floors of classic Terrazzo meet your specifications, assure quality and offer substantial cost savings compared to on-site construction. One-piece molded floor has integral cast drain, installs direct on the finished floor. No sub-pan is required. Permanently watertight. Natural non-slip finish. Custom colors. • Don't need an original? We have over 16 standard models: square, rectangular, and corner models, and a wheelchair access floor.

WILLIAMS

STERN-WILLIAMS CO., INC. • P.O. Box 8004, Shawnee Mission, Kansas 66208

Circle 36 on information card

WE PUT PAVER STONES ON A PEDESTAL

For perfect drainage in any weather

NEW! A far better way to lay paver stones over water-proofed plazas, podiums, arenas and other deck areas. Pave-El® paver pedestals.

With these definite advantages:

- Positive drainage year in and year out
- Longer membrane life and maintains insulation thermal efficiency
- Compensation for unevenness of substrate or pavers
- Superb weatherability; ease of installation and maintenance

Write for detailed specification brochure.

Representative inquiries invited

ENVIROSPEC INC.

Ellicott Station • Box 119 • Buffalo, NY 14205

In Canada: ENVIROSPEC INC., P.O. Box 86, Postal Station "U", Toronto, Ontario M8Z 5M4

PAVE-EL®

Circle 35 on information card

AIA JOURNAL/DECEMBER 1981 87

Deaths from page 87

Philip W. Bancroft, Camden, S.C.

Theodore B. Carroll, Bellevue, Wash.

Albert G. Clay, Niantic, Conn.

William Corbett, E. Orleans, Mass.

Andre Halasz, Livermore, Calif.

Willard T. Jordan, Costa Mesa, Calif.

William E. Lehman Jr., Newark, N.J.

William E. Mahon, Greenville, S.C.

Sumpter Smith Jr., Birmingham, Ala.

Ray Stuermer, South Bend, Ind.

BRIEFS

World Architecture Calendar 1982 features 13 black and white photographs by Norman F. Carver Jr., AIA, whose book on *Italian Hilltowns* was excerpted in the December 1979 JOURNAL. Printed on heavy, coated stock, Carver's images include Stonehenge, a cave house in Spain, the Taj Mahal, the Angkor pavilion at Ta Som, Cambodia, and White House ruin at Canyon de Chelly, Arizona. The 22x14-inch calendar is available for \$7.95 from Documan Press, Box 387, Kalamazoo, Mich. 49005.

Classical America is offering two four-month drafting courses. "Classical Drawing: Instruction in Composition" begins Jan. 25 at the National Academy School of Fine Arts, New York City. "Classical Architecture: Drafting the Orders and Classical Ornament" begins Jan. 26 at Temple University, Philadelphia. For more information, contact Henry Hope Reed, Classical America, 227 East 50 St., New York, N.Y. 10022.

Vietnam Veteran Memorial designs (see Aug., p. 47) will be exhibited at the Octagon and AIA headquarters through Jan. 3. Winning designs, plus honorable mentions and 35 other selected entries, will be displayed.

The Rotch Traveling Scholarship will select one 1982 Rotch scholar to receive a stipend of \$13,000 for eight months of foreign travel. Written requests for application forms must be received no later than Jan. 8. Contact Norman C. Fletcher, FAIA, Secretary, Rotch Traveling Scholarship, 46 Brattle St., Cambridge, Mass. 02138.

The deadline for the 1982 honor awards program of the National Trust for Historic Preservation is Jan. 15. The program recognizes "achievements by individuals and organizations in preservation, conservation and restoration." Contact: 1982 Honor Awards, National Trust for Historic Preservation, 1785 Massachusetts Ave. N.W., Washington, D.C. 20036.

Qualified applicants are being sought for the dean of the college of architecture,

Arizona State University. Applications and nominations should be sent to ASU College of Architecture, Tempe, Ariz. 85281.

Three traveling fellowships for graduate architecture students, the first offered by the Skidmore, Owings & Merrill Foundation, have been awarded. The first award, \$10,000 for nine months of travel and study, went to Lawrence Mitsch of Cornell University. Bruce Lonnan, also of Cornell, received \$7,500 for five months, and Margot Alofsin of Yale University won \$5,000 for three months.

An Ohio State University architecture student, Rei-Lin Hsu, won a medal of distinction in the international student competition at the International Union of Architects congress in Warsaw this summer. His project, the only one receiving a prize for an American student, considered the problems caused by the need for the University of Pittsburgh to expand into the town of Oakland, including the processes of commercial and neighborhood revitalization and the impact of new buildings on the community.

Joseph D. Monticciolo, FAIA, who represents New York on the AIA board of directors, has been named a regional administrator for HUD.

Norman A. Homsy, AIA, has received an award from the Boston Metropolitan Area Planning Council for 15 years of "continuous and distinguished service."

Individuals involved in barrier-free design are invited to join the National Center for a Barrier Free Environment's nationwide network of consultants. Contact Network, National Center for a Barrier Free Environment, Suite 1006, 1140 Connecticut Ave. N.W., Washington, D.C. 20036.

Guidelines for solar energy retrofitting of buildings have been issued by the National Bureau of Standards. "Preliminary Guidelines for Condition Assessment of Buildings Being Considered for Solar Retrofit" is intended to assist in the appraisal of the impact of solar modifications on existing buildings. Copies are available for \$9.50 prepaid from the National Technical Information Service, Springfield, Va. 22161. Order by PB81-217812.

The Historic American Buildings Survey is bringing up to date its alumni mailing list prior to its 50th anniversary in 1983. HABS asks alumni to send a postcard with current address to: Carolyn Pitts, HABS, National Architectural and Engineering Record, National Park Service,

continued on page 91

dryvit SYSTEM, INC.
OUTSULATION

Cost-effective answer for a fast-track project.

The California Farm Bureau Headquarters (facing page) employed the Dryvit System on exposed exterior walls.

The System was field applied on exterior grade gyp. sheathing attached to steel studs.

Compared with conventional construction modes, Outsulation comes in at lower cost to begin with. And because of its speed in erection, overhead costs are also cut.

Look for Dryvit in the General Building File of Sweets Catalog under Section 7.13/Dr.

Wall section detail below:

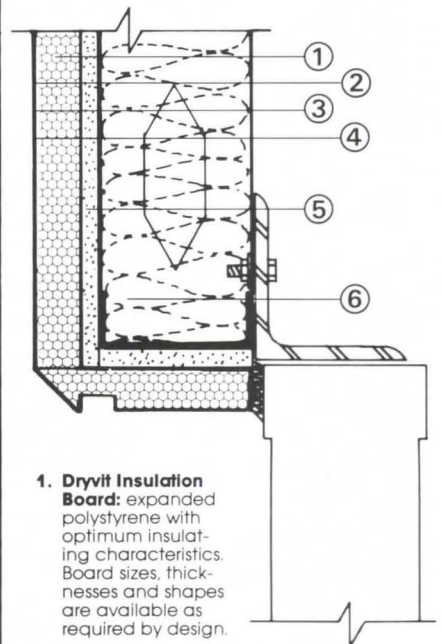

- 1. Dryvit Insulation Board:** expanded polystyrene with optimum insulating characteristics. Board sizes, thicknesses and shapes are available as required by design.
- 2. Dryvit Reinforcing Mesh:** specially woven and treated fiberglass fabric is embedded in the Primus coating to prevent surface cracking.
- 3. Dryvit Primus™/Adhesive:** Dryvit's unique plaster material mixed with Type 1 Portland Cement is used to adhere Dryvit Insulation Board to the approved substrate. It is also used to embed Dryvit Reinforcing Mesh on the face of the board.
- 4. Dryvit Quarzputz™ Finish:** one of four finishes available. This synthetic plaster material has high bond strength, integral color and an applied texture that provides a weather-proof jointless exterior surface.
- 5. 5/8" Exterior Gyp. Sheathing**
- 6. 4" Steel Studs @ 12" O.C.**

DRYVIT SYSTEM, INC.

420 Lincoln Avenue, Warwick, RI 02888
(401) 463-7150
Plant Locations:
Warwick, RI; Tulsa, OK; Columbus, GA

®
OUTSULATION

Energy Conservation Award winner uses 74% less energy thanks to imagination and Outsulation®.



ARCHITECTS: Pflueger Architects

For the award-winning headquarters of the California Farm Bureau, both the engineers and the architects took advantage of several natural and mechanical energy-conserving systems.

Air-conditioning is helped along by a passive evaporative-cooling and storage system. Domestic hot water and heating needs gain from a solar collection system augmented by the rejected heat produced by data-processing functions.

Earth berms, north facing skylights, window overhangs and a ventilation system under the building all play their parts in this energy-efficient design which uses 74% less heating and cooling energy than a comparable conventional structure.

And our own Dryvit Outsulation was the choice for construction of exposed exterior walls. This massive exterior insulation and finish system seals thermal bridges and minimizes thermal shock for optimum energy efficiency.

At the same time, it provides a beautiful



permanent finish in a variety of colors and textures. A finish that resists cracks and staining unlike conventional stuccos.

We're not surprised that this imaginatively-designed, energy-efficient building won its award. Saving energy with beautiful results is what Outsulation is all about. Thousands of commercial, industrial and domestic buildings are witness to its success.

Let us prove how Outsulation can work for you. Call or write, stating your application: new construction or retrofit.

Dryvit System, Inc.

420 Lincoln Ave., Warwick, RI 02888 (401) 463-7150 • Plant Locations: Warwick, RI; Tulsa, OK; Columbus, GA

**How many
people do you
know who have
had open
heart surgery?
Meet another.**



She's not 50 or 60. She's only 8. And this is her third operation. The open heart surgery will help her lead a normal life. Each year, 25,000 children are born with heart defects which can disable them for life.

The American Heart Association is fighting to reduce early death and disability from heart disease and stroke with research, professional and public education, and community service programs.

But more needs to be done.

You can help us save young lives by sending your dollars today to your local Heart Association, listed in your telephone directory.

**Put your
money where
your Heart is.**



Briefs from page 88

U.S. Department of the Interior, Pension Building, 440 G St. N.W., Washington, D.C. 20243

Louis Sauer, FAIA, head of the architecture department, Carnegie-Mellon University, since 1979, has been named director of the university's Institute of Building Sciences. Omer Akin, an associate professor, will head the architecture department.

The highest honor of the National Society of Professional Engineers has been awarded to two engineers in the same year, a first for NSPE. They are Kenneth A. Roe of Greenwich, Conn., and James F. Shivler Jr. of Jacksonville, Fla.

The Eighth World Conference on Earthquake Engineering will be held July 21-28, 1984, in San Francisco. For information on how to submit an abstract or register, contact the Earthquake Engineering Research Institute, 2620 Telegraph Ave., Berkeley, Calif. 94704.

The 1981 National Directory of Landscape Architecture Firms is available free from the American Society of Landscape Architects, 1900 M St. N.W., Suite 320-PR, Washington, D.C. 20036.

Thomas B. Muths, AIA, of Jackson, Wyo., has been appointed by President Reagan to the advisory council on historic preservation. Muths, a member of the AIA board of directors, served on the preservation council previously, from 1976-78.

PRODUCTS

Audio Exit Signs.

Exit signs are controlled by a micro-processor programmed to broadcast a variety of safety messages depending on the emergency situation. (Exit-U's, Inc., Easton, Conn. Circle 165 on information card.)

Barrier-Free Door Operator.

Automatic door operator designed for use by the physically disabled can be installed on any free swinging interior door and meets ANSI specifications. No auxiliary equipment or structural change is required. (Besam, East Windsor, N.J. Circle 175 on information card.)

Window Insulation Film.

A thin layer of aluminum sandwiched between transparent film laminate is adhered to windows with a pressure sensitive adhesive. The line includes reflective film in silver, bronze and gray for solar control and a water clear safety film for store windows and areas requiring greater

visibility. (Van Leer Plastics, Woburn, Mass. Circle 161 on information card.)

White Cedar Shingles.

Fire retardant treated Easter white cedar roof shingles are UL approved for residential and commercial applications. Shingles measure 3x16 inches. (Koppers Co., Inc., Pittsburgh. Circle 164 on information card.)

Electric Erasing Machine.

Hand-shaped electric machine features unbreakable housing, double insulation, a 10-foot cord and eraser refills. A lead pointer attachment is also available. (J.S. Steadtler, Inc., Chatsworth, Calif. Circle 163 on information card.)

Brick Pavers.

Split quarry and brick paving materials are available in ranges of plain or flashed earth colors with smooth or wire cut surfaces. (Summitville Tiles, Inc., Summitville, Ohio. Circle 162 on information card.)

Reflective Fabric.

Insalume is a combination of polyester film, foam and fiber bonded to metallic aluminum designed for heat reflective applications including solar awnings, greenhouse shades, passive solar devices and sun reflectors. (John Boyle & Co., New York City. Circle 172 on information card.)

Indirect Lighting System.

250-watt high pressure sodium lamps are mounted in Torchier fixtures for indirect interior lighting. Reflecting areas range from 140 to 170 square feet depending on location and reflective surface. (Westinghouse Electric Corporation, Bloomfield, N.J. Circle 171 on information card.)

Stone Veneer.

Concrete precast stone veneer can be installed over nearly any interior or exterior, existing or new surface. (Eldorado Stone Corporation, Kirkland, Wash. Circle 185 on information card.)

Bathing Units.

Institutional and handicapped bathing units are molded from a single sheet of acrylic reinforced plastic and feature fiberglass sealed grab bars, curtain rods and pressure valves. Seven models are available in a variety of colors and sizes. (Aquarius Industries, Inc., Nashville. Circle 168 on information card.)

Soft-Sided Storage System.

Closets, shelves and work stations are constructed of fabric and wooden frames. Units range from 34 to 66 inches in height. (Gold Metal, Inc., Racine, Wis. Circle 166 on information card.) □

INDEX

Volume 70
January-December 1981

A

Abercrombie, Stanley: [*The Architecture of Energy*] Jan 48; '*A Building of Great Integrity*.' Mid-May 104; *Buildings, Like Bodies, Have Skin*. Oct 49; *Burly Presence on a Significant Site*. Mid-May 192; *The Changing Skins of Helmut Jahn*. Oct 62; *Clarity Behind a Projecting Facade*. Mid-May 166; *The Company that Design Built*. Feb 54; *Curving Around a Crucial Corner*. Mid-May 208; *Furnishings*. Feb. 78, Mar 96, Apr 76, May 64, Mid-May 352, Je 66, Jy 66, Ag 64, Sep 84, Oct 100, Nov 80, Dec 80; *A Gallery of Architectural Dermatology*. Oct 52; *Glass Tower Brought to Life—and Light*. Mid-May 215; *In Florida They Call It 'Superstore'*. Jy 42; *The Latest Life of the Villard Houses*. Feb 68; *Marcel Breuer as Interior Designer*. Jy 50; *The Pros' Turn*. Sep 58; *Shining and Sinuous Structure*. Mid-May 182; *Toronto*. Dec 38; *When a House Becomes a Museum*. Ag 54; [bk rev] Mid-May 368, Je 60, Jy 72, 76

Acronyms. Jan 33

Adaptive use. *see* Preservation

Advertising. *see* Ethics

A/E procurement. ABA ordinance Feb 11; federal policy Dec 25; Massachusetts Feb 24; public buildings law Feb 11, Apr 14, May 20; Washington State Je 62

AIA Archives. Mid-Ag 19

AIA Component Awards. [Greer and Freeman] Mid-May 30

AIA Foundation. Feb 32; Jy 23; Mid-Ag 19

AIA Honor Awards 1981. [Greer] Mid-May 224

AIA 125th anniversary celebration. Dec 22

AIA Research Corporation. Mar 34

AIA structure. Jan 31; Mid-Ag 45; Nov 18

Algeria. earthquake resistant design Nov 59

"America in Ruins: Beyond the Public Works Pork Barrel." Je 15

American Bar Association. Feb 11

American Consulting Engineers Council. awards May 17, Je 70; energy statement Jan 44; ethics May 19; Iran claims Apr 17

American Correctional Association. Feb 34

American Library Association. Oct 40

American National Standards Institute. Mar 110

American Planning Association. Je 72

American Plywood Association. Je 70

American Society of Heating, Refrigerating and Air-Conditioning Engineers. Apr 15; Nov 13

American Society of Mechanical Engineers. Sep 22

Annual of New American Architecture. Mid-May issue

Antitrust cases. *see* Ethics

Architects Collaborative. Jan 34

Architectural Resources Cambridge Inc. Mid-May 240

Architectural and Transportation Barriers Compliance Board. Mar 104; Ag 18; Nov 84

Architecture of Energy. [Canty] Jan 47

Archives, AIA. Mid-Ag 19

Art galleries. *see* Museums

Art of Conservation. Jan 82

"Arts Edge." Nov 25

Aspen conference. *see* International Design Conference

Associated General Contractors of America. May 19

Association of Collegiate Schools of Architecture. Mar 12; Jy 31

Association of Student Chapters/AIA. Jan 38; Nov 31

Atlanta. Central Library Mid-May 192

Aviaries. New Orleans Apr 25

Awards. ACEC May 17; AIA/ACSA Mar 12; AIA/AFL-CIO May 14, Dec 25; AIA components Mid-May 30; AIA/ALA Oct 40; AIA medalists Jan 13, Feb 50, 54, Mar 12, 16, 23; APA Je 70, 72; BSI Apr 26; DOD May 17; downtowns May 25; firm Feb 40; honor Mid-May 224; Kemper Jan 27; Louis Sullivan Je 74; naval facilities Jan 38; NTHP Jy 31; Owens-Corning Jan 44, May 17, Dec 13; PCI May 17, Dec 16; Pritzker prize May 11; Red Cedar Sep 24; Reynolds May 14; 25-year Mar 9; UIA May 14; Young citation Jan 27

B

Babson, Seth. Mid-May 235

Baltimore. city council May 25; Inner Harbor Je 32

Baltimore's Lively Downtown Lagoon. [Canty] Je 32

Banking facilities. Guatemala City Mid-May 226; Security Bank, Wells, Minn. Jan 66; Trust & Savings Bank, Skokie, Ill. Mid-May 204

Bankruptcy. Ag 20

Banwell White & Arnold Inc. Jan 52

Barker, Michael. [bk rev] Mar 90, Jy 76, Oct 88, 93

Barnett, Jonathan. Mid-May 266

Barrier-free architecture. ATBCB Mar 104, Ag 18, Nov 84; BOCA Je 64

Basic Workings of the Institute. Mid-Ag 45

Bauhaus as You've Never Seen It. [Burns and Burns] Jy 54

Bender, Richard. Mid-May 221

Bendiner, Alfred. Sep 26

Benham-Blair & Associates. Jan 61

Benhamou, Reed. [bk rev] May 68, Ag 62

Bennett, David J. Mid-May 223

Bergstedt Wahlberg Bergquist Rohkohl. Jan 55

Berkeley, Ellen Perry. Mid-May 221

Bird, James W. Je 62

Birkerts, Gunnar. Mid-May 272

Birkerts, Gunnar & Associates. Mid-May 182

Bloom, Martin: *Cultural Colossi: Lincoln Center at 19*. Ag 32

Board of directors, AIA. Ag '81 meeting Nov 18; Dec '80 meeting Jan 27; installation of officers Jan 25; May '81 meeting Je 9; Reagan policy Apr 11; regional reports Feb 36

Bohlin Powell Larkin Cywinski. Jan 67; Mid-May 175

Bollinger, Stephen. Sep 13

Book reviews (signed): *American Architecture, 1607-1976*. Nov 70; *Architectural Graphic Standards*. Mid-May 359; *Architecture of Erik Gunnar Asplund*. Ag 60; *Beaux-Arts Estates: A Guide to the Architecture of Long Island*. Je 60; *Building Conversion and Rehabilitation: Designing for Change in Building Use*. Mid-May 366; *Cities of the American West: A History of Frontier Urban Planning*. Apr 70; *Classic American Railroad Stations*. Apr 72; *CM: The Construction Process*. Nov 73; *Collage City*. Jy 84; *Desert Housing: Balancing Experience and Technology for Dwellings in Hot Arid Zones*. Jan 90; *Design Primer for Hot Climates*. Jan 90; *Dream Houses: The Edwardian Ideal*. Ag 62; *Earth Sheltering: The Form of Energy and the Energy of Form*. Oct 88; *Eliel Saarinen: Finnish-American Architect and Educator*. Ag 60; *Energy-Efficient Buildings*. Jan 84; *Fair Women*. Oct 84; *Fin-de-Siècle Vienna, Politics and Culture*. Feb 74; *Financial Management for Architects*. May 70; *First One Hundred Years of Town Planning in Georgia*. Mid-May 366; *Frank Lloyd Wright's Hanna House: The Clients' Report*. Nov 64; *Furniture of the American Arts and Crafts Movement: Stickley and Roycroft Mission Oak*. Jy 72; *From Bauhaus to Our House*. Dec 72; *Furniture Designed by Architects*. Jy 60; *Gentle Architecture*. Jy 76; *George Nelson on Design*. May 68; *Golden Thread: 2500 Years of Solar Architecture and Technology*. Jan 84; *Grand Domestic Revolution: A History of Feminist Designs for American Homes, Neighborhoods and Cities*. Jy 96; *Historic American Buildings*. Jy 76; *Implementation of Project Management: The Professional's Handbook*. Nov 73; *Interior Planting in Large Buildings: A Handbook for Architects, Interior Designers and Horticulturists*. Ag 62; *Lars Sonck, 1870-1956*. Nov 76; *Le Corbusier Sketchbooks, Volume 1, 1914-1946*. Sep 67; *Life and Work of John Nash, Architect*. Sep 73; *Livable Streets*. Oct 93; *Managing Architectural and Engineering Practice*. May 70; *Mary Colter: Builder upon the Red Earth*. Je 58; *Mechanical and Electrical Equipment for Buildings*. Jan 84; *Metric Architectural Construction Drafting and Design Fundamentals*. Sep 71; *Metric Architectural Drawing: A Manual for Designers and Draftsmen*. Sep 71; *Modern Architecture: A Critical History*. Mid-May 368; *New Space for Women*. Je 60; *Olmsted South: The Old South Critic/New South Planner*. Mar 90; *Passive Design for Desert Homes*. Jan 90; *Passive Solar Design Handbook*. Jan 88; *Post-Modern Classicism: The Last Synthesis*. Sep 77; *Potential of Earth-Sheltered and Underground Space*. Oct 88; *Prehistoric Architecture in the Eastern United States*. Oct 86; *Preservation Comes of Age: From Williamsburg to the National Trust, 1962-1949*. Oct 88; *Preservation: Toward an Ethic in the 1980's*. Apr 72; *Proceedings: Earth Sheltered Building Design Innovation*. Mar 90; *Railway Architecture*. Ag 62; *Solar Heating Systems: Analysis and Design with the Sun-Pulse Method*. Nov 74; *Survey of Passive Solar Homes*. Jan 88; *Thermal Shutters and Shades: Over 100 Schemes for Reducing Heat Loss Through Windows*. Jan 90; *Twentieth Century Limited: Industrial Design in America*. Mid-May 363; *Utopian Craftsmen: The Arts and Crafts Movement from the Cotswolds to Chicago*. Ag 62; *Vienna to Los Angeles: Two Journeys. Letters of Louis Sullivan to R.M. Schindler; Letters Between R.M. Schindler and Richard Neutra*. Mar 88

Books, Etc., to Order Through the Institute. Mid-Ag 122

Boston. Fanueil Hall Marketplace Je 24; state building Mar 37

Boutelle, Sara Holmes. [bk rev] Je 58, Jy 96, Oct 84

Breuer, Marcel. Mar 12; Jy 50; Ag 11

Breuer, Marcel & Hamilton Smith. Mid-May 192

Budget, U.S. *see* Federal budget
 Building codes. *see* Codes
 'Building of Great Integrity.' [Abercrombie] Mid-May 140
 Building Officials and Code Administrators International. Je 64
 Building Owners and Managers Association International. Mar 37
 Building skins. Oct issue
 Building Stone Institute. Apr 26
 Buildings, Like Bodies, Have Skins. [Abercrombie] Oct 49
 Burley, Robert. Apr 14
 Burly Presence on a Significant Site. [Abercrombie] Mid-May 192
 Burns, Deborah Stephens: *The Bauhaus as You've Never Seen It*. Jy 54
 Burns, John Allen: *The Bauhaus as You've Never Seen It*. Jy 54
 Burt Hill Kosar Rittelmann Associates. Jan 34

C

California. Energy Commission Nov 13; state buildings Jan 58, 61
 California Polytechnic State University. Jan 41
 Caltenco Colorado, Inc. Mar 34
 Calthorpe, Peter. Mid-May 222
 Cambridge, Mass. MIT Athletic Facility. Mid-May 198
 Campbell, Robert: *Evaluation: Boston's 'Upper of Urbanity.'* Je 24; *Homage to a Catalanian.* Feb 50; Mid-May 272
 Canada. Montreal Dec 50; Toronto Dec 38; Vancouver Dec 60
 Canty, Donald: *The Architecture of Energy.* Jan 47; *Baltimore's Lively Downtown Lagoon.* Je 32; *Clients'-Eye View of a Wright Classic.* Nov 64; *A Message of Hope and Urbanism.* Je 23; *State of the Art.* Mid-May 138; *A Third Force in Architecture.* Feb 39; *Two Introductions and a Farewell.* Ag 23; *Urban Canada* Dec 35; *Vancouver.* Dec 60; *Variations on a Theme of Responsiveness.* Jan 61; *Welcome!* Nov 35; Mar 51, Apr 33, May 27, Jy 33, Mid-Ag 17, Sep 29
 Carlo, Giancarlo de. Apr 34
 Carmen, Gerald. Jy 11
 Catholic University of America. Jan 42
 Changing Skins of Helmut Jahn. [Abercrombie] Oct 62
 Charrettes. Jan 72
 Chicago. Hershman house Mid-May 242; North Loop Apr 86; Xerox Centre Mid-May 208
 Chrysalis Corporation. Mid-May 242
 Churches. *see* Religious architecture
 Cincinnati. house Mid-May 166
 Cities. *see* Urban affairs; also names of individual cities
 Citizens' Energy Project. Mar 37
 Civic centers. Madison, Wis. Mid-May 232
 Clarity Behind a Projecting Facade. [Abercrombie] Mid-May 166
 Clients. *see* A/E procurement
 Clients'-Eye View of a Wright Classic. [Canty] Nov 64
 Climatology, Minnesota. Mar 60
 Coatesville, Pa. Gaffney residence Mid-May 175
 Codes. barrier-free architecture Mar 104, Je 64, Ag 18, Nov 84; energy conservation Mar 104; firesafety Mar 31; New York City May 22
 Cohen, Marilyn S.: *A Tentative Step Toward Modernism.* May 49

Cold Springs Harbor, N.Y. Jones Laboratory Mid-May 252
 Coles, Robert Traynham. Jan 27
 College architecture. *see* Educational facilities
 Colorado Mountain College. Jan 66
 Commission of Fine Arts. Jan 38
 Committee on Federal Procurement of Architectural/Engineering Services. Apr 14; May 20
 Committees, AIA. long-range planning Jan 31, Je 9, Jy 23
 Community Techtonics. Apr 14
 Company That Design Built. [Abercrombie] Feb 54
 Competitions. ACSA energy Jy 31; AIA handbook Oct 36; ASC/AIA Jan 38; California affordable housing Dec 25; California state buildings Jan 61; Colorado resort Mar 34; exhibition design Oct 110; GSA May 20, Jy 11; *Japan Architect* Apr 26; Mobil poster Jan 82; New Orleans aviary Apr 25; Pittsburgh developer Jan 34; public buildings law Feb 11, 17, Apr 14, May 20; San Juan Capistrano library Apr 26; UIA Jan 38; Vietnam Memorial Je 17, Ag 47; *see also* Charrettes
 Components, AIA. Mid-May 30; *see also* names of individual components
 Computers. Dec 13
 Contacts for Help at AIA. Mid-Ag 52
 Convention, AIA. 1981 program Mar 12; 1982 program Oct 28; QUEST Feb 28, Je 10; resolutions Je 9; theme panels Je 9
 Cook, Jeffrey: *The Idiosyncratic Skins of Bruce Goff.* Oct 69; Mid-May 282
 Coping with a Legendary Winter Climate. [Wright] Mar 60
 Corning, N.Y. Corning Glass Museum Mid-May 182
 Correctional architecture. AIA/ACA exhibition Feb 34; federal facility construction Jy 12; Ramsey County Adult Detention Center, St. Paul. Mid-May 247
 Council of State Planning Agencies. Je 15
 Council on Development Choices. Jan 42
 Courthouses. Dec 16
 Criminal Justice Construction Reform Act. Jy 12
 Cultural centers. *see* Performing arts centers
 Cultural Colossi: Kennedy Center at 10. [Dean] Ag 24
 Cultural Colossi: Lincoln Center at 19. [Bloom] Ag 32
 Curving Around a Crucial Corner. [Abercrombie] Mid-May 208

D

Dallas. One Dallas Centre Mid-May 215
 Davis, Brody & Associates. Mid-May 198
 Dean, Andrea O.: [*The Architecture of Energy*] Jan 48; *Cultural Colossi: Kennedy Center at 10.* Ag 24; *Eero Saarinen in Perspective.* Nov 36; *Evaluation: Futuristic Gesture in Historic Society Hill.* Je 42; *Minnesota's Decidedly Unidentical Twins.* Mar 52; *Montreal.* Dec 50; *New City-Center Built Around an Atrium.* Je 50; *Pert and Plainspoken Sanctuary.* Mid-May 158; *Profile: Hardy Holzman Pfeiffer Associates.* Feb 40; *The Ripley Years: Expansion, Restoration.* May 54; *Simple but Sophisticated Farmhouse.* Mid-May 175; *The Smithsonian Presence on the Mall.* May 42; *University Arena Finely Crafted of Brick.* Mid-May 198; Ag 14
 Deaths. *see* Obituaries

Department of Energy. *see* Energy Department
 Department of Housing and Urban Development. *see* HUD
 Des Moines, Iowa. Des Moines Medical Building Mid-May 201
 Dibner, David R. Feb 11; Jy 12
 Directory of AIA Resources (Yellow Pages) Mid-Ag 69
 Dixon/Carter. Jan 51
 Documents, AIA. Ag 20; Mid-Ag 82, 136; Oct 32
 Downtown Research and Development Center. Feb 20; May 25
 Durham, Robert L. Jan 27

E

Earthquake resistant design. Nov 59
 Ecology. *see* Environment
 Economic Recovery Tax Act of 1981. Sep 13
 Educational facilities. Bauhaus, Weimar, Germany Jy 54; Colorado Mountain College center Jan 66; Hall of Languages, Syracuse University Mid-May 240; Hanover, N.H. school Jan 52; MIT Athletic Facility Mid-May 198; Telluride, Calif. school Jan 48
 Edwards, James B. Mar 102
 Eero Saarinen in Perspective. [Dean] Nov 36
 Ehrenkrantz, Ezra. Mid-May 278
 Elbansi, Barry. Mid-May 278
 ELS Design Group. Jan 61; Je 50
 Energy conservation. Jan issue; ACSA student competition Jy 31; AIA program Nov 18; audits Jan 44; codes Mar 104, Nov 13; DOE policy Je 14, Ag 18; energy use Feb 20; ICED statement Nov 16; lighting Je 64; Owens-Corning awards Jan 44, May 17, Dec 13; public acceptance Apr 82; research Ag 20; residential conservation service Nov 16; solar demonstration survey Dec 21; survey on policy Jy 24
 Energy Department. administrator Mar 102; audit program Jan 44; budget cuts Mar 40, Apr 11; energy policy Je 14, Ag 18; energy use Feb 20; passive solar demonstration program Jan 64; SERI report Je 13
 Energy, Human Ecology and Urban Design. [Villicco] Jan 72
 "Energy in Architecture." Nov 18
 Energy Policy in Perspective: Today's Problems, Yesterday's Solutions. Jy 24
 Environment. Jan 72; Oct 36
 Environmental Protection Agency. Feb 11
 Erickson, Arthur. Dec 60
 Ethics. ACEC May 19; AIA Apr 22, Oct 28; ASME Sep 22
 Eureka Springs, Ark. Thorncrowne Chapel Mid-May 140
 Evaluation: Boston's 'Upper of Urbanity.' [Campbell] Je 24
 Evaluation: A Building That Succeeds in Losing Itself. [LeCuyer] Apr 58
 Evaluation: Futuristic Gesture in Historic Society Hill. [Dean] Je 42
 Extraordinary Competition. [Freeman] Ag 47

F

Facades. Oct issue
 Federal agencies. Mar 102; *see also* titles of individual agencies
 Federal architecture. accessibility standards Ag 18; Museum of African Art Feb 20; public buildings law Feb 11, 17, Apr 14, May 20; *see also* GSA; HUD; Washington, D.C.

Federal budget. Mar 40; Apr 11; May 17, 19; Je 17; Sep 14; Nov 25
 Fellows, AIA. Apr 19
 Fellows, Honorary. *see* Honorary fellows, AIA
 Firesafety. Mar 31
 Fitch, James Marston. Sep 88
 Florida. Burdine's department stores Jy 42
 Florida Association/AIA. Je 62
 Foster Associates. Apr 58
Fourth Annual Review of New American Architecture. Mid-May issue
 Fraker, Harrison. Jan 65
 Freeman, Allen: *AIA Component Awards*. Mid-May 30; *An Extraordinary Competition*. Ag 47; *A Tradition of Clean-Scrubbed Local Governance*. Mar 78
 Freeman, Geoffrey, Associates. Je 50
 Friedman, Mildred. Mar 68
Furnishings. [Abercrombie] Feb 78; Mar 96; Apr 76; May 64; Mid-May 352; Je 66; Jy 66; Ag 64; Sep 84; Oct 100; Nov 80; Dec 80
Furniture by Architects. Jy 60

G
Gallery of Architectural Dermatology. [Abercrombie] Oct 52
 Galveston, Tex. Hendley building Mid-May 254
 Garden Grove, Calif. Crystal Cathedral Mid-May 148
 Gehry, Frank O. Mid-May 221
 Gilbert, Cass. Mar 74
 Girl Scout facilities. St. Paul Jan 55; Shelley Ridge, N.J. Jan 67
Glass Tower Brought to Life—and Light. [Abercrombie] Mid-May 215
 Glenwood Springs, Colo. Colorado Mountain College center Jan 66
Glossary of Acronyms and Abbreviations. Mid-Ag 59
 Goff, Bruce. Oct 69
 Gold medalist, AIA. Jan 13; Feb 50
 Goldberger, Paul. Mar 23
 Granby, Colo. Solar Plaza Jan 51
 Grant Liberty Development Group. Jan 34
 Grassroots, AIA. Mar 26
 Graves, Michael. Apr 26
 Green, Kevin. Mid-May 13; Nov 25
 Greer, Nora Richter: *AIA Component Awards*. Mid-May 30; *AIA Honor Awards 1981*. Mid-May 224; *Previews of Some Coming Attractions*. Jan 64; *St. Paul and the Uses of UDAG*. Mar 82; *Sleek Object in a Shaggy Neighborhood*. Mid-May 201; *Streamlined Bank in a Chicago Suburb*. Mid-May 204
 Gruzen & Partners. Mid-May 247
 GSA. administrator Jy 11; design competitions May 20, Jy 11; Marschall resignation Ag 20; public buildings law Feb 11, Apr 14, May 20; *see also* Federal architecture; Washington, D.C.
 Guatemala City. Banks Mid-May 226
 Gutheim, Frederick. [bk rev] Feb 74, Oct 88, Nov 76
 Gwathmey Siegel. Mid-May 166

H
 Hall, Spencer: *Urbino*. Apr 34
 "Handbook of Architectural Design Competitions." Oct 36
 Hanna, Paul and Jean. Nov 64
 Hanover, N.H. White Mountain School and Living Center. Jan 52

Hardy, Hugh G. Mid-May 278
 Hardy Holzman Pfeiffer Associates. Feb 40; Mid-May 232
 Harkness, Sarah P.: *The Solar Section: Starting Point of Design*. Jan 68
 Hartman-Cox. Mid-May 158, 238
 Hauf, Harold D. [bk rev] Mid-May 359
 Health facilities. Des Moines Medical Building Mid-May 201; Ray Graham Center, Roselle, Ill. Jan 50
 Herbert, Charles, & Associates. Mid-May 201
 Herman Miller, Inc. Feb 54; Mar 12
 Hickey, Gene E., & Associates. Jan 66
 Hinchman & Grylls. Apr 26
 Hoke, John R., Jr. [bk rev] Jan 84
Homage to a Catalanian. [Campbell] Feb 50
 Honor awards. *see* Awards
 Honorary fellows, AIA. Mar 23
 Honorary members, AIA. Feb 28
 Hooper, William D. [bk rev] May 70, Nov 73
 Hospitals. *see* Health facilities
 Hotels, fires Mar 31; Helmsley Palace, New York City Feb 68; New Yorker, Miami Beach Je 18; Willard, Washington, D.C. Nov 21
 Housing. Greek solar project Apr 27; California affordable housing competition Dec 25; President's Commission Dec 29, 32; transformed housing exhibition Dec 22; *see also* Residential architecture
 Housing for the elderly. St. Mary's Gardens, Oakland, Calif. Mid-May 244; The Oaks, Oak Park, Ill. Mid-May 250
 Houston. Texas Commerce Tower Je 70
 HUD. administrator Mar 102; budget cuts Mar 40, May 17; grants aide Sep 13; UDAG program Mar 82, Je 17, Oct 24

I
Idiosyncratic Skins of Bruce Goff. [Cook] Oct 69
In Florida They Call It 'Superstore.' [Abercrombie] Jy 42
 Interior Department. Mar 102
 Interior design. architects' furniture Jy 60; furnishings Jan 48, Feb 78, Mar 96, Apr 76, May 64, Mid-May 352, Je 66, Jy 66, Ag 64, Sep 84, Oct 100, Nov 80, Dec 80; Marcel Breuer Jy 50
 Intern-architect development program. Apr 19; Nov 31
 International Committee of Architectural Critics. Sep 88
 International Design Conference. Ag 14
 International Union of Architects. Jan 38; May 14
 International Union of Bricklayers and Allied Craftsmen. Je 74
 Interprofessional Council on Environmental Design. Nov 16
 Ipswich, England. Willis Faber & Dumas headquarters Apr 58
 Iran. claims against Apr 17
 Irwin, Robert. Apr 25

J
 Jahn, Helmut. Oct 62
 Johansen, John. Ag 40
 Johnson/Burgee. Mid-May 148
 Jones, E. Fay. Mid-May 140
 Jones, E. Fay, & Associates. Apr 26

K
 Kay, Jane Holtz: *The Year's Architectural (and Related) Ideas*. Mid-May 119

Kevin, Roche, John Dinkeloo & Associates. May 28
Key to Understanding Le Corbusier. [Sert] Sep 67
 Klein, Henry, Partnership. Je 74
 Knowles, Ralph. Mid-May 266
 Knoxville, Tenn. SunSphere. Apr 14
 Kober, Charles, & Associates. Jan 54
 Korab, Balthazar: *North Yemen: Land and Buildings*. Feb 58

L
 Laboratories. *see* Research facilities
Latest Life of the Villard Houses. [Abercrombie] Feb 68
 Lawrence, Robert M. Dec 22
 Le Corbusier. Sep 67; Nov 59
 LeCuyer, Annette: *Evaluation: A Building That Succeeds in Losing Itself*. Apr 58
 Legislation. energy conservation Nov 16; federal budget Mar 40, Apr 11, May 17, 19, Je 17, Sep 14, Nov 25; indoor air pollution Oct 24; liability insurance Apr 14; 97th Congress Feb 17; preservation Jan 33, May 19, Sep 13, Oct 24; prison construction Jy 12; public buildings law Feb 11, 17, Apr 14, May 20; urban tax incentives Ag 19
 Lewis, Andrew L., Jr. Mar 104
 Liability. Jan 33; Apr 14; Dec 32
 Library architecture. Atlanta Central Library Mid-May 192; San Juan Capistrano Apr 26
 Licensing. Je 9; Sep 22; Oct 40
 Lighting. Je 64
 Lin, Maya Ying. Je 17; Ag 17
 Loeffler, Jane Canter. [bk rev] Mar 90
 Long-span building panel. Apr 22; Jy 17

M
 Madison, Wis. Civic Center Mid-May 232
 Malpractice suits. Je 62
Marcel Breuer as Interior Designer. [Abercrombie] Jy 50
 Mardirosian, Aram H. Oct 28
 Mariani, Theodore F. Apr 11
 Marlin, William: *The Metropolitan Museum as Amended*. May 28; Mid-May 282
 Marquis Associates. Jan 61
 Marschall, Albert R. Ag 20
 Massachusetts Institute of Technology. Athletic Facility Mid-May 198
Materials Available Through Other Organizations. Mid-Ag 110
 Maves, Mark: *Urbino*. Apr 34
 Mayén, Paul. Ag 54
 McKim Mead & White. Feb 68; May 50
 McLean, Va. Immanuel Presbyterian Church Mid-May 158
 Membership, AIA. *see* Fellows, AIA; Honorary fellows, AIA; Honorary members, AIA
Message of Hope and Urbanism. [Canty] Je 23
 Metrication: *Coming Slowly but Inexorably Closer*. [Vonier] Apr 56
Metropolitan Museum as Amended. [Marlin] May 28
 Miami Beach. New Yorker Hotel Je 18
 Mies van der Rohe, Ludwig. Mar 9
Milestone Takes Shape in California. [Pastier] Jan 58
 Military facilities. naval competition Jan 38
 Miller, Herman, Inc. *see* Herman Miller, Inc.

Miller, William C. [bk rev] Ag 60
 Milwaukee Art Museum. Nov 80
 Minneapolis. Mar issue
Minnesota's Architectural Favorite Son. [Murphy] Mar 74
Minnesota's Decidedly Unidentical Twins. [Dean] Mar 52
 Mitchell, James E. [bk rev] Nov 74
 Mobil Corporation. Jan 82
 Montreal. [Dean] Dec 50
 Monuments. Vietnam Memorial Je 17, Ag 47
 Moore Grover Harper. Mid-May 252
 Morgan, Julia. Jan 41
 Murphy, C.F., Associates. Mid-May 208
 Murphy, Patricia: *Minnesota's Architectural Favorite Son*. Mar 74
 Museums. Corning Glass Museum, Corning, N.Y. Mid-May 182; Crocker Art Gallery, Sacramento Mid-May 235; Fallingwater, Bear Run, Pa. Ag 54; Metropolitan, New York City May 28; National Gallery of Art, Center for the Advanced Study in the Visual Arts, Washington, D.C. Mid-May 259; Smithsonian, Washington, D.C. May 42, 49, 54; see also Civic centers

N
 Nagle, Hartray & Associates. Mid-May 250
 Naisbitt, John. Nov 18
 National Association of Home Builders. May 17; Je 76
 National Association of Housing and Redevelopment Officials. May 17
 National Capital Planning Commission. Feb 20
 National Conference of States on Building Codes and Standards. Mar 104
 National Council of Architectural Registration Boards. certification requirements Je 9, Sep 22; convention resolutions Je 9; exam evaluation Oct 40; IDP Apr 19, Nov 31
 National Endowment for the Arts. federal budget cuts Mar 102, Je 17, Nov 25; TV series Mar 34
 National Historic Preservation Act. Oct 24
 National Housing Conference. May 17
 National Lighting Bureau. Je 64
 National Organization of Minority Architects. May 19
National Solar Energy Education Directory. Sep 88
 National Trust for Historic Preservation. awards Jy 31; inner city venture Je 20
 Nature centers. New Jersey Jan 56
 Naval Facilities Engineering Command. Jan 38
 Nelson, George: *Tribute to the Permissive Shell*. Jy 31; [bk rev] Dec 72
New City Center Built Around an Atrium. [Dean] Je 50
 New Jersey. nature center Jan 56
 New Orleans. park aviary Apr 25
New Prosperity: Building a Sustainable Energy Future. Je 13
 New towns. Eastwood, Roosevelt Island, New York City Mid-May 256
 New York Chapter/AIA. Feb 70; May 22
 New York City. Citicorp May 14; Eastwood, Roosevelt Island Mid-May 256; Lincoln Center Ag 32; Metropolitan Museum May 28; NBC headquarters Mar 34; prescriptive zoning May 22; Villard Houses Feb 68
 Newman/Lustig. Mid-May 204

Niedecken, George Mann. Nov 80
North Yemen: Land and Buildings. [Korab] Feb 58

O
 Oak Park, Ill. The Oaks Mid-May 250
 Oakland, Calif. St. Mary's Gardens Mid-May 244
 Obituaries: Breuer, Marcel Ag 11; Campioli, Mario E. Feb 82; Collins, Peter Sep 91; Daly, Leo A. Ag 70; Dinkeloo, John Ag 70; Douglas, Lathrop Mar 110; Greeley, Mellen Clark Dec 87; Harkness, Albert Je 76; Hunter, Leonard L. Oct 112; Johanson, Perry B. Sep 91; Keck, George Fred Jan 94; Llewellyn-Davies, Richard Dec 87; Mayer, Albert Dec 87; Rambusch, Harold W. May 78; Smith, Anthony Peter Feb 82; Speer, Albert Oct 112; Wachsmann, Konrad Jan 92; Waechter, H.H. Je 76
 Office buildings. Boston, mixed use Mar 37; California state Jan 58, 61; Girl Scout Council, St. Paul Jan 55; Hendley building, Galveston, Tex. Mid-May 254; indoor pollution Mar 34; National Permanent Building, Washington, D.C. Mid-May 238; One Dallas Centre, Dallas Mid-May 215; Professional Park, Princeton, N.J. Jan 65; Solar Plaza, Granby, Colo. Jan 51; space occupancy Mar 37; Willis Faber & Dumas headquarters, Ipswich, England Apr 58; Xerox Centre, Chicago Mid-May 208
 Oklahoma. Quail Spring shopping mall Jan 54
 Oklahoma City. Mummers Theater Ag 40
 Omnibus Budget Reconciliation Act. Sep 14
 Osman, Mary E. Je 10
 Owens-Corning Fiberglas Corporation. Jan 44; May 17

P
 Packard, Robert T. [bk rev] Sep 71
 Passive solar energy. see Solar energy
 Passive Solar Energy Council. Ag 20
 Pastier, John: *A Milestone Takes Shape in California*. Jan 58; *Soaring Space Wrapped in Metal and Glass*. Mid-May 148; *Something Else Altogether in Oklahoma City*. Ag 40; *The Sophisticated Skins of Cesar Pelli*. Oct 74
 Pei, I.M., & Partners. Mid-May 215, 259
 Pelli, Cesar. Oct 74
 Performing arts centers. Kennedy Center, Washington, D.C. Ag 24; Lincoln Center, New York City Ag 32; Mummers Theater, Oklahoma City Ag 40; see also Civic centers
 Periodicals. Architectural. Nov 35
Pert and Plainspoken Sanctuary. [Dean] Mid-May 158
 Peters, Clayberg & Caulfield. Mid-May 244
 Peterson, Charles E. [bk rev] Sep 73
 Pettengill, George E. [bk rev] Apr 72, Ag 62
 Pevsner, Nikolaus. Mar 23
 Philadelphia. NewMarket Je 42
 Photography, Architectural. Mar 51; Sep issue
 Pierce, Samuel R., Jr. Mar 102
 Pittsburgh. developer competition Jan 34
 Piven, Peter A. [bk rev] May 70
 Plano, Ill. Farnsworth house Mar 9
 Policies, AIA. Apr 22; see also specific subjects
 Polls, Architectural. Jan 42
 Pollution, Indoor. Mar 34, 37; Apr 15; Oct 24
 Polshek, James Stewart. Feb 72
 Posters. Jan 82
 Postoccupancy evaluations. case studies Nov 55; Faneuil Hall, Marketplace, Boston Je 24; NewMarket, Philadelphia Je 42; primer Nov

52; Willis Faber & Dumas headquarters, Ipswich, England Apr 58
 Prentice, Tim. Mid-May 223
 Preservation. AIA honor awards Mid-May 232, 235, 240, 242, 250, 252, 254; Bauhaus Jy 54; Chicago's North Loop Apr 86; federal budget cuts May 19; Historic Green Springs Sep 20; legislation Jan 33, Apr 11, Sep 13, Oct 24; tax incentives Mar 104, May 19, Sep 13; UDAG review Oct 24; Villard Houses, New York City Feb 68
Previews of Some Coming Attractions. [Greer] Jan 64
 Price, Edison. Mar 12
Primer on Postoccupancy Evaluation. [Zimring and Reizenstein] Nov 52
 Princeton, N.J. Professional Park Jan 65
 Pritzker prize. see Awards
Profile: Hardy Holzman Pfeiffer. [Dean] Feb 40
 Procurement. see A/E procurement
 Professional conduct. see Ethics
Pros' Turn. [Abercrombie] Sep 58
 Public buildings law. Feb 11, 17; Apr 14; May 20
 Public works projects. Je 15

Q
 Quality Urban Environment Study Team (QUEST). Feb 28; Je 10

R
 Rainey, Reuben M. [bk rev] Apr 70, Ag 62
 Rapp & Rapp. Mid-May 232
 Reagan Administration. energy policy Ag 18; federal budget cuts Mar 40, Apr 11, May 17, 19, Je 17, Sep 14, Nov 25; secretaries Mar 102
 Recertification. see Licensing
 Recreational facilities. MIT Athletic Facility, Cambridge, Mass. Mid-May 198; nature centers, New Jersey Jan 56
 Red Cedar Shingle & Handsplit Shake Bureau. Sep 24
 Regional/Urban Design Assistance Teams. Feb 28; Ag 68; see also Quality Urban Environment Study Team
 Rehabilitation. see Preservation
 Rehabilitation and Historic Preservation Tax Incentives Act of 1981. May 19
 Reizenstein, Janet E.: *A Primer on Postoccupancy Evaluation*. Nov 52
 Religious architecture. Crystal Cathedral, Garden Grove, Calif. Mid-May 148; Immanuel Presbyterian Church, McLean, Va. Mid-May 158; Thornycrown Chapel, Eureka Springs, Ark. Mid-May 140
 Research facilities. Jones Laboratory, Cold Springs Harbor, N.Y. Mid-May 252
 Residential architecture. Cincinnati house Mid-May 166; Dana house, Springfield, Ill. Sep 14; Fallingwater, Bear Run, Pa. Ag 54; Farnsworth house, Plano, Ill. Mar 9; Gaffney house, Coatesville, Pa. Mid-May 175; Hanna house, Stanford, Calif. Nov 64; Hershman house, Chicago Mid-May 242
 Resolutions, AIA. Je 9
 Resources, AIA. Mid-Ag issue
Resources from Suppliers and Manufacturers. Mid-Ag 144

- Reynolds awards. *see* Awards
 Reynolds Metals Co. Mar 23
 Riley, Jefferson B. Mid-May 222
 Ripley, S. Dillon, II. May 54
 Ripley Years: *Expansion, Restoration*. [Dean] May 54
 Roselle, Ill. Ray Graham Center Jan 50
 Rosekrans & Broder, Inc. Mid-May 235
 Roth, Emery, & Associates. Feb 68
 Rouse Co. Je 24, 32
 Rowe, Colin. Mar 12
 Rules of conduct, AIA. *see* Ethics
- S**
 Saarinen, Eero. Nov 36
 Sacramento. Crocker Art Gallery Mid-May 235; state buildings Jan 58, 61
 San Juan Capistrano, Calif. library Apr 26
 St. Paul. Mar issue; Girl Scout Council headquarters Jan 55; Ramsey County Adult Detention Center Mid-May 247
 St. Paul and the Uses of UDAG. [Greer] Mar 82
 Salaries. Sep 88
 San Jose, Calif. state building Jan 61
 Sargent-Webster-Crenshaw & Folley. Mid-May 240
 Sauer, Louis. Je 42
 Scholarships, AIA. Feb 32; Jy 23; Dec 13
 Schools. *see* Educational facilities
 Schuman, Lichtenstein, Claman & Efron. Apr 26
 Selection of architects. *see* A/E procurement
 Sert, Josep Lluís: *A Key to Understanding Le Corbusier*. Sep 67; Jan 13; Feb 50
 Sert, Jackson & Associates. Mid-May 256
 Shell architecture. Jy 34
 Shelley Ridge, N.J. Girl Scout Center Jan 67
 Shepley Bulfinch Richardson & Abbot. Feb 20
Shining and Sinuous Structure. [Abercrombie] Mid-May 182
 Shopping centers. Fanueil Hall Marketplace Je 24; Harborplace, Baltimore Je 32; NewMarket, Philadelphia Je 42; Quail Spring, Okla. Jan 54; Troy, N.Y. Je 50; *see also* Stores
 Short & Ford. Jan 65
Simple but Sophisticated Farmhouse. [Dean] Mid-May 175
 Skidmore, Owings & Merrill. Mid-May 226; Ag 32
Skinnovation. [Villicco] Oct 58
 Skins, Building. Oct issue
 Skokie, Ill. Trust & Savings Bank Mid-May 204
Sleek Object in a Shaggy Neighborhood. [Greer] Mid-May 201
 Smith-Miller, Henry. Mid-May 272
 Smithsonian Associates. Mar 23
 Smithsonian Institution. May 42, 49, 54
Smithsonian Presence on the Mall. [Dean] May 42
 Snelson, Kenneth. Mar 16
Soaring Space Wrapped in Metal and Glass. [Pastier] Mid-May 148
 Solar energy. Jan issue; DOE passive solar program Jan 64; DOE survey Dec 22; Greek housing project Apr 27; pollution Mar 37; SERI report Je 13; SERI surveys Dec 21; *see also* Energy conservation; Energy Department
 Solar Energy Research Institute. Je 13
- Solar Section: Starting Point of Design*. [Harkness] Jan 68
Something Else Altogether in Oklahoma City. [Pastier] Ag 40
Sophisticated Skins of Cesar Pelli. [Pastier] Oct 74
Sourcebook. Oct 36
Sources for AIA Contracts and Forms. Mid-Ag 136
 Spiers, Thomas. Apr 11
 Springfield, Ill. Dana house Sep 14
 Staff, AIA. Jan 31; Feb 34; Ag 23
 Stamps, Architectural. Oct 24
 Stanford University. Hanna house Nov 64
State of the Art. [Canty] Mid-May 138
 Stirling, James. May 11
 Stockton, Calif. Ag 68
 Stone, Edward Durell. Ag 24
 Stores. Burdine's department stores, Fla. Jy 42; *see also* Shopping centers
Streamlined Bank in a Chicago Suburb. [Greer] Mid-May 204
 Stubbins, Hugh, & Associates. May 14
Stylistic Dogma vs. Seismic Resistance. [Wang] Nov 59
 Sunup Ltd. Jan 66
 Syracuse University. Hall of Languages Mid-May 240
- T**
 Taft Architects. Mid-May 254
 Task forces, AIA. evaluation Apr 19; IDP Nov 31
 Taxes. Mar 104; May 19; Ag 19; Sep 13
 Television series. Mar 34
Tentative Step Toward Modernism. [Cohen] May 49
 Telluride, Calif. school Jan 48
 Telluride Designworks. Jan 48
 Testimony, AIA. energy conservation Je 14; Reagan fiscal policy Apr 11
 Theaters. *see* Performing arts centers
Third Force in Architecture. [Canty] Feb 39
 Thompson, Benjamin, & Associates. Je 24, 32
Tile Council of America. Jan 38
 Toronto. [Abercrombie] Dec 38
 Torre, Ace. Apr 25
 Total Environment Action. Jan 56
 "Toward Safer Long-Span Buildings." Jy 17
Tradition of Clean-Scrubbed Local Governance. [Freeman] Mar 78
 Transportation Department. Mar 104
Tribute to the Permissive Shell. [Nelson] Jy 34
 Troy, N.Y. Je 50
 Turnbull, William, Jr. Mid-May 221
 Twenty-five year award. *see* Awards
 2010 Visions. Mid-May 220
Twins' Thriving Cultural Climate. [Wascoe] Mar 68
Two Introductions and a Farewell. [Canty] Ag 23
 Tych, Michael. Oct 110
- U**
 UDAG. *see* Hud
University Arena Finely Crafted of Brick. [Dean] Mid-May 198
 Upton, Dell. [bk rev] Mid-May 366, Oct 86, Nov 70
 Urban affairs. Baltimore Je 32; Boston Je 24; CDC report Jan 42; downtowns Feb 20, May 25; energy Jan 72; inner cities Je 20; Philadelphia Je 42; QUEST Feb 28, Je 10; R/UDATs Feb 28, Ag 68; tax incentives Ag 19; Troy, N.Y. Je 50; Urbino, Italy Apr 34;
- Washington, D.C. Oct 19, Nov 21; *see also* HUD; New towns, and names of individual cities
Urban Canada [Canty] Dec 35
 Urban Design Associates. Jan 34
 Urbino. [Maves and Hill] Apr 34
- V**
Vancouver. [Canty] Dec. 60
 Van der Ryn, Calthorpe & Partners. Jan 72
 Van der Ryn, Sim. Jan 58, 61
 Van Vliet, Wellem. [bk rev] Je 60
Variations on a Theme of Responsiveness. [Canty] Jan 61
 Villecco, Marguerite N.: *Energy, Human Ecology and Urban Design*. Jan 72; *Skinnovation*. Oct 58
 Von Eckardt, Wolf. [bk rev] Sep 77
 Vonier, Thomas: *Metriation: Coming Slowly but Inexorably Closer*. Apr 56
 Vosbeck, R. Randall. energy audits Jan 44; energy goals Je 14; energy research Ag 20; installation Jan 25; 1981 program Jan 25
- W**
 Waechter, H.H. [bk rev] Jy 84
 Wagner, Richard. [bk rev] Apr 72, Mid-May 366
 Walker Art Center. Mar 68
 Wallace, Roberts & Todd. Oct 19
 Wang, Marcy Li: *Stylistic Dogma vs. Seismic Resistance*. Nov 59
 Wascoe, Dan, Jr.: *The Twins' Thriving Cultural Climate*. Mar 68
 Washington, D.C. capitol master plan Oct 19; Kennedy Center Ag 24; Museum of African Art Feb 20; National Gallery of Art, Center for Advanced Study in the Visual Arts Mid-May 259; National Permanent Building Mid-May 238; Pennsylvania Ave. Jan 41, Apr 84, Nov 21; Smithsonian May 42, 49, 54; Vietnam Memorial Je 17, Ag 47; *see also* Federal architecture
 Wasserman, Barry. Jan 58
 Watt, James G. Mar 102
 Weese Seegers Hickey Weese. Jan 50
 Weimar, Germany. Bauhaus May 54
Welcome! [Canty] Nov 35
 Wells, Minn. Security Bank Jan 66
When a House Becomes a Museum. [Abercrombie] Ag 54
 White, Horatio Nelson. Mid-May 240
 Wilson, Richard Guy. [bk rev] Mar 88, Mid-May 363
 Wolfe, Tom. Dec 72
 Wright, Bruce N.: *Coping with a Legendary Winter Climate*. Mar 60
 Wright, Frank Lloyd. Ag 54; Sep 14; Nov 64
- Y**
Year's Architectural (and Related) Ideas. [Kay] Mid-May 119
 "Yellow Pages." Mid-Ag issue
 Yemen. Feb 58
- Z**
 Zimring, Craig M.: *A Primer on Postoccupancy Evaluation*. Nov 52
 Zoning. May 22 □

ADVERTISERS

Michael J. Hanley

Publisher

Michael M. Wood

Director of Marketing

Jesse Sims

Manager, Production and Business

1735 New York Ave. N.W.

Washington, D.C. 20006

(202) 626-7484

Lisa Hoke

Director of Operations

Suzanne Maggi

Assistant to the Publisher

Renie H. Plimpton

Advertising Assistant

ADVERTISING SALES OFFICES

Washington, D.C. (202) 626-7471

1735 New York Ave. N.W.

Washington, D.C. 20006

Philadelphia (215) 639-3731

George T. Broskey, Eastern Manager

3 Neshaminy Interplex, #301

Trevese, Pa. 19047

New York City (212) 736-2131

Jeanne S. Cohen

390 Fifth Ave., Suite #407

New York, N.Y. 10018

Pittsburgh (215) 639-3731

George T. Broskey

3 Neshaminy Interplex, #301

Trevese, Pa. 19047

Ohio (201) 729-4937

Thomas R. Crow

46 Main Street

Sparta, N.J. 07871

New England/New York State

(617) 632-8185

Robert L. Tegen

87 State Road West

Westminster, Mass. 01473

Chicago (312) 663-4116

James A. Anderson, Western Manager

53 West Jackson Boulevard, #356

Chicago, Ill. 60604

Atlanta (214) 352-9273

J. Thomas Dorsey

3840 Valley Lawn

Dallas, Tex. 75229

St. Louis (314) 569-3210

Richard D. Grater

1466 Summerhaven

St. Louis, Mo. 63141

San Francisco (415) 348-8222

Jules E. Thompson

1290 Howard Ave., #303

Burlingame, Calif. 94010

Circle No.	Page No.	Circle No.	Page No.
28	American Airline Freight System 77	38	Haws Drinking Faucet Co. Cov. 3
	<i>Bozell & Jacobs, Inc.</i>		<i>Mandabach & Simms/Pacific</i>
4	American Gas Assoc. 7	1	Howmet Aluminum Corp. Cov. 2-p. 1
	<i>J. Walter Thompson Co.</i>		<i>Crume & Assoc., Inc.</i>
21	Arco Chemical Co. 34	11	Koh-I-Noor Rapidograph 23
	<i>Kight, Haunty, Inc.</i>		<i>KR Adv.</i>
14	Arrigoni Computer Graphics 26-27	3	Levolor Lorentzen 4-5
	<i>Botsford Ketchum Inc.</i>		<i>Muller, Jordon, Weiss, Inc.</i>
15	Atlas Door Corp. 28	22	LOF (Libby-Owens-Ford) .. 70-71
	<i>American Ad Group</i>		<i>Campbell-Ewald Co.</i>
25	Bilco Co. 75	29	MCAUTO Computer Services 78
	<i>McLaughlin, DelVecchio & Casey, Inc.</i>		<i>J. Walter Thompson</i>
18	Canadian General Tower ... 30-31	17	McGraw-Hill Book Co. 30
	<i>Gemini Enterprises</i>		<i>Media Buying Services Int'l. Inc.</i>
8	Columbia Lighting, Inc. 12	5	Nucor Corp. (Vulcraft) 8-9
37	Dryvit Systems, Inc. 88-89		<i>Faller, Klenk & Quinlan, Inc.</i>
	<i>Fern/Hanaway, Inc.</i>	39	Olympic Stain Cov. 4
16	Eastman Chemical Products, Inc. 29		<i>Kraft Smith</i>
	<i>Geers Gross Adv., Inc.</i>	23	PSAE (Masterspec) 11
35	Envirospec Inc. 87		<i>Clarkson Assoc.</i>
	<i>Harold Warner Adv., Inc.</i>	10	Red Cedar Shingle & Handsplit Shake Bureau 24
19	Fairfax Co. 32		<i>Cedarcrest Adv.</i>
	<i>The Cooper/Lecky Partnership, Architects</i>	13	Repla Ltd. 21
76	Formica Corp. 17-19		<i>Ray Gentle Communications Ltd.</i>
	<i>Michael R. Abramson Assoc., Inc.</i>	33	Sculpture Placement 85
2	Forms & Surfaces 2	7	Shand, Morahan Co. 10
	<i>Sherrill Broudy Assoc.</i>		<i>Hakanson & Assoc.</i>
6	Georgia Marble 76	31	Simplex Ceiling Corp. 79
	<i>Corporate Communications & Marketing, Inc.</i>		<i>Leschin Assoc.</i>
24	Gold Bond Bldg., Prod. Div. Nat'l Gypsum Co. 75	20	Steel Joist Institute 33
	<i>Faller, Klenk & Quinlan</i>		<i>Batz, Hodgson, Neuwoehner, Inc.</i>
27	Gold Bond Bldg., Prod. Div. Nat'l Gypsum Co. 77	36	Stern-Williams Co., Inc. 87
	<i>Faller, Klenk & Quinlan</i>		<i>Ad Mar Co.</i>
30	Gold Bond Bldg., Prod. Div. Nat'l Gypsum Co. 79	12	Von Duprin, Inc. 20
	<i>Faller, Klenk & Quinlan</i>		<i>MZB, Inc.</i>
26	Grinnell Fire Protection System 73		
	<i>Hutchins/Y & R, Inc.</i>		
9	Guardian Glass 14-15		
	<i>Baker, Abbs & Klepinger, Inc.</i>		

There are 2 sides to every fountain



THE SIDE YOU SEE

- Chrome-plated bubblers
- Circular stainless steel receptors
- Self-closing lever valve handles
- Extended receptor for wheelchair access
- Stainless steel backplate and louvered grille

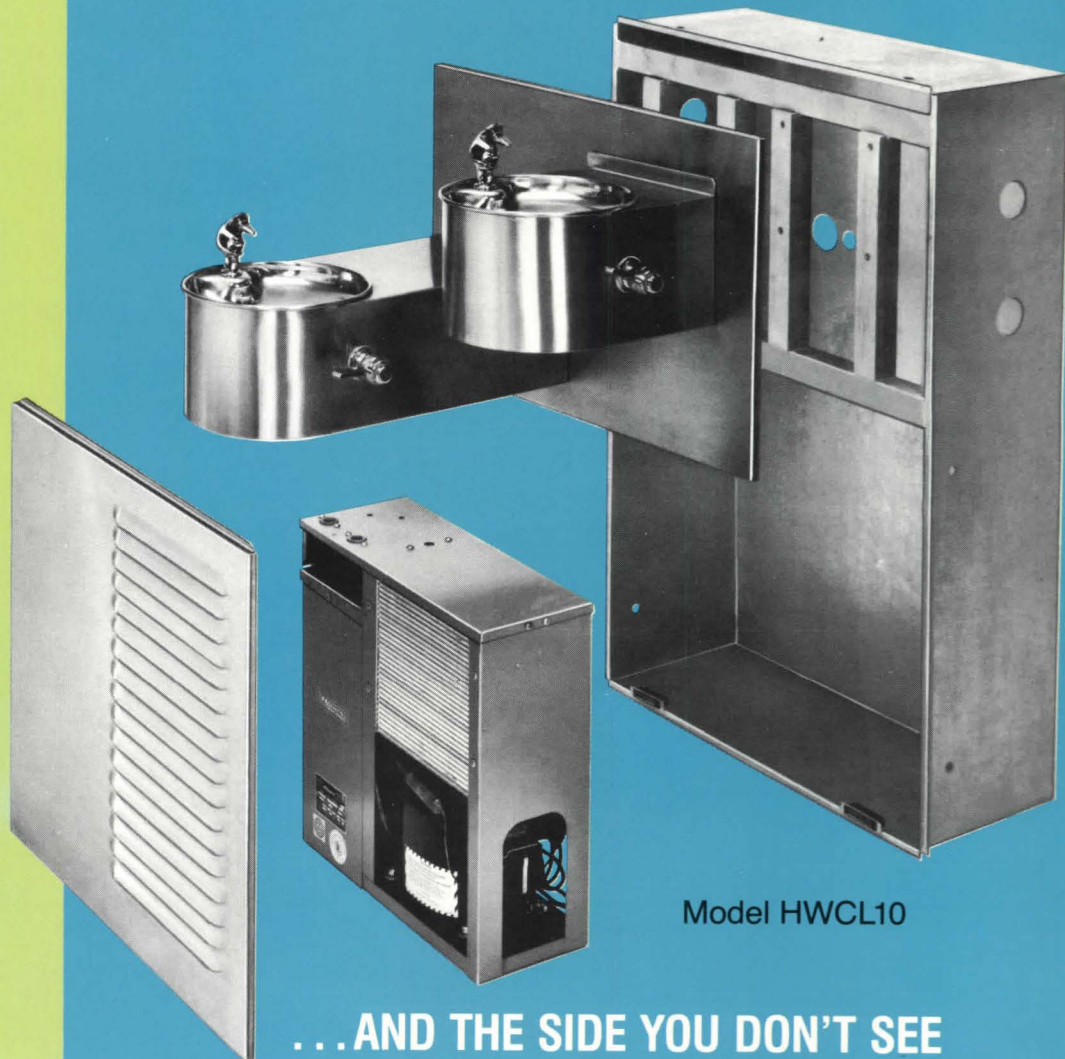

Model HWCL10

...AND THE SIDE YOU DON'T SEE

- Angle steel support struts
- Steel mounting box
- Automatic stream control
- Vandal-resistant bottom plates
- 9.5 gallon per hour chiller with 1/4 hp compressor

At Haws we make the side you see stylish, strong and practical. We put that same quality workmanship in where you don't see it, too, because we know the hidden features pay off in performance. Look at the HWCL10. You don't see the steel mounting box with angle steel struts that provide added support and strength. You don't see the automatic stream control that keeps the flow arched and even... or the vandal-resistant bottom plate* that keeps vital parts safe from mischief makers. And you don't see the efficient chiller unit that can satisfy 114 thirsty users per hour with a cold drink of water. Haws takes care to include these and other special features — because even when you don't see them, you do benefit!



HAWS DRINKING FAUCET COMPANY
P.O. Box 1999 Berkeley, California 94701
Circle 38 on information card

*Optional at extra cost.

Haws®

Beauty that's more than skin deep.



Architect: Wendell Lovett, FAIA, Seattle, Washin

Enhance and protect the natural beauty of wood with Olympic Oil Stain. Olympic *penetrates* wood to protect from within. Rich linseed oil and micro-milled pigments soak down into the fibers, giving wood a deep, uniform finish that stays beautiful no matter how wet or how dry the weather gets.

For additional information, consult your Sweet's Catalog. Or write Olympic: Dept. P, 2233 112th Avenue N.E., Bellevue, WA 98004.

**Penetrates to
protect wood
beautifully.**



Circle 39 on information card