

A R C H I T E C T U R A L
L I G H T I N G

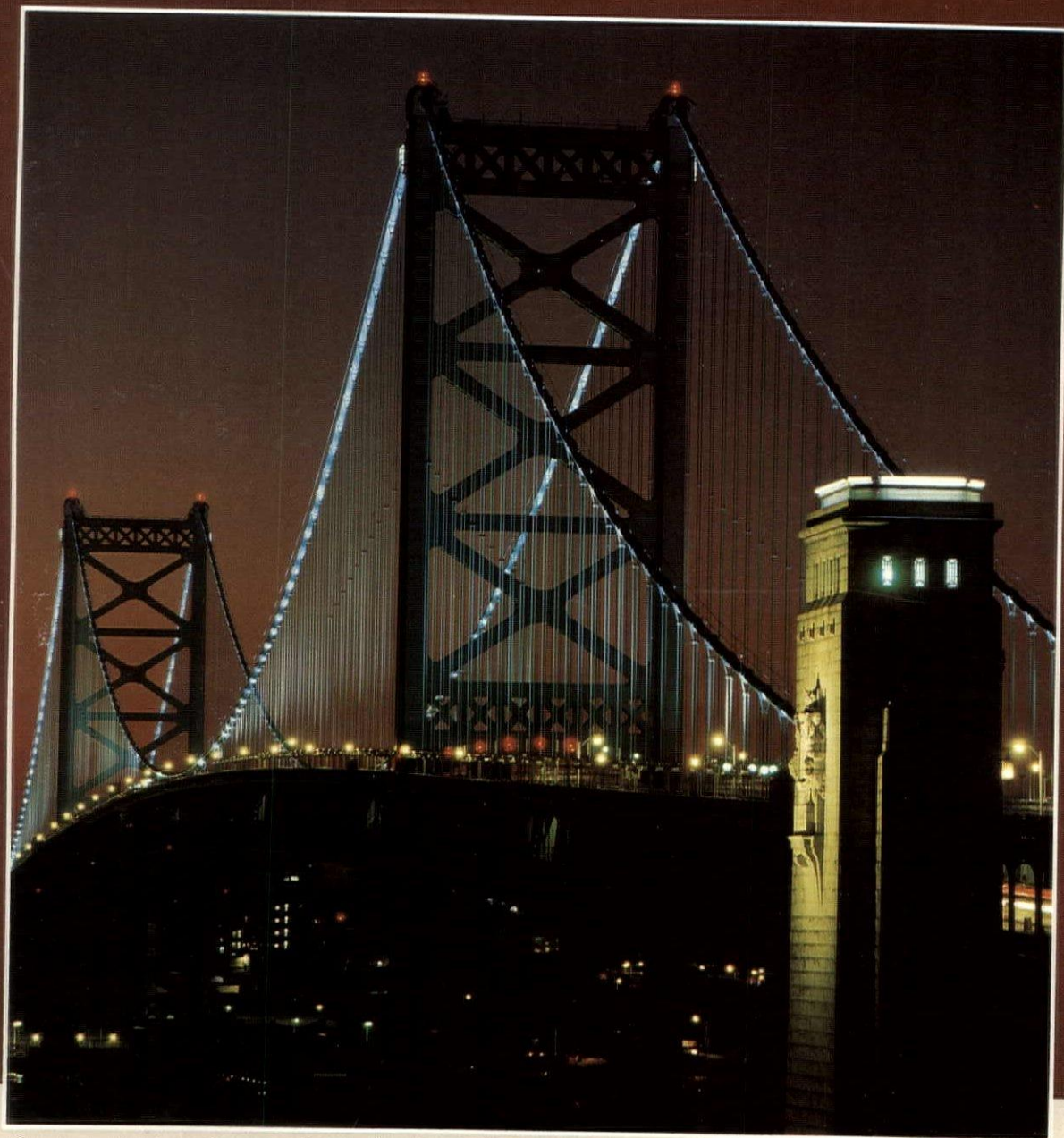

January 1988
Five Dollars

Move up to Hubbell, and see the forest and the trees.



Discover the enchanted world of Hubbell landscape lighting, because we live in a world shaped by light. More than any other stimulus, we respond to light . . . to evoke a mood, an atmosphere, an emotion. Soft light, muted light, starlight, candlelight. Yet, what light does to us in only part of the story. The real



excitement lies in what *we* can do with light.

With Hubbell LightscapingSM you'll discover how contemporary lighting fixtures and techniques improve safety and security; enhance the aesthetic quality of a commercial building, home, garden or pool; and how a minimal investment in lighting can yield maximum enjoyment of outdoor living spaces and leisure time facilities.

Let Hubbell enlighten you to the possibilities of landscape lighting.

Send for our Lightscaping brochure. Write Hubbell Lighting Division, Hubbell, Inc.,

2000 Electric Way, Christiansburg, VA 24073. Or call (703) 382-6111. In Canada, 870 Brock Road South, Pickering, Ontario L1W1Z8. Or call, (416) 839-1138.

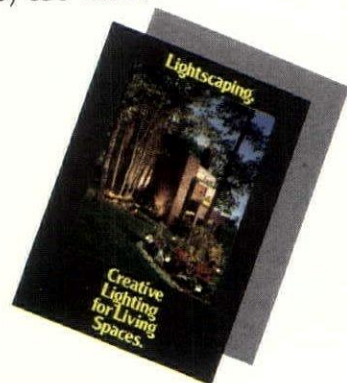

Lighting Division

Providing tomorrow's lighting today.

Circle 1

The Glow Top.
By Gardco.

By day....a refined
landscape element.
By night....a soft
glowing form with
high performance
downlight.

Eighteen inches in
diameter — propor-
tioned for applications
8 to 20 feet. HID
lamps to 250 watts.
And protected by two
patents.

For more information
circle below or call:

800/227-0758

415/357-6900 (CA)

THOMAS
INCORPORATED

Circle 2

 Gardco Lighting

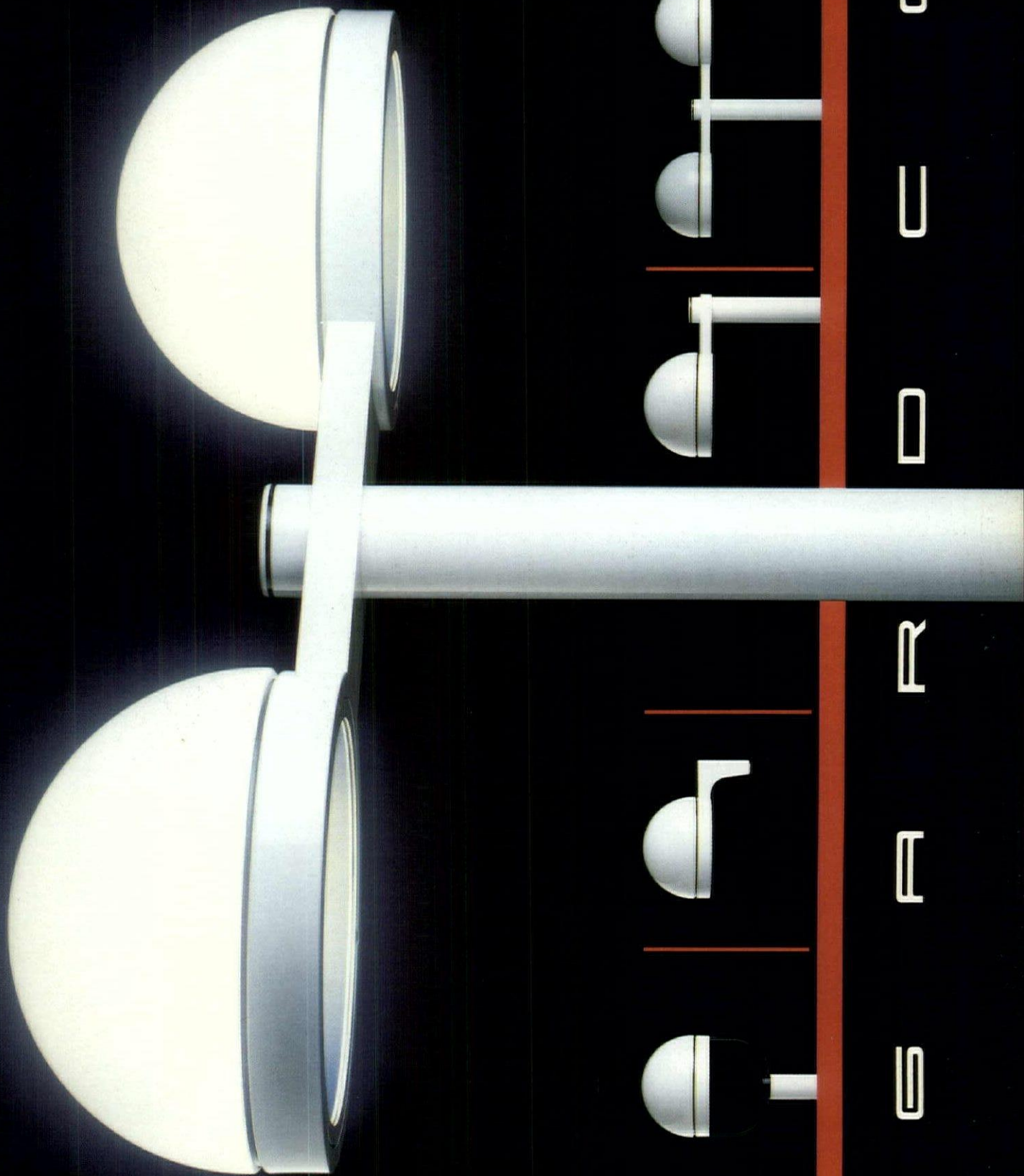

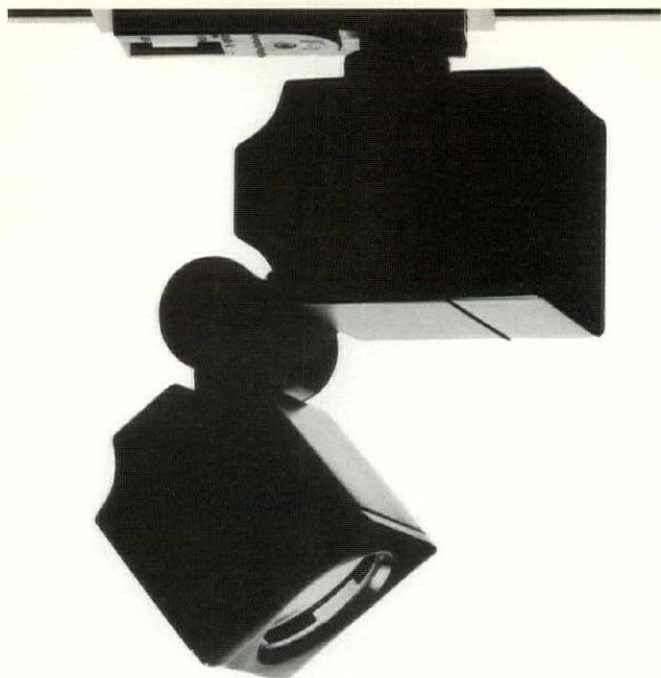

THE LIGHT FOR ALL REASONS

This exquisite new low voltage light uses state-of-the-art MR-16 miniaturization techniques to achieve a great variety of intensities and beam spreads.

For an information kit, write on your letterhead to:
Lighting Services Inc. 150 East 58 St.,
New York, NY 10155



Circle 3



MERLIN

Not much to look at is it? Ah, but it has hidden powers. Just screw in a PAR38 lamp of 90 watts and it will put out a high intensity beam of 150 watts. Magic! For an information kit, write on your letterhead to:
Lighting Services Inc. 150 East 58 Street
New York, NY 10155



Circle 4

ARCHITECTURAL LIGHTING

Architectural Lighting (ISSN 0894-0436) is published monthly by Cassandra Publishing Corporation, an affiliate of Aster Publishing Corporation.

Editorial Offices: 859 Willamette Street
P.O. Box 10460
Eugene, OR 97440-2460
(503) 343-1200

Sales Offices: 195 Main Street
Metuchen, NJ 08840-2737
(201) 549-3000

Circulation Offices: P.O. Box 10955
Eugene, OR 97440-9895
(503) 343-1200

Publisher Edward D. Aster
Associate Publisher Michael Aster

Editor Charles Linn, AIA
Associate Editor M. Jane Ganter
Senior Assistant Editor Gareth Fenley
Assistant Editor Susan Degen

Graphic Designer Lee Eide
Production Manager Stephen Roberts
Advertising Coordinator Helen Hornick

Director of Advertising Robert Joudanin

SUBSCRIPTIONS: U.S.: 1 year (12 issues), \$49; 2 years (24 issues), \$90; 3 years (36 issues), \$129. Foreign surface rates: 1 year (12 issues), \$89; 2 years (24 issues), \$170; 3 years (36 issues), \$249. Foreign airmail: add \$60 per year to foreign surface rates. Single copy price: U.S., \$5; foreign countries, \$10.

REPRINTS: Reprints of all articles in this magazine are available (250 minimum). Write or call: Aster Marketing Services, 859 Willamette Street, P.O. Box 10460, Eugene, OR 97440-2460, USA, (503) 686-1211.

CHANGE OF ADDRESS: Allow 4 to 6 weeks for change; provide old mailing label and new address, including ZIP or postal code. **POSTMASTER:** Send address changes to *Architectural Lighting*, P.O. Box 10955, Eugene, OR 97440-9895.

© 1988 Cassandra Publishing Corporation. All rights reserved. Reproduction in part or whole without written permission is strictly prohibited. *Architectural Lighting* and the logo appearing on the cover of this magazine are registered trademarks of Cassandra Publishing Corporation.

BPA membership applied for September 1986.

Second class postage paid at Eugene, Oregon, and at additional mailing offices.

Aster Publishing Corporation:

Chief Executive Officer, Edward D. Aster; **President,** Richard L. Rudman; **Senior Vice President,** Michael Aster; **General Manager,** Noel R.O. Smith; **Editorial Director,** David Webster; **Senior Production Editor,** Karen Carlson; **Production Director,** L. Ghio Imburgio; **Circulation Director,** Linda Pierce; **Marketing Manager,** Archie A. Anderson.

*Innovative
Solutions for
Outdoor Lighting*

HADCO®

PERFORMANCE PLUS

- All die-cast alum. construction
- IES type III cut-off
- Tempered glass lens
- Variety of light sources
- Variety of mounting configurations
- Available in 2 sizes
- Mounting heights from 3' to 35'

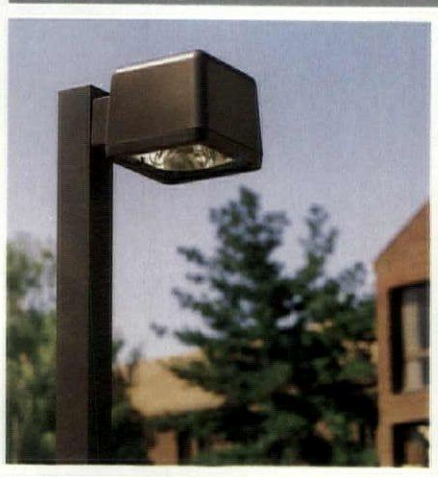
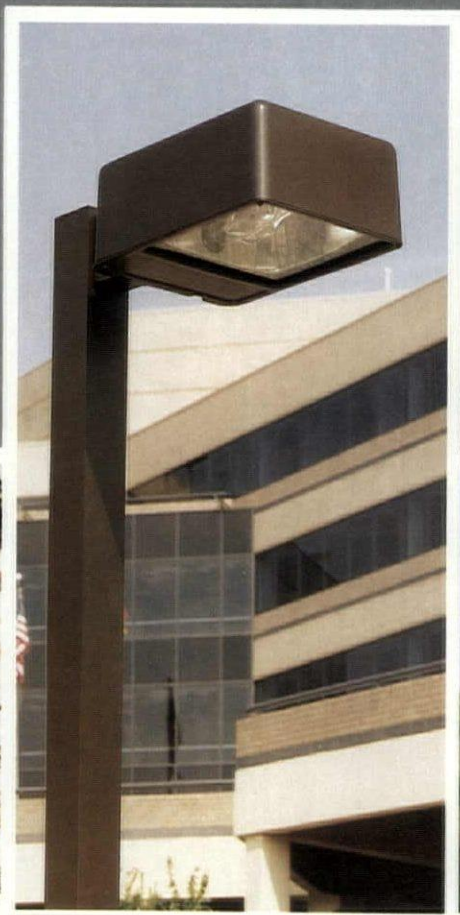

- Sharp 75° cut-off wall fixture
- Bronze polyester powder coat finish
- Complete photometric data and lighting layouts available upon request
- U.L. listed for wet locations

SHARP CUT-OFF LUMINAIRES

HADCO® a GENYTE company

ARCHITECTURAL OUTDOOR LIGHTING P.O. BOX 128 • 100 CRAFTWAY, LITTLESTOWN, PENNSYLVANIA 17340 PHONE (717) 359-7131

Circle 5

Hanover[®]

LANTERN

ARCHITECTURAL
LIGHTING

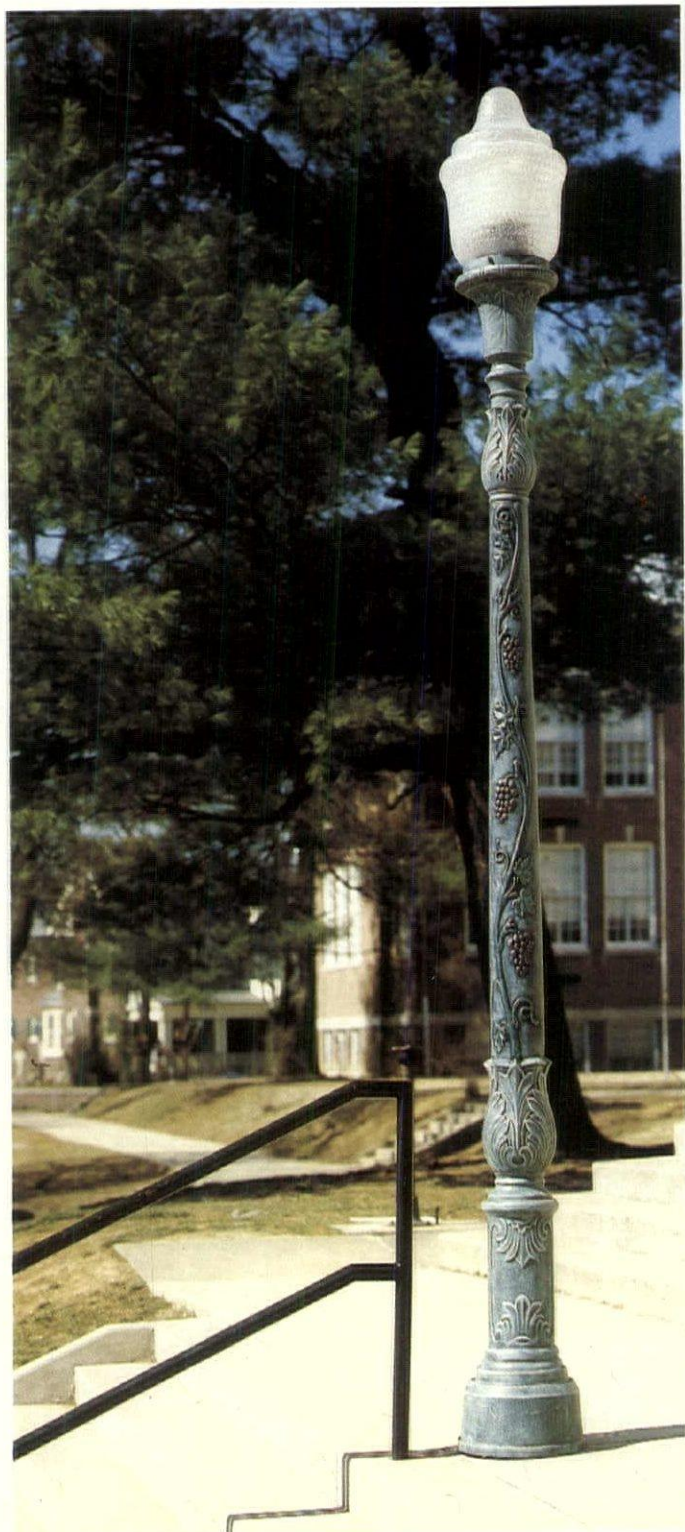

Cast Aluminum,
Energy Efficient H.I.D. Lighting

Hanover[®] A DIVISION OF
LANTERN | HOFFMAN PRODUCTS, INC.
470 HIGH ST. HANOVER, PA 17331

Circle 6

Editorial Advisory Board

Charles C. Benton

Assistant Professor of Architecture
University of California at Berkeley
Faculty Research Associate
Lawrence Berkeley Laboratory
Berkeley, California

Alfred R. Borden IV, IALD

Senior Lighting Designer
The Kling-Lindquist Partnership, Inc.
Philadelphia, Pennsylvania

Carol Chaffee, IALD, IES

Associate
Hammel Green and Abrahamson, Inc.
Minneapolis, Minnesota

David L. DiLaura, FIES

Director of Engineering
Lighting Technologies, Inc.
Associate Professor of Civil, Environmental,
and Architectural Engineering
University of Colorado
Boulder, Colorado

M. David Egan, PE, FASA

Associate Professor of Architecture
Clemson University
Clemson, South Carolina

Raymond Grenald, FAIA

Senior Partner
Grenald Associates, Ltd.
Los Angeles, California

David Lord, PhD, MIES

Professor of Architecture
California Polytechnic University
San Luis Obispo, California

Mojtaba Navvab, MIES

Assistant Professor of Architecture
College of Architecture and Urban Planning
University of Michigan
Ann Arbor, Michigan

Fran Kellogg Smith, ASID, CSI

Founder
Luminae Lighting Consultants Inc.
San Francisco, California

Architectural Lighting's Editorial Advisory Board represents various facets of the lighting professions, and members were chosen for their expertise. EAB members may suggest article subjects, review manuscripts or projects, and answer questions as they arise.

PROJECTS AND MANUSCRIPTS: All submissions are handled with reasonable care, but the publishers assume no responsibility for the safety of artwork, photographs, or manuscripts. Every precaution is taken to ensure accuracy, but the publishers cannot accept responsibility for the accuracy of information supplied or for any opinion expressed herein.

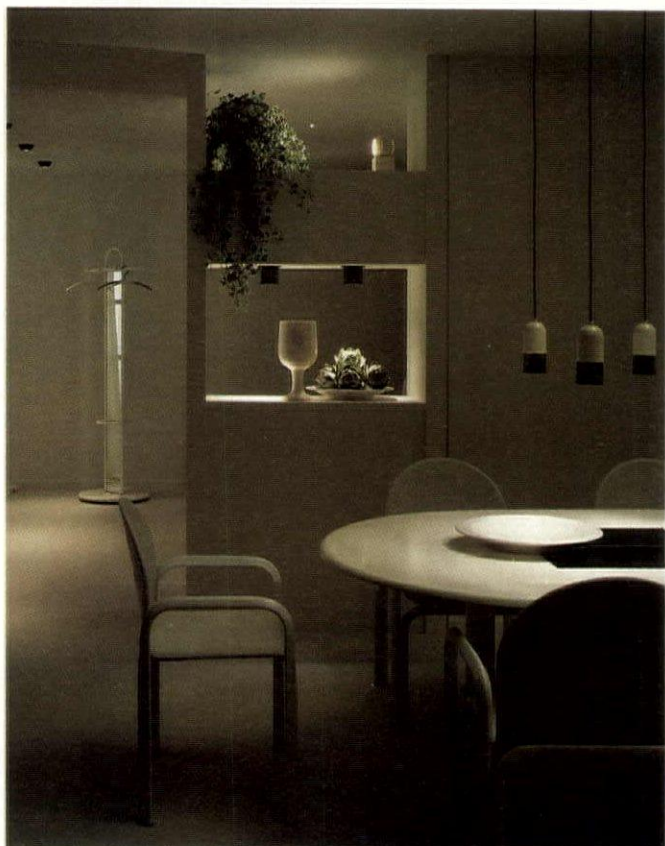

Mark Darley, Photographer

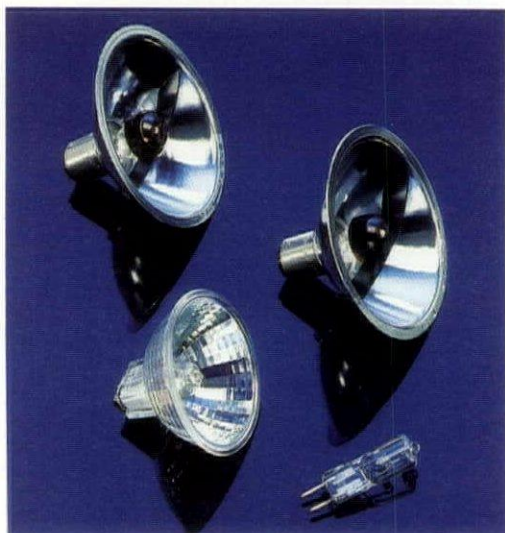

Complete. Unique. Innovative. Halogen.

OSRAM is artistry in light. With lamps for track lights, downlights, wall washers, uplights, floodlights and many applications your creativity will inspire. Available with or without reflector, in low or standard voltage, from 5 to 1500 watts. With a palette ranging from cool through warm, brilliant through soft, you can paint *your* lighting picture.

Uniquely innovative with exceptional design compatibility and range, OSRAM halogen. Call or write today for more information: OSRAM Corporation, P.O. Box 7062, Jeanne Drive, Newburgh, NY 12550, (914) 564-6300; Toll-free, 1-800-431-9980.

OSRAM

Technology Brought to Light

12114 Sherman Way, North Hollywood, CA 91605, (818) 982-4723; Toll-free, 1-800-458-5584; In So. CA, 1-800-247-8675; OSRAM Canada Limited, 6185 Tomken Road, Mississauga, ONT. L5T 1X6, Canada, (416) 673-1996; Fax: 416 673 3281

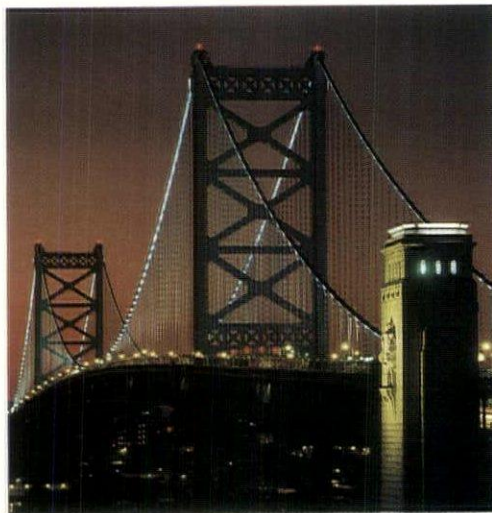

Cover Story

- 22 Animated electric light enlivens Benjamin Franklin Bridge *G.C. Izenour and S. Izenour*
-

Articles

- 30 Demonstration a key tool for lighting designer *C. Linn*
32 Lighting-only renovation gives training facility a new look *J. Brown and G. Steffy*
-

Statements

- 14 Target Productions draws clients with high-end image *G. Fenley*
16 Flexible, economical lighting: Smart for art's sake *S. Mallery*
18 Second life for 60-year-old department store building *G. Fenley*
20 Fewer fixtures, more light for school athletics
-

Columns

- 37 Software Reviews *D. Lord*
39 Lighting Graphics *S. Mills*
41 The Lighting Design Professional *J. Benya*
45 The Daylighting Department *N.M. Lechner*
-

Departments

- 10 From the Editor
12 Letters
48 Book Reviews
50 Product Showcase
60 Product Literature
69 Calendar
70 Manufacturer Credits
70 Advertiser Index



XL2000

Why Not The Best?



TrimbleHouseTM

4658 Old Peachtree Road □ Norcross, GA 30071
Toll Free 1-800-241-4317 □ In Georgia 1-800-243-9393 or 404-448-1972

Circle 8

Custom Design, Quality, Service and Commitment Since 1962.

THE CHIC-LITE

- A stylish fluorescent.
- Superior light output.
- Perfect with any decor.
- Four popular sizes.



Brodwax Lighting

30 Alabama Avenue, Island Park, N.Y. 11558
(516) 889-0250 or call
TOLL FREE 1-800-841-4666 (outside NY state)

**CALL OR WRITE FOR A FREE
20 PAGE COLOR CATALOG.**

Circle 9

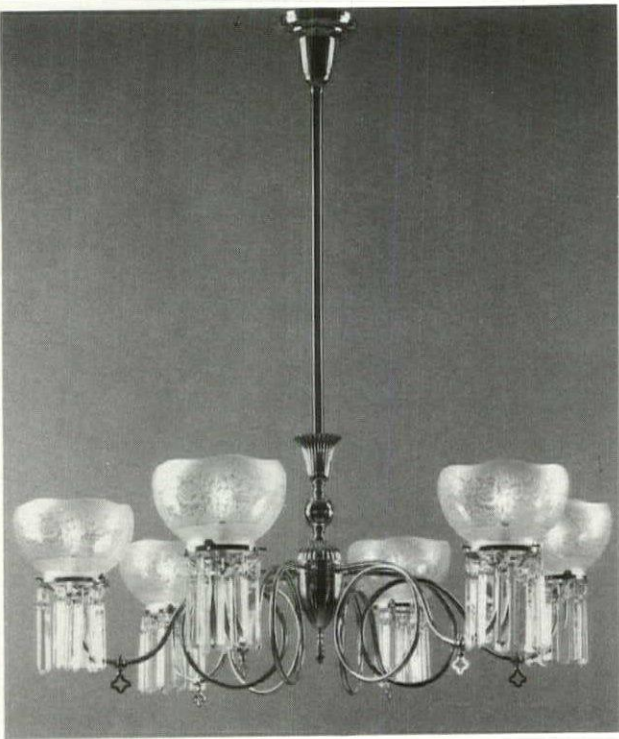

OWELL'S, INC.
A TRADITION OF FINE LIGHTING

P.O. Box 295, 490 Gate 5 Road, Sausalito, CA 94966 415-332-4933

Circle 10

From the Editor

I know what you're thinking. *Another* bridge? The people just published a bridge in July. A bridge is a bridge, right?

Yes and no. The Golden Gate and Benjamin Franklin Bridges do have similar structural designs. But one of the things that makes lighting design exciting is looking at the splendid results designers can get by taking entirely different approaches to very similar problems, like, "Light this bridge."

The lighting design for the Golden Gate Bridge was based on documents written by bridge architect Irving Morrow. Although the design relies on today's lighting technology, the designers took extraordinary pains to re-create what they felt Morrow would have (and could have) done had his intentions come to fruition in 1937.

In this issue, George and Steve Izenour discuss the animated lighting design for the Benjamin Franklin Bridge. It is, for its scale, undoubtedly without precedent anywhere. Imagine, illuminated suspension cables now chase the train from Philadelphia to Camden and back again — and that's not all. The antics of this lighting design are limited only by the imagination of the person programming a computer that lights an 11-foot scale model of the bridge, built especially for the purpose.

There you have it. Two terrific and altogether different solutions to a basic lighting design problem. The solution for the Golden Gate Bridge certainly dignifies one of the nation's grandest designs. The solution for the Benjamin Franklin Bridge goes in another direction — it symbolizes the freedom designers have to technically develop anything they can conceive, and the freedom of the public to enable them to execute it. The Izenours' lighting design is a fitting symbol for a city where they've had a lot of great ideas about freedom and liberty over the years. Hooray for the Izenours! And hooray for Philadelphia!

Charles Linn, AIA

ONCE AGAIN, DRAMATIC OUTDOOR LIGHTING IS IN THE SPOTLIGHT.

Announcing The Second Annual Night Beautiful Contest.

Beautifully lit buildings attract more attention. Especially when Florida Power & Light and the Illuminating Engineering Society stage their annual salute. Any building with exceptional lighting design in the FPL service area can be entered.

For information and entry forms that could put your building in the spotlight, call Dolores Puls, (305) 227-4323. Deadline: April 1, 1988. Sponsored by IES in cooperation with FPL.



Letters

Retrofit reflectors: Look before you leap

Sid Pankin's column on retrofit reflectors in the October 1987 issue of *Architectural Lighting* is by far the best and most comprehensive article on this subject that I have seen in print, including the papers on the subject in the Society journals. I particularly like the way in which Sid covered the precautions to be considered in an evaluation of the effect of a retrofit with these products.

In the process of evaluating this approach myself, I went through my files and information submitted by others in order to find out just what performance could be expected in the "best case" situation, comparing the most efficient luminaire with a white paint reflector and the most efficient one with a specular retrofit reflector. I think it is interesting to note that a well-designed luminaire will give about the same efficiency with a good (88 percent) paint coat or with a high-reflectance specular reflector.

The interesting point, and the one that comes up frequently, is that in the effort to obtain maximum downward candlepower, most of the designers neglect the spacing criterion, and therefore cause severe problems when installing such reflectors in existing luminaires. Sid has carefully called that to attention, and cemented it with his recommendations as to locations for test readings. This should stop some of those birds who change the reflector and then hold a light meter directly under the unit to prove their point.

I have been recommending to some of the manufacturers of these reflectors that they examine the installation first and then use reflectors designed to give the spread, and therefore the spacing criterion, needed to maintain uniformity. Some are trying to do so, but they are having trouble with the "throw it straight down" boys. Sid's column should help.

Bill F. Jones, PE
Consulting Illumination Engineer
Lighting Research Laboratory
Orange, California

This is your forum

Architectural Lighting is your forum for lighting issues. We invite your letters on subjects of interest to our readers.

Address your letters to:
Charles Linn, AIA, Editor
Architectural Lighting
859 Willamette Street
P.O. Box 10460
Eugene, OR 97440

New EAB members

Architectural Lighting is proud to introduce new members of the Editorial Advisory Board. Members are chosen for their expertise in various facets of the lighting professions. EAB members may suggest article subjects, review manuscripts or projects, and answer questions as they arise.

■ Alfred R. Borden IV, IALD

Alfred R. Borden IV, IALD, is an associate and senior lighting designer with The Kling-Lindquist Partnership, Inc., Philadelphia. He has designed lighting for health care facilities, corporate offices, laboratories, process areas, sports facilities, and computer centers.

Borden received a bachelor's degree in theater from Temple University and a master of fine arts degree in theatrical design from New York University's Tisch School of the Arts. He began his career in lighting design by lighting theater and television productions.

Borden has conducted classes in lighting design for the Illuminating Engineering Society and Temple University and is currently an instructor in the School of Architecture at Drexel University. He is a corporate member of the International Association of Lighting Designers, a past section president of the Illuminating Engineering Society, and a member of the United States National Committee of the Commission Internationale de L'Eclairage. Borden's articles on lighting design have been published in several magazines.

■ Carol Chaffee, IALD, IES

Carol Chaffee is an associate with Hammel Green and Abrahamson, Inc., Minneapolis, and group leader of lighting design for the firm. Her responsibilities at HGA include

new lighting system design, existing system analysis, and specifications.

Chaffee was educated at the University of Wisconsin, Milwaukee, and at Marquette University. She entered technical theater work, worked for two years with a mechanical and electrical engineering consulting firm, and joined HGA in 1981. Her architectural lighting design experience includes corporate projects, religious and health care facilities, hotels, and retail, residential, and hospitality spaces.

Chaffee holds memberships in IALD and IES. She has participated on national committees for both organizations and has been active in the Designers Lighting Forum of the Twin Cities. Her lighting designs have received three International Illumination Design Awards.

■ Mojtaba Navvab, MIES

Mojtaba Navvab is an assistant professor of architecture and director of the Lighting and Daylighting Simulation Facility at the University of Michigan. He earned bachelor's and master's degrees in architecture at the University of California at Berkeley. In 1981, he became staff scientist at the Lawrence Berkeley Laboratory and lectured in the university's department of architecture. He joined the Michigan faculty in 1985.

Navvab's research and practice includes independent consulting. He emphasizes quantitative and qualitative evaluation of luminous environments through use of physical and computer-generated models. He is the author or coauthor of many publications about lighting, daylighting, and energy use. Navvab currently chairs the technical committee in CIE (Division III, interior environment and lighting) on scale-model photometry for interior lighting. ■

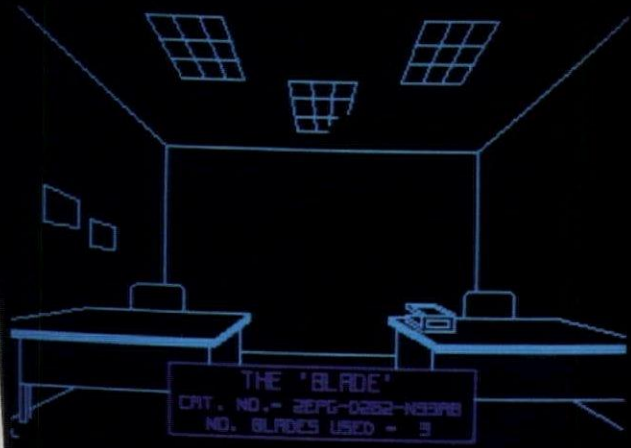

THE BLADE™ SERIES 2EP
2 x 2 GRID TRIGGER
FLOATING DOOR

Series 2EP - 2EPG-0262-1039P

THE 'BLADE'
CAT. NO. - 2EPG-0262-1039P
NO. BLADES USED - 3

FOR CUT TABLE

PERCENTS OF UTILIZATION

FUNCTION CODE

H. E. WILLIAMS, INC.
Carthage, Missouri

A Revolutionary New Light Concept



Now you can be more creative before with THE BLADE™ from H.E. Williams. THE BLADE™ offers efficient, low-glare lighting which you can customize to your own unique design. Choose from a wide selection of louver colors, sizes, and trims.



Put together a creative plan for fluorescent lighting utilizing THE BLADE™, a revolutionary new concept from H. E. Williams. THE BLADE™ offers efficient, low-glare lighting which you can customize to your own unique design. Choose from a wide selection of louver colors, sizes, and trims.



For more information contact:
H.E. WILLIAMS, INC.
Dedicated to Excellence in Lighting

831 W. Fairview Ave., Box 837, Carthage, MO 64836-0837

Circle 12

Target Productions draws clients with high-end image



© 1987 RICHARD MANDELKORN



© 1986 RICHARD MANDELKORN

Project: Target Productions
Location: Charlestown, Massachusetts
Architect: Symmes, Maini & McKee Associates
Lighting Consultant: Paul Chabot, Boston Light Source
Photos: Richard Mandelkorn

Exceptional service and technology are worth little without an impressive image to shape and reinforce client perceptions. At Target Productions, a state-of-the-art video and postproduction house with \$2.5 million worth of equipment, lighting helps to present a dramatic image to existing and prospective clients.

Award-winning television producer Chet Collier, determined to surpass New York competitors, established Target in the Boston area to serve the growing New England market. To provide comprehensive, top-quality services, Target required a facility adaptable to a variety of client needs, not the least of which is to be persuaded — in the words of a television commercial — that “I’m worth it.”

Through a series of programming meetings with Target, the developer, and a lighting consultant, designers at Symmes, Maini & McKee created a cost-effective and visually impressive plan for a 12,000-square-foot space. Much of the design was determined by the need for client involvement and comfort throughout the production process. Light, shape, and color play important roles in expressing the function of administrative, conference, viewing, and dining areas. Simple forms and primary colors, reinforced by lighting combinations, dramatize the significance of each space.

The editing rooms rely on a subtle interplay between lighting and architectural design to reinforce client impressions of power and privilege. The client desk, for example, sits at a higher level than the desk for

Target staff. Both have access to switch and dimmer controls for the room’s incandescent and fluorescent lighting options. “Clients contract for exclusive use of these rooms,” says Lisa Myers, who was project architect for SMMA. “Lighting has a strong effect in giving them a sense of ownership, helping them feel they are something special.”

In the reception area, recessed halogen spots dictate the progression down a corridor and help to contain open office space. “The idea is to keep people moving down the corridor,” Myers explains, “and not to pull them out into areas where people are working.”

Windows in the kitchen, dining, and break area provide welcome relief for clients and staff who often spend 18 hours per day, including weekends, at the facility. “It’s a place where they can completely clear their heads and see what the weather is like,” Myers says. After several days at Target, it may take a while to come down to earth.

—Gareth Fenley

For product information, see the Manufacturer Credits section on page 70.

QUALITY FOR LESS

Buy Direct

Six Reasons Why You Enjoy Doing Business With Ruud Lighting, Inc.

- 1. You receive personalized service.** Our trained Customer Service personnel and Application Engineers are available to assist you in proper ordering and applying Ruud Lighting fixtures to your projects.
- 2. You get the best product with a one year quality guarantee.** Every product is fully computerized tested to assure trouble-free operation. All products are manufactured with the highest quality materials and manufacturing techniques.
- 3. You get the best price.** The best price is made possible by selling the highest quality products direct to the electrical contractor or electrical distributor. In fact, the more you buy, the more you save with our cumulative volume discount.
- 4. You get fast delivery.** High inventory levels and flexible manufacturing techniques assure the best possible delivery.
- 5. You have 30 days to make up your mind.** Our no-risk Sample Order policy assures you of guaranteed satisfaction.
- 6. You may call our Application Engineers for layout assistance or technical information.**

Floodlights

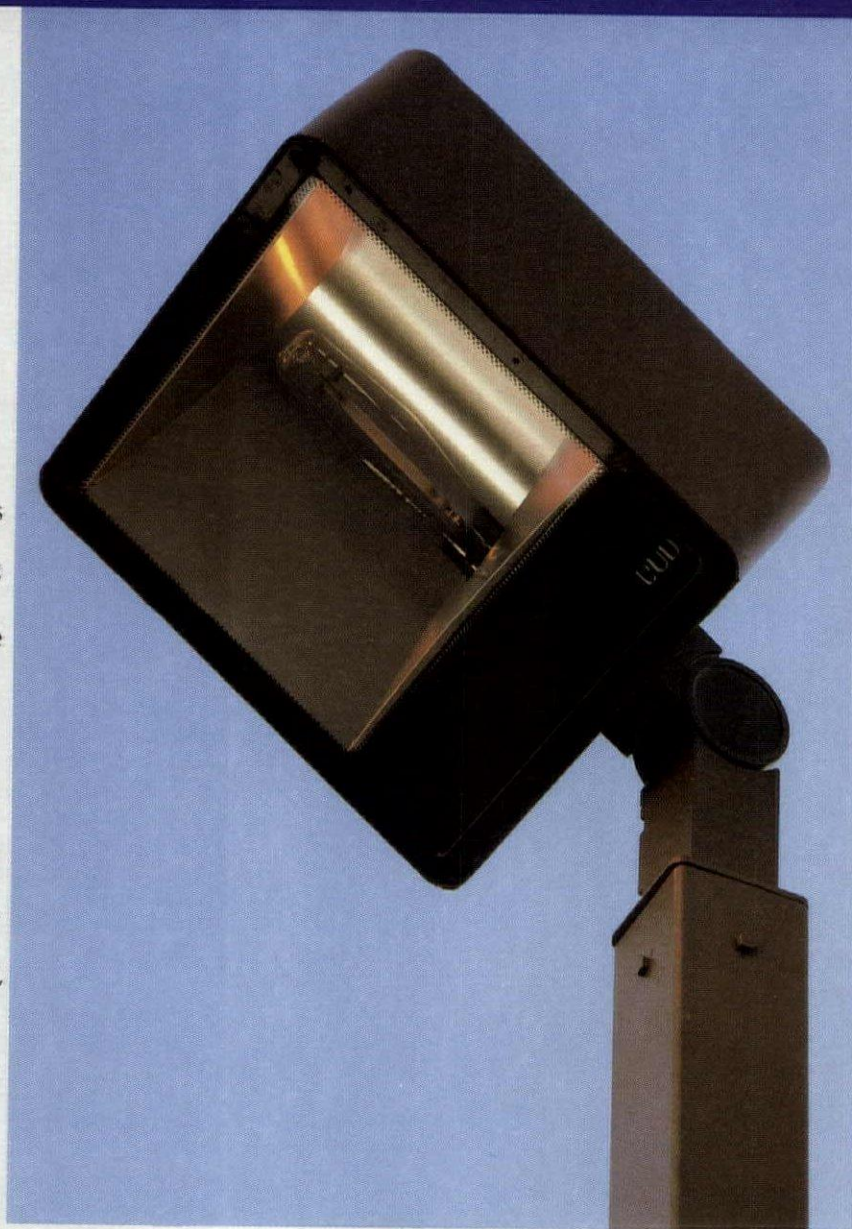

Canopy Lights



Industrial Lights

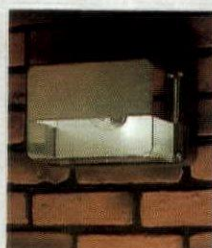

Security Lights



Parking Structure Lights



Parking/Roadway Lights

RUUD LIGHTING

Quality for Less - *Buy Direct*

CALL FOR FREE CATALOG 1-800-558-7883

In Wisconsin Call 414-886-1900

Flexible, economical lighting: Smart for art's sake

Project: A. Asher Fine Art
Location: Los Angeles, California
Architect: Gina Moffitt, Kiyohara, Moffitt & Shaver
Lighting Designer: Vincent Fama
Photos: Stewart Hopkins

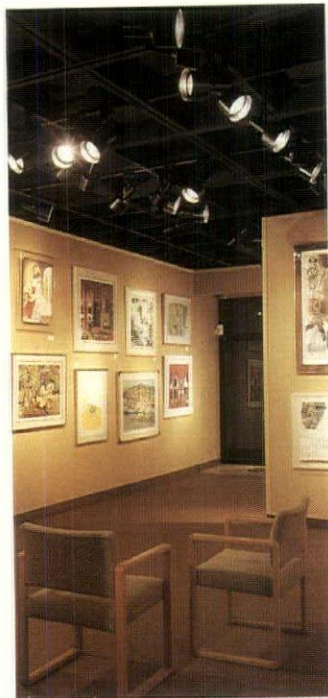

A customer's curiosity is piqued by a painting that hangs from the wall of a semiprivate gallery alcove. Without leaving the customer's side, an employee switches off the overhead lights, dims the neighboring perimeter lights, and boosts the spotlight that has been carefully directed at this piece. The work stands out in this setting, revealing its finest qualities to the attentive buyer.

The gallery design at A. Asher Fine Art combines expert lighting, cost savings, and flexible, modular interior space to create a high-quality environment for viewing and purchasing fine art. The accomplishment is striking in view of the constraints under which architect Gina Moffitt and lighting designer Vincent Fama had to work. Their solution transforms a narrow shopping center module (18 feet by 55 feet) into a space that can be sculpted in a variety of shapes, display areas, and lighting schemes, depending on art inventory and exhibition requirements.

At the heart of the design is a modular ceiling grid that consists of 4-foot by 4-foot squares to which modular walls can be secured in nearly limitless combinations. Each square in the grid is subdivided into 2-foot by 2-foot squares. Track lighting, attached to the beams that define the inner squares, creates a tight lighting grid that allows PAR 38 lamps to be focused on the display walls, wherever they may be.

"It has become clear to us that sophisticated, directed lighting sells art," says David Lester, who with his wife, Lee Ann, has operated several

galleries over the past 10 years. "It focuses attention on the art and emphasizes the good points in that piece."

Lighting can be adapted to the immediate needs of customers as well as to the changing physical structure of the space. A total of 32 circuits allow maximum flexibility and control over illumination. Each of the main overhead tracks has one circuit; the perimeter tracks each have four. A remote control unit allows overhead lights to be turned on or off and perimeter lights to be dimmed; it functions from any of the gallery's outlets. The solid-state dimmers are placed between the fixtures.

The relatively high cost of the lighting equipment — \$10,000 for tracks, fixtures, and specialized controls — is offset by energy and labor savings.

The gallery's cost reductions are impressive. Lamp replacement costs have dropped from \$700 each month to just \$50. "And we're not always on ladders changing the bulbs," Lester says. Electricity consumption is 40 percent lower, too, reflecting the reduced load for air conditioning as well as for lighting.

The modular wall and lighting system has worked so well that the Lesters are considering it for other galleries they operate, where flexibly controlled and directed lighting can give art its greatest market advantage.

—Stephen Mallery

For product information, see the Manufacturer Credits section on page 70.

THE RETAIL ENVIRONMENT IS SOLD ON HOLOPHANE LIGHT CONTROL.

39 FC
40 FC
41 FC
41 FC
40 FC
40 FC
39 FC
37 FC

LIGHT OUTPUT AT EYE LEVEL,
AND ABOVE NEARLY MATCHES
THAT AT THE FLOOR!

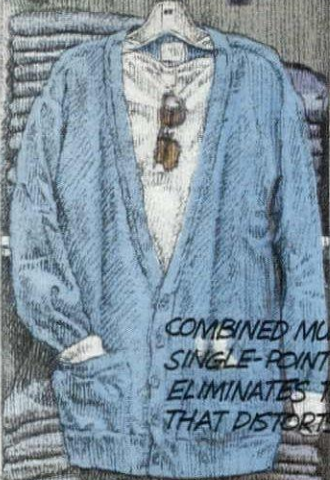

COMBINED MULTI-POINT AND
SINGLE-POINT LIGHTING
ELIMINATES THE HIGH CONTRAST
THAT DISTORTS FORM.

BALANCE OF DIRECT AND
REFLECTED ILLUMINATION
SHOWS TEXTURES IN THEIR
BEST LIGHT.

The best way to create a comfortable environment that brings out all the color, texture and form of quality merchandise is with prismatic lighting specifically designed to do just that.

Holophane's PrismGlo™ combines direct, indirect, multi-point, and single-point illuminating characteristics in a single fixture that is literally without parallel in today's lighting environment.

The PrismGlo starts with total prismatic control. Hundreds of precisely designed prisms are arrayed to place light evenly where it's needed, throughout the vertical range.

It utilizes the softening effects of multi-point illumination with



its uplight component, sending nearly 60% of its illumination upward, to be reflected off the ceiling.

Plus, better light control means fewer fixtures are needed, for a cost advantage that extends from installation into routine upkeep. Compared to fluorescent, there are 1/4 as many fixtures to install, and 1/12 the lamps to burn out.

There simply isn't a better lighting source for the retail environment than the Holophane PrismGlo. It defines form, emphasizes texture, and reveals color like no other fixture ever has. It saves money from the very outset, and makes you and your merchandise shine in the process.

For more information on how to let your retail merchandise do a better job of selling itself with the PrismGlo, see your Holophane representative or write Neil Thompson, Holophane Division, Manville, 214 Oakwood Avenue, Newark, Ohio 43055. (614) 345-9631.



HOLOPHANE
LEADER IN LIGHT CONTROL

Manville

Second life for 60-year-old department store building



The original tenants of 129 East Superior Street, Duluth, Minnesota, would do a double take if they saw the place today. Robert Berquist transformed the 1927 Sears store into a casino-style gaming hall festooned with colored and flashing lights.

"The building had been vacant for three or four years," says Berquist, an architect at Larsen, Harvala & Berquist. "Our primary goal was to provide a visually pleasing and functional gaming environment. Our solution relied heavily on decorative and task-oriented lighting." Neon and animated low-voltage incandescent lighting helped to create visual excitement that calls attention to the building and the special gaming areas within.

A thicket of bare concrete columns with flared capitals dominated the former retail store. Berquist made them eye-catching showpieces. He dropped the ceiling 27 inches to conceal the ventilation ducts and recessed metal halide downlights, but punctuated the soffit with square coffers to expose each column capital and shear plate.

Chasing incandescent light strips are mounted on the reveal formed by the concrete shear plate. The strips reflect off mirrors lining the deeper reveal of

the coffer, which terminates along the bottom edge in recessed neon concealed by mirror tiles and miniature lights. The columns themselves show off new paint, brass trim and tambours, and more mirror tiles and miniature lights.

Berquist designed colorful, animated lighting and signage that conveys a festive appearance from the outside. The exterior animation sequence creates an ascending pattern. After the top corner pilasters have flashed, the entire facade lights up.

The completed design incorporates over 700 lineal feet of neon tubing in 10 different colors in the interior, and over 1700 lineal feet in four different colors of neon on the exterior. The resulting transformation demonstrates adaptive reuse of an existing building, showing how an old space can get a new look through light and color.

—Gareth Fenley

For product information, see the Manufacturer Credits section on page 70.

Project: Fond-Du-Luth Gaming Casino

Location: Duluth, Minnesota

Client: Fond Du Lac Reservation Business Committee

Architect: Robert A. Berquist, Larsen, Harvala & Berquist, Inc.

Electrical Engineer: Foster, Jacobs & Johnson, Inc.

Photos: Before, Robert Berquist; After, Jeff Frey

The Beauty of
Track Lighting...
without the Beasts!

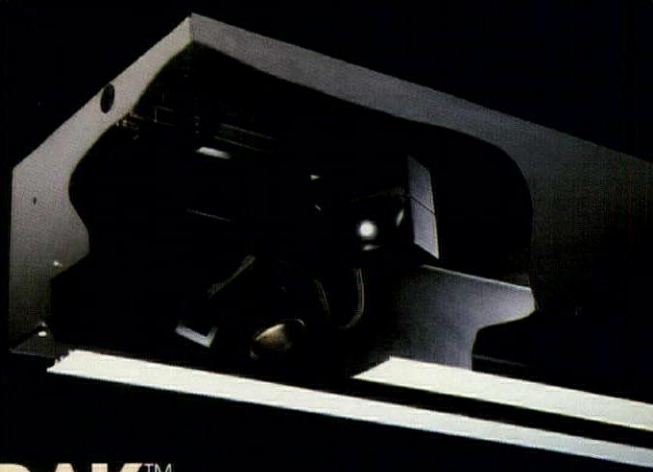

RECESSED•TRAK™

From ALKCO

Track systems for accent lighting used to mean that the most noticeable (and distracting) accents were the track fixtures themselves!

Those days are over. New Recessed•Trak™ fits flush into any ceiling system...turns corners, runs to any length you desire. It tracks without distraction!

Totally concealed inside the housing, lightmodules can be placed anywhere along the track, rotated 380° and adjusted up to 40° from vertical.

You can pinspot, accent, highlight or flood. Optional lenses and filters produce special effects and vivid colors. Twin circuits allow individual control of lightmodules for maximum flexibility.

Miniaturized quartz halogen lamps emit true white light with exceptional color rendering.

Now, when your accent lighting message isn't the system itself, your medium most surely should be Recessed•Trak, from Alkco.

For your copy of Alkco's new condensed *Space Enhancers* catalog, write to the address below.

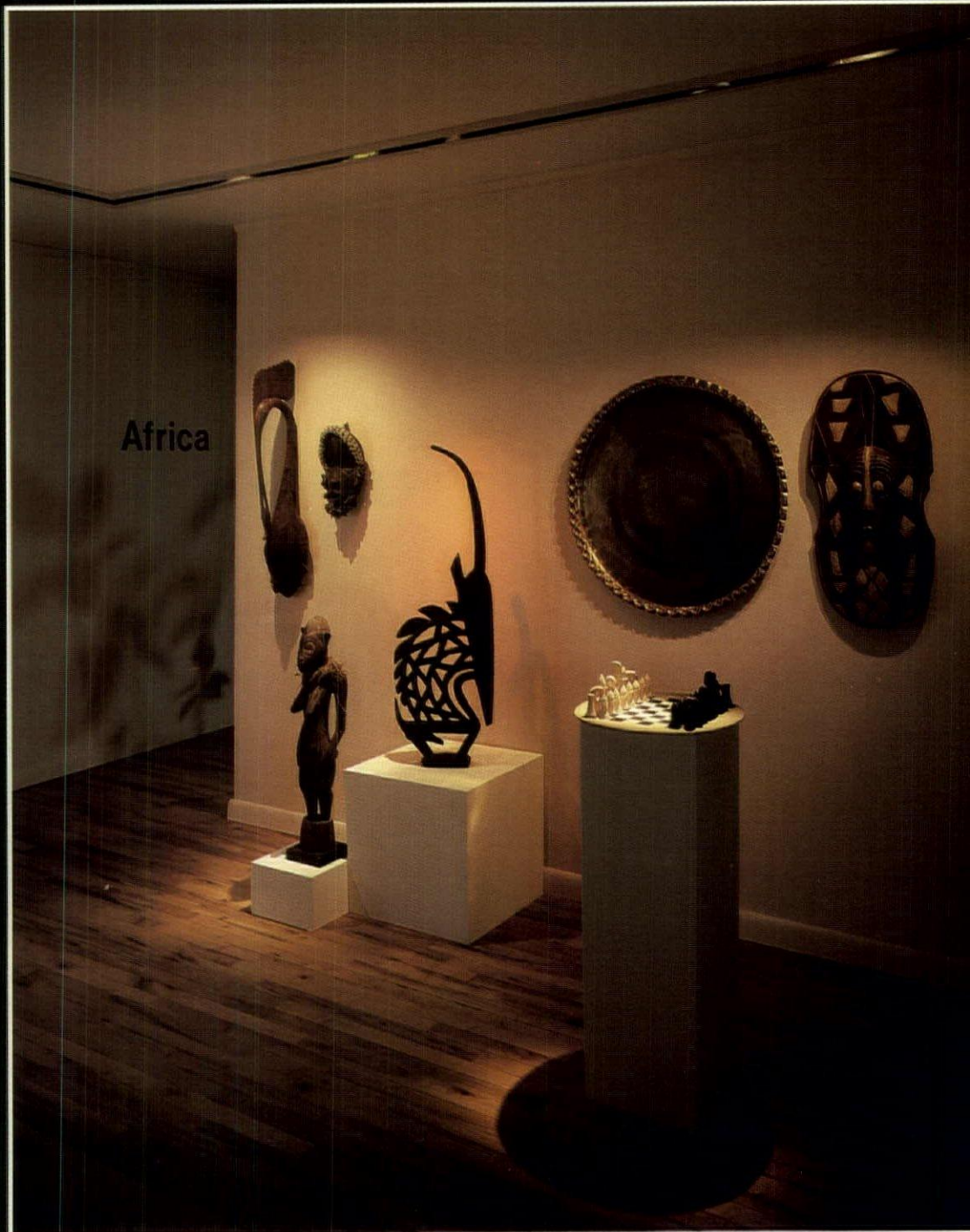

ALKCO
where quality
comes to light

 ALKCO A SUBSIDIARY OF JAC JACOBSEN INDUSTRIES, INC. 11500 West Melrose Avenue, Franklin Park, Illinois 60131 (312) 451-0700

Circle 15

Fewer fixtures, more light for school athletics



Project: Homewood-Flossmoor High School athletic facilities
Location: Flossmoor, Illinois
Facilities Manager: Walter M. Gembala, Director of Buildings and Grounds

"When we switched from a fluorescent lighting system to metal halide in our gymnasium, we expected some significant improvements," says Walter M. Gembala, director of buildings and grounds at Homewood-Flossmoor High School in Flossmoor, Illinois. "We were not disappointed.

Light output increased by almost 100 percent with a system that utilized 50 percent fewer fixtures." The gym was the first of three athletic facilities to be retrofitted; the entire retrofitting program was recently completed at the school's swimming pool and field house. Gembala anticipates energy savings of 30 to 50 percent for the facilities.

The school decided to retrofit because the lumen output of its 26-year-old fluorescent system had depreciated considerably. Levels were down to 28 footcandles in the gymnasium, 31 in the field house, and 40 at the swimming pool. Uniformity was poor because the fluorescents directed the light in a downward pattern only, leaving some floor areas too dark for visual comfort.

Maintenance was also a factor. "We estimate that we had to relamp at least 60 percent of the fluorescents annually," says Gembala — and relamping was no easy task. "In the field house, for example, lamp replacement meant spending three to four days on a scaffold. The facility had to be closed down until the job was completed." Such interruptions were unwelcome in buildings heavily used by the school and community.

The replacement system has 400-watt metal halide luminaires

with vertically ribbed glass reflectors. Unlike aluminum reflectors, the glass ones direct 20 percent of the luminaire's light output upward to be diffused and reflected off the ceiling. The uplight diminishes contrast between the ceiling and the luminaires and provides more uniform light distribution in the space below.

In the 11,000-square-foot gymnasium, 24 metal halide fixtures replaced 48 two-lamp fluorescents. At the pool, 14 metal halides replaced 24 four-lamp fluorescents. Like the fixtures previously used, the new ones are mounted on chains suspended from beams 20 feet above the water. Finally, at the field house, 90 metal halides replaced 288 two-lamp fluorescents.

"Our load will drop from 28 to 16 kilowatts," says Gembala, "so we anticipate substantial energy savings from the retrofit. Our expectations were borne out in the gymnasium where the replacement fixtures have been in operation since October 1985. Before the changeover, energy costs were \$4700 per year; now they run about \$2200. We expect payback in 17 months." ■

For product information, see the Manufacturer Credits section on page 70.

Innovations in lighting design...

Concealed cove or slot...

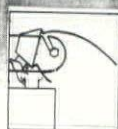
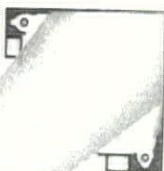

Elliptipar's concealed fluorescent reflector outperforms all alternatives for cove and perimeter "slots." Even illumination, no harsh socket shadows, and small cross section in lengths of 2, 3, 4, 5, 6, 8 and 10 foot (nominal). Economical to purchase & operate.

Circle 55

Incandescent wall-wash...



Elliptipar tungsten halogen wallwashers create color-rich, warmly glowing, evenly lighted walls without scallops or hot spots. Wider spacings save on units and energy. Many styles.

Circle 56

A wall sconce that works...

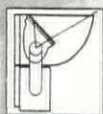

Ensconce[™] features smooth asymmetric distribution from Elliptipar's unique reflector with the new HQI metal halide lamp. Excellent color rendering combines with effective, comfortable indirect lighting—from a decorative wall sconce. Select from many standard designs or specify the basic lighting module with your own custom enclosure.

Circle 57

Compact, versatile, indirect...

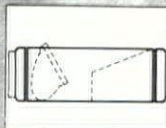
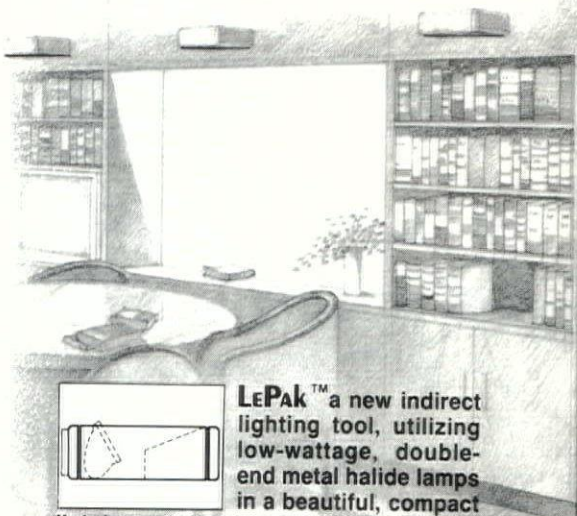

LePak[™] a new indirect lighting tool, utilizing low-wattage, double-end metal halide lamps in a beautiful, compact lighting unit that houses Elliptipar's patented asymmetric reflector. Wall or shelf mounted, LePak provides high efficiency and excellent color rendering/stability.

Circle 58

elliptipar[®] inc.

Performance In and From Lighting

145 Orange Avenue, West Haven, CT 06516 (203) 932-2266





Animated electric light enlivens Benjamin Franklin Bridge

ARTICLE BY
GEORGE C. IZENOUR
AND STEVE IZENOUR

PHOTOGRAPHS BY
EUGENE MOPSIK © 1987

Because of its great span, lack of vertical surface, and minimal structure, lighting the Benjamin Franklin Bridge is almost as difficult as trying to light air itself. Considering the basic physical law that light can be seen only when it strikes and reflects from surfaces or objects, successfully lighting the bridge required the judicious application of innovative lighting techniques for the maximum visual effect.

The principal element of our design is the illumination of hundreds of cables, the essence of a suspension bridge, with metal halide lamps. The static effect of lighting such limited surfaces is subtle. To attract the eye, the design pushes the limits of technology by making a standard light source work in an entirely unexpected way — animation.

Metal halide was a logical choice for lighting the cables because of its high intensity, long life, and energy efficiency, but it was an unusual choice to create the flashing patterns associated with conventional incandescent animation. Like any arc-discharge light source, metal halide requires a finite start-up time before ignition, and repeated switching on and off dramatically shortens lamp life. We had to circumvent these technical limitations to achieve the animation effect.



Project: Benjamin Franklin Bridge

Location: Philadelphia, Pennsylvania, and Camden, New Jersey

Client: Benjamin Franklin Bridge Lighting Committee

Architects: Venturi, Rauch and Scott Brown; project architects Steve Izenour, Miles Ritter, and Malcolm Woollen, with the assistance of Tom Collins, John Andrews, Adam Anuszkiewicz, Matthew Schottlekotte, and Kairos Shen

Lighting Designer: George C. Izenour Associates; George C. Izenour, principal, assisted by James L. Read, Jr., and R. Duane Wilson

Electrical Engineer: Irving Schwartz Associates

Structural Engineer: Keast and Hood Company





An Essential Aesthetic

The suspension bridge is one of the few utilitarian structural objects of monumental size that, in its unadorned natural state, is also an exemplary aesthetic object. Its uniqueness resides in the spare aesthetic of steel in tension, expressed by the main catenary cables that hang from towers and terminate in massive anchorage piers, plus the many vertical suspender cables that support the bridge deck.

This creation of modern structural engineering was made possible by the invention and fabrication of ferrous metal wire and cable. John Roebling and his son George Washington Roebling not only designed, engineered, and built the first large suspension bridges in the United States — at Niagara Falls, Cincinnati, and Brooklyn — but also were the first to develop the means for fabricating the wire and cable essential to their construction.

The Delaware River Bridge — later renamed the Benjamin

Franklin Bridge — was the first structure to span the Delaware River between Camden, New Jersey, and Philadelphia, Pennsylvania. A consortium of structural engineers, with Ralph Modjeski as engineer-in-chief, designed the bridge; Paul Cret was architect for the towers and cable anchorages.

The bridge opened to pedestrian and vehicular traffic in 1926. Its main deck includes a six-lane vehicular highway flanked by two train tracks and two elevated walkways adjacent to the main box beam. Except for roadway and walkway safety lighting, the bridge remained dark at night for more than 60 years.

The idea and the funding for a project to light the span originated with a joint committee of public-spirited citizens from Philadelphia and Camden. They envisioned the project as a permanent installation to celebrate the 200th anniversary of the ratification of the U.S. Constitution in Philadelphia in 1787. The committee authorized a design

competition among 14 Philadelphia architectural firms.

Venturi, Rauch and Scott Brown, with George Izenour as lighting consultant, submitted the winning design solution. Airbrush renderings, required by the competition and executed by Miles Ritter, gave graphic substance to the design. The judges unanimously decided to make the award on the first round of the competition.

Departure from Tradition

Our design evolved from a comparative analysis of other major bridge lighting schemes. We considered possible applications of traditional floodlighting and linear lighting techniques within the competition's stated constraints of bridge color, maintenance, and driving and navigational safety.

Floodlighting, which essentially throws a lot of light at a



MATT WARGO

Airbrush rendering by Miles Ritter accompanied the winning design proposal. The design team developed new technology to achieve this visual effect.



major architectural surface, is applicable only for the masonry mass of the cable anchorages. The cable support towers, with their dark blue color and minimal trussed surface area, would absorb most of the light thrown at them. The linear lighting techniques used to outline a form, such as cold cathode or low-voltage tungsten sources, are expensive and very difficult to maintain because they are almost impossible to access on a gigantic structure like a suspension bridge.

Therefore, many of the techniques traditionally used for large-scale architectural lighting problems were not feasible and had to be eliminated. With the inherent openness and large scale of the Ben Franklin Bridge in mind, we developed four requirements for a lighting system.

Access. All lighting instruments are located on the bridge proper so that they can be accessed and maintained either from the pedestrian

walkways or the anchorage structures.

Outlining of cables. Aesthetically, the lighting system outlines the catenary structure of the bridge, the formal and structural essence of a suspension bridge.

Controlled visibility. To minimize distractions to drivers, most of the lighting effects can be seen in elevation both upriver and downriver, and obliquely as a driver approaches each end of the bridge — but not primarily from the roadway itself.

Animation. Finally, the lighting system is capable of “special effects” or animation. Movement adds to the impact of the subtle lighting effects. A flexible control system offers the opportunity for guest artists to design special effects for holidays and gala occasions.

From the start, the idea of animation was integral to the overall scheme. The concept of an animated lighting design came naturally to Steven Izenour. His 1968 participation in a



Yale School of Architecture design studio with the principals of the firm, Robert Venturi and Denise Scott Brown, resulted in the book *Learning from Las Vegas*.

Admittedly derived from long-time usage in commercial signs — theater marquees and the like — the idea for pro-

gressive animation of a series of individual light sources is not new. However, animation is certainly innovative for a lighting scheme of this monumental scale.

Cable Lighting

The suspender cable lighting system is the primary design



element. This system dramatizes the laciness of the bridge structure. It defines the curve of the catenary above and the roadway below as a series of brightly lit points at each end of the suspender cables.

Metal halide spotlights with parabolic reflectors are directed up to the catenary cable

through each cluster of four galvanized suspender cables. The spotlights are on their own supports, above the main support truss, to protect them from vandalism.

The narrow spotlight beams pick up and reflect off the semireflective surface of the galvanized cables. The bright-

ness of the source itself defines the curve of the support truss and the roadway. The hot spots on the main cable define the catenary curve as a series of bright points seen in elevation.

No light source is visible anywhere in the system to distract drivers crossing the bridge. The lighting of the cable system is confined to the upriver and downriver surfaces of the suspender cables, and only the underside of the catenary cable is visible to drivers crossing the bridge. Seen obliquely from a car, the effect is that of slightly compressed lines of light.

Animation adds a totally unexpected element to the scheme — vertical beams of light chasing back and forth across the river. Two small industrial computers, one for each side of the bridge, generate the animated movement by rapidly switching luminaires. A third computer operates a visual analogue, or model, used to program and

operate the lighting system.

Trains, which cross the bridge as often as every 10 minutes, trigger an infrared sensor that activates a two-minute animation sequence. Other cyclic or random patterns can be created with the programming model and transferred to the bridge.

Engineering the System

Although the lighted bridge looks almost exactly like the original presentation drawings, most of the technology evolved after the competition. Myriad lighting, electrical, and control engineering problems were resolved during a four-month-long design and engineering study. The most complex aspect of executing the design involved the selection — and invention — of components for the cable lighting system.

The design team first built a full-scale model of a single suspender cable cluster and a section of the catenary cable. The model hung from two life-



Workers for W.V. Pangborne Company, the contractor that installed the bridge lighting system, check a luminaire.

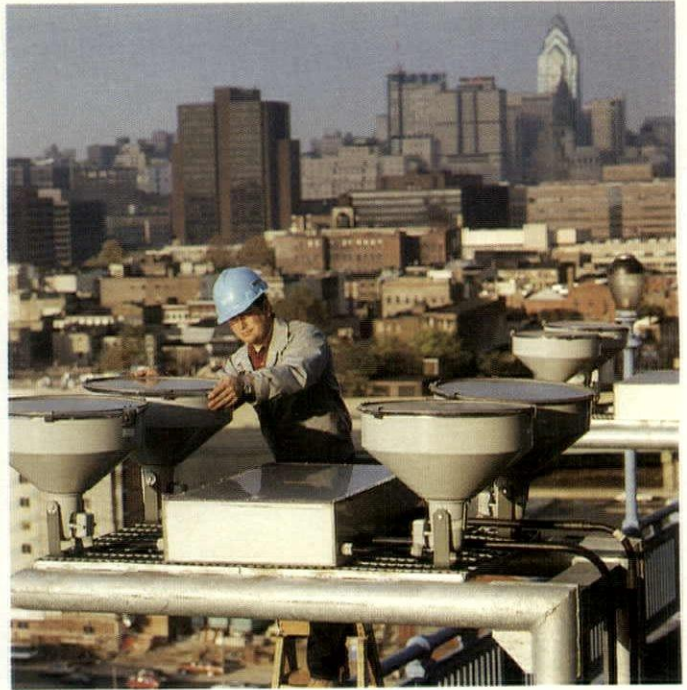

Weatherproof boxes enclose the innovative ballast system that makes metal halide animation possible.

boat davits fastened to the roof at the rear of the architect's four-story office building. A manufacturer furnished samples of short-arc and long-arc metal halide lamps and a single focusable luminaire, which were installed at street level.

A series of full-scale tests established the engineering design criteria and control parameters for the cable lighting system. The full-scale model provided an initial approximation of lighting and control requirements. The test results formed the basis for the engineering design of a complete system for electrically powering, electronically controlling, and physically structuring the mountings for the luminaires.

Data were then refined by a series of more comprehensive tests on the bridge itself, using both single and multiple luminaires in combinations for lighting the various lengths of suspender cables.

Animating Metal Halide

Once the light source was chosen and the luminaire design finalized, switching the light source was the critical problem to be resolved. A series of preprogrammed patterns of movement in a multiple-source system requires switching of individual light sources or clusters of light sources. The

units can be switched on and off, switched between markedly different intensity and color temperature levels, or both.

The metal halide lamp is an arc-discharge light source requiring a finite heat-up time prior to ignition. Because repeated switchings on and off can cause early failure and deterioration of lumen output, switching in this instance was designed to occur between different intensity levels — and therefore color temperatures as well.

Experiments showed that the 175-watt metal halide short arc lamp, once energized at steady state, could be switched to varying power levels — above and below steady state — sufficient for animation. We determined that power could be reduced (switched) to a level slightly above the potential sufficient to sustain the arc, then raised (switched) to a state of overdrive — about 50 percent greater than the steady state — without damaging or otherwise reducing the life expectancy of the lamp.

To simulate pulsing during the tests, a specially designed pulse generator was used to determine pulse length for both ignition and overdrive states, as well as the time between pairs of pulses. During the tests, the pulse generator was modified to handle

multiple light sources so that a reasonable indication of chase conditions from one set of suspender cables to another could be observed.

For actual use on the bridge, George Izenour and his associates devised a new type of ballast system to provide the three power levels required for animation. Three reactors, custom manufactured for the project, provide variable ballasting for each luminaire. The 604 light sources thus require a total of 1812 reactors.

Power switching is effected by solid-state relays at the individual reactors. The relays, reactors, and transient suppressors are mounted on subbases within weatherproof boxes mounted next to the luminaires. To economize on the size of the feeder cables, the light source with the variable ballasting operates from a 480-volt line.

In practice, the lamps are energized when the system is turned on at sunset. All remain energized at steady state until the system is either placed in the pulsing mode or turned off for the night. In the pulsing mode, each sharp pulse — decrease to ignition potential, increase to overdrive potential — provides the change in intensity and color temperature required for animation.

Computer Control

The three identical bridge computers are small programmable industrial controllers (PICs) developed to program and control a roboticized process in automobile manufacturing. One is used with the programming model to devise animation software. The other two control the lighting system on the bridge.

To animate the lighting, the computers send signals through coaxial cable to control modules — one module for every five suspender cable clusters. On the bridge, the control modules in turn feed signals to the solid-state relays, which are in series with the individual reactors.

The computers determine and monitor various kinds of information. They are programmed to "know" the combinations of ballasts for each light source or cluster of light sources for each of the three power levels. This information conditions the "on" time for each of the three levels and the "off" time, or steady state, between any combination of these levels. The computers also monitor the sequencing of each cluster in relation to every other cluster.

Software arranges all these factors into a predetermined series of programs. The computer-generated patterns

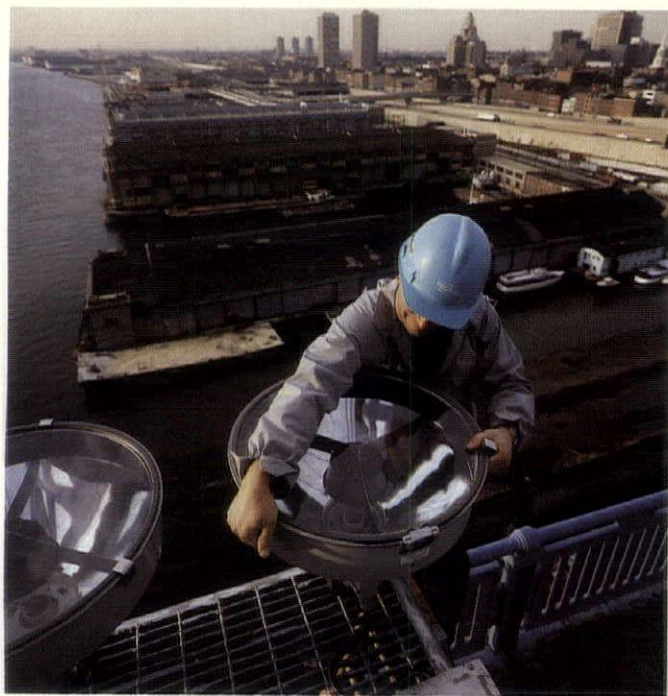

The 604 identical luminaires in the cable lighting system contain 175-watt metal halide lamps.



The luminaires' target is the catenary cable that supports these 200-foot-long suspender cables.

can be activated in a preset timed sequence by yet another program, or randomly triggered by infrared sensors that detect trains passing across the bridge.

The Programming Model

Computer programming makes possible a limitless variety of animation sequences for the bridge. The pulses of dimming and intensifying light travel across the bridge at speeds of 40 to 400 miles per hour — impossible to depict with conventional photography.

Composing animation sequences is facilitated by a programming model, complete with miniature light sources, installed in an administration building at the Camden end of the bridge. The 11-foot scale model of one side of the bridge is arranged in front of the programmer's computer keyboard. The "spare" computer and control modules provide a control setup identical to that on the bridge, while the three intensity levels of the miniature lamps simulate the operation of the metal halide lamps.

A programmer who is satisfied with a given set of program operations makes floppy diskette copies and places them in the two bridge computers — one for each side. In that way, animated

programs as viewed on the analog programming model are transferred — full size — to the bridge.

The Piers

Floodlighting and accent lighting establish the perimeter, solidity, and texture of the four massive anchorage piers. Light floods the upper surfaces from below to accentuate the texture of the stonemasonry veneer. The amber-yellow light is generated by high pressure sodium luminaires mounted on ground-based poles.

Pier accent lighting is limited to the towers, the stone-carved state and city seals on the upriver and downriver wall faces, and a strip of light pipe that reads as a cap on each tower. The light pipe is internally excited by sodium and mercury vapor light sources. The contrast between the warm amber floodlights and the cool blue highlights articulates the architectural scale and quality of detail of Paul Cret's magnificent piers.

Designing for Maintenance

The single most important engineering aspect of the design, as stated in the rules for the competition, was maintenance. Every part of the lighting system must be maintained by existing bridge

maintenance personnel and equipment, from replacing lamps to servicing switchgear, auxiliary controls, and computers. Requirements for standardized components and easy access guided the project from the beginning.

For economical, uncomplicated stocking of spare parts, we standardized the luminaire, the lamp, and the ballasting, power switching, and computer components. To light suspender cables up to 200 feet long, we used a single luminaire design and 175-watt lamp type. The 604 spotlights are individually focused and arranged in groups of one to four to provide appropriate light levels for a range of throws.

Other lighting system elements are relatively simple, too. The pier lighting incorporates two luminaire designs and two lamp types. The three PIC computers are identical, and the modules of the programming computer provide standby spares for the active controllers on the bridge. All the power switching components, transient suppressors, and the specially designed reactors are also standardized.

Above all else, every part of the system has to be easily and quickly accessible. Almost every lighting and control component can be reached by

maintenance personnel without staging or climbing. The only exceptions, the pole-mounted anchorage luminaires, are reached with a cherry-picker crane. The light pipes are accessible from the anchorage roofs. Luminaires for the cable lighting system are accessible from the bridge's walkways, and the PICs are installed in a bridge tower. The substation and power distribution equipment is installed in an anchorage pier.

The Benjamin Franklin Bridge lighting is a practical design, one that can be easily and economically maintained, that evokes the nature of the bridge itself. All light is focused on the two essential elements that describe the structure of the suspension bridge: the piers and cables. The anchorage piers form a distinguished architectural gateway to both Philadelphia and Camden, and the suspender cables and catenary together create an elegant curtain. Innovation with basic technical components made possible the aesthetic success of the project, making the bridge a potent symbolic as well as a physical link between two cities. ■

For product information, see the Manufacturer Credits section on page 70.

Demonstration a key tool for lighting designer

When John Renton Young sets out to show an exterior lighting design to a client, it's a big deal. The building might be the Trump Plaza or Caesar's Palace. It doesn't matter — the client will be treated to a full-scale demonstration of the proposed lighting design right on the site.

"Lighting is image," says Young, whose lighting designs are well known in Atlantic City and Las Vegas. "and if your building and site have a weak image, you can't compete. We started out doing demonstrations 22 years ago, for several reasons. We were doing lighting designs that people said couldn't be done, and we had to show them. We soon realized that the demonstrations were by far the best way to communicate to a client all of the possibilities available through lighting.

"Models, renderings, and computer simulations are great. We do them routinely as a part of the design process. But unfortunately, none of these methods can show the dynamic

Charles Linn, AIA

Charles Linn is editor of Architectural Lighting.

relationship between light and a building or landscaping as well as a demonstration. And that's the most important thing we can show a client."

Preparing for a Demo

"Advance preparation is one of the most important aspects of a lighting demonstration," says Young, "because when we're out there showing someone how beautiful the building is going to be, we can't take any chances. If something goes wrong, it can ruin the whole job. If we can't get it right dur-

ing the demo, what's that going to say about the long-term performance of the lighting system we're proposing?"

Before giving a demonstration, Young and his design team walk the building site during the daytime and at night and finalize the lighting plan, including the locations and types of fixtures they plan to use and lamp wattages. Their drawings are sufficiently complete to establish a plan for circuiting groups of fixtures on site. "Each switch on our panel turns on specific fixture groups, so that we can demonstrate different design alternatives," says Young. "So we're giving the demonstration a controlled sequence, a flow, and not arbitrarily switching on part of the design here and there."

Young's 40,000-square-foot plant in Las Vegas becomes a beehive of activity prior to a demonstration. All of the lamps, fixtures, ballasts, cables, and connectors are tested. Light fixtures are stacked on pallets in the order in which they will

be installed on the site and loaded into a trailer with a forklift. The forklift itself is loaded last.

Technicians adjust and tune the gasoline-powered 55-kilowatt generator that can be used to provide from 120 to 480 volts during demonstrations. A switching panel is used to control the lighting during the demonstration. It is wired to accept the proper number of circuits and placed inside the "command center," a room on the diesel tractor used to tow the equipment trailer to the site. Often a second generator is added to supply power during especially extensive demonstrations. The mobile telephone equipment used for communications is checked and rechecked. Finally, a caravan of technicians and equipment leaves for the site.

Demonstrating on Site

At the site, the forklift is used to unload the pallets stacked with lighting fixtures, which are delivered to locations around the site for temporary installation according to the previously established lighting plan. In the meantime, power has been connected from the generator to the input side of the switching panel. After the fixtures are set, they are ready to be connected to the output side of the panel.

Fixtures are carefully circuiting into groups. Then, on Young's cue — delivered by mobile telephone — a technician stationed in the command center turns a specific switch and instantly demonstrates one of several different lighting design alternatives.

"Say we have a 26-story hotel we're going to illuminate," says Young, "with a lot of landscaping and a porte cochere. We spend the day before the demonstration setting up the lights, and focus them as night falls. When the client comes out, everything is turned off except for any metal

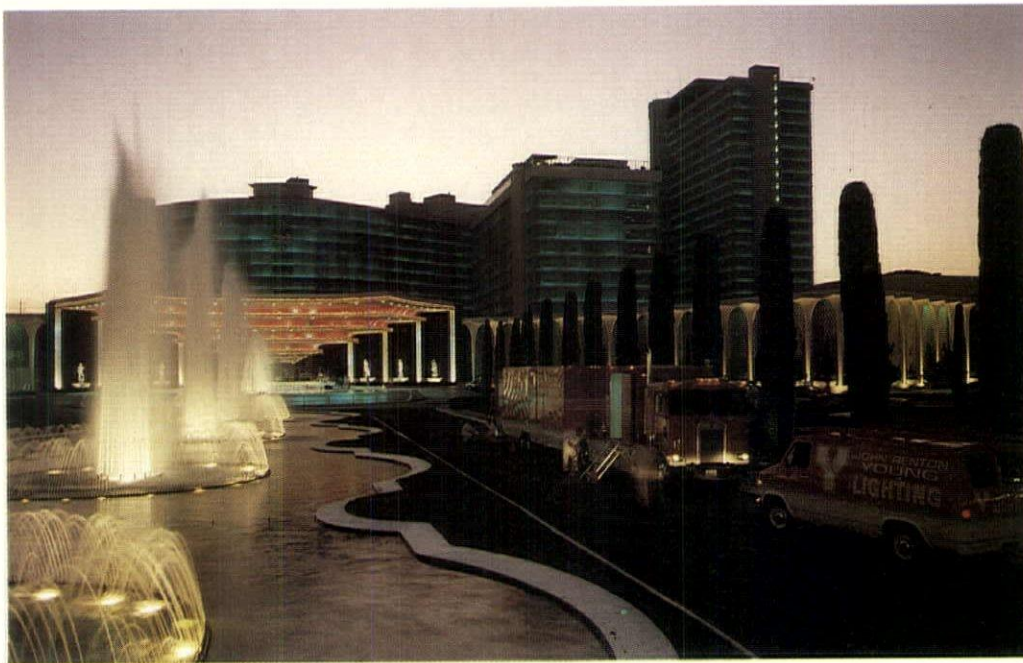

Lighting design team on site at Caesar's Palace during lighting demonstration.



Technicians fine-tune the generator and wire the panel that will be used with it to power and control lighting equipment during the demonstration. Advance preparation is critical to a successful demonstration.

At the site, lighting fixtures are delivered where needed by forklift. Communication — critical to successful demonstrations — is provided by mobile telephone equipment.

halide or high pressure sodium lamps that would have to be warmed up. But we leave the rest of our new lighting around the porte cochere and the landscaping turned off — only our building floodlighting and the owner's existing lighting would be on.

"Now as the client and I are viewing this from a vantage point — say, down the street or from the street entrance — I radio a signal to the command center, and all of a sudden the lights come up on, say, all of the olive tree groups on the site. Later, on my signal, the other lights would come

up on all of the palm tree groups, followed perhaps by lighting on the site's water features. Now the client witnesses his building and grounds come alive through lighting.

"Now, if there's existing lighting out there, we have one of our people down in their switchgear room. We radio him and he turns off the circuit breakers that control their exterior lighting, so theirs is off and ours is on. Then we do the opposite, and out go our lights and on come theirs. Suddenly their building and grounds are plunged into

what seems by comparison to be complete darkness."

Meanwhile, back in the command center, the technician in charge has noted how much energy is consumed by each lighting scheme, and uses a computer to calculate the annual cost of operating and maintaining each of the lighting options. This report is immediately printed out and presented to the client.

"That on-the-spot report is very important — obviously the first thing clients ask is, 'How much will it cost?' and we're prepared to tell them, not just how much the instal-

lation will cost, but all the bottom-line costs as well.

"If nothing else, the full-scale demonstration gives clients the opportunity to see for themselves how the proposed design will perform — so there are no false expectations. It isn't like showing them a plan and saying, 'Well, we're going to light these trees, and this building.' Even though most clients are extremely intelligent, the vast majority of them won't be able to visualize what you're proposing. Ordinarily, the demonstration exceeds by far anything the client had imagined." ■

Lighting-only renovation gives new look to training facility

The GE Center for Advanced Airmanship (CAA) recently got a new look — a look that not only contributes to reduced environmental fatigue for CAA staff and students but also helps the center sell more services. And the only thing changed was the lighting.

The CAA's centerpiece resembles a giant video game, but it's a game with high stakes: training F5 fighter pilots in a computer simulator. GE intends to be the leader in the expanding high-tech computer simulation training market.

To help the CAA sell training, the lighting design team concentrated on ways to enhance the sales effort. The team set out to create a positive first impression for the center and high-quality functional lighting designed to help convey an image of a knowledgeable, people-oriented training center. Simultaneously, they set out to create a learning environment that would reduce stress and fatigue, thus facilitating efficient training sessions.

Few designers will ever be called upon to light a flight simulator, it's true, but many will be called upon to deal with issues of brightness control and balancing light in settings where people make transitions between dark and bright areas. And, with the proliferation of computers in workplaces, many designers are being asked to

Project: GE Center for Advanced Airmanship

Location: Tempe, Arizona

Lighting Designer: Gary Steffy Lighting Design Inc.

Electrical Engineer: Lowry-Sorensen-Willcoxson Engineers Inc.

Manufacturers' Coordinators: Sue Olivetti, Lightolier; Terry McGowan, GE

Electrical Contractor: Code Electric Corp.

Jeff Brown and Gary Steffy

Jeff Brown is a designer with Gary Steffy Lighting Design Inc., and Gary Steffy is president of the firm, which is based in Ann Arbor, Michigan.

deal with lighting for video display terminals.

Successful solutions were found for these and other challenges during work on the CAA project. Most important of all, those solutions demonstrated that improving the quality of lighting has economic value.

The Facility

The Center for Advanced Airmanship is in Tempe, Arizona, near Williams Air Force Base. The center teaches potential pilots — without the risk and expense of leaving the ground — about 78 percent of the tasks they must master to fly an F5. Then, airborne, these novice pilots can make better use of flight instruction time. The \$12 million, 16,000-square-foot facility has the potential to expand and provide training for other aircraft, too. Many international pilots attend the school, and the operators are seeking a training contract with the U.S. Air Force.

Although the flight simulator is the heart of the facility, it occupies only about 5 percent of the facility's area. Most of the area is taken up with support spaces, including a student check-in and check-out

area, circulation areas, a learning center, a computer room, a classroom, and offices for administrators and instructors.

Renovating the Spec Space
The facility — which was built as speculative space — presented an array of challenges typical of renovation projects: standard finish, ceiling system, HVAC, and structural constraints. These gave the design team an opportunity to demonstrate that proper lighting can be achieved in ordinary buildings under many conditions.

People in the center move from spaces of near blackout conditions to spaces where they must be able to read and/or write easily on white paper. Before the renovation, lighting in the facility was typical of speculative solutions: surface-mounted fluorescent wraparound units; two-by-four, four-lamp, lensed fluorescent units; and two-by-four, four-lamp, small-cell parabolic louver fluorescent luminaires. Cool white lamps were in use throughout.

The simulator room was dramatically lit, but the surrounding support areas were

neither visually supportive nor visually connected. The student computer check-in and check-out station, where student contact with the facility begins, was overlighted by glaring, wraparound fluorescent luminaires. Lighting in the formal classroom lacked flexibility, the overlighted administrative offices lacked significant lighting impact, and the instructors' office — where VDT screens mirrored the lensed two-by-four luminaires — was glaring and tense. Putting together the lighting-only renovation plan that corrected these problems was a team effort.

The Lighting Team

A lighting team was assigned to review the training and support spaces and to upgrade the lighting, as necessary. The team, which was also assigned to develop criteria for determining what would be necessary, consisted of an IALD lighting designer, an electrical engineer, an electrical contractor, a lamp manufacturer, a luminaire manufacturer, and GE's CAA operators.

The team conducted a space-by-space review, which helped

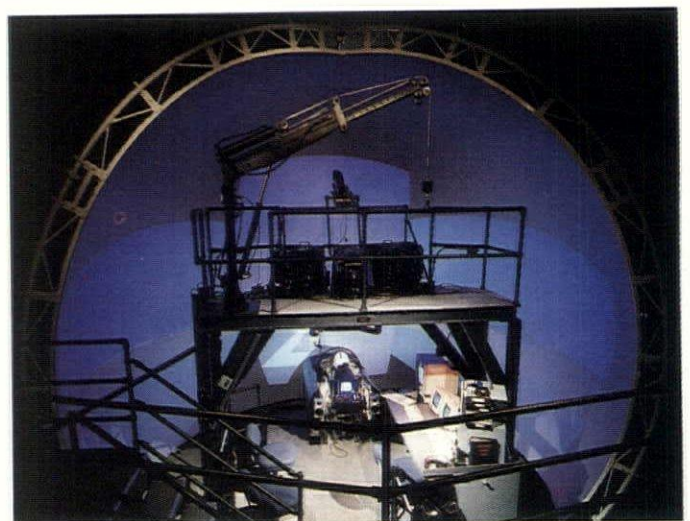

Potential pilots learn about 78 percent of the tasks they must master to fly an F5 — without the risk and expense of leaving the ground.



The centerpiece of the Center for Advanced Airmanship is a computer simulator for training F5 pilots.

its members to identify and agree upon lighting needs for each area. After evaluating the environment, the team determined that the existing lighting equipment was glaring and that the spaces were overlighted, in some cases double the levels generally considered appropriate, in other cases, as much as 10 times suitable levels. The group also said that brightness ratios from surface to surface and room to room exceeded all rational guidelines.

They decided to develop better brightness control and brightness transitions between spaces. They agreed that better lighting would lead to better viewing conditions for VDT tasks and would improve visual comfort, thereby reducing environmental fatigue. Often overlooked, brightness balancing is difficult to achieve in most spaces. In the specialized CAA space, that goal was even more elusive.

The team agreed that a

“softer” lighting approach would help create reasonable transitions between the outside and the inside — both day and night. Spaces could also be made to appear more spacious by carefully addressing surface brightnesses — determining, for example, which surfaces should be bright, and at what level of brightness.

The high-tech nature of the simulation training business suggested a need for a high-touch quality as well. To create a warm, human-scale environment, the team chose 3500K multiphosphor lamps for use throughout the facility. This lamp’s color rendering index is significantly higher than that of standard cool white lamps, promoting improved color perception and more attractive skin tone appearance.

One important design decision was choosing a family, or vocabulary, of luminaires and lamps to address a variety of space and people needs while

providing a unified, cohesive appearance. When lamp color is consistent, surface finishes and colors appear similar from space to space. The team used a variety of lamps from the 3500K color family, ranging from the biaxial 13-watt to the T8 32-watt. One manufacturer can provide off-the-shelf lamps with the same color temperature in a host of sizes; and only a few manufacturers can match reflector finishes across a wide range of luminaire types. Luminaires chosen for this project are finished in a soft, semispecular aluminum to reduce luminaire brightness while providing a softly lighted aperture.

Scheduling was another important part of the planning process. To work around the center’s extensive training schedule — which means most downtime is at night — the team spread the construction schedule over about a year.

Meeting the Simulator Challenge

The simulator is a giant video display, computer-driven pixel by pixel in real time, with a screen that wraps around the pilot’s entire field of view. Three highly specialized video projectors are synchronized to provide this full-screen image. The frontal projection system used is quite sensitive to stray spill light. Because of the unique interreflection characteristics of the wraparound projection screen, stray light creates image washout; and washout on one side of the screen causes washout on the other side.

The stray light restrictions caused “nighttime” cockpit conditions, so all instruments and switches had to be internally illuminated. The F5, however, was designed primarily for daytime missions. Pilots usually have daylight streaming through the canopy for orientation and easy lap reading of maps. The design task, then, was to make the cockpit *relatively* brighter than the video dome (projection screen), which generally has luminances of 3 to 5 footlamberts.

By using 20-watt MR16 lamps in rather small framing projectors, the team produced a glow sufficient for map reading and provided a sense of daylight. The brightness spots created by the MR16 units are filled in by strings of low-voltage lamps in plastic tubes attached to the left and right sides of the cockpit under what would be the canopy lip. This arrangement softly washes the inside surfaces of the cockpit. The low-voltage string lights and the 20-watt lamps are on dimmers for upper limit control. Interfacing this system with the simulator computer allows for light that varies with the time of day, orientation, and sky conditions of the simulated flight.

To heighten the sense of drama associated with the simulator, and to make for better sales presentations, the team introduced a system of track lighting. This theatrical approach, combined with a four-scene preset dimmer control system, helps to introduce potential clients and students to the real center of action.

Relighting Student Support Areas

To make the student computer check-in and check-out station more inviting, the design team eliminated the glaring, wrap-around fluorescent luminaires and arranged surface brightnesses to attract attention to the wall map, while eliminating direct glare and VDT-reflected glare.

The renovated lighting system uses a slim-profile luminaire that provides a comfortable wash of light to the wall and ceiling behind the VDT. This leads the student to the VDT without introducing screen washout. The luminaire uses an efficient T8 fluorescent lamp. The slim lamp permits a small luminaire profile, yet has good optical control for distributing light toward the ceiling and wall. The existing ceiling was left intact except for support and feed cutouts. Unlike the typical grazing light of a traditional fluorescent wall-wash slot, this more frontal light does not accentuate a wall's surface imperfections.

Corridors. Relatively long corridors were fitted with wraparound fluorescent luminaires, which resulted in average illuminance on the floor of 50 footcandles. Because the corridor serves as a transition space from the relatively dark simulator to the brighter classroom and learning center spaces, the team agreed that the lighting also had to serve this transition. So they reviewed brightnesses

rather than illuminances.

Lighting wall and ceiling surfaces helps provide a comfortably bright corridor, where illuminance is only 5 footcandles — making the corridor a *place*, providing an image by which to remember the facility. The wall lighting also helps promote a sense of spaciousness, and the brightness patterning of the sconces helps break up the institutional appearance of the corridor. Each sconce contains two 13-watt biaxial 3500K fluorescent lamps with a color rendering index above 80.

Classroom. The formal classroom — where marker boards, overheads, front video projectors, and rear slide projectors are all used — needed lighting flexibility not offered by the spec lighting. To make the classroom a more effective learning space, the team rearranged switching, added several "layers" of lighting, and developed a dimming zone.

Semispecular, one-by-four, large-cell parabolic luminaires provide comfortable, medium-level, low-glare downlighting for note-taking. A front zone of luminaires is switched separately from a back zone. The back zone is on a dimmer to facilitate note-taking during a variety of audiovisual conditions. A fluorescent wall wash along the back wall helps provide a comfortable sense of brightness to the room.

To highlight the speaker and marker board area, the design team used a series of nondiode 45-watt halogen PAR lamps in spread-lens wall washers. These lamps generate no visible flicker, permit dimming with conventional dimming equipment, and offer the energy savings associated with low-wattage high intensity quartz lamps.

Learning center. Students can learn the operating characteristics of the F5 on the learn-



Student contact with the center begins at the computer check-in and check-out station. Before the lighting-only renovation project, the area was overlighted by glaring, wraparound fluorescent luminaires.

ing center's computer-based instruction system. The nine student work stations have VDT screens of the four-color, IBM-PC type. The specular screens are prone to veiling reflections, luminaire imaging, and reflected glare. Most sessions in the learning center last four hours.

The small-cell, specular parabolic louver luminaires used in the space make for rather a dark ceiling plane — resulting in little or no luminaire washout, imaging, or reflected glare on the VDT

screen. It is easy to overdesign this kind of system, however, so that too much light falls on the VDT screen and on the surrounding work surfaces. This causes screen washout and luminance imbalances between the relatively dark screen and the relatively bright work surface.

To avoid a maximum light level too high for this space, the team used a three-lamp luminaire rather than a four-lamp luminaire. And they used a dimming system designed for T8 lamps to permit instructors to



The corridor serves as a transition space between the relatively dark simulator and the brighter classroom and learning center spaces. In the renovated space, corridor illuminance is only 5 footcandles; previously, average illuminance on the floor was 50 footcandles.

Marker boards, overheads, front video projectors, and rear slide projectors are used in the formal classroom. To provide lighting flexibility not offered by the spec lighting, the lighting design team rearranged switching, added several "layers" of lighting, and developed a dimming zone.

time the students' computer work as well as to change settings to accommodate training manual text tasks as they occur.

Administrative Areas

To minimize glare in the over-lighted administrative offices, the design team eliminated the uniform fluorescent lighting in favor of a comfortable, well-balanced lighting effect. Low-brightness direct luminaires were task-oriented over work surfaces and used with down-lighting and wall-washing.

Large-cell, two-by-two, semi-

specular parabolic luminaires comfortably provide sufficient illuminance with minimum glare. To fill in brightnesses where two-by-two units are not used, biaxial fluorescent downlights provide comfortable, less formal, low-level illumination. Compact fluorescent spread-lens wall washers complete the lighting system, highlighting artwork as well as balancing daylight brightnesses from the window wall. These particular spread-lens units use a specially designed reflector-and-lens system that produces

a relatively "punchy" effect.

In the instructors' office, where VDT screens had mirrored the lensed two-by-four luminaires, the team elected to risk using an unconventional approach — an indirect lighting system. With ceiling brightnesses kept uniform, VDT reflected glare and wash-out were abolished; the room appears comfortably bright and spacious. At 9 feet, the ceiling height was so low that standard indirect units were inappropriate.

Using a new, thin-profile

luminaire with T8 fluorescent lamps, the team was able to keep ceiling brightness ratios below 5 to 1 (maximum to minimum). In addition, the luminous sides of the center luminaire contribute to an overall sense of brightness for the user, mitigating the haziness associated with 100 percent indirect lighting.

Lamp and Luminaire Technology

T8 fluorescent technology may seem relatively new to the U.S. market, but it has been



Before the renovation, VDT screens in the instructors' office mirrored the lensed 2 x 4 luminaires.

widely used in Europe for more than 15 years, primarily because of Europe's distribution voltage standards. The lamp's efficiency is slightly higher than the standard T12 and its size is relatively small. On electromagnetic ballasts, a 4-foot T8 lamp consumes about 20 percent less energy than the T12 (only 32 watts), while producing 91 percent of the lumens (2900) of a T12. Because lamp life is about the same for both types, energy savings give the T8 a long-run economical advantage.

Excellent color rendering characteristics combined with the energy and optics benefits provide a fluorescent system that

is generally more cost-effective than most other solutions — including other fluorescent or high intensity discharge lamps. For these reasons, T8 technology was used extensively at the CAA.

A relatively new piece of equipment used at the CAA is the compact fluorescent spread-lens wall washer. This unit is about the same size as its incandescent counterpart; however, it uses an internal "kicker" reflector designed around two 13-watt biaxial lamps. This provides a photometrically similar distribution and lumen output. Matching aperture sizes with the fluorescent downlights used in the same space was a primary de-



With indirect lighting, the renovated space enjoys a substantial reduction in VDT-reflected glare.

sign concern. This new unit is designed to work in tandem with the compact fluorescent downlights used in the CAA.

The Center for Advanced Airmanship demonstrates that lighting alone can make a difference — a significant one. Some of the evidence is in the comments made by people at the center. A typical comment is, "We had no idea lighting could make such a difference." The people there have responded to differences in lighting color, too. They clearly prefer warm light to cool light. And, it is clear that brightness is in the eye of the beholder. Some people thought spaces were made brighter, while others thought

the same spaces became less bright. But they all noted a difference.

Some spaces worked out much better than others. In some instances, the team failed to practice what they preach — circumventing the design process because they "knew" the solution before they figured out the problem. And they found once again that, given good communication, electrical engineers, contractors, and product manufacturers will bend over backward to satisfy a client's needs. ■

For product information, see the *Manufacturer Credits* section on page 70.

Software Reviews

In addition to reporting on a new lighting calculator by Halo Lighting, this month's column looks at Cerenet, an energy simulation program of interest to lighting designers.

Hand-held Calculator

Halo Lighting has developed a hand-held multifunction calculator that determines the number of fixtures needed and their spacing for any illumination level specified. The recently released calculator requires that users input room dimensions and lamp lumen data. From this information the device calculates and displays — faster than you can read this review — the number of luminaires required, the footcandles of illumination provided, fixture spacing, and the area illuminated by each fixture.

Provided along with the handsomely styled calculator are clearly written instructions with several worked-out examples to help the user get started. The instruction leaflet is like a minicourse in lighting design. This "little calculator that could" will figure lighting for rooms measuring up to 999 feet long by 999 feet wide by 99 feet high.

My first sample run proceeded as follows: After entering the width, length, and height of the room, I pressed the key labeled RCR and the room cavity ratio instantly appeared. Next, I entered the coefficient of utilization from the lighting specification sheet (it's possible to use any value up to .99), then pressed the key labeled CU. I entered lamp lumens (any value up to 99,999) and pressed the key labeled LL, then entered the desired foot-candle value (any value up to 999) and pressed the key labeled FC. At this point the little calculator had enough information to figure an installation with initial footcandles. Finally, after each of the four separate keys was pressed, the following

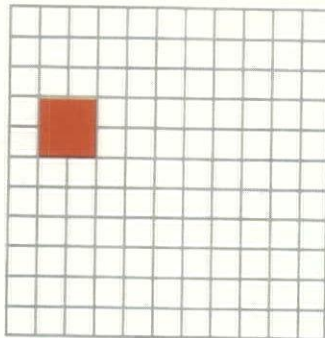

Hand-held calculator and energy simulation software

David Lord

David Lord is a professor of architecture at California Polytechnic State University, San Luis Obispo.

information appeared in order: the number of luminaires required, the footcandles obtained, the area illuminated by each luminaire, and the maximum fixture spacing.

After initial footcandles were calculated, the maintained footcandles were figured, taking into account lamp lumen depreciation (LLD) and luminaire dirt depreciation (LDD). In addition to accomplishing all the above, the HLC-1 can also be used as a standard five-function calculator for addition, subtraction, multiplication, division, and determination of square roots. It also has an automatic shut-off feature for conserving the battery. I can think of one thing Halo could do to improve its device. If it were only powered by solar cells, then electric lighting could be figured by using daylight.

I believe we will be seeing many of these calculators on designers' desks in the future. So, a caution seems in order.

Featured programs

Halo HLC-1 Lighting Calculator

For further information, contact a Halo Lighting dealer or Halo Lighting
400 Busse Road
Elk Grove Village, IL 60007-2195
(312) 956-8400

Cerenet Energy Simulation Software, \$395

Requires IBM PC/XT/AT with at least 128K memory, operating under MS-DOS or PC-DOS, with a color graphics card, Hercules video card, or enhanced graphics adapter. True PC compatibles are acceptable, as long as they can execute IBM-type graphics. 8087 numerical coprocessor recommended. Can be operated from a floppy drive, hard disk, or combination of both. Printer required for hard copy of tabular or graphic output. Climate data for 200 cities is available for \$100. A discount is available for educational institutions. Contact:

Robert J. Koester
Center for Energy Research/Education/Service
Ball State University
Muncie, IN 47306
(317) 285-1135

The ease with which this hand-held calculator makes lighting calculations could lull users into believing it can make intelligent lighting *decisions*. A beginner who has not first learned to do the calculations by hand could make some serious mistakes!

Seeing the HLC-1 made me wish for a memory resident utility program for my IBM PC that would operate like *Sidkick* by Borland. It would be a pop-up calculator — called up on the computer screen with the stroke of a key — that would figure simple lighting problems, then allow a quick return to the previous program.

Cerenet

Cerenet Energy Simulation Software is a user-friendly package that I have enjoyed getting to know over the last few weeks. Due to its speed and ease of operation, Cerenet invites experimentation and reiteration of alternate design solutions. Released after four

years of development at the College of Architecture and Planning and the Center for Energy Research/Education/Service at Ball State University, Cerenet performs thermal modeling of building energy behavior, using a network analysis technique.

Cerenet is accompanied by a well-written manual that covers each operation in detail.

The program can handle up to 19 different temperature nodes in a building. The temperature nodes can be visualized most easily as imaginary temperature measurements at selected points in the building. During a simulation, the temperatures at these probe locations are calculated hourly. Climate data can be accepted from a list of 200 standard cities or can be

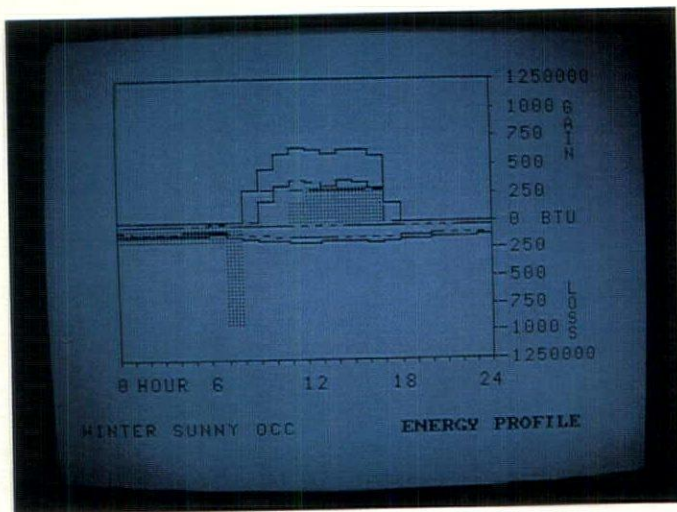

CERENET 2.5/The CERES Office		TEST3.SIM		Selection Output				
FILE: TEST3.SIM	→ WINTER	SUNNY	OCC					
(888)	(888)	(888)	(888)					
HOUR	SOL. GAIN	AMB. TEMP	CALC TEMP	HEAT NRGY	COOL NRGY	NODE 1	NODE 2	NODE 3
1	0.0	22.7	53.4	171.5	0.0	55.0	55.0	48.6
2	0.0	21.9	53.3	104.1	0.0	55.0	55.0	47.8
3	0.0	21.6	53.3	108.0	0.0	55.0	55.0	47.5
4	0.0	21.9	53.3	108.7	0.0	55.0	55.0	47.4
5	0.0	22.7	53.3	105.8	0.0	55.0	55.0	47.5
6	0.0	24.0	53.4	178.3	0.0	55.0	55.0	47.8
7	0.0	25.7	53.5	169.1	0.0	55.0	55.0	48.1
8	0.0	27.7	61.1	929.1	0.0	78.0	78.0	48.5
9	0.0	29.8	70.1	0.0	0.0	78.1	64.5	58.9
10	0.0	31.9	73.2	0.0	0.0	73.2	69.4	64.6
11	0.0	33.9	78.3	0.0	0.0	78.3	76.0	70.7
12	0.0	35.6	81.9	0.0	186.3	88.0	88.0	76.6
13	0.0	36.9	83.0	0.0	208.2	88.0	88.0	80.0
14	0.0	37.7	82.9	0.0	203.2	88.0	88.0	80.7
15	0.0	38.0	83.2	0.0	204.4	88.0	88.0	81.6

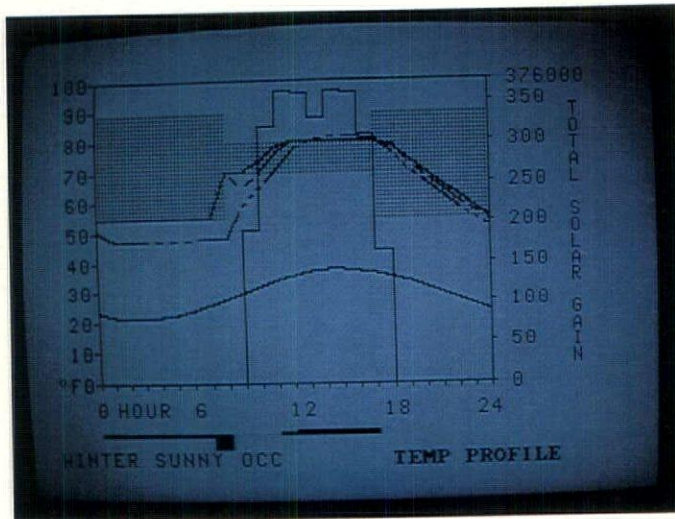

CERENET 2.5/The CERES Office		TEST3.DAT		Climate and Building Data	
AVERAGE	Select A City			NUM OF NODES:	3.00
	ABILENE, TX			OCC HEAT THERM SET PT:	78.00
	ANDROM/CANTON, OH			MOCC HEAT THERM SET PT:	55.00
	ALBANY, NY			OCC COOL THERM SET PT:	88.00
	ALBUQUERQUE, NM			MOCC COOL THERM SET PT:	98.00
	ALLENTOWN, PA			FIRST SIMULATION HOUR:	1.00
	ALPINA, MI			LAST SIMULATION HOUR:	24.00
	AMARILLO, TX			DAYS/WEEN OCCUPIED:	5.00
	ANNETTE, AK			1ST HOUR OF OCCUPANCE:	8.00
	APALACHICOLA, FL			LAST HOUR OF OCCUPANCE:	17.00
	ASHVILLE, NC			CON VENTING 1=YES, 0=NO:	1.00
	ASTORIA, OR			VOLUME (888 cu. ft.):	200.00
	ATLANTA, GA			NR OF GLAZED SURFACES:	5.00
	AUGUSTA, GA				
	AUSTIN, TX				
	BANGERSFIELD, CA				
	BALTIMORE, MD				

Tabular and graphic screen displays generated by the Cerenet energy simulation software. The program allows users to

make speedy visual comparisons of alternate design simulations, identifying peaks and valleys of energy performance.

defined by the user.

Cerenet has been compared to more powerful — and less friendly — number crunching programs and has been validated to within 5 percent. Comparisons must be viewed carefully, however, because each energy program is unique in its way of considering variables.

For architects and designers, the outstanding feature of Cerenet is its rapid calculation time and its colorful and highly graphic display of results. I tested Cerenet using the 8087 math coprocessor on an IBM XT with

a fixed disk and an enhanced graphics adapter. I was able to make speedy visual comparisons of alternate design simulations, identifying peaks and valleys of good and bad energy performance.

I played games with the software by guessing which corrective design measures would shave excessive energy consumption. I was particularly interested in the influence of shading devices on windows oriented in various directions. Cerenet had no difficulty handling the tasks I gave it. My feeling is that in

addition to being useful to the professional, it is also an attractive and powerful educational package that can build student interest.

The opening screen of Cerenet contains a serial number and the owner's registered name. The first step for a new Cerenet user is to further customize the software by entering a secret password. This is a creative way to discourage illegal copying of software and protect the rights of the copyright owner. Anyone who wants to use the software thereafter must have the password to

proceed beyond the opening screen.

The Cerenet main menu offers a choice of editing, simulation, display, and utilities. For the beginner, it supplies a default set of values for a building in a given climate. These values may be overridden as the user gains confidence; I estimate that most designers with some technical background can be getting useful results from Cerenet in two to three hours. Some users will have difficulty ending work sessions because of the

Continued on page 40

Lighting Graphics

All colors of light in the visible light spectrum can be created with a process identified as *additive color mixing*. It uses two or three widely separated colors of light from the spectrum. Red, green, and blue are the most commonly used colors and are typically identified as *primary* colors. To produce white light they must be added together in approximately equal parts. These three colors are not the only ones that function as primary colors, but they have been found through experience to produce the widest range of colors. Red, green, and blue are therefore generally accepted as the primary colors to use for additive color mixing.

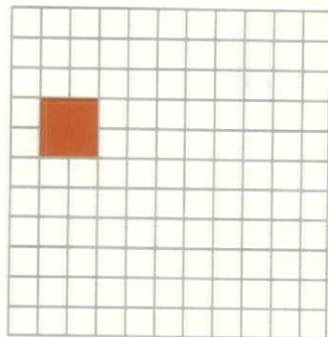

Secondary colors — yellow, cyan, and magenta — are created by mixing two primary colors and are considered to be complementary to the color opposite them on the color circle. In the diagram that accompanies this column, yellow is the complementary color to blue, cyan to red, and magenta to green. Any two colors that produce white light when combined are called *complementary*.

Combining red, green, and blue light in equal parts produces white light.

Using additive color mixing to furnish white light creates interesting effects, particularly with regard to the resulting color highlights and shadows. We have all experienced this at the theater, where it is used effectively, although usually more dramatically than is appropriate for most architectural uses.

A number of readily available light sources can be used for additive color mixing, the col-

The color of white light: Part 3

Sam Mills, AIA, IES

Sam Mills is an architect and lighting consultant with his own firm in Oklahoma City. In this column, he draws on 25 years of experience in lighting and architecture to offer design ideas, technical data, and graphic details that can be used to design coordinated lighting and architecture.

ored PAR flood lamps used for lighting at Christmastime, for example. These lamps, as well as R-type reflector lamps, are made in tints of colors that will function most effectively for the nontheatrical applications where less color saturation is desirable.

Tinted or clear-color PAR and R lamps of blue-white and pink can be combined in approximately equal quantities to furnish white light, as shown in the accompanying drawing. Yellow can also be added for greater color interest. When colors are circuited separately, they can furnish a *warmer* or *cooler* environment with relatively little color distortion. General line A-lamps in color tints of blue-white, pink, and yellow are useful for similar effects.

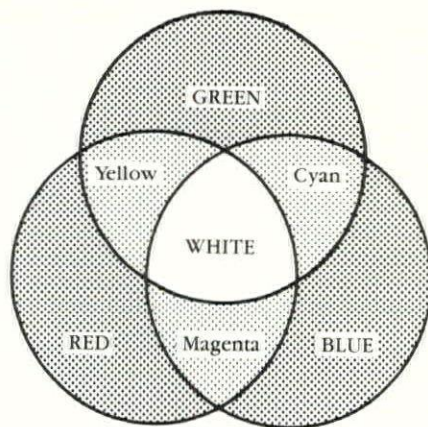

White light from color sources

Mixing primary or complementary colors of light produces white light with interesting color highlights and shadows. Some combinations that can be used are red, green, and blue incandescent lamps, pink and blue-white incandescent lamps, or blue and yellow fluorescent lamps.

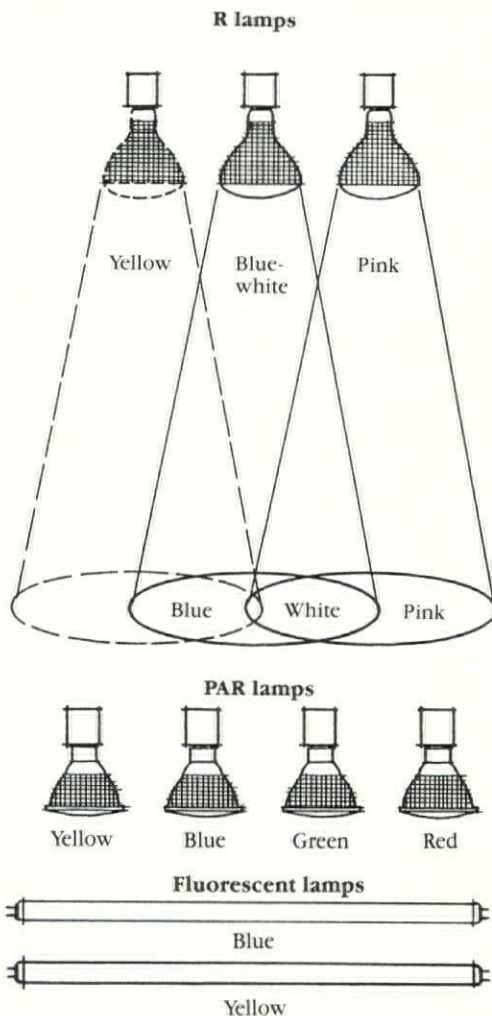

**GROSS
CHANDELIER
COMPANY**

Since 1908

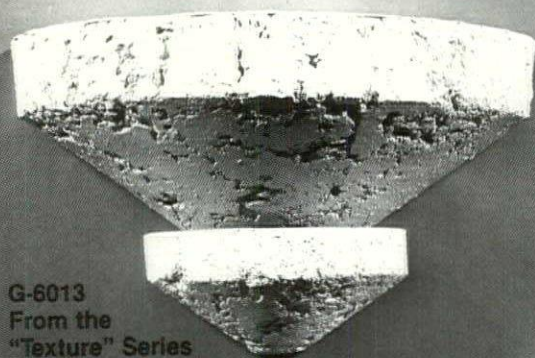

G-6013
From the
"Texture" Series

**Custom Designers and
Manufacturers of
Fine Decorative Lighting**

106 Gratiot St.
St. Louis, MO 63102
(314) 231-1060 1-800-331-2425
FAX (314) 231-2265

Circle 17

Redwood Classics

Maximum Span:
72 inches

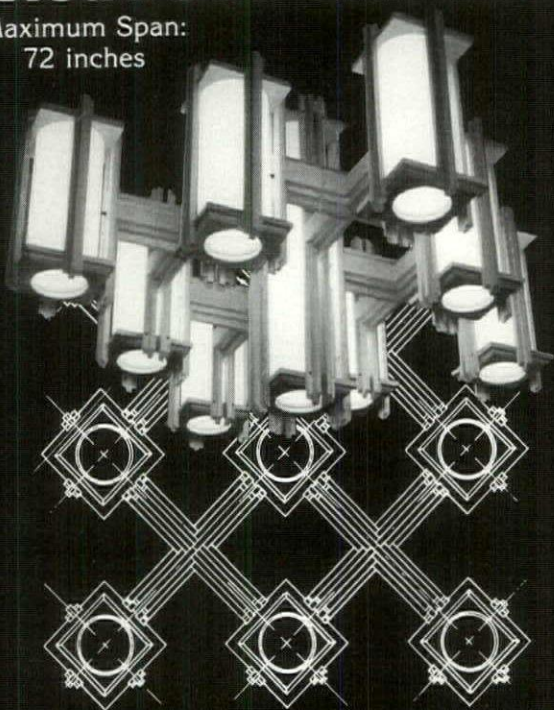

SYLVAN DESIGNS, Inc.

8921 Quartz Ave., Northridge, CA 91324
(818) 998-6868

Circle 18

Relative light output of color lamps

Color	Incan- descent	Fluor- escent
White	100	100
Green	125	130
Yellow	70	70
Pink	45	36
Blue-white	30	80
Red	12	5
Blue	6	37

Values are approximate.

These combinations of color light sources are particularly interesting when used to light display areas, restaurants, gift shops, table settings, and so forth. Although the general lighting effect is that of white light, the combinations create multicolored highlights and shadows.

Any two colors that produce white light when combined are called complementary.

More saturated color lamps in primary colors of red, green, and blue can also be added together to produce white light. With these sources it is important to mix the colors in proportion to the relative efficiency of their light output as shown in the relative light output table.

Blue and yellow (gold) fluorescent lamps can also be used effectively this way to furnish white light—usually with indirect lighting systems. With programmed or manual dimming controls, circuited separately for each color, you can create a range of interesting color tints and hues for subtle changes in color and the architectural environment. ■

Continued from page 38

temptation to try just one more combination of energy-saving features.

Cerenet is accompanied by a well-written manual that covers each operation in detail. Studying the manual is like taking a short course in the energy behavior of buildings. The final chapter of the manual covers applications and illustrates a few of the many ways Cerenet can be used. It quickly becomes apparent that this is a program that helps designers choose strategies and make decisions as well as calculate final energy consumption.

Cerenet can be used in the schematic phase of design, or it can be used to analyze a building that is already built and operating. The only disappointment will be to those California architects who want a California Energy Commission (CEC) certified analysis program. Eventually, Cerenet will be certified; even now it is a more useful design tool than most of the current CEC-certified programs.

Cerenet is the most user-friendly, visually appealing, yet sophisticated and powerful energy analysis program I have yet worked with. This may be a tough position to hold in the competitive and fast-moving field of computer software.

Received for Review
Demonstration diskettes for Lumen-Micro and Lumen-Point have been received for review from Lighting Technologies. They are available on request from Lighting Technologies, 3060 Walnut Street, Boulder, CO 80301. ■

The Lighting Design Professional

This is the first in a series of three columns about fine quality accent, display, and detail lighting to be used in hotels, restaurants, galleries, residences, and similar applications. The series emphasizes low-voltage incandescent and halogen lighting equipment. This month's column examines low-voltage light sources.

The key to the success of low-voltage lighting is the intense focus and great beam control inherent in the lamps. Simply put, the filament is smaller, allowing a better optical match with a reflector of normal size. A larger portion of the light generated by the lamp is focused into the beam, and less is wasted in the field. A 25-watt, 12-volt PAR 36 lamp can have several times the candlepower of a 150-watt, 120-volt lamp.

Low-voltage lighting began to evolve as a serious design tool in the late 1970s. Until then, its primary applications were in locations where safety was the primary concern, such as at swimming pools. During this early period, only a few creative designers explored other possibilities of this technique, and very little lighting equipment was available to the average designer. Much of the early low-voltage lighting was done with automobile and tractor lamps, including PAR and various instrument lamps.

In the mid-1970s, designers began to become aware of the tremendous possibilities of low-voltage lighting. In addition to the small size of many of the lamps, the inherently safer wiring at 12 or 24 volts allowed many installations with a minimum of electric wiring boxes and hardware. Manufacturers introduced low-voltage lighting products that made exciting new effects possible.

Desire was also increasing for drama in electric lighting. Pinspots created "rainlight"

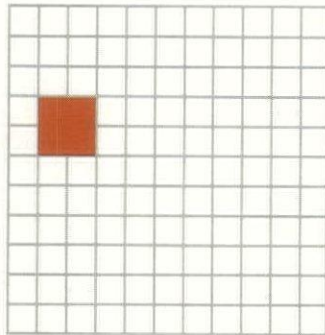

Low-voltage light sources

James R. Benya

James R. Benya is senior principal and CEO of Luminae, Inc., San Francisco. He is a member of the faculty of California College of Arts and Crafts, where he shares his 17 years of architectural lighting design experience with architecture and interior design students. Benya is active in the IES and Designers Lighting Forum of Northern California, and he teaches lighting design classes for the ASID, IBD, and AHLI.

effects in discos of the late 1970s. Interior lighting designers began to explore the possibilities of focused dramatic lighting in homes, stores, and restaurants. The introduction of the MR16 lamp made possible truly small-aperture accent lighting, and smaller track fixtures made this technique more attractive. By the early 1980s, low-voltage was a standard product line for several major lighting manufacturers.

Full-Size PAR Lamps

PAR 36 lamps. PAR 36 lamps are available in architectural and specialty beam spreads. Until recently, they were the most commonly used low-voltage lamps. The architectural lamps are typically 25- or 50-watt



Low-voltage reflector lamps. Top: PAR 56. Center: PAR 46, PAR 36, metal PAR 36 (Osram). Bottom: MR16, MR11, R12, R14, 20-watt Halostar (Osram), 50-watt Halostar (Osram).

units offered in very narrow spot (VNSP), narrow spot (NSP), wide flood (WFL), and very wide flood (VWFL) configurations. They tend to have filament shields and soft-edged round or elliptical patterns.

Specialty lamps — for automobiles, tractors, and so forth — range in wattage from 25 to 100 and have number designations in the 4000 and 7000 series. Most specialty lamp beam spreads are designed for a specific purpose: the 4415, for example, which creates a slash of light, was intended for a tractor headlight.

PAR 36 lamps are generally used in residences, restaurants, galleries, and some commercial displays. There are a few 6-volt PAR 36 lamps, and these have the tightest beam spreads. Most PAR 36 lamps, however, are 12-volt. Advanced lighting designers often stock a variety of architectural and specialty types for artistic lighting situations. In general, any 25- to 50-watt lamp can be used interchangeably in the same fixture. Because PAR 36 lamps tend to run cool, conventional theater gels can be used for color with the lower-wattage lamps.

Quartz PAR 36 lamps.

Sylvania and Philips manufacture a 36-watt, 12-volt PAR 36 lamp that has a small quartz halogen bud lamp fixed inside a traditional glass PAR 36 shell. These lamps permit PAR 36 installations with the advantages of quartz — whiter color and longer life. They are available in VNSP, NSP, and WFL beams. Osram recently introduced metal-bodied PAR 36-sized quartz lamps: 35-watt in 6-volt; 50-, 75-, and 100-watt in 12-volt. These lamps have no outer glass shell, only a filament shield.

Quartz PAR 36 lamps are better suited for commercial display than their conventional incandescent counterparts because of their added punch and whiter color. But, they appear too cool for residences, and — because they produce a bit more UV than incandescent lamps — they are unsuitable for museums. They generate more vibrant color than conventional incandescents when gelled, however, and may be more desirable for these applications.

PAR 46 lamps. PAR 46 low-voltage lamps are relatively uncommon in architectural use. Only one lamp, a 25-watt, 6-volt

Full-size PAR lamp types

Designation	Lamp Type	Wattage Range	Voltage	Beam Types	Maximum Candlepower	Useful for:		Typical Installations
						Spot	Flood	
PAR 36	Incan- descent	25-50	6, 12	VNSP- VWFL	25,000*	Yes	Yes	Track, recessed, semitheatrical
QPAR 36	Quartz	36	12	VNSP- VWFL	33,000	Yes	Yes	Track, recessed, semitheatrical
Metal PAR 36	Quartz	35-100	6, 12	ENSP- VWFL	50,000	Yes	Yes	Track, recessed, semitheatrical
PAR 46	Incan- descent	25-50	6, 12	ENSP- NSP	55,000**	Yes	No	Track, recessed, semitheatrical
PAR 56	Incan- descent	120-240	12	VNSP- MFL	140,000	Yes	No	Track, recessed, semitheatrical
PAR 64	Incan- descent	120	6	VNSP	210,000	Yes	No	Track, semitheatrical

*Up to 50,000 using specialty lamps.

**Up to 95,000 using specialty lamps.

PAR 46 pinspot, is listed as an architectural lamp. The others are listed as specialty lamps. The 30-watt, 6-volt 4535 is extremely popular as a disco pinspot.

PAR 56 and PAR 64 lamps.

The larger-diameter PAR 56 and PAR 64 lamps tend to be high-wattage 120-volt lamps, but several important architectural low-voltage lamps are in this group. These include the 120- and 240-watt, 12-volt PAR 56 lamps and the ultratight 120-watt, 6-volt PAR 64 lamp. They are extremely useful for commercial displays, outdoor sculptures, flags, and other difficult situations that require precise, intense spotlighting over distances of 20 to 50 feet.

Compact Reflector Lamps

Low-voltage technology permits the manufacture of small lamps that have most of the optical control of larger PAR lamps. Early low-voltage compact lamps were designed as reading lights for automobiles and airplanes; they used conventional incandescent filaments. The miniature halogen bud lamp allowed the development of a more intense, highly controlled light source in a compact package. An MR (multi-



Miniature low-voltage lamps. Top: 20-watt halogen bud in wall washer (Luma). Bottom: Miniature halogen lamp (Osram), 5-watt halogen bud (Osram), 5-watt festoon lamp (Lucifer), standard 2 1/2-watt instrument lamp (Radio Shack), automobile dome light, 5-watt wedge lamp (GE).

faceted reflector) lamp has a halogen bud fixed in a sophisticated, computer-designed reflector of faceted glass. Dichroic reflector coatings on the glass allow a beam that is cooler and has less UV content than beams from metal or aluminized glass reflectors.

MR11 lamps. The smallest commercial spot lamp, the MR11, is now available from

several American and European manufacturers. The most common wattage is 20, although 35-watt versions are also made. Beams from NSP to WFL are sold, and the lamps can be purchased with either bipin or bayonet bases.

MR11 lamps tend to have sloppier beams and to be a bit more fragile than their big brothers, the MR16 lamps.

Also, the lamps burn hotter. But their ultracompact size is extremely appealing, and after several years of resistance by manufacturers, a flood of new MR11 fixtures is finally being released.

Halostar. Osram manufactures MR lamps for the American market and also makes its own series of lamps called Halostar. These lamps have a quartz bud fixed in a metal reflector instead of a dichroic glass reflector. The result is a hotter beam, slightly higher efficiency, and apparently more rugged construction.

These lamps are available with silver- and gold-colored reflectors. The gold lamp has a color temperature of about 2600K, approximating that of incandescent. The smaller-diameter, 20-watt lamps are about the size of an MR16; the larger bayonet-base lamps range from 20 to 75 watts.

Halostar lamps are sold in conjunction with a magnetically supported socket and lamp holder called the Orb. Any 12-volt source can supply power to this complete low-voltage fixture. Most of the lighting equipment available in the United States today for

Compact reflector lamps

Designation	Lamp Type	Wattage Range	Voltage	Beam Types	Maximum Candle-power	Useful for:		Typical Installations
						Spot	Flood	
MR11	Quartz	20-35	12	NSP-WFL	5500	Yes	Yes	Track, recessed, linear accent
Halostar	Quartz	20 (small), 20-75 (large)	12, 24	NSP-WFL	3500 (small), 15,500 (large)	Yes	Yes	Track, linear accent
R12	Incandescent	15-25	12	SP-FL	800	Yes	No	Recessed, track
R14	Incandescent	15-25	12	SP-FL	1200	Yes	No	Recessed, track
MR16	Quartz	20-75	12	VNSP-WFL	12,000	Yes	Yes	Recessed, track, linear accent, semitheatrical
Philips GB series (approx. R11-R18)	Quartz	15-50	6, 12	ENSP-VWFL	15,000	Yes	Yes	Recessed, track (typically in special adapter)

these lamps takes advantage of the Orb enclosures.

R12 and R14 miniature reflector lamps. The R12 and R14 are small versions of traditional 120-volt R lamps. They were originally developed as aircraft and automobile reading lights. Very few fixtures are still made for these lamps because their beams are comparatively weak and soft, but they are still useful for down-lighting and wall washing in very tight situations, like yachts, where small recessed fixtures are desired.

MR16 lamps. No new incandescent lamp in the last 25 years has generated as much excitement, creativity, and imagination as this architectural version of a slide-projector lamp. Its small size allows for compact fixtures and narrow, recessed fixture apertures, and its incredible beam control offers a variety of fairly clean, efficient beams with the cool quality of dichroic reflection.

Typically, 20-watt MR16 lamps are used in residences for display and general lighting; the 42-, 50-, 65-, and

75-watt lamps are more often used for commercial display and focal lighting. Most MR16 lamps offer extremely long life (3500 hours), although virtually all architectural fixtures reduce the life of 75-watt lamps considerably. The 20-watt lamp is cool enough to work with some theatrical gels, but at higher wattage, designers must use glass filters or colored lamps.

GB series quartz reflector lamps. In addition to offering MR16 lamps, Philips — like Osram — offers its own line of compact low-voltage lamps. Designated by the ANSI codes GBA, GBB, and so on, these lamps resemble R11 and R17 lamps in shape. They contain a halogen bud surrounded by a reflector-lamp metal enclosure. The beautiful, tight beams have soft edges and no striations. A glass cover allows the lamp to be used "naked"; MR lamps require a glass lens as part of the fixture.

The GB series lamps are most readily available as part of a Philips combination assembly, combining a transformer and a medium base

socket adapter, designed for existing track or recessed fixtures.

Linear Modular Lighting Designers today can take advantage of the revolution in modular low-voltage lighting. Clever manufacturers have devised means to connect low-voltage lamps together into compact linear lighting effects that fit where conventional 120-volt lighting cannot — under shelves, inside cabinets, along and under steps, inside architectural coves, and dangling in arrangements resembling curtains, streams, and chandeliers.

Modular linear lighting systems use small, compact incandescent or halogen lamps mounted along a wiring or power supply bus. Variations in lamp wattage and spacing determine the amount of light produced. The low-voltage systems can be used indoors, outdoors, and in details where safety is an issue.

Light tubing. Tiny, ½-watt incandescent lamps are connected in series or parallel in-

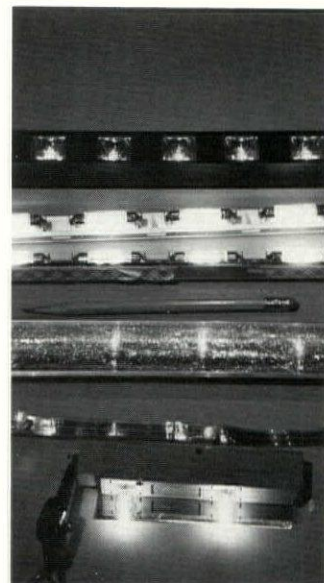

Modular linear incandescent systems. Top to bottom: Microlume, Lucifer series 200, Lucifer series 300, Lite-Channel, Lite-Buds, Lumiere.

side light tubing. The lamps operate at 24 volts — well below rated voltage — to make their life extremely long (50,000 hours or more). Lamps and wiring are slid inside a rigid or

Linear modular low-voltage lighting types									
Type of System	Voltage	Lamp Type	Wattage per Lamp	Lamp Spacing	Primary Uses				Notes
					Accent Niche	Under Shelf	Step Light	Cove Uplight	
Light tubing	24	Incan- descent, series- parallel	0.4-1.0	1"-12"	No	Yes	Yes	Maybe	A,B
Incandescent light strips	6, 12, 24	Incan- descent, bayonet and wedge base	1.0-10.0	2"-6"	Yes	Yes	No	Yes	C,D
Light strip system	12, 24	Festoon, quartz bud, MR11, or Halostar	5, 10; 5-20; 20; 20	2 1/8"	Yes	Yes	No	Yes	E,F
Flexible light buds	12, 24	Incan- descent or quartz bud	0.82-5.0	2"-12"	Yes	Yes	Maybe	No	G
Extruded bud strips	12, 24	Incan- descent bud	0.82	2"-12"	Maybe	Yes	Maybe	Maybe	H
Modular minispot strips	12	Incan- descent bud	1.0	1"-12"	Yes	Yes	Maybe	Maybe	A,H
Showcase lighting	12	Quartz bud	20-50	3"-12"	Yes	Yes	No	No	H

A. Available in multiple-circuit versions for chasing.
 B. Wide variety of tubing shapes, sizes, extrusions, and accessories.
 C. Straight and bent shapes available, but generally not flexible.
 D. Designed primarily for shelf lighting and related applications.
 E. Various lamp holder accessories for accent lighting and shelf lighting.
 F. Several standard extrusions available for exposed mounting.
 G. Self-adhesive backing.
 H. Durable, sealed enclosure.

flexible plastic tube. Sections of tube connect together with simple, plug-together wiring.

Light tubing is usually mounted directly to the surface using either plastic clamps or special aluminum or plastic extrusions. Standard extrusions for stair nosing, theater aisle lights, architectural coves, and many other applications are available. Light tubing is best used for beauty and effect; at its maximum lighting level, it can barely light a countertop.

Incandescent light strips. These systems use instrument lamps of up to 10 watts mounted to a metal or high-temperature-plastic base. Because of the higher wattage, these systems can function under cabinets, inside cabinets, and in other shelf lighting applications where a fairly substantial amount of lighting is needed. Designers should be aware that these systems generate enough heat to dry out woods and fabrics, presenting a minor burn hazard.

Light strip system. Still fairly

unusual among its competitors, Lucifer manufactures a plastic extrusion, bus-bar, and socket system that can hold festoon lamps (instrument lamps that look like fuses), compact quartz bud lamps, or adjustable Halostar or MR11 accent lamps. This variety gives the designer ultimate flexibility when focusing upon fine art vignettes and displays. Again, heat is a concern. A variety of housings, including extrusion tubes, can make this a very interesting lighting design tool.

Miscellaneous bud light systems. Incandescent or halogen bud lights mounted on flexible bands of copper foil create a linear series of *flexible light buds* that can follow any form or outline a shape. Flexible buds work well in designs that do not require a clean, uninterrupted line of light.

Extruded bud strips have buds inside an extruded plastic cover, which often includes a reflector. The rigid series of

light spots is useful in a variety of decorative applications.

Similar to extruded bud strips, *modular minispot strips* surround each bud with a reflector so that the strip has a definite linear focus. These systems create substantial on-axis candlepower, making them very well suited for multicircuit chasing and similar applications.

Showcase lighting fixtures are heavy-duty, high-temperature versions of bud strips. They use miniature bud lamps to create an even wash with halogen color and sparkle. Mounted within a showcase, the fixture can get warm, but it produces unequalled sparkle on jewelry and other displays.

A future Lighting Design Professional column will explore low-voltage lighting equipment and explain how to choose the proper fixtures and lamps for many common lighting design problems. Another column will discuss the finest points of low-voltage technique, including patterns, gobos, lenses, louvers, and color. ■

This column identifies some manufacturers in an effort to help designers identify the sources of some particularly unusual low-voltage products. The author points out, however, that these manufacturers may not be the sole sources of the products mentioned. He urges readers who are interested in low-voltage lighting to contact as many manufacturers as possible to see exactly what is available.

The Daylighting Department

Physical models are by far the best tools for daylighting design for a number of good reasons. Because of the physics of light, no errors are introduced due to scale; therefore, the model can exactly reproduce the conditions of the real building. Slides made of a real space and of an accurate model show identical lighting patterns. No matter how complicated the design, a model can accurately predict the result and make it easy to compare alternative designs. This is true of neither mathematical nor graphical techniques.

Physical models illustrate both the qualitative and quantitative aspects of a lighting system. The qualitative information is especially important because glare, veiling reflections, and brightness ratios are often more important than illumination levels.

Physical modeling is a familiar, popular, and appropriate medium for architectural design. As long as a few basic requirements are met, excellent results can be obtained — even from crude models.

Physical models are the best tools for designing daylighting.

Architectural elements that affect the light entering a space — size, depth, and location of windows, overhangs, and baffles, for example — must be carefully modeled. Reflectance factors should be reasonably close to those of the desired finishes. The best solution is to use actual finishes whenever possible.

External objects that reflect or block light entering the windows should be included in the model test. Opaque walls must be modeled with opaque materials; foam-core boards,

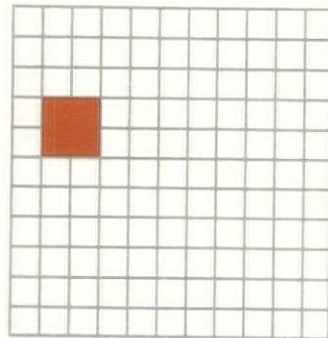

Physical models as daylighting design tools

Norbert M. Lechner

Norbert Lechner is an associate professor in Auburn University's School of Architecture, Auburn, Alabama.

for example, are translucent and must be covered with black paper or aluminum foil to be opaque. All joints must be sealed with opaque tape. Models should be tested under appropriate sky conditions.

Constructing Models

The appropriate quality for a model and the amount of effort it makes sense to expend on its construction depend on the model's purpose. If it will never be used for presentation to clients, a model can be crude yet still be sufficient for determining illumination levels and gross glare problems.

The scale for a model should be at least 1/2 inch to 1 foot. From a lighting point of view, bigger is better, but models built to larger scales can be difficult to build and to transport. A scale of 3/4 inch to 1 foot is usually the most practical compromise.

Use modular construction to

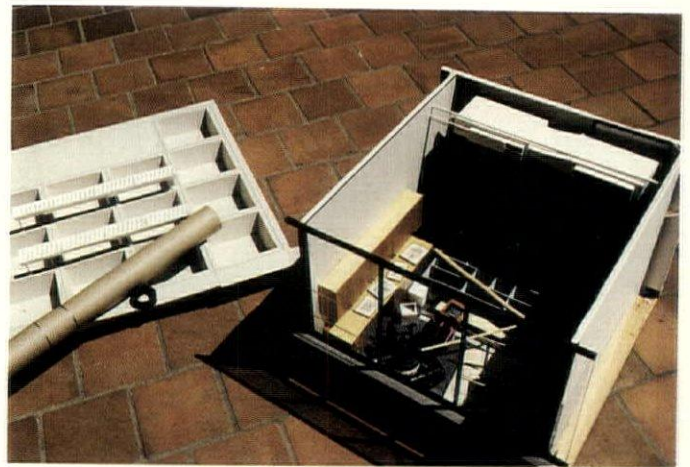

Top view of physical model with ceiling removed.

make it easy to test alternate schemes. For example, a model might be constructed with interchangeable window walls. Add view ports on the sides and back of the model for observing and/or photographing it. Make the ports large enough for a camera lens to get an unobstructed view.

Furniture should be included — especially if it is dark, tall, and extensive — because it can have an important effect on lighting. In crude models, simple blocks painted with colors of appropriate reflectance factors can act as furniture.

Testing Models

A photometer (light meter) is a valuable instrument for testing models. Inexpensive meters are usually adequate, but a meter with a sensor at the end of a wire lead is the most convenient.

The climate of the site determines under which of the two critical sky conditions a model must be tested. In most parts of the United States a model must be tested under both overcast and clear sky with sun. Testing under an overcast sky indicates whether the structure will provide minimum acceptable illumination levels; testing under a clear sky with sun reveals possible problems

with glare and excessive brightness ratios.

Testing models under an artificial sky gives the most consistent results. Hemispherical artificial skies are the most accurate but are very expensive and bulky. Although rectangular mirror skies are smaller and less expensive, they are still quite rare. Unfortunately, most designers lack access to any kind of artificial sky. Consequently, the real sky and sun are usually used to test daylighting models.

Real sky, of course, cannot be controlled like a laboratory's artificial sky. Although overcast and clear skies are quite consistent from minute to minute, they vary greatly from day to day. A partly cloudy sky presents even more problems; the lighting changes so quickly it's impossible to make reliable observations. Never test a model under partly cloudy conditions.

Model testing procedure for overcast skies. All quantitative comparisons between alternate schemes should be based on the daylight factor (DF). The daylight factor is the result of dividing indoor illumination by outdoor illumination — both measured at more or less the same time. Under overcast skies, the daylight fac-



A faculty office in the architecture department at Georgia Tech (top) and a model of the same space (bottom) demonstrate how accurately a model can reproduce the conditions in a real building.

Another view of the Georgia Tech faculty office (top) and the model (bottom) under sunny conditions. The model was built by former Georgia Tech students Ray Hitt, Bonnie Kilpatrick, and Richard Stevens.

tor remains constant even when the outdoor illumination changes (DF is also discussed in the Daylighting Department, March 1987). The design alternative with the highest daylight factor will yield the highest illumination.

To begin testing, with the model at the correct orientation, place it on a table at the actual site or at a site with similar sky access and ground reflectances. If neither of those sites are available, include major site characteristics in the model — buildings, trees, reflecting pools, or large areas of pavement, for example. Then test the elabor-

ated model on a roof or at another clear site.

With the model oriented on the selected site, place a photometer sensor at each of the various critical points to be measured. Those critical points usually are the center of the room and 3 feet from each corner. The top of the sensor should be about 30 inches above the floor. On a model, of course, these measurements are located to scale.

Measure the outdoor horizontal illumination level by moving the sensor to the roof of the model. Then calculate the daylight factor.

Use the view ports on the sides and back of the model to make a visual check for glare, excessive brightness ratios, and the general quality of the lighting. Make photographs for a permanent record.

Model testing procedure for clear skies. The procedure for testing models under clear skies is basically the same as that for testing under overcast skies except that the model must be tilted to simulate the varying sun angles throughout the year. At the very minimum, the model should be tested for the conditions on June 21 at 8:00 a.m., noon,

and 4:00 p.m. and December 21 at 9:00 a.m., noon, and 3:00 p.m. It is very important to test the model under varying sun angles in order to prevent potentially serious glare problems. This procedure is best accomplished by using a sun machine.

Photographing Models
Photographs greatly enhance the usefulness of a physical model as a design tool. Photographs of model interiors allow careful analysis and comparison of various lighting schemes. Photographs of well-constructed models also make

Daylighting tips

Because effective daylighting is a consequence of the architectural features of a building, architects must design buildings in ways that make successful daylighting possible. Here are some of them.

- Use windows to collect daylight, but introduce no more light than is required.
- Distribute light uniformly throughout the space, throughout the day, and throughout the year.
- Use the smallest windows possible to collect the required amount of light to minimize thermal penalties.
- Use high-reflectance matte finishes for most surfaces — especially large-area surfaces.
- Face windows and clerestories south and north, not east or west.
- Above a low minimum, the quality of the light is more important than the quantity.
- Automatic controls are usually necessary to make reductions in energy and power consumption a reality. Although a daylighting design does not eliminate the need for an electric lighting system, it can greatly reduce the energy and power consumption of the electric lights.
- Physical models are a valuable tool for learning more about daylight as well as for checking the quality of a particular design.
- Computer models can be helpful, and microcomputer programs are reviewed regularly in *Architectural Lighting*.

This is Norbert Lechner's last Daylighting Department column. Look for a new Daylighting Department soon. ■

for effective presentations to clients. Remember, however, that cameras do not see in the same way that the human eye sees. Brightness ratios, for example, always appear worse on film than in reality.

Eyes can change focus as required, but the camera freezes one view. Either the near or far image may be out of focus. Nevertheless, photography is a valuable adjunct to physical modeling. To help you get the most value from your physical models, here are some suggestions for photographing their interiors.

Use wide angle lenses. They

provide a large field of view as well as increased depth of field.

Use high speed film — ASA 200 or ASA 400, for example — and a tripod for maximum depth of field.

Bracket each photo. That is, shoot additional frames at least one exposure setting higher and one lower than the meter indicates.

Keep the center of the lens at the standing eye level of a standing scale figure in the model.

Avoid allowing light to leak into the model around the camera lens. ■

ALINEA

BEAUTIFUL LIGHT



The Alinea Light is an Art Deco concept brought to beautiful perfection by Aamsco Manufacturing. A tubular incandescent bulb and fixture, the Alinea radiates a soft, warm light that is especially flattering to flesh tones. Controlled by a standard incandescent dimmer, Alinea makes everything in a room more radiant and beautiful. At 2800K, Alinea bulbs come in three lengths. Fixtures are available in 10 decorator colors. For more information call Aamsco at (201) 434-0722, or write Aamsco, P.O. Box 15119, Jersey City, NJ 07305.



Circle 19



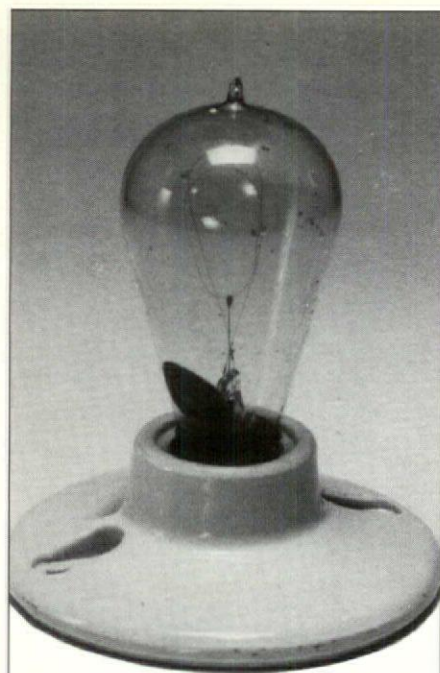

Shed Some Light

We want to publish creative lighting designs that give our readers good ideas. Submit your innovative solutions to indoor or outdoor lighting problems, wherever they may be — ball park, museum, school, factory, retail store, power plant, garden, or office.

Send slides (or larger color transparencies) and a description of the project's lighting. Include information about the design objectives and the project's scope. Remember that *Architectural Lighting* focuses on the lighting rather than the space that was lit. Address all materials to:

Charles Linn, AIA, Editor
Architectural Lighting
859 Willamette Street
P.O. Box 10460
Eugene, OR 97440



Book Reviews

Mechanical and Electrical Equipment for Buildings (seventh edition), by Benjamin Stein, John S. Reynolds, and William J. McGuinness. New York: John Wiley & Sons, Inc., 1986. 1454 pages, \$49.95.

Readers who haven't looked at *Mechanical and Electrical Equipment for Buildings* since their college days will find that this classic text continues, for the most part, to keep up with the times. Each edition encompasses advances in environmental systems, research, and technology. The seventh edition represents a significant step in looking at lighting and daylighting not as mere stand-alone elements of an environmental system, but as integral *parts* of a system with a significant impact on the whole.

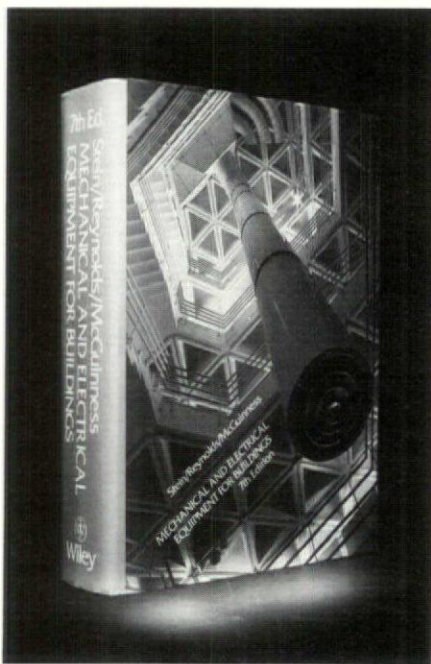

PHOTOSPHERE

Nowhere is this better illustrated than in the chapter on designing for heating and cooling. The influence of envelope design on heating, cooling, daylighting, and electric lighting is discussed in detail in the beginning of the chapter, even before teaching the reader how to calculate heat loss and heat gain. Details on why buildings that have internal-load-dominated configurations offer fewer opportunities for daylighting than buildings designed with skin-load-dominated configurations give readers the chance to understand how the overall layout of a

building can affect its total energy load.

Early in this same chapter, the authors discuss the concept of establishing an energy budget to avoid overheating caused by too much electric lighting. That discussion reinforces the notion that lighting can add significantly to a building's cooling load.

In the chapters devoted specifically to illumination, some sections have been expanded and updated — notably the sections on daylighting, lamp technology, and controls. The sections that appraise various luminaire types and calculation procedures appear to be relatively unchanged from previous editions. This is not a problem, however, given that those sections are extremely thorough and are accompanied by extensive examples.

Later sections advise readers on how to apply this information to typical projects in the real world — schools, commercial interiors, and industrial applications. They also are thorough and give experienced advice; however, some of the illustrative examples are rather dated architecturally. They might not be very inspiring to a student who is studying lighting design for the first time and who has very little idea as to what it *can* accomplish. Aesthetic considerations can perhaps be overlooked in those portions of the book that deal with purely functional issues — waste water treatment, for example. But it is a pity that, after having done an excellent job of explaining the fundamentals of lighting, the book falls short of inspiring readers by picturing dated and ordinary lighting applications.

On the whole, *Mechanical and Electrical Equipment for Buildings* presents an excellent basic, practical overview of environmental systems. It is a suitable reference for those of us who may need an occasional refresher course on some subjects.

Above all, the authors should be commended for charging their readers with the responsibility of designing buildings that are both energy-efficient and comfortable for people to occupy. Despite the mechanistic-sounding title, this is a very human book.

—Charles Linn, AIA
Charles Linn is editor of *Architectural Lighting*.

The Problem

Conventional lighting systems are inefficient and costly—40 to 60 percent of the light from fluorescent lamps can be trapped inside your fixture.

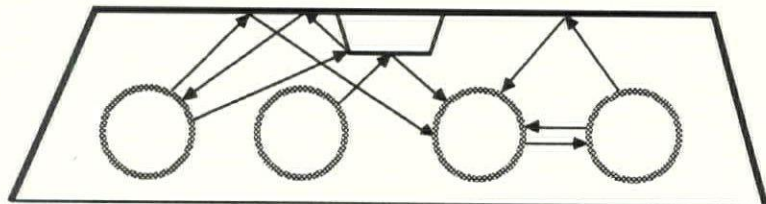

The Solution

An Optical Reflector System from Maximum Technology—to effectively reflect trapped light and redirect it to the work surface, eliminating costly excess lamps and ballasts.

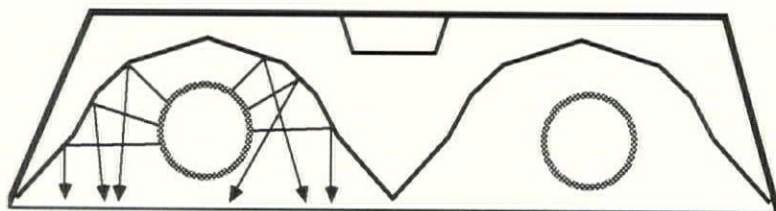

The Benefits

- 40 to 50 percent lower lighting energy costs
- Fewer lamps and ballasts to replace
- Optimum light levels
- Illumination uniformity
- Glare control
- Cooling system load reduction

The Company

The oldest, largest, most experienced reflector manufacturer in the industry.

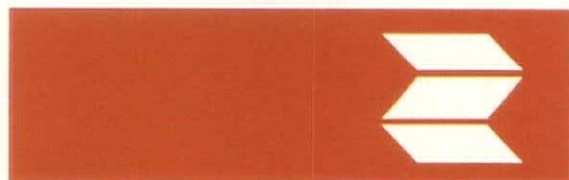

**MAXIMUM
TECHNOLOGY**
The Quality Reflector Company

60 Industrial Way Brisbane, CA 94005 (415) 468-2560

Product Showcase



■ Recessed downlight

Capri Lighting's line of recessed downlights now includes a model designed for sloped ceilings. The model SCR10X downlight features an adjustable socket that directs a beam downward for general illumination or accent lighting. Its housing fits 2-inch by 10-inch joist construction and uses a variety of standard trims. Capri Lighting, Los Angeles, CA.

Circle 60



■ Indirect fluorescent fixtures

Columbia Lighting's DecoLume indirect fluorescent fixtures reduce harsh contrasts between lit and unlit areas. Soft indirect light comes from illuminated side vents and a bottom halo of light. The fix-

tures are constructed of aluminum extrusions that lock in place with no exposed fasteners. They may be bracket-mounted on walls or pendant-mounted on stems or cables.

The 6-inch-wide, 3 1/4-inch-high fixtures are available in lengths from 2 to 10 feet, in 1-foot increments. They accommodate two T8 lamps; a single-lamp model is optional. Three gloss and 10 matte baked enamel finishes are available. Straight, corner, and T connectors are available in matching colors. The luminaires may be mounted individually or in interconnected rows or patterns. Columbia Lighting, Spokane, WA.

Circle 61



■ Low-voltage electronic transformer

The Soft Start electronic transformer for 12-volt halogen lamps weighs only 5 ounces and is recognized by Underwriters Laboratories and approved by the FCC. The unit is designed for a maximum of 60 watts in any combination, and can operate three 20-watt lamps in parallel. The 2 1/8-inch-long, 1 3/8-inch-high, 2-inch-wide unit has a weather-resistant, industrial-grade package and can operate at sub-zero temperatures. Its design eliminates humming, according to the manufacturer. The transformer fits in a standard single-gang outlet box and is suitable for outdoor lighting applications. Innovative Industries, Inc., Electronic Ballast Division, Tampa, FL.

Circle 62

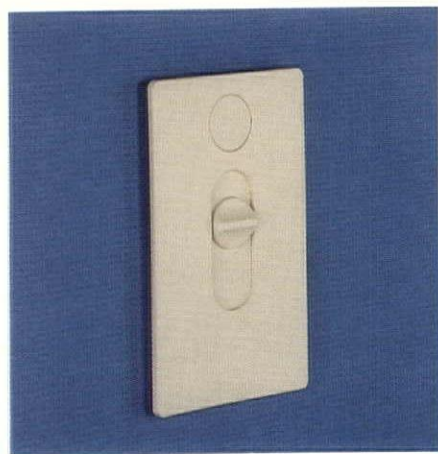

■ Slide dimmer

The Horizon line of UL-listed, specification-grade slide dimmers from Prescolite Controls features silent electronic on-off switching, linear slide control, and multilocation dimming from up to five locations. Maximum RFI filtering, voltage compensation, and common neutral designs are standard. Universal-load models handle incandescent, low-voltage, fluorescent, and neon or cold cathode loads; an incandescent-only model is also available.

Models for loads up to 1500 watts are 3/4 inch thick; matching 2000-watt models are 1 inch thick. Buyers can choose from white, ivory, brown, black, and gray finishes. Also available are matching touch switches for undimmed loads up to 1000 VA and continuous face plates for gang applications. Prescolite Controls, Carrollton, TX.

Circle 63

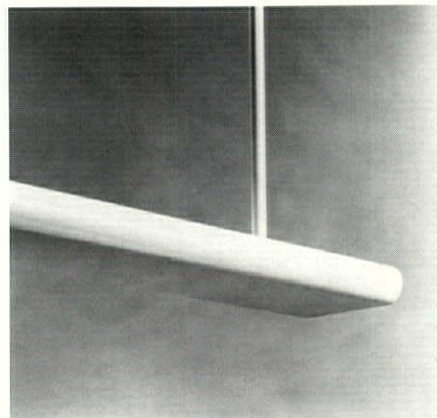

■ Linear system

The LOA 100 linear lighting system from Amerlux is a low-profile oval fluorescent

uplight made of extruded aluminum. The pendant-mounted fixture is available in lengths of 4, 5, 8, and 10 feet. Units can be mounted individually or run continuously with blind splicing. The fixture accommodates two T8 fluorescent lamps and comes in 14 standard matte and 3 standard metallic finishes. Stems are available in white and chrome finishes. Amerlux, Inc., Fairfield, NJ.

Circle 64



■ Emergency wall sconce

The Tier Drop wall sconce from Siltron Illumination can serve as a regular wall fixture or as an emergency fixture. The 17½-inch-wide, 8-inch-deep sconce has seven tiered rings of translucent white acrylic and gold trim at the top. It is mounted on a polished brass plate, which conceals an optional emergency-lighting power pack.

The luminaire accommodates a maximum 150-watt incandescent lamp for regular lighting. A model for emergency and regular lighting uses an Osram Dulux E-13 fluorescent lamp. Options include a high power factor unit, the emergency version with the lamp, and a back plate that can be painted to match color schemes. The sconce is suitable for applications in hotels, restaurants, hospitals, stores, offices, corridors, and meeting areas. Siltron Illumination, Inc., Cucamonga, CA.

Circle 65

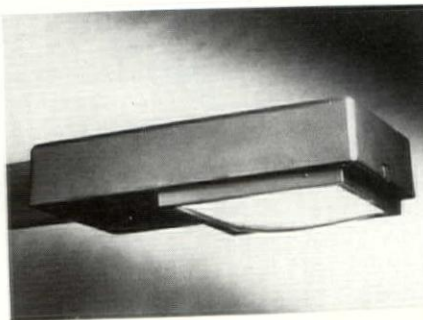

■ HID area lighting

American Electric's Luxmaster outdoor area luminaires feature a precision-formed aluminum reflector in a one-piece rectangular aluminum housing that protects electrical components from weather and contaminants. The luminaire's flat tempered-glass lens is housed in a hinged, easy-to-remove extruded aluminum frame. A socket assembly allows field adjustment to specific illumination patterns,

DINICO
EXPANDING YOUR COLOR HORIZONS

Dinico introduces exterior pastel finishes. For more information on our complete line, in addition to our already available finishes call 1-800-225-0497 or write for our new brochure and color chart to:

DINICO PRODUCTS INC.
123 South Newman Street
Hackensack, NJ 07601

Circle 21

and a removable power-pad electrical assembly provides for quick field installation and servicing.

The luminaire is available in a choice of models for a variety of high intensity discharge lamps and single-voltage or multi-voltage ballasts. A dark bronze finish is standard. The manufacturer recommends the fixtures for applications such as parking lots, shopping centers, campuses, apartment complexes, and parks. American Electric, Commercial and Industrial Lighting Group, Memphis, TN.

Circle 66

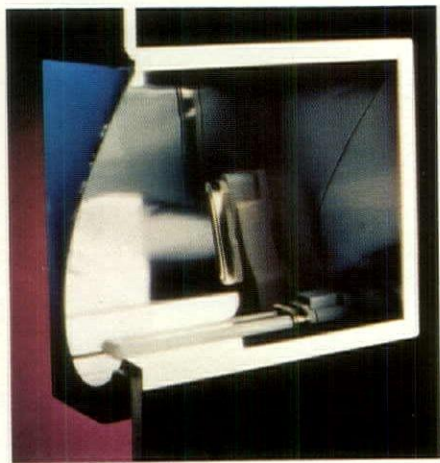

■ Recessed wall washer

Engineered Lighting Products offers a rectangular recessed wall washer for 13-watt compact fluorescent lamps. Its high-purity aluminum reflector system has a carefully engineered curvature that creates even, unscalloped illumination from ceiling to floor. No glare or lamp image is visible from a normal viewing angle, according to the manufacturer. The 4-inch-deep unit can also be recessed in walls.

Models for one and two lamps are available. Both are 7½ inches high. The one-lamp 113 PLWW measures 8⅞ inches long, and the two-lamp 213 PLWW measures 17 inches long. Optional accessories include 120- and 277-volt high power factor ballasts, a 277-volt normal power factor ballast, reflector cleaner, and a clear protective lens. Engineered Lighting Products, El Monte, CA.

Circle 167



■ Crystal desk lamp

Waterford Crystal offers a group of 40 table and desk lamps. The desk lamp shown features two hurricane shades with scalloped tops and diamond and rosette cuts. The mouth-blown, hand-cut hurricanes are mounted on a solid cast brass base. Waterford Crystal Inc., Long Island City, NY.

Circle 68

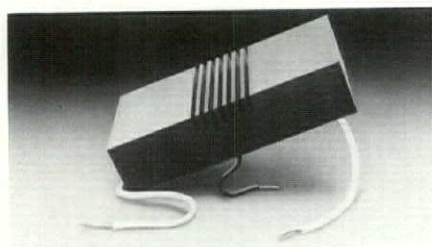

■ Ballast switch

The Switch-It electronic module from Scientific Component Systems provides two-level lighting for existing fluorescent fixtures without rewiring. It allows users to take advantage of daylighting, have low-level security lighting, and cut peak load-hour wattage, according to the manufacturer. The unit alternately sends or cuts off power to selected ballasts each time the existing wall switch is cycled off and on to provide full or limited illumination when and where it is needed. The UL-listed unit can easily be installed and wired into standard 2-foot by 4-foot fluorescent fixtures. Scientific Component Systems, Anaheim, CA.

Circle 69



■ Post and fixture

TrimbleHouse offers an authentic traditional lighting fixture and post fabricated of heavy cast aluminum. The units provide excellent performance, energy efficiency, and uniform lighting distribution with very little maintenance, according to the manufacturer. The post and fixture accommodate a high intensity discharge or incandescent source. They are designed for restorations, renovations, and accent lighting in new projects. TrimbleHouse, Norcross, GA.

Circle 70

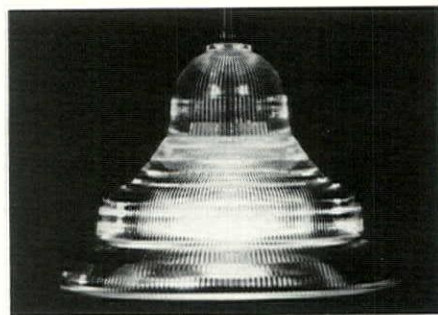

■ Commercial luminaire

Holophane's Liberty Series luminaires come in two styles — a wall-mounted sconce and a chandelier suspended from

a stem. The luminaires have a prismatic glass shade and a solid brass trim that is lacquered for a long-lasting finish. The company recommends using clear incandescent lamps in order to achieve the greatest highlights. The luminaires are suitable for use in restaurants, offices, stores, showrooms, exhibit halls, and other commercial applications. Holophane, Newark, OH.

Circle 71



■ Halogen wall bracket

Boyd Lighting's award-winning Brayton wall bracket was designed by Richard Brayton and engineered by Gary Cross. The bracket has a highly efficient asymmetrical reflector and a curved Pyrex shield assembly that negates secondary refractions for maximum light transmission and efficiency.

The bracket is 4 1/2 inches high, 9 3/4 inches wide, and 1 7/8 inches deep. Its die-cast zinc and aluminum armature and aluminum cylinder come in finishes of gloss white baked enamel, cumulus gray metallic, and polished chrome. The cylinder is also available in white Arabescato, black Marquian, or green Corsi Italian marble with an armature in white or chrome. The wall bracket accommodates one 300-watt RSC base/T halogen lamp and is UL listed for damp locations. Boyd Lighting Company, San Francisco, CA.

Circle 72

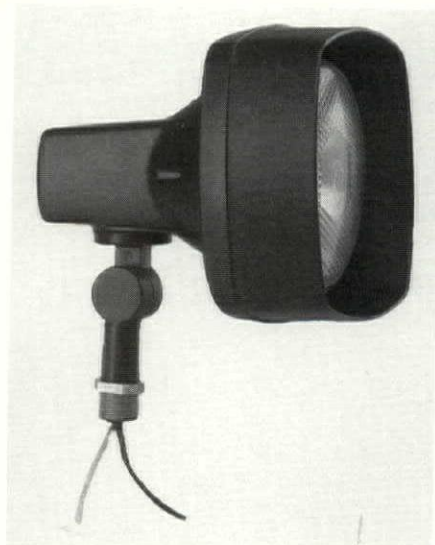

■ Landscape light

Stonco has introduced the L38BZ lamp holder for landscape lighting applications. The unit has extra-long 14-inch lead wires and is double gasketed for overhead horizontal mounting. It accommodates lamps in sizes up to a 150-watt PAR 38 and has a bronze powder finish for durability. Stonco Lighting, Union, NJ.

Circle 73



■ Sign lighting

Radiant Illumination has introduced a line of illuminated informational signs of 5/16-inch-thick extruded aluminum that can accommodate two fluorescent lamps. Several lettering styles, colors, and housing sizes are available. Radiant Illumination, Inc., North Hollywood, CA.

Circle 74



■ Fluorescent starters

Radionic Hi-Tech offers a universal fluorescent lamp starter for 4- to 20-watt lamps. The model FS-U drum/condenser starters can help reduce inventory costs because of their universal application, according to the manufacturer. Radionic Hi-Tech, Inc., Starters Division, Aurora, IL.

Circle 75

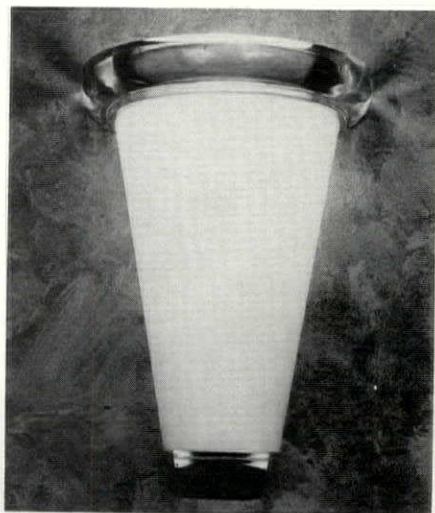

■ Wall sconce

Les Prismatiques offers the Demi-Lune wall sconce, designed by Mark Eckman. The finials, available in eight colors, are made of Prismacolor, a color-infused acrylic material that has the intensity of colored glass but is less fragile. The sconce's body resembles art glass and emits soft, diffused general illumination. Its finials reflect colored light onto walls. The sconce measures 11 inches high, 8 inches wide, and 6 inches deep. It accommodates one 60-watt 2-inch candelabra base lamp. Custom sizes, colors, and finishes are also available. Les Prismatiques, New York, NY.

Circle 76

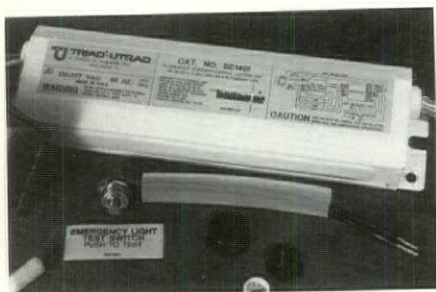

■ Emergency pack

The one-piece, self-contained Ballast emergency lighting pack from Triad-Utrad provides 90 minutes of emergency lighting whenever AC power fails, according to the manufacturer. The emergency pack contains a 10-year maintenance-free nickel-cadmium battery. It is compatible with one-, two-, or three-lamp standard and solid-state ballasts.

The three available models produce light outputs of as much as 545, 670, and 1100 lumens, depending on lamp types. All meet UL, NEC, and NFPA requirements. Model BE140I carries a two-year warranty; models BE140IH and BE175I carry five-year warranties. The emergency lighting pack is suitable for offices, factories, stores, schools, warehouses, and similar applications. Triad-Utrad, AC Division, Huntington, IN.

Circle 77



■ Coated fluorescent lamp

Shat-R-Shield's plastic-coated fluorescent lamps, once limited to use in refrigerated areas, are now also available for normal operating temperatures. The HO/TSC lamp's coating incorporates two DuPont plastics — Teflon on ends

and Surlyn in between. A wire ring near each lamp end forms a bridge where the two plastics connect. If the lamp is broken, virtually all glass, phosphors, and mercury are contained within the plastic coating. The coating does not affect the life of the lamp, according to the manufacturer. Shat-R-Shield, Shrewsbury, NJ.

Circle 78



■ Post-top luminaire

Hubbell Lighting's Sphere post-top luminaire is part of the Nitetorch II line of enclosures in five geometric shapes. The luminaire is gasketed for all-weather protection, is factory-wired for easy installation, and slip-fits a 3-inch tenon or pole. All electrical components are hard-mounted to the housing to allow maximum heat dissipation. The luminaire is UL listed for wet locations.

The two-piece cast aluminum ballast housing has a powder paint coating in bronze, black, or gray. Enclosures are available in acrylic or vandal-resistant polycarbonate; they come in white and three transparent colors — bronze, smoked and clear. The luminaire accommodates a 70-, 100-, or 150-watt high pressure sodium lamp, a 175-watt metal halide lamp, or a 150-watt incandescent lamp. Accessories include a 2³/₈-inch tenon adapter and kits for photocontrols, louvers, and glass refractors. Hubbell Incorporated, Lighting Division, Christiansburg, VA.

Circle 79

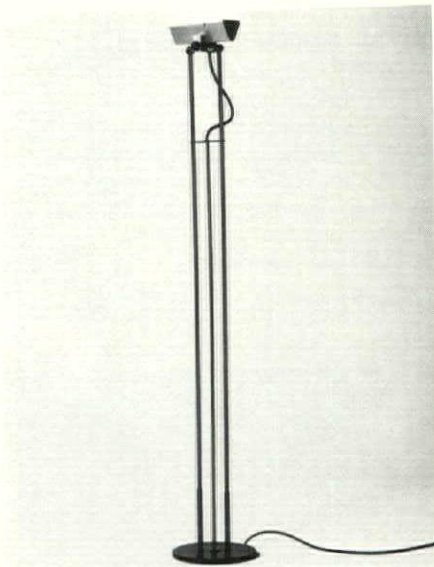

■ Floor lamp

Gullans International offers the Plato 1 floor lamp designed by Douglas Varey. The 6-foot painted steel lamp stands on a 1-foot-diameter base. Its reflector can be adjusted to aim at the floor, walls, or ceiling.

The floor lamp accommodates one linear halogen lamp with a maximum wattage of 300. It is available in two color combinations: a black frame with a light metal gray head and red central stem and button, and a light metal gray frame and head with a black central stem and red button. A matching wall bracket is also available. Gullans International, Long Island City, NY.

Circle 80

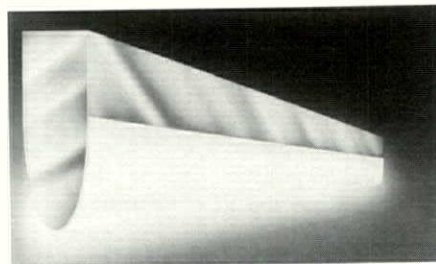

■ Fluorescent luminaire

The Airlume from Guth Lighting has an aerodynamic design to minimize airflow for greater operational efficiency. The 2-inch-wide luminaire has an extruded

lens; prisms are located inside the unit to promote smooth airflow around the luminaire, according to the manufacturer. The UL-listed, IBEW-labeled luminaires accommodate one or two biaxial fluorescent lamps and can easily be mounted to 1½-inch T-bar ceilings.

Single-lamp units, 18 and 24 inches long, accommodate 39-watt and 40-watt lamps, respectively. Dual-lamp units are available in lengths of 36 inches for 39-watt lamps and 48 inches for 40-watt lamps. The stainless steel chassis comes in a standard brushed steel finish and an optional acrylic white finish. Lenses are available in clear prismatic, white translucent, and ultraviolet filtering finishes. The units are listed for 120 or 277 volts. Guth Lighting, St. Louis, MO.

Circle 81



■ Low-voltage track lighting

Lightolier's Super Beamer low-voltage track fixture features a built-in reflector, a low-voltage transformer, and a fully adjustable beam spread. A thumbwheel adjustment widens the beam from 6 to 18 degrees without dimming the lamp itself; two optional spread lenses make wide or stretched beams possible.

The 75-watt fixture accommodates a T4 tubular halogen lamp and comes in matte white and matte black finishes. It can be dimmed with conventional dimmers. The fixture is recommended for homes, offices, restaurants, and hotels. Lightolier, Secaucus, NJ.

Circle 82

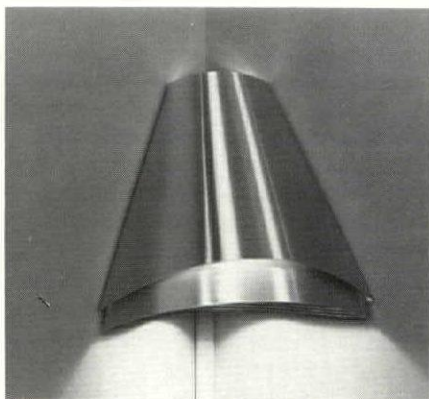

■ Corner-mounted downlight

The Radius II is part of Spectrum Lighting's Corner Lite collection of luminaires designed specifically for mounting in corners. The 10½-inch-high luminaire is 4½ inches wide at the top and 12 inches wide at the bottom. Its baffle assembly provides a low cutoff angle that helps eliminate glare.

The UL-listed fixture is available in satin brass, satin chrome, and white vinyl finishes and carries a one-year manufacturer's warranty. It accommodates one 100-watt incandescent lamp and comes

Circle 23

with a 15-foot cord. An optional cord-covering kit with a molding that can be painted or covered with wallpaper is available. The lamp is recommended for use as a plant light, as a light over a corner or side table, or as an accent light in foyers, halls, and other rooms. Spectrum Lighting Corp., Ledgewood, NJ.

Circle 83

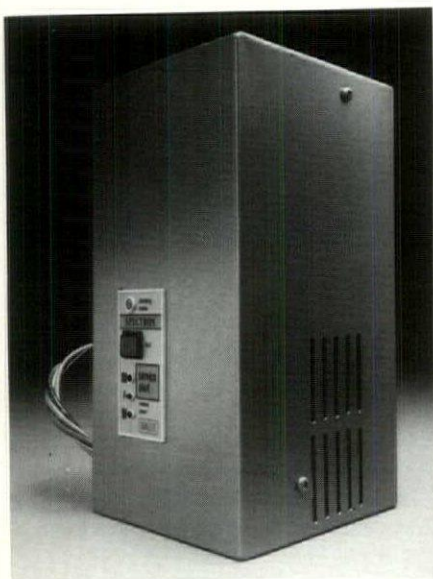

Emergency light retrofit

Dual-Lite's Spectron retrofit kits, part of a full line of emergency AC power systems, are designed to upgrade and enhance existing emergency lighting units, including those of other manufacturers. They come complete with various knockouts, a bolt pattern, and hardware for convenient connection to most existing emergency lighting units.

A central display panel supplied with all systems indicates unit status and provides an audiovisual failure alarm in the event of a unit malfunction. The kits are engineered to replace a unit's battery charger and transfer circuit. They are factory-preset to operate with a unit's existing battery. A universal transformer allows for 120- or 277-volt operation. All kits are designed to handle lamp loads in the 34- to 180-watt range. Dual-Lite Inc., Emergency Lighting Division, Newtown, CT.

Circle 84

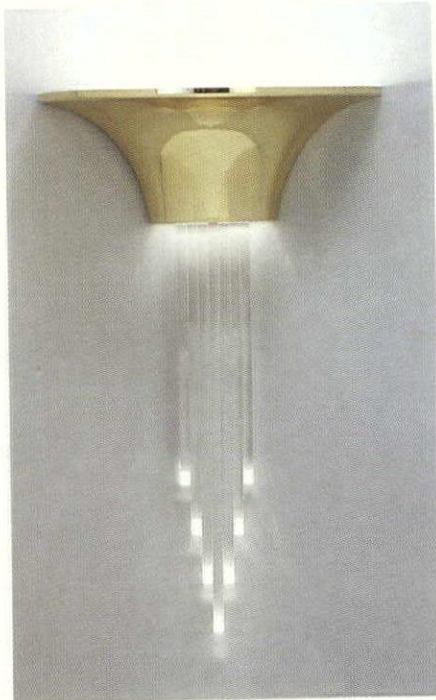

Wall sconce

The CB2131 wall sconce from Visa Lighting provides uplight and also transmits light through seven clear acrylic cascades that extend below the fixture. The wall sconce is 25 inches high, 16 inches wide, and 8 inches deep. Fixture body finishes include polished solid brass, polished chrome, and custom colors. The sconce accommodates one 150-watt incandescent or two 9-watt compact fluorescent lamps. Visa Lighting, Milwaukee, WI.

Circle 85

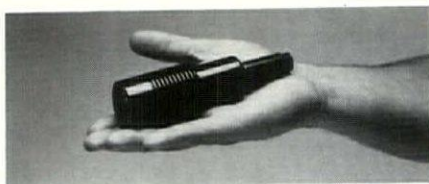

Low-voltage fixtures

CSL Lighting's Miniatura series of low-voltage fixtures are specially designed to accommodate a miniature double-contact bayonet-mount MR11 halogen lamp with dichroic reflector. The 1½-inch-diameter solid aluminum fixtures range from 5¾ to 7 inches in length. The line includes

ceiling fixtures, broad spots, and framing and iris projectors. Four standard beam spreads and a variety of optional apertures are available. The fixtures come in black, white, and brass finishes and can be painted in custom colors. CSL Lighting, Inc., Los Angeles, CA.

Circle 86



Ceiling lamp

Italian architect Achille Castiglioni designed Atelier International's Momi ceiling lamp to resemble a star shining in the night sky. A reflector emits light through evenly spaced metal rods. A round center section of convex glass, surrounded by a larger ring of opalescent glass, directs additional light downward.

The lamp is available in diameters of 13½ and 17½ inches. It accommodates one 100-watt incandescent lamp and is suitable for applications in residences, lobbies, corridors, conference rooms, and restaurants. Atelier International Lighting, New York, NY.

Circle 87



Pocket light meter

GE's Type 214 light meter for field illumination measurements uses a special

filter so that the meter's sensitivity to different light wavelengths closely matches that of the human eye. No correction factors are necessary for different colors of light, according to the manufacturer. The meter is also cosine-corrected for incident light angles.

A slide switch permits selection of one of three linear footcandle scales: 10 to 50, 50 to 250, and 200 to 1000. A 10-to-1 multiplier attachment allows users to make readings up to 10,000 footcandles, making the device suitable for measuring most daylight conditions. The meter comes in its own leatherette case and has an instruction book. GE Lighting, Cleveland, OH.

Circle 88



■ Extended life incandescent

DioLight Technology's Forever Bulb has a lamp life that an independent testing laboratory rated at 60,000 hours, according to the manufacturer. The lamp contains a built-in diode that converts alternating current to direct current, thereby reducing the heat and vibration that decrease lamp life. The lamp fits any standard socket and is recommended for hard-to-reach applications such as ceiling fixtures or outdoor luminaires. It carries a 20-year guarantee. DioLight Technology Inc., Pontiac, MI.

Circle 89

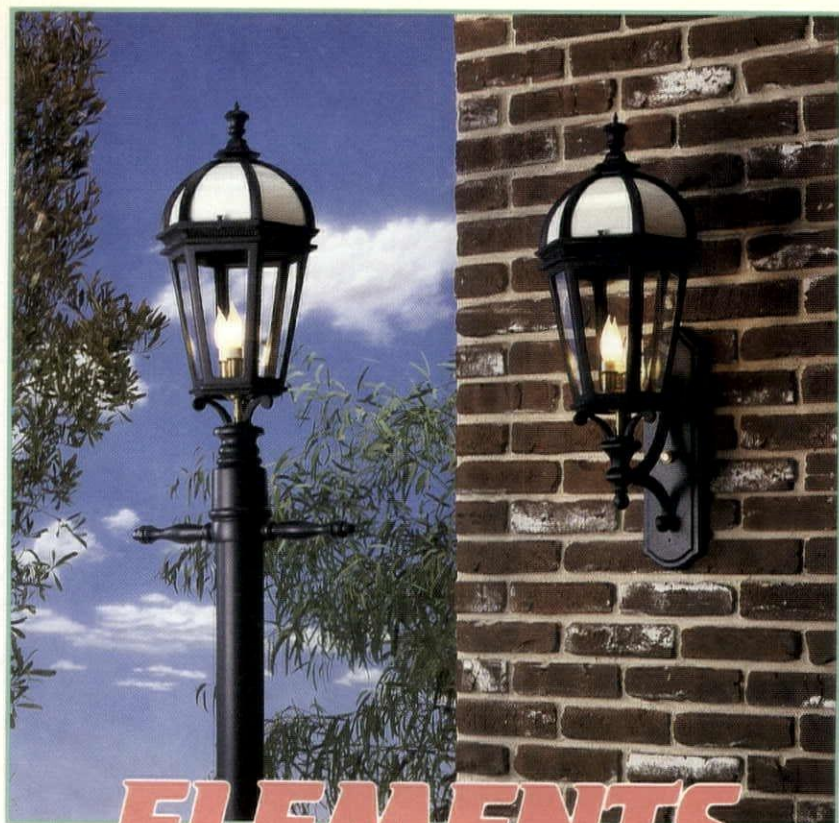

ELEMENTS OF DESIGN



QUALITY • SERVICE
CUSTOM CAPABILITIES

ENVIRONMENTAL LIGHTING FOR ARCHITECTURE, INC.

17891 Arenth Avenue • City of Industry, CA 91748-1197
(818) 965-0821 • FAX (818) 965-9494

Circle 24



■ Exit sign

The self-luminous Betalux-E exit sign from Saunders-Roe Developments is illuminated by Betalight tubes of borosilicate glass. The tubes are coated internally with zinc sulfide phosphor and

filled with tritium gas. The sign requires no maintenance, is waterproof and explosion proof, resists vandalism and tampering, and cannot generate sparks, according to the manufacturer.

The sign measures 8 1/4 inches by 12 3/4 inches by 1 inch and comes with a designer gray casing, a universal arrow kit, and a universal mounting bracket. It is recommended for schools, hotels, office buildings, theaters, and restaurants and for harsh or dangerous environments, such as mines, refineries, and chemical factories. Saunders-Roe Developments, Inc., Winston-Salem, NC.

Circle 90

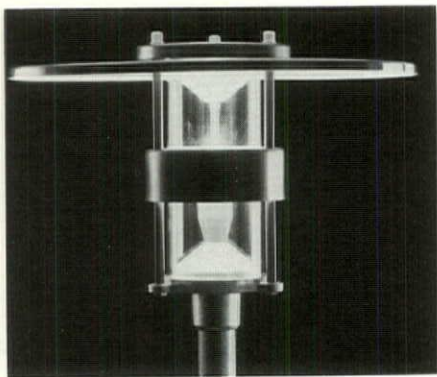

■ Post-top luminaire

The Satellit Maxi/Mini post-top luminaire from Poulsen Lighting was designed by Jens Moller-Jensen. It has a formed, stepped round reflector shade of impact- and vandal-resistant, color-impregnated fiber glass and a cylindrical diffuser of clear polycarbonate. An antiglare ring surrounds the light source. Three 3/4-inch-diameter aluminum rods connect the upper and lower sections to the tenon casting. The lamp holder assembly is field-adjustable.

All reflecting surfaces are finished in weather-resistant baked white enamel, outer surfaces in baked gray enamel. Two sizes are available: the 35-inch-diameter, 25-inch-high Maxi and the 26-inch-diameter, 18-inch-high Mini. Both accommodate high intensity discharge and incandescent sources; wattages vary with models. Poulsen Lighting Inc., Miami, FL.

Circle 91

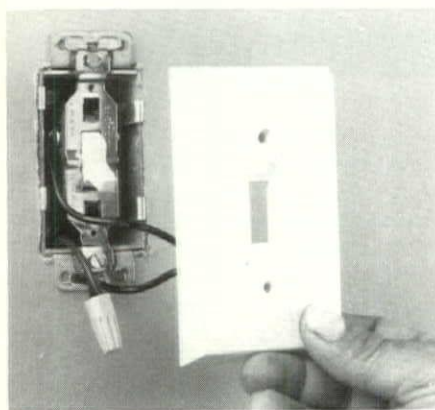

■ Light switch timer

Paragon Electric offers the ET-PD/120 light switch timer, a 120-volt electronic pilot duty interval timer that can be wired with an existing light switch and

contactor to control high-voltage lighting loads. Users can set the adjustable dial so that lights will stay on from 10 minutes to 12 hours. The timer automatically turns lights off within the preset time interval.

The unit can be used in series or parallel. It functions as an interval timer when installed in series to turn a load off automatically after it is turned on manually. The unit can also operate as an off-delay timer when installed in parallel, so that one circuit can remain on longer than another. Paragon Electric Company, Two Rivers, WI.

Circle 92



■ Traditional area lighting

The Charles street-lighting fixture from Welsbach Lighting features historic turn-of-the-century detailing and authentic base designs. Its prismatic globe is available in symmetric and asymmetric distribution patterns and fits in a hinged ring secured by a positive spring-loaded catch.

The fixture can be used separately for retrofitting existing poles or arms. It can also be used in combination with matching arms, poles, and other accessories. An optional photocell is also available. Welsbach Lighting Inc., RWL Corporation, New Haven, CT.

Circle 93

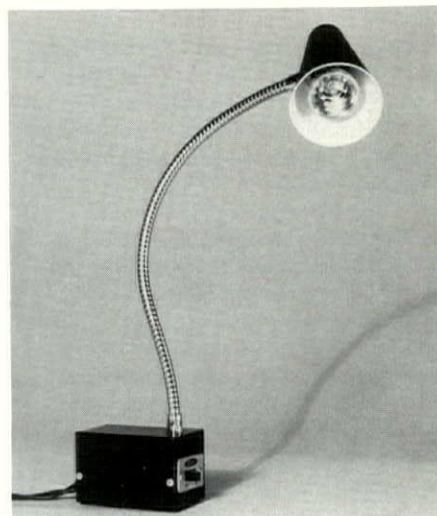

■ Miniature halogen lamp

Roxter offers a high-intensity miniature lamp for an MR11 halogen source, which produces brilliant white light while reducing heat and energy costs. The unit's heavy, magnetic, metal base has a built-in transformer and a black finish. It accommodates one 20-watt MR11 halogen lamp and plugs into a 110-volt AC outlet. A 12-inch chrome gooseneck arm supports the light source. Roxter Mfg. Corp., Long Island City, NY.

Circle 94

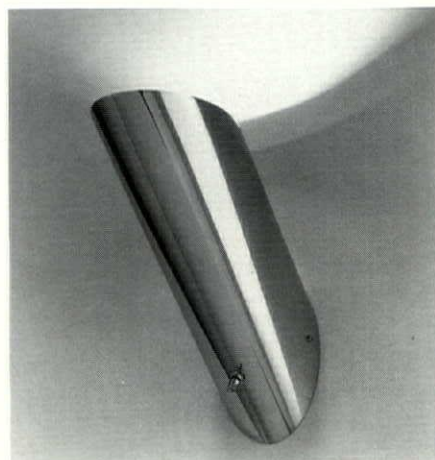

■ Wall sconce

The Zeta cylindrical wall sconce from Brueton Industries was created by Scottish industrial designer Alex Forsyth to look like it is part of the wall to which it is attached. The 10-inch-high, 4 1/2-inch-

diameter cylinder is truncated at a 45-degree angle at both ends and is attached to the wall with a bracket hidden inside the lamp housing. The sconce is made of UL-listed components and is suitable for commercial or residential applications. It accommodates a 150-watt halogen lamp and is available in polished and satin stainless steel finishes. Brueton Industries Inc., Springfield Gardens, NY.

Circle 95

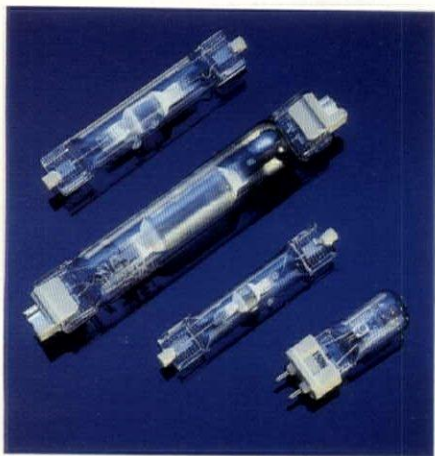

■ **Metal halide lamps**

Single-ended and compact double-ended HQI metal halide lamps from Osram have excellent color rendering and color stability, according to the manufacturer. The 35-, 70-, and 150-watt single-ended HQI-T lamps have a color temperature of 3000K, a color rendering index of 81, and a universal burning position. Because they have the same physical dimensions, all lamps can use the same lenses and reflectors. They are recommended for applications such as downlights, track lights, and small indirect fixtures.

The compact double-ended HQI-TS lamps are available in color temperatures of 3000K and 4300K and wattages of 70, 150, and 250. They can be used indoors for display lighting and area lighting in indirect and track fixtures, sconces, and downlights. Outdoors they are suitable for sign lighting and area lighting in walkways, pool areas, patios, parking areas, and tennis courts. Osram Corporation, Newburgh, NY.

Circle 96

AC, DC or Both . . . Designer Series Signs Fit One Size.

The physical dimensions of Yorklite Designer Series Exit Signs do not change, with or without the battery pack.

Yorklite is trying to help eliminate dimensional fitting problems for exit and emergency lighting designers and engineers. Our unique inter-

lenses are specifically designed to eliminate hot spots and dark areas. Universal knockout arrows are also standard but arrow end caps are available as an option.

All Yorklite Designer Series units are available with 5 Watt PL lamps for excellent illumination as well as high efficiency. Top, back or end



nal battery system design in the PAX model will allow you to choose any Designer Series Exit Sign in all locations, whether self-power or remote power is required.

The durable (injection-molded Lexan®) and compact Designer Series' are available in beige, black or white. Red or green letters (6" x 3/4") are standard and

mounting capabilities also exist for easy installation to any 3 1/2", 4" or single gang box.

Simplify your fitting problem by specifying Yorklite's Designer Series. The Exit Sign that fits one size. For more information concerning emergency lighting or power systems, call us at

(512) 385-1773.

YORKLITE

Yorklite Electronics, Inc.
P.O. Box 19425 • Austin, TX 78760-9425

Circle 25



■ **Flood, security light**

Gim Metal offers the model 3504 floodlight, which features die-cast construction throughout. The fixture comes in versions for a 35- or 50-watt high pressure sodium lamp and for two multitube compact fluorescent lamps of up to 13 watts each. The housing accommodates an optional photoelectric cell for security lighting after dark. The fixture is supplied unassembled to lighting manufacturers with all necessary hardware, tempered glass, and gaskets. Gim Metal Products, Inc., Carle Place, NY. ■

Circle 97

Product Literature



■ Exterior lighting

A 47-page color catalog details Staff Lighting's DZ collection of outdoor luminaires. It includes specifications, lamping requirements, photometrics, and photos of applications for each luminaire. Staff Sales Inc., Highland, NY.

Circle 120

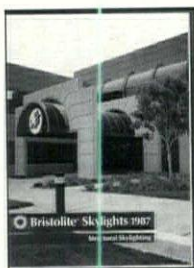

■ Structural skylights

Structural skylights of acrylic, glass, and Lexan Thermoclear are available in a variety of designs. A brochure contains color photos of applications and sketches of typical designs. Bristol Fiberlite Industries, Santa Ana, CA.

Circle 125



■ Grade-mounted lighting

A color catalog illustrates application techniques for three grade-mounted landscape lighting fixtures. Technical data and available options for finishes, lamps, and accessories are included. Imperial Bronzelite, San Marcos, TX.

Circle 121



■ Pendant lamps

A data sheet features dimensions and lamping requirements for Danish-made Lyskaer solid copper pendant lamps. They are available in five styles, including one with a pulley mechanism. Dale Franceschini, San Francisco, CA.

Circle 126

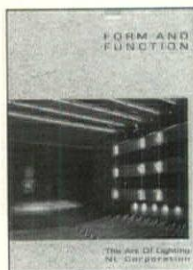

■ Commercial luminaires

A brochure from NL Corporation illustrates applications of the company's products, which include chandeliers, custom fixtures, and luminaires for architectural lighting, track and channel lighting, and church lighting. NL Corporation, Cleveland, OH.

Circle 122



■ Low-voltage tube system

The Inner Spaces system features MR16 lamps in aimable holders recessed inside 3-inch-diameter, fully rotatable aluminum tubular modules. A brochure illustrates applications, accessories, and finishes. U.S. Powerbeam Inc., Little Ferry, NJ.

Circle 127

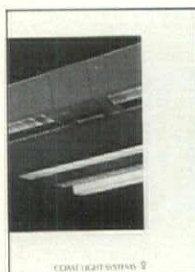

■ Fluorescent fixtures

A brochure illustrates the Litesquare 6x6 linear lighting system, which is available in lamp and housing configurations for uplighting, downlighting, and a combination of both. Coast Lighting Systems, Santa Ana, CA.

Circle 123



■ Water fountains

A color brochure describes commercial water fountain products and systems and includes a list of representative installations and photos of indoor and outdoor applications. Roman Fountains, Albuquerque, NM.

Circle 128

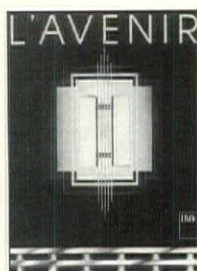

■ Indoor luminaires

A brochure describes the L'Avenir collection of 11 wall, ceiling, and pendant luminaires, lists features, and provides illustrations for each luminaire and its optional finishes. L'Image Industries Inc., St. Albans, VT.

Circle 124

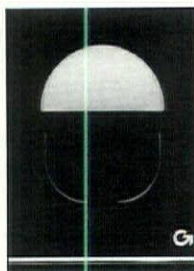

■ Exterior downlighting

The Glow Top luminaire comes in two shapes and mounting styles for post-tops, single and twin arms, and wall brackets. A brochure contains information on lamps, voltages, finishes, and dimensions. Gardco Lighting, San Leandro, CA.

Circle 129



■ Indoor luminaires

A color brochure from Casablanca Lighting illustrates a selection of torcheres, table lamps, and chandeliers. Dimensions, lamping requirements, and available finishes are included. Casablanca Lighting, Valley Forge, PA.

Circle 130



■ HID lighting control

An 18-page brochure presents ZoneMate systems for HID dimming and bi-level HID switching. It details energy savings for commercial and industrial applications and describes operation and control options. Wide-Lite, San Marcos, TX.

Circle 131



■ Indirect lighting

A brochure describes Litecontrol's LCI low ceiling indirect lighting system designed for 8-foot, 6-inch ceilings. The brochure includes photometrics and design guidelines. Litecontrol, Hanson, MA.

Circle 132



■ Light standards

A data sheet provides dimensions and technical details for the French-made Vendôme light standard and matching bracket from Generale d'hydraulique et de mécanique. The standard is available in four metric heights. Flexsol Incorporated, Burbank, CA.

Circle 133



■ Exterior lighting

An Imports and More brochure illustrates a variety of outdoor lighting standards, fixtures, wall brackets, and accessories. Imports and More, Waxahachie, TX.

Circle 134

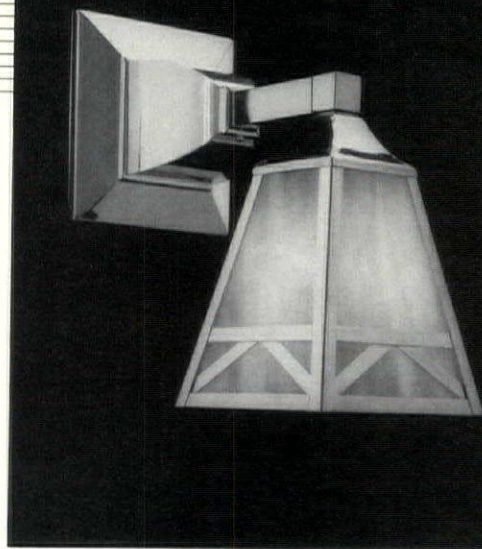

THE AURORA Solid brass Arts & Crafts porch sconce. Send for our free Craftsman Collection brochure or \$3 catalog.



REJUVENATION
LAMP & FIXTURE CO.
901-A North Skidmore
Portland, Oregon 97217
(503) 249-0774

Circle 26

MITY LITE[®] HALOGEN SPOT

Sensation of the year! Roxter's new MITY LITE[®] favorite sculpture, painting, or any small item you want

shines like no other light you've ever seen. This compact (only 2"x2 1/2"x4") halogen light packs a punch of pure white light from its tiny unbelievably efficient low voltage bulb.

Just think—with only 12 watts of power you can light up (and I do mean LIGHT UP) your



to focus your attention on. Light beam is adjustable and convenient line cord switch turns lamp on/off. Total compact light package weighs only 28 ounces. Offered in semi-gloss white or semi-gloss black.

Model No. 7060 (includes MR-11 halogen spot bulb)

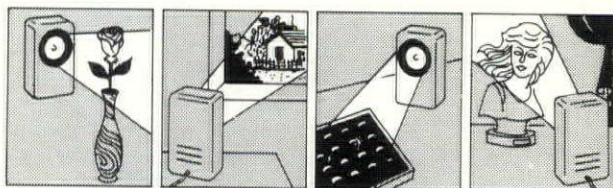

Write or call today for new color catalog.
(718) 392-5060
Mfg. Corp. Better Living Through Better Lighting™
10-11 40th Avenue, Long Island City, NY 11101

Circle 27

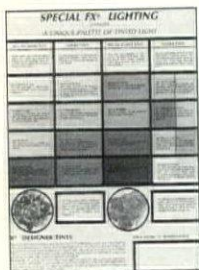

■ Tinted lamps

A data sheet from Special FX Lighting features a palette of designer tints for specialty lamps with suggested applications for each color. Special FX Lighting, Las Vegas, NV.

Circle 135



■ Low-voltage accents

A brochure profiling Reggiani's line of low-voltage accent lighting fixtures includes recessed and semirecessed downlights, wall- or ceiling-mounted spotlights, and accessories. Lightron of Cornwall, Inc., New Windsor, NY.

Circle 136

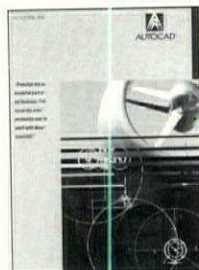

■ Computer-aided design

AutoCAD's programmable drawing and editing capabilities allow users to create, modify, and test designs, combine elements of different plans, and use data in drawings with other software programs. Autodesk, Inc., Sausalito, CA.

Circle 140

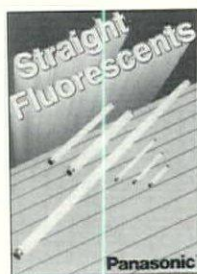

■ Fluorescent lamps

Panasonic's straight fluorescent lamps are available in cool and warm white, daylight, and color-corrected models. A brochure lists colors, wattages, and lengths for preheat and rapid start lamps. Panasonic Industrial Company, Secaucus, NJ.

Circle 141

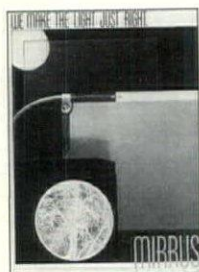

■ Lighting accessories

A data sheet details the Mirrus System from Artifex, which includes a heat-reflecting film, a liquid crystal film diffuser, and photo-quality black and white patterns for ellipsoidal spotlights. Artifex Corporation, Newport Beach, CA.

Circle 137

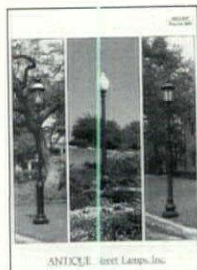

■ Street lamps

Antique Street Lamps offers cast lighting posts, luminaires, matching bollards and signs, and mounting accessories. A brochure describes features, lists heights, and illustrates models. Antique Street Lamps, Inc., Austin, TX.

Circle 142



■ Area lighting

The Softform line of luminaires includes roadway and area lighting fixtures, bollards, illuminated rails, and poles. A color brochure illustrates models and describes features. Sterner Lighting Systems Incorporated, Winsted, MN.

Circle 138

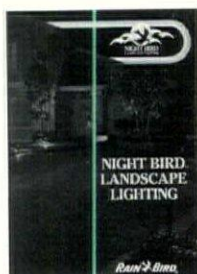

■ Landscape lighting

The Night Bird low-voltage landscape lighting system includes path lights, well lights, floodlights, and a combination timer, photocell, and transformer for controlling outdoor lighting. Rain Bird Sales, Inc., Glendora, CA.

Circle 143



■ Outdoor lighting

Abec's outdoor lighting fixtures for fluorescent or low-voltage sources are crafted in cypress wood and PVC. A brochure illustrates eight fixtures and lists lamping requirements and dimensions. Abec Lighting, Inc., Naples, FL.

Circle 139



■ Track lighting

The Lighting Zone track system features luminaires in traditional and contemporary styles; each has a special black baffle that prevents glare. An 8-page brochure contains color photos, drawings, and specifications. Conservation Technology, Ltd., Northbrook, IL.

Circle 144

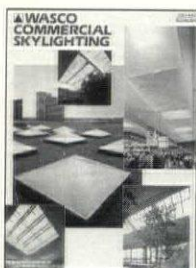

■ Commercial skylights

A 20-page color brochure profiles Wasco's traditional and insulated skylights, vaulted ceiling units, and walkway canopies. Descriptions, specifications, and suggested applications are included. Wasco Products, Inc., Commercial Division, Sanford, ME.

Circle 145



■ Accent lighting

Msetalight Soft Squares systems for low- and line-voltage MR16 lamps include a heat dissipation system, a cool housing, and an adjustable, sliding yoke. A brochure illustrates accessories and mounting options, and provides photometric data. Mseta-USA, Hollywood, CA.

Circle 146



■ Luminaire collection

A six-page color catalog illustrates a collection of chandeliers, pendant lamps, wall brackets, and optional glass shades from Art Directions. Finishes, dimensions, lamping requirements, and diffusers are included. Art Directions, St. Louis, MO.

Circle 147



■ Photometric testing

Lighting Sciences offers a range of technical services for the lighting industry, including photometric testing of indoor and outdoor luminaires. Lighting Sciences Inc., Scottsdale, AZ.

Circle 148



■ Bollards

Emco's bollards come in three 8-inch models: round and square extruded aluminum and round polymer concrete with a flared base. A color brochure illustrates optical systems, finishes, and other features. Emco, Inc., Milan, IL.

Circle 149

The Spider

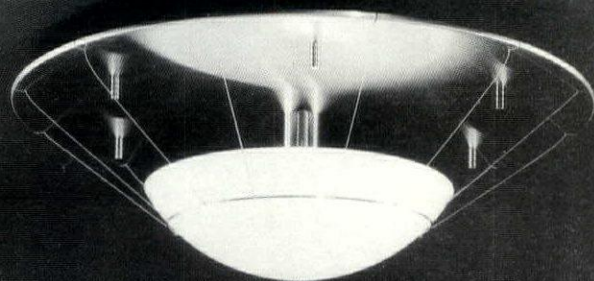

VeArt

VeArt International Inc.
227E Boul. Brunswick
Pte. Claire (Montréal) Qué.
H9R 4X5
tél. (514) 694-1580 - télex 05-821638
fax (514) 738-3311

Circle 28

REPRINT SERVICE

Reprints of all articles published in *Architectural Lighting* are available exclusively through Aster Marketing Services.

Reprints can be used effectively to broaden your exposure, enhance your marketing and educational programs, or promote your product or services.

For further information on volume orders, please contact:

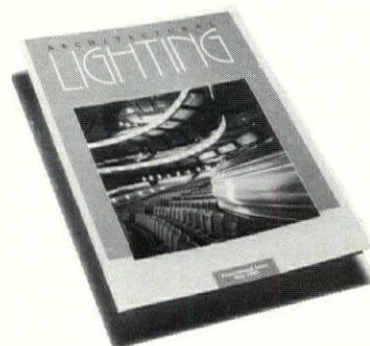

ASTER
PUBLISHING
CORPORATION
MARKETING
SERVICES

859 Willamette St.
P.O. Box 10480
Eugene, OR 97440
(503) 343-1200



■ Sports field lighting

Musco Lighting offers sports lighting systems for new and existing installations, including those for baseball, football, softball, soccer, and tennis. Musco Lighting, Inc., Oskaloosa, IA.

Circle 150



■ Architectural glass

A 32-page brochure features PPG's full range of glazing systems, including reflective coated glass, patterned glass, spandrel glass, laminated glass, strengthened glass, and exterior flush glazing. PPG Industries, Inc., Pittsburgh, PA.

Circle 155



■ Landscape lighting

A catalog from B-K Lighting illustrates and describes a variety of accent lights, direct burial fixtures, light strings, and other landscape lighting fixtures. B-K Lighting, Fresno, CA.

Circle 151



■ Automatic switch

The Switch-O-Matic automatically controls lighting in a space. A data sheet describes the switch's features and discusses potential energy and cost savings. Unenco, Inc., San Leandro, CA.

Circle 156

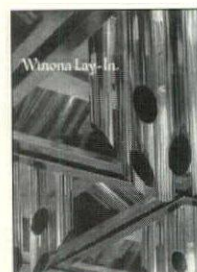

■ Ceiling, wall fixtures

A color brochure illustrates a variety of fixtures for T-bar suspended ceilings, decorative fluorescent strip lights, and fluorescent wall brackets. Winona Studio of Lighting, Winona, MN.

Circle 152



■ Cold cathode lighting

A catalog from National Cathode features cold cathode systems for coves, luminous ceilings and walls, skylights, exposed sculpture, lamps, arches, and stairways and walkways. National Cathode Corp., New York, NY.

Circle 157



■ Illuminated tube

A brochure from TIR Systems features the Light Pipe, a long square or round tube illuminated by a light beam from a separate but adjacent luminaire. The brochure describes the system and shows several applications. TIR Systems, Burnaby, British Columbia, Canada.

Circle 153

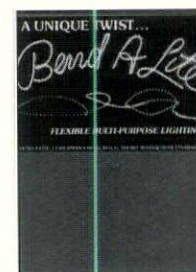

■ Flexible tube light

Bend-A-Lite is a series of parallel tungsten lamps that are wired an inch apart and coated with a solid, transparent, and flexible 1/2-inch-diameter layer of PVC. A brochure describes features, colors, and accessories. Bend-A-Lite, Truro, MA.

Circle 158



■ Wall-mounted wiring

A brochure describes the UL-listed On-Wall Wiring Sure-Snap system for adding new wiring and outlets without breaking into walls or ceilings. The Wiremold Company, Consumer Products Division, West Hartford, CT.

Circle 154

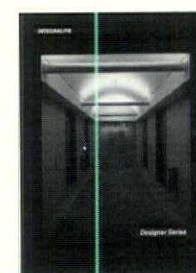

■ Direct, indirect lighting

A color brochure profiles system components, mounting options, diffusers, accessories, and colors for Integratebeams and Integratebeams linear fluorescent luminaires. JW Lighting, Inc., Houston, TX. ■

Circle 159

Calendar

January 20, 1988

Cold cathode lighting, DLF event. Sy White of National Cathode is the speaker. Contact: Sy Bollinger, President, The Designers Lighting Forum of New York, 58 Stratford Ave., Greenlawn, NY 11740, (516) 368-5470.

January 21, 1988

Lighting with fiber optics, joint meeting of Northern California DLF and IES Golden Gate Section, Engineers Club, San Francisco. Presentation by Bill Novey of Art & Technology, Inc. Contact: Paula Goodell, Northern California Designers Lighting Forum, P.O. Box 1429, San Francisco, CA 94101, (415) 550-0333.

January 25-28, 1988

Photometry institute, Independent Testing Laboratories, Boulder, CO. Covers laboratory procedures in measuring performance of luminaires. Contact: ITL, 3386 Longhorn Road, Boulder, CO 80302, (303) 442-1255.

January 28, 1988

Hospitality lighting applications in hotels and residences, DLF event. Michael K. Souter of San Francisco will be guest speaker. Contact: Claudia Holmes, San Diego Designers Lighting Forum, 724 W. Arbor Dr., San Diego, CA 92103, (619) 294-9600 or (619) 294-4154.

January 30, 1988

Entry deadline for the 1987 Edison Award. Competition open to lighting professionals who use a significant number of GE lamps in a lighting design project. Contact: Mr. F.F. LaGiusa, Chairman, Edison Award Competition, GE Lighting, Nela Park, Cleveland, OH 44112, (216) 266-2140.

January 31, 1988

Entry deadline for the Richard Kelly Grant. The Lighting Research and Education Foundation, New York Section of the Illuminating Engineering Society, sponsors the grant. Eligible are completed, current, or proposed projects using light in architectural space, art and sculpture, computers, education, graphics, health care, lighting fixture design, models, research and analysis, and theater. Contact: Jack Richard, IES, 345 East 47th Street, New York, NY 10017, (212) 705-7915. ■

LEHR

Lighting Design & Manufacturing

3M Scotchlamp™ Film Applications:
ARCHITECTURAL LIGHTING

Scotchlamp™ film creates a new way to transport, shape, and direct light. Think of it as light piping; bringing light to a light fixture. Think of it also as the fixture itself; a unique and efficient luminaire.

Opening new design dimensions and establishing new technical standards; it challenges the profession to innovate. Create architectural lighting programs with Scotchlamp™ film applications. Design and develop practical lighting fixtures based on Scotchlamp™ film technology.

LEHR Company has the expertise and in-house ability to engineer, develop, and manufacture light fixtures utilizing Scotchlamp™ film. It has the knowledge of architectural environments and requirements to insure that the lighting will be altogether appropriate and of enduring value.

We will be pleased to discuss with you how LEHR Company can pilot a Scotchlamp™ film lighting program for your next lighting project.

LEHR Company, Inc.
45 Lawton Street, New Rochelle, NY 10801 Tel. 914-636-7500

Circle 29

PERFECLITE

75 YEARS STRONG!
1912-1987

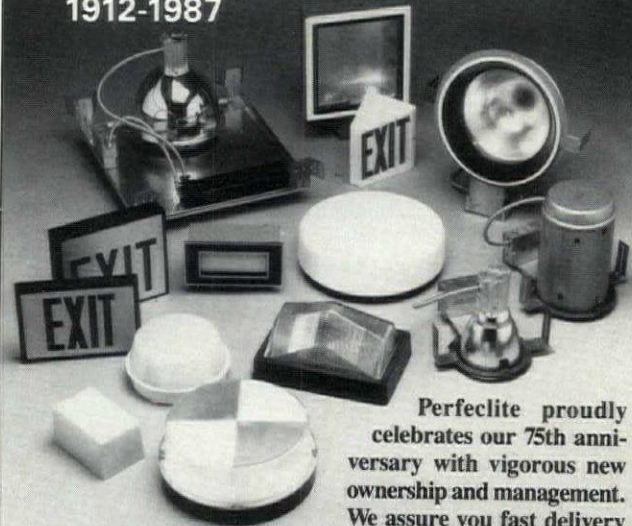

Perfeclite proudly celebrates our 75th anniversary with vigorous new ownership and management. We assure you fast delivery from our 50,000 square foot plant.

Our nationwide network of experienced lighting representatives are ready to assist you. Please call for the Perfeclite rep nearest you.



PERFECLITE CO.

1457 E. 40th Street
Cleveland, Ohio 44103 USA
216/391-8282 FAX: 216/391-7973
TLX (WU) 706180

Circle 30



Manufacturer Credits

Page 14. *Target Productions draws clients with high-end image* (Target Productions, Charlestown, Massachusetts).

Lightolier: Halogen spotlights and floodlights, incandescent recessed and track fixtures, and fluorescent pendants.

Metalux: Fluorescent recessed fixtures.

Eastern: Under-cabinet fluorescents.

Page 16. *Flexible, economical lighting: Smart for art's sake* (A. Asher Fine Art, Los Angeles).

Halo: Single- and 4-circuit raceway tracks and connectors, dimmers, and fixtures.

Leviton: On-off switching modules, dimming modules, and desk-top command module.

Page 18. *Second life for 60-year-old department store building* (Fond-Du-Luth Gaming Casino, Duluth, Minnesota).

Neo-Ray: Flexible tube lights, light curtain, incandescent strip lights with integrated light chaser/strobe.

Omega: Recessed metal halide downlights.

The Neon Shoppe: Interior neon.

Lakehead Sign Co.: Exterior neon.

Falconer: Pink rose and bronze beveled plate mirrors.

Wolf Creek Beveled Glass: 2-inch-square beveled mirrors.

Hordis Brothers, Inc.: Pink rose insulated glazing.

Page 20. *Fewer fixtures, more light for high school athletics* (Homewood-Flossmoor High School athletic facilities, Flossmoor, Illinois).

Holophane: 400-watt metal halide luminaires.

Page 22. *Animated electric light enlivens Benjamin Franklin Bridge* (Philadelphia, Pennsylvania, and Camden, New Jersey).

General Electric: Luminaires and lamps.

GE-Fanuc: Programmable industrial controllers.

Berkshire Transformer: Reactors.

TIR Systems: Light pipe and accessories.

Page 32. *Lighting-only renovation gives training facility a new look* (GE Center for Advanced Airmanship, Tempe, Arizona).

Lightolier: Luminaires.

General Electric: Lamps.

Advertiser Index

Aamsco Manufacturing Inc.	47	LEHR Company, Inc.	69
Alkco	19	Lighting Services Inc.	4
Aster Marketing Services	67	Lutron Electronics Co., Inc.	72
Boyd Lighting Company	71	Maximum Technology	49
Brodwax Lighting Corp.	10	Nowell's Inc.	10
Centrecon Inc.	55	Osram Corporation	7
Dinico Products, Inc.	51	Perfeclite Company	69
Elliptipar Inc.	21	Rejuvenation Lamp & Fixture Company	61
Environmental Lighting for Architecture, Inc.	57	Roxter Manufacturing Corp.	61
Florida Power & Light	11	Ruud Lighting, Inc.	15
Gardco Lighting	3	Sylvan Designs, Inc.	40
Gross Chandelier Company	40	TrimbleHouse Corporation	9
Hadco	5	VeArt International Inc.	67
Hanover Lantern	6	H.E. Williams, Inc.	13
Holophane/Division of Manville Corporation	17	Yorklite Electronics, Inc.	59
Hubbell Incorporated, Lighting Division	2		

3 O Y D

C I R R U S Individually quarried and turned from solid stone, the "Cirrus" Wall Bracket melds classic styling with the rich translucence of natural white alabaster.

Designed by Gary Cross.

Overall Height: 6 $\frac{1}{4}$ "/16cm.
Diameter: 17"/43cm.
Projection: 8 $\frac{3}{8}$ "/21cm.
Outlet Box Mounted.
U.L. Listed.

Showrooms: Atlanta,
Boston, Chicago,
Cleveland, Dallas,
Denver, Hong Kong,
Houston, Los Angeles,
Miami, Minneapolis,
New York, Philadelphia,
San Francisco, Seattle,
Washington, D.C.

Boyd Lighting Company
56 Twelfth Street
San Francisco, CA 94103-1293
Telephone 415 431 4300
FAX 415 431 8603

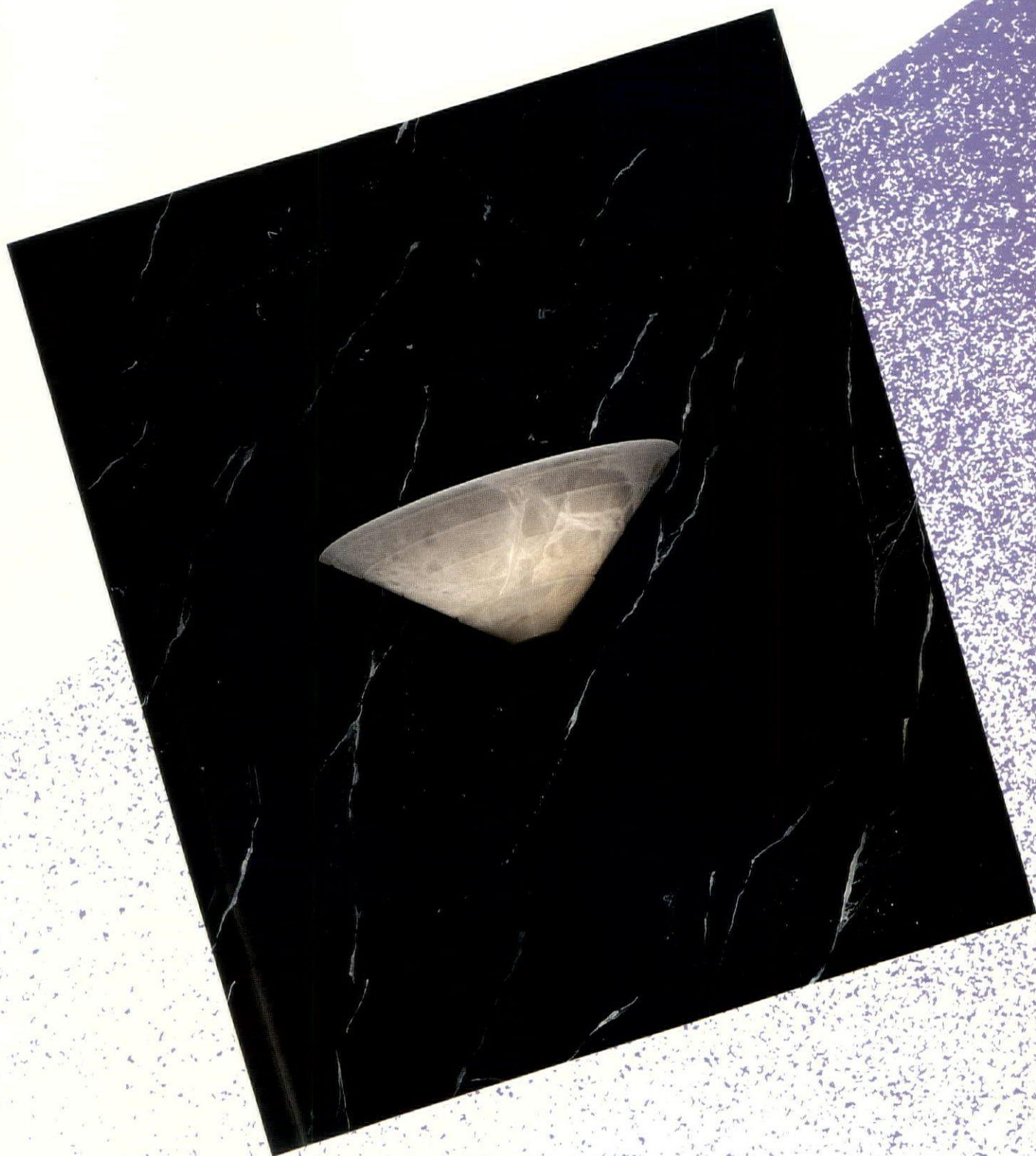

Introducing

GRAFIK Eye™ 

4-Scene, 4-Zone
Preset Dimming Control



GRAFIK Eye Control—Preset dimming with a sleek, thin profile design

Create 4 Distinct Lighting Scenes... Recall Each by Touching a Button

The GRAFIK Eye Preset Dimming Control offers:

- coordinated lighting control in one sleek, thin profile unit.
- control of 4 independent lighting zones (circuits) which create 4 distinct lighting scenes.
- the ability to transform the lighting of any space with the simple touch of a button.

The GRAFIK Eye Control can:

- provide proper lighting levels for multiple functions.
- emphasize unique features that have been designed for the space.
- create different moods or ambiance.

The GRAFIK Eye unit controls up to **2000 watts*** of incandescent, incandescent low voltage, and fluorescent lighting.

* For applications requiring more than 2000W/VA total load, consult the Lutron Hotline.

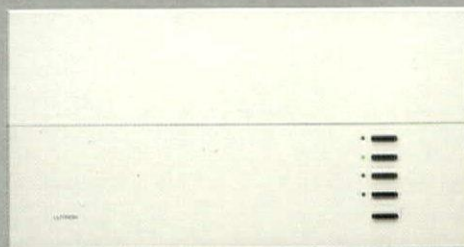

GRAFIK Eye Control with white opaque cover
Dimensions: .295" thin x 8⁷/₈" x 4¹/₂"



Thin profile

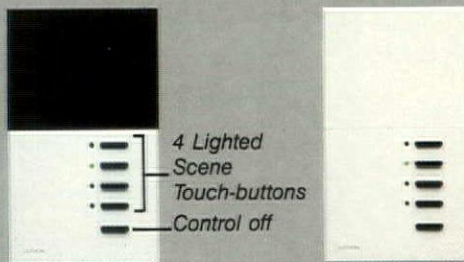

Dimensions: .295" thin x 2³/₄" x 4¹/₂"

Auxiliary Scene Activators provide remote touch-button control from 1 or 2 additional locations. Available with smoked translucent cover and white opaque cover

For more information on the GRAFIK Eye Preset Dimming Control, call Lutron's Hotline toll-free:

(800) 523-9466 (U.S.A.)
(800) 222-4509 (Pennsylvania)

LUTRON®

Lutron Electronics Co., Inc.
205 Suter Road
Coopersburg, PA 18036 U.S.A.

This product is covered by one or more of the following U.S. patents: 3,619,716; 3,731,142; 3,735,020; 3,746,923; 3,824,428; 3,919,592; 3,927,345; 4,207,497; 4,207,498; 4,575,660; DES 249,141; DES 253,342; DES 253,532; and corresponding foreign patents. U.S. and foreign patents pending. Lutron is a registered trademark. GRAFIK Eye is a trademark of Lutron Electronics Co., Inc. Copyright © 1987 Lutron Electronics Co., Inc.