

AUGUST/
SEPTEMBER
1999

lighting

architectural

PETRONAS TOWERS

LED TECHNOLOGY
NEON SPECIFICATION
PROFESSIONAL GROWTH

A MILLER FREEMAN PUBLICATION
U.S. \$7.00
www.archlighting.com
www.lightforum.com

The New DB1000- One Fixture, One Solution.

**Bronzelite's DB1000 Inground Lighting Fixtures
Combine Versatility and Functionality for a
Superior Lighting System.**

Bronzelite® introduces the first of its kind inground lighting fixture that simplifies specification and adapts to your changing job site conditions. The all new DB1000 features a unique multi-tap ballast that can be changed quickly to any voltage requirement, saving installation time and eliminating delays resulting from changing specifications.

For unmatched lighting versatility, select spot, flood or wall-wash reflector assemblies that utilize Bronzelite's TouchAim™ lamping module system with 15° vertical and 360° rotational adjustment. Lamping options range from 32 watt fluorescent to 250 watt HID, including the Philips MasterColor™ metal halide lamps for whiter light and precise color. Built to be practically indestructible, the DB1000's high-strength, corrosion resistant fiberglass reinforced polyester housing will carry loads up to 3,000 pounds*, and the high temperature Rytron™ lamping module will withstand temperatures up to 200° C.

- **Twist-lock Lens Frame**
- **Error-free TouchAim® Adjustment System**
- **Liquid-tight Cables with Toolless Connectors**
- **Multi-Tap Waterproof Ballast Module**
- **Double Lens Protection System with Flat Silicon Gaskets**
- **Cast Bronze Lens Frame with Compression Limiters**

* For loads up to 3000 lbs., DB1000 must be equipped with an optional drive-over lens.

Bronzelite®

100 Craftway Littlestown, PA 17340
(717) 359-7131 Fax (717) 359-9289
www.hadcolighting.com

Learn more on how the DB1000 can simplify your life. Call Bronzelite® for a full color brochure on this remarkable new fixture.



Spec Leviton!

For one-stop SPECing in virtually all lighting control market categories — theatrical, entertainment, architectural, commercial and residential — think Leviton Lighting Control Division.

Leviton makes the most advanced *architectural* lighting control systems in the world. These versatile, pre-set custom controls offer aesthetically pleasing and durable front ends. All kinds of configurations can be accommodated, and they're perfect for commercial applications.

Our Innovator™ series of lighting controls combines advanced *theatrical / entertainment* functions with sophisticated, intelligent controls for capabilities never before available. As examples, LCD monitor displays channel and cue information on demand... up to 384 stage lighting channels and 512 intelligent light channels... up to 1,536 dimmers... up to 128 simultaneous independent auto crossfades to address cue lists.



And Leviton *box-mounted* dimmers offer the finest digital circuitry for advanced control along with high styling. For instance, our Monet™ is the right choice for scene-lighting capability as well as multi-point control.

As a result, we enable you to SPEC Leviton for all your multi-use environments, such as hotels, schools, office buildings, convention spaces, museums, restaurants, sports arenas, concert halls and theaters, to name just a few examples.

Discover the next millenium of lighting control systems today — at Leviton's Lighting Control Division. Join the growing numbers of those who specify Leviton. Call 1-800-323-8920. Or visit our website at www.leviton.com.

LEVITON[®]
 LIGHTING CONTROL DIVISION

Building A Connected World

Circle No. 2 on product service card

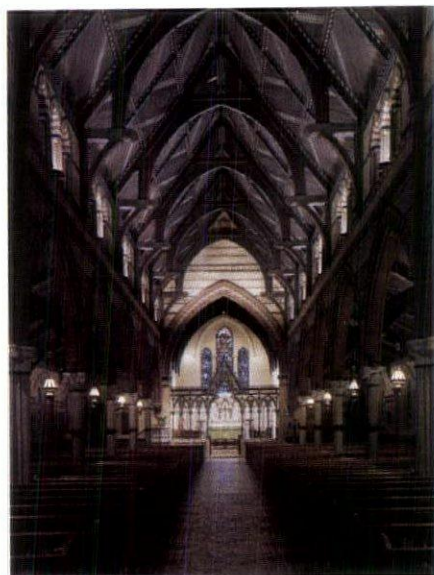

CHURCH OF THE REDEEMER 24

DESIGN FEATURES

- 24 **Heavenly Light**
Lighting gives spirituality new life at the Church of the Redeemer and St. Philip the Apostle Catholic Church
- 28 **Mission Statement**
Historic Union Station impacts the Los Angeles skyline with dramatic lighting
- 30 **Hoop Dream**
A balancing act in light brings transparent beauty to this Houston home
- 32 **Twin Peaks**
Kuala Lumpur's Petronas Towers—the tallest in the world—are dramatically illuminated to create beacons in the night

TECHNIQUE

- 36 Lightning in a Tube—A Primer on High Voltage Tubing
(an NCQLP-approved Recertification Article & Quiz)

TECHNOLOGY

- 40 Getting the LED Out

DEPARTMENTS

- 8 **Editorial**
- 10 **Letters to the Editor**
- 12 **Updates**
 - 12 News
 - 16 People
 - 17 Calendar
- 18 **Insights** Patricia Glasow, LC, IALD
- 22 **Spotlight** Solar System
- 42 **New Products**
- 48 **Perspectives** Pursuing Professional Development

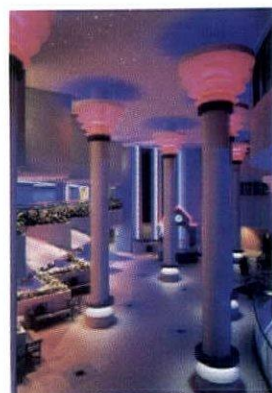

HVT TECHNIQUES 36

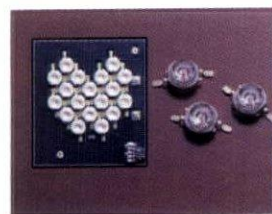

LED TECHNOLOGY 40

ARCHITECTURAL LIGHTING (USPS 000-846, ISSN 0894-0436) is published eight times per year by Miller Freeman Inc., 600 Harrison St., San Francisco, CA 94107, phone (415) 905-2200, and is distributed free of charge to individuals or firms engaged in the specification of lighting products in the U.S. and territories. The cost of all other subscriptions in the U.S. and territories is \$48 per year. A one-year Canadian subscription, payable in U.S. dollars, costs \$60 and all other foreign, \$86. Periodicals postage paid at Long Prairie, MN and additional mailing offices. Presorted standard mail enclosed. Permit no. 329 paid at Long Prairie, MN 56347. POSTMASTER: Send address changes to Architectural Lighting, P.O. Box 1061, Skokie, IL 60076-8061. Architectural Lighting is a trademark owned exclusively by Miller Freeman Inc., a United News & Media Company. Copyright 1999 Miller Freeman Inc. All rights reserved. Reproduction of this magazine, in whole or in part, is prohibited unless authorized by the publisher. Editorial and advertising offices: One Penn Plaza, New York, NY 10119-1198. Phone (212) 714-1300. Customer Service Inquiries: For address changes, single copy sales (\$7 + postage in the U.S., \$8 + postage outside the U.S., payable in advance), and subscription inquiries, write to Architectural Lighting, P.O. Box 1061, Skokie, IL 60076-8061 or call (800) 255-2824 in the U.S. or (847) 647-2105 outside the U.S. Printed in the U.S.A.



Focused
on fluorescent,
committed to
Quality.

Metalux is focused on providing lighting professionals with fluorescent lighting solutions that demonstrate a commitment to quality.

One example is our new Concept Two, 4.5" Thin Line Aperture RP1 Parabolic Series, ideal for contemporary office environments.

Concept Two incorporates the highest quality materials and components to ensure performance and integrity.

Metalux. The greatest name in Fluorescent Lighting.

 **COOPER** Lighting

Visit our web site at www.cooperlighting.com

Circle No. 3 on product service card

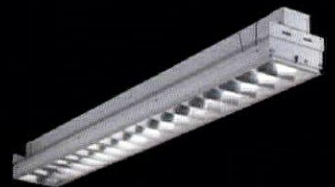

 **Metalux**



ZOOMS

Imagine . . .

projecting any pattern,

any color,

any size,

from 15 to 40 degrees.

ZOUNDS !

For a BP75 information kit,

send your letterhead to:

Lighting Services Inc

2 Kay Fries Drive

Stony Point, NY 10980

(800) 999-9574



www.LightingServicesInc.com

Circle No. 4

architectural lighting

Editor-in-Chief

CHRISTINA TRAUTHWEIN
(212) 615-2631
ctrauthwein@mfi.com

Publisher

CRAIG DILLOUIE
(212) 615-2304
cdilouie@mfi.com

Art Director

JEANNE LAWLOR
(212) 615-2273

Assistant Editor

ALICE LIAO
(212) 615-3067
aliao@mfi.com

CONTRIBUTING EDITORS

WANDA JANKOWSKI, JEAN GORMAN, DAVID HOUGHTON, PE

EDITORIAL ADVISERS

RENEE COOLEY, RENEE COOLEY LIGHTING DESIGN
HOWARD BRANDSTON, LC, FIALD, FIES, H.M. BRANDSTON & PARTNERS
GARY STEFFY, LC, FIALD, GARY STEFFY LIGHTING DESIGN
RAND ELLIOTT, FAIA, ELLIOTT + ASSOCIATES ARCHITECTS

Group Publisher PHILLIP A. RUSSO (212) 615-2368

Production VINCE HABICK (415) 905-2454
fax (415) 905-2236

List Rental (847) 619-9800
fax (847) 619-0149

Circulation WENDY SAAR (212) 615-2687
fax (212) 279-4460

CUSTOMER SERVICE (800) 255-2824
fax (847) 647-5972

Reprints VICKI BREWSTER (516) 365-2646
fax (516) 681-7315
62 Northwoods Rd.
Manhasset, NY 11030

Marketing Assistant LIZ MAVIS (212) 615-2392
fax (212) 279-3955

ADVERTISING SALES

NORTHEAST/INTERNATIONAL CLIFF SMITH (212) 615-2649
fax (212) 279-3955

SOUTHEAST HELENE FINEBERG (914) 762-5056
fax (914) 762-4755

MIDWEST/CENTRAL MARIE KOWALCHUK (773) 792-1830
fax (773) 792-1831

WEST JON HENG (626) 799-3610
PATRICIA OLAIZ HENG fax (626) 799-5853

WEB SALES DAVE BURTNER (541) 344-1909
fax (541) 344-2646

CLASSIFIED SALES (212) 615-2727
fax (212) 279-3955

MILLER FREEMAN, INC.

CEO/Miller Freeman Global: Tony Tillin; Chairman/Miller Freeman Inc.: Marshall W. Freeman;
President: Donald A. Pazour; Executive VP/CFO: Warren "Andy" Ambrose; Executive VP: H.
Ted Bahr; Executive VP: Darrell Denny; Executive VP: Galen Poss; Executive VP: Regina Starr
Ridley; Senior VP: Wini D. Ragus; Senior VP: John Pearson; Senior VP/Production: Andrew A.
Mickus; Senior VP: Mark Kliensky; VP/Circulation: Jerry Okabe



MILLER FREEMAN DESIGN GROUP

Architectural Lighting Contract Design Facilities Design & Management
ASID Design Power Alt.office Journal Alt.office Conference & Expo
InterPlan The Design Show Batimat Design-Build

Miller Freeman, Inc., division of United News & Media
One Penn Plaza, New York, NY, 10119-1198
Telephone (212) 714-1300 Fax (212) 279-3955
www.archlighting.com, www.lighthforum.com

in Miller Freeman
A United News & Media publication

FLAPS

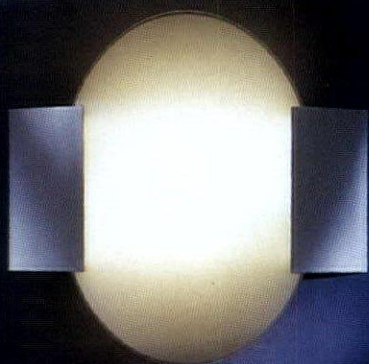

MARCI



WINGS



SPIKE

DESIGNED BY MARCELLO ZILIANI

FLOSUSA

FLOS USA INC. 200 MCKAY ROAD HUNTINGTON STATION NEW YORK 11746 TEL 516 549 2745 FAX 516 549 4220

1 800 939 3567

Circle No. 5 on product service card

Phos™



Think

Prescolite

A NEW QUALITY OF LIGHT

Problem:

The limited space above ceilings and slab ceilings.
When a downlight cannot be recessed, designers need a new solution to the traditional surface cylinder type application.

Solution:

Introducing Ph•s, a new series of modular surface mounted area downlights. Ph•s' unique design gives it a totally fresh new look – smaller in size than any equivalent cylinder.
Ph•s/VSL series comes with Prescolite's patented Virtual Source® optics. Advanced technology in its material construction and processing, complete with Prescolite's *Intelectplus™* ballast, elegant styling, and architectural scaling make Ph•s the smallest, best looking, best performing surface downlight solution available today.

Pictured: Troy Larson, Product Manager
For more information click on www.prescolite.com

● About Light

ing



LIGHTFAIR INTERNATIONAL 1999
Specialty Lighting Category Innovator Award
Best New Product Of The Year Award

Circle No. 6 on product service card

READING FOR EXTRA CREDIT

Over the past couple of years, *Architectural Lighting* has dedicated more than a few pages to the efforts of the National Council on Qualifications for the Lighting Professions (NCQLP), from the inception of its first test administered in November 1997, to recognizing the first class of more than 250 LCs (more than half by examination), to most recently acknowledging the Class of 1999—over 650 LCs including both Test Qualifiers and Granted Certifications. It is, and has been, our belief as a magazine that certification serves the greater good of the lighting industry as a whole by: 1) creating professional status; 2) identifying a knowledge base and curriculum (the education and experience necessary to practice); 3) demanding from practitioners at least a minimum level of technical knowledge and the basic skills to apply it; and 4) fostering continuing education in a field that is constantly evolving.

As the status of the program has grown, so has our commitment to furthering the goals of the NCQLP. To that end, *Architectural Lighting Magazine* is pleased to announce it has formed a strategic partnership with the NCQLP to further benefit those that are Lighting Certified by offering our readers ongoing opportunities for recertification. The objective of recertification, as put forth by the NCQLP, is to assure the continued competence of LC certificants and to encourage continued learning through professional development in an industry of rapidly changing technologies. Or, maybe best stated by Naomi Miller, LC, "The process of recertification is essential to maintaining credibility for the term LC. Although fundamental lighting principles do not change with time, technologies change, research advances and our understanding of human factors and design processes evolve. Continuing education keeps us current and in demand. Recertification ensures that we will not become obsolete Lighting Certified professionals."

Recertification is required every three years—LCs must earn 36 Lighting Education Unit (LEU) credits per three-year certification cycle. And LCs may maintain their LC status by meeting either of the following criteria within each three-year recertification cycle: take and pass the current LC examination or earn the 36 LEUs in approved Professional Development areas, which include NCQLP-approved Recertification Articles and Quizzes. The articles and quizzes are written by industry professionals and reviewed by an NCQLP Peer Review Task Force for content compatibility.

Now, LCs may earn 0.5 Lighting Education Units (LEUs) by reading designated articles in *Architectural Lighting Magazine* and correctly answering the quiz that corresponds to the article. *Architectural Lighting* will score the quizzes and send official notification of the LEUs earned to LCs and the NCQLP. Our first article appears in this issue on page 36, "Lightning in a Tube—A Primer on High Voltage Tubing (HVT)," by Fred Oberkircher, LC. Additional Recertification Articles and Quizzes will appear in future issues of the magazine; each will be designated by the LC logo for easy identification.

In addition to appearing within the pages of the magazine, the articles will be placed on the lighting industry's leading website at www.lightforum.com—the rebranded, new and improved www.qualitylighting.com. And improved, it is. The website, which is now getting some 40,000 hits per month, continues to feature lighting projects categorized by application, in addition to interviews with leading lighting designers. Furthermore, users can locate designers and manufacturers, reference a classifieds section to find career opportunities or enter into a discussion forum on lighting-related topics. The website also offers links to such established industry organizations as Lightfair, IALD, Lighting Research Center, National Lighting Bureau, the Lighting Design Lab and Northwest Energy Efficiency Alliance. As an added benefit, visitors can purchase a variety of lighting books through Amazon.com.

As a final point, remember to keep in touch. Often ideas and responses from our readers dictate the content of the magazine. Our newly developed Light Points column that began appearing earlier this year has not only become a popular form of communication among readers, but has inspired articles. When we asked our readers in the July issue the hottest product shown at Lightfair, the overwhelming response hit my desk: LEDs. We agreed. Check out the Technology column this month, "Getting the LED Out" on page 40, in which Contributing Editor Dave Houghton addresses the developments in this emerging technology and reports

on both its benefits and possible drawbacks.

And the discussion has already started on last month's "In a Perfect World..." in which a sampling of lighting specifiers were asked to provide a "wish list" telling manufacturers what they really—and ideally—want. Readers have already written to tell me what would be on their lists, so now I'd like to take this opportunity to create a dialogue for next issue's Light Points. Tell us, what do *you* want? ■



PHOTO BY CHRIS LAMB

CHRISTINA
TRAUTHWEIN,
EDITOR-IN-CHIEF

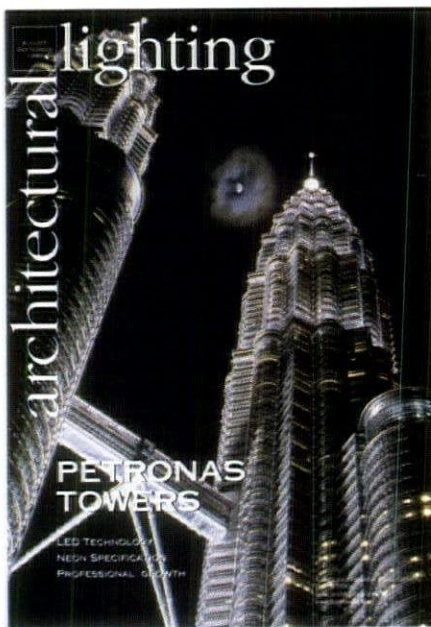

COVER PHOTO:
©JEFFGOLDBERG/
ESTO

Talk to us...

What would be on *your* wish list to manufacturers?

Fax your response to Christina Trauthwein at (212) 279-3955, or respond by e-mail to ctrauthwein@mfi.com. Answers will be printed in the November issue.

With our new panels, lighting control has never been this complete

occupancy
centralized
daylighting
distributed
networking
scheduling

The Watt Stopper's new and innovative lighting control panels give you the exact lighting control you need – in each and every space.

Our panels simplify lighting control by allowing all types of control to work together easily. So, you no longer have to choose one method over another. Your offices, health care facilities, campuses, retail locations, or other buildings can blend controls such as time scheduling, occupancy sensing

and daylighting throughout your facilities.

And because you get all the control you need from one manufacturer, you can be assured that you'll get the right product in the right place. This means you get the most convenience for your occupants and the most savings for your bottom line.

Lighting control has never been this complete or this easy. Call us at 800-879-8585 to learn more.

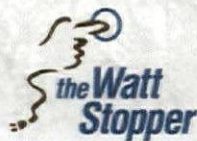

Putting a Stop to Energy Waste®

800-879-8585 • www.wattstopper.com

Circle No. 7 on product service card

To the Editor:

T5 technology is the lamp of the future. However, the future has arrived. When the T8 lamp was introduced in the early '80s, there was great resistance. It took about five years for it to become accepted. However, T5 is coming on much faster than the T8 ever did. It is a matter of education. With that said, I was alarmed by the comments made by Stephen Blackman in the latest issue of *Architectural Lighting's* Light Points—particularly, the comment that due to the lamp's slightly shorter length (metric), "it will take more T5 lamps than the standard-sized T8 to illuminate a linear run of fixtures through a space." Regrettably, this is an uneducated comment. For the linear fluorescent industry, T5 is the greatest development since Bill Gates founded Microsoft. The metric length of the lamp now allows linear systems manufacturers to redesign their systems without having oversize run lengths. A specifier will lay out their runs using 4-ft. increments, but because of the 48-in. (in rounded numbers) back-to-back socket requirement of the T8 lamp, the manufacturer is forced to go to an oversize condition from, depending upon the individual manufacturer's design, $\frac{3}{4}$ in. to as much as $2\frac{1}{2}$ in. per 4-ft. length. The T5 now allows the linear systems manufacturer to maintain 48-in. suspension centers and fixture lengths since the back-to-back socket requirement is now 46 in. (in rounded numbers) without requiring additional lamps in the linear run. Where suspension centers are not used—i.e., cove lighting—the lamps can still maintain 48-in. centers with no need to worry about drop off between the two lamps; they do have good lateral distribution. And with good optical design and proper materials, we have found that the lamp works extremely well in all applications—indirect, direct/indirect and direct systems—without requiring additional lamps in the linear run.

With excellent performance characteristics, T5 systems manufacturers are now able to achieve much wider run spacings with excellent ceiling uniformities. That does mean fewer fixtures are now required for many applications!

A full understanding of this technology will allow lighting designers to achieve much better designs with a lamp that affords them greater efficacy and greater performance characteristics, not to mention full light output at 35°C, improved optical designs from manufacturers, greater spacings and lower profile luminaires.

Availability and price barriers are crumbling every day. Parity with the T8 lamp is close at hand. Our advice is pay attention to the "hype" associated with the T5 lamp and demand that your manufacturers jump on board with the technology before the industry passes them by.

Steven Mitchell

*Focal Point LLC
Chicago, IL*

To the Editor:

I just finished reading the July issue of *Architectural Lighting*. In the Perspectives column, Mr. David Bergman discusses the problems with designing new fixtures for a screw-in, medium-base dimmable CFL lamp developed by Philips. He mentioned that since these new CFL lamps would be interchangeable with regular incandescent lamps, UL is requiring that fixtures designed specifically around such lamps must also meet the "as-of-right" UL clearance dimensions. Mr. Bergman noted that if a "UL passable, reasonably priced, dimmable, integral-ballast-style" CFL screw-in lamp could be developed, a whole new market would be waiting for it.

I think the solution to the UL dilemma is rather straightforward, and Mr. Bergman hit upon it himself: Develop a new base dedicated to the integral-ballast CFL. However, developing an entirely new base that is incompatible with the standard medium-base screw shell would then take the new CFLs out of the replacement market. The solution is to develop a new style medium-base socket that is deeper than normal. The extra depth would be such that an incandescent lamp screwed into such a socket would not work (would not touch the base of the socket). If the new CFL lamps were produced with a correspondingly longer base, then they could be used in the new sockets as well as being usable as a replacement lamp in regular medium-base sockets. This solution would seem to resolve UL's concerns about a non-incandescent fixture being relamped with an incandescent lamp, and would not require Philips to significantly redesign their existing product or design an entirely new product.

Also a note of interest: Mr. Bergman notes of the mindset that screwbase replacement CFLs are "seen as 'incandescent replacements' slated mostly for utility company rebate programs." Our local utility will provide rebates on permanent systems only; a screw-in replacement doesn't qualify since it could simply be replaced with a less-efficient incandescent in the future, negating the benefits of installing the CFL lamp in the first place. I'm sure other utilities look at these lamps the same way. However, the above-mentioned new socket could lead to a new retrofit market of replacing existing medium-base sockets in incandescent fixtures with the new "CFL Only" sockets and installing screw-in CFL lamps. I would think utility companies would recognize this as a permanent system because the concern of an incandescent lamp being used in the future would again be eliminated.

Garry Roscetti, PE

*Cochran and Wilken, Inc.
Springfield, IL*

Phoenix Products Company, Inc. is expanding its *Durability by Design* philosophy with the new Phoenix Intrigue Series™. The Phoenix Intrigue Series combines contemporary design with durable, high-performance lighting in an extensive offering of pole top lights, wall mounts, bollards, accent lights, step lights and a variety of specialty lights to illuminate building and landscape features.



PHOENIX
Intrigue
SERIES

Phoenix Products Company, Inc. 6161 North 64th Street, Milwaukee, WI 53218 USA TEL 414-431-2300 FAX 414-438-0213

Circle No. 8 on product service card

ACQUISITIONS & AGREEMENTS

Cooper Industries has acquired **Corelite**, a Denver-based, privately held manufacturer of linear indirect lighting fixtures for commercial use. Corelite will become part of the Cooper Lighting division. In other news, Cooper Industries has also acquired Manchester, England-based **JSB Electrical plc**, a manufacturer of emergency lighting, fire detection and security systems. JSB Electrical plc will join the Cooper Menvier division, which produces a line of emergency electrical equipment products. In 1998, Corelite and JSB had combined revenues of more than \$50 million.

HDR Architecture, Inc. and **Ehrlich-Rominger** have announced the merger of their architectural practices, creating ER+HDR, one of the nation's largest firms dedicated to the design of technology-based facilities. HDR Architecture is based in Omaha, NE and Ehrlich-Rominger is headquartered in Los Altos, CA.

The Leviton Manufacturing Company has acquired **NSI/Colortran**, a manufacturer of theatrical lighting systems and architectural lighting control systems. A division of NSI Corporation, NSI/Colortran is headquartered in Tualatin, OR.

Hewlett-Packard Company and **Royal Philips Electronics** have signed a memorandum of understanding to expand the scope of their LumiLeds Lighting joint venture. The expanded business will incorporate Hewlett-Packard's high-brightness LED technologies and processes, research and development, manufacturing and sales. Existing LED traffic-signal products developed and marketed by the LumiLeds joint venture and Philips' market research, application knowledge and financial resources will also be included.

LIGHTING DESIGN GUIDELINES INTRODUCED FOR THE NORTHEAST

The DesignLights Consortium (DLC) has recently created lighting guidelines to provide lighting contractors, architects, owners, managers and manufacturers with a model for specifying lighting in schools, retail stores and office buildings. The model focuses on promoting lighting quality, comfort and

efficiency for building occupants and contains recommendations for lamps, fixtures, controls and standard design layouts developed by leading lighting designers.

Published in an eight-page brochure, the design recommendations meet or exceed ASHRAE/IESNA standard 90.1-1989R, Draft

Final Standards—June 1999. As part of the rollout of the guidelines, the DLC is also sponsoring education sessions for electrical contractors about the guidelines' benefits and how to market them to building owners and managers. Guidelines may be ordered by contacting Sarah Dagher at the DLC at (978) 974-9475.

MILANO COMPETITION

AEM SPA, *l'Arca*—an international architecture magazine—and Partners in Business Communications have organized an international architecture competition promoted by the Milan Town Council and sponsored by Milan Polytechnic. Participants will submit designs for a "luminous sign" to be constructed in front of Milan's central station, Piazza Duca D'Aosta. The sign, an urban landmark, will represent the city's homage to the beginning of the third millennium and to Milan's multi-cultural heritage. Requests for information and application forms should be mailed to *l'Arca* Edizioni, the Competition Secretariat of Milan 2001, IIIrd. Millennium, Via Valcava, 6, I-20144 Milan, Italy; phone: 39.02.325346; fax: 39.92.325481; e-mail: arca@tin.it. The submission deadline is October 30, 1999.

Did You Know...? **Lighten Up**

On May 27, 1999, Sky-Tracker Promotional Searchlights entered the *Guinness Book of World Records* for creating the brightest single beam of light and the brightest and largest collection of searchlights assembled in one location. Sky-Tracker assembled the record-breaking display of 206 xenon searchlights to celebrate the grand opening of the Universal Studios Island of Adventure Theme Park in Orlando, FL. The production also featured a 41.5-billion-fc power beam generating light purported to be visible from the space shuttle in outer space. As a precaution, law enforcement agencies were notified within a 50-mile radius to prevent panic.

COOPER Lighting



The Source for Bright Ideas

Call 1.847.806.3586 or visit us at www.cooperlighting.com

HALO®

HOMELUX®

LUMARK®

SURE-LITES®

Metalux®



neoney™

FAIL-SAFE®

Lumière®

USL®
Universal Sports Lighting

UTILITY
LIGHTING SOLUTIONS

MCGRAW-EDISON®
The Architecture of Form & Light

IRIS™
LIGHTING SYSTEMS

OPTIANCE®
BY SUPERVISION®

MWS®
Modular Wiring System

Circle No. 9 on product service card

RESEARCHERS WIN AWARDS

The 1999 Awards for Architectural Research has recognized researchers at Lawrence Berkeley National Laboratory and the University of California, San Diego and the Chinese University of Hong Kong for their breakthroughs in the field of lighting research. The Lawrence Berkeley National Laboratory in Berkeley, CA received an award for combining daylighting and electrical lighting systems as an integrated whole. The goal of the \$1.5 million dollar project was to increase energy savings and promote healthier work environments. Led by Stephen E. Selkowitz, principal and Eleanor S. Lee, project manager, the project team included Liliana Beltran, Robert Clear, Dennis Dibartolomeo, Joseph Klems, Francis Rubinstein, Robert Sullivan and Edward Vine.

The University of California, San Diego and the Chinese University of Hong Kong were honored for the development of an alternative light source for architectural spaces. With a budget of only \$9,000, the researchers developed a potentially groundbreaking application for silicate phosphors, a newly discovered material containing silicon, oxygen and carbon. The project team discovered that the addition of aluminum generated the most efficient light and held the greatest for brightness and chemical stability. The principal researchers were Steven Lombardi, associate professor of architecture, Chinese University of Hong Kong and Michael J. Sailor, professor of chemistry, UCSD. Other members included Laurent Gutierrez, Valerie Portefaix, both from the Chinese University of Hong Kong, and Michael Ansel, Will H. Green and Khoa P. Le of UCSD.

Baskette, page 57
in our new Portfolio.
May it help broaden
your vision of the future.
For your copy...
phone 714 668-3660;
fax 714 668-1107.
Architectural Landscape
Lighting, Santa Ana CA



**ARCHITECTURAL
LANDSCAPE
LIGHTING**

A JJI Lighting Group Company

Circle No. 10

German engineering. At its most brilliant. Coordinated collections of spots, tracks, recessed and surface mounts... state-of-the-art light sources and reflector technology.

The Hoffmeister line by Alkco. Phone 847 451-0700, fax 847 451-7512.



ALKCO

A JJI Lighting Group Company

Circle No. 11

EXPANSIONS...

W.A.C. Lighting has announced plans to open a new warehouse in southern California. The address for the new warehouse is W.A.C. Lighting, 17930 East Rowland Street, City of Industry, CA 91748. W.A.C. Lighting is headquartered in Garden City, NY.

Taliesin Architects opened two new offices in Scottsdale, AZ and Blairsdon, CA. The new Arizona office is Taliesin's second location in Scottsdale. The office can be contacted at 6200 East Thomas Road, Scottsdale, AZ 85259; phone (480) 941-0898, fax (480) 941-0295. In Blairsdon, CA, the new Taliesin office is located at 330 Bota Street, Suite 5, Blairsdon, CA 96103. Taliesin Architects in Wisconsin has relocated to 6502 Grand Teton Plaza, Suite 202, Madison, WI 53719. They can be contacted by phone (608) 829-5700, fax (608) 829-5707 or e-mail ta_madsn@itis.com.

The Stonco/Crescent division of Genlyte-Thomas Group LLC has expanded its sales and marketing operations, transferring them to the company's headquarters in Barrington, NJ. For more information, please contact Crescent/Stonco Division, 120 East Gloucester Pike, Barrington, NJ 08007; phone (856) 546-5500, fax (856) 546-6375.

ON THE MOVE...

Solatube International Inc. has moved to a new 55,000-sq.-ft facility in Vista, CA. The new facility, which combines operations from three previous Solatube facilities, will focus on North American operations and is located at 2210 Oak Ridge Way, Vista, CA; phone (760) 597-4400, fax (760) 599-3099.

Robert Young Associates has moved to 2608 Inwood Road, Dallas, TX 75235. The firm can be contacted by phone at (214) 220-9050, fax at (214) 220-9047.

LightIdeas LLC has moved to new corporate headquarters at 1605 Indian Brook Way, Suite 100, Norcross, GA 30093. To contact LightIdeas, phone (770) 806-9384 or fax (770) 806-0963.

PHILIPS LIGHTING ISO 9001:1994 CERTIFIED

KEMA-Registered Quality, Inc. has announced the ISO 9001:1994 certification of Philips Lighting North America in Somerset, NJ. Certification to ISO 9001:1994 is given to companies who have shown evidence of a Quality Management System.

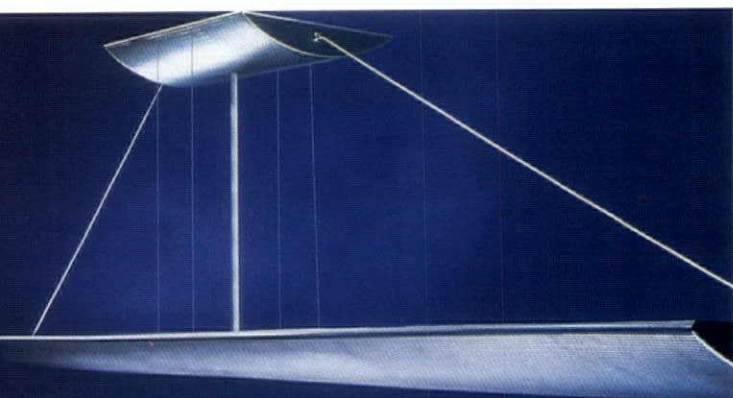

Bridge to Y2K™: cunning, indirect lighting from architecturally-elegant, 8-foot spans needing barely 12-inch clearances... full perf reflectors sparkle direct light down, eliminate shadow zones. LAM Lighting Systems
Phone 800 732-5213,
fax 714 662-4515.

LAM 

A JJI Lighting Group Company

Circle No. 12

Aegis: exceptionally versatile surface mount luminaires. As attractive indoors as out. ADA compliant in all four themes—triangles, panes, circles and plain. d'ac Lighting
tel 914 698-5959,
fax 914 698-6061

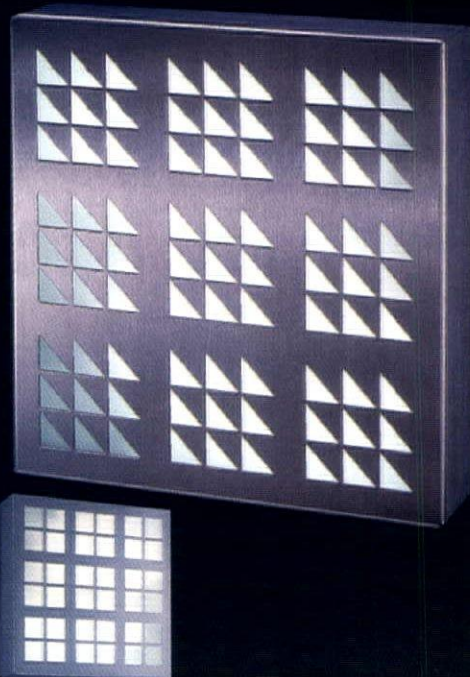

d'ac 

A JJI Lighting Group Company

Circle No. 13

START-UPS...

Light Solutions, Inc. has announced its formation and subsequent entry into the lighting equipment market. The new firm will design, manufacture and market Alum-A-Lite energy-efficient lighting fixtures. Founded by president and CEO Gene Kleffman, Light Solutions, Inc. is headquartered at 730 Osage Street, Suite C, Manhattan, KS 66502; phone (785) 776-9009, fax (785) 776-9933, website: www.lightsolutionsinc.com.

Mark Allen and Scott Searle have announced the formation of **True to Form, LLC**. The company will design and manufacture designer lighting and architectural products as well as offer lighting design solutions to members of the architectural and design community. Allen will serve as president and Searle, as creative director. True to Form, LLC is located at 27520 Avenue Hopkins, Suite D, Valencia, CA 91355; phone (661) 257-5040, fax (661) 775-3873.

GROSS CHANDELIER BECOMES G LIGHTING

After over 90 years in business, Gross Chandelier has adopted a new logo and a new name, "G Lighting." Contemporary in look, the new logo uses the same colors to indicate that although the company is changing their look and name, they are still the same company.

Donald Gersztoff, LC, IALD, principal and project director of the Lighting Design Alliance and formerly a partner of Wheel Gersztoff Seles for 22 years, has passed away. A founding member and former director of the International Association of Lighting Designers (IALD), Gersztoff has created lighting designs for numerous five-star hotels, as well as the corporate headquarters for American Express, International Paper, FNMA, National Westminster Bank and BBDO Worldwide. Other lighting projects include the New York University Law Library, Faneuil Hall Marketplace and the Lance Burton Magic Show in Las Vegas. Gersztoff received numerous lighting design awards. The lighting designer, also a member of the Illuminating Engineering Society of North America (IESNA), taught lighting and theater-related courses on the college level.

Taliesin Architects has named **Lawrence Heiny** design advocate.

Abbey Wadhwa has joined Gary Gordon LLC as lighting designer.

Marianna Kridge has joined DPA Lighting Consultants as lighting designer.

Lord, Aeck & Sargent has named **Jennifer P. Bailey** architect and **Anne Jackson** interior designer.

Schuler & Shook has named **William Conner** project manager in theater consulting.

Lighting Design Partnership has appointed **Graham Large** to its board of directors.

Howard Brandston, FIALD, has been awarded the 1999 Institute Honors for Collaborative Achievement by the American Institute of Architects.

The International Association of Lighting Designers (IALD) has named two new members to its board of directors; **Naomi Miller, IALD** will serve as director at large and **E. Teal Brogden, IALD** as a chairman's selected director. In addition, **Katherine Abernathy, IALD, Reiko Chikada, IALD, Mark Frank, IALD, Adam Grater, IALD, Andy Lang, IALD, Earl Levin, IALD, Mark Major, IALD, Melinda Morrison, IALD, Lee-Roy Prince, IALD, Robert White, IALD** and **Rogier van der Heide, IALD** have joined the IALD as professional members.

Jami Wilson of Light Inc. has been named president of the interNational Association of Lighting Management Companies (NALMCO).

Shad Funkhouser has joined CDAI as lighting designer and project engineer.

Wanda Barchard has joined Einhorn Yaffee Prescott Architecture & Engineering, PC as electrical design engineer.

S.P. Papadatos Associates P.C. has appointed **Pierre Guariglia** associate and **Saverio Crea** and **John Van Lenten** senior associates.

Fox & Fowle Architects has named **Rodney VenJohn, AIA**, senior associate and **Michael Stark** associate.

Tom Zeingenfuss, Lisa Ackerman, AIA, Sherif Wahdan, Clarence Eng, Joel Ivan Plitt, Eric M. Wohnsigl, Sarah Keefer, Ivette Mongalo, Vickie Hobby, Chuck Sheubrooks, Bill Gaskins, Bill K. M. Young, Jessica Burgard, Shirley Lamm and **Ginger O'Keefe** have joined Design Collective, Inc.

E. Tim Carl of Hammel, Green and Abrahamson, Inc. has been awarded the 1999 Young Architect Citation.

Gary J. Lehman has been named president and COO of Advance Transformer Co.; **Scott Miesen** joins as regional sales manager, west central region.

Osram Sylvania has promoted **Robert Jordan** to market development manager and **Christopher Smith** to government representative for Industrial & Commercial Lighting.

Fiberstars, Inc. has appointed **Alan Ruud** and **Jon Merriman** to serve on its board of directors.

Wendy Kaplan of Advance Transformer and **Kathryn Lutz** of Day-Brite Capri Omega have joined the IALD's LIRC committee.

Tivoli Industries has appointed **Darrin S. Wood** national sales manager and **Robert N. Corby** national accounts manager.

WHAT COULD YOU DO?

What could you do with a 5" compact fluorescent downlight with a 6" depth, the same lumen output and wide distribution as an incandescent, optional reflectors for wallwashing or corridor lighting, and even decorative reflector rings?

Triplux 126/5. Our industry's first 5" compact fluorescent for today's low ceilings and squeezed plenums. For information and the name of your local representative call 212-521-6900; fax 212-888-7981.

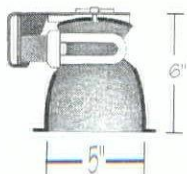
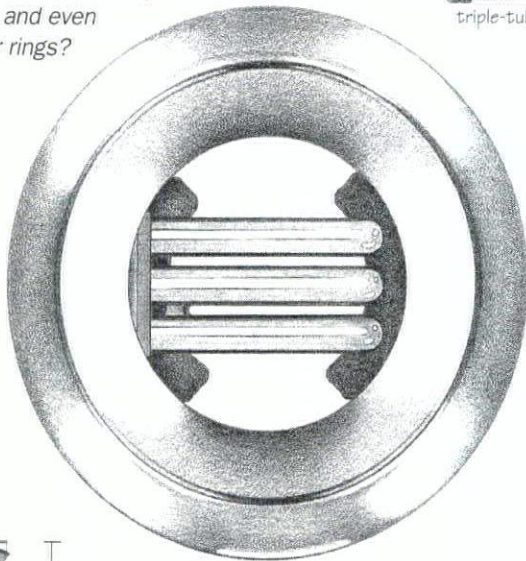
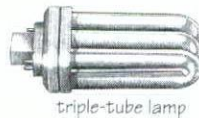

EDISON PRICE
LIGHTING

because light matters.

1999 SCHEDULED EVENTS

October 6-8 Balkan Light '99—First Balkan Conference and Exhibition in Lighting, Varna, Bulgaria; (+359 2) 65-09-20/65-09-55, e-mail: DENIMA@OMEGA.BG.

October 10-23 BSA International Architecture Tour to California; (800) 272-8808, (415) 955-2753, e-mail: info@arctour.com.

October 12-15 Hong Kong International Lighting Fair, Hong Kong Convention and Exhibition Centre; (852) 2240-4030.

October 20-23 Luminaire Asia '99, Singapore International Convention & Exhibition Centre, Singapore; (609) 987-1202.

October 23-November 6 BSA International Architecture Tour to Mexico with an optional extension to Cuba; (800) 272-8808, (415) 955-2753, e-mail: info@arctour.com.

October 24-26 The NECA Show, Ernest N. Morial Convention Center, New Orleans, LA; (301) 215-4549.

October 27-29 Design.y.c. (Interplan, The Design Show, City Lights), Jacob Javits Convention Center, New York City; (800) 950-1314, ext. 2331.

October 27 FEDCON 2000, National Press Club, Washington, D.C.; (800) 283-4699.

October 27 NYSID Lecture: "Orders of Architecture/Origins of Ornament," by Rocco Leonardis, New York School of Interior Design; (212) 472-1500 ext. 194.

October 28 1999 National Summit on Building Performance, Ronald Reagan Building and International Trade Center, Washington, D.C.; (202) 828-7055.

October 28 4th Annual North American Construction Forecast, National Press Club, Washington, D.C.; (800) 283-4699.

November 6-20 BSA International Architecture Tour to Italy; (800) 272-8808, (415) 955-2753, e-mail: info@arctour.com.

November 7-9 Restoration and Renovation exhibition and conference, Charleston, SC; (978) 664-6455.

November 8-9 AEE seminar: "Fundamentals of Lighting Efficiency," San Juan, Puerto Rico; (770) 925-9633.

November 8-13 Batimat: Salon International de la Construction, Paris Expo, Porte de Versailles, Paris, France; (212) 615-2925, (800) 321-3269.

November 16-18 15th Annual Build Boston, World Trade Center Boston, Boston; (800) 544-1898, www.buildboston.com.

November 19-21 LDI 99, Orange County Convention Center, Orlando, FL; (303) 741-2901.

December 21-January 2, 2000 BSA International Architecture Tour to Thailand with an optional extension to Singapore; (800) 272-8808, (415) 955-2753, e-mail: info@arctour.com.

A CROWNING ACHIEVEMENT IN FIXTURE DESIGN

Each member of Lumière's Coronado line of metal halide fixtures is a unique specification grade fixture designed to use the newest in high technology natural color rendering metal halide lamps.

Unique, timeless, and patented design, and patented fixture aiming mechanism set these fixtures at the summit, above all others in their class. The ADEX Award winner for landscape lighting, the Coronado series adds to the long roster of Lumière fixtures honored for design excellence.

Available in versions to accept the PAR 20, 35 watt (Cat. #720), PAR 30, 35 or 70 watt (Cat. #730, pictured), and PAR 38, 70 or 100 watt (Cat. #740) metal halide lamps. Coronado fixtures can be mounted in the ground, on trees or walls, and can be removed from their waterproof composite ballast compartment.

Another groundbreaking, award winning fixture?

Of course, its Lumière!

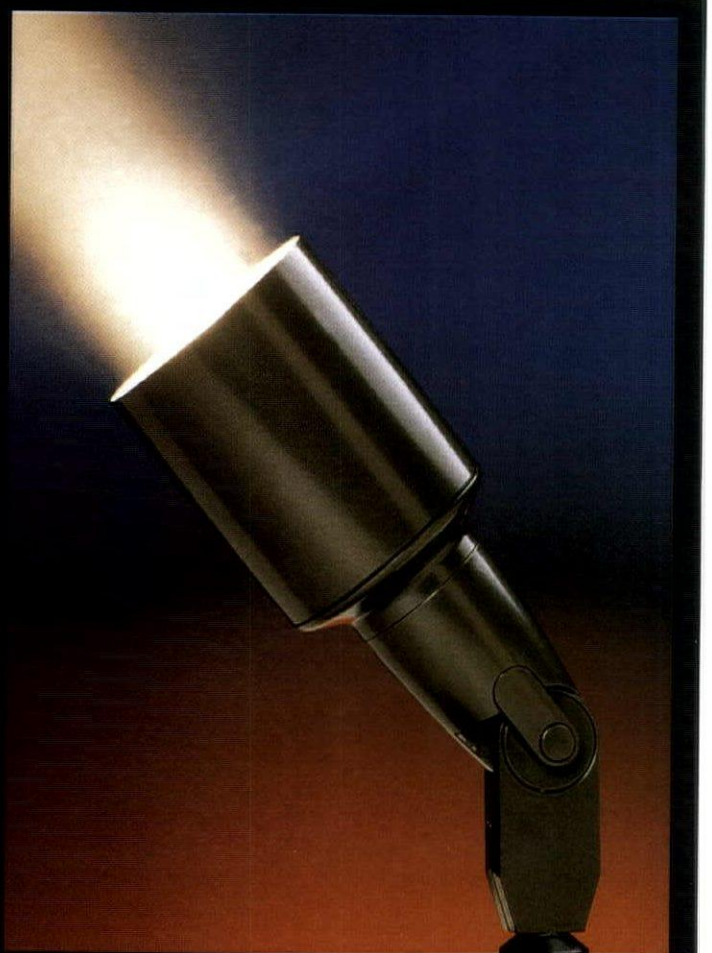

Lumière

COOPER Lighting

2382 TOWNSGATE ROAD
WESTLAKE VILLAGE, CA 91361
TELEPHONE: (805) 496-2003 FAX: (805) 496-2303

In this issue, Architectural Lighting interviews Patricia Glasow, LC, IALD, VP of Auerbach + Glasow in San Francisco. Ms. Glasow has been involved in the design and management of hundreds of lighting projects including Euro Disneyland Resort Center/Lake District, the California Palace of the Legion of Honor, San Francisco Hyatt Regency Hotel and the Ann Taylor Flagship stores. Additionally, she has designed many commercial offices, theaters, exhibit and retail spaces, showrooms, churches, hotels and exteriors in North America, Asia and Europe. Trained as a theatrical lighting designer, she earned her BA in Theater Arts from UCLA, and began her professional career with Strand Century, Inc., a theatrical and video lighting manufacturer. Returning to design, Ms. Glasow worked for the design subsidiary of Walt Disney. She joined the firm of S. Leonard Auerbach & Associates in 1984; 10 years later, the lighting division of the firm became Auerbach + Glasow. Ms. Glasow has received numerous lighting design awards from the IALD, the IES and the GE Edison Awards and is Lighting Certified from the NCQLP. Recently, she served as a steering committee member for the DELTA program at the Lighting Research Center (LRC) and served a two-year term as a committee member on the Lighting Efficiency Advisory Group for the California Energy Commission.

—Christina Trauthwein

AL: Why did you choose to enter the lighting profession?

Glasow: Well, I don't know that I really entered the lighting profession—I grew up in it. I started in theater when I was 14, and my first paying job was working for a professional roadhouse when I was 15. I began as a stagehand and was most interested in lighting. My first conscious decision to go into lighting was when I entered college—after being exposed to lighting in my teens, I realized that's what I wanted to do. It's interesting: Once I started my job in theater at 15, I never had another paying job that was not in lighting. My career was that directed.

AL: So what was it about lighting that really grabbed you at such an early age?

Glasow: In theater it's all very collaborative. Creative, interesting, technical and collaborative. And when you put those four things together, the result is extremely attractive and impressive, especially to a young person. In theater, particularly, it's all very immediate—the outcome of your efforts is realized quickly. I was involved with some fairly large projects—rock and roll shows—and that's when I started realizing that I like big, complicated jobs.

AL: At what point did you decide to pursue architectural rather than theatrical lighting?

Glasow: Right out of college, I went to work for Strand Century in customer service and internal sales for architectural, theatrical and video dimming systems; that was my first exposure to architecture. I then became a manufacturer's rep for a year, ran back to design and got a job at Disney. At that time, the design end of Disney was WED, which then became Imagineering. The lighting designers at Disney—called show lighting designers—are in charge of all aspects of illuminating public spaces. I was hired by Disney for my theatrical background, but ended up doing exhibit, restaurant and exterior lighting. That was my official

transition into architectural lighting. Prior to that experience, in the early 1980s, I was only vaguely aware of an architectural lighting profession.

AL: Do you often rely on your theatrical lighting background when approaching architectural projects?



Glasow: The most positive aspect of theatrical training is gaining an intimate knowledge of the effects of light on people and objects. Color, for instance, in theater can range from subtle to bold and obvious. This leads to an understanding of color, form and modeling. Many designers who do not have the benefit of drawing upon theatrical training approach architecture as a flat field, which it's not. In addition, theatrical lighting trains the designer in the technology and technique of dimming. Many architectural lighting designers have only worked with very simple dimming systems, yet they're designing very sophisticated projects—we're pushing the envelope and pushing the manufacturers, who are regularly developing new systems for us to meet the demands of our projects. There needs to be an understanding of how to properly use dimming in an application. Theatrical training forms a foundation for that.

But what a theatrical lighting design doesn't provide is an understanding of architectural methodology and the

architectural process. In addition, a theatrical lighting background is not nearly as rigorous in drafting and documentation techniques.

AL: What is your design philosophy?

Glasow: Marry collaboration and process. Evaluate the need and the context of the project. Integrate your ideas with the design team and the owner. That's collaboration. Step through the process—the program, the concept, testing the concept against the program requirements and finally, the detailing. If you only care about illumination level and approach a project as just an engineering rather than a design process, the solution shows it: adequate, but common and unremarkable.

AL: Any tips for those entering the field?

Glasow: Whatever your field is, it's important to cross-pollinate with other fields. Learn outside your field. Sometimes, people can be so narrow in their disciplines. For instance, if you're studying architectural lighting, take courses in theater and art. If you're studying theater, take courses in architecture. Also, don't just restrict your interests to related fields. One of the most important things in our field, and in every field, is communication. Take courses in history and English. Learn where we came from and how to communicate. My biggest complaint about the industry is how people communicate both in speech and writing.

AL: What beliefs or professional values do you hope you've instilled in those who work for you?

Glasow: Work hard and love what you do. I'm very serious about my work. We're all very serious about our work here and we work extremely hard, but we like to have fun while we're doing it. I think everyone should find joy in their work, have a good time and laugh a lot. I've adopted my parents' advice to me: Do what you love. Let's face it, we all work under a tremendous amount of stress

(Continued on page 20)

urban design: C. Cortesão, M. Vieira, A. Babo - architecture: C. Prata, J.C. Portugal + F. Mangado Beloqui landscape architecture: I. Teixeira Diniz

urban design: G. Vazquez Consuegra - architecture: J.A. Rocha, J.M. Gigante

architecture: F. Visado Manzanares

architecture: E. Tuñon, L. Moreno Mansilla

architecture: L. Tena, T. Errea - landscape architecture: J. Mendes Ribeiro

architecture: A.P. Benedito

architècti magazine is the most important quarterly publication on architecture in Portugal.

architècti prize has been instituted since 1993, being awarded by a jury composed of famous international architects.

Participate and be this year's winner!

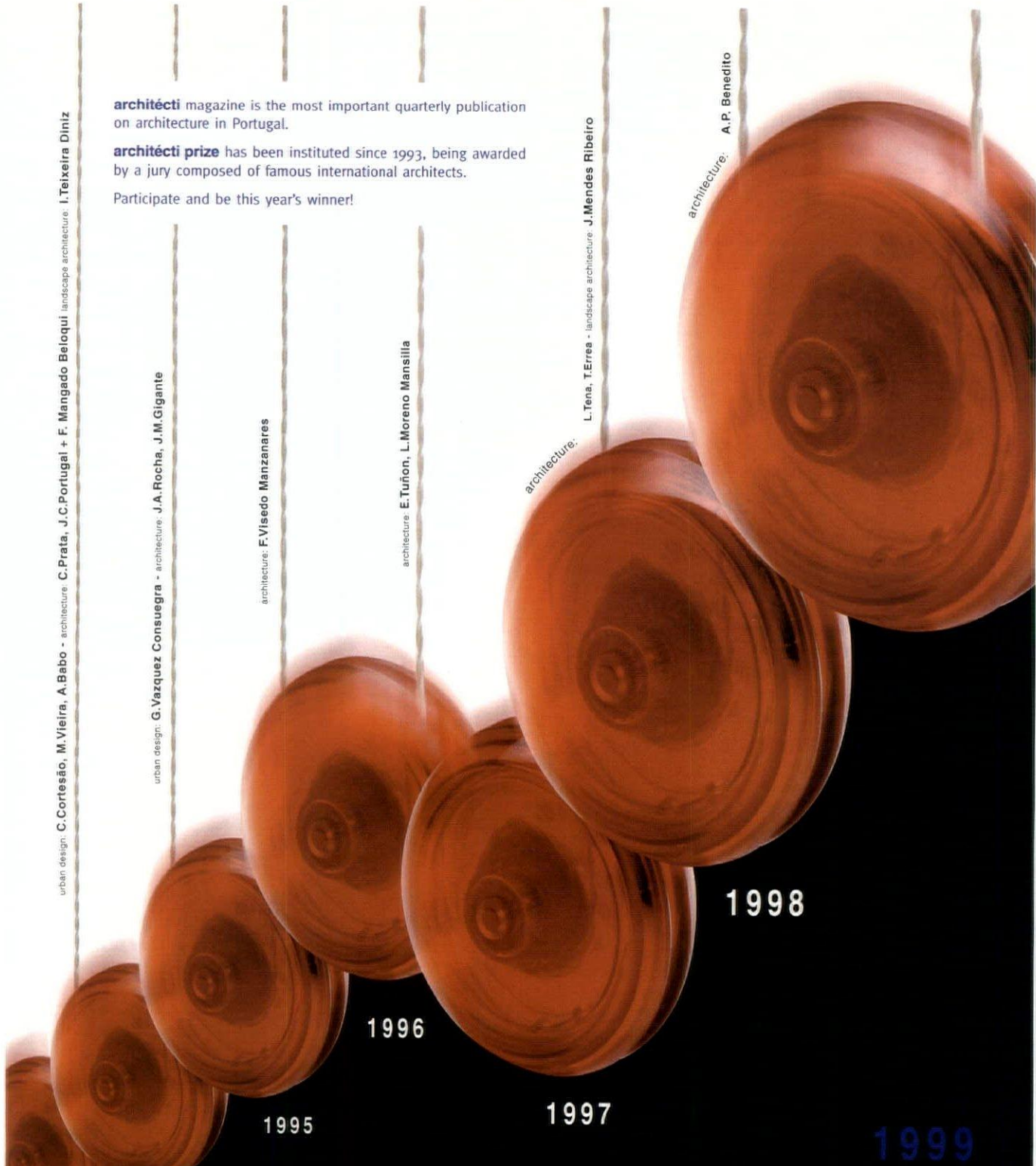

1998

1996

1995

1997

1999

1994

1993

architècti prize - arkial

€ 5.000 (five thousand euros)

The winner will be feature on the cover of **architècti**

Deadline entry: November 6, 1999

This contest is open to architects who are 45 years old or younger, with all real projects, either constructed or not yet constructed which have been completed between September 1995 and September 1999.

Information's: Editora Trifólio, Lda, Rua Guerra Junqueiro n.º 7, 6.º A - 2780-249 Oeiras PORTUGAL
tels: (00351-1-443 58 30) ou (00351-1-443 57 45) fax: (00351-1-443 56 45)
e-mail: architècti@mail.telepac.pt - site: www.architècti.com

ARKIAL
exclusive sponsor

with the support of
Câmara Municipal de Oeiras

(Continued from page 18)

with unreasonable deadlines, so hopefully, the environment we work in is at least a pleasant one.

There is something I routinely tell my designers: Have a broad project view and compassion for what other people on the design team are going through. It's really easy to get wrapped up in our own stuff and for each of us to throw ourselves a personal pity party, but it's important to remember, we're not the only ones involved on a project. I have a lighting designer to architect stress ratio theory: If it's bad for us, it's usually 10 times worse for the architect. We're just doing our discipline; they're coordinating and working with a dozen disciplines. It's important to keep a perspective.

AL: *The largest obstacle to advancing in the field?*

Glasow: Ourselves. There needs to be more cooperation among the different parts of our industry. There's a lot of distrust out there and that hinders progress and communication. Manufacturers have started to cooperate with each other by coordinating things like lamps, ballasts and fixtures, which had always been one of the banes of the industry. It's happening, but it's happening slowly and sometimes, I think, under duress. But it's not just the manufacturers. Lighting designers need to get their act together. Lighting is often one of the most complicated disciplines on a project. It has some of the most difficult coordination problems on jobs. For instance, the distribution network we have to go through is quite complex, which is difficult to explain to architects and owners, and they don't always readily understand. When we have delivery problems, inaccurate orders and installation problems, it just makes our industry, as a whole, look bad. There needs to be greater coordination and communication from the manufacturer through the rep, distributor and contractor to the design team.

AL: *How can the specifier and manufacturer improve their relationship?*

Glasow: I work closely with the manufacturers to form a solid relationship and to garner an understanding of everything from product design to product specification. A lot of that is knowing the product and getting the product in your office before it gets to the job site. A lot of the problems on projects are pricing problems. You can avoid that if you get early, up-front pricing from your manufacturers and reps and learn what

things should cost—that's often where a project goes awry. As a designer, you need to have some control and understanding of this information and not just take a hands-off attitude, which is often the case

AL: *In what direction would you like to see technology heading?*

Glasow: Most fixture design is prompted by new lamp technology. The introduction of the T5 fluorescent, LED development and remote source technology—these all offer exciting design possibilities. Smaller sources

THERE NEEDS TO BE
A GREENING OF THE
LIGHTING
PROFESSION BEYOND
ENERGY
CONSERVATION AND
DISPOSAL METHODS.

and energy-efficient options give us a tremendous amount of flexibility.

When we think about the lighting design profession, sometimes we just think about light fixtures or dimming or the technology that immediately affects us, but there's a much broader issue of where the design profession is going and the technology we're using to get there. Our progress as a profession is dependent on technology and on how we document and think about our work. Right now, we still think about our work in two dimensions. As we get more immersed in 3-D CAD technology, it's going to change the way we design and think about how a project is put together. I'm going to be starting a project in the near future in which the architect plans to model the building completely in 3-D CAD. That means every lighting fixture, every switch, every piece of conduit will be shown, and the design will be computer-tested. So we will see the structural constraints, the possible design conflicts and we'll have a complete understanding of the difficult spaces that we could never quite get by drawing plans and sections. This may

change the paradigm of how we design projects. I think it's going to take more time up front, but it's going to solve problems down the road. Never again will we get in the field and hear, "You can't put that light there; there's a beam there." You will know there's a beam there and you will plan for it ahead of time.

AL: *Has gender ever affected your perception in the industry?*

Glasow: I have been very fortunate. Yes, I have experienced a few unenlightened people, but they have not been barriers; they have not affected me nor my projects. I have a fairly strong personality and I'm also very straightforward and very honest with people. And people respond to that. But, you know, while it's not a major factor, there are isolated instances: Just recently I was on-site talking to a contractor and we were dealing with some very sophisticated dimming issues. One of the other contractors commented, "You know, this is going to get very technical." I was very restrained and said, "That's okay, I designed the system." We went right on and talked.

AL: *As this year starts to wind down, what issue do you feel will be particularly relevant in 2000 and beyond?*

Glasow: There needs to be a greening of the lighting profession beyond energy conservation and disposal methods. When we talk about sustainability in lighting, that's what we usually talk about. But I think it also includes an understanding of material use, manufacturing techniques and the actual energy used to make a product. This is not exclusive to the lighting industry, of course, but I don't think we've really been addressing this issue. We need to have a better understanding and open dialogue about how our industry is affecting the environment and what we can do about it. I really don't know much about it, and can't offer definite solutions, because no one addresses it. But that's just the point. For instance, it's difficult to find information about different finishing techniques for lighting fixtures. Do we care, should we care that our chrome-plated lighting fixtures use a highly toxic bath of chemicals that will be disposed of somewhere, somehow? What are the alternative finishes that we could be using? Are they any better than plating? We should at least have an understanding of the ramifications of the specifications we're putting out there. ■

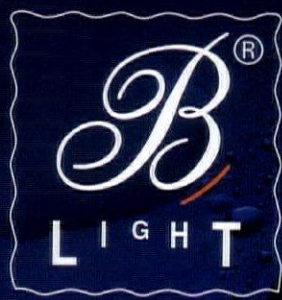

THIS IS THE LIGHT THAT LIT THE LOUVRE
What architectural masterpiece do you need to light?

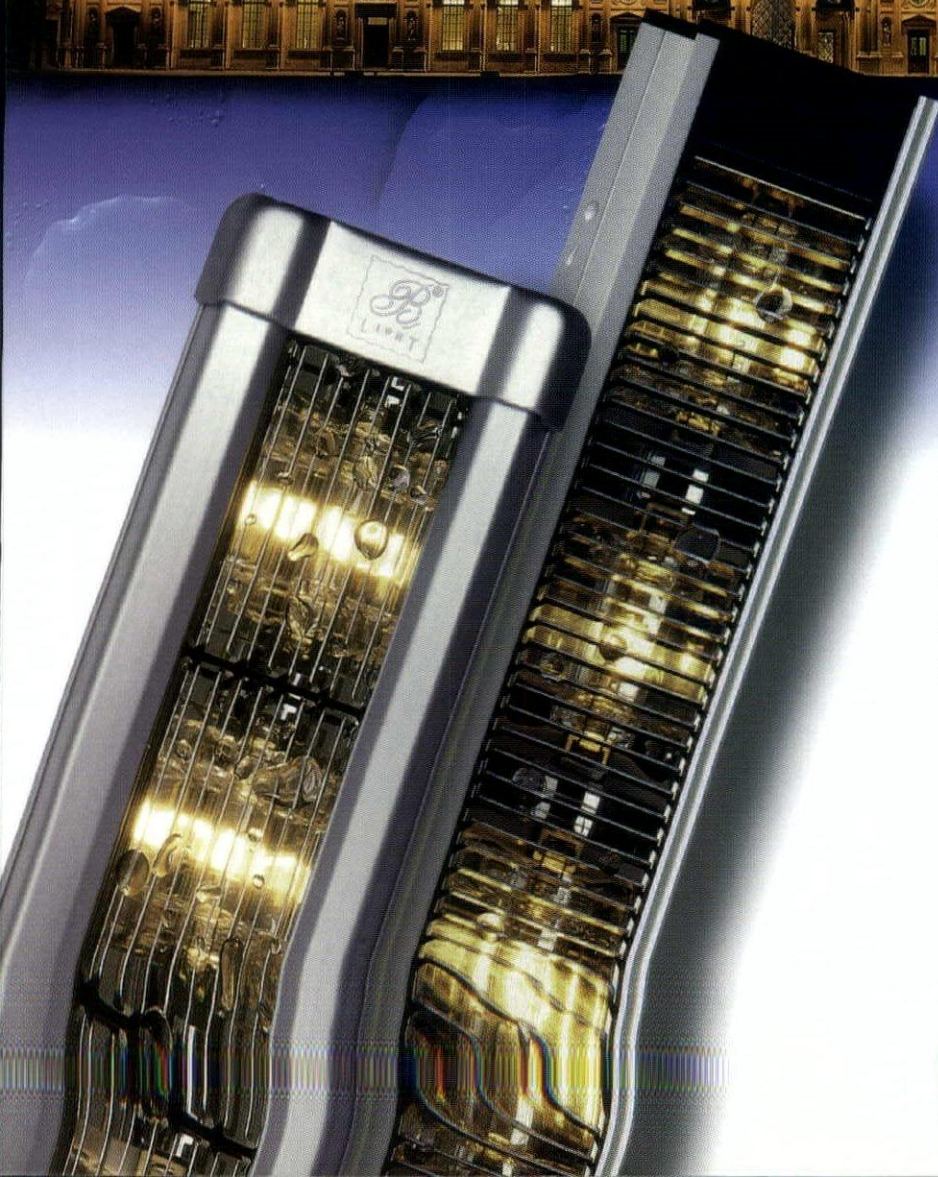
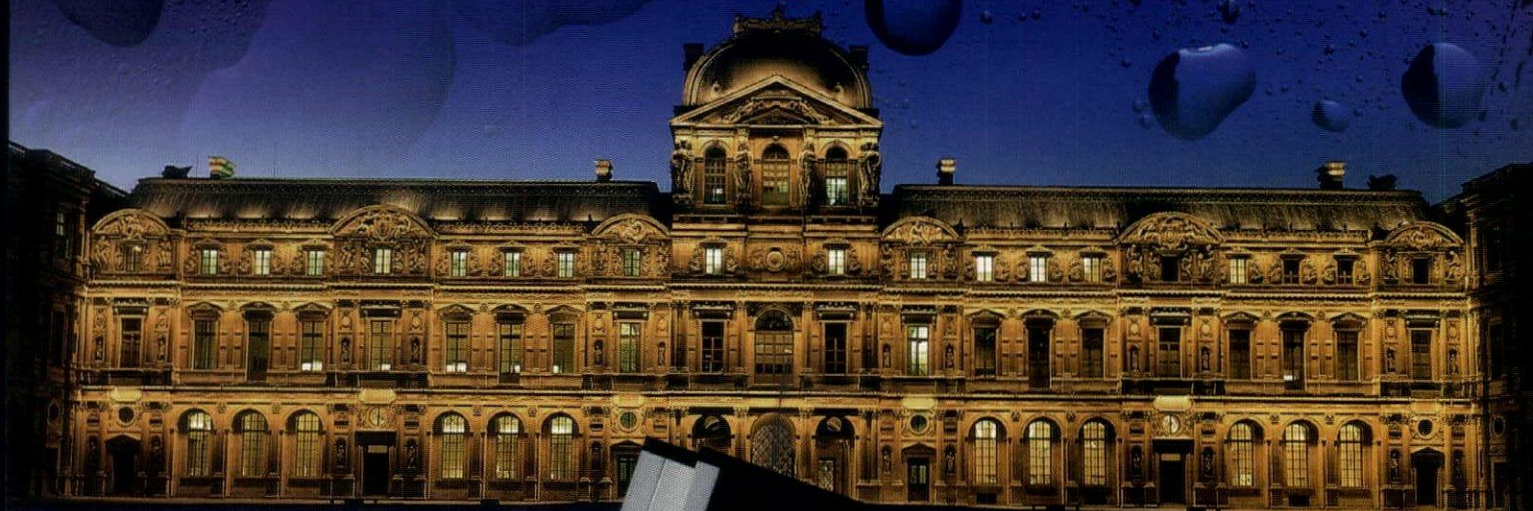

Now this revolutionary fixture is available in the US. Utilizing a Xenon 20,000 hour lamp, this tiny fixture virtually disappears from sight when mounted to the face of a building. No more hot spots, no more blinding flood lights. At last, you can highlight the true architectural detail of a building with the perfect amount of light.

Distributed in the USA by
LIGHT-PROJECT INTL
INC.®



105 Executive Drive #210
Sterling, VA 20166-9558
Phone (703) 471-6411
Fax (703) 471-0312

Circle No. 16 on product service card

Visit our web page at <http://www.lightproject.com>

SOLAR SYSTEM

Playful lighting design adds sunshine on a cloudy day

BY ALICE LIAO, ASSISTANT EDITOR

CHALLENGE When Aurora Health Care began experiencing a high employee turnover rate in its billing services division, the management asked interior designer Judy Barczak of Welman Architects and lighting designer Steven Klein, LC, of Klein Howard Lighting, LLC to transform the dimly lit, windowless office space into a friendlier working environment. Klein said, "Originally, we were hired to correct a deficiency, but the job then expanded into uplifting the spirits of the people who worked in the space and giving them something to cheer about."

DESIGN/TECHNICAL CONSIDERATIONS "The biggest problem was that all the plumbing pipes, steel support beams and HVAC ducts were already in place and could not be moved," said Klein. "A lot of the work was done in planning to avoid obstructions and relocating most of the existing fixtures." The existing gray ceiling also provided little reflectance for the indirect units, which were stem-mounted and lamped with 400W metal halide sources.

As a result, light levels in the office fell below 5 fc, causing employees to complain of headaches and eyestrain.

Further complicating the project, all work had to be done after hours with little disruption to the functioning of the office, as no other facility could accommodate the division and its 500 staff members.

METHOD Klein's solution infuses the office with a playfulness by creating a luminous sky within the concrete confines of the space. Clouds, cut from LR 90 acoustical tile, float at staggered heights ranging from 11 ft. to 14 ft. to conceal existing beams, sprinklers and HVAC ducts. To construct the illusion, cloud designs were drawn freehand and made into templates then interpreted in CAD. Laser Force, a laser entertainment company, projected the cloud edges onto partially constructed grids suspended from bar joists. The grids were then marked, cut and assembled with prefabricated extruded edge pieces. This practical process, now patented, saved the design team hours of installation time. Above the clouds, fluorescent strips silhouette the cumulus shapes by reflecting light off the insulation board and eliminate shadows created by the indirect lighting below.

Klein lowered the original indirect units to a height of 8 ft. 6 in. by mounting them on longer stems. Equipped with new 250W metal halide sources, the fixtures now project light onto the cloud-shaped grids to produce an illuminance of 32 fc with a 35 percent reduction in energy consumption.

The sun, an acrylic sphere internally illuminated with a 32W compact fluorescent source, glides through the office to complete the illusion and act as a temporal reference point for employees. A three-wire track system winding through a 44-in. corridor between the clouds powers a motor attached to the sphere, enabling it to travel about 6 in. a minute. The continuous track system is suspended at varying heights to allow the sun to disappear intermittently behind the clouds. At approximately 6:00 pm, when the sun reaches the end of its path, limit switches and a reversing function turn off the internal lamp and send the assembly back to its starting point. Employees can gauge the time of day through their position relative to the sun and clouds, which according to Klein, fulfills a primeval human instinct. ■

DETAILS

PROJECT
Aurora Healthcare Billing Services Division

CLIENT
Aurora Healthcare

LOCATION
Milwaukee, WI

ARCHITECT
Judy Barczak, Welman Architects

LIGHTING DESIGNER
Klein Howard Lighting LLC—Steven L. Klein, LC, William Feldman, Lynn Howard.

GENERAL CONTRACTOR
Mark McDowell, Grunau Project Development

CEILING CONTRACTOR
Sprinkmann Sons—Dennis Holpfer, Mark Memmel,

LASER IMAGING
Laser Force

ELECTRICAL CONTRACTOR
David Drumel, PE, Uihlein Electric

PHOTOGRAPHER
Eric Oxendorf

LIGHTING MANUFACTURERS
SPI Lighting Inc. (fixtures); Philips Lighting (lamps); William Feldman, Hartwig Exhibitions and Track (sun fixture); Gordon, Inc. (ceiling edges); USG (ceiling tiles)

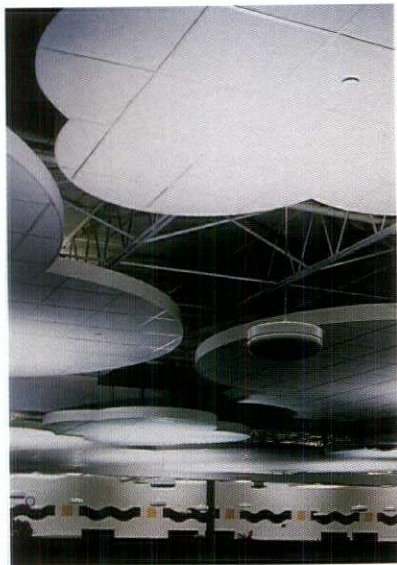

REFITTED WITH 250W METAL HALIDE LAMPS, THE ORIGINAL FIXTURES PROVIDE INDIRECT ILLUMINATION BY REFLECTING LIGHT OFF CLOUDS CUT FROM ACOUSTICAL CEILING TILE (ABOVE). A 32W COMPACT FLUORESCENT LIGHTS THE SUN FIXTURE (RIGHT), WHICH MEANDERS THROUGH THE OFFICE AT A PACE OF 6 IN. PER MINUTE.

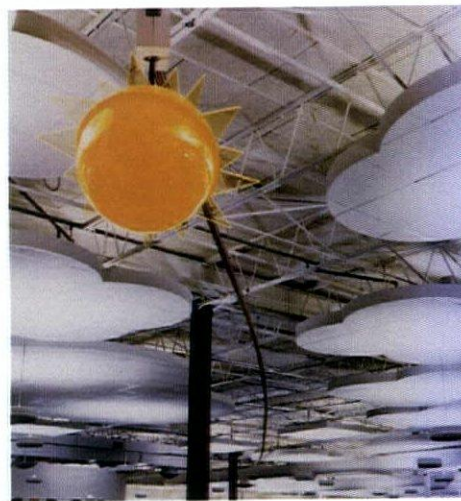

See Your Designs in a Better Light



Fluorescent dimming just got better— and easier—with new Tu-Wire™ Electronic Dimming Ballasts from Lutron.

Lutron's new Tu-Wire™ Ballast has it all:

- Small size for more design flexibility
- 2-wire power and control for easier installation
- 5% dimming for architectural performance
- Superior energy efficiency vs. incandescent

Announcing new models!

- For 18, 26 and 32W compact lamps
- For T8 32W linear lamps

Lutron's new Tu-Wire™ dimming ballasts make it easy to design efficient architectural compact fluorescent lighting systems for demanding commercial *and residential* applications. The first of a new ballast family, Tu-Wire delivers the superior performance you expect from Lutron—the inventor of the electronic dimming ballast.

Combine new Tu-Wire's features with Lutron's many lighting control options, and you'll see why specifier's count on Lutron, the leader in quality fluorescent dimming for over 25 years.

For more information, call toll free 1-877-2LUTRON, Ext. 115



Circle No. 17 on product service card

LUTRON
www.lutron.com

Heavenly Light

FROM DARKNESS TO LIGHT—EXPANDING THE SPIRITUAL METAPHOR
TO BRING NEW LIFE AND SYMBOLISM TO TWO HOUSES OF WORSHIP

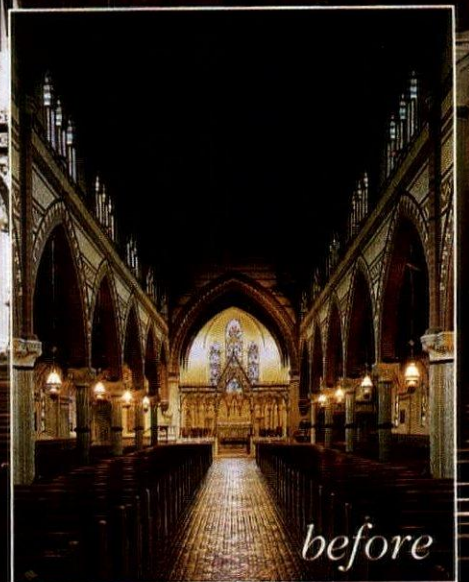

before

The Church of the Redeemer

BY JEAN GORMAN, CONTRIBUTING EDITOR

In the Church of the Redeemer, in Bryn Mawr, PA, lighting designer James Crowell gave an old structure new life by introducing a number of strategically placed lighting fixtures. Designed in 1879 by architect Charles M. Burns, Jr. and completed in 1881, the Gothic Revival-style Episcopal church was originally illuminated only with oil lamps. Later, the original oil lanterns were retrofitted with a series of standard incandescent sources. While these sources brought the illumination into the 20th century, they failed to bring out the rich decorative stencilwork on the ceiling of the nave and side aisles of the church.

The former rector of the church realized that leaving these details in the dark was a lost opportunity: If they could be seen more clearly, the religious experience of church-goers would naturally be enhanced. Thanks to a \$50,000 donation to the church by a member of the congregation in memory of his wife, the new lighting system not only calls attention to the beautiful decorative detailing, but provides additional overall indirect ambient illumination over the pews. (The lighting is one part of an ongoing \$2.2 million major restoration of the church, which includes repointing the exterior stone work, repairing the bell tower and stained glass and rebuilding the organ, among other upgrades.)

CROSS ILLUMINATION

At the base of a series of clerestory windows, the lighting designer discreetly installed upright fixtures with paracylindrical reflectors, which evenly and softly project the light of 500W halogen sources across the ceiling, washing it with a warm glow. These fixtures were aimed to project the light across the nave to illuminate the opposite side of the ceiling in a crisscross pattern that eliminates as much back spill as necessary. They were also adjusted to project all of the light above the 90-degree glare zone with the main thrust of light at 120 degrees, according to Crowell. "A smaller version of this fixture is mounted on the capitals of the columns and aimed at the ceiling of the side aisles," said the lighting designer, who chose the fixture for the optics of its reflector and the 100W halogen source for its small size, since the fixture had to remain exposed. These fixtures add glare-free light

OPPOSITE: AT THE BASE OF A SERIES OF CLERESTORY WINDOWS, UPLIGHT FIXTURES WITH PARACYLINDRICAL REFLECTORS EVENLY AND SOFTLY PROJECT THE LIGHT OF 500W HALOGEN SOURCES ACROSS THE CEILING, WASHING IT WITH A WARM GLOW. SMALLER VERSIONS OF THE SAME FIXTURES USED TO LIGHT THE NAVE FIXTURES ADD GLARE-FREE LIGHT TO THE SIDE AISLES AND LEND VISUAL IMPACT TO THE MULTI-TONED BRICK OF THE INTERIOR SIDE WALLS. NEW CYLINDRICAL DOWNLIGHTS FITTED WITH 150W PAR38 SOURCES ARE MOUNTED AT THE APEX OF THE ARCHES. THESE FIXTURES, IN ADDITION TO THE LIGHT FROM THE ORIGINAL PENDANT LANTERNS, PROVIDE MORE DOWNLIGHT TO THE SIDE-AISLE PEWS.

to the side aisles and lend visual impact to the multi-toned brick of the interior side walls. New cylindrical downlights fitted with 150W PAR38 sources were mounted at the apex of the arches. These fixtures, in addition to the light from the original pendant lanterns, provide more downlight to the side-aisle pews.

The pitched, stenciled ceiling of the chancel is also illuminated with the same 500W halogen sources lighting the nave, while 150W PAR 38 halogen spots behind and in front of the rood screen provide accent light for the pulpit, choir and altar. "Basically, a combination of accent, task and ambient illumination makes it a successful strategy," said Crowell. "It's a really simple yet effective plan."

DETAILS

- PROJECT The Church of the Redeemer
- LOCATION Bryn Mawr, PA
- PROJECT ARCHITECT Richard Wesley, AIA
- LIGHTING DESIGNER James L. Crowell, IESNA, AIA affiliate
- ELECTRICAL CONTRACTOR Wm. L. Hornung & Sons, Inc.
- PHOTOGRAPHERS Barry Halkin; Roger J. Ritchie
- LIGHTING MANUFACTURER Rambusch

St. Philip the Apostle

Ever since the early 1960s, when Pope John XXIII called together Roman Catholic Bishops as well as theologians of every faith at the council of Vatican II to take a fresh look at the Catholic religion, the Church isn't what it used to be.

And in St. Philip the Apostle, a new church in Lewisville, TX, the lighting reflects this change. The parish pastor, Jonathon Scalone, put it this way: "Before Vatican II, people were seen as sinful, in darkness; post Vatican II, we are people of the light. Metaphorically, Christ identified himself with light, and if we extend the metaphor in the New Age, the lighting system in church is a sacramental system—it enhances and facilitates the spiritual experience."

This reaction to the light in the church is what Barbara Chenicek and Rita Schiltz are likely to have hoped for. Both women worked as the interior designers on the church, and both are nuns. As a result, not only are they keenly aware of the rituals that take place within a Catholic church, but they worked passionately to establish a lighting system that would reinforce the rituals of the Sunday liturgy as well as reflect the range of life experiences that take place in the church—from the joy of a baptism to the blessing of a marriage to the somberness of a funeral. "Light to us, short of the structure and volume, is everything," said the designers. "We really wanted light to breathe throughout the space."

Working closely with Gary Steffy, LC, FIALD, IES and Gary Woodall, LC, IALD, IES of Gary Steffy Lighting Design, the interior designers aimed to give the light "a living quality," according to Chenicek. In developing the lighting strategy, the lighting and interior designers collaborated with architect Jim Bransford to create a lighting system that would make the new voluminous structure (the church accommodates 900 people) feel intimate, personal and warm. Part of the solution involved integrating a series of compact fluores-

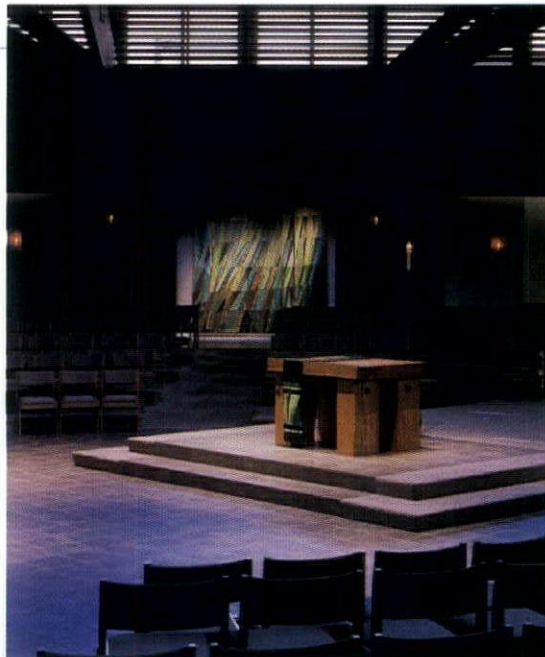

cent and incandescent sources to provide ambient illumination and accent the church's natural, warm-toned materials. Another aspect of the strategy involved integrating carefully controlled daylight into the space. "Daylighting was seen as a key component to the success of the facility," said Steffy. "For us, it is just like any other light source and requires significant and careful control. Our first charge was to help the architect and interior designers work out clerestory and skylight details in the worship space that create a connection with the outdoors without introducing glaring light."

After the design team studied the angles of the sun at all times of the day and throughout the course of the year, they chose to install a fixed grillwork louver system to surround the square-shaped worship space, allowing small slivers of natural light to peel into the space without causing glare in the seating areas that encircle the altar. Once the daylight

ABOVE: IN A RECESSED NICHE, A LITURGICAL TAPESTRY IS WASHED WITH DAYLIGHT THROUGH A CLERESTORY, WHILE IN THE EVENING, FLUORESCENT STRIPS PROVIDE A UNIFORM WASH AND INCANDESCENT TRACKLIGHTS CREATE THE SENSE OF SHAFTS OF SUNLIGHT.

LEFT: LINEAR FLUORESCENTS IN STREAMLINED HOUSINGS COMPLEMENT THE LINES OF THE ARCHITECTURE, WHILE PROVIDING LAYERS OF AMBIENT LIGHT TO THE WORSHIP SPACE. CONNECTED TO PRESET DIMMERS, THEY ARE SWITCHED ON OR OFF TO CONTRIBUTE TO THE SENSE OF RITUAL DURING MASS. THEATRICAL FIXTURES MOUNTED WITHIN THE SKYLIGHT CAVITY OVERHEAD GRAZE THE ALTAR WITH FOCUSED LIGHT.



PHOTOGRAPHY: HEDRICH/BLESSING—GARY QUESADA

issue was resolved, the lighting designers looked at how to address the electric lighting requirements. In order to respect the strong lines of the worship space, which soars upward 55 ft. to an apex of light, the designers introduced 40W linear compact fluorescent sources in streamlined fixtures with thin profiles, arranging them in concentric octagonal rings around the central skylight to echo the pattern of the architectural elements and follow the curvature of the structural beams. The sources offer both up- and downlight to produce a maximum of 20 fc, providing sufficient ambient illumination for reading, when necessary, without resorting to energy-intensive, short-lived incandescents. They are also connected to a preset dimming system, which turns off certain fixtures and dims others during different parts of the ceremonial sequence to create various moods.

BUILDING A MYSTERY

"The interior designers are firm believers in the mystery of light," said Steffy, "so we set up a visual hierarchy, or drama, with light." Part of this drama includes light from 240W PAR56 low-voltage theatrical fixtures mounted on pipes around the skylight, which accent the altar, lectern and celebrant's chair. Axes bisect the worship space and lead to four significant liturgical focal points: a font, an ambry, a liturgical tapestry and a reservation chapel. Each is illuminated with a different configuration of light.

In an enclosed garden gathering area outside the worship space, a two-part lighting system was employed. The first part consists of linear fluorescents mounted on a bulkhead above the grillwork to provide a soft glow, metal halide PAR38 tracklights that pick out special features during a typical day, and 50W infrared PAR30 lamps that highlight yet more focal points during special occasions, such as a wedding. The other part includes 1,000W metal halides, which highlight plants and give them sufficient illumination—200 fc—to live in the enclosed area. In addition, a "sacred column," a unique element of the garden space, is highlighted from above by a series of halogen PAR30 infrared lamps.

Father Scalone points out that the youthful congregation values the subtleties of the lighting system in the new church, but notes that those most struck by the light are visitors. "Awe is the word that comes to mind," he said. "It's not like the sense of wonder you get from the Grand Canyon, it's more an appreciation of a touch of the transcendent that the lighting brings to mind. People's eyes open when the light sequence changes and they are clearly aware of the mood it creates in them." ■

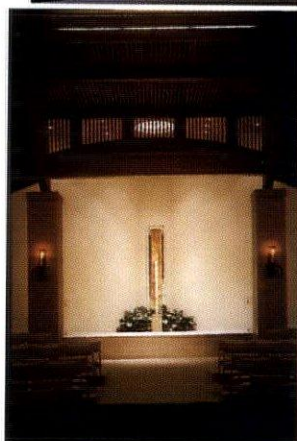
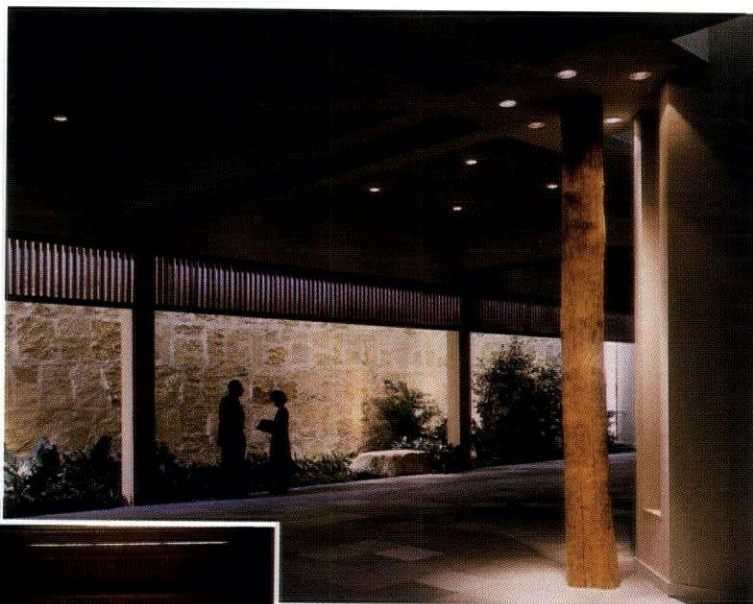

ABOVE: IN AN ENCLOSED GARDEN, LINEAR FLUORESCENT FIXTURES ABOVE THE GRILLWORK PROVIDE A SOFT UNIFORM WASH. INCANDESCENT AND METAL HALIDE PAR LAMPS ADD HIGHLIGHTS. A SEPARATE METAL HALIDE SYSTEM IS USED AT NIGHT TO MAINTAIN THE PLANTS.

LEFT: COLUMNS SUPPORTING CANDLE SCONCES FRAME THE FONT AT THE END OF ONE OF THE

AXES EXTENDING FROM THE WORSHIP AREA. HALOGEN INFRARED PAR30 INCANDESCENT LAMPS IN RECESSED ADJUSTABLE FIXTURES AND A COLD CATHODE COVE IN THE SKYLIGHT WELL HIGHLIGHT THE FONT.

DETAILS

- **PROJECT** St. Philip the Apostle Catholic Church
- **LOCATION** Lewisville, TX
- **ARCHITECT** Jim Bransford, AIA
- **INTERIOR DESIGNER** INAI Studio—Barbara Chenicek, OP, Rita Schiltz, OP
- **LIGHTING DESIGNER** Gary Steffy Lighting Design—Gary Steffy, LC, FIALD, IES, Gary Woodall, LC, IALD, IES
- **INTERIOR LANDSCAPE DESIGNER** Oliver Windham
- **STRUCTURAL ENGINEER** R.L. Woods
- **MECHANICAL/ELECTRICAL ENGINEER** Wells Doak
- **GENERAL CONTRACTOR** W.B. Kibler
- **PHOTOGRAPHER** Hedrich/Blessing—Gary Quesada
- **LIGHTING MANUFACTURERS** Peerless Lighting (direct/indirect fluorescent pendants); Litelab (track lighting and channels for accent lighting); Lithonia (fluorescent strips for skylight wells and clerestory windows); Prescolite (recessed downlights and accents); Indy Lighting (metal halide monopoint accents and semi-recessed accents); EMCO, Linear Lighting (interior garden lighting)

Mission Statement

LIGHTING DESIGNER LESLEY WHEEL ADDRESSES THE STATE OF THE UNION,
ADDING DRAMA TO THIS HISTORIC TRAIN STATION



BY ALICE LIAO, ASSISTANT EDITOR

At the heart of a 51-acre development in Los Angeles' Alameda district, the newly lighted Union Station sets a glowing example difficult to match. "The Catellus Corporation wants to use the beauty of Union Station as a flagship to set the caliber of the development," explained lighting designer Lesley Wheel, FIALD, WGS Lighting Design Inc. "I wanted to create something that impacts the consciousness and causes one to say 'Wow!'"

Built in 1939, the station boasts a blend of California Mission Revival architecture and Art Deco flourishes with touches of motley influences added throughout its history. Wheel, who recently received the first IALD Lifetime Achievement Award, worked with the design team to create a look that would tie the disparate elements together. "We basically had two styles in direct opposition to each other, which the graphic designers and architect had to reconcile." Her contribution: drama and *trompe l'oeil*.

To draw attention to the building, sodium vapor floodlights equipped with barn doors for beam spread control bathe the front facade in amber light. Blue filament metal halide floodlamps with glass filters light the sides and back of the building in a vibrant blue. The designers chose the colors for their resonance when juxtaposed and for their allusions to the sun and night sky.

"The most difficult part in lighting the exterior was keeping the blue and amber from overlapping," said Wheel. Four mockups were conducted to test location and to find the perfect hue. Before installation, each fixture was positioned, tested and focused. Remarkably, "We knew before the fixtures were turned on that they were doing the job intended for them." Precise fixture positioning and aiming create color consistency on the four sides of the clock tower, which is lighted from various distances and heights. Fluorescent sources illuminate the uppermost portion of the tower; metal halide PAR20s accent its corners.

In the front courtyard, WGS's solution provides sufficient general lighting for the pedestrian areas while keeping the visual focus on the main building. Unobtrusive accent lights lamped with PAR20 metal halide sources are mounted on palm trees and aimed downward to illuminate the station's walkways and driveways; at the base of the trees, PAR20 spotlights uplight the crowns. "With the original installation, the whole courtyard looked like a parking lot," said Wheel. "We wanted to minimize the courtyard lighting so that the illuminated station would dominate." To reduce glare in the parking area, Wheel replaced the existing bell-shaped lights with fixtures of similar appearance but different optics. Existing Art Deco "tulip" post uplights,



OPPOSITE: SODIUM VAPOR FLOODLIGHTS BATHE THE FRONT FACADE IN AN AMBER LIGHT. THE WARMER TONES RESONATE AGAINST THE COOL HUES OF BLUE FILAMENT METAL HALIDE SOURCES. INSIDE THE MAIN WAITING ROOM (ABOVE), SPOTLIGHTS ILLUMINATE THE WINDOWS AND UPLIGHT THE CEILING TO BRIGHTEN THE SPACE.

refurbished and refitted with compact fluorescent lamps, and a redesigned landscape further minimize the presence of the parking area.

Drama and "magic" also play a part in brightening the station's main waiting room. Reluctant to penetrate the painted wood ceiling and unable to work with the existing chandeliers, Wheel electrified the windows, adding punch to the space. "The chandeliers were converted at some point from incandescent to compact fluorescent, which explains the dimness of the space," remarked Wheel. "Rather than rewire, I decided to add an interesting element that would draw attention away from the general lighting." The lighting solution places spotlights in the bottom corners of each window to illuminate its vertical sides; a third spotlight is concealed in the center of the window sill to uplight the ceiling. To uplight the barrel vault connecting the main waiting room, a T5 tube is hidden behind a grille mounted above the decorative side walls. According to Wheel, while installing downlights would have increased light levels by 10-20 fc, the effect achieved would have been less dramatic and less energy-efficient. "It's slight of hand, like watching a magician," said Wheel. "It's not nearly as effective if you're conscious of where the instruments are." ■

DETAILS

- **PROJECT** Union Station
- **LOCATION** Los Angeles
- **OWNER** Catellus Corporation
- **ARCHITECT** Rogerio Carvalheiro
- **LIGHTING DESIGNER** WGS Lighting Design Inc.—
Lesley Wheel, FIALD and Lauren MacLeod
- **ELECTRICAL CONTRACTOR** Morrow Meadows
- **PHOTOGRAPHERS** Gil Edelstein Photography; David C. Karp, Lumiere Design & Mfg.
- **LIGHTING MANUFACTURERS** Lumiere Design & Mfg.; Orgatech Omegalux; Philips Lighting

Hoop Dream

THE DELICATE INTERPLAY OF CONTROLS AND LIGHTING
GIVES THIS BASKETBALL LEGEND WHAT HE WANTS—A HOUSE
WITH A DEFINITE HOME COURT ADVANTAGE

BY ALICE LIAO, ASSISTANT EDITOR

“As a lighting designer, you have to understand that with a residential client base, a lot more changes occur,” said lighting designer John Bos. “Owners don’t look at a set of two-dimensional documents and visualize a three-dimensional space, especially a space then sculpted by various lighting effects. For them, it’s a process of discovery.”

Although lighting the 6,000-sq.-ft. addition to Hakeem Olajuwon’s house was Bos’ second encounter with the Houston Rockets basketball star—Bos designed the lighting for the original house—the designer anticipates further adjustments now that Olajuwon has settled into his new quarters. Bos said, “Once he sees how the house operates for six to eight months, we’ll go back in and re-do a lot of the dimming scenes, so that they conform to what he knows he wants.”

A marriage of glass facades and sensitive lighting creates a sense of open, fluid space in the

“I am so pleased with the [controls] system ... it brings to consciousness that lighting sets the mood for the whole home.”

—Hakeem Olajuwon

Olajuwon residence. In the living room, windows span the length of the room on both sides and invite occupants to experience the exterior gardens and fountains as part of the interior living space. According to Bos, “The project was interesting because of the height of the ceilings and the transparency of the walls in the house.” Ceiling heights in the house range from 12 ft. to 16 ft. Bos added, “We really wanted to keep the space as tall as possible, because of Olajuwon’s height.”

Maintaining the clarity of the glass in the evening presented the biggest design challenge. “To keep the glass clear, we lighted the exterior to augment the light inside the house, which was unusual,” said Bos. Outside, in the back of the house, uplights mounted on columns illuminate the ceiling of an arcade to reduce the glare from inside. In the garden and fountain area at the front of the house, palm trees are accented by uplights placed at their base, and a wall is washed with light to minimize reflections. Blue light from mercury vapor sources mounted on trees eases the transition from the porch area to the yard, while simple sconces and step-lights inspired by the work of Mexican architect Legorreta add decorative touches to the exterior of the residence.

The openness of the living room is punctuated by curtains transformed into columns of light. To create the effect, downlights lamped with AR111 lamps and fitted with linear and diffusing lenses were recessed in the ceiling and directed at the curtains. House spots with AR111s provide



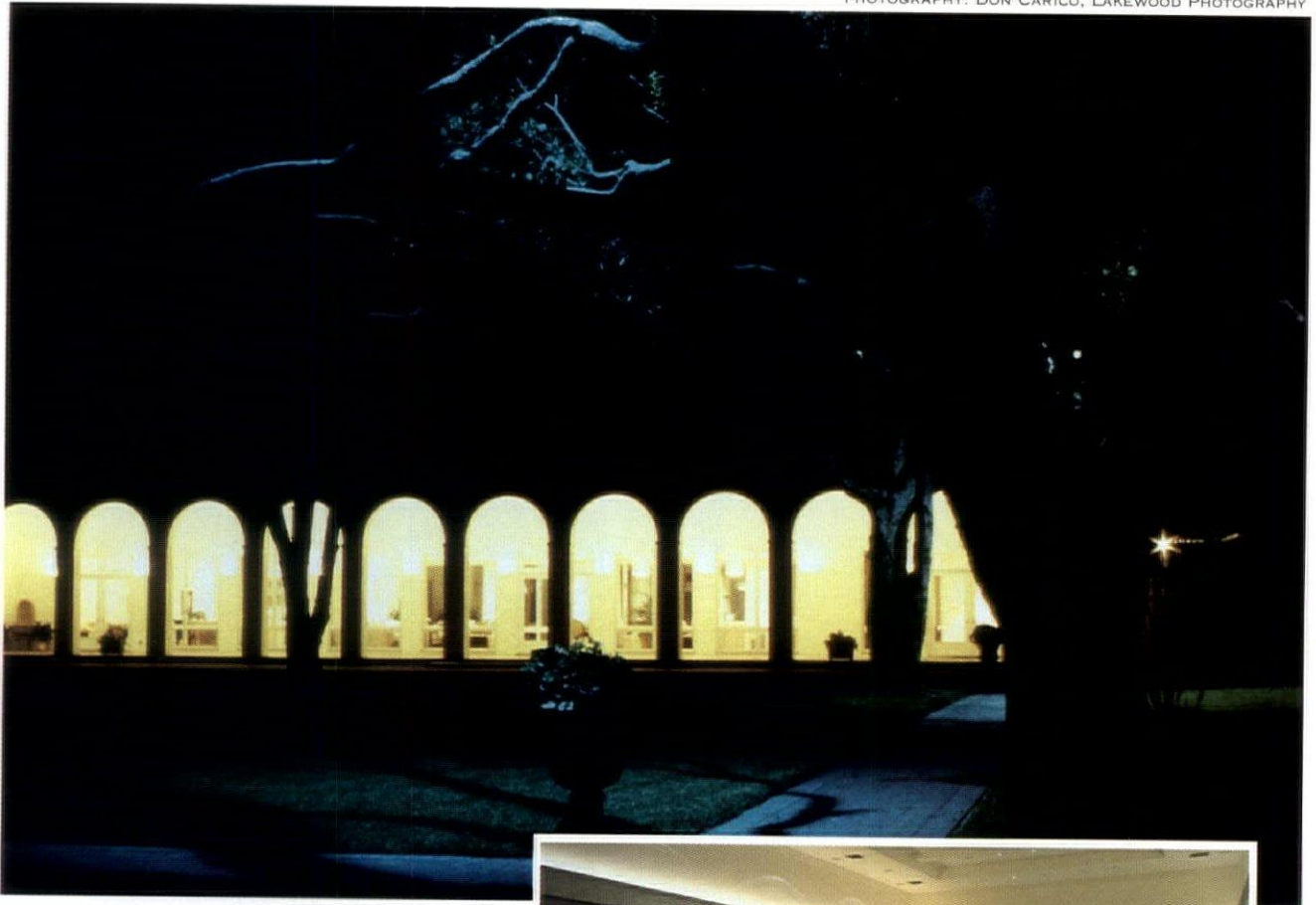

MERCURY VAPOR SOURCES MOUNTED IN TREES WASH THE GROUNDS IN BLUE LIGHT; DECORATIVE SCUNCES AND STEPLIGHTS ACCENT AN EXTERIOR CORRIDOR. A PROGRAMMED TIMER SHIFTS INTERIOR AND LANDSCAPE LIGHTING TO ENSURE THE CLARITY OF THE GLASS WALLS THROUGHOUT THE DAY AND PROTECT THE OPEN FLUIDITY OF THE ARCHITECTURAL DESIGN.

general illumination for the living room and throughout the house. AR111 sources also highlight the artwork on the walls. Above the curtains, incandescent cove-lighting uplights the ceiling in the living room. "We suggested cove-lighting with the addition because once again, the ceilings are so tall, that not to light them would have left a lot of gloominess up above him," said Bos. Reflectors on the AR111 lamp add further interest to the space by producing a scalloping effect on the living room walls.

Performing dual roles, a centralized dimming system balances the interior and exterior light throughout the day to maintain the transparency of the windows and enhance the security of the residence. After dark, controls dim the lights on the curtains, allowing the columns of light to function as Olajuwon's night light; outside, landscape lighting, programmed on a timer, illuminates the surrounding yard and interior courtyard, providing aesthetic accents as well as added secu-

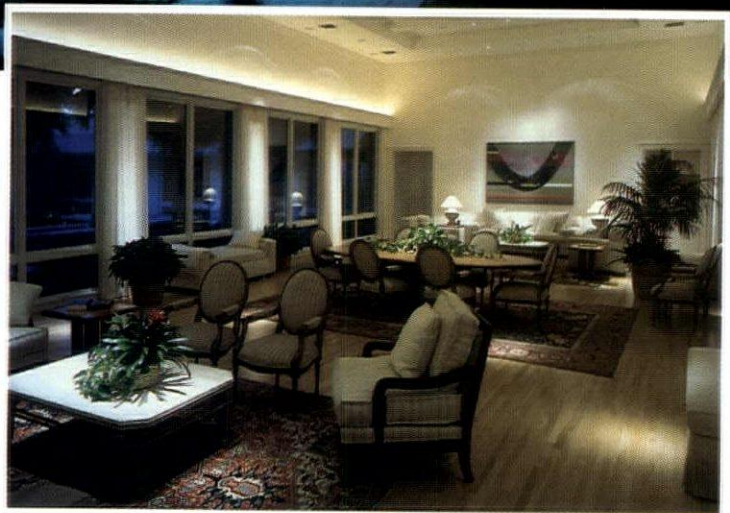

urity. According to Bos, the system also allows him to fine-tune the lighting without re-wiring. He remarked, "One of the big advantages of dimming systems is being able to offer clients—relatively painlessly—the option to change their minds." ■

DETAILS

- **PROJECT** Private Residence
- **OWNER** Hakeem Olajuwon
- **LOCATION** Houston, TX
- **ARCHITECT** Bill Cannady—Willis, Bricker, Cannady Architects, Inc.
- **LIGHTING DESIGNER** John Bos, Bos Lighting Design
- **PHOTOGRAPHER** Don Carico, Lakewood Photography
- **LIGHTING MANUFACTURERS** LiteTouch; Halo Architectural; Belfer Lighting; Bega; Lithonia/Hydrel

Twin Peaks

SLIM AND SLEEKLY STYLISH—THE PERFECT TWIN SET

BY CHRISTINA TRAUTHWEIN, EDITOR-IN-CHIEF

When referring to the “Twin Towers,” one usually thinks of the World Trade Center in New York City. However, there’s another famous set of twins out there, half-way around the globe: Petronas Towers in Kuala Lumpur, currently the tallest buildings in the world. The statuesque, spiral-like office towers, named for the state-owned national oil company, are situated in close proximity—less than 50 meters apart—and, in fact, are joined by a bridge some 40 stories above ground. The narrow and graceful stature of this modern-day architectural landmark, when dramatically illuminated, creates an elegant silhouette against Malaysia’s nighttime sky.

“Architect Cesar Pelli envisioned his building as being a lighted beacon, visible from all points surrounding the city,” said lighting designer Scott Matthews, H.M. Brandston & Partners. “On a clear day in the often hazy tropical atmosphere of Kuala Lumpur, Petronas Towers shimmers, as the sunlight is reflected off the patterned stainless steel and glass exterior,” said Matthews. “The idea was to give the structure an equally luminous quality at night.”

“The towers were designed in a competition,” explained Pelli, “which is quite a different process from sitting down with a client and proposing alternatives.” The basic architectural intention was complete from the beginning, lacking many refinements and changes. “The goal for us, as well as the client, was to create a great symbol for the city and for the country,” said Pelli. As Matthews explained, both the people of Malaysia and this 452-meter-tall architectural symbol are glowing with national pride. “The building has purpose: It represents the country’s newly emerging economy and role as a sophisticated culture. The people of Kuala Lumpur are extremely proud of their accomplishments and see Petronas Towers as evidence of their social advancement and future aspirations.”

INNER SPACE

While the design intent was to create a unique nighttime identity for this structural showpiece, achieving this goal was no easy feat. Though the reflective surfaces add sparkle to the building during daylight hours, the same surfaces proved a challenge to nighttime illumination. “When you direct light upwards at a reflective surface, most of it is reflected upwards to the night sky rather than down toward viewers on the

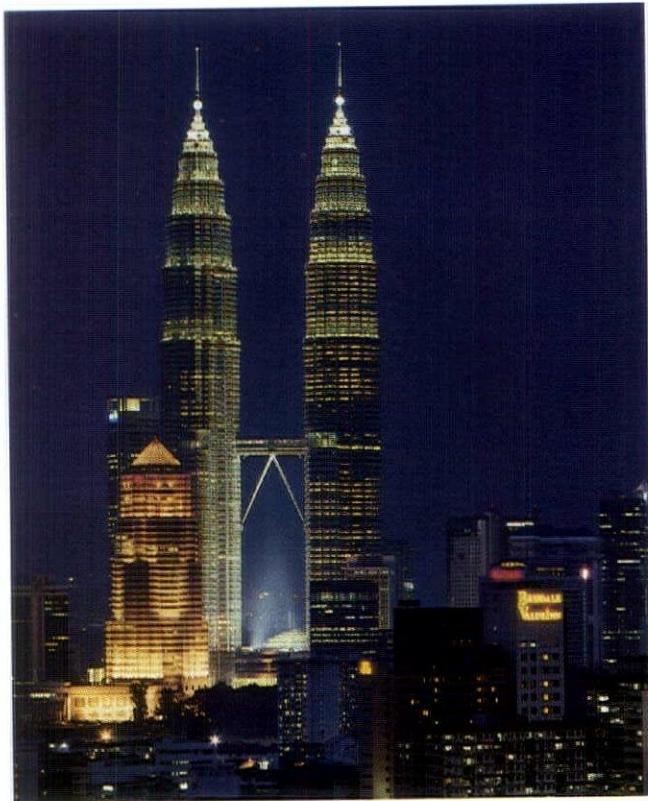

ground,” said Matthews. Add to this the difficulty of equipping a building of this scale with light fixtures, and “technically, it’s very difficult to pull off,” said Matthews, who chose floodlighting as the solution.

According to Matthews, the primary goal was to sufficiently light the surfaces of the building so that it would become the beacon envisioned by the architect and expected by the people—and to do so in a dynamic and intriguing manner. The result? Matthews developed a conceptually simple scheme to light the slot between the two towers. “Lighting the inner surfaces of the towers’ shafts and forming a channel of brightness create the visual impression of great height, reinforce and emphasize the spatial tension between the two towers, accentuate the slot itself and clearly express the structure’s unusual form,” said Matthews.

“The towers are not abstractions like the World Trade Center,” said Pelli, “but are recognizable symmetrical forms. Between them, a very distinct void is created and, for me, the power of that void is what transforms this pair of towers from just two tall buildings into a strong, iconic symbol.”

Typically, if a particularly tall symmetrical building is lighted on one side only, a huge imbalance is created. But for Pelli, lighting the space was more important than lighting the

towers as volumes. "What matters is that the form in the void is balanced and accentuated and reads beautifully at night," said Pelli.

SQUARE DEAL

Petronas Towers, anchoring an ambitious redevelopment of a colonial-era race-course in central Kuala Lumpur, sits atop a five-level retail mall complex, a world-class concert hall and acres of landscaped gardens. Six arrays of floodlights on the podium roof and two more on top of the 42nd-floor skybridge were required to carry the illumination up to the pinnacle of the towers. "The bridge not only connects the buildings, but more importantly, it creates a portal to the sky," said Pelli. "The form helps to create a powerful sense of a huge, well-defined space, like a great door to infinity. Lighting is instrumental in accentuating this characteristic, giving form and presence to that space in the night sky." All floodlighting fixtures house metal halide lamps, ranging from 70W to 150W to 400W; the long-range projectors use 1800W sources.

The five setbacks above the skybridge are highlighted by uplights mounted at the apex of each of their 16 corners, which relate to the 16 points of a star. Each pinnacle and spire receive the light of more than 100 floodlights mounted on its five tiers; in fact, there are more than 250 fixtures lighting each tower. The form of the towers actually derives from Islamic iconography. "In Islam, art is not based on human images—which would be considered idolatrous—but rather on a rich tradition of pattern," said Matthews. "Islamic architecture involves complicated and complex interlocking patterns, in this case, a motif of points and circles."

Said Pelli, "In the design competition for this building we had presented a 12-point star, which was well-received by all involved, particularly the Prime Minister. He did discreetly comment to us, however, that this particular shape, although often overused in Islamic design, is not as strong a form." Pelli then researched Islamic designs, and indeed, occasionally found some 12-point stars but discovered the most common underlay for Islamic design were those with eight points—two interlocking squares. "This basic shape evolves into highly elaborate, complex forms called arabesques," explained Pelli. "Each square is said to be symbolic—for example, the four cardinal directions. For me, the two squares represent heaven and earth interlocked." He added, "The people of Malaysia are keenly aware of the geometry of architecture and, as a guest to



PHOTOGRAPHY: ©JEFF GOLDBERG/ESTO

OPPOSITE: PETRONAS TOWERS GLOWS AGAINST THE NIGHT SKY THANKS TO THE HUNDREDS OF FLOODLIGHTS THAT ILLUMINATE ITS EXTERIOR, AND GLOWS FROM WITHIN (ABOVE) WITH THOUSANDS OF CAREFULLY INTEGRATED LIGHT SOURCES.

their country, it was important for us to make the effort to connect with and show a respect for their culture." The forms are continually expressed to the tops of the towers. Lighting allows them to become richer against the sky.

A 12-ft.-diameter "ball," formed by concentric round stainless steel tubes, anchors each spire. The spheres glow from within from eight 400W floodlights. For added punch, a 5-ft.-diameter "ball" atop each spire is lighted by 16 1800W very narrow floods; the brightness is so intense that it appears to be a lamp itself, rather than the brushed stainless steel sphere it actually is. "All the vertical illumination creates a plume of light that extends above the two towers at night," said Matthews. "When the light hits the clouds, a dramatic effect is produced."

Maintenance and relamping are obviously a bit challenging because of the sheer magnitude of the building. But while necessarily complicated, it is doable. "At the top of each building, directly under the spire, there's a crane-like window-washing device," said Matthews. "Doors in the side of the building open to permit a car to drop the length of the building, enabling maintenance personnel to access all surfaces below, including the floodlights." For fixtures placed at spire level, trained crews can access fixtures via hatches.

WORKING IN CONCERT

"On the interior of the building, the intent was to showcase Malaysian products, patterns and designs," said Matthews. "Many of the furnishings and textures speak to the native craft in either Malaysia or Muslim countries." The towers have identical conventional lobbies that are illuminated by standard incandescent and quartz halogen sources and custom glass and stainless steel pendants.



"THERE WAS A STRONG MOVE AFOOT TO USE LOCAL CRAFTSMAN TO CONSTRUCT THIS BUILDING, BUT IN REALITY, THE STRUCTURE IS SO COMPLEX THAT A SIGNIFICANT AMOUNT OF ITS SOPHISTICATED MATERIALS HAD TO BE IMPORTED," EXPLAINED MATTHEWS. "SO WE TURNED TO A U.S. MANUFACTURER TO CRAFT THE TREMENDOUS PIECES." THESE CUSTOM FIXTURES (LEFT) HOUSE A TOTAL OF 20,000 LAMPS.

Between the two towers is an intimate 863-seat concert hall, which serves as a visual centerpiece to the project. A monumental glass-fronted lobby is the formal entrance to the concert hall. The major feature of this 65-ft.-high space is a group of three custom chandeliers—what Pelli terms "stalactites of light"—which support several tons of laminated industrial patterned glass from bundles of stainless steel tubes of varying diameters. Several thousand 20W quartz halogen capsules, which illuminate the glass, are relamped by pulling their articulated strains of lampholders up through the fixture into the interstitial space above the ceiling. More sculptural forms than "chandeliers," they add elegance and character to the voluminous lobby and create a sense of grand festivity as people enter the theater.

The concert hall has a jewel-box-like appearance, as it glows from within. "It is hoped that world-class orchestras will be attracted to this site to record," noted Matthews, "so the theater was designed with a fairly sophisticated infrastructure for TV, sound recording, etc." This, in turn, created great demands on the architectural and the technical side: superb acoustics, good sight lines and a perfectly reverberant chamber.

"The intent for the concert hall was to make it comfortable, almost residential in feel," said Matthews. "As a result of its size, it was especially important to emphasize its warmth—there's no room for complicated custom fixtures; rather, the lighting is entirely integrated with the architecture." Matthews added, "Cesar's intent was that the architectural surfaces and the decoration in the ceiling do most of the work of inviting the eye. The light just illuminates all those surfaces."

The lower leading edge of each balcony features a row of light "dots"—a light fixture that consists of a custom bronze housing with little festoon lamps inside, glass lenses and reflectors to make it sparkle and glow at the same time.

The walls are lighted at every level with con-

cealed wall washers. Surrounding the space are open grilles and behind them is what appears to be glowing red fabric. There are actually lights inside the space between the grille and the red fabric that illuminate the cavity. "The hall can be tuned," said Matthews. "They have movable acoustic panels in each cavity. By adjusting the panels, the reverberation time in the room can expand or contract, depending on what kind of music is being played. This feature is illuminated."

The ceiling is a field of fiber-optic twinkle lights. "There are 88 fiber-optic illuminators above the ceiling which pump light into more than 3,000 lenses that are in the grid pattern in the ceiling," explained Matthews. Central to the ceiling is a circular form that houses numerous 20W lamps to provide illumination. "It's a modern interpretation of a chandelier," said Pelli.

"There are literally thousands of light sources in the hall, but they're all small and architectural in nature," said Matthews. "They either grow out of the architectural surface or are integrated into the architectural pattern, so they're not intended to be visible as custom light fixtures." In fact, there are actually only two custom light fixtures in the hall: two lighted cylindrical pylons that flank the box for the Prime Minister. "Using a multitude of light sources, rather than several large chandeliers, creates soft light from many directions—not unlike the effect created by an abundance of candles, which was typical of older European opera houses/concert halls," said Matthews.

"This space was a bit tricky to design," said Pelli, "because we wanted to achieve two opposite goals—to be grand yet intimate. The lighting solution was critical in creating the cohesion we desired."

The lighting design for Petronas Towers recently received a Lumen Award of Merit from the New York section of the IESNA. ■

DETAILS

- **PROJECT** Petronas Towers
- **LOCATION** Kuala Lumpur, Malaysia
- **OWNER** Kuala Lumpur City Centre Holdings Sendirian Berhad
- **ARCHITECT** Cesar Pelli & Associates Inc.
- **LIGHTING DESIGNER** H.M. Brandston & Partners, Inc.—Howard Brandston, Scott Matthews, Chou Lien, Jung Soo Kim
- **PHOTOGRAPHER** ©Jeff Goldberg/Esto
- **LIGHTING MANUFACTURERS** Erco (downlights); Philips (floodlights); Baldinger (custom fixtures); Starfire Lighting, Inc. (fiber optics); Bega, Thorn Lighting, Poulsen Lighting (exterior fixtures)

8* - 13 November 1999,
BATIMAT building for success
 a new format with 4 dynamic sectors.

* 8 November is a Pre-Opening Day reserved for press and upon invitation only

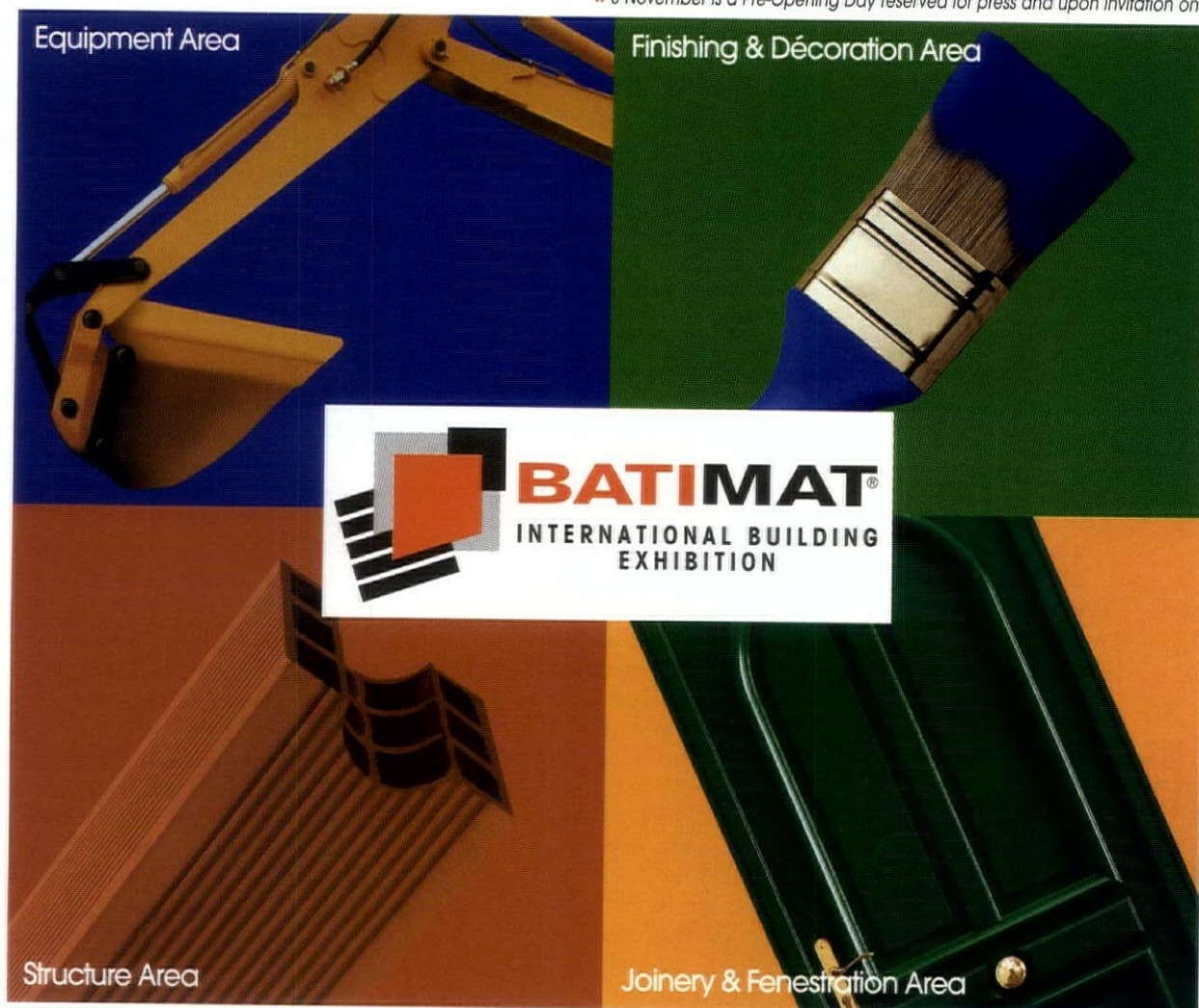

Batimat '99 will be divided into 4 main sections dedicated to your activities, to make the exhibition more efficient and visitor-friendly. Four specialist areas, plus a section devoted to IT and telecommunications solutions - that is the latest initiative by Batimat, the showcase for innovation and the key international meeting place for the construction industry.

Paris expo-Porte de Versailles - Paris - France

Visitors Information : Call toll free: (888) 522 5001 - E-mail: expos@promosalons.com

PROMOSALONS - French American Chamber of Commerce - Suite 940, The Merchandise Mart - Chicago, IL, 60654 - Fax: 00/1 312 595 9529

Exhibitors Information : Laurent Waessa - E-mail: lwaessa@mfi.com

Miller Freeman Inc - 11th floor - One Penn Plaza, New York - NY 10119 - Tel (212) 615 29 25 - Fax: (212) 643 48 03

www.batimat.com - E-mail : info@batimat.com



I would like to visit the exhibition and requestpre-registration card(s)

AL-USA

Name : Surname :

Position : Company :

Activity : Address :

Return the coupon to:

• By post to **BATIMAT**
 MILLER FREEMAN - 70, rue Rivay
 F 92532 Levallois-Perret Cedex
 France

• By fax to +331 47 32 00 00

Postcode : City : Country :

Tel: Fax: E-mail :



Miller Freeman
 A United News & Media company

LIGHTNING IN A TUBE—A PRIMER ON HIGH VOLTAGE TUBING

BY FRED OBERKIRCHER, LC, IESNA, IALD

Your first impression upon entering the main circulation area is the columns that read as either flowers or lollipops. After a few moments, you become aware that the colors of the column capitals are changing in a slow rainbow wave. Then you notice that the column capitals are changing in sync with the column capitals. Welcome to the remarkable integration of light, space and color that was created by the late Craig Roeder for Le Bonheur Children's Medical Center (see photos). Color as a basic philosophical element in health and healing. Color created by passing man-made lightning through a glass tube filled with an inert gas and coated with phosphors. The common term is "neon." The correct term is "High-Voltage Tubing" (HVT). The result, by any term, is magical.

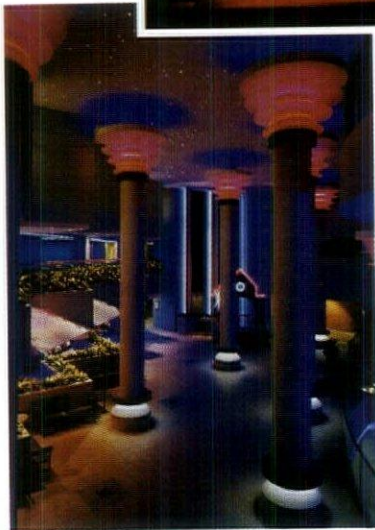
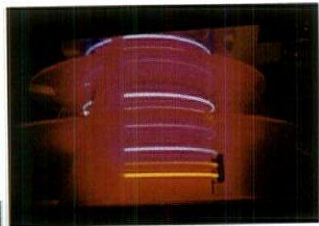

The stigma may be that of outlining letters for a nighttime sign or the glare of Las Vegas, but HVT also has the capability, through color and line, of transforming space more completely than its other light source cousins. In fact, most applications of HVT use white as the color. Whether in a cove

to light a barrel-vaulted ceiling or to float a ceiling plane, or in a curved ceiling slot, HVT is often the source that is never seen but whose effects can help create a total spatial impression. If fluorescent is too bright—and dimming it is not a consideration—then an application for HVT may be appropriate.

To a large extent HVT is still a cottage industry. Mention the incandescent lamp and three leaders in the lamp industry immediately come to mind. Now try and name three manufacturers/suppliers/creators of HVT.

On the one hand, HVT can claim to be one of the last real art forms in the lighting industry. On the other, this lack of name identification has meant that many do not take it seriously as a legitimate form of illumination. Simple advertising signs represent this application. The sign is small, self contained and requires only that it be plugged into a standard residential outlet. If the application becomes more complex, the designer must combine information from three sources. The first is a clear understanding of what lighting goals are to be accomplished. The second is a thorough understanding of the codes involved—the National Electrical Code (NEC) has specific sections dedicated to the proper installation of HVT. And most importantly, the designer must determine the most appropriate manufacturer that will develop and construct the specific products to be used. Think of HVT in the same way as specifying custom lighting fixtures.

THE FACTS ABOUT HVT

During a late summer afternoon, there is an approaching thunder storm. Towering thunder heads produce immense amounts of static electricity as the clouds churn in violent air drafts. The charge continues to build until the potential is great enough to arch across the gap between the clouds and the earth. When the discharge occurs, the air is ionized in the flash known as lightning. HVT takes this principle and changes it only slightly. First the arc must be controlled and for this purpose, a tube is used. Note: Corning Glass and Sylvania are the only U.S. producers of tubing for the HVT industry.

Next, a vacuum is drawn to remove all of the gases, vapors and impurities from the tube. This process requires the use of sophisticated pumps that actually pump molecules. At the same time, a high-voltage, high-amperage transformer bombards and heats the remaining air. This degree of purity is one of the marks of a high-quality process. After a short cooling period, a small amount of an inert gas is introduced. The two gases typically used are neon, which produces a red-orange color, and argon (with mercury), which produces a dull blue color. Thus, clear tubing would permit only two color choices. To extend the

1683

Otto von Guericke obtains light from the discharge of a static electricity device.

1709

Francis Hawksbee produces light by shaking a vacuum tube filled with mercury.

1744

Johann Heinrich Winkler produces light in the same manner, but does it with a heat-bent tube formed in the shape of a name.

1856

Heinrich Geissler produces light in a sealed low-pressure tube utilizing high-voltage alternating current.

1862

Morris, Weare and Monckton are issued British patents for a process that produces colored light from Geissler tubes.

Architectural Lighting Magazine and NCQLP are pleased to announce a new recertification opportunity for LCs, Recertification Articles and Quizzes. LCs may earn 0.5 Lighting Education Units (LEUs) by reading the following article and correctly answering the quiz at the end of the article. After scoring, Architectural Lighting will send official notification of the LEUs earned to LCs. Look for additional NCQLP-approved Recertification Articles and Quizzes in future issues of Architectural Lighting. Responses to the quiz, including contact information, must be forwarded to Christina Trauthwein at Architectural Lighting, One Penn Plaza, New York, NY 10119; or fax to 212-279-3955.



color range, phosphors are used to coat the inside of the tube producing colors such as pink, turquoise and green. Additional colors may be achieved through the use of colored glass, which permits very deep reds, blues and greens. This glass is more expensive and is typically called "Euro Glass." Tubing comes in 4- and 8-ft. lengths but can be special ordered if necessary. The ends of a typical HVT tube are bent back to form the electrode (Figure 1). This facilitates the appearance of a smooth line of light from multiple units.

HVT comes in two diameters. The smaller size, 15mm (about 5/8 in.) is usually referred to as neon, owing to its historical association with the sign industry. The larger size, 25mm (about 1 in.) is quite close to the size of fluorescent tubes. To help differentiate the two types, it was explained that fluorescent tubes had to preheat their cathodes, either through a separate preheat circuit or continuously as in rapid start. HVT, on the other hand, provided voltage directly to the cathodes, thus the term "cold cathode." For either tube size, the process of producing light and color are identical. Light output is a function of color, tube diameter and amperage. As the tube size and the amperage go up, typically so do the lumen ratings (Figure 2, next page).

FIGURE 1

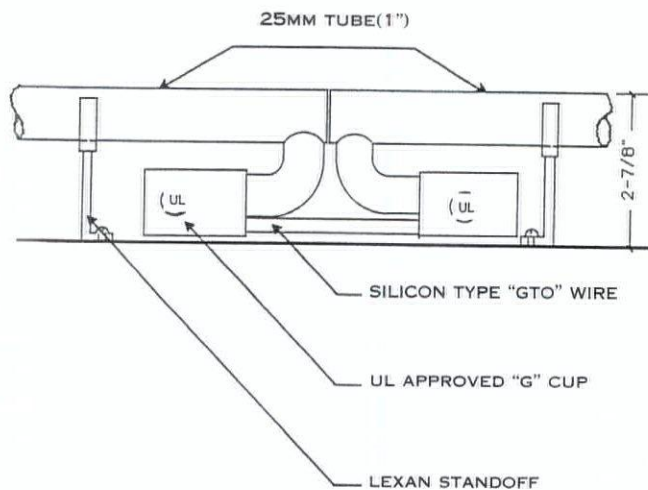

SETTING A PATTERN

Tubes of all diameters are hand-bent using a full-size pattern drawn either by hand or computer. This pattern is placed on a table where an artisan translates the pattern by heating the tube over various types of burners. Several standard types include:

Crossfire. Contains two heads, each with multiple burners, that face each other. The tubing is turned along its axis creating even heat around the tube.

Ribbon. Provides a long ribbon-like flame, useful for heating long lengths of tubing.

Hand Torch. Used for tapering the ends of a tube to install the electrodes.

Creating a two-dimensional product using a pattern requires a skilled craftsman. Creating a three-dimensional product for which there is no actual pattern requires an artist. Several schools still teach the art of bending glass tubing, but this remains one of the last real apprenticeship industries.

As the term High Voltage Tubing implies, this source utilizes voltages beyond normal household levels of 120-240V. Depending upon the total length of the tubing and its diameter, secondary voltages will range between 2,000 and 15,000V. While this number is extremely high, it must also be

remembered that actual current ranges from 30 to 120 mA (one thousand of an amp). Accounting for all of the losses within the HVT system, this still means that HVT is extremely energy efficient, as well as having a long operating life. Transformers are used to increase standard current (often called primary) up to the necessary level. Sizing an HVT system to determine the appropriate transformer size is conceptually the same as sizing a transformer for a low-voltage lighting system. The smallest electronic transformers are about the size of a cellular phone, while the largest are about the size of a shoe box.

(Continued on page 38)

1892

Nikola Tesla produces stunning colored lighting effects by bombarding gases with high-voltage alternating current in phosphor-coated tubes. The tubes spell the word "LIGHT."

1904

D. McFarland Moore finds a way to maintain the pressure in Geissler tubes.

1907

Georges Claude develops a cost effective method for producing rare gases—argon, neon, krypton and xenon.

1915

Claude receives a patent for developing an electrode that has high resistance to corrosion.

1919

European neon is characterized by the juxtaposition of red-orange letters against a green metal background.

1923

Earle Antony brings the Paris "couleur Opers"—a juxtaposition of orange and blue tubing—to Los Angeles, introducing the U.S. to the possibilities of this lighting medium.

FIGURE 2: LIGHT OUTPUT OF COLD CATHODE TUBING—LUMENS PER FOOT

COLOR	15MM		25MM	
	30mA	60mA	60mA	120mA
Green	210	380	300	580
Aqua	160	290	300	330
Warm White—3100K	180	340	220	430
Turquoise	170	310	170	295
Snow White—3500K	150	260		
Coral Pink	130	270		
Daylight—E65	160	280		
White—4500K	160	290		
Turquoise—(E-20)	130	240	230	410
Pink—(H-37)	110	210		
Orchid—(E-80)	100	210		
Blue	110	190		
Purple	90	160		
Lilac	90	160		
Horizon Blue	80	170		
Blue (Neon)	50	90		
Warm White Delux			150	250
Cool White—A3500			230	410
2800 Tricolor			250	480
3000 Tricolor			260	480
3500 Tricolor			260	460
4100 Tricolor			250	430

Chart to be used as a guide only —lumens may change due to pumping or processing

(Continued from page 37)

A P P L Y I N G H V T

So how was the magic of Le Bonheur Children's Medical Center created? The columns were wrapped with a series of tubes separated by sheets of plexiglass. Each tube produced a color, and with multiple tubes and a controller, one color could be made to fade into another, creating the impression of a wave of ever-changing color. Because HVT can be dimmed without color shifts, it was also possible to precisely control not only individual colors, but also to create new colors by the visual mixing of two different colors. In this design, that process was carefully thought out so that the effect was a palette of colors suitable to Roeder's vision of color and health. Still photographs can not capture the feeling that one gets while being in the space and sensing the subtle shifts of color over time.

Lighting is all about providing for the needs of a client. The best lighting goes beyond those needs to create a feeling or sense about the space that is special and unique. HVT can be an appropriate tool at both of these levels, but only through knowledge and understanding. Hopefully, this primer will open the door for further study into this unique form of lighting. ■

Fred Oberkircher, LC, IESNA, IALD is associate professor at Texas Christian University and director of the TCU Center for Lighting Education.

NCQLP QUIZ

- The precursor of the sealed tube that we associate with all HVT lighting was developed in 1856 by:**
 - Georges Claude
 - Heinrich Geissler
 - Otto Von Guericke
 - D. McFarland Moore
- The inert gas that will produce a dull blue color if used in a clear tube is:**
 - Argon
 - Krypton
 - Neon
 - Xenon
- For the color turquoise, the greatest number of lumens per foot is generated by what combination of tube diameter and current rating?**
 - 15 mm, 30 mA
 - 15 mm, 60 mA
 - 25 mm, 60 mA
 - 25 mm, 120 mA
- All of the items listed are advantages of HVT except:**
 - Can be dimmed without color shifts
 - Low wattage input for energy savings
 - More color selections than any other light source
 - Long runs are typically done with just one tube
- With HVT, the most saturated colors are achieved by using tubing that is:**
 - Clear
 - Colored
 - Phosphered
 - Sleeved

The Highlights begin Outside

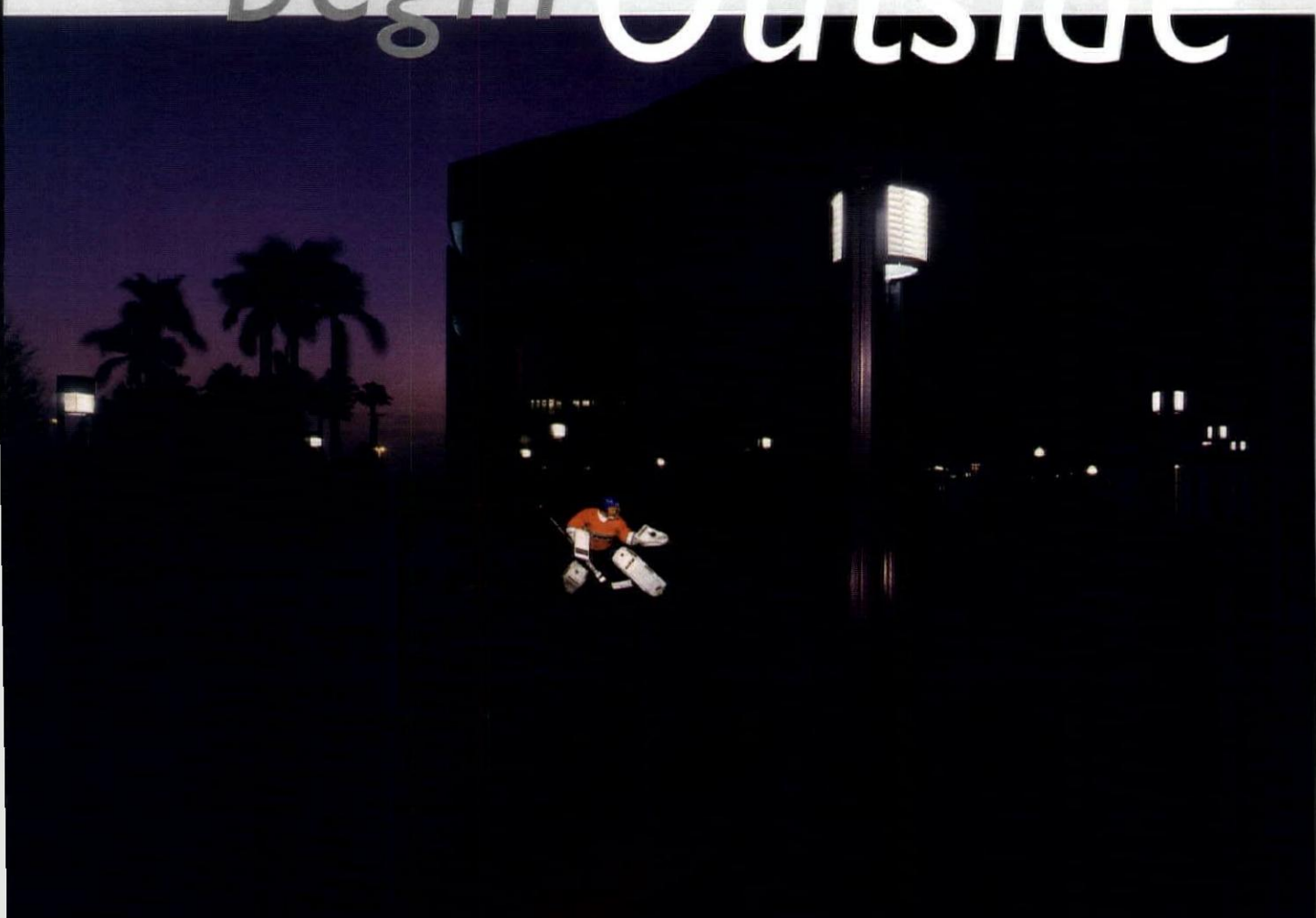

Broward County Civic Arena, Fort Lauderdale, Florida · Architect: Martha Schwartz · Landscape Architect: Edward D. Stone & Associates

CDO Ovalette

In 1998 the Broward County Civic Stadium was built in Fort Lauderdale, Florida, in what used to be part of the Everglades. It is now the home of the Florida Panthers Ice Hockey team.

In addition to developing a lighting concept for the stadium in line with the city's Art and Design program, the design team was assigned to select an urban design luminaire to be integrated harmoniously into the public entrance area in front of the stadium.

The **CDO Ovalette** is now a significant design feature in this urban setting. It meets the requirements for communication in the space and combines good lighting technology with exclusive design. This highly versatile luminaire can be used for a wide variety of applications, e.g. railway concourses, airport terminals, pedestrian walkways, shopping malls or even bus stops.

If you would like to know more about this or other se'lux products, please visit our website or request our product binder.
e-mail: seluxus@selux.com

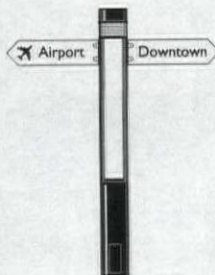

se'lux®

Light. Ideas. Systems.

Circle No. 18 on product service card

www.selux.com

Australia · Austria · Benelux · France · Germany · Great Britain · Italy · Singapore · Sweden · U.S.A.

GETTING THE LED OUT

BY DAVID HOUGHTON, PE, CONTRIBUTING EDITOR

In the 1960s, electronics researchers discovered that certain types of diodes ejected photons when a voltage was applied. Over the following 20 years, these light-emitting diodes (LEDs) found their way into numerous products—mostly as indicator lights and other curiosities such as moving electronic signs. In the late 1980s, lighting specifiers became familiar with LEDs as they took over colored-light applications such as exit signs and traffic signals. And more recently, LED technology has clearly emerged as a trend to be watched: in fact, Color Kinetics was recognized two years consecutively at Lightfair's New Product Showcase—Best New Product of the Year and the Roeder Award—for their LED-based products.

Now that LEDs are coming out in brighter and whiter packages, these tiny lamps are poised to move into the general illumination market. Early possibilities include architectural accent lights, casework and striplights and landscape lighting. Eventually, LEDs may fulfill applications such as cove lights, task lights and even fiber-optic illuminators. Although they will have to overcome hurdles such as high cost and relatively low light output, their impressive pace of improvement bodes well for their future.

The current LED frenzy can be traced to the 1996 announcement that Nichia, a small Japanese company, had figured out how to create high-intensity blue LEDs—a key color previously lacking in the LED spectrum and the “missing link” to create white LEDs. Nichia is still the only producer actually shipping white LEDs, but other players are moving quickly to catch up. Lighting specifiers will benefit from this technology race as new production facilities come on line and higher-intensity products enter the market.

Industry veteran Hewlett-Packard (HP), for example, is working to drive more light—a lot more light—out of each individual LED chip. Their 8mm “power package” LED—

also known internally as the “Barracuda”—uses a chip 16 times larger than the one that powers the older-generation 5mm LEDs. HP's 8mm white LEDs produce 7 lumens of output, compared to about 0.5 lumens for conventional 5mm units. According to HP Marketing Manager Doug Silkwood, the next generation of these units will nearly dou-

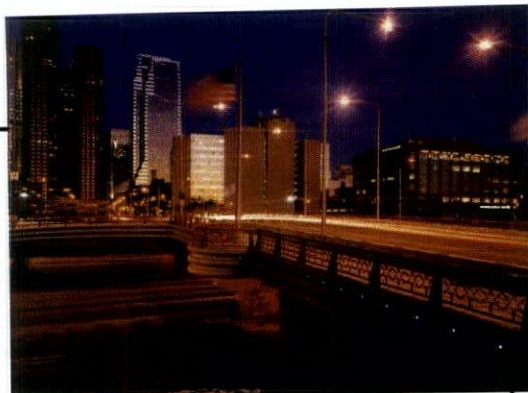

LEDs ARE BEING USED FOR ARCHITECTURAL HIGHLIGHTING, SUCH AS THIS INSTALLATION IN CHICAGO. CCI LIGHTING, **CIRCLE NO. 46**

ble light output again, perhaps to as much as 14 lumens per chip. “We’re betting the farm on high-output whites,” said Silkwood. “For now, we’re focusing on LEDs for end-use applications such as commercial shelf lighting, cove lighting and landscape lighting.” HP is also adjusting the photometrics of their high-output LED chip. Silkwood noted that early designs threw off light in a “donut” pattern, and the new units will have a center-weighted light distribution pattern that will be friendlier to secondary optics.

In May 1999, HP's Lightfair booth was glowing with dozens of their white “power package” LEDs, and some samples have been released to OEMs. They won't be available in production quantities, however, until late 1999 or early 2000. The high-output LEDs will cost about \$9 each in quantity—compared to Nichia's whites at under \$2, HP's high-output reds at about \$3.50 and low-grade reds that cost as little as a nickel each. “High-output LEDs cost more per unit, but on a ‘flux for bucks’ basis, they're very competitive,” said HP's Debra Wilson.

One company that is embracing the possibilities of the new generation of LEDs is CCI Lighting, based in the Chicago area. CCI offers hardwired and screw-base LED lamps designed for harsh outdoor conditions in applications such as building and bridge highlighting. The company's Orion lamp uses 16 LEDs silicone-sealed inside a tempered glass dome. Although he's enthusiastic about LEDs, CCI's Kenneth Esterly points out a few of the hazards of the new lamps. “LEDs are rugged and long-lived, but the enclosure needs to be as tough as the chips are,” said Esterly. “And everybody talks about 100,000-hour lifetime, but if you overdrive the LEDs or let them get too hot, their output is going to drop.” CCI's product prices are indicative of the LED market: last year their blue, green and white Orion lamps cost about \$220 each; this year they cost about \$130. (Red units are much less expensive—as low as \$13 each in large quantities).

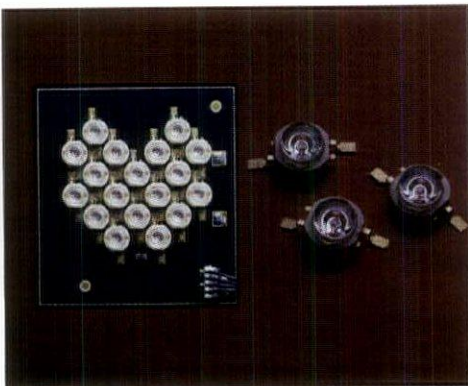

HEWLETT-PACKARD HAS BOOSTED THE SIZE OF THEIR LEDs BY A FACTOR OF SIXTEEN. THESE “POWER PACKAGE” UNITS WILL BE AVAILABLE TO OEMS BOARD-MOUNTED (LEFT) AND LOOSE (RIGHT). HEWLETT-PACKARD, **CIRCLE NO. 45**

California-based LEDtronics—one of the first companies to develop LED traffic signals—has developed a wide array of screw-in LED lamps for decorative, automotive, marine and military applica-

tions. Their "DecorLED" lamp is the same shape and size as a screw-in A19 incandescent—the white unit puts out 22 lumens of light with input power of less than a watt. Red, orange and amber DecorLEDs cost about \$28, while the whites, blues and greens are about \$85 (all prices for large quantities). "We're selling lamps to retail chain stores for window displays and to the casino industry for eye-grabbing incandescent replacements," said Jordon Papanier, Marketing Manager for LEDtronics. He noted that the lamps are also finding their way into some unusual applications such as cow barns and fisheries—some animals seem to regard the LED light as soothing.

Color Kinetics' patent-pending technology adds intelligence to the LEDs and gives lighting designers complete control over what they're able to create, which is a full spectrum of color with color-changing effects. "With that core technology, we have developed a range of products, which includes traditional fixtures and replacements for products such as MR16s," said Kathryn Pattison, VP of marketing at Color Kinetics. "Our C-Series, which produces a soft-edged round spot, is available in a number of sizes and a water-submersible model." This month, the company introduced a fully track-mountable version of the C-Series fixtures.

The attraction of an expanding LED market is

drawing new players to the game. LEDtronics is teaming up with Siemens Solar, a major photovoltaic panel manufacturer, to produce complete LED-based solar lighting systems for applications such as lighting for roadside telephone booths, emergency call boxes and off-the-grid residential installations in the developing world. Uniroyal Technology Corporation, for example—an offshoot of a company better known for making tires—decided in early 1998 to build an LED factory. Uniroyal's new Tampa facility, which started producing high-brightness blue and green LEDs in July of this year, will soon have production capacity of 200 million units per year. "We want to be a partner in developing new LED lighting products," said Andy Lipman, VP of Business Development for the Florida-based company. Lipman is particularly excited about the optical controllability of LED sources. He pointed out that since the solid-state sources throw light in one direction, the natural optical control element is a lens rather than a reflector. "Lenses are cheaper and more efficient than reflectors," said Lipman. "As people design new fixtures for LEDs, this optical controllability is going to help drive cost down and performance up." ■

LED Lighting—The Pros & Cons

Pros

- ✓ **Long life.** LEDs (almost) never die, since their solid-state construction lacks the filaments, cathodes and glass tubes that cause other lamp types to fail. Some LED industry insiders even talk about the possibility of "sealed-for-life" light fixtures that never need relamping. However, LEDs do suffer from lumen depreciation that can limit their useful life (see below).
- ✓ **Rugged.** LEDs are tough—the epoxy-encased chips can be shaken, rattled and rolled without harming them. They also stand up to rapid cycling, dimming and temperature extremes—although high temperatures reduce their light output.
- ✓ **Size.** For designers infatuated with small, easily-concealed sources such as the MR16, LEDs are ideal—producing light out of "nowhere."
- ✓ **Saturated colors.** Colored LEDs produce vibrant, eye-catching colors because they discharge in narrow spectral bands.
- ✓ **Energy efficiency.** Although the lumen/watt efficiencies of LEDs are relatively low (8-30 lm/W compared to 5-20 for incandescents, 60-100 for fluorescents and up to 150 for HID) they can nevertheless save substantial energy in many applications by putting the light right where it's needed. LED exit signs, for example, use only about 2W, while fluorescent signs require 7-13W and incandescents need 40W.
- ✓ **Color mixing control.** Groups of colored LEDs can be computer-controlled to generate different colors and dynamic effects. Perhaps the best example of this is the product line offered by Color Kinetics, which can generate spectacular effects in round and linear LED clusters.
- ✓ **Optical control.** Compared to nearly every other source type, LEDs have the major optical advantage of generating light in a specific direction, which is just what is needed for many lighting applications. Conventional light fixtures need reflectors to get light travelling in a certain direction.

Cons

- ✓ **High cost—for now.** There is no doubt that LEDs are still costly to install; white LEDs are about \$1-5 per lumen output, compared to 0.7¢/lm for fluorescents and 0.1¢/lm for incandescents. Costs are expected to continue dropping, but LEDs will have to rely on their optical and operating efficiencies to match up with conventional sources.
- ✓ **Low output.** Although LED exit signs and other colored applications such as automotive brakelights have impressive brightness, the current white products still have a ways to go before they can really challenge fluorescents and incandescents for illumination tasks. Compared, for example, to a low-wattage compact fluorescent, a white screw-in LED produces only 1/70 the light (with about 1/15 the input electricity).
- ✓ **Off-white.** Current-generation white LEDs are actually blue LEDs with a phosphor built into the epoxy casing (or, in the case of some of the HP products, into the lens surrounding the chip). Another strategy is to combine red-green-blue (RGB) units into a single unit, but so far the blue-plus-phosphor produces the best results. Even this white, however, is not a pure white. LED specialists say that future whites will have a much better appearance.
- ✓ **Lumen depreciation.** Although they don't "burn out" the way conventional sources do, LED output does drop significantly over time. Hewlett-Packard currently warrants their red products to produce at least 50 percent of original light output after five years of use. Lumen depreciation is difficult to nail down, however, because of the rapid pace of change in the industry. For example, before long-term testing of red Al-Ga-S LEDs could be completed, the introduction of superior Al-In-Ga-P units made them obsolete. Lumen depreciation also depends heavily on operating temperature, drive current and other technical factors. Engineers expect, however, that future generations of LEDs will continually improve lumen retention—in addition to initial output and efficiency.

new products

Glassglass pendants from **Luceplan USA** combine hand-blown Italian glass diffusers with hand-rolled translucent oxide colors. The glass diffusers are available in a range of sizes, colorations and globe-, bell-, funnel-, bullethead- and dagger-shaped designs. Glassglass is offered in 200W incandescent, 150W T10 halogen and 30W, 25W or 23W U-shaped compact fluorescent versions. The pendants may be specified in transparent or frosted Italian glass or in combinations of the two. UL-listed. **Circle No. 30**

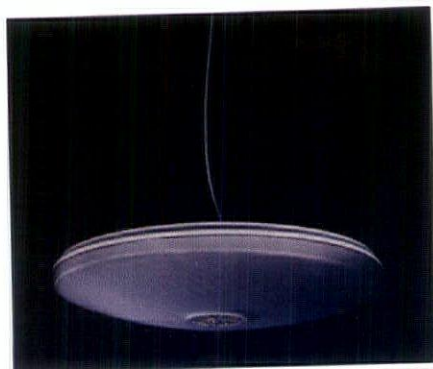
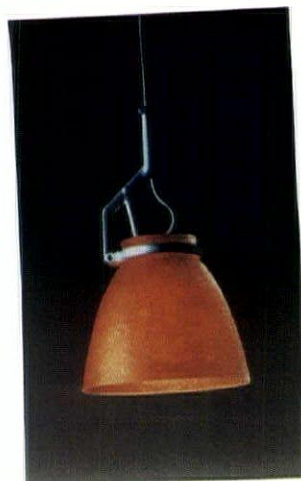

SPI Lighting's ips pendant offers an alternative to HID high- and low-bay lighting. Ips' low-profile housing accommodates an optical system that achieves a 92-percent efficiency. The pendant uses four or eight 40W and 55W compact fluorescent lamps to deliver up to 38,400 lumens. Ips is available with various mounting accessories. UL-listed. **Circle No. 31**

The Watt Stopper's new line of lighting control panels consists of low-voltage switching panels, shut-off control panels, exterior lighting control panels and distributed lighting controls. The low-voltage switching system uses wiring from low-voltage switches to signal relays in a centralized lighting control panel. For simple control, the shut-off control panel works with automatic control switches. With the exterior lighting control panel, on/off control is based on the contribution of ambient light and occupancy schedules. Distributed intelligent control and a LonWorks-based networked communication system also included. UL-listed. **Circle No. 32**

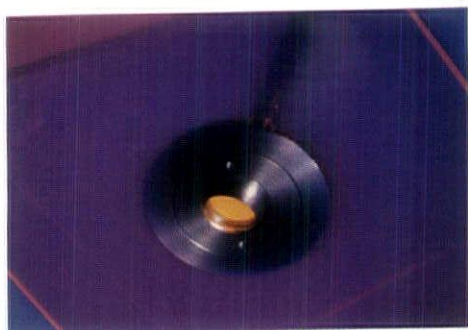
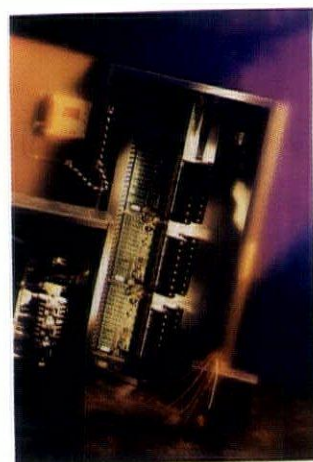

The Eyeball fiber-optic downlight from **Lucifer Lighting** can be adjusted 20 degrees from vertical in all directions and then locked into position with a spanner wrench included with the fixture. Less than 3 in. in diameter, the Eyeball features a detachable "snoot" that aims the light beam and controls glare. Without the snoot, the Eyeball mounts flush with the ceiling or wall. The Eyeball is offered with optically ground clear or frosted lenses and in spot, medium flood and flood beam options. Various finishes available. UL-listed. **Circle No. 33**

Lutron Electronics' new addition to its Hi-lume electronic fluorescent dimming ballast line features an ultra-slim profile with a physical cross section measuring 1 in. high and 1.18 in. wide. Ideal for one- and two-lamp, low-profile fixtures, the ultra-slim profile ballast offers continuous, flicker-free dimming performance for T5 HO linear fluorescent lamps down to one percent. The new ballast features three-wire line-voltage control technology, low harmonic distortion, inrush-current-limiting circuitry and end-of-lamp-life protection. CSA-, UL-listed. **Circle No. 34**

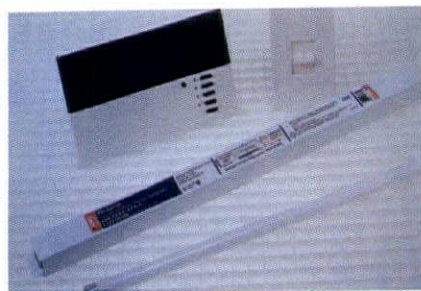

(continued on page 45)



M9000 NIGHTWASH

Takes In-grade Lighting into the New Millennium

The Hydrel 9000 Series established the benchmark for in-grade lighting with excellent photometrics, modular design, and factory sealed components.

The new M9000 Series provides cooler operation, external aiming, increased drive-over strength, and optional aesthetics, all refinements to further assist lighting project designers.

The M9400 and M9800 are now available in single or new double lensed models, providing more aiming and cooling options. Both feature a variety of lighting distributions.

M9400 – 70 Watts HID in a very compact nine inch diameter footprint – accommodates quartz, fluorescent, incandescent, and the new color-corrected metal halide lamps.

M9800 – Most powerful in-grade light in the world – 400 Watts HID in an eighteen inch diameter footprint.



Low surface temperatures generated by the new double lensed models make them an excellent option for areas high in pedestrian activity.

HYDREL
In-grade Lighting

Lithonia Lighting

Hydrel Architectural Outdoor Products

12881 Bradley Avenue, Sylmar, California 91342

Phone 818-362-9465 Fax 818-362-6548

Website www.lithonia.com

Circle No. 19 on product service card

For the 40 years of BATIMAT
"Lux/Design...40 years later".



A design confrontation of lighting products, selected from the 60's era and today, will take place at BATIMAT '99. Lux/Design will showcase the best in lighting solutions from the 1960's and Year 2000. All products will be carefully selected by a panel of French and Italian architectural experts.

A presentation organized by BATIMAT and ARCA.

To visit Lux/Design at BATIMAT '99

International Trade Exhibitions in France, INC.

Call toll free: (888) 522 5001

E-mail: tradeshows@itef.com

Washington Office

1611 N. Kent St. - Suite 903 - Arlington, VA.22209

Fax: (703) 522 5005

To participate in the Lux/Design presentation

Laurent Waessa

Miller Freeman Inc.

11th floor, One Penn Plaza, New York, NY 10119

Phone : (212) 615 29 25

Fax: (212) 643 48 03

E-mail : lwaessa@mfi.com



Paris expo-Porte de Versailles - France

From the 8th to the 13th of November 1999 - In partnership with

ARCA

* The 8th, preview day reserved for the Press and on invitation

in Miller Freeman
A United Tech & Media Company

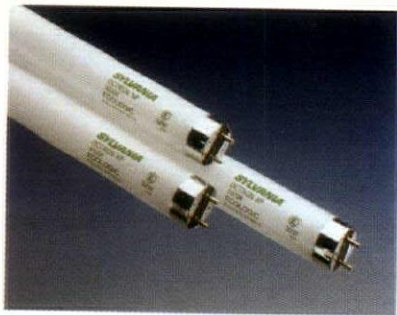

From **Osram Sylvania**, the Ecologic version of the Octron 800XP linear fluorescent T8 is compliant with the Federal Toxic Characteristic Leaching Procedure (TCLP) test and provides 20 percent longer lamp life—24,000 hours—than standard T8 lamps. New phosphor and coating technology produces 3,000 lumens or 93 lumens per watt, an 85 CRI and a lumen maintenance of 94 percent. The Octron 800XP Ecologic also reduces end darkening, and coupled with Quicktronic can extend group relamping cycles up to one year. **Circle No. 35**

Luminosities by **Lightolier** utilizes translucent organic composites sealed in thin-film polymers to create specification-grade wall sconces. Welded steel frames support the luminous surfaces, which produce a warm and diffused light. The series offers 12 ornamental-style options from four different patterns: Grid, Wood, Pick-Up-Sticks and Parchment. ADA-compliant, Luminosities is available with 60W incandescent or compact fluorescent sources with electronic or magnetic ballasts. UL-listed. **Circle No. 36**

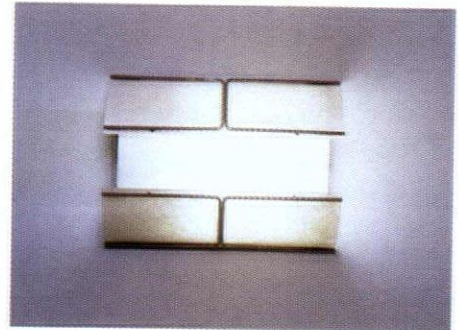

From **Venture Lighting**, the new energy-efficient 750W metal halide pulse-start lamp produces 80,000 lumens with a rated life of 12,000 hours in a enclosed, clear, base-up version. Available with a universal burning position, the lamp provides 72,000 lumens. Both versions have a color temperature of 4000K with a CRI of 65. Venture Lighting also offers newly engineered metal halide ballasts for the 750W pulse-start lamp. **Circle No. 37**

**WAS YOUR
COMPANY
FEATURED IN
A RECENT
ISSUE?**

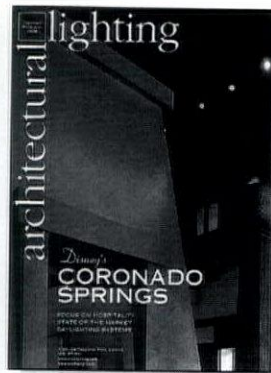

IS THERE AN EDITORIAL FEATURE YOU WOULD LIKE TO SHARE WITH YOUR COLLEAGUES, CLIENTS OR PROSPECTS? IF SO, WHY NOT TAKE ADVANTAGE OF AN EXCELLENT OPPORTUNITY TO PASS THE MESSAGE ALONG. ORDER ECONOMICAL REPRINTS TODAY.

AVAILABLE IN ORIGINAL FULL-COLOR, OR BLACK & WHITE, REPRINTS CAN BE OBTAINED FOR ANY ISSUE OF ARCHITECTURAL LIGHTING.

For a free price quote, contact Vicki Brewster, Reprints Manager at 516-365-2646. Or for further information, contact Vince Habick, Production Manager at 415-905-2454.

THE POWER OF PARTNERSHIP

As a leading supplier to the lighting industry, Hatch has valuable expertise you can share. We can provide technical advice and testing, as well as a convenient single source for quality electronic transformer and ballast products. Most catalog products are shipped from inventory within 24 hours. For special needs, we can adapt or modify existing models or design a custom solution to meet your requirements. Partner with Hatch for the best service, support and quality products in the industry.

*Electronic Transformers and Ballasts
for the Lighting Industry*

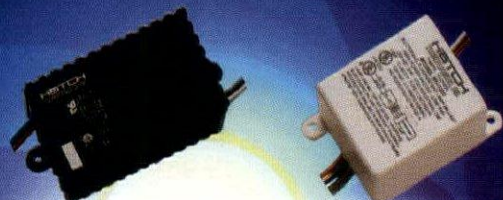

HATCH TRANSFORMERS, INC.

5403 W. Gray St., Tampa FL 33609
Phone 813-288-3006 • Fax 813-288-8105
Website: www.hatchtransformers.com

CLASSIFIEDS

POSITIONS AVAILABLE

Director of Lighting Design

Stanford Hotels Corporation, seeks Lighting Designer / Project Manager for a San Francisco based Hotel Company with 17 Hotels.

Responsible for designing and managing lighting renovations and aesthetic improvement works, both interior and exterior.

Min. five years hands-on experience. Requires travel within the United States - averaging approximately 50% of the time.

Interested candidates may fax / E-mail or regular mail their resume to:

Stanford Hotels Corporation
433 California Street, 7th Floor
San Francisco, CA 94104-2011
Tel: (415) 398-3333 Fax: (415) 982-7781
E-mail: joyce@stanfordhotels.com

Specification Sales

The leading lighting and controls rep agency in South Florida has positions open for specification sales professionals in the Miami/Ft. Lauderdale markets. Account responsibilities will include calling on architects, electrical engineers, landscape architects, and Interior designers. A 4 year degree in lighting design, architecture, engineering, Interior design, or equivalent industry experience is desirable. We offer an attractive compensation program which includes company sponsored training, 401K and health insurance programs. Send your resume with salary requirements to:

Lighting Dynamics, Inc., Attn: Tony Plonner, 1715 S.E. 4th Ave,
Ft. Lauderdale, FL 33316 Fax: 954-763-1503,
e-mail LDIFTL@AOL.COM.
All replies will be held in strict confidence.

SPECIALTY LIGHTING

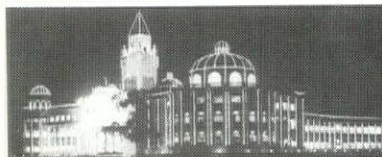

flexible neon
fiber optic
chasing effects
tree lighting
UL listed

belt lights
tape lights
colors
in/outdoor
strip lights

bendalite.com 1-800-Flex-Neon

Rates are quoted as per issue/per inch.
All classified advertising is prepaid.

PER COLUMN INCH

1x\$99 4x \$94 8x \$89

LIGHTING SALES CARIBBEAN / CENTRAL AMERICA

Lighting Rep firm looking for person to service accounts in the Caribbean and Central America. Responsibilities include calling on distributors, end-users, contractors and the specification community. Five years experience in lighting sales and fluency in both English and Spanish a must. Attractive compensation program includes company sponsored training, 401K, health and disability insurance programs.

Send resume, with salary requirements to:

Lighting Dynamics International, ATTN: Tony Plonner, 1715 S.E.
4th Avenue, Ft. Lauderdale, FL 33316, FAX: 954-763-1503
e-mail ldifl@aol.com. All replies will be held in strict confidence.

A LIGHTING INDUSTRY VP, MARKETING/SALES

Entrepreneurial, experienced executive sought for innovative, independent and well-respected lighting fixture manufacturer. Progressive skills required in sales management (of RSM, Quotations and international manufacturer representatives) and marketing (electronic/print catalogs, pricing, promotions, technical training). Showroom & budget responsibilities.

Mail/fax resume with salary history and references to:

CEO, The Kirlin Company, 3401 East Jefferson Avenue,
Detroit, MI 48207-4232, Fax 313-259-7923 or 313-259-9409

Senior Designer

Senior-level designer sought. The successful candidate will have outstanding project management skills, and be responsible for project design, production and administration. You must communicate well with clients, design team members and contractors. Travel, both domestically and internationally, will be required. Familiarity with Windows, Word, Excel and other spread sheet applications and AutoCad 14 is necessary. Please send a resume, salary requirements and cover letter addressing your approach to good lighting design to:

Susan Tracey Stearns, Ross De Alessi Lighting Design,
2815 Second Avenue, Suite 280, Seattle, WA 98121

TRACK & RECESS

LIGHTOLIER

See what "Designing with Light" is all about with our full line of Lightolier track, recessed, fluorescent & controls.

SHOWROOM LIGHTING BY GREGORY

Ph: 212-226-1276 or 800-796-1965

lbgl58@aol.com • www.lightingbygregory.com

ARCHITECTURAL LIGHTING 1999 CLASSIFIED RATES & INFORMATION

PRODUCTION OPTIONS

Photo.....\$25 Bold.....\$10 Special Border.....\$10
Reverse.....\$15 Logo.....\$20 (additional charge per issue)

CONTACT ARCHITECTURAL LIGHTING • ONE PENN PLAZA NY, NY 10119 OR CALL 800-950-1314 EXT. 2727

ADVERTISER	PAGE	CIRCLE NO.
Alkco.....	14.....	11
Architectural Landscape Lighting.....	14.....	10
B-K Lighting	47.....	21
Cooper Lighting	3, 13.....	3, 9
D'ac Lighting.....	15.....	13
Davis-Muller	Cov. 3.....	22
Edison Price Lighting.....	16.....	14
Engineered Lighting Products.....	47.....	20
Flos USA	5.....	5
Hadco, Inc.	Cov. 2.....	1
Hatch Transformers, Inc.....	45.....	24
Lam Lighting	15.....	12
Leviton Mfg. Co.	1.....	2
Light Project	21.....	16
Lighting Services Inc.....	4.....	4
Lithonia/Hydrel	43.....	19
Lithonia Lighting	Cov. 4.....	23
Lumiere Design & Mfg., Inc.....	17.....	15
Lutron Electronics Co., Inc.	23.....	17
Phoenix Products Co., Inc.	11.....	8
Prescolite•Moldcast.....	6-7.....	6
Se'lux Corp.....	39.....	18
The Watt Stopper, Inc.....	9.....	7

Publisher is not liable for errors or omissions.

Our fixtures are so highly coveted,
that when customers buy them...
they promptly hide them.



Photo by Mark Dell'Aquila



Our 'Hole in the Wall' fixtures are plaster/fiberglass castings. They illuminate your space without calling attention to themselves. Call us for more information at 626.579.0943 or visit our website at www.elplighting.com.

ENGINEERED LIGHTING PRODUCTS



Circle No. 20

Quality to Last a Lifetime!™

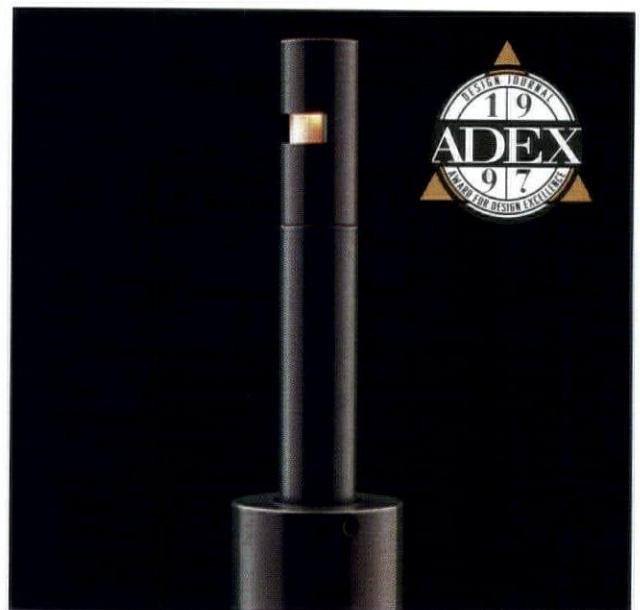

The Litestick™ and its "award-winning" design bring several words to mind when used for path and small area lighting; sleek, sexy and wow! Its one inch diameter and small lens opening belies its ability to make a dramatic lighting statement after dark, but says it all about its ability to disappear during the daylight hours. The Litestick is unique in its design and unequalled in its quality.

B-K LIGHTING . . . the number one choice in specification-grade, outdoor architectural lighting.

7595 N. Del Mar Avenue, Fresno, California 93711 • 559.438.5800 • FAX 559.438.5900
e-mail: Contact@BKlighting.com • www.BKlighting.com

Circle No. 21

PURSuing PROFESSIONAL DEVELOPMENT

BY GARY STEFFY, LC, FIALD, IES

Professional development—for advancement and reward. Sometimes for no other reason than the personal reward of better lighting designs. Other times for the satisfaction of understanding a concept of technology. And still other times for business growth. Professional development not only affects each of us personally, but ultimately affects the profession and further affects society. As we elevate ourselves, we elevate the profession in the public's eye. We elevate our ability to get the most out of lighting energy. The process takes time; indeed, it is never-ending.

Three facets of professional development in our field of lighting deserve attention and, when balanced—that is, when they are each used to support the other—do yield results in the form of better practice, more business and higher quality business. These facets are lighting design, illuminating engineering and communication.

Lighting design is an art that is increasingly influenced by controllable issues such as initial cost, energy consumption, environmental sustainability and construction schedule; and uncontrollable forces such as lighting representatives (and their packages), distributors (and their packages) and manufacturers (and their packages). Using the leverage of professional development—increased knowledge and how to use that knowledge—will help to regain at least some control over what may appear to be uncontrollable. If you know the energy requirements and the sustainability issues inside and out and have developed a design that tightly addresses both—and if these are priority criteria for your client (remember, you help establish the priorities), it will be that much more difficult for substitutions and packages to meet all of the lighting design criteria that your originally specified equipment meets. This is especially powerful when you've seen professional development growth on other, perhaps more mundane, lighting design issues (like daylighting luminances and luminance balancing; transient adaptation effects; and so on). Understanding your implied fiduciary responsibilities to the client ratchets up your strength and ability to write the right specification to support your design and then to *hold* that specification.

Illuminating engineering is a science that is increasingly influenced by computers and computer-literate graduates. Here, an understanding of “what goes in” and “what comes out” is crucial to successful results. Increasingly, however, it also appears that knowing “what's in there that is manipulating what's coming in and how it goes out” (the software engine) is a must if one is to avoid the pitfalls of any given software package. So, getting to some of the relevant IES paper sessions or at least reviewing the *Journal* should start showing on the radar for periodic consideration. At the very least, reading an article or two each year on the topic wouldn't hurt.

Communication skills are paramount to your continuing education, client education, the education of the contracting and purchasing team and ultimately your ability to sell and hold the specification of a design. This is what drives more and higher quality business. There's no need to go after what might appear to be the *crème de la crème*. You can elevate the very clients you now have by educating them on lighting and on why they need to do what you're recommending that they do! We're talking here about the conveyance of technical knowledge and aesthetic concept. Technical

discourse alone won't sell concepts. Explaining the technical aspects in a way that is appreciated by the client and in a way that supports the design aesthetic is a must. Solid communication development can be found in: teaching (college-level courses, industry seminars, IES meeting sessions, Lightfair seminars, university guest lectures or retreats); technical paper review (IES and CIE paper discussions at respective conferences); book reviews; technical committee work; NCQLP committee work; and writing (articles, book passages, books, letters to the editors).

Any one of these experiences will improve your professional communication skills and professional expertise. The pressure alone of the risk of sounding like a fool will drive you to research and think through the topics. For this reason, unfortunately, most folks simply don't participate. This is the classic “no pain, no gain.” Don't let this stop you from these valuable forms of professional development. Technical committee work and reviewing papers and books put you in the direct stream of current thinking, arguing and researching. Teaching, especially to college students, can be stressful, yet most rewarding. As with any speaking engagement, preparation is a necessity. Students' naiveté and freshly placed lighting knowledge are a volatile mix—yielding terrific, unexpected questions for which answers may require research and in-depth thought. The inevitable “thinking on your feet” translates to direct skill enhancement for client presentations and addressing lighting with other project team members.

This works. However, it takes time—a commitment on your part and years to cultivate. I remember my design experience at Smith, Hinchman & Grylls (now SHG) in

Detroit in the early 1980s—there was a challenge by our leader (mentor really), Steve Squillace, PE, FIES, to publish something on a reasonably regular basis; review or write IES papers; participate on IES committees; and teach. We were all eager to accept the challenge. Today, you'll find articles, reviews, papers and published designs on a regular basis by the likes of Jim Benya, PE, LC, IALD, FIES; Naomi Miller, LC, IALD, FIES; David DiLaura, LC, IALD, FIES; and Sandra Stashik, PE, LC, IALD, FIES—all on Squillace's team in the early '80s. It took perhaps five years for us to see the results of such professional development activity, but they were substantive and consistent across the group.

Market forces will drive you to grow professionally. The NCQLP is pushing the level of knowledge and ethical standards required by not only designers but by manufacturers, representatives, facility managers, maintenance engineers and the like. As each professional's level ratchets up, the industry as a whole is elevated, lighting is elevated, and ultimately society is better because of it. The NCQLP codifies professional development in lighting for a variety of professionals involved in lighting.

Sustaining professional development activities will help you to reap the benefits consistently and over the long term. Perhaps most importantly, you'll have the satisfaction of giving something back. ■

Gary Steffy, LC, FIALD, IES is principal of Gary Steffy Lighting Design in Ann Arbor, MI.

PROFESSIONAL
DEVELOPMENT WILL
HELP REGAIN SOME
CONTROL OVER THE
UNCONTROLLABLE.