

AL-2003-M

W-1007-1A

2003
MARKET
ISSUE

lighting

architectural

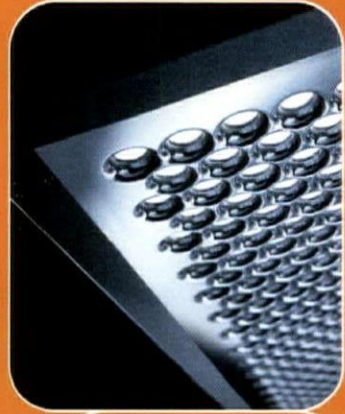

2003
Market
Issue

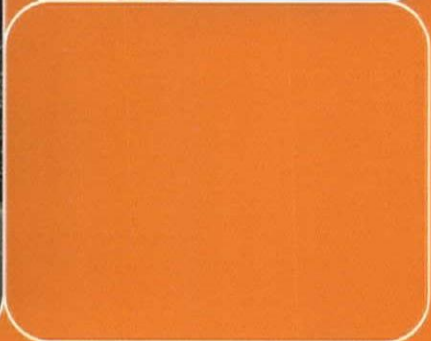
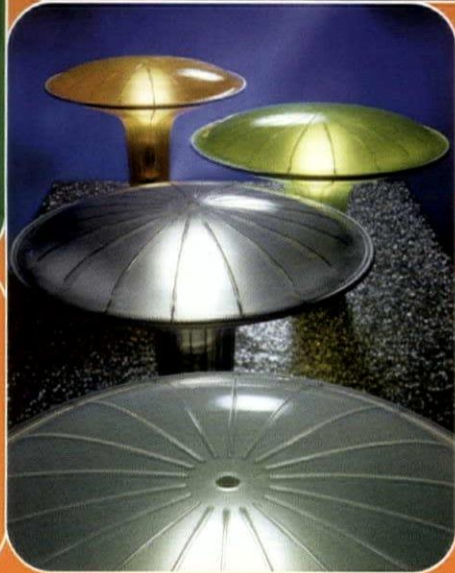
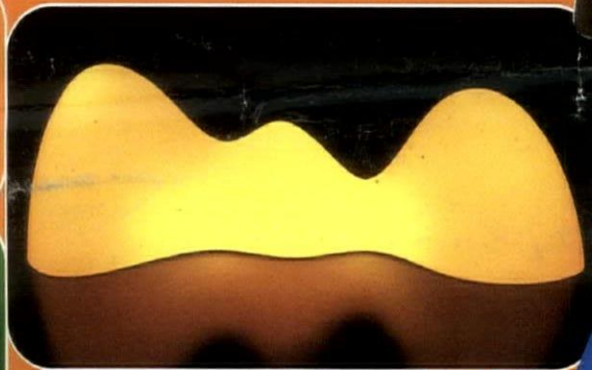

What to Specify in 2003

Site for Sore Eyes—Finding What You Need Fast!

License to Thrill: New Products with Promise

U.S. \$7.00

Lightfair Booth #2037



Remember when this
was all you had to know
about color consistency?

These days, your lighting has to deliver consistent color for retail displays and other color-critical applications. The SYLVANIA TRU-COLOR® line features METALARC® POWERBALL™ CERAMIC® metal halide lamps, CAPSYLITE® halogen PAR lamps and TRU-AIM® halogen MR16 lamps, all of which provide excellent color rendering and stable, reliable color properties over their full service life.



SEE THE WORLD IN A NEW LIGHT **SYLVANIA**



See us at LIGHTFAIR, call 1/800-LIGHTBULB, or visit www.sylvania.com

Circle No. 38 on reader service card



Now Alanod offers **MIRO-SILVER®** for today's most innovative light-reflecting applications.



Light pipes • Solar tubes • HID-reflectors • LCDs • LEDs

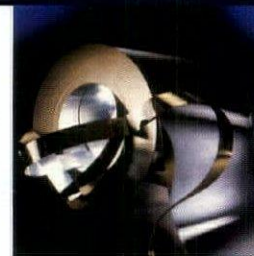

Introducing **MIRO-Silver** Even more reflective

Alanod® introduces all-new **MIRO-Silver®**, our most reflective surface ever. **MIRO-Silver** is specifically designed to increase the effectiveness of today's most innovative light-reflecting applications—uses as varied as brightening LCD screens, collecting natural daylight, and increasing the efficiency of LEDs and HID reflectors. Of course, **MIRO-Silver** is also an excellent choice for fluorescent lighting. **MIRO-Silver** has a total reflectivity of 98%—absorbing a mere 2% of visible radiation. And in the solar range **MIRO-Silver's** reflectivity is 95%.

MIRO-Silver maximizes performance in advanced applications by greatly increasing reflectivity. For solar pipes, **MIRO-Silver** is especially effective because it is highly reflective at all angles. HID fixtures, such as indoor and outdoor lighting, will benefit from the highest reflector efficiency in the industry for extended periods of time at HID operating temperatures. LCD screen, laptop, flat-screen TV, and active signage reflectors will match the highest efficiency of their light-source to **MIRO-Silver's** reflectivity. LED arrays can take advantage of **MIRO-Silver** as an advanced reflector medium, making the most of their output and controlling the direction and focus of light. And **MIRO-Silver** maximizes the efficiency of fluorescent luminaires, especially those utilizing multiple reflections.

MIRO-Silver consistently outperforms other reflective surfaces. Not only is it highly reflective, it is also the most durable, heat-resistant surface in the industry. For years Alanod has set the standard for maximum total reflectivity which is why every major American lighting manufacturer uses **MIRO®** products. They know that when they specify **MIRO** they are specifying superior quality that lasts.



NOTHING REFLECTS LIKE ALANOD
America's leading supplier of reflective surfaces

Circle No. 2 on reader service card

MIRO® The fastest, easiest way
to reduce lighting costs.

ASK YOUR SALES REP FOR A MIRO COMPARISON

US SALES EAST :: 718.321.0002

US SALES WEST :: 208.726.3003

CANADA :: 905.840.6868

VISIT US AT LIGHTFAIR BOOTH # 433

Visit us online
www.alanod.com



Savannah



**OVERLAND
PARK**

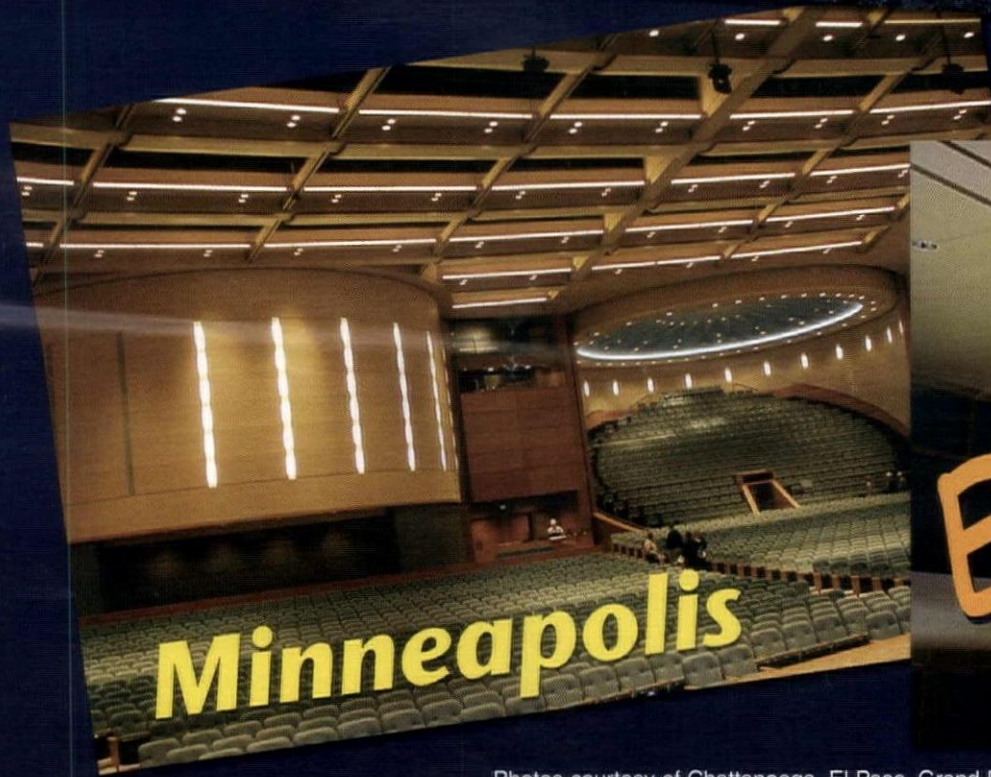
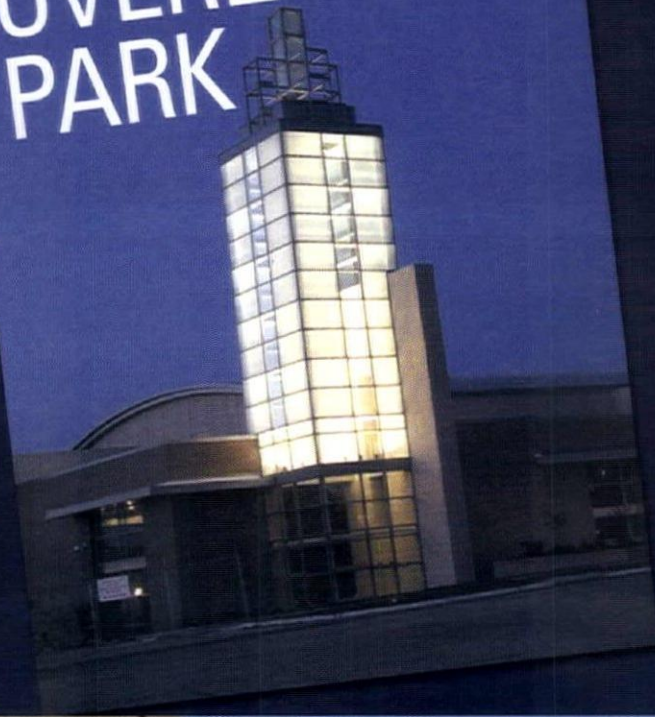

Minneapolis



El Paso

Photos courtesy of Chattanooga, El Paso, Grand Rapids, Minneapolis, Natchez, Overland Park, Pittsburgh, Portland, Reno-Sparks, and Savannah Convention Centers.

Leviton's Dimensions D-8000. Truly conventional wisdom.

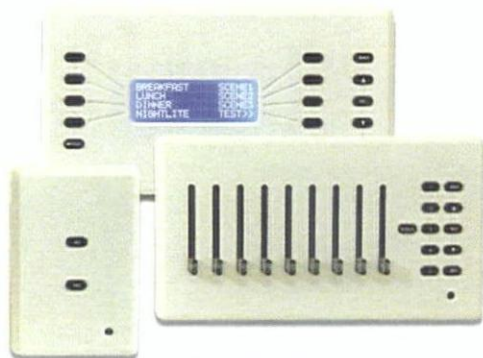

Dimensions
D-8000

Convention center managers across the country are wildly applauding the Dimensions D-8000 Digital Lighting Control System. ■ Its ability to adapt quickly to a wide variety of functions and gatherings, while integrating architectural, theatrical and conservation lighting requirements, has provided unmatched flexibility. ■ Small wonder. The D-8000 seamlessly combines with i-Series high-density dimming racks, a-2000 modular dimming, relay systems — and the

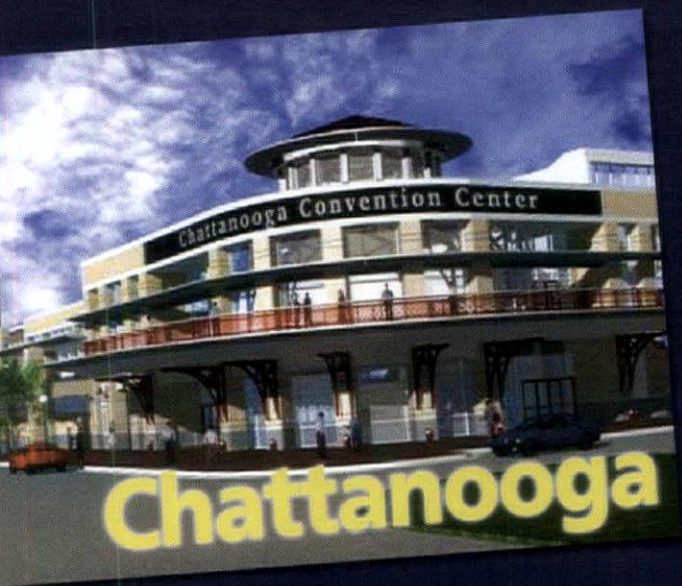

Chattanooga

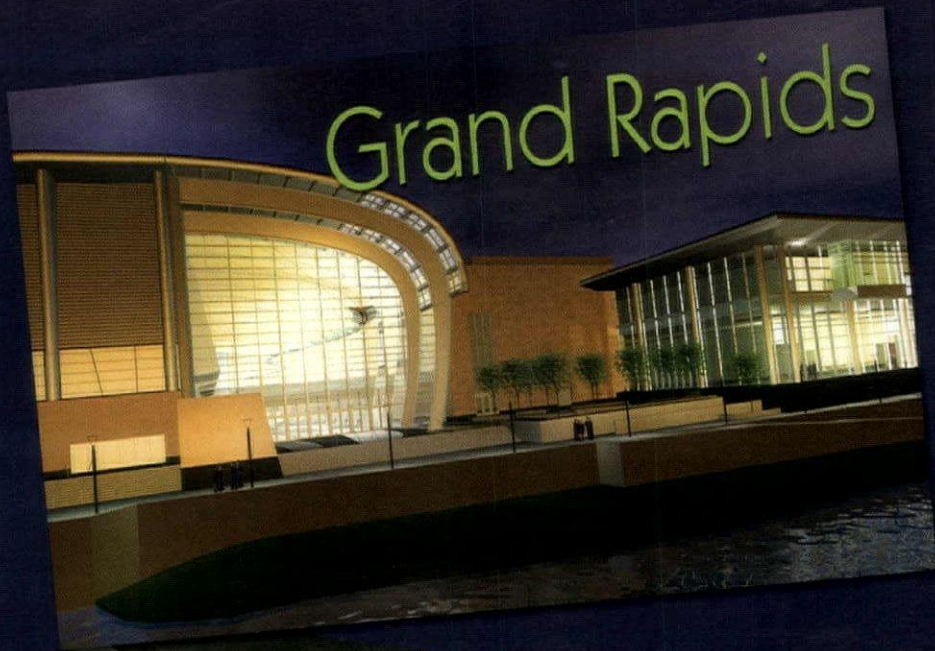

Grand Rapids



Pittsburgh



Reno-Sparks

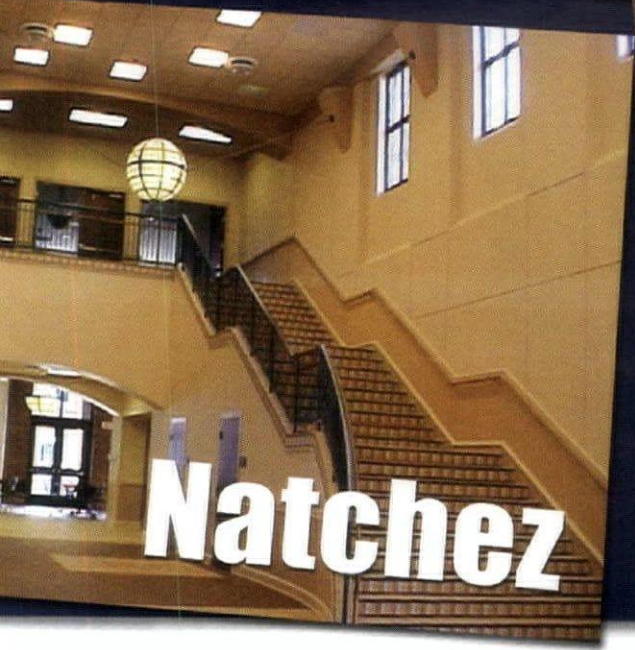

Natchez

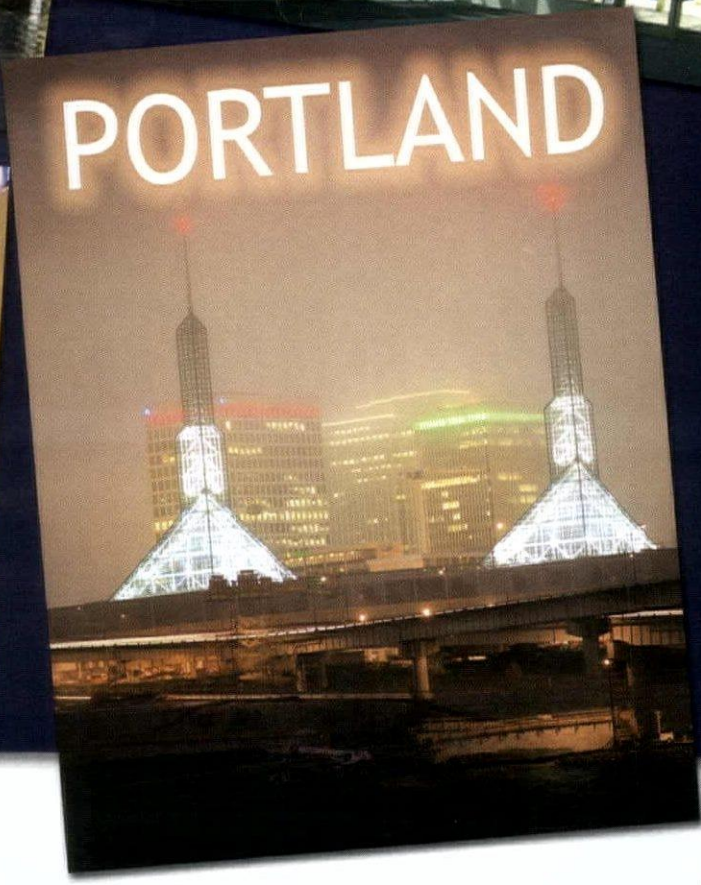

PORTLAND

extraordinary capabilities of the Innovator control consoles — to form the most powerful lighting control solution available today. Altogether, it puts managers in complete control of every lighting situation, all the time. ■ Leviton's flexible Dimension D-8000. Whether a rock concert or business convention, garden show or psychology lecture, it always puts you in the best light. ■ For more information, contact Tom Leonard at 503-404-5506.

LIGHTING CONTROL DIVISION

Circle No. 46 on reader service card





TENAYA[®]



*You Must
be Dreaming!*

We just made your dreams
come true. See how in
booth #1929 at
Lightfair 2003



PRODUCTS

-  26 Decorative
-  36 Track
-  38 Task
-  40 Downlights
-  44 Indirect & Direct/Indirect
-  48 Outdoor & Landscape
-  52 Lamps, Ballasts & Controls
-  56 Industrial
-  57 Emergency
-  58 LEDs
-  61 Special Product Advertising Section

INDUSTRY REPORT

- 16 **Easy Access**
Saving Time, Increasing Information on the Internet
- 18 **Technology Licensing**
Today's Ideas, Tomorrow's Products
- 60 **Architectural Lighting Master Classes**
The Event, the Products

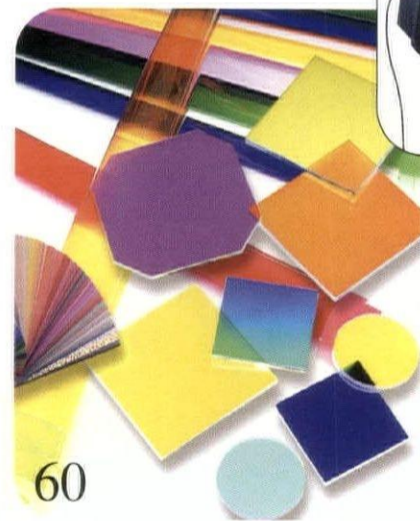

ARCHITECTURAL LIGHTING MASTER CLASSES

DEPARTMENTS

- 12 **Editor's Note**
- 14 **The Inbox**
News in the industry

18

LICENSING NEW TECHNOLOGY



Architectural Lighting (Vol. 18, No. 4 USPS 000-846, ISSN 0894-0436) is published seven times per year (Bimonthly except Monthly in March and June) by VNU Business Media, Inc., 770 Broadway, New York, NY 10003-9595 and is distributed free of charge to individuals or firms engaged in the specification of lighting products in the US and territories. The cost of all other subscriptions in the US and territories is \$48 per year. A one-year Canadian subscription, payable in US dollars, costs \$60 and all other foreign, \$96. Canada Post Publications Mail Agreement No. 40031729. Periodicals Postage Paid at New York, NY and additional mailing offices. Printed in the USA. POSTMASTER: Send changes of address to Architectural Lighting, PO Box 1061, Skokie, IL 60076-8061.

Architectural Lighting is a trademark owned exclusively by VNU Business Media, Inc. Copyright 2003 VNU Business Media, Inc. All rights reserved. Reproduction of this magazine, in whole or in part, is prohibited unless authorized by the publisher. Editorial and advertising offices: 770 Broadway, New York, NY 10003. Phone (646) 654-4500. Customer Service Inquiries: For address changes, single copy sales (\$7 in the US, \$7 + postage outside the US, payable in advance) and subscription inquiries, write to Architectural Lighting, PO Box 1061, Skokie, IL 60076-8061 or call Customer Service at (847) 647-7987 outside the US.

CREST
Exciting new glass shapes



"I saw it first."



TRI-CREST

The right look for you. Veins offered in frosted as standard —also available in red, green and blue

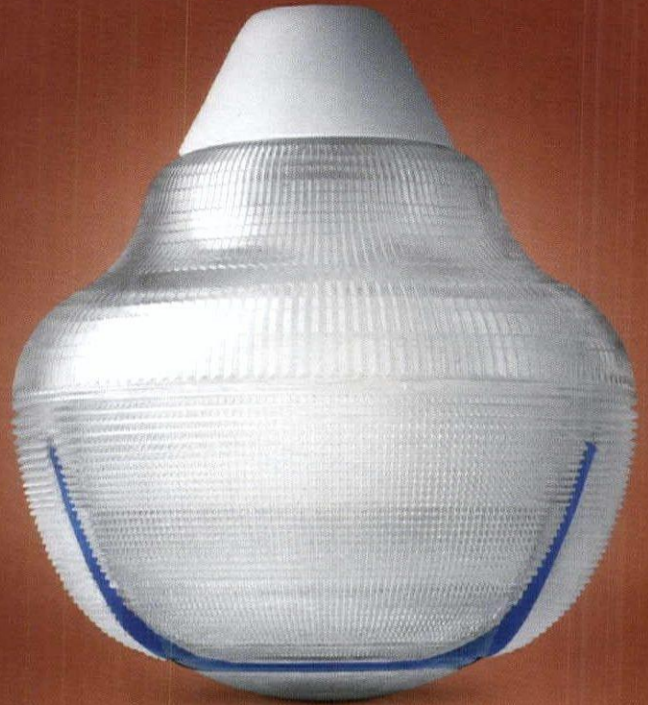

"Now, that is top of the line..."



Illuminate™
The new shape of light™

More reasons why you should choose Illuminate.

UNIQUE BALLAST DESIGN

Industry's first architectural ballast housing—
either integral or surface
Shapes available in large and compact sizes

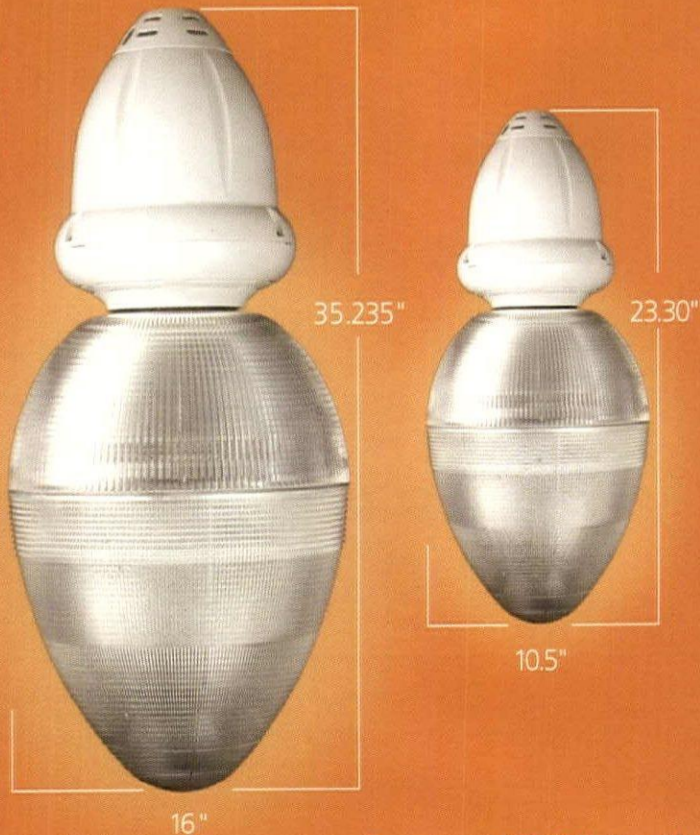

See us at LightFair booth 2349
See us at AIA Show booth 3836

EGG WITH WALL BRACKET

Many decorative accessories and mounting configuration options
Indoor/Outdoor damp location

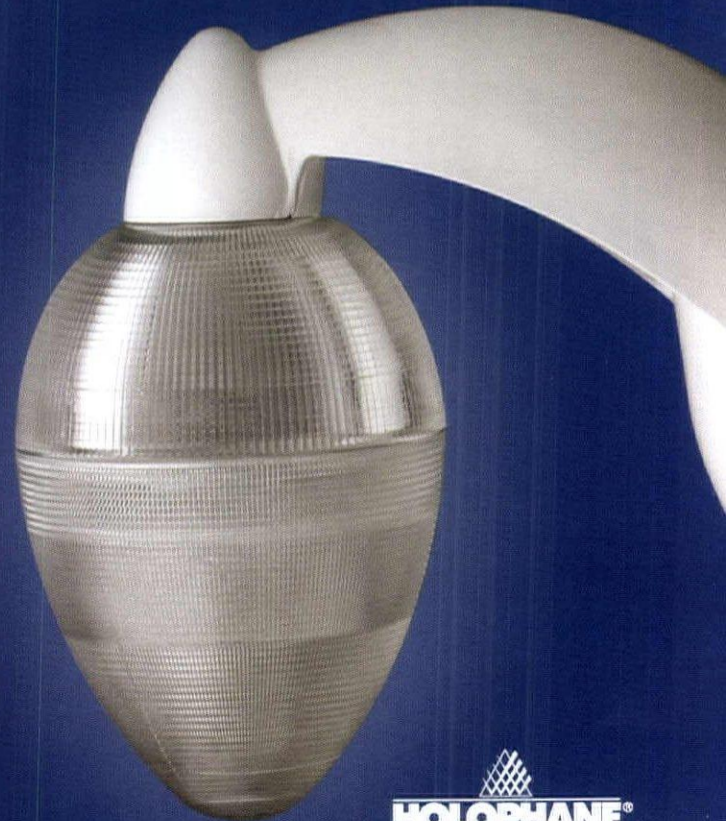

Contact your local Holophane factory sales representative, call (740) 345-9631 or write to Holophane, 214 Oakwood Avenue, Newark, Ohio 43055. Visit us at www.holophane.com.

Circle No. 43 on reader service card

[OPTA]



DESIGNER ROBERTO FIORATO

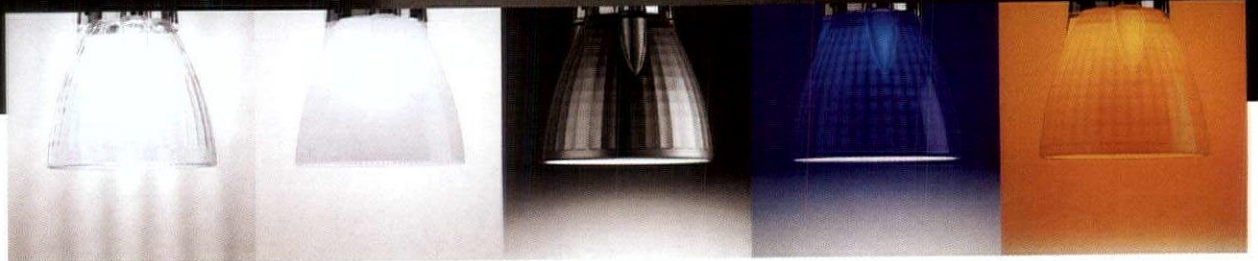

LIGHT & ART SUSPENDED

Faceted pressed glass pendants. Five brilliant colors. Three sizes.

PRISMA NORTH AMERICA, INC.
300 PETTY ROAD, SUITE C
LAWRENCEVILLE, GA 30043
VOICE 770.822.2115 - FAX 770.822.9925
EMAIL: INFO@PRISMALIGHTING.COM

Circle No. 5 on reader service card

PRISMA[®]
ARCHITECTURAL LIGHTING

architectural lighting

MAY/JUNE 2003

VOL.18, NUMBER 4

EDITORIAL STAFF

EDITOR-IN-CHIEF

CHRISTINA TRAUTHWEIN
(646) 654-4481
fax (646) 654-5816
ctrauthwein@vnuuspubs.com

ART DIRECTOR

JONATHAN MARSLAND
(646) 654-4472
fax (646) 654-4480
jmarsland@vnuuspubs.com

MANAGING EDITOR

ALICE LIAO
(646) 654-4482
fax (646) 654-5816
aliao@vnuuspubs.com

CONTRIBUTING EDITORS

WANDA JANKOWSKI, JEAN NAYAR,
DAVID HOUGHTON, PE, CRAIG D'LOUIE,
MARK NEWMAN, PAUL VRABEL, LC

EDITORIAL ADVISERS

JAMES BENYA, IALD, BENYA LIGHTING DESIGN
HOWARD BRANDSTON, LC, FIALD, FIES,
BRANDSTON PARTNERSHIP
RENEE COOLEY, COOLEY MONATO STUDIO
CRAIG D'LOUIE, ZING COMMUNICATIONS
KENNETH A. DOUGLAS, IALD, LC,
THE MINTZ LIGHTING GROUP
GARY STEFFY, LC, FIALD, GARY STEFFY LIGHTING DESIGN

SUPPORT

PRODUCTION

VINCE HABICK
(646) 654-7238
fax (646) 654-7317

CIRCULATION MANAGER

MARIE SYLVESTRE
msylvestre@vnuuspubs.com

CIRCULATION COORDINATOR

MICHELE LARSEN
mlarsen@vnuuspubs.com

LIST RENTAL

(845) 620-9000
fax (845) 620-9035

CUSTOMER SERVICE

(847) 647-7987
fax (732) 380-2422

REPRINTS

PARS INTERNATIONAL, INC.
(212) 221-9595
fax (212) 221-9195
reprints@parsintl.com

PUBLISHER

SUZANNE TRON HABER
(646) 654-5756
fax (646) 654-4484
sthaber@vnuuspubs.com

GROUP MARKETING MANAGER

KELLY CARSON
(646) 654-7654
fax (646) 654-7365
kcarson@vnuuspubs.com

ADVERTISING SALES

NORTHEAST/INTERNATIONAL

CLIFF SMITH
National Business Development Manager
(646) 654-4478
fax (646) 654-5816
csmith@vnuuspubs.com

MIDWEST/CENTRAL

ROB BROCKLEY
(312) 583-5505
fax (312) 583-5507
rbrockley@architecturemag.com

WEST

JON HENG / PATRICIA OLAIZ HENG
(626) 799-3610
fax (626) 799-5853
patsbea@msn.com

TEXAS

MITCH DUFFY
(281) 895-9229
fax (281) 895-9209
mduffy@vnuuspubs.com

SPECIAL PROJECTS, ADVERTISING

CLASSIFIED ADVERTISING

MICHAEL PARRISH
(646) 654-5763
fax (646) 654-5816
mparrish@vnuuspubs.com

Color your world with Contour.

A NEW WAVE IN INTERIOR LIGHTING

Circle No. 30 on reader service card

Forms+Surfaces

www.forms-surfaces.com

800.451.0410

770 Broadway, New York, NY 10003

Real Estate and Design Group

Richard O'Connor, President
Stan Itzkowitz, VP, Operations

Real Estate and Design Group Publications: Architectural Lighting, Architecture, Commercial Property News, Contract, Hospitality Design, Kitchen & Bath Business, Multi-Housing News

Other VNU Business Publications Groups

General and Specialty Retailing; Retail and Food Media; Retail Design; Travel, Performance and Healthcare

vnu business publications

President & CEO: Michael Marchesano; Chief Operating Officer: Howard Lander; Group Presidents: Mark Dacey (Marketing/Media & Arts); Robert Dowling (Film & Performing Arts); Mark Holdreith (Retail); John Kilcullen (Music & Literary); Richard O'Connor (Travel, Performance, Food Service & Real Estate/Design); Vice Presidents: Joanne Wheatley (Information Marketing); Barbara Devlin (Manufacturing & Distribution)

vnu business media

President & CEO: Michael Marchesano; Chief Operating Officer: Howard Lander; Chief Financial Officer: Joe Furey; President - VNU Expositions: Greg Farrar; Executive Vice President - eMedia and Information Marketing: Tomi Nevitt; Vice President/Business Development: John van der Valk; Vice President/Business Management: Joellen Sommer; Vice President/Communications: Deborah Patton; Vice President/Human Resources: Sharon Sheer; Vice President/Licensing and Events: Howard Appelbaum

BPA

Copyright © 2003 by VNU Business Media, Inc. All rights reserved.



eLumitTM

www.eLumit.com

Search Engine:

fast
free
intuitive
comprehensive
product database
new product updates
spec-building tools
...the future of light

editor'snote

Welcome to Lightfair—and to our at-show annual Market Issue. We've pulled together just about 200 products, ranging from decorative fixtures to lamps to controls, to bring you what we think is an interesting and comprehensive selection of what the lighting manufacturers have to offer. Some were introduced within the past year, others are set to debut at Lightfair. We hope you'll take a moment to peruse the issue and set aside some time to visit the booths of those participating in Lightfair 2003. And while you're at it, don't forget to stop by and visit us at **booth 2037!**



Christina Trauthwein,
Editor-in-Chief

But, of course, this is just a small sampling of all that's out there...please continue to send us your product information or let us know about any exciting technology and design you find particularly noteworthy. We'd love to include it on the pages of *Architectural Lighting*. And, speaking of reader participation, I invite all of you who do attend Lightfair in New York to send in your responses to the following questions to be included in a post-Lightfair article (just email me at ctrauthwein@vnubuspubs.com):

- What's the most innovative product you saw?
- The most notable trend?
- What seemed to be missing?
- How about the most promising technology?
- What do you hope to see developed for next year?

Now, speaking of Lightfair, let me just take a moment to say a few words about a subject of which many of you may already be aware, but if not, just might be a topic of discussion as we head into this year's event: The IALD's recently announced European-based official media partner.

Since launching 17 years ago, *Architectural Lighting* has consistently and avidly supported the IALD, particularly in the past decade as the proud cosponsor of the IALD Lighting Design Awards. We—the magazine and the staff—have lent our encouragement, experience and assistance in not only growing the lighting industry and profession, but particularly, the prestigious Association through countless editorial coverage, student scholarships and dedicated effort to promoting the annual Awards event. From serving for many years as co-chair of the judging committee to producing the printed program to presenting the awards to the many distinguished winners, it has been an honor to play a role in this process of growth and development and one I will recall fondly as I've greatly enjoyed the experience. *Architectural Lighting* firmly believes in providing our readers with the best—and we look forward to the future with the IALD and a continued relationship of support and mutual cooperation, albeit redefined.

And on that note, I'm pleased to announce another addition to our editorial advisory board. Coincidentally enough, this year's new IALD Awards co-chair: Kenneth A. Douglas, IALD, LC, associate principal at The Mintz Lighting Group. Ken joined the firm in 1989 after several years as a theatrical lighting designer and has been the lead designer on many outstanding projects, earning him multiple lighting design awards from both the IESNA and the IALD. Ken acts a project manager and designer for a variety of project types such as signature bridges, corporate campuses, courthouses, academic buildings and retail venues. His most noteworthy projects include The Thomas Jefferson Memorial in Washington, D.C. (see cover story of our August/September 2001 issue); the Sprint World Headquarters in Overland Park, KS; and the Victory Bridge in New Jersey. Welcome Ken—we look forward to your experience and insight!

As you know, I am always available to hear your ideas, suggestions and criticisms. Please email me at the aforementioned address or call me at (646) 654-4481. ■

On the cover (clockwise from top right): *Énergie's* Level family of fixtures; *Xilver BV's* Droplet; *Ushio's* JDW Safety Quartz Halogen Lamp; *Luceplan's* Agaricon table lamp; *Flux, Inc.'s* Fixture Two; *Ivalo Lighting's* Aliante sconce; *North American Lighting Spectrum's* Blob (center).

design with light

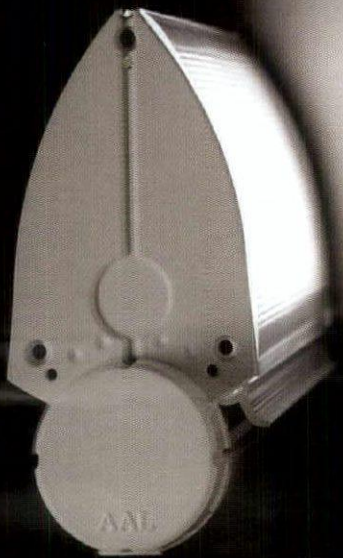

Pivot™

PRECISION FLOODLIGHTING + INDIRECT LIGHTING

Beautifully illuminate any surface directly or indirectly with the new Pivot series from AAL. Linear fluorescent sources, individually or in continuous rows, for interior or exterior applications. The Pivot, the third essential tool for designing with light.

ARCHITECTURAL
AREA
LIGHTING



www.aal.net/pivot



www.aal.net/cypher



www.aal.net/oculus



Hubbell Lighting

Circle No. 34 on reader service card

TECH trak™

Tech Lighting's Tech trak™, the first-ever hand-bendable line-voltage track lighting system.

The revolutionary design features a sleek metal track that can be curved in the field to form practically any shape, while simultaneously providing powerful and versatile illumination options.

Tech trak™ — it's track lighting with a twist.



EPA RECOGNIZES SYLVANIA & WESTINGHOUSE

The U.S. Environmental Protection Agency (EPA) has named Osram Sylvania as Energy Star Partner of the Year for its contribution to reduce greenhouse gas emissions by making and promoting energy-efficient products. The company was recognized at an awards ceremony in Washington, D.C. on April 15. A partner in the program since 1999, Osram Sylvania will have 65 percent of its product line Energy Star-qualified by the end of this year.

At the same ceremony, EPA awarded Westinghouse Lighting Corp. a 2003 Energy Star award for educating Americans about the importance of reducing greenhouse gas emissions through energy-efficient lighting. As a leading partner in the Energy Star "Change a Light" campaign, Westinghouse Lighting Corp.'s efforts made it easy for Americans to purchase lighting that has earned the Energy Star label. The company's focus is to create awareness nationally, as well as to educate consumers on the benefits of Energy Star lighting products by using in-store promotions, supporting compact fluorescent lamp sale events and providing informative point-of-purchase materials.

PUBLICATIONS ADDRESS OUTDOOR LIGHTING & FIXTURE MARKET

The **Commission Internationale de L'Eclairage (CIE)** has published a new standard to replace "CIE S003 Spatial Distribution of Daylight—CIE Standard Overcast Sky and Clear Sky," which was released in 1996. This new standard defines relative luminance distributions and incorporates both the CIE Standard Clear Sky and the CIE Standard Overcast Sky. Also new from the CIE is a guide on limiting the effects of obtrusive light from outdoor lighting installations.

Both publications are available from the CIE/USA, C/O TLA Lighting at 7 Pond Street, Salem, MA 01970.

The 2003 edition of "The U.S. Lighting Fixtures Market" is now available from **Market Studies, Inc.** The report offers statistics, forecasts, analytical summaries and recommendations and includes a directory of 2,600 U.S. lighting fixture companies. For more information, phone (919) 845-0050, fax (919) 845-0035 or visit www.marketstudies.com.

ON THE MOVE

Genlyte Controls has completed the relocation of the three brands that comprise the Genlyte Thomas Group's controls division. Entertainment Technology, Lightolier Controls and Vari-Lite all began working from a new single location on April 1. The move consolidates all operations of the three companies in one facility. Each of the three brands will continue to operate and function as individual companies, according to Genlyte Controls General Manager Steve Carson. "Having each of the companies in a single

location and under the same roof will allow us to operate more efficiently and take greater advantage of the synergies and resources that the companies share," he said. The new facility, which has more than 70,000 sq. ft. of manufacturing and office space, is located at 10911 Petal St., Dallas, TX 75238. The toll-free phone numbers for each of the companies will remain the same: Entertainment Technology, (800) 223-9477; Lightolier Controls, (800) 526-2731; and Vari-Lite, (877) 827-4548.

Xelogen

xenon lamps taken to the next level

*CAN BE USED IN OPEN FIXTURES
NO SHIELDING REQUIRED*

Long Life - up to **20,000** hours

Dimmable - dimming does not shorten lamp life

Filled with low pressured Xelogen gas - glass shielding not required

Lower heat output - safer and offers more flexibility in fixture design

Do not emit damaging UV rays - ideal for artwork and sensitive fabric

Handling - can be installed with bare hands without affecting lamp life

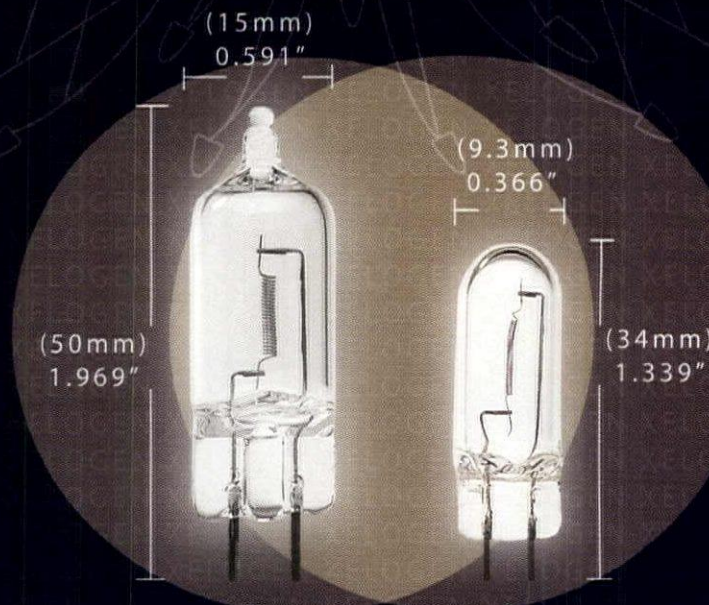

Low Voltage Series

Visit us at Lightfair booth #1043

THHC Lighting - Synonymous with Quality Lighting Since 1986

1300 John Reed Court, Unit D, City of Industry, CA 91745 USA Phone 626.330.8368 Fax 626.330.3616 U.S. Toll Free (877) XELOGEN (935-6436)
e-mail: sales@thhclighting.com www.xelogen.com

Circle No. 62 on reader service card

pure innovation.

YOUR VISION. YOUR PROJECT. YOUR LIGHTING SOLUTION.

Architectural

Display

T5 / T8

Fluorescent

Incandescent

Linear

Low Profile

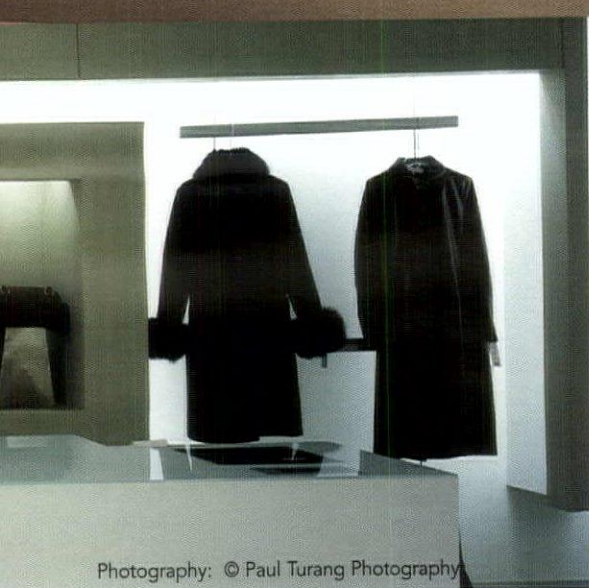

Photography: © Paul Turang Photography



Photography: Mark F. Heffron

Photography: John Edward Linden

specification challenges?

call Bartco Lighting for solutions ▼

714.848.0892

"Slide by Side"



manufacturers of quality lighting products

Circle No. 49 on reader service card

tel 714.848.0892 fax 714.848.6843

bartcoLIGHTING.com

Visit us at:
Lightfair International 2003
Javits Convention Center, Booth 1877
New York, May 6-May 8



Easy Access

Saving time, increasing information on the Internet

BY CHRISTINA TRAUTHWEIN, EDITOR-IN-CHIEF

Architectural Lighting and Architecture Magazines have entered into a partnership with Searchspec.com. As part of the new relationship, visitors to Searchspec.com will be able to easily visit the magazine's websites—lightforum.com and architecturemag.com, respectively. Visitors to these sites will, in turn, be able to access Searchspec.com as a new standard product search feature. In addition, visitors to Searchspec.com will be able to access select articles from Architectural Lighting's archives.

Most people believe the Internet Revolution is over. But what many don't realize is that in the lighting industry, the Internet has already won, and that the next big push is coming.

Only six or seven years ago, the idea of publishing spec sheets on websites and making them available to the public was considered somewhat radical. Now most manufacturers offer spec sheets on their websites. According to a new survey conducted by Searchspec.com and Lightsearch.com, 84 percent of specifiers "go to the manufacturer's website" first when they need a spec sheet, IES files or other critical spec information for a new product they're interested in, compared to 15 percent who contact the manufacturer's sales rep and 3 percent who prefer to contact the manufacturer directly.

The Internet succeeded because it meets two key criteria—it saves time and increases information. Now, two out of three specifiers say they use the Internet *everyday* to find products, manufacturers and manufacturer sales reps for active projects, and one out of three uses the Internet everyday to do general product research not directly related to a project. Today, only 17 percent of specifiers say they primarily use traditional print catalogs and CDs to acquire much of the product information they use for active projects, while 28 percent say they mostly use websites and 70 percent say it's about evenly split.

So while the Internet failed to revolutionize the product channel, it did revolutionize the information channel—particularly in regards to literature fulfillment and spec support for standard products. However, a key problem has persisted. Specifiers have saved time by going to a website instead of calling a sales rep to get literature, but are they saving time mucking through websites doing the actual research? With the hundreds of possible websites and all of the different varieties of website architectures, are specifiers actually saving time versus browsing print catalogs? And with project schedules becoming increasingly compressed, is there still enough time for choice?

Last June, the process of solving this problem began with the launch of Searchspec.com, created by ZING Communications, Inc., a marketing communications and consulting firm specializing in the lighting industry. Searchspec.com is designed to enable easy access to more product choices in less time for today's busy lighting specifier. It connects specifiers with critical spec information for thousands of products in a standard format. Hundreds

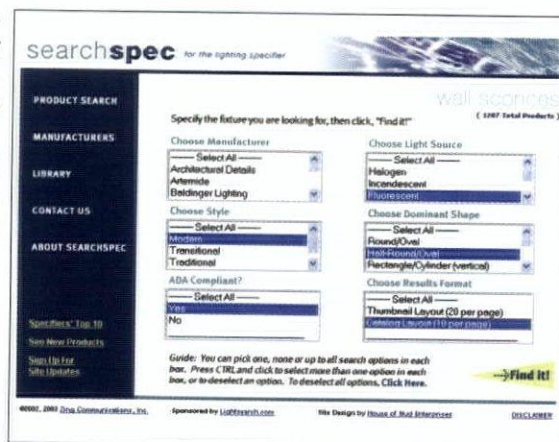

of architects, lighting designers, engineers and other specifiers use the site everyday to find new products, acquire spec sheets and IES files, see products in projects and find contact information for manufacturers and their sales reps.

To use the site, the lighting professional picks a product category, designates general spec criteria and then browses a dynamic catalog of products that meet his or her criteria. After finding the right product, the specifier can then download the spec sheet, IES files, etc. In addition, the specifier can also see all new products, see select products in projects and view products that are the most popular on the site in a series of "top 10" lists. In its simplest form, using Searchspec.com is like imagining a product need and seeing up-to-date catalogs on the shelf flop down and open to the exact pages for the products that meet the need, along with color product photos, attached IES files and contact information for the nearest sales rep.

Although various sites exist to provide similar services, besides Searchspec.com, eLumit is the other major site offering fast, standardized access to product choice and spec information. Each uses a different approach based on choices that address the capabilities of the Internet—with the understanding that each of these choices poses tradeoffs for the user—and also the quirks of the Internet, which is a very powerful but at times unpredictable medium. All specifiers are encouraged to try both sites out and choose the site that best matches their "search personality" and needs.

By adding intelligence to product search available on a single website, and standardizing the results with easy access to critical spec information, Searchspec.com advances the Internet's ability to save time and increase information for specifiers. As a result, this type of Internet tool is expected to become standard practice in the future. The site is accessible at its own URL and also as an advanced search feature on Lightsearch.com, the online directory visited monthly by 50,000 lighting professionals. As of March 5, Searchspec.com offered more than 3,400 products from 85 manufacturers/ brands in seven major categories and projected that by Lightfair the site would offer more than 5,000 products in ten categories (with a "product" being a "product series," not individual model numbers, to make searching faster and results easier to browse).

Manufacturer	Photo	Product	Actions
Lumetta		Large Square Recess, 8022 Light Source: 100W Incandescent, 21W Fluorescent Dimensions (H x W x Projection from Wall) 2 1/8" x 14.00" x 4.00"	Download Download Spec Sheet
The Original Cast Lighting		Depth, 8754 Light Source: (2) 100W Incandescent Dimensions (H x W x Projection from Wall) 2 1/8" x 14.00" x 4.00"	Download Download Spec Sheet
L'Esprit Lighting		Recessed Translucent Quarter Sphere, 9354 Light Source: (2) 100W Incandescent Dimensions (H x W x Projection from Wall) 2 1/8" x 14.00" x 4.00"	Download Download Spec Sheet
The Original Cast Lighting		Light Source: (2) 100W Incandescent Dimensions (H x W x Projection from Wall) 2 1/8" x 14.00" x 4.00"	Download Download Spec Sheet
The Original Cast Lighting		Depth, 9054 Light Source: (2) 100W Incandescent Dimensions (H x W x Projection from Wall) 2 1/8" x 14.00" x 4.00"	Download Download Spec Sheet
L'Esprit Lighting		Colturi Series, 8450 980 Light Source: (2) 100W Incandescent Dimensions (H x W x Projection from Wall) 2 1/8" x 14.00" x 4.00"	Download Download Spec Sheet
Recessed Lighting		Height, 10000 2000 Light Source: (2) 100W Incandescent Dimensions (H x W x Projection from Wall) 2 1/8" x 14.00" x 4.00"	Download Download Spec Sheet
L'Esprit Lighting		Hi-Rail, 10002 Light Source: (2) 100W Incandescent Dimensions (H x W x Projection from Wall) 2 1/8" x 14.00" x 4.00"	Download Download Spec Sheet
Lumetta		Large-Square Recess, 8022 9800 Light Source: 100W Incandescent, 21W Fluorescent Dimensions (H x W x Projection from Wall) 2 1/8" x 14.00" x 4.00"	Download Download Spec Sheet
L'Esprit Lighting		Arctic Quarter Sphere, 11007 Light Source: (2) 100W Incandescent Dimensions (H x W x Projection from Wall) 2 1/8" x 14.00" x 4.00"	Download Download Spec Sheet

The first paragraph of this article stated that the "next big push is coming," but Searchspec.com is only a first step in that direction as it is an "open loop" that connects the specifier to spec information but does not walk them through the entire construction process. The Internet offers even more dramatic capabilities, for example, such as automated access to pricing, availability, shipment tracking and final documentation. The small number of progressive vendors that offer these capabilities are generally doing so privately and through a non-integrated patchwork of services. As Internet technology becomes more reliable and its utility is increasingly validated to manufacturers, it will be possible in the future for lighting professionals to generally search for a product, then specify it down to the exact model number and "close the loop." This specification process would generate pricing based on volume, real-time availability, real-time delivery tracking, documentation and an XML-wrapped bundle of cost and performance data that could be read by any software platform used by any professional in the construction process.

The Internet has matured to a large extent and most users are now using DSL or cable to connect to it, opening significant possibilities. Sites like Searchspec.com and eLumit.com are an important first step in realizing this future by standardizing search and access and streamlining communication between specifiers and manufacturers. ■

Cool-Lens Well Light

70-175 W Metal Halide

For safe illumination of trees, columns, canopies or architectural features from pedestrian areas.



KIM LIGHTING

16555 East Gale Avenue
City of Industry, CA 91745
626/968-5666

www.kimlighting.com

Circle No. 12 on reader service card



Hubbell
Lighting, Inc.



Technology Licensing

Today's ideas just may become tomorrow's products

BY CRAIG DILOUIE, CONTRIBUTING EDITOR

Technology licensing turns years of research and development into products that can be quickly made commercially available across the industry, matching their utility to existing supplier brands, manufacturing facilities, distribution networks and expertise. This article will review some of the multitude of new ideas that may become tomorrow's hot new products through licensing—from Honeywell International, Revelations in Design and Ultrawatt Energy Systems.

FIXTURE OPTICAL SYSTEMS

Honeywell International is a familiar name in the construction industry, a Fortune 100 company—one of the 30 select companies represented by the Dow Jones Industrial Average—with over \$24 billion in sales in 2001 and more than 115,000 employees in 100 countries. What many don't know, however, is that Honeywell is very active in licensing its intellectual properties, with more than 1,500 granted licenses that provide over \$100 million in annual revenue—some of which comes from lighting manufacturers utilizing technology originally designed for backlighting LCDs.

The company is now offering a linear suspended direct/indirect optical design, a fiber-optic lighting system and an LED lighting system based on this core technology, each modeled and analyzed using the Advanced Systems Analysis Program (ASAP)—an optical ray trace, analysis, design and modeling pro-

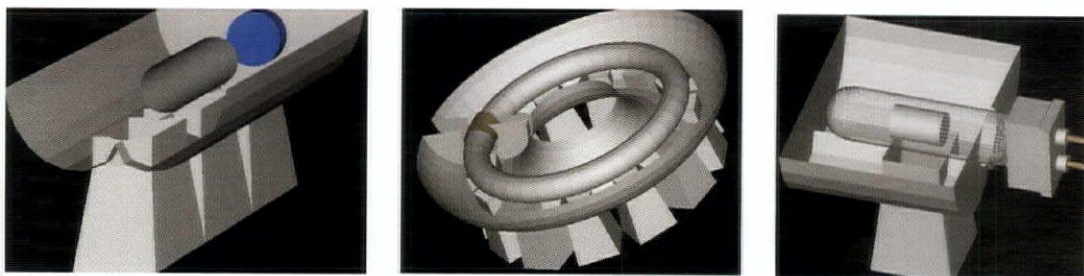

Figure 1: Honeywell's optical system distributes about 80 percent of the light up and 20 percent down for VDT applications, with the downlight component substantially devoid of glare and with a 95-percent efficiency when used with formed, sheet-metal reflectors. Shown are ASAP model renderings of the linear, circular and ceramic arc metal halide models.

percent down for VDT applications (see Figure 1).

The fixture design employs a hybrid of cusp-reflector (uplight) and an array of non-imaging optics (downlight). Key to the design was the development of a geometry whereby light does not reflect back to the lamp.

The ASAP model shows that the downward component has an angular distribution compliant with DIN-5035/7 specifications, which means it is substantially devoid of light between 60 and 90 degrees of vertical to eliminate glare. ASAP also shows 95 percent of the lamp lumens delivered to the upward/downward targets with formed, sheet-metal reflectors, such as Specular+ from Material Sciences Corp.

The non-imaging optics used for the downlight component can also be formed from solid glass or plastic for aesthetic reasons. The design can be used in conjunction with a mild diffuser spaced below the non-imaging optics to eliminate a direct view of the lamp through the collimators and spread the downlight source over a larger area.

Fiber-Optic System. The original application for this technology was to develop a highly efficient fiber-optic lighting system for use in the backlighting of LCDs. Unique to the approach are stackable, injection-molded, non-imaging fiber collimators used at each end of the fiber.

At the input end of the fiber, the stackable feature avoids illuminating the gaps between adjacent fibers, producing a minimum efficiency improvement of 10 percent over traditional coupling losses into fiber bundles. At the output end of the fiber, the stackable feature can be used to form unique, uniform, geometrical illumination patterns, which can be projected to a targeted area via low-cost, off-the-shelf lenses. Alternatively, the stackable non-imaging optics can be user-configured into custom signage in the form of letters, graphics and so on.

The approach eliminates the dark gaps observable in traditional fiber-bundle illumination approaches and is compatible with color wheels or other color-selective fiber-coupling techniques. Three unique light collection optical approaches are available to maximize efficiency, eliminate lamp shadow, ensure equal distribution of lumens per fiber and reduce cost. The optical fibers can be off-the-shelf plastic fibers such as Mitsubishi's ESKA, large-core fibers such as Optiflex from Fiberstars and StaFlex from Lumenyte, and glass fibers, such as those produced by Schott Glass and Asahi Glass.

"The proposed systems are driven toward low cost

and high efficiency to remove traditional market barriers to fiber-optic lighting," said Bob Saccomanno, manager of licensing and intellectual property for Honeywell's Teterboro, NJ operations. "Existing illuminators are generally expensive, require custom fiber cables and have end-optics that are generally limited, such as circular lenses. Our intent is to allow the user to buy their own lamp, cable and so on and use our injection-molded, non-imaging optics to easily put low-cost, highly efficient, high-performance systems together, including unique output configurations. Commercialization of these systems will reduce cost, while increasing efficiency and versatility in typical fiber-optic applications—such as accent lighting, heat/UV-sensitive applications and pool and spa lighting—and potentially opening new applications."

LED System. Based on its fiber-optic technology, Honeywell saw an application for LEDs. Most LED arrays have dark interstitial regions between LEDs. By using hollow, stackable, collimating, non-imaging optics to distribute LED light, a crisp edge is provided to the illumination pattern, removing the dark gaps between LEDs and making this technology ideal for LED signage (see Figure 2).

NEW HUMAN-LIGHTING INTERFACE

The Symmetron controller from Austin, TX-based Revelations in Design, designed as a replacement for standard switches and dimmers, allows occupants to control multiple lighting and other devices through simple hand motions in close proximity to the front of the control box or through physical contact/directional motion of a ball controller.

These hand motions are translated to a broad variety of commands using existing low-voltage circuitry; the occupant can select a single device or group of devices and then control the discrete attributes of these devices. The Symmetron controller, for example, can turn on and off a single light or bank of lights and also raise or lower light output to preference (dimming).

Designed to replace banks of controllers with a single device and programmable for three- and four-way circuits, this passive interface is suited to any traditional lighting setting and may be designed to integrate lighting control with plumbing, HVAC, mechanical, electronic and virtually any other electrical system. For example, in a conference room, the Symmetron controller could integrate the

(Continued on page 20)

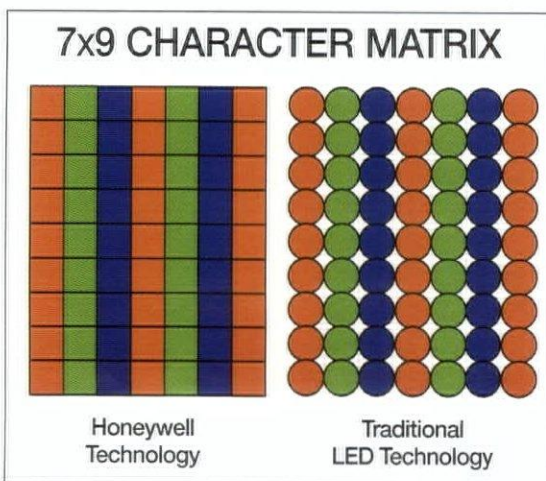

Figure 2: Honeywell's design of LED arrays eliminates the dark interstitial spaces between the LEDs. With square/triangular outputs, the LEDs can be arranged to form 2D/3D images.

gram provided by Breault Research Organization. The intellectual property packages encompass patents (and pending applications) that describe both design methodologies and low-cost manufacturing methods. Trade secret information in the form of optical models/analyses and supply-chain information is also available.

Direct/Indirect. Honeywell designed an optical system for linear, circular and U-shaped fluorescent lamps (and other sources such as ceramic arc metal halide) that distributes about 80 percent of the light up and 20

Switching and dimming systems from one global resource.

A hallmark of architectural and technological sophistication, the Bank of China, Beijing, utilizes Lutron dimming and switching systems to enhance and highlight its stunning architecture and improve building performance.

See us at Lightfair, Booth #854.

Photography by Kerun Ip, courtesy of Pei Partnership Architects LLP.

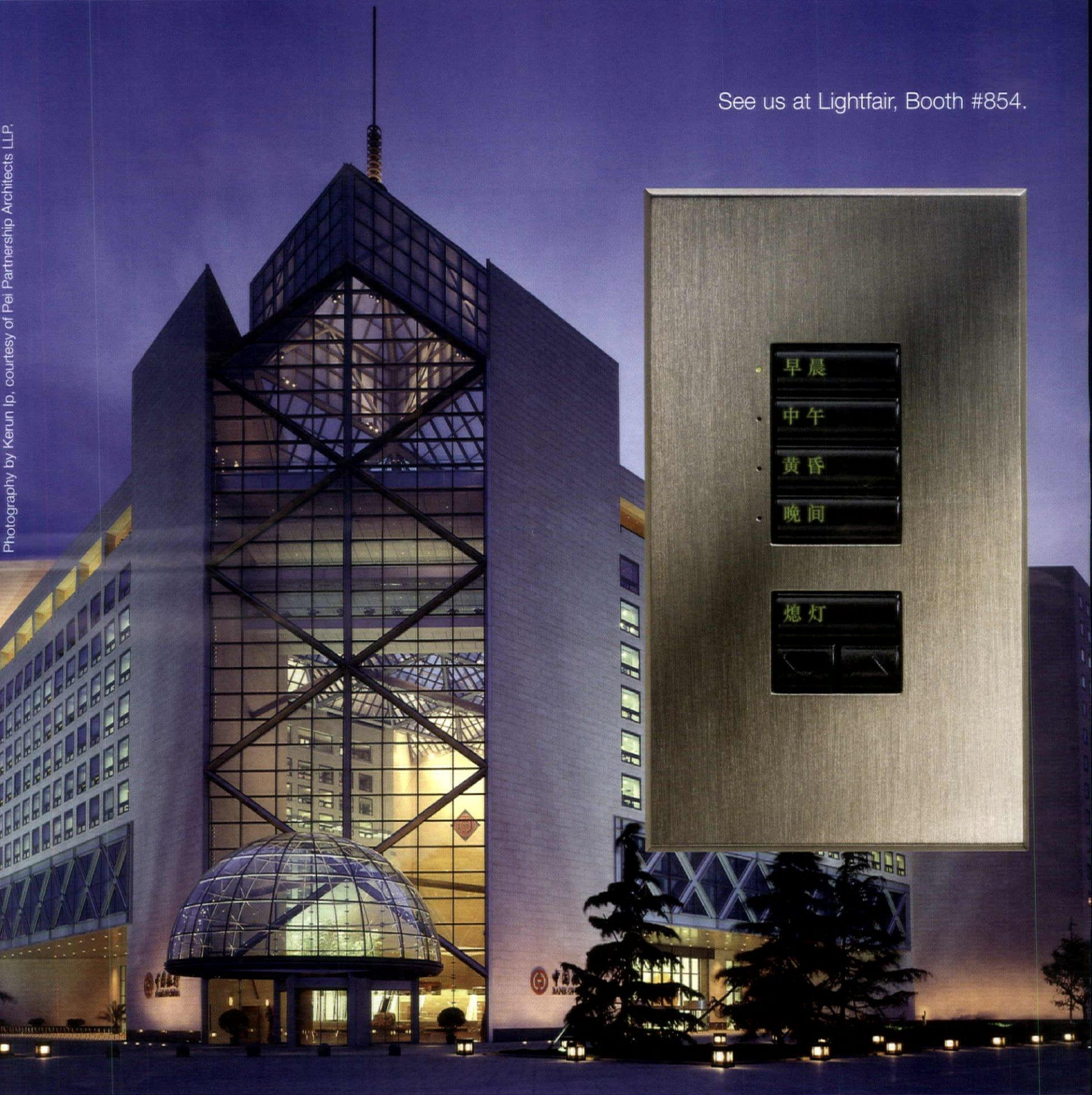

Lutron lighting controls provide comprehensive dimming and switching solutions for any project, anywhere in the world. Call us at **877-258-8766** ext. 200 or visit us at www.lutron.com/architecturallighting.

Lutron controls your light.™

Circle No. 9 on reader service card

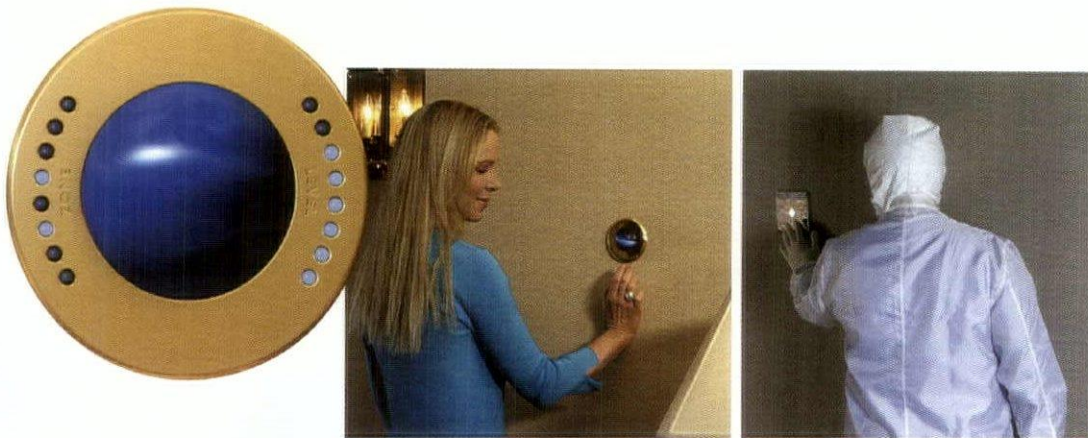

The Symmetron controller (above left) is designed for multiple applications including residential where it is capable of interfacing with stereo/home theater systems and cleanrooms and healthcare facilities where the touchless device helps to maintain a sterile environment.

banks of switches, dimmers and other controls used to control lighting, ventilation, audio/visual and telephony into a single multi-use device controlled by hand motions.

In residential applications, the Symmetron controller is capable of interfacing with stereo/home theater systems, enabling occupants to select the various functions of the stereo, CD player, TV set, tuner, cassette or video player; then select volume, play, pause, fast-forward, rewind, mute, station tuning and so on. All other home devices, such as ovens, washers and refrigerators can also be controlled by a single or small group of controllers. In addition, the Symmetron can be incorporated into whole-house integrated computer systems.

Feedback may be provided using LED or LCD displays or even audible and/or tactile response. The actual device is independent and does not require a computer and integrates the controller, computer, dimmer and feedback technology components into a device small enough to install in a standard gang box. The technology's operation is dependent on existing electrical systems but not on individual devices, meaning it is expected to be versatile to accommodate future building technologies as well as existing systems. The Symmetron controller's functionality also evolves with the ever-changing needs of the occupant through simple reprogramming.

"The Symmetron offers limitless architectural design possibilities," said Jonathan Josephson, CEO of Revelations in Design, who conceptualized the technology with Sylvia Pettit, the company president, while working together on a lighting design project. "Picture a world with no buttons, switches or knobs used to activate and control any electrical device. With simple finger movements, occupants can operate their lighting, surround sound, air-conditioning/heating and security with controls that blend seamlessly with the environment, accenting and enhancing the architecture it adorns. Embodiments can be configured to read movement, check for authorization by fingerprint recognition and may also be used as a camera for security monitoring. In cleanrooms and hospitals, touchless controls with no moving parts and sealed, flat surfaces provide the ability to help maintain a sterile environment and reduce probability of contamination caused by contact. The world operates more intuitively, more gracefully and more cleanly with intelligence that is built around the occupant."

"With the Symmetron controller, we have crossed the threshold between design and intuitive function and can truly say we are 'turning the world on,'" said Sylvia Pettit.

"We are not changing what is done, we are changing *how* it is done," added Hunt Pettit, SVP of marketing, Revelations in Design.

GLOBAL DIMMING

Energy, environmental and productivity concerns have heightened interest in lighting controls systems that can provide flexibility while reducing energy consumption. Ultrawatt Energy Systems, Inc. of Fort Myers, FL, a developer and marketer of energy conservation intellectual properties founded in 1992, now offers a viable solution.

The major buzz in the industry over the past year has been the Digital Addressable Lighting Interface (DALI) protocol, which enables facility operators to individually address and control each ballast and either preset it to automatically dim or dim according to ambient conditions over the full 1-100-percent range. However, because DALI requires a dedicated low-voltage wiring network, requires premium digital ballasts and significant planning, installation and commissioning, digital networks are often not practical for existing buildings. Ultrawatt is hoping to capture this market and also present an alternative for new construction by offering the PowerGate Intelligent Management System, a technology that delivers similar benefit but with less complexity and a lower installed cost (see Figure 3).

PowerGate, the result of 10 years of research and testing and over \$30 million in investment, provides the energy-saving benefits of automatic shut-off and up to 50-percent dimming for fluorescent electronic and HID and up to 30-percent dimming for fluorescent magnetic lighting systems, with dimming occurring over a nominal one-minute period. Using the software, facility operators can individually address each circuit as the point of control. Bi-way communication takes place between the point of control (a PC) and any number of lighting circuits in any number of buildings, located anywhere, using the Internet, a dial-up connection or LAN. An integrated meter logs data for energy savings verification and circuit analysis, and the system also provides the capability of 24/7 power monitoring.

"PowerGate now comprises an intellectual property portfolio, including commercialized products with proven utility, which we are actively marketing to both select large customers and compatible manufacturers for licensing," said Gary Wendt, CEO of Ultrawatt. Wendt, who recently joined the company in a senior advisory role to Tim Yablonowski, the company's founder and president, is best known for his 24-year career at General Electric, where he founded GE Capital and built it into the company's largest business with more than \$255 billion in international assets and 90,000 employees. "PowerGate is a sophisticated technology built into a relatively simple line of products that can help corporations maximize profits, reduce air pollution at power plants, participate in utility demand response/load curtailment programs and LEED, and gain other benefits that produce an excellent cost-benefit."

PowerGate sounds like a power reducer controlled by software at a central control station, and it comes from that family. However, Ultrawatt's technology is nonetheless unique, protected by more than 20 patents, and most importantly, its performance and sales claims have been verified in numerous independent tests and pilot installations. The

core of the technology is a proprietary capacitive power-switching system integrated in each control unit, which installs between the circuit breaker and the load. It measures the operating characteristics of the lighting circuit; after a warm-up period, the internal power switch begins to operate in conjunction with internal capacitance values, gradually reducing the RMS voltage to the load by precise timing. During this operation, phase-shifting of the line voltage and current waveforms (as measured at the control unit's input) occurs. The result is a clean sine wave that the company has patented. Line current is shifted to lead the line voltage, producing a pronounced leading power factor (typically adding 30-50 degrees of phase lead compensation at each load bank); as many facilities have an overall lagging power factor due to inductive loads such as air-conditioning compressors, the compensation often yields a more desirable higher power factor closer to the optimal value of 1.0 at the facility's main utility power feed.

PowerGate has been tested by organizations such as Advance Transformer, Osram Sylvania, ETL, FCC, SMUD, UL, utilities and the Lighting Research Center, and installed in beta sites including facilities at Boeing, General Electric, NASA, Sygma/Sysco Foods, Sears and O'Hare International Airport. Testing at Advance Transformer documented a lower ballast case temperature that led the company to conclude that standard fluorescent and HID ballasts would tend to experience an increase in service life in a lighting system controlled by PowerGate, a benefit that may also relate to some extent to lamps; at the Sygma/Sysco Foods beta site, Sylvania Lighting Services, the contractor responsible for maintaining the lighting system, reported lamp failures well below the norm after two years of operation.

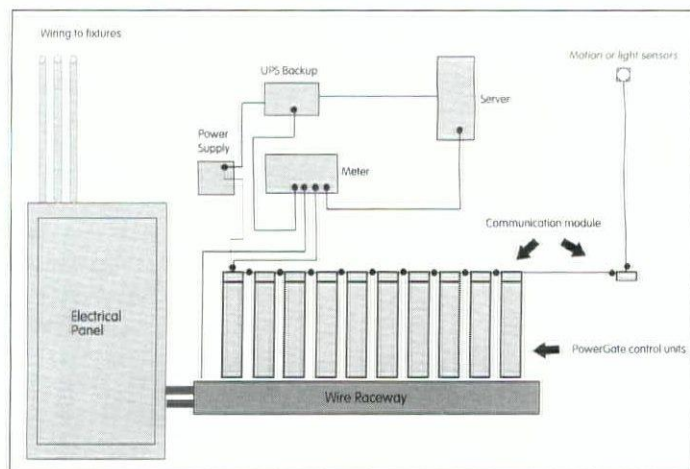

Figure 3: Ultrawatt's PowerGate software offers multiple benefits—including less complexity and lower installed cost—for both existing and new construction.

PowerGate technology is centered around the PowerGate Intelligent Lighting Management System but is expanding with a wall/ceiling-mounted unit that performs a dual-dimming and occupancy-based automatic switching function; basic stand-alone, outdoor and small application models without the software; and an energy management system version that combines lighting control with HVAC control and a smaller footprint.

Manufacturers interested in:

Honeywell's technologies—contact Bob Saccomanno, manager of licensing and intellectual property, at (201) 393-3589.

Revelations in Design's Symmetron multiple device controller—contact Hunt Pettit, SVP of marketing, at (512) 619-6329 or hpettit@r-in-d.com.

Ultrawatt's PowerGate—contact Tim Yablonowski,

martinarchitectural

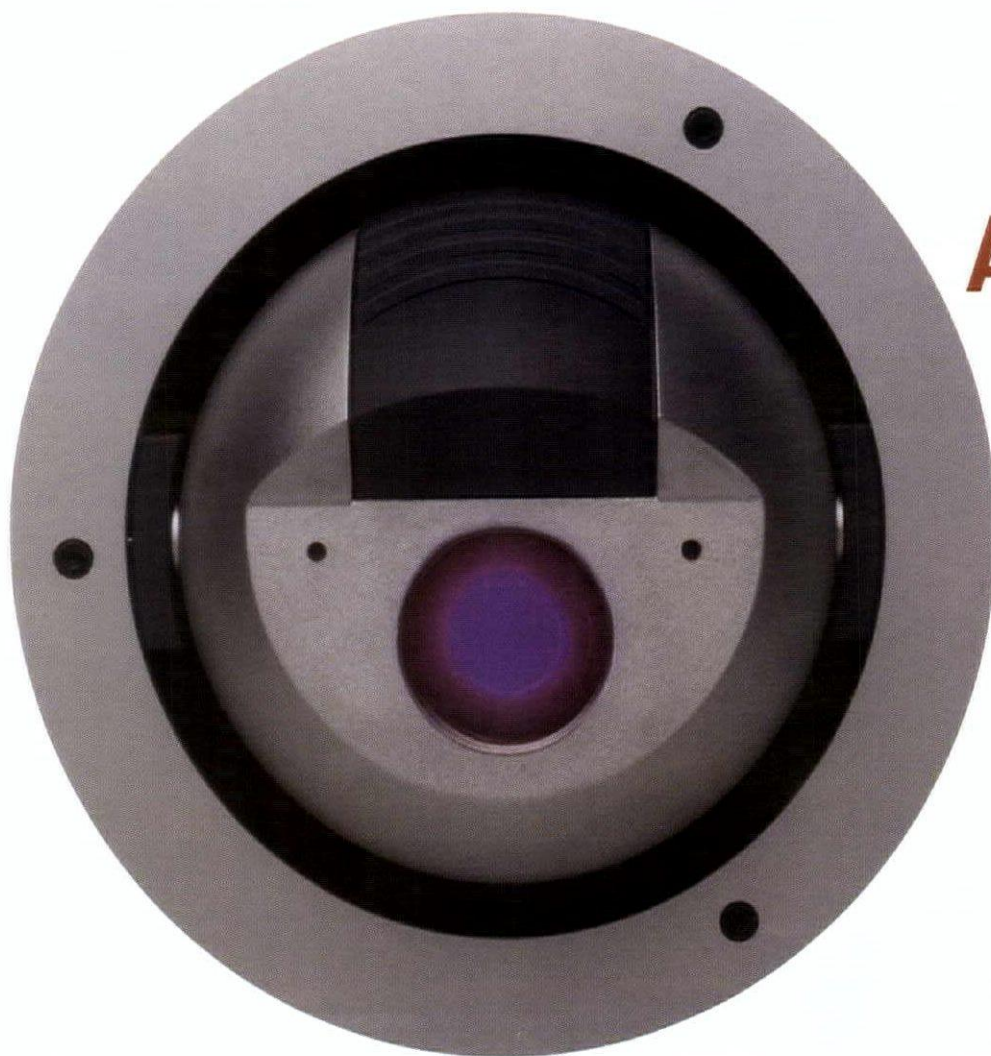

Alien 05

Create a spectacle...



Martin

www.martin-architectural.com • Tel. +1 954 858 1800



Color changing
downlight

Circle No. 54 on reader service card

K-12 Schools + Higher Education

architecture

CONFERENCES

The Booming Education Market Series

Boston: Monday, August 11, 2003

Los Angeles: Wed, September 3, 2003

Chicago: Monday, October 13, 2003

New Jersey: Friday, November 7, 2003

Covering the latest in education facility design trends, best practices and business development, *Architecture's* Booming Education Series is designed to gear architects & educational professionals with the tools to lead the education construction industry into 2004.



Offering valuable AIA and State CEU's

Who should attend

Design and Construction Industry Leaders

- >Architects >Contractors >Engineers >Specification Writers
- >Interior Designers >Developers >Building Inspectors
- >Lighting Designers

Educational Facility Decision-Makers

- >Educators >School District Leaders
- >Facility Directors/Managers >Campus Architects
- >Purchasing Managers >Funding Agencies

To Register

Log onto www.architecturemag.com/conferences or www.lightforum.com

\$295 (per event) Early Bird Registration

(early bird dates vary according to location, refer to website)

\$395 (per event) Regular Registration

- For more registration information call 646.654.4581
- For sponsorship opportunities call Publisher, Suzanne Tron Haber at 646.654.5756

architectural lighting **ACE.al** AWARDS

ARCHITECT'S CHOICE
FOR EXCELLENCE

CHOSEN BY
LIGHTING DESIGNERS & ARCHITECTS

AWARDED BY
ARCHITECTURAL LIGHTING

Recognizing:
durability,
customer service,
value,
design.

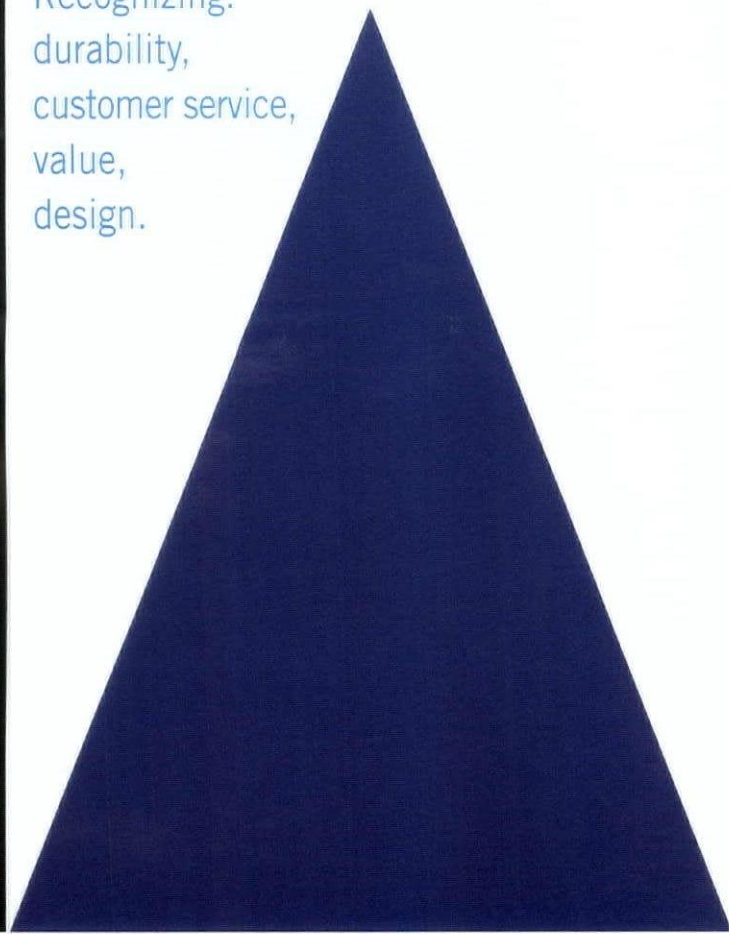

Some
opinions
are more
powerful
than
others.

And we all know
opinions can change.

After last year's
successful debut,
Architectural Lighting's
ACE.al Awards have
become a mark of
distinction and dependability.

Now in its 2nd year, it's
that time again to voice
your opinion and honor
those manufacturers
who have demonstrated
exceptional value,
durability, service
and design.

HOW THE PROGRAM WORKS

1. Take a few minutes to review the list of building materials manufacturers appearing in the ballot section following this page.
2. To vote for those manufacturers that best meet the criteria detailed on this page, locate their assigned number and circle it on the ballot card at the end of the section.
3. Then simply fax your ballot to 646-654-5816. Your response must be received by July 1, 2003 in order to have your vote counted. Only official ballots published by the magazine will be accepted.

VOTING CRITERIA

Select the manufacturers who have provided you and your projects with the best:

1. Value
2. Durability
3. Customer Service
4. Design

Winners will be announced in the
December 2003 issue of *Architectural Lighting*.

**Cast your opinion in *Architectural Lighting*
and let the industry know who you trust and depend on.**

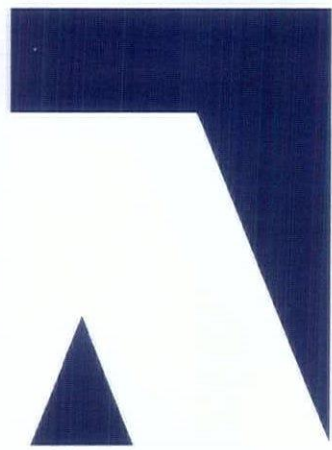

The 2nd Annual ACE.a Awards Lighting Specifier's Choice for Excellence

Recognizing Excellence in Lighting Products + Manufacturers

- | | | | | | | | |
|----|--|-----|--------------------------------------|-----|-----------------------------|-----|---|
| 1 | 3M Light Fiber | 53 | ETC | 105 | Lightech | 158 | RSA |
| 2 | Adaptations | 54 | Eureka | 106 | LightIdeas | 159 | Ruud |
| 3 | Advance | 55 | Exceline | 107 | Lighting Services Inc | 160 | Schonbek Worldwide Lighting Inc. |
| 4 | Alanod | 56 | F.A.D Lighting | 108 | Lightolier | 161 | Schott-Fostec LLC |
| 5 | Alera Lighting | 57 | FC Lighting | 109 | Lightolier Controls | 162 | Se'lux U.S. |
| 6 | Alkco | 58 | Fiberstars | 110 | Light-Project International | 163 | Sea Gull Lighting |
| 7 | ALS - Architectural Lighting Systems | 59 | FLOS | 111 | Linear Lighting | 164 | Selecon |
| 8 | Altman Lighting | 60 | Focal Point | 112 | Litecontrol | 165 | Sentry Electric Corporation |
| 9 | Ambiance Lighting Systems | 61 | Foscarini | 113 | Itemakers | 166 | Sirmos |
| 10 | American Glass Light | 62 | Gardco Lighting | 114 | Lithonia | 167 | Solara Lighting |
| 11 | ANP Lighting | 63 | GE Lighting Systems | 115 | Louis Poulsen | 168 | Solatube International Inc. |
| 12 | Architectural Area Lighting | 64 | Gotham Architectural
Downlighting | 116 | LUCEPLAN USA, Inc. | 169 | Special FX Lighting Inc. |
| 13 | Architectural Landscape Lighting | 65 | Guth Lighting | 117 | Lucifer Lighting | 170 | Specialty Lighting Industries |
| 14 | Ardee | 66 | H.E. Williams | 118 | Lumec-Schreder | 171 | Spero Lighting |
| 15 | Aromat Corp. | 67 | Hadco | 119 | Lumiere | 172 | SPI Lighting |
| 16 | Arroyo Craftsman | 68 | Halo | 120 | Luminis | 173 | Spring City Electrical
Manufacturing |
| 17 | Artemide | 69 | Hampstead Lighting | 121 | Luraline Products Co. | 174 | Starfield |
| 18 | Artistic Tile | 70 | Hatch Transformers | 122 | Lutrex | 175 | Sternberg |
| 19 | Bartco Lighting | 71 | Hemera, Inc. | 123 | Lutron | 176 | Stingray Lighting |
| 20 | Beacon Products, Inc. | 72 | Hessamerica | 124 | Luxo Corp. | 177 | Studio Due s.r.l |
| 21 | Bega Lighting | 73 | Hex Architectural Lighting | 125 | Luxo Italiana | 178 | Super Vision International |
| 22 | Beghelli | 74 | High End | 126 | Lyric Lighting (Seagull) | 179 | Sure-lites |
| 23 | Beta-Calco | 75 | Holophane | 127 | Manning Lighting | 180 | Targetti |
| 24 | Birchwood Lighting | 76 | Hubbell | 128 | Martin Professional | 181 | Tech Lighting LLC |
| 25 | B-K Lighting | 77 | HUNT Dimming | 129 | MaxLite | 182 | Teka Illumination Inc. |
| 26 | Boca Flasher | 78 | Hydrel | 130 | McGraw Edison | 183 | Terzani |
| 27 | Boyd Lighting | 79 | Icon International | 131 | Mercury | 184 | The Original Cast Lighting |
| 28 | Bruck Lighting Systems | 80 | IL America Inc. | 132 | Metalumen | 185 | The Watt Stopper |
| 29 | C.W. Cole & Co. | 81 | ILEX | 133 | Metalux | 186 | THHC Lighting |
| 30 | Charles Loomis | 82 | Illuminating Experiences | 134 | Neoray | 187 | Thomas Daybrite |
| 31 | Color Kinetics | 83 | Illumination Lighting | 135 | Nessen | 188 | Times Square Lighting |
| 32 | Columbia Lighting | 84 | Induction Lighting | 136 | New Metal Crafts | 189 | Tracoman |
| 33 | Con.daz Lighting | 85 | Industry + Design Light | 137 | New Star Lighting | 190 | Translite Sonoma |
| 34 | Con-Tech Lighting | 86 | Indy Lighting | 138 | Nora Lighting | 191 | Trend Lighting Co., Inc. |
| 35 | Cooper Lighting | 87 | Insight Lighting | 139 | Nordic Aluminium | 192 | Tridonic Inc. |
| 36 | Cyclone Lighting Inc. | 88 | Intertech | 140 | NoUVIR Research | 193 | Troy-CSL Lighting |
| 37 | D'ac | 89 | IRIS | 141 | O Luce | 194 | Unilight Ltd. |
| 38 | Davis/Muller Lighting | 90 | JJI Lighting Group | 142 | Orbit North America | 195 | Universal Lighting Technologies |
| 39 | Delray | 91 | Juno Lighting | 143 | Original Cast Lighting | 196 | Ushio America |
| 40 | Derek Marshall Lighting | 92 | Kenall | 144 | Osram Sylvania | 197 | Valmont Industries, Inc. |
| 41 | Dernier & Hamlyn | 93 | Kim Lighting | 145 | Pathway-The Lighting Source | 198 | Vantage |
| 42 | Dreamscape Lighting Mfg. | 94 | Kurt Versen | 146 | PCI | 199 | Varon Lighting |
| 43 | Eclipse Lighting Inc. | 95 | Lam Lighting | 147 | Peerless | 200 | Visa Lighting |
| 44 | Edison Price | 96 | Lamar | 148 | Pennsylvania Globe | 201 | Vistawall |
| 45 | Eiko Ltd. | 97 | LBL | 149 | Philips Lighting | 202 | W.A.C. Lighting |
| 46 | Electrix | 98 | Ledalite | 150 | Phoenix Products Co. | 203 | Waldmann |
| 47 | Electronic Theatre Controls | 99 | Ledtronics Inc. | 151 | Prescolite Lighting | 204 | WE-EF Lighting USA |
| 48 | Elite Bohemia/Bar Del
International | 100 | Legion Lighting | 152 | PRISMA | 205 | Wendelighting Inc. |
| 49 | Elliptipar | 101 | Leola | 153 | Progress Lighting | 206 | Wila Lighting |
| 50 | Engineered Lighting Products | 102 | Leucos USA | 154 | Prudential Lighting | 207 | Winona |
| 51 | ERCO | 103 | Leviton | 155 | Q-Tran Inc. | 208 | Zaneen Lighting |
| 52 | ESTILUZ, INC. | 104 | LexaLite International | 156 | Quality Lighting | 209 | Zumtobel Staff |
| | | | | 157 | Rosco Laboratories, Inc. | | |

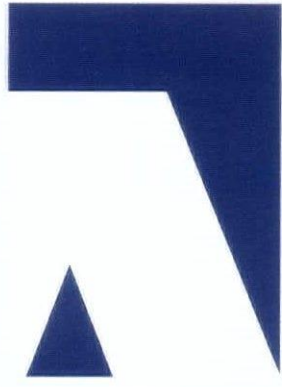

The 2nd Annual ACE.a Awards

Lighting Specifier's Choice for Excellence

Recognizing Excellence in Lighting Products + Manufacturers

Please fax ballot to 646-654-5816 or download ballot at www.lightforum.com.

1	2	3	4	5	6	7	8	9	10
11	12	13	14	15	16	17	18	19	20
21	22	23	24	25	26	27	28	29	30
31	32	33	34	35	36	37	38	39	40
41	42	43	44	45	46	47	48	49	50
51	52	53	54	55	56	57	58	59	60
61	62	63	64	65	66	67	68	69	70
71	72	73	74	75	76	77	78	79	80
81	82	83	84	85	86	87	88	89	90
91	92	93	94	95	96	97	98	99	100
101	102	103	104	105	106	107	108	109	110
111	112	113	114	115	116	117	118	119	120
121	122	123	124	125	126	127	128	129	130
131	132	133	134	135	136	137	138	139	140
141	142	143	144	145	146	147	148	149	150
151	152	153	154	155	156	157	158	159	160
161	162	163	164	165	166	167	168	169	170
171	172	173	174	175	176	177	178	179	180
181	182	183	184	185	186	187	188	189	190
191	192	193	194	195	196	197	198	199	200
201	202	203	204	205	206	207	208	209	

I would like to vote for the following suppliers who were not listed

1. _____ 3. _____

2. _____ 4. _____

Name _____ Phone _____

Title _____

Company _____

Address _____

City _____ State _____ Zip _____

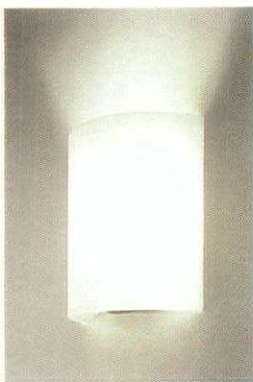

From the **Leucos** Design Studio, the Celine collection offers pendants, wall sconces and table and floor lamps. Celine P (shown) is an ADA-compliant wall sconce producing indirect illumination via a white handblown glass diffuser. A white metal backplate mounts directly to a standard 4-in. junction box. Measuring 10 in. wide, 10³/₈ in. high and 4 in. deep, the glass diffuser is secured to its base with a nickel brushed metal plate. Celine P uses one 100W A19 incandescent or two 13W compact fluorescent sources. **Circle No. 100**



Metalumen's Carré square pendant series provides direct/indirect lighting and is available in 24- and 33-in. square models. Carré offers a choice of decorative glass and five mounting options and accepts up to eight biac compact fluorescent lamps. Outer and center lamps are independently wired for maximum switching control. An MR16 lamping option allows for up to five 50W lamps. **Circle No. 101**

Designed by Angel Bellini, **Warisan's** collection of mother-of-pearl and mussel-shell mosaic fixtures include the Lusi Krang table lamp, which features a rectangular mother-of-pearl and mussel checkerboard mosaic shade and square base formed of polished teak and supported by four metal legs. Lusi Krang measures 7⁷/₂₅ x 6 x 7 in. and uses 60W A17 or A19 incandescent lamps. The Amadis sconce also sports a mother-of-pearl and mussel shell mosaic shade, measures 12 x 7⁷/₂₅ x 17¹/₂ in. and uses 40W A17 or A19 incandescent lamps. The shades are finished with a polyurethane resin coating that is UV-stable and water- and heat-resistant. **Circle No. 103**



Dernier & Hamlyn, founded in 1888, specializes in decorative lighting and custom designs. The company's products have been specified on many world-famous projects including Royal Albert Hall, 10 Downing Street, Windsor Castle and the Palace of Westminster (Houses of Parliament), as well as restoration of the chandelier in the Throne room at St. James' Palace. **Circle No. 102**

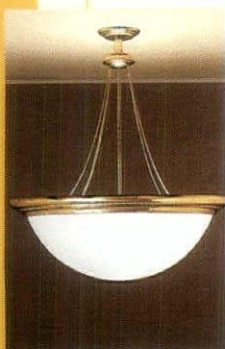

Starfire Lighting's Traditional Series Pendants provide direct/indirect lighting via dome-shaped diffusers offered in a variety of hand-painted finish options. Fixtures mount to the ceiling through a conventional recessed junction box and a choice of single or multiple mounting stems, rods, cables and chains in a range of polished or brushed metallic finishes. Pendants may be specified in 18- or 24-in. widths with standard mounting heights of 30 in. or 30-, 36-, 42- and 52-in. widths with mounting heights of 42 or 48 in. Custom mounting heights are also available. Lamping includes fluorescent and incandescent sources in various wattages. **Circle No. 105**



Ivalo Lighting has extended its Aliante line to include the Aliante Sconce, which features a 4-ft.-long shell formed from .062-in.-thick aluminum through the use of automotive stamping techniques. The shell is available in satin or brushed finishes with clear or black anodization. Vertically centered in the shell, a 21-in. frosted polycarbonate lens diffuses the light. The sconce may be specified with the lens or as a solid unit and offers a choice of 120V and 277V dimming and non-dimming options. **Circle No. 104**

W.A.C. Lighting has expanded its line of Line-Voltage Ceiling Pendants with blue, red and amber (shown) glass in the Sniffer style. Pendants are offered with a durable cord set available in black and white and 96-in. lengths. The cord can be customized to any length in the field. Line-Voltage Ceiling Pendants can be attached to any of W.A.C. Lighting's four track systems as well as other systems most commonly used in the industry. **Circle No. 107**

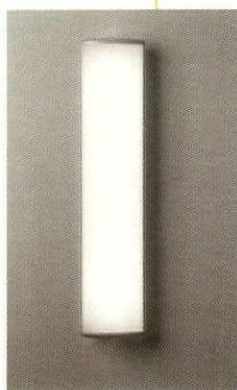

Advent's ADA-compliant Arc sconce can be mounted vertically or horizontally and uses T5 and T5/HO lamps in a variety of wattages. Diffusers are available in opal acrylic, natural paper over acrylic, fabric with inner acrylic, perforated aluminum with inner acrylic and stainless-steel mesh with inner acrylic lenses. Fixtures are offered in a variety of finishes and sizes. Options include decorative accents, emergency lamping, dimming, corner-mount kit, sand-blasted opal acrylic lens with sealer, tamperproof screws on end-caps and 277V ballast. Arc also offers ceiling-mount and pendant models. C/UL-listed. **Circle No. 106**

Meyda Tiffany's Fleur-de-lis chandelier (Model #49726) features thousands of pieces of art glass in its shade and is designed with an art glass hub above the shade. The fixture was handcrafted using the company's copperfoil construction process and measures 32 in. high and 45 in. wide. Lamping is incandescent or compact fluorescent. **Circle No. 108**



(Continued on page 28)

CLAIRE
design Danilo De Rossi

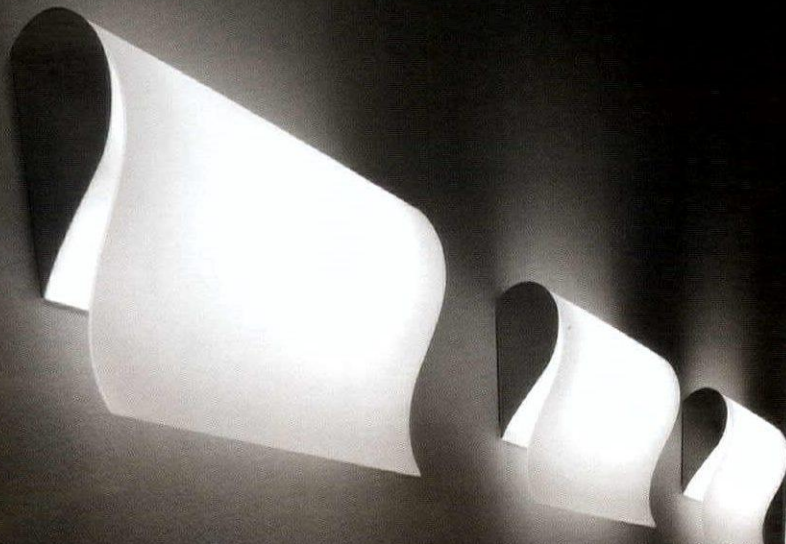

LEUCOS

See us at Lightfair 2003 Booth 1843

LEUCOS USA INC. 11 MAYFIELD AVENUE - EDISON, NJ 08818 - 7829 Tel. (732) 225-0010 Fax (732) 225-0250
leuco@susa@aol.com - www.leucos.com
Circle No. 11 on reader service card

a.d. LEUCOS ph. STUDIO FUOCO

EPY 7431

EPY 7431

(Continued from page 25)

Aqua Gallery's Oversize It collection was designed by Ayala Serfaty in response to the need for larger lighting fixtures in hospitality applications. Fixtures in the series are formed of metal wire structures wrapped in naturally crushed silk that is then treated with a water-resistant and flame-retardant epoxy coating. Fixtures are available in five colors. The Palm Beach 9 (shown) is a chandelier measuring 9 ft. long and 4 ft. in diameter and uses compact fluorescent lamps. **Circle No. 109**

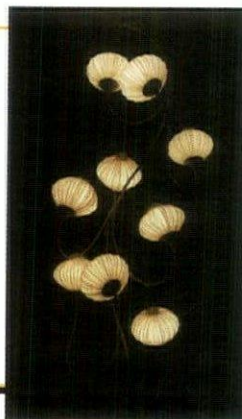

Designed by award-winning architects Renato Toso and Noto Massari for **Leucos**, the Pandora pendant sports retro curvilinear contours reminiscent of seminal Italian industrial design of the 1960s and '70s. The fixture is equipped with a satin white handblown glass diffuser measuring 17⁷/₁₀ in. in diameter and 13⁴/₅ in. high and metal hardware finished in brushed nickel. Pandora uses one 100W A19 silver-bottom incandescent lamp for downlighting and one 100W A19 incandescent lamp for diffused illumination. Double switching is available. **Circle No. 110**

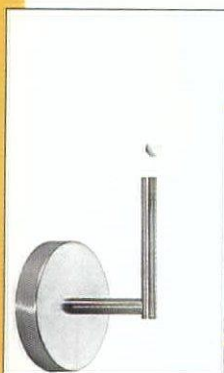
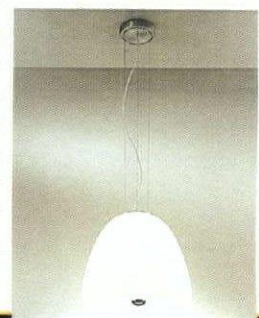

From **Watermark Design**, the Loft Lighting sconce measures 4¹/₂ in. wide, 12 in. high and extends 6¹/₂ in. from the wall. The sconce is available with a white or frosted acrylic shade and a choice of 32 electroplated or enameled finishes, including satin nickel (shown). Loft Lighting uses one candelabra-base 60W incandescent lamp. **Circle No. 111**



Derek Marshall Lighting's new collection of sconces is characterized by the use of colored glass that is cut and positioned on white opal glass and then fired to red-hot heat, creating a fusion that permanently welds all the glass together. After cooling, the fused glass is cut, ground and polished and fired again, allowing it to mold smoothly into the sculptured form

of the sconce. Measuring 16 in. wide and 12 in. high, Sensu (shown) extends 4 in. and uses a 100W incandescent lamp; compact fluorescent is also available. The sconce attaches to the mounting bracket with brushed chrome knobs. Polished brass is optional. **Circle No. 112**

Delray Lighting's Kone combines glass diffusers and precise aluminum downlight reflectors to provide general illumination and tasklighting. Available in two sizes of clear and opal glass, Kone uses compact fluorescent sources and comes equipped with an aircraft cable mounting system adjustable to a variety of lengths. **Circle No. 113**

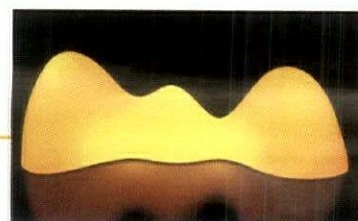
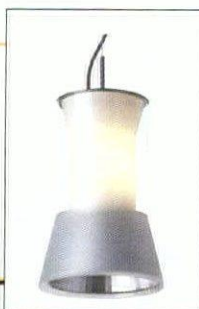

Designed by Karim Rashid for Foscarini and distributed exclusively in the U.S. by **North American Lighting Spectrum (NALS)**, Blob free-form table, ceiling and wall fixtures are constructed from formed steel covered in a molded polypropylene light-diffusing shade. The 18.8-x-6.25-in. Blob S uses one 24W compact fluorescent lamp, while the 39.58-x-11.38-in. Blob M uses two 36W compact fluorescent lamps. Blob XL measures 49.58 x 19.75 in. and is lit with two 55W compact fluorescent lamps. Table and floor models are portable and plug-in controlled via an on/off switch and in-line electronic ballast on the cord. Ceiling and wall models may specified wired-in with remote concealed ballasting. C/UL-listed. **Circle No. 114**

Excelite's Galaxis series of wall sconces includes the Quadris V, which is equipped with a front panel that is 1/4 in. thick and available in white faux alabaster and textured white acrylic. The open top and bottom provides up- and downlighting as well as air circulation. The Quadris V sconce accepts two 26W max. quad-tube compact fluorescent lamps. **Circle No. 115**

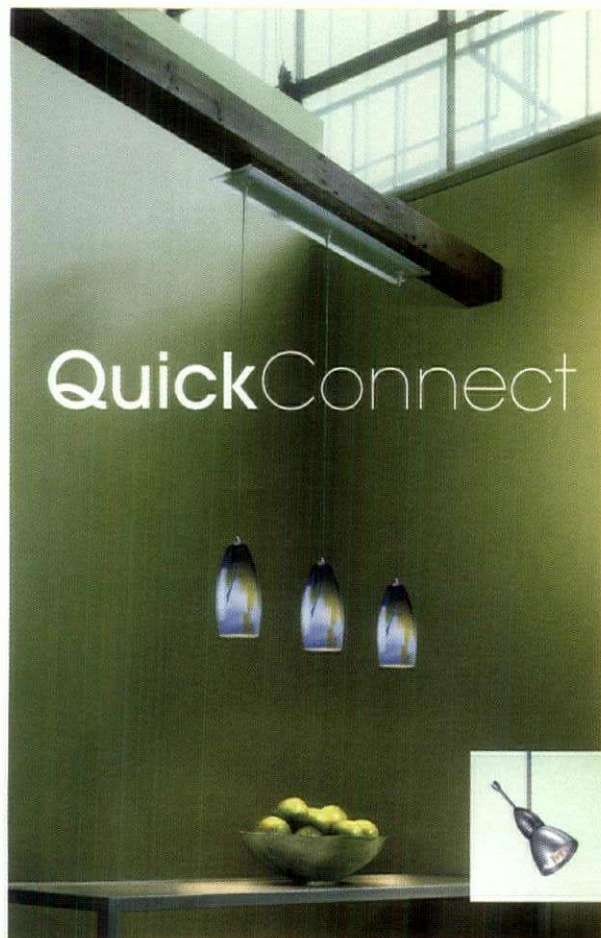

QuickConnect

DESIGN EXCELLENCE IN LIGHTING

Integrated with the new Low Voltage Monorail System, the versatile QuickConnect Series features innovative ceiling canopies, components, pendants and fixtures. Perfect for monopoint, multipoint, track and monorail applications, QuickConnect accessories ensure design continuity and installation efficiency for both retrofit and new construction.



CORPORATE HEADQUARTERS
615 SOUTH STREET
GARDEN CITY, NY 11530
TEL: 800.526.2588
FAX: 800.526.2585
EMAIL: SALES@WACLIGHTING.COM

WEST COAST OFFICES & OPERATIONS
168 BREA CANYON ROAD
CITY OF INDUSTRY, CA 91789
TEL: 877.810.6695
FAX: 866.810.6615

DALLAS SHOWROOM
DALLAS TRADE MART #3321
2100 STEMMONS FRWY
DALLAS, TX 75207



TARGETTI
COLLECTION
at
CHELSEA
ART MUSEUM

CURATED BY AMNON BARZEL

FROM MAY 7 TO JUNE 8 2003
from Wednesday through Sunday, noon to 6 pm

C H E L S E A A R T M U S E U M
556 WEST 22 STREET NEW YORK CITY

artlight@targetti.it www.targetti.com

www.chelseaartmuseum.org

the exhibition is supported by

GUCCI

(Continued from page 28)

From **North American Lighting Spectrum (NALS)**, Foscarini's Supernova pendant is composed of 14 graduated parallel discs that together form a 19³/₄-in.-high and 11¹/₂-in.-wide sphere. The discs serve as louvers and may be specified in polished stainless steel, matte aluminum or colored lacquered aluminum. The pendants suspend from the ceiling via aluminum aircraft cables entwined with a silver electrical cord. Units are adjustable to 78³/₄ in. Illumination is provided by a single 150W incandescent lamp. **Circle No. 116**



From the **Aurora Lampworks'** new collection based on historical lighting fixtures, the Westchester pendant is inspired by Art Deco design and results from the restoration of the Michaelian Office Building, which was built in the late 1920s. The Westchester is nearly 2 ft. wide with a 4¹/₂-in. banding and uses two 100W incandescent lamps (or compact fluorescent equivalent). Available finishes are antique brass or satin nickel. The diffuser is offered in glass and Lexan. Flush-mount models are also available. **Circle No. 119**

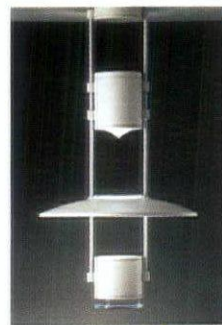

D'ac Lighting's Terminal pendant features a pair of aluminum stems suspended 43 in. from the ceiling surface and attached to two cylindrical housings. Equipped with a frosted colored glass lens and a 150W metal halide lamp, the lower housing provides 85-percent downlight and 15-percent uplight, which is reflected through and off the surface of a domed shade that separates top and bottom housings. Construction is cast aluminum with a spun-aluminum shade. Standard finish is chip- and fade-resistant baked powdercoat enamel in metallic gray. Custom colors may be specified. C/UL-listed for dry locations. **Circle No. 117**

Created by **New Metal Crafts** for a new office building in Chicago, this 5-x 8-ft., sculptured aluminum light fixture is lit with two 17W T8 fluorescent lamps and two 40W PAR20 lamps housed in an aluminum weather-proof back box. This fixture extends 1 ft. from the wall and features polished- and satin-finish aluminum-plate face panels with vertical fins at the center and eight horizontal ribs. The acrylic panel emits light down the front and is hinged to facilitate relamping. **Circle No. 118**



The Regh Associates Collection from **Baldinger Architectural Lighting** includes the Upton series, which features a wall sconce and pendant fixture with four tapers that branch out from the center (shown), and the Endicott pendant fixture, which measures 36-in. in diameter, and wall sconce. The entire collection is available in polished, satin and antique brass or polished and satin nickel finishes. **Circle No. 120**



(Continued on page 32)

MAXIMIZE YOUR DESIGN OPTIONS...

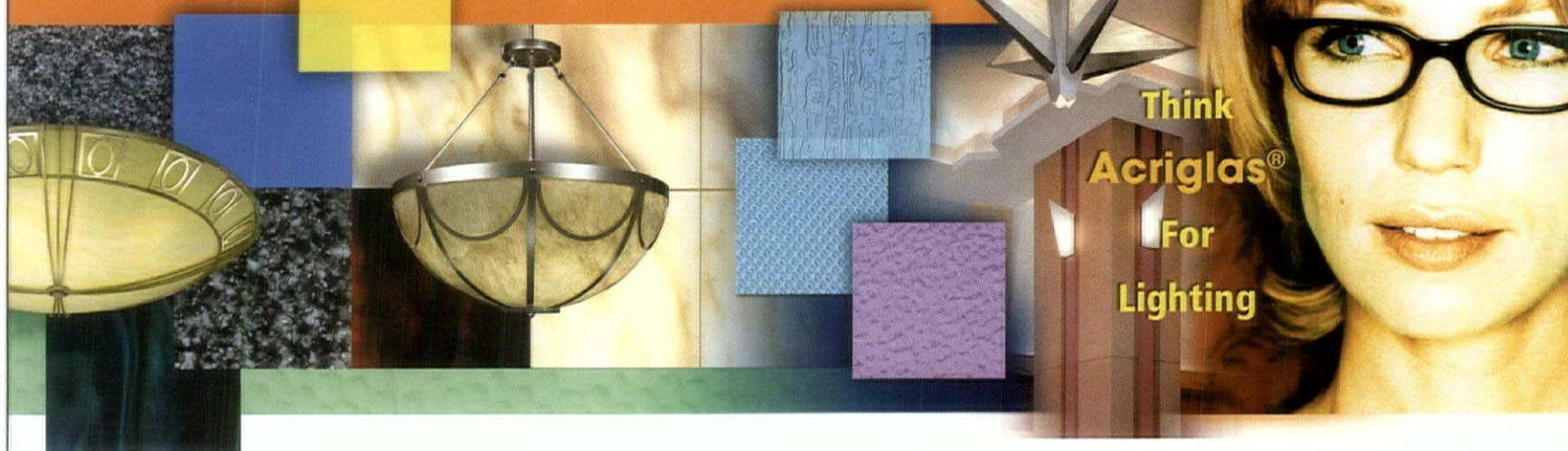

Think
Acriglas®
For
Lighting

Think Acriglas® - Cast Acrylic Sheets for Lighting

- More Perfect Than Nature With Greater Variety Than Glass
- Combine Colors, Texture and Patterns for Unlimited Design Flexibility
- Durability, Ease of Manufacturing and UV Light Stability
- Turn Ordinary into Something Extraordinary with This Cost Effective Lighting Solution



Tel: 800.222.4680 | Fax: 201.333.1237
www.acrilex.com

Marble

Granite

Frosted

Textured





Lighting for every personality

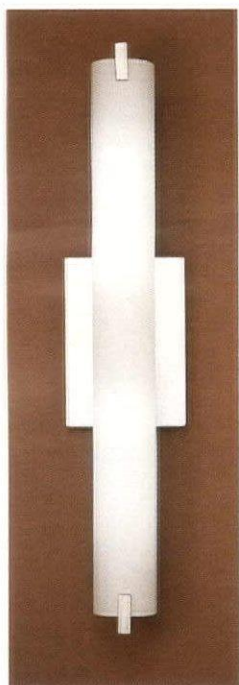

ELF by
ILLUMINATING
EXPERIENCES:
*Geometrically
expressive*

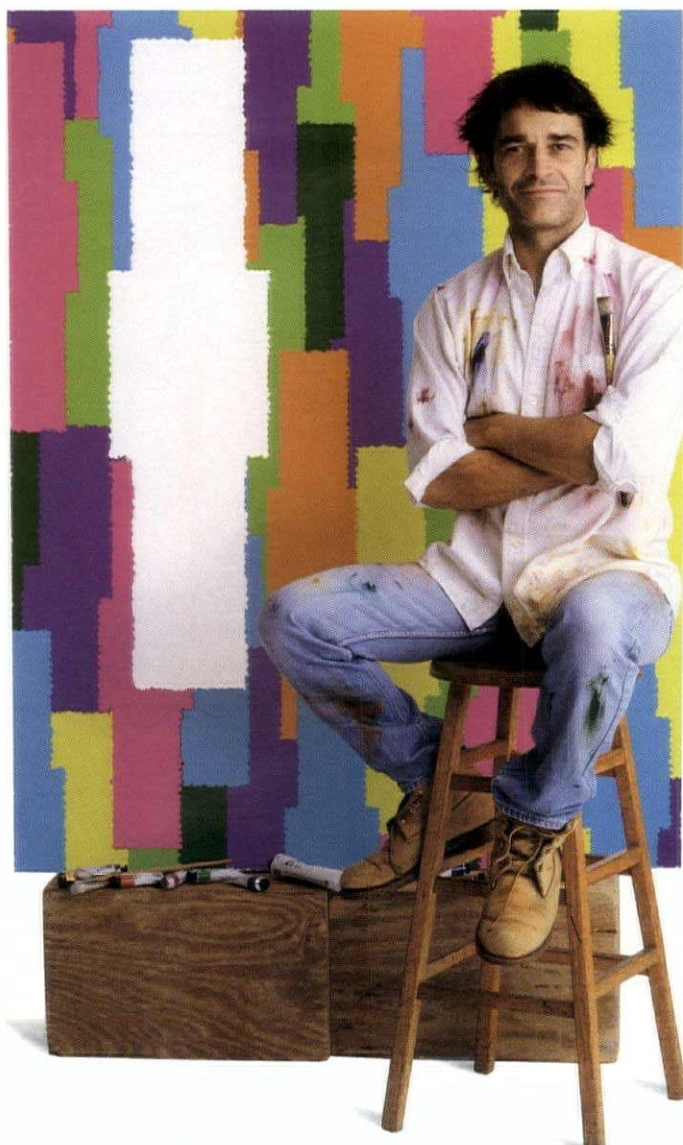

illuminating  experiences

Whose life are **you** lighting?

p: 800-734-5858 f: 732-745-9710 e: customerservice@illuminatingexperiences.com

Circle No. 76 on reader service card

(Continued from page 30)

R. Jesse's NI Series includes a table lamp, floor lamp and sconce, each with a variety of custom options. The series offers steel components polished and then plated with nickel; lacquered and sanded wood; and Pyrex diffusers. The NI-100 sconce (shown) is available in cocobola wood from South America as well as bird's-eye maple, mahogany, bacoti and walnut with polished nickel. A custom alternative of unfilled travertine is also available. Diffusers are offered in natural Manhasset linen and natural or white Pongee silk. NI-100 measures 13 x 5 in. with a 5-in. projection and uses a 40W incandescent lamp. **Circle No. 121**



Lightolier has added an integral emergency battery pack option to its BowShield series of ADA-compliant wall sconces, which sport a "bowed" piece of handcrafted glass that slips into a die-cast holder. Each style is offered in two proportions. Die-cast holders are available in either satin brass or satin nickel finishes. BowShield offers a choice of universal voltage electronic, dimmable electronic or high-power factor magnetic ballasts. **Circle No. 122**

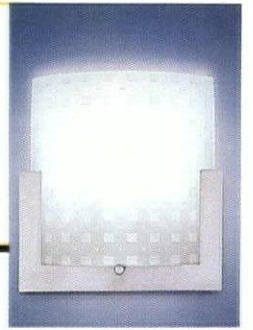

Sea Gull Lighting's Sussex Collection offers one- and three-light pendants, wall-mounted fixtures and three- and five-light chandeliers. The collection is characterized by a brushed nickel finish as well as polished rods, chains and canopies and satin white glass shades. **Circle No. 123**

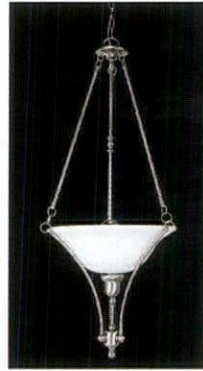

Modernica is celebrating the anniversary of the Bubble Lamp with the release of the 50th Anniversary Edition Diamond Bubble Lamp. Designed in 1947 by George Nelson, the fixtures are fashioned from lightweight steel and translucent, synthetic material, which was originally developed during World War II to waterproof armaments. Mass production of the Bubble Lamp began in 1952 and since then, the fixtures have gained popularity in both ceiling and floor lamp versions. **Circle No. 125**

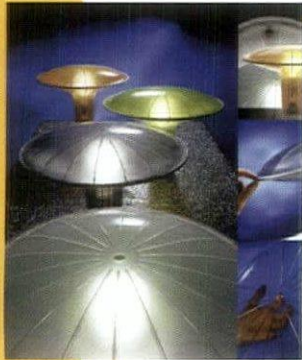
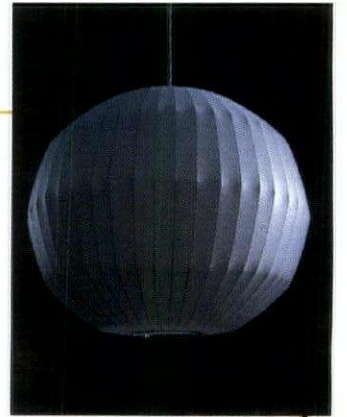

From **Luceplan**, Agaricon table lamp sports a ribbed and semi-transparent outer shell formed of high-pressure injection-molded polycarbonate and color achieved by mixing raw neutral plastic with a pre-pigmented material prior to molding. Pressing or releasing the extruded aluminum ring on the rim of the lid, which is equipped with a sensorial dimmer, adjusts the lamp's brightness or turns it on and off. Measuring 14 in. in diameter and about 3 1/2-in. around the base, Agaricon is

available in gray, classic green, orange or jade green and uses up to 150W incandescent lamps. **Circle No. 124**

(Continued on page 34)

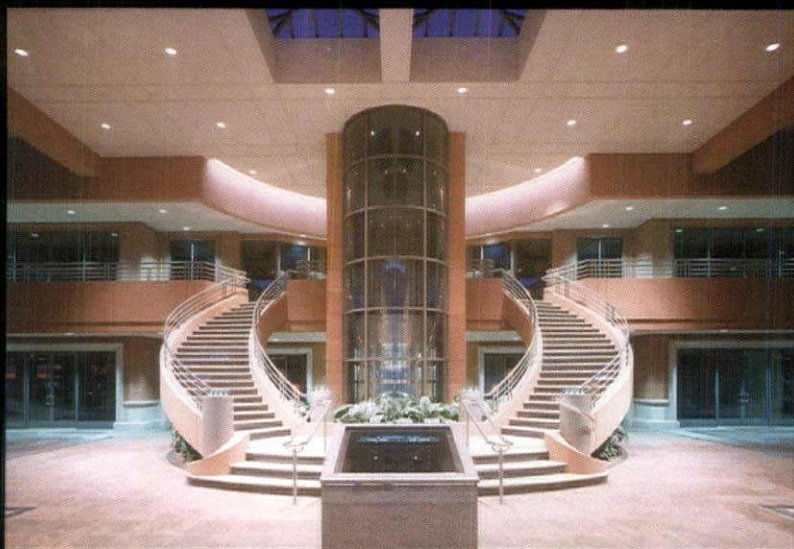

architectural cove lighting

electrix
ILLUMINATION

Form, Function, Flexibility.

wall sconces

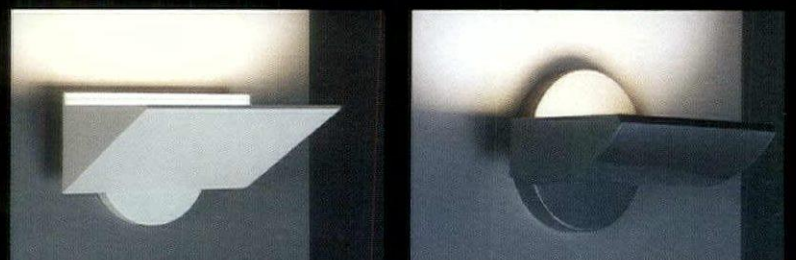
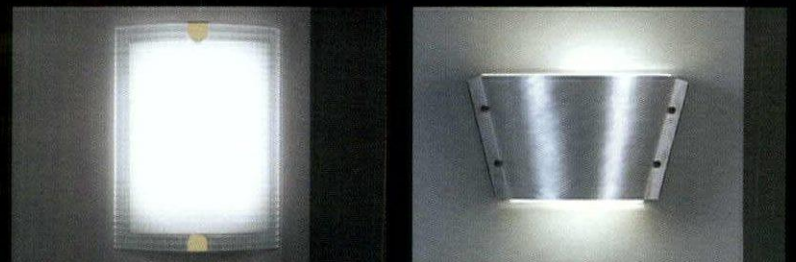

Field Curvable Flexible Modules

See us at Lightfair Booth #2355

www.electrix.com TEL 203.776.5577 FAX 203.624.7545

Circle No. 18 on reader service card

NeoCon®

World's Trade Fair 2003

June 16-18, 2003

The Merchandise Mart • Chicago, Ill. USA

THE WORLD'S TRADE FAIR FOR INTERIOR DESIGN & FACILITIES MANAGEMENT

www.merchandisemart.com



Featuring:

- Buildings Show®
- Office Expo by OFDA
- TechnoCon™
- NEWHospitality
- Fine Design Residential Home Furnishings Show™

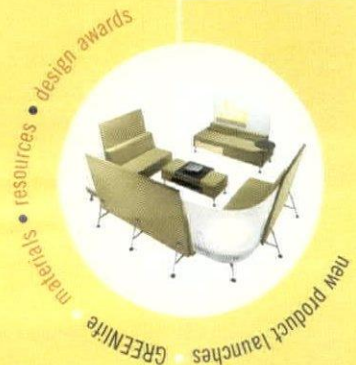

Combine career-advancing information, access to the latest resources and inspiration, and your performance can't help but reach new levels. For 35 years, NeoCon® has been the epicenter of design innovation, with this year's event boasting thousands of new products/services, over a hundred educational programs, 1,200 exhibitors, and countless networking events and award programs. Take your work to a whole new level — get to NeoCon 2003.

For more information, call 800.677.6278 or visit, www.merchandisemart.com.

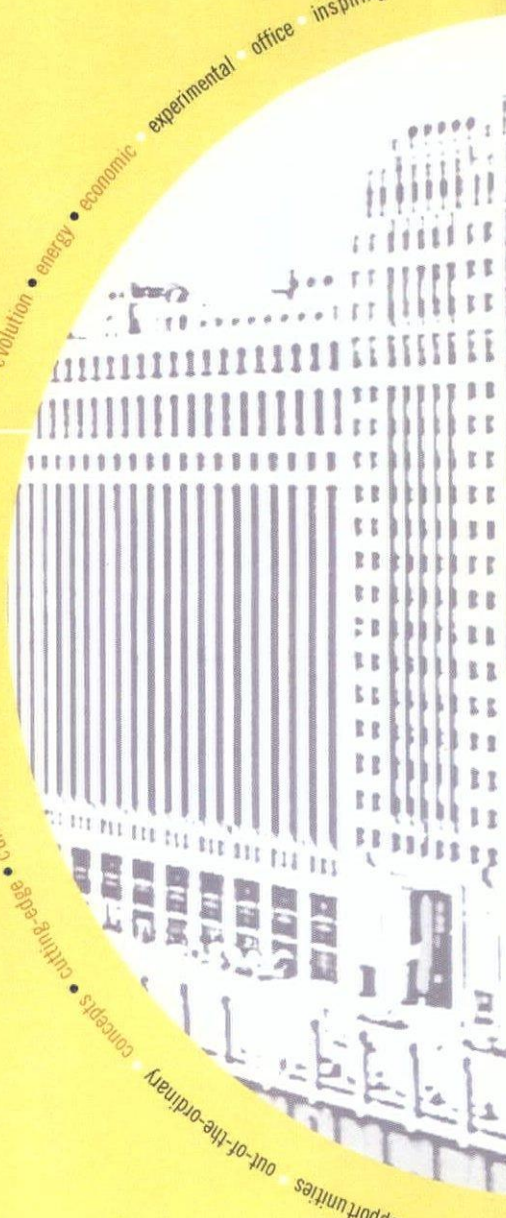

opportunities • out-of-the-ordinary • concepts • cutting-edge • current • efficiency • environment • effective • explore • evolution • energy • economic • experimental • office • inspiring

(Continued from page 32)



Luraline's Andorra collection consists of pendant, sconce and ceiling and linear fluorescent fixtures that combine satin-finish acrylic cowls available in four colors with satin white or satin-etched clear acrylic materials that frost when illuminated. Fixtures are accented with details finished in satin nickel. Custom colors and configurations are available. Andorra includes incandescent, compact fluorescent with magnetic or electronic ballasts, and T5 linear fluorescent models. **Circle No. 126**

From Flux, Inc., Fixture Two is a surface-mounted ceiling fixture in brushed nickel with a frosted glass diffuser. The fixture measures 5 1/4 in. wide and extends 5 1/4 in. from the ceiling. Illumination is provided by a medium-base 50W 120V incandescent lamp. **Circle No. 127**

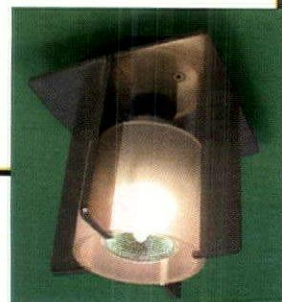

COLE
Lighting

LIGHTING SINCE 1911

DownLites

Quality

Function

Style

- Cast Aluminum Trim
- Concrete Mount
- Dry Ceiling Mount
- Metal Halide
- Fluorescent
- Incandescent
- Interior/Exterior

See us at Lightfair 2003, Booth #560

C. W. Cole & Company, Inc.
Fax (626) 443-9253
Tel. (626) 443-2473
info@colelighting.com
www.colelighting.com

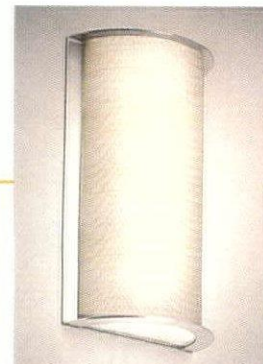

Combining the warm appeal of fabric with the durability of acrylic-type shades, Knoll Textiles' Imago may now be specified as a shade option on a wide range of sconces from Nessen Lighting. The resin-encapsulated shade fabric is offered in a choice of 10 colors and textural patterns that range from denim to tweed to linen. Imago is offered on wall sconces with rectangular or tubular shades and may also be specified as a replacement shade for existing Nessen fixtures. Material thickness ranges from 2-3 mm thick. **Circle No. 128**



Illuminating Experiences presents Peroni. The glass shade is available in diameters of 14 and 16 cm and heights of 30 and 40 cm, respectively. Peroni comes in clear, satined amber, satined white, frosted with clear edge, and frosted with satined sectors. Fitting is chromed metal. **Circle No. 129**

Engineered to be seen . . . indirectly

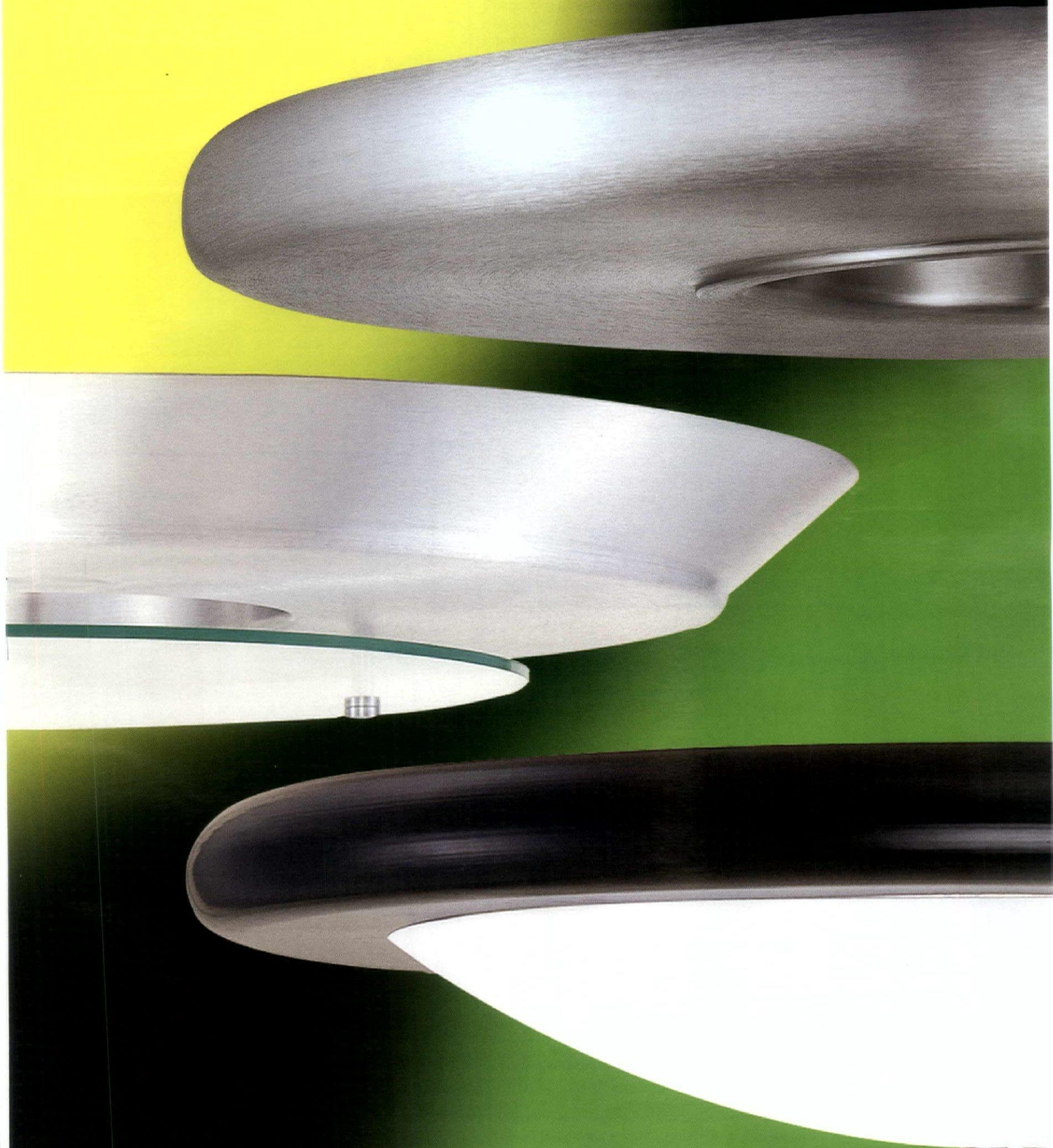

ORIGINAL CAST™ LIGHTING

6120 DELMAR BLVD. • ST. LOUIS, MO 63112 • 314.863.1895 • FAX 314.863.3278 • THEOCL.COM

Circle No. 4 on reader service card

30TH
YEAR



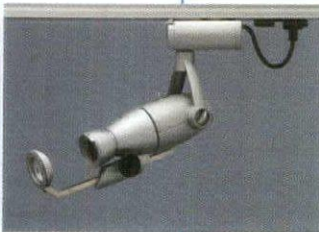

Arch, developed by Troll and offered by **Énergie**, features a multi-swivel system that allows its shallow-profile spotlights to move, position and lock without the need of tools or external fasteners. Free movement in all directions within the hemisphere gives the user total control to experiment with this small light optical equipment. Lighting solutions are made simple with a wide variety of fixtures, accessories and lamping options to choose from. Fixtures are constructed of high-quality cast aluminum and are available in gray, black or white. Arch 9 is shown. **Circle No. 130**

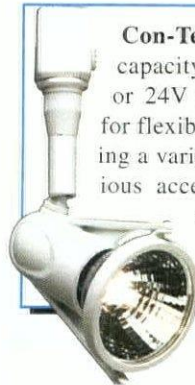

Con-Tech's Symphony MiniTrack line has a 25 AMP capacity and is rated for use at 12V (300W capacity) or 24V (600W capacity). The Symphony line allows for flexibility in a variety of lighting applications, offering a variety of fixture and track lengths along with various accessories, transformers and installation accessories to customize lighting plans. Lamp choices include MR11, MR16, AR111 and T4 wedge-base xelogen. **Circle No. 131**

Lighting Services Inc's 261 Series fixture, the latest in the company's Wall Wash Series, is designed to evenly light vertical surfaces utilizing the energy-efficient MR16 bi-pin lamp (up to 71W). The sculpted design of the 261 Series Spotlight provides a visually quiet, glare-free light to enhance any interior space. The 261 Series unit features internal accessory clips for multiple accessories; a LSI 50- x 50-degree molded spreadlens and aluminum kicker reflector for spreading light evenly onto the wall; a fully rotational front end for lens rotation and positive front rotation lock; and two-tone paint for control of unwanted spill light. The 261 Series Wall Wash unit is available in 100V, 120V and 230V, as well as a variety of finishes including platinum, graphite, black, white and silver. UL-, CUL- and CE-listed. **Circle No. 132**

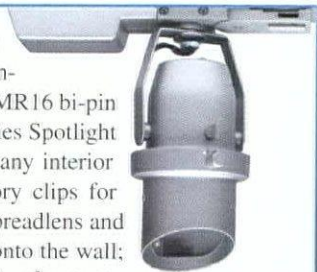

Added to the Uni-Plug Series, **Bruck Lighting's** Rainbow pendant can be mounted to any of the company's eight track systems and features a combination of two glass shades. The inner shade is a frosted white cased glass and the outer is clear with a dichroic coating. When the fixture is lit, the pendant displays a fusion of dichroic colors; unlit, the glass assumes a liquid-mercury-like finish. Rainbow can also be ceiling-mounted via a ceiling canopy. **Circle No. 133**

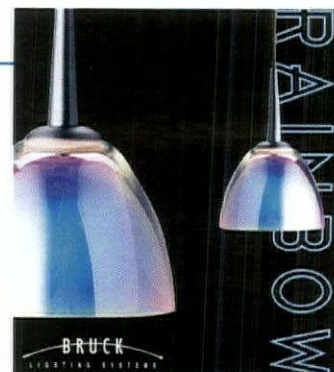

Offering product photography, dimensional drawings and technical information, **Lithonia Lighting's** 32-page catalog on tracklighting features traditional trackheads such as flatback, roundback, gimbal ring and lampholder as well as new products such as PAR shades and metal halide lampholders. Accessories, louvers and filters, track layouts and lamp information are also included. Available in one- and two-circuit configurations, Lithonia Lighting track is constructed of low-profile, heavy-gauge, extruded aluminum. Track sections and connections are designed with dimensional restrictions of T-bar grid ceilings in mind. **Circle No. 134**



Offering 150 new fixtures including trackheads and pendants, the Low-Voltage Mono Rail System from **W.A.C. Lighting** features a single-circuit, two-conductor rail that is available in 4- or 8-ft. lengths and may be specified with mounting options such as suspended and aircraft cable suspension. The rail can also be field cut for custom lengths and offers both remote and decorative surface-mount transformers. Sections can be joined to form longer electrically conducted runs or utilize electrically isolated connectors for multiple circuits on a continuous run. Mono Rail can be custom-designed with curves to negotiate challenging corners and is also hand-bendable. **Circle No. 136**



Cooper Lighting's Halo L2004 solid-state adapter allows Halo Linea lampholders to be placed on standard Halo Power-Trac and Lazer-by-Halo Trac systems. The L2004 adapter's electronics step down the 120V line voltage to 12V and powers Linea lampholders functioning with 12V MR11 and MR16 lamps and T3 G4-base bi-pin lamps. The device withstands overloads up to 75W continuously and permanent short circuits. The overload and short-circuit protection automatically resets after the overload or short is removed without cycling input power. L2004 attaches electronically and mechanically anywhere on a single- or double-circuit track and is offered in white and black. **Circle No. 135**

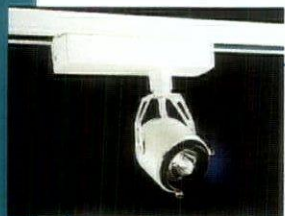

Remote Controlled Lighting's spot fixtures, available from Translite Sonoma, create a new dimension in accent lighting. For the first time, unskilled personnel can redirect lighting without the use of ladders. Director DR2 (shown) is a low-voltage track-mounted spot fixture for the PAR36, AR111 and MR16 lamps. DR3 is a larger version for metal halide lamps up to 150W. Both fixtures are controlled using a simple hand-held controller incorporating RCL's Select & Direct control protocol. DR2 has been designed for use in hotel banqueting suites, restaurants, galleries and museums, while DR3 is aimed at the retail market. Both fixtures have the ability to store positions for future use and DR3 can be programmed to sequence through these positions in a continuous loop. Director products have already been installed in hotels in London, Athens, Hong Kong and Shanghai, national museums in London, Paris and Amsterdam and restaurants, galleries and auction houses in London. **Circle No. 137**

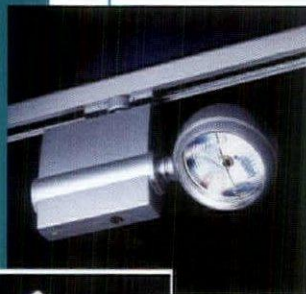

From **Juno Lighting**, the Professional Halogen Series of track fixtures offers two lines that operate both standard line-voltage light sources—PAR20, PAR30 and PAR38—and low-voltage MR16, PAR36 and AR111 lamps. The enclosed Conix and the open-back Pro-Gimbal Ring each feature aiming and rotation locks that enable precise focus and are designed to hold simultaneously two light control lenses, louvers and/or color filters. Both can operate with all Juno line-voltage track and system accessories, including two-circuit track and monopoint mounting options. The Professional Halogen Series is also compatible with Juno's MH₂ metal halide track series. **Circle No. 138**

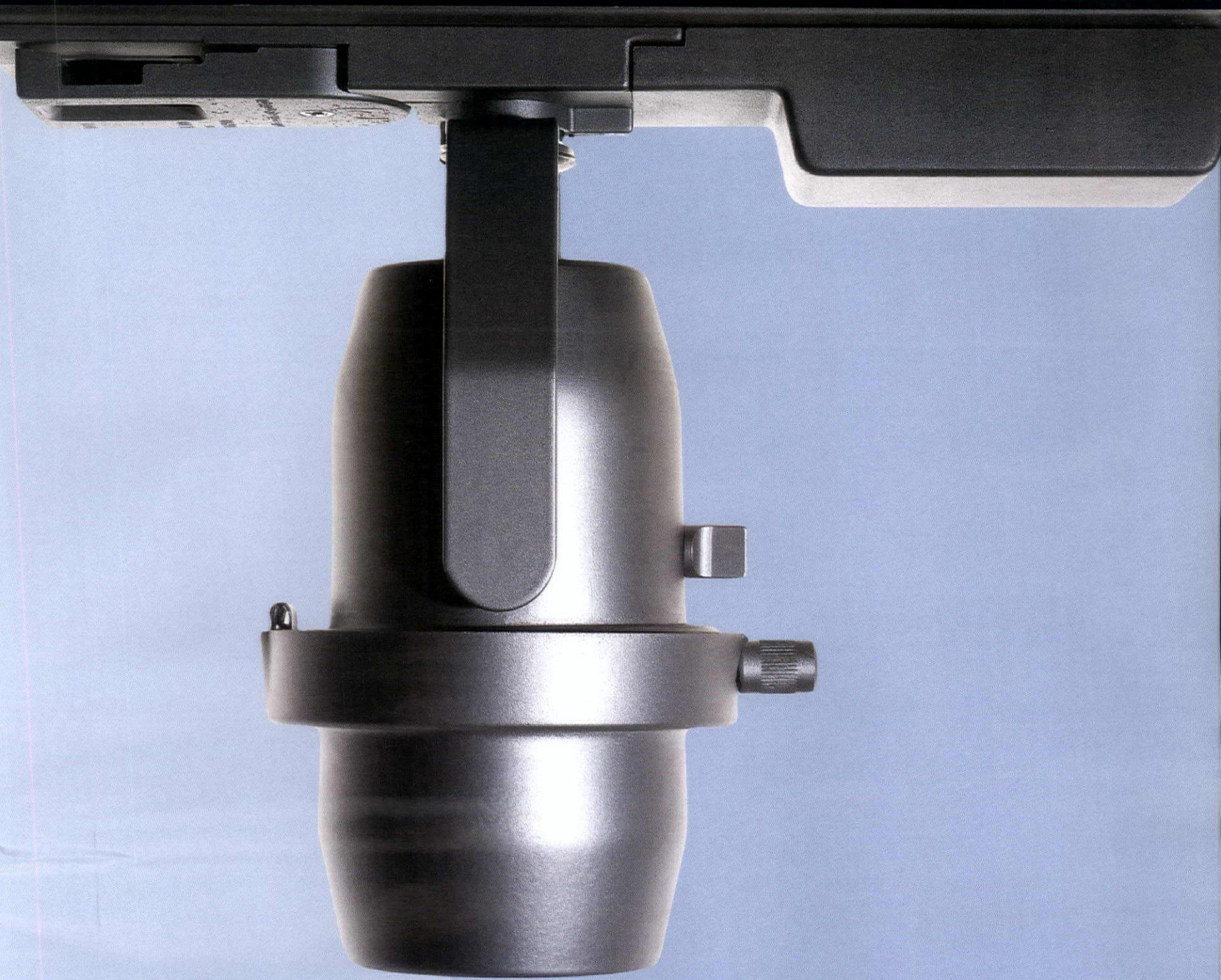

light bite

260	LAMP TYPE	MR16	
	VOLTAGE	120, 230, 277	20-75 watts
	DIMENSION	5.8" (148 mm) x 3.4" (86 mm)	UL/CUL/CE listed

Small *is* beautiful, and energy efficient too. The sculpted good looks of the 260 Series features a neat side-car transformer, keeping the fixture unobtrusively tight to the ceiling. A built-in cross baffle ensures a visually quiet light, with great colour rendition from the tungsten halogen MR16 lamp; all this, plus any variety of accessories, equals great effects. Size *does* matter.

Lighting Services Inc The premier specialty lighting manufacturer.

Circle No. 39 on reader service card





RAB Electric Mfg.'s Smart Task is a fluorescent undercabinet fixture that features an integral sensor and is available in 12-, 21-, 24-in. lengths.

The sensor controls up to 250W of fluorescent light and swivels 330 degrees to aim as needed. Smart Task is available in a bright white epoxy powdercoat finish. **Circle No. 139**

From **Delaney Industries**, the EnviroLux Picture Light is an LED-based tasklight available in 3-, 6- and 12-in. head sizes. The 12-in. fixture operates at 2W and puts out approximately 50 lumens. Constructed of white LEDs in a brushed aluminum frame, the EnviroLux Picture Light is offered with a base that can be attached with screws or in a clip-on version. Fixtures are powered by an AC to DC plug-in transformer. Battery operation may be specified. **Circle No. 141**



Designed by Niels Diffrient for **Humanscale**, the Diffrient

Light tasklight sports anodized aluminum parallel arms that maintain the reflector shade position during placement and allow light to reach 42 in. from the base. The shade is adjustable 360 degrees horizontally and 220 degrees vertically. Lightweight and cool to the touch to facilitate one-hand positioning, the Diffrient Light uses a 26W quad-tube fluorescent lamp and in-line electronic ballast and is available in single and double parallel arm models. A variety of desk and wall-mounting options are offered. **Circle No. 140**

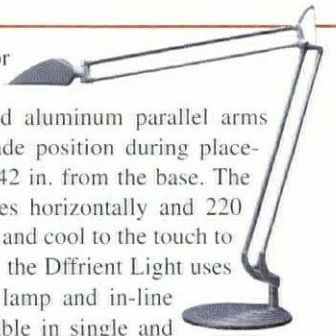

Starfire Lighting, Inc.'s Tru-Lux Vanity Series brochure details in full color the features of the T5 linear fixture that is designed to provide balanced illumination in a sleek architectural profile. Tru-Lux is suited for unobtrusive placement alongside or above commercial or residential vanity mirrors and features integral or remote electronic ballast, in addition to standard or custom lengths. Schematic drawings, product measurements, lamp data as well as complete ordering information are provided. **Circle No. 142**

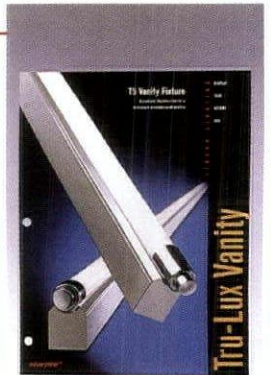

Luxo's Calypso asymmetric tasklight features a tapered shade that conceals a 13W U-shaped compact fluorescent lamp and the company's counterbalanced, concealed-spring lightarm, which is triple-jointed and multi-adjustable. A parallel motion feature ensures that the lamphead remains horizontal to the work surface during adjustment. Calypso is available with a weighted table base or edge clamp. Louvered shade is optional. Calypso offers powdercoated tubular metal lightarms with integral springs and base and shade formed of ABS. Electronic ballast is built into the base. **Circle No. 143**



Halogen 120 from **Alkco Lighting** is an under-cabinet linear lighting system characterized by a rounded edge profile. Housings may be specified in four lengths and can be used alone or linked via in-line connectors or cords to form continuous rows. A sandblasted, semi-opaque glass diffuser shields the lamp. Halogen 120 can be operated with a wall dimmer switch. Housings are durable extruded aluminum with injection-molded polycarbonate knockout end-caps. Standard finish is white resin polyester powder coat or anodized aluminum with matching endcaps. C/UL-listed. **Circle No. 144**

Juno Lighting has introduced three new undercabinet fixtures series. The Pro Halogen Series utilizes 12V halogen lamps in one-, two- and three-lamp versions and sports a prismatic clear glass lens and housing/integral reflector system that reduces mounting surface temperatures to under 60 degrees Celsius. Fixtures can be installed flush to the rear back-splash or to the front lip of cabinetry. Mini-Halogen Series fixtures are 3-in. wide, use 120V 24W halogen lamps, which do not require a transformer, and feature an integral high/low/off rocker switch and compatibility with standard incandescent wall dimmers. The Mini-Fluorescent Series fixtures measure 1 5/8 in. wide, and 7/8 high and are offered in a 12-in. 8W and 21-in. 13W models. Both include an electronic ballast. All three series allow for plug-together connection. **Circle No. 145**



12-Volt Pro-Halogen



120-Volt Mini-Halogen



Mini-Fluorescent

The Diva from **Waldmann Lighting** sports an adjustable lamphead with a ribbed design made from anodized aluminum and parabolic louvers to reduce glare. Fixtures are equipped with aluminum spring-balanced, adjustable arms in a twin vertical design, use one 13W compact fluorescent lamp and mount by clamp for standard and rounded surfaces, wall bracket and designer table base. Diva is compliant with the ANSI/HFES 100-1988 voluntary standard for computer workstations and is warranted for 10 years. **Circle No. 146**

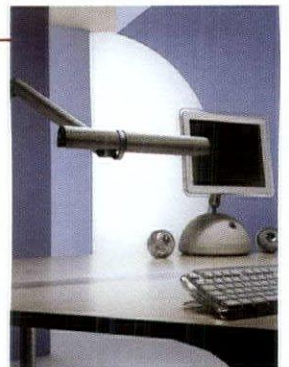

Luxo's Air portable adjustable asymmetric tasklight sports the company's parallel-motion, multi-adjustable, counterbalanced spring arm that is created from a cluster of exposed slender rod shapes. The one-piece, wedge-shaped shade ensures a broad pattern of right-angled distributed light with a sharp beam cutoff. A stem at the base of the shade allows rotatability. Edge-clamp base is standard. Air uses a 35W 12V halogen lamp and has powdercoated tubular steel arms with integral dual tempered-steel springs, pivot points covered in ABS and a base and shade formed of ABS. Matte black and gray aluminum finishes are standard. **Circle No. 147**



Elements of Lighting

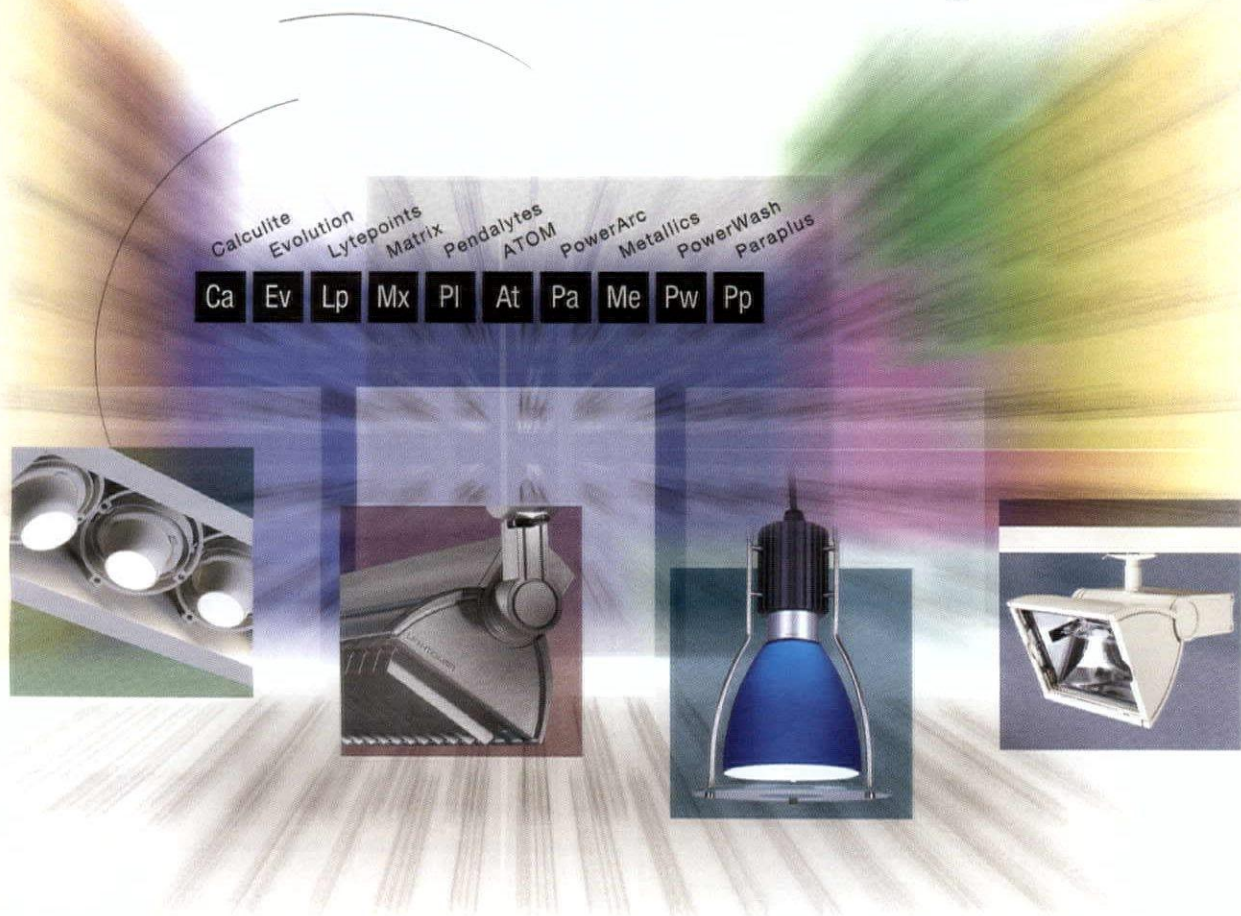

Great lighting starts with innovative products, visionary people and a drive for excellence. The successful chemistry of any lighting application is the integration of these elements in a way that delivers the magic and impact of light. Dedicated to this philosophy for over 99 years, Lightolier remains committed to lighting that makes a difference, for people and business.

Visit us at Lightfair, May 6-8, 2003. **Booth #719.**



© 2003 Lightolier

LIGHTOLIER[®]
Lighting that makes a difference.SM

Circle No. 35 on reader service card

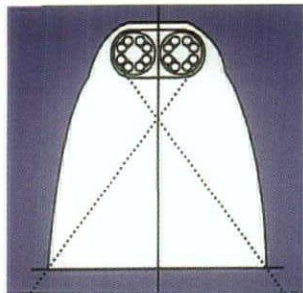

Designed for use with GE's biax high-output compact fluorescent lamps, **FC Lighting's** recessed VM-1200 can accommodate two 70W, two 57W or a combination of both PL lamps. Lamps are available in 3000K, 3500K and 4000K. VM-1200 produces minimal glare and iridescence, measures 12 in. in diameter and features a vacuum-metalized reflector that provides a 55-degree cutoff. **Circle No. 148**

Circle No. 148

CCT ARC rotatable recessed downlights from **Targetti North America** mount flush against ceiling surfaces for visual unobtrusiveness and feature an arced lamp orientation that enables the lamphead to be adjustable and aimable through 359-degree horizontal and 35-degree vertical rotation. Self-locking mechanism is optional. Reflector is computer-enhanced, vacuum-metalized, 99.9-percent pure aluminum with a proprietary Scratch Resist coating. Outer aperture ring is anodized cast aluminum with a white baked enamel finish. Steel mounting brackets connect the reflector to a finned aluminum heat dissipater. CCT ARC accepts HID, halogen and incandescent lamps. Electronic ballasts may be specified. C/UL-listed. **Circle No. 149**



Prescolite's TriLume offers downlight reflectors that provide three distinct levels of brightness. Reflector finishes for Prescolite's Virtual Source reflector optics include American Matte,

a patent-pending process that creates a softly diffused textured finish without sacrificing efficiency and hides fingerprints, dirt and minor scratches; Specular clear Alzak for mid-range levels of brightness; and German import Euro Spec, which provides the lowest brightness level and is suitable for applications where extreme brightness is not desired. All reflectors are formed of cast aluminum that is spun on a computer-controlled spinning machine and then chemically polished. **Circle No. 151**

Circle No. 151

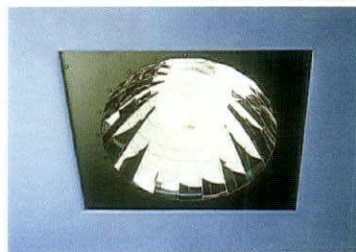

From **Eclipse Lighting**, Oculux series recessed fixtures are characterized by a patent-pending reflector system designed for use with Philips' 165W QL induction lamp. The reflector is formed of aluminum and multi-segmented, and the 18-x-13 1/2-x-9-in.-high aluminum housing features an integral high-frequency electronic generator, junction box, hanger bars and black finish pan for flush

recessed mounting in most ceiling types. UL-listed for through-wiring and damp location. **Circle No. 150**

Circle No. 150

Lightolier's Calculte Matrix square- and rectangular-aperture downlights are designed around compact fluorescent lamps and include the 4 1/2-in. square fixture, which offers a small aperture and uses one 26W or 32W triple-tube lamp. The 4 1/2-x-9-in. rectangular downlight uses a 26W quad-tube or 32W, 42W or 57W triple-tube lamp. The 9-in. square models accept two 26W quad-tube or 32W or 42W triple-tube lamps. Standard open reflector trims control glare with 55-degree visual and reflected cutoff. UL-listed for installation in wet locations, lensed trims incorporate a regressed prismatic lens to soften the lamp image. Lensed wallwashers provide even vertical illumination. All fixtures feature universal electronic ballasts that accommodate 120V or 277V operation and offer end-of-lamp protection. **Circle No. 152**

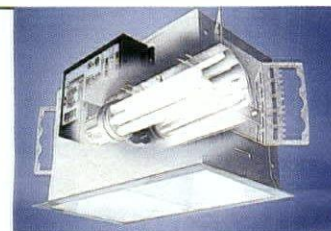

Circle No. 152

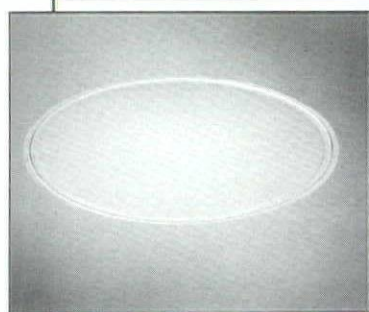

From **Focal Point**, Skydome can be mounted in grid or drywall ceilings and is offered in 2-, 3- and 4-ft.-diameter models. Housing is one-piece, die-formed 20-gauge cold-rolled steel, forming 8 5/8-in.-deep, 2-x-2-, 3-x-3- and 4-x-4-ft. recessed fixtures. White acrylic concave lens is retained in precision-spun, one-piece steel doorframe and

secured to the housing via torsion springs. Convex or flat white acrylic lens is available. Housing and steel components are finished in polyester powdercoat applied over a five-stage pretreatment. High-reflectance white finish is standard. Lamping options include biax and T8 fluorescent lamps. **Circle No. 153**

Circle No. 153

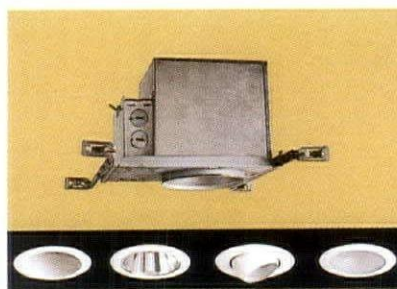

Juno Lighting's 4-in. PAR IC1 downlight measures 6 x 6 x 6 in., allowing installation in tight plenum spaces such as in soffits and near eaves. The housing design is Air-Loc-rated without requiring the use of supplemental gasketing. The rating complies with energy efficiency

requirements, which do not allow conditioned air to escape a recessed fixture and unconditioned air in the attic to enter through it. An internal heat shield allows IC1 to operate 50W R20 and 50W PAR20 lamps without a socket extender. Trim ring has a beveled edge and matches the design of Juno's Universal and Aculux recessed downlights. **Circle No. 155**

Circle No. 155



Con-Tech's Varia Series of concealed adjustable fixtures can be used with any combination of the company's 3-in. trim offerings.

The housings are available in two- through five-lamp models and are suited for highlighting many environments. **Circle No. 154**

Circle No. 154

(Continued on page 42)

The Emperor has no clothes!

The Truth About What Is Going On In Lighting Today.

In a third annual "Lightfair" interview Ruth Ellen Miller, a Magna Cum Laude business graduate with a college teaching credential in Art and Design not only tells us what is going wrong in the lighting market today, but how new technology holds the key to success in today's market. Ruth Ellen is President and co-founder of NoUVIR Research, Delaware Business Person of the year 2000, and has been featured on PBS television and in college textbooks as an expert on proprietary technology. Ruth Ellen also teaches, lectures and is a published author on lighting design and theory. Matthew Scott



MS: Ruth Ellen this is your article. Why focus on industry issues rather than your products? Is this good marketing?

REM: Absolutely! These issues are hurting our industry. They are driving sales overseas. They are costing architects and designers business. Most of all, they are wiping out your profit margins. If you understand the issues, you'll be able to succeed in today's market. If you don't, then, "Say goodnight, Gracie."

Beside all that, I think that NoUVIR fiber optic technology is the answer to the problems designers and architects are facing. If you understand what is hurting sales, you'll understand why NoUVIR is a wonderful solution.

MS: What is hurting lighting sales?
 REM: Age! The truth is that most lighting technology is ancient. Incandescent light bulbs are more than a hundred years old. Fluorescents started in the 30's. They used arc lamps at World's Fairs way back in the 1800's. Sure we've made things a little more efficient, a little smaller or a little larger and use different packaging or different shapes, but the bottom line is that this is still old, old technology! There is nothing new or exciting in most of what is on the market today. Everybody is selling the same stuff. Worse yet, everyone is selling the same stuff just a little cheaper than the next guy. You cannot be really successful in that kind of market!

MS: So what can people do?
 REM: A good many of them go out of business. When you try to compete purely on price, even if you win, you end up losing. Take a look at lighting industry stats. Every year imports, particularly Asian imports, are taking a bigger chunk of the market. Eventually even the imports are going to price themselves out of a profitable position. They will be selling millions of units and making nothing. You can't win selling the same old stuff. There is always someone willing to sell a little less, just a little cheaper.

MS: That's industry, how about designers?
 REM: It works exactly the same way with architects and designers. If you are hawking the same old stuff, you'll forever be in a war with everybody else for smaller and smaller profits. That's a bad business plan. Almost anybody can design with track-lights or Chinese fluorescents. You just bolt it down and go. They'll give you a "how to" book at Home Depot. How can you sell a design that your customer has seen a thousand

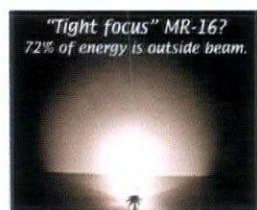

times or sell lighting hardware from a discount store?
 MS: So what is a lighting designer supposed to do?
 REM: You need an edge. You need to be able to do something others cannot do, something that takes you out of the crowd. Today fiber optic lighting is that edge. This is new technology. Light without any heat. Light without any UV. Perfect spectrum, perfect color balance, pure-white, stone-cold, perfectly controlled lighting that you can put anywhere and build into almost anything. You can do things with NoUVIR fiber optic lighting that no one has been able to do before. This is new, different, marketable.

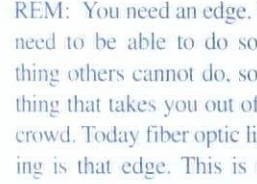

MS: How is it new?
 REM: Going to Lightfair? Take a close look at what is shown. Look at your ability to control things like aim and focus and intensity. Can it compare to NoUVIR's adjustable zoom 5° to 50° beams? How much of the lighting that you look at is scatter, spill or glare? With NoUVIR all of the energy is in the beam. There is no scatter, zero! You control the light

A lot of people are talking green. How much greener can you get than a reduction in light bulbs? That's what NoUVIR can give you.

One major museum in the southwest replaced 700 framing projectors with 40 NoUVIR fiber optic systems. They doubled the light levels on their exhibits, and took out 660 light bulbs! When you factor in their savings in the heat their air conditioning doesn't have to remove from the gallery, they saved over 300,000 watts in that one gallery alone. That's new. That's green.

MS: But everyone at lightfair is claiming new.
 REM: Like soap flakes. New and improved. Look at it! Most of it is ugly. Remember the Riddler's comments as he went through the art gallery in the movie *Batman*? "Crap... crap... crap... crap... that one's O.K.... crap..." If you are honest you'll see a lot of Lightfair the same way. Most of it is not new. Most of it is not better. Some is just weird, pretending to be new. The truth is the Emperor has no clothes. Declining sales prove it.

MS: Allright, NoUVIR really is new. I still don't see how that is a solution for architects and designers
 REM: Look, there are a million people fighting over the low end. There is only one best. We are the leader in fiber optic end lighting. We have 23 US patents in fiber optic technology. That's four more than we had last year. Leading means more than starting ahead, it means staying ahead. We have a proprietary position in the market. No one can do what we do. We literally have no competition.

MS: So how does that help?
 REM: Picture the industry as a pyramid, lots of people on the bottom, lots of competition and few profits. The place to be is at the top. There are a few top designers in the world. Some of them are living on their reputation. They haven't done anything new for years. They won't stay on top. The people who are exploring new technology, learning the new design capabilities of truly modern lighting, they are the ones who will move to the top and stay there. For the next ten or twenty years that new technology is going to be NoUVIR.

MS: What about LEDs?
 REM: LEDs are where fiber optics was before NoUVIR. They are great for effects but limited for practical lighting. Color temperature and color rendition is lousy. They advertise 100,000 hour life, but the latest

research from people like RPI shows that they lose 40% or more of their intensity in the first 4000 hours. They are tri-stimulus sources, like fluorescents, so there are a lot of missing colors and the color changes as they age, just like HID sources. But keep watching. In ten years, they may have these things fixed. They may end up as practical and cost effective as NoUVIR fiber optics. They may not. I know they are not there yet.
 MS: Do you suggest abandoning conventional lighting?
 REM: Absolutely not! Parking garages and department stores are always going to use cheap fluorescent or HID sources. The low end will always be there. For those applications, you'll have to use those kinds of lights. The base of the pyramid rests on conventional lighting. It always will. What I am suggesting is a way out of the rat race at the base, a way to move up into truly new and exciting lighting, a business strategy to work quality lighting design with unique products. Most people won't make the effort. They are comfortable in the herd. Get out in front! Take the initiative and become a design leader? The future is here. Grab it. Control your lighting and your market. Discover the wonderful possibilities of NoUVIR! Help us change the world! Change yours!

Perfect color, perfect light.



Test Question -

What's the best way to light...



This very famous ship's telegraph? (Underwater)

These world renowned ruby slippers?



These handformed Tiffany vases?



If you didn't say, "NoUVIR," plan on a long and difficult career.

NoUVIR Research The best light in lighting!

Perfect color, perfect control, fully adjustable aim, focus and intensity, no scatter, spill or aberration, pure-white, stone-cold fiber optic lighting with no UV and no IR... NoUVIR.

Call (302) 628-9933 for a free 130-page catalog.

Everything you need to know about fiber optic lighting or visit www.nouvir.com to learn about preventing photochemical damage.

INDOOR ARCHITECTURAL LIGHTING



www.indylighting.com

12001 Exit Five Parkway
Fishers, IN 46038

317-849-1233 • fax 317-576-8006

Circle No. 71 on reader service card

(Continued from page 40)

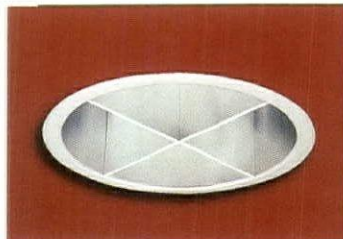

Offered in 6- and 8-in. apertures, **Prescolite's** Virtual Baffle features a 360-degree rotatable trim design for easy jobsite alignment of the cross baffles. The 6-in. model uses one horizontally mounted 42W max. triple-tube or two quad-tube (26W total) compact fluorescent lamps. The 8-in. version accepts one or two triple-tube

lamps up to 42W each; two 13W twin-tube lamps; or two quad-tube lamps up to 26W each. Virtual Baffle fixtures sport a one-piece, 18-gauge corrosion-resistant steel housing platform, universal adjustable mounting brackets and a retention mechanism. B24 bar hangers are available for T-bar ceilings. Specular clear Alzak finish is standard. B24 bar hangers are available for T-bar ceilings. UL-listed. **Circle No. 156**

From **CSL**, the 2800 Adjustable Wallwash/Downlight trim is adjustable 130 degrees and available in white, black and brushed nickel. **Circle No. 157**



From **Lithonia Lighting**, the new Commercial Downlighting product line offers fixtures in 8-, 6-, 5- and 4-in. apertures. Lamping options include compact fluorescent, incandescent, low-voltage and HID sources. **Circle No. 158**



Prescolite's Litebox 6- and 8-in. recessed downlights and trims for 45-degree sloped ceilings provide direct downward illumination and are suited for use in contract and residential applications that have angled, domered or

cathedral ceilings, as well as other architectural high-ceilinged spaces such as building lobbies, restaurants and hospitality and entertainment venues. Housings are available in IC-rated new construction, IC-rated remodel or non-IC-rated remodel housing configurations. The 6-in. housing features black and white finish baffle trim options and the 8-in. housing features back and white finish baffles, as well as clear and gold Alzak reflectors. The smaller housing fits ceilings with slopes of 9 to 45 degrees, with pitch angles of 0/12 to 12/12 and accommodates PAR30L or BR30 incandescent lamps up to 85W. The larger housing is designed for ceilings with slopes of 9 to 45 degrees, pitch angles of 2/12 to 12/12 and accommodates PAR38 or BR40 lamps up to 250W. **Circle No. 159**



Illuminating Experiences presents Coupé from DeMajo Murano, a company known for its collection of handmade, individually signed pure crystal. This 12V trim kit for recessed lighting is available with or without a transformer. Coupé accepts a 50W GU 5.3 lamp. Diameter is 4 3/4 in. Exposed height is 2 3/4 in. Colors are amber, white or clear glass. **Circle No. 160**

Special FX® Lighting manufactures unique color products Any Light • Any Fixture • Any Color

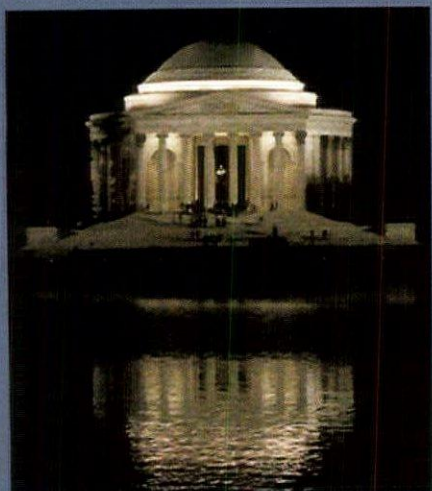

FX® high temperature color correction and UV block
Jefferson Memorial, Wash. DC

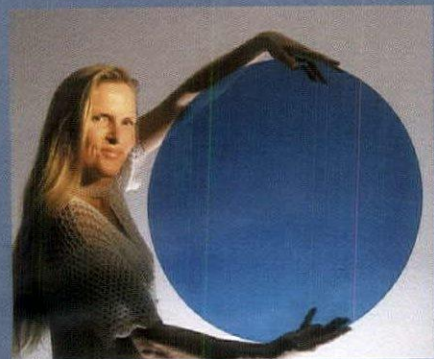

FX® has perfected permanent color/filter coatings for all types of glass and polymers



FX® manufactures lenses for all types of lighting. All colors are standard. Delivery is fast.

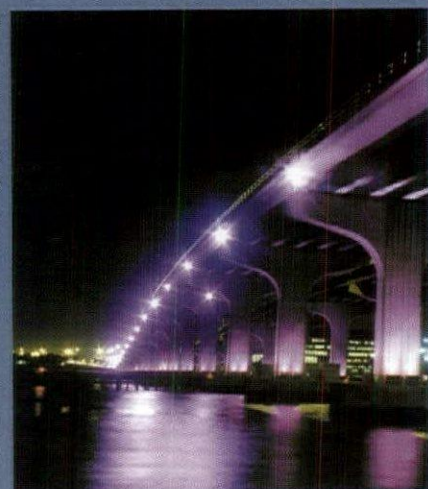

Special FX manufactures durable, cost effective color lenses for all challenging environments.



NEW! Higher Temp EZ•Glass•HT™ the most durable, practical, cost effective way to achieve architectural color on all glass lenses/ware

**Visit our new updated website
see pictures • find info • download specs**

- EZ•Glass•HT™
- Dichro•X™ hybrid lenses
- All types of dichroics
- Tempered Glass •Glassware
- Polycarbonate •Polymers
- Floro Tubes •Films
- Light Bulbs •Compact Floro
- Spectrometer Testing
- Kelvin Matching
- Hundreds of colors standard

<http://www.fxlight.com>

Circle No. 79 on reader service card

We custom color a variety of private label OEM products

**Special FX® Lighting • Celebrating 18 years of innovation
PO Box 177 • 293 N. 2260 W. • Hurricane UT 84737
435.635.0239 (voice) 435.635.3929 (FAX) info@fxlight.com (email)**



Featuring acrylic glass screens housed in steel and aluminum fixtures, **Orgatech's** Lightguide Collection provides near-perfect 90/10 luminosity with T5 or T5/HO fluorescent lamps. Fixtures have a steel wire suspension with adjustable Y grippers, connecting leads and an integral electronic ballast. Dimming and presence-detection ballasts are also available. Lightguide includes Lightwing with curved 2-x-12.374-in. panels and Lightplane (shown), which measures 2 x 12.875 in. Both control and deflect lateral light downward. The 1.625-in.-high Prisma is available with colored decorative elements and Lightstar sports blue or white LEDs that are mounted in twin laminated clear-tempered glass panels. **Circle No. 161**



Partnering with Regent of Basel, Switzerland, **Énergie** now offers the Level family of direct/indirect fixtures, which feature a patented Micro Downlight Technology (MDT) that controls the brightness and glare of fluorescent lamps. The MDT downlight component consists of a series of miniature downlights, which are actually numerous parabolic-shaped holes. Available in 4-, 8- or 12-ft. lengths, Level can be used as a stand-alone linear pendant or connected to form linear runs. Construction is extruded aluminum. **Circle No. 162**

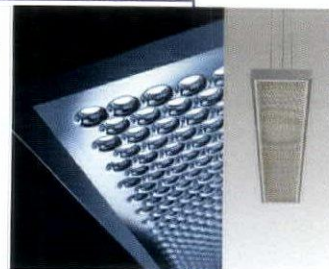

Zumtobel Staff Lighting's ML (Mellow Light) series of recessed and surface-mounted fluorescent luminaires features the patent-pending Light Chamber, which provides uniform brightness, translucence and visual depth; the proprietary rectangular Micro Grid Diffuser and optional inlays are available in yellow, blue and green. Recessed models are available in 2x2, 1x4, 2x4 configurations and for lay-in, slot-grid, gypsum board and Armstrong Optima Vector ceilings. Surface-mount versions are offered in a 1x4 configuration and for continuous-row runs. ML accepts 40W, 50W, 80W T5TT, 28W T5 and 24W and 54W T5/HO fluorescent lamps. **Circle No. 164**

Paraplus recessed direct/indirect fixtures from **Lightolier** are available in 2x4, 2x2 and 1x4 sizes with multiple lamp options ranging from linear T8 and T5 lamps to twin-tube T5 lamps in the 2x2 model. The louver hinges from either side of the fixture. The standard unit is suitable for grid and slot-grid ceiling types. On a slot-grid ceiling, Paraplus fits flush to the face of the slot grid. Paraplus can be row-mounted in continuous rows and has passed UL1598 for air return capabilities. **Circle No. 165**



The Sky Oculus series of recessed, surface and suspended round luminaires from **Prudential Lighting** provides designers with clean, organic forms combined with modern lamp technologies. The P-3900 fixture (shown) is offered in 2-, 3- and 4-ft. diameters available in surface or suspended mountings (shown). The one-piece, spun-steel housing gives a broad palette of applications and possibilities. **Circle No. 163**



Forms+Surfaces' Contour indirect series fixtures are formed of Aero corrugated aluminum that is flexible and formable. Fixtures are available in 4- and 8-ft. linear lengths and can be suspended individually, or linked together in rows or configured in clusters or patterns via various angled connectors. Anodized finish in matte silver is standard. A variety of colors is also available. The fixture uses T5, T5/HO or T8 lamps. **Circle No. 166**

Vista Lighting's Questra linear wall sconce features an ellipsoidal acrylic direct/indirect diffuser positioned at the leading edge of elongated chevron end brackets. The diffuser pivots through a 210-degree arc. The housing acts as a wiring chamber to facilitate mounting via standard BX or Romex connectors without need for an outlet box. Available in 28 1/4-, 40- and 51 3/4-in. lengths, Questra uses one narrow-gauge bi-pin 24W-54W T5 fluorescent lamp. Extruded aluminum body has removable white opal acrylic diffuser. Aluminum end brackets are finished in brushed aluminum. C/UL-listed. **Circle No. 167**

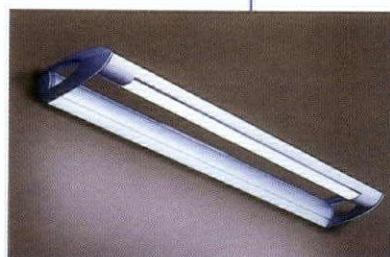

From **Lam Lighting Systems**, Zenith AA wall- and ceiling-mounted asymmetric lighting fixtures provide indirect light at right angles. Affixed to mounting brackets, the housing is field-adjustable and lockable into position. Fixtures feature a computer-enhanced, brightly polished asymmetrical metal reflector system. Lamping includes metal halide, T8, T5 and compact fluorescent sources. A clear, tempered glass lens shields against glare. Shrouds are also available. Zenith AA may be specified in clusters of two, three or four for large installations. Construction is extruded aluminum. **Circle No. 168**



FC Lighting's Spyke, a die-cast aluminum exterior/interior wall sconce, may be specified in direct, indirect or direct/indirect versions with aperture hardware allowing on-site light-throw pattern adjustments of up to 120 degrees. Measuring 5 7/8 in. wide, 6 1/4 in. high and 4 in. in diameter, Spyke uses quartz T4 and metal halide G12 lamps in wattages ranging from 50W to 175W. Finish is black or white powdercoat. Custom colors are available. **Circle No. 169**



44



Elliptipar's Gondolier modular display lighting system is equipped with an asymmetric reflector that projects light from the top of a gondola to the bottom from a height of 7 ft. or more and with minimal shadowing of lower shelves. The modules hook onto the gondola uprights. Other features include integral electronic ballasts; a choice of cord and plug or through-wiring for an entire row; locked aiming; and optional snap-on lens. The system uses T5 lamps and offers a variety of lengths. **Circle No. 170**



Lightolier's EYE-Q direct/indirect or direct series offers a linear prismatic lens in place of a louver. Suitable for schools, offices and retail stores, the EYE-Q Lens is available in 4- and 8-ft. lengths with a direct/indirect ratio of 45-percent downlight and 55-percent uplight when using the optional top lens. EYE-Q can be suspended via stems or cables or surface-mounted. Lens hinges from either side of the luminaire. EYE-Q uses T8 lamps and electronic ballasts. Housing is 20-gauge steel. **Circle No. 171**

(Continued on page 47)



Offering segmented/hammered reflectors and various peak angle distributions, the optical system of **ExceLine's** Indirector allows the lens to remain at or near horizontal, increasing uniformity when fixtures are used in a series. Lockable arms have seven-position "ratchet" adjustment. Lockable optical housing rotates 160 degrees. Internal reflector is adjustable. Indirector offers wall- and ceiling-mounted models in two styles, five sizes and a choice of solid and perforated designs with remote or integral ballast. A "window" option is also available. Lamping includes metal halide, compact fluorescent and halogen sources. Finishes are matte white, metallic aluminum and dark titanium. Custom colors are available. **Circle No. 172**

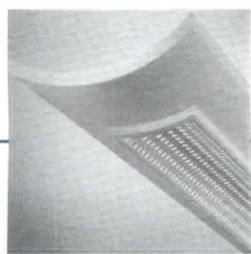

Focal Point's Verve III is offered in radial parabolic louver, concave square media, concave slot media and concave round media versions. Providing low iridescent and brightness and glare control, radial parabolic louver models in one-lamp T5/H0 and two-lamp T8 configurations are RP-1-compliant; with downlight reflector and dual circuit options, three-lamp models produce direct/indirect distributions up to 100-percent direct or indirect or 30-percent direct and 70-percent indirect. Concave versions come standard with white acrylic diffuser insert and specular interior ends. Accent gel inserts in various colors are available for concave shielding media. **Circle No. 173**

explore

the possibilities with the new Magellan low voltage rail lighting system. Named for the famed explorer that pushed beyond the known limits of his world,

Magellan offers a variety of exciting fixtures and accessories in a mix of contemporary colors.

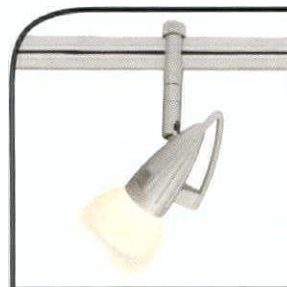

MAGELLAN
Expand your horizons.

FIXTURES · RAIL · ACCESSORIES

12V or 24V

25 AMP

CON-TECH LIGHTING

2783 SHERMER ROAD
NORTHBROOK, IL 60062

T 800.728.0312

F 847.559.5505

www.CON-TECHLIGHTING.com

ECHO

ECHO'S ADJUSTABLE LUMINAIRES REFLECT AN EVEN LEVEL OF LIGHT OVER CEILINGS, WALLS, AND WORK PLANES. ITS OPTICAL SYSTEMS INCORPORATE THE LATEST ENERGY-EFFICIENT LAMP TECHNOLOGY. ECHO - A BRIGHT IDEA FOR AIRPORTS AND ATRIUMS, LOBBIES AND LIBRARIES. (262) 242-1420, WWW.SPILIGHTING.COM

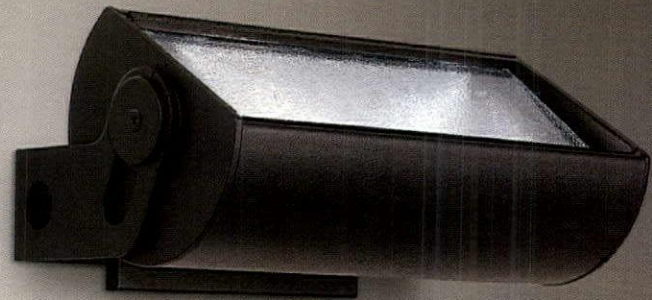

SPI LIGHTING

Circle No. 86 on reader service card

(Continued from page 45)

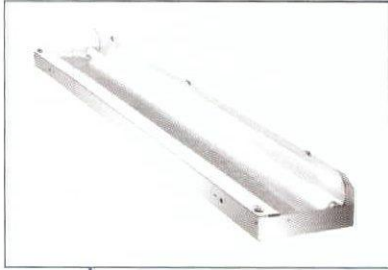

Designed for T5/HO and T8 lamps, Super Cove from **Prudential** features a three-piece optical system. A formed 95-percent reflective specular aluminum reflector throws light at low angles. Galvanized steel bottom reflector directs and diffuses light on the ceiling to eliminate striations. White backlight reflector fills

the cove cavity with light. Super Cove is available in 2-, 3-, 4-, 6- and 8-ft. lengths. Housing and endplates are die-formed, 20-gauge steel. T8 fixtures have instant-start electronic ballasts and T5/HO fixtures have programmed-start electronic ballasts. **Circle No. 174**

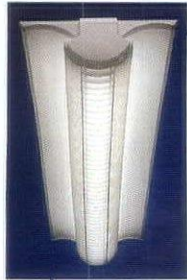

Lithonia Lighting's Avante line includes 2-x-2- and 2-x-4-ft. side-mount diffuser units and surface/suspended fixtures available in 1x2

and 1x4 sizes. Both accept compact fluorescent, T8, T5 and T5/HO lamps. Reflectors are finished in high-reflective matte white paint or stepped aluminum. Side-mount units may be mounted end-to-end and sport injection-molded plastic light traps that secure the diffuser to facilitate lamp access and prevent light leakage. Surface/suspended models offer cable-suspended and stem- and surface-mounting options. Field-joinable 2-, 4- and 8-ft. units allow continuous-row mounting. **Circle No. 175**

Lytespread Alpha from **Lightolier** uses two 28W or 54W T5 lamps with electronic ballasts and is available in 4-, 8- and 12-ft. lengths. A patent-pending reflector design allows the T5 lamp to emit the majority of the light at 107 degrees, creating a ceiling uniformity that meets or exceeds the IES RP-1 preferred criteria for office lighting.

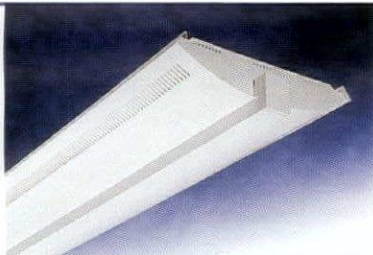

Suspended on aircraft cables, fixtures can be mounted 24 in. from the ceiling on 18-ft. centers and obtain less than a 5:1 ceiling brightness ratio while maintaining 55 fc. Dimming ballasts and emergency battery packs are available. **Circle No. 176**

Litecontrol's Inde-Pendants series consists of four direct/indirect fixture styles—Scion, Nexus, Echelon and Mantra—in two sizes. Ranging from 32 to 39 in. in diameter, large fixtures offer a choice of

three- or six-lamp designs that use 39W, 40W, 55W or 55W twin-tube compact fluorescent lamps to provide indirect illumination. Junior-size fixtures vary from 23 to 29 in. in diameter and accept four 26W, 32W or 42W triple-tube compact fluorescent lamps. For downlighting, large models use one 21W or 38W 2D lamp; smaller fixtures use one

21W 2D lamp. Large fixtures suspend via a combination of a stem and three- or four-part aircraft cable assembly. Smaller fixtures also offer a single-stem mounting system. **Circle No. 177**



KONE Compact Fluorescent

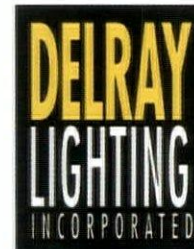

www.delraylighting.com

Circle No. 40 on reader service card



Cypher from **Architectural Area Lighting** features reflector/refractor optics that provide smooth, even illumination for floodlighting and indirect lighting applications. The design allows the Cypher to be mounted in any orientation to address various lighting tasks for interior and exterior applications. **Circle No. 178**

Metro, developed by Belgian manufacturer Multiline and offered by **Énergie**, features watertight gasketing, stainless-steel screws with stainless-steel inserts and an eight-phase aluminum finish process. This shallow ingrade uplight is available with a round, square or triangular trim and is available in symmetric or asymmetric distributions. Metro may be specified with a cast-aluminum recessed housing for concrete or drive-over applications. **Circle No. 179**

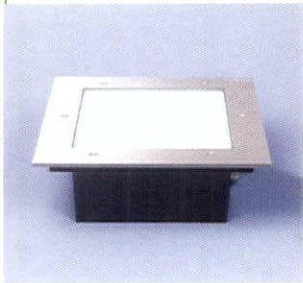

Ruud Lighting's DU Series is an easy-to-install sealed well light. This in-ground fixture is suited for lighting shrubbery, trees or architectural accents in residential, commercial or institutional settings. Accessories for the watertight housing include an external glare shield and external linear grate, which both control glare. The grate also protects the lens from falling objects. Louvers and color filters also are available. The DU Series is available in line or low voltage. Lamp selections include halogen (MR16 and PAR36) and HID (metal halide, HPS and MH-PAR) sources through 75W. **Circle No. 181**

The McGraw-Edison brand of **Cooper Lighting** announces the Generation CVL Series of outdoor architectural cutoff post-top luminaires, which offers low glare, minimal uplight and high efficiency. Part of the Generation Series, the decorative post-top line combines exceptional cutoff photometric performance, modular fixture design flexibility and maintenance ease for residential communities, office complexes, downtown streetscapes, roadways, outdoor retail applications, city parks and school campuses that demand dark-sky benefits and light control. The Generation Series CVL Optical System utilizes a vertical lamp position located in the top of the luminaire to prevent any direct glare to pedestrians or motorists. The modular design offers three different bases/housings, four banding/cage types, four tops and four different finials. The cast-aluminum housing is available with up to 250W metal halide and HPS or 85W QL electrodeless fluorescent systems. **Circle No. 180**

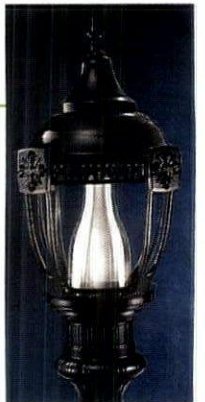

The SignMaster SI-17 Series luminaires from **Metrolux Lighting** have a computer-enhanced reflector design that reduces light pollution while delivering more light more evenly to overhead and roadside directional signs and outdoor advertisements along city streets, rural highways intersections and rest stops. The luminaires are characterized by a contemporary wedge-shape design. Each unit contains a curved, horizontally faceted, sectional metal reflector system, which permits the light beam to be concentrated on the message and yield optimum lighting distribution across a range of sign sizes, shapes and outdoor environmental conditions. **Circle No. 182**

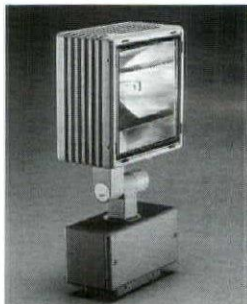

The Farino floodlight from **HessAmerica** features a finned cast aluminum housing with six different optical systems designed around ceramic metal halide sources for precise control. The fixture is available in three rectangular (80-degree horizontal x 10-degree vertical, 80-degree horizontal x 20-degree vertical, 80-degree horizontal x 35-degree vertical) and three spot (10-, 20-, 35-degree) distributions. Multiple shielding, control and color filter accessories complement this new offering. **Circle No. 183**

Design ACT-16 Acorn post-top luminaires from **Quality Lighting** are equipped with an internal spectrum metal reflector system and a rotationally molded, UV-stabilized polycarbonate globe, which diffuses light. Sharp cutoff and rotatable anti-light trespass are optional. The fixture uses a vertically oriented HPS or metal halide lamp in a range of wattages and standard or high-power ballasts with single or double fusing for application versatility. Housing is formed of durable, but lightweight aluminum; ballast housing is spun aluminum. Finish is electrostatically applied textured polyester powdercoat. Paint finishes meet or exceed ASTM requirements for a 1,000-hour salt-spray test. **Circle No. 184**

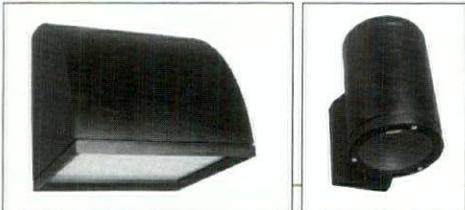

Lumux introduces its wall-mounted fixtures with fully shielded light sources for up/down dual lighting in indoor or outdoor applications. Construction is low-copper, die-cast aluminum with a corrosion-resistant polyester powdercoat finish. Fixtures are equipped with a tempered glass diffuser and vandal-resistant stainless-steel screws and accept a variety of lamps, including 150W HID sources. Fixtures may be specified in any RAL color. Suitable for wet locations. **Circle No. 185**



From **Lithonia Lighting**, the Gateway Series has added four new outdoor architectural fixtures that feature new grille patterns and offer a choice of round or oval face styles. Fixtures can be ceiling- or wall-mounted and positioned in a vertical or horizontal orientation. The low-profile round VGR and oval VGO (shown) use compact fluorescent lamps and most models are ADA-compliant. The deep housing VGR-C and VGO-C use higher-wattage multi-lamp compact fluorescent and HID lamps. Housings are marine-grade, die-cast aluminum finished in polyester powdercoat. Lenses are injection-molded polycarbonate. Tamper-resistant, IP65-rated enclosures are warranted for life against breakage. **Circle No. 186**



Sonne from **Selux** is a solar outdoor lighting fixture that combines architectural design and advanced solar technology. Sonne offers complete unit installation, maintenance-free material for luminaire, panel and battery controller enclosure, compact fluorescent lamp up to 42W, Smart Controller, environmentally friendly sealed gel batteries, galvanized steel and recycled ABS materials. **Circle No. 187**

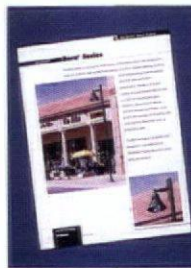

Holophane's Bern Series fixtures consist of a bell-shaped reflector and a choice of nine prismatic glass reflectors. Fixtures are available with a choice of IES Type-II/4-way, III (asymmetric), IV (asymmetric) or V (symmetric) photometric light distributions. Lamping options include HPS, metal halide and mercury vapor sources in wattages of 35W-175W. The Bern Series is offered with Holophane's line of GlasWerks decorative posts, arms and brackets. Units can also be wall-mounted. Brochure available. **Circle No. 188**

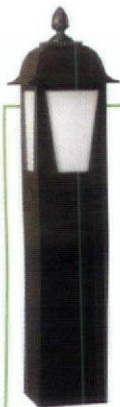

The 75000BOL Fairfax Lane Bollard from **Hinkley Architectural** features a mounting base constructed of corrosion-resistant, cast-aluminum alloy and an extruded aluminum bollard shaft with a 6-in. diameter and .125-in. wall thickness. The top is cast aluminum. The fixture is offered with galvanized steel anchor bolts with nuts and washers, stainless-steel fasteners available with a tamper-resistance effect and a 4KV pulse-rated medium-base socket. Model 75000BOL uses up to 100W metal halide, mercury vapor, HPS and incandescent lamps. A compact fluorescent version with an HPF ballast and socket is also available up to 42W. Optic options include a Type-V cone reflector, glass and louvered refractors and a 180-degree house-side shield. Various finishes are available. **Circle No. 189**



Hadco has expanded its recessed Steplyte family to include a performance LED light source. These fixtures utilize the high-output 1W Luxeon white LED and, depending upon the lumens required, are available in either a 3W or 5W series, with integral reflector and transformer included. Fixtures are available with louver, mini-screen louver, translucent lens or bubble lens and are constructed of marine-grade, die-cast aluminum alloy. **Circle No. 190**

One Source for Decorative Poles



Avenue

Classic Contemporary Steel and Aluminum Poles

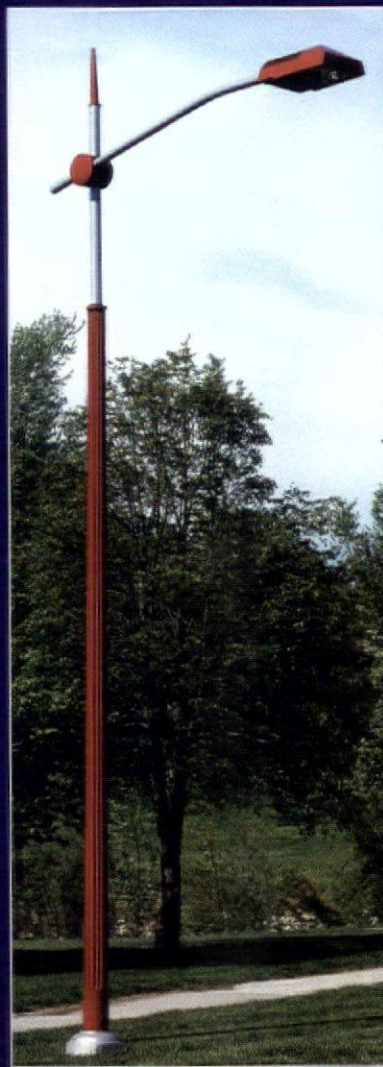

CITYQUARTZ

Contemporary Architectural Steel and Aluminum Poles



Columnar

Historic in Nature... Contemporary in Style



Now Available!

Imagine™

Interactive CD Program
A Decorative Pole Design Configurator

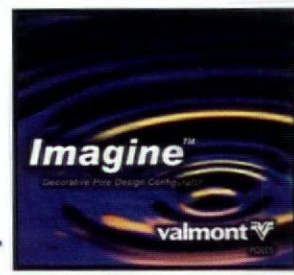

To order **Imagine™**, contact us at 1-888-223-0608 or visit us at www.valmont.com.

valmont 
POLES

With Pivot from **Architectural Area Lighting**, lighting designers can wash a wall, highlight signage or indirectly illuminate a space. The Pivot uses energy-efficient fluorescent lamps and electronic ballasts in a small compact luminaire design. The Pivot is available in four individual lengths or can be used in continuous rows. The Pivot is engineered for mounting in any orientation for indoor or outdoor applications. **Circle No. 191**



ExceLine's GeoFlood Compact Fluorescent Series floodlights sport a die-cast aluminum housing, flat clear tempered glass lens and formed and polished and/or segmented specular aluminum reflectors. Fixtures feature lockable, five-degree incremental aiming adjustment, use triple-tube compact fluorescent sources in configurations ranging from two 26W to three 42W lamps and are available with accent, cutoff, facade, horizontal and vertical optical systems. Exterior components are painted with Duraplex II polyester powdercoating. Fixtures are offered in six designer finishes. C/UL-listed. **Circle No. 192**

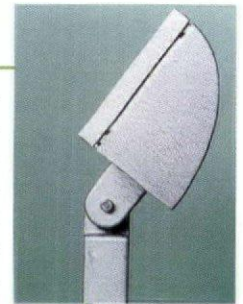

Designed for low mounting heights, **Bega's** Rectangular Recessed Wall Fixtures provide illumination for steps, stairs, ramps and other locations where guidance and security lighting is required. The fixtures are composed of .125-inch-thick, clear, tempered glass machined flush to one-piece die-cast aluminum faceplate and housing formed of die-cast and extruded aluminum components with an integral wiring compartment. The series uses 75W compact fluorescent lamps with electronic ballasts. Standard finish is black or white textured powdercoat over a phosphate base. **Circle No. 193**

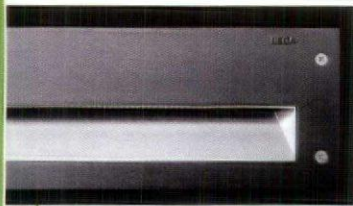

NiteBrite outdoor HID lighting from **Day-Brite Lighting** introduces the Economic Outdoor Series of low-wattage, outdoor fixtures. Included are the NFL miniflood, which uses 70W, 100W and 150W HPS lamps, and the NFM floodlight, which accepts 70W, 100W and 175W metal halide lamps. The NQF quartz flood (shown) is available with 500W and 1500W quartz lamps and the NWP wall pack is offered in 50W and 70W HPS versions. The NWL wall light accepts 70W and 100W HPS lamps and the NCL canopy light accepts 50W and 70W HPS lamps. The NPL PAR lampholders accommodate up to two 150W PAR38 lamps. **Circle No. 194**

LightForm+, a Forms+Surfaces company, offers the L209 Lighthouse Bollard. Compact fluorescent and HID models are constructed in durable cast aluminum with a powdercoat finish. The fixture measures 9 in. in diameter at the base and a nominal 42 in. in height. The head of the fixture is 9.4 in. in diameter. UL-listed for wet locations. **Circle No. 195**



Ruud Lighting's Narrow Beam Cutoff Floodlight (CN Series) produces both narrow/vertical and wide/horizontal distribution. The fixture is suited to light outdoor recreation fields, building facades, signage and similar applications. The 22-in. housing adapts to a 2-in. adjustable fitter or yoke mount. Lamp wattages, in probe- or pulse-start metal halide and HPS, range from 320W through 1000W. The optical system tilts above horizontal allowing optimal placement of the main beam to best suit the application. **Circle No. 196**

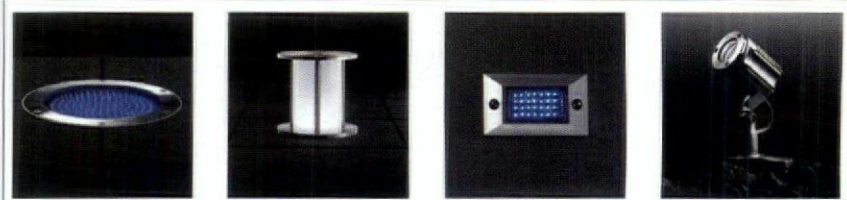

From **Hinkley Architectural**, the 75008BOL Direct Burial Bollard sports a bollard shaft made of extruded aluminum with a .125-in. wall thickness and topped with cast-aluminum. Stainless-steel fasteners are used throughout the fixture and available with a tamper-resistance effect. The bollard is offered with a 4KV pulse-rated medium-base socket and accommodates up to 100W metal halide, mercury vapor, HPS and incandescent lamps. A compact fluorescent model with a HPF ballast and socket is available up to 42W. Optic options include a Type-V glass refractor and a 180-degree house-side shield. Various finishes are available. **Circle No. 197**



Louis Poulsen Lighting's family of Inground/Accent products is comprised of buried uplights, namely Pharo, Nimbus and WeeBee. By adding the Dome, Pharo can be changed into a 360-degree pathlight or 180-degree pathlight and wall-wash combination. Nimbus and WeeBee are also available as marker lights, Tripos and Tripos mini, or as recessed wall lights, along with Dex, a rectangular steplight. For accenting purposes, the surface-mounted WeeBee Spot completes the product range. Lamping options include low-wattage ceramic metal halide, compact fluorescent, low-voltage halogen as well as LEDs, which are available in white, blue, green, red and amber. Inground/Accent Products are suitable for illuminating a wide variety of architectural and landscape projects, including building facades, columns, canopies, statues and foliage. **Circle No. 198**



The Treva bollard from **HessAmerica** is a geometrically styled bollard for low-level pathway lighting and accenting. The heavy-wall, cast-aluminum bollard is constructed for rugged durability. All exposed hardware is stainless steel. Three optical configurations are available to meet a variety of lighting design applications. All models have three low-level apertures for general pathway lighting, while an optional fixed uplight or a field-adjustable upper-level aperture (shown) can be specified for accenting. Treva uses 39W ceramic metal halide PAR30 lamps. **Circle No. 199**

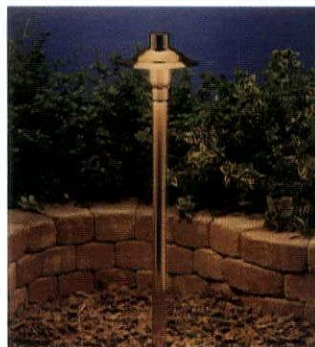

Kichler Landscape Lighting's Model 1535CO is an adjustable pathlight equipped with a copper shade and stem that will develop a natural patina over time. The adjustable top shade allows for flexibility of the light beam spread. The fixture includes a 24.4W lamp and 8-in. non-corrosive stake. **Circle No. 200**



Lithonia Lighting's Aeries line of low-profile, architectural area and roadway fixtures has expanded to include a wall-mount option that is available in two sizes. The smaller size is suitable for pedestrian areas and the larger version is appropriate for open parking areas, entry drives and roadways. The Aeries wall-mount can be oriented lens-down or lens-up for indirect lighting. The entire Aeries series features anodized segmented reflectors that are interchangeable and rotatable in 90-degree increments and offer a range of distribution patterns. Lamping options include HPS, metal halide and compact fluorescent sources in various wattages. **Circle No. 201**

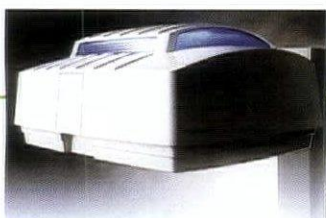

Paradigm PDM-24 pole-mounted outdoor area and roadway lighting fixtures from **Quality Lighting** feature curved light-heads punctuated on three sides with Edge-Glo accent windows available in a range of lens colors. Mounting arms can be specified to accommodate single-, dual-, triple- or quad-luminaire heads. Paradigm PDM-24 sports a proprietary computer-designed, segmented, multi-surface optical system for lamps up to 400W and offers a choice of six distribution patterns. Die-cast aluminum housing is finished with an electrostatically applied polyester powdercoat. C/UL-listed for wet locations. **Circle No. 202**

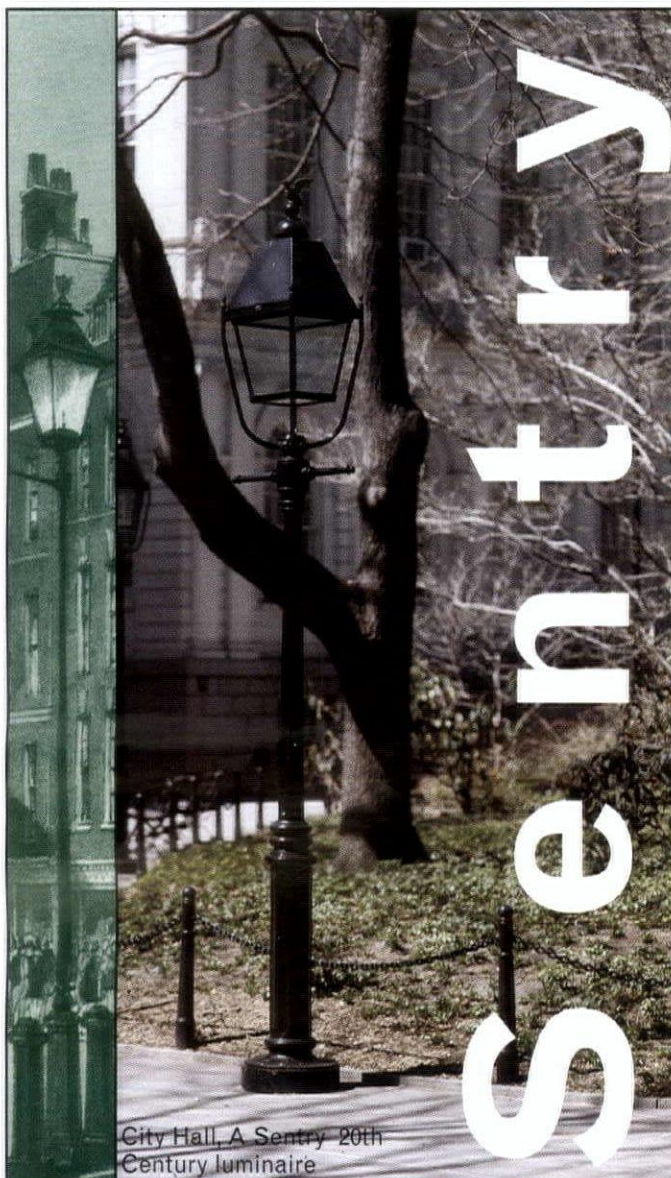

City Hall, A Sentry 20th Century luminaire

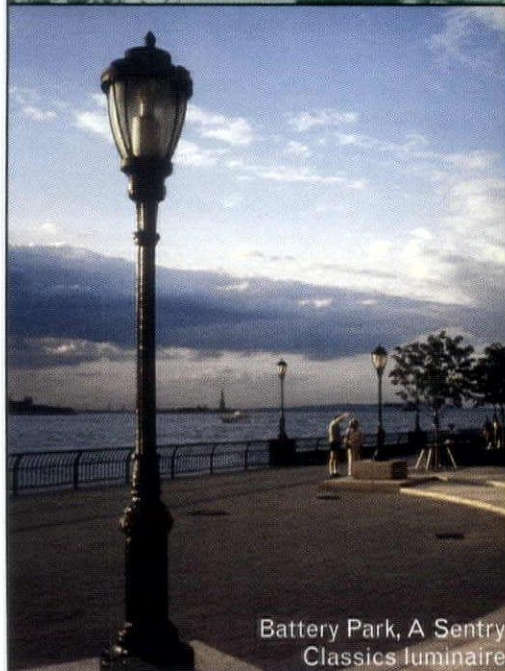

Battery Park, A Sentry Classics luminaire

Sentry

LUMINAIRES

POLES

BOLLARDS

ACCESSORIES

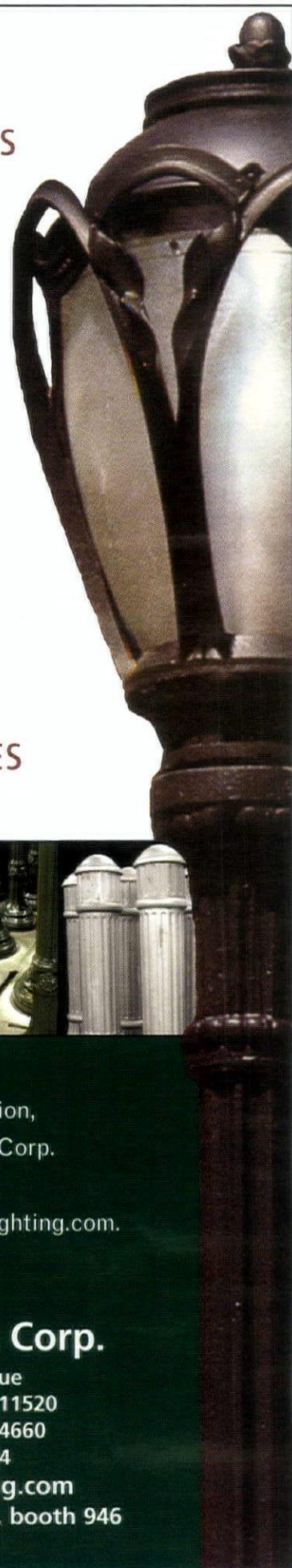

For more information,
call Sentry Electric Corp.
at 516.379.4660,
or visit us at www.sentrylighting.com.

Sentry Electric Corp.

185 Buffalo Avenue
Freeport, New York, 11520
telephone: 516.379.4660
fax: 516.378.0624

www.sentrylighting.com

Visit us at Lightfair 2003, booth 946

IllumaTech Dimmers/Fan Speed Controls from **Leviton's Lighting Control Division** combine traditional rotary dimming

with Leviton's Decora design. Dimmers are available in illuminated and non-illuminated models; fan speed controls are available in single-pole, single-rotary dial and duplex-rotary dial models. Illuminated models feature a green LED that serves as a device locator in darkened areas. Duplex rotary dial models control both a fan and light source in a single compact device. The dimmers offer push-on/off switching for both single-pole and three-way installations when used with a three-way switch. IllumaTech Dimmers/Fan Speed Controls are compatible with screwless and standard Decora wallplates, feature a built-in radio/TV interference filter and are suitable for multi-gang installations in residential and commercial installations or any area where ceiling fan noise is undesirable. Available colors are white, ivory and almond. **Circle No. 204**

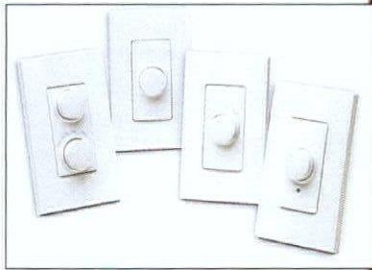

Osram Sylvania's new Pentron Eco and Pentron HO Eco low-mercury fluorescent lamps have passed the EPA's TCLP test and replace the company's Pentron and Pentron HO, which were first introduced in 1996. The Pentron Eco is an Ecologic lamp, engineered to meet the goal to develop products that are more energy-efficient, offer long service life and have less impact on the environment. Measuring 5/8 in. in diameter, Pentron Eco and Pentron HO Eco are available in nominal 2-, 3-, 4- and 5-ft. lengths and

may all be operated on the same Quicktronic PS and Quicktronic PHO electronic ballasts as the Pentron T5. When used in luminaires specifically designed for them, Pentron Eco Systems can produce between 5-20 percent more light than T8 systems while reducing the impact on the environment. **Circle No. 206**



Advance Transformer's Optanium energy-efficient electronic ballasts for T8 lighting systems are available in a standard light output design with a .88 ballast factor and a low-watt design with a .78 ballast factor. Ballasts are instant-start, high-efficiency designs that substantially reduce ballast wattage losses compared with standard-efficiency units, helping users lower operating energy costs significantly. The low-profile the housing has same mounting "footprint" as standard electromagnetic and electronic ballasts. An independent lamp operation feature allows other lamps to continue operating if one or more lamps in a fixture fails. Operation between 40kHz and 54kHz helps prevent interference problems with IR control systems and commonly used Electronic Article Surveillance systems. An auto-restrike capability feature eliminates the need to reset power mains after failed lamps are replaced. Ballasts can operate three or four lamps on both 120V and 277V systems. **Circle No. 208**



All of **GE Lighting's** 2-, 3- and 4-ft. T8 linear fluorescent lamps are now Ecolux products. Ecolux lamps exceed the Toxic Characteristic Leaching Procedure (TCLP) standards set by the Environmental Protection Agency. The TCLP test is a landfill disposal test that determines whether used fluorescent lamps are to be managed as standard waste or hazardous waste upon disposal. Lamps that pass the TCLP testing requirement are considered non-hazardous waste, per federal regulations. **Circle No. 203**

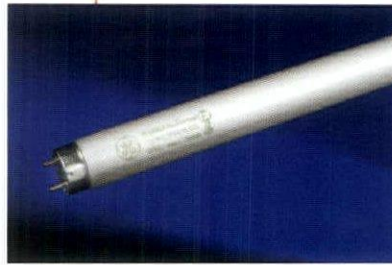

Universal Lighting Technologies

offers three new product fliers highlighting the Triad brand High Efficiency and AccuStart ballasts. When paired with energy-saving T8 lamps, Universal's High Efficiency ballasts cost up to 40-percent less to operate than T12 energy-saving systems and up to 6-percent less than standard electronic T8 systems. AccuStart electronic ballasts incorporate Programmed Rapid Start technology and is ideal for frequently switched and short-cycle applications, including classrooms, restrooms and occupancy-sensor applications. The new literature provides specification information, catalog numbers, wiring diagrams and appropriate lamp applications. **Circle No. 205**

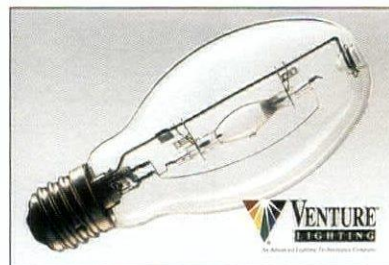

Venture Lighting's Uni-Form pulse-start series now includes a 125W metal halide mogul-based lamp for enclosed rated luminaires. Developed for retrofit applications, the 125W Uni-Form pulse-start lamp is an alternative to the 175W universal metal halide lamp and provides 12,000 initial lumens, 8,400 mean/design lumens

and a color temperature of 4000K. Compared to a traditional 175W pulse-start metal halide lamp, the 125W lamp offers more mean lumens over life and provides 50-percent longer life at 15,000 hours. CRI is 65. **Circle No. 207**

Ushio America's PulseStrike metal halide lamps feature a formed-body arc tube in which the quartz glass is contoured to follow the natural curve of the arc between the electrodes. The design allows for the use of a higher fill gas pressure in the arc chamber and reduces the damage to the electrodes caused by starting. The lamps feature higher lumens per watt, superior uniformity, longer lamp life, reduced thermal losses and greater energy savings as well as faster warm-up and restrike over standard probe-start metal halide lamps. PulseStrike metal halide lamps are rated for both open and enclosed fixtures and are available in medium base 70W, 100W and 150W and mogul base 250W, 320W, 350W and 400W in clear and coated finishes. **Circle No. 209**

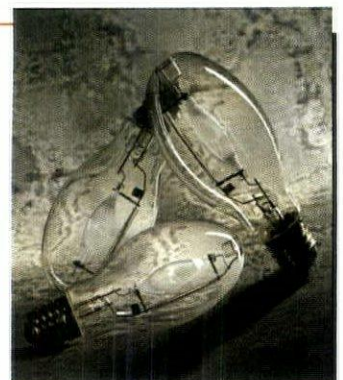

Osram Sylvania's Octron XP Supersaver Curvalume Ecologic lamps work in tandem with Quicktronic Programmed Start PSX ballasts to form the Octron XP Curvalume Supersaver PSX System, which offers a 24,000-hour average rated lamp life, provides up to 60-percent longer life than instant-start at 15,000 hours and uses 27-percent less energy. Other system features include a lumen maintenance of 95 percent and a CRI of 82. Compared to a T12 energy-saving lamp and ballast system, the Octron XP Curvalume Supersaver PSX System provides 40-percent energy savings, 33-percent longer lamp life and 91 percent of the maintained light levels with improved color rendition in three popular color temperatures (3000K, 3500K, 4100K rare earths vs. cool white and warm white halo phosphors). **Circle No. 210**

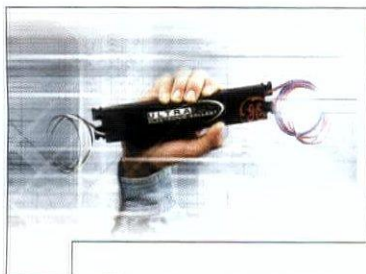

From **GE Lighting**, the Ultramax electronic ballast combines multi-voltage capabilities with high energy efficiency, enabling one ballast to run on 120V or 277V; delivers cost savings of up to 40 percent over standard ballasted T12 systems; and features Multi-Voltage Control, which can virtually "read" the incoming voltage and adapt automatically to any voltage from 108V to 305V. The Ultramax line is the first to offer Anti-Striation Control, which reduces common "barber pole effect" lines across the lamp. Ultramax is also the first full line of T8 electronic ballasts to earn UL's type-CC rating, a feature called Arc Guard, which eliminates the damaging effects arcing can have on lamps, ballasts and sockets. Available in all T8 applications, the ballasts for 2-, 3-, 4- and 8-ft. T8 lamps are available in three ballast factors: low watt, normal light output and high light output. **Circle No. 211**



The IntelliVolt technology of **Advance Transformer's** Centium electronic ballasts (ICN-4S54-90C-2LS) enables them to operate one, two, three or four F54T5/HO fluorescent lamps at any voltage between 120V and 277V as well as 36W/39W, 50W and 55W long twin-tube lamps and F58T8 lamps. A high-low switching option makes Centium ballasts compatible with California Energy Commission Title 24 and allows a fixture to be switched via a variety of devices from operating four lamps to two lamps or three lamps to two or one lamp. Features include a temperature rating of 90 degrees Celsius, 20-ft. remote mounting, 0-degree Fahrenheit cold starting, auto-restart capabilities, programmed-rapid start ignition for extended lamp life in frequent starting conditions and lamp end-of-life protection circuitry. Total Harmonic Distortion is less than 10 percent and power factor is greater than 98 percent. The ballast operates at a frequency between 40 kHz and 54 kHz. **Circle No. 212**

The ballast operates at a frequency between 40 kHz and 54 kHz. **Circle No. 212**

For use in high- or low-bay HID lighting applications, **Delta Power Supply's** patented SuperBallast electronic ballast boasts a 95-percent efficiency and long lamp life, reduces lumen depreciation for 150W-450W HID lighting systems and offers dimming to 35 percent of power without degrading lamp life. A patented, high-frequency Fast-Start feature provides quick ramp-up time and lamp-preserving start-up to maximize lamp life; uses lower starting current than conventional magnetic ballasts; and delivers full light output in less than 75 seconds. Continuous dimming capability allows lamps to be dimmed via standard 0-10V feedback from control devices. SuperBallast self-compensates for line-voltage fluctuations from 190V to 304V and restricts power variation seen by the lamp to no more than 0.5 percent, enabling accurate color rendering over the life of the lamp. **Circle No. 213**



SAVE ENERGY with Lighting Controls

Visit the Lighting Controls Association's web site to access free educational guides about lighting control/ballast products, technologies and applications – from dimming to automatic switching to integrated lighting control.

Members of the Lighting Controls Association include:

- Advance Transformer
- HUNT Dimming
- Leviton
- Lightolier Controls
- Lithonia
- OSRAM SYLVANIA
- PCI
- Tridonic
- ULTRAWATT Energy Systems
- The Watt Stopper

Lutron Electronics' Eco-10 IR is a fluorescent ballast with a built-in IR dimmer. The Eco-10 IR offers personal control of overhead lighting through the use of a handheld IR transmitter, allowing the light to be set to various levels. The ballast can be installed like standard non-dimming ballasts, offering individual fixture control. Eco-10 IR can also be installed like a three-wire dimming ballast and used with a central control system, such as Lutron's Grafik 6000, digital microWatt or RadioTouch. Eco-10 IR measures 9.5 in. in length, 1.6 in. in width and 1 in. in height and is available in one- and two-lamp models for 32W T8 lamps (277V). **Circle No. 214**



Osram Sylvania has expanded its Soft White DuLux EL family of screw-based compact fluorescent lamps to include a series of Energy Star-rated products. The 28/19/12W 3-Way Twist can be operated at three different light levels and provides a soft white light similar to a 30/70/100W three-way incandescent lamp. The 30W Twist produces 2000 lumens and the 4W Flame Shape Medium and Candelabra Base and 7W Torpedo Medium and Candelabra Base lamps offer energy savings for decorative applications. MiniTwist lamps are now available in 7W, 11W, 19W and 23W. Also added to the DuLux EL family are 15W BR30 Frosted and SafeLine lamps, 14W A19 Soft White lamp, a non-attracting insect Buglight lamp and a low-energy, low-heat 11W G25 globe for bathroom vanity light strips. These lamps feature a 6,000-10,000-hour average rated lamp life, a CRI of 82 and color temperature of 3000K. **Circle No. 215**

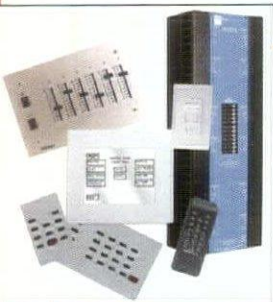

Simplicity Series digital dimming systems from **HUNT Dimming** simplify installation with its compact, lightweight design and minimal wiring requirements. The series includes wall-mounted control stations with LCD touchscreens, which provide visual and intuitive digital lighting control for single-location operation, monitoring and programming of all lighting zones; push-button control stations,

which offer control through pre-programmed and field-changeable functions; and handheld IR remote controls. Simplicity digital dimming panels contain 12 individually addressable outputs with each circuit capable of being dimming or switched. Four to 12 power modules can be provided per dimming panel. Each dimming module is multi-rated to control incandescent, fluorescent (phase-control), low-voltage (electronic or magnetic), neon, cold-cathode, fan-speed and non-dim (or switched) sources. C/UL-listed. **Circle No. 216**

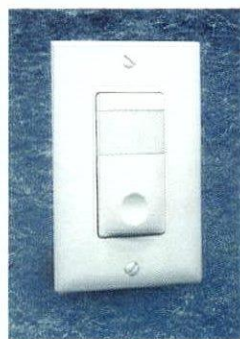

From **The Watt Stopper**, the new AS-100 Automatic Control Switch provides automatic facility-wide lighting control as well as local, manual on/off control. Designed to replace a conventional wall switch, the AS-100 receives signals over standard power wiring from a lighting control panel or occupancy sensor to automatically turn on, off or delay off lighting. No additional wiring is required from the controlling system, streamlining installation.

Users can also manually operate area lighting on and off via a front push button. The AS-100 requires no neutral, allowing for easy integration into retrofit projects. Installation is further simplified by terminal-style wiring, which eliminates the need for wire nuts. Other features include shut-off blink and beep warnings. **Circle No. 217**

Lithonia Lighting's Synergy lighting control system integrates all aspects of lighting control into a single scalable platform, from basic low-voltage switching and occupancy sensing to daylight harvesting and complex networked architectural dimming. With the BACnet protocol native to its design, Synergy lighting controls inter-operates with the rest of a building's automated control systems. The control system is compatible with Lithonia's Sequel preset dimming controls and Digital Equinox switching technology, RS232 interface, DMX512 compatibility and Script Logic. **Circle No. 218**

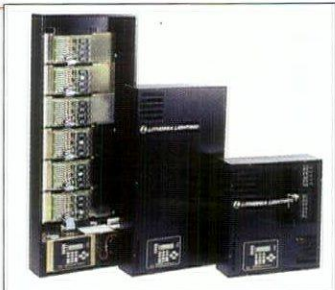

From **Leviton's Lighting Control Division**, the Dimensions D3200 Series offers multi-point dimming and scene control systems that feature on-screen wizards to guide residential and commercial end-users through programming and operation.

The D3206 Controller/Dimmer is a self-contained dimmer unit offering eight scene buttons for a total of 32 scenes and access to 186 zones maximum. Rated 2000W/VA (1000W/VA per zone and 1200W/VA per side), the D3206 can control multiple scenes in home theaters, dining and living rooms. The unit also features a built-in "learning" IR receiver that can be programmed to work with any handheld IR controller. Offering the same features as D3206, the D3208 provides access to 248 zones and combine/separate control for partitioning zones in restaurants, ballrooms and other commercial applications. The D3208 allows scheduled scene changes based on time-of-day events or dawn/dusk settings. **Circle No. 219**

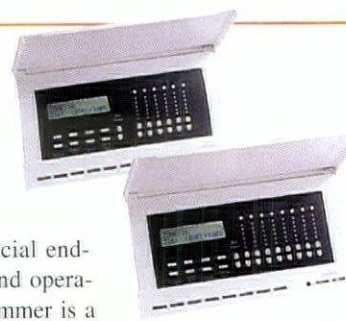

The new PL-H compact fluorescent lamp from **Philips Lighting** features a multiple-burning position and high lumen output of

9000 lumens. The white light of the PL-H lamp also provides stable color rendering, long life and high lumen maintenance. **Circle No. 220**

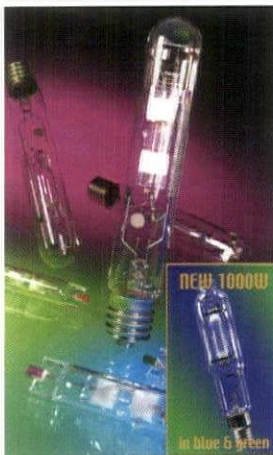

Ushio America has added a 1000W lamp to its Colorlite series of metal halide lamps. The 1000W Colorlite features the same characteristics as their 150W and 400W counterparts, including high color saturation, consistent color, high efficiency and long life. The new Colorlite mogul-base lamp operates on standard M47 ballasts and allows the application of color to lighting design projects without the use of gels and filters. **Circle No. 221**

The MS 875W/HOR/BT37/PS pulse-start metal halide lamp from **Venture Lighting International** is now available for horizontal applications. The 875W horizontal lamp provides energy savings of up to 155 system watts per luminaire, compared to a traditional 1000W universal metal halide system, and offers 95,000 initial lumens with a life rating of 12,000 hours. The 875W pulse-start lamp provides 109 lumens per watt compared to the 94 lumens per watt offered by a standard 1000W metal halide lamp. **Circle No. 223**



The JDW Safety Quartz Halogen Lamp from **Ushio America** consists of a low halogen fill pressure, inner quartz bulb and a thick outer hard glass jacket. The jacket self-contains any quartz in case of lamp breakage, reduces UV light and allows lamp installations to be performed with bare hands. The Safety Quartz also features a proprietary EU11 base to be used with its matching socket, whose design, for safety considerations, will not accept standard mini-can E11-based halogen lamps. The overall design of the lamp allows for smaller open fixture design and facilitates lamp replacement and maintenance. The lamp is available in 120V, 85W with a clear or frosted inner capsule. **Circle No. 222**

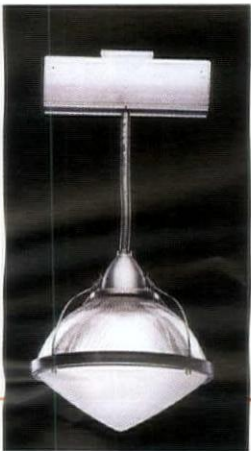

Holophane's Prismatron electronic ballasts are now offered for use with single metal halide luminaires. Available with the company's full line of high-bay prismatic glass optics, the ballasts may be used with 320W, 350W and 400W conventional and pulse-start metal halide lamps and feature silent operation, color stability and flicker-free illumination. Prismatron ballasts will dim lamps to as low as 25 percent of the lumen output and may be used with industry-standard, low-voltage control circuitry, including occupancy sensors and programmable controllers. If the luminaire is turned off while in a dimmed state, a "hold-high" capability allows the lamp to return to full level output power when the luminaire is turned on again. FCC compliance ensures compatibility with other EMI and RFI sensitive electronic devices. **Circle No. 224**

NEW..USHIO's
PulseStrike™
METAL HALIDE LAMPS

Formed arc tube body

High efficacy

Better color performance & consistency

Faster starting time

Improved hot re-strike capability

Longer Life

Shrouded arc tube for open fixture use

Mogul Base
 250W, 320W, 350W, 400W

Medium Base
 70W, 100W, 150W

USHIO

www.ushio.com 800.838.7446

The CentaGlo luminaire from **Holophane** features a low-brightness design to create a visually appealing environment in a wide range of commercial and industrial applications. The fixture provides an upward lighting component that skims the overhead to reduce the contrast between the ceiling and the fixture. Both symmetrical and asymmetrical distributions are available for open areas or aiseways. Designed with both a borosilicate glass reflector and refractor, the CentaGlo reflector directs most of the light back into the refractor while allowing the designed amount of uplight to pass into the environment. The refractor then takes the reflected and direct light components and redirects them into a useful distribution pattern. Glass refractor sidewalls minimize brightness while boosting vertical illumination. **Circle No. 225**



Lithonia Lighting has redesigned and retooled its IntegraSeal fixtures to meet the ISO14644-1 universal cleanroom classification as well as the older U.S. Federal Standard 209E. The retooled versions also meet requirements for 90 percent of cleanroom applications. The IntegraSeal product family includes the SRT Series (shown), which meets ISO7, 8 (Class 10,000 and 100,000) and offers a new recessed housing with caulk-sealed seams for a precision fit; and the SRH and SSH Series, both of which meet ISO 5, 6 (Class 100 and 1,000). **Circle No. 226**

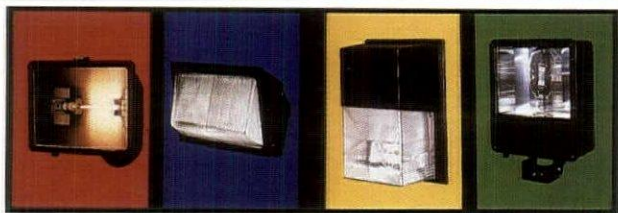

Stingray Lighting's Complement Series offers a range of contractor-friendly lighting products, including floodlights, industrial lighting, surface-mounted fixtures and landscape lighting. Fixtures have low installation and operating costs and require negligible scheduled maintenance over many years of continuous use. The series includes HID high- and low-bay units as well as surface wall-mounts, parking and commercial garage lights and floodlights. Compact fluorescent options also available. UL-listed. **Circle No. 228**



From **Eclipse Lighting**, the 546 Series offers 1x4 fixtures that use 54W T5/HO fluorescent lamps. Equipped with a specular aluminum reflector and open-grid louvers, fixtures are designed for high-bay lighting in industrial and commercial applications and offer instant-on performance and a CRI of 85. Die-formed steel housing measures 3 7/8 in. in profile and is finished with a polyester powdercoat. The series is available for surface, pendant or chain mounting. UL-listed for wet locations. **Circle No. 227**



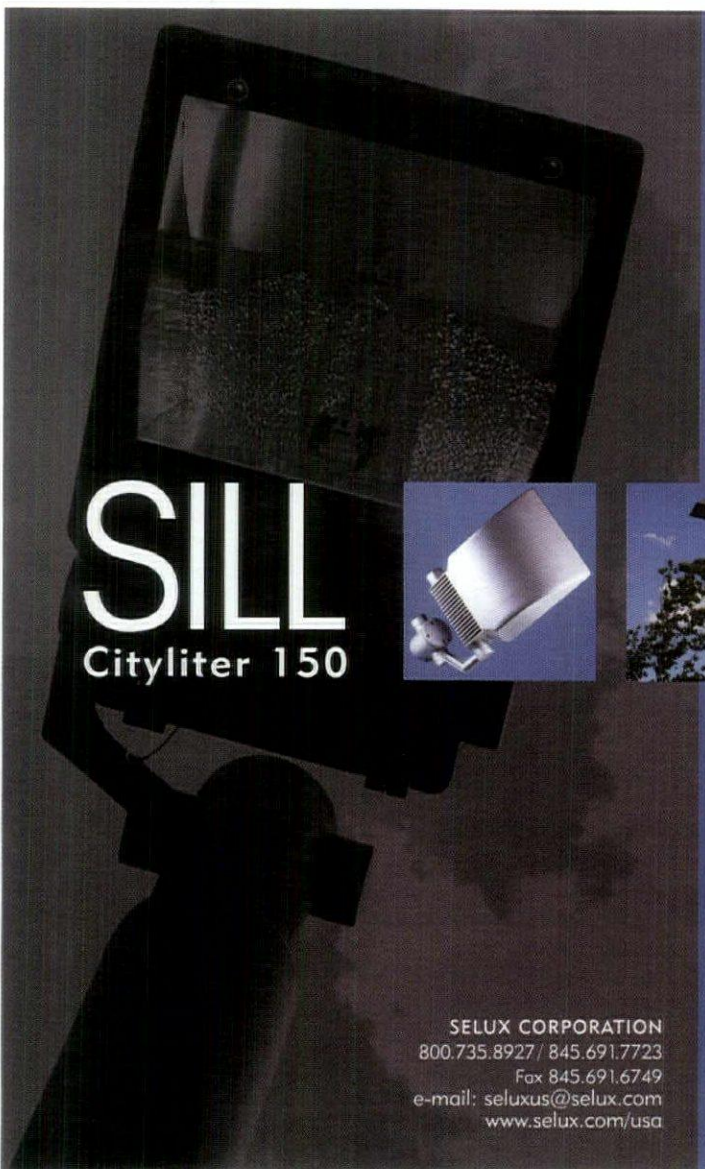

Providing an alternative to HID high-bay fixtures, the HBC Series from **Day-Brite Lighting** uses 26W, 32W and 42W compact fluorescent lamps in two-, four-, six- and eight-lamp configurations. The eight-lamp model uses four ballasts. The series' electronic ballasts feature programmable start and are enclosed in standard die-cast, high-bay ballast housings. Acrylic reflectors are factory-assembled to the ballast housing and are available in 16-, 19- and 22-in. sizes. **Circle No. 229**



selux

SILL

Cityliter 150

The Cityliter is architecturally designed with precision reflector engineering, available in asymmetric narrow or wide beam optics, for direct or indirect illumination.

SELUX CORPORATION
 800.735.8927 / 845.691.7723
 Fax 845.691.6749
 e-mail: seluxus@selux.com
 www.selux.com/usa

Circle No. 85 on reader service card

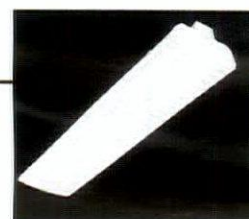

Lithonia Lighting's new MS5HB T5/HO fluorescent high-bay fixtures are designed for retail, warehousing and light industrial applications with mounting heights up to 30 ft. Multi-faceted reflectors provide optical control, narrow distribution to accommodate aisles and wide distribution for open areas. Open blade louver offers shielding and glare control. Other features include T5/HO rotary locking sockets and a polymeric paint finish. MS5HB is available with open optics and uplight, a variety of installation options and an optional T8 unit. **Circle No. 230**

ing and light industrial applications with mounting heights up to 30 ft. Multi-faceted reflectors provide optical control, narrow distribution to accommodate aisles and wide distribution for open areas. Open blade louver offers shielding and glare control. Other features include T5/HO rotary locking sockets and a polymeric paint finish. MS5HB is available with open optics and uplight, a variety of installation options and an optional T8 unit. **Circle No. 230**

Crescent/Stonco's T-Bay fluorescent fixtures are designed to replace conventional HID lighting in industrial applications and accept multiple suspensions methods, including 3/4-in. threaded pipe for direct replacement of existing high-bay fixtures. Ends and reflector panels are hinged to facilitate mounting, wiring and access to the ballast chamber. T-Bay is available in a four-light 54W T5 and six-light 32W T8 fluorescent models. Other features include a 20-gauge die-form housing, instant on, built-in switching and low-temperature operation. **Circle No. 231**

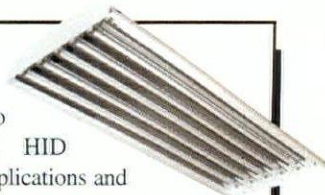



Lightolier's Outlook architectural-grade emergency lighting features self-testing/self-diagnostics nickel metal hydride batteries and LEDs. Products include two- and four-head emergency lighting units and thin-profile exit signs available in die-cast aluminum and thermoplastic. The series is designed to be easy to install and contractor-friendly. All products are UL-listed and comply with NFPA Life Safety Codes. **Circle No. 232**

From **Lithonia Lighting**, the redesigned ELM2 and ELM emergency lighting units feature MR24 lamp-heads, krypton lamps and Quick-Mount three-minute installation. Units are equipped with high-impact thermoplastic housings that include impact-resistant, scratch- and corrosion-proof and UV-stabilized and lead-calcium batteries. The ELM2 offers fully adjustable optics. Both boast a 25-percent smaller footprint and tool-less entry to facilitate installation and maintenance. **Circle No. 234**

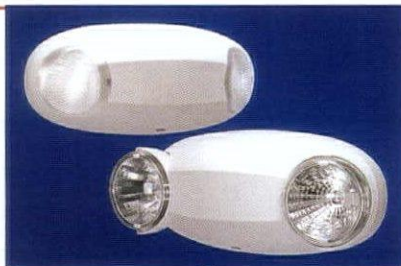

Pathway the Lighting Source has published a product selection guide of the company's commercial and industrial emergency lighting. Products include SVS self-diagnostic systems, LED exit signs, ADA illuminated signage and emergency lighting systems in recessed, surface and vandal-resistant styles. **Circle No. 233**

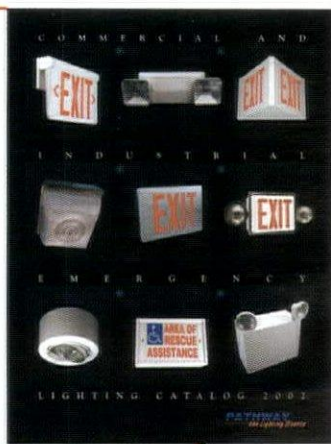

From **Cooper Lighting**, Surelites LPX LED polycarbonate exits and emergency lighting products are available in AC only and self-powered units. AC-only units feature push-in AC power connectors and optional two-circuit, FTBR operation and are listed for damp locations. Self-powered models have line-latching, solid-state switching, brownout circuitry, low-voltage disconnect, overload/short circuit protection and a test switch and power indicator light. Exits can be ceiling-, wall- or end-mounted. Universal exits may be field-configured as a single- or double-face sign, included with all exits. CSA-certified and UL-listed. **Circle No. 235**

From **Cooper Lighting**, Surelites LPX LED polycarbonate exits and emergency lighting products are available in AC only and self-powered units. AC-only units feature push-in AC power connectors and optional two-circuit, FTBR operation and are listed for damp locations. Self-powered models have line-latching, solid-state switching, brownout circuitry, low-voltage disconnect, overload/short circuit protection and a test switch and power indicator light. Exits can be ceiling-, wall- or end-mounted. Universal exits may be field-configured as a single- or double-face sign, included with all exits. CSA-certified and UL-listed. **Circle No. 235**

The Ultimate Exit (UX) Series from **Cooper Lighting's** Surelites brand offers self-diagnostics, laser fast-test and vandal-proof silicone gasketing.

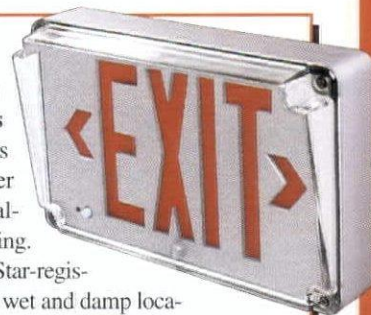

The series is Energy Star-registered and UL-listed for wet and damp locations as well as outdoor-rated. The units may be installed in 4-in. hose-down or high-temperature environments, freezers and outdoor parking areas. UX is also NSF-listed (National Sanitation Foundation) for use inside "splash zones" in food processing. Fixtures are equipped with a die-cast aluminum housing and polycarbonate lens. **Circle No. 236**

Better lighting maintenance doesn't come from better lighting, just better lighting information.

n Status
 Status 7:30AM
 Check Lamp, linear
 Check Lamp, compact
 Check Fixture, linear
 Check Lamp, BLAX 2L
 Check Lamp, linear 1LTB 22W

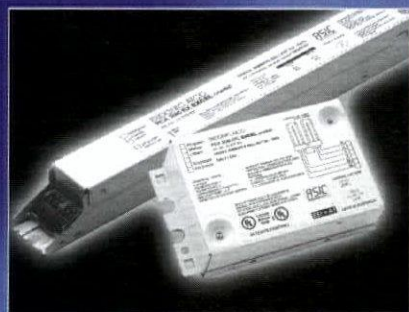

DALI Digital Addressable Lighting Interface. The lighting language for today's managers in the digital world - and Tridonic provides it.

Our DALI interface allows lighting managers to pinpoint the location of an outage, specify what kind of lamp must be replaced, monitor daily energy lighting usage, or simply adjust the lighting levels, all on a PC from their central office.

For more information about our digital technology and our full line of DALI compatible digital linear, compact and biax ballasts, call us at 1-866-TRIDONIC or contact us by email at sales_usa@tridonic.com.

Circle No. 25 on reader service card

a world of bright ideas®

TRIDONIC.ATCO

From **LEDtronics**, MR16-style TrackLEDs are direct incandescent replacement lamps that combine InGaAlP and SiC/GaN LED technology with a standard MR16 bi-pin base. TrackLEDs offer a power draw of 0.8W to 4W, an 11-year operating life and a choice of six sunlight-visible colors: green, white, blue, yellow, red and orange. Standard TrackLEDs come in 12/14V DC. Custom voltages such as 48V DC, 120V AC and 240V AC may be ordered with factory approval. TrackLEDs are available in 12, 24 and 42 5mm discrete LED configurations. **Circle No. 237**

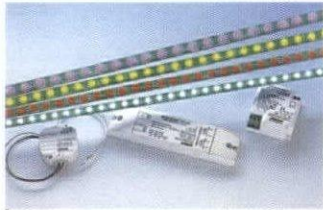

Osram Opto Semiconductors' LINEARlight Colormix LED Dimmable System utilizes the LINEARlight Colormix module in conjunction with the Optotronic LED power supply, Optotronic OTDIM electronically stabilized dimming module and the LINEARlight optic lens. The LINEARlight

Colormix module provides dynamic control of colored illumination via three chips inside each LED with a viewing angle of 120 degrees per LED. Each module (450mm) consists of 30 surface-mounted LEDs, can be subdivided into smaller units of LEDs and can be expanded to include as many as 10 modules with one feed-in unit. The systems can be used various large-scale applications. **Circle No. 239**

From **Io**, Tile is a luminous plane designed to be used as a decorative accent luminaire. Available in recessed and surface-mount models, the 5-in.-wide fixtures are offered in 5-, 10-, 14- and 18-in. lengths in red, green, blue and amber. Frost blue and frost green options utilize white LEDs coupled with a tinted lens. The .66-in.-deep tile frame is anodized extruded aluminum and houses an acrylic lens. Gypsum board recessed housing frame is extruded aluminum and offers a flangeless edge condition. All recessed and surface-mounted housings come standard with bar/joist hangers and junction boxes. All exposed hardware is satin anodized aluminum. **Circle No. 240**

Resembling glass neon, Plexineon from **iLight Technologies** is made of durable plastic composite materials, comprised of high-intensity LEDs and encased in a fully sealed unit. Plexineon features high-temperature resistance, moisture resistance and is suitable for exterior and interior applications as well as wet locations. The product can be used in long, straight pieces; connected to form one continuous piece; factory-bent into letters or curves; cold-bent in the field for gentle arcs; equipped with mitered edges or bent convex or concave. Available in red, amber, green, blue and white, Plexineon products



boast an even glow, last up to 180,000 hours running 24/7 365 days a year and may be programmed to include special effects such as color changes and chasing lights. **Circle No. 238**

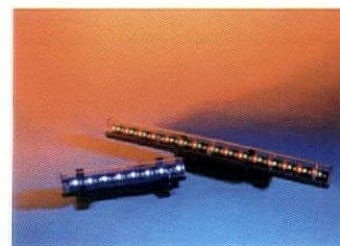

From **Color Kinetics**, the iColor Cove NXT expands on the company's iColor Cove line and provides a

beam angle of 120 degrees for a uniform distribution of color. Modular in design, the iColor Cove NXT is available in fixed lengths of 6 in. and 12 in., with each segment cased in a low-profile, vented, molded plastic housing. The new system also features streamlined wiring and installation options. **Circle No. 241**

Facets
It's Your Light!

Designer Series by
LURALINE www.luraline.com
2388 Northwest 150 Street • Opa Locka, Florida 33054
Toll-Free: 800.940.6588 • Fax: 305.685.6500

Circle No. 60 on reader service card

EXCITING
FUNCTIONAL
TRENDSETTING

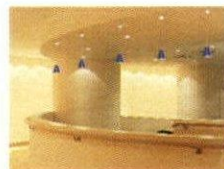

EVERY THING
LOOKS BETTER IN
THE RIGHT LIGHT.

With three systems to select from, the Ambiance® Lighting Systems brand delivers low voltage lighting solutions with design flexibility.

Add linear, track and rail lighting to projects and dramatically change the way you and your clients look at a room.

Perfect for residential, commercial, and architectural applications.



AMBIANCE® LIGHTING SYSTEMS

Circle No. 67 on reader service card

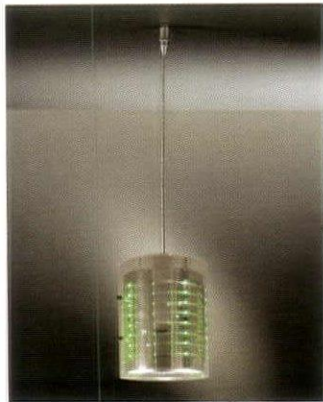

Part of **Bruck Lighting's** Uni-Lights Series, Artu is a MR16 pendant featuring 32 LEDs available in white, blue, red, green and amber. The fixture measures 5³/₁₆ in. in diameter and 6³/₁₆ in. in height. A 59-in. cable length is standard. **Circle No. 242**

Traxon's Mood Light is an LED-based fixture capable of producing millions of additive RGB colors with variable intensity. A basic unit consists of four diffuser panels contained within an aluminum frame and measures 50 x 50 x 3 cm. Multiple units may be combined to form a variety of flat or three-dimensional configurations in wall- or pendant-mounted form or as a stand-alone object. Color combinations and effects can be controlled via a handheld IR remote control. **Circle No. 243**

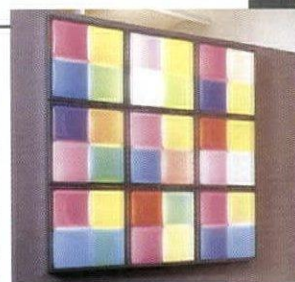

From the Netherlands-based **Xilver BV**, the Droplet is an automated moving LED luminaire capable of producing up to 16 million color shades. The

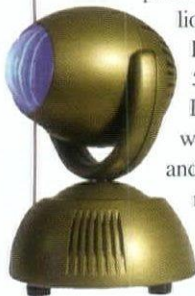

Droplet measures 5.11 in. x 7.25 in., is DMX-controlled with 360-degree pan and 260-degree tilt movement and has a beam angle of 10 degrees with lenses available for changing to 18- and 30-degree beam angles. Other features include 0-100-percent fluent dimming, a maximum power consumption of 35W, silent operation and a specially designed universal mounting plate, which enables pre-wiring and pre-fixing on wall boxes. Standard housing colors are silver, black and white. Custom colors are available. **Circle No. 244**

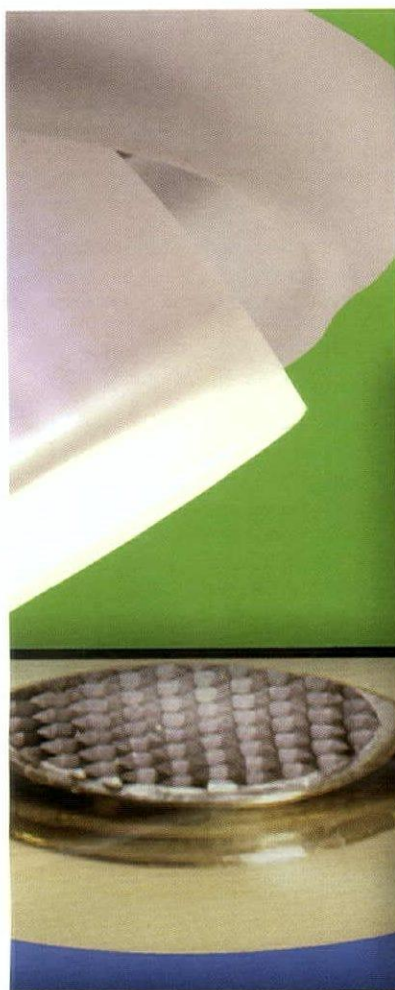

CSL **CREATIVE[®] SYSTEMS LIGHTING**

LOW-VOLTAGE RECESSED LIGHTING



Mule Lighting's dynaLUX LEDs consume 1W of power and reduce energy usage by up to 80 percent when compared to incandescent lamps of similar brightness. The series includes LEDison lamps, which offer an alternative to incandescent lighting; the G45 for decorative applications; and the R63, which features a reflective coating for added brightness. The FlameTip combines the curves of an incandescent chandelier lamp with the energy efficiency of an LED source. Also included are the LEDelier and the all-purpose A19. **Circle No. 245**

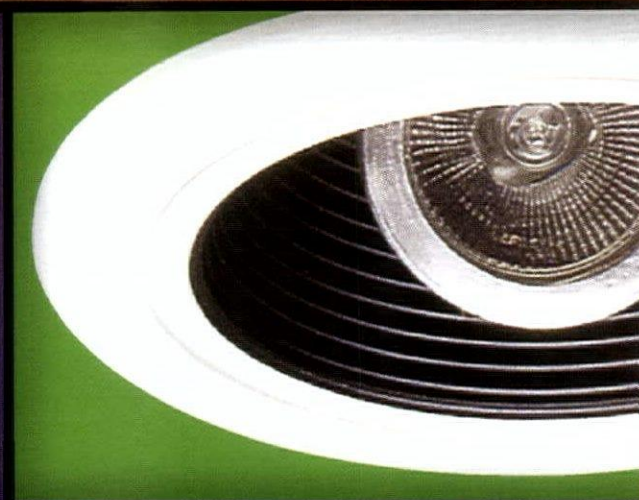
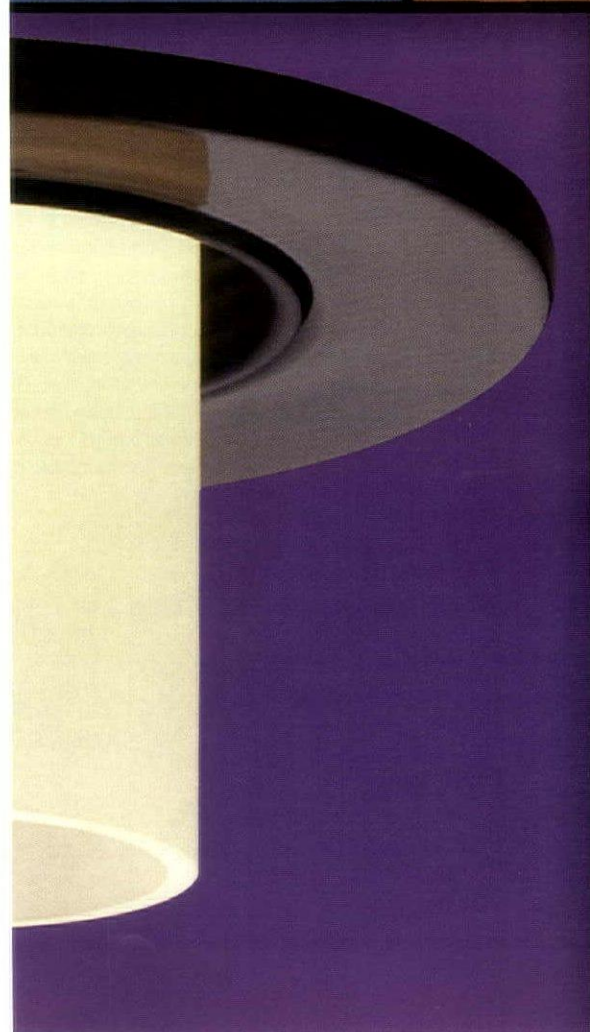

See our comprehensive new catalog featuring our complete line of miniature low voltage recessed lighting. Fixtures with 1.8", 2.7" and 3.6" ceiling cutouts are available in accent, task and wall wash models.

CREATIVE SYSTEMS LIGHTING

A DIVISION OF TROY-CSL LIGHTING, INC.

14625 E. Clark Avenue, City of Industry, CA 91745

Tel: 626.336.4511 Fax: 626.330.4266

Circle No. 66 on reader service card

Architectural Lighting Master Classes

ARCHITECTURAL LIGHTING
ALMC
MASTER CLASSES

More than 150 architects, engineers, lighting consultants and owners gathered at the end of February for the second annual Architectural Lighting Master Classes, a high-energy, two-day seminar produced by Sonny Sonnenfeld, *Architectural Lighting* and *Architecture* in association with Paul Gregory of Focus Lighting Inc. and Jonathan Speirs of Jonathan Speirs & Associates. Faculty members for this informational and inspirational event included Howard Brandston, Brandston Partnership; Ann Kale, Ann Kale Associates; Bill Warren, Willard L. Warren Associates; Fred Oberkircher, Texas Christian University; and Cindy Limauro, Carnegie Mellon University.

The Master Classes focused on *creativity* and included presentations on the lighting design of Toys 'R Us in New York's Times Square, the lighting of the Gateshead Millennium Bridge in Newcastle, England, as well as techniques and fixture performance for wall-lighting, recent research in vision and color theory, electrical and energy codes, trends in office lighting design and architecture as theater.

In addition to the seminars, many noteworthy manufacturers exhibited their products. Participating manufacturers included: Apollo Design Technology, Inc.; Wybron; ETC; ALM Systems; RSA Lighting; Altman Stage Lighting; Rosco; Martin Professional; Color Kinetics; Selecon Performance Lighting; Rambusch; Advent/SPI; Lee Filters; LiteTouch; Minolta Corp; and



Left to right: Keynote speaker Howard Brandston, *Architectural Lighting* Editor-in-Chief Christina Trauthwein and ALMC creative consultant, Paul Gregory take a moment to pose for a photo during the two-day event at Manhattan's John Jay College, which brought together architects, lighting designers and manufacturers who exhibited products (right).

Lightolier. Following is just sampling of the Manufacturers' Showcase.

As of press time, plans are underway for next year's event. Stay tuned and we'll keep you posted on the dates and times. It's an event not to be missed!

Color Kinetics' iColor Series intelligent LED systems offers a range of linear designs and replacement lamps. The latest addition, iColor Accent, marries Color Kinetics' digital control with the latest LED advancements for an affordable, low-voltage, indoor/outdoor direct-view linear light, available in 1-, 4- and 8-ft. lengths. **Circle No. 246**

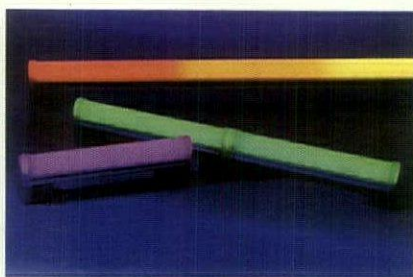

Apollo Gel Tubes provide creative, low-cost color control of fluorescent lighting. Color gel inserts are pre-assembled into clear polycarbonate tubes with end caps. Place the fluorescent light inside the tube and install. Available in three sizes—1-in. x 48-in. T12, T8 and T5—with any Apollo Gel. **Circle No. 249**



Martin Architectural has expanded its line of interior color-changing products with the introduction of the Cyclo series, a range of tubular washlights featuring RGB color-mixing or color-correction control. The Cyclo is a surface-mounted fixture with a slim design. Designed for use in cove lighting, perimeter lighting, light walls or behind semi-transparent materials and in spaces where room is restricted, Cyclo comes in three varieties. Cyclo 02 is a fluorescent color-temperature changer that can recreate natural fluctuations in daylight. The smallest in the series, the luminaire consists of two dimmable T5 tubes, a warm white at 2700K and a daylight white at 6000K. The Cyclo 03 and Cyclo 04 (shown) offer full color-mixing using RGB technology to generate white light of any temperature as well as virtually all colors and shades. The Cyclo 04 features an additional white 4000K tube for extended color control and an improved functional light quality. All three are controlled via a 0-10 V signal. **Circle No. 247**

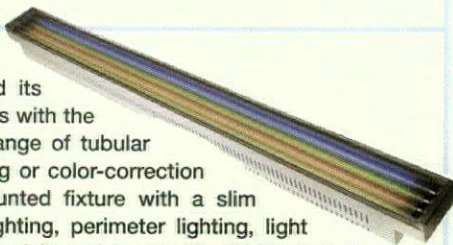

ALM Systems Inc.'s Mirage 5000 is a digital user-control interface with up to 96 channels and 24 presets of capability all in a user-friendly design. The system components and accessories include entry station and preset stations; master preset recall station; room combiner panels; RF handheld controls; screen and curtain control; timers, occupancy sensors, ambient light level sensors; dimmers and enclosures for all types of loads; theatrical consoles; and emergency power transfer systems. Applications include restaurants, convention centers, retail stores, hotels, churches, boardrooms and schools. **Circle No. 250**



ETC's Unison Control Stations are suited for applications such as theaters, hotels, churches and convention centers. Unison offers lighting-control flexibility: Program the desired lighting looks on a theatrical console or at a multi-page Unison LCD touchscreen station; then select presets with a touch of a button or have it done automatically by the integral astronomical timeclock. Control is provided via fully programmable button, fader and LCD stations. Unison's Link Power control network offers topology-free wiring. That means stations can be wired in any configuration: star, bus, or loop. **Circle No. 1**



Wybron's Eclipse II is a DMX-controlled douser that does mechanically what can't be done electronically: dimming HMI and other "non-dimmable" lights across the full spectrum of brightness, from pitch dark to the brightest light.

The Eclipse II mechanically douses the light while the power stays on so there's no need for hot restrikes. The douser, which mounts on the front of a lamp much like a color changer, blocks the light source to the degree specified. The Eclipse II features an array of fins that operate like a camera aperture and comes in two sizes—1K and Large Format, which is available in standard enclosed and weather-sealed models. Both are DMX-programmable and are driven by any Wybron Coloram II power supply. **Circle No. 248**

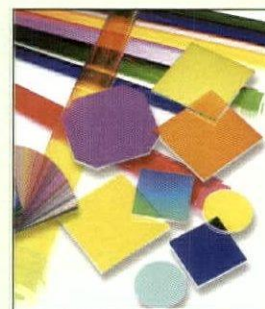

LEE Filters manufactures a variety of professional-quality lighting filters for the lighting and imaging markets. Lighting filters include the Architectural Series consisting of the Glass Series and fluorescent sleeves, color correction, color effects and diffusions. **Circle No. 3**

Sentry Electric Corp.

Sentry Centre Street Lantern. This extraordinary early American-style lantern incorporates beveled glass panels and is topped with a brass eagle on a pyramid-perch finial. The luminaire features an internal luminous ceiling that hides the light source and provides greater visual comfort, ideal for many elegant exterior applications. This unique luminaire is built to New York City's vandal-resistance specifications with high-strength aluminum structure. **Circle No. 51**



THHC Lighting



THHC Lighting is the leading manufacturer of low-voltage and line-voltage low-pressure xenon lamps for variety of general and specialty illumination applications. They include landscape, showcase, decorative and architectural designs.

THHC Lighting offers the most complete line of xenon lamps in the industry, including: wedge-base, festoon, rigid loop, cartridge, G4 bi-pin, GY6.35 bi-pin, E11, E12 and BA15D lamp. For more information: www.xelogen.com or 877-Xelogen. Visit us at Lightfair booth 1043. **Circle No. 55**

Special FX Lighting

Special FX Lighting announces a new generation of high-performance color lighting products and color coating services. New EZ•COLOR•HT is a super-tough, weatherproof, color-fusing/coating process invented and perfected by Special FX. This new process creates permanent high-transmission, high-temperature coatings in all colors for all types of glass and glassware. Special FX manufactures the most cost-effective permanent color and filter solution for every lighting application. **Circle No. 52**



Tridonic

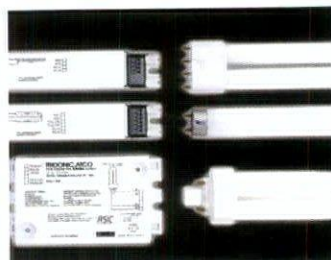

Tridonic is a global full-line ballast supplier of superior, digital, linear, compact and biax digital ballasts, all DALI-compatible. Our DALI/DSI digital interface creates sophisticated lighting control along with increased flexibility and reduction in energy and installation costs. For more information, call us at (866) TRIDONIC or contact us by email at sales_usa@tridonic.com. **Circle No. 57**

Targetti

Lightfair attendees are invited to enjoy the Targetti Light Art Collection featuring 32 works on the poetry of light at the Chelsea Art Museum from May 7 to June 8, located on the corner of 22nd Street and 11th Avenue, and open Wednesday through Sunday, noon to 6 p.m. **Circle No. 53**

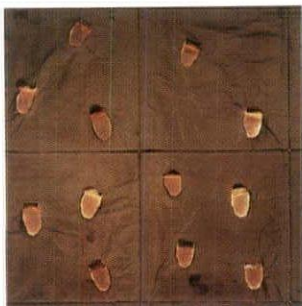

W.A.C. Lighting



W.A.C. Lighting's new Low Voltage Monorail System features a bold, eye-catching look, cutting-edge technology and accommodates 150 contemporary pendants and fixtures. Easy to assemble, it bends in the field to create graceful curves and negotiate corners on ceilings and walls. The firm also offers five state-of-the-art track systems; pendants; recessed housings/trims; metal halide trackheads; compact fluorescent wallwashers; miniature, flexible fixtures; button lights; display lights; track extensions/suspensions, accessories. Phone (800)526-2588, fax (800)526-2585, email sales@wacighting.com, www.wacighting.com. **Circle No. 58**

adindex

ADVERTISER	PAGE	CIRCLE NO.
Acrix, Inc.	30, 61	84, 6
Alanod - GmbH & Co. KG	1, 61	2, 14
Altman Stage Lighting	Cov. 3	89
Architectural Area Lighting	11, 61	34, 15
B-K Lighting	4-5	7
Bartco Lighting	15, 61	49, 16
Bruck Lighting Systems	61	17
C.W. Cole	34, 61	50, 19
Con-Tech Lighting	45, 61	73, 20
CSL—Creative Systems Lighting	59, 61	66, 21
Delray Lighting	47, 61	40, 22
Electrix	32, 61	18, 23
eLumit	12, 61	
Erco Lighting	Cov. 4	31
Forms+Surfaces	10	30
Holophane Corp.	6-7, 61	43, 26
Illuminating Experiences	31	76
Indy Lighting	42	71
Kim Lighting	17	12
Leucos USA Inc.	27	11
Leviton Mfg. Co.	2-3, 62	46, 27
Lighting Controls Association	53, 62	
Lighting Services Inc	37, 62	39, 28
Lightolier	39, 62	35, 29, 32
Luraline Products Co.	58	60
Lutron Electronics	19	9
Martin Professional	21, 62	54, 33
Merchandise Mart	33	87
Nordic Aluminium	62	36
NoUVIR Research	41, 62	24, 37
Original Cast Lighting	35	4
Osram Sylvania	Cov. 2, 62	38, 42
Prima Lighting	62	44
Prisma Architectural Lighting	9, 62	5, 47
Sea Gull Lighting	58	67
Selux Corp.	56, 62	85, 48
Sentry Electric Corp.	51, 63	56, 51
Special FX Lighting	43, 63	79, 52
SPI Lighting	46	86
Targetti Sankey	29, 63	88, 53
Tech Lighting	13	8
THHC Lighting	14, 63	62, 55
Tridonic	57, 63	25, 57
Ushio America	55	10
Valmont Industries	49	13
W.A.C. Lighting	28, 63	72, 58

Publisher is not liable for errors or omissions.

HOW GREEN WILL YOUR NEXT PROJECT BE?

An update on the proper handling and disposal of spent lighting products

BY ANTHONY AMARO, LC, CLMC

I want to start by thanking *Architectural Lighting* for being so gracious to allow me to address an operations and maintenance issue that is often under the radar of architects and many building owners. It is, however, a matter in which lighting designers can significantly impact and improve the environment through informed recommendations to architects and retail, commercial and industrial clients. Residential clients are exempted from these regulations.

The basics are that all gaseous discharge lamps, primarily fluorescent and HID, require a small amount of mercury to function properly and reliably over their rated life. Heavy metals such as mercury and lead have been found to be injurious to human health. Does this mean that the workhorse lamps of our industry may be hazardous to our health? The environmental authorities think so and have enacted regulations for their proper disposal. Your customer, the lighting end-user, will always be held ultimately responsible for compliance with these regulations.

In 1990, the U.S. EPA adopted the Toxicity Characteristic Leaching Procedure (TCLP) as the approved method to determine if waste products are hazardous because of their content of heavy metals. When that happened, most fluorescent lamps were found to contain mercury levels high enough to classify them as hazardous waste. This created quite a stir, especially since the Resource Conservation and Recovery Act (RCRA) also mandated transportation by hazardous waste haulers and possible costly disposal in a hazardous waste landfill.

The lamp manufacturers immediately went to work on this problem. In the 12 years since they began this work, they are to be commended for having made significant progress. A recent study by NEMA indicates a 67-percent

per lamp depending upon the amount of service provided with recycling.

Despite the availability of recycling nationwide, the recycling rate remains relatively low with only 20–25 percent of all spent lamps going to recycling. One of the obstacles has been costly transportation. As mentioned above, when these rules first came into effect it was technically necessary to use a hazardous waste hauler. Hazardous waste hauling is simply impractical for lighting users, so in 1999, the U.S. EPA allowed spent lamps to be handled as "Universal Waste." This does not mean the authorities now consider this waste to be any less hazardous; it only means they need not be shipped by a hazardous waste hauler, *provided they are destined for recycling*. They can be shipped to the recycling company, whole and intact, by a common carrier freight line.

Despite the fact that these rules have been in place for several years, awareness remains relatively low among the business community at large. To address this issue, three key initiatives are now in various stages of development:

- First, the lamp manufacturers, through NEMA, recently announced a voluntary program to change the labeling of all mercury-containing lamps. The lamps and their packages will soon be marked "Hg" to indicate they contain mercury. Hg is the international symbol for mercury.

- Second, the U.S. EPA, in cooperation with the Association of Lamp and Mercury Recyclers (ALMR) and the National Electrical Manufacturers Association (NEMA), will conduct a national outreach and education campaign to promote recycling of mercury-containing lamps. This outreach program will provide information and training to local governments, businesses and the public.

Recommend recycling of all spent lighting products as well as energy-saving products and systems on each project.

reduction in the use of mercury for the production of lamps. Prior to 1990, the industry used 27 tons per year. That number is now down to approximately nine tons per year. The important result for the user is that many of the lamp types now being offered by the major manufacturers are "characteristically non-hazardous." Wow, thanks, so that's the end of the story—or so many people may mistakenly think. However, as with most things in life, it isn't quite that easy.

Being characteristically non-hazardous only addresses the technical aspect of the situation. In addition to the U.S. EPA, all the states have jurisdiction in these matters. The U.S. EPA provides the regulatory framework and each state is then allowed to make its policies more stringent than those of the U.S. EPA. The states have enforcement authority and the lighting end-user (waste generator in EPA terms) must determine if the waste is hazardous and manage it properly. The dynamics of local and state regulations affecting these matters are motivated by the physical availability of landfill space and the politics in each jurisdiction. The trend over time has been to become more stringent rather than less so. The result of this rule becoming procedure over the years has been a patchwork quilt of rules and policies that vary from state to state and are sometimes confusing. Some states with more stringent regulations are Connecticut, Florida, Maine, Minnesota, Rhode Island, Vermont, Oregon, Pennsylvania, New York and Washington. Some have ruled that *no lamps* containing mercury (regardless of the amount) are allowed in landfills. California recently announced they will adopt such a policy in 2005.

Two points of caution here: First, everyone is encouraged to check with state and local authorities for the latest information regarding proper disposal. Second, remember that the rules are dynamic and heavy metals are long-lived. If the landfill has a problem with mercury at some time in the future, authorities will seek out the organizations that dumped mercury products there. These entities will then be held responsible for the clean-up under the "Super Fund" law. Environmental clean-ups are always costly, often running into the millions. For these and other reasons, the lighting industry is now recommending recycling spent lighting products.

The complexity of regulations and the high cost of compliance have given birth to an industry dedicated to recycling spent lamps. Rather than depositing them in a regulated hazardous waste landfill, it is now possible to have them recycled. By this method—now available nationwide—the lamps are de-manufactured, reducing them to four products: glass, aluminum, phosphor powder and mercury, which are then returned to the economy for reuse. The cost of this service can range from \$.35 - \$1.50

- Third, The U.S. Green Building Council will launch the Leadership in Energy and Environmental Design (LEED) Rating System for Existing Buildings in November. LEED for Existing Buildings (LEED-EB) is a set of performance standards for greening the operation, maintenance and upgrade of existing buildings. The LEED-EB credit structure addresses the leveraging of green strategies into system upgrades, whole-building cleaning and maintenance practices, indoor air quality, energy/water efficiency programs and recycling. The Occupant Recycling Credit within LEED-EB focuses on diverting the waste and toxins generated by building occupants from disposal in landfills and awards credit for on-going recycling activities. Recycling of spent lighting products can contribute to achievement of LEED-EB's recycling/landfill diversion requirements.

Today's lighting designer can have an impact in this awareness continuum. Given a choice, I think people want to do the right thing. Our industry thinks that recycling of spent lighting products is the right thing to do for the environment and everyone concerned. Today's lighting designer can easily communicate this message to architects and lighting end-users. I encourage you to advocate "Green Building": Recommend recycling of all spent lighting products as well as energy-saving products and systems on each project. By recycling, your clients will come into compliance with the regulations and improve the management of future risk.

To learn more about recycling and for links to state regulations, refer to www.earthpro.com. Another website, www.almr.org, produced by the Association of Lamp and Mercury Recyclers (ALMR), also provides helpful resources. ALMR is currently developing expansions to the site, to be posted by the end of 2003, which include training, electronic databases, infrastructure availability state-by-state. For more information on the U.S. Green Building Council LEED-EB visit www.usgbc.org/LEED/existing/leed_existing.asp. ■

Anthony Amaro, LC, CLMC is VP of business development for Earth Protection Services, Inc. (EPSI), where he is responsible for sales, product development and financial functions of the PA-based company. In addition, Amaro is past VP of the IESNA, Nashville Section; past president of the Corporate Council of the American Institute of Plant Engineers; member of the Association of Professional Energy Managers; and earned a letter of distinction from the EPA Green Lights Program for outstanding service. Amaro has served in senior positions at Motorola Lighting, MagneTek Corporation and Sylvania Lighting Services.