

manley + wood

ALL

architectural lighting

EDUCATED ENVIRONMENTS
THREE PROJECTS LIGHT A LEARNED PATH
PLUS LOAD SHEDDING AND ENERGY MANAGEMENT | MAINTAINING A LIGHTING DESIGN



* Dark Sky - Star light, star bright...

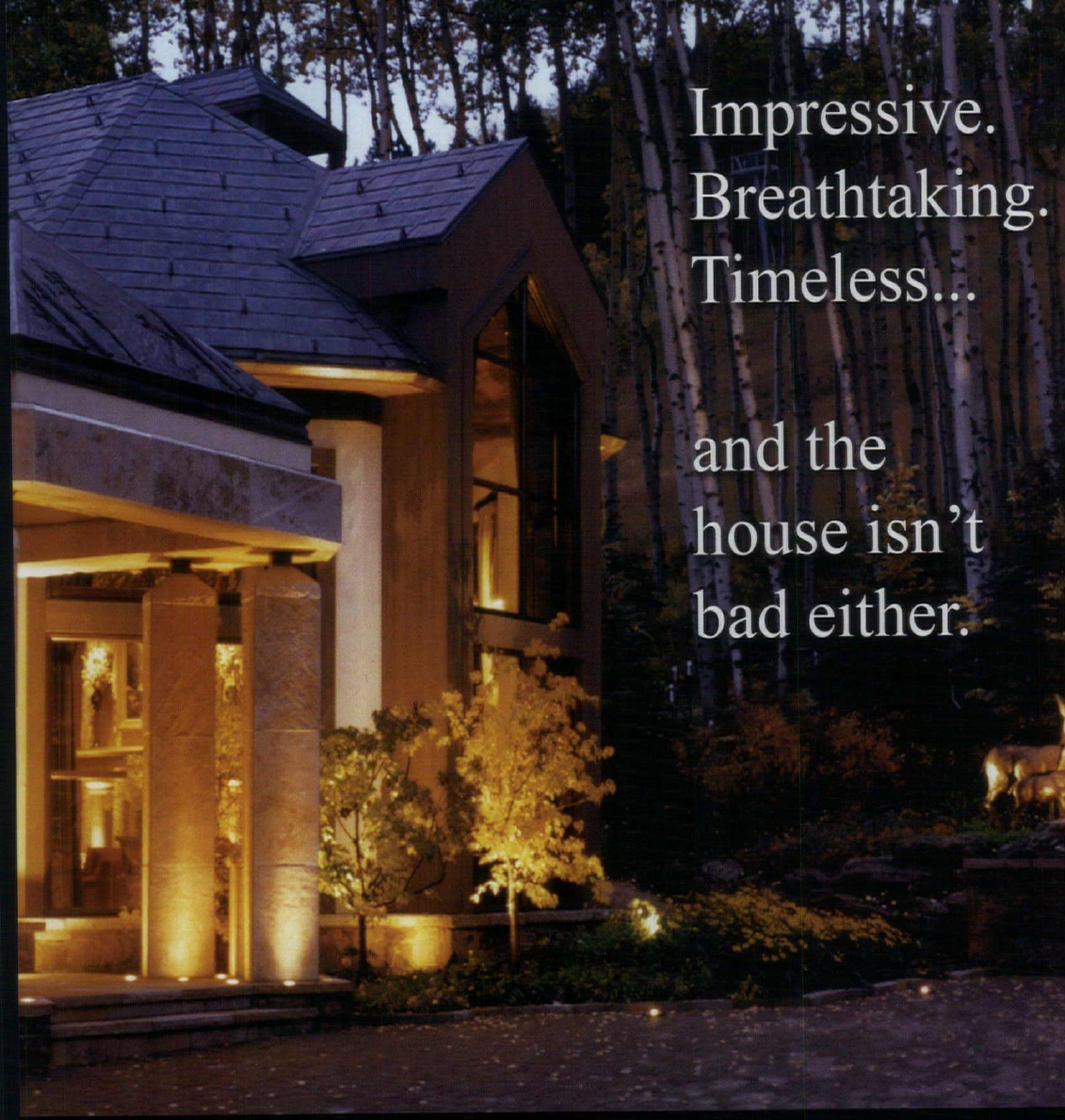

Impressive.
Breathtaking.
Timeless...

and the
house isn't
bad either.

LANDSCAPE ARCHITECTURAL LIGHTING

B-K
LIGHTING



TEKA
ILLUMINATION

www.bklighting.com • 559.438.5800 • www.tekaillumination.com

Circle no. 23 or www.archlighting.com/productinfo

DESIGNERS
AND MANUFACTURERS OF
ARCHITECTURAL LIGHTING
SINCE 1974

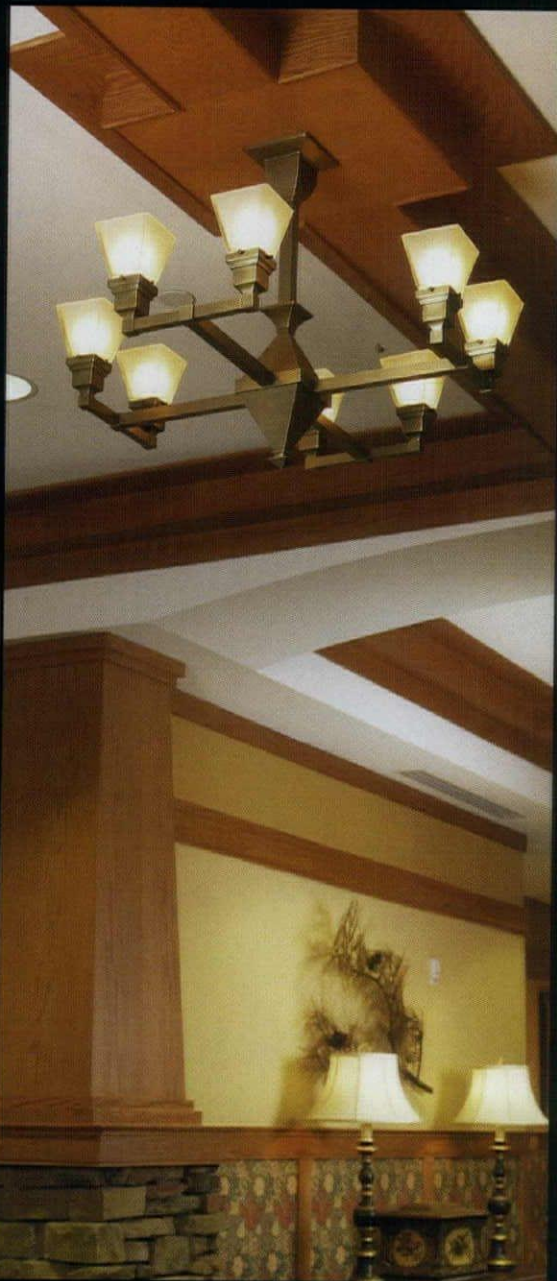

BRASS LIGHT GALLERY
COMMERCIAL • RESIDENTIAL • VINTAGE

www.brasslight.com
Contact: commercial@brasslight.com

Milwaukee • 131 South 1st Street • 800.243.9595

AL
architectural lighting

MARCH | 07
VOL 21 | NO 2

EDITORIAL

EDITOR-IN-CHIEF

NED CRAMER
ncramer@hanleywood.com
(202) 729-3612

EDITOR

ELIZABETH DONOFF
edonoff@hanleywood.com

EDITORS AT LARGE

JAMES BENYA, HOWARD BRANDSTON

CONTRIBUTING EDITORS

GREGG ANDER, JULIE SINCLAIR EAKIN,
KEVIN H. HOUSER, JEAN NAYAR, MARGARET MAILE PETTY, AARON SEWARD,
MATTHEW TIRSCHWELL

EDITORIAL ADVISORS

GREGG ANDER, FRANCESCA BETTRIDGE,
ROBERT DAVIS, MARK LOEFFLER

DESIGN

ART DIRECTOR

CASEY MAHER
cmaher@hanleywood.com

SUPPORT

DIRECTOR OF PRODUCTION AND

PRODUCTION TECHNOLOGIES
CATHY UNDERWOOD
cunderwood@hanleywood.com
(202) 736-3317

PRODUCTION MANAGER

CHAPPELLA LEFTWICH
cleftwich@hanleywood.com
(202) 736-3432

**SUBSCRIPTION INQUIRIES, ADDRESS
CHANGES, CUSTOMER SERVICE, AND
BACK ISSUE ORDERS**

Architectural Lighting
P.O. Box 1061
Skokie, IL
60076-8061
(847) 763-1958

REPRINTS

FosteReprints
(866) 879-9144

hanleywood

One Thomas Circle, N.W. Suite 600 Washington, DC 20005

HANLEY WOOD BUSINESS MEDIA President: Peter M. Goldstone (202) 736-3304; Chief Financial Officer/Chief Operating Officer: Frederick Moses; Director/Operations: Ron Kraft; Vice President/Circulation and Database Development: Nick Cavnar; Vice President/Marketing: Ann Seltz; Vice President/Production: Nick Elsener; Controller: Virginia Frazier

HANLEY WOOD, LLC Chief Executive Officer: Frank Anton; Chief Financial Officer: Matthew Flynn; Chief Administrative Officer: Frederick Moses; Chief Information Officer: Jeffrey Craig; Vice President/Corporate Development: Joe Carroll; Vice President/Human Resources: Wendy Entwistle; Vice President/Information Technology: Nelson Wiscovitch; Controller: Randy Best

FROM HANLEY WOOD, LLC, PUBLISHER OF ARCHITECT, AQUATICS INTERNATIONAL, BIG BUILDER, BUILDER, BUILDING PRODUCTS, CONCRETE & MASONRY CONSTRUCTION PRODUCTS, CONCRETE CONSTRUCTION, THE CONCRETE PRODUCER, CUSTOM HOME, EL NUEVO CONSTRUCTOR, THE JOURNAL OF LIGHT CONSTRUCTION, MASONRY CONSTRUCTION, MULTIFAMILY EXECUTIVE, POOL & SPA NEWS, PROSALES, PUBLIC WORKS, REMODELING, REPLACEMENT CONTRACTOR, RESIDENTIAL ARCHITECT, AND TOOLS OF THE TRADE MAGAZINES.

PRIVACY OF MAILING LIST Sometimes we share our subscriber mailing with reputable companies we think you'll find interesting. However, if you do not wish to be included, please call us at 888.269.8410.

Sustainable Lighting Solution

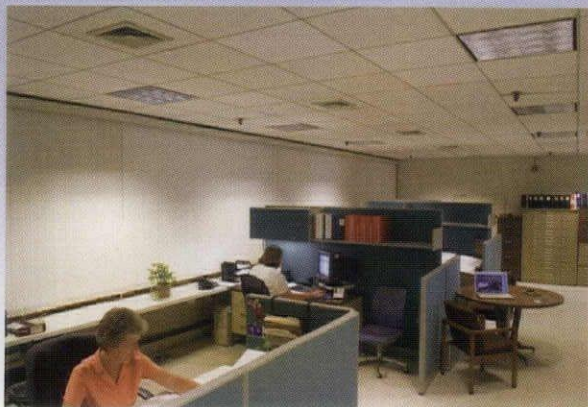

Before



After

HP90

High Efficiency Fluorescent

.68

Watts per Square Foot

56

Footcandles

HP90 offers broad light distribution that evenly illuminates vertical surfaces eliminating dark bands and scalloping on the upper part of the walls that create a cave-like effect. The illumination of all surfaces both vertical and horizontal creates soft balanced brightness that enhances the ability to see and work in the space. Contact your Lightolier Sales Representative for more information.



13



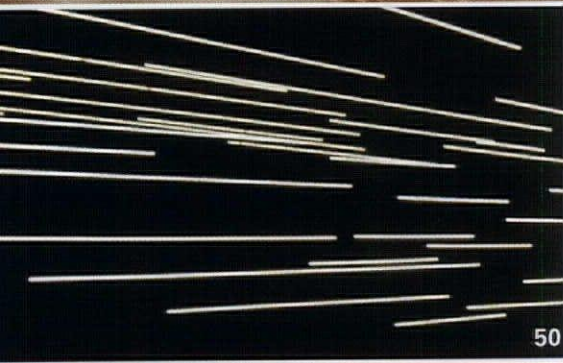

42



50



industry

- 09 **comments**
- 13 **briefs** / Refract, Reflect, Project: Light Works from the Collection at the Hirshhorn Museum; IESNA Annual Conference recap; and more
- 25 **report** / Connectivity for Smart Buildings 
- 72 **exchange** / Emergency Lighting—Whose Responsibility Is It: the electrical engineer or the lighting designer? 



projects

- 31 **highlight** / Schermerhorn Symphony Center, Nashville
- 32 **library** / Literary Light **COVER STORY** 
- 38 **school** / Process Makes Perfect
- 42 **day-care center** / Daylight Designs 

AUDITORIUM DESIGN FOCUS

- 49 **project** / Agbar Tower Auditorium, Barcelona
- 50 **project** / Billy Wilder Theater, Los Angeles 
- 52 **products** / Lighting Assemblies

details

- 57 **method** / Maintaining A Lighting Design 
- 61 **technology** / The Color White 
- 71 **ad index**

Cover: The main stairway and view to the stacks and open reading areas at the Minneapolis Central Library. PHOTOGRAPHER JEFF GOLDBERG/ESTO

This page: Thomas Wilfred's *Study in Depth, Opus 152*, (1959) at the Hirshhorn Museum and Sculpture Garden, Washington, D.C.; the etched-glass façade treatment at the Skanderborggade day-care center, Copenhagen; fluorescent T5 tubes convey *Lines of Light* at the Billy Wilder Theater, Los Angeles; the interior of the Agbar Tower auditorium, Barcelona.

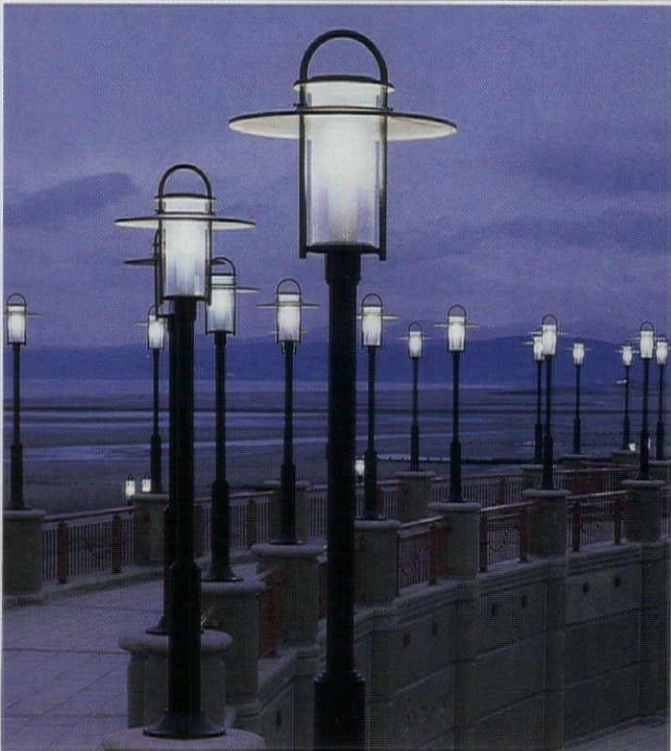
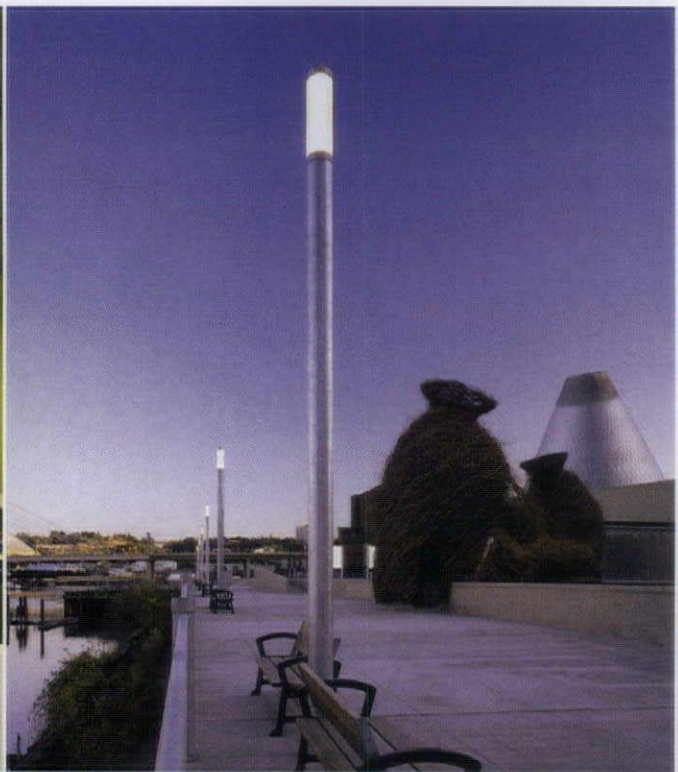

SELUX offers a comprehensive range of high quality light fixtures. Innovative luminaires designed to help lighting professionals and architects create exceptional interior and exterior spaces in which to live and work.

se'lux[®]

■ | Light. Ideas. Systems.

Bright Ideas, Bold Innovations

A Brighter Idea Than Fluorescent



Case Study: Big Box Retail Store in Southern California

Compared to T5 fluorescent highbay lighting systems, Venture's Uni-Form® pulse start metal halide systems are a smarter choice:

- **More light**, more reliable as metal halide is not affected by temperature
- Greater **energy savings**
- **Less cost:** Lower initial costs per fixture; less labor and less maintenance

Visit Us at LightFair: Booth 509

From



VENTURE
LIGHTING

For More Information, Call or Download the Brochure On-Line:

800-451-2606

FAX: 800-451-2605 E-MAIL: venture@adlt.com

VentureLighting.com/BrighterIdea

© 2007 Venture Lighting International.
Venture and Uni-Form are trademarks or registered trademarks of Venture Lighting International

Circle no. 70 or www.archlighting.com/productinfo VLI-0833A3-0207



Lead the Way

"THE MORE THINGS CHANGE, THE more they stay the same."—So the saying

goes. This quote has stuck with me since reading through the September 1973 issue of *Progressive Architecture* (P/A) last spring. I was directed to this volume while doing research associated with my curatorial responsibilities for the installation of the Richard Kelly exhibit at the Center for Architecture in New York City. In particular, what is so striking about P/A's coverage, besides its obvious comprehensiveness, is the similarity of issues discussed—lighting design as an emerging profession, biological considerations in lighting environments, daylighting, energy conservation, the latest lamp sources, visual comfort—with the topics we address today. One is left wondering, has there been any progress in 33 years? Of course there has. Yet still, I find it compelling that the core issues facing the lighting design community appear unchanged, and are in fact probably only further complicated today by new technologies, increasingly stringent building codes, and the changing dynamics of design practice.

Discussing the role of light in the creation of spaces along with lighting's interaction with other building systems such as temperature, the P/A Editorial makes reference to a blackout of the period. Familiarly eerie, only just this past summer most of the United States was gripped in a heat wave of 100-plus degree weather. So precious was electricity, New York ordered a citywide mandate to dim lighting and reduce elevator usage. The lobby of the building where I work was noticeably darker, and 5 of the 11 passenger elevators were taken "offline," yet everyone was able to continue with their daily activities with little inconvenience. The question, at least in my mind is, why does it take extreme circumstances to bring these pressing issues about energy consumption, global warming, and the environment to people's attention?

Last year in his keynote speech at Lightfair, Dr. David Suzuki addressed this very issue of the environment and the way in which the "global economy is using the planet as a consumptive product." (A bit ironic that it was presented in Las Vegas, a city equated with excess, not necessarily conservation). Ten days later I sat in a presentation at the American Institute of

Architects National Convention given by Robert F. Kennedy Jr. speaking about the same issues—the responsibilities we, as designers, have to create greener environments and promote emerging technologies that more responsibly interface with the environment. Beyond the call to arms, and the talking points of statistics, both men voiced a similar sentiment: In the absence of political leadership, design leadership can, should, and needs to step forward.

To some extent, this has already happened. For example, current AIA president R.K. Stewart has been instrumental in crafting the AIA's position on sustainable design, going so far as to issue a call for a "minimum reduction of fifty percent of the current consumption level of fossil fuels used to construct and operate buildings by the year 2010." On February 20, 2007, Architecture 2030, a non-profit organization founded by architect Ed Mazria, to address the building sector's role as the single largest creator of greenhouse gas emissions, hosted an interactive web cast. Called the *2010 Imperative Global Emergency Teach-in*, the program addressed "achievable strategies to transform the built environment," and was seen by close to 500,000 students, faculty, deans and working professionals in the fields of architecture, planning, and design across North and South America.

The problem is, at this scale—the larger design community, and certainly the broader public arena—these activities do not stem from the voice of the organizations that represent the professional lighting design community, and they should. I do not mean to imply that the lighting community is not involved with these issues, it is, but its presence in and authorship of the discussion is missing, and with it colleagues' and the public's understanding of the active role lighting plays in sustainable design issues. I welcome the day when I can direct inquiries about the IALD and IESNA's specific positions on sustainable design, carbon emissions, and energy code regulations to a clearly stated platform. Until that time, the lighting community is foregoing a real opportunity to lead.

ELIZABETH DONOFF
EDITOR

Low voltage lighting has just reached a new level of

Sophistication.

Designers have asked for **black**.

Challenges in developing a conductive black surface seemed insurmountable—until now.

Introducing Basis Track in a bold, glossy, obsidian black finish that takes the sophistication of modern architecture to the next level.



The art of lighting design.

Circle no. 71 or www.archlighting.com/productinfo

Come see **Basis in Black** at Lightfair in booth 538.
www.translitesonoma.com

There's no such thing as
Too Thin



Precision
Architectural
Lighting

Elegant from any angle, PAL
trim new Delgada series
blends architecturally inspired
design, energy efficient
technology and the enduring
beauty of extruded
aluminum.

When your next
project calls for compact
style, the ultra-slim
specification-grade Delgada is
the choice. Contact your
PAL representative today.

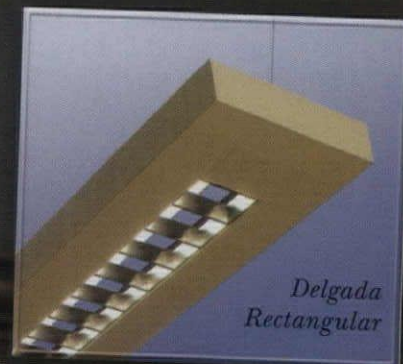

*Delgada
Rectangular*

4830 Timber Creek Drive
Houston, TX 77017
p: (713) 946-4343
f: (713) 946-4441

Circle no. 40 or
www.archlighting.com/productinfo

www.pal-lighting.com

**Introducing Z-MAX with "zero current" switching.
Never before have zeros added up to so much.**

**Zero current leakage.
Zero-crossing switching.
Zero contact pitting.
Zero arc showers.
Zero competition.**



DeVos Place
Grand Rapids,
Michigan



Now there's a relay system that gives you incredibly more life for your money – plus a broad range of energy management solutions. ■ Z-MAX, the proprietary switching circuitry from Leviton Lighting Management Systems, is specifically

designed to control electronic ballast loads and deliver an industry-leading 10-million-cycle life. Far above the 6,000-cycle UL requirement, Z-MAX's performance is made possible by innovative design that lets you switch under full load conditions at zero crossing with true zero current. The result is air-gap switching that completely eliminates arc shower pitting at the contacts, the number one obstacle to longevity. ■ A built-in astronomical time clock, advanced networking and your choice of digital and low-voltage switches make Z-MAX the most advanced lighting control relay system available. There's simply nothing else like it. ■ Leviton's Lighting Management Systems delivers the broadest range of energy management solutions. From occupancy sensors to fully networked daylighting controls to facility-wide control, we're your single-source solution. To learn more, call 800-996-2276 or visit us at www.leviton.com.

Z-MAX is a trademark of Leviton Manufacturing Co., Inc.
© 2005 Leviton Manufacturing Co., Inc.
An ISO-9001 Registered Quality Manufacturer.

Circle no. 35 or www.archlighting.com/productinfo



REFRACT, REFLECT, PROJECT

DRAWING FROM SELECTIONS IN ITS OWN PERMANENT COLLECTION, THE HIRSHHORN MUSEUM AND Sculpture Garden in Washington, D.C. examines the role of light in contemporary art since the 1950s with its current exhibit *Refract, Reflect, Project: Light Works from the Collection*. The exhibit's premise is that "throughout the history of art, light has been linked to fundamental questions of vision and perception." In turn, artists have "struggled and experimented with how to depict the ephemeral and intangible qualities of light in all mediums—from painting to photography, sculpture to installation—using both natural and artificial light as a material."

Organized by artistic movements with art works representing minimalism, conceptualism, kinetic art, immersive environments, photography, and experimental film, the exhibit displays a wide range of work from the familiar to the new. Artists one would expect to see in such an exhibit—Dan Flavin, James Turrell, and Olafur Eliasson—are all represented, and in turn provide core selections.

Flavin's *Monument for V. Tatlin*, 1967, a sculpture of cool white fluorescent tubes seems remarkably fresh and pertinent proving the staying power of this revolutionary artist who pioneered the use of working with light as both a physical and qualitative material. James Turrell's *Milk Run*, 1976, a light projection of fluorescent tubes with red, yellow, and blue gels within a "room," challenges the viewer's sense of space, color, and depth while maintaining a calm, serene, and "other-worldly" viewing experience. The effect of Olafur Eliasson's *Round Rainbow*, 2005, is mesmerizing. Comprised of a 575W spotlight with barn doors, the light is projected through an offset round plate disc with a small opening onto a rotating faceted acrylic ring suspended from the ceiling and positioned approximately eight feet away from the spotlight. Light refractions cast moving projections on the three adjacent walls. Deciphering the speed at which the acrylic ring turns, and following the changing thickness and thinness of the lines has a hypnotic effect.

One of the next generation of artists working with light, Spencer Finch's *Cloud (H2O)*, 2006, a sculptural chandelier that interprets the formation of water molecules is poetic in both its simplicity—suspended clusters of light bulbs—and its scale—it stretches across the better portion of the gallery ceiling.

A refreshing view of light's artistic qualities whether viewed as an object or experienced, *Refract, Reflect, Project: Light Works from the Collection*, is an excellent introduction for those not familiar with light. And it no doubt also serves as a reminder to museum and curatorial staff of the treasures within their permanent collections. **ELIZABETH DONOFF**

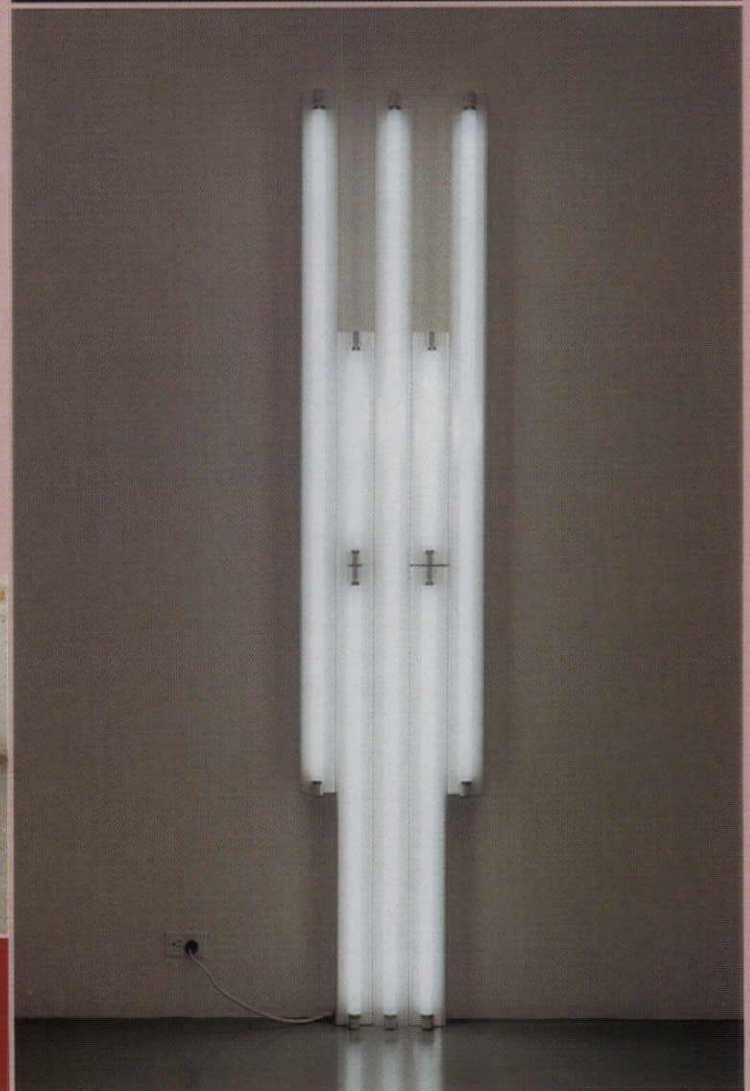
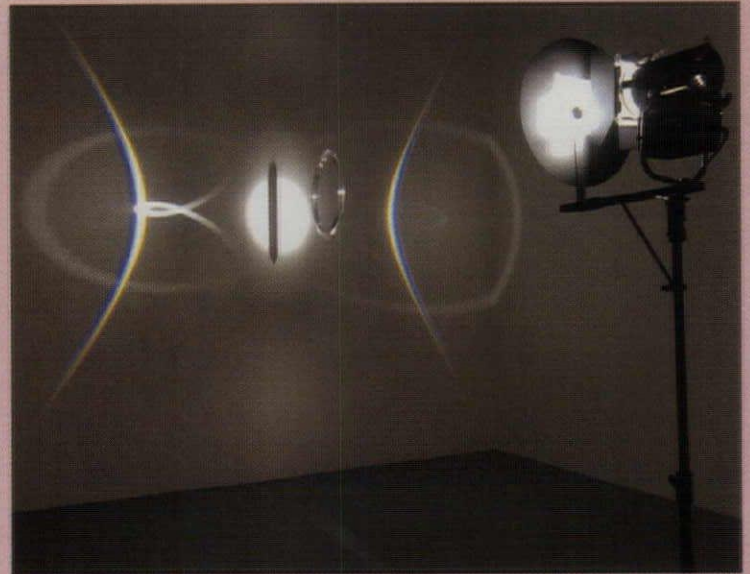

Selections from *Refract, Reflect, Project: Light Works from the Collection*: Iván Navarro's *Flashlight: I'm not from here, I'm not from there*, 2006 (above); Dan Flavin's *Monument for V. Tatlin*, 1967, (bottom right); and Olafur Eliasson's *Round Rainbow*, 2005.

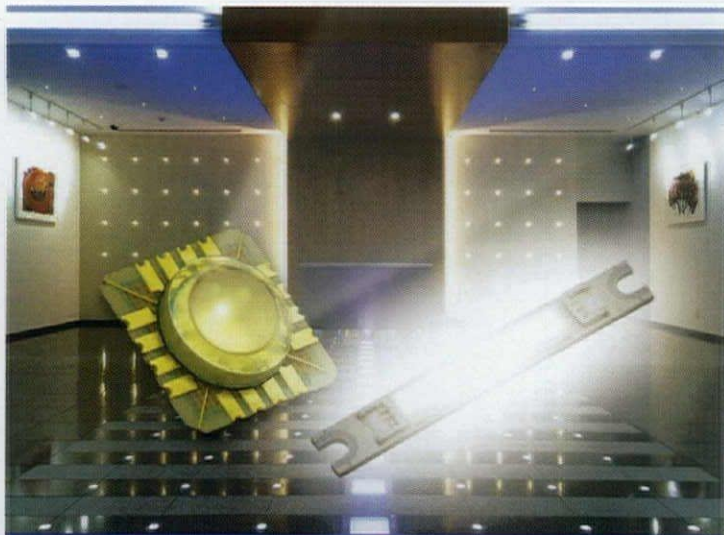

New Orion® White LEDs deliver more light with less power!

*These new LEDs are the brightest
and most efficient ever.*

Whether you are designing a new fixture or updating a classic, these new high-efficiency Citizen LEDs offer high performance and design flexibility, to give you an edge. Efficiency is greater than many fluorescents, and other LEDs. Lead-free and environmentally friendly

ORION
CITIZEN ELECTRONICS

**New CL-652S Orion LEDs
offer 85lm (70lm/watt)**

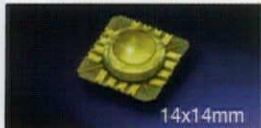

14x14mm

The Orion offers trend-setting brightness with unheard of efficiency. Luminous Flux: cool white is 85lm (70lm/watt). Warm white model is 57lm (47lm/watt). Draws 1.2 watts. Configure as 8 junctions in series for just 44mA or in parallel for 350mA. 14x14mm.

**New CL-L100 ultra-flat,
245lm LEDs (70lm/watt)**



50x7mm

The CL-L100 packs a super luminance flux of 245lm with high efficiency. Space-saving thin package releases flat, well dispersed illumination. Power consumption is 3.5 watts. 50x7mm.

CITIZEN ELECTRONICS CO., LTD.

Specifications: www.cecol.com
Sample Requests: email: info@cecol.com

Phone

North America — +1-847-619-6700 Asia — +852-2793-0613
Japan — +81-3-3493-2081 Singapore — +65-6734-1398
Europe — +49-69-2992-4810

CITIZEN
Micro Human Tech.

IESNA ANNUAL CONFERENCE

BUILDING ON THE SUCCESS AND EXCITEMENT OF LAST YEARS' CENTENNIAL CONFERENCE, THE Illuminating Engineering Society of North America (IESNA) restructured its 2007 Annual Conference, held from January 28-30, 2007, at the Point Hilton Squaw Peak Resort in Phoenix, to include a broad range of invited speakers. The official conference tagline was *Light Matters: Integrating Light Into Our Visual Environments*, but there was an equal focus on integrating the 8,296-person membership into the activities of the society.

At the Gala Dinner and Reception, 2006-07 IESNA President Kevin Flynn reinforced strategic changes being made by the society within three broad themes: membership with an emphasis on connections and sharing; knowledge with an emphasis on creation and facilitation; and communication with an emphasis on public outreach. The Membership and Networking Luncheons, on the first two days of the conference respectively, were both new formats designed to allow every attendee to actively participate in the conference and contribute to the society. The Membership Luncheon included a town hall-style meeting that provided an open forum for the society's leaders to answer questions from the membership. The Networking Luncheon was organized as a collection of roundtables. Prominent members of the society were invited to provide a discussion topic and act as table-hosts. Upon arrival in Phoenix, attendees selected a table with a subject of interest. The 20-plus topics included: "Should we Lose the Lumen?" hosted by lighting designer Naomi Miller, "Should the Incandescent Lamp be Banned as a General Illuminant?" hosted by 2005-06 IESNA president Dr. Alan Lewis, and "The Renovation Revelation" hosted by Cheryl English, vice president of Technical Services and Industry Relations for Acuity Brands Lighting.

Like the Centennial Conference of 2006, this year's program had a large number of invited paper presentations and seminars. The conference's success was due in large part to the number of invited speakers from outside the traditional IESNA community, important because it expands the discussion and offers a broader exchange between lighting design and allied professions. Such an instance was the opening talk by Dr. Thomas Albright, director of the Vision Center Laboratory at the Salk Institute for Biological Studies. Dr. Albright discussed the neurophysiologic techniques used to study how the brains of rhesus monkeys process light. In another invited seminar, Dr. Michael Terman of Columbia University discussed the role of light as an antidepressant, energizer, and sleep modulator.

Human health and the photobiological aspects of light were recurring conference themes, and in other seminars lighting designer Jill Klores provided an overview of considerations when designing lighting for neonatal environments. Dr. Mariana Figueiro, an assistant professor at Rensselaer Polytechnic Institute, summarized recent scientific studies that claim architectural lighting may influence the incidence of breast cancer and cancer growth. Though there is still much work to be done to understand the inner workings of the eye-brain system, both in terms of how it governs sight and other biological functions, it is clear that a deeper understanding of human biological requirements has the potential to influence how we light the built environment.

Steps were also made to reach out to students. A student portfolio review allowed student attendees to receive feedback on their work from lighting designers Peter Hugh, Howard Brandston, and Lisa Bertolino. Plans were also announced to set up an IESNA mentoring program for emerging professionals and students. Overall the conference was a success because of the networking opportunities, lighting discussions, and up-to-the-minute technical content delivered by experts. **KEVIN W. HOUSER**

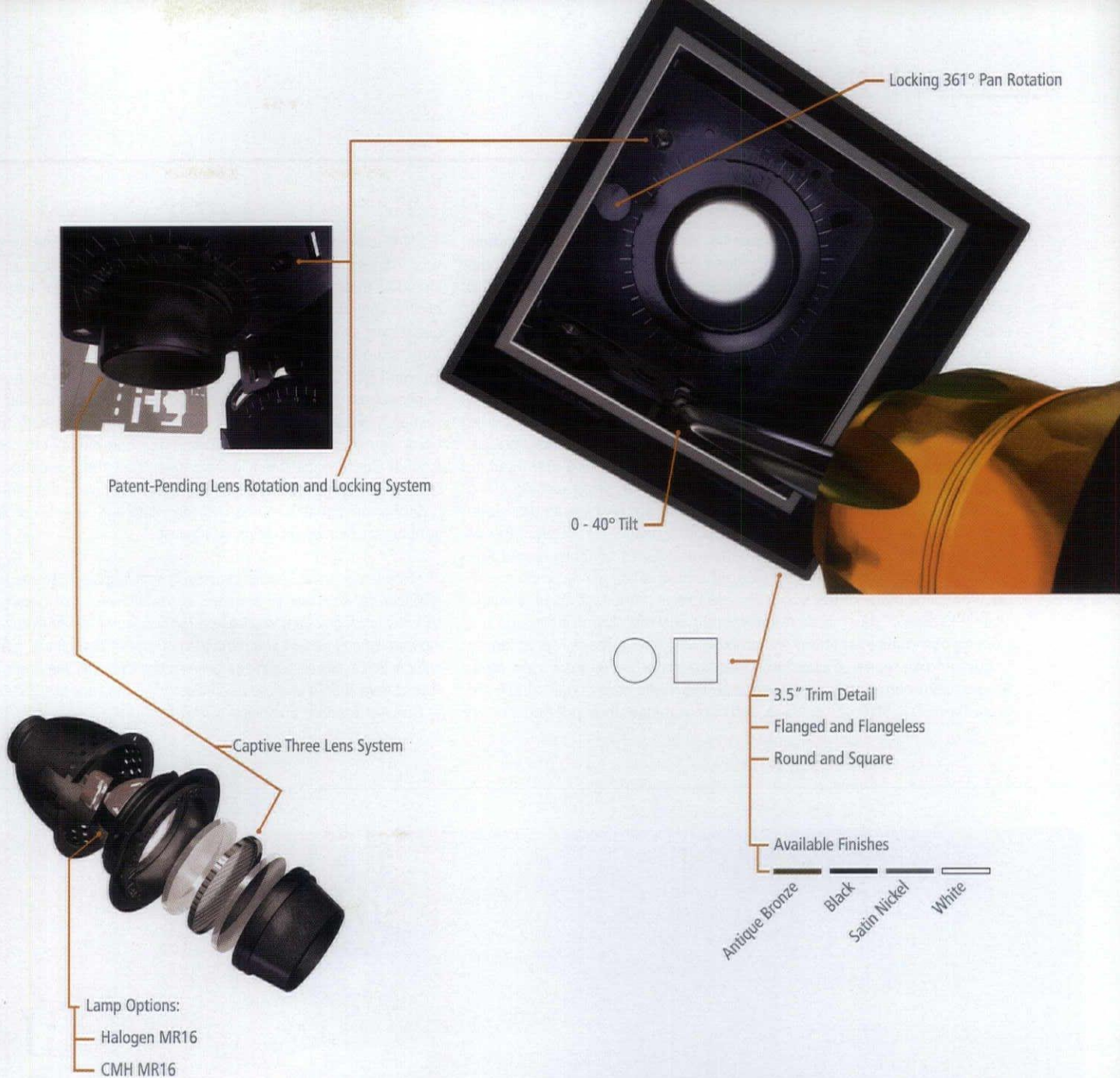

Lamp Options:
 — Halogen MR16
 — CMH MR16

designers aim the light
 maintenance re-lamps the light
ELEMENT remembers the light

the first downlight with a lens rotation locking system

ELEMENT 

for more information or a product demonstration visit us at booth #1621 at

www.element-lighting.com Circle no. 82 or www.archlighting.com/productinfo



IESNA EDUCATION SUMMIT

IN AN ADDITIONAL IESNA ANNUAL CONFERENCE DAY, THE SOCIETY SPONSORED AN EDUCATION summit planned by Dr. Ronald Gibbons, IESNA vice president of educational activities. Organized in response to the society's 2006-2010 strategic plan, which identified profession development and lighting education as one of five strategic goals, approximately 60 invited guests participated in the summit representing all segments of the lighting industry: academia, lighting design, consulting engineering, utilities, government, and manufacturing.

Working groups identified pressing issues related to collegiate and university programs, professional development and continuing education, outreach to allied professionals, and educating the general public about the importance of quality lighting. Research and Teaching were identified under the broader heading of Learning, and it was proposed by participants to unite these activities in order to take advantage of their natural synergies and to make the best use of financial resources.

A conceptual model was suggested that, if successfully implemented, would link many of the society's research and educational objectives. The first stage of this model resides within the membership through the existing committee structure, whereby IESNA committees would identify outstanding research questions that are important to their topic area. An oversight committee would organize the research proposals from the more than 50 IESNA committees and communicate their priorities to the

IESNA Board of Directors, which would issue requests for proposals. Per this model's format, research would be performed at universities and include student involvement, thereby increasing the intellectual capital of the society's future members, while addressing important research questions as defined, vetted, and prioritized by the society. Research results would then be disseminated through IESNA channels such as the journal LEUKOS, the annual conference, and incorporated into society publications. The new knowledge and discovery that stems from research would also serve as the impetus for updating IESNA publications and would create a demand for continuing education. Like the Annual Conference itself, it was clear that the Education Summit was organized by the society as a forum for input from the membership with the long-term goal of increasing the value and relevance of the IESNA to lighting professionals. **KEVIN W. HOUSER**

Dr. Houser is an associate professor and founding faculty member of the architectural engineering program at the University of Nebraska-Lincoln. He teaches undergraduate courses on the fundamentals of illuminating engineering and lighting design and graduate courses in daylighting, light sources, and color science. His research has been recognized with the Taylor Technical Talent Award from IESNA and the Leon Gaster Award from the Chartered Institution of Building Services Engineers (CIBSE).



brilliant



by design

Cris Glass Shades
European crystal in geometric shapes
for elegance and performance.
For use with the Sirius rail system.

www.siriuslighting.com
Lightfair Booth 1356

sirius[®]
the true measure of light



Mahoning County Courthouse Youngstown, Ohio

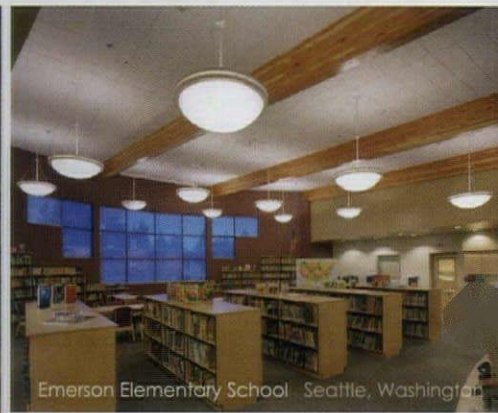

Emerson Elementary School Seattle, Washington



RAC Main Gallery St. Louis, Missouri

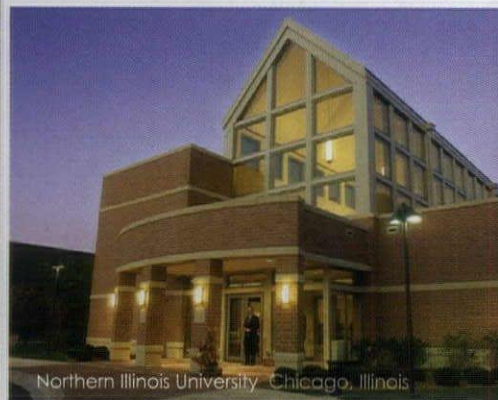

Northern Illinois University Chicago, Illinois

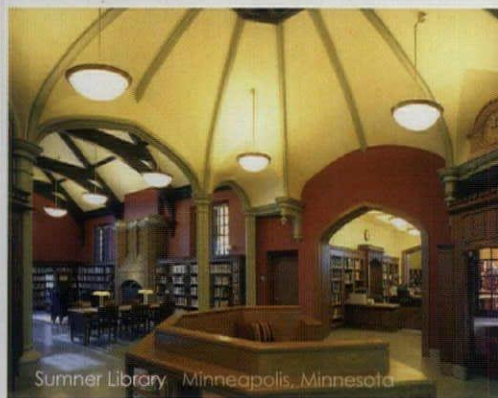

Sumner Library Minneapolis, Minnesota

Over the past thirty years, OCL has supplied the light fixtures for thousands of architectural projects. Though the projects vary greatly, OCL's quality adheres to the same high standards. Whether the fixture is indoor or outdoor, for a restaurant or for a school, OCL has a solution.



ARCHITECTURE OF THE NIGHT

ALTHOUGH TODAY THE ILLUMINATED NIGHTTIME PRESENCE OF BUILDINGS, MONUMENTS, AND urban spaces is not uncommon, this was not always the case—the advent of electric lighting in the nineteenth-century changed that. Such is the subject matter of the exhibition currently on view at the Netherlands Architecture Institute, *Architecture of the Night—Luminous Building*, which runs through May 6, 2007, in Rotterdam.

Over the past 100 years electric light has completely transformed the public realm. Beginning with the illumination of the Eiffel Tower at the 1889 World Exhibition in Paris, lighting enabled an even greater monumentality for such landmark structures and buildings. Modern architecture, with its large expanses of glass, redefined a building's interaction with its surroundings. Windows, which let natural light inside by day, at night, allowed these same internally electrically illuminated spaces to cast light back out into the urban realm. With the invention and development of LEDs, building skins have become interactive light sources. Yet, the evolution of illuminated buildings and the abundance of electric light in our nighttime environments is not without concern, and the exhibition seeks to address issues of light pollution and safety, as well.

A comprehensive and chronological overview of electric light's impact on architecture and the built environment, *Architecture of the Night* is sure to provoke and inform how "light, the city, and the future have changed since the invention of electricity." **A|L**

The staples of Modern Architecture—glass, steel, and concrete—made large glass expanses possible for buildings of the 1920s and 1930s. This allowed an abundance of daylight to permeate spaces by day, and by night the reverse effect, as internally electrically illuminated buildings cast their light back out into the urban realm. The Van Nelle Factories, Rotterdam, 1931, is one such example. A model is on display as part of the exhibition.

IMAGE COURTESY OF THE NETHERLANDS ARCHITECTURE INSTITUTE

Tambient.
lighting at work

Lights the ceiling, task and immediate surround from one T5 lamp, furniture mounted. As low as 0.6 w/sf.

www.tambient.com
Lightfair Booth #3147
a division of Sylvan R. Shemitz Designs, Inc., makers of elliptipar



Design
with Light

*New York Times Mock-up, College Point Queens, NY
Renzo Piano Building Workshop, Fox & Fowle – Architects
Gensler – Interiors*

A New Vision

- WindowManagement™ Solutions
- Daylighting Controls
- Mecho®/5 and Ecoveil™ the first complete window treatment to receive “Cradle to Cradle™” Silver Certification from MBDC
- www.mechoshade.com

 **MechoShade®**
The Architect's Choice.™

MechoShade Systems, Inc.
718-729-2020 • www.mechoshade.com

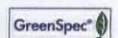
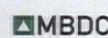

Circle no. 78 or www.archlighting.com/productinfo

© 2007, MechoShade Systems, Inc. All Rights Reserved.
Photography: James R. Morse

IALD BUILDS IMAGE AT GREENBUILD 2006

THE INTERNATIONAL ASSOCIATION OF LIGHTING DESIGNERS' (IALD) PARTICIPATION AT GREENBUILD 2006, the largest green building conference in the United States, was a positive return on investment based on the response given by visitors to the association's tabletop exhibit. Greenbuild, the annual conference of the U.S. Green Building Council (USGBC), marks the second exposition, in recent history, at which the IALD has exhibited outside of the traditional lighting industry venues.

Held November 4-16, 2006, at the Denver Colorado Convention Center, the show attracted 13,500 visitors. Exhibit hall presence brought nearly 1000 attendees to the IALD's tabletop exhibit. Particular interest focused on the IALD's *Guidelines for Specification Integrity, Advocates of Quality Lighting* brochure, and to receive information about the IALD Annual Conference—Enlighten 2007—scheduled for October 11-13, 2007, in Montreal, Canada.

IALD staff manned the exhibit booth, along with the help of IALD members Nancy Clanton, Carol Jones, Insiya Divan, Stefan Graf, Mark Loeffler, and Faith Baum. All familiar with sustainability in lighting, this group of lighting professionals informally polled booth visitors to assess their familiarity with the IALD, and the IALD as a resource for hiring independent lighting designers for projects. Of the 1000-plus visitors, comprised of architects, educators, engineers, building owners, developers, building product manufacturers, and specialized consultants, only less than half indicated that they had heard of the IALD. But thanks to the presence of the IALD

booth, and efforts by IALD staff and members in attendance, visitors were interested to learn of the IALD, its purpose, and its membership. Many conference attendees expressed a need for including lighting designers on current projects, and planned to visit the IALD web site to locate a lighting designer in their community. **MARSHA L. TURNER**

Marsha L. Turner is the executive vice president of the IALD.

GREENBUILD 2007 MOVES TO CHICAGO

INITIALLY SCHEDULED FOR LOS ANGELES, THE HOST CITY LOCATION FOR GREENBUILD 2007 HAS BEEN moved to Chicago. The conference and tradeshow dates, as previously announced, will remain unchanged—November 7-9, 2007.

The reason for the recent change was due to scheduling issues at the Los Angeles Convention Center. As explained by the USGBC in a prepared statement, "We'd like to thank the USGBC Los Angeles Chapter and Los Angeles Host Committee for their incredibly hard work to make Greenbuild 2007 a success, and we're looking forward to bringing Greenbuild to Los Angeles in the near term."

Greenbuild 2007 will be held at Chicago's new West Building at McCormick Place, a LEED registered project. For more information about the conference and tradeshow visit, www.greenbuildexpo.org. **A|L**

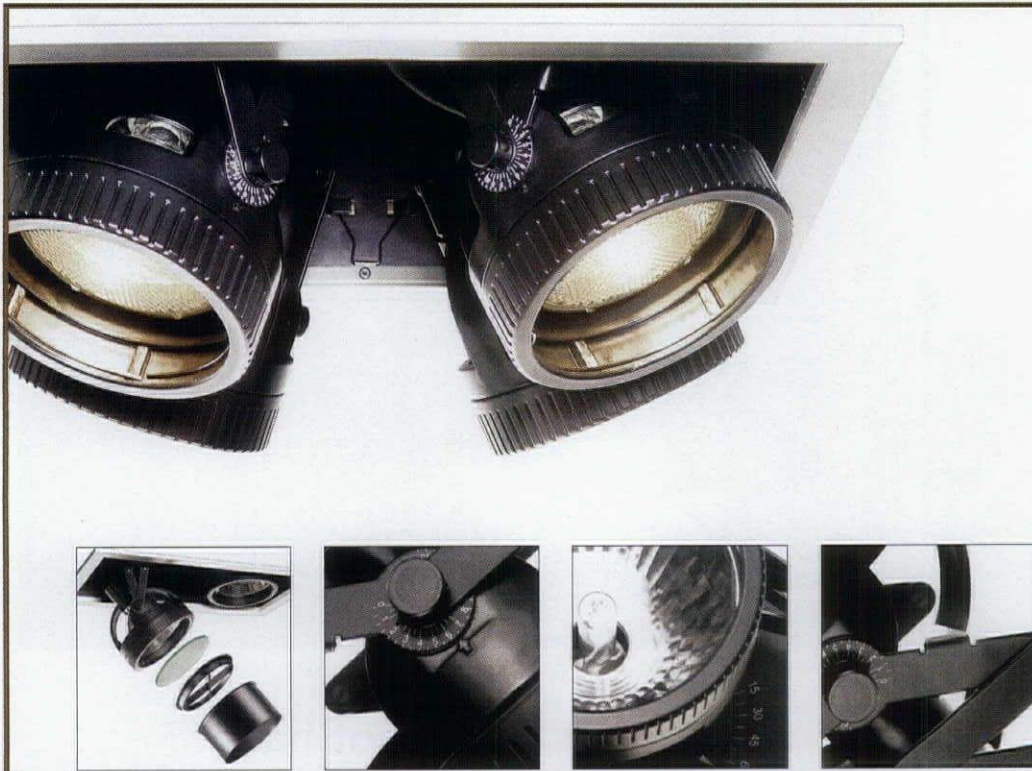

PRECISION MODULES

Multi recessed luminaires crafted with aimable, lockable and adjustable elements that employ a robust architectural style and superior performance.

See us at Light Fair, Booth #521 and HD Expo, Booth #2442.



**ARCHITECTURAL
LIGHTING**

Tel: 866.788.2100 W2lighting.com



Square D® lighting control

The connection between style and stability.



Saturn™ DLT Keypad



PowerLink® G3 Control Center

There are two sides to every building. Now you can count on the Square D® brand to bring them together. Square D Clipsal® lighting controls introduce a new level of style and ambience to any environment. Dim the lights across an entire facility or the family room, from a single keypad. Square D PowerLink® systems deliver proven performance – reducing energy costs through schedule and occupancy-based lighting control. Together, they form the kind of complete solution you won't find anywhere else. Reliable. Convenient. Flexible. And seamlessly integrated. See for yourself where elegance meets engineering. Visit www.squaredlightingcontrol.com and make the connection.





equation™

FIND BALANCE. CREATE IDENTITY. TRANSFORM YOUR SPACE.

Focal Point is proud to introduce **Equation™**, a new recessed luminaire with the perfect combination of modern aesthetics and outstanding performance. Featuring **MicroGlow™** lens technology, **Equation™** delivers efficient, uniform illumination with a soft visual appearance. Available in multiple sizes and lamp configurations, **Equation's** sleek architecture truly expresses The Art of Light.

Circle no. 49 or www.archlighting.com/productinfo

AESTHETICS + PERFORMANCE = EQUATION™



FOCAL POINT®

T H E
A R T O F
L I G H T®

Visit focalpointlights.com for specifications and other details on Equation.

Connectivity for Smart Buildings

BY GREGG D. ANDER

ARCHITECTS HAVE ALWAYS BEEN ON THE CUTTING EDGE OF DESIGN—AND today's issues of energy efficiency, global warming and equipment control represent today's "design edge." As emphasis on energy efficiency has expanded, architects and designers have responded with enhanced energy efficient designs. The coming trends in the utility industry once again provide increasing opportunity. This time it will be building owner cost savings through...Automation and Connectivity.

There are a number of concepts with which today's architect or designer must familiarize himself or herself if they are to assure modernity in their designs. Demand Response, ZigBee networks, and Advanced Metering Infrastructure are some of the most current.

DEMAND RESPONSE

Today, utility commissions in almost every state have ordered utilities to implement, or at a minimum, study the concept of controlling dispatchable electric loads; typically referred to as "Demand Response." Electric utilities ask commercial and industrial customers to reduce electric consumption during critical times by allowing the utility or an independent curtailment provider (aggregator) direct control over certain electrical loads. Alternatively, a signal may be received by a building owner or operator, and they in turn drop a portion of the load. Utility control is implemented to ensure grid reliability. Demand Response through remote curtailment often provides an additional revenue stream to the building owner, as well as mitigate high energy pricing during peak demand periods. This ultimately reduces cost to customers. And just like energy efficiency, demand responsiveness is easier, less expensive, and simpler when the control protocol is incorporated into the design rather than an item considered as an afterthought.

While many programs currently focus on controlling air conditioning and motor loads, utilities are looking to lighting as the next target application for Demand Response. Electric utilities are investing billions into infrastructure—enter the Smart Meter and Advanced Metering Infrastructure (AMI). Across the nation, utilities are installing smart meters in businesses and homes creating two-way networks so the utility can remotely read meters, connect and disconnect services, and signal equipment to reduce electric consumption at critical times.

Through the communication connectivity and control integration of AMI and the designers' integrated design, these networks provide building owners the ability to better manage costs while enjoying the benefits of automation. This increased functionality allows owners to participate in new and emerging programs and tariffs, which will allow them to reduce operating costs while increasing electrical grid efficacy and reliability. But the entire portfolio of initiatives goes beyond today's idea of a smart meter. Before we know it, "plugged-in" smart designs will be the standard.

COMMUNICATION PROTOCOLS

"Response-enabled" messages must, at a minimum, provide businesses the awareness of what is happening on the electric grid and what benefit their participation provides. This is accomplished with a message datacast to every participating facility providing the energy manager the ability and awareness of when to respond. The most reliable responses are automated, and this is accomplished with new grid-aware wireless systems.

Understanding how these concepts integrate into design starts at the point where the automation signal is sent and received—the communication protocol. One protocol that holds real promise is the ZigBee network.

ZigBee is a mesh network communication standard utilizing a 2.4 GHz frequency (an open and unlicensed protocol) operating through a Gateway format such as BACnet and LonWorks for building management, Supervisory Control and Data Acquisition systems (SCADA), and Modbus for industrial networks. The Gateway allows disparate networks to exchange information. Wireless sensor networks, such as ZigBee, are well suited for the harsh radio frequency (RF) environments common in commercial and industrial (C&I) applications.

As applied to the C&I marketplace, ZigBee is about enhancing reliability through control. This wireless technology allows the building owner to integrate and centralize management of lighting, heating, cooling, and security. Under the heading of building management, one can also automate control of multiple systems to improve conservation, flexibility, and security.

Optimizing lighting controls using an open protocol like ZigBee enables integration of a mesh network comprised of 100 percent digital microprocessor-based devices with embedded radios. The network is scalable and flexible up to 65,000 network nodes where the lighting ballasts become the control and communication nodes providing the Digital Lighting Network (DLN) backbone. Control ranges from a single personal space to an enterprise distribution. The selected software and user interfaces determine the user experience. One such interface, which incorporates the system's real-time monitoring, web-based automation and load shedding capability is the Lutron Electronics Digital microWATT system. This system connects analog devices making the devices "smarter," meaning building owners and managers get the best of both worlds: Use of existing analog components (retaining reliability and reducing operational costs), along with the added value of digital technology integrated to outside networks.

Mesh network proponents suggest that the use of a standard protocol with appropriate software will simplify lighting control system design and commissioning in new construction and retrofit applications, as well as reducing cost and complexity of system installation. This is accomplished by using a common platform, which is more cost

There are a number of concepts with which today's architect or designer must familiarize himself or herself if they are to assure modernity in their designs. Demand Response, ZigBee networks, and Advanced Metering Infrastructure are some of the most current.

effective than creating a new proprietary solution every time a technology is implemented. Utilities are interested in using the AMI technology on their electric distribution system integrated into their SCADA systems, and then combined with a ZigBee local area network in the business to communicate with lighting systems, thermostats, and other controllable devices.

ONE FINAL THOUGHT...

There is growing concern that Global Warming may be accelerating at an alarming pace. California's Assembly Bill 32, "The California Global Solutions Warming Act of 2006" requires the state to study ways of mitigating greenhouse gases through load control or mitigation. Demand Response and load automation will certainly play a role.

Understanding how the utilities intend to implement these smart technologies and how the technologies interface with architectural design is essential. Request your utility to present at industry meetings or invite them into your offices. Architects and lighting designers enhance professionalism and the value delivered to customers by assuring designs offer customers functionality for today and... for tomorrow.

Mr. Ander is a member of numerous professional organizations and serves on the Board of Directors of the Sustainable Building Industry Council, the New Buildings Institute, the Collaborative for High Performance Schools, and the California Commissioning Collaborative. He is the author of *Daylighting Performance and Design* and has won awards for various energy related projects. Mr. Ander has executive produced six environmentally-focused television programs. "Greener Buildings/Bluer Skies," won a 2006 Emmy Award.

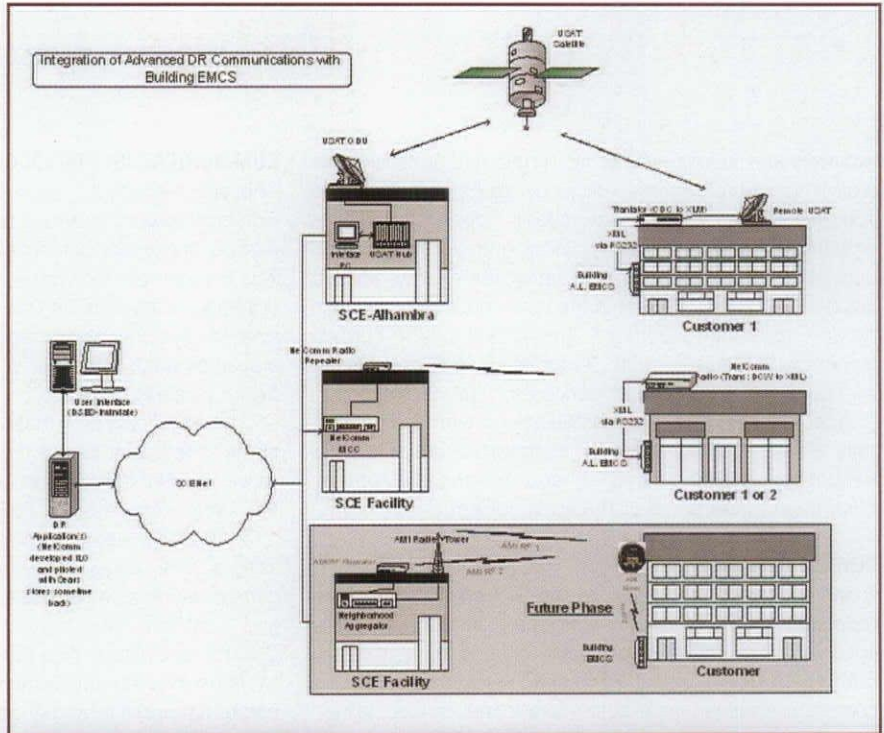

A conceptual diagram of a building Energy Management Control System (EMCS) being tested by Southern California Edison. The system allows customers different means of connectivity, such as satellite, smart meter systems, and radio frequency, to communicate with the utility provider.

RESOURCES

For those interested in researching additional information on connectivity, building automation and associated topics, the following references are provided

CALIFORNIA PIER ICLS

<http://cltc.ucdavis.edu/projects/active-projects/pier-technology-demos-at-uc-csu-campuses>
Information from studies at UC Davis on wireless lighting technologies.

EPRI (ELECTRIC POWER RESEARCH INSTITUTE) epri.com

Information on advancing the efficiency of electricity utilization, free for download.

GRID-FRIENDLY APPLIANCE

<http://availabletechnologies.pnl.gov/technology.asp?id=61>
Information on smart appliance controllers.

GRIDWISE ALLIANCE gridwise.org

Reliable and resilient electric system by integrating infrastructure and market structure so that energy can be generated, distributed, and consumed more efficiently and cost effectively.

INSTITUTE OF ELECTRICAL AND ELECTRONICS ENGINEERS

ieee.org/portal/site
Information directly related to lighting automation in Standards 802.11, 802.15.1 and 802.15.4.

INTELLIGRID CONSORTIUM epri.com/IntelliGrid/

Pave the way for the power grid of the future through open standards, coordination of R&D, collaboration, and a leadership role in the standards boards and regulatory bodies.

LUTRON ELECTRONICS lutron.com/technical_info

Information on currently offered automation products as well as new technology developments.

SMARTSYNCH smartsynch.com/products/smartmeter.html

Information on Smart Metering and related equipment for both the residential and commercial markets.

SOUTHERN CALIFORNIA EDISON sce.com/PowerandEnvironment/ami

Information on Automated Metering Infrastructure.

ZIGBEE ALLIANCE zigbee.org/en/resources/presentations.asp

Information related to Zigbee protocols and related topics.

YOUR VISION. YOUR PROJECT. YOUR **LIGHTING** SOLUTION.



BFL255

bartco LIGHTING
Leading the way and lighting it.

lighting design: Tillotson Design Associates photography: ©2006 Elizabeth Felicella

retail / commercial / institutional / hospitality / residential

Visit us at **LIGHTFAIR** booth number **1721**

tel **714.230.3200** fax 714.230.3222

bartcoLIGHTING.com

manufacturers of quality lighting products

Circle no. 21 or www.archlighting.com/productinfo

O E GREAT LAMP. TWO GREAT FIXTURES.

With the new 20 watt ceramic metal halide MR-16s now available you can save energy, select three different beam spreads, get 80+ CRI and 9,000 hours of consistent color.

Take that lamp and place it in one of our fixtures. You get great performance, the right aesthetics, and application flexibility.

FleXsion

- single & twin track fixtures
- integral electronic ballast
- cast aluminum construction
- 120V operation
- flexible monorail track system

ModuleX M3.7 Downlights

- miniature 3" aperture
- cast aluminum construction
- fixed, adjustable, and wall wash trims
- decorative trim accessories
- round & square trim shapes

FleXsion Track R-16 MH

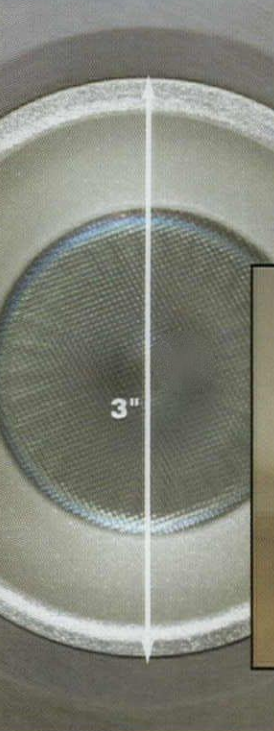

ModuleX M3.7 R-16 MH



THE "BIG PICTURE"

Utilities in California are addressing a number of concerns, including; reliability, cost, environmental quality, restructuring, and generation diversity to name a few. Resource Plans are filed with regulators, which identify energy efficiency, demand response, renewables, traditional generation (natural gas, coal, nuclear, etc.), peaker plants, and purchased power. This portfolio of demand and supply side activities is a requirement to keep buildings reliably and cost-effectively energized. Energy efficiency activities target equipment resulting in permanent load reductions while demand response addresses dispatchable

loads. Load management involves the integration of technology and controls, which permanently shift loads.

In order for energy efficiency activities to be included in a resource plan, these programs need to be cost-effective, verifiable, and reliable. Rebates are often implemented to encourage decision makers to make energy related decisions. These incentives can go directly to owners or may also go upstream to distributors or manufacturers. Third-party organizations may also deliver these programs. Modifications to Building and Appliance Codes also yield savings opportunities.

California Use per Person is Not Increasing

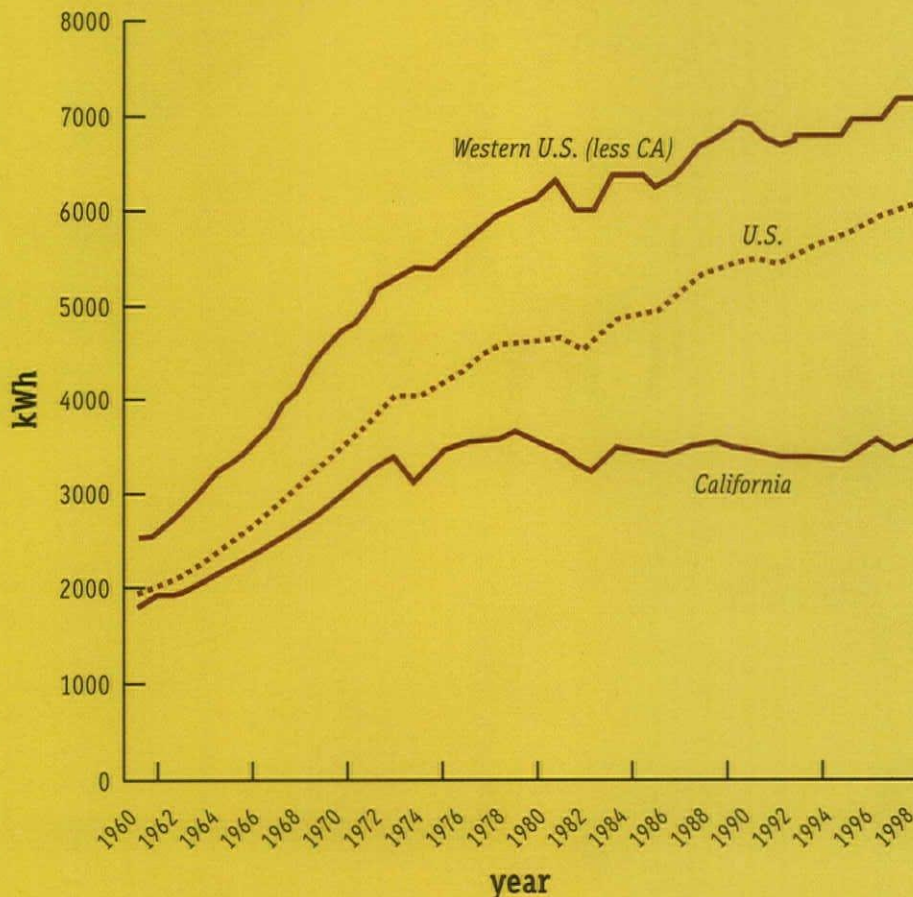

As a result of these aggressive demand-side management programs and initiatives in California, energy use per person has not increased since the 1973-1974 Oil Embargo.

*Your impressive lighting design
will only be surpassed by your customers' applause!*

Kramer Squares with New *Slideways*TM System



*Patented **Slideways**
system provides easier
access from below than
other products.*

A specification grade of square aperture downlights to *satisfy* your exacting design criteria.

Achieve desired illumination with a *variety* of HID, CFL or incandescent lamp sources.

Create your mood, emotion and atmosphere with a wide selection of aperture sizes, trim colors and textures.

Kramer robust design assures long life and worry-free, specification *confidence*.

Kramer *delivers* unparalleled product availability to meet your tightest project requirements.

**Blend your sophisticated designs with
performance, practicality and personality.**

kramer[®]
L I G H T I N G

kramerlighting.com

Circle no. 69 or www.archlighting.com/productinfo

For detailed information visit our website or contact your local Kramer Lighting representative.

BE THE FIRST ON YOUR BLOCK

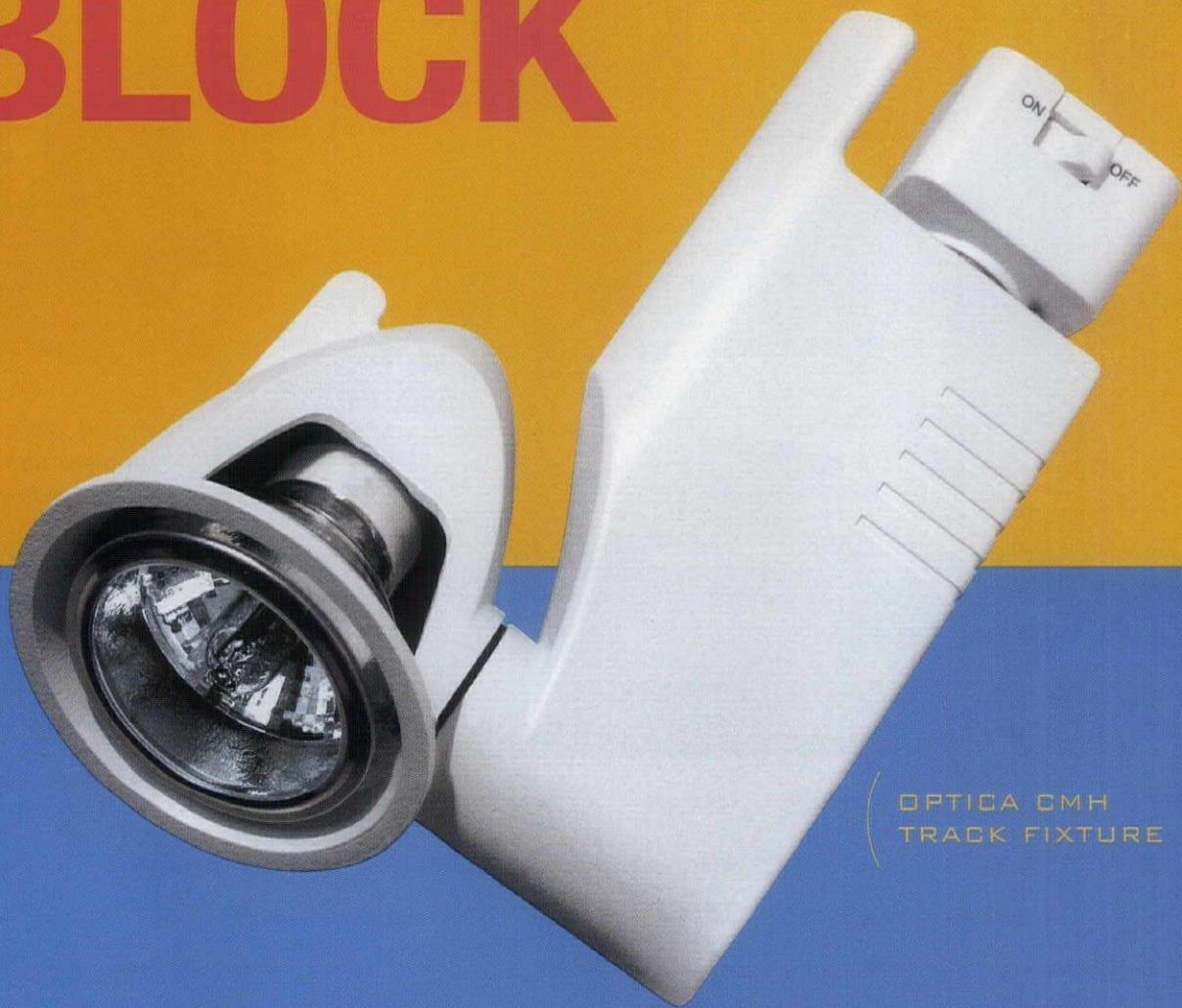

OPTICA CMH
TRACK FIXTURE

THE NEW OPTICA 20W CMH MR16 TRACK FIXTURE IS THE COOLEST LIGHT GOING, AND NO ONE HAS IT BUT CON-TECH. MICRO SLIM DESIGN, WITH LOCKABLE AIMING FOR 358° HORIZONTAL ROTATION AND 180° VERTICAL ROTATION. MORE EFFICIENT THAN A HALOGEN LAMP AND 3 TIMES THE LAMP LIFE. IT'S METAL HALIDE POWER IN AN MR16 PACKAGE. AND BEST YET, CON-TECH HAS IT, RIGHT NOW.

Circle no. 24 or www.archlighting.com/productinfo

RECESSED

TRACK

RAIL

DECORATIVE GLASS

SCONCES

EMERGENCY

CON-TECHLIGHTING.COM
800-728-0312



makes it better.

LIGHTFAIR
BOOTH 1357

MENTION NASHVILLE, TENNESSEE AND YOUR MIND WILL INSTANTLY THINK OF COUNTRY MUSIC and the Grand Ole Opry, rather than classical music and symphony halls. But, with the debut of the Schermerhorn Symphony Center in September 2006, that has changed.

Charged with the task of creating a family of fixtures that would have “grandeur and sparkle” while addressing the diversity of spaces, New York-based Susan Brady Lighting Design (SBLD) began by researching period luminaires. The studio found inspiration in the chandeliers—upside down wedding cake-like forms from which varying length stems with glass globes extend—designed by architect Otto Wagner for the St. Leopold am Steinhof Church in Vienna. SBLD worked with Crenshaw Lighting to custom design 40 different fixture styles throughout the project. Because the architects did not want to use downlights in the main public spaces, the lighting designers relied on ceiling suspended chandeliers, as well as wall-mounted and torchiere-style luminaires. But custom design did not mean open-ended budget. Rather, limited means meant creative solutions, and the lighting designers repeated details and kept materials simple. All of the luminaires are nickel silver with a variety of finishes—polished, satin, and angle hair, and have 6-inch glass globes with a cracked texture to emulate the feel of candlelight. One of the significant challenges, explains lighting designer Attila Uysal, was in understanding the scale of the project and how that would translate to the different fixtures. “We worked with a concept of units,” he says, “defined, but flexible.”

The most elaborate fixtures—eight grand chandeliers—are found in the concert hall. Occupying the main portion of the room, four of the eight measure seven feet in diameter by seven feet high, and utilize over 80, 75W halogen A-lamps to provide a soft illumination. The other four chandeliers are outfitted with adjustable theatrical units with 500W PAR lamps for the stage lighting. Located over the side balconies, a line of smaller bracket-mounted chandeliers form a secondary layer of light. Ceiling suspended and wall-bracketed chandeliers, also of a smaller scale, illuminate the lobby and provide a jewel box-like feel to the space.

One of the more interesting features of the 197,000 square-foot, 1,872-seat concert hall, which predates SBLD’s involvement on the project, is the presence of indirect daylight. Not normally found in performance spaces, in part due to theatrical lighting requirements, after touring concert halls worldwide, in particular Vienna’s Musikverein, the architects decided natural light was an important element to include in the interior. Blackout shades and flexible lighting controls help to provide the balance between daylight and electric sources.

The family of custom luminaires carries to the building exterior as well. Here, according to Uysal, scale was a major issue. “All the building elements are big. In turn, the fixtures are simpler, but the form is reminiscent of the interior chandeliers.” Decorative custom fixtures, such as post top lanterns and sconces accent the entrances, while metal halide luminaires mounted on street poles around the site provide a floodlight wash across the main façade.

Aesthetically speaking, when it comes to architectural styles, the new building makes an interesting statement given the current trend toward the “contemporary”—a neo-classical exterior coupled with an interior inspired by the Viennese Secessionist Movement. Nevertheless, when it comes to the building’s illumination, it is artfully executed in the hands of SBLD. **ELIZABETH DONOFF**

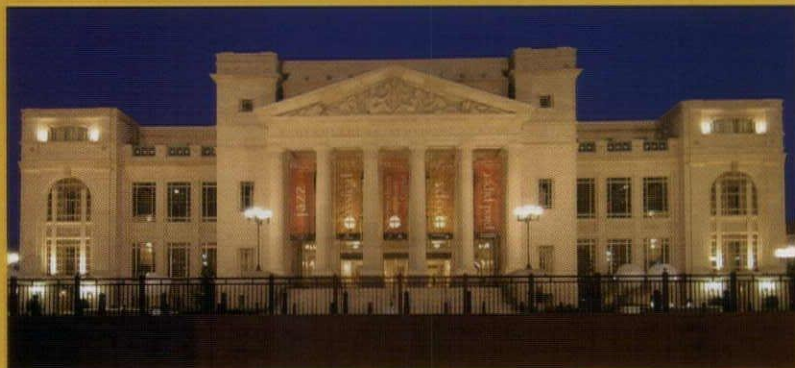

The building’s neo-classical façade (above). Custom designed chandeliers lend a jewel box-feel to the main lobby (below). The concert hall interior (bottom).



PROJECT: Schermerhorn Symphony Center **LOCATION:** Nashville **DESIGN ARCHITECT:** David N. Schwarz/Architectural Services, Washington, D.C. **ARCHITECT OF RECORD:** Earl Swensson Associates, Nashville **CONSULTING ARCHITECT:** Hastings Architecture Associates, Nashville **LIGHTING DESIGNER:** SBLD Studio, New York **BUILDING COST:** \$120 million **LIGHTING COST:** \$3 million **PHOTOGRAPHER:** Attila Uysal/SBLD Studio **MANUFACTURERS:** B-K Lighting, Crenshaw Lighting (all custom fixtures); Sterner, Sternberg, Winona, USA Illumination

LITERARY LIGHT

An ideal lighting scheme for the Minneapolis Central Library enhances the architecture, supports human comfort, and exceeds demands for energy efficiency.

The new glass- and Minnesota limestone-clad Central Library casts a striking form against the backdrop of downtown Minneapolis (below).



BRIMMING WITH CIVIC STRUCTURES, MUSEUMS, THEATERS AND PERFORMANCE HALLS, Minnesota's Twin Cities—Minneapolis and St. Paul—are often touted as the cultural center of the heartland. Over the past few decades, virtually every major arts and cultural facility in the two cities have reinforced that notion by expanding their existing facilities or building new ones. Last year alone, the twin towns burnished their reputation as cultural capital of the Midwest with the opening of more than \$300-million-worth of new arts and cultural buildings designed by world-class architects.

Among these vibrant new structures is the 353,000-square-foot Minneapolis Central Library, designed by renowned architect Cesar Pelli and his New Haven-based firm Pelli Clarke Pelli. The design of the building transforms the concept of "library" from a staid, inward-looking repository of books to an outward-reaching community center. And thanks in part to its thoughtful lighting scheme; designed by New York-based Cline Bettridge Bernstein Lighting Design, the building truly shines—literally and figuratively.

Located in downtown Minneapolis not far from the Mississippi River between Hennepin Avenue, the city's primary thoroughfare, and Nicollet Mall, its pedestrian shopping street, the glass- and Minnesota limestone-clad library reaches out to the city and draws it in. Its centerpiece is a soaring 5-story atrium topped with a 60-foot-long wing-like zinc canopy. Linking the building's North and South wings, the atrium is flooded with natural light during the day. At night, it glows like a beacon, with the cool light of surface-mounted 4000K metal halide uplights, which bring out the blue tone of its dynamic zinc roof canopy, and the warm light of 3000K ceramic metal halide downlights, softly illuminating the warm-toned surfaces below. The building's alternating wall panels of clear and fritted glass also contribute to the lighting effects, diffusing the light during the day, and permitting views deep into the space at night.

As in the atrium, the lighting throughout the building was developed hand-in-hand with the architecture to meet the needs of a modern library, including the technological advances of the information age. "Libraries are different than they were in the past," says William Butler, Pelli Clarke Pelli's lead architect on the project. "What used to be an end place for books is today a communications hub, which not only houses bound books, but also offers access to digital information, with librarians navigating an information network." At the same time, says Butler, current library environments need to operate on two distinct social levels. "On the one hand, a library is a grand civic building that embodies the cultural values of a community—they're much more social than they were before, and serve as centers for community gathering, with spaces for book clubs and lectures. On the other hand, it needs to respond to individuals, with spaces that function on a residential scale, where you can sit down in an easy chair next to a floor lamp, kick off your shoes and curl up with a book. The character and the quality of the light is essential at both these levels."

From the user's viewpoint, the lighting in the new library had to address the needs of two primary groups—the librarians and the public, according to Francesca Bettridge, principal lighting designer on the project. From an operations standpoint, the lighting had to be flexible, meet strict energy codes, and be executed within an extremely limited budget. "Modern light levels have to be high enough to be comfortable for both aging and young eyes," says Bettridge. "At the same time we had to meet the state's energy requirements and create lighting in the open stacks and reading areas that could be flexible enough to be moved, if necessary, in the future. So we came up with what we describe as a task/ambient solution."

The airy, loft-like spaces, which house the reading areas and the open stacks of books in the North wing and the secure compact storage stacks

in the South wing, are defined with a grid of mushroom-shaped concrete columns and different colored carpets on each floor. To provide ambient illumination in these areas, the lighting designers created a series of sleek, low-profile rectangular indirect pendant fixtures. Made of white painted-metal and hung from cables from the ceiling, these fixtures contain 54W T5HO fluorescent lamps that reflect off the ceiling and provide an average of 35 footcandles of sustained illumination. In effect, says Bettridge, "The whole ceiling becomes a light fixture offering even, shadow-free ambient light that's very pleasant."

Over the tall open stacks in these areas, the lighting designers modified the linear indirect pendant fixtures with a custom T-shaped bracket that contains T5 fluorescents in louvered troughs that provide glare-free downlight along the circulation paths on both sides of each book stack as well as a wash of light on the books from top to bottom. (Full-scale mockups of these fixtures were developed and reviewed by a group of exacting librarians before they went into production.) These fixtures are also connected to occupancy sensors and turn on only when the circulation paths are actually being used. Within the adjacent shorter stacks, the lighting designers incorporated hidden 28W T5 fluorescents behind a lip along their upper edges to provide a wash of light on the faces and spines of the books below.

At the reading tables on each floor, the lighting designers provided elegant task fixtures. Reproductions of table lamps seen by Francesca Bettridge at the Royal Library Extension in Copenhagen, these sleek fixtures provide a subtle link to the Scandinavian roots of many of the city's residents, and can be controlled individually by the user. With all of the power and data cabling running beneath raised floors, the task lighting is also powered from the floor, making it extremely flexible. "In addition, the fixtures at the perimeter and in the atrium are on photo cells," says Bettridge, "so when there's a lot of natural light, they automatically turn off to harvest the daylight." Thanks to these devices, the building uses 30 percent less energy than the minimum required.

Two other areas that received special lighting attention are the Children's Library and what is known as Teen Central, an area created for teens with input from 14 teenage advisers. In the children's section, the lighting designers created a dynamic canopy of light overhead with sunburst-like radial patterns of linear fixtures containing T5 sources. They also introduced shots of vibrant color by nestling LED strips into the branches of abstract tree shapes situated throughout the space. These sources are programmed to provide a kaleidoscope of ever changing colored light over the course of the day. In the teen section, slim T2 lamps, integrated in vertical coves behind diffusers in the millwork of an undulating red wall unit containing books and magazines, accent its sinuous shape. In this area, 37W MR16 track fixtures also punch light onto tables and globe-like pendants of different sizes were fitted with colored bulbs as a fun, slightly irreverent touch.

According to Tom Hysell, a managing principal of the Minneapolis-based Architectural Alliance, the architect of record on the project, the response to the library since it opened has been extraordinary. "One of the first things people talk about when they enter the building is the beautiful sense of light," he says. Architect William Butler credits the success of the building, and the lighting in particular, with the collaborative approach by all parties of the team from the beginning. "Each reinforced what the other needed all along and the building got stronger and stronger," he says. "Usually lighting is driven more by utility than by celebratory reasoning, but because the different aspects of this building were accentuated with light, in ways that make each one unique, the entire building feels more glorious." **JEAN NAVAR**



The centerpiece of the library is a 5-story atrium topped with a 60-foot-long zinc canopy, which allows an abundance of natural light into the building (above). Just as electric and natural light is layered and balanced throughout the building, so too are the types of reading and work areas. The open reading rooms and atrium perimeter use thin linear T5 pendant fixtures, sometimes in rectangular patterns, other times in lines, to uplight the ceiling. Depending on the location, they are lensed, UV-lensed or open top. To minimize visual clutter, the lighting designers devised custom T-shaped brackets fitted with T5 fluorescents and mounted them atop every other book stack to provide diffused downlight illumination along the circulation paths between stacks. Controlled by occupancy sensors, the fixtures are ultra-efficient (facing page, top and bottom).







In the area of the library dedicated to teenagers, T2 lamps integrated in the millwork of an undulating red wall unit accent its curving shape. MR16s punch focused light onto the tables and colored bulbs in the pendants introduce an element of surprise (facing page, top). Surface-mounted T5s in playful radial patterns on the ceilings of the children's section of the library, add interest and ambient illumination (facing page, bottom). LED strips nestled into the branches of the abstract tree forms are programmed to provide changing kaleidoscopic color (below). Rectangular indirect linear pendants containing T5 fluorescents and fitted with asymmetric reflectors and frosted lenses illuminate the ceilings of each floor. Linear fluorescents hidden along the front edge of low stacks wash the books with a minimum of 20 footcandles of light. Small LED strips highlight the edges of the wood frame of the staircase (above).



PHOTO BY ELIZABETH DONOFF

DETAILS

PROJECT Minneapolis Central Library, Minneapolis
CLIENT City of Minneapolis/ Minneapolis Library Board
DESIGN ARCHITECT Pelli Clarke Pelli Architects, New Haven, Connecticut
ARCHITECT OF RECORD Architectural Alliance, Minneapolis
LIGHTING DESIGNER Cline Bettridge Bernstein Lighting Design, New York
PROJECT SIZE 353,000 square feet
PROJECT COST \$138.8 million (total building and construction costs)
LIGHTING COST \$210,825
PHOTOGRAPHER Jeff Goldberg/Esto

MANUFACTURERS

Color Kinetics
 LED Effects / SGF Associates
 Lighting Services Inc.

Lightolier
 Louis Poulsen
 Lutron

Michael's Lighting
 Modular
 Nuf Design
 Peerless
 Sterner
 Zumtobel Lighting

APPLICATIONS

Children's Library color-changing LEDs
 LEDs at atrium grand stair
 Surface-mounted downlights in atrium, tracklighting throughout project
 Tracklighting throughout project
 Circulation desk tasklights
 Dimming ballasts for daylight harvesting in open reading areas, T5 pendants near exterior windows
 Table-mounted tasklights
 Multiheaded adjustable accent lights
 Decorative pendants in Teen Central
 T5 pendants in reading areas and atrium perimeter
 Atrium ceiling uplights
 High stacks T5 pendants on motion sensors; pendant direct louvered fixture assemblies mounted to wireway channel in offices, closed stacks, and minor public areas

 more information at ARCHLIGHTING.COM

PROCESS MAKES PERFECT

HIGH-PERFORMANCE DESIGN CREATES HEALTHY ENVIRONMENTS FOR HIGH-PERFORMANCE LEARNING.

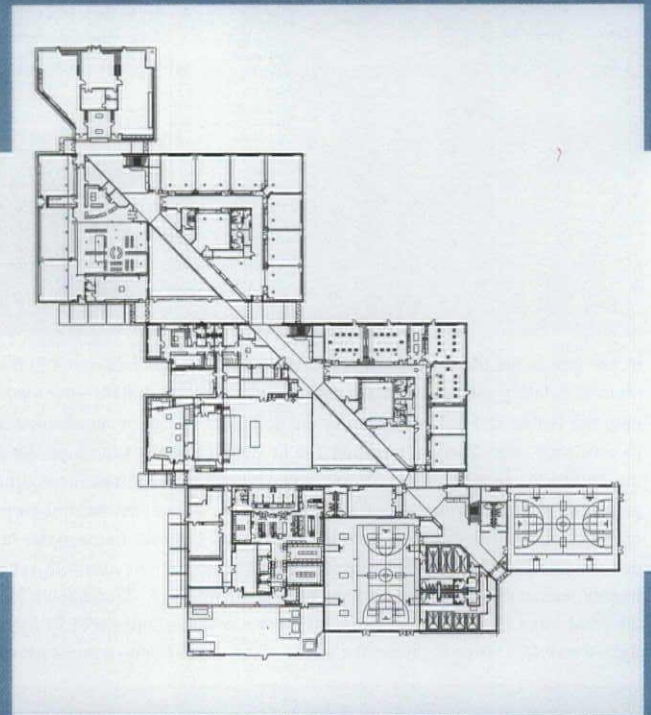
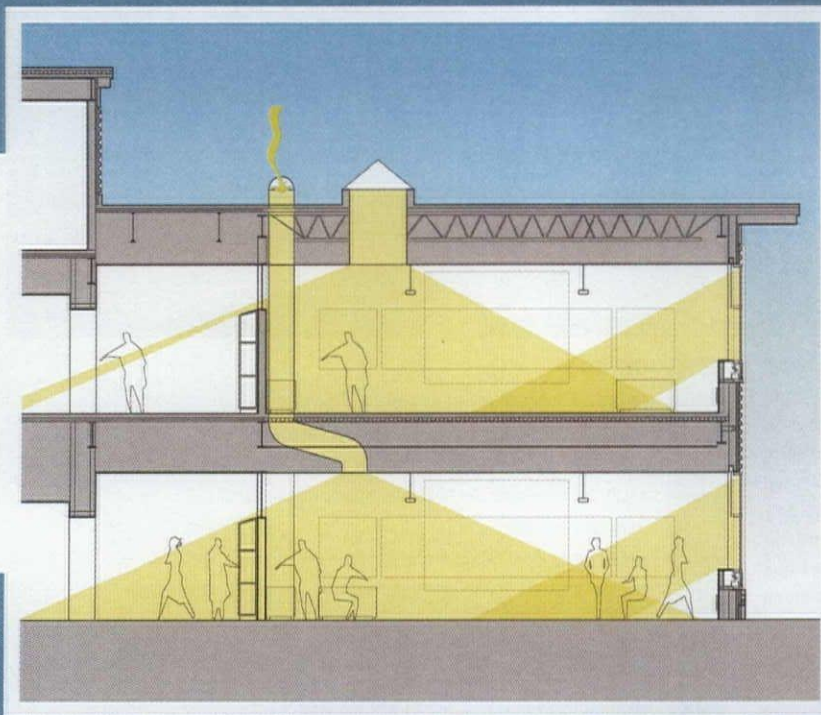

CONSIDERING THE STAGGERING BENEFITS OF HIGH-PERFORMANCE SCHOOLS, IT SEEMS AN OBVIOUS choice to “go green.” High-performance schools offer an exceptionally cost-effective means to enhance student learning, using on average 33 percent less energy than conventionally designed schools, and provide substantial health gains, including reduced respiratory problems and absenteeism. According to the 2006 study, *Greening America’s Schools, Costs and Benefits*, co-sponsored by the American Institute of Architects (AIA) and Capital E, a green building consulting firm, high-performance lighting is a key element of healthy learning environments, contributing to improved test scores, reduced off-task behavior, and higher achievement among students. Few argue this point more convincingly than architect Heinz Rudolf, of Portland-Oregon-based Boora Architects, who has designed sustainable schools for more than 80 school districts in Oregon, Washington, Colorado, and Wyoming, and has pioneered the high-performance school movement. Boora’s recently completed project, the Baker Prairie Middle School in Canby, Oregon is one of the most sustainable K-12 facilities in the state, and illustrates Rudolf’s progressive and research-intensive approach to school design.

For the Baker Prairie Middle School, the design process began by inspiring the planning committee to support “a sustainable building that is connected holistically and where everything works together,” according to Rudolf, who led the project. The Baker Prairie planning committee—roughly 40 individuals including the district superintendent, school administrators and board members, teachers, and parent association and community representatives—initially had been resistant to Boora’s proposal for a high-performance school because they were fearful of the increased costs, maintenance requirements, and perceived “extravagance” of green architecture. To illustrate the intrinsic simplicity and advantages of the school as they proposed, Rudolf took the committee on a tour of a number of existing sustainable schools Boora had designed in the region. The immediate experience of these daylight suffused and sustainable spaces was powerful enough to convince even the most resistant critics among the committee. An important first-step, Rudolf feels exposing people to functioning sustainable spaces is essential to mitigating common misconceptions about green design.

Once the client had agreed to a sustainable program, thorough analysis of the site and the location of the proposed building began. For Rudolf



The 138,000-square-foot Baker Prairie Middle School in Canby, Oregon, is organized into three “pods,” staggered along a diagonally placed central corridor to allow all classrooms and most areas direct access to daylight (facing page, left). A sectional drawing shows how daylight enters the building—through windows, skylights, and an 8-foot horizontal offset daylighting shaft (facing page, far left). Architect Heinz Rudolf and the team from BetterBricks discuss the project (above left). In the daylighting lab, Heinz Rudolf with a model of the building on the heliodon (above right). Rudolf enlisted the help of local Canby High School students, enrolled in a construction course, to build a full-scale classroom mock-up on the actual Baker Prairie Middle School site (below, left and right).

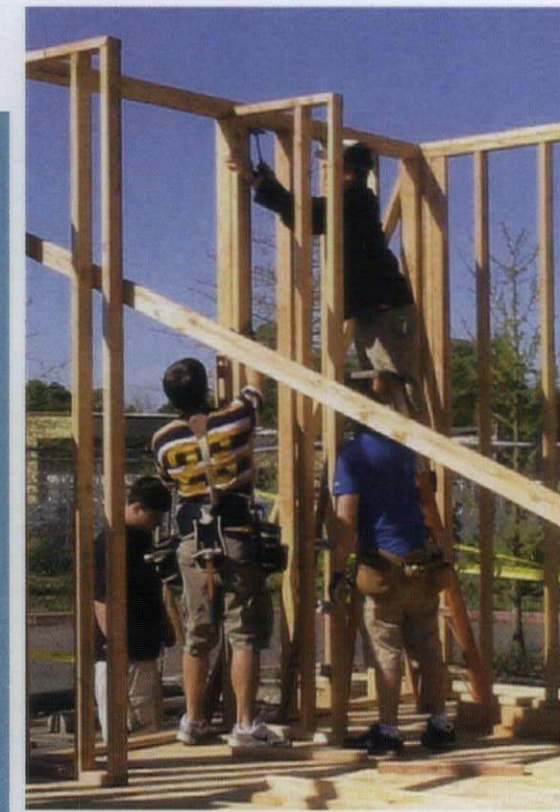

this step is of primary importance to ensure "maximum opportunities for bringing daylight into the building." Once the optimum site location is determined, daylighting can be further enhanced through design—"hollowing out" interior spaces, creating transparency between rooms, and determining appropriate ceiling heights and daylight apertures. At Baker Prairie, Rudolf organized the interior spaces of the 138,000-square-foot school into three "pods," staggered along a main corridor that runs diagonally through the plan. This program allows all classrooms and most areas direct access to daylight, which is harvested through abundant windows, skylights, clerestories, and prism-like atriums that connect ground-floor areas with outdoor spaces.

As changing classroom needs often necessitate great flexibility in lighting conditions, Rudolf designed the daylighting to work in partnership with electric light. When necessary daylight can be supplemented by efficient T8 fixtures, or in the opposite extreme, when darkened room conditions are required, daylight can be shut out entirely with mechanized shading systems. These systems are also in place in the library, gymnasiums, and common areas. Furthermore, energy reduction is ensured throughout the school with automatic lighting controls, including occupancy sensors, time clocks, photocell sensors, bypass switches, and lighting relay panels. After the initial design phase, an extended period of empirical investigation took place. This involved extensive computerized daylight modeling followed by the construction and testing of 1/2-inch and full-scale models. For the latter, Rudolf enlisted the help of local Canby High School students, enrolled in a construction course, to build a full-scale mock-up on the Baker Prairie site. It was an extraordinary opportunity for the high school students, who received substantial hands-on experience in construction as well as in the principles of sustainable design. While the expense of such mock-ups generally makes this kind of testing prohibitive for such modestly budgeted projects, Rudolf secured donations from the Portland-based non-profit organization, BetterBricks for the \$6000 mock-up construction budget, and the necessary interior finishes from the Northwest company, Miller Paints.

The mock-up was essential to the design process for several reasons, primary among them, the ability to test a proposed 8-foot horizontal offset daylighting shaft provided by manufacturer Solatube. This critical experimentation revealed proper placement of lens openings in the ceiling, as well as allowing adjustments in the placement of skylights and the T8 fixtures. The most invaluable result of the mock-up was not revealed until much later when several million dollars had to be cut from the construction budget. Typically elements associated with sustainable design—skylights, windows, controls, and other mechanical systems—are the first to be sacrificed. Thanks to his extensive research however, Rudolf was able to convincingly illustrate the tremendous benefits the school's sustainable features proposed, particularly in terms of projected energy savings. After reviewing the results of this research, the school board agreed to keep the high-performance systems and find other areas for budgetary reductions. As Rudolf describes, "In a way it saved the project—they could have said 'let's just go to strip lighting and eliminate the daylight sensors and dimmers' and so forth—but they certainly wouldn't have ended up with the building they received."

Completed in January 2007 the Baker Prairie Middle School is a success with the community as well as with its 800 students, who according to Rudolf, "absolutely love it." While the project was designed with the goal of obtaining LEED Silver certification (the project is in the final stages of the application process), the completed school is within a point of Gold—due in no small part to Rudolf's research-driven and integrated approach to the design of sustainable schools. It is not daylighting or natural ventilation or energy-efficient mechanical systems alone that make a project truly sustainable, as Rudolf argues, "all of these have to be considered together...if one element is out of sync with the other than the whole design will fail. If one system is altered, then all systems are implicated." Baker Prairie has elegantly achieved this holistic balance and has given its students the immeasurable advantages of a healthy and dynamic environment for learning. **MARGARET MAILE PETTY**

DETAILS

PROJECT Baker Prairie Middle School, Canby, Oregon

CLIENT Canby School District, Canby, Oregon

ARCHITECT/INTERIOR DESIGNER Boora Architects, Portland, Oregon

LIGHTING DESIGNER Interface Engineering, Portland, Oregon

IMAGES Courtesy Boora Architects

PROJECT SIZE 142,700 square feet

BUILDING COST \$23,100,000 (total construction cost); \$161.88 per square foot

LIGHTING COST \$370,000 (material costs); \$2.59 per square foot

WATTS PER SQUARE FOOT 0.74

MANUFACTURERS

Peachtree Lighting
Firelite

Paramount Industries
Rebelle
Capri Lighting
Day Brite Lighting

Jammar Lights
LumenArt
Gardco Lighting

Luminaire
Guth Lighting
Orgatech

APPLICATIONS

Vertical fluorescents
Wall-mount fluorescent T8; standard stem-mounted classroom fluorescent T8

Gym fluorescents
Two-story hallway compact fluorescent
Low-voltage tracklight
Restroom fluorescent T8 striplights; undercounter fluorescent T5s

Low-profile tracklights; metal halides
Hand-blown accent lights
Pole lights Gullwing; exterior half cylinder wall series compound fluorescent

T8 vandal-resistant locker room fixtures
Exterior vapor-proof fluorescent "Jelly Jars"
Exterior floodlights; compact/linear fluorescents

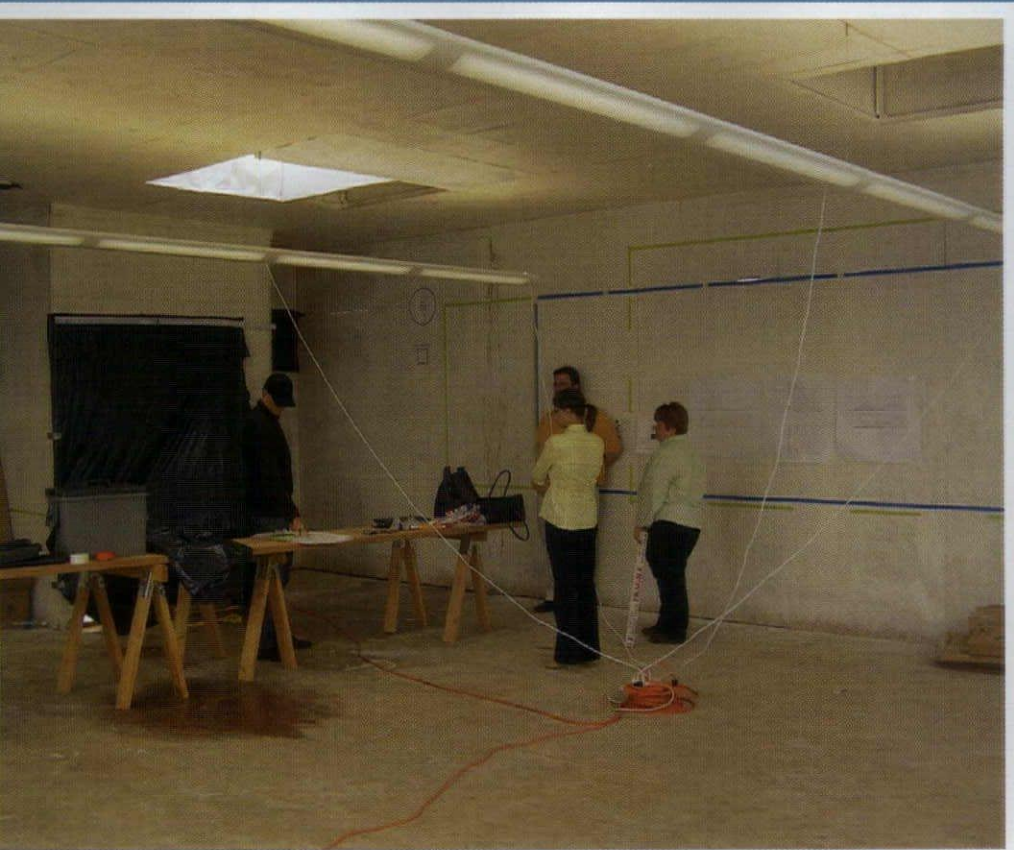

Testing lighting levels inside the classroom mock-up (above, left and right) was essential to the design process for several reasons, primary among them, the ability to test a proposed 8-foot horizontal offset daylighting shaft, provided by Solatube, seen from the roof during mock-up construction (below left). This critical experimentation revealed proper placement of lens openings in the ceiling (below right), as well as allowing adjustments in the placement of skylights and the T8 classroom fixtures.





DAYLIGHTDESIGNS

Solar studies aid in the creation of architectural form and program for a day-care center.

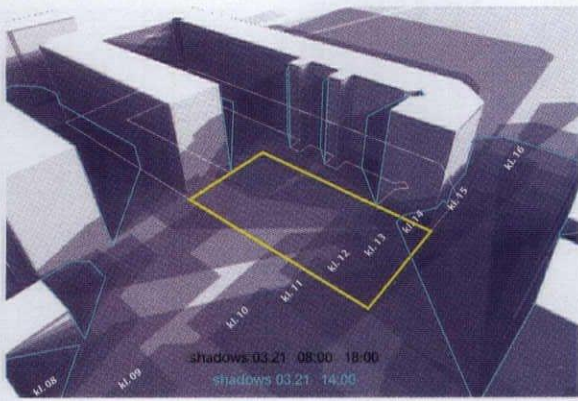

A NEW DAY-CARE CENTER IN COPENHAGEN, DENMARK, EXEMPLIFIES THE NOTION OF MAKING the most of what you are given given. Supplanting a narrow courtyard, on the site of a former mechanic's shop in a neighborhood of densely organized nineteenth-century housing the 835-square-meter (approximately 8,987 square feet) facility owes its form and sensibility to the architect's interpretation of strict conditions governing both the neighborhood and the building's unique program.

Setback regulations decreed a distance of five meters (approximately 16 feet) from existing structures on the north and east sides of the site. To satisfy fire codes, the façades facing those buildings could not have windows. In addition, institutional buildings in the district are relegated to one story and Danish law requires the outdoor space of its day-care centers (which are provided for every child over one year) to be equal to the square footage indoors. The client needed three separate nurseries with attending amenities such as a cloakroom, kitchen, diaper changing areas, and places for napping. And finally, in this region where winters are notoriously dark, the design had to make the most of the sun's path across this confined area without casting shadows on neighboring buildings.

"We cut out what we could," says Dorte Mandrup, whose eponymous firm is responsible for the innovative solution. "It quickly became clear that the outdoor space would need to be placed on the roof of the building." The architect and her colleagues provided a natural connection between indoors and out by creating a central ramp linking the spaces that constitutes a unique play area in itself. The 30-degree slope, clad in rubber, rises from outside a common room beyond the center's entrance, and is enhanced by the presence of weatherproof beanbags with removable shade umbrellas. The sun's passage there during the summer, from northeast to northwest, echoes the cut of the ramp's slope and offers the optimal exposure to the south and west.

Capitalizing on the amount and direction of daylight, as well as allowing for multiple functions within all spaces, helped to shape the structure's tightly programmed form and determine its materiality. The southern and western walls, made of etched glass, welcome as much light as possible, protect the children from the gaze of those outside and keep them from losing concentration while allowing views out. The etching marks appear like slender trees, a theme that is echoed in the area beneath the ramp, where an interior forest of concrete support-columns is broken by swings hanging from the ceiling overhead. The children play in this area during cold and wet weather.

In Denmark, public buildings must use low-energy light bulbs. Mandrup regrets that the illumination they provide is diffuse and without direction and that they convey only about 80 percent color accuracy. "We used color in the furnishings to get warmer light into the indoor spaces," she explains, outlining their method of compensation. Another thoughtful adjustment that saved space came in the way of designing the circulation as a centrally located common room, off of which the main activities may be easily reached.

Danish national code requirements gave rise to an open-air napping retreat tucked in the northeast corner, away from light and noise. During daily rest times the children are placed there in down sleeping bags. "We believe they sleep longer and awaken more rested after being outside," says Mandrup.

The courtyard's history as a car mechanic shop constituted a contaminated site. Following guidelines, Dorte Mandrup Arkitekter covered the ground plane with a net and topped it with concrete. The two planes forming the building's lower level and rooftop playground rise in opposing directions from that surface. Surrounding the outdoor ramp and rooftop and augmenting the rhythm of the frosted window bays are squares of a white, transparent polyester fabric that also provide screening while welcoming light. While the rooftop is outfitted with a barbecue, sand box, water zone, and tricycles, quieter, more focused play may occur in another small yard available to two of the nurseries and located on the western edge of the site at ground level.

Apart from providing a healthy atmosphere for the local children it shelters, the day-care center is a good neighbor: It contributes a refined

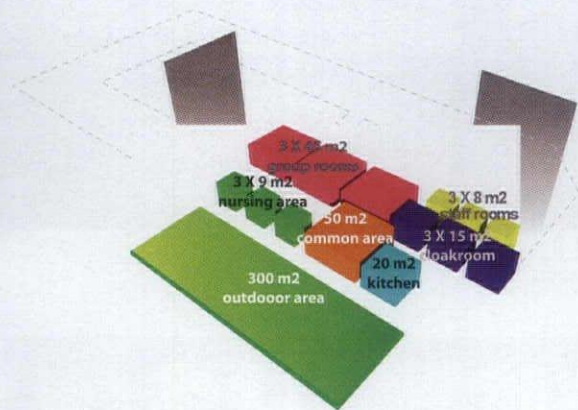
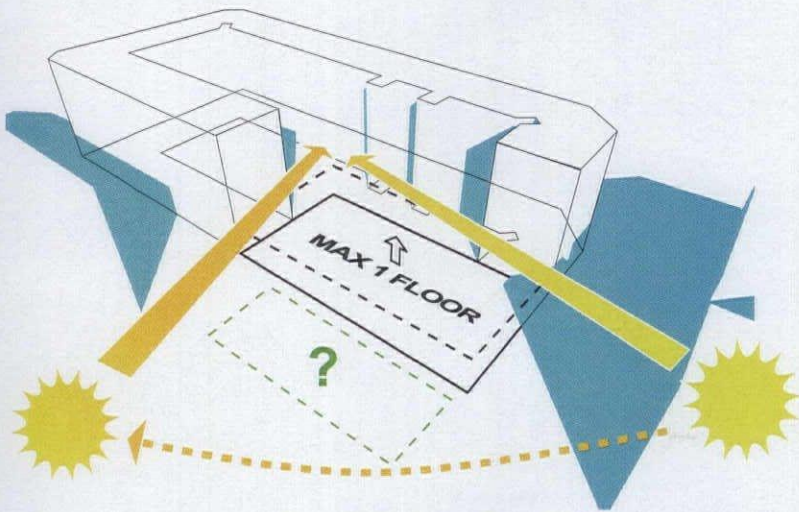

Copenhagen-based Dorte Mandrup Arkitekter wasted no space in their new day-care center, which accommodates local toddlers in a neighborhood of mostly nineteenth-century housing (facing page). Light and shadow were tracked and documented at the March equinox for a precise handle on the sun's orientation in relation to neighboring buildings (top). Daylight moves from south to west across the site, where zoning regulations required a one-story structure (center). The packed program, in which outdoor space needed to match indoor square footage, resulted in all activities being accessed off of a common room to eliminate hallway space normally assigned to circulation (above).

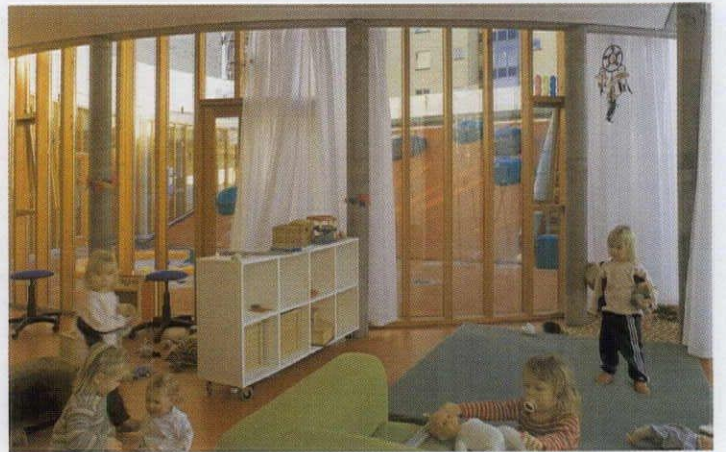
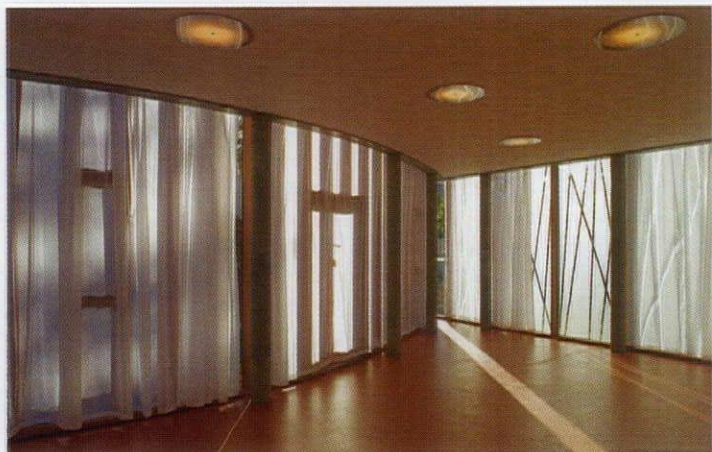

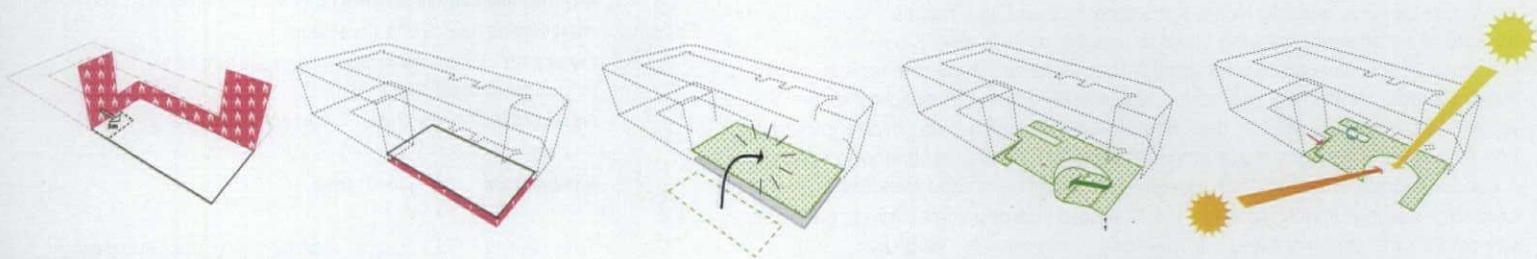

The one-story day-care center is a good neighbor to the surrounding buildings. Consisting of two planes—one for the ground floor areas and another for the roof play area—the building takes advantage of the site's sun orientation. Etched glass on the day-care center's western elevation echoes the screen of trees in the foreground (spread above). Children at play in a communal area that faces the outdoor ramp leading to the rooftop (facing page, left). Natural light grazes the floor in the nursery. Custom-designed ceiling fixtures provide a balance of electric light (facing page, far left). The architects referred to an extensive series of diagrams they created in preparation for making design decisions (above). Diagrams, left to right: Fire regulations required a five-meter setback from adjacent buildings; a new concrete surface was laid over a net to cover oil and dirt from the site's past as a mechanic's garage; outdoor areas on the roof receive maximum light over frequently dark winter days; a ramp provides a natural connection between the ground floor and roof, and links indoor to outdoor space; light, air, and setback regulations shaped the building and its surrounding surfaces.



As dusk falls, lights in the building's southwest corner cast a glow behind frosted glass; children play on swings in this area during inclement weather. The entrance to the facility is to the right, and is indicated by a door in the third bay of the clear glass section (above).

and unpretentious building to the settled district and also makes provision for the tenants of an adjacent housing block to use the rooftop after 5 p.m. each day. The presence of the day-care center amidst the hustle and flow of everyday adult life also provides comforting memories, especially when the building glows like a lantern in the waning light of day. Who doesn't remember the mysterious sensation of watching sunlight move across the floor of a favorite childhood space, like a sundial? Understanding that exposure to such elemental delights is the first order of meaningful architecture is the first step in producing buildings such as the day-care center that live on in our memories long after we've grown.

Julie Sinclair Eakin is Executive Editor of Cite: The Architecture and Design Review of Houston. Trained as an architect, she is the author of The Architecture of Beauty published in 2005 by Rockport Publishers.

DETAILS

PROJECT Day-care Center Skanderborggade, Copenhagen

CLIENT City of Copenhagen, Department of Labor & Family Affairs

ARCHITECT AND LIGHTING DESIGNER Dorte Mandrup Arkitekter, Copenhagen

PHOTOGRAPHER Jens Lindhe, Copenhagen

PROJECT SIZE 835 square meters (building and exterior play areas)
(approximately 8,987 square feet)

PROJECT COST \$7 million Danish Krone (approximately \$1.23 million)

MANUFACTURER

Thorn Lighting

APPLICATION

Custom-designed ceiling fixture in nursery

 more information at ARCHLIGHTING.COM

Coming Soon at Lightfair

hallmark

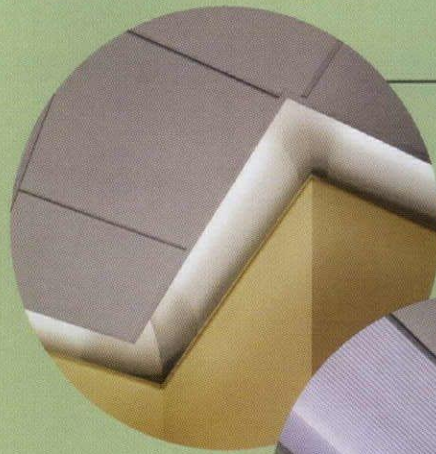

Perimeter Plus

on the mark

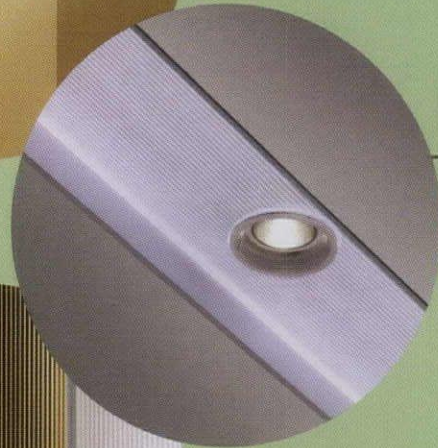

BiFocal MH

benchmark



Whisper 3d

marksman

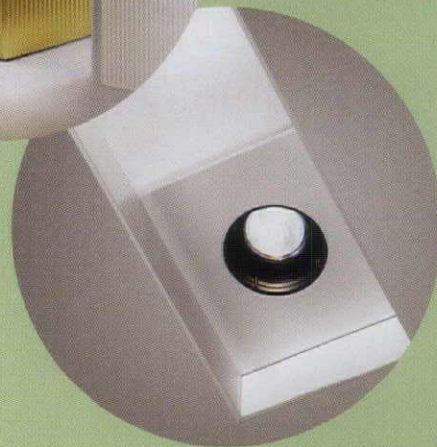

SLOT6 MH

marketmaker

Seems like people are always talking about us.

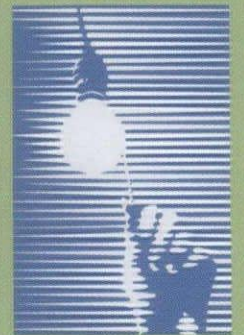

Remarkable.

mark architectural lighting

Circle no. 80 or www.archlighting.com/productinfo

3 Kilmer Road

Edison, N.J. 08818

732 985 2600 - P 732 985 8441 - F

www.marklighting.com

2007

LIGHTFAIR[®]

INTERNATIONAL

INTERNATIONAL

The future. Illuminated.

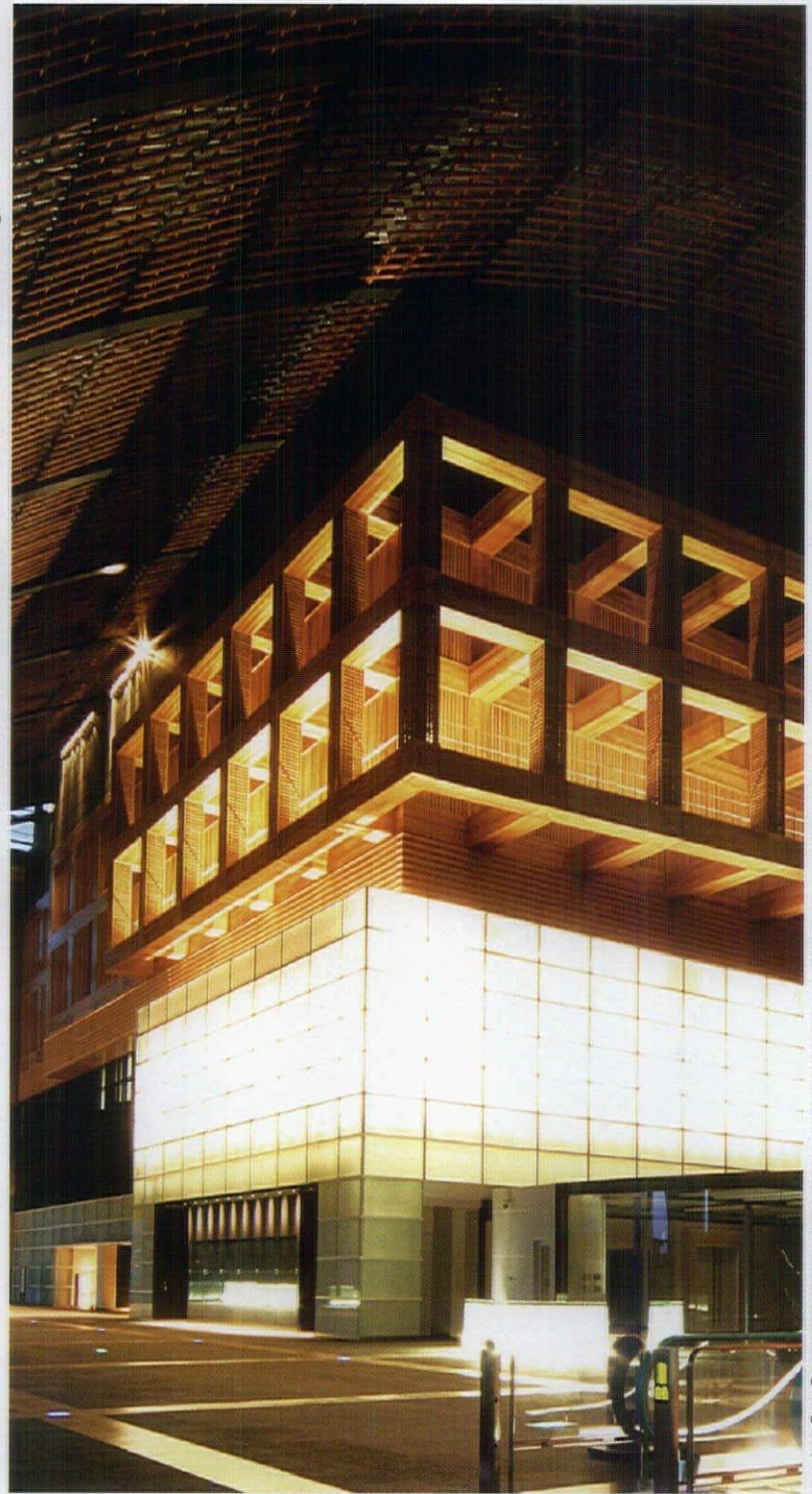

Lighting Design: Reiko Chikada Lighting Design Inc. Photography: Matsushita Electric Works, Ltd., Yamada Shomei Lighting Co., Ltd.

WATCH THE FUTURE SHINE

Join thousands of architects, designers, engineers and other industry colleagues for the lighting event of the year... **LIGHTFAIR INTERNATIONAL**. It's the future. Illuminated. Only here.

MAY 8-10, 2007
JAVITS CONVENTION CENTER, NY, NY USA
www.lightfair.com



Sponsored by
The Illuminating
Engineering Society
of North America

IALD

Sponsored by
The International
Association of
Lighting Designers



Produced &
Managed by
AMC, Inc.



Official On-Site
Event Directory

AGBAR TOWER AUDITORIUM, BARCELONA

CHALLENGE When asked to design a lighting scheme for the already-completed 316-seat auditorium in Barcelona's Agbar Tower, Martin Architectural's Spanish representative ECLER had to follow in some dauntingly large footsteps. French architect Jean Nouvel's 35-story tower, with its elliptic plan and domed top, resembles not so much a traditional skyscraper as a force of nature. In Nouvel's words, the tower is "a fluid mass that bursts through the ground like a geyser under permanent, calculated pressure." A fitting metaphor considering the building's primary tenant, the Agbar Group, is Barcelona's water company. The tower's skin continues this hydrological reference, featuring thousands of colored aluminum sheets and tinted glass louvers that create a shimmering range of coppery reds to cool blues, meant to resemble an iridescent film floating on water. At night these colors are picked up by a computer-controlled system of 4,500 RGB LEDs designed in collaboration with celebrated lighting artist Yann Kersalé. Nouvel expected the auditorium lighting to embody this same level of invention. ECLER project manager Antonio Tejerina explains, "The exterior illumination of the tower was revolutionary; and the auditorium had to be revolutionary in terms of what lighting can provide."

ARCHITECTURAL AND LIGHTING SOLUTION While the architects wanted to create a degree of correspondence between the exterior and auditorium lighting, such as maintaining the colorful effect, the concept behind each is quite distinct. "By day, the exterior lighting relates to the real colors of the façade," explains project manager Jean-Pierre Bouanha of Ateliers Jean Nouvel. "Meanwhile, the auditorium lighting had to permit the possibility of changing the

colors and the intensity of light depending on the function taking place in the auditorium, whether it's a lecture, meeting, or projection. The lighting had to be very flexible."

To provide versatility for a range of lighting needs and a diverse color palette, ECLER chose a system of fluorescent luminaires that employ RGB color mixing technology. Each fixture, in a slim housing, combines three, 28W T5 lamps controlled by a remote DMX dimming system. "By dimming each lamp differently you get the end color, a mix of colors, or any temperature of white, depending on the need of use," says Tejerina.

Nouvel also wanted the auditorium's lighting to fit seamlessly within the space and generate the desired effect without calling people's attention to the fixtures themselves. Since the auditorium was already finished when ECLER received the commission, the challenge was to find a discreet way to integrate their system within the defined envelope. In the end, ECLER and Nouvel located the luminaires—90 in all—in coves at the juncture of walls and ceiling, and walls and floor. From these positions, the fixtures wash the stainless-steel mesh walls—which act as reflectors—from above and below, radiating color and light throughout the auditorium.

The space features other light sources that were in place when ECLER began its work; downlights in the ceiling for general illumination and emergency purposes. But, Tejerina says, 80 percent of the time, once everyone using the auditorium is in and seated, their system provides all of the required ambient illumination, whether users are watching a film or taking notes at a lecture. With the right technology and application, lighting can break the boundary between decoration and service. **AARON SEWARD**

DETAILS

PROJECT | Agbar Tower Auditorium, Barcelona

DESIGN TEAM | Ateliers Jean Nouvel, Paris with b720 Arquitectos, Barcelona (architects); ECLER, Barcelona (lighting consultant)

PROJECT SIZE | 550,000 square feet (building)

PHOTOGRAPHER | Allan Toft, Aarhus, Denmark

MANUFACTURER | Martin Architectural

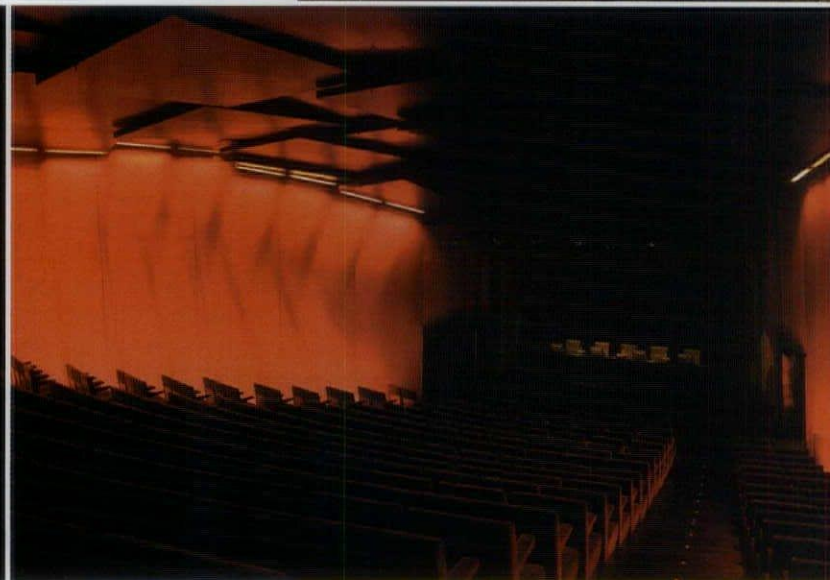
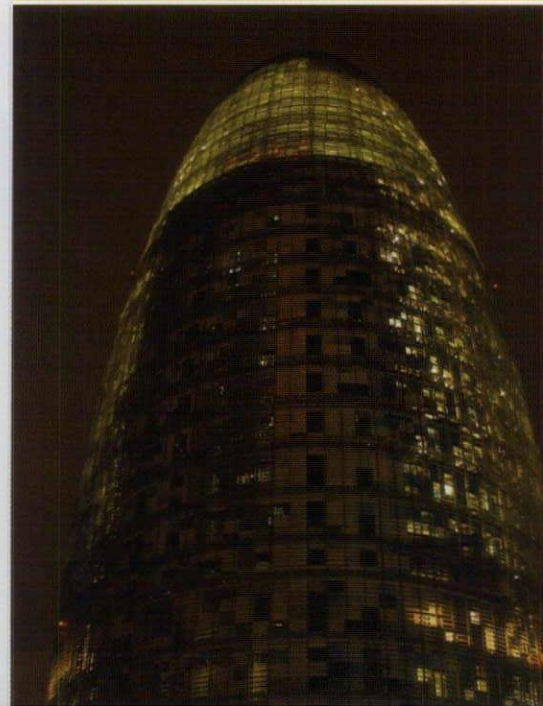

BILLY WILDER THEATER, LOS ANGELES

DETAILS

PROJECT | Billy Wilder Theater at the Hammer Museum, UCLA, Los Angeles

DESIGN TEAM | Michael Maltzan Architecture, Los Angeles (architect); Lam Partners, Cambridge, Massachusetts (lighting designers)

PHOTOGRAPHER | Wil Carson, Michael Maltzan Architecture, Los Angeles

PROJECT SIZE | 11,500 square feet

PROJECT COST | \$7.5 million

WATTS | 2.7 watts per square foot

MANUFACTURERS | Cole, Columbia, Delray, Edison Price, Focal Point, GE, iLight, Kurt Versen, Ledalite, Lighting Service Inc, Litecontrol, Lithonia, Nippo, Osram Sylvania, Prudential, Robe, Selux

CHALLENGE Situated on the corner of Wilshire and Westwood Boulevards, the Hammer Museum has always functioned as a gateway between the city of Los Angeles and the UCLA campus. But for years this threshold remained unfinished as the completion of the museum's master plan was delayed due to budgetary shortfalls. After a generous \$5 million gift from Audrey Wilder, wife of the late film director and writer Billy Wilder, for whom the theater is named, the museum was able to hire Michael Maltzan Architecture and Cambridge, Massachusetts-based lighting design firm Lam Partners to create the new 295-seat theater—a screening room capable of projecting everything in the university's extensive film and television archive, from the earliest nitrate films to the latest in digital video.

courtyard by inserting full-height glass walls at both entrances of the long, narrow lobby. Similar glass walls separate the lobby from the screening room, tying the city, museum, and theater together in a series of unbroken sight lines.

To induce the excitement and anticipation of a movie-going experience without falling into movie house clichés, the designers used lines of light as a metaphor for film. "Cinema is painting with light—light passing through film," explains Lam Partners principal Paul Zaferiou. "Our challenge was how to give this physical form." This idea begins in the lobby, which features a 50-foot-long mural of images from Wilder's *Sunset Boulevard*, where the designers placed 31W linear T6 fluorescent lamps in a uniform pattern across the ceiling. The fixtures, which light seamlessly from end-to-end, are recessed just enough to leave the curve of the bulbs exposed, like rungs in a ladder of light.

The theme continues in the dark volume of the theater, where a randomized pattern of white 3500K linear LED strips hang from the ceiling and walls. To maintain the light strips' thin profile and give the impression that they are floating in space, the fixtures are wired to remote transformers, concealed above and behind accessible ceiling and wall panels. The effect resembles the beginning of a jump to warp speed, which is right in line with the designers' intentions. "You come in through the length of the lobby, moving from a regular pattern to one that begins to accelerate in space," says Maltzan.

This sense of movement is reinforced by the lighting scheme's dimming system. As a movie is about to start, the LED strips, which are wired to 12 dimmers, dramatically fade from front to back of the auditorium space, transitioning the audience to what is about to take place on screen. "It's as though the light is being pulled back into the projector," says Zaferiou. The reverse effect occurs at the end of the movie. The dimming system also helps the theater adapt to different uses, such as lectures and musical performances. Lam Partners programmed 16 presets to meet any of the space's functional needs. The lobby itself has four presets, which adjust to different times of day, and communicates when a screening is in progress by dimming down to a minimal amount of light.

As in the best examples of architecture, the Billy Wilder Theater proves that lighting can be expressive and functional at the same time. Starting with a closed and unapparent building, the designers used lighting to create transparency and a sense of motion that act as a form of architectural signage, attracting visitors. The project's patterned lines of light may reference film, but their net effect is greater than a metaphor: They help to mend a piece of the urban fabric linking the city, the museum, and the UCLA campus. **AARON SEWARD**



 more information at ARCHLIGHTING.COM

Aside from transforming a blank concrete shell into one of the world's most sophisticated cinemathèques, the architects were asked to design a distinct destination within the museum that also functions as a link in the larger narrative between city and campus. Since the technological components of the projection booth gobbled up a large portion of the budget, the challenge was to create a strong space with minimal financial resources.

ARCHITECTURAL AND LIGHTING SOLUTION Lighting became the answer. "From the beginning," says Michael Maltzan, "we looked at light and pattern of light as one of the ways to create an iconography in the building and help to direct people coming to the museum." As a first step, the designers opened the building to views from the street and museum's



A glass wall allows a preview into the auditorium from the lobby corridor. The reflection of the luminaires in the glass speaks to the project's design parti—*lines of light* (facing page). A fluorescent cove defines the top edge of the lobby box office (above left). Linear T6 fluorescent lamps are placed uniformly across the lobby corridor ceiling (above right). The ordered pattern of light gives way to a dynamic arrangement of white 3500K linear LED strips in the 295-seat theater (below).



LIGHTING ASSEMBLIES

**FC LIGHTING | FCWSX8050 SURFACE-MOUNT LIGHT | FCLIGHTING.COM**

Built tough, this surface-mount light has been exclusively designed for high-abuse applications such as schools, health care facilities, and high-security zones. Good for exterior or interior use, the 12-inch-diameter, 4-inch-deep marine-grade aluminum fixture is available with fluorescent, incandescent, and LED lamps. The luminaire is ADA compliant, UL-listed for wet locations, and IP-rated against moisture and dust. **CIRCLE 125**

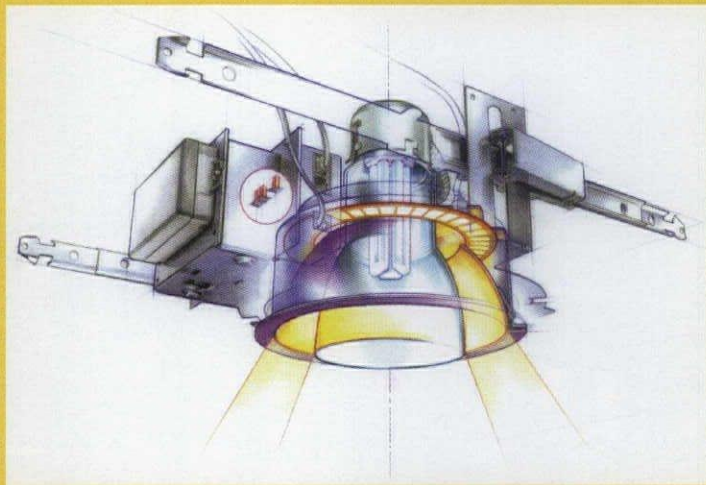
**GOTHAM ARCHITECTURAL DOWNLIGHTING | CANDÉO LED | GOTHAMLIGHTING.COM**

This recessed downlight combines a compact fluorescent source that provides general illumination with color-changing LEDs that add a decorative touch, all within a single dual reflector luminaire. Each source can be controlled separately, allowing it either to be turned on or off. The fluorescent lamp can be dimmed, when equipped with a ballast. **CIRCLE 126**

**PRESCOLITE | SIGNOS M | PRESCOLITE.COM**

Part of Prescolite's ArchiTrak family of architectural tracklighting, Signos M has a sleek contemporary design with die-cast aluminum construction. A modular variety of shades and optical reflectors are available, including a 10-degree spot, 25-degree medium, and 40-degree flood. The fixtures feature 180-degree horizontal and vertical aiming adjustment without tools, can take six metal halide lamp types, and is offered in three finishes: Zet (metallic silver), black, and white. **CIRCLE 127**

TIMES SQUARE LIGHTING | RECESSED LIGHTING | TSLIGHT.COM

Available in up to four lamp configurations and offered in linear, square, and L-shaped configurations, Times Square Lighting's five new lines of recessed fixtures—low-voltage MR16, metal halide MR16, metal halide PAR30, metal halide T6, and low-voltage AR111—feature adjustable lamp housings that allow for full-frontal access for easy re-lamping and tool-free accessory changes. They can accept a wide range of lenses and filters, and can be installed with or without trims. **CIRCLE 128**

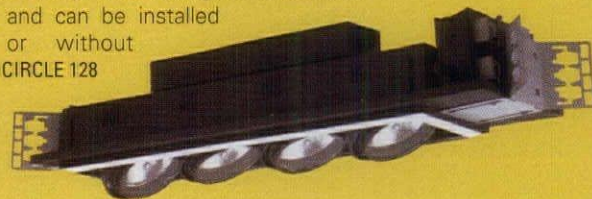
**UNIVERSAL LIGHTING TECHNOLOGIES | UNIVERSALBALLAST.COM**

BALLASTAR T5 Designed to replace traditional magnetic T12 high output ballasts in existing or new fixtures, according to the manufacturer, the latest addition to its Basic-12 electronic ballast family is capable of reducing energy consumption by more than 10 percent. With universal input voltage (120 to 277 volts), the Basic-12 operates with F96, F48, F60, and F72 lamps. **CIRCLE 129**

T12HO ELECTRONIC BALLAST For use with F28 T5 lamps, according to the manufacturer, the new Ballastar T5 ballast is the most efficient T5 light-level moderator available today—eight percent more efficient than standard T5 ballasts. A single control lead allows users to switch from full light output down to 50 percent power level with a standard wall switch or lighting relay, making it easier to implement new energy code requirements without special equipment. **CIRCLE 130**



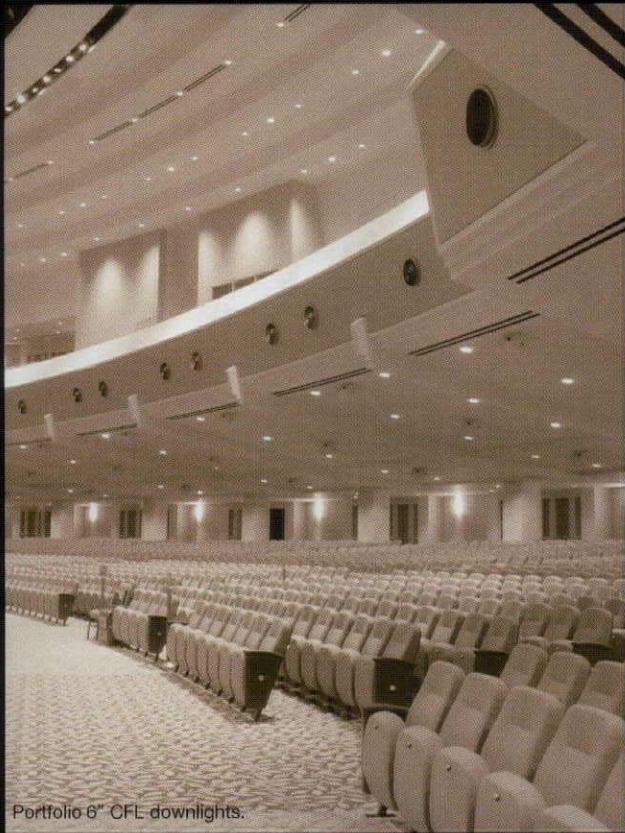
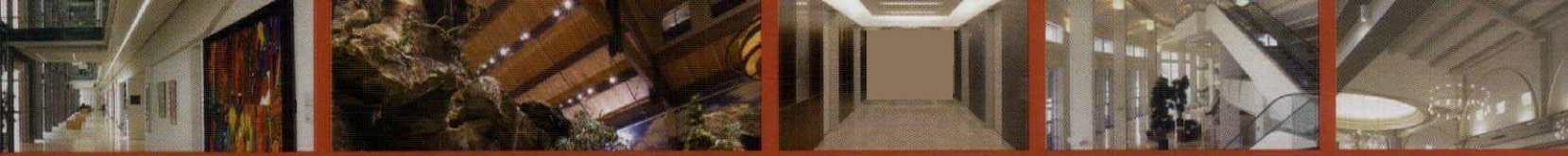

Portfolio 6" CFL downlights.

COOPER Lighting

cooperlighting.com

Cooper Lighting provides versatile and distinctive architectural lighting solutions that enrich any environment.

Inquire about the industry's most trend-setting architectural products.

Come see for yourself!
Visit us at Lightfair 2007, Booth 2209.



Portfolio™ C6042

Medium and wide beam distribution from a single vertically mounted compact fluorescent lamp. Adjustable socket position maintains focus for varied reflector types.



Lumiere® Rio

Rio Architectural Step Light Series provides beauty, performance and durability featuring transitional styling, low profile design and no visible fasteners.

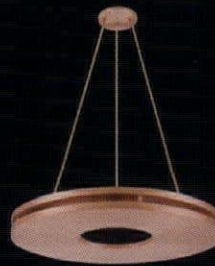

Shaper™ 1200

Direct/Indirect or Indirect High Performance Pendant features solid, open or frosted glass center design and is available in three diameters.



Sure-lites® AEL

The Architectural Emergency Light is designed to provide superior illumination while blending into the surrounding space. The AEL is available in four finishes: Silver, Black, Bronze and White.



Circle no. 25 or www.archlighting.com/productinfo



WHERE ECOLOGY MEETS TECHNOLOGY

MAY 15-17, 2007
ANAHEIM CONVENTION CENTER

**Two great
events in one!**

**ecobuild
america**

Sustainable, Green and High-Performance
Solutions for the Built Environment

WWW.ECOBUILDAMERICA.COM



Science & Technology for Architecture,
Engineering & Construction

WWW.AECST.COM

The **Premier Conference and Exhibition**
for Green Building, Sustainable Design,
Renewable Energy, Environmental Planning,
Building Information Modeling, and Construction
Technology.

Featuring the National BIM Conference

Held in Cooperation with: Endorsed by:

Media Sponsor:

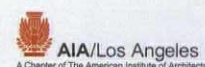

hanley wood
Magazines

ARCHITECT Remodeling architect

AL

Register online today

For exhibiting, advertising, or sponsorships, please call 1.800.966.2862

IT'S GOOD TO **LOOK AHEAD**

THE FIRST ANNUAL **R+D SUMMIT**

**R+D SUMMIT
AT SCI-ARC
OCTOBER 4-5, 2007
LOS ANGELES**

THE INAUGURAL R+D SUMMIT WILL BE AN INFORMATIVE, INNOVATIVE, AND THOUGHT-PROVOKING LOOK INTO THE WORLD OF ARCHITECTURAL TECHNOLOGY. ARCHITECTS, ENGINEERS, AND ACADEMICS WILL GATHER FOR THIS EXCLUSIVE TWO-DAY EVENT, HELD IN CONJUNCTION WITH AND ON THE CAMPUS OF THE SOUTHERN CALIFORNIA INSTITUTE OF ARCHITECTURE. THE R+D SUMMIT AGENDA WILL BE STRONGLY TIED TO TECHNOLOGICAL ADVANCES IN BUILDING MATERIALS, PRODUCTS AND SYSTEMS. THE EVENT'S WORKSHOPS WILL BE LED BY R+D AWARD WINNERS AND OTHER LEADERS IN THE FIELDS OF BUILDING TECHNOLOGY.

ABOUT SCI-ARC

SCI-Arc, an independent, degree-granting educational laboratory, tests the limits of architecture in order to transform existing conditions into the designs for the future. With its location in a quarter-mile-long former freight depot in the intensely urban Artist District in Downtown Los Angeles, SCI-Arc provides a uniquely inspiring environment in which to study Architecture.

ARCHITECT

FOR MORE INFORMATION EMAIL:

RDSUMMIT@HANLEYWOOD.COM

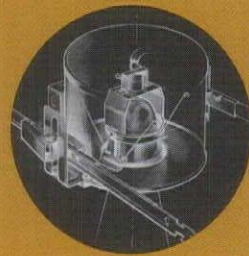
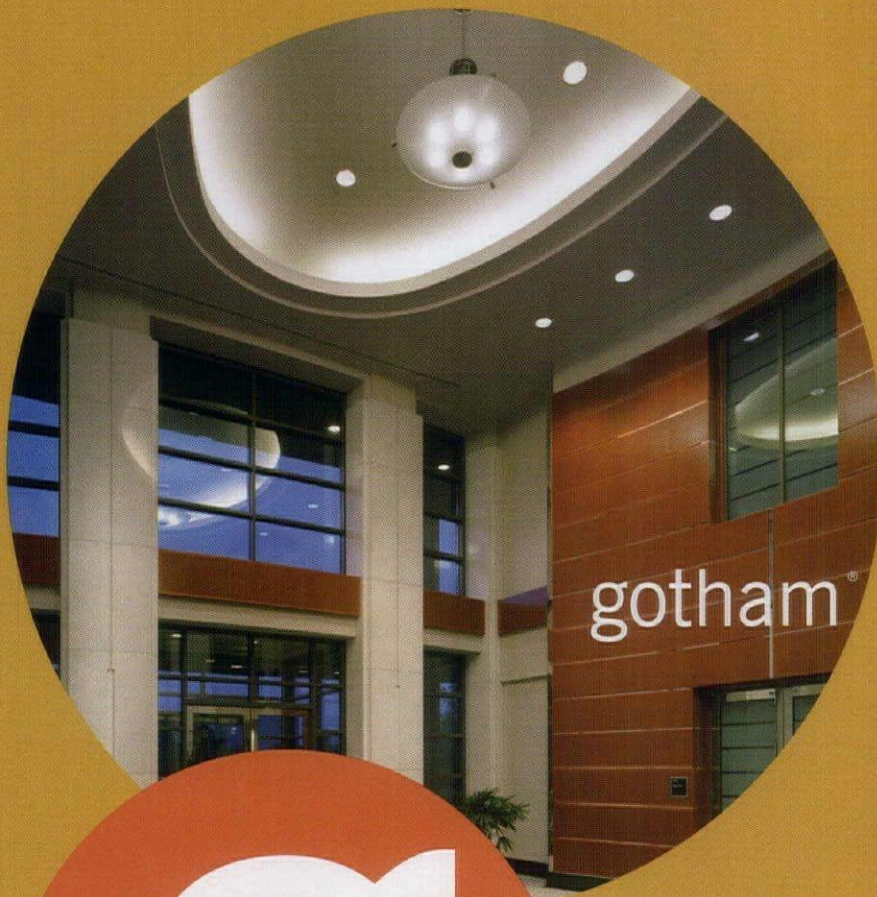

DOWNLIGHT

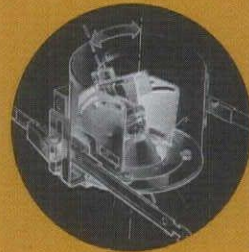

ACCENT

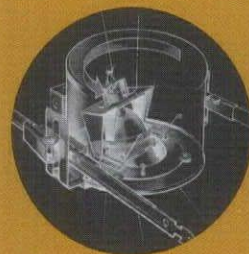

WALLWASH

t4/t6 luminaires

Realize ultimate performance and design latitude from a single lamp type.

The light is crisp and expressive, with excellent uniformity and color quality. The energy performance can't be matched. No wonder ceramic metal halide is becoming a source of choice for retail, commercial and institutional environments.

Gotham takes full advantage with the industry's most complete family of T4/T6 recessed downlights, accent and lensed wallwash luminaires, allowing you to satisfy an array of lighting applications using a single lamp type.

WWW.GOTHAMLIGHTING.COM

An **Acuity** Brands Company

Circle no. 33 or www.archlighting.com/productinfo

Maintaining a Lighting Design

BY MATTHEW TIRSCHWELL

STEPS FOR LONG-TERM SUCCESS ONCE THE PROJECT IS TURNED OVER TO THE CLIENT

PICTURE THIS SCENARIO: A HOMEOWNER OF A MAGNIFICENT apartment entrusts her residence to a new house manager. She shows him where the project manuals are located and wishes him good luck. The manager peruses the manual and finds some old construction documents to re-lamp a downlight in the living room. Light fixture "Type A" says recessed downlight. He sees that the light takes an MR16 lamp; he has heard of that before. He opens some drawers in the kitchen and finds one that is packed with a lot of lamps that were leftover from construction. With dusty fingers, from the construction-coated lamp box, he pulls out the trim, changes the lamp, and inserts it back in. Instantly the lighting design is ruined. Why? Well the lamp was not "Type A," but "Type M," and it called specifically for a GE: QMR16/C/NFL25-EXZ. What the house manager installed was a 50W MR16 flood made by a "no-name" company whose inferior product with a cheap reflector is turning the light green. And on top of that, when he installed the now fingerprint-laden trim, the light is no longer aimed on the Chagall masterpiece hanging on the wall, but on the floor.

Or something more common: walk down any high-end retail or mall environment and look at the fluorescent cove or display lighting. Chances are you will see a myriad of different colored lamps. How did something so simple as changing a light bulb, apparently become so difficult?

HOW TO BEGIN

Lighting design does not end with the project's completion. A look down the road shows the many pitfalls that can take a creative effort and transform it into a muddle of mediocrity. The key is providing the right information and the right training to allow long-term benefit. There are numerous factors involved in maintaining a lighting design, and several solutions to achieve success.

A few years ago, providing lighting design services to my high-end clients, I realized that only very careful attention *after* construction

was the way to ensure the design would last and continue to meet their expectations. In response to this need for maintaining designs, in 2004, within the constructs of my own lighting design practice, I created a separate division called Elu to maintain my projects as well as the work of other lighting designers and architects.

Lighting design maintenance is accomplished by preventative care, a thorough and complex database of every single luminaire (refrigerators included), documentation of the

make decisions that do not consider long-term maintainability. For example, designs that require two different beam spread lamps in the same multiple lamp fixture; projects designed with no less than 75 different lamp types; framing projectors placed 36 feet in the air over a staircase that takes three men half-a-day to erect scaffolding to change a light bulb; and so on. Designers do not think who will have to deal with these problems. If specifiers were required to maintain their projects, their design strategy would most certainly change.

OUTSIDE FACTORS

Lamp manufacturers are another factor in the equation of maintaining a lighting design. For example, in the 32W T8 fluorescent variety there are approximately 90 different lamps to choose from by the three major manufacturers and over 150—yes, you read that correctly—ONE HUNDRED FIFTY—different MR16 lamps to choose from with different beam spreads, wattages, IR capabilities, cover glass lenses, and overall reflector quality.

Additionally, a final focus may change all the lamps from one beam spread to another, or color temperature, depending on the artwork, finishes, or other special feature. Often, the originally specified lamps never make it onto the job

site. Some contractors will bring in construction lamps—cheap lamps just so the fixtures turn on—but never replace those lamps with the correctly specified ones.

Lamps are not instant gratification. Most specialty lamps have to be ordered with a one-week minimum lead-time before they arrive. Therefore, the lamp originally specified will be changed with one that is in stock a.k.a.—an "equivalent."

Even if the proper lamp does find its way to the project, there is still the issue of long-term care, as demonstrated in the apartment scenario mentioned at the start of this article. The project's continued health is delegated to someone who is not familiar with, or even trained in lighting. Office managers, stock clerks, bus boys, and

Maintaining a lighting design does not start when the project is complete. Rather, it starts with the initial design concept and implementation.

dimming system, and other associated elements. Through this exercise of maintaining projects, I have accumulated some key experience.

INITIAL ISSUES

Lighting maintenance begins with the specifier who is hired to create a beautiful space with light and create contract documents that support that vision. Construction documents consists of two key items: a lighting plan and lighting specifications along with the associated cut sheets and details. However, these two items do not benefit an owner who does not have the knowledge or the experience to review two different sets of documentation and locate the appropriate information.

We at Elu observed that specifiers often

house staff do not have the experience or the interest in maintaining lighting. Electricians are often brought in to service lighting and usually add their own take (and fingerprints) to the situation. As new personnel are hired, and the job is assigned to them, there is even less inclination

to maintain the lighting scheme and make sure it adheres to the original design intent. Yet, despite these difficulties, there are solutions that can be implemented during the initial project design to ensure a balance between design and ease of maintenance.

SOLUTIONS - INITIAL DESIGN

Good design requires planning. As the designer, you weigh different options daily. Here are some ideas to consider for the long haul.

- Not all lamps are created equal, especially when it comes to lamp life. If a lamp lasts 6,000 hours longer than its slightly higher-output cousin, consider what the advantages of two years more of use are before replacement is required.

- Dimmers and soft starts on incandescent lamps may extend lamp life.

- When designing a space within the auspices of a larger environment, contact the facilities manager for a list of lamps already in use.

- Re-think placing lighting fixtures in out-of-reach locations, such as over ramps, stairs, fixed furniture, and other uneven terrain. There may be another solution that in turn does not require specialized equipment to maintain it.

- Evaluate what type of abuse—environmental or man made—a fixture will receive, and consider options to prolong the fixture's life.

- Avoid specifying lamps that have the same base, or socket, that can perform quite differently. A PAR lamp with an Edison base may very quickly be substituted with a standard A-lamp. F28T5 lamps and F54T5HO lamps have the same dimension and base, so attempt to use only one-wattage on each project.

- Specify adjustable aiming fixtures that have locking capabilities.

- Do not design fixtures that you cannot access. One situation Elu has come across, in its experience, involves a wall-mounted fixture where a piece of glass was added to the wall detail, which then had to be broken in order to change the lamp.

- If you have a large quantity of fixtures that require transformers or ballasts, order additional gear in the event one fails. It will be faster and cheaper to replace gear already on site than to order one and have the electrician charge for twice the necessary service calls.

- There may be valid reasons to design an application requiring specialized and financially painful maintenance, but that issue must be placed before the owner so a calculated decision can be made.

POST CONSTRUCTION

Elu has developed a sophisticated system that

The best views aren't always outside the window.

Shape, color and installation ease come together in lighting systems so perfectly suited to setting the style, you won't want to look at anything else.

AMBIANCE
LIGHTING SYSTEMS

Sea Gull Lighting Products, LLC
A Generation Brands Company

www.SeaGullLighting.com

arrives at an overall concept: Flip the maintenance of these systems to a lighting designer's point of view and ask: What was the design intent, and how can it be maintained? The system is designed so that a layperson can handle day-to-day events, but outside personnel on a regular schedule can confirm that the lighting system is being followed and operating properly.

In addition, a second set of documents needs to be created—paperwork that represents the final installation, and the means to maintain it. Remember, what the end-user needs is less technical and more straight forward.

Reference documentation should include the following:

- A list of rooms, where the fixtures are located.
- A picture of the fixture in the space so it can be visually identified.
- The lamp manufacturer and model number.
- A list of all the lamps on the project. A constantly replenished stock of lamps in an appropriate storage device is also a good idea, and where to order replacement lamps.
- Information on how to handle and change the lamp, clean the reflectors, aim the light, etc.
- Any information about how the light is controlled.

The documentation also needs to include information about centralized control, daylight or occupancy sensors, or if there is a building management system or load shedding equipment controlling the light. Lastly, personnel on site must be appropriately trained. When a new person is brought on, they must be familiarized with the lighting maintenance procedures and trained on the system.

CONCLUSION

Lighting maintenance is a lot like a well-manicured lawn: it needs constant care and attention, for without it, it quickly becomes overgrown and inundated with weeds and dandelions. Analyze all that will need to be implemented to maintain the design, and make decisions that will help to ensure long-term appreciation of your design effort. In particular the specifier should consider the cost of implementing such a system or provide a specification that requires this documentation to be produced. Every single project needs this information. Anticipate the need and create information to help the end-user.

Matthew Tirschwell has been designing theatrical and architectural lighting systems for sixteen years. He has a Bachelor's degree of Fine Art in Theatrical Design from Ithaca College, and a Master's degree in Architectural Lighting Design from Parsons The New School for Design.

Tirschwell and Company, incorporated in 1999, designs lighting for high-end residential, retail, corporate, restaurant, and hospitality environments. In 2004 he started Elu, a lighting maintenance division for the absolute pinnacle high-profile clients.

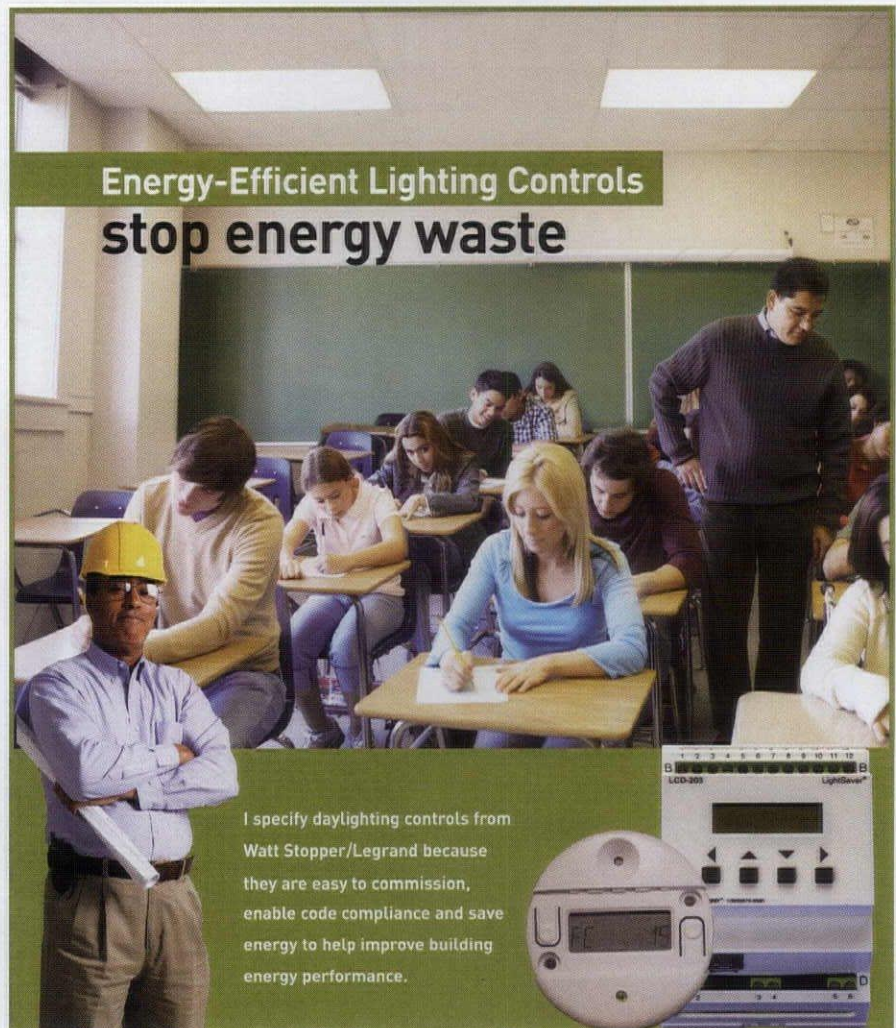

**Energy-Efficient Lighting Controls
stop energy waste**

I specify daylighting controls from Watt Stopper/Legrand because they are easy to commission, enable code compliance and save energy to help improve building energy performance.

Our daylighting control system, based on advanced technology photosensors, can improve a building's energy performance well above prerequisite standards and will reduce its environmental impact regarding energy usage.

- Single or multi-zone control
- Stand alone or networked control
- Low-profile design that blends into building decor
- More choice from the brand professionals trust

Get information on our new LS-101 simplified ON/OFF daylighting controller and a complete product selection guide.
800.879.8585 | www.wattstopper.com/psg

Complete lighting control solutions for every building.
Occupancy and Vacancy Controls | Daylighting Controls | Lighting Control Panels | Wireless RF Lighting Controls

 **Watt Stopper**

 more information at ARCHLIGHTING.COM

■ PUTTING A STOP TO ENERGY WASTE®



 **legrand**



**LIGHTCongress wishes to thank
the attendees of the 2007 symposium
for a truly illuminating experience.**

LIGHTCongress® 2007

www.lightcongress.com



The Color White

BY JAMES R. BENYA

ARTISTIC AND SPECIAL EFFECTS LIGHTING ASIDE, ALMOST ALL architectural lighting uses white light. Until only very recently, however, the designer has been forced to choose a particular color temperature. With fluorescent lamps, the light color can be varied by the particular phosphors to create just about any desired hue, ranging from incandescent-matching 2700K to icy blue-white 7500K and higher. The most popular choice currently seems to be 3500K, as it strikes a comfortable balance between warmth and daylight.

But in the last 20 years, there has been a new wave of research in vision, photobiology, and human factors. The results clearly indicate that human health, visual preference, visual acuity, and visual task performance can be affected by certain qualities of light. Combined with the latest lamp technology, some of these findings might affect designers' choice of white in a major way.

BASIC PRINCIPLES OF THE LIGHT COLOR SPECTRUM

The international standard for describing the color of light is the 1931 CIE Chromaticity Chart. The apparent color of light can be plotted using X and Y coordinates, with the area in the center of the chart being white and the areas surrounding being the various colors of the rainbow.

The black body locus (curve in the middle) describes the color of light emitted by a theoretical non-oxidizing object as it is heated. The temperature of the object is measured on the Kelvin scale. When heated to about 1000 degrees Kelvin (K) the object will radiate a dull reddish light. As the temperature increases (counter clockwise motion) the color of the object's light becomes warmish white, then coolish white before becoming blue above 10,000K. It's tempting to refer to the black body's white light as "perfect." Among practical light sources, there are only two that emit white light in a manner closely resembling the black body, the sun and the incandescent lamp (until the filament melts). Dim an incandescent lamp and watch the color temperature vary.

Compared to the black body, almost all other white light sources, especially modern light sources like fluorescent, LED, and HID lamps, are not perfect. Nonetheless, we can describe their color by the point on the black body locus to which the color of the real source is most closely matched, called the *correlated color temperature* (CCT). The problem with this system is that a practical light source, such as a fluorescent lamp, is often far different from the color rendering qualities of the black body's light. In order to help judge the quality of the light source, a sys-

tem called *color rendering index* (CRI), is employed. It is a 0-100 scale in which 100 means, effectively, color rendering equal to that of the light of the black body. CRI is not a perfect system, but it is generally a very useful indicator of practical color quality. As a general rule, light sources less than 50 CRI render colors poorly and should not be used when color discrimination is important. Because of their abundance and low cost, most architectural light sources today should have CRI of at least 80.

COLOR TEMPERATURE AND HUMAN PREFERENCE

In 1941, the fluorescent lamp was newly invented, and the color of white to be manufactured was an open question. A. A. Kruithof, a scientist working for Philips, performed informal studies and created Kruithof's Curve, a graph suggesting color temperature preference as a function of light level. Because of the informal nature of his study, most lighting experts do not take this curve too seriously, but intuitively it often tends to match our experience. For example, there appears to be a preference for warmer light sources in colder climates, and vice versa. Likewise, many individuals prefer higher color temperature sources by day, and lower CCT sources by night, similar to Kruithof's findings.

One explanation for this kind of innate human response to seek complementary color temperatures pairings can be derived from nature. Because the color temperature of daylight varies between 1800K (rising and setting sun) and 5500K-plus (noonday sun and sky), these preferences may in part be due to solar or circadian cycles. There is also the suggestion that very warm sources are reminiscent of the fire used for light at night.

But these explanations are not perfect; history and culture sometimes work to the contrary. In several Asian societies, high CCT lamps seem to be preferred indoors at night in restaurants, homes, and stores, differing both from Kruithof's Curve and natural light cycles. Nonetheless, for those of us designing for western society and taste, the ideal lighting system would most likely be cool by day and warm by night.

COLOR TEMPERATURE AND VISION

From the 1960's to around 1990, an unexplained phenomenon called "visual clarity" was a common discussion topic among lighting practitioners. When viewed under the light of high CCT, high CRI lamps, many tasks appeared easier to see, yet the cause could not be explained by the vision scientists of the era. Starting in the late

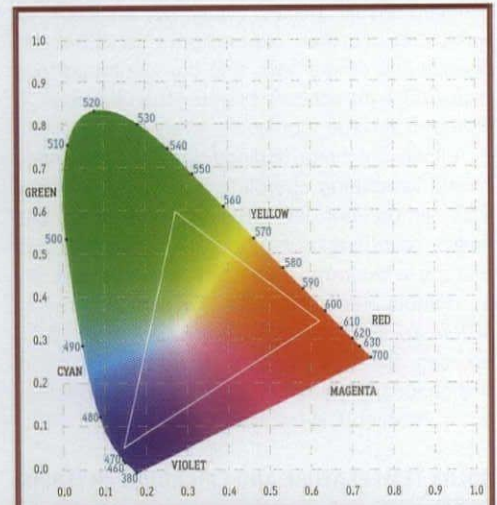

A representation of the 1931 CIE Chromaticity Chart (above). Gradation of color is approximate.

DAYLIGHTING COLOR IS NOT PERFECT

From Beaux Arts artists to modern day color experts, critical evaluations of color have always been made under natural daylight. Often neglecting daylight's wide color temperature range, people generally consider it to be the definitive reference color of light. So it might come as some surprise that daylighting can not be counted on for these qualities.

The culprit, of course, is modern building glass. We all know that ordinary plate glass can cast a greenish tint, but that is only the beginning. Considering the many various tints of glass is only part of the clue. The real hidden culprit is modern Low-E glass. In order to reduce infrared heat transmission, red light is reduced too, and transmitted light can turn greenish-blue. It's not uncommon for the glazing system to reduce the CRI of "daylight" to less than 80.

It's possible to predict the resulting color rendering of just about any glazing system using Window software. Free from Lawrence Berkeley National Laboratory, and designed to assist architects in assessing the qualities of composite glazing systems, Window also calculates the CRI of the resulting daylight. Window takes a little work to be able to use on a regular basis, but it an indispensable tool with at least one very useful feature that a lighting designer could really use.

1980's, important new work by Dr. Sam Berman and his colleagues at Lawrence Berkeley National Laboratory finally provided an explanation. An abundance of shorter wavelength blue light causes the pupil of the human eye to contract, and through increased depth of field and reduced visual noise, visual performance is enhanced. Further experiments by Berman, Navaab and others have also demonstrated that high CCT light appears brighter than lower CCT light at the same footcandle levels.

Based on these findings, large-scale experiments retrofitting complete buildings with high CCT lamps, but lower-than-normal footcandle levels, have been conducted by Pacific Gas and Electric with some success. Whether this is an acceptable practice is still being debated among vision scientists. However, use of high CCT sources for task lighting is probably a good design idea, especially when detailed inspection or intricate work is involved.

COLOR TEMPERATURE AND CIRCADIAN RHYTHMS

The human's daily cycle of waking and sleeping, called the circadian rhythm, is triggered by blue

light. At the start of each day, exposure to daylight re-sets the body clock and causes the levels of melatonin in the bloodstream to fall. About 12 hours later, as night descends, the melatonin levels will naturally begin to rise, and the human will become sleepy.

For most people, awakening in the morning and exposure to natural light is all that is needed to maintain a healthy cycle. But under some conditions, such as persons living underground or suffering from Seasonal Affective Disorder, artificial stimulus may be necessary. A regimen of light exposure including specific requirements for the duration, intensity, and cycle of light has been used to successfully address these conditions. Almost any high CCT fluorescent lamp can be used to simulate daylight's effect; special "circadian" lamps can provide enhanced benefits for less energy and lower light levels. In Europe, Osram and Philips both sell high CCT fluorescent lamps specifically for this use, and manufacturers are even investigating the use of blue LED lamps in special fixtures and apparel. Imagine wearing a blue light cap to treat your winter depression.

An equally important aspect of circadian rhythm is dark nights. When exposed to light containing blue, even through a closed eyelid, the human's melatonin level drops and sleep is affected. In other words, blue-poor low CCT lamps at night may be just as important in maintaining a healthy human cycle. Dimmed incandescent and candlelight are just about perfect for this desired effect. For night lights, consider red or amber LEDs, as they won't cause you to wake up.

From this information, a designer might be tempted to design specifically to address circadian rhythms to the point of promising better health. As a general rule, there is no scientific evidence to support the use of high CCT lamps in normal applications, as indoor light levels are too low and occur too late in the waking cycle. Moreover, circadian phase shifting and the treatment of sleep disorders require light level treatment that generally can not be provided by building lighting systems, and if undertaken, should be overseen by a physician.

COLOR TEMPERATURE AND DAYLIGHTING

For all practical purposes, daylight is a high CCT,

When a hole in your ceiling is *a good thing.*

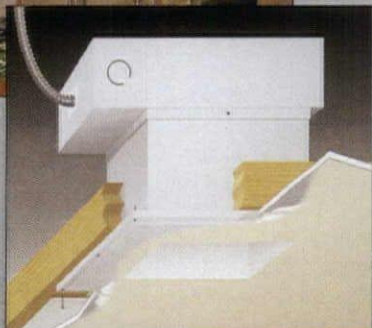
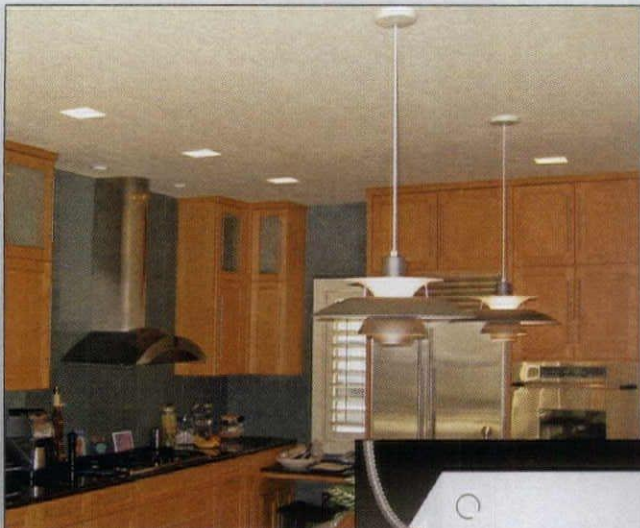

Our "Hole in the Ceiling" fixtures are plaster/fiberglass castings. Once installed, they appear to be a custom built drywall "light niche." They illuminate your space without calling attention to themselves.

Call us for more information at **626.579.0943** or visit our website today at www.elplighting.com

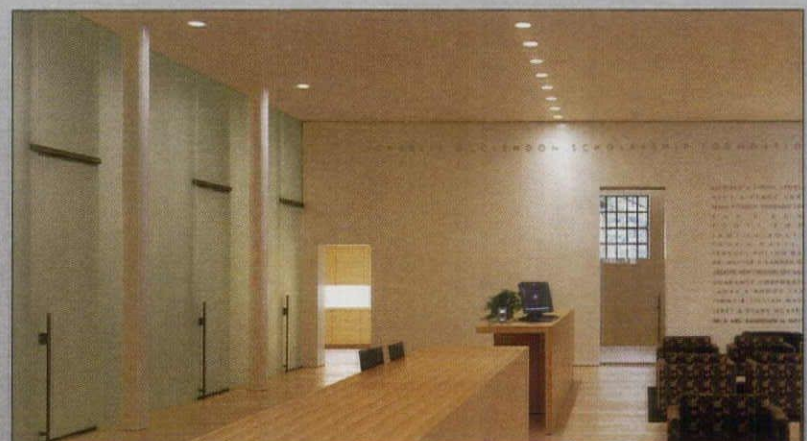

ENGINEERED LIGHTING PRODUCTS



high CRI light source. Those who think daylight is 100 CRI are mistaken; when filtered by almost any window glass, the color quality of the light is altered and CRI can vary considerably. But overall, the CCT remains high.

One principal daylighting scheme involves dimming electric lights in response to daylight. Making the electric light color match daylight more closely is a design concept worth considering. Even if the maximum color temperature of the lamp is only 5000K, the similarity will be appealing.

WHAT IF....

Two technological advances may provide interesting dimensions. Rather than be stuck with the inherent color qualities of the light source, what if its color temperature could be varied? This exciting concept, once only a dream to lighting designers, is becoming a reality. The obvious candidate to create this effect is LED lighting, but being a bit more practical, it can also be accomplished using fluorescent lamps, or perhaps a hybrid of the two.

Those following LED developments will note that there are two possible ways of providing color temperature variation:

1. RGB mixing, in which at least three prime colors of light are blended to produce a visible "white" light. Using slightly different amounts of R, B, and G, different color temperatures are produced. Recently, some 7-color systems have been designed to provide better color saturation and white quality.

2. Mixing high and low CCT white LEDs in the same system, or a unique combination of white LEDs and specific color LEDs to warm or cool the light.

The biggest problem with LEDs is color quality. There are very few LED systems, including RGB that can produce high quality white light at less than 3000K. Moreover, with the current efficacy of LED systems being quite a bit less than 50 mean lumens per watt, color changing using LEDs is probably too inefficient and costly for everyday lighting.

On the other hand, fluorescent lamps can be placed in the same luminaire to create a color mixing scheme, too. In this case, two high CRI lamps, one with low CCT and one with high CCT, can be individually dimmed to produce white light with variable CCT. Such an approach is simple, relative-

ly cost effective, and uses modern, state of the art fluorescent technology. Other blending approaches, like a combination of a warm-toned white lamp with a totally blue lamp are also possible.

With these intriguing technologies in mind, one might wonder if a color temperature variable lighting system is worth the hassle. After all, the daily cycle of color is perfectly natural, and it might help make buildings even more livable and beneficial for the human occupants. But for the time being, the only arguments in support are the potential for enhanced visibility by day and better natural rhythms at night. But since we seldom awaken, work, relax, and sleep in the same space, perhaps this theory's biggest uses will be in the design of submarines, mines, health care facilities, and other environments in which a person's natural cycle can't be maintained by the normal cycles of daylight. For office buildings, factories, schools, and other places where we spend only the waking hours of our lives, a color temperature dial might be interesting, but probably not essential.

 more information at ARCHLIGHTING.COM

*Sometimes the very best lighting
is the lighting you don't see!*

32 fiber optic spotlights in one freestanding 2" bannister!

*Adjustable focus, cross-room throws, 100 CRI, no UV and no IR... only from **NoUVIR Research.***

Call (302) 628-9933 for a free 130 page catalog of totally cool fiber optic lighting (or visit www.nouvir.com).



A|L LIGHT & ARCHITECTURE design awards 4

ENTRY DEADLINE May 24, 2007 POSTMARKED LATE ENTRY **June 1, 2007** (\$25 FEE PER ENTRY)

Architectural Lighting magazine announces the Fourth Annual A|L Light & Architecture Design Awards honoring outstanding and innovative projects in the field of architectural lighting design. The A|L Design Awards recognize and reward excellent lighting within criteria relevant to individual categories. To acknowledge issues of notable importance in today's practice of lighting design, and design techniques particular to lighting, A|L will also present the A|L Virtuous Achievement Awards (ALVA), which recognize projects that achieve the Best Use of Color; the Best Incorporation of Daylight; and the Best Lighting Design on a Budget. All winning projects will be published in the July/August 2007 issue of A|L and be featured on archlighting.com.

Questions?

Contact: Elizabeth Donoff, Editor edonoff@hanleywood.com

COMPLETE SIX-PAGE FORM IS AVAILABLE FOR DOWNLOAD AT WWW.ARCHLIGHTING.COM

PLEASE COMPLETE ONE ENTRY FORM PER SUBMITTING FIRM.

1 ENTRANT		FIRM	
CONTACT NAME (PERSON SUBMITTING THE ENTRY)			
ADDRESS		CITY	
STATE	ZIP/POSTAL CODE	COUNTRY	
TELEPHONE	E-MAIL		

2 PAYMENT	
FEE \$130 (FIRST ENTRY)	
\$95 (EACH SUBSEQUENT ENTRY) X _____ =	
\$95 (EACH ALVA ENTRY) X _____ =	
LATE FEE \$25 X _____ = (FOR EACH PROJECT ENTRY POSTMARKED AFTER 05/24/2007)	
TOTAL	

MAKE CHECKS PAYABLE TO ARCHITECTURAL LIGHTING
EACH SUBMISSION MUST BE ACCOMPANIED BY A CHECK COVERING THE ENTRY FEE.
INTERNATIONAL ENTRANTS, SEND DRAFTS IN U.S. DOLLARS.

3 SIGN	
I CERTIFY THAT THE PARTIES CREDITED EXECUTED THE SUBMITTED PROJECT AND THAT IT MEETS ALL ELIGIBILITY REQUIREMENTS. I UNDERSTAND THAT ARCHITECTURAL LIGHTING MAGAZINE MAY DISQUALIFY ANY ENTRY THAT FAILS TO MEET SUBMISSION REQUIREMENTS. (SIGNER MUST BE AUTHORIZED TO REPRESENT THOSE CREDITED.)	
NAME (PRINT)	
SIGNATURE	
DATE	

A|L reserves the right to reject any entry and to terminate the competition at any time. Any disputes relating to the competition shall be resolved exclusively by A|L and the panel of judges. This contest is governed by New York laws without regard to its conflict of laws principles. All entrants and clients submit themselves to the exclusive jurisdiction of courts in the southern district of New York.

DEADLINE

May 24, 2007 POSTMARKED LATE ENTRY **June 1, 2007** (\$25 FEE PER ENTRY)

SEND ENTRIES TO

A|L LIGHT & ARCHITECTURE DESIGN AWARDS
One Thomas Circle, N.W. Suite 600 Washington, DC 20005

ELIGIBILITY

- The competition is open to all design professionals worldwide.
- Projects must be completed after July 2005.

SUBMISSION REQUIREMENTS

3. All entry materials must be contained in one large envelope per project, with the submitting firm and project name printed on the outside of the envelope. Include one photocopied set of all entry materials, as well as color printouts of the digital images. Entries should be mailed to: A|L Light & Architecture Design Awards, One Thomas Circle, N.W. Suite 600, Washington DC 20005. A|L is not responsible for lost, misdirected, or postage due mail.

4. Each submission must be accompanied by a signed entry form and a check covering the entry fee (see Entry Fees). The form may be photocopied. Both the form and check should be included in the project envelope.

5. A Project Details Form must also be contained in each project entry envelope. It should include (a) the project name, location and date of completion, lighting designer, architect, client/owner, photographer, and additional consultants; (b) the entry category, and if the submission should be considered for any of the ALVA Awards (see Categories); (c) project name, project size in square feet, watts per square foot, project cost, and lighting installation cost; (d) a written description (600 words max.) of the project brief, project challenges, and design solutions; (e) luminaire and lamp type including manufacturer list and application; and (f) the digital image files should be numbered and keyed to the 600-word description to clarify what is depicted. Submissions being considered for any of the ALVA Awards should include (g) the ALVA entry category; (h) project name; (i) explanation (300 words max.) of why the project excels in the particular ALVA category(ies); and (j) up to 6 additional digital images numbered and keyed to the 300-word description.

6. Images must be in digital format. Additional image submission requirements: (a) one CD per project; (b) either TIF or EPS file format; (c) 300 dpi resolution; (d) approximately 8-inches by 10-inches. For general entry categories, please include no fewer than 7 and no more than 12 images. Provide up to 6 additional images for each ALVA submission. Label the image files using the project name and numbers that correspond to the image descriptions. Use no more than 12 characters.

7. Please avoid the use of fill light when photographing the project; if its use is unavoidable, identify which shots include fill light.

8. To maintain anonymity during the judging process, no names of entrants or collaborating parties may appear on any part of the submission except on the signed entry form and on the project envelope.

CATEGORIES

9. Identify each submission on its own Entry Form and on the Project Details Form as one of the following categories. (A|L reserves the right to change the category of a submission.)

- Residential
- Interior Lighting
- Exterior Lighting
- Whole Building Projects

Projects will not be judged against each other, but rather as superior examples of a lighting solution within their category. Each category may have more than one winner or no winner at all.

10. Appropriate submissions may also be considered for the A|L Virtuous Achievement (ALVA) Awards. Projects must first be submitted in a general category in order to be submitted in an ALVA category(ies). These awards require the following additional information:

Best Use of Color

Entrants must include an explanation (no more than 300 words) clarifying the use of color in the project. "Use of Color" may be interpreted liberally; however, judges will be asked to consider the complexity of the design.

Best Incorporation of Daylight

Entrants must include an explanation (no more than 300 words) clarifying how the project integrates daylighting with electric lighting. In addition, entrants must include ASHRAE 90.1 or LEED documentation indicating that daylighting provides persistent on-peak energy savings.

Best Lighting Design on a Budget

Entrants must include an explanation (no more than 300 words) clarifying why theirs is a budget project; in addition, they must include project construction costs, lighting materials costs, and lighting and electrical subcontractor costs (preferably on a per-square-foot basis). Judges understand costs are relative to project type; however, they reserve the

right to determine whether it is truly a budget project.

JUDGING

11. An independent panel of judges will award prizes to projects at their sole discretion, based on the complexity of the project program and the lighting solutions applied. Decisions of judges are final.

12. Judging will take place in June 2007. Winning entrants will be notified in late June 2007, and their projects will appear in the July/August 2007 issue of A|L.

PUBLICATION

13. Winners of the A|L Design Awards agree to have their projects and names published in A|L, on A|L's website, and in any other media, and must provide further information and publication-worthy graphic materials as needed by A|L. Winners also agree to secure permission for publication from clients and photographers prior to entry. Photographer(s) will receive proper citation credit, but will not receive payment for images published as part of the editorial design awards coverage in both print and online.

14. Winners will be required to sign and return within a specified time a Publicity Release. Winners will also be required to sign a document stating that the entry is the original work of the winner and does not infringe on any proprietary right, including but not limited to copyright, trademark, and the rights of publicity and privacy of any party, and grants A|L the right to use the entry in print and electronic medium.

ENTRY FEES

15. Each submission must be accompanied by a check covering the entry fee (\$130 US for the first entry; \$95 US for each subsequent entry and \$95 US for each ALVA entry). Make check payable to Architectural Lighting. International entrants, send drafts in U.S. dollars. Entry fees are non-refundable and will not be returned for any reason.

DEADLINE

16. Entries must be postmarked by May 24, 2007. Late entries will be accepted until 5p.m. (EST), June 1, 2007.

RETURN OF ENTRIES

17. A|L will ONLY return entries that provide a self-addressed stamped envelope with proper postage. A|L shall not have liability for damaged or misplaced entries.

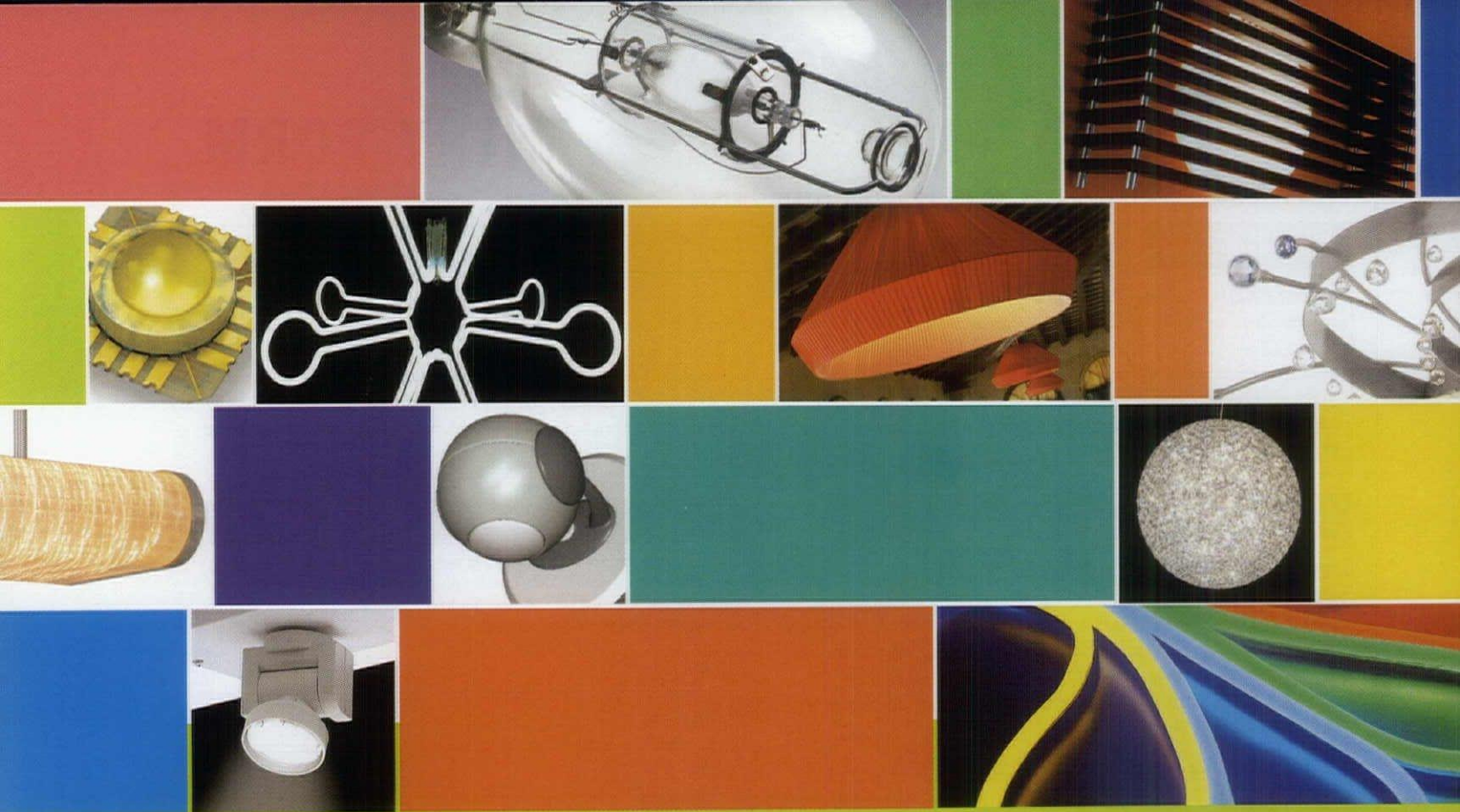

CALL FOR SUBMISSIONS

2007 LIGHTFAIR MARKET ISSUE PRODUCT GUIDE

Architectural Lighting Magazine invites you to forward new product information for editorial consideration in our **APRIL/MAY 2007 LIGHTFAIR MARKET ISSUE PRODUCT GUIDE**. Submitted products should have been released since June 2006.

This annual special issue showcases over 200 products in 15 product categories, including:

- Controls
- Decorative
- Downlights
- Emergency
- Fiber Optics
- Indirect and Direct/Indirect
- Industrial
- Lamps and Ballasts
- LEDs
- Outdoor and Landscape
- Software
- Specialty (i.e., Daylighting/Shading Devices)
- Task
- Theatrical
- Track

EXTENDED DEADLINE: MARCH 19, 2007

PLEASE SEND MATERIALS TO:

Elizabeth Donoff, Editor
 Architectural Lighting Magazine
 Hanley Wood Magazines
 One Thomas Circle NW, Suite 600
 Washington, DC 20005-5811

Please note:

Submissions will not be accepted electronically.

PRODUCT SUBMISSIONS MUST INCLUDE THE FOLLOWING:

- Submitter's contact information
- Product information sheet
- Disc with images in correct format
- Color printout of images

Material Submission Requirements:

- All artwork must be 300 dpi, and at least 4" x 6" or the closest approximation. Appropriate file types are Photoshop TIFF, EPS, or PSD, and should be formatted for a Mac. There should be no text on the images; that information should be included in the printout. Please label the digital images using the following format: "Manufacturer_Product Name".
- Color printout of digital image(s).
- Include the submitter's name, address, phone number, and e-mail address on the color printout. Also label the printout using the naming format above.
- Printout of product description.
- Include a press release with information about the product(s), as well as a technical spec sheet with the product details. Also include the submitter's name, address, phone number, and e-mail address on the product description page.

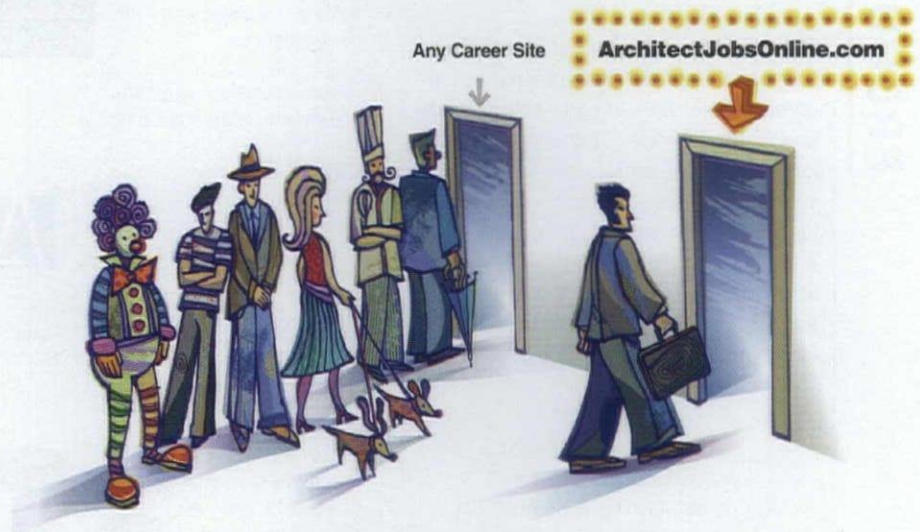

Get out of the crowd, and into a job. At ArchitectJobsOnline.com.

To advance your career in commercial or landscape architecture or CAD design, you need to look where the jobs are: ArchitectJobsOnline.com. We're the official career site of *ARCHITECT* and *residential architect* magazines. Which means all our job listings are in your industry, from the highest concentration of architects available online. Unlike general job sites, we offer exclusive industry content that helps you research prospective employers, plus valuable career advice and nationwide salary comparisons. So visit ArchitectJobsOnline.com today. And leave the mass market job sites to those other characters.

ARCHITECT JOBS ONLINE



••• Job Listings • E-mail Alerts • Career Tools • Industry Intelligence •••

Bartco Lighting, Inc.



The BFLSLM is the lowest profile linear specification grade T5 fluorescent staggered fixture with integral ballast available on the market. This ultra miniature luminaire is for small-scale installations where seamless illumination is required. Ideal applications include backlighting, edge lighting, undershelf and vertical accent lighting. The BFLSLM is available for all standard output, 39W and 54W high-output lamps.

714.230.3200
 info@bartcolighting.com
 www.bartcolighting.com
 Visit us at LIGHTFAIR booth#1721

CIRCLE 301

Ambiance Lighting by Sea Gull Lighting

Ambiance Lighting Systems by Sea Gull Lighting delivers the right light for dramatic effects. Miniature recessed fixtures deliver dramatic, crisp, white light - perfect for highlighting architectural and design features.



www.SeaGullLighting.com
 A Generation Brands Company

CIRCLE 303



Ardee Lighting

Focus and Varianti decorative recessed downlights provide crisp-white, high-performance illumination in a contemporary, precision-machined aesthetic.



The collection is suited for use galleries and museums, upscale hospitality venues, kitchen, dining and living areas, professional and executive offices, reception areas, specialty retail and the like. Ardee Lighting, telephone:

(704) 482-2811. www.ardeelighting.com.
 CIRCLE 304

Edison Price

LED square

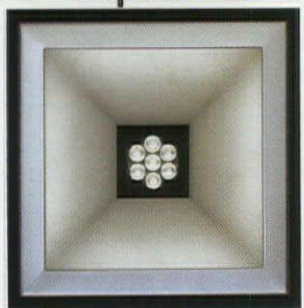

LED is here: 4" and 5" square recessed downlights and wallwashers, designed to Edison Price standards of optical precision, durability and finish. Powered by an integral 25-watt solid state light engine delivering 520 lumens of 3000° K white light for over 50,000 hours, with no UV and no projected heat. Visit www.epl.com, keyword LED, for spec sheets. CIRCLE 302

Cecol

New low-profile high brightness LEDs



Users say this low-profile LED is a "best-kept secret." The super luminance flux CL-L100 has 245lm with high efficiency (70lm/watt at 3.5 watts). Space-saving package releases flat, well dispersed illumination. One-third power consumption of incandescent lamps; smaller and safer than fluorescents. 50x7mm.

Visit www.cecol.com or call 847-619-6700.

CIRCLE 305

LOOKING TO SPEC APPLIANCES?

We have more than 10,100 to choose from.

Now you can find all the product information you need instantly.

SEARCH. FIND. COMPARE.

You'll find 35 manufacturers of refrigerators, ranges, dishwashers, and more, as well as descriptions, specs, installation instructions, and dealers within minutes.



hanley wood

ebuild

www.ebuild.com
 ebuild. The professional's guide to building products™

Cree

Cree is leading the lighting revolution. Cree's XLamp XR-E LED produces typical luminous flux of approximately 80 lumens at 350mA and up to 210 lumens at 1A. The XR-E LED is currently available in production quantities. To discover the future of LED lighting for yourself, visit www.cree.com/xlamp, or call 800.533.2583.

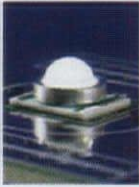

Please visit Cree at Lightfair Boot #2721

CIRCLE 306

NoUVIR Research

NoUVIR's fiber optic EXPERIMENTAL KIT includes a high-power projector, a ready-to-use bundle of 32 fibers (6', 10' and 20' long), 30 luminaires (pinspots, spots, eyeballs and floods), and 5 tracks. Plan and clearly demonstrate any fiber optic lighting design with this specially-priced X-KIT. Demonstrate expertise. Gain clients. Show the best.



CIRCLE 308

Sentry Electric

Sentry offers a comprehensive line of luminaires from classic designs to contemporary and modern. Sentry offers a wide selection of matching poles in a full range of heights. Matching bollards are available as unlit or lighted models. Sentry offers a wide selection of wall brackets, cross arms and accessories.



516-379-4660 www.sentrylighting.com

CIRCLE 310

ERCO

Characterized by its patented reflector design, the Grasshopper family features the innovative Spherolit technology, which allows the option of spot, flood or wide-flood, utilizing new miniature 20 watt / 39 watt metal halide lamps. Suitable for outdoor use (IP65) the die cast Grasshopper offers unique mounting versatility for Lighting Professionals.



CIRCLE 307

SELUX

PRO SERIES precision floodlights are available in three sizes with lamping choices that range from 13W CFL to 1000W H.I.D. Housings are of die-cast, highest purity aluminum. Choice of mounting, beam patterns, lenses, filters and louvers, as well as unique CARDANIC SYSTEMS gimbal mounting frames for suspended and pole mount applications.



For more information, please call SELUX Corporation at: 1-800-735-8927
Email: seluxus@selux.com
Website: www.selux.com/usa CIRCLE 309

W2 Architectural Lighting

Bridging function and design, W2 Architectural Lighting introduces "Architectural Elements," a family of contemporary pendants crafted with a sleek design and scale for large, challenging commercial spaces, at Lightfair. W2 Architectural Lighting, a division of W.A.C. Lighting, offers specification grade products for commercial, hospitality and retail applications.



W2 Architectural Lighting
Tel: 1.866.788.2100 www.W2lighting.com
CIRCLE 311

FOR INFORMATION

on how to be a part of the next ARCHITECTURAL LIGHTING special advertising section, contact Drew Ferrara at 202.736.3343.

hanley ▲ wood

VISIT US AT
LIGHTFAIR 2007
BOOTH 1362

Sentry Electric

Your Vision... Our Expertise

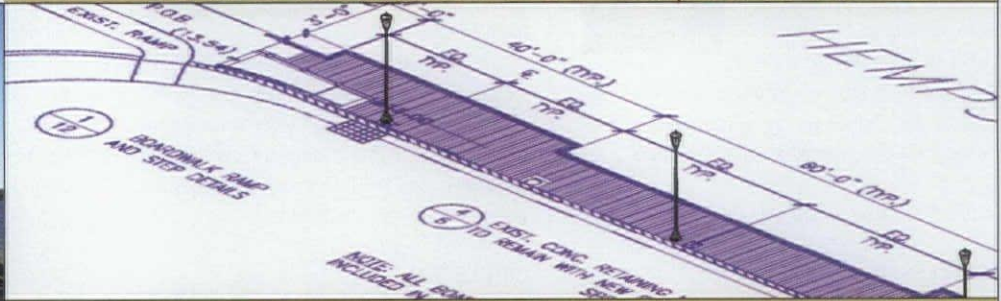
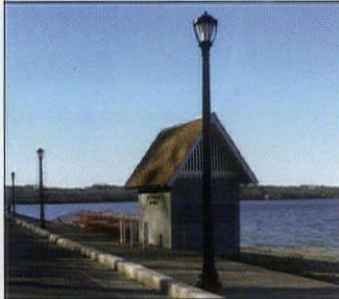

Luminaires Poles Bollards Accessories

NEW CATALOG
AVAILABLE SPRING 2007.

RESERVE YOUR
COPY NOW

For more information, call Sentry Electric, LLC
at 516.379.4660, or visit us at www.sentrylighting.com

SENTRY ELECTRIC, LLC
185 Buffalo Avenue Freeport, New York, 11520
WWW.SENTRYLIGHTING.COM



Circle no. 46 or www.archlighting.com/productinfo

WE PROMISE. NO BORING CONTINUING ED.

Manufacturers who sponsor AIA continuing education courses through Hanley Wood /Architect CES get better results. Why? Because Architect CES writes and produces courses that are more compelling, memorable, entertaining and relevant to today's architects. Plus, they're delivered in your choice of convenient formats including: print, online, or lunch and learn PowerPoint.

For more information on sponsoring a course, contact Russ Ellis today at 202.736.3310.

Continuing education that holds your interest

ARCHITECT

Course development and content management provided by

ARCHITECTCES

hanleywood

PAGE ADVERTISER CIRCLE NO.

58.....	Ambiance Lighting System by Sea Gull Lighting	45
28	Ardee Lighting	50
27	Bartco Lighting	21
3	B-K Lighting	23
4	Brass Light Gallery	54
14	CECOL	22
30	Con-Tech Lighting	24
53	Cooper Lighting	25
19	Cree	26
20	Electrix	72
62	Engineered Lighting Products	73
C2-1	ERCO	77
24	Focal Point	49
71	G Lighting	74
56.....	Gotham	33
2	Insight Lighting	79
29	Kramer Lighting	69
12	Leviton	35
60	Light Congress	-
48	Lightfair International	51
5	Lightolier	36
71	Luraline	76
C4.....	Lutron	37
47.....	Mark Architectural Lighting	80
21	MechoShade	78
63.....	NoUVIR Research	39
17	Original Cast Lighting	81
11.....	Precision Architectural Lighting	40
C3	Prudential Lighting	42
23	Schneider Electric	43
7	Se'lux	53
70	Sentry Electric	46
16	Sirius	59
18	Tambient	29
15.....	Tech Lighting	82
10.....	Translite Sonoma	71
8	Venture Lighting	70
22	W2 Architectural Lighting	56
59.....	Watt Stopper	75

Publisher is not liable for errors or omissions.

AJL architectural lighting (Vol. 21, No. 2 USPS 000-846, ISSN 0894-0436) is published seven times per year (bimonthly, except monthly in March and June) by Hanley Wood, LLC, One Thomas Circle, N.W., Suite 600, Washington, DC 20005. Periodicals postage paid at Washington, DC and additional mailing offices. Printed in the USA. POSTMASTER: Send changes of address to Architectural Lighting, PO Box 1061, Skokie IL 60076-8061.

Canada Post Publications Mail Agreement No. 40031729. Return undeliverable Canadian addresses to: Deutsche Post Global Mail, 4960-2 Walker Road, Windsor ON N9A 6J3.

Distributed free of charge to individuals or firms engaged in the specification of lighting products in the US. Per year, all other US subscriptions \$48; Canada, \$60; foreign, \$96. Payable in US dollars. For subscription inquiries, address changes, and single copy sales (\$7 in the US, \$7 + postage outside the US, payable in advance) write to Architectural Lighting, PO Box 1061, Skokie IL 60076-8061 or call 847-647-7987.

AJL architectural lighting is a trademark owned exclusively by Hanley Wood, LLC. Copyright 2007 Hanley Wood, LLC.



G Lighting

GROSS CHANDELIER

Fine Lighting Since 1908

www.glighting.com

sales@glighting.com

St. Louis, MO

800-331-2425
Fax 314-631-7800



Catalog and custom lighting to meet your specifications.

Circle no. 74 or www.archlighting.com/productinfo

for Quality lighting
Green buildings

LURALINE
efficient lighting solutions since 1967
www.luraline.com

Circle no. 76 or www.archlighting.com/productinfo

Lighting Challenges in 2007...continued

A continuation of the Jan/Feb 2007 Exchange page discussion surrounding "Lighting Challenges in 2007." Responses are always welcome to Exchange topics. Replies can be submitted directly to exchange@archlighting.com or edonoff@hanleywood.com.

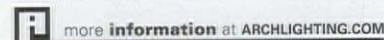

EMERGENCY LIGHTING—WHOSE RESPONSIBILITY IS IT: THE ELECTRICAL ENGINEER OR THE LIGHTING DESIGNER?

MIKE ROGERS, SENIOR ELECTRICAL DESIGNER AND LIGHTING DESIGNER |
M.E. GROUP, INC. / REVEAL LIGHTING

Your opening editor's comment "It Takes Two," in the Jan/Feb 2007 issue compelled me to join in the dialog. There is one item from the Exchange forum that caught my eye, which I felt warranted further discussion.

I am privileged to work in parallel fields, as both electrical designer and lighting designer, and I would like to offer my opinion regarding Francesca Bettridge's topic of "Emergency Lighting" from the Jan/Feb 2007 issue of Architectural Lighting.

As an electrical designer, working with outside lighting designers always presents challenges regarding defining points of responsibility and limits of liability. Since our firm acts as the registered professional engineer for projects, we are ultimately responsible for all aspects of the electrical engineering design, including lighting. When teaming with an outside lighting consultant, we encourage the lighting designer to provide advice on an integrated emergency lighting solution that meets the needs of the project as an absolute minimum. Ideally, the lighting designer should insist on providing this input and should provide a complete design, including calculations and documentation where needed.

As a lighting designer, I want to guide the lighting design in all aspects, including providing emergency illumination. By taking responsibility for the design and integration of the emergency lighting I can be assured that the systems and components used are integrated into the design, rather than slapped on over the top of the design. If the project includes any specialty, custom, and/or decorative fixtures that are powered by battery or generator, some electrical engineers would be hard pressed to calculate these sources accurately. If the lighting designer has already created models of the spaces including all fixtures, textures, and reflectances, then they would be the best suited for completing the emergency lighting calculations.

By abandoning the task of performing emergency lighting design and calculations, the lighting designer also abandons their control of what emergency lighting fixtures might be used, and what types of technologies might be applied to their projects. I'm sure that we have all seen a beautiful office atrium, hotel ballroom, or restaurant with thoughtfully integrated, gorgeous lighting systems accompanied by the dreaded industrial frog eye emergency fixture. My advice is to include emergency lighting design and calculation into your lighting design fees and take ownership of the entire lighting design. This topic could easily be expanded to include who should be responsible for running energy calculations for projects, another common point of contention between electrical engineers and lighting designers.

Mr. Rogers, IESNA, LC, LEED, has over 25 years experience with a wide variety of project types, working in the electrical engineering consulting field, and 15 years experience as a lighting designer. A member of the IESNA since 2000, he currently serves on the Rocky Mountain Section of the IESNA Board of Managers, as Membership Chairman, and is the immediate past President of the Rocky Mountain Section of the IESNA.

FRANCESCA BETTRIDGE, PRINCIPAL | CLINE BETTRIDGE BERNSTEIN LIGHTING DESIGN

I think that Mr. Rogers has made some important and thoughtful points, and I would like to respond to them and add a few more for consideration.

In over twenty years of practice, the emergency lighting has always been in the scope of the electrical engineer; it is only within the last few years that we have found a growing resistance, actually a refusal, on the part of some engineering firms to do the calculations for the emergency lighting. This is a new practice that we are increasingly being asked to deal with so that it doesn't "fall between the cracks" when consultants are submitting proposals. I maintain that because the engineers sign the drawings and are responsible for meeting the emergency lighting codes, they should do the emergency lighting calculations and determine how much is necessary to meet code.

One can keep design control by coordinating efforts with the others on the team and reviewing the electrical drawings during the construction document phase. The method of emergency lighting—generator, battery packs etc.—is usually decided by budget, the architect, owners, and the engineers. No architect or lighting designer would choose emergency wall packs unless there was no other choice due to budget.

We state in our contracts that we will provide our AGI files and photometric information to the engineers for their use in calculating the emergency lighting requirements. This is standard professional practice.

In conversations with engineers about why they are now excluding the calculations from their services, it seems to boil down to not wanting to use staff time to calculate the emergency lighting requirements, and in this litigious environment, not wanting to take any risks with light levels by using a "seat of the pants" approach. I think it really is about fees, the fast pace of jobs, and not wanting to dedicate staff to the task.

Our office makes extensive use of computers for models and calculations, but that doesn't mean that we do this for every space in every project. Requiring the lighting designers to supply the calculations and holding them to the high standard of proving their work with computer analysis means that more of our fee is spent crunching numbers and less time is spent on design. This is a topic that deserves further discussion. I repeat my first point that this is a change in the scope of services that had previously always been provided by the engineer; for some engineering firms, it is still a matter of course that it is included in their services.

Throughout her career, Ms. Bettridge, IALD, IESNA, LC, has collaborated with highly esteemed architects on award-winning national and international work, which encompasses a broad range of types and styles. She has been honored with multiple Lumen, IALD, and GE Awards. Ms. Bettridge is a professional member and former secretary of the International Association of Lighting Designers, and has served on the Board of Managers and the Richard Kelly Scholarship Committee of the New York Section of the Illuminating Engineering Society. A graduate of Barnard College, Ms. Bettridge studied at Parsons The New School for Design and the Open Atelier of Design, which she helped found. She has also taught at the Fashion Institute of Technology and Parsons The New School for Design.



Prudential Ltg

Over AND Above

{sculptural form _ lighting}

You light an ordinary space with ordinary fixtures. But ordinary isn't in your design vocabulary. Your space surprises, and so should the overhead lighting. We offer an extensive catalog of linear fixtures, including our new Aparia, M7 and P-40 pendants, that go far beyond the basics. Meticulously sculpted from a range of intriguing materials, and delivering the highest levels of optical performance. For extraordinary lighting visit our website at prulite.com.

Circle no. 42 or www.archlighting.com/productinfo



Light creates Life. Create with Prudential Ltg.

Lutron® EcoSystem™ | light control solution

The only fluorescent light control solution that makes it easy to save energy, and gives users complete control of their light in a constantly changing commercial building.



“We really took the time to select the best technology for our campus renovation, and we chose EcoSystem from Lutron.”

Jeff Choma, Manager of Mechanical and Electrical Systems
Georgian College, Ontario, Canada

What Jeff says about EcoSystem:

Save time – “It fits well into our constantly changing environment. When we remove or add walls, we simply remove or add devices without power rewiring or changes to conduit.”

Save money – “EcoSystem has saved the college \$137,000 annually on lighting.”

Satisfied employees – “People love having lighting customized just for them.”

World-class quality and support – “Lutron simply has the best product and support.”

The technology behind it:

- Sensors and controls connect to fixtures with low-voltage wires and a PDA-style programmer assigns them to any fixture(s).
- Combine tuning, occupancy sensing, daylight harvesting and manual dimming at any time, any location.
- Employees can control their own light, or facility personnel can do it for them with the wireless programmer.
- Lowest field return rate in the industry.
- Factory service, start-up and training.

Learn more

at www.ecosystemlightcontrol.com.

For immediate consultation,
call **1.866.898.3615**.

© 2007 Lutron Electronics Co., Inc.

Circle no. 37 or www.archlighting.com/productinfo

See us at **Lightfair Booth #1638**.

 **LUTRON®**