

**A·L**  
ARCHITECTURAL LIGHTING

30 YEARS

**INSIDE:** STREETLIGHTING  
IN L.A. • SAN DIEGO'S  
CABRILLO BRIDGE •  
DAYLIGHTING METRICS •  
TECH TRENDS • ONE-ON-  
ONE: VODE'S TOM WARTON

ANNUAL PRODUCT

ISSUE



VF100

# EF600 SYSTEM

## Surface Mounted Asymmetric LED Uplight

Semi-Specular Reflector

Protective Lens

LED Board with 3 Power Levels

Adjustable Light Shield

1.25"

4.00"

### EF600 Features

- LED source available at three power levels up to **1200 Lumens per foot**
- Backlight Shield for variable adjustment of distribution
- Advanced Optics with asymmetric distribution
- Dense Pitch for uniform output
- Integral semi-specular reflector
- Captive lens for horizontal or vertical mounting
- Tight binning ensures color consistency within 2 MacAdam Ellipses
- Field-Replaceable integral LED driver
- Integral wiring compartment and thermal protection
- Quick disconnect through wiring
- Hinged joiners for following contoured coves
- Long continuous runs with a single feed

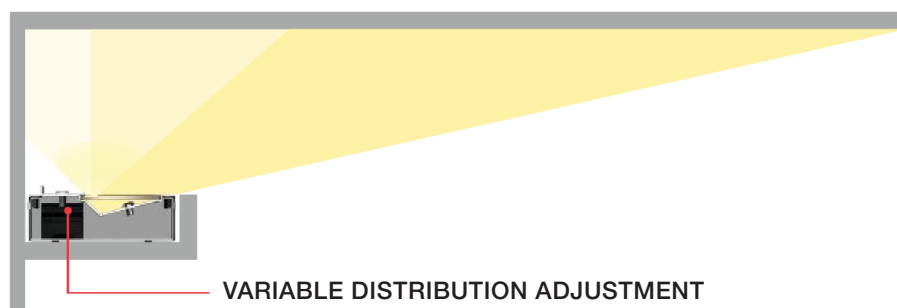
**Distribution** Per 4' Fixture

**Total Output: 3328 lm**

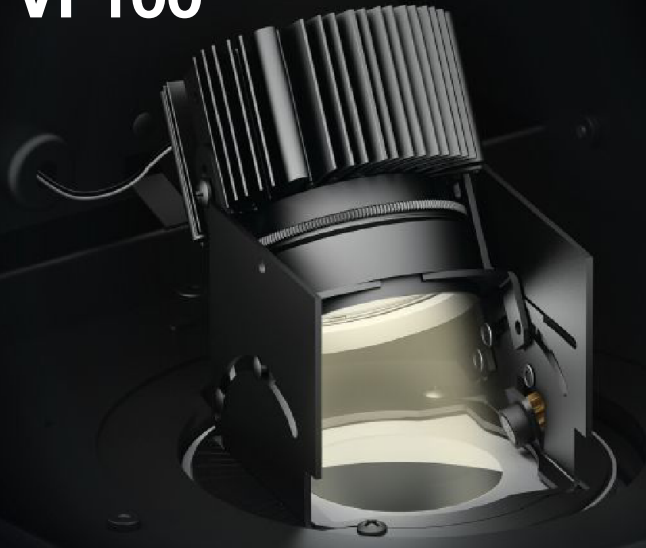
**Efficacy: 100 lm/w**

**CRI >80**

The EF600 from LF Illumination, is a complete linear cove / surface mounted lighting system. Available in fixed lengths from 2' to 8', the fixtures may also be ordered in custom lengths. The small 4" wide x 1.25" high footprint ensures that the EF600 will fit into the tightest of mounting spaces. A unique feature to the EF600 is the adjustable light shield. This provides variable distribution for different applications. The shield is easily adjusted at the top of the fixture. Position markers are present to assure consistent placement of the shield in longer runs.



# VF100



Don't be a baby.  
Be a **MINI**.

The **VF Series MINI Recessed housing** from LF Illumination offers shallow plenum friendliness with the added bonus of **Adjustable LED** fixtures and a **Quick 10 Day Delivery**.

## VF Series Features

- **MINI** Housing - **3.63" Height**
- Small Housing - 5.40" Height
- LED output up to 1600 lumens
- CCT ranging from 2700K - 4000K
- Multiple beam spreads
- Latest dimming technologies
- 4.0" Trimless / 4.5" Trimmed
- Beveled or flat styles
- Adjustable **HOT AIMING**
- Fixed lamp and wall washers
- Field replaceable LED optics
- MR16 and CMH also available

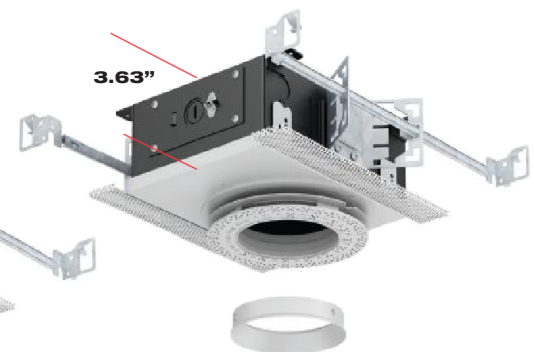
# VF150



Backed by LF Illumination's 50+ years of combined experience and knowledge in recessed architectural lighting, VF Series fixtures meet and exceed the needs of today's lighting designers and specifiers for small recessed fixtures that perform. Available in fixed or adjustable downlighting as well as wall wash fixtures. Hot aiming and rotatable square fixtures are standard.

**VF150 - LAMP AND AIMING IN THE HOUSING**

**VF100 - LAMP AND AIMING ON THE TRIM**



2016  
CALL FOR  
ENTRIES

THIRTEENTH  
ANNUAL

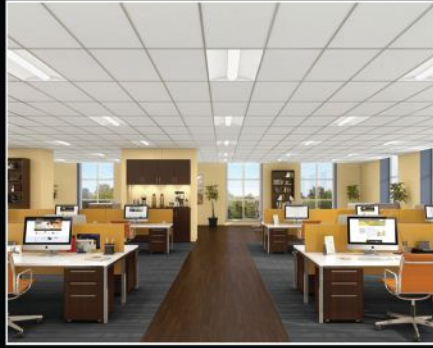
A.L

LIGHT AND  
ARCHITECTURE  
DESIGN AWARDS

ARCHITECTURAL LIGHTING's 13th annual AL Light & Architecture Design Awards honors outstanding and innovative projects in the field of architectural lighting design. Winning projects will be published in the July/Aug 2016 issue and featured on [archlighting.com](http://archlighting.com). The awards program is open to design professionals worldwide. Projects must have been completed after July 2014.

**Early Deadline:** May 4, 2016  
**Final Entry:** June 3, 2016

Full details and entry forms available at [aldesignawards.com](http://aldesignawards.com)



# ELEVATE

YOUR EXPERIENCE

Enhancing the environment with aesthetically appealing solutions

Improving the quality of light through performance and control

Increasing savings through reduced energy footprint

Heightening reliability with greater safety and security



Lightfair International 2016 Booth 3645

April 26-28 | San Diego, CA Convention Center

# DIALux evo



**LIGHTFAIR**  
INTERNATIONAL  
The future, illuminated.  
**April 26–28, 2016**  
San Diego  
Booth 7036

## Design lighting for entire buildings? Now you can.

With DIALux evo you can design lighting intuitively for complex spaces.

Learn more about its smart features and unique business model: DIALux is free for commercial and private use.



[discover.dialux.com](http://discover.dialux.com)

MAR/APR 2016  
VOL 30, NO 2

# A·L

## ARCHITECTURAL LIGHTING

**EDITOR-IN-CHIEF**  
Elizabeth Donoff  
edonoff@hanleywood.com  
202.729.3647

**MANAGING EDITOR**  
Greig O'Brien  
gobrien@hanleywood.com

**EDITORIAL**  
**SENIOR EDITOR, BUSINESS, PRODUCTS, AND TECHNOLOGY**  
Wanda Lau

**ASSOCIATE EDITOR, BUSINESS, PRODUCTS, AND TECHNOLOGY**  
Hallie Busta

**ASSOCIATE EDITOR, DESIGN**  
Deane Madsen

**ASSISTANT EDITOR, BUSINESS, PRODUCTS, AND TECHNOLOGY**  
Selin Ashaboglu

**ASSISTANT EDITOR, DESIGN**  
Sara Johnson

**CONTENT PRODUCER**  
Chelsea Blahut

**DIGITAL CONTENT INTERN**  
Angie Cook

**ART DIRECTOR**  
Robb Ogle  
rogle@hanleywood.com

**ART**  
**SENIOR GRAPHIC DESIGNER**  
Megan Mullsteff

**GRAPHIC DESIGNER**  
Ryan McKeever

**PHOTO EDITOR INTERN**  
Alexander Cortez

**MULTIMEDIA**  
**VIDEO PRODUCTION MANAGER**  
Lauren Honesty

**VIDEOGRAPHER/VIDEO EDITOR**  
Jim Van Meer

**CONTRIBUTING EDITORS**  
Elizabeth Evitts Dickinson,  
Bill Millard, Aaron Seward

### EDITORIAL ADVISORY BOARD

Gregg Ander, FAIA, IESNA • Francesca Bettridge, IALD, IESNA •  
Barbara Cianci Horton, IALD • Kevin Houser, IESNA, EDUCATOR IALD •  
Mark Loeffler, IALD, IESNA • Paul Zaferiou, IALD

**SUBSCRIPTION INQUIRIES, CHANGE OF ADDRESS, CUSTOMER SERVICE, AND BACK-ISSUE ORDERS**

ARCHITECTURAL LIGHTING  
P.O. Box 3494  
Northbrook, IL 60065  
alit@omeda.com  
Local: 847.291.5221  
Toll-Free: 888.269.8410

**PRODUCTION**  
**PRODUCTION MANAGER**  
Marni Coccaro  
mccoccaro@hanleywood.com  
**AD TRAFFIC MANAGER**  
Pamela Fischer  
pfischer@hanleywood.com

**INSIDE SALES**  
**AD TRAFFIC MANAGER**  
Annie Clark  
aclark@hanleywood.com

**REPRINTS**  
Wright's Media  
hanleywood@wrightsmedia.com  
877.652.5295

**LIST RENTALS**  
Statistics  
Jennifer Felling  
jfelling@statistics.com  
203.456.3339

## archlighting.com

One Thomas Circle, N.W. Suite 600 Washington, DC 20005

A·L ARCHITECTURAL LIGHTING (Vol. 30, No. 2 USPS 000-846, ISSN 0894-0436) is published six times per year (Jan/Feb, March/April, May/June, July/August, Sept/Oct, Nov/Dec) by Hanley Wood, One Thomas Circle, N.W., Suite 600, Washington, DC 20005. Periodicals postage paid at Washington, DC, and additional mailing offices. Printed in the USA. Postmaster: Send changes of address to ARCHITECTURAL LIGHTING, P.O. Box 3494, Northbrook, IL 60065.

Canada Post Registration #40612608/G.S.T. Number: R-120931738. Canadian return address: IMEX, P.O. Box 25542, London, ON N6C 6B2.

Distributed free of charge to individuals or firms engaged in the specification of lighting products in the U.S. Publisher reserves the right to determine recipient qualification. Per year, all other U.S. subscriptions \$48; Canada, \$60; Foreign, \$96. Payable in U.S. dollars. For subscription inquiries, address changes, and single-copy sales (\$10 in the U.S., \$15 in Canada, \$20 for other countries, payable in advance) write to ARCHITECTURAL LIGHTING, P.O. Box 3494, Northbrook, IL 60065 or call 847.291.5221 or toll-free 888.269.8410.

A·L ARCHITECTURAL LIGHTING is a trademark owned exclusively by Hanley Wood. Copyright 2016 Hanley Wood. Reproduction in whole or in part prohibited without written authorization.



# ECLIPSE mini & maxi

performance  
you can count on

Eclipse features a complete family of aesthetically designed bollards, pendants, post-top and wall mount luminaires that deliver greater durability, performance and lighting efficiency.

- Scaled to fit various applications with two available body sizes (6", 8")
- New moulded silicone optics offer greater color stability and performance with full cutoff, asymmetric light distribution and optional backlight control
- High efficiency of up to 110 lumens/watt
- Lifetime beyond 130,000 hrs (L70)
- 5-year warranty



**LUMINIS**®

[luminis.com](http://luminis.com) | [info@luminis.com](mailto:info@luminis.com)



**WHERE VINTAGE AND  
MODERN COLLIDE®**



[WWW.BARNLIGHT.COM](http://WWW.BARNLIGHT.COM)

800-407-8784



**DESIGN GROUP**

GROUP PRESIDENT  
Ron Spink  
rspink@hanleywood.com  
202.736.3431

GROUP EDITORIAL DIRECTOR,  
DESIGN AND COMMERCIAL CONSTRUCTION  
Ned Cramer

**ADVERTISING SALES**

SENIOR DIRECTOR,  
INTERNATIONAL ACCOUNTS  
Dan Colunio  
dcolunio@hanleywood.com  
202.736.3310

VICE PRESIDENT,  
GENERAL MANAGER OF DIGITAL  
Christie Bardo  
cbardo@hanleywood.com  
202.736.3363

NATIONAL ACCOUNT MANAGER,  
LIGHTING  
Cliff Smith  
csmith@hanleywood.com  
864.642.9598

SENIOR ACCOUNT DIRECTOR, MID  
ATLANTIC, SOUTHEAST  
Susan Shepherd  
sshpherd@hanleywood.com  
404.386.1709

STRATEGIC ACCOUNT MANAGER,  
MIDWEST  
Michael Gilbert  
mgilbert@hanleywood.com  
773.824.2435

STRATEGIC ACCOUNT MANAGER,  
WEST  
Suren Sagadevan  
ssagadevan@hanleywood.com  
310.863.1153

STRATEGIC ACCOUNT MANAGER,  
CHINA, HONG KONG, TAIWAN  
Judy Wang  
judywang2000@vip.126.com  
86.13810325171

NEW ACCOUNT SETUP  
Jaeda Mohr  
jmohr@hanleywood.com  
202.736.3453

VICE PRESIDENT, MARKETING  
Matthew Carollo

AUDIENCE MARKETING DIRECTOR  
Mary Leiphart

NEW ACCOUNT SETUP  
Erika Taylor  
etaylor@hanleywood.com  
202.380.3942

DIGITAL PRODUCT DIRECTOR  
Nickie Denick

**HANLEY WOOD MEDIA**

PRESIDENT, MEDIA  
Dave Colford

VICE PRESIDENT,  
PRODUCT DEVELOPMENT  
Rizwan Ali

SENIOR VICE PRESIDENT,  
AUDIENCE OPERATIONS  
Sarah Welcome

EXECUTIVE VICE PRESIDENT,  
STRATEGIC MARKETING SERVICES  
Tom Rousseau

SENIOR DIRECTOR,  
PRINT PRODUCTION  
Cathy Underwood

VICE PRESIDENT,  
CLIENT OPERATIONS  
Mari Skelnik

SENIOR VICE PRESIDENT,  
STRATEGIC MARKETING SERVICES  
AND CONSUMER MEDIA  
Jennifer Pearce

CHIEF DESIGN DIRECTOR  
Aubrey Altmann

DIRECTOR OF ANALYTICS  
Jennifer Malkasian

**HANLEY WOOD**

CHIEF EXECUTIVE OFFICER  
Peter Goldstone

VICE CHAIRMAN  
Frank Anton

CHIEF FINANCIAL OFFICER  
Matthew Flynn

PRESIDENT, MEDIA  
Dave Colford

PRESIDENT, DIGITAL  
Andrew Reid

PRESIDENT, METROSTUDY  
Christopher Veator

PRESIDENT, MARKETING  
Jeanne Milbrath

SENIOR VICE PRESIDENT,  
MARKETING  
Sheila Harris

VICE PRESIDENT,  
CORPORATE ACCOUNTS  
Ryan Flom

VICE PRESIDENT,  
FINANCIAL PLANNING AND ANALYSIS  
Ron Kraft

SENIOR VICE PRESIDENT,  
CORPORATE DEVELOPMENT AND  
GENERAL COUNSEL  
Michael Bender

DIRECTOR OF SALES,  
EMERGING ACCOUNTS GROUP  
Philip Hernandez

VICE PRESIDENT,  
CORPORATE CONTROLLER  
Keith Rosenbloom

From Hanley Wood, publisher of ARCHITECT, AQUATICS INTERNATIONAL, BUILDER, CONCRETE & MASONRY CONSTRUCTION PRODUCTS, CONCRETE CONSTRUCTION, THE CONCRETE PRODUCER, CUSTOM HOME, THE JOURNAL OF LIGHT CONSTRUCTION, MASONRY CONSTRUCTION, MULTIFAMILY EXECUTIVE, POOL & SPA NEWS, PROSALES, PUBLIC WORKS, REMODELING, REPLACEMENT CONTRACTOR, and TOOLS OF THE TRADE magazines.

**Disclosure:** ARCHITECTURAL LIGHTING will occasionally write about companies in which its parent organization, Hanley Wood, has an investment interest. When it does, the magazine will fully disclose that relationship.

**Privacy of mailing list:** Sometimes we share our subscriber mailing with reputable companies we think you'll find interesting. If you do not wish to be included, please call us at 888.269.8410.



**architectural  
area lighting**

[www.aal.net](http://www.aal.net)



**Next  
Generation**  
LUMI ARES



# KICK™

CONTEMPORARY URBAN LUMINAIRES

[www.aal.net/products/kick\\_medium\\_scale/](http://www.aal.net/products/kick_medium_scale/)



**HUBBELL**  
Lighting

## PRODUCTS

- 43 INTRODUCTION
- 44 DECORATIVE
- 50 DIRECT/INDIRECT
- 56 DOWNLIGHTS
- 60 INDUSTRIAL
- 62 EXIT/EMERGENCY
- 64 LAMPS AND BALLASTS
- 68 LEDS AND DRIVERS
- 72 LIGHTING CONTROLS  
AND SYSTEMS
- 76 OUTDOOR
- 82 SPECIALTY
- 86 TRACKLIGHTING
- 90 WALLWASHERS
- 94 MANUFACTURER INDEX



## TECHNOLOGY TRENDS

- 55 COLOR QUEST
- 71 LED PRICE POINTS
- 75 LIGHTING AND THE INTERNET OF THINGS
- 89 DIGITIZATION OF PRODUCT LIBRARIES

## DEPARTMENTS

### 12 COMMENT

**A Regulatory Affair**

### 14 BRIEFS

**The Bay Lights; PolyThread Pavilion; Color Wheels; and more**

### 23 REPORT

**Los Angeles is replacing the majority of its streetlights with LEDs, saving the city on energy use but changing the hue of its built environment**

### 30 IN FOCUS

**Cabrillo Bridge, San Diego**

### 32 TECHNOLOGY

**Annual daylighting performance metrics, explained**

### 104 ONE-ON-ONE

**Interview with Tom Warton, president of Vode Lighting**

## ARCHLIGHTING.COM

As always, check out our website for expanded article coverage, videos, and news. Also, subscribe to our email newsletter, AL Notes, and find a link to ARCHITECTURAL LIGHTING's digital edition.

**On the Cover:** Landscape Forms' FGP Pedestrian Light; **This page:** Orgatech Omegalux's Butterfly Wall

# All this... and brains too

Lighting engineers Eco Engineering used Lumenbeam Luminaires to enhance the architecture at Cincinnati City Hall, all while reducing energy consumption by 84%. Find out more at [Lumenpulse.com](http://Lumenpulse.com)

See Lumenpulse at Lightfair 2016 (Booth #1827)

**84%**  
Reduction in  
energy consumption



**lumenpulse**™

# EXPERIENCE THE SPACE... NOT THE LIGHTING FIXTURES.



*Pictured: Napkin Studio, North Canton, OH  
Lights shown: 2x2 panels Lights not shown:  
6", 8" downlights. 2x4 panels*

## TILT™

THIN LIGHT TECHNOLOGY  
by Lauren Illumination



1x1 to 2x4 Panels



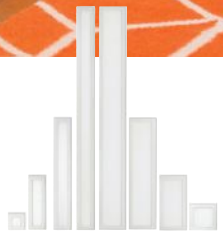
4" to 24" Round Downlights



4" to 12" Square Downlights

**Architectural excellence is brought to life with beautiful, natural, light reflected in stunning colors and textures.**

TILT's sleek, modern, fixture design allows its high-quality light to illuminate your work without taking center stage. You'll appreciate how the beauty of a space shines instead of a bulky fixture obstruction. Our low voltage, Class 2 System provides high-quality light and energy-efficiency options for standard and custom sizes in panels, round and square downlights and linear products. Visit [www.laurenillumination.com/AL](http://www.laurenillumination.com/AL)



4" Linear Series, 6" Linear Series



Low Voltage Distribution System



WLVD - Wireless Dimmer



Wireless Occupancy Sensors



Surface Mount with Hanging Kit

2162 Reiser Avenue S.E. | New Philadelphia, OH 44663 | **855.440.8458** | [www.laurenillumination.com](http://www.laurenillumination.com)  
TILT is a product brand of Lauren Illumination - A Lauren International Company



## A REGULATORY AFFAIR



On Jan. 27, the California Energy Commission (CEC) approved the Title 20 appliance efficiency regulations that apply to general service LED lamps (“bulbs,” in consumer terms). This move sets the first in-state energy efficiency standards for LED lamps used in household fixtures and chandeliers, as well as directional lamps with a diameter of 2.25 inches or less, which are the type of lamp often used in tracklighting for retail, hotel, and museum applications. Sounds like a good thing, right? It would, except there’s more here than meets the eye. Because California operates according to stricter energy guidelines than other states, they are allowed, as outlined in the Energy and Independence Security Act of 2007, to adopt rules two years in advance of federal passage. But should the federal government meet its rulemaking deadlines on time, then the federal regulation supersedes anything at the state level.

The National Electrical Manufacturers Association (NEMA) usually agrees with the CEC on matters pertaining to lighting regulation—but not in this case. NEMA reached out to the CEC repeatedly during the 45-day comment period, which began in December 2015, stating its reasoning and providing data to support its position. While the CEC did respond to a few of NEMA’s requests for additional information, it did not fundamentally change its stance on the issue. As the vote approached on Jan. 27, NEMA reached out again and provided a 16-page comment response to the CEC, which is available on its website.

One of the main issues that has set NEMA and the CEC at odds is the role of color—color rendering index (CRI), specifically—as it relates to energy efficiency. Starting in January 2018, all lamps in California will have to meet certain CRI requirements and have a lamp life of 10,000 hours. The smaller, directional lamps will have to have a lamp life of 25,000 hours. According to the Associated Press, the CEC has suggested this requirement “will save consumers more than \$4 billion in utility bills over 13 years.”

But as NEMA points out, the Title 20 rulemaking language advocates for a high CRI requirement for R8 values. In order to achieve this, manufacturers would have to produce lamps with a minimum CRI of 90 to meet the requirement, rather than lamps with a CRI of 82, which the new rules permit in other applications. Higher CRI lamps are less energy efficient and cost more to produce. The CEC move would mean California consumers would have to buy more expensive, less efficient, higher CRI lamps, compared to consumers in other states. Price point is regularly cited as one of the main barriers to adoption of LED lamps.

While the CEC has already voted and approved this measure, the disagreement between the two groups highlights the bureaucratic nature of regulatory discussions and the archaic, opaque nature of the review and comment process. No one comes out a winner, least of all the consumer.

The pace of LED developments is far faster than the regulatory process. All stakeholders—from manufacturers to government agencies—have to figure out a better way to work toward energy efficiency that allows consumers choice and doesn’t regulate “design” out of lighting design. However, all this could be moot as the U.S. Department of Energy holds its hearings on general service lamps on April 20 in Washington, D.C. Depending on the outcome, it could supersede most, if not all, of the energy standards adopted in the Title 20 rulemaking. •

Elizabeth Donoff  
Editor-in-Chief  
edonoff@hanleywood.com



<b>LP1</b>	<b>SuperSPOT LED SERIES</b>	<b>50,000 HOUR LIFE</b>
	74,000 CBCP (1090 Lumens/15 watts)	4° Optic
	Color Temperature: 3000K; CRI: 90	No UV or IR
<p>The LP1 SuperSPOT LED Series is a powerful, tightly focused LED spotlight designed specifically for tight beam applications. Designed to take the place of aging low voltage sources, such as PAR36 or AR111, this efficient, high power LED fixture can produce a 4 degree beam with 74,000 CBCP (1090 lumens/15 watts). The LP1 SuperSPOT features a proprietary tool-less field replaceable LED assembly, as well as a discreetly hidden driver, compatible with trailing edge electronic low voltage dimmers (dimmmable to 5%).</p>		
<p><b>Lighting Services Inc</b> The premier specialty lighting manufacturer.</p>		

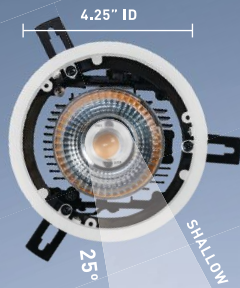


**LIGHT WAVES**

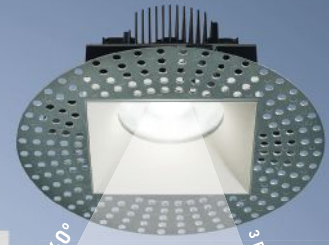
The Bay Lights, an LED lighting installation by artist Leo Villareal for the San Francisco Bay Bridge that uses 25,000 connected LED light points supplied by Philips Color Kinetics, was officially relit on Jan. 28. The piece originally debuted in March 2013 and was intended as a two-year installation, but an overwhelming response from the local community led for a push to see the artwork permanently installed. Nonprofit art organization Illuminate (also instrumental in the 2013 installation) spearheaded a fundraising campaign with assistance from the California Department of Transportation and the Metropolitan Transportation Commission. [bit.ly/AL\\_BayBridge](http://bit.ly/AL_BayBridge)







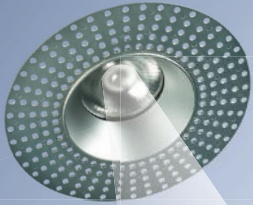
4.25" ID  
2.5°  
SHALLOW HOUSING



4.25" ID  
60°

3 FLANGE OPTIONS: KNIFE EDGE, TRIMLESS, MICROFLANGE OR STANDARD. MAX. GOOF

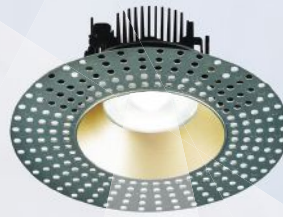
UP TO 2200 DELIVERED LUMENS



SECURE RETENTION AND NO CRACKING IN CEILINGS 0.125" THROUGH 1.25"



0.07



UNIQUE SLIDING PIVOT AIM FOR NO CLIPPING UP TO 30° OF 40° ADJUSTMENT



13°

# FRAXION

PERFORMANCE AND BEAUTY.  
SMARTS AND SCIENCE.

Introducing Fraxion™ downlights. Discover the most innovative features, advanced engineering, and sleekest design sensibility to meet the needs and dreams of architects and designers. Enjoy exceptional adjustability, punchy angles and smooth transitions for beam to field. Consider installation option with industry's most forgiving flange allowance for contractor goof. Ball plungers, field changeable optics and a new complete family of fixtures give you more ways to make space come alive. Fraxion — everything you've ever wanted, and a few welcome surprises, in a single fixture. PATENT PENDING.

[luciferlighting.com](http://luciferlighting.com)

**LUCIFER**  
LIGHTING COMPANY

### WOVEN LIGHT

The "PolyThread Knitted Textile Pavilion," designed by Jenny E. Sabin, is a glowing structure that uses photoluminescent and solar-active yarns to capture and deliver light. Currently on view as part of the exhibition *Beauty—Cooper Hewitt Design Triennial* at the Cooper Hewitt, Smithsonian Design Museum in New York, this portable and lightweight pavilion was constructed as a proposed solution for providing illumination to communities in parts of the world that have no access to electricity. Luminaires in the gallery simulate sunset and sunrise and enable the pavilion to demonstrate how it absorbs light during the day and radiates it at night. *Beauty* is on view through Aug. 21. [bit.ly/AL\\_Polythread](http://bit.ly/AL_Polythread) •

# Knowledge you can build on.



## Information you can count on.

Even if you're a veteran lighting professional, you never stop learning. The Lighting reSOURCE features information, education and inspiration powered by over 100 years of expertise to energize your lighting career. From LED toolkits and photo galleries to original feature content on emerging lighting trends, The Lighting reSOURCE gives you 24/7 access to the information you need to deliver world-class results. Enhance your lighting knowledge at [TheLightingResource.Eaton.com](http://TheLightingResource.Eaton.com).

# EATON

Powering Business Worldwide

Follow us on social media to get the latest product and support information.





### COLOR WHEELS

This light art installation at the Targetti stand was one of the highlights of Light+Building in Frankfurt this March. From Stockholm-based visual artist Aleksandra Stratimirovic and Athens, Greece-based lighting designer Athanassios Danilof, in collaboration with Targetti Sankey, "Color Wheels" was "created as a perceptual instrument to investigate the experience of color and light through temporal luminous color arrangements," according to the designers. The artwork is displayed in triptych form. Each section consists of six circles that are engaged in a concentric layout. The color sequence is generated using LED light strips. As the duo explains in the installation's accompanying statement, the viewer is engaged in a "visual experience [that] is stimulated by successive brightness, hue and saturation hierarchies of reflected light on each circle. The perceptual process is enabled in an attempt to investigate color harmonies and analogies as well as complementary, simultaneous and sequential color contrasts and chromatic afterimages. Visual constancy is challenged." [bit.ly/AL\\_ColorWheels](http://bit.ly/AL_ColorWheels) •

Elizabeth Donoff

# E kūlia i ka nu'u...



**B-K LIGHTING**.com

What will inspire you?

Come get inspired at LFI 2016 booth #1319





# Where technology and creativity come together

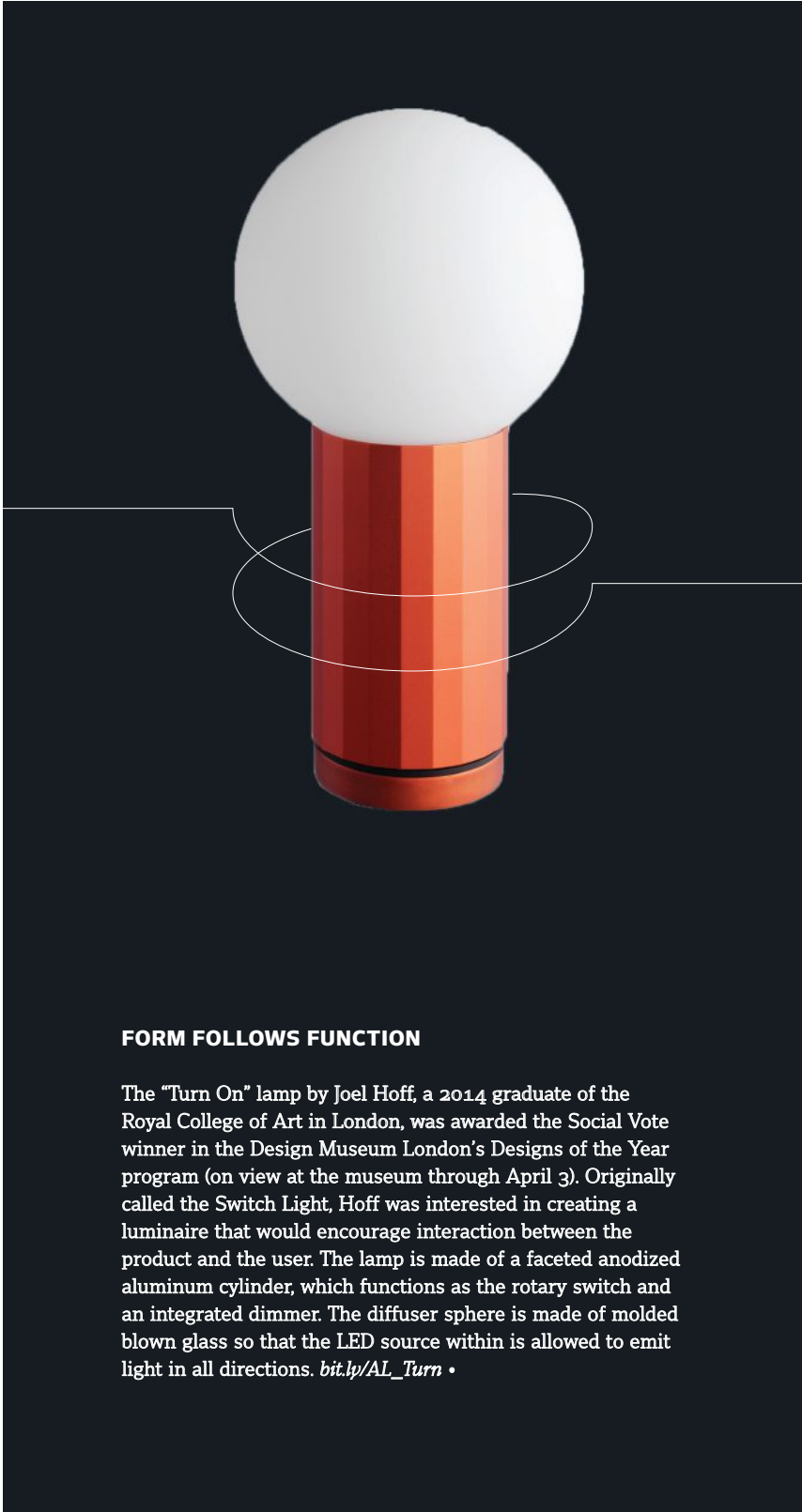
Whether you're looking for a source of inspiration or a reliable partner, Philips Lighting has the cost-effective, creative solutions you need to bring your lighting demands to life. Get the quality Philips portfolio of brands you've always trusted, with an approach that's unique and inspired by you.

innovation ✦ you

Photo credit: Darius Kuzmickas

See more ways that we take lighting beyond illumination at [philips.com/lighting](https://philips.com/lighting)

# PHILIPS



**FORM FOLLOWS FUNCTION**

The “Turn On” lamp by Joel Hoff, a 2014 graduate of the Royal College of Art in London, was awarded the Social Vote winner in the Design Museum London’s Designs of the Year program (on view at the museum through April 3). Originally called the Switch Light, Hoff was interested in creating a luminaire that would encourage interaction between the product and the user. The lamp is made of a faceted anodized aluminum cylinder, which functions as the rotary switch and an integrated dimmer. The diffuser sphere is made of molded blown glass so that the LED source within is allowed to emit light in all directions. [bit.ly/AL\\_Turn](http://bit.ly/AL_Turn) •

Courtesy Wrong for Hay

**PHILIPS**

**PHILIPS**  
COLOR KINETICS

**PHILIPS**  
LEDALITE

**PHILIPS**  
LIGHTOLIER

**PHILIPS**  
Day-Brite\*

**PHILIPS**  
LUMEC

**PHILIPS**  
GARDCO

**PHILIPS**  
HADCO

**PHILIPS**  
CHLORIDE\*

**PHILIPS**  
Stonco\*

**Learn more about our brands**

[philips.com/lighting](http://philips.com/lighting)

\*Available in US only

# ADVANCED HIGH CEILING

# METEOR



6" Cylinder / Recessed Downlight  
2000-10500lm | DMX | TRIAC



[www.meteor-lighting.com](http://www.meteor-lighting.com)



# LOS ANGELES: FAREWELL TO FILM NOIR SEPIA

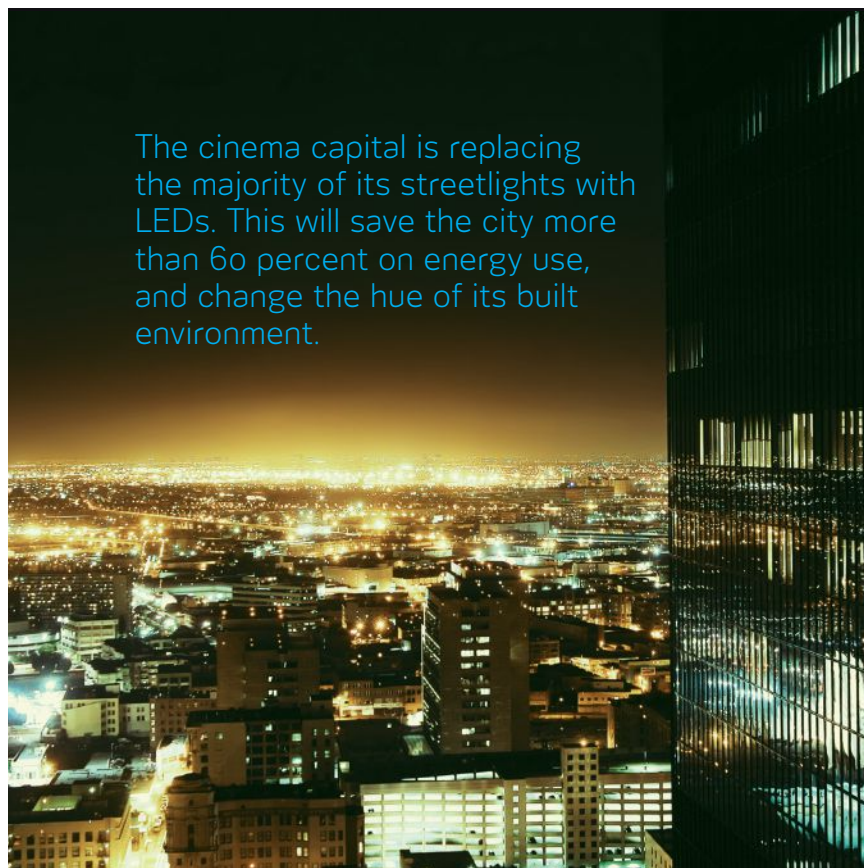
text by Bill Millard

The most prominent industry in Los Angeles—the film business—has long treated the city’s yellow-hued streetlighting as more of a celebrated feature than a drawback. The chromatic conventions of Southern California settings in the color-film era include a distinctively sallow nocturnal glow that is now vanishing from direct experience. The late Dave Kendrick, a film technician and writer for the website No Film School, lamented this loss in a December 2014 post, “Why Hollywood Will Never Look the Same Again on Film: LEDs Hit the Streets of LA & NY,” about a major LED streetlighting conversion program replacing a combination of high-pressure sodium (HPS, which makes up about 95 percent of the city’s total streetlighting), metal halide, mercury vapor, and incandescent light sources. The switch to LED streetlights faces no real obstacles, as the advantages in energy and monetary savings, along with the reduction of maintenance costs, are substantial.

Leading the lighting charge of Los Angeles’ decade-long effort to reduce energy consumption is Ed Ebrahimian, director of the city’s Bureau of Street Lighting (BSL). Ebrahimian credits an iterative evaluation process with helping the BSL achieve ever higher performance from its vendors as lighting technologies have advanced. The scale of L.A.’s program, which is the nation’s second-largest municipal streetlighting system after New York City’s, has afforded the city substantial leverage in its discussions with lighting companies. “We did not commit to one manufacturer,” he says. “We said what we’ll do [is] six months of testing of whatever is available in the market, and we pick the two best manufacturers and obtain pricing from them, and then we go with the lowest pricing that we receive from them for the next six months. Then we start the six-month evaluation process again.”

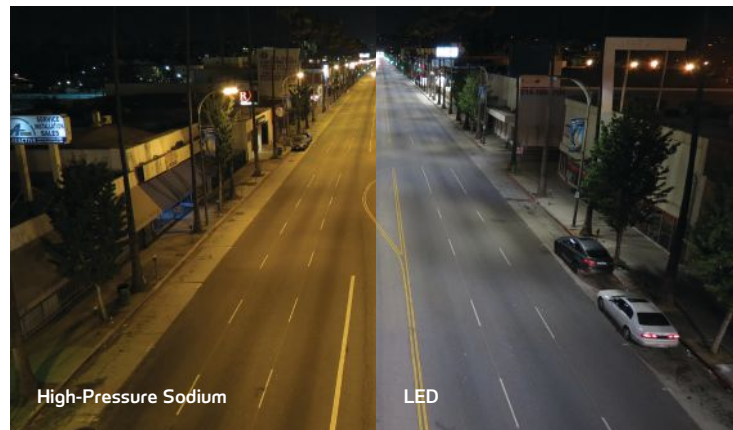
## PROS AND CONS OF EARLY ADOPTION

After seven cycles of this process, which started in February 2009, he says, “The technology is at a point that, more or less, a lot of manufacturers are very close to each other. Six years ago, that wasn’t the case. We challenged all the manufacturers.” Ebrahimian and colleagues investigated a range of color temperatures, up to a bluish-white 6000K, before settling on 4000K that, at present and despite concerns about lighting quality from the



The cinema capital is replacing the majority of its streetlights with LEDs. This will save the city more than 60 percent on energy use, and change the hue of its built environment.

With the adoption of LED streetlighting, L.A.'s nighttime ambiance has transformed from an amber to a bright white nocturnal glow. Here, a look at Van Nuys Boulevard, before, with high-pressure sodium lamps (left), and after the upgrade (right) to LEDs.



## DETAILS

**Scale:** Of the city's total 215,000 streetlights, which include more than 400 different styles, the original goal was the conversion of 140,000 streetlights, mainly focusing on the replacement of cobrahead-type fixtures.

**Progress:** 165,000 fixtures were converted from February 2009 to March 2016, and an estimated 7,500 new poles have been installed. The first phase was completed in June 2013; the second phase, currently underway, is retrofitting 70,000 decorative, historic-style streetlights.

**Financing:** \$57 million program, supported by \$40 million in financing from a loan by the LADWP and financed by Bank of America's "Green Bond," plus energy rebates and the city's Street Lighting Maintenance Assessment Fund.

**Energy Savings:** 60 percent reduction in energy consumption, equivalent to 60,000 tons of CO<sub>2</sub>; \$8.8 million savings realized annually, compared with \$15 million to \$16 million annual pre-program costs; system is currently at 63 percent energy efficiency.

**Equipment:** Cree (Ledway, XSP2, and XSP2L series); Leotek (GreenCobra and Ecobra); Philips (StreetView, CityTouch, and Philips/Ericsson SmartPole); Philips Hadco; American Electric; GE Lighting's LightGrid outdoor wireless controller

**Major Players:** Bureau of Street Lighting, Los Angeles Department of Public Works; Los Angeles Department of Water and Power; Office of the Mayor, City of Los Angeles; Clinton Climate Initiative; C40 Cities Climate Leadership Group; Bank of America

lighting design community, has become a de facto national standard. It's the "closest to the color temperature of the moon at night," Ebrahimiyan says. The city's minimum requirements also include specs for remote monitoring units that feature GPS locators, reporting of energy usage and electrical faults, and coordination with dimmers.

The BSL program has approved a succession of LED luminaires that offer the equivalent of eight power categories of HPS lamps for both commercial and residential streets, from 70W equivalents to 400W-plus equivalents. Lamps that achieve a 100W-equivalent illuminance at a 35W power consumption, for example, have superseded lamps from a few years ago that took 52W to achieve the same light output.

As an early player in the global conversion to solid-state lighting, Ebrahimiyan says that one of the greatest challenges the city has faced has been the absence of national standards for LED fixtures. Throughout the process, the BSL has had the opportunity to see the latest, most advanced products and, by providing feedback, has helped those standards to evolve.

At the outset of L.A.'s conversion initiative, "We had some second thoughts," Ebrahimiyan recalls. "Should we start now, or should we wait for the technology to change or to stabilize? Which took about five to six years." The BSL opted to realize early cost savings, with the flexibility to adopt more-efficient equipment as it became available. Ebrahimiyan acknowledges that the timing of investments may differ for cities with smaller energy bills. "When you have a large system, I think any time you have an opportunity to change it to an efficient system is good. If you have a very small system, maybe it's best to wait."

## SOLID-STATE VALUE

As the BSL began the streetlighting conversion, it opted to install all-new LED fixture heads atop existing poles rather than upgrade new LED modules for use in older fixture heads as some manufacturers suggested. "Warranties are extra important," Ebrahimiyan notes. "Once you remove a fixture and install a new [one] ... you start the warranty for that fixture that day, and the warranty stays intact up until the end of the warranty. If you put it [a new LED module] inside some other fixture, then all sorts of complications happen."

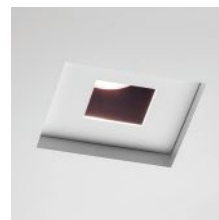
For new streetlighting installations, the BSL's directive is to specify only LED sources and fixtures. The impact on maintenance has been substantial. Repair-event counts dropped from 70,000 in 2008, before the



# A SIMPLY SUPERIOR LED

Providing superior lighting solutions to the design community, No. 8 Lighting's LED luminaires outperform the other downlights in installation, operation and function.

- Beautiful color 95 & 85 CRI
- Higher lumen output delivering up to 1200 lumens
- Expanded beam spread options including 13, 15, 25, 40, 70 and 14 x 50 degree
- Smaller, airtight IC housing—rated for spray foam and conventional insulation, in single and multi-lamp configurations
- Multiple dimming driver options
- Multi-step binning process with guaranteed maximum variation of 1 x 2 SDCM
- Interchangeable lamp modules (adjustable, fixed, wallwash and mirror reflector)
- Wide array of trims and finishes for almost any ceiling environment



ARCHITECTURE & INTERIOR DESIGN  
RICHARD LANDRY  
ROOM PHOTOGRAPHY  
ERHARD PFEIFFER

[8lighting.com](http://8lighting.com)



HONGLITRONIC  
鸿利光电  
stock code: 300219



LEDIA  
萊帝亞照明

LET EXCELLENCE DOMINATE



Over 1 Million Square Feet Base. More Than 2000 Employees.

**LIGHTFAIR® INTERNATIONAL 2016**  
San Diego Convention Center · San Diego, CA April 26-28, 2016  
**Booth No.: 6525**



**LED Linear Highbay Light**  
80/120/160W, 100-120lm/w, ETL/DLC  
Pending, 4ft, 0-10V Dimming  
Optional, Easy Hanging Kit



**LED Shop Light**  
30W-40W, 100-120lm/w  
ETL/DLC/4ft, Linear Linkable



**LED Wing-Pendant Light**  
30W-54W, 100-120lm/w, ETL/DLC/  
4ft, Linear Linkable  
0-10V Dimming Optional



**LED High Bay Light**  
60W, 80W, 110W, 150W, 180W  
100lm/w, ETL/DLC  
0-10V Dimming



**LED Vapor Tight Light**  
24W-60W, 100-120lm/w, ETL/DLC  
2ft&4ft, 0-10V Dimming Optional



**LED Flat Panel Light**  
30W/36W/54W, 100lm/w, ETL  
/UL/DLC, 2X2', 2X4', 1X4'  
0-10V Dimming Optional

**Guangzhou LEDIA Lighting Technology Co., Ltd**

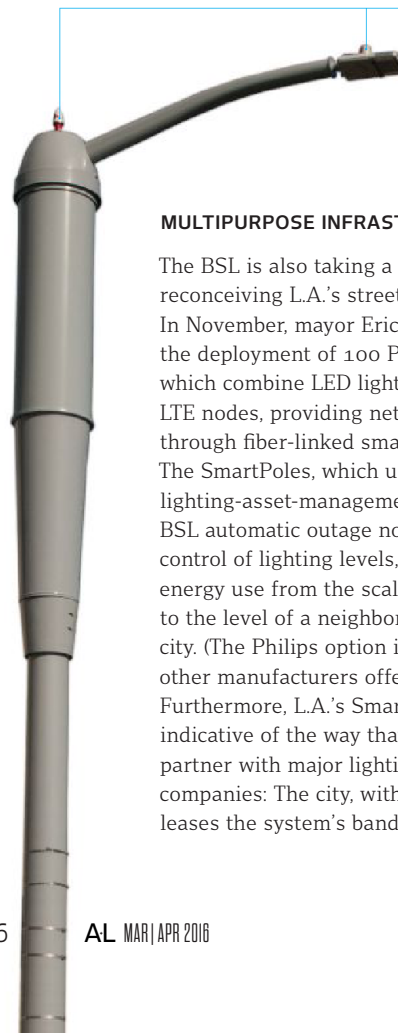
Factory Add: 1 Xianke 1st Road, Huadong Town, Huadu Dist.,  
Guangzhou, China  
E-mail: steven.deng@ledialighting.com | Tel: 0086-20-37706057  
US Add: 8 Bond St Ste 301 Great Neck, NY 11021  
US SALES OFFICE: QUICK RESPONSE & INSTANT SERVICE  
E-mail: sales@ledialighting.com | Tel: +1-516-504-8000  
www.ledialighting.com

## REPORT

program's rollout, to 46,300 in 2012. The new equipment has also reduced energy consumption by 60 percent, Ebrahimian says, and the lower power loads have eliminated longstanding problems with blown switches and fuses, so the program has not had to spend money replacing circuits underground. With the longer life of LED fixtures, once the system is fully deployed, the city expects to save \$2.5 million each year.

As in Detroit, copper theft has become a serious problem for Los Angeles over the past decade coinciding with a rise in copper prices. Ebrahimian notes that the BSL has responded by hardening pole boxes with fiberglass composite lids and bolts that tighten in ways that are harder to break. He estimates that this approach has succeeded in 99 percent of the areas served. Since "once you harden one area, the problem basically moves to the other block," these gains have also worked in tandem with tighter law enforcement and a subsequent decline in copper prices. While positive public reactions to the quality of light are one success of the program, Ebrahimian points to police data on nocturnal street crimes such as vandalism, burglary, and vehicle theft as another. Even amid general national improvement in crime statistics, he says that the city has seen a decline of about 10 percent in these offenses between 2008 and 2014, from the times of 7 p.m. to 7 a.m., all of which points to a meaningful correlation with the improved lighting.

L.A. has installed 100 Philips SmartPoles that couple LED lighting with network connectivity.



### MULTIPURPOSE INFRASTRUCTURE

The BSL is also taking a leading position in reconceiving L.A.'s streetlights as network hubs. In November, mayor Eric Garcetti announced the deployment of 100 Philips SmartPoles, which combine LED lighting with Ericsson 4G/LTE nodes, providing network connectivity through fiber-linked small-cell technology. The SmartPoles, which use Philips' CityTouch lighting-asset-management system, gives the BSL automatic outage notification, remote control of lighting levels, and extensive data on energy use from the scale of a single light point to the level of a neighborhood or the entire city. (The Philips option is just one possibility; other manufacturers offer similar systems.) Furthermore, L.A.'s SmartPole program is indicative of the way that many municipalities partner with major lighting and technology companies: The city, with Philips and Ericsson, leases the system's bandwidth to mobile



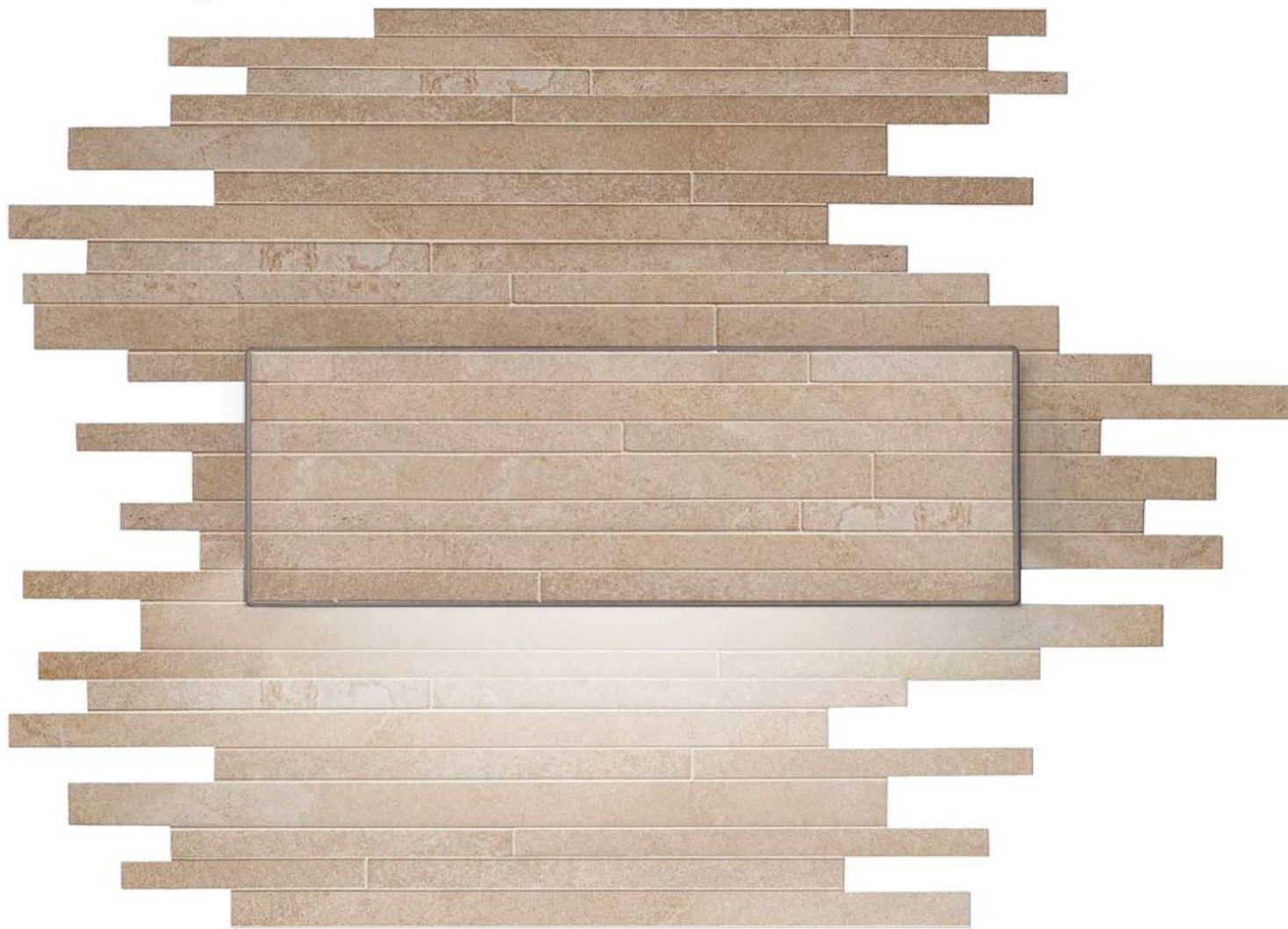
Creativity is more than just being different.

Anybody can plan weird; that's easy.

What's hard is to be as simple as Bach.

Making the simple awesomely simple,  
that's creative.

~Charles Mingus



The MIMIK series of fixtures gives the designer the ability to clad the fixture in any material they choose because being creative sometimes means keeping it simple. Available in multiple shapes and sizes both as a bollard or wall mount fixture; the MIMIK offers an assortment of lumen packages and optics to fit the needs of your next project. For more information on the MIMIK and other beautifully simple lighting visit [PRISMA Architectural a brand of Performance iN Lighting.](http://www.pil-usa.com)

BOOTH  
4706  
APRIL  
26-28  
San Diego  
Convention  
Center

**MX**  
—  
steps  
it up

**MX 3.5 Inch Downlighting Delivers up to 1850lm and Now Features:**

- A 50% increase in lumens
- Tunable White & Warm Dynamic Dimming
- All-new remodel construction housing
- Black, white, satin nickel, antique bronze and wheat architectural trim finishes

intense<sup>®</sup> | a LEVITON<sup>®</sup>  
LIGHTING | company

Visit it us at [www.intenselight.com](http://www.intenselight.com)

## REPORT

operators who install FCC-licensed wireless equipment in the poles, making the project self-funding. The city plans to add 500 more SmartPoles over the next four years.

San Jose, Calif., also recently announced a 50-SmartPole pilot program. If more cities follow suit, as many are, streetlights are poised to become a pivotal component of the ubiquitous communication environment known as the Internet of Things. With 5G connectivity on the way and cellular data traffic expected to

**The Los Angeles program offers a model of networked streetlights as a key component of tomorrow's "smart city": easier to maintain, easier to control, easier on the energy budget, and easier on the eyes.**

grow nine-fold by 2020, according to the June 2015 Ericsson Mobility Report, cities that use SmartPoles or equivalent systems will be better prepared for an information-saturated future.

Appropriately, in a city known for being image-conscious, the BSL maintains online maps that help citizens track the progress of the LED streetlighting conversion program and includes before-and-after images that dramatize the contrast in the appearance of various L.A. locations from 2002 to 2012. The bureau also distributes the L.A. Lights app, allowing individuals to report lighting problems via their iPhone or Android device. The BSL's LED program won a Bright Idea Award from Harvard's John F. Kennedy School of Government in 2012, and its partnership with the Clinton Climate Initiative adds media visibility.

The L.A. program has not only exceeded Ebrahimian's expectations, but the L.A. city government's as well, and has helped municipalities and the lighting industry advance LED streetlighting developments in the U.S. Moreover, it offers a model of networked streetlights as a key component of tomorrow's "smart city": easier to maintain, easier to control, easier on the energy budget, and arguably—despite pockets of nostalgia for the sepia tones of the HPS lamp—easier on the eyes. •

# IOLITE

## 1", 2" + 4" ADJUSTABLE MODULAR **LED** DOWNLIGHTS

Nora/NSpec Lighting is proud to introduce Iolite LED, the new 1" downlight and 2" and 4" adjustable. The die-cast aluminum trims in square and round designs feature sharp, clean edges. Aimed down for general lighting or adjusted to highlight or wall wash a focal point, the Iolite modular system allows users to field change the beam spread without the use of tools. The Iolite LED module produces 600-800 lumens at 95 CRI in various kelvin temperatures. The Iolite family comes in IC new construction, remodel, and 4" retrofit.



NIO Series

YOUR SINGLE SOURCE  
FOR LED LIGHTING



LED Sapphire  
850 to 8000 Lumen  
Architectural



LED Track  
Dedicated and  
Specifiable



LED Multiples  
1 to 3 Adj. Lights  
Flanged and Trimless



LED Panels  
Edge-Lit Technology  
2x2, 1x4, 2x4

**NORA | NSPEC**  
LIGHTING

Lightfair Booth # 2837  
Globalshop Booth # 2381

[www.noralighting.com](http://www.noralighting.com)

# CABRILLO BRIDGE

text by Elizabeth Donoff

photos by Steve Lerum Photography

Originally built in 1914 for the 1915–16 Panama-California Exposition, the Cabrillo Bridge is the main gateway to San Diego’s Balboa Park. For the park’s centennial in 2015, the spandrel-style concrete structure, which measures 769 feet long, underwent a major rehabilitation and seismic retrofit as part of a collaboration between the city and the California Department of Transportation that included a lighting treatment.

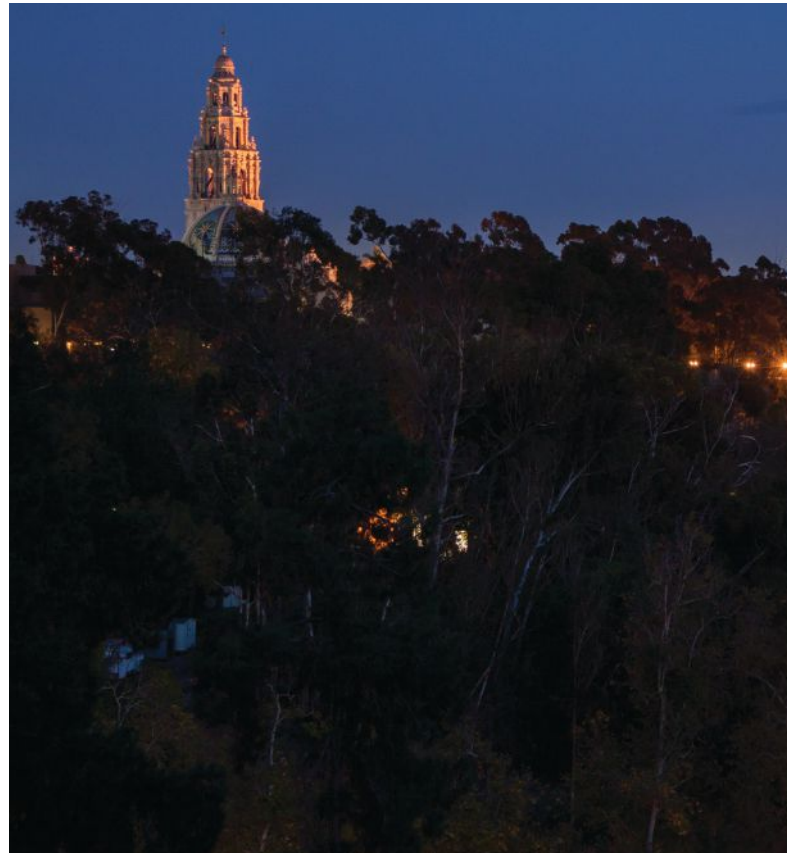
Engineering firm CH2M was hired to oversee the lighting; the company, in turn, called on Faith Baum, principal at New Jersey-based Illumination Arts (IA), a lighting design firm known for its expertise with bridges. Baum and IA’s senior designer Elizabeth Johnson embraced the challenges of the project brief and the site—the bridge crosses Cabrillo Canyon, along which runs state Route 163, host to more than 100,000 vehicles a day.

One of the more unusual aspects of the project was that the stakeholders already had an idea of how they wanted the bridge, which is listed on the National Register of Historic Places, to be illuminated: They wanted its façade lit. Baum and Johnson were quick to point out that this wasn’t the only possibility, and doing so would make the bridge appear flat. Using renderings and an elaborate on-site mock-up, the lighting designers showed that they could achieve the client’s desired effect by lighting the undersides of the seven 46-foot-wide arches rather than the bridge face. Lighting the arches would give dimensionality to the structure and its 14 piers, which vary from 60 to 129 feet tall, without interfering with the freeway below or the existing 70W high-pressure sodium streetlights on the bridge above (neither of which were part of the project scope).

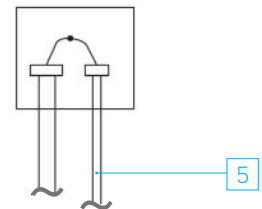
Bridges are one of the few project types that have been ahead of the curve in using LEDs, Baum says. When this project commenced in the summer of 2012, “The [LED] technology we had at the time was ready to do this project,” Johnson says.

The lighting strategy employs a single fixture type, a spotlight, but in two different sizes: 140W for the primary extra-large fixture and 50W for the smaller fixture used at the bridge’s end piers. The mock-up determined a client-preferred color temperature of 3000K. A precise linear spread lens aligns the fixture’s elongated beam with each pier leg. Pairs of fixtures sit at the base of each leg to achieve the cross-lighting effect.

As is often the case with complicated lighting projects that appear to have a simple solution, a tremendous amount of behind the scenes work



## Extra-Large Luminaire Installation Detail



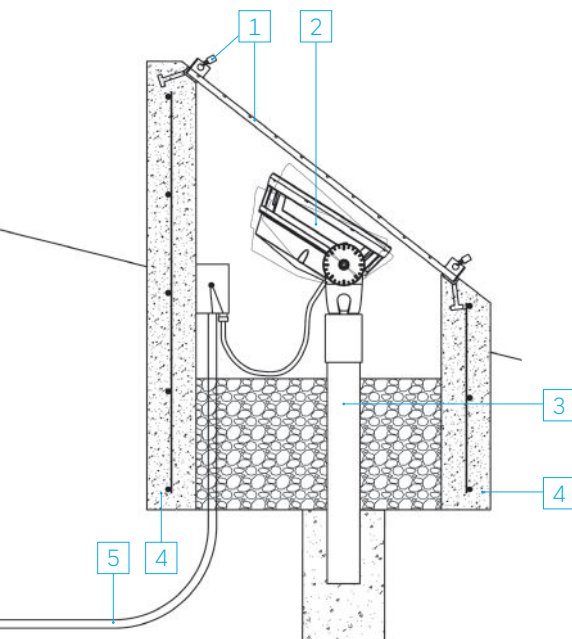
### Legend

- 1 Grate with grate lock
- 2 Fixture head
- 3 Fixture mounting pole
- 4 Concrete enclosure
- 5 Conduit to junction box





San Diego's Cabrillo Bridge, which passes over state Route 163, serves as the main gateway to Balboa Park. The illuminated tower of the Museum of Man sits off in the distance.



and coordination was involved. Because IA was not going to be on-site for the fixture aiming, Johnson spent a significant amount of time documenting the aiming points for the engineers. She determined the vertical and horizontal tilt for each luminaire so that they would all hit the correct locations on each arch. The slope of the site required a range of vertical aiming angles—from 123 degrees at the shallowest point to 150 degrees at the steepest. And adding to the complexity were the jogging paths that run along the slopes of the canyon. To prevent fixture tampering and to avoid blinding joggers, the designers built a custom concrete enclosure with a cover grate.

Surprisingly, this was the first time the bridge had been lit for aesthetic purposes. The lighting design successfully celebrates the structural form and enhances its nighttime appearance, all while furthering the landmark's significance for the local community. •

## DETAILS

**Project:** Cabrillo Bridge, San Diego • **Client:** City of San Diego partnering with California Department of Transportation (CALTRANS) • **Original Architect:** Thomas P. Hunter (bridge built in 1914) • **Engineer (lighting):** CH2M, San Diego • **Engineer (seismic retrofit):** T.Y. LIN International, San Diego office • **Lighting Designer:** Illumination Arts, Bloomfield, N.J. • **Project Size:** The spandrel-style concrete bridge has seven 46-foot-wide arches, 14 hollow piers, and measures 769 feet long • **Project Cost:** \$23 million • **Lighting Cost:** \$200,000 • **Code Compliance and Watts per Square Foot:** Not Applicable

## MANUFACTURER

**Lumenpulse:** Lumenbeam large and extra-large fixtures used throughout with a narrow-spot beam spread and a linear spread lens

# ANNUAL DAYLIGHTING PERFORMANCE METRICS, EXPLAINED

text by Kevin Van Den Wymelenberg,  
with Alen Mahić

A building interior filled with daylight is one of the most photogenic and iconic demonstrations of sustainable design. But until recently, it was anybody's guess as to what a "daylit" space looked like—and anybody's right to define measures of success as best suited for their project. The lack of consistency not only created confusion among designers, building scientists, owners, and occupants, but it also prevented fair comparisons between built environments and between design options.

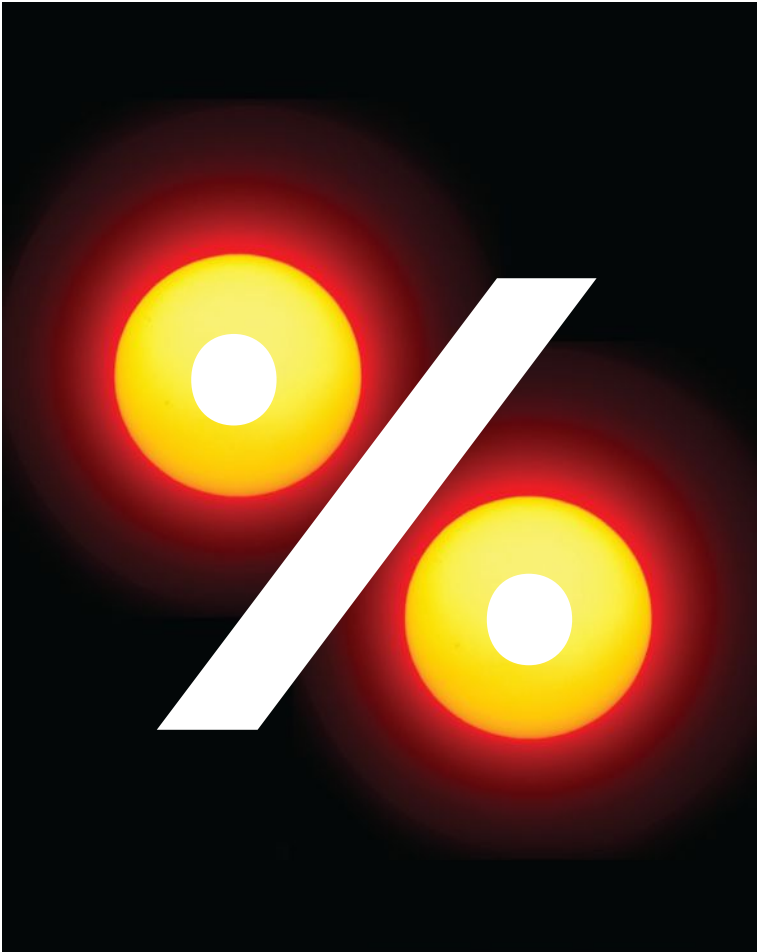
In 2000, the U.S. Green Building Council (USGBC) introduced the LEED rating system to standardize metrics for several primary sustainable design characteristics, including daylight. But equitable comparisons of daylight performance still weren't possible until 2013, when the Illuminating Engineering Society (IES) adopted and published the testing and calculation guide *Lighting Measurement 83 (LM-83), Approved Method: IES Spatial Daylight Autonomy (sDA) and Annual Sunlight Exposure (ASE)*.

LM-83 is the first IES-adopted, evidence-based annual daylighting performance metric in the lighting industry. It resulted from a six-year-long research effort by the IES Daylight Metrics Committee (DMC), led by the energy-efficiency consultant Heschong Mahone Group (now a part of the TRC Companies), that included human-factors field research in which subjects answered questions about their visual preferences and comfort levels in more than 60 spaces across three building types (classrooms, offices, and other) and several climate zones.

The DMC, an international team of about 15 daylighting experts, building scientists, designers, manufacturers, and code consultants, also

fostered the development of computational methods to run annual daylight simulations of the same spaces studied in the field, vetted the results, and crafted the resulting daylighting guidelines and criteria within LM-83. (Full disclosure: I have chaired the DMC since 2012, served as vice-chair from 2009 to 2012, and was a committee member before that.)

Also known as climate-based daylight metrics or dynamic-daylight metrics, sDA and ASE are now incorporated in



Adopted by the Illuminating Engineering Society, *Spatial Daylight Autonomy* and *Annual Sunlight Exposure* allow designers to quantify and compare the success of daylit spaces.

# UNICO<sup>5</sup>

CUSTOM LED ILLUMINATED MIRROR

The Unico 5 LED illuminated mirror is part of a series of frameless mirrors consisting of evenly placed bands of light. Custom sizes and optional features are available.

Explore all of our luxury mirror options available on our website at [www.aamsco.com](http://www.aamsco.com).



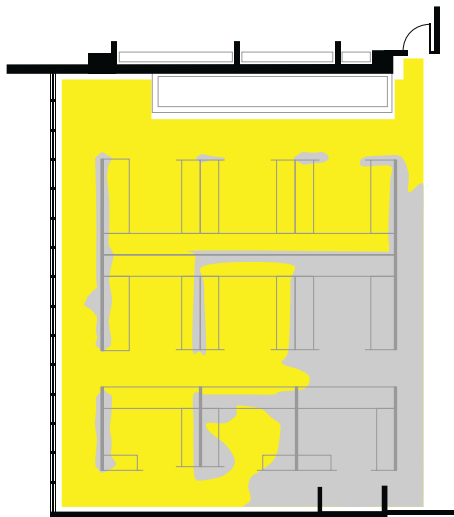
THE INTELLIGENT ALTERNATIVE SOURCE<sup>SM</sup>

**AAMSCO LIGHTING, INC.**

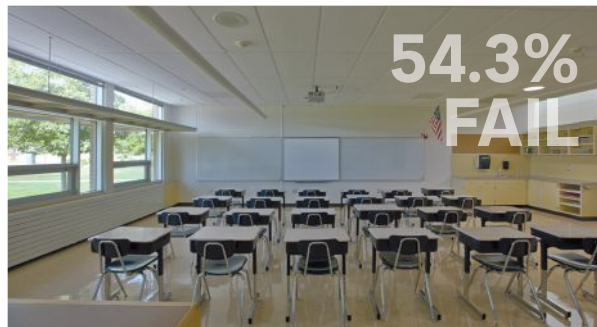
100 Lamp Light Circle  
Summerville, SC 29483

1-800-221-9092 • Fax 843-278-0001

**Figure 1. Spatial Daylight Autonomy (sDA) Evaluation**



Lighting designers can use sDA values to compare different spaces on equivalent daylighting terms. Based on simulations using LM-83's methodology, 68.5 percent of the office (top) achieves a minimum of 300 lux for half of the analysis hours, while only 54.3 percent of the classroom (bottom) does. Thus the office would have daylighting that is "nominally accepted" by users, while the classroom would fail the daylight sufficiency criteria by missing the 55-percent sDA mark.



**sDA<sub>300, 50%</sub>**  
 ■ 51%–100%  
 ■ 0–50%

common lighting analysis and design software packages, such as Diva-for-Rhino, OpenStudio, Radiance, Daysim, and LightStanza. The creation of LM-83 and these two annual daylight metrics have added rigor and complexity to daylighting design consultation and building performance assessment, and establish performance expectations that can be referenced in project specifications and owner's requirements.

**SDA: IS THERE ENOUGH DAYLIGHT?**

Spatial Daylight Autonomy (sDA) examines whether a space receives enough daylight during standard operating hours (8 a.m. to 6 p.m.) on an annual basis using hourly illuminance grids on the horizontal work plane. In lieu of collecting a year's worth of data in the field, sDA is calculated virtually through computational simulation with precise parameters. It references a local climate file—such as an EnergyPlus data file available from the U.S. Department of Energy—to run hourly illuminance maps in the lighting software packages, and incorporates an algorithm to approximate manual operation of window blinds.

Floor areas, or grid points, in the building model that achieve 300 lux for at least half of the analysis hours count as meeting the daylighting threshold. As a result, sDA values can range from zero to 100 percent of

MechoSystems makes the key automated window-shading ingredients for LEED® points in a number of categories. Our automated SolarTrac® WindowManagement® system, as an important example, is part of the recipe for the LEED Platinum-rated USGBC Headquarters.



**SolarTrac®**  
Ultimate in WindowManagement®

**MechoSystems**  
Design with light®

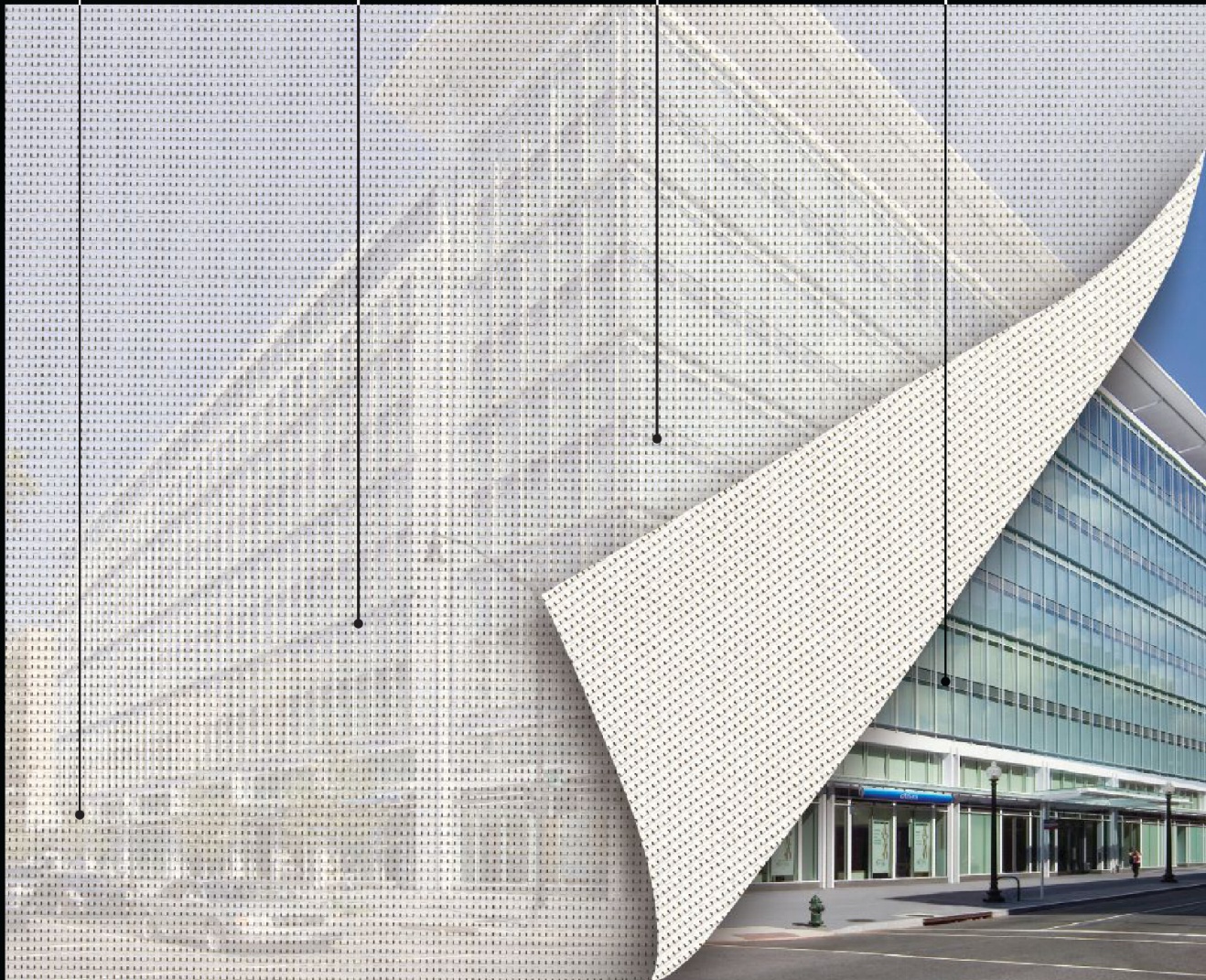
T: +1 (718) 729-2020  
F: +1 (718) 729-2941  
E: [marketing@mechosystems.com](mailto:marketing@mechosystems.com)  
W: [mechosystems.com/solartrac](http://mechosystems.com/solartrac)  
[@mechosystems](https://twitter.com/mechosystems)

SolarTrac calculates sun angles according to building and zone criteria.

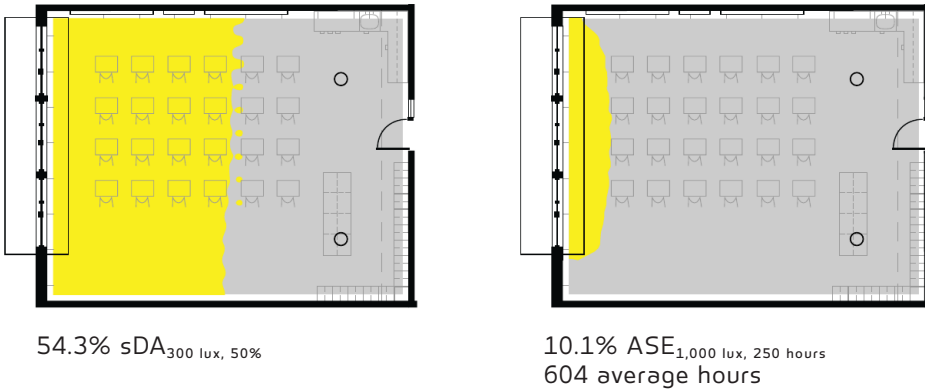
Natural light is optimized, and outside views are maximized.

Radiometers monitor real-time sky conditions to control shade positions.

Shades adjust automatically to eliminate glare and solar-heat gain.

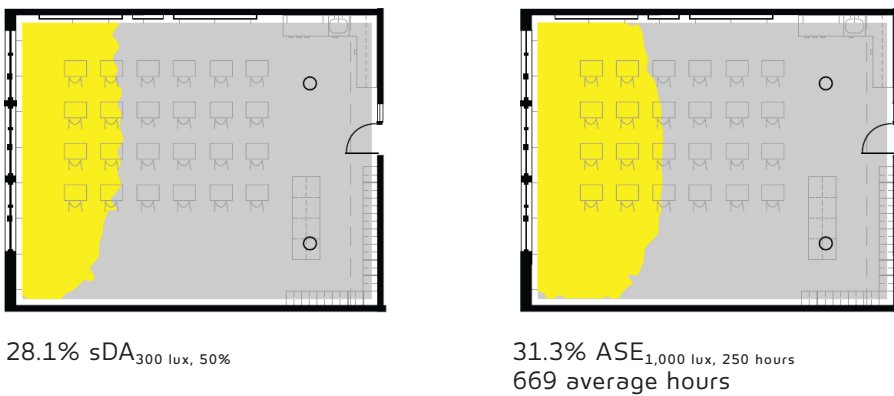


**Figure 2a. Classroom with Exterior Overhang and Light Shelf**



A classroom with an exterior overhang and light shelf (Fig. 2a) has a much higher Spatial Daylight Autonomy (sDA) score than a classroom without the features (Fig. 2b) due to the assumption that occupants would deploy manual blinds more frequently in the latter scenario. Adding an overhang and light shelf increases the classroom's sDA value from 28.1 percent to 54.3 percent, and decreases the Annual Sunlight Exposure from 31.3 percent to 10.1 percent, both of which are improvements according to LM-83. Note that tubular daylighting devices installed at the back of the classroom will likely provide more annual illumination in reality than what is captured through the simulation method.

**Figure 2b. Classroom without Exterior Overhang or Light Shelf**



**sDA<sub>300 lux, 50%</sub>**  
■ 51%–100%  
■ 0–50%

**ASE<sub>1,000 lux</sub>**  
■ 250+ hours  
■ 0–250 hours

the floor area in question. An sDA value of 75 percent indicates a space in which daylighting is “preferred” by occupants; that is, occupants would be able to work comfortably there without the use of any electric lights, and find the daylight levels to be sufficient. An sDA value between 55 percent and 74 percent indicates a space in which daylighting is “nominally accepted” by occupants. Lighting designers, therefore, should aim to achieve sDA values of 75 percent or higher in regularly occupied spaces, such as an open-plan office or classroom, and at least 55 percent in areas where some daylight is important.

**ASE: A PROXY FOR GLARE AND OVERHEATING**

With higher levels of daylight sufficiency comes the potential for glare and solar heat gain. That’s where Annual Sunlight Exposure (ASE) steps in. Meant to complement sDA, ASE is intended to help designers limit

Light + Acoustic

SATTLER



Soft Delta



Sof Quadra



Luce Verde Anello

Sattler produces beautiful lighting elements in multiple shapes and sizes to illuminate a space and excite the senses

Acoustical fabric or organic moss diffusers create a beautiful lighting effect as well as sound dampening

**inter•lux**  
tools for lighting

[inter-lux.com/sattler](http://inter-lux.com/sattler)  
[answers@inter-lux.com](mailto:answers@inter-lux.com)

## Meant to complement Spatial Daylight Autonomy, Annual Sunlight Exposure is intended to help designers limit excessive sunlight in a space.

excessive sunlight in a space. While ASE is a crude proxy for glare phenomena, it measures the presence of sunlight using annual hourly horizontal illuminance grids rather than luminance measures, so it is technically not a glare metric.

ASE uses a simulated 1,000 lux as an indicator value for sunlight, but the simulated value can differ significantly from what is measured in the physical world, which considers secondary bounce-off surfaces. Like sDA, ASE values range from zero to 100 percent, with the latter suggesting that the entire floor area of the space in question exceeds the simulated value of 1,000 lux for at least 250 hours per year. Thus, to reduce the potential for glare and thermal stress, designers should aim for low ASE values.

LM-83 provides preliminary guidance for recommended ASE limits, cautioning that spaces with ASE values exceeding 10 percent will likely result in visual discomfort. The DMC is presently refining the criteria for recommended practice of interpreting ASE results, but designers can use ASE immediately to make relative comparisons among proposed design options. In the future, the DMC will provide better criteria to guide absolute performance thresholds using ASE.

The sunlight analysis method implemented in simulations using LM-83's methodology to calculate ASE is also used to trigger the human operation of manual blinds, which affects the determination of sDA. As a result, areas with high ASE values may have lower sDA scores because the algorithm assumes building occupants will close window blinds or draw the window shades manually if excessive sunlight persists.

### THE FEEDBACK

Since publishing LM-83 in 2013, DMC members have been actively educating designers worldwide through presentations and soliciting feedback from early adopters who are implementing sDA and ASE calculations in their software packages, and from designers using the software to inform their work. Feedback has been as varied and lively as the debate among IES DMC members during the process leading up to the publication of LM-83. But there have been a few repeated questions:

First, can a space with the right amount of daylight for one task, say classroom learning, be adequate for all other tasks, such as office-computer work? This is a limitation of the current version of LM-83. The next iteration of the guidelines may provide more nuanced criteria by space and use type.

Second, why does the algorithm simulating the use of manual blinds in the software programs seem to behave like an automated shading system? After LM-83 was released, several new studies on manual blind use were published. These will inform future versions of LM-83, and likely reduce the frequency of operation from the current manual blind algorithm.

Third, why does LM-83 use the same performance criteria to evaluate a building in Anchorage, Alaska, as it does a building in San Diego, when the former has significantly less potential for annual daylight hours? Since LM-83 only includes surfaces at 300 lux at 50 percent time in its sDA value, the theoretical maximum value for sDA is still 100 percent, even in Anchorage. That said, it is more difficult to achieve the recommended criteria in northern latitudes with fewer hours of daylight.

### RESOURCES

Below is an introductory list of resources and articles on LM-83 and its development.

"Dynamic Daylight Performance Metrics for Sustainable Building Design," by Christoph Reinhart, John Mardaljevic, and Zack Rogers, *Leukos*, 2006. Available at [bit.ly/1Rw3uaU](http://bit.ly/1Rw3uaU).

"Daylight Metrics and Energy Savings," by John Mardaljevic, Lisa Hescong, and Eleanor Lee, *Lighting Research & Technology*, 2009. Available at [1.usa.gov/1ReG9ay](http://1.usa.gov/1ReG9ay).

*Lighting Measurement 83 (LM-83), Approved Method: IES Spatial Daylight Autonomy (sDA) and Annual Sunlight Exposure (ASE)*, by the IES Daylight Metrics Committee, IES, 2012. Available at [bit.ly/1UA26EF](http://bit.ly/1UA26EF).

"Predicting the Daylit Area—A Comparison of Students Assessments and Simulations at Eleven Schools of Architecture," by Christoph Reinhart, Tarek Rakha, and Dan Weissman in *Leukos*, 2014. Available at [bit.ly/1RgDzyF](http://bit.ly/1RgDzyF).



# What do Dorothy, Kansas and NoUVIR have in common?

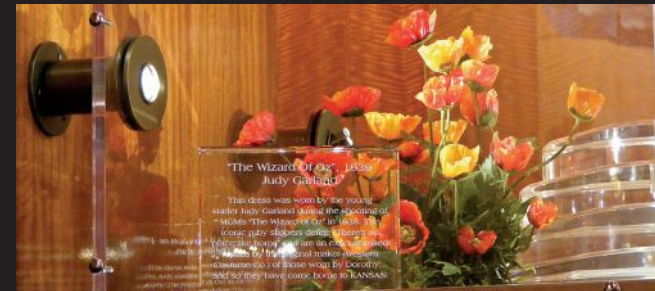
This original, 78-year-old, one-of-a-kind, film test dress performs in Kansas 365 day a year. (In November a second movie shoot dress worn by Judy Garland sold for 1.56 million dollars.) This deserves to be center-stage, free from glare and reflection and totally safe from UV and IR. It deserves NoUVIR! Beautiful! Safe! Energy efficient! We invented museum lighting!



## How did they do that?



A \$12.00 lamp in a NoUVIR® projector powers...



12 aimable luminaires hidden in case supports...



along with two true 5° beam pinspots in the 14' tall ceiling (12" beams from 12' throws with no scatter or spill)...

to add sparkle and highlights to Dorothy's ruby slippers, crystal texts or other details.



## NoUVIR LIGHTING!

302 628-9933

[www.nouvir.com](http://www.nouvir.com)

Perfect control over aim and focus, perfect color and balance, a 10-year warranty and absolutely no UV or IR...

There's no place like NoUVIR!

## DMX CONTROL

**Times Square Lighting's range of DMX controlled LED fixtures are ideal for museums, retail stores, restaurants, and light labs.**



**Manufacturing Center:**  
5 Holt Drive • Stony Point, NY 10980  
PH: (845) 947-3034 • FX: (845) 947-3047  
[tslight.com](http://tslight.com) • [info@tslight.com](mailto:info@tslight.com)

### THE FUTURE

For now, sDA and ASE are most applicable to space types similar to those the DMC evaluated in the research—namely classrooms, offices, and other common commercial spaces, such as lobbies and conference rooms. The DMC recommends further refinement of performance criteria by space type, but this requires additional research to provide satisfactory evidence for these new criteria.

A broad way to address questions about LM-83 is to consider the model for building codes and performance certification programs, such as LEED. Building codes for energy and life safety simplify problems and create compliance pathways that can be enforced economically by jurisdictions. Performance certification programs reward projects that exceed best practices and, in doing so, define specific thresholds against which designs can be evaluated.

The DMC wrestled with ways to make sDA and ASE applicable to designers in support of decision making, while also anticipating that code and standard organizations would adopt and implement them. In fact, LEED v4 aims to include sDA for an additional credit beyond the existing daylight-compliance pathways.

Inevitably, in the process of creation, designers will test and challenge the noble efforts of codes and standards committees. Science answers one daylighting performance question and art finds good reason to throw it out and ask different questions. This reality signifies the urgent need for increased funding to support evidence-based research and revisions to refine—or redefine—established metrics and criteria.

In the meantime, lighting designers should reach for high sDA values while implementing strategies to lower ASE values, and strive to lower ASE values without sacrificing sDA. They should do this not because a particular certification program may reward a project with an extra point, but simply because it's a matter of good design. •

**Kevin Van Den Wymelenberg** is an associate professor at the University of Oregon, where he directs the Energy Studies in Buildings Laboratory (ESBL). He is also the chair of IES's Daylight Metrics Committee.

**Alen Mahić** is a research assistant at ESBL with a focus on digital daylight and energy simulation.



# The Chicago Cubs' 1st Pick

See why they chose us as the lighting control backbone of the Chicago Cubs' enhanced Wrigley Field and the 1060 Project.

Visit LFI Booth #2345.

# AUDACY™

## BE AUDACIOUS

Learn more at [audacywireless.com](http://audacywireless.com)



ADVANCED WIRELESS SOLUTIONS BY

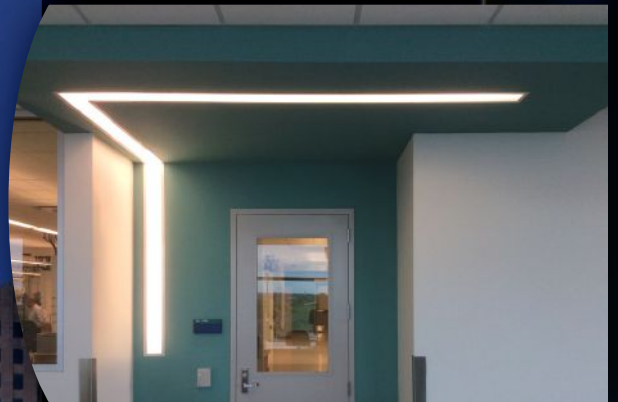


System solutions by PAL's Microlinea Series 5 LED:  
[www.pal-lighting.com/systemsolutionsA](http://www.pal-lighting.com/systemsolutionsA)



+1.713.946.4343  
[www.pal-lighting.com](http://www.pal-lighting.com)

REALIZE YOUR VISION:  
**INSIDE AND OUT**





# 2016 ANNUAL PRODUCTS ISSUE

text by Elizabeth Donoff

With nearly 500 products submitted for this year's Annual Product Issue, it's fair to say that the lighting industry is in a healthy state. From that impressive group, ARCHITECTURAL LIGHTING has selected 168 products across 12 product categories, all of which represent both the lighting industry's diversity and its recent technological achievements.

Since the introduction of LEDs about a decade ago, there has been a seismic shift in the industry, encompassing everything from how fixtures are developed to how designers use the new source. The lighting community has felt its fair share of growing pains and the industry as a whole has made the adjustments necessary. To be sure, there are still areas for continued improvement and further research, such as in optics, lighting quality, and component compatibility, but, in general, the products on the following pages represent the continued maturation of LED fixtures.

These are not the products of yesteryear. A luminaire has become so much more than an object that delivers light; sophisticated functions and lighting controls are now standard for many fixtures and these features provide a baseline for the current generation of product offerings. The transition from analog to digital can be seen in all aspects of the industry, and in this, the third edition of our issue-accompanying Technology Trends series, we examine how the Internet of Things, color, LED price points, and the digitization of product libraries and literature is shaping the next generation of products. As always, our product coverage serves as a reference guide to the best that the industry has to offer. •



**Mush, Jader Almeida** • These floor or table (shown) and suspension luminaires feature a brass frame and a transparent glass diffuser. Created by Brazilian industrial designer Jader Almeida, the luminaires are currently being distributed in the U.S. by Artefacto, which has showrooms in Florida. The standing fixture measures 20" tall by 15" wide, and showcases the designer's use of clean lines and timeless materials. • [artefacto.com](http://artefacto.com)



**Phase, Two.Parts** • The diffuser on this futuristic-looking pendant has been 3D printed from ceramic and glazed to create a warm glow when illuminated with the integrated 2.5W LED. Available in 2700K and delivering 280 lumens, the roughly 5"-square fixture head conceals the light source, wiring, and connectors. The housing is offered in white and black with a choice of a white, black, red, orange, yellow, green, or blue cord. • [two.parts](http://two.parts)

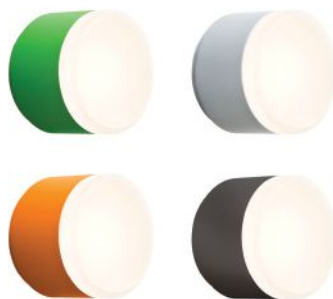


**Ethos Collection, Global Lighting**

• Danish designer Tom Rossau is bringing his luminaire designs to the U.S. in a new collaboration with Global Lighting for 15 fixtures in its Ethos Collection. The pendants (TR10, shown) use either LED or fluorescent sources ensconced in materials that include birch and oak veneers, brushed aluminum, polypropylene, and coated paper that have been bent, twisted, and pleated to create visually dynamic shades. • [globallighting.com](http://globallighting.com)



**Copycat, Flos** • London-based designer Michael Anastassiades uses a small metallic orb to support a larger illuminated one in Copycat, a tabletop fixture. The 16W luminaire features a hand-blown opal glass diffuser and is lamped with a single chip-on-board LED in 2700K with a CRI of 83 that delivers 1,380 lumens. The base is 3.5" wide and is made of aluminum finished in galvanized 24-karat gold, polished aluminum, black nickel, or copper. The diffuser is 11.8" wide by 11.9" tall. For use indoors. • [usa.flos.com](http://usa.flos.com)



**Omni, Creative Systems Lighting**

• A machined acrylic diffuser and aluminum housing pair in this flush-mount wall sconce, which can be specified as a single unit or in multiples. The 12W LED Omni comes in 2700K with a CRI of 90 and delivers 840 lumens. Dimmable, it is offered with a concave, stepped, inner-stepped, or flat diffuser. Finishes include galvanized, semigloss white, matte black, and lime green. The fixture is UL and cUL listed for damp or wet locations. • [csllighting.com](http://csllighting.com)



**Fiamma 15/30, Artemide**

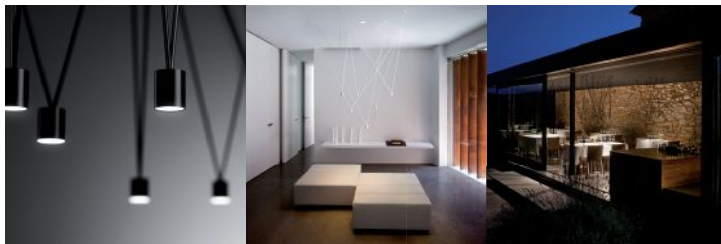
• This floor and suspension luminaire completes the company's Fiamma family of fixtures. Now in floor, ceiling, and suspension models, it is available in 3000K with a CRI of 95 and an efficacy of 55 to 77 lumens per watt, depending on the model. Designed by Paris-based architectural firm Wilmutte & Associés, it has a 3D geometric surface made of machined aluminum and can be finished in a choice of anodized gray or black. • [artemide.com](http://artemide.com)



## Match...

**A new concept based on co-creation.**

Design by Jordi Vilardell & Meritxell Vidal.



Visit [www.vibia.com](http://www.vibia.com) to discover, create and inspire.

 [facebook.com/vibia.light](https://facebook.com/vibia.light)  [twitter.com/#/VibiaLight](https://twitter.com/#/VibiaLight)

VIBIA, INC. 272 Fernwood Ave. Edison, NJ 08837. P. 732 417 1700. F. 732 417 1701. [sales@vibialight.com](mailto:sales@vibialight.com)

**VIBIA**  
LIGHT IS CREATION



**Gravy LED Wall Sconce, Konzept**

• This wall sconce uses edgelit technology to emit warm and even illumination. The fixture head is fitted with a dimmable 5.5W LED in 2700K and is attached to a circular plate that can be adjusted on a swivel track to direct light to the user's liking. Gravy can be specified in 15 combinations of finish materials including chrome, oiled-walnut veneer, felt, and water-based paint. It is available in either hardwired or plug versions. • [konzept.com](http://konzept.com)



**Kone3 LED, Delray Lighting**

• In pendant and semi-recessed mounting options, this LED fixture provides direct and indirect light. It is available in 2700K, 3500K, and 4000K with a CRI of 92 and has a 120-degree beam spread. Zero-to-10V dimmable down to 15% or phase-control and zero-to-10V dimmable down to 1%, the fixture comes as either a 21W unit delivering 2,000 lumens or a 31W unit delivering 3,000 lumens. Options for opal or clear glass shades afford a contemporary appearance. • [delraylighting.com](http://delraylighting.com)



**City Loft, Kichler**

• This contemporary pendant, with its rotatable arms, can be adjusted to suit a variety of styles and applications. A white opal-etched glass diffuser shields a single A21 lamp with a medium-base socket. The fixture measures 21.25" tall by 16.25" wide, and it comes with a 36" chain. It is finished in a choice of nickel, bronze, or brass. The collection also includes a 17.25"-tall wall sconce. • [kichler.com](http://kichler.com)



**Tartan, Foscari**

• From Milan-based designers Ludovica and Roberto Palomba, the matte-glass Tartan pendant emits both diffused and direct light and is made of white glass that has been blown into a mold with the engraved pattern to create a raised relief on the fixture's surface. Acid etching adds the look of material softness. The fixture can be lamped with a single 100W E26 halogen lamp or a single 26W LED. It measures 13.75" in diameter, and it can be suspended 74.75". • [foscarini.com](http://foscarini.com)



**Suspenders, Sonneman**

• For use in open spaces, this modular kit of parts includes power bars, rods, cables, and pendants that lighting designers can use to create large-scale installations that are both architectural and luminous. Pendant options include crystal and etched glass in oval, drum, ball, and chiclet shapes. The remote-controlled power bars come in 24", 36", and 48" lengths, with a black satin finish. • [sonnemanawayoflight.com](http://sonnemanawayoflight.com)



**Pin-Up, Studio Italia Design**

• A 90-degree hinge on this wall sconce allows users to move the fixture head in order to alter the amount of illumination it provides. A single 8.7W LED in 3000K delivers 650 lumens. The luminaire measures approximately 6" tall by 4" wide, and its metal frame can be specified in three finishes: matte white, coppery bronze (shown), and chrome. • [sid-usa.com](http://sid-usa.com)





**Oberlin, Feiss** • Clear beading accents this orb-style pendant, which is fitted with two 14W LED modules that direct light upward and downward, delivering 1,000 lumens at 2700K with a CRI of 90. Dimmable, it comes in a satin nickel finish in two sizes: 25.63" tall by 20" in diameter or 43.75" tall by 32" in diameter. • [feiss.com](http://feiss.com)



**Togon Grande, LBL Lighting** • This spun-metal shade's geometric symmetry evokes that of hand-spun pottery, and comes either fully or partially painted with an aluminum ring. A white cord completes the contemporary aesthetic. The pendant has an E26 base for incandescent or LED lamping options; the latter is available in 2700K with a CRI of 80, delivers 1,980 lumens, and is dimmable via a low-voltage electronic dimmer. The shade measures 13" tall by 20" in diameter. • [lblighting.com](http://lblighting.com)



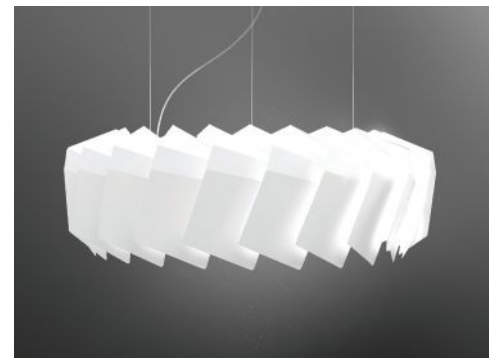
**Patera, Louis Poulsen** • Inspired by the Fibonacci sequence, this globe-shaped pendant's matte-white PVC shade features cutouts engineered to shield the light source from view while creating a warm, even glow and directing illumination downwards. It comes in 2700K and 3000K with a minimum CRI of 80, and it can be lamped with incandescent or LED light sources. It measures 23.6" in diameter by 23.9" tall and has a PVC power cord or stainless steel aircraft cable for suspension. • [louispoulsen.com](http://louispoulsen.com)



**Ignis, Cerno** • Southern California industrial design studio Cerno has partnered with New York-based lighting design firm iCrave Lighting to produce Ignis. The industrial-chic pendant pairs either a maple or a walnut frame with a shade that can be specified in brass (shown), aluminum, rose gold, or glossy white finishes. The shade is available in two sizes—11.5" by 17" and 14.75" by 24"—with corded or rigid suspension. • [cernogroup.com](http://cernogroup.com)



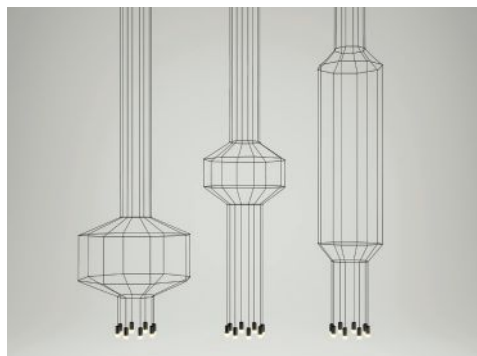
**Layers, Axo Light** • This line of eight large-scale ceiling-mount or pendant luminaires features single- or multicolored diffusers. Each luminaire produces direct downward and diffused ambient light, and is intended for commercial, hospitality, and institutional applications. Shade sizes range from 36.6" to 60" wide and from 37.75" to 119.6" tall. Lamping options include sets of three, nine, or 15 dimmable, 17W GU24 LEDs or 26W E26 compact fluorescent lamps. • [axolightusa.com](http://axolightusa.com)



**Moto, Eureka Lighting** • Thermoformed polymethyl methacrylate fins are arranged in a circle to form this suspension luminaire, whose shade diffuses light while creating a sense of motion. Moto is lamped with a 64W LED light engine in 3000K and 4000K and has a zero-to-10V dimming driver. Three aircraft cables suspend the fixture up to 74.4" from the ceiling and it can be adjusted on-site. It measures 38.4" wide by 12.6" tall. • [eurekalighting.com](http://eurekalighting.com)



**Dove LED, Modern Forms** • The Dove LED table and floor lamps feature slanted forms and a streamlined frame that integrates touch dimming and a USB port. The table version is 18" tall with a 12"-long arm, while the floor model (shown) is 54" tall and has a 13"-long arm. Both are available in 3000K with a CRI of 85, and run on a 120V/220V system. Titanium and black finishes are offered. • [modernforms.com](http://modernforms.com)



**Wireflow, Vibia** • Lacquered rods and black electrical wiring turn simple pendants into full-scale installations. Conceived by Israeli-born designer Arik Levy, the surface-mounted, sculptural Wireflow can be customized in two- and three-dimensional arrangements whose ends are fitted with dimmable 3W or 3.7W LED lamps featuring pressed-glass diffusers that direct ambient illumination in all directions. The surface-mounted system is 1V-to-10V electronic dimmable. • [vibia.com](http://vibia.com)



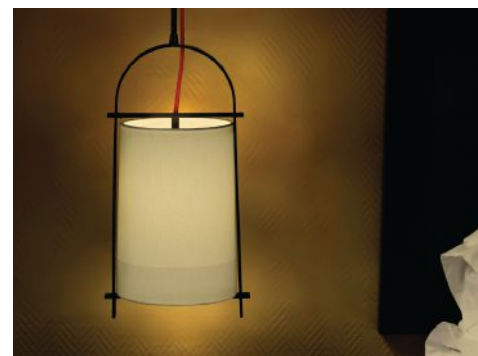
**Transit, Progress Lighting** • This streamlined, 14"-square LED surface-mount luminaire uses a 120V AC light source, eliminating the need for a driver. Available in 3000K with a CRI of 90, it is fitted with two LED modules at 17W each behind a white acrylic diffuser. The fixture's steel construction is finished in plated-brushed nickel and covers a standard, 4" recessed outlet box. It extends 3.75" from the ceiling. • [progresslighting.com](http://progresslighting.com)



**Zita, Molto Luce/Ledra Brands** • A press-formed aluminum shade with two side slats for accent illumination shapes this pendant, which is offered in 7.8", 11.8", 15.7", and 23.6" widths for use in hospitality and residential applications. The fixture runs on 230V and has a single E27 base. It can be suspended on a cable up to 9.8' and provides toolless adjustability. The shade comes with a white-painted exterior and the option for either a white- or melon-painted interior. It is IP20 rated. • [moltoluce.com](http://moltoluce.com)



**Calcite, Ligne Roset** • These pendant and floor fixtures pair white Carrara marble and milled steel. The pendant's circular flat marble shade is roughly 3" in diameter and 0.8" thick, suspended from a 59" black electrical cable. A 13W LED module in 2700K provides 940 lumens. The floor version is 68.9" tall with a steel base and stem and a head made of polished white Carrara marble. It has a foot-operated switch and dimmer, and is lamped with a 16W LED in 2700K delivering 1,280 lumens. • [ligne-roset-usa.com](http://ligne-roset-usa.com)



**To-Ji, Boyd Lighting** • Created with San Francisco designer Jiun Ho, To-Ji comes as a pendant or wall sconce. The line is named after the To-Ji, or East Temple, in Kyoto, Japan, and features a curved metal frame that emulates the form of a water bucket to evoke Buddhist principles of simplicity. The pendant comes in 18" and 24" frame heights and the sconce is 18" tall. Finish options include brass, nickel, and gold, and cord colors include charcoal, dark olive, and red. • [boydlighting.com](http://boydlighting.com)

**NEW!**



**FOREST LIGHTING**

Sustainable illumination



**univ8™**  
LED T8

*Install with or  
without a ballast.*

See us at Lightfair!  
Booth 1311

## Ballast. Or no ballast. You choose.

Introducing UniV8™ LED T8 Lamp. The all-purpose lighting retrofit solution.

New from Forest Lighting, a universal T8 LED lamp, designed for retrofitting lighting fixtures with a ballast... or without. UniV8 is easy to install; you can use the existing ballast with no rewiring, or direct wire without the ballast. Available in 15W and 19W, and four color temperatures. Visit our website or call us today for more information on the new UniV8 LED T8 Lamp.

### Affordable Performance.



**LED Human-Centric Troffer Retrofit Kit, ABBLighting** • For use in patient rooms, this 2' by 2' troffer mimics the sun's shift throughout the day and can be tuned from 2700K to 6500K at a CRI of 80-plus thanks to a wireless adjustable driver. The fixture can be controlled using a remote or a mobile app. Dimmable, it comes in 18W, 25W, and 32W models and delivers up to 3,250 lumens. • [abblighting.com](http://abblighting.com)



**M-LED My White, Selux** • Available with tunable white light from 2700K to 6500K, this family of dimmable, linear luminaires is suited for use in offices and schools as well as patient spaces in healthcare applications. The company recently added 2.4" and 3.9" widths to the existing 1.4" option. Six lens distributions are offered, including symmetrical, asymmetrical, and batwing. Mounting options include pendant, surface, recessed flanged and flangeless, and wall options. • [selux.us](http://selux.us)



**Tilt Linear Product Series, Lauren Illumination** • Intended for use in classrooms, offices, hallways, and retail lighting applications, this light panel series comes in dimensions ranging from 4" wide by 48" long to 10" wide by 48" long. Custom sizes are also offered. The fixtures are available in 3000K, 3500K, 4000K, and 5000K with a CRI of 80-plus or 90-plus and provide between 450 lumens and 500 lumens per foot. Grid- and flush-mount versions are available. • [laureninternational.com](http://laureninternational.com)



**Mirel LED, Zumtobel** • For retrofit applications, this louvered fixture features lenses and a light source that are visible to the user, with optics offering directional and batwing light distribution. The fixture is available in 3000K, 3500K, and 4000K with a luminous flux from 2,800 lumens to 3,800 lumens and a CRI greater than Ra80. Dimming includes zero-to-10V and DALI. Installation options include lay-in, recessed or surface-mounted, and high-output/high-efficiency. • [zumtobel.us](http://zumtobel.us)



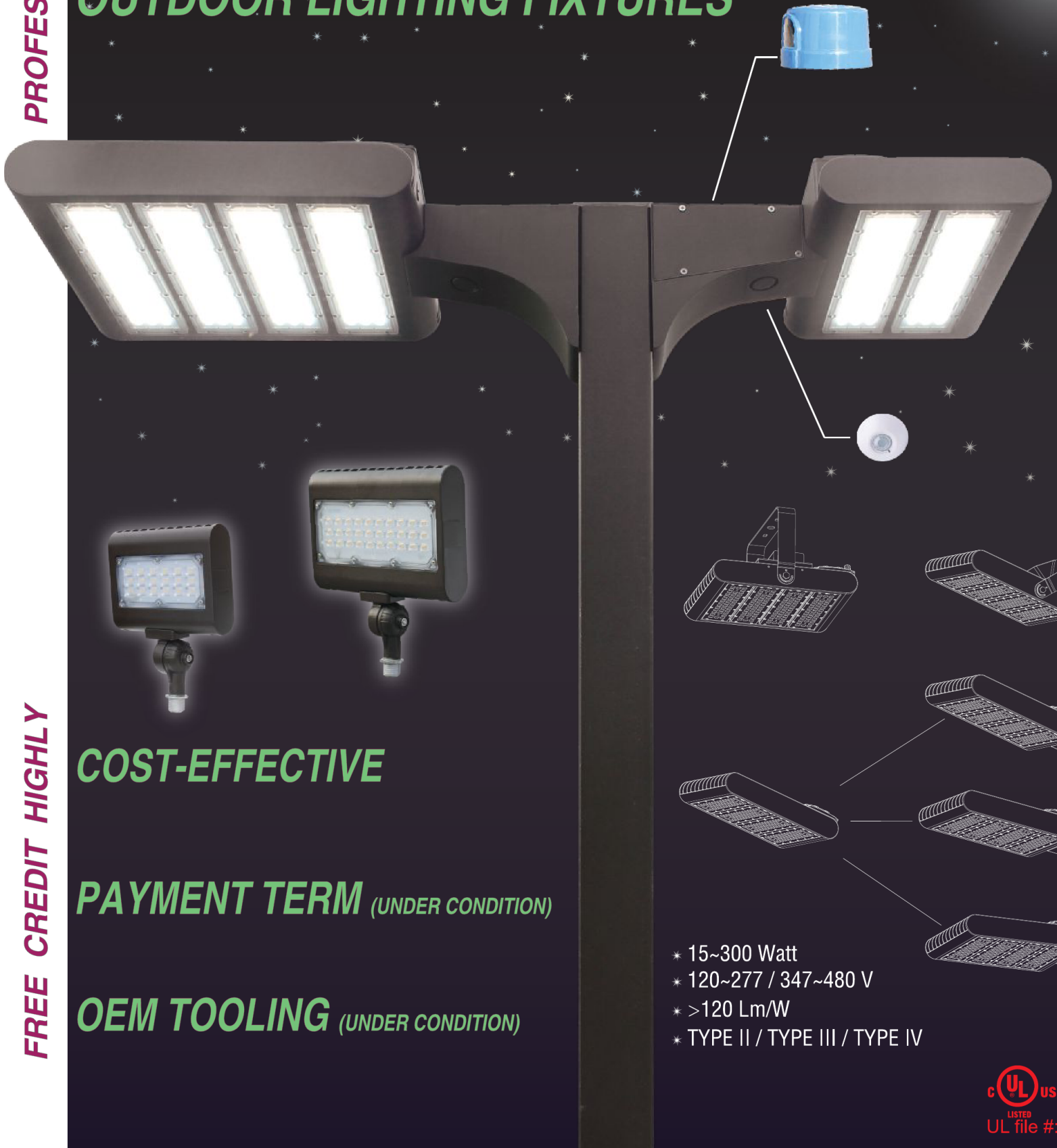
**Stellina, Amerlux** • This 1.5"-thick commercial retail luminaire features a one-piece extruded aluminum housing with die-formed galvanized and cold-rolled steel components and can be mounted as a direct pendant, indirect pendant, or low-bay fixture. It is offered in 2700K, 3000K, 3500K, and 4000K, takes 120V/277V, and is zero-to-10V, Lutron Hi-lume, and DALI dimmable. The luminaire can be specified with integrated sensors and controls for digital photometric, dimming, and motion sensing. • [amerlux.com](http://amerlux.com)



**FloatPlane LED, Philips Ledalite** • These suspended or wall-mounted LED luminaires are 1.2" high by 8" wide and are available with either a curved- or straight-edged profile. Available in 3000K, 3500K, and 4000K with a CRI of 80-plus, each fixture delivers up to 129 lumens per watt and offers distribution options of 70% up, 75% down, or 100% down. In 4', 6', or 8' runs with white, titanium, black, and custom finish options. Daylight and occupancy sensors can also be added. • [ledalite.com](http://ledalite.com)

PROFESSIONAL

# THAILIGHT OUTDOOR LIGHTING FIXTURES



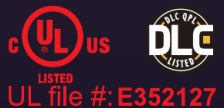
FREE CREDIT HIGHLY

**COST-EFFECTIVE**

**PAYMENT TERM** (UNDER CONDITION)

**OEM TOOLING** (UNDER CONDITION)

- \* 15~300 Watt
- \* 120~277 / 347~480 V
- \* >120 Lm/W
- \* TYPE II / TYPE III / TYPE IV

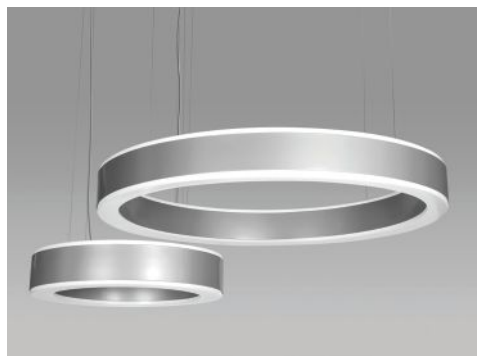


THAILIGHT SEMICONDUCTOR LIGHTING CO., LTD  
DongGuan | China T: +86 769 87061601 · F: +86 769 83713167

W: [www.thailight-led.com](http://www.thailight-led.com) · E: [info@thailight-led.com](mailto:info@thailight-led.com)



**Corelite Iridium i2 WaveStream LED Luminaire, Eaton** • Eaton had added a replaceable WaveStream direct/indirect light engine to its Iridium i2 WaveStream LED luminaire. A wide batwing distribution makes the fixture suitable for low-ceiling spaces. It comes in 3000K, 3500K, and 4000K with a CRI of 80-plus and has an efficacy of up to 120 lumens per watt. Multiple up/down distributions as well as integral daylight and occupancy sensors and an emergency battery backup are offered. • [eaton.com](http://eaton.com)



**Katrina Circular Luminaire, Birchwood Lighting** • Dual rings of continuous LED light are delivered in 2700K, 3000K, 3500K, and 4000K with options for direct/indirect and direct-only light distribution in this cable-suspended or surface-mounted luminaire. The 6"-tall aluminum housing is fitted with a single-piece, frosted white acrylic lens and comes in 2' and 4' diameters. The fixture has a powdercoat finish in silver matte, white matte, and black matte. • [birchwoodlighting.com](http://birchwoodlighting.com)



**Narrow Linear Architectural Luminaires, LaMar Lighting** • With a 2.25"-wide profile, these wall, surface-mount, and recessed luminaires can be specified in spaces requiring continuous rows of light. In 2', 4', 6', and 8' lengths, they are available in 3000K, 3500K, 4000K, and 5000K. Universal 120V/277V inputs are standard with optional zero-to-10V dimming. The die-formed steel housings have a baked white enamel finish with reflectance exceeding 87%. • [lamarlighting.com](http://lamarlighting.com)



**High Performance 6" Aperture, Finelite** • These 6"-aperture recessed, direct, surface-mounted, and air-return LED luminaires have an extruded aluminum body and can be specified in 2'-minimum increments with the option for 90-degree corners. The system is available in 3000K, 3500K, and 4000K with an efficacy of up to 108 lumens per watt. A zero-to-10V integral driver provides dimming to 10%. • [finelite.com](http://finelite.com)



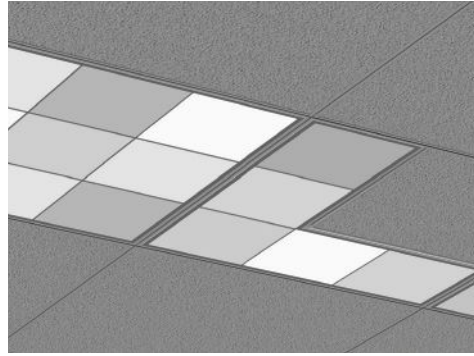
**LED Contemporary Architectural Troffer, Hubbell Lighting/ Columbia Lighting** • This recessed architectural LED luminaire has a centered triple lens for even illumination for applications such as offices, schools, and retail. The fixture comes in 2' by 2' and 2' by 4' configurations in 3000K, 3500K, 4000K, and 5000K with a CRI of 80. It can be surface- or cable-mounted. LED modules and electrical components are accessible from below. • [columbialighting.com](http://columbialighting.com)



**Vaeder, Modular Lighting Instruments** • A honeycomb structure runs beneath an ultrathin diffuser in this ceiling-mounted or suspended luminaire, helping to reduce glare in office environments. It is available in 3000K with a CRI of 80-plus, delivers 74 lumens per watt, and takes a 120V input. The fixture is approximately 49.7" long by 7.9" wide by 2" tall. Black, white, and gray are offered for the honeycomb and the housing comes in white and gray. • [supermodular.com](http://supermodular.com)



**Delta, LightArt** • Four geometric designs—Delta (shown), Hex, Quad, and Loop—join the company’s Essentials line of thin-gauge, LED luminaires with a bio-based resin shade. Delta is 54” by 46” by 4” and comes in 3000K, 3500K, and 4000K with a CRI of 80. Adjustable cables allow it to be suspended 24” to 96” from the ceiling, and it can be mounted to a standard J-Box. Shade options include cinder and rosewood, as well as blue, red, and yellow. • [lightart.com](http://lightart.com)



**Rubik, Acuity Brands Mark Architectural Lighting** • Three-, five-, and nine-grid recessed luminaires have been reconceived as a kit of parts to create new illumination patterns without modifying the ceiling. The versatile system is available in static or tunable 3000K, 3500K, 4000K, and 5000K, with a CRI of 80-plus or 90-plus, as well as grayscale and color accent options. Dimmable, it delivers up to 440 lumens per cell. The 20-gauge, cold-rolled steel housing has integral T-bar clips. • [marklighting.com](http://marklighting.com)



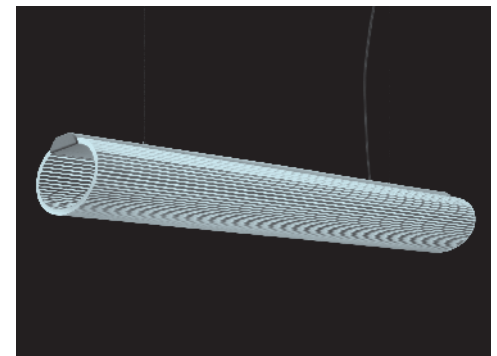
**After 8, Molto Luce/Ledra Brands** • An 0.18” profile makes this slender suspension luminaire suitable for a range of architectural applications. It offers 70% downlight and 30% uplight and is available in 2700K and 3000K, delivering 1,470 lumens and 1,520 lumens, respectively, with a CRI of 80-plus. A milled-aluminum housing in black (shown), white, and bronze finishes is fitted with miniature LEDs and a diffuser. • [moltoLUCE.com](http://moltoLUCE.com)



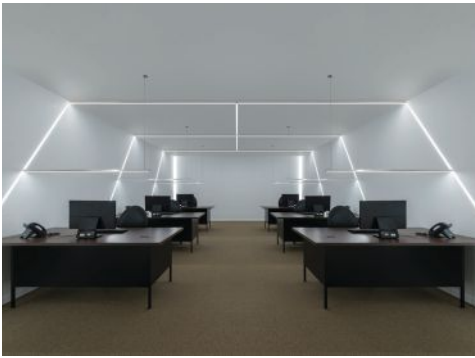
**Vivaa, Waldmann Lighting** • In 16” and 24” diameters, this suspended stainless-steel luminaire comes in 3000K and 4000K, offering 40% direct and 60% indirect illumination. The six-LED version delivers 7,000 lumens and weighs 17.9 lbs., while the four-LED version delivers 5,300 lumens and weighs 9.5 lbs. Both take a direct power supply and have a satin-white acrylic diffuser. • [waldmannlighting.com](http://waldmannlighting.com)



**Eggboard, Artemide** • A sound-absorbing square with a raised, sinusoidal pattern surrounds this 29W LED downlight, available in 3000K or 4000K at a CRI of 80-plus. Roto-symmetrical reflectors are used to deliver lumen packages of 1,720 lumens and 1,790 lumens with a 32-degree beam spread. Green, gray, and white colorways are offered for the board, which comes in dimensions of 31.5” square as well as 63” by 31.5”. • [artemide.com](http://artemide.com)



**Clara, Architectural Lighting Works** • A hollow, lensed body distinguishes this LED luminaire, which comes in linear suspended (shown) and wall sconce models. It is available in 3000K and 4000K at a CRI of 80-plus and delivers more than 89 lumens per watt. Clear and frosted acrylic lenses feature thin white lines to direct and diffuse light. Remote control options include zero-to-10V, DALI, and DMX drivers with dimming down to 1%. The suspended version comes in 2’, 4’, and 8’ sections. • [alwusa.com](http://alwusa.com)



**TruLine 1A and Cirrus with In/Out Connector, PureEdge Lighting •**

This connector pairs the TruLine 1A recessed luminaires and the Cirrus ceiling-mount and suspension fixtures. For use in horizontal, vertical, diagonal, and geometric configurations across single surfaces or multiple planes in commercial spaces, the 1"-wide TruLine 1A has a 0.6" plaster-in extrusion for installation flush with the wall, merging with the 1"-square Cirrus fixtures at the connector to provide continuous light. • [puredgelighting.com](http://puredgelighting.com)

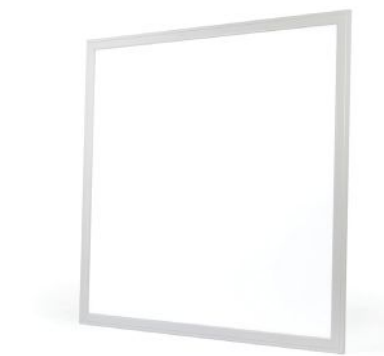


**Baldur, Nordeon USA •** This LED light-line system combines spotlighting and direct/indirect illumination in surface- and pendant-mounts. It is available in 3000K, 3500K, 4000K, and 5000K with a CRI of 80-plus and delivers 4,000 or 6,000 lumens for the 4' units and 6,000 or 9,000 lumens for the 6' units. Wide, medium, and narrow beam spreads are offered, in addition to batwing, wallwasher, and diffused light distribution. In white, black, and silver finishes. Zero-to-10V and DALI dimmable. • [nordeon-usa.com](http://nordeon-usa.com)



**Up + Down Pendants, V2 Lighting Group •**

These pendants come in round and square versions with 3", 4.5", and 6" diameters. Available in 2700K, 3000K, 3500K, and 4000K with a CRI of either 83 or 98, they are fitted with two LED modules that deliver up to 4,000 lumens, depending on the fixture's size. Zero-to-10V or phase dimming down to 10% is standard. The fixtures have a powdercoat finish and are rated for use in wet and damp locations. • [v2lightinggroup.com](http://v2lightinggroup.com)



**Panel Lyte, Acolyte LED •**

This ceiling-mounted LED luminaire emits light from all four sides and fits in standard, dropped-ceiling configurations. The fixture can be specified in a 2' by 2' 45W model and a 2' by 4' 65W model, both of which have an 0.43" profile and seamless corner joints to avoid light leaks. It is available in 3000K, 4000K, and 5000K with a CRI of 80. Dimmable, it takes 100V/277V AC power and includes an onboard driver. • [acolyteled.com](http://acolyteled.com)



**Meridian, Visa Lighting •**

A contemporary circular shape makes this luminaire suitable for applications such as lobbies, restaurants, airports, and atriums. It is available in 3000K, 3500K, and 4000K with a CRI of 82. It delivers 79 lumens per watt and is zero-to-10V dimmable down to 10%. The modular fixture has an integral driver and mounts to a 4" octagonal J-Box. Available in 24", 36", and 48" diameters. • [visalighting.com](http://visalighting.com)



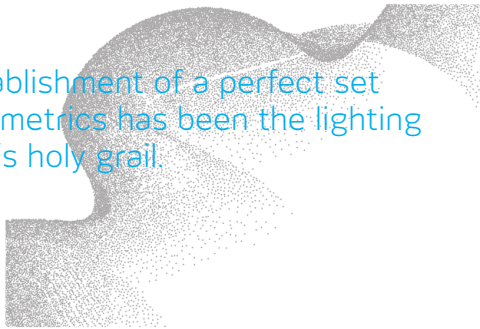
**Olescence, Acuity Brands**

**Peerless •** This linear suspension fixture combines LEDs and OLEDs. A direct-view downlight OLED panel in a 6.5" by 0.5" profile works with LED indirect optics to produce 3000K, 3500K, and 4000K in a CRI of 80-plus and 90-plus. The fixture has an efficacy of up to 88 lumens per watt, and optional dual-circuit switching. It can be specified in 4', 6', and 8' sections in white, black, and painted aluminum. • [peerlesslighting.com](http://peerlesslighting.com)



## COLOR QUEST

The establishment of a perfect set of color metrics has been the lighting industry's holy grail.



text by Elizabeth Donoff

Color has always been a significant topic in lighting. It's a complicated and nuanced issue that at its core is shaped by no fewer than eight key concepts: constancy, temperature, rendering, difference, appearance, shift and stability, colorfulness, and matching. The industry's current primary color metric, the Color Rendering Index (CRI), isn't perfect but it has served as the closest way of addressing the issue.

But with the introduction of LEDs, color has become even more important, and the industry has been looking for a way to establish a measurement system that better corresponds to the characteristics of LED light. In the mid-2000s, one attempt to address the problem was creation of the Color Quality Scale (CQS), but that never really took off. This past fall, a major step was made toward providing a more comprehensive way of evaluating color with the release of *TM-30-15, IES Method for Evaluating Light Source Color Rendition*. The new metric proposes 99 color-evaluation samples, as opposed to the much-smaller batch of 14 currently used by CRI. That said, this new system still has areas, such as the computation of the reference luminance and fidelity, where there is room for further clarification, notes Kevin Houser, professor of architectural engineering at Penn State University and one of TM-30's authors. To help you better understand the new TM-30 color metric, Houser has set up a website where you can find more information: [personal.psu.edu/kwh101/TM30/main.htm](http://personal.psu.edu/kwh101/TM30/main.htm)

The word is still out on TM-30. Some companies, such as Xicato and Soraa, have already started incorporating TM-30 data in their product spec sheets. Others, such as Philips, Osram, and GE Lighting, have voiced concerns, as has the Lighting Research Center in Troy, N.Y. To be sure, TM-30 will be one of the key buzzwords at LightFair this year as the industry determines if this new metric will lead to a better way to evaluate color. •

## Introducing the new Mirada Series by LSI

- Industry-leading photometry through an exclusive, new optical system by LSI
- Contemporary, sleek, low-profile styling
- Area Lights and Wall Packs on display at **LightFair Booth 1711**

LSI Industries Inc.  
10000 Alliance Road  
Cincinnati, Ohio 45242

[www.lsi-industries.com](http://www.lsi-industries.com)  
Phone 513.793.3200  
Fax 513.793.0147





**Incito 2" Family, Acuity Brands Gotham Lighting** • This line of round and square downlights, wallwashers, adjustables, and cylinders lets designers create multilayered lighting schemes. Four lumen packages—500, 750, 1,000, and 1,500—are offered, along with 13 field-changeable silicon optics that come in 5-degree increments from 15 degrees to 55 degrees, as well as four elliptical distributions. Control options include nLight, zero-to-10V, and 120V phase-cut dimming. • [acuitybrands.com](http://acuitybrands.com)



**OneFrame, DMF Lighting** • This low-profile, small-aperture downlight is fire-rated, eliminating the need for boxing, and offers tool-free height adjustment. It is available in 2700K, 3000K, 3500K, and 4000K with a CRI of 93-plus. It uses 120V/277V inputs and offers TRIAC and electronic-low-voltage dimming down to 5%. Round and square trims are offered. For new construction with a deep J-Box, bar hangers pivot for horizontal or vertical mounting. • [dmflighting.com](http://dmflighting.com)



**RSA Combolight Gen 3, Eaton** • This multilamp recessed LED luminaire is suited for new construction applications with insulated or noninsulated ceilings as well as retrofit projects. It is available in 2700K, 3000K, 3500K, and 4000K with a CRI of 95-plus. With integral and remote power supplies, dimming options include DALI down to 0.1% and zero-to-10V down to 1%. In configurations of up to six linear and four square arrangements with trim and trimless options. • [eaton.com](http://eaton.com)



**ML1 and ML2 LED Modulinear Luminaires, Jesco Lighting** • These aimable, dimmable recessed downlights have been updated to offer white light from a low-profile housing. Each fixture has a single 22.5W or 15W high-output, chip-on-board LED that provides color clarity at 2700K, 3000K, 3500K, or 4000K with field-changeable beam spreads. Cold-rolled steel housings have separate wiring compartments, with matte black, white, and silver finishes. • [jescolighting.com](http://jescolighting.com)

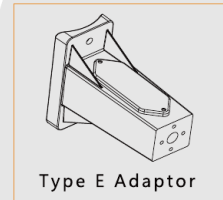
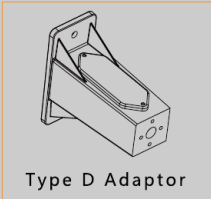
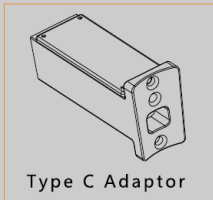
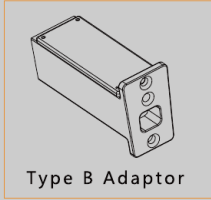
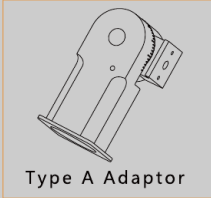


**Juno 2" LED Downlights and Adjustables, Acuity Brands Juno Lighting Group** • An alternative to 6", 65W incandescent downlights, these 2" LED fixtures deliver up to 600 lumens and consume 10W. They are available in 2700K, 3000K, 3500K, and 4100K with a CRI of 80 or 90-plus. They are UL and cUL listed for wet locations and come in cone and baffle styles. White, black, satin nickel, and brushed bronze finishes are offered. • [junolightinggroup.com](http://junolightinggroup.com)



**MX Multiple with Tunable White, Intense Lighting/Leviton** • These recessed multiples are tunable from 2100K to 4300K and work with zero-to-10V, Lutron EcoSystem, and DMX digital control systems with dimming to 0.5%. Configurations of up to four heads are offered, and each can be adjusted up to 25 degrees vertically and 360 degrees horizontally. Each head delivers up to 1,000 lumens. Narrow flood, flood, and wide-flood beam spreads are offered. • [intenselighting.com](http://intenselighting.com)

- Professional OEM & ODM manufacturer.
- High efficiency for customization solution: Only 8 hours is needed.



**LED PARKING LIGHT**

Power:24W/48W/80W/100W/150W/200W/300W  
High Luminous Efficacy up to 100LM/W  
With SAMSUNG LED chipset  
With built-in MEANWELL driver  
Five kinds of installation way optional  
ETL Listed



**LED RECESSED  
COMMERCIAL DOWNLIGHT**

6INCH Power:18W/23W/27W  
8INCH Power:18W/23W/27W/33W/40W/54W  
With CREE LED chipset  
0-10V dimming optional  
UL Listed



<http://www.cdnlighting.cc>  
Email:lamixu2016@gmail.com  
Mob: +86-135 0017 4656  
Skype: dicav-lami



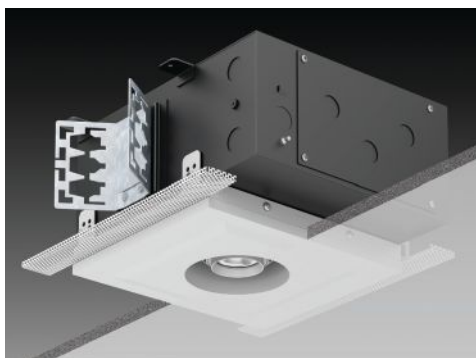
**Third-Generation Aculux 3¼" LED Luminaires, Acuity Brands Juno Lighting Group** • These 27W LED downlights replace 39W ceramic metal halide fixtures, delivering up to 2,000 lumens and producing over 21,000 center-beam candlepower in a 12-degree spot. Ten beam spreads between 12 and 60 degrees are offered, and the fixtures deliver an efficacy of 80 lumens per watt. Round, square, flush-mount, and self-flanged trims are offered. • [junolightinggroup.com](http://junolightinggroup.com)



**Holon 40 LED, Kreon** • An offset hinge permanently tensions these 8.4W directional LED spotlights, allowing them to remain fixed at any angle. For use indoors in residential applications, the fixtures can be recessed or surface-mounted and are rotatable 355 degrees horizontally and tilt 90 degrees vertically. They are available in 2700K with a CRI of 80-plus and provide 780 lumens. Their aluminum housing comes in white and black powdercoat finishes. • [kreon.com](http://kreon.com)



**D3, Ketra** • These 3.5" tunable downlights deliver saturated and pastel light from a single-point source. Available from 2700K to 6500K at 1,100 lumens and a CRI of 90-plus, the fixture can be specified with beam distributions of 15, 25, 40, and 60 degrees. Round, square, flanged, and flangless apertures are available. The fixtures are wireless and TRIAC dimmable down to 1%, and are offered in white, black, semi-specular, and primer finishes. • [ketra.com](http://ketra.com)



**VF300, LF Illumination** • The aperture and throat of these recessed, trimless downlights are made from plaster, allowing them to be painted for use with drywall and other plaster-in ceilings. The LED module comes with a wide or tight beam for adjustable spot lighting, as well as with an MR16 gimbal for LED retrofit or halogen lamps adjustable up to 10 degrees. The field-changeable LED includes optional 2700K to 1800K sunset dimming. Its 4" aperture throat has a 40-degree visual cut off. • [lfillumination.com](http://lfillumination.com)



**LumeLex 2048 Series, Lighting Services Inc** • This fixed LED pendant features an architectural housing and has an efficacy of 65 lumens per watt for use in hospitality applications. It can be specified with dim-to-warm technology from 2800K to 2000K and is fitted with a mixing optic for even light distribution at 15- to 60-degree beam spreads. The LED module is field-replaceable and the system is compatible with various dimmers down to 1%. • [lightingservicesinc.com](http://lightingservicesinc.com)



**LP Mini Downlight System, Louis Poulsen** • The LED light engine on this 17W recessed downlight is built into the ceiling while the light distribution components are located below the ceiling plane. Available in 3000K and 3500K, the system takes a 120V/277V input and is zero-to-10V dimmable. Multiple options for light distribution components and trims are offered and require a 4.125"-diameter cutout. The fixture is cUL US listed for damp locations. • [louispoulsen.com](http://louispoulsen.com)



**Syrios Square Cube, Luminis** • This compact luminaire comes in ceiling-mounted downlight and wall-mounted up- and downlight variations. It is available in 3000K, 3500K, and 4000K with a CRI of 80 and at 2700K with a CRI of 90. Zero-to-10V dimmable, the fixture delivers 1,000 lumens and includes a 26-degree reflector with a 40-degree flood optic and a linear spread lens. Its 5" housing is made of seamless extruded aluminum with a sealed LED module. • [luminis.com](http://luminis.com)



**Cylinder Slim Series, Meteor Lighting** • Outputs from 2,000 lumens to 10,400 lumens make this 6" aperture LED downlight suitable for spaces with varied ceiling heights. In 2700K, 3000K, 3500K, 4000K, and 5000K with optional color tuning and with a CRI of 75, 85, or 90, it can be specified with beam spreads of 15, 25, 40, 60, and 100 degrees. Dimming options include DMX, zero-to-10V, and DALI. Surface-, wall-, stem-, and aircraft-cable-mounting options are offered. • [meteor-lighting.com](http://meteor-lighting.com)



**Smart Cake, Modular Lighting Instruments** • Gently sloping sides help to evenly distribute light in this single-source LED downlight, which is offered with three trim options and white, black, and gold finishes. For ceiling-recessed or surface-mounted applications, the fixture comes standard in 2700K and 3000K with a CRI of 90-plus and with an efficacy of up to 81 lumens per watt. With medium, spot, and flood beam distributions. The fixture is IP20 rated. • [supermodular.com](http://supermodular.com)



**Baby LED, USAI Lighting** • At less than 2" tall and with 3" to the finished ceiling, this ultrashallow housing comes in round, square, trimmed, and trimless variations, making it suitable for a range of recessed applications, particularly those with shallow plenums. It is available in 2700K, 3000K, 3500K, and 4000K with a CRI of 80-plus as well as 2700K and 3000K with a CRI of 90-plus. Two lumen packages are offered: 14W with 900 delivered lumens and 20W with 1,150 delivered lumens. • [usailighting.com](http://usailighting.com)



**Trimless MLS, Nora Lighting** • The company's trimless MLS fixtures are now available in one-, two-, and three-light linear configurations with LED or PAR30 medium-base light sources. For new construction and retrofit hard-ceiling applications, a mud-in ring facilitates clean edges. Available in 2700K, 3000K, 3500K, and 4000K with a CRI of 90-plus. It is offered with 40-degree and 15-degree beam spreads. Dimming options include TRIAC and zero-to-10V controls. • [noralighting.com](http://noralighting.com)



**SliverLED MR, USAI Lighting** • A 3.5"-deep housing and 0.04" trim suit this low-profile, 2" aperture downlight for use in applications with shallow plenums, and it can be lamped with a range of low-voltage LED MR16 GU5.3 base 15W (maximum) replacement lamps. It is available with white or black baffle options with trims in white, black, textured white, and metalized gray. For new construction applications, the fixture takes a 120V input. • [usailighting.com](http://usailighting.com)



**Metalux SWLED Surface and Wall Luminaire, Eaton** • Replacing linear fluorescent lamps in low-bay industrial fixtures, wraparounds, and striplights, this luminaire is available in 3500K, 4000K, and 5000K with a CRI of 85. It can be fitted with sensors for dimming, occupancy sensing, or daylight harvesting, and is controllable via a handheld remote that includes an option to switch the fixture to an energy-saving mode. With three lensing options, it can be ceiling or wall mounted or suspended. • [eaton.com](http://eaton.com)



**Chaperone LED Indirect Garage Luminaire, Amerlux** • For parking garages, this fixture uses indirect light to cut glare. It is available in 4000K and 5000K with Type III and Type V distribution. The 40W and 75W models deliver up to 5,625 lumens with an estimated efficacy of 75 lumens per watt. It has an aluminum housing and a clear acrylic lens. An integral driver runs on 120V/277V systems, and can include line-voltage occupancy sensors and a wireless network control. • [amerlux.com](http://amerlux.com)



**Philips Gardco SoftView LED, Philips Lighting** • This surface-, pendant-, or trunion-mounted LED parking garage fixture pairs edgelighting and uplighting to provide uniform illumination. Available in 3000K, 4000K, and 5700K, it delivers up to 8,614 lumens, with zero-to-10V dimming, wireless controls, and integral motion response. Accessories include a step-down transformer and handheld programmer. Finishes are white, bronze, medium gray, custom, or RAL colors. • [usa.lighting.philips.com](http://usa.lighting.philips.com)



**LED Linear Highbay Series, MaxLite** • This high-bay downlight delivers up to 24,000 lumens at an efficacy of 120 lumens per watt to replace fluorescent high-bay and high-intensity discharge fixtures. It is available in 5000K at a CRI of 70-plus. The 12" by 24" luminaire can be base, pendant, stem, cable, chain, or surface mounted, and is offered with narrow and wide lens distribution. The fixture is zero-to-10V dimmable and can be specified with daylight, occupancy, and bi-level sensors. • [maxlite.com](http://maxlite.com)



**Everline LED Parking Garage Luminaire, Universal Lighting Technologies** • This 15"-wide LED parking garage luminaire is available in 3500K, 4000K, and 5000K at a CRI of 70 or 80 and delivers either 4,400 lumens or 9,500 lumens with wide, narrow, and aisle optics. Its extruded-aluminum housing has a hinged door for access, and it can be surface-mounted to a recessed J-Box with an optional pendant-mount accessory. The fixture can be used in wet locations. • [unvlt.com](http://unvlt.com)



**Starduster C1 Series, Paramount Industries** • An acrylic housing with stainless steel end-caps and smooth surfaces for easy cleaning make this luminaire, which offers an output of 122 lumens per watt, suitable for use in food-processing facilities. Standard in 4000K with a CRI of 80-plus, it is also available in 3000K, 3500K, and 5000K. It can be suspended or surface-mounted and comes in 24.8", 48.8", and 96.8" lengths. The enclosure has a NEMA 4X rating for corrosion resistance. • [paramountlighting.com](http://paramountlighting.com)

we think a fixture  
should be as *beautiful*  
as its surroundings



Debuting at LightFair 2016 in the  
New Exhibitor Pavilion. Booth 416.

*shown: dCrest directional light*

holm

A Hunter Industries Company



**Exitronix Tempo Pro Life Safety Series, Barron Lighting Group •**

This family of LED emergency luminaires includes an exit/emergency combination unit, an emergency unit, and a remote unit. The housings are injection-molded and flame-rated, and include fully adjustable lamps for top, side, forward, or backlight distribution. The universal exit combination system includes single- and double-face options and can be mounted from the top, back, or side. • [barronltg.com](http://barronltg.com)



**HotSpot Plus All-in-One LED Driver and Emergency System, Fulham •**

This system packages a 40W, constant-current dimmable LED driver, an emergency LED driver, and a 6.4V DC backup battery. The battery provides 5W for 180 minutes or 10W for 90 minutes. The fixture comes in two sizes: 6.9" by 3" by 1.1" and 9.5" by 2.4" by 1.34". It includes an illuminated test switch, self-diagnostics, and a custom emergency power level. • [fulham.com](http://fulham.com)



**LED Exit Sign with Emergency Light, Elco Lighting •**

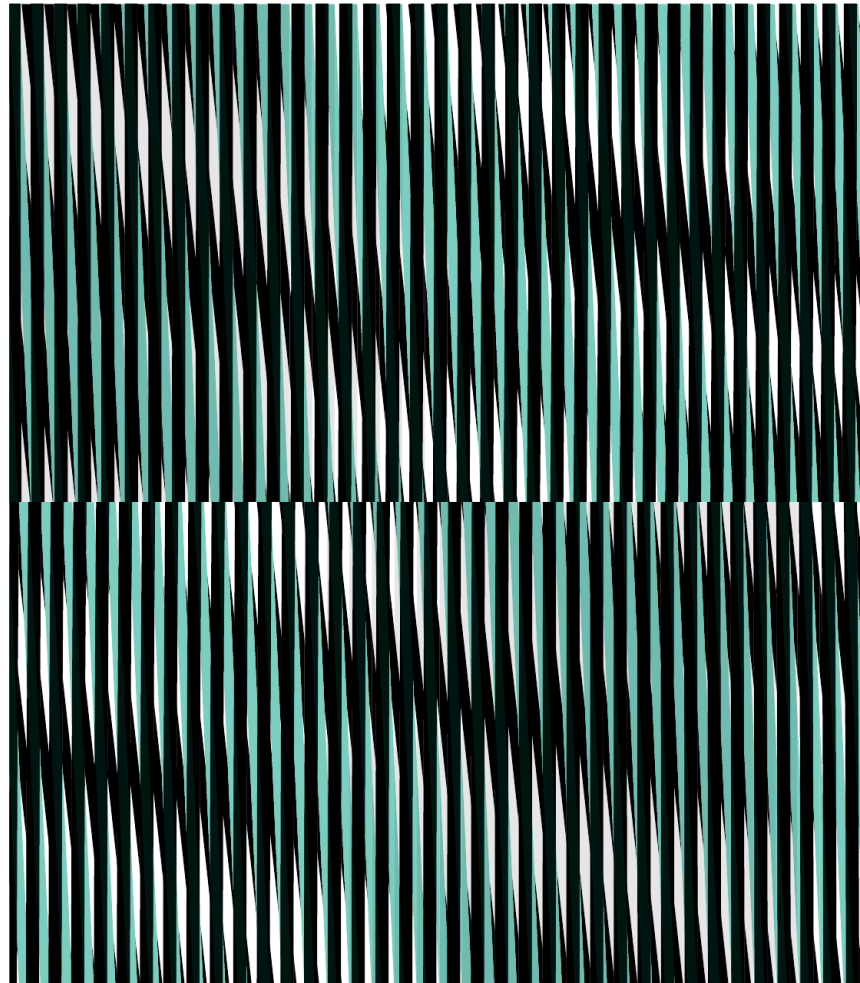
This contemporary-style LED exit sign is flanked by two emergency lights, each fitted with a 5W adjustable MR16 halogen lamp head. The unit is designed to be ceiling-mounted, allowing for its single- or double-sided use. Features include snap arrows, a 120V/277V dual-voltage driver, two 6V backup batteries offering 90 minutes of power each, and the option for red or green lettering. • [elcolighting.com](http://elcolighting.com)

**designjunction**  
+  
**dwell**  
on design

Cutting-edge design +  
captivating conversations

13–15 May 2016  
ArtBeam, 540 W21st Street  
NY 10011

Register now at:  
[thedesignjunction.co.uk/new-york](http://thedesignjunction.co.uk/new-york)





# Dynamic Light with a Compact Footprint Rosco Miro Cube™



Lighting: Chris Werner Design  
Interior: The Scenic Route

*Over 850 Rosco Miro Cube LED fixtures light the newly renovated Petersen Automotive Museum in Los Angeles, California. With 100,000 sq. ft. of ever-changing exhibits, the museum chose the gorgeous light from Rosco's versatile Miro Cube to illuminate the luxurious automobiles on display.*

Rosco's Miro Cube LED luminaires feature powerful light output from a compact 4-inch cube. Available in tunable white (2800-6500K), color-mixing (RGBW), and black light UV models, this versatile fixture is the perfect solution for museums, high-end retail stores and boutiques, or any other architectural setting that requires a beautiful wash of light from a compact fixture.



Rosco Miro Cube™  
Designed by The Black Tank

## Miro Cube Features:

- Track mountable
- Self-contained - no external power supply needed
- Each fixture includes a variety of spread lenses for complete beam control
- Available ARC configuration that offers streamlined power and control connectivity

**rosco**  
[www.rosco.com](http://www.rosco.com)

# LAMPS AND BALLASTS



**EarthBulb LED Linear Tube, EarthTronics** • This Type-A, direct-install T8 LED replacement lamp features instant-on electronic and emergency backup ballasts, and is available in 3000K, 4000K, and 5000K with a CRI of 80-plus. A 300-degree beam spread offers even illumination for use in applications such as office, retail, hospitality, restaurant, and long-term care facilities. The new line includes a 6" U-bend along with 24", 36", and 48" tubes. • [earthtronics.com](http://earthtronics.com)



**TW Series PAR30 LED, Cree** • Intended for use in track and recessed fixtures in applications requiring accent lighting, this line of PAR30 lamps is available in 3000K with a CRI of 90. Fully dimmable, the lamps can be specified with 25- and 40-degree beam spreads and they come in short- and long-neck lamp styles. • [creebulb.com](http://creebulb.com)



**LED Plug-In CFL Replacement, GE Lighting** • This 12W LED lamp has a plug-in base to replace CFLs without the need for tools. It is available in 2700K, 3000K, 3500K, and 4000K with a CRI of 80 and delivers up to 1,000 lumens. According to the manufacturer, it contains no lead or mercury, and provides two-and-a-half times the life of an average CFL while consuming half the energy. • [gelighting.com](http://gelighting.com)



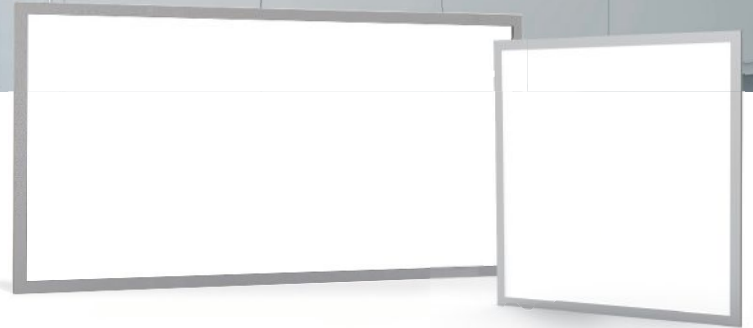
**MR16 12V 7.5W High CRI DIM, Green Creative** • An addition to the company's 20W, 35W, and 50W MR16 replacement lamps, this LED lamp provides an alternative to a 75W halogen lamp. Dimmable, it is available in 2700K, 3000K, and 4000K with a CRI of 82 or 92. Color clarity within a four-step MacAdam ellipse makes the lamp suitable for use illuminating merchandise, art, food, and other retail displays. Available in three options for beam distribution: spot, narrow flood, and flood. • [gc-lighting.com](http://gc-lighting.com)



**PAR Refine Series, Green Creative** • The company's fourth-generation of PAR lamps includes PAR38, PAR30 long and short neck, and PAR20 lamps in three options for beam distribution: spot, narrow flood, and flood. Each is fitted with a flat-faced optic that combines a reflector, a focus lens, and a shaping lens to mimic a halogen-style lamp. The fully dimmable lamps are available in 2700K, 3000K, and 4000K with a CRI of 90. Suited for use in enclosed fixtures. • [gc-lighting.com](http://gc-lighting.com)



**A19 LED Smartbulb, Ilumi Solutions** • This Wi-Fi-enabled A19 lamp delivers the lumen equivalent of a 60W incandescent while offering color tuning from 2000K to 8000K as well as a full set of RGBW color options. The lamp offers a plug-and-play setup without the need for a bridge or gateway. Additionally, it is controllable using a companion app that is offered for mobile devices on iOS and Android platforms. For indoor use. • [ilumi.co](http://ilumi.co)



## PANEL LYTE FIXTURES INTEGRATED LED SOLUTIONS

[www.acolyteled.com/panellytes](http://www.acolyteled.com/panellytes)

Our Panel Lyte is a high brightness LED fixture that fits into most standard dropped ceiling or can be cable hung. An excellent replacement for fluorescent troffers in office spaces, schools, hospitals and public places.

- Size is 2'x2' and 2'x4'
- Ultra-thin at 0.43", includes onboard driver
- Seamless corner joint coverage
- Clean even light spread - Lights on all four sides
- Certified UL, ELC and FCC
- White Color in 3000K, 4000K, 5000K



[www.acolyteled.com](http://www.acolyteled.com) | 212 629 6830 | [SS@acolyteled.com](mailto:SS@acolyteled.com)  
LEDs | Fixtures | Drivers | Channels | Controllers | Parts & Accessories

# LAMPS AND BALLASTS



**Ultra LED HO PAR Lamps, Osram Sylvania** • Designed to replace high-power halogen and high-intensity discharge (HID) lamps, these chip-on-board PAR30 and PAR38 lamps deliver up to 94 lumens per watt for use in retail, grocery, and storage spaces. Available in 3000K and 5000K with a CRI of 81 or 82, and in either a 19W or a 26W option, the 120V dimmable lamps also include a 277V option for HID replacement lamps and are UL wet rated. • [sylvania.com](http://sylvania.com)



**Ultra LED MR16 Lamps, Osram Sylvania** • Designed to replace halogen lamps in accent, display, track, and recessed downlighting applications for museums, offices, and residential applications, this line of LED MR16 lamps offers instant-on with full-light output and stable color, according to the manufacturer. The 6W, 8W, and 9W lamps are available in 3000K with 25- and 35-degree beam spreads. The lamps are dimmable down to 10%. • [sylvania.com](http://sylvania.com)



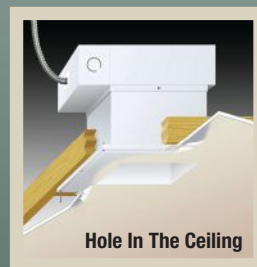
**Vivid Flicker Free MR16 Lamp, Soraa** • The company has added proprietary digital drivers to its line of MR16 LED lamps to eliminate flicker. At 6W, 7.5W, and 9W, the new lamps are alternatives to 35W, 50W, and 75W halogen lamps, respectively. They are available in 2700K, 3000K, 4000K, and 5000K with a CRI of 80 or 95, and include the company's LED phosphor technology for rendering colors and whites in retail and other display environments. • [sorraa.com](http://sorraa.com)



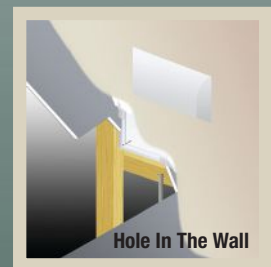
Duket Architects Planners

## Amazing Designs DESERVE Exceptional Luminaires

Our "HITC" and "HITW" fixtures are GRG (Glass-fiber Reinforced Gypsum) castings. When installed, they blend into the surface and appear to be custom-built drywall "light niches." LED in all models!



Hole In The Ceiling



Hole In The Wall



**ELP** ENGINEERED LIGHTING PRODUCTS

Visit [elplighting.com](http://elplighting.com)  
or call us at (626) 579-0943



*tape light*  
**LED TAPE LIGHT**

---

- White light, single colors, side emitting, color changing RGB, and wet location listed
- Energy efficient standard, high, and super high output white light
- Low profile surface, recessed, 45° angled, double wide, and round mounting channels
- Plug-and-play connectors
- Field cuttable and dimmable
- Uniform light distribution
- No infrared or ultraviolet radiation
- cCSAus Listed to UL Standards as a complete system, not just components, for safety and reliability
- Damp and wet location listed

**CONTECH**<sup>®</sup>  
**LIGHTING**

 **eco TECHNOLOGY**  
sustainable energy solutions

[www.contechlighting.com](http://www.contechlighting.com)

See these and other new products at LightFair 2016!  
Visit us at booth 3516



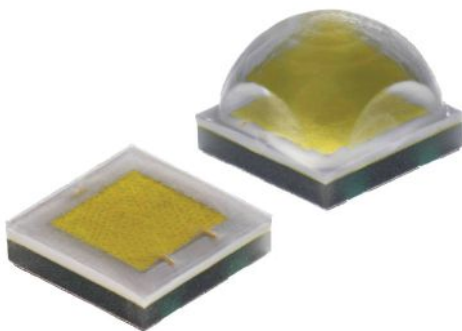
**LightShape, Acuity Brands eldoLED** • The company has added its LightShape technology to its DualDrive and SoloDrive LED drivers for applications requiring tunable white light. Using the company's FluxTool Web application, specifiers can tune the driver for warm dimming or white applications, such as setting the current per LED output, color temperature, lumens per LED, and dimming curve. For use with a standard LED driver, and a zero-to-10V or a DALI dimmer. • [eldoled.com](http://eldoled.com)



**SR308 and SR312 LED Light Engines, Terralux** • For use in new and retrofit commercial wall sconces, these LED light engines can be mounted either horizontally or vertically and they deliver up to 152 lumens per watt. They are available in 2700K, 3000K, 3500K, and 4000K and with five lumen packages from 850 lumens to 2,100 lumens. Universal 120V/277V, zero-to-10V dimming is also included. • [terralux.com](http://terralux.com)



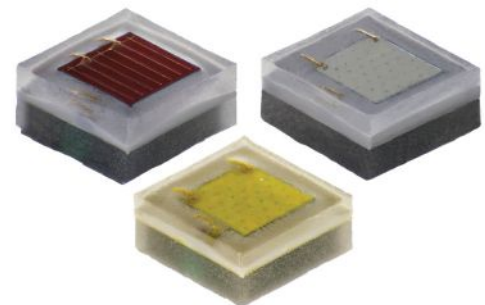
**Zero-Load Transformers, Ambiance Lighting Systems** • The RFID modules in these transformers cut interference from commonplace devices such as garage door openers and sensitive arc-fault circuit breakers. Local on/off switches eliminate the need for a wall switch, and a secondary facing can be swapped out via quick-release connectors without affecting the 120V wiring. In three sizes that can be replaced with larger models as the lighting system's requirements change. • [ambiance-lighting.com](http://ambiance-lighting.com)



**XLamp XHP35 LEDs, Cree** • This family of high-power LEDs delivers up to 1,833 lumens from a 3.5mm-square footprint. They are available in color temperatures from 2700K to 8300K with a CRI of 70, 80, or 90, and they feature the company's two- and three-step EasyWhite color rendering. A 12V, monolithic power-die delivers drive currents at 1A or less. • [cree.com](http://cree.com)



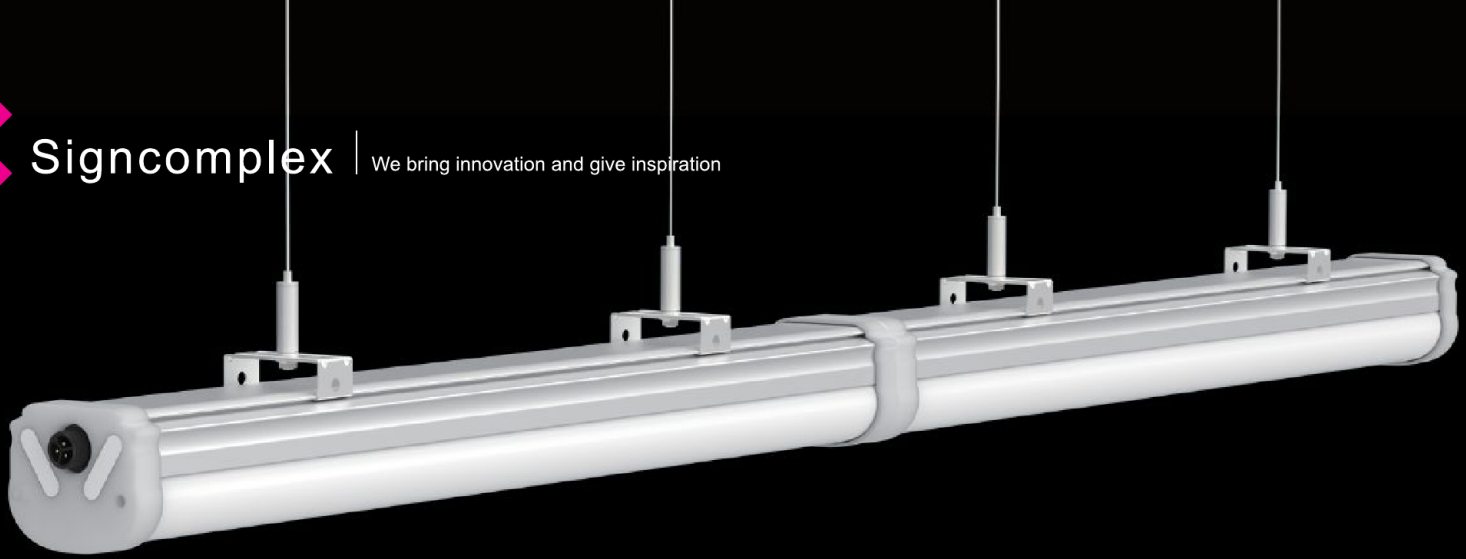
**LED96W-LT, Thomas Research Products** • This 96W LED, line-voltage dimmable driver has universal input and works with both leading-edge and trailing-edge dimmers. The 20W driver accepts universal 120V/277V AC inputs, while a constant-current design eliminates flicker. It is UL listed for use in hazardous locations and features an IP66-rated thermal plastic housing for wet-location use. • [trpssl.com](http://trpssl.com)



**XLamp XQ-E High Intensity LEDs, Cree** • These ultracompact white and color LEDs afford improved color mixing and consistency, doubling candela performance, according to the company. Available in white, red, red-orange, amber, green, blue, and royal blue, the LEDs are fitted with a primary optic that decreases the optical source size by more than half. The white options are available from 2700K to 6200K with a CRI of 70, 80, or 90. • [cree.com](http://cree.com)



**Signcomplex** | We bring innovation and give inspiration



## IP65 Seamless connection Tri-proof lamp

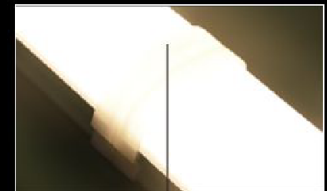
IP65 Seamless connection Tri-proof lamp, the first one which realizes IP65 waterproof seamless butt joint, and assembling and disassembling is unnecessary; convenient and quick to install; adopt special end cover, no dark area after seamless butt joint, good vision effect.



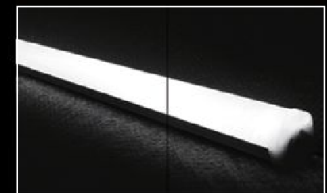
seamless joint, IP65.



the male end cap and female end cap can be out jointed.



no dark area on seam section.



230° beam angle, perfectly replace fluorescent tube.



**LIGHTFAIR**

**INTERNATIONAL**

The future. Illuminated.

**2016**

**SAN DIEGO, CA USA**  
**San Diego Convention Center**

**PRE-CONFERENCE**  
**April 24 - 25, 2016**

**TRADE SHOW & CONFERENCE**  
**April 26 - 28, 2016**

**Booth No.: #345**



[www.signcomplex.com](http://www.signcomplex.com)  
[marketing@signcomplex.com](mailto:marketing@signcomplex.com)  
phone: +86 755 2760 8650  
fax: +86 755 2760 8651



**Araya 5 with Tunable Color, Lumenetix** • These logic modules connect to tunable-color, high-power round and mid-power linear LED arrays, delivering tunable and dimmable light from 1650K to 8000K with a CRI of 90-plus within a two-step MacAdam ellipse. In-line spectral capture and storage create a unique color model for each Zhaga-compliant LED array with consistent CRI and CCT. It is compatible with zero-to-10V wired controls and has on-board DMX and Bluetooth. • [lumenetix.com](http://lumenetix.com)



**Hi-lume Premier, Lutron** • This high-performance LED driver can control 96W of 24V constant-voltage loads while providing continuous dimming down to 0.1% and with a smooth fade from there to zero. For use with striplighting in applications such as cove, under- and overcabinet, and pathway lighting. A field-adjustable knob offers low-end output tuning to assist with fixture-to-fixture matching. It is UL listed and has an integrated wiring compartment. • [lutron.com](http://lutron.com)



**InvisiLED Pro3, WAC Lighting** • This LED tapelight delivers up to 475 lumens per foot while consuming 5W, and has a profile that is less than 0.125" deep by 0.375" wide. It is available in 2700K, 3000K, 3500K, and 4500K with a CRI of 90 and 95. Bendable with curved clip accessories, it is suitable for undercabinet, accent, and cove lighting applications and is field-cutttable to custom lengths. Linear runs can be installed in lengths of up to 40 feet. Electronic-low-voltage dimmable. • [wacighting.com](http://wacighting.com)



**Static White 3.0 and RGB 3.0 Matrix RibbonLyte, Acolyte LED** • This pair of 24V LED striplights provides white and RGB light around curves and angled corners, consuming 3W per foot each. Static White is available in 2400K, 2700K, 3000K, 3500K, 4100K, and 6000K with 15 LEDs per foot delivering roughly 317 lumens per foot. The RGB option has 13 LEDs per foot delivering about 110 lumens per foot. The former is field-cutttable every 4.85" and the latter every 2.78". • [acolyteled.com](http://acolyteled.com)



**LiniLED RGB and Top Power 2700K and 3000K, Organic Lighting** • Designed to be used indoors and outdoors, these plug-and-play LED striplights are available in RGB and 2700K and 3000K for cabinet, retail, signage, marine, and other all-weather applications. The strips are 0.5" wide by 0.25" deep, can be specified in runs of up to 33' with 11 LEDs per foot, and are field-cutttable every 8". A constant-voltage, dimmable LED driver ensures consistent illumination. • [organiclighting.com](http://organiclighting.com)

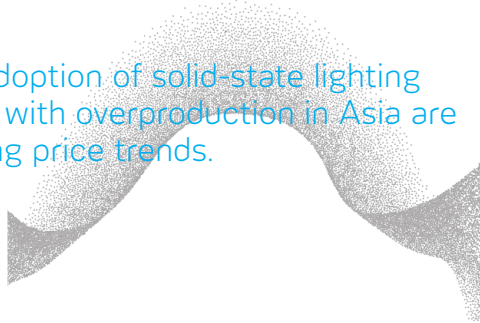


**Everline PA Series LED Driver, Universal Lighting Technologies** • This programmable LED driver takes a 120V/277V input and provides a Class 2, 55W constant-current output, programmable down to 40% of the maximum rated current. It has input frequencies from 50 Hz to 60 Hz and a minimum dimming current of 15mA. Zero-to-10V dimming includes relative dimming, dim-to-off, and dimming curves. The driver measures 14.25" long by 1.18" wide by 1" tall, and it weighs 1 lb. • [unvlt.com](http://unvlt.com)



LED PRICE POINTS

Wider adoption of solid-state lighting coupled with overproduction in Asia are impacting price trends.



Any new technology that enters the marketplace usually comes with a very high price tag. That was certainly the case with LEDs when they showed up about a decade ago: LED lamps and luminaires were significantly more expensive than their incandescent, halogen, and fluorescent counterparts, as manufacturers sought to recoup their R&D investments.

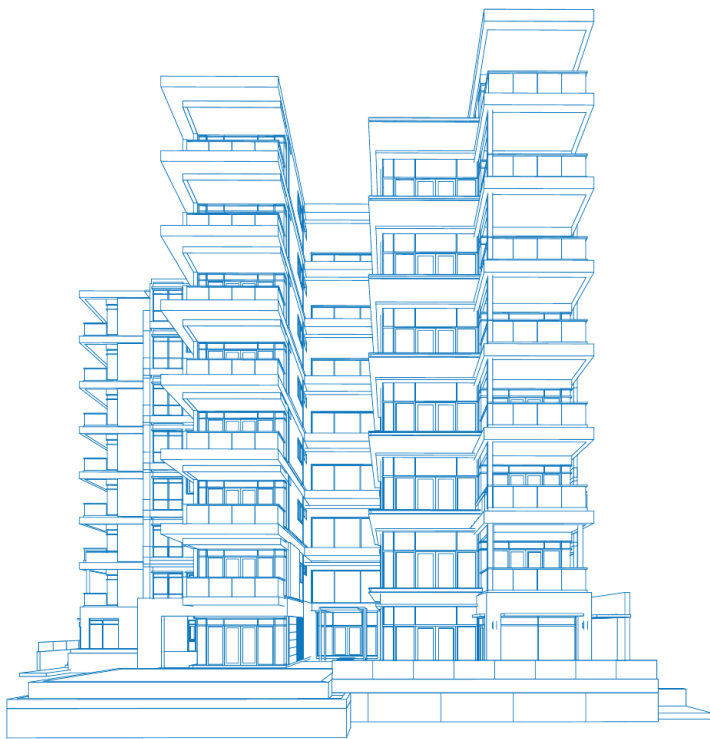
Research and Markets' March 2015 report "United States LED Lighting Market Forecast & Opportunities, 2020" forecasted that the U.S. lighting market would reach \$5.2 billion (U.S.) by the end of last year. Then, in their May 2015 report, "World LED Lighting Markets," the market research and analyst group said, "By late 2014, LED lighting was closing in on 40% penetration of the global lighting market." That's a significant market share given that LED overproduction in China has flooded the market and shrunk profit margins for companies dealing in individual LEDs.

In the consumer market, November 2014's "The Evolving Price of Household LED Lamps: Recent Trends and Historical Comparisons for the US Market" from the Lawrence Berkeley National Laboratory (LBNL), found that since 2011, U.S. sales of LED replacement A-lamps had increased tenfold, while the price had fallen by a factor of two or more. The rapid price decrease is attributed by the LBNL to a couple of things. One is "Haitz's Law, which is the observation that the per-lumen price of LEDs has fallen by a factor of 10 in each decade since their invention in the 1960s." The second is the "general observation that new technologies tend to fall in price as their production increases." Early generations of LED

A-Type and PAR replacements lamps, for example had price tags of \$75 to \$200. Now that range has fallen to between \$10 and \$100.

But purchase cost is not the only way to evaluate LED lamp and luminaire prices. Willem Sillevius-Smitt, vice president of sales and marketing for Xicato, notes that the operating cost of the fixture over its lifetime is just as important and should be taken into consideration. •

text by Elizabeth Donoff



# Panasonic

Come see our **Smart Building and Retrofit Solutions** at

**LIGHTFAIR 2016**

**BOOTH #4637**



**EVERLINE®  
SMART FIXTURE  
LED COMPONENTS  
DRIVERS & MODULES**

**DIALOG®  
SMART BUILDING  
AND ADVANCED  
LIGHTING CONTROL**

[www.unvlt.com](http://www.unvlt.com)

[www.douglaslightingcontrol.com](http://www.douglaslightingcontrol.com)



**Large Range PIR LT30, Aura Light**

• The ability to handle temperatures as low as -30 C makes this sensor suitable for use in cold-storage areas and outdoor spaces. It can be installed in applications with ceiling heights of up to 50', and it offers detection ranges of 90, 180, 270, and 360 degrees. It is IP65 rated with a housing that is designed to protect against humidity and frost. The sensor is available in on/off as well as in 1V-to-10V and DALI dimming options. • [auralight.com](http://auralight.com)



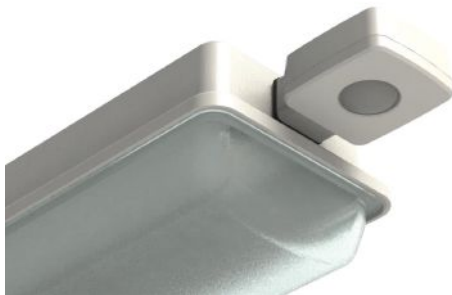
**Mini Sensors, B.E.G. Controls •**

These ceiling-mount sensors cover a floor area of 32' when mounted on an 8'-tall ceiling and offer passive infrared detection. They can be used indoors and outdoors and are programmable for occupancy and vacancy modes with remote adjustment via companion Android or iOS apps. Each sensor includes a photocell and the option to extend its coverage range with four additional sensors. • [begcontrols.com](http://begcontrols.com)



**Hue Wireless Dimming Kit, Philips Lighting •**

A Philips Hue lamp and a portable, battery-powered dimmer switch pair in this off-the-shelf kit for residential applications. The dimmer can be used as a regular wall switch or as a remote control. The 9.5W dimmable A19 LED lamp is available in 2700K with a CRI of 80-plus and delivers 800 lumens. A single dimmer switch can control up to 10 Philips Hue lamps, and up to 12 switches can connect to a home's Hue Bridge Wi-Fi controller. • [usa.lighting.philips.com](http://usa.lighting.philips.com)



**Bluetooth Fixture Controller and Sensor, Douglas Lighting Controls**

• For use with new and existing vapor-tight linear fixtures, this fixture-mounted sensor uses closed-loop control dimming to balance daylight in parking garage applications. It includes integrated 360-degree, passive-infrared occupancy sensing, daylight sensing, Bluetooth detection, dimming control, and bi-level set points. • [douglaslightingcontrols.com](http://douglaslightingcontrols.com)



**Infina Hardwired, Jesco Lighting •**

This 120V line-voltage LED linear lighting system can be wired behind walls, ceilings, and in coves, with a profile of 0.75" wide by 0.25" tall. It can be custom cut in 4" lengths with a maximum run of 150', and it is controllable using a wall switch. It is available in 2700K, 3000K, and 4000K with a CRI of 80-plus. It is UL-rated for interior applications and ETL-listed for interior and exterior plug-in. The system is electronic-low-voltage dimmable. • [jescolighting.com](http://jescolighting.com)



**Lighting System, Ketra •**

This lighting system includes fixtures, controls, and software. All light sources offer tunable RGBW LED light from 1400K to 10,000K, with white light at a CRI of 90-plus and with dimming down to 0.1%. The system features custom user-input keypads, distributed controls, and a network interface (shown), and it can accommodate occupancy, vacancy, and daylight sensors. DMX input, full-universe output, and wireless connectivity are also offered. • [ketra.com](http://ketra.com)



## MOLTO LUCE

- Architectural linear and circular pendants
- Decorative, wall and ceiling mount light elements
- Large, unique, high design, pendants

## BRUCK.

- Decorative artisan glass
- Line and low voltage track systems
- LED accent, linear and decorative fixtures

## WILA

- Complete downlight series with XICATO®
- Cylinder and low bay series
- Performance, line voltage track and heads

Dynamic lighting applications call for unique lighting solutions.

At LEDRAbrands technology lab in California, our engineers are always working toward bringing performance and aesthetics to new levels of innovation.



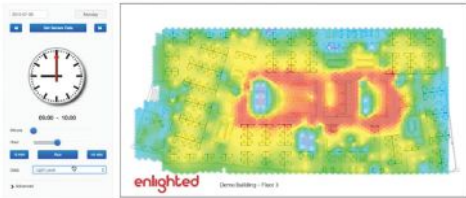
Visit us at Lightfair 2016  
San Diego Convention Center  
April 26-28  
Booth 4843

P 714.259.9959

BruckLighting.com

MoltoLuceLighting.com

WilaLighting.com



**Aire and Space, Enlighted •** Facility operators can use this pair of building-management tools to monitor systems such as lighting and HVAC while tracking occupant activity. Aire uses Enlighted's distributed occupancy sensing network to provide demand-driven heating and cooling. Space is a cloud-hosted application that offers information on building usage and occupancy patterns via customizable maps. Both tools offer real-time analysis. • [enlightedinc.com](http://enlightedinc.com)



**Caséta Wireless, Lutron •** This smart-home control system for indoor and outdoor lighting and shading products can be operated from anywhere using a wall switch, remote control, or a companion iOS and Android app. The system functions through the company's Smart Bridge, which connects to the home's Wi-Fi and uses radio frequency to communicate with other compatible Lutron devices in the home. The system works with LED, CFL, halogen, and incandescent lamps. • [lutron.com](http://lutron.com)



**Wireless Receptacle Controls, WattStopper/Legrand •** These wireless receptacles extend occupancy-based lighting technology to plug loads by turning off the power to selected receptacles. Two receptacles—15A and 20A—are included, along with a radio-frequency transmitter, and feature auto on/off control as well as override and testing capabilities. With options for use with stand-alone occupancy sensors and the company's Digital Lighting Management platform. • [wattstopper.com](http://wattstopper.com)



**Greengate VisionTouch 5, Eaton •** This Web application lets facility managers access their building's Greengate lighting controls system without the need to install dedicated software. The program features an interactive floor plan that shows the status of components including fixtures and sensors. Up to 500 users can simultaneously control, review, and schedule light levels for individual fixtures and fixture groups. The system can also import AutoCAD drawings. • [eaton.com](http://eaton.com)



**Encelium Wireless Area Lighting Controller, Osram Sylvania •** This controller can be used with devices such as zero-to-10V dimmable luminaires, LED drivers and ballasts, and GreenBus II devices, eliminating the need for batteries in the latter. It requires a standard 0.5" knockout for installation. A terminal block affords direct sensor connection, and it can accommodate wireless control for loads of up to 20A. It measures 3.5" long by 2.7" wide by 1.6" tall. • [sylvania.com](http://sylvania.com)



**Hub and Lighting Control App, Legrand •** Legrand has updated its Adorne Wi-Fi lighting system. The new Hub is a back-end control center that syncs with a home's Internet-connected lighting controls and lamps via Wi-Fi, while the new Legrand Lighting Control App allows occupants to manage fixtures from anywhere in the house using a mobile device. The Hub and app are compatible with select controls in the company's Adorne portfolio. • [legrand.us](http://legrand.us)

**THE INDUSTRIAL INTERNET OF THINGS**

Thanks to the ubiquitous presence of lighting, an estimated 50 billion devices will be online by 2020. But will they be able to communicate with each other and with us?

text by Wanda Lau

When light fixtures were recognized as an ideal platform for the sensors empowering the Industrial Internet of Things, or simply the Internet of Things (IoT), longtime players in the lighting industry found themselves competing—or teaming up—with tech companies to develop the software and hardware systems to bring nearly every personal device, object, and square foot of habitable space online. For instance, GE launched Current, a digital power service that outfits its clients with LED lighting networked with sensors on its cloud-based Predix platform, while Philips and Cree have partnerships with IT giant Cisco to offer Power-over-Ethernet-based (PoE-based) LED lighting systems. Google’s Thread network and Apple’s HomeKit framework are currently targeting the residential market, while tech startups Enlighted and Sensity Systems have carved niches in the commercial and urban infrastructure space.

Cost, data security, and the logistics of equipping objects with sensors are a few of the hurdles to connecting a projected 50 billion devices by 2020, as estimated by Cisco and DHL. Another is the fear of technological obsolescence. With the current lack of a common networking protocol in IoT, what will ensure that components made by different companies can communicate with each other in the future?

Enlighted chief technology officer Tanuj Mohan isn’t worried. The key to the IoT’s success, he says, lies in the quality of the data. As long as networks are delivering reliable information to the cloud and granting access through open APIs (application programming interfaces), the method

of delivery is inconsequential. Cree’s SmartCast PoE platform, for example, offers an open API based on the Constrained Application Protocol (CoAP) that lets third parties access occupancy and power data to adjust its luminaires. And that’s only the beginning, says Gary Trott, Cree vice president of product strategy. “The SmartCast API enables integrations that we can’t imagine yet. We have already conceived of additional data and metadata that we can make available in the future.” •



JIUZHOU  
GREEBLE

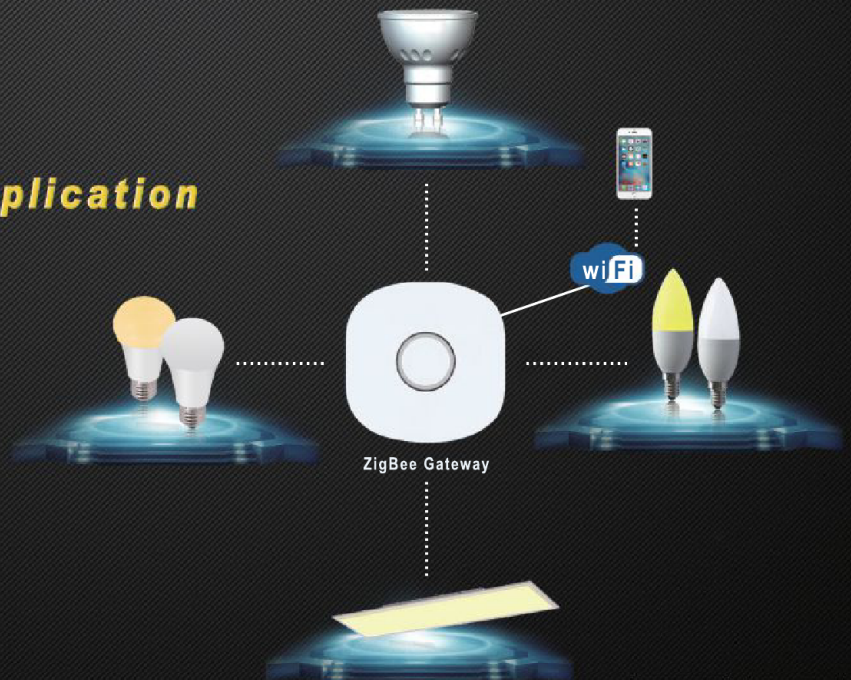
**Your ideal Smart home application**

**Dimmable Range: 10% - 100%**  
**CCT Tunable, RGBW changing**

**Controlled by App and Remote**  
**Control Distance: 30m**

◆ Jiuzhou Greeble (JEZETEK) is  
a certified member of ZigBee Alliance.

◆ welcome to LIGHTFAIR International in USA  
April 26th~28th in 2016 Booth No.: 3048



Tel:86-755-21389841 Email: daisy.liu@scjz-led.com  
www.jiuzhou-intl.com www.scjz-led.com



**Montreal Wall, Access Lighting •**

This marine-grade, wet-location LED wall sconce is available in 3000K with a CRI of 90-plus and it delivers 1,600 lumens. Measuring 11.96" wide by 2.48" tall and extending 3.46" from the wall, the streamlined aluminum housing makes the fixture suitable for use in contemporary applications, and it comes in a choice of black, bronze, or satin finishes with a frosted glass diffuser. • [accesslighting.com](http://accesslighting.com)



**Dyna Drum SO, Acclaim Lighting •**

This high-output, outdoor-rated LED floodlight has an adjustable yoke, on-board digital display, and a 100V/277V AC internal power supply, making it suitable for façade illumination and as an area floodlight. It is available in RGBW, RGBA, tunable options from 2400K to 5500K, and in 2700K, 3000K, 3500K, 4000K, and 5500K. A 6-degree beam spread is standard. DMX-512 and channel controls are offered. IP66 rated for use in wet locations. • [acclaimlighting.com](http://acclaimlighting.com)



**Tear Drop LED II, Acuity Brands Holophane •**

For use with Acuity's Holophane Tear Drop high-intensity discharge luminaires, these LED retrofit kits offer up to 20,000 lumens and use the existing fixture's castings and prismatic glass optics, replacing the door, gasket, light engine, electronics, and cover plate. They are available with three or five chip-on-board LEDs in 2700K, 3000K, 4000K, and 5000K with asymmetric or symmetric light distribution. • [holophane.com](http://holophane.com)



**Insigna, Amerlux •** A single row of three, four, six, or eight LED modules in 3000K, 4000K, and 5000K make this fixture suitable for a range of architectural wallwash applications. It delivers up to 29,570 lumens with an efficacy of up to 92 lumens per watt and is compatible with 120V/277V systems with auto-sensing and zero-to-10V dimming. In 18", 24", 36", and 48" lengths with direct-, tenon-, and mast-mounting options. A remote driver and external glare shield are optional. • [amerlux.com](http://amerlux.com)



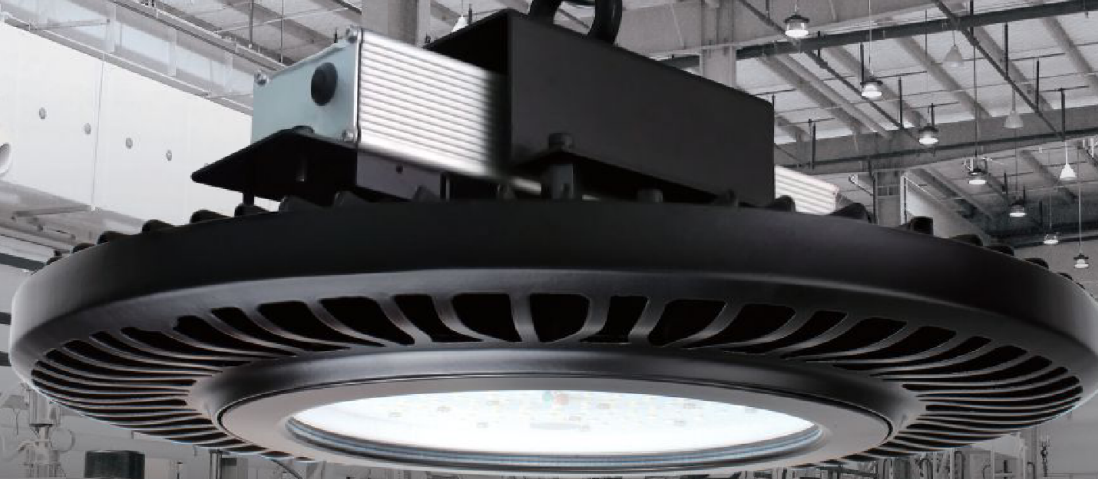
**Light Column Pathway Bollard, Forms+Surfaces •**

This 14W LED bollard joins the company's Light Column family with its minimalist form and stainless steel construction. It is available in 3000K and 4000K and uses a 100V/277V input. The LED driver is zero-to-10V dimmable. The bollard is 9.75" tall and comes in 5" and 6" diameters with a white-frosted acrylic lens and a stainless steel head-cap. Satin or powdercoat finishes are offered. • [forms-surfaces.com](http://forms-surfaces.com)



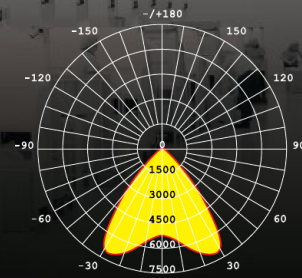
**Invue Arbor Post Top Luminaire, Eaton •**

With Eaton's WaveStream LED technology and AccuAim optics, this post-top fixture comes in 3000K at a CRI of 80 and 4000K at a CRI of 70 with outputs of 2,000, 4,000, 8,000, or 9,500 lumens per watt. Controls include zero-to-10V dimming, occupancy sensors, and LumaWatt wireless controls. In single and dual post-top and wall-mount options with Type II, III, IV asymmetric, and V symmetric distribution. • [eaton.com](http://eaton.com)



# LOTUS HIGH VOLTAGE

*We Know Your Highbay Repair / Installation Cost is High*



90° lens light distribution



## LED BAY LIGHT

- High voltage constant current driver,
- Input voltage 277 - 480V/AC
- Up to 115 lm/watt (120lm/watt R70)
- Power 60W - 230W
- Easy installation with suspension or wall mounting
- Ingress Protection IP65
- Beam angle 60° /90° /120°
- 5 Years guarantee



LED BAY LIGHT

TRANSPARENT SERIES JADE CEILING LIGHT

LED PANEL LIGHT

**SHEENLY**<sup>®</sup>

www.sheenly.com sales@sheenly.com



INTERNATIONAL

The future. Illuminated.

**2016**

Booth No.: **6830**  
Date: April 26-28

**DISTRIBUTORS IN THE U.S. WITH STOCKS**



**Powershine MK2 D, Griven USA** • For large-scale architectural lighting applications, this fixture features two adjustable LED arrays in RGBW, tunable white from 2700K to 6500K, or a choice of 3000K or 6300K, with an efficacy of 61.8 lumens per watt. Features include thermally isolated LED drivers and shielding accessories. A model intended for use in locations with regular ice and snow is also available. • [griven-usa.com](http://griven-usa.com)



**ArcheType X Site/Area, Hubbell Lighting/Kim Lighting** • The optics on this site and area luminaire can be configured in the field or factory to standard or custom distributions, and they offer 355-degree rotation and a 70-degree module tilt independent of the luminaire. The fixture is available in 3000K, 4000K, and 5000K with a range of lumen packages. Its head is 27.3" long and 19.4" wide, and it extends up to 36.4" from the pole. The sealed optical chamber is IP66 rated. • [kimlighting.com](http://kimlighting.com)



**FGP Pedestrian Light, Landscape Forms** • This site luminaire joins Milan-based designer Francisco Gomez Paz's line of site elements for the company and comes in 12', 14', and 16' heights with a top-mounted, cast-aluminum head on a tapered pole. In Type III and Type V distribution with 30 LEDs each, it is available in 3000K, 3500K, and 4000K with a 100V/277V AC input. It is zero-to-10V dimmable and IP66 rated with a diffuse lens that manages glare and asymmetric optics to direct light. • [landscapeforms.com](http://landscapeforms.com)



**Arceos ARA3, Hubbell Lighting/Spaulding Lighting** • This low-profile site luminaire can be mounted at up to 50' for use in spaces such as parking lots, auto dealerships, and transportation facilities. In three configurations: 26,000 lumens at 293W, 40,000 lumens at 435W, and 51,000 lumens at 580W. Controls include standard and wireless on/off and zero-to-10V dimming and occupancy sensors with on/off and dimming. With universal- and mast-arm mounts. • [spauldinglighting.com](http://spauldinglighting.com)



**Agena LED, HessAmerica** • The company has added LEDs to this indirect LED area luminaire, designed by French architect Jean-Michel Wilmotte. It is available in 3000K and 4000K, delivering 2,201 lumens and 2,305 lumens, respectively. A single chip-on-board LED is positioned within a polycarbonate reflector to produce a 40-degree beam spread. In matte silver-gray metallic or graphite gray finishes and with a stepped steel or aluminum pole in nominal heights of 13'. • [hessamerica.com](http://hessamerica.com)



**Evolve LED Streetlight ERL1, GE Lighting** • This LED roadway luminaire is designed as an alternative to conventional high-intensity discharge fixtures and has an integral heat sink and reflective optics that minimize glare. It is available in 4000K at a CRI of 70. An IP65-rated, die-cast enclosure can accommodate either a 1.25" or a 2" mounting pipe. The fixture comes with choice of black, gray, or dark bronze corrosion-resistant polyester powdercoat finishes. • [gelighting.com](http://gelighting.com)





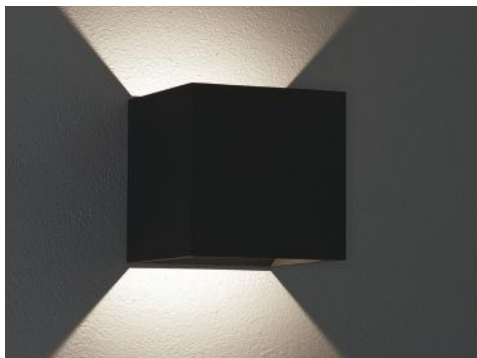
**Prisma Architectural Guell, Performance In Lighting** • These LED floodlights have a die-cast aluminum housing, flat tempered-glass diffuser, and high-performance reflectors made of iridescent-free, plated aluminum that has been polished and oxidized. The three fixture models each come in 3000K, 4000K, and 5000K with symmetric and asymmetric wide beam spreads. The fixtures can be pendant, trunnion, and knuckle mounted. All are IP66 rated. • [pil-usa.com](http://pil-usa.com)



**XALM LED, LSI Industries** • This area light is the first addition to the company's Mirada Series. It is available in 3000K, 4000K, and 5000K with a CRI of 70 and delivers up to 36,700 lumens in Type II, Type III, Type FT, and Type 5W light distribution. Dimmable, the luminaire also includes options for integral and wireless controls. Its sealed, die-cast aluminum housing has a cast-aluminum wiring access door and high-performance silicone optics. • [lsi-industries.com](http://lsi-industries.com)



**Lumec ClassicStyle and SleekVision with ClearGuide Technology, Philips Lumec** • Philips' Lumec brand now offers its ClassicStyle and SleekVision post-top (shown) and bollard luminaires with its ClearGuide Technology. Precision rings distribute light to avoid directly exposing the LEDs. Both lines offer a die-cast heat sink, an IP66-rated housing with acrylic or polycarbonate globes, a standard zero-to-10V dimming driver, and wireless control options. • [lumec.com](http://lumec.com)



**Outdoor QB 2-Light, Bruck/Ledra Brands** • This extruded-aluminum wall sconce in a contemporary cube design provides upward and downward light throw from an indirect LED light source. The Outdoor QB 2-Light is available in 3000K with a CRI of 80-plus. It has an onboard driver and can be surface-mounted to cover a standard J-Box. The fixture is 5.125" square and extends 5.125" from the wall. In anthracite bronze and silver finishes. • [brucklighting.com](http://brucklighting.com)



**ColorBurst Intellihue Powercore Gen2, Philips Color Kinetics** • These spot and wallwash fixtures come in a choice of: RGBW, RGBA, RGB; 2700K to 4000K at a CRI of 80-plus; or tunable white from 2000K to 10,000K above and below the blackbody curve. Beam spreads of 20, 40, 60, and 80, and 10 degrees by 40 degrees are offered. Accessories include glare shields, a louver, and a rock guard. Surface, stake, and standard J-Box mounts are offered. • [colorkinetics.com](http://colorkinetics.com)



**Vivat, Structura** • A slim, aluminum frame and wood accents pair in this 4"-by-4"-base LED pathlight, which can be specified with a 4W LED in 2750K for marker and pedestrian models and in 3000K for dual- and single-sided versions. The anchor base and mounting hardware are concealed, and a welded-in baseplate attaches to the ground using a concrete bolt kit or earth spike. The fixture is ADA compliant. • [structura.com](http://structura.com)



**Verve, Troy Lighting** • An opal or seeded glass diffuser is capped with bronze-finished aluminum and brass while connecting bands bridge the two and surround the source. It is lamped with a single, 12W LED in 2700K with a CRI of 90 delivering 840 lumens and has 120V incandescent dimming. The fixture is 20" tall by 8.5" wide with a 17.25" tall by 5.75" wide by 1" deep backplate. It is California Title 24 compliant. • [troy-lighting.com](http://troy-lighting.com)



**Eclipse Mini, Luminis** • Joining the company's Eclipse family of outdoor luminaires is this line of bollards, pendants, post-top, and wall-mounted fixtures with a 6" footprint and intended for park and pedestrian applications. Optics offer full cut-off to eliminate light trespass while added controls reduce backlight, uplight, and glare. It comes standard in 4000K with a CRI of 80 as well as 3000K and 3500K options and delivers between 700 and 4,700 lumens, depending on the fixture type. • [luminis.com](http://luminis.com)



**G-Profile, SGM Light** • For use in television and theater productions, and architectural installations, SGM Light has added a moving-head LED framing luminaire that can deliver beam-shaping images and projections. Four individually controllable blades are each adjustable plus-or-minus 30 degrees, and the module can be rotated through 45 degrees. The fixture allows for combining framing techniques with five rotating gobos and opens for gobo animation and interaction. It is IP65 rated. • [sgmlight.com](http://sgmlight.com)



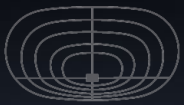
**Inula Bollard LED, Selux** • This LED pathway luminaire reduces light spill and uplight while providing 360-degree illumination. It measures 8" in diameter and can be specified in heights from 2.5' to 4'. It is available in 3000K, 4000K, and 5000K with an efficacy range from 59.3 lumens per watt to 82.3 lumens per watt and is zero-to-10V dimmable. Finishes include white, black, bronze, and silver. An emergency battery pack, Hi-Lo switching, and a Dark-Sky optical chamber are available. • [selux.us](http://selux.us)



**LED Accent Light, WAC Lighting** • This fully adjustable accent fixture has on-board wattage adjustment from 2W to 16W. The fixture is tunable from 1600K to 4000K, and delivers up to 1,000 lumens. It is intended to replace 10W to 75W halogen MR16 fixtures. Beam spreads from 10 degrees to 60 degrees are offered with an internal continuous dynamic adjustment mechanism. The housing comes in either corrosion-resistant cast-aluminum or marine-grade brass, both in a bronze finish. • [wacighting.com](http://wacighting.com)



**LED Architectural Flood Lights, MaxLite** • With a light output ranging from 5,660 lumens to 13,940 lumens, these floodlights replace 175W to 400W metal halide lamps. The line is offered in wide and spot beam spreads in 4000K. A curved aluminum body and a tempered glass front create a contemporary appearance. The fixtures are IP65 rated for use in harsh environments and are adjustable via a threaded knuckle or slip-fitter arm. • [maxlite.com](http://maxlite.com)



# ArcheType™ X

Kim Lighting is proud to announce the new LEAR™ (Light Engine Adjustable Ready) module, a concept that brings unparalleled flexibility to the lighting industry. By incorporating this latest design, Kim Lighting has developed the first outdoor luminaires with independently adjustable LED emitters. We call this concept theType X distribution. X is whatever you want it to be.

- LED modules rotate 355 degrees with 70 degrees of tilt for maximum flexibility
- Create your user defined distribution specific to your site using AGi32 v16 new feature Design Isolines
- Site, flood, wall product options



Infinite adjustability...



**KIM LIGHTING**

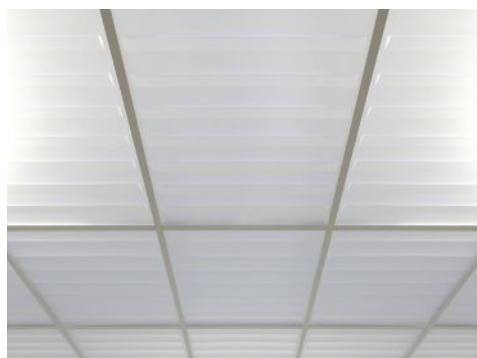
<http://www.kimlighting.com/typex/>



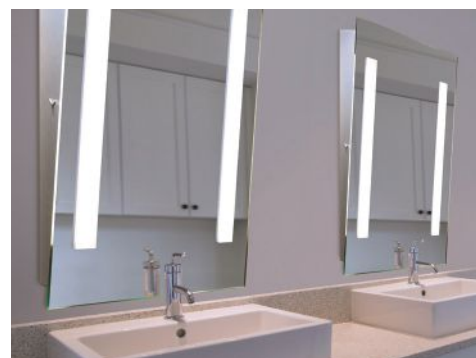
**HUBBELL**  
Lighting



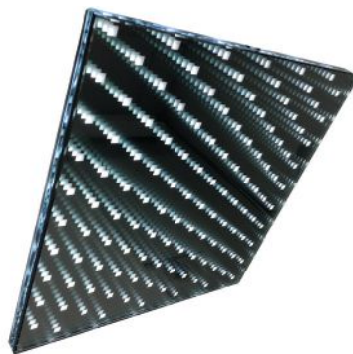
**Daylight Dimmer, Solatube International** • This 29"-diameter skylight dimmer joins the company's SkyVault Series daylight capture system for high-bay commercial spaces. A butterfly baffle offers even light distribution and reduces flare when opening or closing. It can be integrated into zero-to-10V digital lighting control systems. Up to eight units can be wired together on one 24V transformer, and up to six transformers can be controlled on a single-circuit array. • [solatube.com](http://solatube.com)



**Frosted and Clear Ceiling Panels, Ceilume** • The company has added frosted and clear options to its line of thermoformed, lay-in ceiling panels. They are available in 40 patterns, two sizes, and are washable, water-resistant, VOC-free, and suitable for use in drop-out ceilings beneath fire sprinklers. The panels can be paired with above-ceiling luminaires for zoning or to vary the illumination effect. • [ceilume.com](http://ceilume.com)



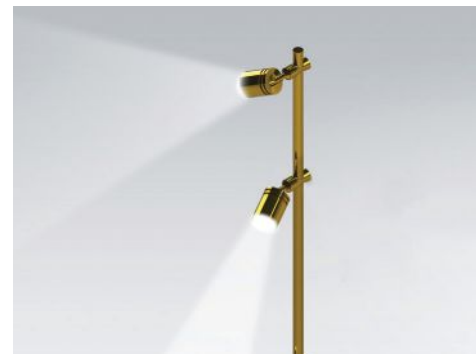
**Angled Wheelchair Mirror, Aamsco** • This line of mirrors for commercial, residential, and hospitality applications is angled downward to accommodate wheelchair users. Joining the company's Mirror-Lux line, the ADA-compliant mirrors have luminous inlays in 12W and 18W LED variations that require a 120V/277V input, have a high-power electronic ballast, and are fitted with 120V TRIAC dimming drivers. The mirrors are ETL-listed for damp locations. • [aamsco.com](http://aamsco.com)



**Celeste Glass, Sensitile Systems** • A variety of LED patterns and depths are available for these customizable luminous panels, for which the company recently added a glass option in addition to the existing acrylic resin. For use in backlighting and retail signage applications, the panels are available in color-changing RGB as well as in 2700K, 3000K, 4000K, and 6500K. Available in 4' by 8' panels with the option for clear or low-iron glass. • [sensitile.com](http://sensitile.com)



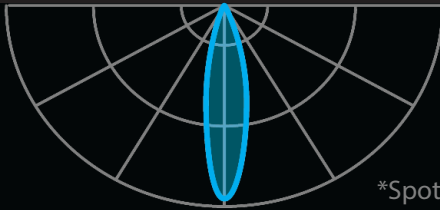
**Reflexions Collection, FlexArray** • These LED vanity mirrors come with single- or double-edge profiles. Available in 2400K, 3000K, and 4000K with the option to pair 2400K and either 3000K or 4000K. A user-operated push-button and dial offer on/off control and dimming, and wireless control is also available. For use as a vanity, dressing mirror, or decorative feature, the mirrors come in 26" by 32.5", 34.5" by 44", and 34.5" by 66" sizes, and can be mounted horizontally or vertically. • [flexarray.com](http://flexarray.com)



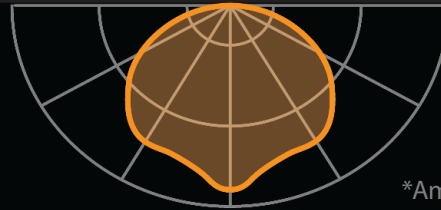
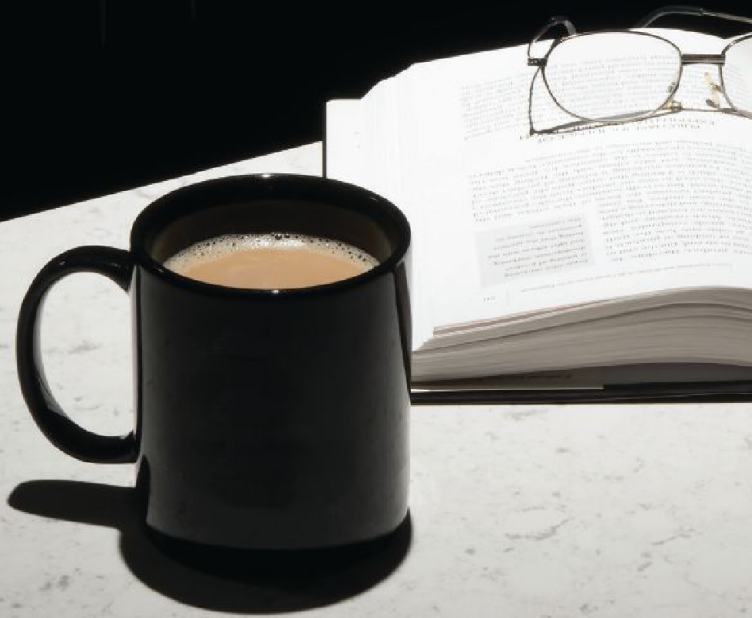
**Pixis Bell, Eclipse Architectural Lighting** • For retail displays up to 15' tall, this mini LED spotlight can incorporate up to five independently controllable 3.5W heads on its stem. The fully rotatable heads have field-changeable optics of 18, 24, and 41 degrees and can pivot up to 80 degrees. The fixture is available in 2700K, 3000K, 3500K, and 4000K with a CRI of 85 or 95. Its machined-aluminum construction includes a brass stem, and it can be mounted to wood and glass. • [eclipselighting.com](http://eclipselighting.com)

# WAC LIGHTING

Set the right atmosphere, NATURALLY.



\*Spot light distribution  
High brightness  
Crisp white light



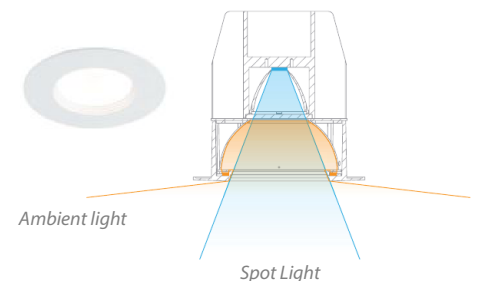
\*Ambient light distribution  
Lower brightness  
Warm white light



## Introducing our Duo LED Downlight

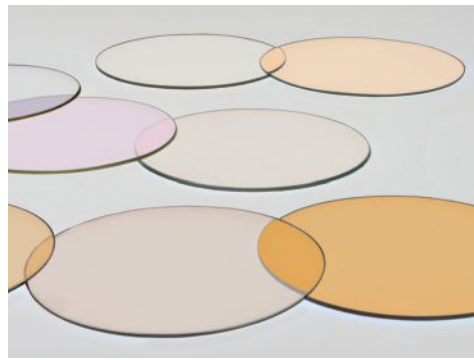
Change activity, change the lighting. Our Duo Downlight responds; changing from Bright to Dim, Crisp White to Warm White, and Direct Spot to Indirect Ambient, all in one natural motion when adjusting the wall dimmer.

*\*Control with a recommended Lutron Maestro MAELV-600 dimmer. For more information see [www.waclighting.com/duo](http://www.waclighting.com/duo)*

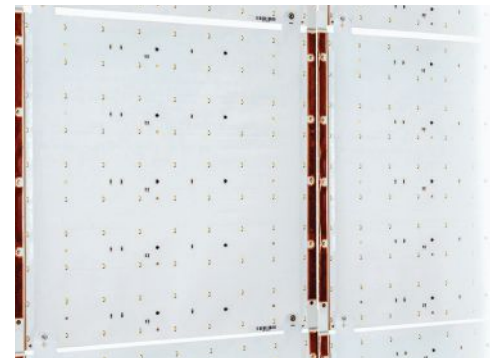




**Kreios Fresnel and Profile, Osram Sylvania** • For theatrical lighting applications of small- to medium-size event stages, these aluminum and iron spotlights offer a high output in a compact footprint. The 80W Fresnel (shown) is available in 3000K with a CRI of 92, as well as in RGBW with tuning from 2800K to 6500K. The 80W Profile comes in 3000K with a CRI of 92. Both are IP20 rated for indoor use. • [sylvania.com](http://sylvania.com)



**Polycarbonate Dichroic Architectural Lighting Filters, Lee Filters** • A dichroic coating and polycarbonate base combine to create clear and pure colors that resist fading, making these filters suitable for use in permanent installations to color-correct LED sources. The 0.03"-thick filters are designed to fit within the accessory slot of small fixtures. Five stock colors along with custom options are available. The filters can withstand temperatures of up to 100 C on each side. • [leefilters.com](http://leefilters.com)



**Cooledge Tile, Cooledge Lighting** • For backlighting applications, these LED sheets come in 2700K, 3000K, 3500K, 4000K, and 5700K with a CRI of 80-plus and have an efficacy range between 120 lumens per watt and 125 lumens per watt. The LEDs have a Lambertian distribution and offer color consistency within a two-step MacAdam ellipse. The sheets are field-cuttable in 2.4" increments and join via snap-in power connectors. Zero-to-10V or 1V-to-10V dimmable. • [cooledgelighting.com](http://cooledgelighting.com)



**Aerio, Echy** • Fiber optics collect and transport sunlight indoors to be diffused by Aerio, a suspended luminaire from French tech company Echy. A companion mobile app lets end-users switch from natural to electric light, with integrated LEDs providing backup. The fixture measures 49.2" long by 3.93" wide by 0.98" tall and weighs approximately 7 lbs. It can be suspended up to 9.8' via steel cables and is intended for use with the company's fiber-optic daylight collection system. • [echy.fr](http://echy.fr)



**Eugene Art Light, Robert Long Lighting** • This solid brass, 11W fixture includes a 22" dimmable LED strip and a perforated cover to provide soft, diffuse light for illuminating artwork. The reflector is 24" wide by 2" tall by 2" deep and comes with a 19" wide by 3" tall by 1.25" deep mounting bracket. The fixture extends 6.5" to 9" from the wall. Finish options include light oxidized copper or brass, oil-rubbed bronze, polished nickel or brass, oxidized brass, and black brass. UL listed. • [robertlonglighting.com](http://robertlonglighting.com)



**LightFlex CCT, Acuity Brands Sunoptics** • A patented remote phosphor panel allows this tubular prismatic daylighting system to adjust between 3600K and 3700K throughout the day to minimize the color temperature variation between natural and electric light. For use in suspended ceiling applications, the system can be specified with adjustable elbows to bypass obstructions. A color-shifting lens is optional. • [acuitybrands.com](http://acuitybrands.com)



LIGHTFAIR



INTERNATIONAL

The future. Illuminated.

2016

**NEW THIS YEAR**

**SAN DIEGO, CA USA**  
San Diego Convention Center

**PRE-CONFERENCE**  
April 24 – 25, 2016

**TRADE SHOW & CONFERENCE**  
April 26 – 28, 2016

[LIGHTFAIR.COM](http://LIGHTFAIR.COM)

IALD



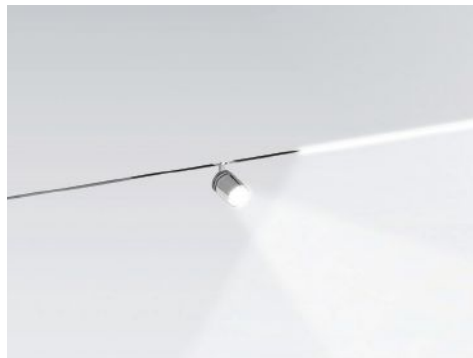
  
AmericasMart  
Atlanta

LIGHT AND  
TECHNOLOGY IN A  
NEW LANGUAGE.

PHOTO CREDITS  
ZHENHAI CULTURE & ART CENTER, NINGBO,  
ZHEJIANG, CHINA | LIGHTING DESIGN: NINGBO YONGQI  
LIGHTING CO LTD | PHOTOGRAPHY © XING KAIQUN



**L516 COB Track Luminaire, Jesco Lighting** • Each fixture in this trio of aimable, line-voltage, high-output track luminaires is fitted with a single, chip-on-board LED. The fixtures, which can be specified at 18W, 27W, or 49W, are available in 2700K, 3000K, 3500K, and 4000K with a CRI of 80, 90, or 97, and with beam spreads from 18 degrees to 60 degrees depending on the model. • [jescolighting.com](http://jescolighting.com)



**Lifeline, Eklipse Architectural Lighting** • This fixture features the company's compact Mili and Pixis fixture heads on a magnetic track. The LED Mili (right) measures 0.182" wide by 0.5" tall and is designed for shelving systems; a 35-degree asymmetric beam spread covers the work surface while the light source remains hidden from view. Pixis' fixture head (left) can be fully rotated and tilted up to 80 degrees vertically with field-changeable optics in 18, 24, and 41 degrees. • [eklipselighting.com](http://eklipselighting.com)



**Saliot, Minebea** • A companion app for these trackheads from Japanese lighting manufacturer Minebea allows lighting designers to adjust beam spread, pan, tilt, dimming, and zoom for a single fixture or an entire network. Available in 2700K, 3000K, 3500K, 4000K, and 5000K with a CRI of 83 or 95, each fixture offers beam distributions from 10 degrees to 30 degrees and has a 1mm-thick lens. • [minebea.co.jp](http://minebea.co.jp)



**Hornet HP A-14 LED Light Engine, Amerlux** • The company updated this LED light engine for track fixtures to deliver 1,369 lumens at 75 lumens per watt, an 18% increase on both measures from the previous model, while its center beam candlepower increased by 20% to more than 12,200 candelas, according to the company. It can deploy color temperatures from 2200K to 4000K with a CRI of up to 90-plus. With adapters for one, two, and three circuits. • [amerlux.com](http://amerlux.com)



**Trac-Lites 10W LED R600L Series, Acuity Brands Juno Lighting Group** • For use in retail, commercial, and residential accent lighting applications, the 10W LED R600L Series track fixtures replicate the light output and distribution of a 50W halogen lamp. The luminaires are available in 2700K, 3000K, 3500K, and 4000K with a CRI of 80 or 90. They can be specified with narrow flood and flood beam spreads using interchangeable, precision-molded custom lenses. • [junolightinggroup.com](http://junolightinggroup.com)



**R-2, SGM Light** • Integrated wireless controls and sensors enhance the functionality of these LED rail lights by allowing for their control over distance via wireless DMX. Available in 3000K and 4000K as well as RGBW, the fixtures provide a light output range of 48 lumens per watt to 125 lumens per watt. For use with the company's C-5 Wireless DMX Controller, designers can create and schedule scenes. The luminaire is offered with a black or a white housing. • [sgmlight.com](http://sgmlight.com)



PHILADELPHIA!

Let architecture ring

**AIA Convention 2016**  
May 19–21, Philadelphia

Day 1 keynote speaker:  
Kevin Spacey

Why you shouldn't miss it  
[aia.org/convention](http://aia.org/convention)





**Iyon M LED, Zumtobel** • Designed for passive cooling, this LED spotlight's streamlined form makes it suitable for accent lighting in retail spaces and showrooms. It is available in 3000K and 4000K with a CRI of 90-plus and has a light output range from 2,200 lumens to 3,300 lumens. Flood, spot, and wide flood beam spreads are offered. For use with the company's Eutrac system, dimming options include TRIAC, 1V-to-10V, and DALI. In white and black finishes. • [zumbel.us](http://zumbel.us)



**Fokis, Tech Lighting** • This 14.8W trackhead features a field-adjustable optic that can be turned by hand to adjust the beam spread from 20 to 50 degrees. A locking mechanism features indicator markings to ensure consistent aiming when working with multiple fixtures. Fokis is available in 2700K, 3000K, and 3500K with a CRI of 90, and it delivers 1,500 lumens. Satin nickel and white finishes are offered. • [techlighting.com](http://techlighting.com)



**Revo, Nora Lighting** • The company's Revo motorized track fixture, which can be controlled using a handheld remote, is now available with a wider range of LED PAR lamps. Fitted with an E26 base, the fixture accepts PAR20, PAR30, and PAR38 LED lamps from 8W to 90W. For high-ceiling applications, the trackheads can be rotated 340 degrees horizontally and 200 degrees vertically. Each is 5" wide by 4.25" long by 2" in diameter. • [noralighting.com](http://noralighting.com)



**Ledo, Targetti USA** • This compact 24W LED projector is field-adjustable up to 90 degrees vertically and up to 355 degrees horizontally. It is available in 3000K and 4000K and delivers 2,712 lumens per foot. Spot, flood, medium-wide flood, and wide flood optics are offered. A black polycarbonate back ring on the front optic has a radial grid for heat dissipation. Accessories include colored chromatic filters, a corrective lens, cut-off tubes, and anti-glare diffusers. • [targetti.us](http://targetti.us)



**Maxima NSP, Edison Price Lighting** • This track-mounted spotlight can illuminate artwork, signage, and other objects from ceiling heights of up to 20'. It is available in 2700K, 3000K, 3500K, and 4000K with lumen outputs of 1,400 to 2,700 lumens and a CRI of 80-plus or 98. For use on 120V or 277V tracks, the luminaire can be dimmed to 10% by an internal rotary dimmer. Fully rotatable, it can be tilted up to 90 degrees vertically. With white, black, silver, and custom paint finishes. • [epl.com](http://epl.com)



**Anthony, Flos** • From Italian designer Antonio Citterio, this LED spotlight family can be used with the company's Running Magnet 2.0 magnetic track system, offering a 90-degree tilt and 360-degree rotation. It is available in 2700K and 3000K with a CRI of 80 or 95 and lumen outputs of 1,200 lumens or 1,710 lumens. The spot heads have a cast-aluminum radiator and an on-board switch dimmer. With black, white, and chrome finishes. • [usa.flos.com](http://usa.flos.com)

## SAVING SPACE

Product literature libraries are going digital as lighting design firms cut down on physical space in an effort to keep up with rapid advances in LED technology, putting a new kind of pressure on manufacturers to keep up.



text by Hallie Busta

Fast growth in LEDs is causing lighting design firms to rethink their product libraries, devoting less space to printed materials while growing their digital footprints. Chicago-based lighting design firm Schuler Shook took its product-information library digital two years ago, and now its designers pull and share specs directly from manufacturer websites—and because new technology means the information changes quickly, designers often must pull fresh files for each project. “This is the modern version of standing in front of the catalog library when searching for a fixture,” says Grant Kightlinger, a project lighting designer at Schuler Shook. Similarly, at Cline Bettridge Bernstein Lighting Design (CBBLD), in New York, a product librarian collects materials sent to the firm and issues a monthly internal email detailing what’s new. The related files are saved to the firm’s server and are keyword searchable using the software NewForma.

The fewer clicks it takes to find product information online, the better, says CBBLD senior associate Nathalie Faubert. “We have limited fees, we are rushed with time, and are trying to issue [drawings and documents] very quickly,” she says. “We don’t want to spend too much time on things [like finding product information on a website].” And while the Internet may be many designers’ go-to source for product documentation, the manufacturer’s rep relationship is still vital. In Washington, D.C., the 10-person team at MCLA Architectural Lighting Design regularly meets with reps to learn about new products, as do Schuler Shook and CBBLD. Keeping the length and frequency of the meetings to a minimum, while maintaining contact with the same rep or agency, is key to productive encounters. “When we need information, we need it quickly,” says MCLA principal Maureen Moran. While designers need to keep pace with change at the manufacturer level, those manufacturers must stay attuned to designers’ tight project deadlines and new, tech-driven workflows. Because if a company’s product information isn’t easy to find online, busy lighting designers may be inclined to take their business elsewhere. •

**ARCHITECT**

THE TENTH ANNUAL

**R+D AWARDS****CALL FOR ENTRIES**

Are you revolutionizing the process and product of architecture? ARCHITECT wants to celebrate the groundbreaking research, materials, and technologies that are advancing the building industry at every scale—from design strategies and building systems to products, software, and fabrication methods.

ENTER TODAY: [RDAWARDS.COM](http://RDAWARDS.COM)



**Ai Cove, Acclaim Lighting •** Dimmable from 3000K to 1800K using a standard, TRIAC dimmer, this interior cove fixture is suitable for architectural applications. The luminaire can be specified in 1' and 4' sections, delivers 500 lumens per foot with a CRI of 90, and it consumes 10W per linear foot. The fixture has a 120-degree beam spread. An IP20-rated polycarbonate housing makes the fixture suitable for use in dry locations. It is also offered with zero-to-10V and DMX controls. • [acclaimlighting.com](http://acclaimlighting.com)



**LPW8 Series, Lighting Services Inc •** A field-replaceable, chip-on-board LED panel powers this stem-mounted wallwasher. The LPW8 Series delivers 2,180 lumens through an asymmetric, total-internal-reflection optic. An integral driver is compatible with trailing-edge electronic low-voltage (ELV) dimming down to 5% with options for use with LumenTalk through DMX, TRIAC, ELV, or zero-to-10V systems down to 1%. • [lightingservicesinc.com](http://lightingservicesinc.com)



**Trov, EcoSense •** A range of optical distributions, including direct-view and asymmetric, makes this linear LED luminaire series suitable for interior and exterior cove, grazing, and wallwash applications. The dimmable system is available from 2200K to 2500K with a CRI of 80- or 90-plus as well as with red, green, blue, and amber LEDs. A flip-to-flat hinge allows designers to adjust the beam spread from zero to 180 degrees. • [ecosenselighting.com](http://ecosenselighting.com)



**Linealight Paseo, Inter-Lux •** This outdoor linear LED luminaire offers emission options for diffused light, wallwashing, and grazing. It is available in 3000K and 4000K with a CRI of 75. Its polycarbonate casing can be specified with either a transparent or opalescent diffuser while a power supply cable located on the fixture's bottom allows for daisy-chaining. Dimming options include 1%, zero-to-10V, and 120V/277V. The fixture is ETL wet-location listed and IP67 rated. • [inter-lux.com](http://inter-lux.com)



**Stacklite CZR, Edison Price Lighting •** This compact, track-mounted wallwasher has been updated to include an LED light source. Four chip-on-board linear LED arrays are available in 3000K and 3500K with a CRI of 80 or 90. The fixture delivers up to 2,400 lumens and is dimmable down to 1%. The internal LED mounting assembly can pivot vertically up to 50 degrees. A surface-mounted version is also available. • [epl.com](http://epl.com)



**LED DW Series, Engineered Lighting Products •** Vertical light throw and an indirect reflector that eliminates scalloping combine in this wallwash and grazing fixture, which can be installed less than 2' from the surface that it is illuminating. The company recently updated the fixture with 11W LED modules in 2700K, 3000K, 3500K, and 4000K with a CRI of 80-plus. Dimming options include zero-to-10V controls. The fixture's housing provides tool-free access to the driver and wiring. • [elplighting.com](http://elplighting.com)



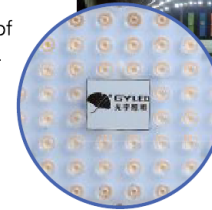
## Tmast Flood Light



LEDs:  

Tmast series is an innovative program for field lighting. Single Module is of 200W, combinations of different modules offer high power lamps from 200W~800W. Each 200W module is independent, with separate electro-optical system and heat extraction system, which can provide different lighting distribution to meet different lighting requirements, moreover, the weight of lamp is only up to 22.5kgs(800W), easily for mounting.

Model: **GY496TG**  
 Power: **200/400/600/800W**  
 Luminous Efficiency: **100lm/W**  
 Beam Angle: **13°/30°/60°/90°/120°**  
 Power supply: **Meanwell, Inventronics, Moons**  
 Dimming (optional): **Dali, 0~10v**  
 Recommended Mounting Height: **10~50m**



## High Bay Light, Flood Light



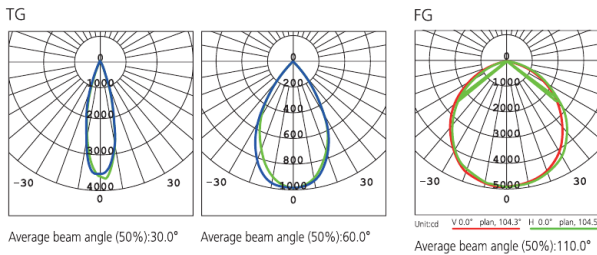
- To deliver high-lumen output: up to 110lm/W (lamp), 140lm/W (LEDs)
- To replace HID high-bay lights up to 400W by 50% energy-saving
- Reasonable design of lamp structure with user friendliness

Beam Angle:  
**30°/60°/110°**  
 Power supply:  
**Meanwell**  
 Dimming (optional):  
**Dali, 0~10V**



Model: **GY380TG, GY380FG**  
 Power: **140/200W**  
 Weight: **7.5Kgs**

Model: **GY300TG, GY300FG**  
 Power: **80/120W**  
 Weight: **5.3Kgs**



LEDs:  

**Provider for High Power LED Lighting Products and Solutions**  
 National New High-tech Enterprise, Ranking NO.1 among Chinese LED street light enterprises

**SHANXI GUANGYU LED LIGHTING CO.,LTD.**

Sales Center (Beijing) Tel: **86 10 62113630** Fax: **86 10 62153948** Celular: **86 18610264858**  
 Email: [sales@gyledlight.com](mailto:sales@gyledlight.com) Skype ID: [rayking188](https://www.skype.com/user/rayking188) [www.gyledlighting.com](http://www.gyledlighting.com)

# WALLWASHERS



**PureGlow IntelliHue Powercore, Philips Color Kinetics** • Philips Color Kinetics redesigned this linear luminaire with a novel optic that mixes internal channels and reduces mixing distance. It offers tunable white light in 2700K to 6500K with high CRI Ra and CRI R9, as well as saturated color, and delivers a minimum of 750 lumens per foot. Three beam spreads are offered. The fixture uses up to 13W per foot, runs on 100V/277V AC, and is controllable via DMX and Ethernet. It is IP20 rated. • [colorkinetics.com](http://colorkinetics.com)



**ZipWave LED 707, Vode Lighting** • For use with acoustical ceilings in corporate, hospitality, and healthcare applications, this wallwasher is available in 2700K, 3000K, 3500K, and 4000K with a CRI of 84 and delivers up to 708 lumens per foot. Rail lengths of 24", 36", 48", 60", and 72" are offered with a 20" integral-power housing and profiles of 1.8" by 3.7" for the ceiling cove and 1.6" by 3.8" for the wall cove. Dimming options include 1%, 10%, zero-to-10V, DALI, and Lutron EcoSystem. • [vode.com](http://vode.com)



**MicroWash Asymmetric, Prudential Lighting** • This LED wallwasher offers up to 250 degrees of tilt capacity to illuminate signage and artwork. It is available in 2700K, 3000K, 3500K, and 4000K, and delivers up to 1,080 lumens per foot. The fixture can be surface-, cable-, or stem-mounted to walls and ceilings. Dimming options include zero-to-10V, step, and DALI. • [prulite.com](http://prulite.com)



**Butterfly Wall, Orgatech Omegalux** • This forward-throw, indirect LED wall and ceiling luminaire is suitable for use in large, open spaces such as shopping malls and airports. In 12" and 18" squares that are 4.5" and 7" deep, respectively, and with curved sides that taper to the front, each delivers up to 16,000 lumens and come in wattages from 32W to 95W. The housing is offered in black, bronze, silver, or white polyester powdercoat finishes. UL listed for wet locations. • [orgatechomegalux.com](http://orgatechomegalux.com)



**EF600 Series, LF Illumination** • In 2' to 8' lengths with a clear or diffuse lens, this linear LED cove- and surface-mounted lighting system features three LED power levels delivering up to 1,200 lumens per foot. A 4" wide by 1.25" tall metal housing allows for installation in tight spaces. The fixture has a field-replaceable integral LED driver and built-in thermal protection and wiring. Offered with a white powdercoat finish. • [lfillumination.com](http://lfillumination.com)



**640 Cove LED, Wilal/Ledra Brands** • With a low-profile housing, this linear line-voltage LED cove fixture is available in 3000K and 4000K with a CRI of 80-plus. Dimmable down to 1%, the fixture has a 120-degree beam spread and delivers 500 lumens per foot. Its extruded-aluminum housing comes in a white finish. • [wilalighting.com](http://wilalighting.com)

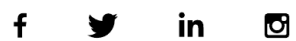


# UNVEILING

SAN DIEGO - LIGHTFAIR - 4.26.2016



#LFI2016 #VISALIGHTING



**RS LED** Leader of Advertising Signage  
Expert of Panel Lighting

**2'X2'**  
40W | 50W

**1'X4'**  
40W | 50W

**2'X4'**  
50W | 63W

**Choose Us**

- ◆ ISO 9001 & 14001 certified factory
- ◆ In-house LED packaging  
In-house PMMA extrusion  
In-house power supply manufacturing
- ◆ 5 years warranty

Signage & Outdoor Advertising Lighting | Shopfitting Lighting | Commercial Lighting

**408-748-8889**

2320 Walsh Ave,  
Santa Clara, CA 95051  
Info@rishang-led.com  
jun.huang@ledlamps.com.cn  
www.RS-LED.com  
www.rishang-led.com

RS LED

MANUFACTURER	CATEGORY	
Aamsco	Specialty	82
ABBLighting	Direct/Indirect	50
Access Lighting	Outdoor	76
Acclaim Lighting	Outdoor	76
	Wallwashers	90
Acolyte LED	Direct/Indirect	54
	LEDs and Drivers	70
Acuity Brands eldoLED	LEDs and Drivers	68
Acuity Brands Gotham Lighting	Downlights	56
Acuity Brands Holophane	Outdoor	76
Acuity Brands Juno Lighting Group	Downlights	56,58
	Tracklighting	86
Acuity Brands Mark Architectural Lighting	Direct/Indirect	53
Acuity Brands Peerless	Direct/Indirect	54
Acuity Brands Sunoptics	Specialty	84
Ambiance Lighting Systems	LEDs and Drivers	68
Amerlux	Direct/Indirect	50
	Industrial	60
	Outdoor	76
	Tracklighting	86
Architectural Lighting Works	Direct/Indirect	53
Artemide	Decorative	44
	Direct/Indirect	53
Aura Light	Lighting Controls and Systems	72
Axo Light	Decorative	47
Barron Lighting Group	Exit/Emergency	62
B.E.G. Controls	Lighting Controls and Systems	72
Birchwood Lighting	Direct/Indirect	52
Boyd Lighting	Decorative	48
Bruck/Ledra Brands	Outdoor	79
Ceilume	Specialty	82
Cerno	Decorative	47
Cooledge Lighting	Specialty	84
Creative Systems Lighting	Decorative	44
Cree	Lamps and Ballasts	64
	LEDs and Drivers	68
Delray Lighting	Decorative	46
DMF Lighting	Downlights	56
Douglas Lighting Controls	Lighting Controls and Systems	72



EarthTronics	Lamps and Ballasts	64
Eaton	Direct/Indirect	52
	Downlights	56
	Industrial	60
	Lighting Controls and Systems	74
	Outdoor	76
Echy	Specialty	84
EcoSense	Wallwashers	90
Edison Price Lighting	Tracklighting	88
	Wallwashers	90
Eklipse Architectural Lighting	Specialty	82
	Tracklighting	86
Elco Lighting	Exit/Emergency	62
Engineered Lighting Products	Wallwashers	90
Enlighted	Lighting Controls and Systems	74
Eureka Lighting	Decorative	47
Feiss	Decorative	47
Finelite	Direct/Indirect	52
FlexArray	Specialty	82
Flos	Decorative	44
	Tracklighting	88
Forms+Surfaces	Outdoor	76
Foscarini	Decorative	46
Fulham	Exit/Emergency	62
GE Lighting	Lamps and Ballasts	64
	Outdoor	78
Global Lighting	Decorative	44
Green Creative	Lamps and Ballasts	64
Griven USA	Outdoor	78
HessAmerica	Outdoor	78
Hubbell Lighting/Columbia Lighting	Direct/Indirect	52
Hubbell Lighting/Kim Lighting	Outdoor	78
Hubbell Lighting/Spaulding Lighting	Outdoor	78
Ilumi Solutions	Lamps and Ballasts	64
Intense Lighting/Leviton	Downlights	56
Inter-Lux	Wallwashers	90
Jader Almeida	Decorative	44
Jesco Lighting	Downlights	56
	Lighting Controls and Systems	72
	Tracklighting	86



The Vode ZipTwo™ micro-profile LED is, at 9mm thick, barely a line in space. Thin as it is, it delivers 800 lm/ft and mounts in a snap. For contractors and designers, **consider it a peace offering.**





housing innovation,  
vision & economics

# SEPTEMBER 28-29, 2016

## JW Marriott at LA LIVE Los Angeles, CA

**HIVE '16** is a new event experience that spans over two days and includes keynote addresses, educational content, leading industry speakers, featured trends, and the inventive HIVE Innovation Lounge which will leave you inspired and thinking differently about housing.

REGISTER TODAY:  
[ar.hwhive.com](http://ar.hwhive.com)

*Limited passes available*

Save \$2,000 when you register by April 30, 2015  
with promo code **SPRINGFEVER**

TITLE SPONSOR



FOUNDING SPONSOR



**NETWORK** with the most influential thinkers from across the country

**EXAMINE** innovative products, latest technologies, and exclusive data in the HIVE Lounge

**EXPLORE** the top five transformative forces in housing: Demographics, Economics, Design, Products, & Business Management

[Hwhive.com](http://Hwhive.com)

**hanleywood**

Where Data Drives Action

MANUFACTURER	CATEGORY	
Ketra	Downlights	58
	Lighting Controls and Systems	72
Kichler	Decorative	46
Koncept	Decorative	46
Kreon	Downlights	58
LàMàr Lighting	Direct/Indirect	52
Landscape Forms	Outdoor	78
Lauren Illumination	Direct/Indirect	50
LBL Lighting	Decorative	47
Lee Filters	Specialty	84
Legrand	Lighting Controls and Systems	74
LF Illumination	Downlights	58
	Wallwashers	92
LightArt	Direct/Indirect	53
Lighting Services Inc	Downlights	58
	Wallwashers	90
Ligne Roset	Decorative	48
Louis Poulsen	Decorative	47
	Downlights	58
LSI Industries	Outdoor	79
Lumenetix	LEDs and Drivers	70
Luminis	Downlights	59
	Outdoor	80
Lutron	LEDs and Drivers	70
	Lighting Controls and Systems	74
MàxLite	Industrial	60
	Outdoor	80
Meteor Lighting	Downlights	59
Minebea	Tracklighting	86
Modern Forms	Decorative	48
Modular Lighting Instruments	Direct/Indirect	52
	Downlights	59
Molto Luce/Ledra Brands	Decorative	48
	Direct/Indirect	53
Nora Lighting	Downlights	59
	Tracklighting	88
Nordeon USA	Direct/Indirect	54
Orgànic Lighting	LEDs and Drivers	70
Orgatech Omegalux	Wallwashers	92



The Vode RaceRail™ suspended LED is remarkably adaptive. With rails that rotate infinitely and lock at any angle, and drivers that can be placed 100 feet away and dim to 1%, **it's more than OK.**





# LET THE LIGHT IN!

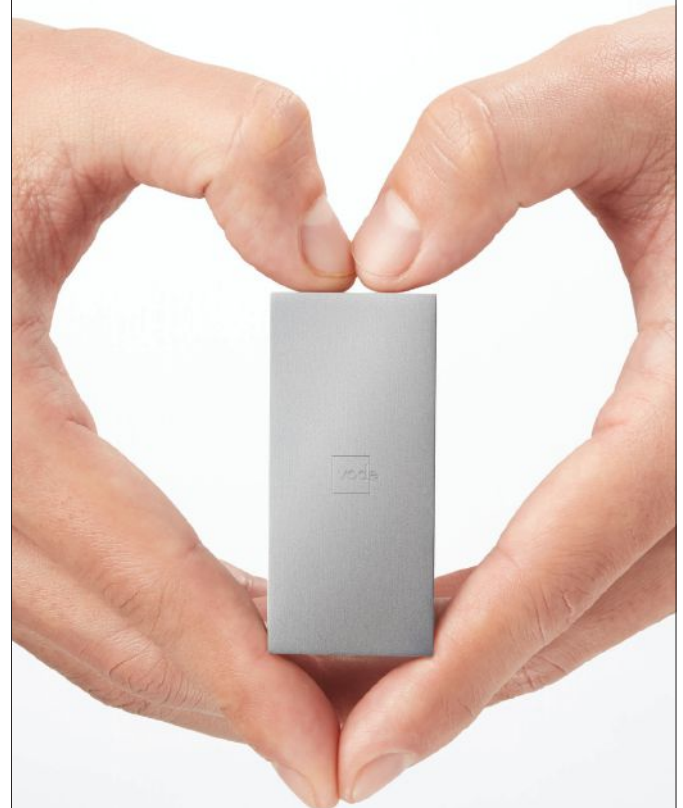
Get up-to-date with web-exclusive essays and articles, including news and events, project and product slideshows, detailed product and technology coverage, how-to guidance from industry experts and social media feeds.

[archlighting.com](http://archlighting.com)

MANUFACTURER	CATEGORY	
Osram Sylvania	Lamps and Ballasts	66
	Lighting Controls and Systems	74
	Specialty	84
Paramount Industries	Industrial	60
Performance In Lighting	Outdoor	79
Philips Lighting	Industrial	60
	Lighting Controls and Systems	72
Philips Color Kinetics	Outdoor	79
	Wallwashers	92
Philips Ledalite	Direct/Indirect	50
Philips Lumec	Outdoor	79
Progress Lighting	Decorative	48
Prudential Lighting	Wallwashers	92
PureEdge Lighting	Direct/Indirect	54
Robert Long Lighting	Specialty	84
Selux	Direct/Indirect	50
	Outdoor	80
Sensitile Systems	Specialty	82
SGM Light	Outdoor	80
	Tracklighting	86
Solatube International	Specialty	82
Sonnemän	Decorative	46
Soraa	Lamps and Ballasts	66
Structura	Outdoor	79
Studio Italia Design	Decorative	46
Targetti USA	Tracklighting	88
Tech Lighting	Tracklighting	88
Terralux	LEDs and Drivers	68
Thomas Research Products	LEDs and Drivers	68
Troy Lighting	Outdoor	80
Two.Parts	Decorative	44
Universal Lighting Technologies	Industrial	60
	LEDs and Drivers	70
USAI Lighting	Downlights	59
Vibia	Decorative	48
Visa Lighting	Direct/Indirect	54
Vode Lighting	Wallwashers	92
V2 Lighting Group	Direct/Indirect	54
WAC Lighting	LEDs and Drivers	70
	Outdoor	80
Waldmann Lighting	Direct/Indirect	53
WattStopper/Legrand	Lighting Controls and Systems	74
Wila/Ledra Brands	Wallwashers	92
Zumtobel	Direct/Indirect	50
	Tracklighting	88



The Vode DoubleBox™ suspended LED provides both direct and indirect light for open office, conference room and classroom applications. It's 1,900 lm/ft at its most efficient. **What's not to love?**





**MCWONG**

Surge Protection

480/347V Stepdown

LED Emergency Battery Pack

www.mcwonginc.com

30+ YEARS OF EXCELLENCE Since 1980

Aamsco has patented The ALINEA LED as the replacement for the incandescent lamp which has been discontinued. With an average life of 50,000 hours and a 3 year limited warranty, it will ensure many years of use without the frequent re-lamping that is typical of incandescent lamps. The ALINEA LED is available in two color temperatures; 2400K with 90CRI and 3500K with 85CRI. The ALINEA LED fits into all existing ALINEA luminaires, as well as in any fixture using a standard S14s socket, with no modifications needed.

Consider the ALINEA Luminaire when choosing a lighting solution in your next design.



www.aamsco.com

AAMSCO



**STEALTH**

High performance LED wall wash luminaires

Available in (6) wattage/lumen packages, delivering up to 5900lm

High output LED array with an optically engineered custom reflector

Wide, smooth beam provides excellent uniformity

Track and Recessed luminaires

CONTECH LIGHTING

www.contechlighting.com

See these and other new products at LightFair 2016! Visit us at booth 3516


LIGHT DIRECTORY

ARCHITECTURAL LIGHTING RESOURCE

LIGHTDIRECTORY.COM: Products, Catalogs, News, Jobs, Events, iPhone/Android apps

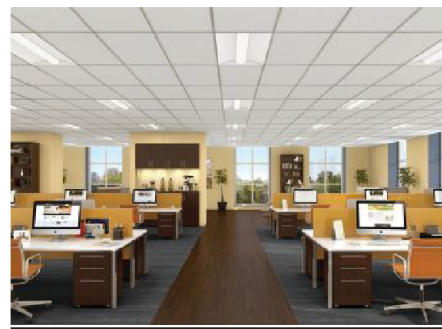
ACOLYTE

We Make Solutions



www.acolyteled.com

Complete Integrated LED Lighting Solutions



**ELEVATE**

YOUR EXPERIENCE

HUBBELL Lighting

www.hubbellighting.com

ImagiLux

ULTRA-THIN LED PANELS

SEE > [imagiluxled.com/AL](http://imagiluxled.com/AL)

**FOR INFORMATION**

on how to be a part of the next **ARCHITECTURAL LIGHTING MAGAZINE**

special advertising section, contact Jaeda Mohr at 202-736-3453.

hw



**Eco Friendly. Fashion forward.**

AMERICAN MADE LED LIGHTING

BARN LIGHT USA

WWW.BARNLIGHT.COM

800-407-8784



**FOREST LIGHTING**

Sustainable Illumination

Affordable Performance.

T8 & T5 LED Linear Lamps.

Forest Lighting T8 and T5 LED Integrated Linear Lamps feature a unique design allowing multiple lamps to be connected up to 20 feet, for maximum interior-space installation flexibility and 40% energy savings. These affordable LED lamps feature an integrated universal driver and can be surface mounted. Available in 2 & 4 foot lengths, and last up to 50,000 hours. In-stock now. UL, DLC.

Forest Lighting, 2252 Northwest Pkwy SE, Suite D, Marietta, GA 30067

800-994-2143 [www.forestlighting.com](http://www.forestlighting.com)



**WILA**  
LED brands

**624 2" DOWNLIGHT**

- XICATO® XTM
- SDCM 1 x 2
- Down, Wall Wash, Adjustable
- Retrofit / New Construction
- 2 1/4" aperture
- Wet Rated

P 714.259.9959 [WilaLighting.com](http://WilaLighting.com)



**MayaLED MA30**

**Zero uplight**

The MayaLED MA30 is a new pedestrian scaled bollard designed to compliment the existing MayaLED family of wall and post top luminaires.

- Beautiful design
- Great performance
- Absolute control
- Full cut-off

[luminis.com](http://luminis.com)

**LUMINIS**

**SunDialer®**

The automated system is the advanced solar-tracking controller for small-scale and retrofitted projects. It positions shades on windows based on real-time sky conditions, maximizing personal comfort and views to the outside. And it's highly energy efficient, too.



**MechoSystems**  
Design with light®

T: +1 (800) 437-6360  
W: [mechosystems.com](http://mechosystems.com)



**LSI**

**LumeLEX 2048**  
Fixed Downlight

Dim to Warm

[www.LightingServicesInc.com](http://www.LightingServicesInc.com)

**Quantum Vue™**



Quantum Vue is an easy-to-use facility management tool you can use on any device. Access building performance and energy data, as well as monitor, control, and optimize a Lutron light and shade control system. Quantum Vue also provides hassle-free scheduling and real-time tuning.

[lutron.com/QuantumVue](http://lutron.com/QuantumVue)



**Lotus High Voltage**  
ETL&DLC listed, Sheenly LED Bay Light

- Full range Industrial Lighting solutions: 60W - 230W
- High Voltage up to 480V AC
- 5 years Guarantee, water-proof, dimmable
- Beam angle 60°/90°/120° is optional
- Innovative heat sink design, ventilated self-cleaning ability
- Easy wall-mounted or suspension installation

**SHEENLY®** | Sheenly Lighting Co., Ltd.  
sales@sheenly.com  
[www.sheenly.com](http://www.sheenly.com)

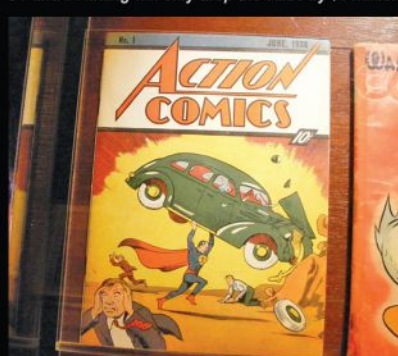
**DESIGN  
DEFINE  
DISAPPEAR**

THE NEW SHAPE OF LIGHT.

Ask us about our new QUICK SHIP program!

**LUCIFER**  
LIGHTING COMPANY

10¢ in 1938 to \$3.2 million in 2015!  
UV and IR fading will only drop the value by \$3 million




One of the many treasures protected by NoUVIR®

Protect your investments with IR and UV free

**NoUVIR LIGHTING**

[www.nouvir.com](http://www.nouvir.com)



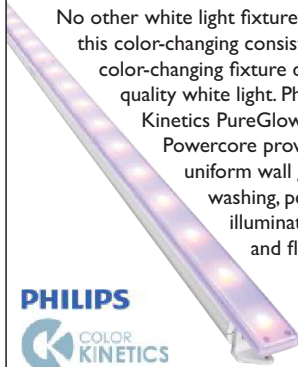
**Astro**

The Astro is light for urban spaces. With it's timeless appearance and various configuration options, Astro's lighting technology and form provide a ground-breaking solution for the many requirements of urban spaces. Sustainability is a key feature. Its LED technology and numerous control options ensure low energy consumption and high energy-efficiency. Find this product on our website at [selux.us](http://selux.us)

**selux**

**Enhance the beauty of your surfaces with Philips Color Kinetics PureGlow**

No other white light fixture can deliver this color-changing consistency, and no color-changing fixture delivers this quality white light. Philips Color Kinetics PureGlow Intellihue Powercore provides gentle, uniform wall grazing and washing, perfect for illuminating textured and flat surfaces.



Visit [bit.ly/PhilipsPureGlow](http://bit.ly/PhilipsPureGlow) to learn more

**Panasonic**

Come see our *Smart Building and Retrofit Solutions at*  
**LIGHTFAIR 2016**  
**BOOTH #4637**

<b>Universal</b> Lighting Technologies	<b>DOUGLAS</b> LIGHTING CONTROLS
<b>EVERLINE®</b> SMART FIXTURE LED COMPONENTS DRIVERS & MODULES	<b>DIALOG®</b> SMART BUILDING AND ADVANCED LIGHTING CONTROL
<a href="http://www.unvlt.com">www.unvlt.com</a>	<a href="http://www.douglaslightingcontrol.com">www.douglaslightingcontrol.com</a>

**Panasonic**

Universal Lighting Technologies is a member of the Panasonic Group.  
Douglas Lighting Controls is a member of the Panasonic Group.



**Match**

Design by Jordi Vilardell & Meritxell Vidal.

**Ceiling light sculptures**

Discover Match at [vibia.com](http://vibia.com)

[facebook.com/vibia.light](https://facebook.com/vibia.light) [twitter.com/VibiaLight](https://twitter.com/VibiaLight)



**LED performance and linear style that your budget will love**

Philips Ledalite FloatPlane LED suspended and wall mount luminaires offer a fresh and playful design. The two profile options - Curve and Edge - and sleek, minimalistic size (only 1.2" h x 8" w) blend seamlessly into your unique layout. And, with performance outputs up to 129 LPW, you can have the distinct energy savings of LED with the affordability of fluorescent luminaires.

Visit [bit.ly/floatplaneLED](http://bit.ly/floatplaneLED) to learn more



**WAC Lighting® adds High-output Spot Luminaires in Endurance® line**

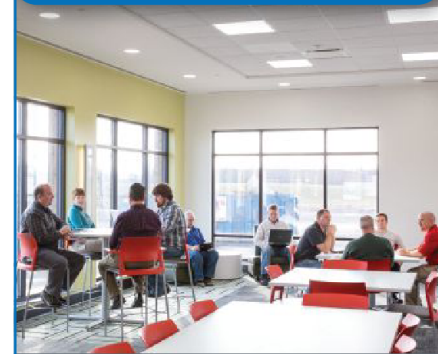


The 15-watt LED single spot replaces a 75-watt halogen fixture while the 30-watt LED double spot is the ideal retrofit for a 150-watt halogen fixture.

Both Single and Double Spots are designed with lockable aiming and a sensor-ready receptacle to accept available optional photo and motion sensors. Tightly engineered with factory sealed LED light engines, the luminaires are IP66 rated for wet locations.

**1.866.788.2100 • [www.waclighting.com](http://www.waclighting.com)**

**You Imagine It, We Light It.**



Panels, Downlights, Linear, Controls, Accessories and More

[laurenillumination.com](http://laurenillumination.com)  
855.440.8458



**Unprecedented uniformity for your white-light applications**

Philips Color Kinetics EvenBalance Powercore offers gentle, uniform wall grazing and washing for illuminating textured and flat surfaces.

When your project demands clean, uniform illumination free from beam striations and socket shadows, this luminaire delivers. Built upon the latest breakthroughs in optical engineering, EvenBalance has an ultra-compact form factor allowing for installation in tight spaces.



Visit [bit.ly/evenbalance](http://bit.ly/evenbalance) to learn more

**RXT Series**

Compact Xicato™ LED at 1300 & 2000 lumens



[www.tslight.com](http://www.tslight.com) • (845) 947-3034



**Congratulations**

TO HANLEY WOOD'S JESSE H. NEAL AWARD WINNERS

Hanley Wood is committed to publishing quality content that serves the information needs of construction industry professionals. Our editors have once again been honored by the most prestigious editorial awards program. Join us in congratulating them.

**2015 WINNERS**

- REMODELING  
Best Cross-Platform Package
- ARCHITECTURAL LIGHTING  
Best Media Brand
- ARCHITECT  
Best Use of Social Media
- POOL & SPA NEWS  
Best Technical Content

**2015 FINALISTS**

- MULTIFAMILY  
EXECUTIVE
- REMODELING  
ARCHITECT
- ARCHITECTURAL  
LIGHTING
- JOURNAL OF LIGHT  
CONSTRUCTION
- PROFESSIONAL  
DECK BUILDER



ADVERTISER	PAGE	WEBSITE	PHONE
Aamsco Lighting Inc.	33	www.aamsco.com	800-221-9092
Acolyte	65	www.acolyteled.com	212.629.6830
Architectural Area Lighting	7	www.aal.net/products/kick_medium_scale/	
Architectural Lighting	2	aldesignwards.com	
Architectural Lighting	98	archlighting.com	
Audacy	41	audacywireless.com	
B-K Lighting, Inc.	19	B-KLIGHTING.com	
Barn Light Electric Co.	6	WWW.BARNLIGHT.COM	800-407-8784
CDN Lighting	57	http://www.cdnlighting.cc	
Con-Tech Lighting	67	www.contechlighting.com	
Dial GmbH	4	discover.dialux.com	
Eaton's Cooper Lighting Business	17	TheLightingResource.Eaton.com	
Engineered Lighting Product	66	elplighting.com	626-579-0943
Forest Lighting	49	www.forestlighting.com	800-994-2143
Hanley Wood	96	hwhive.com/AR	
Hubbell Lighting, Inc.	3	www.hubbelllighting.com	
Hunter Industries	61	holmlighting.com	
Informa Exhibitions	62	thedesignjunction.co.uk/new-york	
Intense Lighting	28	www.intenselight.com	
Inter-Lux	37	inter-lux.com/sattler	
Kim Lighting	81	http://kimlighting.com/typex/	
Lauren Illumination	10-11	www.laurenillumination.com	855.440.8458
Ledia Lighting Technology Co., Ltd.	26	www.ledialighting.com	516-504-8000
Ledra Brands	73	BruckLighting.com	714.259.9959
LF Illumination LLC	C2-1	lfillumination.com	
LIGHTFAIR International	85	LIGHTFAIR.COM	
Lighting Services Inc.	13	www.LightingServicesInc.com	800 999-9574
LSI Industries	55	www.lsi-industries.com	513.793.3200
Lucifer Lighting	15	luciferlighting.com	
Lumenpulse	9	Lumenpulse.com	
Luminis	5	luminis.com	
Lutron	C4	lutron.com/findafixture	
MechoSystems	35	mechosystems.com/solartrac	718-729-2020
Meteor Lighting	22	www.meteor-lighting.com	
No. 8 Lighting	25	8lighting.com	
Nora Lighting	29	www.noralighting.com	
NoUVIR Research	39	www.nouvir.com	302 628-9933
Performance in Lighting	27	www.pil-usa.com	
Philips Lighting	20, 21	philips.com/lighting	
Precision Architectural Lighting	42	www.pal-lighting.com	713.946.4343
Rishang Optoelectronics Co., Ltd.	94	www.rishang-led.com	408-748-8889
ROSCO	63	www.rosco.com	
SELUX	C3	selux.us	
Shanxi Guangyu-GYLED	91	www.gyledlighting.com	
Sheenly Lighting Co.	77	www.sheenly.com	
Sichuan Jiuzhou Electric Group Co. Ltd.	75	www.jiuzhou-intl.com	
Signcomplex	69	www.signcomplex.com	
Thailight Semiconductor Lighting Co, Ltd.	51	www.thailight-led.com	
The American Institute of Architects	87	aia.org/convention	
Times Square Lighting	40	tslight.com	845-947-3034
Universal Lighting Technologies	71	www.unvlt.com	
Vibia, Inc.	45	www.vibia.com	732 417 1700
Visa Lighting	93	-	
Vode Lighting	95, 97, 99	-	
WAC Lighting	83	waclighting.com	



**TOM WARTON**

**“With all that is being discovered, it still comes back to design. Design is how we are using technology, knowledge, and experience.”**

An entrepreneurial spirit and an inquisitive nature characterize Tom Warton, co-founder and president of Sonoma, Calif.-based Vode Lighting. In his early 20s, he spent time in Brazil, importing mineral specimens to exhibit in the United States. To showcase the dazzling colors, he experimented with different types of lighting, using some of the first MR16 lamps available on the market. In the early 1990s, he was involved with several lighting companies, including SF12v, Sonoma Lighting, and Translite Sonoma. By the early 2000s, however, he was considering a career change, but several conversations with industrial designer Scott Yu at San Francisco-based Gingko Design convinced him otherwise. Together, they founded Vode in 2006 and brought on partner George Mieling to serve as chief operating officer. The company’s mission: To design architectural lighting using integrative environmental thinking, rather than viewing lighting strictly in terms of fixtures. With 2016 marking Vode’s 10th year in business, this has been a successful strategy that has guided the company well.

**What fascinates you about light?**

The constant change.

**Do you have a design/lighting philosophy?**

Make things that solve problems.

**What makes a great luminaire?**

Great lighting is actually not about the luminaire, it’s about people experiencing life in a certain way—in our case, that’s in the built environment. A great luminaire is the one that no one sees and no one thinks about.

**How has the business of lighting changed?**

Before: Pick a fixture. Now: System thinking, quality of light, connectivity, need it tomorrow.

**What is the most misunderstood aspect of luminaire design and product development?**

Nothing is designed in a vacuum. Context is everything. All projects have something special. Understand the problem.

**What do you say to lighting designers that are frustrated by LEDs?**

Look at the opportunities! The long spec cycle clashes with rapid obsolescence. Lighting designers need to advocate for involvement—and billable hours—through to the end of the project. As architectural product manufacturers, we have to do a much better job of promoting this concept to the market. When the lighting designer is not involved, projects suffer. •

interview by Elizabeth Donoff  
photo by Gregory Goode

# L I G H T M O V E S



LIGHTFAIR® International  
April 26-28, 2016  
Booth #5823



[selux.us](http://selux.us)



**selux**



# Hi-lume® Premier 0.1% LED drivers

The incandescent-like performance you expect, with the benefits of LEDs

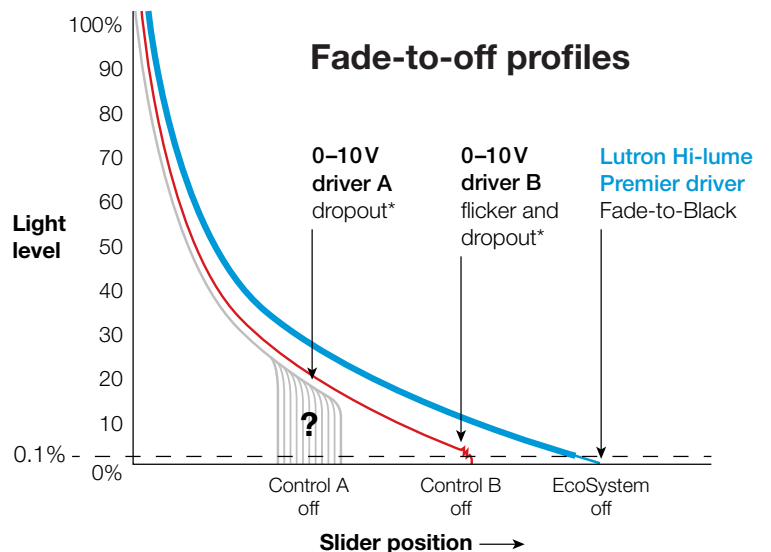
## Deliver a beautiful lighting experience

- Smooth, flicker-free dimming down to 0.1%, with Soft-on, Fade-to-Black™ technology
- Guaranteed interoperability with Lutron 3-wire and EcoSystem™ controls
- Wired or wireless control options

Find a list of fixtures that work with Hi-lume Premier 0.1% and Hi-lume 1% drivers at [lutron.com/findafixture](http://lutron.com/findafixture).

Contact your Lutron representative to schedule an in-person demo today or visit [lutron.com/hilumepremier](http://lutron.com/hilumepremier).

Available for cove, under cabinet, and exterior 24V constant voltage LED lighting, 25–96W, UL Listed



\*The lowest light level attained depends on the load tested.

