

A.L
ARCHITECTURAL LIGHTING

ANNUAL PRODUCT ISSUE:
160-PLUS NEW PRODUCTS
ACROSS 14 CATEGORIES
• LI-FI • HORTICULTURAL
LIGHTING • INDUSTRY
VOICES • ONE-ON-ONE:
ENLIGHTENED'S JOE COSTELLO

THE
TRANSFORMATION
OF LIGHT

MAY/JUNE 2017

h w

**High performance architectural lighting
in the industry's smallest recessed
housing for adjustable fixtures.**

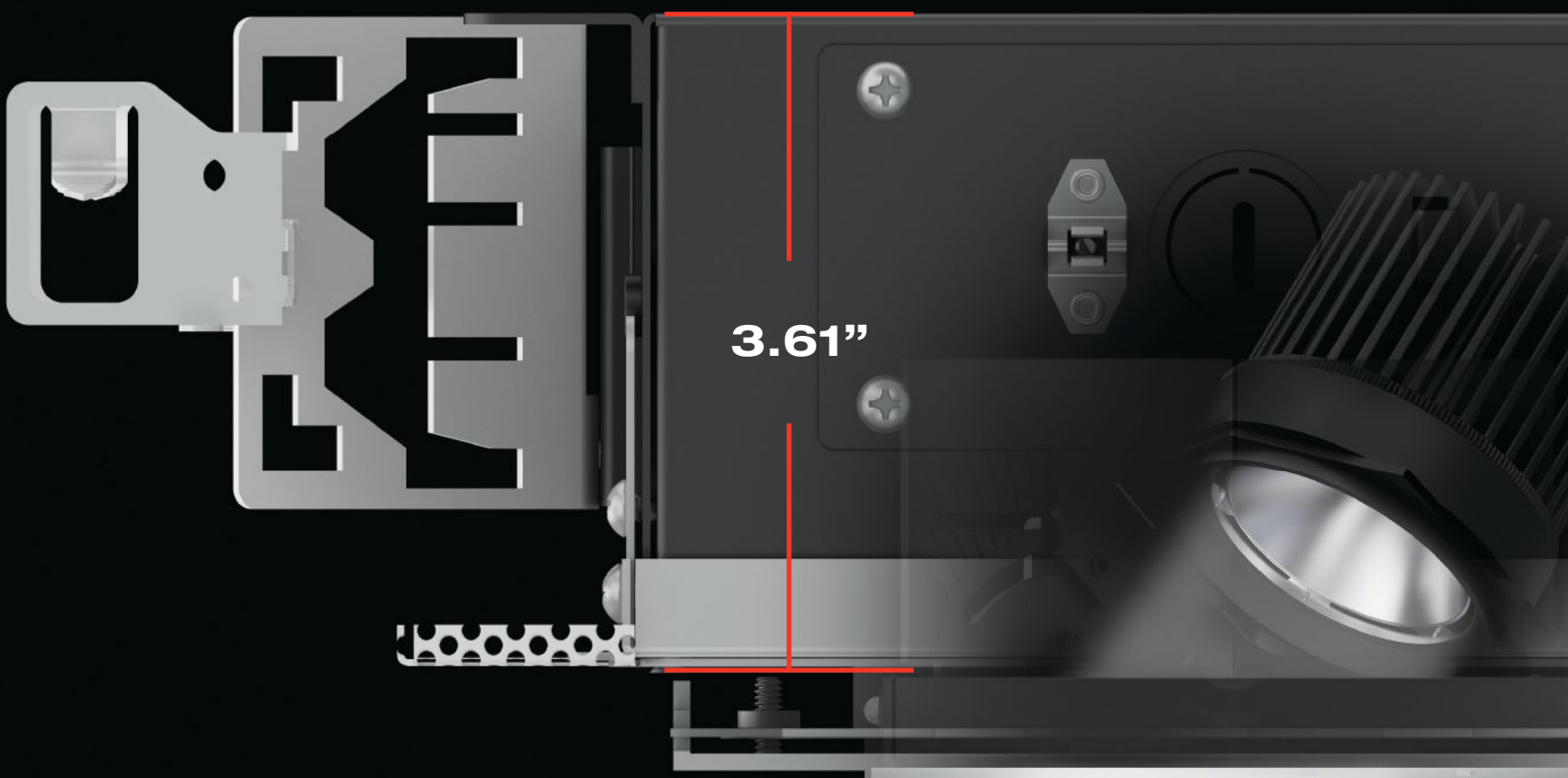

3.61"

All in the palm of your hand.

VF100 MINI

Recessed Mini Housing

The VF100 Series of recessed adjustable downlights and housings represent the pinnacle of innovation and design of small aperture recessed products for the architectural lighting industry. Backed by LF Illumination's 50+ years of combined experience and knowledge in this product field, these fixtures meet and exceed the needs of today's lighting designers and specifiers for small recessed fixtures that perform. The VF100 series is available in fixed or adjustable downlighting as well as wall wash fixture. All aiming and adjustment are done via mechanisms on the trim insert. Hot aiming and rotatable square fixtures are standard. Also available is our "Small" housing with a 5.42" height. The small housing can accommodate deeper fixtures such as our adjustable beveled trims.



Shallow Plenum? No problem.

The VF100 Mini Housing is the smallest California Title 24 compliant housing you can get that will accommodate adjustable tilt aiming of the fixture. At just 3.61" deep, the Mini is truly a small wonder.



4.5" Trim or 4.0" Trimless

The VF100 housings are available with an adjustable trimless mud ring that is just as much at home in a drywall ceiling as it is in wood, stone, grid or other ceiling types. Trim flange version is available as well.



Hot Aiming Adjustment

All adjustable VF100 fixtures include HOT AIMING so the fixture can be aimed with an ordinary Phillips screwdriver while it is powered on. Fixed position downlights and wall washers are also available.

**VF100 products are available
with a 10 day ship time**

LF ILLUMINATION™

lfillumination.com

©2017 LF ILLUMINATION LLC

A·L

ARCHITECTURAL LIGHTING

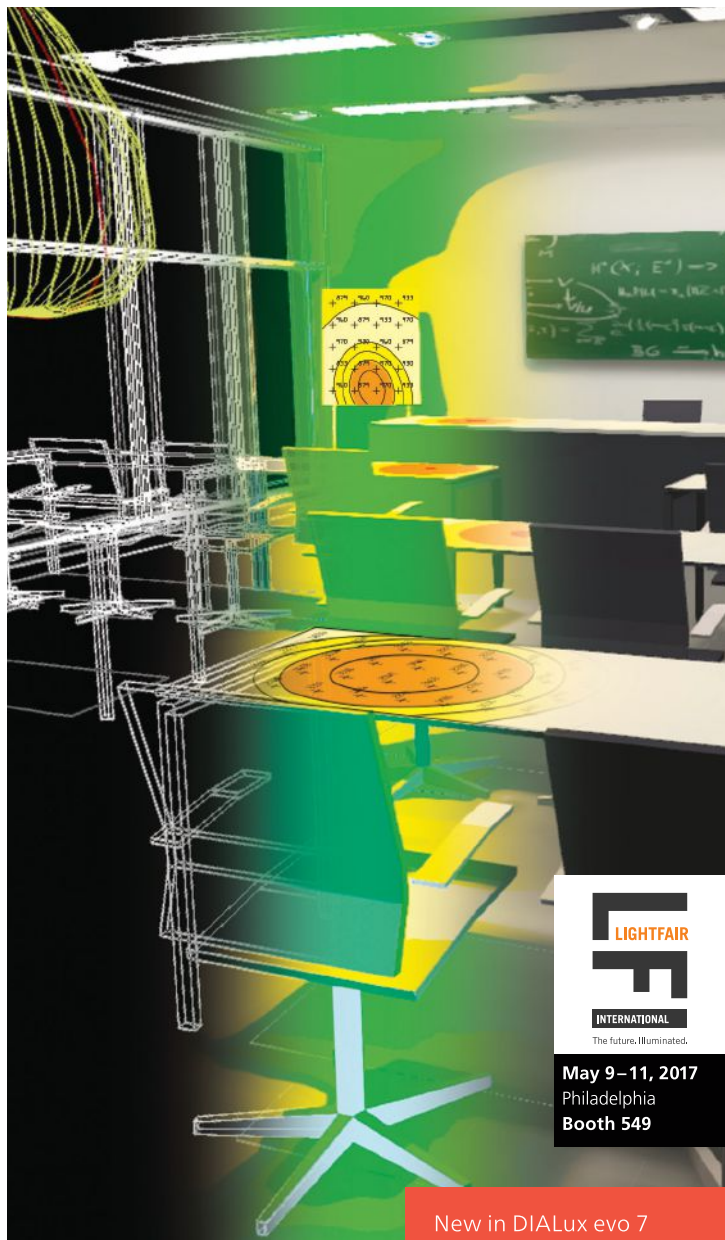

LIGHTFAIR
INTERNATIONAL
The future. Illuminated.

May 9 – 11, 2017
Philadelphia
Booth 549

New in DIALux evo 7
IFC Import (BIM)

DIALux

Free software for
professional lighting design.

Plan, calculate and visualize
architectural lighting for
whole buildings, indoor and outdoor spaces,
daylight and daylight systems.

Further information at
www.dialux.com

EDITOR-IN-CHIEF
Elizabeth Donoff
edonoff@hanleywood.com
202.729.3647

MANAGING EDITOR
Greig O'Brien
gobrien@hanleywood.com

EDITORIAL
EDITOR,
BUSINESS, PRODUCTS, AND TECHNOLOGY
Wanda Lau

ASSOCIATE EDITOR,
BUSINESS, PRODUCTS, AND TECHNOLOGY
Katharine Keane

ASSOCIATE EDITOR, DESIGN
Sara Johnson

ASSISTANT EDITOR,
BUSINESS, PRODUCTS, AND TECHNOLOGY
Selin Ashaboglu

ENGAGEMENT EDITOR
Chelsea Blahut

EDITORIAL INTERN
Victoria Carodine

ART DIRECTOR
Robb Ogle
rogle@hanleywood.com

ART
SENIOR GRAPHIC DESIGNER
Megan Mullsteff

MULTIMEDIA
VIDEO PRODUCTION MANAGER
Lauren Honesty

VIDEOGRAPHERS/VIDEO EDITORS
Jim Van Meer
Dan Tayag

CONTRIBUTING EDITORS
Elizabeth Evitts Dickinson
Belinda Lanks
Aaron Seward
Mimi Zeiger

EDITORIAL ADVISORY BOARD

Gregg Ander, FAIA, IES • Francesca Bettridge, FIES, IALD •
Barbara Cianci Horton, FIALD • Kevin Houser, FIES •
Mark Loeffler, IALD, IES, LEED FELLOW • Paul Zaferiou, IALD

**SUBSCRIPTION INQUIRIES, CHANGE
OF ADDRESS, CUSTOMER SERVICE,
AND BACK-ISSUE ORDERS**

ARCHITECTURAL LIGHTING
P.O. Box 3494
Northbrook, IL 60065
Local: 847.291.5221
Toll-Free: 888.269.8410

PRODUCTION

PRODUCTION MANAGER
Marni Coccaro
mcoccaro@hanleywood.com
AD TRAFFIC MANAGER
Pamela Fischer
pfischer@hanleywood.com
INSIDE SALES
AD TRAFFIC MANAGER
Annie Clark
aclark@hanleywood.com

REPRINTS

Wright's Media
hanleywood@wrightsmedia.com
877.652.5295

LIST RENTALS

The Information Refinery
Brian Clotworthy
brian@info refinery.com
800.529.9020

archlighting.com

One Thomas Circle, N.W. Suite 600 Washington, DC 20005

A·L ARCHITECTURAL LIGHTING (Vol. 31, No. 3 USPS 000-846, ISSN 0894-0436) is published six times per year (Jan/Feb, March/April, May/June, July/August, Sept/Oct, Nov/Dec) by Hanley Wood, One Thomas Circle, N.W., Suite 600, Washington, DC 20005. Periodicals postage paid at Washington, DC, and additional mailing offices. Printed in the USA. Postmaster: Send changes of address to ARCHITECTURAL LIGHTING, P.O. Box 3494, Northbrook, IL 60065. Canada Post Registration #40612608/G.S.T. Number: R-120931738. Canadian return address: IMEX, P.O. Box 25542, London, ON N6C 6B2.

Distributed free of charge to individuals or firms engaged in the specification of lighting products in the U.S. Publisher reserves the right to determine recipient qualification. Per year, all other U.S. subscriptions \$48; Canada, \$60; Foreign, \$96. Payable in U.S. dollars. For subscription inquiries, address changes, and single-copy sales (\$10 in the U.S., \$15 in Canada, \$20 for other countries, payable in advance in U.S. dollars) write to ARCHITECTURAL LIGHTING, P.O. Box 3494, Northbrook, IL 60065 or call 847.291.5221 or toll-free 888.269.8410. For reprints, call or email Wright's Media: 877.652.5295 or hanleywood@wrightsmedia.com.

A·L ARCHITECTURAL LIGHTING is a trademark owned exclusively by Hanley Wood. Copyright 2017 Hanley Wood. Reproduction in whole or in part prohibited without written authorization.

Introducing the All New Mirada Lighting Series

Architectural LED Area Lighting & Wall
Sconces with Precision Silicone Optics



Area Light
Side View



- High-performance, precisely-molded silicone optics with scratch resistance and no discoloration over time
- Industry-leading LSI photometry through a patent-pending optical system
- Contemporary, sleek, low-profile stylings well-suited for architectural applications
- Available with award-winning integral wireless lighting controls
- LSI poles with precisely matching finishes also available



MANUFACTURED IN
USA*

* The majority of LSI's products are assembled in USA facilities by an American workforce utilizing both domestic and foreign components.

Visit LFI Booth 3601

LSI Industries Inc.
10000 Alliance Road
Cincinnati, Ohio 45242
513.793.3200



www.lsi-industries.com



AOK[®]

Quality, Honesty, Service and Innovation

IP66 LM79 ISO:9001
IK10 TM21 ISO:14001

LFI 2017 BOOTH
4259



Multiple installation brackets available
Multiple optical lens available
Motion sensor and smart control system available
<0.2% failure rate
5 years warranty for complete fixture
Replacement ship within 24hours



130 lm/w



IU SERIES

LED UFO High Bay Light
100-200W, 600W Replacement



130 lm/w

IH SERIES

LED Linear High Bay Light
95-400W, 1500W Replacement



130 lm/w

IT SERIES

LED Parking Lot / Street Light
75-265W, 1000W Replacement



170 lm/w

I SERIES

LED Modular Flood Light
40-400W, 2000W Replacement



170 lm/w

IL SERIES

LED Modular Street Light
40-280W, 1500W Replacement

www.aokledlight.com



A.L

ARCHITECTURAL LIGHTING

DESIGN GROUP

GROUP PRESIDENT
Ron Spink
rspink@hanleywood.com
202.736.3431

VICE PRESIDENT, EDITORIAL DIRECTOR,
DESIGN AND COMMERCIAL CONSTRUCTION
Ned Cramer

ADVERTISING SALES

VICE PRESIDENT,
GENERAL MANAGER OF DIGITAL
Christie Bardo
cbardo@hanleywood.com
202.736.3363

NATIONAL SALES MANAGER—
EAST AND TEXAS
Cliff Smith
csmith@hanleywood.com
864.642.9598

STRATEGIC ACCOUNT MANAGER,
MIDWEST
Michael Gilbert
mgilbert@hanleywood.com
773.824.2435

STRATEGIC ACCOUNT MANAGER,
WEST
Suren Sagadevan
ssagadevan@hanleywood.com
310.863.1153

SENIOR ACCOUNT MANAGER,
CANADA
D. John Mægner
jmægner@yorkmedia.net
416.598.0101, ext. 220

NEW ACCOUNT SETUP
Jaeda Mohr
jmohr@hanleywood.com
202.736.3453

VICE PRESIDENT, MARKETING
Matthew Carollo

STRATEGIC ACCOUNT MANAGER,
CHINA, HONG KONG, TAIWAN
Judy Wang
judywang2000@vip.126.com
86.13810325171

NEW ACCOUNT SETUP
Erika Taylor
etaylor@hanleywood.com
202.380.3942

AUDIENCE MARKETING DIRECTOR
Diana Turco

HANLEY WOOD MEDIA

PRESIDENT, MEDIA
Dave Colford

VICE PRESIDENT,
PRODUCT DEVELOPMENT
Rizwan Ali

SENIOR VICE PRESIDENT,
AUDIENCE OPERATIONS
Sarah Welcome

EXECUTIVE VICE PRESIDENT,
STRATEGIC MARKETING SERVICES
Tom Rousseau

SENIOR DIRECTOR,
PRINT PRODUCTION
Cathy Underwood

VICE PRESIDENT,
CLIENT OPERATIONS
Mari Skelnik

SENIOR VICE PRESIDENT,
STRATEGIC MARKETING SERVICES
AND CONSUMER MEDIA
Jennifer Pearce

CHIEF DESIGN DIRECTOR
Aubrey Altmann

DIRECTOR OF ANALYTICS
Jennifer Malkasian

HANLEY WOOD

CHIEF EXECUTIVE OFFICER
Peter Goldstone

VICE CHAIRMAN EMERITUS
Frank Anton

CHIEF FINANCIAL OFFICER
Matthew Flynn

PRESIDENT, MEDIA
Dave Colford

PRESIDENT, DIGITAL
Andrew Reid

PRESIDENT, METROSTUDY
Christopher Veator

PRESIDENT, MARKETING
Jeanne Milbrath

SENIOR VICE PRESIDENT,
MARKETING
Sheila Harris

SENIOR VICE PRESIDENT,
CORPORATE ACCOUNTS
Ryan Flom

VICE PRESIDENT,
FINANCE
Ron Kraft

DIRECTOR OF SALES,
EMERGING ACCOUNTS GROUP
Philip Hernandez

VICE PRESIDENT,
CORPORATE CONTROLLER
Keith Rosenbloom

From Hanley Wood, publisher of ARCHITECT, AQUATICS INTERNATIONAL, BUILDER, CONCRETE & MASONRY CONSTRUCTION PRODUCTS, CONCRETE CONSTRUCTION, THE CONCRETE PRODUCER, CUSTOM HOME, THE JOURNAL OF LIGHT CONSTRUCTION, MASONRY CONSTRUCTION, MULTIFAMILY EXECUTIVE, POOL & SPA NEWS, PROSALES, PUBLIC WORKS, REMODELING, REPLACEMENT CONTRACTOR, and TOOLS OF THE TRADE magazines.

Disclosure: ARCHITECTURAL LIGHTING will occasionally write about companies in which its parent organization, Hanley Wood, has an investment interest. When it does, the magazine will fully disclose that relationship.

Privacy of mailing list: Sometimes we share our subscriber mailing with reputable companies we think you'll find interesting. If you do not wish to be included, please call us at 888.269.8410.

COMPLETE FAMILY OF INTERIOR
AND EXTERIOR COLUMNS,
BOLLARDS, PENDANTS AND WALL
TO ENHANCE YOUR ENVIRONMENT

LUMISTIK

SCALED TO FIT



PRODUCTS

- 31 INTRODUCTION
- 32 DECORATIVE
- 38 DIRECT/INDIRECT
- 44 DOWNLIGHTS
- 50 EXIT/EMERGENCY
- 52 HORTICULTURAL
- 54 INDUSTRIAL
- 56 LAMPS & BALLASTS
- 58 LEDS & DRIVERS
- 64 LIGHTING CONTROLS
& SYSTEMS
- 70 OUTDOOR
- 78 SPECIALTY
- 80 TRACKLIGHTING
- 84 TASKLIGHTING
- 86 WALLWASHERS
- 88 MANUFACTURER INDEX

DEPARTMENTS

- 10 COMMENT

What's next for lighting?

- 12 BRIEFS

Neon light at Tate Britain; Richard Meier Light; and Luxo's L-1 tasklight celebrates 80 years.

- 19 REPORT

The grow light market is valued at \$2.5 billion and expected to reach \$5.11 billion by 2022.

- 24 TECHNOLOGY

Numerous applications, including internet connectivity and data security, stand to benefit from light-fidelity technology.

- 96 ONE-ON-ONE

Interview with Joe Costello, chairman and chief executive officer, Enlighted

ARCHLIGHTING.COM

As always, check out our website for expanded article coverage, videos, and news. Also, subscribe to our email newsletter, AL Notes, and find a link to ARCHITECTURAL LIGHTING's digital edition.

On the Cover: Illustration by Daniel Hertzberg; Photography by Jeff Elkins

Meet a real chameleon

The all-new Lumenalpha architectural Cylinder family balances fluid design with best-in-class performance. Take advantage of their field-changeable optics and accessories, color-matching capabilities, and a full range of mounting options.

For an exclusive preview at Lightfair, stop by the Lumenpulse Group Booth (#1435).

Products Shown:

Cylinder Nano, Surface Mount, in matte black, with an asymmetric wallwash optic
Cylinder Medium, Pendant, Stem Mount, in matte blue, with a narrow optic and decorative ring

lumenalpha[™]
part of the lumenpulse group

apure.
LIGHTING REDEFINED

THE MOST POWERFUL ARCHITECTURAL LIGHT FIXTURE RECESSED IN LESS THAN ONE INCH

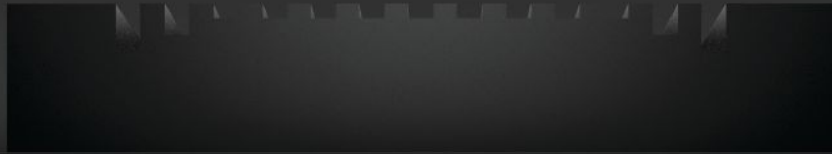

Design by
**PORSCHE DESIGN
STUDIO**

WHAT'S NEXT FOR LIGHTING?



One could argue that the first phase of the LED lighting revolution is complete. Of the more than 350 products submitted to ARCHITECTURAL LIGHTING's editorial call for submissions to this Annual Product Issue, all were LED. Ten years ago, when the technology was just arriving on lighting's doorstep, it didn't seem possible that the industry, not always known for its ability to quickly adapt to change, would be able to embrace the new, evolve, and move forward.

Now we enter a second phase of technological upheaval, in which the lighting industry will be embracing "smart" platforms. Lighting is still deciphering the meaning of this next great leap forward, and, based on the industry's experience with the transition to solid-state lighting, it will be interesting to see how quickly companies and design firms can sort things out. I suspect that it will take another three years for "connected" lighting to move beyond being merely a catchy marketing phrase to an integral part of the job, but I doubt it will take a full decade.

We should also expect to witness the continued evolution of the marketplace. Just a few years ago, it seemed unfathomable to imagine the lighting industry operating without some of its legacy players. And yet, that is exactly what has come to pass. I'm confident, however, that the industry as a whole will find a way to self-correct, and that those companies that really want to be in the business of lighting—and who understand what that means in the 21st century—will find business models that enable them to succeed. In turn, new players will step into the space left vacant by those companies who decide to leave the market segments which they once dominated.

The rapid change we're seeing certainly doesn't make it any easier for lighting designers or lighting manufacturers to keep pace with the vast amount of information associated with all of those new product developments. Throughout this issue, you'll find responses from lighting designers and manufacturers to a series of questions that we posed to them:

- How do you keep up with new product information?
- How has the specification process changed with the introduction of LEDs?
- What makes a great luminaire?
- How is the Internet of Things affecting the lighting industry?

This series of questions is our way of taking the lighting community's pulse on a handful of important, day-to-day issues that are impacting those who work with and specify lighting products.

And as we enter the heart of the lighting trade show season, I'm curious to know how you would respond to these questions. As you walk the aisles of Lightfair and attend its seminars, what are the new products and technology platforms that stand out to you? To get the conversation started, in this Annual Product Issue, we've selected 160-plus products as your guide. •

Elizabeth Donoff
Editor-in-Chief
edonoff@hanleywood.com



LPW8

LPW8 WALL WASH SERIES

50,000 HOUR LIFE

Delivered Lumens: 1420

CRI: 90

Color Temperature: 2700K, 3000K, 3500K

Watts: 36

The LPW8 Series is an elegant, stem mounted wallwash fixture powered by COB LED technology. Utilizing an asymmetric TIR optic, the LPW8 produces 2725 lumens (36 watts) of a seamless, even wash of light for the most demanding applications of museum and retail lighting. The LPW8 Series features a discreetly hidden integral driver which is compatible with trailing edge electronic low voltage dimmers (dimmable to 5%).

Lighting Services Inc The premier specialty lighting manufacturer.



NEON INSTALLATION AT TATE BRITAIN

An installation by filmmaker Cerith Wyn Evans titled *Forms in Space ... by Light (in Time)* is on view at the Tate Britain in London through Aug. 20. The artwork, created for the annual Tate Britain Commission, is made of nearly 2 kilometers (6,561 feet) of neon tubes suspended from the ceiling of the museum's Duveen Galleries. Arranged in three sections, the sculpture of straight lines, sweeping curves, and spiraling forms finds its starting point in a single neon ring and ends in a maze of neon lines. Evans' "drawing in space" takes its inspiration from the precise movements used in Japanese Noh theater and his interest in choreology—the practice of translating movement into notational form. —Elizabeth Donoff [Read more at *archlighting.com*](#) •

365° TOOL-LESS ROTATION

SUSPENDED
STEM
ADJUSTABLE

SELF-LOCKING TILT 372° ROTATION

PROPRIETARY OPTIONS
15°, 25°, 40°, 60°

FULLY
ADJUSTABLE

2.6"

UP TO 2200 DELIVERED LUMENS

PURE GEOMETRY. ADVANCED ENGINEERING.

Uninterrupted clarity of form. Now, even more refined. With sleek installation options, high-output LED sources, and a fresh, unexpected silhouette. Circle or square, wall-mount, track, or suspended, the entire Cylinder—and Squilinder—line conceals all adjustment mechanisms, mounts and power supplies, without sacrificing adjustability. So, all you'll see is the light, and shapes, you love. PATENT PENDING.

luciferlighting.com

LUCIFER
LIGHTING COMPANY

RICHARD MEIER LIGHT

Pritzker Prize-winning architect Richard Meier, product designer Ana Meier, and lighting designer Hervé Descottes (of New York-based lighting firm L'Observatoire International) have partnered to launch a 12-piece lighting collection under the name Richard Meier Light. The luminaires, sculptural in form, explore "the interplay of form and shadow," Descottes says. "The designs reveal a dialogue between geometries at different scales, while retaining the precision so distinctive of Richard's cannon of work." The LED fixtures use a range of materials such as glass and Corian and include wall sconces, pendants, and table and floor lamps. The collection is on view at the Ralph Pucci showroom in New York. —E.D. *Read more at archlighting.com* •





LS1 UPDN Pendant, direct: 3000K / indirect: RGBW

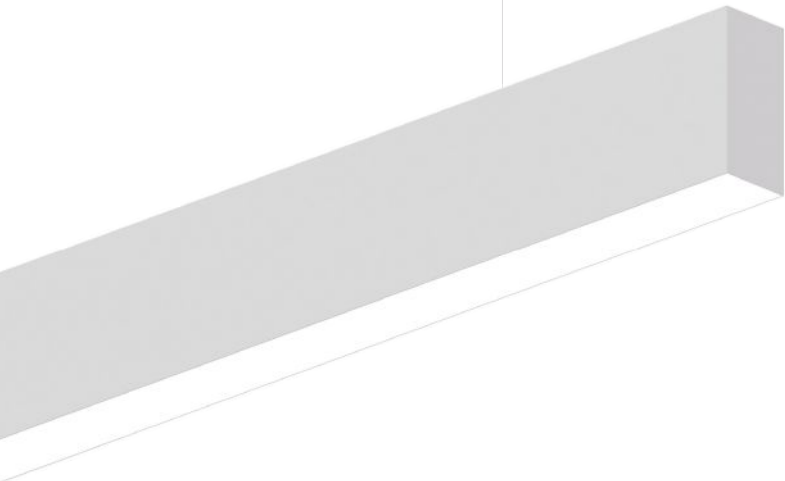

coronet

Designed Locally. Built Locally.

High-end customizable architectural luminaires with sleek appearances that fit modern spaces.



Quickship



Color Changing LEDs



Patterns

www.coronetled.com | 973.345.7660



LUXO'S L1 TASKLIGHT CELEBRATES 80 YEARS

The iconic L-1 tasklight from Luxo, designed by the company's founder, entrepreneur Jac Jacobsen (1901–96), is celebrating its 80th anniversary this year. Originally designed in 1937, the lamp's articulated three-pivot spring-arm—which allows it to move and stay balanced in different positions—and its up-and-down and rotational head movement were a technical achievement and remain a benchmark for tasklighting. Today, the fixture is available in an LED version (L-1 LED), as well as with traditional lamping. According to Luxo, more than 25 million L-1s have been sold worldwide. —E.D. *Read more at archlighting.com* •

Courtesy Luxo



BEAUTIFUL RECESSED LED LIGHTING.
DESIGNED TO SUIT YOUR STYLE.

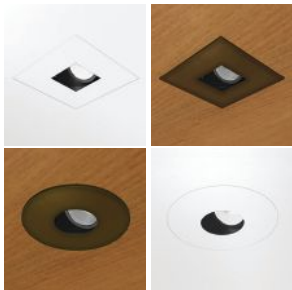

SMALL IN SIZE – BIG ON IMPACT.

THE NEW POWERFUL **400 SERIES**
RECESSED LED FROM No. 8 LIGHTING.
OFFERING COMPACT DESIGN FOR ANY
CEILING TYPE THAT IS EASY TO INSTALL,
AIM, AND ADJUST — FOR ACCENT, WALL
WASH, AND GENERAL LIGHTING APPLICA-

TIONS. AVAILABLE IN PAINTABLE WHITE AND OIL-RUBBED BRONZE,
ROUND AND SQUARE TRIMS.

8LIGHTING.COM

INTERIOR DESIGN: ESTEBAN INTERIORS • PHOTOGRAPHY: ROBERT BENSON PHOTOGRAPHY

ALPHABET



LET'S SHED SOME LIGHT ON THE SUBJECT...

NU Technologically Advanced Downlights

- Economical solution with premium components
- 3", 4" and 6" in round, square, trimless
- Downlight, wall wash, adjustable
- 2" shallow plenum
- Remote Phosphor, Biological/Circadian, Color Tuning
- Bluetooth® dimming and beam adjusting

NU4A 4" Adjustable

- 360° Rotation
- True 40° Tilt
- Hot Aiming
- Round and square



VISIT US AT BOOTH 2741

LIGHTING'S NEXT CROP

The grow light market is valued at \$2.5 billion and expected to reach \$5.11 billion by 2022.



text by Elizabeth Donoff

One of the fastest-growing sectors in the lighting industry is grow lights. Defined as fixtures for indoor farming, commercial greenhouses, vertical farming, and research applications, this market segment was valued at \$2.5 billion in 2016 and is expected to reach \$5.11 billion by 2022, according to market research firm MarketsandMarkets.

So why the increased demand for such a specialized type of luminaire and lighting system? Several factors are contributing to the interest in horticultural and agricultural lighting systems. First, greater attention is being paid to the correlation between world population growth and food supplies and prices. Crops, in both the developed and developing world, are at risk

with the increase in number of climate-based and manmade disasters, which interrupt grow cycles, as well as the lack of access to clean water and ever diminishing water resources for many areas around the world.

Second is the legalization of marijuana in the United States. According to *Governing.com*, as of March 2017, 26 states and the District of Columbia “currently have laws broadly legalizing marijuana in some form.” Medical usage has been the primary reason for the push to legalize the substance, but California, Colorado, Nevada, Oregon, Washington, Maine, Massachusetts, and the District of Columbia have also legalized marijuana for recreational use. And because marijuana cannot be transported across state lines, entire new industries are popping up in these states to meet the increased demand. According to an April 1 article in *The New*

York Times, “A Real Estate Boom, Powered by Pot,” the demand for industrial and warehouse spaces has increased so dramatically that it has pushed commercial real estate values up by more than 50 percent in less desirable neighborhoods.

THE NEED FOR SPACE—AND LIGHT

Growing plants, no matter the type or reason, requires a tremendous amount of space. This is not just for the vast quantity of seedlings, but to accommodate the cooling and ventilation systems that must be put in place to respond to the intense power consumption, and heat output from the high-wattage light fixtures required to see a crop through from germination to flowering plant. This is one instance where a lighting segment has not completely transitioned to LEDs. Different plant types require different amounts of light along the light spectrum, often requiring what is referred to as full-spectrum light, and growers usually determine a customized light formula to optimize growth. That is why high intensity discharge (HID) reflectors—as well as specially designed high-pressure sodium, metal halide, and ceramic metal halide lamps—are still used, particularly for the cultivation of cannabis. These lamps can range between 315W to 1,000W and can deliver as much as 150,000 initial lumens over a 24,000-hour lamp life. Multiply that amount of light in a facility that often has a minimum of 10,000 square feet and hundreds of plants and light fixtures, and you can understand why cooling and ventilation become so critical.

Aubrey Bradley, founder of Growlite, a lighting manufacturer that specializes in horticultural luminaires, points out that not many growers are willing to discuss what they do, since it only very recently became legal. Often, facilities are not ventilated correctly and personnel do not take the proper steps to wear protective eye gear to shield from the high wattage and intense light output. (Plants absorb light, whereas people see light.) Cannabis, Bradley notes, is a “heavy light saturation plant.” His company has been working to bring safe and energy-efficient products to the market sector. “We were the first [company] to have a UL listing on our products. No one even understood what that meant and why it was important.”

Further complicating the issue is that for a newly legalized crop such as cannabis, there are no strict regulations. Bradley believes that, in time, more regulations will come. And those regulations are in the interest of cannabis

With square-footage at a premium in cities, “living walls” bring plants and greenery into building interiors.





 DELTALIGHT®

IMAGINE. CREATE.

We develop lighting solutions that enhance people's life, and therefore people's quality of life. We bring our experience in light to the service of architects, interior and lighting designers, realizing what is in their mind, creating a lighting scenography integrated in the architecture. Using the right light in the right way to make architectural concepts stand out.

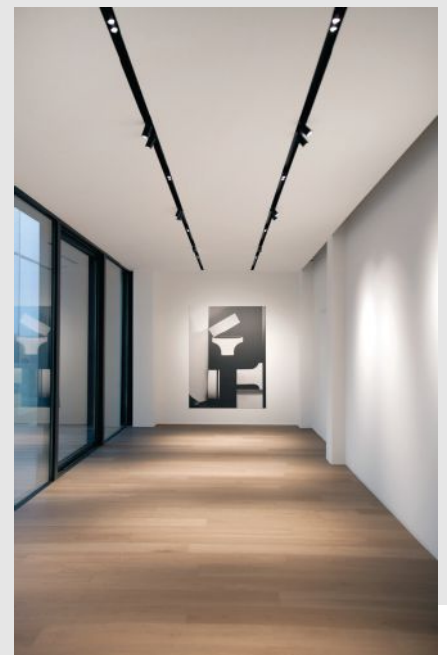
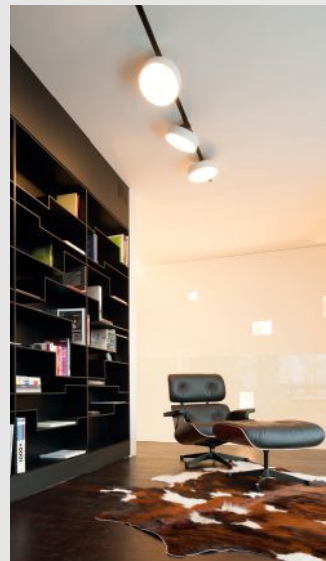

www.deltalight.us

producers and users, he says, because they not only ensure safer growing environments, but a more consistent product for the end-user.

Additional regulation could also lead to further luminaire testing and crop research so that, potentially, different plants could be trained to respond to specific color temperatures. While Bradley doesn't think LEDs "are quite there yet" for the full grow-cycle of a cannabis plant, "LEDs are quite good for the vegetative state of the plant and the root structure," he says. Companies like his are starting to explore various combinations of HID and LED sources to provide a greater spectrum than just a heavy red (700nm range) or a heavy blue (400nm range).

"We're starting to prototype fixtures that can alter the [light] spectrum, some of them even on demand. We can actually come up with spectral prescriptions fixed to crops. What might work best for lettuce might be different from broccoli, or sunflowers, or geraniums," says Pete Rumsey, executive vice president of business development, at Lighting Science.

URBAN FARMING

At present, there are only a handful of lighting manufacturers producing products for growing applications. Lighting Science is one, and the company has developed an entire product line—VividGro, launched in 2015—around various types of planting scenarios. Most recently, it has turned its attention to vertical farming, which has become very popular in dense urban areas such as New York City, because of "the decreasing availability of cultivatable land" coupled with the demand for locally sourced food. Its T8 LED grow lamp, for example, is geared specifically toward vertical farming. According to MarketsandMarkets, this sector is expected to reach an estimated \$3.88 billion by 2020, an increase from 2015, when it amounted to \$1.1 billion.

And while vertical farming is still relatively new in the United States, in countries such as Singapore and Japan it is already a widely accepted form of farming. Philips has an entire division—Horticultural LED Solutions—dedicated to urban farming and is working with

A greenhouse facility equipped with HID reflectors.

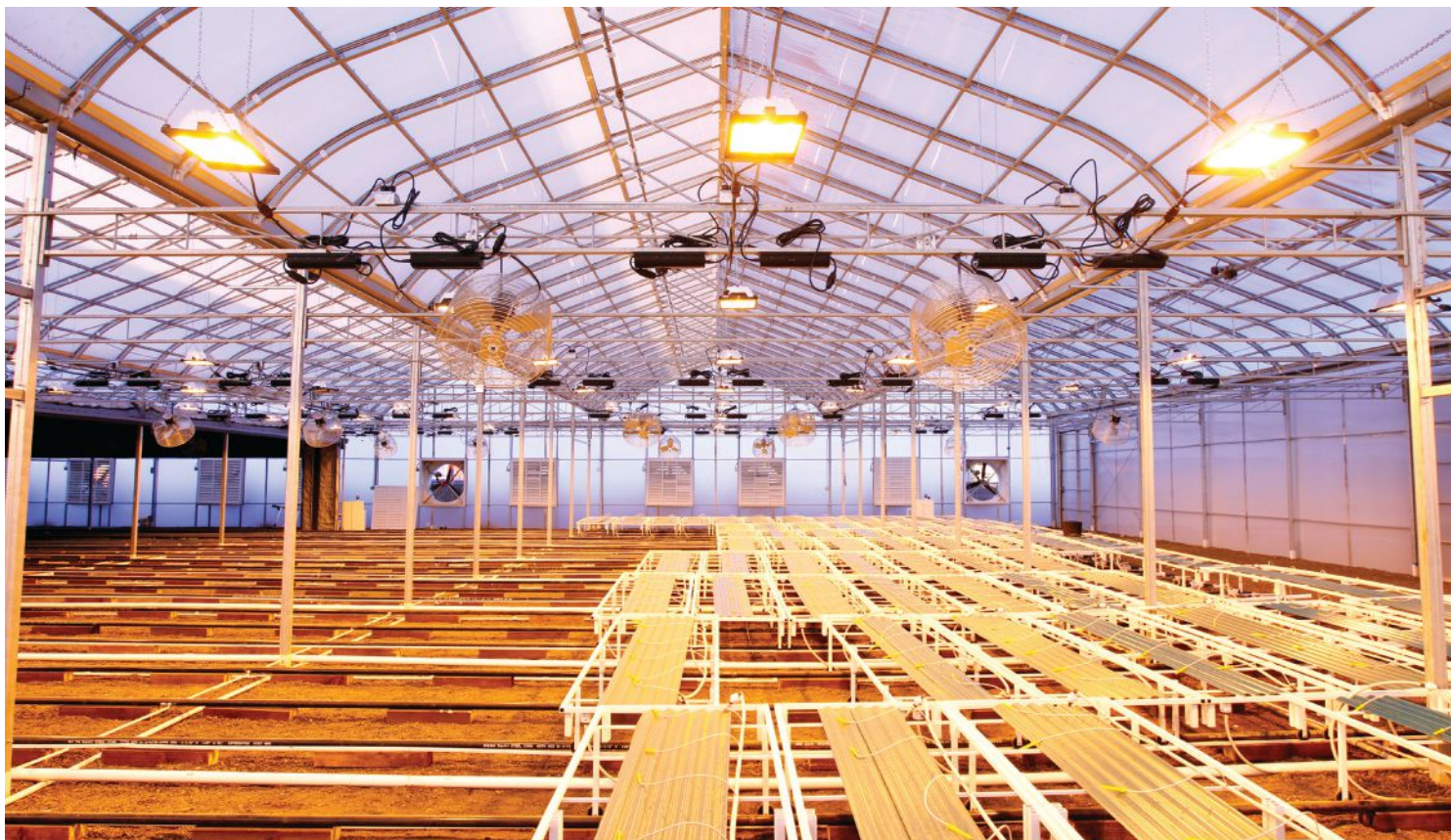

Courtesy Growlites/Barron Lighting Group

“We’re starting to prototype fixtures that can alter the [light] spectrum, some of them even on demand. We can actually come up with spectral prescriptions fixed to crops. What might work best for lettuce might be different from broccoli, or sunflowers, or geraniums.”

—Pete Rumsey, executive vice president of business development, Lighting Science

grow centers in the Netherlands, the United Kingdom, the United States, Singapore, and Japan to test new LED grow lamps and systems. According to Philips’ research, a single city farm center can produce food to feed 50,000 people. With 6.4 billion city dwellers projected by 2050, urban farming becomes an increasingly attractive and necessary option in global food production.

Going forward, more companies will start to explore this particular market segment. In February, Philips collaborated with Colorado State University to host the first LED Horticulture Lighting Research Summit. The university’s \$7.5 million horticultural research center in Fort Collins, Colo., opened in 2015 and is set up with Philips’ LED horticultural product line as investigators explore new applications. •

Prevoke inspiration.

An Inspiration. A living testament to the dedication of pure materials, lean-and-green manufacturing and technological advancements. Continually seeking to improve both our company and the lighting profession itself.

Investment in simplicity, functionality and powerful designs makes sense and are not only usable but desired by the design professional. To have the desire to be better is what drives us, and more importantly **inspires us.**



TEKA ILLUMINATION.com

What will inspire you?



Arcade Series™ Full Shield
Shown in Black Chrome Finish

LI-FI: HIGH-SPEED COMMUNICATION VIA LED MODULATION

by David Geer

As our nonstop exchange of information fills the electromagnetic spectrum available for Wi-Fi, light fidelity (Li-Fi) is emerging as one solution to pick up the slack. Li-Fi turns LED lamps into internet and broadcast data transmitters, creating a new form of high-speed, optical wireless communication that leverages the visible and infrared (IR) light spectrums.

Harald Haas, a professor of mobile communications at the University of Edinburgh, in Scotland, debuted Li-Fi technology to the public during a 2011 TEDGlobal Talk before co-founding PureLiFi, a company that builds on his university research. The technology has since taken off. In April 2017, the Institute of Electrical and Electronics Engineers (IEEE) even formed a task group to revise *802.15.7-2011: IEEE Standard for Local and Metropolitan Area Networks* in part to include Li-Fi.

LI-FI FUNDAMENTALS

To send data, Li-Fi relies on the modulation of light at frequencies that are imperceptible to the human eye in most lighting applications. As semiconductors, LEDs can turn on and off up to a million times per second, enabling the diodes to send data quickly, says Tom Van den bussche, founder of Toric, a lighting-technology company based near Paris.

In a Li-Fi installation, a digital signal processor integrated or attached to an LED driver takes data from a network, server, or the internet and converts it into a digital signal—basically a sequence of discrete voltage levels. The LED driver in each fixture converts the digital signal into a photonic signal, transmitting it at a very high frequency as an Orthogonal Frequency Division Multiplex

(OFDM) signal, says PureLiFi chief operating officer Harald Burchardt. OFDM signals are also employed in 4G LTE and Wi-Fi technologies because they use many small-bandwidth channels collectively rather than a single large-bandwidth channel. The decoder on the receiving device—say, a computer or smartphone—then translates the OFDM signals into data for the user.

PureLiFi currently offers a product that acts as “a Li-Fi access point that replaces a bulb [and] unites the signal processor and driver into a single replacement LED lamp for the room lighting fixture,” Burchardt



Numerous applications, including internet connectivity and data security, stand to benefit from light-fidelity technology.

THE LIGHTING QUOTIENT®



2017: 40 YEARS manufacturing **elliptipar®** & **tambient®**

2019: 10 YEARS since LED product line launch

2020: 100 YEARS in lighting - centennial celebration

2023: 60 YEARS since SRSA lighting design practice founded

elliptipar®



THE LIGHTING QUOTIENT®

tambient®

says. Each access point has a unique IP address, allowing the fixtures to talk to each other and to hand over data transmissions seamlessly as, for example, a user walks down a hallway with their device.

Currently, PureLiFi's technology requires each receiving device to have a USB dongle with a photoreceptor to receive the signal and a decoder to convert the data from photonic to electronic, Burchardt says. The dongle also houses an infrared LED to modulate the upload signal for returning data to the luminaires and into the network.

Ideally, the Li-Fi access point, lamp driver, router, and LED system would connect to the internet using either power-line communication (PLC), which sends data over cables also used to power the hardware, or power over Ethernet (PoE), which sends power over Ethernet cables, says Peter Babigian, a partner at New York-based technology consultant Cerami & Associates. Both PLC and PoE aim to reduce costs by providing data and power over the same cable.

LI-FI'S COMPETITIVE ADVANTAGE

The capabilities of Li-Fi are more advanced than visual light communication (VLC) and Wi-Fi. VLC is a one-way, point-to-point optical communications technology while Li-Fi enables two-way communications over multiple frequencies for mobile and networked connections. While VLC and Li-Fi are both "light communication technologies," Babigian notes, the latter is a hybrid of VLC and IR communications. "The downlink [aspect]—LED to photodetector—is VLC, but the uplink is infrared," he says.

Currently, devices must employ a USB dongle, such as this one by PureLiFi, to receive and decode downlink data, and to modulate an upload signal for sending uplink information via Li-Fi.

Burchardt says that the radio spectrum allotted for wireless communications spans only 300 gigahertz while the visible light spectrum spans 300 terahertz, from red light at 400 terahertz to violet at 700 terahertz. Thus, light has 1,000 times more frequency available for wireless communications than radio—though its full capacity has yet to be realized. "While Li-Fi has the potential to achieve much higher data rates than we can currently achieve using Wi-Fi," Burchardt says, "we haven't seen any commercial systems that are 100 times faster." PureLiFi's product currently reaches upload and download speeds up to 43 megabits per second, he says, though speeds have topped the tens of gigabits per second under controlled settings in the lab.

Unlike Wi-Fi, Li-Fi transmits data to devices via direct and incident light without risk of disrupting sensitive electronics, such as those found in hospitals or on airplanes. And because Li-Fi is directional, requiring a line of sight between the transmitter and the receiving device, it cannot transmit data through walls. "Li-Fi's security concerns will be very few because you have to be physically in the area where the light is to hack it—and then people will notice you," says Toric's Van den bussche.

Li-Fi's directionality also reduces the risk of interference with other devices vying for a connection. "Co-channel interference, a source of noise, and electrosmog (electromagnetic radiation from the simultaneous use of mains electricity and wireless technology), which exist in radio waves, are absent in Li-Fi," Babigian says.

Data density—the broadband capacity and data rates per square meter—is also greater in Li-Fi than Wi-Fi. While people using the same Wi-Fi access point will compete for bandwidth, Li-Fi's limited coverage—it has a range of about 10 meters (33 feet)—and multiple access points per room reduce competition for bandwidth. Keep in mind though that the amount of bandwidth allocated to a business or residence is ultimately determined by its internet service provider (ISP); that is, no matter how quickly a device connects to the internet, the bandwidth from there on out will only be as fast as the ISP offers.

Van den bussche notes one final advantage: The Li-Fi spectrum, unlike Wi-Fi, is entirely free to everyone as no regulatory body owns the light spectrum—and no entity will ever be able to claim it because this is physically impossible. Thus, no license will be required to communicate with it.

IDEAL LI-FI APPLICATIONS

Li-Fi can be used anywhere that can be outfitted with wireless communications and electric lighting: commercial buildings, retail environments, and smart cities for in-vehicle data transmission. “As IoT [Internet of Things] and smart applications gain traction, Li-Fi offers the omnipresent wireless connections that these devices and applications need,” Burchardt says.

Along with its use in bidirectional internet communications, Li-Fi holds promise in cataloging and entertainment applications. Toric and Luciom, a French VLC company acquired by Philips Lighting in late 2016, refer to these three respective applications as Li-Fi Internet, Li-Fi Tag, and Li-Fi Broadcast categories. Li-Fi Tag uses a router to broadcast the same tag repeatedly, for example, to confirm the specific row and shelf of a product in a store or distribution center, Van den bussche says. The data flows one way from the emitter to the receiver, such as a device used for tracking inventory. Li-Fi Broadcast uses a router to transmit data, videos, music, and shopping coupons one way to consumer devices, such as smartphones.

“As IoT and smart applications gain traction, Li-Fi offers the omnipresent wireless connections that these devices and applications need.”

—Harald Burchardt, chief operating officer, PureLiFi

Li-Fi is also advantageous in indoor navigation and warehousing uses because it can pinpoint the location of a product in three dimensions while RFID only offers dimensions along the horizontal plane. “In applications for the disabled,” Van den bussche says, “you could use Li-Fi to guide the blind not only to where the door is, but to where the handle is.”

THE ECONOMICS OF LI-FI

Incorporating Li-Fi Tag into a project requires a relatively straightforward modification to the driver of each LED fixture. “You then need to check again whether the fixture is still within its spec,” Van den bussche says. “This is mainly an electromagnetic compatibility check, which the fixture manufacturer would perform.”

The complexity of installation increases with Li-Fi Broadcast since it requires an internet LAN connection—which most commercial businesses have—for each transmitter as well as a dongle for each receiving device.

Li-Fi Internet, at least in the case for PureLiFi’s networked technology, requires the installation of integrated Li-Fi luminaires, or access points, and either PoE or PLC for the backhaul.

Still, the logistics of installing Li-Fi is just one factor. Cost is another. Even as the radio spectrum fills up, Li-Fi will likely complement Wi-Fi but not replace it. “It is not cheap to run Ethernet cables to every Li-Fi module when you can just use Wi-Fi,” says Vitaliy Vinogradov, an internet-industry veteran and the CEO of Modern Place Lighting, an LED fixture manufacturer in West Palm Beach, Fla. Installing PoE LED lighting helps clear a path for Li-Fi because the associated backhaul cost is less when both power and data use the same infrastructure.

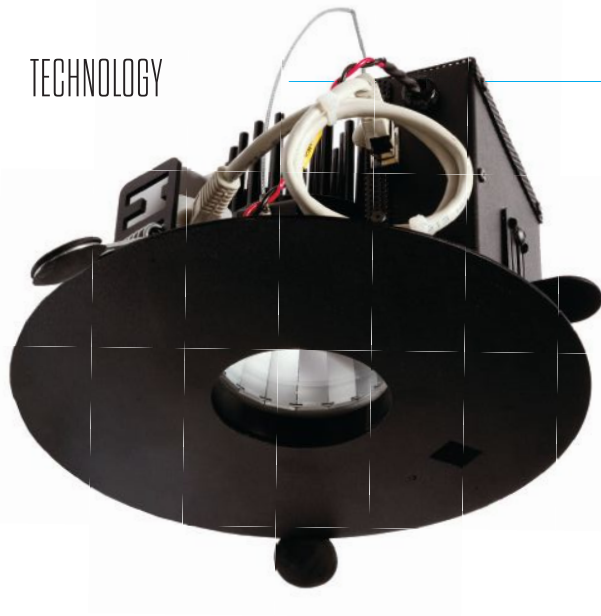

PureLiFi's integrated LED luminaire serves as a Li-Fi access point and features a router and lamp driver. It is compatible with LEDs from multiple manufacturers.

However, other Li-Fi components are also expensive. "Li-Fi needs to come down in cost by a factor of 50 to 100 as internal Li-Fi stacks cost \$1,000 to \$2,000 per transmitting unit," Van den bussche says. Plus, Li-Fi requires more transmitting units than Wi-Fi. "These need to come down to \$100 a piece to be comparable." Shrinking Li-Fi systems so smartphones and laptops can house internal Li-Fi receivers is an ongoing and expensive R&D effort, he adds, but "costs will come down as usage increases."

TAKEAWAYS FOR LIGHTING DESIGNERS

Each commercial Li-Fi vendor will package the components of Li-Fi—specifically, the router, lamp driver, and LEDs—differently so lighting designers will need to understand these distinctions and learn how to work with, install, maintain, and use each vendor's products. When reviewing Li-Fi products to specify, lighting designers should also evaluate performance metrics, including whether the Li-Fi system truly offers bidirectional (downlink and uplink) communication, and its compatibility with other manufacturers' LEDs.

Operating LED lights below 60 lux will typically cause Li-Fi transmissions to cease; some loss of network speed and transmission range may even begin beforehand. "There are solutions for encoding data into ultra-short light pulses that are imperceptible to humans, increasing the potential for using Li-Fi in darker environments," Babigian says.

Solid objects like walls and doors can keep Li-Fi from escaping a room, but within a room, a Li-Fi transmitter's lamp would have to be entirely covered by something that does not allow light to pass in order to cut off the signal completely. "[Designers] have to be concerned about the availability of the light in a room due to concerns over line-of-sight," Van den bussche says. "You can't have things inappropriately reflecting or blocking the light." The exception, of course, is when reflection is desired to increase the availability of the signal.

IN THE REAL WORLD

PureLiFi is currently in trials in Singapore, with the blessing of the city-state's Info-communications Development Media Authority. "Though Li-Fi will eventually need to be available natively on smartphones and computers, people are putting the money into R&D, and it is only a matter of time," Van den bussche says. "The first solutions should come to market in three to five years with more mainstream solutions in five to 10 years."

But as long as the internet connection leading up to the Li-Fi remains slower than Li-Fi itself, Li-Fi won't have a lot of viability. "For example, Cox Communications gives its Pensacola, Fla., customers a 1-gigabit-per-second router even though the fastest internet speed offered to residential customers is 300 megabits per second, which is less than one-third of the router's capabilities," Vinogradov says. "Implementing Li-Fi is like trying to sell a city on a big bridge over a small creek."

In commercial applications, a fiber-wire connection is currently much faster and far more reliable than Li-Fi, Vinogradov notes. Gigabit fiber optic internet currently offers speeds up to 1 gigabit per second. However, if Li-Fi can reach the tens of gigabits per second in real-world applications that researchers have witnessed in the lab, it could become a true game-changer in wireless communications. •

David Geer is a former internet-service-provider and telecommunications technician who writes about the internet, emerging technology, and a host of other topics for national and international publications.



Multiple options. Endless possibilities.

The new Pendant Multiples, available with Hornet HP or C3 Mini accents, open up a world of design possibilities. They are offered in curved or straight configurations with an uplight option and can adjust from recessed to semi-recessed accents in seconds.

Our new Pendant Multiples let your vision take shape.

Learn more at amerlux.com

Follow us on Twitter [@AmerluxLighting](https://twitter.com/AmerluxLighting).



Pendant Multiples



Available in curved and straight configurations.



INTRODUCING **The ConTech Adjustable Downlight!**

4" Round R4A Series

4" Square R4ASQ Series

6" Round R6A Series



- Deep full-cone trims for downlighting, angle-cut trims for accent lighting
- Generous adjustment mechanism with 360° of rotational adjustment and 45° degrees of tilt adjustment provides exceptional versatility
- Can accommodate vaulted ceilings up to a 12/12 pitch
- Six wattage/lumen packages are available with multiple beam distributions provided by unique, water-clear faceted optics

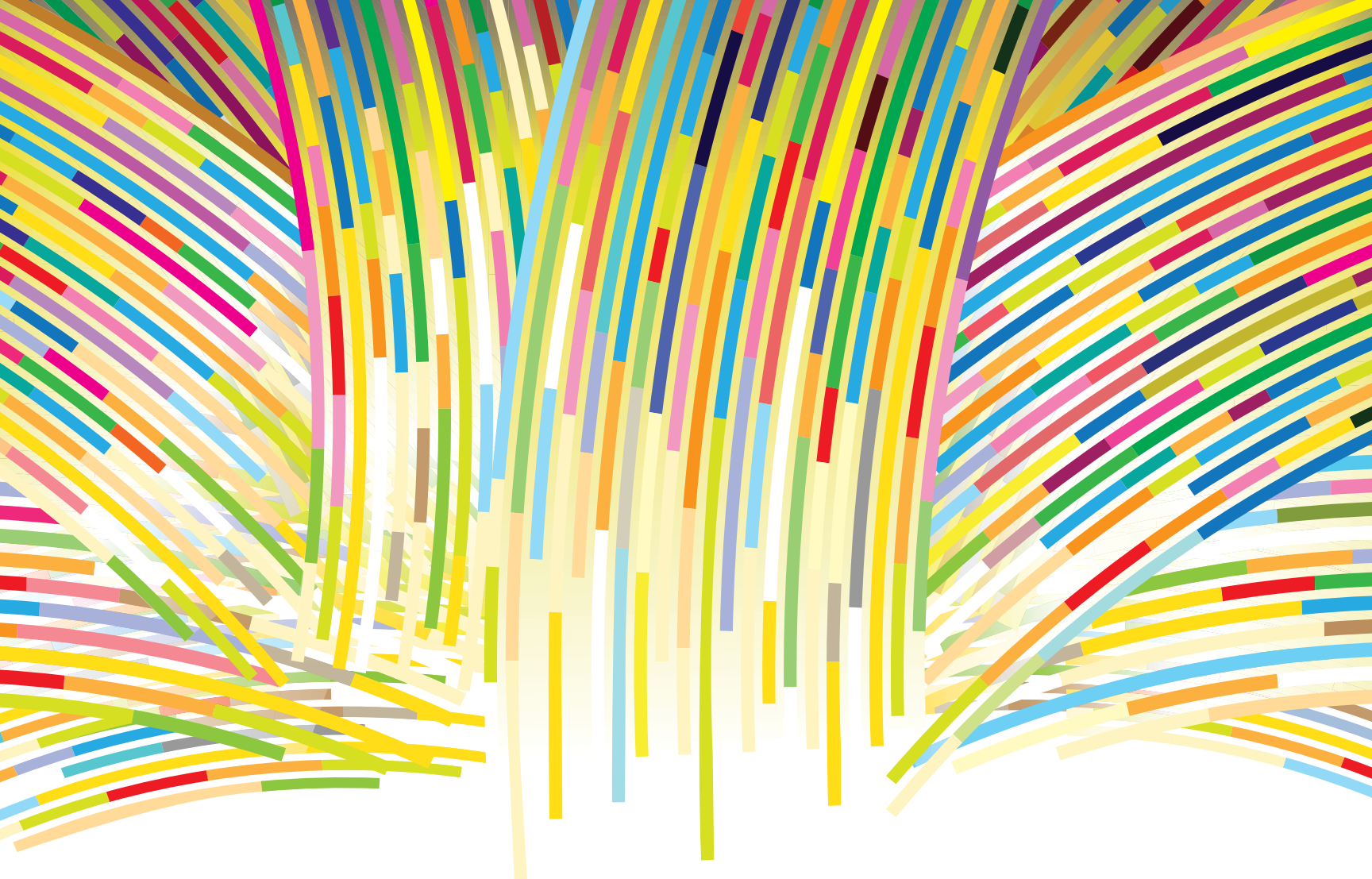

THE TRANSFORMATION OF LIGHT

text by Elizabeth Donoff

illustration by Daniel Hertzberg

The evolution of this Annual Product Issue mirrors the evolution taking place within the lighting industry. Over the past decade, product categories have morphed as LEDs have taken hold. Of the 160-plus products across 14 categories on the following pages, all are LED.

The transformation of lighting has been exciting, and it certainly has its own set of complexities and frustrations—as is the case with all new technologies. But the outcome is some of the most sophisticated products the lighting community has ever seen. While some might argue that the rise of solid-state lighting has resulted in fewer options, limiting design freedom, what lighting designers can achieve with the current generation of LED luminaires is remarkable.

Nevertheless, challenges remain, and designers and manufacturers alike must remain diligent in reviewing testing data, spec sheets, and product samples. Solid-state lighting demands rigorous review based on new metrics and design criteria. In a continued effort to help decipher what this all means, we queried lighting designers and manufacturers about how they stay up to date and navigate the ongoing seismic shift. •

DECORATIVE



Aplomb Large, Foscarini • Made out of specially processed concrete, this disc-like suspension luminaire is designed by Studio Lucidi & Pevere in Milan. Available in white, concrete gray, and brown with a black or white cable and canopy, this 17.75"-diameter fixture with a 71" ceiling drop provides direct downlight with an embedded 9.2W 2700K multichip LED with a minimum CRI of 90. • foscarini.com/us/en



Brigit, Arkoslight • This suspended luminaire provides both downlighting and lateral diffused illumination through a white, orange, or red pleated shade. 22.8" by 16.5", the fixture is fitted with a 30W LED offered at either 3000K or 4000K with a minimum CRI of 80 and delivers 4,850 to 5,050 lumens. • arkoslight.com



Cubist, Troy Lighting • This Postmodernism-inspired fixture is comprised of three inset, askew, rectangular iron prisms finished with bronze and gold leaf. Wall- or ceiling-mount options measure 19" by 17.5" or 9.5" by 13.5". Pendant options measure 25.5" by 21.25" by 39.75" or 21.75" by 18" by 33.75". The 12W LED module, housed in a stainless steel frame with acrylic diffuser, is offered at 2700K at a CRI of 90. 120V incandescent dimming available. • troy-lighting.com



U-Light, Axo Light • An inverted U-shaped aluminum frame fixed to a dimmable LED-embedded ring with an acrylic diffuser comprise this dome-like fixture designed by Finnish architect Timo Ripatti. U-Light comes in three wattages: 57.6W, 86.4W, and 108W, and three fixture sizes, respectively: 35.4" by 32.5"; 47.25" by 44.3"; and 62.9" by 56.1". Finish options are anthracite gray or rust brown. • axolightusa.com



Square Sconce, LightArt • This geometric contemporary wall-mounted luminaire is available in more than 250 finishes with customizable dimensions, materials, hardware, and illumination. The 8" by 8" by 3" standard option requires 120V to 277V input uses a 6W 3000K (with a CRI of 81) LED with a zero-to-10V dimming capability. 3500K or 4000K options are also available. • lightart.com

Salt, Arkoslight • With a shade-integrated driver, this LED pendant luminaire has a streamlined look and provides diffuse downlight akin to a high-bay fixture, but in a decorative package. It measures 13.8" by 16.5", and can be selected with four wattage options—23W, 30W, 39W, or 53.5W—offered at either 3000K or 4000K with a minimum CRI of 80, and delivers 3,200 to 8,000 lumens (depending on wattage and color temperature selections). • arkoslight.com



WAC LIGHTING

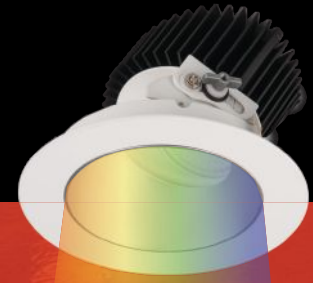

AETHER 3.5" Color Changing Shallow IC LED Downlight

ilumenight™
transforms your space
into a work of art with
the touch of a finger.

AETHER offers a complete
lighting solution toolbox with
Downlight, Adjustable Accent
and Wallwash options.

**Standard Bluetooth,
0-10V, DMX dimming
control protocols**

STEP 1 Download FREE ilumenight™ App

STEP 2 Setup Login

STEP 3 Command all ilumenight luminaires at will



WAC





Photon 48 Chandelier, LBL Lighting •

This starburst pendant features 18 2W 3000K 90-CRI LED modules embedded into an aluminum core diffused by extending solid, square-faceted, acrylic arms. Available in two sizes (34" and 48") and finishes (aged brass and satin nickel), the luminaire comes with a field-cuttable 12' cable in either bronze or clear to match the finishes. • lblighting.com



Mayfair Pendant and Lamp, Vibia •

Reminiscent of 19th-century library or billiards lamps, the Diego Fortunato–designed family of luminaires includes a pendant and a table lamp. The pendant (shown) includes three shades in a radial configuration. The 57.6W 2700K pendant is dimmable down to 1 percent and provides indirect lighting via a reverse throw beam. The table lamp version measures 20.5" tall with an 11.8" by 2.4" shade anchored to a metal disc base. Two LED strips totaling 19.2W offered in 2700K with an optical sensor dimmer emit indirect illumination. The diffuser shades for both styles are available in matte white, matte gold, graphite polished copper, and green or orange with black nickel finishes. • vibia.com/us

How has the specification process changed with the introduction of LEDs?

“We used to have a list of 10 to 20 common fixtures that we used as ‘go to’ fixtures on certain project types, but now there is so much that is new that you cannot maintain such a standard list. We find ourselves writing fixture schedules from scratch more often, and we don’t specify any product we haven’t seen or analyzed. This will continue as new products are introduced every six months.”

—Denise Fong, Principal, Stantec



c2 anelli, Viabizzuno • Designed by Tel Aviv, Israel–based Rama Mendelsohn, this suspended fixture—named for the Italian word for “rings”—is made of oxidized, extruded aluminum with square-faceted edges. Available in satin brass and stainless steel finishes, the ring measures 41.7" in diameter with an embedded interior satin polycarbonate diffused 40W 3000K LED. A larger option measures 78.7" in diameter with an 80W LED, also available at 3000K. • viabizzuno.com



The Ellipse Series, Niche • Designed by Niche CEO Jeremy Pyles, these hand-blow glass pendants are a modern take on the circular form. Available in a large and small option measuring 12.5" by 10" and 9.75" by 8.25", respectively, each fixture size comes in eight colorways including smoke, amber, and rose. Lamping options include incandescent, LED, and compact fluorescent at both 120V and 240V. • nichemodern.com

Navicula, David Trubridge Design • Designed to represent the ocean-living microscopic photoplankton called diatom, this curvilinear suspended fixture is made of thin, CNC-cut bamboo plywood strips, in either natural or caramel finishes, and fastened with nylon clips. Available in three sizes—57", 77", and 100"—the luminaires can be fitted with 8W, 11W, or 18W 2700K LED light bars for the small, medium, and large sizes, respectively, all with a CRI of 90. • davidtrubridge.com



Ashton, ILEX Architectural Lighting • This tapered drum shade pendant is outfitted with a triple rod stem that comes in brushed nickel, matte black, and satin brass finishes. Measuring 36" long with an 18"-diameter shade, this fixture takes three 60W incandescent medium base Edison lamps. • ilexlight.com



Seraph Square Pendant Seraph Modular System, Blackjack Lighting • This 24"-square LED luminaire accommodates up to 25 individual pendants and can be installed as a single fixture or aligned with others to create a geometric pattern or even cover an entire ceiling. The fixture uses up to 37W with an output of 2,050 lumens and is offered at 2700K with a CRI of 90. A 4000K upgrade is also available. Finishes include polished chrome and matte black. • blackjacklighting.com



Trumpet Pendant, Tracy Glover Studio • This conical shade fixture featuring a candelabra-based socket is highly customizable; it is available in three glass pattern finishes including smooth, glass-wrapped, and bubbled, in 23 colors, and in seven metal finishes, with seven cord options. Measuring 12" tall with a diameter that reaches 6" wide, this pendant runs on a 120V system and accommodates a Bulbrite filament-style nostalgic 2W 2200K LED lamp offered at a CRI of 80. • tracygloverstudio.com



Core, élan Lighting, a Kichler company • Inspired by celestial and lunar forms, this pendant incorporates a ring embedded with an LED that surrounds an interior textured amber acrylic disk that rotates to create an eclipse effect. The luminaire uses a 16.5W 2750K LED to deliver 652 lumens. The 20.25" disk can be suspended from lengths between 23" and 77" and comes in brushed nickel with a clear white acrylic disk. • elan-lighting.com



Metropolis, Corbett Lighting • This modern pendant includes interconnecting gold-leaf-covered iron cubes to create a sculptural frame around two 14W 2700K (90-CRI) LED modules behind a white acrylic diffuser. Available with universal dimming, the 44.5" by 47.5" fixture is suspended by 10'-long aircraft cables embedded with a micro power cord to give the appearance that the luminaire is floating in midair. • corbettlighting.com



Spokes Large, Foscarini • Designed by Italian studio Garcia Cumini Associati, and drawing inspiration from antique lanterns, aviaries, and bicycle wheel spokes, this second-generation Spokes fixture is larger than the original. Curved, varnished steel rods attach to discs creating a 27.5"-diameter orb. Two 40W LEDs available in 2700K at a minimum CRI of 90 provide diffused and direct illumination. The fixture requires either a 120V/277V input. • foscarini.com/us/en



UNO Helix/Spiral, Delray Lighting • Intended for lobbies, atria, and other high-ceilinged areas, the UNO Helix (shown) features a 1"-wide aluminum corkscrew shape and comes in 3', 4', and 5' diameters. Designed with a similar profile, the UNO Spiral, with a gradually widening coil of illumination, is intended for wall or ceiling mounts. Both are outfitted with programmable, dimmable LEDs available at 3000K, 3500K, and 4000K as well red or blue, all at a CRI of 90. • delraylighting.com

What makes a great luminaire?

“A great luminaire design is giving a lighting designer a tool to do their job. This starts with thinking about the fixture within the fabric of the architecture. Products start from a need and technology gives us an opportunity. Today’s luminaires have to be future-proofed; they have to be designed with technology evolutions in mind so that they can be maintained and upgraded; they have to be sustainable.”

—Douglas James, Director, Whitegoods



E=MC2, WAC Lighting • This solid aluminum linear pendant measures just 0.5" tall by 0.5" wide by 47" long and suspends from two thin power cables with an adjustable leveler that enables customizable positioning. Available in brushed aluminum or brushed black finishes with a maximum ceiling drop of 110", the fixture uses 30W 3000K LEDs at a CRI of 90 with dimmability down to 10 percent. • wacighting.com



Quality, Reliability and Consistent Performance

LED LIGHTING SOLUTIONS

Nora/Nspec Lighting can be your single source for indoor LED lighting in commercial, retail, hospitality, multi-family and residential applications. Provide general broad illumination with LED Edge-Lit Panels or Center Basket Troffers. Light high ceilings and corridors with our 850L to 8000L Sapphire Series. Provide dramatic or general recessed down light with Onyx, Cobalt, lolite or Marquise. Linear lighting for coves and under cabinet can be accomplished with ten families of LED Tape, LED SBC Lightbar or line voltage Bravo Frost and LEDUR products. Nora offers dedicated LED and LED compatible track heads while LED multiples provide up to three adjustable LED modules in a single opening. Define an area or provide flexible general lighting with the new iLENE LED Pendants and larger Cylinders. Highlight paths of egress with Nora/Nspec LED step lights, emergency and exit products.

Nora/Nspec Lighting...Big enough to do it right, small enough to care.



iLENE LED Pendant
2", 3", 5" up to 2000 lm



LED Sapphire Series
4", 6", 8" up to 8000 lm



LED lolite Series
1", 2", 4" up to 800 lm



LED Multiples
Trimless, 1 to 3 Lamps



LED Track
Dedicated and Specifiable



LED Bravo Frost
12" to 32", 500 lm/ft

NORA | NSPEC
LIGHTING

800.686.6672 www.noralighting.com



Lightfair Booth #2313

DIRECT/INDIRECT



Ametrix ASYC 2.0 Natatorium, Eaton •

The ASYX 2.0 family of luminaires is designed for harsh pool environments. It includes wall mount, single pendants, dual pendants, and quad pendants in six different sizes and can be mounted face up or face down. Lumen packages range from 2,300 to 120,000-plus and four color temperatures are offered with a CRI of 80-plus. It has rotatable optics—zero, 90, 180, and 270 degrees. • eaton.com

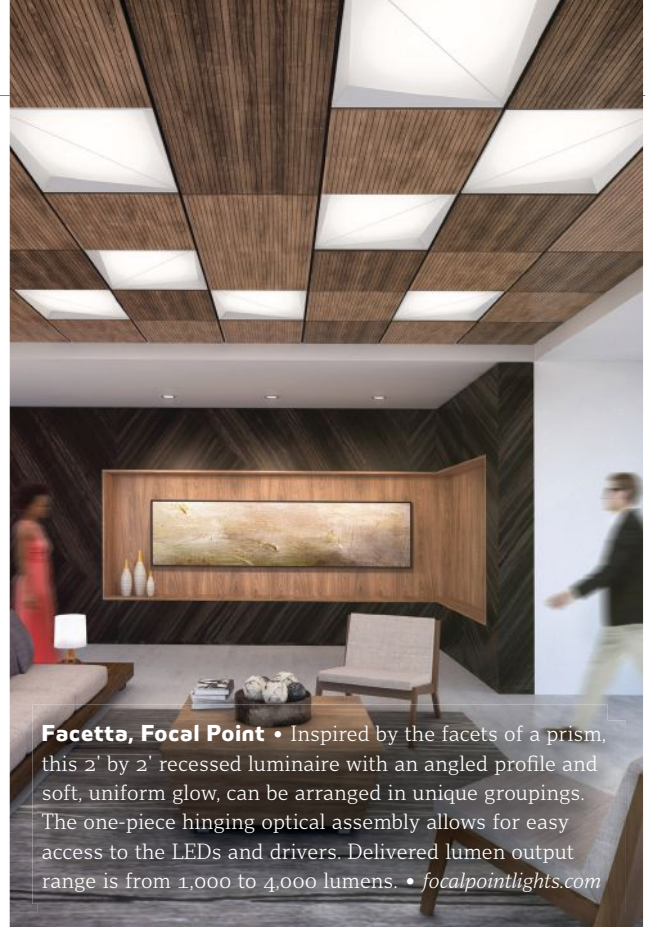

Facetta, Focal Point • Inspired by the facets of a prism, this 2' by 2' recessed luminaire with an angled profile and soft, uniform glow, can be arranged in unique groupings. The one-piece hinging optical assembly allows for easy access to the LEDs and drivers. Delivered lumen output range is from 1,000 to 4,000 lumens. • focalpointlights.com



NeoRay Covera, Eaton • This direct/indirect luminaire is available in 2' and 4' lengths and is suspended from the ceiling using LuxWire-powered aircraft cable. The fixture is available in 2700K, 3000K, 3500K, and 4000K and uses Eaton's curved WaveStream optics. Zero-to-10V dimming is standard. Available in three standard powdercoat finishes—silver, white, and black—or optional architectural hydro-graphic finishes—white oak, white marble, gray ash, brown willow, dark walnut, and carbon fiber. • eaton.com



Transition, Specialty Lighting • This linear LED fixture has a 1" by 1" aluminum housing, and is available in 1', 2', 3', and 4' lengths (custom lengths can be requested) at 2700K, 3000K, 3500K, and 4000K. The lamp can be rotated 45 degrees. It has two lens options—diffuse or clear—and runs using 120V/277V, or universal voltage, and includes a dimmable power supply. • specialtylighting.com



Fold, Fluxwerk • For spaces with presentation, projection, or video conferencing requirements, this linear luminaire offers multiple light distributions. Direct-only is 100 down, and the four direct/indirect options are: 20 up/80 down, 45 up/55 down, 55 up/45 down, and 65 up/35 down. The distributions are fully dimmable or switchable via independent control. Three endcap styles—arch, oblique, and slant—and three finish options—white and black powdercoat and clear anodized. • fluxwerk.com

C70 Series Performance Cylinders, Pathway Lighting • This family of cylinder luminaires is available in eight styles and can be used indoors and out. Cylinder heights range from 6" to 29"; nominal diameters from 2" to 7". Output is from 500 to 3,000 lumens. Multiple beam spreads are available and zero-to-10V dimming is to 1 percent. Mounting options include surface, stem, straight cord, and wall. Five standard finishes and RAL custom colors. • pathwaylighting.com





selux

E X E L I A

with Tritec Module

Selux Exelia uses the new Tritec Module – a modern day LED refractor designed for exterior post top fixtures. The indirect light source provides comfortable vertical illumination. Choose from one, two, or three stacks – perfect for pedestrian areas. Tritec Module is available in three Selux exterior post top product families: Saturn, Quadro, and Exelia.

See us at Lightfair 2017 – Booth# 5827

selux.us



L4R Recessed Linear, Ketra • The L4R recessed linear provides continuous lines of light. It uses Ketra's fully tunable spectrum to deliver high-quality white, saturated, and pastel light from a 4" aperture with a flush opal lens. Available in lengths from 2' to 12', and a variety of mounting and finish options. Power and control requires a wired connection to a Ketra N3 satellite. Programmable digital dimming to 0.1 percent. • ketra.com



Mini CoveLine LED, Solid State Luminaires • At 0.875" tall, the Mini CoveLine LED is the lowest profile cove-style fixture in its class, according to the manufacturer. The fixture has a 180-degree, adjustable mounting bracket and plug-n-play connectors. Available in 1' and 4' lengths at 2700K, 3000K, 3500K and 4000K, it uses a 120V/277V power supply and is dimmable to zero brightness. • solidstateluminaires.com



Slimgot, Arkoslight • This linear fixture features an aluminum body that serves as its heat sync. Its truncated pyramid shape optimizes the luminous flux output of the LEDs. It is available in two sizes: The 120 is 3.93' long by 3.5" wide, uses 17W and is available in 3000K and 4000K and a CRI of 80-plus. The 150 version is 4.92' long by 3.5" wide and uses 21.5W at 3000K and 4000K with a CRI of 80-plus. White or neutral finish. • arkoslight.com



Idoo Pendant, Waldmann Lighting • A direct/indirect suspended luminaire with a slim profile, it provides uniform, glare-free light via edge light and lightguide technology. Available in 49W with a CRI of 80-plus, light distribution is 34 percent direct and 66 percent indirect. • waldmannlighting.com

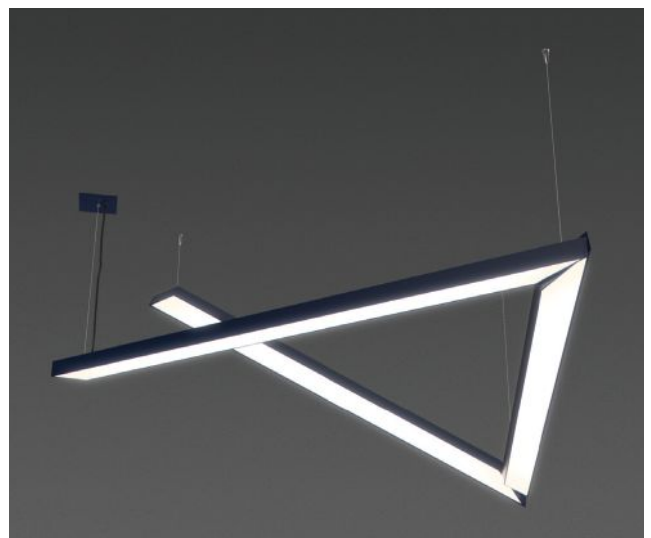

RPD 15, Neidhardt, Architectural Lighting Works • This linear fixture has segments that can be rotated 30 degrees in each direction. Available in arm lengths up to 96" at 2700K, 3100K, 3500K, and 4000K, the fixture delivers 1,000 lumens per foot. Standard finish choice is brushed aluminum or satin white (RAL or Pantone colors are also available). Options include emergency power pack and integrated driver. • neidhardtinc.com



NeoRay Converge, Eaton • Featuring a wing shape design, this luminaire provides visual comfort using a unique uplight distribution using a proprietary light mixing chamber. Available in 4' and 8' lengths at 3000K, 3500K, and 4000K, the fixture uses Eaton's curved WaveStream optic; and LuxWire aircraft cable suspension system. Zero-to-10V dimming is standard, and DALI dimming is also available. For lighting controls, the fixture is both distributed low-voltage power and LumaWatt Pro enabled. • eaton.com



Surprise HueBella Pendant, Archlit • This linear system includes adjustable modules, downlights, and blind sections. The housing is an aluminum extrusion with white, black, or custom color finishes, and is suspended from the ceiling using aircraft cable. Available in 2700K and 3000K with a CRI of 90-plus, it uses 13W per linear foot. A film shields the LED driver boards from view, eliminating the diode dot pattern. Dimming options include TRIAC 120V/277V and zero-to-10V. Round or square plate canopy options are offered. • archlit.com



Elliptipar Ensconce S43X, The Lighting Quotient • This family of high-lumen indoor (with damp location option) asymmetric LED uplights is designed to replace 250W to 1,000W conventional source products. Precision optics create a distribution ideal for illuminating surfaces at airports, transit centers, pools, field houses, and auditoriums with even washes of uniformly colored light. Four models range from 9" to 33" wide, for wall or pendant (single, back-to-back, or side-to-side) mounting. • thelightingquotient.com

What makes a great luminaire?

“Great luminaire design is respectful of the architecture and, most importantly, the comfort of people in a space. As technology evolves, we can continually expand the definition of quality of light to beyond the visual context to include respect for the circadian system to indulging the human desire that the luminaire knows who we are and what we like. The bar is constantly being raised; a great luminaire is a design that is future-proofed and ready for what ever comes next.”

—Jimalee Beno, Vice President, Strategic Specification Accounts, C&I Sales Channel, Acuity Brands



Transparency, Nordeon USA • Designed for office applications, this slim profile fixture—it's just 0.9" deep—uses edge lighting to achieve the illumination effect. When turned off, the luminaire is completely transparent. Available in 40W, 54W, and 67W at 3000K and 4000K, the fixture measures 47.1" by 19.6" and can serve multiple workstations. Zero-to-10V dimming. • nordeon-usa.com



Pilot PCM, Insight Lighting • This AC plug-and-play cove and accent lighting is offered in standard white light options of 2700K, 3000K, 3500K, and 4000K at a CRI of 82 standard (90 CRI optional) and static colors (red, green, blue, and amber) in 3.5W, 5W, 7W, 10W, or 13W per foot. The luminaire is available in 1' and 4' modules and has a 120-degree beam spread. Aluminum extrusion with molded endcaps, powdercoat finish white. • insightlighting.com

Compose, i2 Systems • An indirect, code-compliant cove LED lighting system for open-plan workplaces. The cove measures 2.5" wide by 1.4" tall and comes in 1', 18", and 4' lengths. It projects light across the ceiling at close to 100 lm/W and avoid hotspots and uneven illumination when mounted up to 6" from the ceiling. This allows the system to deliver 40 footcandles of light at 0.7W per square foot in an open plan and 0.5W per square foot in private offices. Zero-to-10V dimmable. • i2systems.com



Metalux Linear WaveStream, Eaton • This linear fixture with a low profile measures less than 3.2". It is available in 4' and 8' length at 3500K, 4000K, and 5000K and can be configured as a single fixture or in a continuous row for surface or suspended applications. It uses WaveStream technology with AccuAim optics. Zero-to-10V dimming is standard. California Title 24 compliant. Integral sensor options are available. • eaton.com



Lumencove Nano 2.0, Lumenpulse Group •

Lumencove Nano 2.0 features Lumendrive, a patented Lumenpulse technology, which drives LEDs without requiring a power supply or driver. The fixture delivers up to 113 lm/W and offers a unique 10-year warranty. • lumenpulsegroup.com

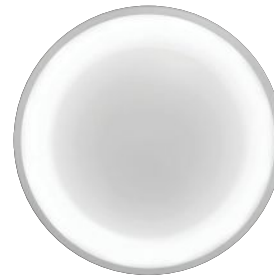

Symmetry, Visa Lighting • This luminaire is offered in three versions: patient room over bed, general use, and tunable. The tunable version is available in a white range of 1650K to 8000K (plus full gamut of saturated colors). Dimmable via zero-to-10V or DMX-RDM to 1 percent. It can be installed in drywall ceilings and T-bar grid systems. The LED power supplies are located within the housing and accessible from below the ceiling. Chicago plenum rating option is available. • visalighting.com



Stream Oval Linear, Prudential • Inspired by forms found in nature, the Stream Oval linear luminaire has a curved-edge profile. It uses a 98 percent high diffuser reflector film to provide a uniform line of light. It measures 5.5" by 3" and is available in 4' and 8' lengths at 3000K, 3500K, and 4000K. It uses 13W per linear foot at standard output. Light distribution can be specified as down only, up and downlight, or symmetric glow. Finish options are textured matte white, premium or custom color. • prulite.com



Volumetric Troffer, Sylvania LEDVANCE Luminaires • An LED replacement for fluorescent ceiling fixtures, these LED troffers are offered in two sizes—2 by 2 and 2 by 4—from 25W to 42W at 3500K and 4000K with a CRI of 80-plus. The fixture has a single white diffuse polycarbonate curved lens and is zero-to-10V dimmable down to 1 percent. • sylvania.com

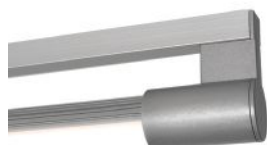

Stick LED, Delray Lighting • The Stick LED's directional lamp rotates 270 degrees, in 15-degree increments, to aim light where needed. Available in 2', 3', and 4' lengths in 15W and 25W at 3000K, 3500K, and 4000K, the fixture can be pendant or surface mounted, in stand-alone and/or continuous row configurations. • delraylighting.com

What makes a great luminaire?

“You have to think of a product as a product line, not a single entity. And a great product design team is essential to this. It’s a rigorous process. Our product development teams are organized around our product groups with representatives from all departments. This has been made significantly easier with the advent of LED technology, the only source for which we design new products.”

—Rick Shaver, Executive Vice President,
Research and Development, Edison Price Lighting

Global supplier

for high quality outdoor lighting solution



Characteristic

- Using the most common CSA standard, Modular design to integrated cooling, waterproof, optical and waterproof line connector, platform design and manufacturing; can provide ODE services
- Long life span, good heat dissipation. Using LED with LM-80(L70/L90) report
- Cost effective options and high efficiency solution(meets DLC4.0)

Application

street lighting, airport lighting, port lighting, gymnasium lighting, hall lighting, square lighting

SHENZHEN REFOND OPTOELECTRONICS CO.,LTD.

ADD: Building#1,10th Industrial Zone, Tian Liao Community, Gong Ming Area, Guang Ming New District, SHENZHEN, CHINA

TEL:+86-139 2343 3407 FAX:+86-755-66839300 E-mail:konny@refond.com

www.refond.com



Innovation enrich life **REFOND**

DOWNLIGHTS



BeveLED Block, USAI Lighting •

This fixture is designed for direct installation onto a finished ceiling when recessed lighting is not possible. Classic white—in 9W, 12W, 16W, or 24W—is offered at 2200K, 2700K, 3000K, 3500K, or 4000K. Warm dimming glow—in 16W—is offered at 2700K, 3000K, or 3500K. Both are available at a CRI of 80 or 90 respectively with multiple conduit mounting configuration options. • usailighting.com

Panos, Zumtobel • This luminaire features a twist-and-lock fastener and is available in four sizes (2.25", 3.5", 4.75", and 5.25") in round and square options either flanged or flangeless. Offered in 13W or 19W (based on fixture size), it can be selected in 2700K, 3000K, 3500K, or 4000K with a minimum CRI of 80 or 90. • zumtobel.com



Contortionist, Lighthouse Lighting •

• Available in 4" square or round with multiple finishes, this line of luminaires is highly customizable and allows full light output when adjusted to 40 degrees. Offered in 9W, 10W, 12W, 14W, 17W, and 20W, this luminaire is available in 2700K, 3000K, 3500K, or 4000K at a CRI of 83 or 98 with 28-, 40-, and 60-degree beam spreads and comes in five finishes. • lighthouselighting.com



Minus, Apure • This minimalist series offers two options—round with a 0.4" aperture and square with a 1" aperture, both with 20- and 40-degree beam spreads—for precise illumination. Both sizes are offered with Cree LEDs at 2700K, 3000K, or 4000K with a CRI of 80 or 90. • apure-system.com

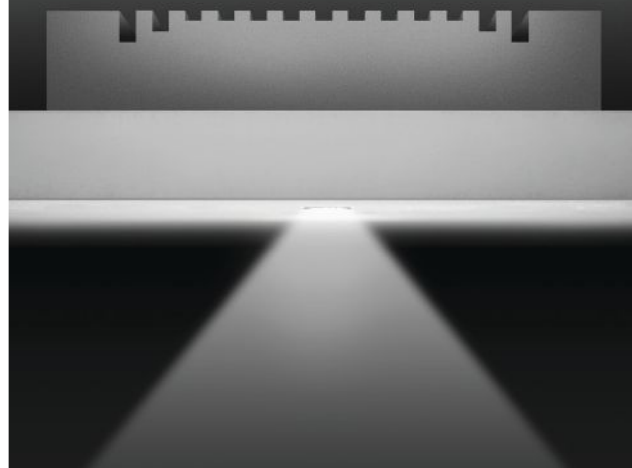

C68QSLBV, Pathway Lighting •

This 8" cylinder luminaire with a 6" aperture is designed for high-ceilinged areas such as auditoriums, theaters, or large houses of worship. Available in surface mount, cable straight cord, and pendant mount options, this fixture features a Bridelux Vero 13W LED module with a CRI of 80 or 90. There are five standard finishes as well as five beam distributions including 30-, 34-, 40-, 46-, and 70-degree spreads. • pathwaylighting.com



Lumenalpha Clear Small, Lumenpulse Group •

This round aluminum-framed module is designed for commercial, residential, or hospitality applications. The fixture features a 2.6" aperture with beam spreads available in 10, 20, 40, 60 degrees, as well as asymmetrical options. Offered at 2200K, 2700K, 3000K, 3500K, or 4000K with a minimum CRI of 80 or 95 respectively, this system has a 28-degree tilt and 355-degree rotation capability. • lumenpulsegroup.com

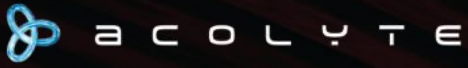

COMPLETE INTEGRATED LED LIGHTING SOLUTIONS

www.acolyteled.com



Zuma Restaurant | New York.
Product used: 1.5 Static White RibbonLyte 2400K in AS1 Channel (24V, IP20, frosted lens, 122 lumens/ft).
Lighting Designer: ML Studio | Photographer: Jesse Ross.

DOWNLIGHTS



1" Square Trim, Creative Systems Lighting • This 2.5"-by-2.5" die-cast aluminum trim with a 1" aperture is available in six finishes including white powder-cast and satin aluminum with reflectors and baffles available in black, haze, white, and shower light options. • csllighting.com



Fraxion 3", Lucifer Lighting • This sliding, adjustable fixture requires 3.5" recess depth for the 3" module. Using a Citizen LED module integral to the housing, the fixture is offered in 2700K, 3000K, 3500K, and 4000K at a CRI of 80, 90, or 97, respectively. With beam spreads available in 17-, 25-, 40-, and 60-degree options, this fixture can rotate 365 degrees and has a 62-degree cutoff. • luciferlighting.com

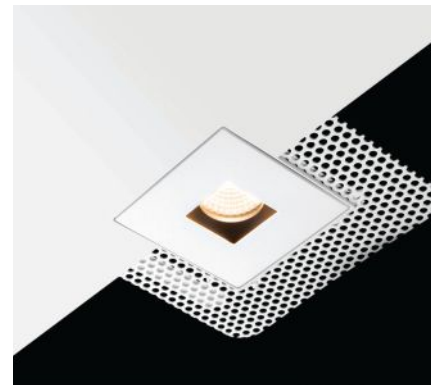

Alba 1 Q, Zaniboni Lighting • Designed with an edgeless trim, this luminaire has a low profile and blends well with ceilings. Featuring a 1" aperture, the fixture is fitted with a 3.5W or 7W LED offered at 2700K, 3000K, 3500K, or 4000K with a CRI of 80 or 95 and with beam spread options of 24 and 36 degrees. It is available in matte white, matte white with black interior, matte black, and custom finishes. • zanibonilighting.com

How is the Internet of Things affecting the lighting industry?

“Data collected from a smart lighting system can help a facilities team understand how a building is used, what spaces are occupied and when and where a building is using most of its electricity. With the right control system, building managers can then connect to the system from anywhere in the building—or the world—to optimize building performance, respond to occupant requests, enhance comfort, and improve building value.”

—Eric Lind, Vice President, Global Specifications, Lutron Electronics



Bullseye, LF Illumination • This double-gimbal lamp holder allows for 45-degree locking tilt adjustment. Offered in 4", 5", and 6.75", this luminaire can be specified in round or square aluminum inserts, with or without a trim. LED options include Bridgelux and Cree LED modules which range in wattage, color temperature, CRI, and beam spread. • fillumination.com



Canā, Kreon •

This recessed mounted channel adds an architectural element to ceilings with round or square modules, available in black and white, floating in deepened aluminum channels—available in 40", 80", and 120" options for the Eco-downlight LED family. • kreon.com

Volta 4.5", WAC Lighting • This fixture can be selected in square or round with trimmed or trimless apertures. Available in 15W, 23W, and 34W at 2700K, 3000K, 3500K, or 4000K with a CRI of 85 or 90 depending on color temperature, it is dimmable zero-to-10V. Reflector and trim finishes include black, black and white, copper bronze, haze, haze and white, and white. • wacighting.com



Mood, Reggiani • This highly customizable adjustable luminaire (also in fixed and wallwash options) is available in small, medium, large, and extra-large sizes, in nine finishes, with six plate shapes, four trim shapes, and narrow, medium, wide, and very wide beam spreads. Available in 3.5W, 8.5W, 12W, 17W, 24W, and 33W options offered at 2700K, 3000K, 3500K, or 4000K with a minimum CRI of 80 or 90 based on color temperature selection. • reggiani.net



Halo ML4, Eaton •

This 5" recessed luminaire features an interchangeable 2" round or square aperture for pinhole downlighting, and is also available for direct attachment to concrete pour ceilings. Fitted with a 4" LED module, this fixture is available at 2700K, 3000K, 3500K, and 4000K all at a CRI of 90 delivering 900 lumens with a 25-, 40-, and 55-degree light distribution. Finish options include matte white, matte black, and brushed nickel. • cooperindustries.com



Calculite LED Generation 3, Philips Lighting •

Providing visual comfort and uniform illumination, this round 4" luminaire is ideal for commercial and retail spaces. Available with three beam spreads—43, 56, and 76 degrees—this fixture is offered at 2700K, 3000K, 3500K, or 4000K with a CRI of 80 or 90 and dimmable down to 1 percent. Finish options include white matte, block matte, champagne bronze, and comfort clear. • usa.philips.com



4" Gravity Downlight, Intense Lighting • This luminaire features a patent-pending selectable collar that adjusts to ceiling thicknesses from 0.5" to 2.25". Offered in 12W, 25W, 35W, 46W, and 63W at 2700K, 3000K, 3500K, or 4000K with a CRI of 82 (or a CRI of 92 at 2700K and 3000K). Beam spread can be specified at 14, 20, 30, 40, or 50 degrees. • intenselighting.com

DOWNLIGHTS



Cylinder Mini Series, Meteor Lighting •

Designed for 15- to 40-foot ceilings, this aluminum cylinder luminaire can be selected with 8" or 10" aperture at 9.25" or 10.8" tall. Offered with 45W, 85W, or 110W LEDs (based on size) at 2700K, 3000K, 3500K, 4000K, or 5000K with a CRI of 85, this luminaire requires an input of 120V/277V. Beam spreads vary based on wattage, and range from 10 to 100 degrees. • meteor-lighting.com



Reflections, Element by Tech Lighting •

This decorative recessed dome features a scalloped petal design for indirect LED illumination in 5"-, 8"-, and 12"-diameter aperture options and is fitted with 9.2W, 15.9W, and 31.8W LEDs respectively. Offered at 2700K, 3000K, and 3500K or warm color dimming from 3000K to 1800K with a minimum CRI of 90, this luminaire is dimmable zero-to-10V. • element-lighting.com

How has the specification process changed with the introduction of LEDs?

“We are typically specifying a specific lumen output or package for each fixture type in our schedules. Previously, with traditional lamp sources, you would base a portion of the specification around lamp wattage. For the most part you knew what you were getting; with LEDs there can be significant differences from manufacturer to the next at the same rated wattage.”

—Jamie Perry, Associate, Lam Partners



NU Downlight Series, Alphabet Lighting •

This family of luminaires can be specified in 2", 3", 4", and 6" aperture options with square or round trims for both new construction and retrofit. They have downlight, wallwash, and adjustable capabilities. • alphabetlighting.com



RSA MRZ, Eaton •

This family of recessed fixtures is offered with 6W, 10W, 14W, and 17W at 2700K, 3000K, 3500K, and 4000K at a CRI of 83 or 97 with dimmability to zero. Beam spreads are available in 15-, 25-, 40-, and 55-degree options as well as asymmetric wash. It uses 120V/277V inputs, is available in multiple finishes, and each head can rotate 45 degrees out of the fixture and 365 degrees around. • cooperindustries.com



NoUVIR fiber optic pendant beams easily adjust 15° to 50°
Jones Archaeological Museum, Moundville, AL © 2009 NoUVIR

**No UV
No IR
No Heat
No Fading
No Damage**

CASES to SPACES,

**If it's rare,
If it's valuable,
If it's important,**

It deserves

NoUVIR LIGHTING!



Fiber optic spots light both case contents and gallery from "headless" track suspended below ceiling.

Bata Museum, Toronto, Canada © 2011 NoUVIR

Pure-white, Stone-cold, fiber optic lighting with No UV and no IR!

Call **NoUVIR® LIGHTING** 302-628-9933

EXIT/EMERGENCY



Sure-Lites SEL Emergency Light, Eaton

• The SEL Emergency Light series comprises damp-location-listed, slim-profile fixtures fitted with two adjustable LEDs. The 4W SEL25 can be mounted every 25', the 7W SEL50 every 50', and the 4W SEL60 every 60'. Features include keyhole mounting slots, a 120V/277V dual-voltage driver, a 4.8V battery backup, and optional self-diagnostics. Finishes are offered in white and black. • cooperindustries.com



Sure-Lites LPXW Exit Series, Eaton • This series of UL 924-compliant fixtures is suitable for outdoor applications and can withstand extreme temperatures. The series is offered in a 2.7W AC-only LPXW6 model and a self-powered LPXW7 model, which uses 3.3W or 3.4W depending on voltage input. The 12.4"-wide by 9.17"-long fixture features a 120V/277V driver and is available in colors of silver, white, and black, as well as lettering in red or green. Top- or end-mount options available. • cooperindustries.com

SCL Series, Barron Lighting Group

This series of emergency lights feature a toolless hinged door for easy accessibility to its 6V nickel-cadmium battery. Fitted with two adjustable 3.6W LED lamp heads, one fixture can be mounted every 60'. The 5.33" by 9.17" unit has a 120V/277V dual-voltage input, a backup battery offering 90 minutes of power, an optional self-diagnostics feature, and a numeric indicator. The fixture is also available with a 58-degree wide-beam lens optic. • barronltg.com



➔ REVIEW Our Products & Contact Us Today!

CELESTE | ➔ <http://tsq.li/celeste-pendant>



81.5W House Light

CR75 | ➔ <http://tsq.li/cr75-fixture>



65W, 7000 Lumen LED
Replaces 500W PARS



5 Holt Drive,
Stony Point, NY 10980
(845) 947-3034
www.tsilight.com

Illuminate Your Space!

Times Square Lighting has the capability to turn your bright ideas into lighting reality.

In our 75 years, we have dedicated ourselves to the lighting community with superior products and innovations.



UP DOWN LIGHT

12W / 30W / 50W
120 lumens per watt
30 / 60 beam angle
RGBW optional
UL/cUL & DLC certified



PARKING LOT LIGHT microwave sensor option



120W
130 lumens per watt
Compatible for photocell
or microwave sensor
UL/cUL & DLC certified



CANOPY LIGHT FOR GAS STATION

120W
130 lumens per watt
Low profile
Compatible for microwave sensor
Easy installation
Change the mounting for parking garage
UL/cUL & DLC certified

inogeno
OUTDOOR LIGHTING BY **THAILIGHT**

A leading manufacturer of industrial lighting

THAILIGHT SEMICONDUCTOR LIGHTING CO., LTD
DongGuan | China T: +86 769 87061601 · F: +86 769 83713167
W: www.thailight-led.com · E: info@thailight-led.com



VividGro LED T8 Grow Lamp, Lighting Science • Designed specifically for vertical farming and grow chambers, this T8-style LED lamp is part of Lighting Science's VividGro line. The lamp provides high-output, low-heat radiation, and the manufacturer's patented grow spectrum optimizes photosynthetic absorption at each stage of plant growth. The 4' lamp comes in a clear glass housing, consumes 15W, and has a 250-degree optical distribution. The lamp can operate in temperatures ranging from minus 4 F to 104 F. • vividgro.com



HDE Double-Ended Horticultural Reflector, Barron Lighting Group • Designed for indoor and greenhouse applications, this double-ended horticultural reflector features a patented concealed vacuum airflow technology to maximize performance and thermal dissipation. It has four-way, field-selectable 8" removable flanges, as well as solid plates and louvered plates for fully sealed air-cooled or non-air-cooled operation, respectively. The fixture measures 17.5" by 10.5" by 9.75" and is UL listed for damp locations. • growlite.com



Luxeon SunPlus Series, Lumileds • The SunPlus 20 line of LEDs provides greenhouse farmers supplemental high-bay lighting for 24-hour or year-round growing cycles. Specific wavelengths can be used for photosynthesis, such as blue (420nm–480nm) and red (620nm–670nm), or multichannel solutions that optimize light output for specific plant life-stages such as seedlings, germination, and flowering. The 2mm by 2mm high-power LEDs come in royal blue, deep red, far red, lime, and cool white. • lumileds.com/horticulture

What makes a great luminaire?

“Ultimately you have to understand the application—what the product needs to do—without adding many extras. This allows you to provide the most important deliverables in the required time frame.”

—Ken Czech, Vice President—Product Development, Focal Point



HSE Single-Ended Economy Horticulture Reflector, Barron Lighting Group • This grow light features the ease of a single-ended, mogul-based HID lamp in a small footprint. It measures 17.5" by 11.5" by 4.5" and has a standard removable universal ballast bracket with a self-leveling feature for quick mounting. The housing is constructed of heavy-duty 22-gauge steel. The convex hybrid reflector technology provides 95 percent reflectance for even and intense illumination. A 12" 16AWG ballast connector and a 15' lamp extension are standard. • growlite.com

Newly Enlightened.

The Feelux FLX Pro Series Collection —
NDPro, HDPro and MonoRailPro

Love your light even more. Spot free illumination with a quick connection system. 90+ CRI and consistent Kelvin temperatures for optimal performance. Specify the FLX Pro Series Collection now for your upcoming projects.

Illuminate your thinking at feeluxlighting.com.



FEELUX

3000 Northwoods Pkwy, Suite 165
Peachtree Corners, GA 30071
678.668.7005 | feeluxlighting.com

Change your light. Change your life.



Craft, Zumtobel •

The Craft family of high bays come in two versions: Craft M (shown) and Craft L. Both are available with either a narrow beam distribution designed specifically for warehouse shelving or a wide beam option for manufacturing/production areas. The fixtures operate between minus 104 F to 131 F. Powdercoated internal cooling ribs provide thermal management and aid in minimal dust accumulation. • zumtobel.us



High Bay LED Retrofit Kit, Fulham • This retrofit kit is comprised of the company's WorkHorse LED programmable driver, ThoroLED module with instant on/off, lens, mounting collar, heat sink, and driver housing. It is field-installable and designed to replace 100W, 175W, 250W, and 400W HID lamps. Its 5000K at a CRI of 80 is standard, as is its zero-to-10V dimming. Operates in a temperature range from minus 13 F to 113 F. • fulham.com



LED Acrylic High Bay Pendant, MaxLite •

A direct replacement for 200W to 600W metal halide fixtures. The fixture features LED optics and a 16" acrylic reflector. It measures 24" tall by 16.25" wide and provides between 11,000 to 22,000 lumens at 140 lumens per watt. Rated for damp locations, it can operate from minus 4 F to 122 F and is dimmable using zero-to-10V controls. An optional battery backup and motion sensors are available. • maxlite.com

Swea, Nordeon USA • This IP65-rated high bay luminaire is designed for applications that require a mounting height of 20' or more. Available in 3000K, 3500K, 4000K, and 5000K at a CRI of 80-plus, with narrow-, medium-, or wide-beam distributions, it provides 120 lumens per watt in either an 8,000- or 10,000-lumen package. The fixture operates between minus 31 F and 113 F. Zero-to-10V dimming is optional. • nordeon-usa.com

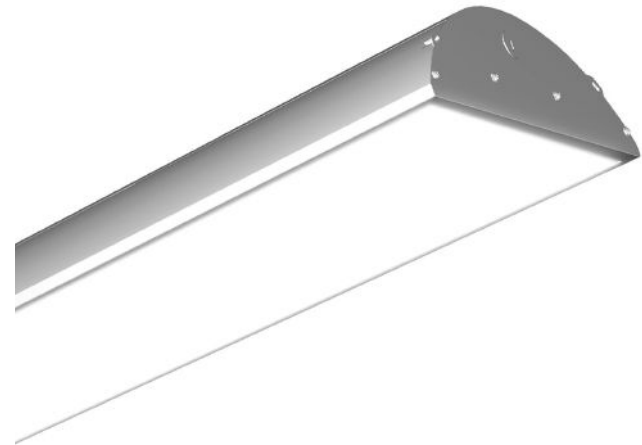

LED High Bay, TCP • This LED high bay is suited for myriad applications such as warehouses, commercial facilities, aisles (open and stock), retailers, schools, and gymnasiums, all of which require mounting heights up to 60'. UL approved for damp locations, the fixture is available in 62W, 92W, 123W, and 185W in 4100K and 5000K at a CRI of 70-plus. Zero-to-10V dimming is standard. Optional control items include emergency backup, occupancy sensors, and daylight harvesting. • tcp.com

Metalux VHB LED High Bay, Eaton •

Designed to replace HID and fluorescent high bays, this 15" by 18" LED fixture features high-impact polycarbonate optics in both narrow and wide distributions. Available in 3500K, 4000K, and 5000K with a CRI of 80-plus in three lumen packages: 9,000, 12,000, and 18,000. Zero-to-10V dimming driver is standard; occupancy and daylight sensors are optional. • cooperindustries.com



GO BOLD OR GO HOME



+1.713.946.4343
www.pal-lighting.com

System solutions by PAL: The new Microquad LED series.
www.pal-lighting.com/systemsolutions3

LAMPS & BALLASTS



LED T8 Tubes, Generation 3, TCP •

These LED replacement lamps for linear fixtures are available in 2' and 4' lengths with a G13 base in 9W (17W equivalent) and 12W (32W equivalent) at 3000K, 3500K, 4100K, and 5000K with a CRI of 80. Rated for enclosed fixtures, so no rewiring is necessary. The LED T8 Tubes are programmable, Instant Start and Rapid Start ballast compatible, as well as fluorescent ballast compatible. • tcp.com

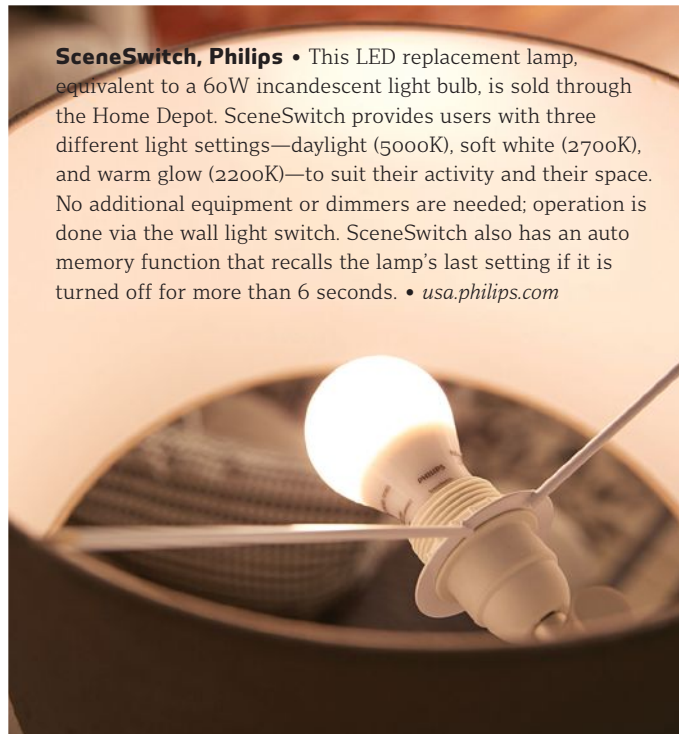

SceneSwitch, Philips • This LED replacement lamp, equivalent to a 60W incandescent light bulb, is sold through the Home Depot. SceneSwitch provides users with three different light settings—daylight (5000K), soft white (2700K), and warm glow (2200K)—to suit their activity and their space. No additional equipment or dimmers are needed; operation is done via the wall light switch. SceneSwitch also has an auto memory function that recalls the lamp's last setting if it is turned off for more than 6 seconds. • usa.philips.com

MR16 8.5W High CRI LED Lamp,

Green Creative • This MR16 LED lamp is designed to replace 75W halogen lamps. It provides 550 lumens with a center beam candlepower of 2700 candela. It is intended for commercial applications. The lamp is available in 2700K, 3000K, and 4000K with a CRI of 92. It has an R9 value of 65 and a R13 value of 93. It can be used in enclosed fixtures and has three beam spread options: 15, 25, and 35 degrees. • gc-lighting.com



A.L
ARCHITECTURAL LIGHTING



Content Licensing for Every Marketing Strategy

Marketing solutions fit for:

Outdoor | Direct Mail | Print Advertising | Tradeshow/POP Displays
Social Media | Radio & TV

Leverage branded content from Architectural Lighting to create a more powerful and sophisticated statement about your product, service, or company in your next marketing campaign. Contact Wright's Media to find out more about how we can customize your acknowledgements and recognitions to enhance your marketing strategies.

Call Wright's Media at 877.652.5295,
visit our website at wrightsmedia.com/sites/hanleywood
or email us at hanleywood@wrightmedia.com



lively

Featuring Limit OLED Pendant

- OLED sources
- 80 CRI
- Dimmable 0-10V



visalighting.com/limit

 VISA LIGHTING

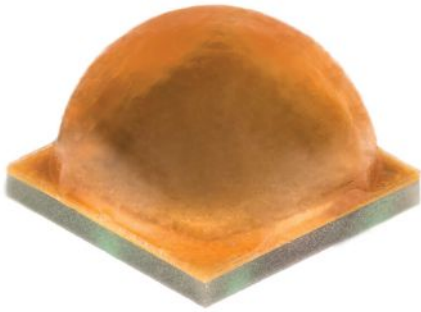

XLamp XHP50.2 LED, Cree • The latest generation of extreme-high-power LEDs, the XHP50.2 delivers up to 7 percent more lumens and 10 percent higher lumens per watt than its first generation cousin the XHP50, while package size remains the same: 5mm by 5mm. This means upgrades can be made by easily replacing the LED arrays. The diode features Cree’s EasyWhite technology and is available in a color temperature range from 2700K to 6500K with CRIs of 70, 80, and 90, depending on color temperature selection. • cree.com



Flex STP 73, Optic Arts • The Flex STP 73 is a high-performance LED fixture that features a very tight LED pitch and can blend in shallow channels for direct view applications. Field-cuttable, it is designed for use in coves, undercabinets, and shelves. Available in 1800K with a CRI of 90-plus, and 2750K, 2900K, and 3550K with a CRI of 95-plus, it uses 7.3W per linear foot and runs on 24V DC. Dimming options include magnetic low-voltage, zero-to-10V, DMX, and Lutron (two-wire, three-wire, and Ecosystem). IP20-rated for dry locations. • opticarts.com

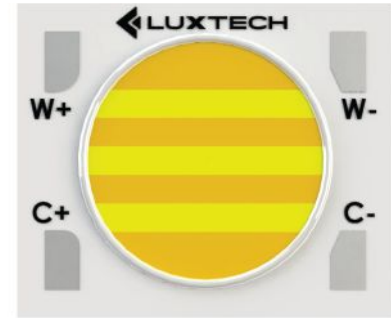

COB Downlights Modules, Luxtech • These chip-on-board LED downlight modules are offered in two color profiles: Dynamic White and Warm Dim. The Dynamic White allows for brightness and correlated color temperature to be adjusted independently of one another. The 15mm module (shown) is compatible with tunable drivers, DMX, and zero-to-10V dimming. It has a 15mm light-emitting surface, a maximum output of 3,700 lumens, a color range of 2700K to 6500K, and a CRI of 90-plus. • luxtechled.com

How has the specification process changed with the introduction of LEDs?

“Lack of standards makes it difficult. Even within the same manufacturer, it can be difficult to select products. You find yourself choosing something and getting locked into a particular driver or LED technology based on systems; you lose the freedom to design. While it may seem like there are more options, it’s actually a narrower palette than before.”

—Sean O’Connor, Principal, Sean O’Connor Lighting



Wattstopper Blanco 3 Logic Module, Legrand • The Blanco3 module mixes three colors of LEDs to offer a tunable white range of 2700K to 6500K with a CRI of 90-plus. Field mixing is possible within 2” of the array. On-board thermal feedback maintains color consistency within a two-step MacAdam ellipse. A patented process captures and stores color characteristics so that delivered light can be dimmed from 100 percent down to 1 percent while color profile is maintained. • legrand.us/wattstopper

LIGHTFAIR

INTERNATIONAL

The future. Illuminated.

2017

Date: May 9 - 11

Hall F, Booth No.: #5201

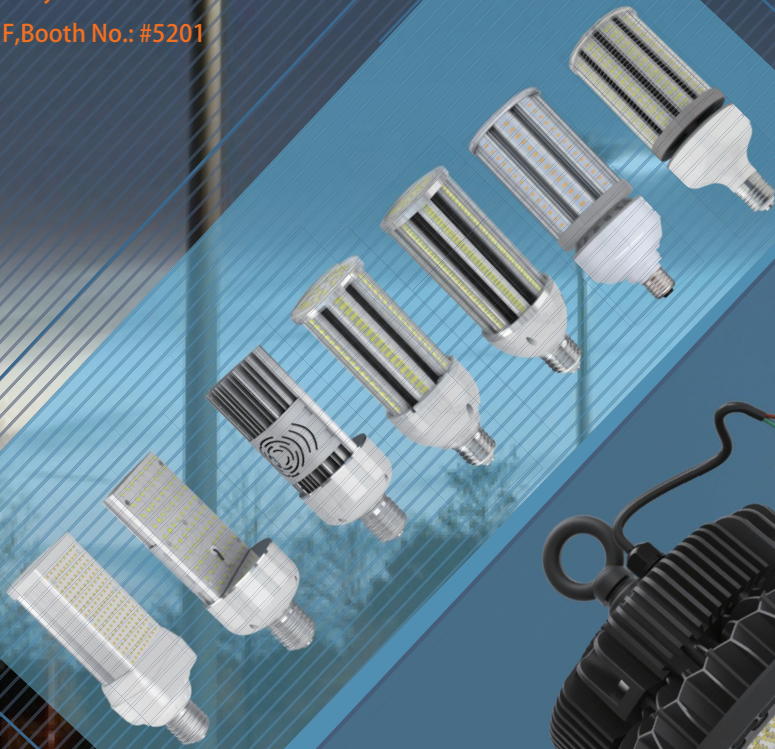

LED corn lamps

Focus on LED corn lamps for 6 years

12W 16W 20W 27W 36W 45W 54W 80W 100W 120W 140W → 180° corn lamp
 30W 40W 50W 60W 80W 100W 120W → 180° corn lamp
 HID Replacement with E26 /E27 /E39 /E40 base

120lm/W
 135lm/W
 150lm/W
 IP 64
 DLC
 CE
 RoHS
 cUL US
 Warranty 5 years

CIBAY II High Bay

1. MEANWELL, INVENTRONICS driver are optional, 1-10V dimmable or 0-10V dimmable is available
2. Seoul and Epistar LEDs are optional, efficiency is up to 130lm/W
3. supply 120°, 90°, 45° beam angle, also we supply reflector for your choice
4. Motion sensor is optional
5. U bracket, Hook, Half inch pipe mounting are available

100W 150W 200W 240W
 CRI>80
 IP 65
 IK08

130lm/W
 DLC
 CE
 RoHS
 cUL US
 SAA pending
 Warranty 5 years



www.signcomplex.com
 marketing@signcomplex.com
 phone: +86 755 2760 8650
 fax: +86 755 2760 8651



Switchex, Nora Lighting • Dimmer switch and power supply are combined into a single unit that installs in a standard single-gang electrical switch box. It accepts 120V AC power and converts it to low-voltage 12V (60W max.) or 24V (100W max.) DC. Dimming is smooth from 100 percent down to 5 percent. cUL listed. Face plates come separately and are offered in glossy white, glossy light almond, and glossy dark brown. • noralighting.com



Dual Profile array, Tuning Module, Lumenetix • This tunable color module comes in two profiles: Dynamic Dimming (warm dim halogen) with a range of 1800K to 3050K or Tunable Color from 1650K to 8000K. The five-color array delivers up to 1,500 lumens at a CRI of 90-plus and includes Bluetooth, zero-to-10V, and DMX controls. For color gamut control, gradients of saturated colors from 1 percent to 100 percent can be added to color points. • lumenetix.com



Dynamic White Linear Module, Luxtech • This dynamic white linear LED module allows for independent brightness and color temperature control within a three-step MacAdam ellipse. It measures 0.787" wide and available in three lengths: 5.5", 11", and 22". It has a nominal output of 1,100 lumens per foot, and can incorporate two selectable CCTs from the following range: 2700K, 3000K, 3500K, 4000K, 5000K, and 6500K, all with a CRI of 90-plus. • luxtechled.com

Q-Cap-D1, Q-Tran LED • The Q-Cap-D1 is the first encapsulated linear LED fixture designed and manufactured in the United States. IP68-rated, the fixture is customizable and can be used indoors and outdoors, and is submersible in both chlorinated and saltwater conditions. White color options are available from 2500K to 5000K with a CRI of 95-plus, as are static color, RGB, and RGBW. Fixture lengths are available up to 16'. Lumen packages range from 200 to 430 lumens per foot. • q-tran.com

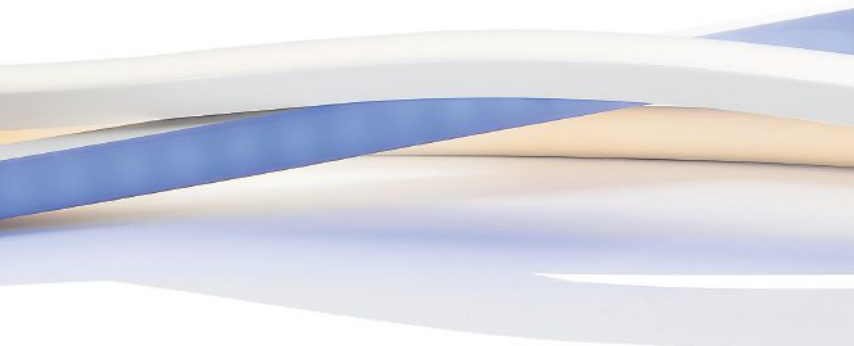

DirectAC LED Engines, Fulham • Designed for wall sconces and ceiling fixtures, these circular LED light engines eliminate the need for a driver. They are available in power levels from 10W to 34W; 2700K, 3000K, and 4000K with a CRI of 80 standard (3500K and 5000K at a CRI of 90, custom); and offer smooth TRIAC and ELV dimming down to 10 percent. It has a 120-degree optical-grade polycarbonate lens. The engine meets Title 24 requirements. • fulham.com



Everline ID Series Drivers, Universal Lighting • These 1,500-milliamp programmable drivers provide 55W constant current output and work with universal (120V/277V) input voltage. They can execute control commands for zero-to-10V standard dimming or through Universal's new digital protocol (smartphone app) with ID Series Compatible Smart BLTE sensors from Douglas Lighting Controls. • unult.com



THE ASHBERY GROUP



landscapeforms®

A modern interpretation of traditional lighting design.

State of the art LED technology and optics. Emotionally evocative. And a superb visual experience.

**Designed by
Robert A.M. Stern Architects**

Find us at landscapeforms.com or contact us toll free at 800.430.6205.

DESIGN. CULTURE. CRAFT.





PrimaLine Gen 2 LED Tape Light, Alloy LED • Designed to serve as a primary light source, the PrimaLine 6.6 and PrimaLine 8 Gen 2 tape lights use new, high-efficiency 2835 diodes that deliver 132 lumens per watt and 1,000 lumens per foot. Unlike other tape light that is a single row of diodes, the Gen 2 tape family has two or three rows of chips to maximize brightness in a single package. The light tape is offered in 8' sections with 8' leads, and uses an aluminum mounting channel for installation. • alloyled.com



DOSM LED, Amerlux • This optically sealed, IP66-rated, module for exterior luminaires allows outdoor fixtures to be retrofitted with LED sources. The module uses a convection-cooled constant current driver with automatic voltage sensing for 120V/277V input. It provides uniform light distribution and allows for greater fixture center spacing. Available in cool, neutral, or warm color temperatures, it is Dark Sky compliant and meets IES standards for full cutoff for Type 2, 3, or 5 light distribution patterns. • amerlux.com



Q-Cap-D3, Q-Tran LED • This encapsulated LED fixture uses an interior curved surface to reflect light by mounting the LED on the side of the profile to conceal the diodes from view. The fixture has a polished white finish and a bending radius of 3". Offered in 2500K to 5000K with a CRI of 90-plus, as well as static colors including amber and color-changing RGB. Lengths can be customized up to 16'. It offers a delivered lumen package of more than 350 lumens per foot at 5W per foot, and is dimmable down to 0.01 percent. • q-tran.com

How has the specification process changed with the introduction of LEDs?

“LED product specification requires more detailing regarding color temperature, lumen output, controls, and dimming. Some of what is learned is from installation issues, which has been the case from the introduction of LEDs. We test new products and query the manufacturer based on our experience before committing to a specification.”

—Maureen Moran, Principal, MCLA

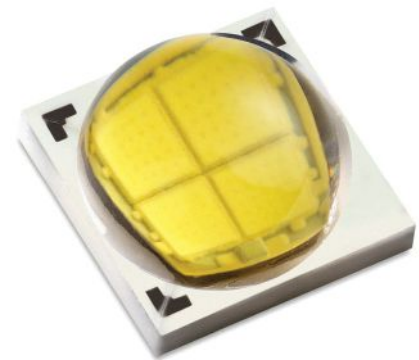

Luxeon MX, Lumileds • This LED package is designed for high-bay industrial and outdoor streetlighting applications. The diode features double the flux compared to previous diode generations that allows it to deliver 1,200 lumens at 150 lm/W at 85 C for a 12V device. The multi-die emitter is available in a color temperature range from 3000K to 6500K with a CRI of 70, 80, or 90 depending on the color selection. Optically compatible with the Luxeon M and can be upgraded. • lumileds.com

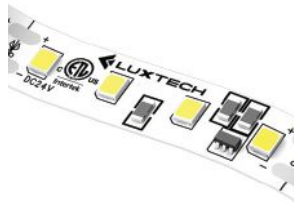

Flex, Luxtech • The Flex family of LEDs is a flexible module in light tape format designed specifically for the North American market. Flex CC can be cut in 1" increments up to 8' and delivers 2,000 lumens per foot. Flex Reach (shown) is available in 550 lumens per foot in runs up to 20', and 1,110 lumens per foot in runs up to 10'. It achieves 99 percent brightness consistency across the entire tape length, and can be cut into 1.5" increments depending on the application. • luxtech.com

Vintage Dim Module, Optic Arts •

This constant-voltage dimming module with one output has a voltage range of 10V to 26V DC, a maximum power output of 100W and a maximum current of 4 amps. It dims below 1 percent on most zero-to-10V dimmers. UL-listed, it can be used in dry and damp locations. It measures 2.2" by 1.46" by 0.57" and fits in the low-voltage wiring compartment of the driver. It operates in temperatures between minus 20 C to 50 C. • opticarts.com

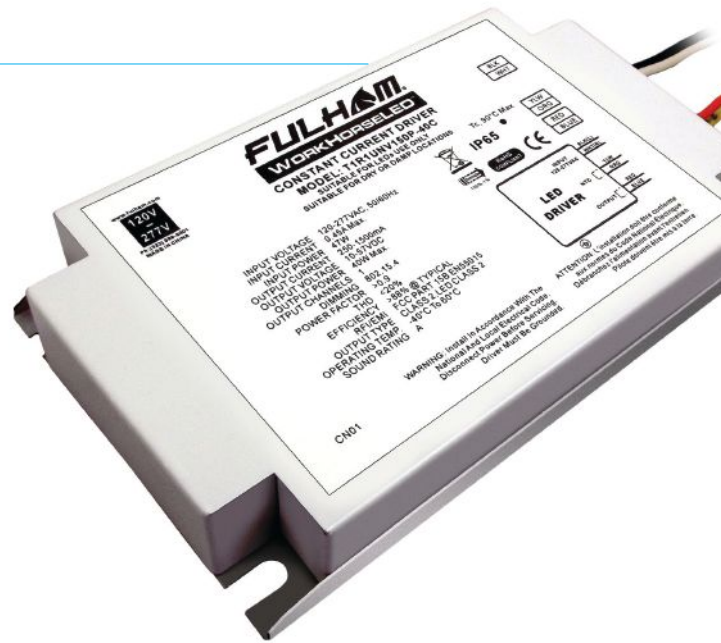

WorkHorse LED Extreme Programmable Drivers, Fulham • These constant-current drivers are designed for outdoor use and high-power output applications. The XP Series can handle 4W to 200W; the XE Series handles 96W and 185W. All use the company's SmartSet platform that allows for auto programming, or programming via a handheld controller or PC software. IP65-rated, zero-to-10V and wireless dimming options are available. • fulham.com



Artist and installation names projected inside an art gallery using the Rosco Image Spot.

ROSCO INTRODUCES
Image Spot™
Brilliant Imaging.



Image Spot from Rosco is a compact and powerful LED projector, featuring crystal clear optics that provide vivid gobo projection up to 12m or 40ft away. Image Spot is passively cooled, ensuring silent projection in both IP40 (indoor) and IP65 (outdoor) models. Brilliant Imaging for your next design.



Wattstopper Radiant Tru-Universal Dimmers, Legrand •

These dimmers work with most dimmable lamp, load, and fixtures using typical residential and light commercial wiring, with the one exception of zero-to-10V LED drivers. After lamp-type selection is made, the dimmer's self-calibrating function automatically sets the minimum voltage of the lamp to prevent flicker. • legrand.com



Vive, Lutron • A wireless lighting control solution for new and existing commercial buildings, Vive can be configured at all scales of complexity, from basic occupancy sensors to integrated lighting management system. Controls can be matched to the fixture package including switching, zero-to-10V, phase control, EcoSystem, or any combination. Dimming options down to 1 percent. The system can be expanded at any time. • lutron.com



Wattstopper DW-311, Legrand • The DW-311 dual technology zero-10V dimming wall switch occupancy sensor is designed for small to medium-sized applications such as restrooms and conference rooms with cubical partitions. The sensor combines passive infrared and ultrasonic technologies to detect movement in a space that has obstacles, such as wall partitions, which might impede direct line of sight movement to the sensor. • legrand.com

Universal Dimming Module, Acclaim Lighting • The Universal Dimming Module is a multi-protocol driver designed to convert popular control protocols for ease of communication between devices and fixtures. The UDM inputs are DMX and zero-to-10V; its outputs are DMX, zero-to-10V, and IGBT digital line voltage dimming. The module can intake a voltage of 1,000W at 120V AC or 2,000W at 240V AC, while outputting 100V/277V AC. • acclaimlighting.com



Bluetooth Lighting Control System, Douglas Lighting Controls • This stand-alone, wireless lighting control system is for commercial applications. The system devices include: fixture-mounted controller and sensor; fixture controller; sensor switches (shown); and Dialog Gateway. A smartphone app enables commissioning and control capabilities. Each device serves as its own wireless node. • douglaslightingcontrols.com

N4 Hub, Ketra • The N4 Hub serves as a bridge between Ketra's product offerings and its digital interfaces, such as Design Studio, Ketra app, and API commands. Multiple hubs can be used to create networks, or KNetS, which can incorporate up to 50 devices. Mounting options include tabletop, wall-mount, or conduit-mount. Using an internet connection, the N4 Hub can connect to Ketra's cloud servers to provide backup and remote maintenance functions. • ketra.com



ALINEA[®]

BEAUTIFUL LIGHT



Linear Wall Sconce
Now available with LED!

AAMSCO LIGHTING, INC.

100 Lamp Light Circle • Summerville, SC 29483
Toll Free: 1-800-221-9092 • Fax: 843-278-0001
www.aamsco.com

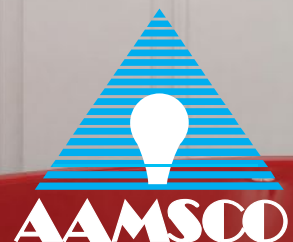

The Alinea® LED S14S Linear tube was invented and designed by AAMSCO Lighting Inc. [Delaware] and is patented in both the European Union and in the United States of America. ALINEA® is a registered trademark of AAMSCO Lighting Inc. [Delaware], and the Alinea® LED tube is covered under U.S. Patent # D 672,083 S and E.U. Patent # 001973132-0001. We attach singular importance to our aforesaid intellectual property rights and action will be taken against any party who violates these rights.

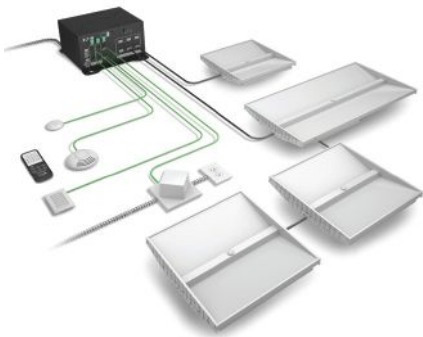

Distributed Low-Voltage Power System, Eaton • This Distributed Low-Voltage Power System simplifies LED lighting and controls installations. The system leverages line voltage AC for power distribution and low-voltage DC for safe, quick connectivity, and to reduce specialized labor and material requirements of Class 1 installations. Power and control connections are via pre-terminated cables. Available with integrated sensors and plug-load controls. • eaton.com



Energy Manager, Enlighted • The Energy Manager (EM) monitors, manages, and analyzes energy savings and other data collected by the Enlighted Smart Sensor network—up to 1,500 individual sensors—using a secure online interface. Features include: lighting control management (adjusts software profiles and retains lighting data for up to 36 months), power metering, building system performance, and data security. The EM can be installed on a corporate or gateway network, or as a stand-alone system. • enlightedinc.com



WaveLinx Wireless Connected Lighting System, Eaton • This low-cost lighting control system does not require new wiring. It works with building networks and provides data for energy and space analytics. California Title 24 compliant, the WaveLinx system is designed with upgrades in mind. The mobile app allows secure on-site configuration and personalized user adjustments. It features automatic code commissioning without IT network setup. • eaton.com

How is the Internet of Things affecting the lighting industry?

“The Internet of Things is helping to not only connect humans to their devices, but also connect devices to each other, regardless of brand or borders, to bring a whole new level of possibilities in linking different—and previously siloed—objects to one another.”

—Tobin Richardson, President and CEO, Zigbee Alliance



LumaWatt Pro Connected System, Eaton • The LumaWatt Pro Connected System uses Enlighted’s sensors to create a comprehensive connected lighting system with IoT capabilities. Advanced integrated sensors in the luminaire capture data from the surrounding space. Secured software oversees lighting control functions including occupancy sensing, daylight dimming, task tuning, and scheduling. • eaton.com

Let *elegance*
light your way

rNook-16 recessed wall light



Introducing the rNook-16 recessed wall light from Holm. With a sleek design, minimal profile, and innovative functionality, the rNook offers variable intensities and is field-adjustable for optimal throws in any setting. To learn more, [visit holmlighting.com](http://holmlighting.com).

Visit us at Lightfair Booth 3819

holm



Wattstopper LMTS-101-CCT, Legrand

• The LMTS-101-CCT allows building occupants to adjust correlated color temperature. The interface works with fixtures that use Legrand's tunable white Blanco and Araya logic modules. Time-based CCT control occurs via astronomical clock entry for specific locations, which determines sunrise and sunset. Custom CCT event scheduling is also an option. • legrand.com



Smart Sensor, Enlighted

• The Smart Sensor is designed for indoor lighting applications. The sensor measures occupancy and motion, ambient light, temperature, and fixture energy consumption. It has a programmable microprocessor and operates using wireless communications. Sensor behaviors and schedules are stored in the sensor and backed up with the company's Energy Manager. The device is 3.46" by 3.46" by 1.18". • enlightedinc.com



EcoSpec Linear Dimming Control Module, Ecosense

• This module is only for use with Ecosense products. It is rated to directly mount to a junction box in a plenum space and for easy access. It uses a zero-to-10V dimming signal. A fixed line voltage input converts the signal to an electronic low-voltage dimmed output for up to 1,000W with a 277V load and 450W on a 120V load. • ecosenselighting.com



VerifEye BMO 3.0, Leviton • The VerifEye BMO 3.0 software and mobile app measures, monitors, and manages energy usage. It also offers tenant billing capabilities, and expansion modules for more specific data tracking such as energy code compliance. • leviton.com

Lumina RF Dimmers, Leviton • Leviton has expanded its wireless dimming products to include a 600W and a 1,000W in-wall dimmer (shown) and a 300W plug-in dimmer. The in-wall devices are three-way enabled and use a matching remote to create three-way applications, including hallways and rooms with multiple entrances. The Lumina RF 300W Plug-In Module provides manual on/off control directly from the plug-in device. • leviton.com



CubeConnect, Rosco • The CubeConnect system provides wireless control of the company's Miro or Braq Cubes from distances up to 2,000' using a 2.4-GHz radio receiver. The CubeConnect transceiver can accept lighting control commands from DMX512, Bluetooth Limited Energy, or Serial DB9 connections, and then returns the data via either the wireless antenna or DMX output. • rosco.com



Power Over Ethernet Lighting System, Zaniboni Lighting • The company's power over Ethernet system is designed for its suite of downlights and low-voltage installations. The POE system uses a 120V 50- to 60-Hz power injector to provide 24V DC to the fixture. Up to eight fixtures can be powered via a single power injector. • zanibonilighting.com

Wattstopper Architectural Dimming LCAP Panel, Legrand •

The LCAP series of lighting control panels provides modular preconfigured architectural dimming and integration options for a wide range of commercial applications. UL listed, the series offers the highest amperage dimming and switching options. Dimming curve for each dimming channel can be customized to provide smooth dimming and consistent lighting when mixing brands. • legrand.com



How has the specification process changed with the introduction of LEDs?

“We are at the point where most luminaires are simply expected to be LED. However, designers now need to be more mindful of other criteria during specification including efficacy, lumens versus delivered lumens, color, remote driver locations, and controls. Perhaps the most complex specification issue is controls. LEDs present an added complexity to communicate and document dynamic/animated effects.”

—Jean Sundin, Principal, Office for Visual Interaction

ONE SWITCH AWAY FROM ANYTHING.



We're more than ballasts. We're Panasonic.

Universal Lighting Technologies, Inc. is Panasonic's Commercial Lighting division for North America. With over 70 years in business, we offer a comprehensive product line and full lighting control strategy for almost every application imaginable.

For more information, visit www.unvlt.com or call **1.800.225.5278**.

OUTDOOR



Arini, Hess America •

Arini is offered in three pole styles: straight, inclined, or curved. The light engine uses 56W in 3000K and 4000K with a CRI of 80. It provides 4,144 to 5,678 delivered lumens depending on distribution and color temperature. A cast knuckle provides positive or negative 60-degree horizontal and negative 90-through positive 40-degree vertical adjustability. Optics include three rotationally symmetric distributions and two elliptical beam patterns.

• hessamerica.com

eW Blast Powercore gen4, Philips Color Kinetics • This high-performance, forward-throw, asymmetric exterior wallwash LED luminaire with white light (3000K with a CRI of 81) is designed to provide uniform lighting across large surfaces. The housing is offered in black, gray, and white, and there is also the option to add a rock guard with either a full glare-shield or a half glare-shield. It provides 2,521 lumens, and has an efficacy of 52.7 lm/W using an input voltage of 100V/277V AC. • colorkinetics.com



Dart, Targetti • These floodlight projectors are offered in two sizes: Dart Small (3" by 4.13" by 2.8", shown), and Dart Medium (5.3" by 7.52" by 5.8"). Dart Small is available in 5W, 12W, and 16W at either 3000K or 4000K with a CRI of 84. The IP67-rated fixture runs on 24V DC and is pre-wired with a 10'-long cable. The fixture mount is adjustable up to positive or negative 45-degree horizontal rotation and positive 150- to negative 45-degree vertical rotation. Finish is ferrite gray. • targetti.us



Rincon, Forms+Surfaces • The Rincon family of luminaires (Pedestrian version shown) is now offered with directional shields in a perforated stainless steel with a satin finish. Shields are available in both standard (Huron, Willow, Vertical, and Horizontal) and custom designs. They can be specified for one, two, three, or all four sides of the luminaire. The fixture uses 30W 3000K warm-white and 4000K neutral-white LEDs from Cree. • forms-surfaces.com



Everglades Dual-Source Directional Light Fixture, Dauer Lampen •

This cast brass landscape fixture can be used as a pathlight, uplight, wallwasher, or a combination of those. It uses one 12V MR16 LED and one 12V MR8 LED in sealed fixture heads that can pivot to customize aiming angles between 15- to 100-degrees. It measures 17.25" tall and is 1.5" wide at the base and 3.875" wide at the top. Pre-wired with a 5" wire lead. • dauerlampen.com



Trov, Ecosense •

Trov is an LED platform that creates more than 20,000 luminaire configurations. The optical system has a vast range of cove, graze, and wallwash, as well as a line of light beam angle assortments and a new asymmetric beam option. The system uses a hybrid digital power supply for line voltage LED linear dimming down to zero. The Flip-to-Flat feature allows 180-degree rotation and reduces the fixture profile to just 24.7mm (0.97"). • ecosenselighting.com



Enhancing
the Human
Experience
Through Light

FLC200 LED SERIES

High Power Floodlights offer best-in-class efficiency, sublime glare control, and an extended variety of optical choices. Available in WHITE, RGBW and GOBO Projector.



FLC240 CC LED



FLC230 LED GOBO

we-ef

WE-EF LIGHTING USA LLC
Tel + 1 724 742 0030
info.usa@we-ef.com
www.we-ef.com



Nanolume Exterior, Boca Flasher • An IP65-rated outdoor version of the company's interior Nanolume. Made of anodized aluminum with a tempered glass lens, it is coated in a durable finish—black or white—and can withstand harsh conditions. It measures 0.834" by 0.994" and is available in 1', 2', and 4' lengths. It uses 3W or 6W per linear foot and works with standard line voltage dimming from 100 percent to zero. • bocaflasher.com



Mirada Round LED Area Light, LSI Industries • The latest addition to the Mirada family of luminaires, the fixture features high-performance, molded-silicone optics that provide light transmittance of 93 percent and do not yellow or crack with age. Available with high-brightness LEDs in 3000K, 4000K, and 5000K at a CRI of 70, it offers between 17,100 and 35,300 lumens depending on wattage and color temperature selection. Zero-to-10V dimming. • lsi-industries.com



Stilo Path, Targetti • Stilo Path comes in two heights: either 43.31" or 31.5" tall by 10.39" by 3.15". It is available in 14W and 24W at either 3000K or 4000K with a CRI of 84. A high-efficiency anodized aluminum reflector with convex facets and high reflectance provides a greater level of illuminance uniformity. Works with electronic phase and zero-to-10V dimming. The IP68-rated anodized extruded aluminum housing has a ferrite finish. • targetti.us

Ashbery, Landscape Forms • The Ashbery Lighting collection was designed by Robert A.M. Stern Architects and Fisher Marantz Stone. It includes a 12', 14', and 16'-tall pedestrian luminaire, a 3'-tall pathway light (shown), and a wall-mounted fixture. The family of products are made of cast aluminum and use 3000K, 3500K, and 4000K LED modules for the appropriate light distribution depending on fixture type and application. • landscapeforms.com

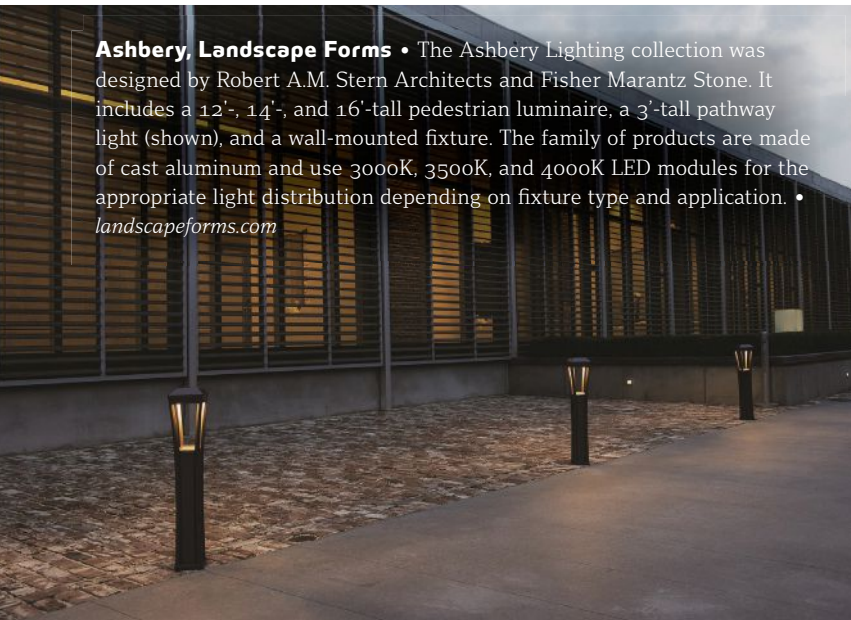

Pad Parking Garage and Canopy, Above All Lighting • Designed for parking garages and canopy applications such as gas stations and drop-off areas, this LED fixture can be surface or pendant mounted. It measures 18.98" by 16.38" by 1.58" and is available in 65W, 100W, and 120W at 3000K, 4000K, 4500K, and 5000K. Its patented air-cooling design includes weep holes so water does not pool on the back of the fixture. Housing finish is white. • aboveallighting.com



Lumenfacade, Lumenpulse Group • The Lumenfacade family now includes nine new optical distributions for a total of 15: Grazing (10 by 30 degrees, 10 by 60 degrees, 10 by 90 degrees, 15 by 20 degrees); Accent (8 by 8 degrees, 10 by 10 degrees, 30 by 30 degrees, 35 by 35 degrees); Floodlighting (30 by 60 degrees, 60 by 60 degrees, 50 by 80 degrees, 80 by 80 degrees, 90 by 90 degrees); as well as wallwashing and direct view. • lumenpulsegroup.com



Bolt, Meteor Lighting • This high-lumen-output luminaire is designed for arena and stadium lighting. Two modules can be joined together with a specially designed twin bracket (shown). This version offers 440W or 560W and uses an advance aiming system that allows each module to rotate and tilt 180 degrees horizontally and vertically for precise aiming. A flicker-free video feature supports HDTV live broadcasting and superslow-motion replays. Remote driver system allows driver to be installed at ground level. • meteor-lighting.com



Kona XS, Erco • A cousin to the company's Kona family, the Kona XS is designed specifically for lighting objects in tight urban areas such as museum sculpture gardens. The IP65-rated Kona XS features a high degree of glare control via Erco's Spherolit LED lenses. Available in 3000K warm white and 4000K neutral white, the fixture has projector—narrow spot, spot, and flood distributions—as well as floodlighting and wallwashing options. The housing is a high-quality cast aluminum with a double powdercoat finish. The fixture hinge tilts 130 degrees. • erco.com



Mozart Series, Sun Valley Lighting • The Mozart Series is now offered in two sizes—34.5" by 26" and 26.5" by 20"—and an expanded range of LED arrays. The constant-current LED driver operates using 120V/277V AC input. The fixture is available as a single pole, double pole, or wall mount. It meets full cutoff standards and, with the company's VLED driver, it complies with Type II, III, IV, and VSq distributions. Finish options include white, black, dark bronze, and green, as well as custom colors. • usaltg.com

How do you keep up with new product information?

“Weekly rep lunch 'n' learns. It can often be a balance between the billable deliverables and finding time for these product demos, but the frequent presence of manufacturers is a strength to our firm's product knowledge. We are constantly reviewing new LED products in a very hands-on manner; that testing and experimenting with a product can never be replaced by reviewing product cutsheets or websites.”

—Jamie Perry, Associate, Lam Partners



Chaperone LED Indirect Garage Luminaire, Amerlux • Designed to replace sodium downlights, the Chaperone LED is available in 48W and 73W at 4000K and 5000K with a lumen output up to 5,470. It has a die-cast aluminum housing and heat sink, a clear acrylic lens, and an integral driver. It meets Type III and Type V cutoff requirements. It measures approximately 6" by 15". Line voltage occupancy sensors and wireless network control system are options. Silver finish. • amerlux.com

OUTDOOR



OmniBlast, Schröder •

Designed for sports venues, this fixture provides high horizontal and vertical lighting levels for HDTV broadcasting using the company's three light distribution options: LensoFlex 3, BlastFlex, and Reflectors. Fixture heads can be configured in one, two, and three modules (shown) on the same bracket. Available with 3000K, 4000K, and 5700K white LEDs, the fixture delivers up to 137,600 lumens. • schreder.com

Zaphir, Griven USA • Designed for illuminating building façades, bridges, monuments, and the like, this compact (13" by 8.2" by 4.75") projector uses 40 high-power LEDs in RGBW, dynamic white, static white, or cool white. It has five symmetric beam distributions—7, 11, 20, 43, or 68 degrees—and two elliptical beam patterns—41 degrees horizontal by 9 degrees vertical, or 38 degrees horizontal by 21 degrees vertical. It includes an integral thermally isolated LED driver, and continuous dimming from 100 to 1 percent. • griven-usa.com



Landscape Mini Accent, WAC Lighting

• This IP66 wet location fixture is designed to replace halogen landscape luminaires. It is available in either a solid die-cast brass or corrosion-resistant aluminum housing in a bronze finish. It uses a 9V-to-15V system input and can be used as an uplight or a downlight. It is available in 2700K or 3000K and delivers up to 365 lumens with four continuous adjustable beam spreads: 10, 25, 40, and 50 degrees. • wacighting.com

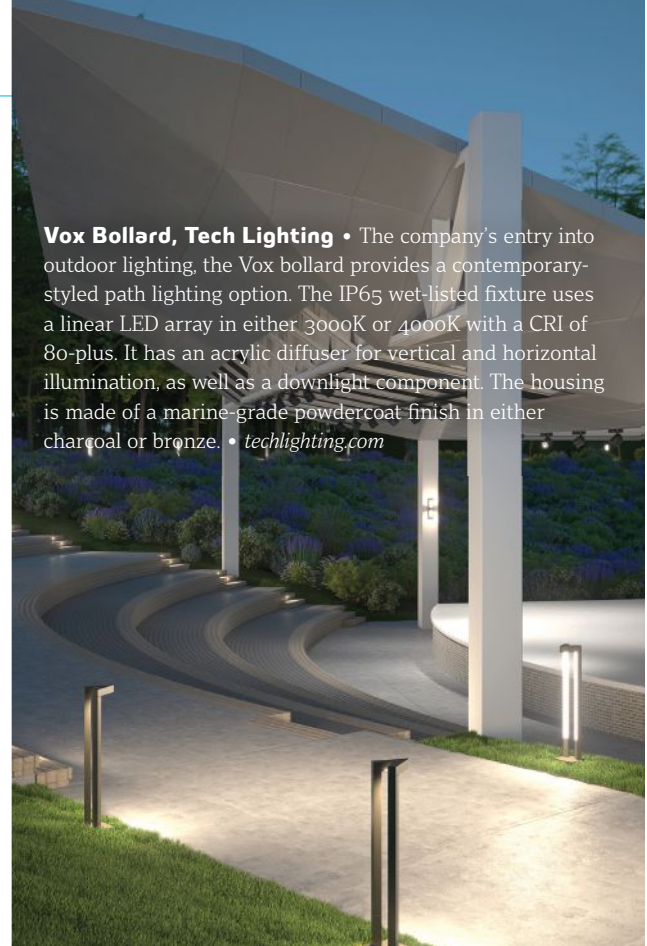

Vox Bollard, Tech Lighting • The company's entry into outdoor lighting, the Vox bollard provides a contemporary-styled path lighting option. The IP65 wet-listed fixture uses a linear LED array in either 3000K or 4000K with a CRI of 80-plus. It has an acrylic diffuser for vertical and horizontal illumination, as well as a downlight component. The housing is made of a marine-grade powdercoat finish in either charcoal or bronze. • techlighting.com

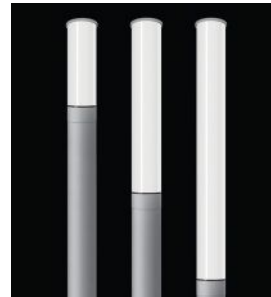

Lumistik, Luminis •

The Lumistik family is offered in bollards, columns, pendants, and wall luminaires. It has an extruded aluminum base and a high-impact acrylic diffuser and a clear lens with an integral optical system to provide 360-degree illumination. Lumistik is offered in 6" and 8" diameters in overall lengths from 72" to 312". It is available in 2700K, 3000K, 3500K, and 4000K at a CRI of 80. Lumen output range is 830 to 12,450 depending on model. • luminis.com



Rise, Ecosense •

A scalable exterior-rated product platform, Rise can be configured to offer spot, accent, landscape, signage, and floodlighting. Individual modules (2.5" by 2.5"), can illuminate a single object or be aimed separately. Rise features a center beam candlepower two times greater than anything market available, a tight 5-degree beam angle, and a locking system that allows for a 360-degree pan and 180-degree tilt using a single twist. • ecosenselighting.com

LUMENRAIL® LIGHTS YOUR WAY



SEE US AT LIGHTFAIR® IN
PHILADELPHIA - BOOTH #3810



LUMENPOD®



BANTAM™



LUMENLINEAR™



LUMENPOST™

Lumenrail illuminated handrail systems elevate the aesthetics of common area life safety designs. High performance linear or point-source LED luminaires can serve as primary or supplemental lighting.

They often eliminate the need for additional site lighting.

Visit us to see how we custom build each illuminated rail system to meet codes and unique design specifications.



888.243.6914
SYSTEMS@MAILWAGNER.COM
WAGNERARCHITECTURAL.COM

PHOTO: ©WAYNE CABLE 2017 | ©2017 R&B WAGNER, INC. | ALL RIGHTS RESERVED

 **WAGNER**
ARCHITECTURAL SYSTEMS



Aura, Structura •

This solid accoya wood LED ring is available in diameters from 2' to 6'. It is suspended using a catenary cable system or ceiling mounted. Hardware is stainless steel. The dimmable power supply is IP65 rated; the luminaire is IP67 rated and treated with a low VOC waterborne matte exterior finish with UV and mildew inhibitors. Available in 2700K, 3000K, 3500K, and 4000K. • structura.com



Shuffle, Schröder •

Designed for urban environments in today's connected world, this pole system features plug-and-play modules where lighting and controls, WLAN, motion sensors, CCTV, EV charging, and loudspeaker capabilities can be combined in a single unit. Up to five modules can be installed in a column. Lighting options include 180-degree and 360-degree distribution. All modules have quick connectors and are delivered pre-wired. • schreder.com



MPluse, MaxLite •

This surface-mount luminaire has a flexible design and can be installed as an open face or a full cutoff fixture. It is available in 25W, 50W, and 100W in 3000K, 4000K, and 5000K. The die-cast aluminum housing has a polycarbonate lens with a patent-pending visual comfort technology. Available in Type III and Type IV optics for asymmetric and symmetric distributions. Finish options are: silver chrome, polished bronze, black, white, and custom. • maxlite.com

How is the Internet of Things affecting the lighting industry?

“People are accustomed to doing something their way for the last 50 years. When they are asked to change to something new, like an IoT platform: One, they don't quite understand it; and two, they don't see why they should at this point. Even people who are more forward thinking may say, 'I have this completely electronic system that is mine—but I now have to share its controls and data with you?' The big challenge moving forward will be education and the integration of different departments.”

—Sohrab Modi, Chief Technology Officer and Senior Vice President of Engineering, Echelon



Everest Solar Lamp GS-109B-S, Gama Sonic • This solar streetlighting luminaire uses a GS solar lamp with 11 LEDs in a polycarbonate dome and a 5W, 190mm by 190mm solar panel. Charging provides three nights, or 18 to 20 hours of run time. The fixture provides 200 lumens and uses a 3,000-mAh Li-ion battery. The housing is cast aluminum with a black finish. Overall dimensions are 23" by 11" by 92". • gamasonic.com

Visit us at LFI 2017
BOOTH #1257



GREENCREATIVE

GOODBYE GLARE...HELLO COMFORT

SootheOptic TECHNOLOGY

PANEL ELEVATE SERIES



2X2' 30W – 3450lm



2X4' 38W – 4300lm

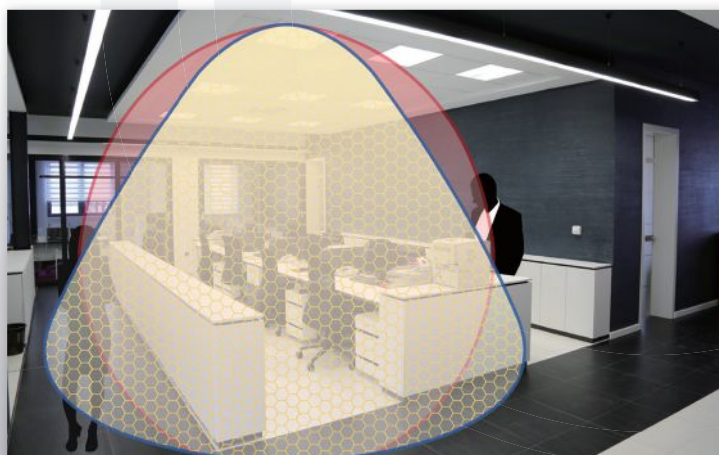

GREEN CREATIVE Panel
UGR <19

- Comfortable light at all viewing angles
- More useful light
- No perceptible discomfort

Standard LED Panel
UGR >23

- Harsh glare at viewing angles >65°
- More wasted light
- Perceptible discomfort

120-277V – 0-10V dimming – 75,000-hour lifetime
10-year warranty – UGR <19 – Edge-lighting technology

www.greencreative.com – info@greencreative.com – (866) 774-5433



Find out more



GoboLED 80 D, GrivenUSA • For theatrical lighting applications, this solid-state luminaire with an aluminum housing and tempered-glass lens projects graphic designs, patterns, textures, and logos for indoor and outdoor applications. Fitted with an 80W LED offered at 6500K, the luminaire measures 16.7" by 8.8" by 6.8" and allows for adjustment of the beam angle from 19 to 35 degrees. • griven-usa.com



Solar Electric NightLight, Solatube • This tubular prismatic system redirects daylight through an acrylic dome lens into a reflective tube and provides illumination—with a minimum CRI of 99—for spaces measuring up to 300 square feet. Available in two sizes, this model is also outfitted with a photovoltaic panel that collects solar energy to charge a battery-powered 2.4V 4000K LED (80 CRI) nightlight that automatically illuminates in the evening. • solatube.com

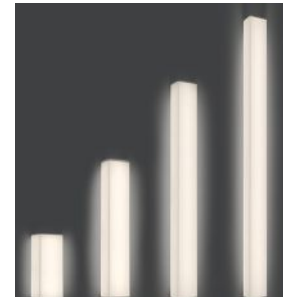

Lidea, Alva • This wall-mounted luminaire features an ecologically friendly resin shade for commercial spaces, especially bathroom vanities. Each of the four size options including 12" with a 12.6W LED, 24" with a 25.2W LED, 36" with a 38W LED, and 48" with a 50.5W LED, are offered at 3000K with an average CRI of 85 and are zero-to-10V dimmable. The luminaire is available with four resin shade options. Light output settings can be selected at 100, 75, 50, or 25 percent. • alvalight.com

Limit, Visa Lighting • This minimalist-styled pendant—a single plane folded into six segments—can be suspended at different angles or grouped in multiples to create a unique, geometric flowing look. Each 39.5"-long segment is fitted with three individually controlled, low-voltage 24V DC OLED panels offered at 2900K with a CRI of 80 and dimmable at zero-to-10V, delivering 850 total lumens. The fixture can be specified in 16 powdercoat finishes. • visalighting.com

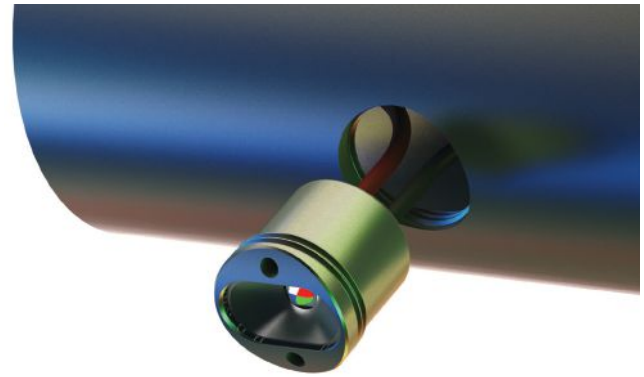

Zeta750 HR2, Alphabet Lighting • This LED handrail module can be selected for new or retrofitted applications or metal structures. Each module is fitted with a 1.5W LED offered at 2700K, 3000K, or 4000K, at a minimum CRI of 80, or 5000K, at a minimum CRI of 70. Modules are available in stainless steel, aluminum, brass (shown), and super-duplex steel with wide, narrow, or asymmetric beam spreads. • alphabetlighting.com

Licaso, Lighting Analysts Inc • This climate-based annual daylight simulation software can be applied as an add-on to AGI32 and Autodesk Revit with ElumTools to determine aggregate illumination of every hour of daylight in specific rooms of existing building models. The program calculates workplane illuminance time in minutes instead of hours or days. It produces LEED v4 and LM-83 daylight metric calculations in minutes. • licaso.com

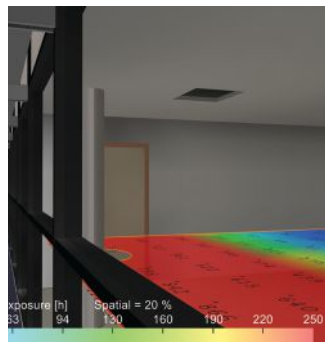



VOKSLYTE™

Merging the art of metal and the science of light



TANGENT Down™ • North Hills Tower II, Raleigh, NC • Design: Cline Bettridge Bernstein • Duda Paine Architects

TANGENT™

Tangent™ LED luminaires can be manufactured as:

-  elliptical
-  curvilinear
-  circular
-  seamlessly intersecting
-  rectilinear
-  freeform
-  arcs of any radius and compound radiuses

Why choose from a limited family of standard curvatures or shapes, when VoksLyte™ will manufacture **exactly what you want**. Available in hanging or recessed shapes to wherever your imagination leads you.

Unconstrain yourself...the possibilities are endless.



TANGENT Down™ Trimless Mud Flange • Escola De Negocios - Sao Paulo, Brazil



Store, Targetti • This track-mounted LED projector, suitable for retail applications, is housed in a scratchproof-treated, die-cast aluminum optical chamber. The 23W and 37W fixture is available in 3000K and 4000K with a CRI of 84 or 97, depending on the color temperature. The 6.18"-tall luminaire comes with spot, flood, medium-wide flood, and wide flood beam spread options, and can be tilted 90 degrees as well as rotated 355 degrees. Offered in plaster white and deep black finishes, Store is zero-to-10V dimmable. • targetti.us



Fundamentals Track, Intense Lighting • This family of LED tracklights comprises six accent and wallwash luminaires for commercial applications. The 14W, 30W, 32W, and 60W fixtures are available in 2700K, 3000K, 3500K, and 4000K—the wallwash is only offered in 3000K—at a CRI of 80, and provide a light output range of 1,400 to 5,450 lumens depending on the fixture model and wattage. The track heads mount on a single- or double-circuit track system, as well as J-type and L-type singles. • intenselighting.com



Odin, Nordeon USA • This square LED spotlight offers versatile ambient and accent lighting through Nordeon's ClickFast system, which allows for toolless installation with the company's Baldur light line track. The die-cast aluminum head is offered with nine 11W or 22W LEDs, or 16 19W or 38W LEDs. The fixture is available in 2700K, 4000K, and 6000K at a CRI of 80-plus and delivers a range of 1,000 to 1,600 lumens. Fixture finishes include white, black, or silver. • nordeon-usa.com

How do you keep up with new product information?

“Meeting with ‘trusted’ vendors, staying up to date with lighting-centric publications, actively talking with lighting peers, and attending conferences and trade shows such as Lightfair. We also review LED samples with an eye toward aesthetics, performance, and especially future maintenance and/or disposability protocols.”

—Thomas A. Kaczowski, Group VP, Director of Lighting, HOK



Magic Wand MRE O, Edison Price Lighting • For use in commercial, retail, and residential accent lighting applications, this fixture is designed to be used with 12V MR16 retrofit lamps including Philips' 6.6W or 7W LEDs, and Soraa's 6W, 7.5W, or 9W Brilliant or Vivid LEDs. The tracklight comes with a 2.5"-diameter aperture and measures 4.75" tall with a permanently tensioned, concealed swivel, which allows for 350-degree rotation and 90-degree tilt. The housing is available in four finishes including standard matte white and industrial silver; custom finishes are also available. • epl.com

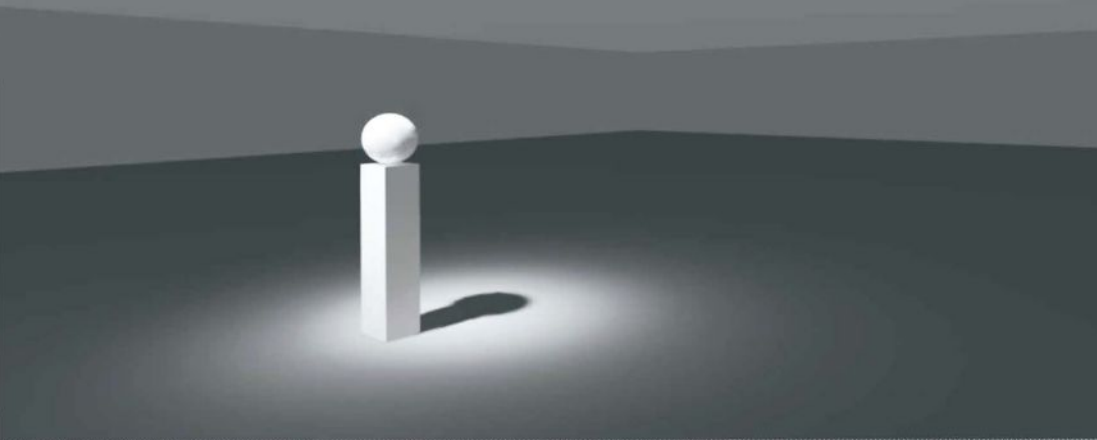

Directional lights



Beam angle 15°/30°
 Shielding angle 36°
 Tilt angle 0°~30°
 Rotatable through 355°



Round



Square



Trimless Round



Trimless Square

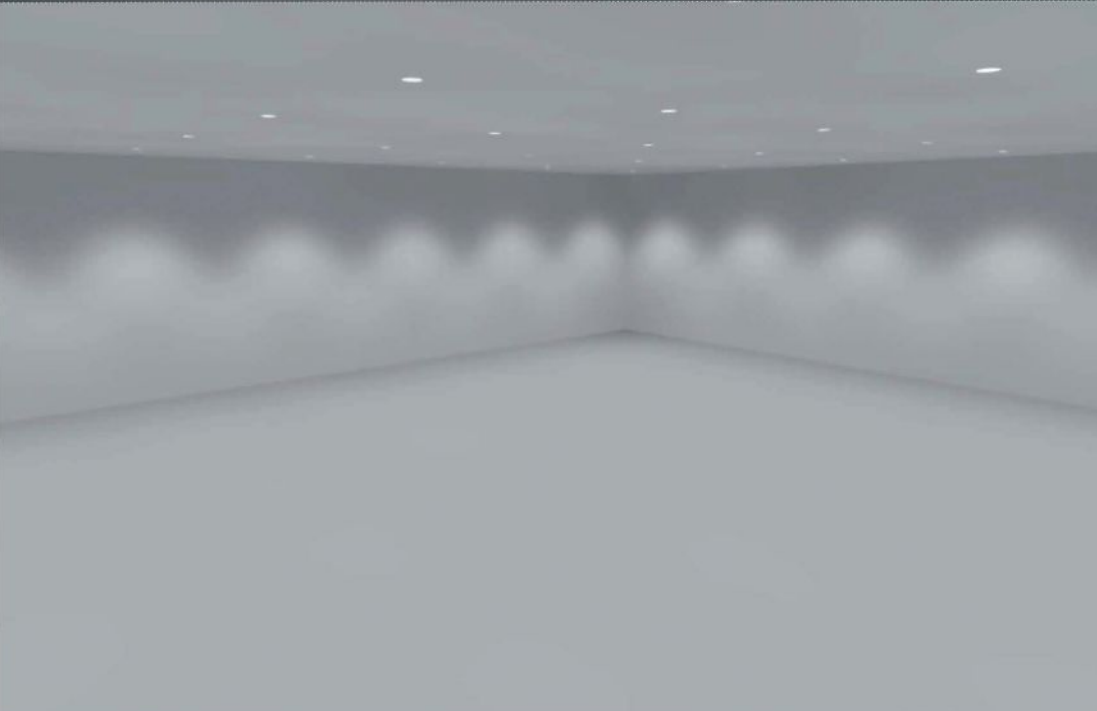

Downlights



UGR < 19
 Shielding angle 30°
 Batwing (75°)



Round



Square



Trimless Round



Trimless Square



Wall-washers



Top flat edge
 No gap between ceiling & wall
 High uniformity
 Shielding Angle 50°



Round



Trimless



Infra-Structure, Flos Architectural • From Belgian designer Vincent Van Duysen, this family of Bauhaus-inspired fixtures is suitable for ambient lighting and comes in several formats including: pendant luminaires, spot 90 tracking magnet, spot 120 tracking magnet, and downlight. A 24V modular track can be surface mounted in a grid and fitted with the range of 9.6W, 12.5W, 35W, and 36W fixtures available in 3000K at a CRI of 80. • architectural.flosusa.com



Parscan, Erco • This track-mounted spotlight can illuminate artwork in museums or galleries and becomes a downlight when the fixture head is directed downwards—merging the support bracket and head. The cylindrical fixture is available in 3000K and 4000K and is offered in three lumen packages, ranging from 210 to 6,600 lumens depending on wattage and color temperature. The luminaire offers seven beam spread options including narrow spot, wide flood, and wallwash. • erco.com

Gravity High Power Track, Intense Lighting • These tracklights are the newest addition to the company's Gravity collection, and feature TIR optics for greater beam control. Offered in 14W, 20W, 25W, 35W, 39W, and 40W in 2700K, 3000K, 3500K, and 4000K at a CRI of 82 or 92. The luminaires can be adjusted 358 degrees horizontally and 258 degrees vertically. Beam spread options include 14, 24, 36, 50, and 80 degrees. • intenselight.com



Gala 5 10°, Zaniboni Lighting • Suitable for illuminating artwork and retail spaces, these luminaires can be mounted onto low profile tracks for flexibility. The 13W, 18W, and 26W fixtures are available in 2700K, 3000K, 3500K, and 4000K at a CRI of 80 or 95. Delivering between 762 and 1,856 lumens, depending on the wattage, the 5"-diameter tracklight has a beam distribution of 10 degrees. • zanibonilighting.com



Cata, Artemide • This family of LED projectors uses transparent optics, which can be switched out to provide a range of beam spread options. Comprised of 33W Cata Catadioptric and 22W Cata Tir models, the fixtures are available in 3000K and 4000K at a CRI of 80. Catadioptric is offered in three beam spread options of 10, 14, and 64 degrees; Tir is offered in five beam spread options of 8, 16, 28, and 48 degrees as well as a wallwasher option. • artemide.net



LumeLEX 2020 Series, Lighting Services Inc • This compact 5W fixture is the company's newest and smallest LED cylinder. It measures 4.25" long and is available in 2700K and 3000K at a CRI of 90-plus with a light output range of 270 lumens, and a beam spread of 4 degrees. The fixture mounts into a single- or double-circuit 120V track system or onto a canopy. Black, white, and silver finishes are offered. • lightingservicesinc.com



**Lumenalpha Spot Small,
Lumenpulse Group •**

Part of the Lumenalpha Collection, this fixture is fully adjustable and intended to replace ceramic metal halide lamps. Measuring 9.18"-tall-by-3.3"-diameter, it can be specified in 6.5W, 8W, 11W, 17W, and 28W. Available in 2200K, 2700K, 3000K, 3500K, and 4000K at a CRI of 80-plus or 90-plus. • lumenpulsegroup.com

How is the Internet of Things affecting the lighting industry?

“Digital communications and LED lighting are transforming existing lighting infrastructure into information pathways with the capacity to collect and share data, and that offers new insights that enable—and drive—the Internet of Things.”

—Jim Anderson, Market Segment Manager, Philips Lighting

Achieve Smart IoT Lighting with Pacific LED Drivers & PacWave Motion Sensors/Wireless Controls



Robust 50-400 watt outdoor UL Class P programmable dimming drivers with 12V auxiliary output and dim-to-off Capabilities

- UL Class P – enable unparalleled flexibility in luminaire design.
- Rugged for outdoor application – 10KV built-in surge protection, IP67 rated housing, optimal thermal design ensures long life in harsh outdoor environment.
- Programmable – Constant power programmable current reduces inventory, enables flexible fixture design and makes future upgrades easier.
- 12V aux and dim-to-off: 0-10V dimming with dim-to-off pairs perfectly with PacWave's smart IoT ready motion sensors and other intelligent devices.



Innovative wireless, mesh-ready, beaconized PIR, Microwave, and Ultrasonic Bi-level motion sensors and White-Tuning Wireless Fixture Controllers.

- Patent-Pending Design – enables easy integration with multiple wireless protocols. Our sensors support wireless meshing through multiple software partners.
- Outstanding Detection, Performance and Range – Superior design and signal processing ensure maximum coverage with minimal unintended detection.
- Flexible Applications – With multiple technologies and form factors to choose from, PacWave's comprehensive IoT ready motion sensors are suitable for a wide range of applications.



Come visit us in May at Lightfair International in Booth 5542



**McWong International
1921 Arena Blvd.,
Sacramento, CA 95834**

**www.mcwonginc.com
support@mcwonginc.com
(916) 371-8080**



Horizon Colors, Humanscale •

This award-winning minimalist table lamp—which first debuted in 2009—is now available in five vibrant colors: twilight blue, dusk pink, sunrise orange, morning pink, and bronze gold. The 9W fixture, which utilizes thin-film LED technology for even, glare-free illumination, comes in 3000K and has a high-efficiency night-light option which uses only 1W. The die-cast aluminum fixture head houses the ultrathin LEDs and acts as the heat sink. • humanscale.com



Silk LED SBC Lightbar, Nora Lighting •

Suitable for retail, commercial, and residential applications, this low-profile tasklight comes in 2700K, 3000K, and 4000K at a CRI of 90-plus. A frosted lens eliminates diode glare and LED hotspots to provide even illumination. The fixture uses 5W per foot while delivering 350-plus lumens, and is offered in five lengths at a maximum run of 20' with a 100W driver and 12' with a 60W driver. Available in natural aluminum and black finishes. • noralighting.com



Sanna Lightbar, Teknion • Lightbar is the latest addition to San Francisco-based Pablo Designs' Sanna collection for office systems furniture company Teknion. The sleek table lamp can segue from ambient to tasklighting by rotating the semi-detachable head 360 degrees across a horizontal plane. The 8W fixture is available in 3000K at a CRI of 90-plus, with a lumen output of 610. Finish options include crisp gray and brushed aluminum. • teknion.com

What makes a great luminaire?

“A good product solves a problem. Product development is about the flexibility you can build into a product as well as full-proofing it technically to anticipate what could go wrong.”

—Ann Schiffers, Senior Vice President Specification Sales, USAI



Tambient L305 Mast Mount, The Lighting Quotient • Updated to accommodate an extruded aluminum dual-arm computer monitor frame, the slim L305 provides an integrated task and ambient lighting solution for office spaces. The fixture is available in 40W or 60W and comes in 3500K at a CRI of 80-plus as a standard option. (Custom options of 3000K and 4000K are also available.) Offered with two base configurations: a four-way flex base or a USB hub. • thelightingquotient.com

ALL IN ONE

Highbay - Lowbay - Floodlight 50% Inventory Reduction



G.REVOLUTION



Premium 4.1

K2

© Maria Ly on commons.wikimedia.org

Let's reach quality peaks!

And What If Only One Single Product Could Meet All Your Expectations?

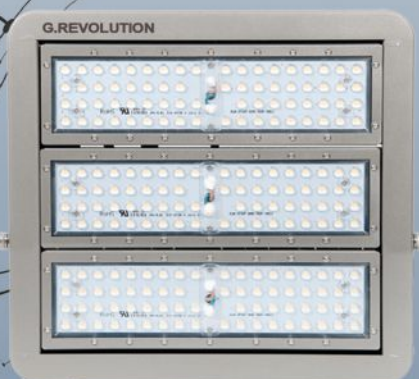

- Payment days UP to 150 days
- Replacement of 150W~1500W HPI/HID/HPL
- Best Heatsink & Anti dust design
- 6000Hrs ErP Test Finished
- 5 years Warranty
- OEM Provided
- Glare Rate UGR < 19
- IEC62471 Exempt Group
- Operating Temp: -40°C ~+ 52°C
- IP67 & IK08 & Dimmable

WWW.QHGPR.COM INFO@QHGPR.COM



Areas of applications: Industrial halls, warehouses - exhibition halls - Railway stations, airports, ports - Billboard lighting - Facade and building illumination - Sport halls - Street & road lighting - Demanding surrounding

WALLWASHERS



Lightgap, Erco • Suitable for architectural wallwash and grazing applications, this asymmetrical linear fixture can be mounted 3.8" from the wall to provide uniform illumination. Lightgap comes in lengths of 12.25", 36", and 72" and is offered in 6W, 18W, and 36W in 3000K and 4000K at a CRI of 90-plus. The luminaire can pivot vertically 10 degrees and is switchable or zero-to-10V dimmable. • erco.com



HP-WG Wall Grazer, Finelite • This wallwash and grazing luminaire, which evenly illuminates vertical surfaces to create contrast on textured walls, is available in a minimum length of 2' with custom increments of 0.06" with 2", 4", and 6" concealed optic options. The fixture comes standard in 3000K, 3500K, and 4000K (with tunable white options between 2700K and 6000K) at a CRI of 80-plus and 90-plus. • finelite.com

How has the specification process changed with the introduction of LEDs?

"It costs us more time to prepare the necessary documentation. That makes it even more of a challenge given how rapid the project cycle has become, especially when you are creating a performance specification and require a sample fixture for review."

—Andrew Mackinnon, Principal, Gabriel Mackinnon



Pilot PGM, Insight Lighting • Suitable for interior cove, grazing, or wallwashing applications, this AC-plug luminaire comes in 1' and 4' lengths. Available in 2700K, 3000K, 3500K, and 4000K, as well as with static red, blue, green, and amber LEDs, at a CRI of 82. Three power package options: 7W per foot, 10W per foot, and 13W per foot. Dimming options include zero-to-10V and TRIAC. • insightlighting.com

LeeSti Legato Ceiling Adjustable, Archlit • Installed just 1.5" from the surface it is illuminating, this wallwasher can include a protective film to minimize LED diode imagery. Available in 2700K and 3000K, Legato delivers 1,300 lumens per foot and 1,400 lumens per foot, respectively. Trimmed or trimless options offered. The fixture can be specified in 1', 2', and 4' sections in 12.5W, 25W, and 50W. Dimming options include zero-to-10V and DIM TRIA. • archlit.com





i402 Dual Optic Ambi-Aimable Asymmetric LED Luminaire, Electrix Illumination • A new addition to the company's i400 family, this ultra-slim fixture provides even illumination for walls over 10' tall and is suitable for interior cove, grazing, and wallwash applications. The dimmable luminaire is available in 2700K, 3000K, 3500K, and 4000K at a CRI of 85-plus, and delivers up to 2,000 lumens per foot. Rail lengths are 22.25", 33.25", and 44.25", and come in 15.2W or 21W per linear foot. • electrixillumination.com



LW Series Wall Washer, ELP • This series of recessed, asymmetric wallwashers is suitable for drywall, T-bar, and trimless installations for wallwash, floorwash, and indirect lighting applications. Offered in lengths of 1', 2', 3', and 4', the luminaires use 11W, 22W, 33W, and 44W, respectively. Available in 2700K, 3000K, 3500K, and 4000K at a 90-plus CRI, it delivers more than 1,325 lumens per foot. • elplighting.com



K5-i400 LumiLedge High Performance Symmetric Fixed Linear LED Luminaire, Electrix Illumination • This low-profile luminaire offers narrow, asymmetric distribution for indirect lighting and can be fitted into Electrix's K5 Knife Edge System for cove applications. Available in 7.6W-per-linear-foot or 10.5W-per-linear-foot options, in 2700K, 3000K, 3500K, and 4000K at a CRI of 85-plus. Rail lengths are offered in 22.25", 33.25", 44.25", 66.25", and 88.25". • electrixillumination.com

What makes a great luminaire?

“Luminaires want to be fit for the intended purpose. Ease of installation and maintenance, excellent appearance, creation of the perfect lit-effect, and economic considerations must all be part of the product, as well as backup materials such as spec sheets, websites, and samples.”

—Veit Mueller, Managing Director Thorn Gulf Ltd., SVP Zumtobel Group, Middle East, India, and Africa



Pantrac, Erco • This cubic, track-mounted wallwasher, which can be specified for indoor and outdoor applications, provides even illumination through the company's patented Spherolit lens technology and custom LED modules. The 6.6"-tall by 4.7"-wide luminaire is offered in a range of wattages from 12W to 24W in 3000K and 4000K at a CRI of 90-plus. The fixture delivers between 1,260 to 3,300 lumens and can be installed at a maximum wall height of 13'. • erco.com

MANUFACTURER

CATEGORY

Above All Lighting	Outdoor	72
Acclaim Lighting	Lighting Controls & Systems	64
Alloy LED	LEDs & Drivers	62
Alphabet Lighting	Downlights	48
	Specialty	78
Alva	Specialty	78
Amerlux	LEDs & Drivers	62
	Outdoor	73
Apure	Downlights	44
Archlit	Direct/Indirect	41
	Wallwashers	86
Architectural Lighting Works	Direct/Indirect	40
Arkoslight	Decorative	32
	Direct/Indirect	40
Artemide	Tracklighting	82
Axo Light	Decorative	32
Barron Lighting Group	Exit/Emergency	50
	Horticultural	52
Blackjack Lighting	Decorative	35
Boca Flasher	Outdoor	72
Corbett Lighting	Decorative	36
Creative Systems Lighting	Downlights	46
Cree	LEDs & Drivers	58
Dauer Lampen	Outdoor	70
David Trubridge Design	Decorative	35
Delray Lighting	Decorative	36
	Direct/Indirect	43
Douglas Lighting Controls	Lighting Controls & Systems	64
Eaton	Direct/Indirect	38
		41
		42
	Downlights	47
		48
	Exit/Emergency	50
	Industrial	54
	Lighting Controls & Systems	66
Ecosense	Lighting Controls & Systems	68
	Outdoor	70
		74
Edison Price Lighting	Tracklighting	80
élan Lighting, a Kichler company	Decorative	35

Electrix Illumination	Wallwashers	87
ELP	Wallwashers	87
Enlighted	Lighting Controls & Systems	66
		68
Erco	Outdoor	73
	Tracklighting	82
	Wallwashers	86
		87
Finelite	Wallwashers	86
Flos Architectural	Tracklighting	82
Fluxwerk	Direct/Indirect	38
Focal Point	Direct/Indirect	38
Forms+Surfaces	Outdoor	70
Foscarini	Decorative	32
		36
Fulham	Industrial	54
	LEDs & Drivers	60
		63
Gamma Sonic	Outdoor	76
Green Creative	Lamps & Ballasts	56
Griven USA	Outdoor	74
	Specialty	78
Hess America	Outdoor	70
Humanscale	Tasklighting	84
i2 Systems	Direct/Indirect	42
ILEX Architectural Lighting	Decorative	35
Insight Lighting	Direct/Indirect	42
	Wallwashers	86
Intense Lighting	Downlights	47
	Tracklighting	80
		82
Ketra	Direct/Indirect	40
	Lighting Controls & Systems	64
Kreon	Downlights	47
Landscape Forms	Outdoor	72
LBL Lighting	Decorative	34
Legrand	LEDs & Drivers	58
	Lighting Controls & Systems	64
		68
		69















Leviton	Lighting Controls & Systems	68
LF Illumination	Downlights	46
LightArt	Decorative	32
Lightheaded Lighting	Downlights	44
Lighting Analysts Inc	Specialty	78
Lighting Science	Horticultural	52
Lighting Services Inc	Tracklighting	82
LSI Industries	Outdoor	72
Lucifer Lighting	Downlights	46
Lumenetix	LEDs & Drivers	60
Lumenpulse Group	Direct/Indirect	42
	Downlights	44
	Outdoor	72
	Tracklighting	83
Lumileds	Horticultural	52
	LEDs & Drivers	62
Luminis	Outdoor	74
Lutron	Lighting Controls & Systems	64
Luxtech	LEDs & Drivers	58
		60
		63
MaxLite	Industrial	54
	Outdoor	76
Meteor Lighting	Downlights	48
	Outdoor	73
Niche	Decorative	35
Nordeon USA	Direct/Indirect	41
	Industrial	54
	Tracklighting	80
Nora Lighting	LEDs & Drivers	60
	Tasklighting	84
Optic Arts	LEDs & Drivers	58
		63
Pathway Lighting	Direct/Indirect	38
	Downlights	44
Philips Lighting	Downlights	47
	Lamps & Ballasts	56
Philips Color Kinetics	Outdoor	70
Prudential	Direct/Indirect	42
Q-Tran LED	LEDs & Drivers	60
		62
Reggiani	Downlights	47
Rosco	Lighting Controls & Systems	68

LEE Filters presents **ZIRCON**

A New Color Correction Filter

A longer lasting LED color correction filter with a thickness of 180 micron.

Attach directly to the source to achieve a desired color temperature.

	801 Minus Green 1
	802 Minus Green 2
	803 Minus Green 3
	804 Minus Green 4
	805 Minus Green 5
	806 Warm Amber 2
	807 Warm Amber 4
	O32 Warm Amber 5
	808 Warm Amber 6
	809 Warm Amber 8
	R31 Warm Amber 9
	810 Diffusion 1
	811 Diffusion 2
	812 Diffusion 3

Offered as precut to fit
standard LED lamps

Stocked in sheets and rolls

Available in 11 colors
and 3 diffusions.



leefilters.com/architectural

MANUFACTURER

CATEGORY

Schröder	Outdoor	74
		76
Solatube	Specialty	78
Solid State Luminaires	Direct/Indirect	40
Specialty Lighting	Direct/Indirect	38
Structura	Outdoor	76
Sun Valley Lighting	Outdoor	73
Sylvania LEDVANCE Luminaires	Direct/Indirect	43
Targetti	Outdoor	70
		72
	Tracklighting	80
TCP	Industrial	54
	Lamps & Ballasts	56
Tech Lighting	Downlights	48
	Outdoor	74
Teknion	Tasklighting	84
The Lighting Quotient	Direct/Indirect	41
	Tasklighting	84

Tracy Glover Studio	Decorative	35
Troy Lighting	Decorative	32
Universal Lighting	LEDs & Drivers	60
USAI Lighting	Downlights	44
Viabizzuno	Decorative	34
Vibia	Decorative	34
Visa Lighting	Direct/Indirect	42
	Specialty	78
WAC Lighting	Decorative	36
	Downlights	47
	Outdoor	74
Waldmann Lighting	Direct/Indirect	40
Zaniboni Lighting	Downlights	46
	Lighting Controls & Systems	69
	Tracklighting	82
Zumtobel	Downlights	44
	Industrial	54



The only lighting product that is designed, approved, and patented to replace the cross members on a suspended grid ceiling system.

The **F3BAR LED™**
by JLC • tech

See our new products at
LIGHTFAIR 2017 (Booth #3987)

www.JLC-TECH.com

370 Corporate Park, Pembroke, MA 02359
781-826-8162 | info@jlc-tech.com

©2017 JLC-Tech LLC, All Rights Reserved



FOURTEENTH
ANNUAL

A.L

LIGHT AND
ARCHITECTURE
DESIGN AWARDS

2017 CALL FOR ENTRIES

ARCHITECTURAL LIGHTING's 14th annual AL Light & Architecture Design Awards honors outstanding and innovative projects in the field of architectural lighting design. Winning projects will be published in the July/Aug 2017 issue and featured on archlighting.com. The awards program is open to design professionals worldwide. Projects must have been completed after July 2015.

Early Deadline: May 19, 2017
Final Entry: June 5, 2017

Full details and entry forms available at aldesignawards.com

h LIGHT DIRECTORY ARCHITECTURAL LIGHTING RESOURCE

LIGHTDIRECTORY.COM: Products, Catalogs, News, Jobs, Events, iPhone/Android apps



ALINEA LED
NOW AVAILABLE IN COLORS

CONTACT US FOR MORE INFORMATION
800-221-9092



4 hours under conventional lighting!



Just because you're not lighting the Magna Carta doesn't mean photochemical damage isn't an issue!

Learn everything every lighting designer or architect needs to know about light, matter, fading, ending photochemical damage and evaluating light sources in under 50 pages. \$30.00 - ships free US/CA!

NoUVIR[®]
RESEARCH INSTITUTE

302.628.9933
www.nouvir.com

FOR INFORMATION on how to be a part of the next ARCHITECTURAL LIGHTING MAGAZINE special advertising section, contact Jaeda Mohr at 202-736-3453.



ALPHABET



- Economical solution with premium components
- 3", 4" and 6" in round, square, trimless
- Downlight, wall wash, adjustable
- 2" shallow plenum
- Remote Phosphor, Biological/Circadian, Color Tuning
- Bluetooth[®] dimming and beam adjusting

AlphabetLighting.com P 714.259.9959 by **LEDRA**brands

LSI

LumeLEX 2020

Compact LED Cylinder

4 Degree Beam
5 Watts
26000 CBCP



www.LightingServicesInc.com

Shallow Fit[™]



BabyLED[®]: Don't give an inch.

Give ceilings their glory with the shallowest and tiniest recessed LED housing in the world. BabyLED[®] delivers 1150 lumens of award-winning lighting performance while using less than 2.5" of plenum space. Let your ceilings stand tall, and give them the room they deserve with BabyLED[®].

USA!
Lighting

845-565-8500 usalighting.com

AXT Series

Compact Xicato[™] LED at 720 & 1300 lumens.

➔ <http://tsq.li/axt-series>



TIMES SQUARE LIGHTING

(845) 947-3034 | www.tsilight.com

selux

ARCA

Sleek. Flexible. Reliable.

This high-performance luminaire is a visually comfortable and energy efficient pedestrian pathway luminaire. The option of up to four heads and the flexible arrangement of luminaires make Arca the perfect choice.

www.selux.us





VoksLyte[™] Tangent UpDown

Available in any custom diameter, freeform, ellipse, curvilinear, rectilinear, rectangular, racetrack and straight...you get the message.

www.VoksLyte.com



Image Spot™
LED Gobo Projector
Brilliant Imaging.



WWW.ROSCO.COM



DIALux

The world's number one lighting design and calculation tool for architectural lighting, interior and exterior, road lighting and daylighting. No matter how you approach your jobs: DIALux enables both numeric results analysis and visual evaluation with realistic renderings.

Get your free copy at www.dialux.com



MayaLED MA30
Zero uplight

The MayaLED MA30 is a new pedestrian scaled bollard designed to compliment the existing MayaLED family of wall and post top luminaires.

- Beautiful design
- Great performance
- Absolute control
- Full cut-off

luminis.com



ARCHITECT

The Journal of the American Institute of Architects

You Deserve More.



The premiere website for practicing architects—featuring news, project galleries, continuing education, blogs, videos and more is architectmagazine.com.

- > More projects
- > More news
- > More tech
- > More critiques
- > More products
- > More business

Get more today at architectmagazine.com



hanleywood



ACOLYTE

NEONLYTE **FLEX** CHANNEL

Learn more at www.acolyteled.com

Newly Enlightened.

The Feelux FLX Pro Series Collection—NDPro, HDPro and MonoRailPro

- Spot free illumination
- Quick connection system
- 90+ CRI



FEELUX
678.668.7005 | feeluxlighting.com



PAL Microquad

In suspended, as elegant as a chandelier. In recessed, as functional as a troffer. A new kind of lighting system for both new and existing spaces. See why Microquad is your next ideal system solution.

Precision Architectural Lighting
www.PAL-lighting.com
+1.713.946.4343

Vornado chandelier introduced in dweLED by WAC Lighting



Harmony out of Chaos. Smooth as watching the flightpath of fireflies. The Vornado chandelier is introduced in the dweLED line by WAC Lighting.

The hand crafted Vornado LED Chandelier is a simple, yet dynamic statement piece and free flowing mobius strip of light.

Constructed of solid aluminum, the chandelier features a frosted extruded diffuser with even illumination.

T 1.800.526.2588 or by visiting www.waclighting.com.

**Instant ambience.
Pure magnetism.**



For more information, visit amerlux.com/cynch.

Follow us on Twitter @AmerluxLighting.



we-ef

NEW FLC240-CC LED FLOODLIGHT



1. Perfect solution for parking lot, street, tennis court, etc;
2. UL, cUL and DLC certified in 100-277VAC, 347VAC and 480VAC versions;
3. Compliance with Title 24 regulation, built-in motion sensor available, photocell sensor available;
4. Multiple fixture color available, fast delivery, US warehouse stock available;
5. 24 hours service, immediate response, US service center;
6. Replacement send out within 24 hours;
7. System efficacy 130lm/w, long lifespan, supreme temperature control;
8. Traditional lamp replacement from 150W to 1000W;
9. Type II, III, IV and V optical lens available, and multiple brackets / adaptors for easiest installation

www.aokledlight.com



Quality, Honesty, Service and Innovation



LUMEN RAIL

WAGNER



WAGNERARCHITECTURAL.COM



coronet

Loop
pendant



www.coronetled.com

EVERLINE® High Bay Modules



The EVERLINE® High Bay Modules provide excellent lumen maintenance with an L90 rating of greater than 50K hours while operating at high Tc temperature of 90°C. Two of these modules operating with the EVERLINE® D23CC90xxxT-F family of drivers provides 12,400 lumens with a system efficacy greater than 130 lumens per Watt, making them ideal to be combined in multiples for high bay lighting fixtures, for both universal voltage (120-277V) and high range voltage (347V-480V) applications.



A member of the Panasonic Group **Panasonic**

The Montur L P LED is the ground version in the Montur series. This bollard features an aluminum framing free of welding seams and an unobtrusive 13W LED cluster. The Montur is also available for wall and ceiling with LED clusters or filament-LED lamps and suitable for interior or exterior applications.



DELTA LIGHT®

S315 Big Efficacy

- Concealed wall washer or aimable cove
- 8 lm/ft single LED
- Up to 200 lm/W



S434 Large Lumens

- Up to 52,000 lumens
- 670W input vs. 1080W for equivalent metal halide
- L90(10k) > 60,000 hours per TM-21

THE LIGHTING QUOTIENT™



T3BAR LED™
by JLC • TECH

The only lighting product that is designed, approved, and patented to replace the cross members on a suspended grid ceiling system.

See our new products at **LIGHTFAIR 2017 (Booth #3987)**

www.JLC-TECH.com
781-826-8162 | info@jlc-tech.com

ADVERTISER	PAGE	WEBSITE	PHONE
Aamsco Lighting Inc.	65	www.aamsco.com	800.221.9092
Acolyte	45	www.acolyteled.com	
AL Light & Design Awds	91	aldesignawards.com	
Amerlux Global Lighting Solutions	29	amerlux.com	
AOK LED Light Company Limited	4	www.aokledlight.com	
Apure Distribution, LLC	8-9	APURE-SYSTEM.COM	
B-K Lighting, Inc.	23	tekillumination.com	
Con-Tech Lighting	30	www.contechlighting.com	
Coronet	15	www.coronetled.com	973.345.7660
Delta Light US	21	www.deltalight.us	
Dial GmbH	2	dialux.com	
Feelux Lighting	53	www.feelux.com	678.668.7005
Green Creative	77	www.greencreative.com	866.774.5433
Hunter Industries	67	holmlighting.com	
JLC Tech	90	www.JLC-TECH.com	
Landscape Forms	61	landscapeforms.com	800.430.6205
Ledra Brands	18	AlphabetLighting.com	714.259.9959
Lee Filters	89	leefilters.com/architectural	
LF Illumination LLC	C2-1	lfillumination.com	
Lighting Services	11	www.LightingServicesInc.com	800.999.9574
LSI Industries	3	www.lsi-industries.com	513.793.3200
Lucifer Lighting	13	luciferlighting.com	
Lumenpulse	7	-	
Luminis	5	www.luminis.com	
Lutron	C4	lutron.com/designfreedom	1.888-LUTRON1
McWong Inc.	83	www.mcwonginc.com	916.317.8080
No. 8 Lighting	17	8lighting.com	
Nora Lighting	37	www.noralighting.com	800.686.6672
Nouvir Research	49	-	302.628.9933
Precision Architectural Lighting	55	www.pal-lighting.com/systemsolutions3	713.946.4343
Refond Optoelectronics Co, Ltd.	43	www.refond.com	
ROSCO	63	www.rosco.com	
SELUX	39	selux.us	
Shenzhen Green Power Revolution AG	85	WWW.QHGP.R.COM	
Signcomplex	59	www.signcomplex.com	
Thailight Semiconductor Lighting Co, Ltd.	51	www.thailight-led.com	
The Lighting Quotient	25	-	
Times Square Lighting	50	www.tslight.com	845.947.3034
Titanic Lighting Co., Ltd.	81	titanic.gmc.globalmarket.com	
Universal Lighting Technologies	69	www.unvlt.com	800.225.5278
USAI	C3	usailighting.com	845.565.8500
Visa Lighting	57	visalighting.com/limit	
Vokslyte	79	www.Vokslyte.com	
WAC Lighting	33	wacighting.com	
Wagner Companies	75	WAGNERARCHITECTURAL.COM	888.243.6914
Weef Lighting USA LLC	71	www.we-ef.com	424.742.0030

JOE COSTELLO

“Technology is a revolutionary force; it takes what was a dream and makes it a reality over time, almost every time.”



For more than 25 years, Joe Costello has been paving the way in electronic design automation. Undergraduate studies in mathematics and graduate studies in physics first led Costello to the world of semiconductors. A summer job at National Semiconductor during grad school provided an introduction to Jim Solomon, a pioneer in the semiconductor world. In 1988, Costello joined Solomon's Cadence Design Systems, which revolutionized the field of chip design. Costello went on to serve as Cadence's CEO. Now at Enlighted, as its chairman and chief executive officer, Costello is helping to lay the groundwork for the integration of the Internet of Things (IoT).

How do you describe IoT?

It's the ability to tap into all of this rich information by doing search with various applications, and the power of that information being so freely accessible and exchangeable.

What makes lighting such an attractive partner, or vehicle, for IoT?

I think people are confusing the two, trying to make it seem as if they are the same thing. They are not. There's a good connection, but they have different DNAs. It's a partnership, not a marriage.

What's the starting point for lighting and IoT to find the right connection?

The light fixture is a vehicle for introducing IoT systems into a building. But it troubles me that so many of today's buildings are not being built or remodeled with anyone thinking about an

IoT system. It's estimated that 140 million LED luminaires will be shipped in North America next year, but not many will be equipped with a sensor of any kind. That's a tragedy; a generation of buildings will never have the opportunity for "smart" capabilities.

What are some of the criteria you consider important to foster innovation?

You have to give smart people freedom of action to think and one way is to encourage fast failure. In old industries, mistakes are not encouraged. You have to foster experimentation where the known result is going to be failure a significant fraction of the time.

What skills are needed for the digital age?

You need to have a disruptive mindset at multiple levels. •

interview by Elizabeth Donoff
photo by Margo Moritz

Being shallow can be a good thing.



BabyLED®: Don't give an inch.

Give ceilings their glory with the shallowest and tiniest recessed LED housing in the world. BabyLED® delivers 1150 lumens of award-winning lighting performance while using less than 2.5" of plenum space. Let your ceilings stand tall, and give them the room they deserve with BabyLED®.



Shallow Fit™

 Want to learn more?

Download a PDF at usalighting.com/shallowfit

845-565-8500

usalighting.com

© USAI Lighting 2016. All rights reserved.
Covered by patent numbers 7832889 and 8469536.

USAI[®]
Lighting

Design Freedom Made Easy

72,000+ Lutron-enabled fixtures from over 350 manufacturers deliver guaranteed dimming performance

- Wired or wireless systems
- Fixed or variable color temperature
- Performance dimming from 100% to 0.1%



Render the right environment



lutron.com/designfreedom

24/7 Tech Support: 1-888-LUTRON1