

INDEX TO VOLUME CXV  
THE

AMERICAN ARCHITECT

239 WEST 39TH ST., NEW YORK

JANUARY TO JUNE, 1919

EDITORIAL COMMENT

Figures refer to text pages

5295-3  
24 10 19

-A-

Architect of Tomorrow, 97.  
Architect President of Royal Academy, 310.  
Argument, A False, 678.  
Art, A Leadership in, Needed, 167.

-B-

Build Now, 269, 373.  
Building Conditions Improving, 881.  
Building, Speed Up at Once!, 375.  
Building Work Reviving, 547.  
Busy, Why Not Get (Farm Building), 785.

-C-

Circular of Advice, Revision of, 373.  
Convention at Nashville, 609, 645.  
Convention, Before the, 609.

-D-

"Democratizing the Institute," 515, 575.  
Design and Fitness, Conflict Between, 457.

-E-

Education, A Report on, 167.  
Educational Measure, A Comprehensive, 232.  
Efficiency Test, An, 270.  
Efficiency and Service, 815.  
Examinations, Psychological Test in Student, 201.

-F-

Farm Buildings, Architectural Improvement of, 98, 373, 548, 785.

-H-

Housing Problems in New York, Solving, 87.  
Humanities in Educational Curricula, 576.

-I-

Industrial Welfare Bill, 309.  
Institute, Democratizing the, 515, 575.  
Iowa's Housing Law, 677.

-K-

Kohn's, Mr., Review, 749.

-L-

Labor Value Measured by Production, 786.  
License Engineering Profession, Movement to, 202.

-M-

Market, What an "Open" Means to Building, 750.  
Memorials, and the American Academy of Arts and Letters, 202.  
Memorials in New York, 131.  
Memorials, War, 98.  
Money More Available for Mortgage Loans, Making, 815.

-N-

Nashville Convention, 609, 645.  
New York State Association, 881.  
Nineteen-Nineteen, 1.

-O-

Opportunities, Wasted, 489.  
Opportunities, Wasted, Recovered, 87.  
Opportunity, Conserving an Architectural, 104.

-P-

Plan Service by Institute Chapters, 85.  
Post-Office Building in City Hall Park, 882.  
Post-War Committee, Co-operating with (Architectural Education), 415.  
Post-War Committee, Program of, 339.  
Post-War Committee, Relationship of Architect to Public, 489.  
Post-War Program, Relation of the Institute to Other Professional Societies, 457.  
Profession, Safeguarding the, 678.  
Public Works, Planning Department of, 490, 552, 646.  
Publicity Methods, Illegitimate, 416.

-S-

Safety and Sanity, 70.  
Shadows and Straws, 69.  
Specification, The Definite, 131, 374.  
Sport of Chance or Master of Destiny, 331.  
State Societies, 69, 340.

-T-

Teaching History by Pictures, 310.  
Thousand in 1919, 677.

-W-

What Could Be Done, 709.

TEXT ACCORDING TO SUBJECT

Figures refer to text pages

-A-

Advertising, Architectural. By F. E. Davidson, 26.  
Advertising, Architectural. By Thomas Crane Young, 26.  
Advertising Need, Architect Urges, 850.  
Advertising, Question of, 108.  
Allerton House, Arthur Loomis Harmon, Architect, 773.  
Arch of Democracy, Brooklyn, N. Y. By F. J. Helmle, 94.  
Architect, Does He Function as He Should. By Robert D. Kohn. (Post-War Committee Program), 291.  
Architect and the Builder. By Thomas T. Hopper, 543.  
Architect and Engineer. By Edward Pearce Casey, 27.  
Architect of Tomorrow. By Alfred H. Granger, 91.  
Architects as Bridge Builders. By Thomas Hastings, 23.

Architects and Engineers. By Willis Polk, 6.  
Architects, Registration of. By D. Everett Waid, 738.  
Architectural Casuerie, 878.  
Architectural Competitions. By Thomas Crane Young, 311.  
Architectural Criticism, 707.  
Architectural-Engineering Practice, Looking Forward to, 4.  
Architectural History of a Western Town. By Thomas E. Tallmadge, 443.  
Architecture After the War. By C. H. Blackall.  
Architectural Education, 7.  
Organization, 89.  
Efficiency, 331.  
What Is an Architect, 481.  
Architecture, Analyzing Development in American. By David J. Yaron, 405.  
Architecture and Engineering. By Thomas Crane Young, 403.  
Architecture, English Review of American, 784.

Army Educational Commission, 844.  
Art in Industry, England Revives, 783.

-B-

Bank, People's National, of Brooklyn. Koch & Wagner, Architects, 703.  
Beauty and Economics. By Harvey Wiley Corbett, 11.  
Build Now, Why Not? By J. C. Murphy, 485.  
Build, We Are Going to. By Willis Polk, 6.  
Building Costs and Earnings:  
The Office Building Outlook. By William Marshall Ellis, 17.  
How Office Building Managers Have Met War Conditions. By Edwin S. Jewell, 19.  
Building for Health. By Woods Hutchinson, 121.  
Buildings a Factor in Production Costs. By F. E. Davidson, 810.

## TEXT ACCORDING TO SUBJECT

(Continued)

## —C—

Chicago Architectural Exhibition, 32nd Annual, 671.  
 Circular of Advice. By Henry K. Holsman, 367.  
 Classic Tradition, Plea for a, 572.  
 Clock, The Long Case (Grandfather), 307.  
 Colonial Trust Co., Philadelphia. Pa. Alfred Bossom, Architect, 877.  
 Color of Surroundings Affects Health, How, 787.  
 Commodore Hotel. Warren & Wetmore, Architects, 337.  
 Contracting, Some Aspects of Modern. By F. E. Davidson, 236.  
 Convention, American Institute of Architects, Nashville, 633, 665.  
 Craftsman, Developing the American. By Richard F. Bach, 484.  
 Craftsmanship, Fine Example of French, 706.

## —E—

Educating for Architectural Practice. By Frederic W. Garber, 9.  
 Engineering Conference at Chicago, April 23-25, 642.

## —F—

Farm Buildings, Improvement of. By George W. Maher, 453.  
 Fire Protection Association, Annual Meeting of National, 814.  
 France, An American Architect in. By Alfred P. Shaw, 333.  
 Furness House, Baltimore. Edward Hughes Glidden, Architect, 272.  
 Future of Government Villages. By Clarence Wilson Brazer, 219.

## —G—

Garage and Entrance Turns. By A. D. Taylor, 699, 777.  
 Gateway of the Nation. By F. B. and A. Ware, 603.

## —A—

Academy of Arts and Letters, 29.  
 Academy and Its Methods of Exhibiting, 711.  
 Agriculture, British Reconstruction Plans Aid, 488.  
 Air Fields Being Established, 711.  
 Airplane Boxes Big as Cottages, 179.  
 Airplanes for Forest Fire Protection, 712.  
 American Academy of Arts and Sciences, 821.  
 A. I. A., Next Convention, 75.  
 Amortization Committee Is Named, 312.  
 Ante-War Conditions Again, 524.  
 Apprentice School of Design, A National, 391.  
 April Building Starts Well, 650.  
 Architect, Is Willis Polk an, 245.  
 Architect, State, Employed by North Carolina, 465.  
 Architects Hear Lectures, 584.  
 Architects Ask Government Aid, 762.  
 Architects, Iowa, Public Suggestions for the General Public, 825.  
 Architects, New Jersey, Organize Memorial Committee, 418.  
 Architects, State Board of, Named, 822.  
 Architectural Assets, Ascertaining, 618.  
 Architectural Bureau Claims Big Savings, 855.  
 Architectural Exhibition, Chicago, 493.  
 Architectural League Dines French Commissioner, 419.  
 Architecture a Profitable Investment for Owner, 487.  
 Architecture, A. E. F. Study, Other Aspects of, 885.  
 Army Storage Buildings, 713.  
 Art Censor, English Post Office as, 488.  
 Art Commissions, 650.  
 Art Conventions, Three in New York, 518.  
 Art and Letters, New Place for, 855.  
 Art, Progressive Work for, 648.  
 Art School in France, American Army as, 461.  
 Art Study, Reconstruction of, 789.  
 Art, Teach, Through the Children, 821.

Government Housing: What Will Follow. By C. Grant LaFarge, 55.  
 Group House, Advantages and Possibilities. By Richard Henry Dana, 163.

## —H—

Hotel Lincoln, Indianapolis, Ind. Rubush & Hunter, Architects, 238.  
 Hotel Pennsylvania. McKim, Mead & White, Architects, 297.  
 House of Allan S. Lehman. John Russell Pope, Architect, 192.  
 Houses, New, for Old. Alteration for O. L. Schwanke. Dwight James Baum, Architect, 679.  
 Housing Development That Solves Lodger Problem. Godley, Haskell & Sedgwick, Architects, 565.

## —L—

London, Notes From. By Selwyn Brinton, 599, 739.

## —M—

Mapping by Airplane, 873.  
 Memorials, Observations on Types of. By A. L. Brockway, 511.  
 Memorials of the War, 849.  
 Miami, Florida, Italian House at. Gordon E. Mayer, Architect, 805.  
 Mill Creek Park, Youngstown, Ohio. By J. A. Schweinfurth, 869.

## —O—

Office Organization, Architectural, for Post-War Conditions. By Daniel Paul Higgins, 13, 60.

## —P—

Paris, Plans for Greater, Are Forming, 850.  
 Park Avenue Improvement in New York, 756.  
 Plasterwork, Development of Ornamental. By Maximilian F. Friederaug, 536.

Post-War Committee, Review of. By Robert D. Kohn, 735.

## —R—

Roosevelt, Memorial to Theodore. By George W. Maher, 268.

## —S—

Scarboro-on-Hudson School. Welles Bosworth, Architect, 477.  
 Sparrow House and Rabbit House. By Joy Wheeler Dow, 505.  
 Specification Clauses. By Francis W. Grant, 570.  
 Structural Service. By D. Knickerbacker Boyd, 233.  
 Supply and Demand, Law of. By Willis Polk, 173.

## —T—

Tod Homestead Cemetery, Youngstown, Ohio. J. A. Schweinfurth, Architect, 848.  
 Town Halls as War Memorials. Kilham & Hopkins, Architects, 607.  
 Training School and Home for Young Girls, Brooklyn, N. Y. Ludlow & Peabody, Architects, 751.

## —V—

Victory Building Proposed at Springfield, Mass. Albert Winslow Cobb, Architect, 454.  
 Victory Memorial Building, Washington, D. C. Tracy & Swartwout, Architects, 847.  
 Villa Borghese. By Joy Wheeler Dow, 837.

## —W—

Wales, Housing Policy for, 879.  
 Wentworth-Gardner House, Portsmouth, N. H., 372.  
 Westinghouse Village at South Philadelphia, Pa., 223.

## CURRENT NEWS

Art Works Asked by French for Those Ruined, 463.  
 Artists to Go to France, 826.  
 Artists' War Achievements, 581.  
 Arts Convention, Wide Interest in, 687.  
 Atlantic City Architects Organize, 313.

## —B—

Baling Saves 50 Millions in Shipments, 180.  
 Balzac's Home Is Restored, 791.  
 Bank Loans Abroad, Our, 142.  
 Bank Loans Increase in Washington, 687.  
 Banking Affiliations, To Extend, 208.  
 Banks, Bill to Establish Home Loan, 523.  
 Banks Study Amortization of Loans, 585.  
 Battle Plane, First American, in National Museum, 685.  
 Beauties, Hidden, 857.  
 Beauty, Conservation of, 713.  
 Beauty, Simplicity of, 760.  
 Belgian Ruins, To Preserve, 278.  
 Belgium, Portable Homes for, 648.  
 Belgium, Reviving the Industries of, 180.  
 Billboards, Unightly, 825.  
 Bolshevism, To Eliminate, 616.  
 Borglum Honored by France, 464.  
 Brainard, Owen, 519.  
 Brick Shipments Halted, 859.  
 Bricks Needed by Britain, 887.  
 Bridges, Architects Design Pittsburgh, 886.  
 British Architects Exhibit American Timber, 274.  
 British Army Huts for Homes, 711.  
 British Labor Situation, To Study, 247.  
 British Lumber Control Ended, 617.  
 British Provide Cottage and Farm for Soldier, 278.  
 British Suburban Development, 144.  
 British Surplus War Property, Disposal of, 553.  
 British Trade, May Resume, 523.  
 Brooklyn Architects Hold Monthly Dinner, 280.  
 Brooklyn Chapter Meetings, 620.  
 Brooklyn Industrial Exhibit, 717.

Budget Plan, For National, 789.  
 Build Now! 363, 495.  
 Build Now Campaign Backed by Convention, 389.  
 Build Now, Says Senator Underwood, 584.  
 Build Now, Urges Willis Polk, 821.  
 Builder, Day of the, 887.  
 Builders, Giving the, a Chance, 683.  
 Builders Ask for Boom Campaign, 492.  
 Builders Plan Five Day Week, 716.  
 Builders' Show Active, 553.  
 Builders Urged to Watch Opportunities, 494.  
 Building Activity, Bright Future, 101.  
 Building Activity, Campaign to Stimulate, 619.  
 Building Activity Resumed, 426.  
 Building Boom Hits Midwestern States, 143.  
 Building Boom, Revise Laws to Aid, 716.  
 Building Campaign, Co-operative with, 421.  
 Building Construction in the United States, 41.  
 Building, Demands for, 465.  
 Building Erected in 33 Hours, 760.  
 Building Exhibit, Portland, Ore., 620.  
 Building, Hasten, Is Advised, 465.  
 Building of Houses by State Is Urged to Limit Cost, 391.  
 Building, Immediate, 578.  
 Building Increase, Predicts Big, 652.  
 Building Loan Report, 712.  
 Building Manager Condemns Tax, 174.  
 Building Market, Price Concessions Aid, 280.  
 Building Operations Show Gain, 459.  
 Building Optimism Grows, 683.  
 Building Plans to Last Ten Years, 717.  
 Building Plans Show Decided Gain, 392.  
 Building Prospects, Optimistic as to, 584.  
 Building Reports Optimistic, 522.  
 Building Research, 824.  
 Building Revival in Small Projects, 388.  
 Building, Rush, to Cut Down Rents, 684.  
 Building Shortage, Northeast, 50 Per Cent, 318.  
 Building Situation, H. I. Cobb Outlines, 492.  
 Building Stabilization Report Prepared, 426.  
 Building Starts in Detroit, 616.  
 Building, To Be Steady Growth in, 280.



## CURRENT NEWS

(Continued)

Building Supply Ban Lifted in Uniontown, 826.  
 Building Trades Questioned by Dept. of Labor, 550.  
 Building Work Increases, 577.  
 Buildings, Decay in, 76.  
 Burial Ground in France for Our Men, 347.  
 Business Boom Predicted, 523.  
 Business Conditions, 31.  
 Business Revival, Expect, 578.  
 Business Unit, Largest in the World (War Risk Insurance), 76.  
 Button, Bronze, for Discharged Soldier, 422.

## —C—

Cady Architectural Library Goes to Trinity College, 275.  
 Cady, J. Cleveland, 583.  
 California, Financing Building in Southern, 459.  
 Canada Provides Money for Houses, 888.  
 Canada Pushes Housing Bill, 420.  
 Canadian Lumber Supply, 580.  
 Canadian Rail Construction, 578.  
 Canadians in War, Artists' Work Shows, 891.  
 Canal Terminals, To Hasten, 423.  
 Canal Tonnage Shows Decline, 209.  
 Capital, Private, and New Construction, 682.  
 Carpenters Urge \$7 a Day Minimum Wage, 793.  
 Cathedral, Raise Fund for National, 348.  
 Cemetery in France, Suggests, 392.  
 Chamber of Commerce, World, 760.  
 Chicago Building Hold Up, Explain, 584.  
 Chicago School of Architecture, 579.  
 Chicago Stadium, 856.  
 Chimney, Montana Has World's Tallest, 145.  
 Cities, Bill Plans for Dividing, 497.  
 Citizenship, School of, Favored, 462.  
 City, An Ideal, 886.  
 City Plan for Janesville, Wis., 618.  
 City Planning Conference, 621.  
 Civic Beauty, Safeguarding, 681.  
 Civic Pride, Where, Is Born, 649.  
 Claim Board, Secretary Creates, 346.  
 Cleveland Building Figures Show Gain, 246.  
 Cleveland Chapter, A. I. A., 580.  
 Clubhouse for 77th Division, 550.  
 Club House for Discharged Officers, 180.  
 Coal Export Co-operation, 174.  
 Coal Production Decreases, 104, 312.  
 Coal Shortage in France Will Boom Industry, 209.  
 Code Changes Urged to Aid Construction, 686.  
 Colleges to Admit "War Special" Students, 348.  
 Comfort Station Problem, San Francisco, 760.  
 Community Boards, Importance of, 77.  
 Community Buildings as Soldier Memorials, 613.  
 Competition, Award in American Housing, 762.  
 Competition for Rebuilding French Towns, 582.  
 Competition for Memorial Tablet, Polachek, 676.  
 Competition, Sacramento State Building in, 124.  
 Construction Activity in Europe, 524.  
 Construction Activity, Survey Indicates Early Start, 763.  
 Construction Codes for Safety Uniformity, 273.  
 Construction Data, New Bureau Formed to Secure, 103.  
 Construction, Discuss Stimulation of, 524.  
 Construction Field in South America, 752.  
 Construction Financing, Wants Investigation of, 826.  
 Construction Industry to Convene, 651.  
 Construction, Is Cost High? 455.  
 Construction, Plans to Urge, 346.  
 Construction Problems Discussed at Conference, 425.  
 Construction Projects Stopped by War Department, 104.  
 Contractors, To License Building, 583.  
 Contracts Executed in Year, Public, 273.  
 Contracts, May Make Public, 276.  
 Convention, Impression of George W. Maher, 822.  
 Co-operation of Builders and Labor Urged, 522.  
 Copper to Europe, 106.  
 Copper Men Go Abroad, 246.  
 Copper Purchased by Italian Government, 145.  
 Cost Probe Started by Legislators, 553.  
 Costs, Comparative, in Quarter Century of Building, 350.  
 Cox, Kenyon, 466.  
 Craftsmanship, Development of, 597.  
 Craftsmanship in Brazil, 521.  
 Credits, Urges Liberal to Our Foreign Purchasers, 690.

## —D—

Dam, U. S. Engineers Build World's Biggest, 177.  
 Danish Demand for American Building Specialties, 752.  
 Daylight Saving, Results of, 78.

Debt Comparisons and Obligations, 207.  
 Debt, World's War, Vast Sum, 175.  
 Decorative Arts and Industries Association Formed, 108.  
 Deposits in Postal Savings, 207.  
 Detroit's First Builders Show, 351.  
 Detroit Is Assured Financing of Building Projects, 651.  
 District of Columbia Improvements, 652.  
 Draughtsmen Needed, 716, 790.  
 Dust and Fumes Problem Solved, 273.  
 Duvenceck, Frank, 244.

## —E—

Education, Architectural, 161.  
 Education, The New Architectural, 157.  
 Electrical Workers' Latest Demands, 651.  
 Employer, Reward for the Just, 887.  
 Employers Urged to Build, 690.  
 Employment Service Activities, U. S., 461.  
 Employment Service, Cut Made in, 494.  
 Employment Service, Report of U. S., 888.  
 Employment Service, Work of the U. S., 77.  
 Engineering Societies Employment Bureau, 244.  
 Engineers Elect Officers, St. Louis Chapter, 277.  
 England's House Building Needs, 823.  
 England's Housing Appropriation, 277.  
 England's War Memorials on Large Scale, 276.  
 England, Reconstructing Architectural Practice in, 93.  
 England Is Short 500,000 Houses, 247.  
 English Housing Problems, 615.  
 Estimates, Are Costs Less Than Current? 555.  
 Estimating Recession of Prices, 102.  
 Exhibits Drawings, Child Aged Two, 617.  
 Exports, Issue Bonds to Promote, 684.  
 Exports from France to U. S., 247.  
 Exports, January, Set Record, 418.  
 Exposition, Next Congress to Take Up World's, 717.  
 Extensions Asked, to Cost \$2,000,000, 178.

## —F—

Farm Buildings, Architectural Improvement of, 377.  
 Farm Conditions Abroad, 276.  
 Farm Dwellings Planned, Model, 273.  
 Farm Land Values Rise, 685.  
 Farms and Soldiers Again, 758.  
 Federal Home Loan Bank Legislation, 714.  
 Ferryhouse Built to Stay, 650.  
 Film Exchanges, Hazard of, 129.  
 Financing the Expected Boom in Building, 171, 205, 241.  
 Financing Foreign Readjustment, 102.  
 Fire Hazards, Eliminating, 423.  
 Fire Loss, 143.  
 Fire Loss, Co-operation Against, 274.  
 Fire Investigation and Prevention, 823.  
 Fire Protection, Cincinnati Leads in, 650.  
 Fire Protection Furthered by Concrete Roads, 145.  
 Food Costs, France Cuts, 462.  
 Food, War Cost of, 345.  
 Foreign Born and Native Workers, Better Relations, 75.  
 Foreign Market at Home, 618.  
 Foreign Trade, To Master, 278.  
 Forest Fire Control, County Organizations for, 77.  
 Forest Laboratory Door Tests, 649.  
 Forest Laboratory Tests, 495.  
 Forest Protection in Canada, 577.  
 Forest Reserve in New York Big, 144.  
 France Chary in Rebuilding, 681.  
 France, Her Roads Saved, 78.  
 France, Labor Shortage Holds Up Public Work in, 791.  
 France Offers U. S. Monument Site, 350.  
 France, Restoring Orchards of, 315.  
 Freight Rates, Building Industry Asks Lower, 419.  
 Freight Rates Reduced on Building Materials, 425.  
 French Building Loss, 551.  
 French Forests, Would Replant, 579.  
 French Plan Monument, 608.  
 French Sand Breaks Commodity Prices, 352.  
 French, Would Let Rebuild in Own Way, 857.  
 Fuel Problem, Great Britain's, 313.  
 Fuel Saving by Restricted Industries, Results of, 244.  
 Furniture High in Great Britain, 712.  
 Furniture Market in South America, 551.

## —G—

German Forests for French Indemnity, 713.  
 Goodyear's, Prof., Research, 78.  
 Government Campaign to Promote Buildings, 74.

Government May Dispose of 5000 Acres of Land, 392.  
 Government Offers Business Data to Industry, 760.  
 Government to Spend \$305,369,464 on Public Improvements, 584.  
 Grand Central Palace, New York, World Trade Mart, 824.  
 Great Britain Allows Trade in Hardwood, 350.  
 Guarantee of Labor Stability Urged to Aid Building, 248.

## —H—

Harbor and River Bill, 106.  
 Hardwood Surplus Disposal of, 496.  
 Highway Building, Comprehensive, Urged, 422.  
 Highways, National, Proposed, 279.  
 Historic Philadelphia House to Be Razed (Guernsey Mansion), 581.  
 Historic Property Sold, Timothy Ball House, 578.  
 Home Improvement Week, 683.  
 Homes, Million Ready for, in Detroit, 793.  
 Homes, Salvaging Old, 711.  
 Homes for Standard Oil Employees, 685.  
 Homes for Workers Made Possible, 888.  
 Honor Roll Memorial in Chicago, 96.  
 Hospital, American, for London, 857.  
 Hospital Construction in the Future, 315.  
 Hostess Plan at Harvard, 713.  
 Hotel, A Larger "Largest" Proposed, 685.  
 Hotels Pennsylvania and Commodore Rentals Set New Mark, 314.  
 House Building, Motor Car Methods in, 825.  
 House Shortage in Wilmington Ends, 889.  
 Houses the Remedy, More, 462.  
 Houses, Workmen's, in Britain, 683.  
 Housing Appropriation Not All Used, 174.  
 Housing Bill Approved, Philadelphia, 793.  
 Housing Bureau Director Named, New, 352.  
 Housing Campaign to Issue Message, 822.  
 Housing Exposition, 424.  
 Housing Hampered by Michigan's Code, 793.  
 Housing, New Bill Aims for Cheaper, 496.  
 Housing Plan in New London Abandoned, 687.  
 Housing Plan, Co-operative, in Washington Square, New York, 789.  
 Housing Plans to Be Made Public, 553.  
 Housing Poor, Means Big Labor Turnover, 889.  
 Housing Problem Gets More Serious, 716.  
 Housing Problems in America, 550.  
 Housing Problems Serious, Local, 886.  
 Housing Projects, Will Recommend Continuance of, 209.  
 Housing Workers, Need for, Still Great, 391.

## —I—

Illinois Architects' Joint Committee Report on Reconstruction, 65; on Housing, 105.  
 Immigration at Low Mark, 177.  
 Improvements, Should Take Up Public, 142.  
 Industrial Art, America Must Wake Up in, 682.  
 Industrial Art Exhibit, 552.  
 Industrial Arts School Opened, 104.  
 Industrial Co-operation, 30.  
 Industrial Readjustment of Liberated Regions of France, 105.  
 Industrial Training and Foreign Trade, 713.  
 Industrial Unrest, Meeting, 580.  
 "Inharmonious Distribution of Expenditure," 791.  
 Institute Widens Scope of Organization, 522.  
 International Federation of Architecture, 207.  
 Inter-Racial Council Formed, 349.  
 Iron Exports Held Up, 245.  
 Iron Industry, Oldest, 76.  
 Iron, Malleable, Use and Development, 616.  
 Iron Ore in 1918, 460.  
 Italians Place Big Southern Pine Order, 243.  
 Italians to Recover Stolen Art, 885.

## —J—

Japanese Architecture, 759.  
 Japanese Bath Houses, 790.  
 Jerusalem's Architecture, Future of, 347.  
 Jobs for New York's 27th, 493.  
 Jugo-Slavs Build Monument Extension, 856.

## —K—

Kansas City Chapter Meets, 549.

## —L—

Labor, 31.  
 Labor Conditions, Report on, Joint Committee of Illinois Chapter and Illinois Society of Architects, 126.  
 Labor, Imported, Barred, 75.  
 Labor Readjustment Calls for Americanization, 108.

## CURRENT NEWS

(Continued)

- Labor Shortage Holds Up Public Work in France, 791.  
 Labor Situation, Survey of, by Employment Service, 29.  
 Labor Takes Reasonable View, 244.  
 Lafayette's Statue, Inscription for, 421.  
 Landscape Architects Hold Meeting on Reconstruction, 75.  
 Landscape Prize, 549.  
 Lane's Land Plan, to Support, 247.  
 Largest Office Building, The World's, 208.  
 Legal Decisions, 72, 100, 166, 308, 380, 414, 452, 545, 574, 755, 814, 883.  
 Lime, Building, in 1918, 421.  
 Lincoln Highway Markers, Permanent, 714.  
 Loan Market Improving, 417.  
 Loans, Billions Tied Up in Foreign, 615.  
 Loans Sought Here by Other Nations, 180.  
 London's Housing Reform, 713.  
 Los Angeles' Area, 180.  
 Lumber Bureau Protests Freight Charges, 466.  
 Lumber and the Box Industry, 583.  
 Lumber Congress, Hines to Address, 423.  
 Lumber Course Proves of Wide Value, 350.  
 Lumber Demand Arises in London, 278.  
 Lumber Demand Will Tax Mills' Capacity, 579.  
 Lumber Famine, Says World Faces, 712.  
 Lumber Prices in Washington, D. C., 793.  
 Lumber Production in 1918, 716.  
 Lumber Shortage in Italy, 494.  
 Lumber Stock Decreases, Western, 712.  
 Lumber Stocks in France, American, 686.  
 Lumbermen Confer with Government Officials, 352.  
 Luxembourg Museum to Have American Art, 347.
- M-
- Macmonnies Statue at Princeton, 549.  
 Marbles of Italy, 581.  
 March, Building Increases in, 621.  
 March Contracts Show Improvement, 619.  
 Masonry in Ancient Times, 880.  
 Massachusetts Building Program, 229.  
 Material Prices Kept Up After 1865.  
 Material Prices, Wants Specified for Seasons, 582.  
 Materials, Discuss Disposal of Surplus Building, 279.  
 Materials, Surplus Supplies of Building, 279.  
 Materials Testing Research Library, 617.  
 Medal Designs, Ask for New Naval, 275.  
 Medals and Relics, Collecting War, 274.  
 Memorial Armory for Washington Proposed. (See Roosevelt), 716.  
 Memorial Bridge in Maine, 244.  
 Memorial, Civic Type of War, Proposed for Boston, 259.  
 Memorial, Club Plans War, 713.  
 Memorial, Construct Reflection Pool at Lincoln, 826.  
 Memorial, The Dishonest, 684.  
 Memorial Forest, National, 888.  
 Memorial Highways, 31.  
 Memorial to Negro Soldiers and Sailors, 891.  
 Memorial, Rheims, for American Dead, 614.  
 Memorial to U. S. Dead Fliers, 420.  
 Memorial Suggestions, Architects Aid with, 520.  
 Memorial Theaters, 619.  
 Memorials, Advisory Committee on War, 387.  
 Memorials, Aid in Selecting Appropriate War, 461.  
 Memorials, Ask Federation's Aid in Planning, 686.  
 Memorials, Federation Defines Attitude, 858.  
 Memorials, Pamphlet by Municipal Art Society, 581.  
 Memorials, Stirling Calder Discusses, 885.  
 Memorials, War, Cities Deciding on, 176.  
 Memorials, War, Resolution of Ill. Chapter on, 177.  
 Michigan Architects Elect Shilling President, 318.  
 Military Experience, What Architects Taught Him, 486.  
 Mineral Products Score Record, 174.  
 Miniature, Origin of the Word, 825.  
 Mississippi Valley Highway, 884.  
 Model Cities, Planning, 760.  
 Model Towns, British, 144.  
 Models Prepared for Home Builders, 686.  
 Money Costs, Not Material Prices, Retarded Post-War Building, 794.  
 Money Rates, Easier, Noted in Federal Report, 317.  
 Montana Architects Hold Convention, 178.  
 Monument to America's Womanhood, 276.  
 Monument to Chicago Heroes, 614.  
 Morse, George Tremaine, 684.  
 Mortgage Amortization, Campaign for, 491.  
 Mortgages, Wants Stock Exchange to Trade in, 858.  
 Motion Picture Forum, First, 888.
- Municipal Governments, Co-operating with (Work of Illinois Chapter, A. I. A.), 24.  
 Municipal Reconstruction in America, 108.  
 Museum Exhibitions, Art in Trades Shown in, 316.
- N-
- National Academy Officials, 620.  
 National Architectural Society Proposed, 74.  
 National Building Bank, Discuss a, 617.  
 Naturalization in a Year, 423.  
 New Orleans Architects Elect Officers, 277.  
 New Orleans Skyscrapers, 717.  
 New York Apartments Will Cost \$2,000,000, 209.  
 New York Chapter on Memorials, 146.  
 New York City's Waterfront, 277.  
 New York's Construction Program, 426.  
 New York's Oldest Building Going, 856.  
 New York Society of Architects, 245, 494, 621, 762.  
 New York State Association, 761.  
 New York State Board of Registration, 75.  
 New York State Passes Rent Bill, 656.  
 New York State Will Democratize Profession, 620.  
 North Dakota Legalizes Home Building Plan, 421.  
 Norway Gets American Building Materials, 278.  
 Norwegian Exposition Shows American House, 859.
- O-
- O'Brien, Arthur T., Dies, 465.  
 Office Building, Big, Started in New York, 648.  
 Open Market Aids Construction, 718.  
 Optimism Predominates, 175.  
 Organization Aids Business and Technical Workers, 316.  
 "Own Your Own Home" Campaign Plans Announced, 466, 522.
- P-
- Paint Peace Conference Scenes, 348.  
 Paint Manufacturers Association, 619.  
 Park System, Rhode Island Architects Aid, 497.  
 Pavement, Keep Intact Five Years, 577.  
 Partnership Discrimination in Income Tax Bill, 208.  
 Peace Time Problems, Meeting, 143.  
 Pennsylvania Architects Meet, 621.  
 Pershing Highway, 521.  
 Pershing Stadium Will Be Erected, 549.  
 Perseus, Famed, Is Uncovered, 549.  
 Philadelphia Needs 20,000 New Houses, 713.  
 Philadelphia Plans War Memorial, 424.  
 Pine Men Refuse Prices, 553.  
 Pittsburgh Chapter Meeting, 497.  
 Plan for Federal Body to Supervise Industry, 107.  
 Plywood Manufacture, Improve Methods of, 463.  
 Political League, New Home for, 648.  
 Pope's Statue for Pershing, 178.  
 Portland's Extensive Building, 521.  
 Portrait Gallery, Gift for a, 30.  
 Post Office Building Contracts, Urge Award of, 318.  
 Post-War Committee, 520.  
 Post-War Committee Program, 291.  
 Posters Issued by Department of Labor to Stimulate Building, 210.  
 Post-War Committee, 388.  
 Post-War Committee Activities, 497.  
 Post-War Problems, To Study, 207.  
 Pottery, New British, 618.  
 Pottery Study, Pursue, 461.  
 Price of Basic Materials, To Stabilize, 388.  
 Price History of the War, 387.  
 Price Levels Following the War, 714.  
 Price Movements Favor Builders, 466.  
 Prices Doubled Since 1914, 685.  
 Prices, False Economy to Await Lower, 417.  
 Prices Reduced to Aid Building, 389.  
 Prices, Stabilizing Market, 496.  
 Prices and Wages to Continue High, 101.  
 Prices Yesterday, Today and Tomorrow, 720.  
 Prisoners Manufacture Road Signs, 464.  
 Progress Toward Resumption of Normal Conditions, 108.  
 Prosperity, Making Permanent, 349.  
 Prohibition, Another Need Emphasized by, 620.  
 Public Undertakings to Be Pushed to Completion, 348.  
 Public Works Urged to Avert Idleness, 248.
- R-
- Railroad Administration Aids Homeseekers, 651.  
 Railroad Income Short One-fourth, 345.  
 Railways, Capital in American, 279.
- Raw Materials Should Not Be Sacrificed, 74.  
 Reconstruction of Detroit's Blocks, 493.  
 Reconstruction, International, 29.  
 Red Tape in City Management, 617.  
 Re-education of Disabled Soldiers and Sailors, 130.  
 Reforestation in Europe, 577.  
 Reforestation, Helping France in, 421.  
 Registration of Architects, Minnesota Proposes, 583.  
 Registration of Michigan Architects, 681.  
 Registration Laws, To Unify State, 762.  
 Rehabilitation Bonds, 102.  
 Rents, High, Speed Building, 619.  
 Rents Likely to Increase, 102.  
 Reserve Officers to Be Trained, 106.  
 Residence, Historic Salt Lake, to Be Razed, 317.  
 Responsibility for Safe Building Construction, 313.  
 Responsibility, Our Immediate, 420.  
 Rheims Cathedral, Past and Present, 759.  
 Rheims Construction to Cost Billion Dollars, 760.  
 Rhode Island Chapter Meeting, 178, 620.  
 Roads, Improved, and Congress, 274.  
 Roads and Merchandise Traffic, Good, 313.  
 Roof Landing for Planes, 717.  
 Roosevelt Birthplace Bought, 493.  
 Roosevelt Memorial Bird Fountain, 350.  
 Roosevelt Memorial Exhibition, 462.  
 Roosevelt Exhibit, 614.  
 Roosevelt Memorial, Belleau Wood as, 614.  
 Roosevelt Memorial Bill, 614.  
 Roosevelt Memorial Road, 608.  
 Roosevelt Memorial to Teach Living Service, 613.  
 Roosevelt National Park, Redwood District to Be Known as, 178.  
 Roosevelt Park, Oyster Bay Plans, 246.  
 Rotch Traveling Scholarship, 552.  
 Rubber Supply, The World's, 30.  
 Russia Loses Works of Art, 758.  
 Russian Housing Difficulties, 760.
- S-
- Sacramento Capitol Extension Delayed, 578.  
 Sacramento State Buildings Competition, 124.  
 Salt Lake Predicts Building Boom, 348.  
 San Francisco Schools to Cost \$1,059,000, 464.  
 School Building Contracts Awarded by Group Method, 140.  
 School House Problem, 521.  
 Scotland, Report of Royal Commission on Housing in, 179.  
 Seattle Builders Elect Officers, 178.  
 Seattle to Experiment in Color, 651.  
 Seaweed Aids British Building, 615.  
 Service, Coming Extension of Architectural, 271.  
 "Shadows and Straws," Again, 146.  
 Shingles, Wooden, Permitted, 823.  
 Short Notes of News Interest, 275.  
 Situation Improved, Teague Reports, 464.  
 Skyscrapers, Weight of New York, 179.  
 Soldier Not to Be Discharged Against His Will, 246.  
 Soldiers, Disabled, Studying Architecture, 687.  
 Soldiers, Employment of, 74.  
 Soldiers Increase Home Shortage, 619.  
 Soldiers, Placing Disabled, 422.  
 Soldiers and Sailors, Retraining Disabled, 464.  
 Soldiers Studying French Art, Our, 550.  
 Soldiers for Suburban Development, 179.  
 Soldiers Trade School at Camp Dix, 143.  
 Southern California Chapter, A. I. A., 32, 245, 519, 649.  
 Stabilization of Commodity Prices, 523.  
 Stabilization Plan, To Formulate, 622.  
 Standardization as Aid to Price Reduction, 346.  
 State Board of Architecture, Would Create, 276.  
 Statistics, Industrial, Greatness of U. S. Exemplified in, 791.  
 Statuary Costing \$125 Worth \$25,000, 649.  
 Steel Center, New York, World's? 649.  
 Steel Industry Slowing Down, 175.  
 Steel Men Win Fight for "Open" Prices, 688.  
 Steel Orders Smallest Since Oct., 1915, 274.  
 Steel Price Lowering Looked For, 312.  
 Steel Price, New, 524.  
 Steel Society, New Branch for, 145.  
 Steel, Structural, 208.  
 Steel Trade, Note Rise in, 145.  
 Steel Workers' Wages Not to Be Cut, 208.  
 Stone, Artificial, from Mica and Clay, 824.  
 Structural Materials, Testing, 418.  
 Survey of Available Space for Housing, 759.
- T-
- Tenement House Bill, Vote to Support, 318.  
 Tent Camps, Stop Work on, 29.  
 Tent City to Provide Housing? 616.



## CURRENT NEWS

(Continued)

Theater Curtain a Mirror, 856.  
Theater, Pawtucket's Civic, 759.  
Things to Remember as a Result of Victory, 29.  
Three-Family Bill to Become a Law, 426.  
Timber Markets, South African, 577.  
Timber Shortage, Britain's, 823.  
Timidity, Scores Business, 345.  
Trade Agents Wanted Abroad, 106.  
Trade, New Organization to Expand, 579.  
Training, Seven Million Workers Need, 790.  
Treasury Department Calls for Money, 243.  
Treasury Requirements, More Certificates for, 142.  
Tree Planting in New Bedford, Mass., 711.  
Trees, Cut Out Park's Dead, 314.  
Trees, Planting in Farm Gullies, 617.  
Trees, Urging Planting of, 144.

## —U—

Unemployed, Jobs for, 417.  
Unemployment Exaggerated, 420.  
Unemployment, Fight by Constructing Homes, 419.  
U. S. to Finish Philadelphia Houses, 243.  
U. S. Selling Agency to Market Timber, 144.

—V—  
Venice Since the War, 856.  
Victory Emblem, Devises New, 577.  
Victory, Responsibilities of, 390.

## —W—

Wage Scale for Construction in Washington, D. C., 762.  
Wage Standardization and Administration, 247.  
Wages, Reduced, and Building Resumption, 459.  
Walls, How the Ancients Built, 486.  
War, After the, 30.  
War Boomed Building, 273.  
War Contract Adjustments Recommended, 315.  
War Debt, To Pay, 492.  
War History, Asks Data for Compiling, 423.  
War Pictured in Natural Colors, 856.  
War, Saving During the, 345.  
War Trade Balances, 345.  
Washington Architects Optimistic, 497.  
Washington Chapter Sponsors Bill to Regulate Use of Title, 520.  
Washington Hears of Much Building, 246.

Washington Memorial Discussed, 425.  
Washington State Chapter Elects Officers, 207.  
Waste, Elimination of, Due to Building Codes, 128.  
Waste Reclamation Section Made Permanent, 179.  
Weights and Measures, Origin of English, 790.  
Wicks, Wm., 856.  
Wilson to Dedicate French Memorial Site, 790.  
Window, Newark, Designed by R. A. Cram, 580.  
Women as Naval Architects, 793.  
Wood, Purple, from Panama, 76.  
Wood Wastes Utilized to Conserve Lumber Supply, 463.  
Work, Where, Is Waiting, 582.  
World Capitol, Plans for, 107.  
World Trade, Growth of in Century, 197.

## —Z—

Zinc, City Built of, 577.  
Zone Ordinance in Alameda, 551.  
Zone Restrictions to Be Urged, 858.  
Zones, Building, for Ohio, 419.  
Zoning System, Many Cities Adopt, 178.

## TEXT ACCORDING TO AUTHORS

*Figures refer to text pages*

## —A—

Abrams, Duff A.:—  
Effect of Time of Mixing on the Strength of Concrete, 85.  
Allen, John R.:—  
Test of the Conductivity of Window Shades, 561.  
Ashford, Snowden:—  
Build Now? 517.

## —B—

Bach, Richard F.:—  
Developing the American Craftsman, 484.  
Ballinger & Perrot:—  
Cabinet Factory, Victor Talking Machine Co., Camden, N. J., 109.  
Bamberger, Simon:—  
Improving Farm Buildings, 22.  
Barnett, Tom B.:—  
Federating Architecture, 21.  
Blackall, C. H.:—  
Architecture After the War: Architectural Education, 7.  
Organization, 89.  
Efficiency, 331.  
What Is an Architect? 481.  
Bossom, Alfred E.:—  
Colonial Trust Co., Building, Philadelphia, Pa., 877.  
Bosworth, Welles:—  
Scarboro-on-Hudson School, 477.  
Boyd, D. Knickerhacker:—  
Structural Service, 233.  
Brazier, Clarence Wilson:—  
Future of Government Villages, 219.  
Brinton, Selwyn:—  
Notes from London, 599, 739.  
Brockway, A. L.:—  
Observations on Types of Memorials, 511.  
Brown, Frank Chouteau:—  
Civic Type of War Memorial, 259.  
Brown, W. S.:—  
Daylight vs. Sunlight in Sawtooth Roof Construction, 33.  
Butler, Howard Russell:—  
Leadership in Art, 342.

## —C—

Casey, Edward Pearce:—  
Architect and Engineer, 27.  
Corbett, Harvey Wiley:—  
Beauty and Economics, 11.

## —D—

Dana, Richard Henry, Jr.:—  
The Group House, Advantages and Possibilities, 163.  
Davidson, F. E.:—  
Architectural Advertising, 26.  
Buildings a Factor in Production Costs, 810.  
Some Aspects of Modern Contracting, 236.  
Deyo, J. Albert:—  
Water Supply in Garage Basements, 861.  
Dix, Henry N.:—  
Equivalent Temperature of Guaranteed Steam and Hot Water Heat, 358.

Notes on Chimney Flues, 530.  
Dobbin, C. E.:—  
Swimming Pools for Public Schools, 319.  
Public School Buildings, Standardization of Plans for, 892.  
Dow, Joy Wheeler:—  
Sparrow House and Rabbit House, 505.  
The Villa Borghese, 837.  
Dundlap, Elmore:—  
Waste Due to Building Codes, 375.

## —E—

Eckland, Henry C.:—  
Practice of Architecture, 169.  
Edwards & Sayward:—  
Practice of Architecture, 72.  
Art of Planning, 376.  
Edwards, W. A.:—  
Architectural Practice, 170.  
Ellis, Wm. Marshall:—  
The Office Building Outlook, 17.

## —F—

Franklin, M. S.:—  
Civic Type of War Memorial, Boston, 259.  
Friederang, Maximilian F.:—  
Development of Ornamental Plasterwork, 536.  
Furber, Pierce:—  
Building Codes, 491.

## —G—

Garber, Frederic W.:—  
Educating for Architectural Practice, 9.  
Godley, Haskell & Sedgwick:—  
Housing Development Solves Lodger Problem, 565.  
Granger, Alfred H.:—  
Architect of Tomorrow, 91.  
Grant, W. Francis:—  
Specification Clauses, 570.  
Grey, Elmer:—  
International Conference, 170.

## —H—

Harmon, Arthur Loomis:—  
Allerton House, 773.  
Hastings, Thomas:—  
Architects as Bridge Builders, 23.  
Hebble, F. J.:—  
Arch of Democracy in Brooklyn, 94.  
Higgins, Daniel Paul:—  
Architectural Office Organization for Post-War Conditions, 13, 60.  
Holmes & Flinn:—  
"Skin Specialists," 343.  
Holsman, Henry K.:—  
Circular of Advice, 367.  
Hopper, Thomas T.:—  
Architect and the Builder, 543.  
Hoxie, Frederick J.:—  
Roof Construction for Factories with Excessive Moisture, 181.  
Hutchinson, Woods:—  
Building for Health, 121.

## —I—

Ives, F. W.:—  
Farm Improvement, 611.

## —J—

Jewell, Edwin S.:—  
How Office Building Managers Have Met War Conditions, 19.  
Jones & Furbringer:—  
Practice of Architecture, 169.

## —K—

Kahn, Albert:—  
Allied Conference of Architects, 99.  
Kilham & Hopkins:—  
Federating Architecture, 170.  
Kohn, Robert D.:—  
Post-War Committee Program Architectural Practice, 291.  
Review of Post War Committee's Activities at Nashville Convention, 735.  
Post War Committee, 375.  
Standardization of Building Products, 499.  
Kunze, E. A.:—  
Short Cuts to Calculations, 865.

## —L—

LaFarge, C. Grant:—  
Government Housing, What Will Follow, 55.  
Lavanoux, M.:—  
Rebuilding St. Gervais, 21.  
Lee, Edward B.:—  
International Conference, 170.  
Lockwood, Greene & Co.:—  
Practice of Architecture, 71.

## —M—

Maher, George W.:—  
Farm Buildings, Improvement of, 453.  
Mayer, Gordon E.:—  
Italian House at Miami, Florida, 805.  
McKim, Mead & White:—  
Hotel Pennsylvania, 297.  
Millard, Julian:—  
Architectural Practice, 631.  
Miller, Woolley & Evans:—  
Automobile Center, Salt Lake City, 281.  
Morgan & Dillon:—  
Practice of Architecture, 99.  
Morgan, Walls & Morgan:—  
Practice of Architecture, 271.  
Murphy, J. C.:—  
Why Not Build Now? 485.

## —O—

Olin, Herbert Scott:—  
Competitions, 612.

## —P—

Perrot, Emile:—  
Practice of Architecture, 71.  
Polk, Willis:—  
Architects and Engineers, 6.  
Law of Supply and Demand, 173.  
We Are Going to Build, 6.  
Pond, Irving K.:—  
Federating State Societies, 203.



## TEXT ACCORDING TO AUTHORS (Continued)

—R—  
Rankin, John Hall:—  
Sacramento Competition, 344.

—S—  
Schenck & Williams:—  
Practice of Architecture, 71.  
Schweinfurth, J. A.:—  
Mill Creek Park, Youngstown, Ohio, 869.  
Shaw, Alfred P.:—  
An American Architect in France, 333.  
Smith, Hinchman & Grylls:—  
Practice of Architecture, 375.  
Smith, Wm. Graves:—  
Quantity Survey, 170, 204, 491.  
Stickney, G. H.:—  
Present Status of Industrial Lighting Codes, 694, 771.

Swan, Herbert S.:—  
Industrial Zoning, 500.  
Planning Sunlight Cities, 427.  
Zoning the Billboard in New York, 288.

—T—  
Tait, W. Stuart:—  
Useless Waste in Concrete Construction Due to Legal Requirements, 79, 147, 187, 211, 254.  
Tallmadge, Thomas E.:—  
Architectural History of a Western Town, 443.  
Taylor, A. D.:—  
Garage and Entrance Turns, 699, 777.

—V—  
Varon, David J.:—  
Analyzing the Development in American Architecture, 405.

—W—  
Waid, D. Everett:—  
Registration of Architects, 738.  
Ware, F. B. and A.:—  
Gateway of the Nation, 603.  
Warren & Wetmore:—  
Hotel Commodore, 337.

—Y—  
Young, Thomas Crane:—  
Architectural Advertising, 26.  
Architectural Competitions, 311.  
Architecture and Engineering, 403.

## CRITICISM AND COMMENT

*Figures refer to text pages*

Allied Conference of Architects. By Albert Kahn, 99.  
Art, Leadership in. By Howard Russell Butler, 342.  
Build Now? By Snowden Ashford, 517.  
Building Codes. By Pierce Furber, 491.  
Competitions. By Herbert Scott Olin, 612.  
Farm Buildings. Architectural Improvement of (Letters from Agricultural Colleges), 377.  
Farm Improvement. By F. W. Ives, 611.  
Farm Buildings, Improving. By Simon Bamberger, Gov. Utah, 22.

Federating Architect. By Tom P. Barnett, 21.  
Federating State Societies. By Irving K. Pond, 203.  
Planning, Art of. By Edwards & Sayward, 376.  
Post-War Committee. By Robert D. Kohn, 375.  
Practice of Architecture. By Schenck & Williams, Emile Perrot, Lockwood, Greene & Co., Edwards & Sayward, 71; Morgan & Dillon, 99; Henry C. Eckland, Jones & Furbringer, Wm. Graves Smith, Kilham & Hopkins, Edward B. Lee, Elmer Grey,

W. A. Edwards, 169, 170; Morgan, Walls & Morgan, 271; Smith, Hinchman & Grylls, 375.  
Quantity Surveyor. By Wm. Graves Smith, 170, 204, 491.  
Quantity System. By Francis W. Grant, 343.  
Sacramento Competition. By John Hall Rankin, 344.  
"Skin Specialists." By Holmes & Flinn, 343.  
To Aid a Worthy Cause (Rebuilding St. Gervais). By M. Lavanoux, 21.  
Waste Due to Building Codes. By Elmore Dunlap, 375.

## DEPARTMENT OF ARCHITECTURAL ENGINEERING

*Figures refer to text pages*

A. S. M. E. Code for Low-Pressure Boilers, 212.  
Architect, Specialist and General Practitioner, 631.  
Architectural Practice. By Julian Millard, 631.  
Automatic Sprinklers, New Code for, 588.  
Automobile Center, Social Hall Ave., Salt Lake City. By Miller, Woolley & Evans, Architects, 281.  
Back Venting vs. Simplified Plumbing, 795.  
Building Contract of the Future, 595.  
Building a Home for an Industry, 467.  
Building Codes, Amending, 664.  
Cabinet Factory, Victor Talking Machine Co., Camden, N. J. By Ballinger & Perrot, Architect, 109.  
Calculations. Short Cuts to Accurate. By E. C. Kunze, Architect, 865.  
Chimney Flues, Notes on. By Henry N. Dix, 530.  
Code, Building Department and Architect, 398.  
Code Committee Meeting, 256.  
Code Revision, Important, 149.  
Concrete, Physical Properties of Dense, 867.  
Concrete Reinforced in Office Building Construction, 900.  
Conductivity of Window Shades. By John R. Allen, 561.  
Correct Proportioning of Concrete Mixes, 721.  
Daylight vs. Sunlight in Sawtooth Roof Construction. By W. S. Brown, 33.

Double Stairway, Its Design and Construction, 557.  
Duty to Your Profession, 153.  
Effect of Lime on Strength of Cement Mortar, 152.  
Effect of Time of Mixing on the Strength of Concrete. By Prof. Duff A. Abrams, 85.  
Electricity, Importance of, in Largest Hotel, 734.  
Engineering Societies Employment Bureau, 151.  
Engineering Unity, 562.  
Equivalent Temperature of Guaranteed Steam and Hot Water Heat. By Henry N. Dix, 358.  
Factory Roof Timbers, 868.  
Flat Slab Construction, 288.  
Ford Shipbuilding Plant, River Rouge, Mich., 526.  
Forest Products Laboratory and the Architect, 663.  
Friendly Possibilities of Engineering Societies, 150.  
Industrial Lighting Codes, Present Status of. By G. H. Stickney, 694, 771, 835.  
Planning Sunlight Cities. By Swan & Tuttle, 427.  
Printing Trades, Modern Buildings for, 691.  
Public School Buildings, Standardization of Plans for. By C. E. Dobbin, 893.  
Quantity House Production Methods, Con-

struction Branch, Emergency Fleet Corporation, 353, 393.  
Reinforced Concrete Building Stands Extreme Overload, 768.  
Reinforced Concrete Tests, 733.  
Research Graduate Assistantships, 287.  
Roof Construction for Factories with Excessive Moisture. By Frederic J. Hoxie, 181.  
Standard Elementary School Medical Clinic, 564.  
Standard School House Equipment, 625, 657.  
Standardization of Building Products. By Robert D. Kohn, 498.  
Statically Indeterminate Structures, Analysis of, 836.  
Structural Material Made of Thin Sheet Steel, 249.  
Swimming Pools for Public Schools. By C. E. Dobbin, 319.  
Underwriters Laboratories, Second Report, 892.  
Unusual Concrete Construction, 563.  
Useless Waste in Concrete Construction Due to Legal Requirements. By W. Stuart Tait, 79, 147, 187, 211, 254.  
Warm Air Furnaces for House Heating, 765.  
Water Supply in Garage Basements. By J. Albert Deyo, 861.  
Wisconsin Industrial Lighting Code, 500.  
Zoning the Billboard in New York. By Herbert Swan, 288.  
Zoning, Industrial. By Herbert S. Swan, 500.

## BOOK REVIEWS

*Figures refer to text pages*

Architecture and Democracy. By Claude Bragdon, 411.  
Formal Garden, 408.

Mathematics, Handbook for Engineers, 504.  
Meaning of Architecture, 875.  
Applied Mechanics, 503.

Automatic Sprinkler Protection, 504.  
School Building Program for Cities, 154.

## ILLUSTRATIONS ACCORDING TO AUTHORS

*Figures refer to the number of the issue, not to the text pages*

- Baum, Dwight James:—  
House of O. L. Schwenke, Bayshore, L. I., N. Y., 2264.
- Bosson, Alfred E.:—  
Colonial Trust Co., Philadelphia, Pa., 2270.
- Bosworth, Welles:—  
Vanderlip School in Scarborough-Hudson, N. Y., 2258.
- Brockway, A. T.:—  
Court of Nations, Syracuse, N. Y., 2262.
- Cobb, A. W., and A. H. Lavelle:—  
Victory Federal Building, Springfield, Mass., 2257.
- Cook, Horace:—  
John Kinsey School, Philadelphia, Pa., 2245.  
Oliver Wendell Holmes School, Philadelphia, Pa., 2246.
- Coolidge & Carlson:—  
Free Hospital for Women, Brookline, Mass., 2245.  
House of Henry A. Morss, Marblehead, Mass., 2245.  
House of Mr. Burton P. Gray, Newton Centre, Mass., 2257.  
House of Miss Winsor, Newton Centre, Mass., 2257.
- Dennison & Hiron:—  
First National Bank, St. Johnsville, N. Y., 2249.
- Donohue, John William:—  
School of Our Lady of Hope, Springfield, Mass., 2265.
- Eames & Young:—  
Warehouse for Washington University, St. Louis, Mo., 2249.
- Glidden, Edward Hughes:—  
Furness House Baltimore, Md., 2252.
- Godley, Haskell & Sedgwick:—  
Naval Ordnance Housing Development, South Charlestown, W. Va., 2261.
- Harmon, Arthur Loomis:—  
Allerton House, New York, 2267.  
Gallery for Cleveland Museum of Art, 2259.  
House of Wm. H. Reid, Springdale, Conn., 2259.  
Apartment House, New York, 2265.
- Hart, Henry C.:—  
Office Building for Cosden & Co., Tulsa, Okla., 2270.
- Hastings, Thomas:—  
Arch of Freedom, New York, 2247.  
Arch of Victory, New York, 2262.
- Helmle & Corbett:—  
Arch of Democracy, Brooklyn, N. Y., 2247.
- Jaekle, W. L.:—  
Church of the Holy Rosary, Dayton, Ohio, 2256.
- Jones & Furbringer:—  
High School, Lucy, Tenn., 2246.  
House of Dr. Robert Fagin, Memphis, Tenn., 2252.  
House of John R. Flippin, Memphis, Tenn., 2257.  
House of J. W. Wyatt, Memphis, Tenn., 2249.
- Kahn, Albert:—  
Ford Building, New York, 2255.
- Karper, Louis:—  
Office Building, Detroit, Mich., 2260.
- Koch & Wagner:—  
People's National Bank, Brooklyn, N. Y., 2265.
- Lott, Louis:—  
House of Dr. E. S. Breeze, Dayton, Ohio, 2257.
- Ludlow & Peabody:—  
Training School & Home for Young Girls, Brooklyn, N. Y., 2266.
- Mayer, Gordon E.:—  
House of Charles L. Briggs, Miami, Fla., 2268.
- McKim, Mead & White:—  
Hotel Pennsylvania, New York, 2253.
- Ogden & Candler:—  
Proposed Soldiers Memorial for Chicago, 2262.
- Pope, John Russell:—  
House of Allan S. Lehman, Tarrytown, N. Y., 2250.
- Price & McLanahan:—  
Musical Arts Building, Philadelphia, Pa., 2260.
- Reiley & Steinback:—  
Garage for Edward C. Schaefer, Premium Point, N. Y., 2266.
- Rubush & Hunter:—  
Hotel Lincoln, Indianapolis, Ind., 2251.
- Sauter, Roland F.:—  
First Presbyterian Church, Santa Barbara, Cal., 2263.
- Schweinfurth, J. A.:—  
Tod Homestead Cemetery, Youngstown, Ohio, 2269.
- Schermerhorn, C. E.:—  
House and Garage of F. A. Schick, Bethlehem, Pa., 2269.
- Siebert, John S.:—  
Cullen School, Cardiff, Cal., 2246.
- Study, Guy:—  
Allies Shop, St. Louis, Mo., 2256.
- Warren & Wetmore:—  
Commodore Hotel, New York, 2254.
- Zimmerman, Saxe & Zimmerman:—  
Building for Thomas Cusack & Co., New York, 2245.

## ILLUSTRATIONS ACCORDING TO SUBJECT

- Apartment Houses**  
Allerton House, New York. Arthur Loomis Harmon, Architect, 2267.  
Apartment House, 78th St. and West End Ave., New York. Arthur Loomis Harmon, Architect, 2265.
- Administrative and Governmental**  
Sacramento, Cal., State Buildings Competition. Weeks & Day, Dennison & Hiron, Hewitt, Ash & Curtis, Bliss & Faville, Adolph Sherrer, Tracy & Swartwout, Ward & Blohme, Architects, 2248.
- Banks**  
Bank, Building for People's National, Brooklyn, N. Y. Koch & Wagner, Architects, 2265.  
Colonial Trust Co., Philadelphia, Pa. Alfred C. Bosson, Architect, 2270.  
First National Bank, St. Johnsville, N. Y. Dennison & Hiron, Architects, 2249.
- Beaux Arts**  
Beaux Arts, 2248, 2255, 2259, 2266, 2267, 2269.
- Ecclesiastical**  
Church of the Holy Rosary, Dayton, Ohio. W. L. Jaekle, Architect, 2256.  
First Presbyterian Church, Santa Barbara, Cal. Roland F. Sauter, Architect, 2263.
- Educational**  
Training School and Home for Young Girls, Brooklyn, N. Y. Ludlow & Peabody, Architects, 2266.  
School on Estate of Frank A. Vanderlip, Scarborough-on-Hudson, New York. Welles Bosworth, Architect, 2258.  
Cullen School, Cardiff, Cal. John S. Siebert, Architect, 2246.  
High School, Lucy, Tenn. Jones & Furbringer, Architects, 2246.  
John Kinsey School, Philadelphia, Pa. Horace Cook, Architect, 2245.  
Oliver Wendell Holmes School, Philadelphia, Pa. Horace Cook, Architect, 2246.  
School of Our Lady of Hope, Springfield, Mass. John William Donohue, Architect, 2265.
- Frontispieces**  
Entrance to the Hall of the Ambassadors, The Alhambra, Granada, Spain, 2245.  
Courtyard, The Royal Palace, Guadalajara, Spain, 2246.  
Cloister of the Cathedral, Tarragona, Spain, 2247.  
Detail, The Alcazar, Seville, Spain, 2248.
- Courtyards**  
Courtyard, Convent of St. Thomas, Avila, Spain, 2249.
- Hotels**  
Commodore Hotel, New York. Warren & Wetmore, Architects, 2254.  
Hotel Lincoln, Indianapolis, Ind. Rubush & Hunter, Architects, 2251.  
Hotel Pennsylvania, New York. McKim, Mead & White, Architects, 2253.
- Manufacturing and Industrial**  
Building for Thomas Cusack Co., New York. Zimmerman, Saxe & Zimmerman, Architects, 2245.  
Ford Building, New York. Albert Kahn, Architect, 2255.  
Furness House, Baltimore, Md. Edward Hughes Glidden, Architect, 2252.  
Garage for Edward C. Schaefer, Premium Point, N. Y. Reiley & Steinback, Architects, 2266.  
Office Building, Detroit, Mich. Louis Kamper, Architect, 2260.  
Office Building for Cosden & Co., Tulsa, Okla. Henry F. Hart, Architect, 2270.  
Warehouse Building for Washington University, St. Louis, Mo. Eames & Young, Architects, 2249.
- Miscellaneous**  
Allies' Shop, St. Louis, Mo. Guy Study, Architect, 2256.
- Monumental**  
Arch of Democracy, Brooklyn, N. Y. Helmle & Corbett, Architects, 2247.  
Arch of Freedom, New York. Thomas Hastings, Architect, 2247.  
Arch of Victory, New York. Thomas Hastings, Architect, 2262.  
Court of Nations, Syracuse, N. Y. A. L. Brockway, Architect, 2262.  
Polachek Memorial Tablet Competition, 2264.  
Soldiers Memorial, Suggested for Chicago. Ogden & Candler, Architects, 2262.  
Tower of Jewels, New York, 2262.
- Residential**  
House of Dr. E. S. Breeze, Dayton, Ohio. Louis Lott, Architect, 2257.  
House of Charles L. Briggs, Miami, Florida. Gordon E. Mayer, Architect, 2268.  
House of Dr. Robert Fagin, Memphis, Tenn. Jones & Furbringer, Architects, 2252.  
House of John R. Flippin, Memphis, Tenn. Jones & Furbringer, Architects, 2257.  
House of Burton P. Gray, Newton Centre, Mass. Coolidge & Carlson, Architects, 2257.  
House of Allen S. Lehman, Tarrytown on the Hudson. John Russell Pope, Architect, 2250.  
House of Henry A. Morss, Marblehead, Mass. Coolidge & Carlson, Architects, 2245.  
House of Wm. H. Reid, Springdale, Conn. Arthur Loomis Harmon, Architect, 2259.  
House of O. L. Schwenke, Jr., Bayshore, Long Island, N. Y. Dwight James Baum, Architect, 2264.  
House and Garage of F. A. Schick, Bethlehem, Pa. C. E. Schermerhorn, Architect, 2269.  
House of Miss Winsor, Newton Centre, Mass. Coolidge & Carlson, Architects, 2257.  
House of J. W. Wyatt, Memphis, Tenn. Jones & Furbringer, Architects, 2249.



## ILLUSTRATIONS ACCORDING TO LOCATION

*Figures refer to the number of the issue, not to the text pages*

**California—**

- Cardiff:—  
Cullen School. John S. Siebert, Architect, 2246.  
Sacramento:—  
State Buildings Competition, 2248.  
Santa Barbara:—  
First Presbyterian Church. Roland F. Sauter, Architect, 2263.

**Connecticut—**

- Springdale:—  
House of Wm. H. Reid. Arthur Loomis Harmon, Architect, 2259.

**Florida—**

- Miami:—  
House of Charles L. Briggs. Gordon E. Mayer, Architect, 2268.

**Illinois—**

- Chicago:—  
Proposed Soldiers Memorial. Ogden & Candler, Architects, 2262.

**Indiana—**

- Indianapolis:—  
Hotel Lincoln. Rubush & Hunter, Architects, 2251.

**Maryland—**

- Baltimore:—  
Furness House. Edward Hughes Glidden, Architect, 2252.

**Massachusetts—**

- Brookline:—  
Free Hospital for Women. Coolidge & Carlson, Architects, 2245.  
Marblehead:—  
House of Henry A. Morse. Coolidge & Carlson, Architects, 2245.  
Newton Centre:—  
House of Burton P. Gray. Coolidge & Carlson, Architects, 2257.  
House of Miss Winsor. Coolidge & Carlson, Architects, 2257.  
Springfield:—  
School of Our Lady of Hope. John William Donohue, Architect, 2265.  
Victory Federal Building. A. W. Cobb and A. H. Lavelle, Architects, 2257.

**Michigan—**

- Detroit:—  
Office Building. Louis Kamper, Architect, 2260.

**Missouri—**

- St. Louis:—  
Warehouse for Washington University. Eames & Young, Architects, 2249.  
Allies' Shop. Guy Study, Architect, 2256.

**New York—**

- Bayshore, L. I.:—  
House of O. L. Schwenke. Dwight James Baum, Architect, 2264.  
Brooklyn:—  
Arch of Democracy. Helmle & Corbett, Architects, 2247.  
Training School and Home for Young Girls. Ludlow & Peabody, Architects, 2266.  
People's National Bank. Koch & Wagner, Architects, 2265.  
New York:—  
Building for Thomas Cusack & Co. Zimmerman, Saxe & Zimmerman, Architects, 2245.  
Allerton House. Arthur Loomis Harmon, Architect, 2267.  
Apartment House, 76th St. & West End Ave. Arthur Loomis Harmon, Architect, 2265.  
Commodore Hotel. Warren & Wetmore, Architects, 2254.  
Ford Building. Albert Kahn, Architect, 2255.  
Tower of Jewels, 2262.  
Arch of Victory. Thomas Hastings, Architect, 2262.  
Hotel Pennsylvania. McKim, Mead & White, Architects, 2253.  
Arch of Freedom. Thomas Hastings, Architect, 2247.  
Johnsville:—  
First National Bank. Dennison & Hiron, Architects, 2249.  
Premium Point:—  
Garage for Edward C. Schaefer. Reiley & Steinback, Architects, 2266.  
Scarboro-on-Hudson:—  
Vanderlip School. Welles Bosworth, Architect, 2258.

**Tarrytown on the Hudson:—**

- House of Allan S. Lehman. John Russell Pope, Architect, 2250.  
Syracuse:—  
Court of Nations. A. L. Brockway, Architect, 2262.

**Ohio—**

- Cleveland:—  
Gallery in Cleveland Museum of Art. Arthur Loomis Harmon, Architect, 2259.  
Dayton:—  
House of Dr. E. S. Breese. Louis Lott, Architect, 2257.  
Church of the Holy Rosary. W. L. Jaekle, Architect, 2256.  
Youngstown:—  
Tod Homestead Cemetery. J. A. Schweinfurth, Architect, 2269.

**Oklahoma—**

- Tulsa:—  
Office Building for Cosden & Co. Henry C. Hart, Architect, 2270.

**Pennsylvania—**

- Bethlehem:—  
House and Garage of F. A. Schick. C. E. Schermerhorn, Architect, 2269.  
Philadelphia:—  
Colonial Trust Co. Alfred C. Bossom, Architect, 2270.  
Musical Arts Club. Price & McLanahan, Architects, 2260.  
John Kinsey School. Horace Cook, Architect, 2245.  
Oliver Wendell Holmes School. Horace Cook, Architect, 2246.

**Tennessee—**

- Lucy:—  
High School. Jones & Furringer, Architects, 2246.

**Memphis:—**

- House of Dr. Robert Fagin. Jones & Furringer, Architects, 2252.  
House of John R. Flippin. Jones & Furringer, Architects, 2257.  
House of J. W. Wyatt. Jones & Furringer, Architects, 2249.

**West Virginia—**

- South Charleston:—  
Naval Ordnance Housing Development. Godley, Haskell & Sedgwick, Architects, 2261.



PAVILION AT BOAT LANDING  
HOUSE OF CHARLES L. BRIGGS, MIAMI, FLA.  
GORDON E. MAYER, ARCHITECT



4. 11. 1901

100

100

100



ENTRANCE TO THE HALL OF THE AMBASSADORS, THE ALHAMBRA, GRAN-  
ADA, SPAIN

*THE AMERICAN ARCHITECT*

# THE AMERICAN ARCHITECT

Founded 1876

VOL. CXV

WEDNESDAY, JANUARY 1, 1919

NUMBER 2245

PUBLISHED EVERY WEDNESDAY BY  
THE ARCHITECTURAL AND BUILDING  
PRESS, INC.

No. 243 West Thirty-ninth Street, New York

E. J. ROSENCRANS, PRESIDENT AND TREASURER  
WILLARD C. HOWE, VICE-PRESIDENT

WILLIAM H. CROCKER, Editor  
ARTHUR T. NORTH, Engineering Editor

Subscriptions in the United States and Possessions,  
Mexico and Cuba, TEN DOLLARS. Other Countries,  
TWELVE DOLLARS  
SINGLE COPIES (Regular Issue) 25 CENTS

CHICAGO OFFICE, Mallery Building. PAGE A. ROBIN-  
SON, Western Manager. ST. LOUIS OFFICE, Wright  
Building. CLEVELAND OFFICE, Guardian Building.  
SAN FRANCISCO OFFICE, 320 Market Street.

Owned by United Publishers Corporation—H. M. Swetland, President;  
Charles G. Phillips, Vice President; W. H. Taylor, Treasurer;  
A. C. Pearson, Secretary. Entered as second-class matter January  
6, 1909, at the Post Office at New York, New York, under the Act of  
March 3, 1879.

## 1919

**S**TANDING at the threshold of 1919 and looking forward, the vista is one that should arouse a considerable degree of pride in every American citizen. After four years of war in Europe, and eighteen months of participation on the part of the United States, the storm has become calmed. We may feel all of that deep satisfaction which results from a duty well performed. It will not be proper boastfully to refer to our own part in this war. The true story of what we have accomplished may be left for future historians to record. While the destiny of the world hinges about the calm deliberations of the peace commission, we in this country may fix our eyes wholly on the future, firm in the belief that unless we falter or fail to profit by the lessons of the past, we shall steadily move forward to our rightful position before all the world.

**W**ITH the cessation of hostilities and the demobilization of our large land and sea forces, many complex problems are being presented, on the proper solution of which will chiefly depend the success of the future.

The return to America of more than two million men, suddenly taken away from their usual occupations and as suddenly brought back, will so greatly affect labor conditions in this country as to constitute perhaps the first and most important

question of all. The introduction of women and minors into every phase of industrial labor has served to bridge this country over an important crisis. It will be our duty to show a due appreciation of the non-combatants whose work, if less spectacular, has been quite as patriotic as that of the men who have gone overseas to fight. The problem of retaining this large element in employment and at the same time finding remunerative work for the returning soldier and sailor is most intricate.

**A**S no nation may succeed which shows ingratitude to its defenders, it becomes vitally necessary that we provide employment for the large number—estimated at a quarter of a million men—who either by mutilation, wounds or other physical conditions incident to service, have become incapacitated from pursuing their pre-war vocations. These the Government will regard with the utmost paternal care. A large appropriation has already been made to provide educational facilities at technical schools and colleges for men in this class. This feature of the Government's work in the rehabilitation of its defenders will, it is quite certain, be carried forward to the highest state of efficiency. While we may deplore the cause that has led to the necessity for a work of this kind, there is no doubt that the result will react to the great benefit of the



## THE AMERICAN ARCHITECT

individual and also to the development of a high order of citizenship. A man taken from civil life, with perhaps but a limited earning capacity, returned to this country after months of military training, discipline and contact with the big things of the world, will, when re-educated to meet his new conditions, become a valuable and patriotic citizen.

---

THE experience gained during this war has developed, and in large numbers, types of men who will put the impress of their fine abilities on every future undertaking. In every professional rank there has been learned the lesson that it is the practical, workable idea that counts, that gets results. There has been no place in the turmoil of preparation and the steady grind of the daily task for the theorist, the dreamer or the poseur. It has been shown that men of the highest ideals can only successfully work with their fellows when they combine with such ideals the hard, practical sense that leads to success.

Particularly has this been shown in the fields of architecture and engineering. Just what history has been written in this country during the past two years in the annals of these two professionals need not be dwelt upon here. They have been discussed and argued to a point where further allusion would only be repetition. It has been clearly demonstrated that in times of stress, or active operation, only one type of man can survive in the daily turmoil of war's activities. That man will be the most practical and most efficient that can be found. Whatever errors of omission or commission may in the future be set against our Government, it will be conceded that it sought out in every field of endeavor the most practical and efficient and aggressive type of men it could find. That large group of men with yearly earning capacities of upwards of a million dollars, who patriotically set aside every selfish consideration to serve their country at a salary of one dollar a year, exemplifies the class that will in the future dominate every field of labor. The lesson is obvious.

---

THE suspension of building operations for a period of many months, does not afford an opportunity to refer to the progress of our architectural development. Building in this country, with the exception of the Government's operations, has been practically at a standstill. But, in the feverish activity displayed in the vicinity of our

shipyards, cantonments and munition plants, there has been opportunity to note the probable future effects of a very matter-of-fact attitude toward building and the architectural progress that may have accompanied it.

Possibly this war has served to develop features of industrial housing to a greater extent than any other. In design and plan, the homes of our industrial workers have been so vastly improved as to mark an epoch in this phase of construction. Architects may claim and prove their contention that it is to their abilities that this great advance is due. In every instance where large operations have been under architectural control, there has been no word of inefficiency, and the results are so very good that they will exert the most lasting influence on our domestic architecture.

---

MEANWHILE, the large number of men in the profession of architecture who at great personal sacrifice have closed their offices and gone to the war, are returning educated to all those higher things which their trained powers of observation will have taught them. It is among this class that we may with calmness look for that type of man who will show to all the world just what an architect is and means to his profession. There are problems now that architects must take up and solve. They must realize that while they are artists, trained in the power of artistic expression, they are also business men and must become good executives. With the military training received by the architect, the higher and broader outlook he has acquired, he will regard everything he undertakes with the view of a super-educated, practical man. The future of architecture under the control of men of this type looks brighter now than ever before. It will be this class of men who will dominate the profession. It will be these men who, having learned that much of the study in their college courses was, as referring to their future work, so much lost time, will see to it that the curricula of our architectural educational institutions are revised so as properly to fit the young man for the work before him.

---

THIS question of education in architecture is one of the first that the profession in its efforts towards reconstruction in its own field will need to consider. Undoubtedly many of the things in architectural practice about which we so loudly

## THE AMERICAN ARCHITECT

complain today are due to faulty educational methods. Modern methods will need to be very largely revised. In the leading article in this issue this important topic is very thoroughly discussed by Mr. C. H. Blackall. Without doubt there will be a very general agreement with Mr. Blackall's presentation of this subject and concurrence with the measures he proposes for the improvement of present methods.

Tom P. Barnett, in a communication printed on another page, makes the admirable suggestion that our rich men could find a very useful opportunity for a great and valuable work in the founding of schools of craftsmanship in Europe for American men and women. The immense amount of good that would be derived, especially during the next five years, from the establishment of such schools, is too apparent to need further urging. Along certain well-developed lines, the American Academy in Rome has been for years carrying forward a work of this nature. If this valuable institution were more liberally endowed and placed on the most practical basis, it could at once take control of these trade schools and make them, in the field of craftsmanship, as valuable to the American student as it now is in the higher field of the Beaux-Arts.

The successful future of architecture will depend more largely on the successful development of craftsmanship than is at once apparent. If some group of liberal donors will generously provide for these trade schools in Europe, they will do more to advance the progress of architecture, and that is

art, in this country, than by the hoarding of collections or the endowment of classic memorial museums and libraries.

**A** PERFECTED and smoothly working organization always produces results if energetically administered. But any body representative of certain fields of endeavor can reach its goal only when it receives co-operation from those it endeavors to serve. Organized architecture in this country has seen many vicissitudes and in spite of its handicaps has accomplished a certain measure of good results. But it has been almost entirely in the hands of certain men who, day and night, have labored to serve, and who have in many cases become disheartened by lack of support, unwarranted criticism and cold indifference. We shall have to make the profession more democratic, and we shall have to make its organization more truly representative.

There is as pressing a need for two organizations, state federated societies and the Institute, as there is for two parties in our national Government. Until this has been brought to consummation, we can hope for little, if any, practical result. With correct educational methods, methods that will be based on the counsel of practicing architects, with two well organized parties, each striving to outdo the other in effort for the common good, we shall have an organized profession that the Government in future crises will not ignore, for the very good reason that it will be impossible to do so.





# Looking Forward to Architectural-Engineering Practice

THE construction of buildings in 1918 was restricted to those having an occupancy devoted to war purposes. This limitation naturally confined the new work to certain industrial plants, army and navy base warehouses, ordnance depots, shipbuilding plants and industrial housing prospects. These undertakings are of a permanent character. New cantonments and additions to those constructed in 1917, loading plants and hospitals were very largely of temporary construction.

In all of this work there was nothing developed which is of especial interest from the purely architectural or engineering viewpoint. The buildings were strictly utilitarian in character and the designs made to use available materials. The main feature of this work was the matter of constructing the buildings in as short a time as possible. This required the use of executive ability which resulted in the competent organization of all the elements employed. The outcome of these undertakings has, as a whole, been adequate to the needs.

One great benefit will accrue to the building industry from the bringing together, in intimate contact, the architect, engineer and contracting forces from all parts of the United States. Each came to the job with his local methods and ideas and the most meritorious generally got proper consideration. Local prejudices have been largely wiped out and architects and engineers are approaching a unity of thought, method and purpose that could not have been effected in any other way or in so short a period of time. To illustrate: A well-known western engineer was assigned to oversee the planning of a large pier to accommodate ocean-going vessels and railroad connections. This engineer's experience had never included a contact with such a problem. He found that the concrete floor slabs were designed, as customary in that port, as simple beams supported at both ends. To secure economy in materials he suggested that they be designed as continuous beams. Opposition to this proposal was based on the theory that the simple beam would best meet the condition resulting from a settlement of the supporting pile foundations and *precedent*. An investigation showed that no pier in that large port had any such settlement and that the expensive and wasteful design was made to care for a condition that never happened. The pier has been built on the continuous beam design

and the future will disclose the correctness of the new idea. Numberless other instances could be cited to show the great advantage of this commingling of professional men, all working against time to achieve a common end.

Construction methods will profit by this experience and those from every locality will have gained some valuable knowledge to apply in the work of normal times. The fixed procedure, guided by precedents, will be diluted with the short-cut and direct methods of the newer communities where problems are solved, as they arise, by using the best judgment available in lieu of a definite experience. Some practices of the older sections will be carried away to strengthen the usages of the younger communities.

It would appear then that a gain has been made in the ability to adjust building construction to the available materials and in the equalization of methods of design and building, obliterating some localisms and making some of these general in their application.

There is no doubt but that the revival of the building industry will be hastened by the knowledge gained during the abnormal period just terminated. This knowledge and experience will be applied to a better use of the materials that enter into the structural parts of the building, such better use being accomplished by giving the materials more work to do through the increase of fiber stresses, an added refinement in structural design and other means. As a nation, Americans have been wasteful in the use of many materials, due to their comparative cheapness. No material is cheap to-day and it is probable that their cost will never reach the pre-war levels. This increase in cost will, in many instances, be overcome by a more intelligent use. Construction equipment will be improved to reduce human labor, and labor will undoubtedly become more valuable as the relations between the employer and the craftsman become more reasonable and satisfactory. The common interest of both will become more apparent during what appears to be a short, necessary and somewhat troublous period of readjustment.

The relations between architects, engineers and contractors can be modified in some ways, resulting in economies. Under present procedure there is a wasteful duplication of work. This obtains in the necessity of contractors maintaining drafting or-



## THE AMERICAN ARCHITECT

ganizations to supplement the work of the architect and engineer; this is not general, but its cost assembled into one sum is an element of considerable moment. This can be eliminated by the better and more complete preparation of the drawings in the first instance as one organization always can give complete service more cheaply than two separate organizations.

The duplication of estimates made by general and all sub-contractors is a very large item of building cost which, like fire insurance, is a tax on every building that is constructed. This tax can be eliminated by the introduction and universal use of a system of quantity surveys similar to those in use in England and other countries. The estimator always adds a safety margin for incomplete plans and specifications, unfortunately all too common. Before a guaranteed quantity survey can be made, the obscure points, omissions and overlapping of specifications must be eliminated before the survey can be completed. This safety margin is an appreciable percentage of the total building costs and is a tax due to incompetent plans and specifications. This condition is general enough to deserve close study and energetic efforts to correct it. There are several other related wastes that will be eliminated by the use of this method.

By the adoption of safety methods the waste due to injuries to workmen can be very materially reduced by the consequential lowering of liability insurance costs. Attention to fire prevention during construction will result in savings in fire insurance.

One of the greatest wastes in building construction is that due to building codes. The progress in code making has in no way kept pace with the progress in engineering knowledge. There are engrafted on all codes requirements for the sole purpose of consuming materials without any return whatever in real value to the owner and the public. These demands, favorable to special interests, should be eliminated at once and the code made in the interest of the public. Such changes would

decrease temporarily the amount of some materials used, with a consequent lowering of the cost of building construction, but the vastly increased amount of building will ultimately result in a greater consumption of all materials.

Building commissioners have excused some of these unreasonable conditions by the palpably incorrect reason that such laws must be made to combat the worst conditions of designing, inspection and contracting service. On the contrary, such codes should be made for the best conditions and strictly and honestly enforced. By so doing the incompetent or dishonest designer and contractor will disappear as a matter of natural elimination.

The status of the contractor will be improved for the reasons before mentioned and such activities will be recognized as a business inseparable from a profession. The contractors are fast becoming men of technical training, business and social standing equal to that of the architect and engineer, and they, as such, will compel the consideration to which they are entitled. Their rights in the matter of awarding contracts and fair dealing must be recognized.

The architect or engineer who has the welfare of the building industry at heart and also his personal business interest must face the problems of 1919 with the determination to be a vital element in that work. To do this he must first clean his own house in order that he can render the complete service that will be demanded of him; so design that construction waste is eliminated; adopt a quantity survey system to overcome the tax of individual estimates; reduce the liability and fire insurance tax by supervision for safety, and take immediate and energetic steps to secure a radical and common-sense revision of building codes.

Prosperity will come in any event, but it is the duty of those engaged in architectural and engineering practice, with the co-operation of the contractor, to make themselves a vital and potent factor in its rehabilitation.



# "We Are Going To Build"

By WILLIS POLK

NOW that the frosts of war that drove the building industries into hibernation have been dispelled by the grateful warmth of the armistice, the dormant bear of investment finance stirs in its slumbers, rub its eyes and prepares to seek whom it may devour! But, dazed from its long inactivity, emaciated from its enforced fast, is cautious. It is like the architects, and the architects are like the twenty cats, camped around one tiny knot-hole from which one timid little mouse exposes one bristly little whisker. So queries Mr. Investment Finance: Can we build now? What about capital issues? What about priorities? What about the next Liberty Loan? What about the high cost of labor? What about the high price of materials? Still the spring thaw that releases the stored up snows of winter, with its resultant freshets, will wash away all obstacles.

Shall we wisely impound and direct this flood or shall we permit its uncontrolled flow to wreak destruction equal to, or greater than, the devastation of war? Therefore, Mr. Capital Investment, Mr. Labor and Mr. Materialman, hearken unto my voice! Sit ye at my feet and learn wisdom! Labor will never be cheaper. My father after the Civil War was glad to cut, haul and pile good oak cord wood for one dollar a cord. I guess we are glad to pay \$20 to-day.

Still we can buy a better elevator for less money to-day than we could ten years ago. We can buy a better automobile for less money to-day than we could five years ago.

We can build a better building for less money to-day than we could twenty years ago.

Twenty years ago more steel was put into the foundation of the Claus Spreckels Building in the form of grillage than was recently put into the entire Hobart Building from base to roof. We didn't know better then; we know better now. We can do better things now for less money than we could then. James Phelan, it is said, traded a band of mules for the lot upon which the Phelan Building stands to-day. What are we going to trade for the opportunities of this moment?

We are going to build and build and build, wages and prices to the contrary notwithstanding. The sleeping giant stirs; the sleeping giant awakens; look out when he sheds the superfluous hair from his shaggy fur! Stand aside, oh timid ones, lest thou be devoured!

The late D. H. Burnham used quizzically to relate that H. H. Richardson held that an architect's first duty was to get a job. Then he would solemnly observe, "But Henry was wrong! An architect's first duty," he maintained, "was to DO the job."

"But do it well," he would always add.

## *Architects and Engineers*

*The relationship between Architects and Engineers is like the relationship between bricks and mortar.*

*The present tendency on the part of the investing public to rely more on the Engineer than the Architect can only result in a happy rivalry that will tend to cement the functions of both Architects and Engineers into an inseparable union, with resultant benefit to the investing public.*

WILLIS POLK



# Architecture After the War

## 1. Architectural Education

By C. H. BLACKALL, F.A.I.A.

UNDER the above title the writer ventured to make some predictions regarding the probable conditions of architecture after the war. We are now safely out of the war and so far without any prospect of an economic crash or any profound social disturbances. We are just beginning to feel the returning waves of prosperity in our profession and all the indications are that by next Spring the architects will have all the work they can reasonably take care of and that many will be snowed under with the increasing tide of large and important commissions. We cannot, therefore, postpone decisions as to what we shall do with ourselves and our profession. The decision must be made now and it must be made as far as possible so as to endure for the new era which we believe is coming in. We may continue to theorize as to what it may be, but we are now in the midst of an actual condition and we must trim our sails and plan our course accordingly.

The very first question to be answered by the profession is what to do with the young men who are not yet in it but to whom we must look to carry on the work in the future. Architectural education in the United States thirty or forty years ago was a comparatively simple problem. There were few who wanted it, fewer still who could profit by it, and the profession itself was interested only in an academic fashion. But we no longer have an apprentice system; boys do not enter architects' offices now to learn the business, but go to a school of architecture. Moreover, the requirements for a successful architect are so vastly enlarged, there is so much more that should be acquired by the young practitioner, that what might have answered in the 'seventies is hopelessly out of date to-day.

Nor have our schools altogether kept up with the procession. It is right and fitting that the professional element should have predominated in the past, and it is also quite proper that schools of architecture should have leaned to the conservative rather than to the radical and should have accepted and taught the tested methods, and have had in view the ripened, accepted aims of the past rather than the newer eclecticism of to-day; but without desecrating in the slightest the work the schools have done, the net result in the last twenty-five years has been to force architectural education into more academic lines, to restrict independent thought and, above all, to foster academic methods in place of the severely

practical requirements of everyday business. Our architectural schools never have been business schools in any sense. They must be that now. They have given a prominence to art which was once quite proper, but the relative importance of pure art in architecture has decreased and the business and practical sides of the profession have enormously enlarged, so if our schools are to turn out the men that the profession wants, there must be some very radical changes instituted at once.

These changes will not come of the free initiative of the schools. That is to be expected. They must come from the profession itself and architects of to-day have a manifest duty in this respect. There has been altogether too much separation between the profession and the school; too much treating the teaching of architecture as if it were an end in itself rather than the preparation for a life work and as if the academic successes were tangible achievements rather than mere groundings. The profession has greatly drawn away from the schools as a natural consequence of such teaching and it has been each year increasingly harder to interest the actual practitioner in the work of the young men. We do not even see our putative successors, or know they are in existence except at rare intervals, but if we are properly to meet the after-war opportunities our first task right to-day is to get busy with our architectural schools.

It would be more than presumptuous to claim that any one point of view is necessarily the best one, or that any one expression could be absolutely depended upon as showing the way in which the schools can change. But it is worth while to mention at least some of the views which have found expression regarding architectural education, and then it is up to the profession and the schools themselves to determine the real consensus of need, to find out just what the architects want as a practical necessity, and then to cast out absolutely from the college curriculum and the college training everything which would detract from turning out architects at Commencement Day capable of carrying forward the work which we soon will have to leave. This is not an impossible program at all. It is simply applying to architectural education the common sense deductions of any efficient business, cutting out the non-essentials, omitting mere mental activities and getting down to real hard facts of necessity. Four years ought to be ample to train any young

## THE AMERICAN ARCHITECT

man for architecture if he has the right stuff in him, and while it is the task of the schools to formulate and apply the necessary training, it will be impossible to accomplish real good unless the profession as a whole takes hold and helps out, and not only helps in the starting but follows it up and takes a real interest in architectural education and in those who are striving to acquire it, at the same time insisting upon giving the young men the training the architects want, as distinguished from what educators, so called, might feel was the theoretical equipment. The profession knows better what it wants than any academic board. We have a right to demand consideration from the schools. They are training the young men not for themselves but for us, and if the profession shows a consistent and coherent desire for certain architectural training, the schools themselves will be only too glad to give the profession what it wants.

Individual views, as was stated before, are of value only as far as they help to draw out expression from others, and what is said here is put forward merely as a starter, reserving to the writer always the privilege of changing his mind and acknowledging that one man's view is by no means final.

Fundamentally the architectural training should be that of a business man. Architecture is no longer merely a profession. We may dodge it all we please, but the real fact remains that we are running a business. We try to be professional and we shall continue to be so, but let the young men be taught from the beginning that they are entering a most exacting business in which the business element stands first, that all the rest fails to be of value to the community or to the individual unless it is businesslike and successfully so, that the business of the future is not to be the business of the individual but of groups, that the day of the dilettante in architecture has gone but that at the same time we must keep the ideals and associations which have made architecture a fine art, that we must not let go the good things of the past but build on them, basing everything upon the fact that the mission of architecture is primarily to serve and not to adorn and that the aim of architectural education, to put it in one way, is to make a business man out of a poet. That is the first point to insist on.

Architecture, next to being a business, is construction. That is only less important because it is a means to an end, and construction should be taught in the schools not as a science but as a practical, applied art. A man should look at building construction as the mechanic looks at a machine. It is not an occasion for calculus or the higher mathematics. In fact all the mathematics that an architect needs ought to be imparted to him before he

enters the school, but the application of the fundamental facts of geometry, a few theorems in trigonometry and a raft of practical experience is what enables a young man to be sure of himself in constructing a building. Cut out mathematics as such absolutely. There are fortunately plenty of men in this world whose minds run to such things, but they are not the successful architects. We can profit by their work and spare our boys many hours of mental anguish, but insist upon the instruction being real and not theoretical, upon its applying to actual cases rather than to ideal ones, and limit absolutely and rigorously the time expended on theoretical construction to the barest necessity; emphasize, enlarge and multiply the practical applications. This is the second point.

Architecture is a case of co-operation. No longer does one man do it all. The same principle should be applied in the teaching of architectural design. It is not fundamentally a case of intelligent planning and secondarily a case of appropriating adornment, but let our young men be thoroughly grounded in planning and in that vague quality which we call common sense, which is so hard to define but so easy to understand. Once that logical, rational, orderly system is imbued in the minds of the young men, the mere adornment will come very easily. But our schools ought to abolish the idea at once that length of time in a school is any measure of a man's ability. Personally I believe the atelier system is a far better one than we have followed here. It has already, to be sure, been adopted to a certain extent in Harvard and some of the other schools, but we ought to stop at once any idea of separating the young men by years. Put them all together where the weak will rub shoulders with the strong, where the advanced students can really be part of the teaching force and where the example of those around them will count for far more than the precept of the teacher, and above all rigorously exclude from the teaching force any instructor who has ideas of his own which he wishes to impose on the students, for what we need more than anything else is to develop the student's own ideas, to stimulate his imagination, to foster the right kind of emulation and competition with those who are stronger than himself, to set before them ideals which are a little beyond his reach so he will grow to them, but especially to develop the man from within. I am talking now of planning and design. This condition would never arrive when a man is ranked with his equals. He should be measured with those who are stronger than himself, and that is one of the strong arguments in favor of the atelier system. I believe it should be adopted and carried out in every architectural school which aims to turn out real architects, and that no student should be allowed



to work up his designs all by himself free from the frank and often rough-shod criticism of those who are in the same class with himself. This is the third point.

Architecture on its artistic side is a retrospective art. Therefore the history of architecture should be studied, but not as a thing by itself, which has been only too often the case in the past. It should properly be looked at as a formulation of historic precedent leading to the work of to-day, representing the point of view toward real architecture and directly or indirectly correlated to the actual work which the young architects will be called upon to perform. It should never be academic in its teaching, never be abstract, never be merely ideal, but it should be in every case a practical application of past experience. This is the fourth point.

There are lots of other points, but they are minor ones in the writer's judgment. Frank discussions and mutual conferences between the architectural teachers and the architectural practitioners will show many paths which may be followed to advantage, but fundamentally in preparation for the architecture of the future our young men must be grounded in the idea that architecture has its predominant business side, that construction is not a mere theory to be elucidated by abstruse mathematics, that design is not one person's whim and fancy but should be the combined effort of the

community and the times, and that the history of architecture means simply knowing what the other man has done and then trying to do it a little better. To teach this to our young men calls for the highest ability which the profession can produce. We cannot expect our young men to rank high unless they are under the direction of the ablest teachers and helpers that can possibly be obtained. Our schools must make up their minds to get this kind of service and pay for it. I say this without any failure to recognize the splendid work which has been done in the past by the leaders of our architectural schools, but the tendency has been a little too pronounced to look on the position of architectural teacher as a sort of stop-gap between the return from the *École des Beaux Arts* and the time when one's friends can get enough jobs together to warrant starting in business. If we want the best we must use the best means and then we must pay the price, whatever it is, but the best is none too good. The harvest is coming. Already the first effects of after the war are beginning to be felt in the architects' offices, and we believe we are on the very threshold of one of the largest developments of architecture the world has ever seen. The war has brushed away many of our ideas, has wiped out some of the traditions, and in order to meet the new era let us first of all set our architectural schools in order.

---

### Educating for Architectural Practice

By FREDERIC W. GARBER

NOT being pedagogically inclined, I can approach the discussion of architectural education with serenity and a one hundred per cent sure cure. It has always seemed to me that the fault with builders and architects has been that they are not working as harmoniously as they should to accomplish the same ideals. This friction is due to lack of similar training. I would not have architects become contractors, or contractors, architects. I am convinced that some architects would make good contractors, but no contractor could, without training, become an architect. A course in architecture would assist any contractor. The architect, with a general knowledge of contracting, would make a super-architect.

If architectural education could be divided into two large groups—first, building, and second, architecture—the two camps would become united. Under building, a certain amount of architectural training should be taught, but greater stress should

be laid on making the pupil a thoroughly competent builder. The science of drawing, specifications, strength of materials, structures, the business of building, etc., should be included in the curriculum: in fact such studies as would fit a student, after serving an apprenticeship with a construction company, to become a good contractor.

The faculty for such a course should be composed, in part, of good contractors and architects. The standard to be attained should be fixed by federal law. No contractor should be permitted to do business without the equivalent of such a standard course. The privilege to practice should carry with it government responsibilities of such a nature as would prohibit cheap, hazardous construction. This would eliminate underwriters and simplify building codes. From such a course could be drawn contractors, material supply men and manufacturers of building materials, etc.

The second group (architecture) should be ap-

## THE AMERICAN ARCHITECT

proached only after the course in building, or its equivalent, has been mastered, and should consist of advanced architectural study. This training should be such as is mapped out by our best colleges. There should be no hampering federal restrictions to this course. The faculty should be composed, in part, of the best practicing architects, and some contractors. Such a course would not be too practical, and contact could, through the faculties, be maintained with the best practice of the day. The net result would in time bring about ideals that would be understood by all those participating in building. The first course would have a tendency to remove those not qualified as builders,

and by the same means, would disqualify incompetent men whose ultimate aim was to practice architecture.

In the educational preparation for practice as above outlined, the Government, in some manner through a licensing department, should require all men to be prepared in that branch of military science wherein they would best qualify to serve their country. The requirements of the Government should be such as would maintain efficiency through a continuation course for those in practice. Then, in case of hostilities, the Government would have a large, efficient reserve body, which it could draw upon with ease and economy.

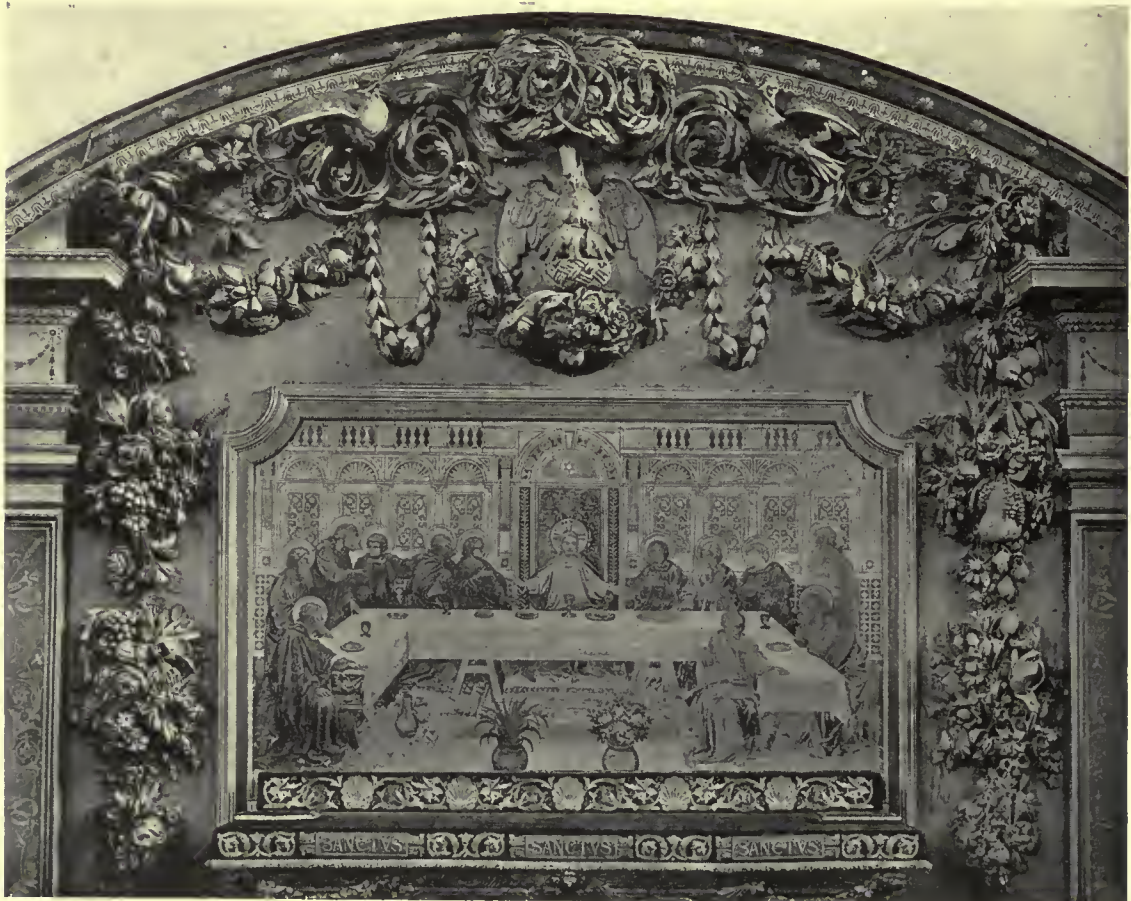

CARVED REREDOS—TUDOR PERIOD



# Beauty and Economics

By HARVEY WILEY CORBETT, A. I. A.

A period of reflection is good for the soul. The architects have had such a period, they have reflected, they have put their reflections into print, but has it been good for the architectural soul? Are we justified in supposing that the ideas put forth indicate a general discontent with things as they were, or is it nothing but the outpourings of ordinarily busy minds trying to occupy themselves during a dull period? Perhaps the architects, like the rest of humanity, stirred by the great war to depths never before dreamt of, are unwilling to return to the *status quo ante*. The President tells us it would be a disservice to restore the railroads to pre-war conditions. Labor certainly does not want to return to pre-war wages or pre-war hours. And even the soldiers, many of them, would like to change their pre-war jobs. The architects, therefore, are not alone in their demand for a new deal. Shall it be from the same old pack of cards, or may we start with an entirely fresh deck?

The first step in any change or reform movement is to want something, and the second step is to crystallize thought on what is wanted. Let us suppose for the sake of argument that all the various criticisms and suggestions we have been flooded with, both in the architectural press and the daily papers, are made seriously and with the best interests of the profession at heart, and that what has been put forth is representative of the wishes of the profession at large. Then can we assume the first step in reform is under way, viz., something wanted; can we crystallize thought on what this something is?

A glance over the field of criticism both constructive and destructive is not very encouraging. The range of fire extends all the way from art instruction in elementary education to a complete shift in standards of professional ethics. It would seem that we do not catch the youthful mind in our architectural net early enough, and those we do catch are fed up, stuffed, you might say, on the wrong brain food. We do not catch the public mind often enough and frequently when we do, it slips through the meshes of our net and swims away with less appreciation for our architectural efforts than it had before it was snared. It would seem from some of the criticism that our code of ethics only served to bind the truly artistic soul in its imaginative flights and did not prevent the purely commercial soul from committing architectural murder in the name of art. And, finally, the question of the architect's responsibility comes up only to find

him accused of being a very "artful dodger," hiding behind the screen (very thin, by the way) of artistic license whenever he makes practical mistakes, and ducking behind the shield of practical necessity whenever he commits architectural atrocities.

Can we possibly discover in this wide range of fire any single purpose or central idea which may become the guiding thought of our proposed shift to the new status? Are we aiming at a common target, and if so what is it?

Personally I believe all criticism, all suggestion, all denunciation, all sarcasm, would be stilled if, as a professional group, we could gain more sympathetic appreciation of our architectural efforts on the part of the general public. If, during the war, work for which we considered ourselves peculiarly fitted was given over to lawyers, engineers and builders, it was not because of an unappreciative government, but entirely because of an unappreciative public opinion. Government is only public opinion personified, and public opinion is the final arbiter in all matters of art as well as in business or democracy.

Architects deal in a commodity which the public wants. Buildings are more universally needed than any other one thing we can imagine. Every form of human activity goes on in connection with some form of building, supposedly arranged and planned for its particular purpose. The function of the architect has never been better defined than as one who builds beautifully, one who harmonizes beauty and utility, one who seeks through a comprehensive sense of arrangement to give satisfying expression to the practical needs, desires and aspirations of national life. Why, then, is not the architect the one man who should be the guiding spirit in all this tremendous work? Why is he not the most important citizen in the community, whose opinion is sought above all others, the one to whom all turn for decision and direction? Some one has said, "Let me feed the world and I will reform it." He might better have said "let me house the world and I will ennoble it." For the work of the architect could and should extend to every type and kind of building, whatever its nature or purpose may be.

It is, of course, ridiculous to assume that the architect occupies any such exalted position in any community at the present time. But why not? If, as we have said, his function is to harmonize utility and beauty, one of two things must be true—either the public does not want "beauty" or the architect

## THE AMERICAN ARCHITECT

fails to harmonize the sort of beauty he provides with the very essential utility. Which is it? I am entirely satisfied it is not the first one. I believe the public wants beauty and appreciates to the full, every effort that is made, however inadequate or temporary, in this direction. I believe every architectural effort towards beauty is approved and applauded far beyond its merit by an admiring public. It only needs the quality of real beauty to bring forth unrestrained admiration, so deep rooted in the human soul is the love and longing for the beautiful in all its varied forms. We do not, as a professional group, need to break out into advertising to bring the public "up" to an appreciation of our efforts in this direction. They are already there. We simply need to "deliver the goods," the *demand* is nationwide.

How about the second item, the "utility" which is to go along with the beauty? I think we have here the source of all our difficulties, the origin of all our disagreements, the point of departure which seems to drive us away from sympathy and true understanding with the public and leads us into a group apart, exclusively superior, out of touch with every day human demands and out of harmony with practical common sense requirements. This is the stumbling block where architect and public fall out and wherein originates that very unfortunate and in most cases very unfair impression that architectural beauty is an expensive luxury to be enjoyed only by the rich, and that architects are a dangerous group to deal with if one's purse-strings are limited and one's business necessities vital.

The fault, if there be fault, is surely not with the public. It must be with the architects. In the new era let us correct it, in the new day which we all feel is about to dawn let us make sure that we take our proper place.

How shall we go about it? Certainly not by teaching art in the primary schools in the hope of bringing up a public so imbued with love of the beautiful that they will bankrupt their business to achieve it. Certainly not by changing our architectural schools into business colleges so that whatever other crimes he may commit in the name of art, the student will never make an error in figures. Nor should we attempt to give the student a so-called "practical" equipment which pretends to acquaint him with all the working details of plan arrangement throughout the entire gamut of our ever-changing building requirements. This is manifestly impossible. But we CAN give him a very deep and serious conception of the far reaching importance of his mission in life. We can give him an open and elastic mind, well trained in rational analysis, a common sense groundwork in construc-

tion and a clear understanding of the really limited number of plan elements which are permissible in good building. And finally we can give him the fullest and most complete knowledge of architectural forms in the round, that he can possibly absorb, with an abundance of motives and styles, and the technical facility for expressing them, so that when he goes forth to build he will not be cramped in the solving of the practical, economical and utilitarian elements of his problem by a limited supply of architectural ideas with which to round out and finish off his work.

Now as to the practitioner himself: he, too, could consider with advantage the seriousness of his mission. He, too, could with perfect propriety come off his little pedestal, get down to earth, and associate with his fellow men, the general public, until he thoroughly understands and comprehends their point of view. Let him get it well grounded in his mind that his function in life is one of service—that he is here to help solve humanity's problems as far as his intimate technical knowledge of building affects those problems, that he must never lose sight of the coldly economic side of the case, but must get results within the means available and without sacrifice of those vital elements of plan arrangement or structural simplicity which mean so much in sound financial return to his client. Let him assume full financial responsibility for the accuracy of his estimates and the reliability of his drawings—that is not a new idea, every conscientious practitioner does that now; but he need not assume responsibility in the sense in which a contractor does, for the simple reason that he is not obliged to take a gambler's chance nor permitted to share in the gambler's profits.

As to the code of ethics, no man whose instincts are those of a gentleman need ever be worried by the code. He does not have to read up on table manners before attending a dinner, nor does he have to run over the code of ethics to determine his conduct in practice. All that is written in our code would be followed without it by every right minded man.

And, finally, let us clear our minds on one thing. Public appreciation comes from rendering public service. Let the architects show by their rational common sense grasp of the fundamental economic conditions underlying every problem that they know and sympathize with the public; let them show that they possess a mental equipment sufficiently broad and elastic to solve those requirements, and then prove in solving them that their technical skill as architects is resourceful enough to harmonize those essential requirements with appropriate and imposing beauty.



# Architectural Office Organization for Post War Conditions

By DANIEL PAUL HIGGINS

A HEALTHY professional practice, like a healthy person, may take ill and "die" practically over night. Continual vigilance is necessary to keep abreast of the times, and this vigilance is the price of successful professional growth.

We have known of startling examples of architects suddenly acquiring reputations and who have undeniably possessed more than ordinary artistic talent, but who have not been able to understand the importance of a "foursquare" reputation.

Special reference can be made to an article on the "Business of Architecture" in the October, 1916, number of the *Architectural Review* in which the writer gives a definite story briefly, of architects who have had splendid opportunities for success, but who have "died". The death rate is high and is startling enough to render of first importance the questions (1) What is behind this high death rate? and (2) What is to be done to lower it?

If you can call to mind the pictures you have seen illustrating many early types of architects, and their organizations, or I should say, lack of organizations, you will appreciate the reason which is largely responsible for this high death rate.

It is impossible to avoid some passing reference to the desire of some of these prototypes to be known for their artistic qualifications only, seeking to create impression by adopting a pose and manner, fashioned after painters and musicians, often adopting distinct peculiarities of dress, speech and action. This false pose has had many followers, and even to this day it is still effected by some architects with old fashioned notions, who are still prone to support the mistaken theory that in order to be a successful architect it is only necessary to be regarded as a man of artistic temperament and that business and organization will interfere with their art.

It is only fair to admit that among the older types of architects there were many men of great ability, who, if assisted properly by a smooth and complete organization would have been more successful, but being fettered by old methods and old organizations were free to progress only as far as they could draw the old system along with them.

Although Americans and their institutions are known for their rapid-fire progress in modern thought and teachings, this reputation cannot be credited to our schools of architecture in the sense

of teaching the importance of modern and scientific business methods and organization to keep step with the present day commercial demands made on the profession. Students are taught to do wonderfully large and monumental work; lectures and criticism are freely given by eminent practicing architects on design; but seldom, if ever, are the students made to realize what awaits them in the way of intricate structural and difficult business problems. After a delightful atelier training and experience, they are graduated to meet the ever-exacting business man. They then begin to feel the first pangs of disappointment, for they are at loss to understand his language. The big dreams they have dreamed begin to fade away when they are actually confronted with intricate building and business problems with nothing but a haphazard, hit or miss organization to assist them. Possessing very little business or structural knowledge themselves, their attempts at method in the eyes of the modern client, who has made his money through business systems, appear very amateurish and in a short time breed not only discontent, but very often distrust.

It is this same weakness in the school system of England that fosters the Quantity Survey methods where, as here, the business men are interested first in proper financial consideration with art following as of lesser importance. While this particular system is not strong in America, there is a dangerous equivalent in the modern building organizations which in the past few years have made serious inroads in the architectural profession, receiving not only business but government recognition.

In addition to the many present strong organizations of this character, the writer is aware of similar or even larger organizations in contemplation whose aim, like that of the existing organizations, is to capitalize the weak business and structural organization of the average architect when offering their services to the business client in order to control the entire building project. They propose to take over much of the business of the architect's office, preparing careful lists of materials and quantities and holding themselves responsible for securing the correct estimation of all necessary materials; receiving bids, supervising deliveries, requirements, all of which under a proper system of specialization of functions in an architect's organization could be more efficiently handled.

## THE AMERICAN ARCHITECT

In order to cope with the increasing competition of the modern building organization, the first essential is the introduction of an interesting course in modern business methods and organization in the schools of architecture by means of lectures, readings, etc., by men in the profession, who, by experience are recognized as business authorities, thereby giving the student an appreciation of actual organization requirements, a broader and more comprehensive knowledge of architecture in all its phases, instilling in him greater confidence to approach his business client in a forceful and intelligent manner and in such a way as to inspire confidence and respect.

The Bible should have contained this commandment for the benefit of architects: "Put not your entire faith in your art, but be ye chiefly concerned regarding business principles and proper attention to the vital monetary interest of your client, for in their acceptance there are good returns."

A client who has come to regard business dealings as a matter of confidence and whose experience with many types of business men has brought him by various stages to a position where he can observe that real efficiency is quantitative and not descriptive, is concerned with the measure and assurance of quantity as well as quality.

To gain the respect and confidence of this type of client, an architect should thoroughly appreciate that the elements of economy in building construction are:

Simplicity of design.

Low cost of construction.

High quality of construction.

Speed of construction.

All four points should be considered of equal importance and unless a client is assured by his keen sense of observation that his architect is working for the attainment of these elements he will feel that he has made a mistake in his selection. For clearer amplification of the necessity of strict observance of the elements as set forth above, let us consider the fourth point. Speed is vital in a modern building project because it conserves and contributes to the income on the investment. Perhaps long before the consummation of the architect's plans, the owner has by careful calculations, figured on a completion date for the purpose of establishing an earning basis and any careless delay by the architect beyond that date creates an unusual inconvenience. The client cannot be expected to excuse this or to continue his confidence when the architect has so upset his financial plans.

A common abuse of this same confidence is the lack of consideration on the part of the architect for the financial limitation established by the owner on the cost of the structure. It has been the writer's experience on many occasions to listen to architects

tell of how certain commissions cost from twenty-five to fifty per cent more than the original allotment. This practice of proceeding with designs fully realizing that they cannot be executed for any amount near that determined upon is largely responsible for the hesitancy with which the average prospective client approaches an architect who is known for his artistic qualifications, having heard through friends of experiences with the over-ambitious architects who gave them a building of meritorious design, but which did not, in the final analysis, meet their financial anticipations.

On the surface, this may be considered good business for the architect, but in these days of business efficiency what is not good business for the owner certainly in the end will not be good business for the architect. This weakness is capitalized by modern building organizations in their clever presentation of their architectural services to a business client who regards architecture in this respect as the only business wherein such laxity is permitted.

An instance in point is where a broker client refused payment for services on the grounds that he instructed his architect not to exceed a certain amount, and when estimates were received the cost exceeded that amount by twenty per cent. His defence was sustained by the court, the architect receiving nothing for his services and in addition losing the important commission. The architect's plea for another chance was refused because of the prodigious waste of time already caused his client, who in turn asked the architect what he would think if he commissioned his broker to buy certain stock, specified as to description and amount, if the broker were to spend half as much again, or even a point more than ordered.

The modern building tendency is toward comfort and convenience, and so contemporary architecture puts utility first and art following as a matter of course. In these days utility is the paramount issue and though not the only consideration, it is consistently the first. Manifold economic conditions compel it, notably the ever increasing population, the growth of cities, the facilities of travel, the expansion of commerce, capital increase, new industries and the disposition of communities to work, to live and to obtain their pleasure and amusement within the radius of a few municipal miles.

These conditions, particularly intensive population, create high land values, and high land values demand large and necessarily complicated structures in order to obtain an adequate return on the money invested in land. This creates the necessity of modern organization to supersede the older systems where dependence was placed on the contractors' assuming much of the architect's business, assisting, or practically making all mechanical or electrical lay-



outs, full size details, etc., and where other loose methods, too numerous to mention in this article, were characteristic of the older organization, such as the costly method of making architect's details on brown paper of ungainly size, and which necessitated tracing whenever a copy was required; desultory and ineffectual supervision with a lack of practical knowledge as to proper building methods, cost of materials and inability to adhere to completion dates. Eventually, of course, buildings were finished but many times at a practically ruinous cost. Delays have eaten into the rental returns on buildings, thereby defeating the contemplated ratio of income to investment. In many cases the architect's drawings and specification were loosely checked and in consequence of their omissions the contractor demanded exorbitant "extras." Furthermore, due to the incomplete condition of plans and specifications, changes were ordered which in addition to extra cost, tended to invalidate the original completion date, for extras invariably carry with them an extension of time. In addition to these defects in the old methods of architectural organization, the interests of the employees were in a continual state of conflict. Complete harmony was impossible, duplication of work frequent, each employee being inclined to exaggerate the importance of his respective duties. Few had a genuine interest in the business as a whole, not realizing how costly is the absence of lack of specialization and co-operation of function. Specialization of functions was unthought of and much waste of valuable time and loss of considerable profit resulted by return movements and double handling of matters. The seat of the whole trouble was the absence of organized control.

Just now the attention of the thoughtful and progressive architect centers on questions of practical concern, questions of efficiency in organization for the most satisfactory and economical execution of work with profitable returns to himself, questions brought to focus by the modern conditions already mentioned.

It is significant that, despite the modern tendency to centralize great industries, not until recent years has any effectual attempt been made to establish in the practice of architecture some semblance of scientific organization, and to date there are only a few architects' firms who are not clinging tenaciously to old methods permitting the modern building organization to advertise itself as a machine which has perfected all its component parts as the inherent problems of building construction will permit it, appealing thereby to the client of modern commercial ideas much to the embarrassment of architecture, within its own organization with assurances of the best consideration to the client's monetary and structural interest. The apparent progress made by the so-

called modern building organizations in this direction makes paramount the question not only as to the continued prestige and the integrity of the profession, but to save our architecture from the irretrievable damage it must suffer from insidious and unappreciative commercial control.

It is realized by the architect who thinks along modern lines that there must be something done in the way of reconstruction of the schedule of things, and it is also realized that reconstruction must be carried out with a view to the security of the business and structural reputation of the architect under such conditions as prevail with the modern client rather than with a view to the impeccable preservation of the idolized scheme of "art for art's sake only."

While many attempts have been made by architects in late years to improve their organizations to meet demands made by the development of architecture and building to its existing and ever increasing condition of manifold complexity, and while great improvement has been made over the older systems, the value of a scientific organization based on the specialization of functions has not yet been fully appreciated by them in general. This development is bound to come in the same sense as it came to commercial business, but for the present the large majority of architects are prone to accept the notion of placing an individual in complete charge of all functions with the title of "business manager," whose training and general education is invariably along practical lines only, with little or no real business technique. In many cases he is expected to attend to clients' requirements, to supervise business details and routine, oversee the making of drawings, write specifications, supervise construction, etc.

The fallacies of this type of management where all functions are autocratically controlled by an individual of technical training and experience, are injurious to the solution of the fundamental problem of providing for continuity in the life of the organization, for in many offices where this system exists, architectural merit, business and other important factors are made subordinate to the manager's particular interest and sympathies.

Where full control of all functions in an organization is vested in this type of manager, who in most cases has been trained as a building superintendent, there is little or no appreciation for consistent design or business policy, his appointments of designers are injudiciously made and his supervision, interest and direction in matters of design and business are superficial and haphazard. Designers are free to experiment and develop many different styles and his far-reaching authority permits him to interfere with the essential quality of design to effect some change in the construction of the building.

## THE AMERICAN ARCHITECT

Changes in design made by him often re-act upon its merit since design is entirely secondary to his own particular sympathies and interest.

Here is an example in point, where the arbitrary change in method of construction sanctioned by the so-called "business manager" interfered seriously with the intention of design, especially since in this case, in the execution of important half timber work, good construction meant good design, where any change either as regard dimensions or material used would lead to a different interpretation of the work when completed. This manager, whose control was absolute, being appealed to by the contractor for permission to make certain changes owing to a shortage of material on hand, granted it without consulting the designer. The design called for certain lengths and dimensions of timber, but the material which was allowed to be substituted in no sense corresponded to the dimensions called for, with the result that when completed, the work was found to be pieced together out of a great number of short lengths which in the use of ceiling beams and such construction reduced this particular effort of the designer to the appearance of a mere amateurish attempt.

In the case of the organization where specialization of functions is featured, this matter would be decided by the head of design who would never permit such an alteration from the drawings to be made, as he could readily have so adjusted his design as to utilize intelligently the material on hand.

At this stage it is proper to state that an article so brief as this is a very inadequate vehicle for the citation of many other defects of this type of management, but it would not be well to stop here without calling attention to a few more dangerous elements. The architect in an effort to shift the responsibilities of the details of his practice in giving such absolute control to an individual is making himself solely dependent on this man and must accept his policy as the policy of the architect's practice, reflecting either credit or discredit on the reputation of the architect, in accordance with the efficiency or inefficiency of the manager's method and control of functions. In most cases this manager is apt to feel that organization and "system" are non-essential for his purpose. He prides himself frequently on his "close attention to all details" and believes—perhaps rightly—due to his shortsightedness in the development of capable subordinates—that, without his personal supervision, everything would go wrong. Now, the first step in systematic management is classification; and that is just where most managers of the old type fail. They do not know how to classify; hence their

work is done in a helter-skelter fashion. No one in the office knows what they may be doing in an hour's time. Routine matters are not attended to, correspondence piles up, business is neglected; such things presage trouble, and if not ultimate failure, the growth of the practice is stunted.

Considerable loss of profit is inevitable under this system, on account of: (1) Lack of interest on the part of the subordinates; (2) waste by the assignment of men to work for which they are not fitted or especially trained; (3) lack of proper scientific accounting and report system devised for the particular needs of the architect's practice; (4) confusion and loss of time in duplicate of accounts and reports; (5) making of accounting records by stenographers or office boys, upon which the architect must depend for data in making decisions of policy, etc., and (6) the general dissipation of energy in the attempt by one person to perform too many and too varying functions when each requires special knowledge and training. To a manager of the old type, a business department headed by an individual especially educated and trained as such, would be considered as much of a luxury as the carved figures which decorate the bowsprits of a sailing vessel, or perhaps the tin traffic policeman or other freakish figure, on the radiator of an automobile. He fails to realize that the ability properly to conduct the business requires an exacting and a difficult training, the power accurately to analyze new situations, to conduct independent research, and to judge intelligently of the relative value of data. The word business is generally misunderstood by most architects, and the old type of business manager as meaning routine and red tape which in their minds can be capably taken care of by any clerk regardless of his or her training.

It is commonly the case where there are any important changes in conditions, managers of this character do not outgrow their habits, and attempt to govern new conditions by the same means and the same methods as were found adaptable to smaller organizations. But no one man can now get and keep in personal touch with all details of a fair sized practice without producing confusion and loss through adherence to those relics of management which are applicable to small practices. In the final analysis, allowing that this manager, whose control and direction are supreme, is proficient in all functions, in the absence of the development of subordinates to head important departments, there is no pyramiding of system, and should he leave the organization, the foundation of the architect's practice would collapse.

*(To be continued)*



# Building Costs and Earnings

## The Office Building Outlook

By WILLIAM MARSHALL ELLIS

*President of the National Association of Building Owners and Managers.*

THE sudden ending of the great war has at once confronted the entire civilized world with the most far-reaching and intricate problems affecting every department of human life. Not only will the maps of three continents have to be redrawn in many important particulars and the inter-relations of the nations determined upon new principles and in the light of fresh conceptions of mutual co-operation, fair dealing, and friendliness, but in every land the social customs of the people will be profoundly modified; and, last, but not least, much in the business structure of each nation must be readjusted and reconstructed.

Office buildings present no exception to this general rule but rather seem to demand that the greatest courage, vigor, and skill be exercised without delay in re-establishing such a proper balance between income and expenditures that convenient, comfortable, and efficient service can be rendered to the business public and at the same time produce net earnings sufficiently large fairly to compensate capital now invested and to attract the new capital necessary to supply the constantly growing office requirements of our country. If we hope to make these important adjustments intelligently and promptly, it is necessary to face present conditions as they exist, without flinching and without false optimism.

The War Industries Board was clearly right in classifying office buildings among the essential industries of our country for, in general, the business of the country is directed and controlled in these great fire-resisting structures. They make a vital contribution to the growth and prosperity of all modern cities.

As in the case of the railroads and other industries supplying an essential service, the renting public can well afford to pay whatever it costs to provide suitable office facilities for its use, plus a reasonable return on the capital invested in so doing. Office rentals are such a small proportion of the total business expense of individuals and companies paying them that it is comparatively easy from the standpoint of the consumer to make any upward modification in rates that an accurate analysis of the situation may show to be justified.

What then is the general situation as regards office building earnings? While conditions vary in

different cities, and in any city there may be isolated examples of buildings already paying a satisfactory return on invested capital, it is frankly admitted by owners and managers generally that current income has in no adequate measure kept pace during recent years with the startling increases in operating costs.

An analysis of the advance in prices of a few of the leading items in office building construction during the past five years shows the following comparisons:

### APPROXIMATE INCREASE SINCE 1913

Structural steel .....	90 to	100%
Brick, tile and terra cotta.....	40 to	50%
Lumber (interior trim, maple flooring and rough lumber).....	45 to	50%
Elevator construction and repairs.....	35 to	50%
Steam fitting and piping.....	50 to	60%
Plumbing .....	90 to	100%
Electric wiring .....	90 to	100%
Plastering .....	45 to	50%
Marble .....	20 to	25%
Glass .....	150 to	200%
Painting and decorating.....	30 to	40%

The cost of building repairs, alterations and general maintenance has also advanced in like proportion.

A review of wages paid to building employees engaged in the operation and maintenance of a large group of Chicago office buildings shows average increases amounting to about 3 per cent per annum for the years 1907 to 1917, with much larger increase during the past year.

General taxes, the largest single item entering into the cost of building operation, had steadily advanced for many years prior to the war. The tax bills for a similar group of downtown properties in Chicago shows an average increase of 3.9 per cent per year for the years 1907 and 1917. With city, state, and federal governments constantly broadening the scope of their activities, it seems reasonable to expect further increases in taxes.

Fuel is another large and important item in building operation which should not be overlooked. Present prices of coal are about 100 per cent above those charged three years ago, and there is no immediate relief in sight. It is generally believed that the present high prices of fuel will be somewhat reduced in the post-war readjustments, but all items of cost entering into the mining and distribution of coal have increased to such an extent that we cannot expect to return to pre-war prices.

With the development of these increases in operating costs, building managers throughout the coun-

## THE AMERICAN ARCHITECT

try immediately began to check up to see whether they could curtail any expenses which might have crept in through channels of unwise competition, or otherwise, thereby endeavoring to avoid making general increases in rentals. Though they have in some instances eliminated numerous small items, the readjustments that can be made without seriously depreciating the quality of service rendered are so unimportant as to produce but slight effect upon total expenditures. The most important of these adjustments have been the metering of electric current furnished to tenants and the elimination of expensive, and in many cases unnecessary, alterations for tenants, the aim being in both cases to charge direct to each tenant the cost of any special service furnished by the building.

Labor is such an important item in building operation and there is such small opportunity for the substitution of mechanical devices for hand labor that it is very difficult to make extensive readjustments without demoralizing the service.

Service is the keynote of building operation, and the quality of service required by tenants should largely regulate the rental to be paid for offices. If a large measure of special service is to be rendered, the tenant should pay for it outright, or the rental should be adjusted to the volume and quality of service required. Low rentals and high-grade service cannot be reconciled, and it is my observation that most tenants in modern office buildings demand and can well afford to pay for high-grade service.

In the analysis of new office building projects all the above items, together with the question of land values and rates of interest, must be given careful consideration. Where the land is owned in fee, the income tax and other forms of ever increasing taxation make higher earnings on such fees imperative. Where leaseholds are to be negotiated, a higher rate of interest must be secured for the same general reasons. The day of 4 per cent fees has apparently passed. Where a building loan is to be negotiated it is conceded that higher rates of interest will prevail. Investors who in recent years have been fortunate enough to secure ninety-nine year leases on a 4 per cent basis, and long term building loans on a  $4\frac{1}{4}$  to  $4\frac{1}{2}$  per cent basis, hold a decided advantage over their competitors who are financing building operations to-day. Comparatively fortunate also are those who built at pre-war prices of both material and labor, and yet many buildings erected under those favorable conditions are to-day paying an inadequate return.

Building owners frequently have accepted heavy losses during the past few years without materially raising rentals in the hope that the conditions which produced such losses in net income were only temporary, but now I believe it is the consensus of well-

informed opinion that regardless of fluctuations in prices of material and labor there will be no receding to pre-war levels, at least for years to come. Higher rentals are therefore inevitable.

We are told by leading representatives of organized labor that they propose to maintain at any cost the gains which they have made during the war, and that no increase in hours of labor or decreases in wages will be permitted without a desperate contest. The labor item is a very large factor both in the construction and operation of buildings and observation leads me to believe that increased efficiency does not follow advances in wages. In fact, it seems to be generally conceded that the keen demand for labor created by the war and the high wages paid in the war industries, regardless of efficiency, has had a demoralizing effect upon many workmen and that it will take time for labor again to restore its efficiency to a peace basis. There will undoubtedly be a large volume of work where the need for buildings for certain requirements is so urgent as to make the cost a secondary matter. There are also many railway terminals and other great projects where the work has already begun and where it will be an economy to push on to completion as rapidly as possible regardless of cost. This work should tend to stabilize both the material and labor markets and give those who have considerable supplies of material on hand a chance to move them at current prices and at the same time provide employment for a large volume of labor pending permanent readjustment.

The modern office building industry is in its infancy, relatively speaking, dating back only a little over thirty years at the outside, while the great majority of existing buildings have been erected within the past twenty years. Because of the much talked of permanent character of these structures and the comparatively short time during which they have been erected, depreciation and obsolescence have hitherto been frequently minimized or entirely overlooked by owners and managers. This has resulted many times in establishing rental schedules that have produced, we will say, 4 to 6 per cent net on the investment without, however, deducting any depreciation charge. In reality, after deducting a reasonable depreciation and obsolescence charge—which in my judgment should not be less than 2 per cent on fire-resisting office buildings—these owners have been receiving a net return of 2 to 4 per cent or less, a return certainly not compatible with the risk incurred and service rendered by them. The filing of Income Tax Schedules has recently aroused building owners to the necessity of taking cognizance of this item when computing the income tax on their investments, and I believe the federal government should establish depreciation rates on all types of



## THE AMERICAN ARCHITECT

buildings that would be uniform throughout the country. Investors who disregard this important item are misleading themselves, and will in time face crushing replacement charges which cannot be met from current income.

I believe all fair-minded men—and in this category I include most tenants—will agree that 6 per cent net after deducting depreciation charge is certainly not an unreasonably high rate of return on office building investments, and that owners are fully justified in revising their rental schedules sufficiently to produce such results.

I have scrutinized with great care the conditions surrounding the operation of office buildings to-day and I do not hesitate to admit that from the standpoint of earnings the situation requires the most skillful and energetic attention, but I am still decidedly optimistic about the outlook for office building investments. Some of the most important reasons on which this optimism is based I would sum up as follows:

1—The essential character of the service rendered by office buildings, and the ability of the rent-

ing public to pay an equitable price for this service.

2—The fact that readjustments and reconstruction are in the air, and that it will be relatively easy to make proper modifications in business practices.

3—My knowledge of the high character and intelligence represented in building owners and managers, and my confidence that in the light of up-to-date experience they will endeavor to revise their rental programs to produce 6 per cent after deducting all charges against income, including a proper depreciation and obsolescence charge.

In regard to the erection of new buildings, I am strongly opposed to the artificial stimulation of office building investments by over-emphasizing in any locality the demand for more office space, or by exaggerating the rate of income that has been secured by existing office buildings. I am, however, firmly of the opinion that the assured business activity of this country will be constantly demanding new office buildings of the highest type, and that with an intelligent and prompt adjustment of income to modern operating conditions the necessary capital will be available for such investments.

### How Office Building Managers Have Met War Conditions

By EDWIN S. JEWELL

MANAGER, CITY NATIONAL BANK BUILDING, CHICAGO

**T**HE business of managing office buildings does not differ radically from other lines of business, except that office space is usually sold under contract for a period of years and this makes it difficult to meet unexpected changes in conditions such as were brought on by the European war.

Up to the year 1917 there had never been a disturbance in the operating cost department of office buildings except the occasional ripples caused by discontented labor.

The first problem that office buildings had to face following the declaration of war was the enormously increased cost of fuel. The records of most buildings will show a fuel cost for 1917 about double the cost in previous years.

Operating conditions became so binding in the Fall of 1917 that office building managers began seriously discussing ways and means for preventing heavy losses. The following letter sent by one office building to its tenants will fairly illustrate the conditions with which office buildings were confronted, following the declaration of war by the United States:

"The present rates for rental were adopted nearly eight years ago and were based upon 6 per cent earn-

ings on what the property cost the present owners, plus expense for operation, maintenance, service and taxes.

"Since that time the cost for coal, supplies, taxes and payroll for the forty or more employees required for the care, service and maintenance of the building is more than \$25,000 per year greater than when this schedule was adopted. The increase of expense is equivalent to about \$5 per month on each single room that now rents at \$18 per month, and in that proportion for all other rooms.

"It does not seem advisable to lower the quality of service nor the standard of tenants. It, therefore, seems right and necessary to ask the tenants to pay a part of this increased cost, from such time as their present leases expire."

The rapid increase in operating expenses prompted building owners' and managers' associations throughout the country to investigate every kind of outlay, with the result that several cities discovered that the tax situation was becoming alarming.

The Omaha Association explained the tax conditions to tenants by enclosing a card with January, 1918, rent bills, which gave the following information:

#### INFORMATION FOR OCCUPANTS OF OFFICE BUILDINGS AND APARTMENT HOUSES

IN OMAHA

January, 1918

This is a ten-year record of general taxes assessed to the Omaha National Bank Building. The experience of other Omaha office and apartment buildings has been similar.

# THE AMERICAN ARCHITECT

1909.....\$ 8,585.50	1914.....\$14,073.04
1910..... 10,208.00	1915..... 13,962.96
1911..... 9,933.30	1916..... 17,062.40
1912..... 10,296.00	1917..... 17,362.20
1913..... 14,757.60	1918..... 20,193.20

The taxes to be paid in 1918 are \$11,607.70 more than in 1909—an increase of 135 per cent.

The tendency to increase the taxes and operating costs from year to year makes it self-evident that increasing rentals are justified and necessary, if buildings are to pay a fair net interest return upon such investment.

PUBLICITY COMMITTEE,  
Building Owners' and Managers' Association of  
Omaha.

By Spring of 1918 the cost of building and painting materials had advanced to a point which made alteration a real problem. This condition was met in Portland, Oregon, and some other cities by building managers adopting the following rule:

In the case of Office Buildings, the cost of moving, removing or erecting partitions, installing plumbing and changing electric wiring in excess of 4 per cent of the term rental provided for in the lease, shall be charged to the tenant.

The enforcement of this rule will have a tendency greatly to reduce the cost of alterations in some cases and in other cases where extensive alterations are necessary it will help the owner or manager to secure a longer lease than normally would be made.

Since the army draft law went into effect, labor conditions in office buildings have taxed the ingenuity of building managers and tried the patience of tenants.

The Equitable Building of New York explained the cause of poor service to tenants in its monthly publication. The following is an epitome of the Equitable Building's remarks on the labor situation:

### PLEASE BE PATIENT

If now and then, during the period of the war, the service does not come up to your expectation, have confidence that the Building Managers are doing the best they can under the circumstances.

The elevator men are in the army and navy.

The porters are in the factories.  
The cleaning women are in the packing houses.  
The engineers are with the railroads.  
The firemen are on the transports.  
The carpenters and painters are in the shipyards.

Notwithstanding the inferior and uncertain service rendered by office buildings, the pay roll has jumped up during the past year from 10 to 25 per cent.

In cases where operating costs cannot be further reduced without impairing the service and where it is not advisable to make greater increases in rents, a method of economizing has been adopted which because of its eminent fairness is proving very practical.

The following notice sent by one office building to its tenants will illustrate this method of holding down expense:

### NECESSITY COMPELS US TO CONSERVE

For years many odd jobs have been done for tenants, and materials have occasionally been furnished free because the value seemed small.

On account of the greatly increased cost of everything, the practice of furnishing "extras" to tenants must be discontinued and services rendered that are not a part of the care and maintenance of the premises will be charged on the basis of time and material plus 10 per cent.

The tendency has been for office building managers to take tenants into their confidence and lay everything on the table face up. Tenants have met building managers good naturedly and in a very generous spirit.

As a result of these strenuous and trying times, office building managers and tenants will understand each other much better and will work in greater harmony in the future. The false notion that office buildings yield their owners large profits will fade away and greater appreciation on the part of the tenants and more sympathetic attitude on the part of owners and managers should logically follow.



A CARVED WOOD DETAIL BY GRINLING GIBBONS.





PLATE I

JOHN KINSEY SCHOOL, SIXTY-FIFTH AVENUE, PHILADELPHIA, PA.

HORACE COOK, ARCHITECT





THE AMERICAN ARCHITECT

VOL. CXV, NO. 2245

JANUARY 1, 1919

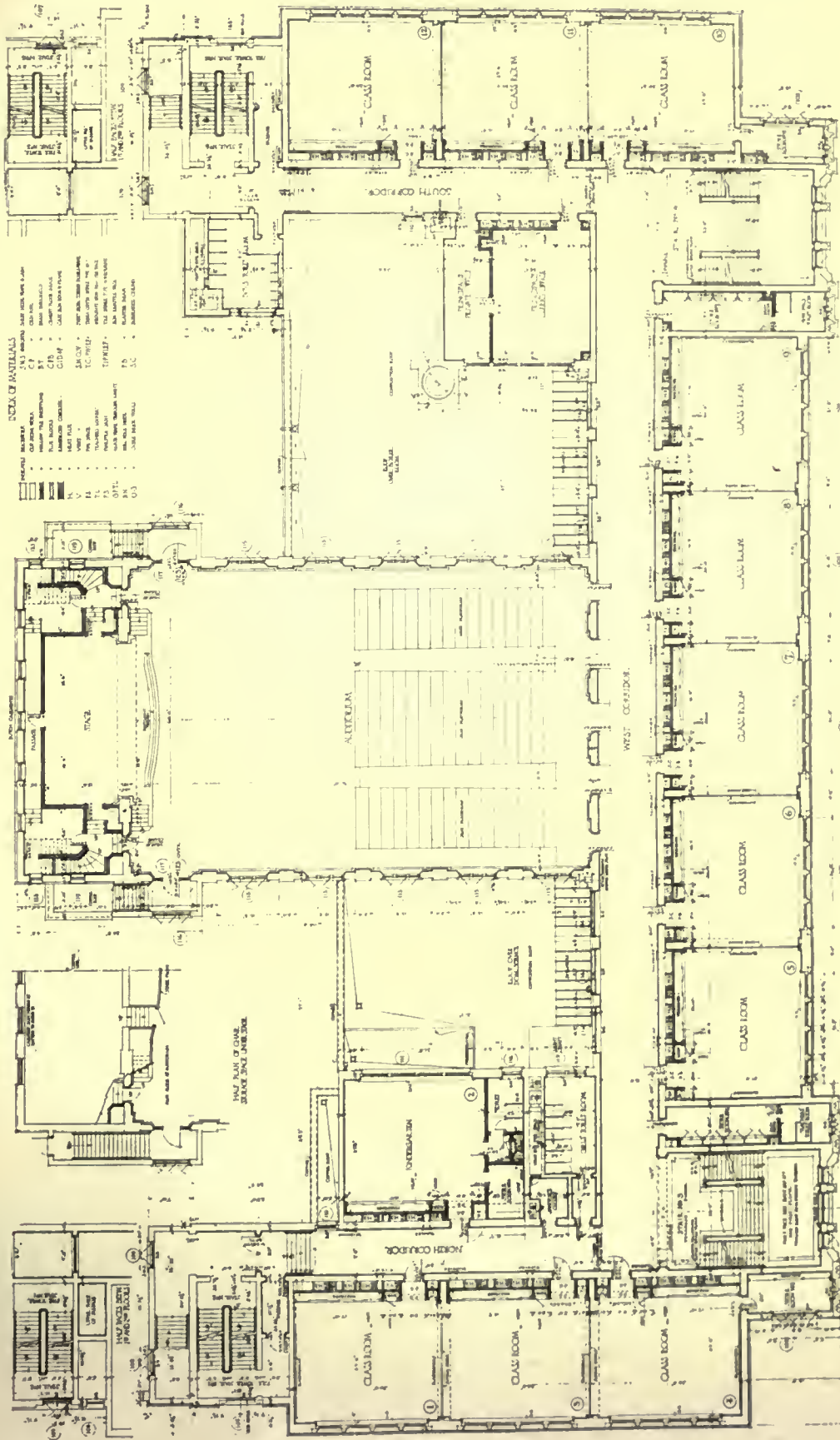

PLATE 2

FIRST FLOOR PLAN

JOHN KINSEY SCHOOL, SIXTY-FIFTH AVENUE, PHILADELPHIA, PA.  
HORACE COOK, ARCHITECT





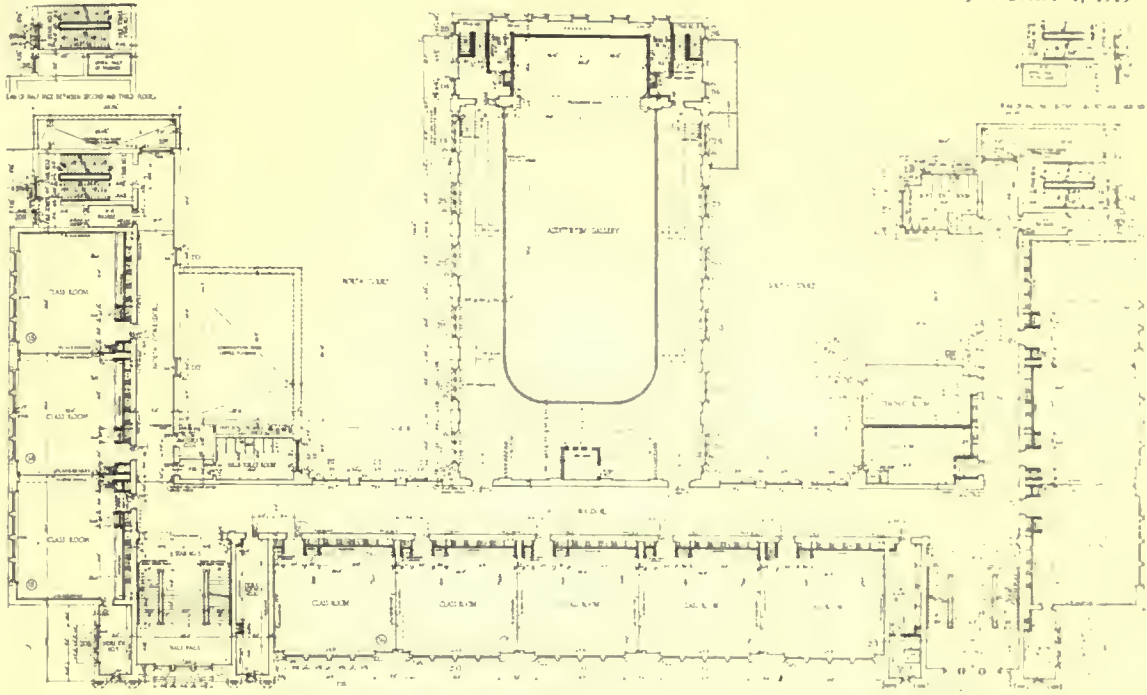

SECOND STORY

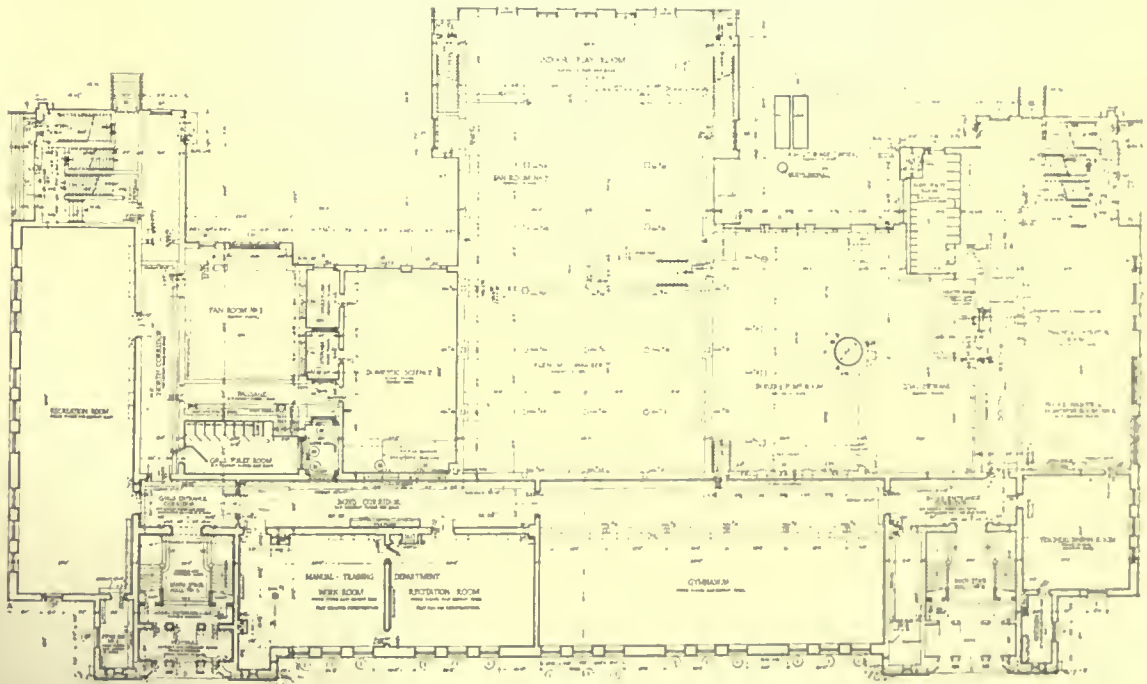

BASEMENT STORY

PLATE 3

JOHN KINSEY SCHOOL, SIXTY-FIFTH AVENUE, PHILADELPHIA, PA.

HORACE COOK, ARCHITECT





THE AMERICAN ARCHITECT

JANUARY 1, 1919

VOL. CXV, NO. 2345

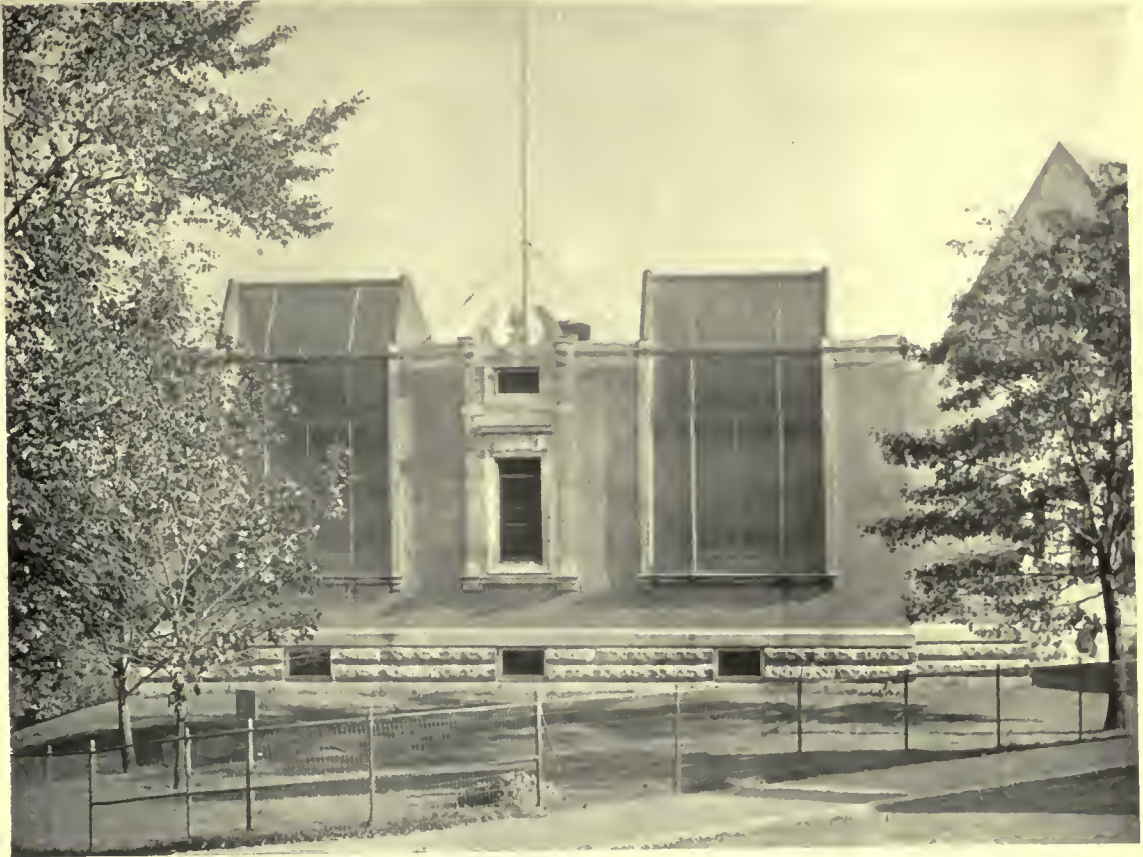

PLATE 4

FREE HOSPITAL FOR WOMEN, BROOKLINE, MASS.  
COOLIDGE & CARLSON, ARCHITECTS







OPERATING BUILDING



LAUNDRY BUILDING

PLATE 5

FREE HOSPITAL FOR WOMEN, BROOKLINE, MASS.  
COOLIDGE & CARLSON, ARCHITECTS







PLATE 6

HOUSE OF HENRY A. MORSS, MARBLEHEAD, MASS.  
COOLIDGE & CARLSON, ARCHITECTS







HARBOR FRONT

ENTRANCE FRONT

HOUSE OF HENRY A. MORSS, MARBLEHEAD, MASS.  
COOLIDGE & CARLSON, ARCHITECTS







HARBOR FRONT



HARBOR FRONT

PLATE 8

HOUSE OF HENRY A. MORSS, MARBLEHEAD, MASS.  
COOLIDGE & CARLSON, ARCHITECTS







DINING ROOM



LIVING ROOM

PLATE 9

HOUSE OF HENRY A. MORSS, MARBLEHEAD, MASS.  
COOLIDGE & CARLSON, ARCHITECTS







STAIRWAY



DETAIL IN DINING ROOM

HOUSE OF HENRY A. MORSS, MARBLEHEAD, MASS.

COOLIDGE & CARLSON, ARCHITECTS





PLATE 11

BUILDING FOR THOMAS CUSACK COMPANY, BROADWAY AND FIFTH AVENUE, NEW YORK

BUCHMAN & KAHN, ZIMMERMAN, SAXE & ZIMMERMAN, ASSOCIATED ARCHITECTS





# Criticism and Comment

## An Opportunity to Aid a Worthy Cause

(THE AMERICAN ARCHITECT will be pleased to receive any remittances that may be sent to it, in aid of this object, and will see to it that they reach their proper destination.)

The Editors, THE AMERICAN ARCHITECT:

I am enclosing copy of a letter received from Mr. Lavanoux, who is a New York draftsman now in France. I can make no better appeal than he has already made in this letter.

FRANK E. WALLIS.

New York.

FONTAINEBLEAU, November 28, 1918.

MY DEAR MR. WALLIS: Knowing draftsmen as you do, and being acquainted with their many shortcomings, you will, I hope, pardon my long silence, which is due not so much to laziness but rather to the "put it off to another day" habit.

Before coming to Fontainebleau about a month ago to enter the artillery school, I spent a few weeks in Paris visiting churches and roaming around my favorite haunts, l'Île de la Cité and the quais. In the course of my wanderings I came upon the old church of Saint-Gervais, near the Hotel de Ville. This church, as you know, was hit on Good Friday by one of the Big Bertha shells. The damage, loss of life, etc., was undoubtedly spoken of in the home papers. I spent a few hours in the church, viewing the damaged vault, the spots of blood on the stone floor, and ended my visit by interviewing Monsieur le Curé, l'Abbé Gauthier. We spoke of a thousand and one things, among which, naturally, was the question of reconstruction of the vault and pillars. M. le Curé told me that some persons had expressed a desire to help him financially, but nothing was ever done. He also told me that he had written to Cardinal Gibbons, asking His Eminence to head a campaign for funds, but that Cardinal Gibbons pleaded an overwhelming amount of work and his age, which prevented him from taking any active part in such an undertaking. It was then that I suggested to M. l'Abbé Gauthier that I endeavor to interest architects of New York in the matter. He seemed to be pleased with the idea, saying that he would feel most grateful for any help the members of the profession would give him. With your help and influence, I believe an appeal might be written up and published in a leading architectural publication. Any sum would be gladly received and could be forwarded to M.

l'Abbé Gauthier. The example would spur others, and in the end substantial aid could be given the Parish of Saint-Gervais, thus enabling the authorities to rebuild. Do you think the idea a good one?

With very sincere good wishes for Christmas and New Year, I remain,

Very sincerely,

(Signed) M. LAVANOUX.

## Federating Architecture

The Editors, THE AMERICAN ARCHITECT:

A conference, such as is suggested in your issue of Nov. 27 under the article "Federating Architecture Among the Allies" would, undoubtedly, be of great benefit to the profession of architecture throughout the country.

You suggest an organization "that will stand for architecture wherever it will be practiced in the United States." It does not seem desirable to me to have centralization of all architectural activities in one society, as it eliminates rivalry, competitive thought and action. It would be more satisfactory if there were two great architectural societies in this country instead of one. Where there is only one organization, that body appears to become quickly infected with dry rot and finally with stagnation.

One can readily imagine what would happen to the progress and liberty of the United States if our political activities were governed by the Republican or the Democratic party alone.

During the period of the war the profession of architecture was almost totally ignored in all great undertakings erected by the Government, except in a few isolated instances. The work was almost universally turned over to contractors to execute. This being the case, it does not appear that at the present time any architectural society held much weight in the national councils. That those in authority selected builders to carry out great projects without securing the assistance of architects should be a matter of profound regret to all who understand the value of architectural counsel and service.

As to what part American architects should play in the reconstruction of the buildings destroyed in Europe I would not hazard a guess. While the European architect and builder can learn many lessons relating to problems of plumbing, heating, ventilating and utilitarian building ideas in general

## THE AMERICAN ARCHITECT

from the American architect and engineer, I am of the opinion, when it comes to a matter of artistic development of European building, it may be left to the European architect, who appears, in every case, to have developed the most reasonable scheme of architecture to fit the environment and locality in which it is placed.

Viewing the architectural reconstruction of Europe from the broad standpoint of artistic development, it is hoped that the European architects will be free to design their own buildings in their own way. Leaving patriotism out of the question, I wonder how many artists would like to see Paris or Rome reconstructed to correspond with New York City or Chicago?

It would be very fine for architecture in this country if American architects could become pupils of European architects during the period of reconstruction in Europe.

It would be a splendid idea if some of our wealthy Americans established trade schools in France and Belgium where the young American craftsman could be properly educated in the fundamentals of his trade. This would be of infinite benefit to the workers in arts and crafts, the woodworker, the stone carver, the bronze and metal worker, and the various branches of the building profession calling for artistic craftsmanship.

I have no doubt that under such conditions the standard of American art and art appreciation in general would be brought to a higher standard in this country than exists at the present time.

It is useless to hope for any material artistic development in the United States as long as at least 80 per cent of the building in this country is executed by speculative builders and our city building departments are permitted to issue building per-

mits to these speculative builders on plans not prepared by responsible architects, and which violate every code of correct sanitation and good building.

TOM P. BARNETT.

### Improving Farm Buildings

*The Editors, THE AMERICAN ARCHITECT:*

I have read with interest your editorial on farm architecture. I am confident that the day is fast approaching when our farmers will invest considerable sums of money in permanent farm buildings. The present excellent condition of the farmers with reference to income will be one of the chief factors in bringing about the expenditure of large amounts in the erection of substantial buildings which will replace, in many instances, the rather forlorn structures that characterized the early stages of our agricultural development.

The farm home, which has developed into a paying proposition, soon must have modern conveniences such as running water, improved heating methods and sanitary fixtures, as well as other items of convenience and beauty which are necessary to keep the most desirable class of citizens upon the farm. Furthermore, the natural beauty of our state provides unusual opportunity for the development of the very finest type of homes in the rural districts if only sufficient income can be established and maintained to justify the investment. The matter is one of the most important things in connection with making farm life in Utah what it should be.

That the subject is being given attention is reflected in the biennial report of the president of the Utah Agricultural College.

SIMON T. BAMBERGER,

Salt Lake City, Utah.

Governor.





# Architects as Bridge Builders

By THOMAS HASTINGS, F.R.I.B.A.

STEAM and the rapid development of the railroad as a new method of transportation in the first half of the nineteenth century and probably the consequent discovery of steel as a new and economical material in construction have had a dominating influence upon modern design in bridge construction.

The railroads had to bridge the rivers and pierce the mountains, and the rapid demands upon what was practically a new profession, the position occupied by the modern engineer, are responsible for many unfortunate results which will take generations of changing conditions before they are rectified. The engineers and architects were separated as never before. Design in the construction of these larger and all important problems was almost eliminated, and quite naturally the æsthetic viewpoint was practically disregarded in the hurried development and changing conditions. The engineer saw primarily the quantitative side, while the architect continued to see first the qualitative side. Fortunately, the educated engineer in recent years more generally realizes that when a design looks well it will build well. The realization of this fact is so true in Europe that the engineers are given the theory of certain first principles in architecture, while the architects have always been given perhaps too much engineering. The architects at the École des Beaux Arts lecture at the École Polytechnique, while their professors lecture at the École des Beaux Arts, more especially on the analytical side of construction.

While much interesting architectural work has been accomplished with the proper use of iron, most of the iron bridges have been considered as purely engineering problems. In recent years bridge builders, even when building for railroads, have been inclined to consider favorably the return to masonry construction in order to save in maintenance or upkeep. This is an encouraging sign of

the times, and it is to be hoped that under these conditions architects will be employed rather than engineers. A stone bridge is unquestionably, both as a matter of appearance and economy, an architectural problem. The mathematics involved are rather descriptive than analytical, involving interesting problems of stereotomy entering into the architect's legitimate practice—problems with which he must of necessity be familiar. The Romans were the first great roads and bridge builders of the world, and their aqueducts and bridges, splendid in design and beautifully constructed, are to be found all over Europe, and even in Asia Minor and Northern Africa. These Roman bridges are to be found crossing the rocky channel of the Jordan River and the swift running waters of the Rhine, as well as on the River Tiber and the Pau. Some of the most splendid bridges were built in the Gothic period; indeed, outside of their cathedrals, there are perhaps no more imposing, lasting and beautiful monuments standing to the genius of the Mediæval architects than such bridges as Pont St. Benegal, crossing the Rhone at Avignon, Le Pont des Consuls over the Tarn at Montauban or those at Albi and Villeneuve. Spain, too, is rich with bridges—Roman, Moorish, Mediæval and Renaissance, many illustrating oft-times in their great simplicity splendid architectural problems well solved. These great engineering achievements either make a landscape more beautiful than nature unadorned or totally destroy the natural surroundings. We associate with Europe the well-built roads with walls or terraces, great bridges and other features which have been designed or guided with art. These create an atmosphere which, together with the well-planned avenues and park systems, often attract us more while traveling in Europe than do the pictures and sculptures or *objets d'art* in the galleries and museums frequented by the average man abroad.





TENTATIVE MODEL FOR THE NEW MADISON STREET BRIDGE OVER CHICAGO RIVER  
*Submitted by the Municipal Art Committee of the Illinois Chapter of the American Institute of Architects*

## Co-operating with Municipal Governments

Being an Account of the Work of a Special Committee of the Illinois Chapter, A. I. A.

THE constructive value of co-operation on the part of architectural societies with committees of city governments having to do with municipal art has been many times demonstrated. A concrete example is presented in the work of a special committee of the Illinois Chapter of the A. I. A. Even casual survey of a city's needs in the proper control and direction of its activities in the field of constructive art will disclose opportunity for the most valuable co-operation on the part of architects.

In Chicago these opportunities were more apparent than in most cities. The large engineering problems in which the city has been engaged soon suggested that there was a good opportunity for the counsel of architects to impart the saving touch of good art to well-planned constructions, and that among the largest possibilities was the architectural refinement of the many bridges which the city had within its limits.

To quote an admirable report made by George W. Maher, who at that time was chairman of the Municipal Art Committee of the Illinois Chapter:

The river bridges had always been a mooted issue in the minds of the people of Chicago. Here seemed to be the opportunity to demonstrate the assistance the profession could effectively render in improvements of this character which would materially assist the city beautiful idea.

The problem was at once entered into with enthusiasm although the outlook at first was certainly discouraging. It required considerable effort on the part of the committee to convince the city authorities that the architects were really in earnest and intended to be of real constructive value in this important undertaking of assisting in beautifying the bridges. It also required the consent of the City Plan Commission so that we could properly co-operate with them.

The first bridge improvement the committee interested itself in was the Chicago Avenue bridge. Sketches were made and approved by the City Bridge Department and later architectural details prepared and employed in its construction. The design proposed, however, was not fully carried out, but the appearance of this bridge was a distinct improvement and formed the entering wedge for greater opportunity.

The committee early recognized that it should interest itself in the important bridges since these would form a precedent for future bridges. As Madison Street bridge was to be one of these, since from its location it forms one of the main gateway entrances to the city from the great depots to the west, permission was asked by the committee to assist in designing this particular bridge. The accompanying illustration, taken from the architect's model, shows the principle of design that was established by the com-



## THE AMERICAN ARCHITECT

mittee—namely, that the bridge proper should be a bascule deck type bridge; the usual overhead steel construction being placed under the bridge or as executed on the Jackson Boulevard bridge.

The architectural features, however, to embellish the Madison Street bridge consist of granite abutments instead of concrete as on the other bridges, also at the east and west approaches to the bridge proposed monumental pylons on which will be placed electric lights beautifully to illuminate the bridge. The tower houses and balustrades to be constructed of matt glazed terra cotta in close imitation of granite. Pedestals have been suggested by the committee to be of granite and to extend out from the pylons for future bronze statuary. The statuary to typify notable historic events.

At the present moment the Franklin-Orleans Street bridge is being erected following this principle of design. The Monroe Street bridge, which had already been designed, has been changed at the suggestion of the committee to conform to the Madison Street bridge.

The designs of the Madison Street bridge are completed and approved and the bridge will be erected according to the designs and recommendations of the Municipal Art Committee, Illinois Chapter, A. I. A.

This report has been quoted at some length, as it affords an opportunity to become familiar with methods of action and architectural treatment.

Just at this time, when there will undoubtedly be put under way a great many projects of civic improvement that have been delayed on account of

the war, there is an opportunity larger than ever before for the profession of architecture to take up its rightful position in our communities, and by a proper and unselfish co-operation with the city governments and their engineers exert a very strong and beneficial influence on these matters.

Many important bridges and municipal engineering works are to-day monuments of good art because this close co-operation between the engineers and architects has been effected.

Glenn Brown's Q Street Bridge at Georgetown, D. C., Edward Pearce Casey's work on the Washington bridges, the work of Carrere & Hastings on the bridges spanning the East River in New York are all earlier good examples. To these we must add the very strong and good influence exerted by the Illinois Chapter of the Institute.

It is in work of this character that the profession of architecture may hope to secure and maintain all its rights to recognition as a profession, and there is no more danger that the architect and engineer may lose their respective identities than there ever was that the diagnostician and the surgeon might at any time be merged.





# Two Opinions on Architectural Advertising

By THOMAS CRANE YOUNG

THE American Institute of Architects having removed the article in its code of ethics which condemned the practice of advertising, further agitation along that line no longer seems to be necessary. Nevertheless, as few architects have as yet taken advantage of their new-found liberty, some further discussion may be desirable to create a better understanding of the sort of advertising which may be permissible.

It is quite natural that this prohibition should have been included in the code at the time it was written, for then the whole practice of advertising was in disrepute for the reason, probably, that the prevailing modes were offensive to the sight, the printed matter being frequently unreliable and often deliberately calculated to deceive. It was quite general for publications to print any sort of matter indiscriminately, provided only that they were paid the current rates for space. Probably the first blow was given to this practice by the United States Government when it was made a crime to issue false statements concerning food and drugs offered for sale to the public. Then the subject was taken in hand by the Advertising Associations, and since, largely through their efforts, a thorough reform is in the process of accomplishment.

The influence of the higher class of magazine has always been a potent factor in the improvement of advertising methods, and now their advertising pages are full of interesting and valuable information. [So, too, the automobile industry has produced forms of advertising of attractiveness and character, and at times of real artistic merit.]

While many forms of advertising still in use are extremely vulgar, the same criticism may be made of much of our national architecture. Nevertheless, it must be admitted that from a purely evil thing has been developed a new field of work for the artist as well as a most valuable means of spreading public information. This usefulness has been recognized by the United States Government as illustrated in their exploitation of the recent War Loans, in which they enlisted the patriotic services of the greatest artists that the country has produced.

There has been much complaint from a certain class of architects that the public has not been properly informed as to the character and value of architectural service, and this is no doubt true in part. But the means is at hand by which this ignorance may be dispelled, and if the architectural pro-

fession contains within itself the amount of good taste and artistic merit which are a part of their claim for recognition, there need be no fear of a loss of professional dignity through the proper form of advertising. The quality of advertising would be as difficult to control as the quality of architecture produced by the individual. Whatever method of expression may be adopted, it will probably show some indication of the character of the one who advertises. But the one requirement that could and should be rigidly enforced is that the truth and nothing but the truth be contained in any advertised statement.

---

By F. E. DAVIDSON

SINCE the ban on architectural advertising has been removed by the Institute I have been studying the problems connected with the subject from various angles and have made some investigation as to the probable financial return which might reasonably be expected from display advertising. The data secured lead me to believe that as a financial proposition alone, display advertising by a professional man would probably not yield a sufficient return on the money invested to justify it.

At the present moment it is my thought that the only advertising that any architect should do, in addition, possibly, to signing his buildings during construction, would be to have his professional card appear in the publications that his particular class of clients read, particularly if he specializes in a certain line of work. I very much doubt the wisdom of an architect's attempting anything in the way of display advertising, for I not only believe that such advertising would be in bad taste, but that it should be condemned from every other viewpoint as well.

I am, of course, speaking of the architect as a professional man. If the only object in life of an architect is to make money, then obviously he would not be an architect.

I think it quite probable that those architects who in the future may combine the functions and responsibilities of the contractor with those belonging exclusively to the profession of architecture, may and probably will do a considerable amount of display advertising. It is after all a question of viewpoint.

Why is any man following the profession of

architecture? Certainly not to make money. Money is, after all, a very insignificant thing. But if the acquisition of money alone is the only thing to be desired, then the architect should cease to call himself an architect and become a contractor; in which line of work, no doubt, it will be necessary to do some display advertising, for the reason that contractors as a class are advertisers and the public expects it of them.

For myself I am not practicing architecture expecting to get rich. I am in the game because I love it and know of no other profession that is

bigger or embraces so many subjects of interest, or that provides so many opportunities for patriotic and unselfish labors for the general good. My work is my play. It never gets tiresome. I never get weary of it, and I am satisfied with enough financial return to live decently and enjoy some of the luxuries of modern civilization. I believe that such a return is all that any professional man, or for that matter, any man, is entitled to. But I must add that the professional fees commonly paid architects are not in all cases sufficient to secure even this minimum of net financial return.

## The Architect and Engineer

By EDWARD PEARCE CASEY

EVER since the Renaissance there has been a continued tendency toward specialization, which is quite in keeping with the ever-expanding field of knowledge. At that time there were many geniuses in the arts and sciences, frequently well versed in all of them as far as they were then developed. The various artistic and engineering professions were concentrated in the same individual. Design, in its common sense and constructive aspect, was generally governed by good taste; since the practical and the artistic were combined in the same mind, there was a logical give and take to secure the best all-around result.

Now specialization has reached such a height that many of our leading architects seem totally indifferent to their lack of knowledge of anything but pure design in its various phases.

One would think their work would be illogical in a constructive sense, as it often is, thereby suffering in its attainment of good results.

In order to obviate the difficulties of present-day specialization, it is necessary to co-ordinate, as far as may be, the product of many minds. Architects frequently employ, or are in close association with, experts in the various subjects closely allied with architectural design, and thereby secure a thorough and exact working out of these particular parts. But often this is done to such an exaggerated extent that it results in an injury to the whole, which can be prevented only by a dominating spirit well versed in the fundamentals and possibilities of the numerous subjects involved and possessed of knowledge how to balance their various claims.

The situation is analogous, on a small scale, to that of an army. One might as well say that the head of an army need not be versed in the possibili-

ties and limitations of the engineers, infantry, artillery, cavalry, supply, and other branches of the whole. What would be the result if he were not possessed of a general knowledge of the functions and methods of the various branches of the complete organization?

Our various architectural schools are at present attempting to give instruction in subjects allied to architecture, subjects, which are often parts of architecture: painting and sculpture; engineering, civil, mechanical, sanitary and electrical; in acoustics, ventilation, heating, etc.; but many seem to think this is not very essential, and the general result in producing a broad vision over the entire field is as yet not especially marked in the profession.

It became apparent at the last convention of the American Institute of Architects that the profession is not a little annoyed by the slight attention paid it by army authorities, who evidently, and with some justification, have assumed that there was nothing architects could do in connection with war or an army.

How they have changed since the old days when they were the first called upon to erect fortifications and fashion engines of war! Possibly, as a profession, they have but themselves to blame for this general attitude, since for many years prominent members of the profession have given the public the impression that they are but slightly interested in the purely engineering and other scientific aspects of their art; so much so, in fact, that the erroneous idea has gone abroad that an architect is one practiced principally in the ornamentation of buildings and structures. Many will recall occasions when a well-intentioned engineer,



## THE AMERICAN ARCHITECT

having fully designed and calculated a structure, calls upon an architect to make it more presentable by the addition of ornament—a few frills.

This misconception is reflected by the novice in the study of architecture, who is apt to be carried away with the fascination of detail, moldings, ornament, etc., until he really thinks this is the most important part of the art, but as he progresses he becomes convinced how much more important are the beauties of the fundamental composition and proportions of a design, and how often buildings failing in this respect try to redeem themselves by relying upon details, moldings and ornament. But he will learn that redemption by this means is impossible, both as applied to buildings and to purely engineering works.

It is true that the Government has recognized that in some parts of design, the architect, even as it conceives him to be, might be useful, and has given him some share in the plan of hospitals, cantonments and housing schemes, but as for considering him sufficiently accomplished in all-around constructive work, making him eligible as an engineer officer of the army, there has been very little done.

Specialization has without doubt come to stay, and architecture and engineering will remain separate professions. Each will doubtless continue to be still further subdivided into specialties, but no specialist should allow his line of vision to become so narrow that it becomes the source of difficulty.

The two professions of architecture and engineering do not seem to have the respect for each other that should exist between two branches of the same calling. This is all the more to be regretted because they formerly were substantially the same profession. Architecture was held to include everything constructable from building temples to constructing catapults. The remedy for this really unfortunate attitude is for each profession to extend its knowledge more widely over the field of the other, and not look with contempt upon such knowledge. This is not as difficult as many seem to think, and is at present really attempted more on the part of the architect, in the architectural schools, than it is on the part of the engineer in the schools of engineering. The architect should study the broad principles of engineering in all its branches, but need not go deeply into their details; while the engineer should devote more study to the æsthetic side, to the beauty of proportion and form, of composition and character in design, but he also need not delve deeply into sculpture, painting, and ornament, nor into the planning and designing of build-

ings. This broadening of the point of view and extension of knowledge might be accomplished with great benefit to the work of all specialists in each of the two professions.

Although at the present time some architects have extended their studies on the scientific and purely engineering side, even to the extent of becoming graduates of engineering schools, the practice is not as yet general enough to impress the public that the profession as a whole can be entrusted with work which it undoubtedly could accomplish.

Artistic and practical natures are not at all incompatible, as the history of art abundantly shows. Many of the best architects and painters of the Renaissance were also engineers. One of the best-known architects of antiquity, Vitruvius, seems, judging from his writings, to have been able to make almost anything, useful or ornamental.

Probably of all the works commonly assigned to engineers, viaducts and bridges are the most conspicuous and require the most attention on the æsthetic side. Until recent years the works of man, structures nautical and terrestrial, utensils and machines, were, even from the most remote periods, generally made with a view not only to their usefulness, but also with a view to their good looks. This tendency still prevails in some fields, but is lamentably lacking in others, notably in that of the design of bridges. As a building, involving the combination and harmonizing of many arts, sciences and trades, one mind, or at least harmonious minds, should direct the whole from beginning to end, both inside and out and round about, in order to avoid discord both in the process and in the result, so in works of engineering. Often both an architect and an engineer are appointed for the construction of a bridge. If they are of a harmonious mind, the one possessing a knowledge and respect for engineering, and the other a knowledge and respect for pure design and æsthetics, they will work together and in entire accord, and something presentable may be accomplished; but if they are not harmonious, as so often happens, each looking askance at the other and holding his profession in contempt, working separately, each making his own designs and then trying to harmonize them, the result is a failure. The two should begin their work at the same time, harmonizing and balancing the requirements as if they were one individual, so that the result may be æsthetically correct and at the same time rational and stable. Then one might say the work has beauty with character and is entitled to be called a work of art.



## Stop Work on Tent Camps

Abandonment of all construction work in progress or projected at "tent camps," originally laid out for mobilization of the National Guard and later used for general training purposes, was ordered by the War Department. Exception is made in cases where it is shown that the completion is necessary in the interest of health of troops.

The camps affected by the abandonment order are Sevier, South Carolina; Bowie, Texas; McClellan, Alabama; Logan, Texas; Beauregard, Louisiana; McArthur, Texas; Hancock, Georgia; Wheeler, Georgia; Kearney, California; Wadsworth, South Carolina; Fremont, California; Sheridan, Alabama; Doniphan, Oklahoma; Cody, New Mexico, and Greene, North Carolina. These camps will be used for demobilization, but when this is complete they will be closed. Base hospitals at the camps will be used as convalescent hospitals.

Orders also were issued to-day for the abandonment of proposed buildings for a motor school at Camp Taylor, Kentucky, and for additional construction at Camp Funston, Kansas.

## Academy of Arts and Letters

At the recent annual meeting of the Academy of Arts and Letters the following officers were elected: William Dean Howells, president; William M. Sloane, chancellor; Robert Underwood Johnson, secretary, and Thomas Hastings, treasurer. In addition to the foregoing, members of the board of directors are: Dr. Nicholas Murray Butler, Edwin H. Blashfield and Augustus Thomas. Others present at the meeting were: Daniel Chester French, Hamlin Garland, Cass Gilbert, Robert Grant, Brander Matthews, Gari Melchers, Paul Elmer More, James Ford Rhodes, William Roscoe Thayer and J. Alden Weir.

## Things to Remember

There are reasons why we must live up to the principles of permanent peace and a new order of society, based not on rival national claims, but on a reign of justice. It is not only a matter of honor, but a matter of practical wisdom, of protection to ourselves, of insurance to the world. We must remember two things as we face the responsibility of victory: The first is that there are no more parochial problems; all problems are to-day world problems. The form of monarchy in Greece, or the labor problem in Sweden may become vital elements in affecting the fate of the world. So much

the war has taught us. Secondly, we need above all else, at this juncture, clarity of purpose and sanity of judgment. There is no room for sentimentalism, whether it takes the form of forgiveness and pity, or whether it takes the form of revenge and hate. We must be sane in understanding the world's vital need of the moment, and in devising means to secure it.

— From a recent address by Henry Crosby Emery before the Economic Club of New York.

## Survey of Labor Situation To Be Made by Employment Service

An immediate survey of the labor situation in industrial centers throughout the country will be made by the United States Employment Service, according to a statement issued by the Department of Labor. The machinery for this survey has been set in motion by the Employment Service at the request of the Secretary of War and the chairman of the War Industries Board.

The purpose of the information sought is, it is said, to enable the War Department and the War Industries Board as far as possible to avoid labor difficulties through the too rapid curtailment of war contracts and demobilization of the army. It is expected that the information will give the Government a view of the immediate labor situation, so it will know as early as possible in which centers there is a shortage or a surplus of labor, and how rapidly demobilization in these centers can be effected.

## International Reconstruction

In war we have made common cause with the Allies. We should likewise make common cause with them in seeking the solution of the immediate problems of reconstruction which they face, because of the efforts they put forth in the war. These problems peculiarly depend for their solution upon commerce.

Raw materials and industrial equipment which we possess the Allies urgently require, that they may reconstitute their economic life. We should deal generously with them in sharing these resources.

In order that we may share our materials with the Allies, we must also provide them with credits through which they may make the necessary payments.

Our ocean tonnage must supply our troops overseas and help to provision the inhabitants of war-

## THE AMERICAN ARCHITECT

devastated regions. The part of our ocean tonnage not required for these paramount needs, and vessels of associated countries which are in a similar situation, should be entered in the common service of all nations. This common service should secure to all nations their immediate needs for food, raw materials, and transport for their products.

---

### Industrial Co-operation

The war has demonstrated that through industrial co-operation great economies may be achieved, waste eliminated and efficiency increased. The nation should not forget, but rather should capitalize, these lessons by adapting effective war practices to peace conditions through permitting reasonable co-operation between units of industry under appropriate Federal supervision. It is in the public interest that reasonable trade agreements should be entered into, but the failure of the Government either clearly to define the dividing line between those agreements which are, and those which are not, in unreasonable restraint of commerce, or to provide an agency to speak for it on application of those proposing to enter into such agreement, in effect restricts wholesome co-operation and deprives both industry and the general public of its benefits. The conditions incident to the period of readjustment render it imperative that all obstacles to reasonable co-operation be immediately removed through appropriate legislation.

---

### After the War

Now that the war is over, says *The American Contractor*, the reconstruction of the world becomes the dominant question of the hour. American railroads will have to be rebuilt and enormously expanded, making a greater demand for steel rails than the entire steel rail capacity of the country. American highways will require the expenditure of billions of dollars to develop a system worthy of the name.

Our rivers and harbors will have to be deepened and the water transportation interests utilized in keeping with the vast traffic of that hour. Building activities which have been halted for the last four years will then have to leap forward, and building supply materials will be in a great demand. More than \$1,000,000,000 will have to be expended upon the reconstruction and restoration of the industrial interests of France, and hundreds of millions upon the rebuilding of Belgium.

All Great Britain will have to take up enormous house building construction work, for houses are badly needed, and for reshaping its railroads, its merchant marine and other activities. Russia will be opened up to broad world encircling business development. South America and Africa, Canada and Australia and other countries will all begin a period of construction work, because for the last four years the world has concentrated its whole thought upon war. Then it will turn with equal eagerness to the work of the upbuilding influences brought into existence by peace. Great enterprises and small will be in evidence everywhere throughout the world.

The man who fails to keep this situation constantly before his mind, and so shape his business as to be ready to turn his activities upon the mighty opportunity which will then come to the brain and the machinery and capital of the world, will miss a chance such as may never again come to him. It behooves every business man in all the land to be ready to make the most of the unusual situation.

---

### Gift for a National Portrait Gallery

Announcement has been made that Christoffer Haamevig, a banker of New York and former Norwegian shipbuilder, has donated \$100,000 to lay the foundation for a national portrait gallery in the United States similar to that in London. The money is to be used in buying portraits of officials who have "formed the driving force of America's efforts in the great war."

The first portrait to be painted will be that of President Wilson, who will sit soon after his return from France. Others who have been invited to have their portraits painted are Secretaries Lansing, Baker, Daniels, McAdoo and Lane, Generals Pershing and March, and Admiral Sims.

---

### The World's Rubber Supply

The world's rubber supply comes in part from Ceylon, Malaya, South and Central America, Asia and Africa, but the "Middle East" is really the great rubber area, and Singapore, Penang, Batavia and Colombo the chief rubber ports of the world. Before the war a large proportion of our supply reached us indirectly via England, and London was the world's real rubber market. But that has been changed, and now two-thirds of all rubber imports come to us directly from the ports of the British and East Indies. Brazil, which in 1912 supplied



us with more than two-fifths of our rubber, now supplies but one-ninth. This shift is due largely to the change from wild to cultivated sources of supply.

## To Plant Memorial Highways

Active co-operation of the Governors of all the States in the Union is expected in the plan to plant, along transcontinental highways and public roads, memorial trees for the nation's dead soldiers and sailors. Charles Lathrop Pack, president of the American Forestry Association, who originated the idea, says that it already has been taken up by many towns and cities. The General Federation of Women's Clubs has before it a proposition to plant memorial trees along the Lincoln highway.

"There can be nothing more appropriate," said Mr. Pack recently, "than to have each State through which a motor highway passes plant 'victory oaks' or 'victory elms' for her soldiers or sailors who have died in battle. The motor has played a mighty part in the winning of the war, and it would be a fine thing for these highway organizations to take up plans for memorial trees.

## Business Conditions

A report by the Comptroller of the Currency shows that on June 30, the close of the last fiscal year, the aggregate resources of the 28,000 State and National banks in the United States amounted to \$40,310,000,000. Of this amount \$22,371,000,000 was credited to the 21,175 State, savings, and private banks and trust companies, and \$17,839,000,000 to the 7705 National banks. Deposits of the State banks amounted to \$18,567,000,000 and loans to \$12,426,000,000, an increase of 5 per cent in the deposits and of 6.5 per cent in the loans as compared with the record of a year previous. National banks showed \$14,021,000,000 deposits, an increase of 9.8 per cent, and \$9,620,000,000 in loans, an increase of 9.1 per cent. The deposits of all banks, State and National, totalled \$32,589,000,000, and loans, \$22,046,000,000.

The readjustment of business to peace conditions is proceeding, but is still affected by the uncertainty as to when and how fast prices will return to normal levels. It is observable that consideration of the labor problem is entering insistently into all calculations, and while in some quarters opinion inclines to the belief that labor must soon accept sharp reductions in wages, there is a very strong drift toward the view that now, if ever, is the time to seek that co-operation of capital, management,

and labor which will result in increased production, cheaper prices, and fairer returns to these elements. A notable event of the period is the recommendation of the American Iron and Steel Institute that steel prices be revised downward, but that the wage scales be left at present levels, for a time at least. The note of optimism is dominant at all gatherings of business men to discuss readjustment problems. Announcement has been made that Government stores of food and other articles available for civilian use will not be dumped on the markets.—

From the Bulletin of the Guaranty Trust Co.

## Labor

The labor problem, says *Hardwood Record*, is causing more worry than any other feature of the reconstruction program. There can be no arbitrary reduction of wages to the pre-war basis. Were such folly attempted employers would suffer as much as employees, and capital as much as labor. That there will be a gradual readjustment is inevitable, but we should remember that for every loss there is some compensation.

The difficulty lies in the fact that the workingmen of the country have, in the main, raised their living standards to comport with the extravagant war-time wages, and they do not want to give up those standards now, even to make room for returning soldiers. When the armistice was signed, the Department of Labor announced that it would control the demobilization of our army and thus prevent it from swamping the labor market. Apparently, however, the Department of Labor overestimated the docility of the War Department, as General March, Chief of Staff, has announced that demobilization would be made by the army at the rate of 30,000 men a day. A demobilization at that speed threatens to overrun any channel into which the Department of Labor might seek to lead it. As a matter of fact, the Department's program for an "industrial demobilization" has hit a number of snags. One of these is the opposition of the Governors of the Western States, who fear it will prevent an adequate return of labor to the farms.

Secretary McAdoo injected an element of confusion into the general wage readjustment by an eleventh-hour increase to railroad telegraphers, totaling \$30,000,000 a year. At the same time the United States Shipping Board is advertising widely its intention of maintaining its generous wage scales, and is even showing signs of hoping to maintain the overtime schedules. Wages will have to be readjusted to cope with conditions. To reduce wages at once, however, with the cost of living still



## THE AMERICAN ARCHITECT

unreduced, would be dangerous. On the other hand, it is difficult to see how present abnormal standards can possibly be maintained under normal conditions. Mr. Gompers has declared that labor means to retain all it has gained during the war in better wages, better working conditions, and shorter hours, and it may be that there are stormy times ahead of us in this regard. It is hard, however, to get away from the old law of supply and demand, and if the supply of labor greatly exceeds the supply of jobs, the price of labor is pretty sure to react accordingly, regardless of the views of Mr. Gompers or anyone else. No real drastic reduction in wages paid to labor will be possible until costs of living decrease. It will be at least a year before the countries of Europe can produce enough of their own food to bring about lower food prices, and during this year wages will remain fairly high and perhaps will never go back to the pre-war basis.

Labor will probably go down very little during the next few months.

---

### Southern California Chapter, A. I. A.

The one hundred and twenty-first regular meeting of the Southern California Chapter, A. I. A., was held Dec. 10, 1918. The meeting was called to order by the president, J. J. Backus.

As guests of the Chapter there were present State Senator Dwight Hart and Mr. Prine, of the *Southwest Builder and Contractor*.

Minutes of the one hundred and twentieth meeting were read and approved.

There were no reports from the executive committee nor from the standing committees.

Under the head of "New Business" the secretary read the following communications:

From the assistant secretary, George B. Robinson, of the Technical Societies, calling the Chapter's attention to a vacancy on the State Railway Commission, and suggesting that the Chapter communicate with the Governor recommending that an engineer be appointed to this commission. The letter was ordered filed.

From Architect Anton Cervený, suggesting that the Chapter interest itself in the establishment of a Museum of Architecture. The letter was ordered filed.

The secretary reported the death of Francis W. Young, which occurred on Nov. 24. Mr. Wackerbarth moved, and it was duly carried, that a resolution of condolence be drafted.

The following officers were elected for the coming year:

President—H. M. Patterson.

Vice-President—Lyman Farwell.

Secretary—H. F. Withey.

Treasurer—August Wackerbarth.

Executive Committee—S. B. Marsten, Robert H. Orr and Walter E. Erkes.

Under the head of "Debates," the subject of the desired changes in the State Hotel and Housing Law was brought up, and generally discussed. It was moved by Mr. Allison, and duly carried, that the Chapter go on record as favoring the elimination of that clause in the Hotel Law which limits the construction of hotel buildings to the height of one and a half times the width of the abutting street, and that the height limit of 150 ft. be retained, as the bill now stands. The president thereupon instructed the committee on permanent legislation to draft a recommendation to that effect in proper form and submit to the Legislature.

# Department of Architectural Engineering

## Daylight vs. Sunlight in Sawtooth-Roof Construction<sup>1</sup>

By W. S. BROWN, Assoc.-Mem. Am. Soc. M. E.<sup>2</sup>

[The building is an important element in all production processes. A space with four walls and a roof, in which men and machines were housed, was at one time considered to constitute a manufacturing plant. It is now universally agreed that such a plant must, in addition, have light, heat, ventilation, sanitary arrangements and contented and healthy workmen.

The new world competition in manufacturing will necessitate an increased production to compensate for the American wage scale and properly constructing the building in order to make these increased productions possible. The designers of industrial buildings may not have considered the sawtooth skylight except in a very general way and the complete and scientific analysis of its function here printed, we believe, is the first analysis of that kind which has been made. The necessity of utilizing daylight, which is to be had without cost, fully justifies a careful consideration of this kind of lighting. To properly design the sawtooth skylight may involve some concentrated study, but all correct designing involves real work to which the owner is entitled when purchasing architectural service.

THE AMERICAN ARCHITECT voices a sincere appreciation of the successful effort to place the sawtooth skylight among the measurable factors in building construction and of the generosity displayed by the investigator in making the data public.]

*Empirical research of the amount of direct sunlight and the intensity of daylight to be admitted on the working plane in sawtooth construction.*

*An equation is derived to determine the time of admission of direct sunlight and the number of hours of its duration with a given orientation of sawtooth buildings and the slope of the lighting area.*

*Further considerations are made in regard to the influence of the size and slope of the sawtooth lighting area on the relative intensity of daylight received from the northern sky. Special examples are given illustrating the manner of computing the amount of diffused light entering a building under several specified conditions.*

MANY processes of manufacturing require for best results, natural illumination consisting of sufficient and well-diffused daylight with, at the same time, however, the important limitation that little or no direct sunlight shall fall upon the working plane.

2. That is, there is a sharp distinction between daylight and sunlight and their relative desirability. The former consists of illumination by reflected and refracted light, properly designed fenestration, resulting in an evenly distributed, well-diffused light with consequent lack of sharp shadows and contrasts. The latter, or illumination by direct sunlight, is objectionable for many reasons of vary-

ing relative importance, such as the following: Its heating effect, especially in warm, southern climates; its color, which has a sensation value containing a greater proportion of red rays than daylight; its actinic effect upon materials used in manufacturing processes; and the fact that it is unidirectional and of excessive intensity, resulting in glare, sharp shadows and contrasts.

3. *Diffusion of daylight* in sawtooth buildings is obtained by placing the sawteeth so that the glass or lighting area faces the northern sky; sufficient intensity being dependent, among other things, upon the size and slope of the lighting area. *Evenness of distribution* is procured by properly apportioning the lighting areas. The amount of direct sunlight admitted daily, the time of its admission, and its duration are evidently dependent upon three considerations, the last two of which may be varied within certain practical limits. They are:

- a The day of the year, determining as it does the sun's path across the sky.
- b The direction in which the lighting area faces as regards the points of the compass.
- c The slope of the lighting area.

4. For a given lighting area, a variation in its slope is accompanied by a very appreciable change in the amount of daylight admitted, as will be demonstrated later. That is, as the pitch of the lighting area is made steeper, the amount and duration of direct sunlight entering the building is lessened, and at the expense of the general illumination. Conversely, as the slope of the lighting area is *decreased*, the intensity of daylight is correspondingly *increased*, but there also is concurrent therewith a greater amount and duration of direct sunlight.

5. The question then becomes: How steep should this slope be? What is the proper balance between the two contending requirements of little sunlight and much daylight? Also at what time of day will the direct solar rays fall upon the working plane, in what locations and volume, and for how long a period?

6. Naturally, no general answer can be given to these questions. Each individual problem should be worked out only after careful study has been made

1. Presented at the annual meeting of the American Society of Mechanical Engineers, December, 1918.

2. Industrial Engineer, F. P. Sheldon & Son, Providence, R. I.

of the particular conditions and requirements which have to be met, not excluding first cost. In the Southern States, for example, the tendency is to adopt a more nearly vertical lighting area than in the northern part of the United States or Canada, on account of the greater altitude of the sun and its intense heat. Occasionally it has been found advantageous to so locate machinery as to avoid any direct sunlight during the working hours.

7. With a view, therefore, to clearing up such questions as these, the writer's firm, F. P. Sheldon & Son, undertook to work out, in conjunction with what empirical data they already had, a rational method of design for sawtooth roof construction.

8. The subject is necessarily divided into two closely related parts, the first concerning *direct sunlight*, its amount, time of admission, duration, and location on the working plane; the second part relating to intensity of *daylight* upon the working plane.

PART I. THE ORIENTATION OF SAWTOOTH BUILDINGS AND THE SLOPE OF THE LIGHTING AREA AS RELATED TO THE REQUIREMENTS OF LEAST DIRECT SUNLIGHT

9. The amount of direct sunlight admitted daily, its time of admission and duration are dependent upon the factors given in *a*, *b* and *c* of Par. 3.

10. In the practical problem of the sawtooth roof, the effective slope or *vertical angle* of the lighting area, on account of projecting jets, gutters, and sash rails, and the interference of roof rafters, etc., is *greater* than the pitch of the glass itself. This often amounts to as much as 7 deg. or 10 deg. Similarly the *horizontal angle* or bearing of the lighting area with respect to the sun's rays may be greater or less than the nominal angle on account of projecting vertical sash bars, etc. This difference often amounts to as much as 5 deg. or 8 deg.

11. The position of the sun at any given time depends upon the latitude of the place, time of day, and calendar date, and may be obtained from standard altitude and azimuth tables. Knowing this, the time of admission and duration of direct sunlight for any day of the year may be calculated as follows:

12. In Fig. 1, let the plane determined by the three points, *A*, *C* and *D*, represent the lighting-area plane, and let points *A*, *B* and *E* define a plane parallel with the horizon. These two planes intersect in line *AF*. The acute angle *v* is then the effective slope or vertical angle of the lighting-area plane. Also let line *AB* represent the horizontal direction or bearing of the sun with respect to the building at any assumed calendar date and time. That is, angle *h* = the difference between the sun's true bearing or azimuth and the true corrected bear-

ing or azimuth of the lighting-area ridges, each azimuth being read easterly or westerly from north, according to whether morning or afternoon conditions are being computed.

13. Now pass plane *ABC* through *AB* perpendicular to plane *ABE*, cutting the lighting-area plane *ACD* in line *CD*. By construction this plane also contains the sun's altitude line through point *A*. Consequently, it is evident that if vertical angle *x* is greater than the altitude of the sun, a condition

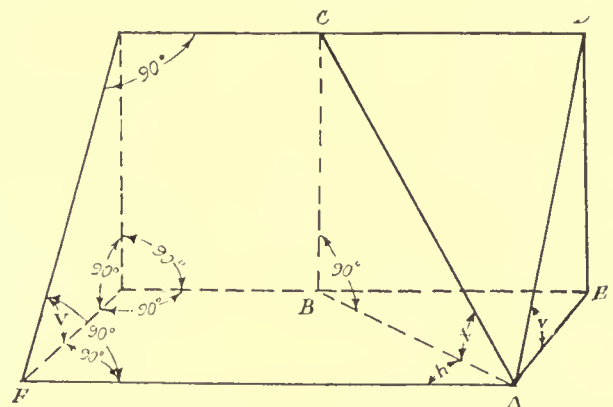

FIG. 1. TO ILLUSTRATE ADMISSION AND DURATION OF DIRECT SUNLIGHT.

of total shade exists within the building at the given time. And contrariwise, if *x* is less than the solar altitude, the sun is in front of the plane of the lighting area and some direct sunlight is entering the building.

14. Now, to find *x* in terms of *v* and *h* (see Fig. 1),

$$AE = ED \cot v$$

and

$$AB = ED \cot x$$

and

$$\cos (90 - h) = \frac{AE}{AB}$$

Substituting in the last equation the values of *AE* and *AB*,

$$\cos (90 - h) = \frac{\cot v}{\cot x}$$

whence,

$$\sin h = \frac{\cot v}{\cot x}$$

and

$$\tan x = \sin h \tan v \dots \dots \dots [1]$$

15. From the above equation, exact information may be obtained as to the time of admission of direct sunlight and the number of hours of its duration. The following example illustrates the method of procedure:

EXAMPLE I. *Given*, a sawtooth building located in north latitude 36°. Orientation of building is such that azimuth of sawtooth ridges = 99° 08' E. Angle of glass = 73°. *Required*, to find sunlight conditions on June 10 (sun's declination 23° N.).

16. By inspection, according to azimuth table, sunlight will enter the building from sunrise until



at least 9:20 a. m. apparent time, because the sun's azimuth up to that time is less than that of the sawtooth ridges. The method now consists in finding by trial at what time the sunlight entirely disappears from the shed.

17. Assume 10:20 a. m., at which apparent time, according to the tables, the sun's azimuth =  $114^{\circ} 08' E.$ , and its altitude  $64^{\circ} 46'$ . Now,  $v = 73^{\circ}$  plus a correction for projecting jets, gutters, etc., as previously explained. (This may be found from detailed section of building and will here be assumed as  $7^{\circ}$ .) Then  $v = 73^{\circ} + 7^{\circ} = 80^{\circ}$ . Applying the correction as explained in Par. 10,

$$h = 114^{\circ} 08' - (99^{\circ} 08' - 5^{\circ}) = 20^{\circ}.$$

Entering Equation [1],

$$\tan x = \sin 20^{\circ} \tan 80^{\circ}$$

whence

$$x = 62^{\circ} 43'.$$

18. Since at this time the solar altitude ( $64^{\circ} 46'$ ) is greater than  $x$ , a small angle of sunlight is entering the shed. The above process may be repeated with a slightly larger assumed value of  $h$ , with the result that within a few minutes all direct sunlight will be found to be entirely excluded from the building.

19. To obtain afternoon conditions, the operation should be further continued until such time as sunlight is found to re-enter. In this case, instead of assuming the time and computing  $h$ , the reverse method will be pursued and, as a further short cut, it may be reasoned that since the lighting area faces slightly toward the east (that is, N.  $9^{\circ} 8' E.$ ),  $h$  at the transition period will be less than in the morning.

20. The westerly azimuth of the sawtooth ridges is now used for reference with the tables and equals  $90^{\circ} 0' - 9^{\circ} 8' = 80^{\circ} 52'$ . Try  $h = 6^{\circ}$ , at which time the sun's azimuth becomes  $(80^{\circ} 52' - 5^{\circ}) + 6^{\circ} = 81^{\circ} 52'$ , the apparent time being, from the tables 4:34 p. m., and the sun's altitude being from the tables  $30^{\circ} 10'$ . Entering Equation [1],

$$\tan x = \sin 6^{\circ} \tan 80^{\circ}$$

whence

$$x = 30^{\circ} 41'$$

21. Since  $x$  is  $0^{\circ} 31'$  greater than the solar altitude, it is evident that no direct sunlight is entering. However, this angular difference is very slight and if the computations were carried on a step further, sunlight would be found to come in approximately five minutes later.

22. In this case then, on June 10 a condition of total shade exists within the building from approximately 9:20 a. m. until 4:34 p. m., *apparent time*. Where the apparent time is different from standard time, the proper allowance should, of course, be made. Furthermore, an additional correction must be applied in places where the daylight saving plan is in effect.

23. Generally it will be found advisable to solve a given problem for at least two sets of conditions,

that of the longest day of the year (June 21, declination  $23\frac{1}{2}^{\circ} N.$ ) and the average day of the year (March 21 and Sept. 23, declination  $0^{\circ}$ ).

24. In the example above, it will be noted that the duration of total afternoon shade is 4 hr. and 34 min. and is considerably greater than the duration of morning shade, which is only 2 hr. and 40 min. This is due to facing the lighting area slightly ( $9^{\circ} 8'$ ) toward the east, and suggests quite a range of possibilities as regards orientation.

25. By applying the principles of descriptive geometry, the amount and location of direct sunlight at any given time may be obtained, if desired, by finding the lines in which the solar rays through the top and bottom limits of the lighting area intersect the working plane—the direction of these rays being taken from altitude and azimuth tables. It may also in this case be necessary to include the effect of side walls, division walls, etc.

26. For convenience, Table 1 is appended, giving different values of  $x$  for assumed values of  $h$  as applied in the second method of Example 1. Its use makes unnecessary any reference to trigonometrical tables, unless closer results are desired, for angles not given.

PART 2. THE RELATIVE INTENSITY OF DAYLIGHT RECEIVED FROM THE NORTHERN SKY AS INFLUENCED BY THE SIZE AND SLOPE OF THE SAWTOOTH LIGHTING AREA

27. It doubtless has been noted that, by essence, Part 1 lends itself to exact mathematical solution. This is not the case, however, with Part 2, for which, as will be explained later, the answer is not to be found so precisely on account of the necessity of introducing certain more or less arbitrary and variable factors. It should therefore be applied only with discrimination and strict regard for its practical limitations.

28. The total amount of diffused daylight entering a building through sawtooth sash and made available for use (direct sunlight being excluded) may be analyzed as consisting of:

$d$  = light from the sky *directly* incident upon the working plane.

$rd$  = light from the sky *directly* incident upon the under side or ceiling of the sawtooth roof and thence being diffusely *reflected* to the room below (*one reflection*).

$r_1c$  = *combined* light from the *sun and sky*, diffusely reflected from the upper outdoor surface of the adjacent sawtooth roof directly to the room below (*one reflection*).

$r_2c$  = *combined* light from the *sun and sky*, diffusely reflected from the upper out-

door surface of the adjacent sawtooth roof, to the under side or ceiling of the sawtooth in question and thence being again diffusely reflected to the room below (two reflections).

29. The total amount of light entering the building and due to the summation of the above four elemental quantities is therefore

$$L = d + rd + r_1c + r_2c \dots \dots \dots [2]$$

30. In the following derivations for each of the above four quantities, it will be noted that the individual values obtained (and therefore also the total value  $L$ ) are purposely not expressed in terms of any particular standard unit of flux or intensity of illumination. On the contrary, they represent only the relative or comparative amounts of light fur-

31. However, the intensity of illumination in foot-candles could doubtless be approximated, if desired, for a given set of conditions, by applying a theoretically or experimentally determined constant, based correspondingly on the sun's position, general atmospheric conditions, kind of glass, whether single- or double-glazed, whiteness of roof, etc.

*Determination of the quantity  $d$  or light from the sky, directly incident upon the working plane, see Fig. 2.*

32. In arriving at the quantity of light represented by this heading, one of the basic assumptions is that: *The intensity of skylight upon, or the amount of skylight transmitted through, a given point in space is directly proportional to the extent or solid angle of sky to which it is exposed.* This carried a

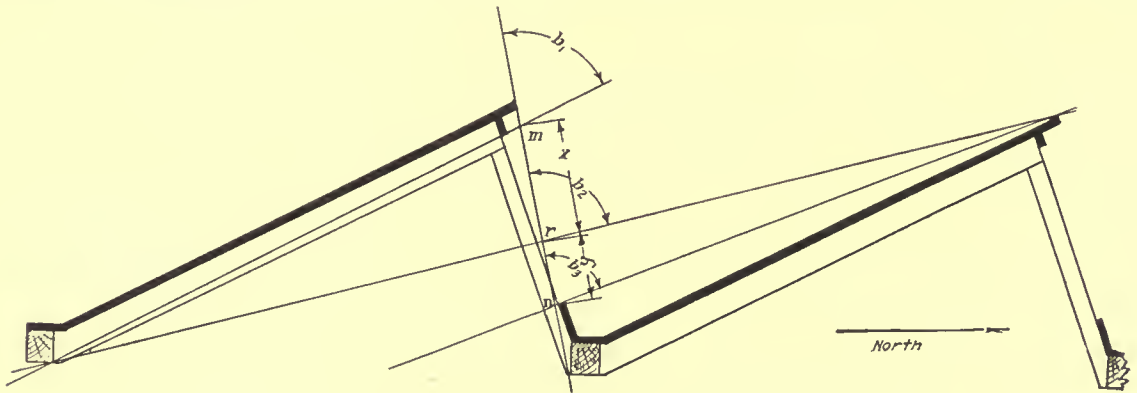

FIG. 2. TO ILLUSTRATE THE AMOUNT OF DIRECT SKYLIGHT.

TABLE 1.—SHOWING VALUES OF  $(x)$  IN TERMS OF  $(h)$  AND  $(v)$

$A^\circ$	$x$ for $v=70^\circ$	$x$ for $v=75^\circ$	$x$ for $v=78^\circ$	$x$ for $v=80^\circ$
3	8° 11'	11° 03'	13° 50'	16° 30'
5	13° 28'	17° 59'	22° 18'	26° 16'
7	18° 29'	24° 28'	29° 52'	34° 36'
10	25° 30'	32° 57'	39° 24'	44° 32'
15	35° 28'	44° 01'	50° 40'	55° 44'
20	43° 15'	51° 55'	61° 05'	62° 43'
25	49° 15'	57° 36'	63° 20'	67° 22'
30	53° 59'	61° 49'	66° 59'	70° 34'
35	57° 36'	64° 58'	69° 41'	72° 56'
40	60° 30'	67° 22'	71° 42'	74° 40'
50	64° 36'	70° 43'	74° 30'	77° 03'
60	67° 15'	72° 48'	76° 12'	78° 30'
70	68° 49'	74° 05'	77° 18'	79° 22'
80	69° 44'	74° 47'	77° 50'	79° 52'
90	70° 0'	75° 0'	78° 0'	80° 0'

nished under their several respective headings. And for the analytical purposes of design, it is believed that, on account of the extreme variability of natural light from day to day and from hour to hour, the use of these values should prove to be fully as satisfactory as if they were expressed in some such term as "foot-candles" of intensity. Especially is this true in view of the fact that they may be employed in conjunction with values computed for buildings already in service and of known degree of excellence as regards natural illumination.

step further and accommodated to the requirements of the problem in question, reads: *The intensity of skylight upon, or the amount of skylight transmitted through, a given point or horizontal line is directly proportional to the vertical angle of the sky to which it is exposed, providing the exposures in a horizontal direction on either side of that vertical angle are equal and symmetrical.*

33. The verity of the above statement, of course, presupposes the sky to be of uniform brilliancy throughout, whereas, as a matter of fact, it is known to be brightest near the sun and near the horizon. However, in the particular problem under consideration any error due to this circumstance should be relatively small for the reason that the sky angle to which a sawtooth roof is exposed, ordinarily embraces a fair average of, and at certain times of day, practically the complete variation of the extremes noted.

34. Now referring to Fig. 2, it is evident that the amount of direct skylight admitted by the typical construction shown is directly proportional to the sum of the total number of degrees of sky which each unit area of the "true effective area" passes, and may therefore be expressed by a summation

of the product of the above unit areas and their respective sky angles.

35. By inspection, points *m*, *r* and *n* transmit directly to the working plane sky angles  $b_1$ ,  $b_2$  and  $b_3$ , respectively, the average sky angle transmitted by all points between *m* and *n* being very closely

$$a = \frac{x \frac{b_1 + b_2}{2} + y \frac{b_1 + b_2}{2}}{x + y}$$

measured in degrees.

36. For parallel light rays making an angle *a* with the lighting plane, the "true effective area" would be  $s_{x,y} \sin a$ , where  $s_{x,y}$  = the area of the

ance should be made for the obstruction due to vertical sash bars, etc.

*Determination of the quantity rd or light from the sky directly incident upon the under side or ceiling of the sawtooth roof and thence being diffusely reflected to the room below. See Fig. 3.*

39. By inspection, point *m* transmits to the under side of the roof, sky angle *e* and all points below *m* in the lighting-area plane transmit continually decreasing angles until the value zero is reached at *r* and below.

40. Therefore, the average sky angle transmitted

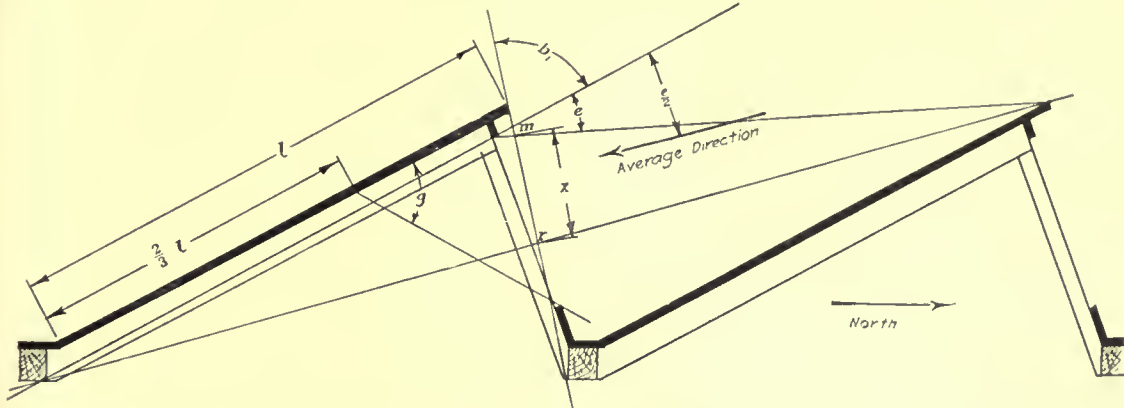

FIG. 3. TO ILLUSTRATE THE AMOUNT OF PURE REFLECTED SKYLIGHT FROM CEILING.

opening in the lighting-area plane as defined in Part I, having a height of  $x + y$ . But in this case, as will be seen by inspection, the angular direction of the light rays passing any point varies in respect to the plane between the average limits of zero and *a*. Therefore, the "true corresponding effective area" may be expressed by  $s_{x,y}$  times the average sine of this variable angle, between the limits of zero and *a*. This average sine by simple integration is found to equal  $\frac{\text{vers } a}{a}$  where angle *a* is in radians. If expressed in terms of degrees as before, it equals  $\frac{180 \text{ vers } a}{\pi a}$ . Whence

$$\text{True effective area} = s_{x,y} \frac{180 \text{ vers } a}{\pi a}$$

37. Let *F* = the floor area in sq. ft. over which the light from area  $s_{x,y}$  is effective, that is, one bay long and a properly chosen assumed width corresponding to the width selected for  $s_{x,y}$ . Then,

$$d \text{ (per sq. ft. of } F) = \frac{a s_{x,y} \frac{180 \text{ vers } a}{\pi a}}{F} \dots \dots [3]$$

38. In computing the value of  $s_{x,y}$  proper allow-

between points *m* and *r* is closely  $\frac{c}{2}$ , being effective in this case over the *upper part only* of the opening in the plane of the lighting area, this portion being expressed by area  $s_x$  in sq. ft.

41. Some of this light will be absorbed by the ceiling itself, the amount depending upon the color and other surface characteristics of the latter. Let  $R_1$  represent the coefficient of reflection of this surface.

42. Furthermore, on account of the diffuse reflection from the under side of the roof some light is *reflected back* through the glass without being utilized.

43. For simplicity of computation the proportion of reflected light utilized to the total may be taken with sufficient accuracy as  $D = \frac{180^\circ - g^\circ}{180^\circ}$ , since

the amount of light obtained under this heading is usually relatively insignificant.

44. As *e* is always small the "true corresponding effective area" may be assumed with sufficient accuracy as being measured at right angles to the average direction of light ray. Whence,

$$\text{True effective area} = s_x \sin \left( b_1 + \frac{e}{2} \right)$$



Then,

$$rd \text{ (per sq. ft. of } F) = \frac{R_1 D \frac{c}{2} \sin\left(b_1 + \frac{c}{2}\right)}{F} \cdot [4]$$

Determination of the quantity  $r_1c$  or combined light from the sun and sky, diffusely reflected from the upper outdoor surface of the adjacent sawtooth roof direct to the room below (see Fig. 4).

45. The relative illumination obtained under this heading is dependent, among other things, upon the amount of light incident upon the roof and the capacity of the latter to reflect it to the interior of the building.

46. Let  $K$  represent the average ratio of the intensity or quantity of direct sunlight and skylight incident upon 1 sq. ft. of roof surface as compared with the intensity or quantity of skylight only inci-

and [4], the measure of the quantity of direct skylight incident upon and passing area  $s_{x,y}$  was taken

as  $d + \frac{rd}{R_1 D}$  then it follows that

$$r_1c = K S_1 R_2 P_1 \left( d + \frac{rd}{R_1 D} \right) \dots \dots \dots [5]$$

Determination of the quantity  $r_2c$  or combined light from the sun and sky diffusely reflected from the upper outdoor surface of the adjacent sawtooth roof to the under side or ceiling of the sawtooth in question, thence being again diffusely reflected to the room below. (Two reflections.—see Fig. 5.)

51. The relative illumination obtained under this heading is also dependent, among other things, upon the amount of light incident upon the roof and the capacity of the latter to reflect it to the interior of

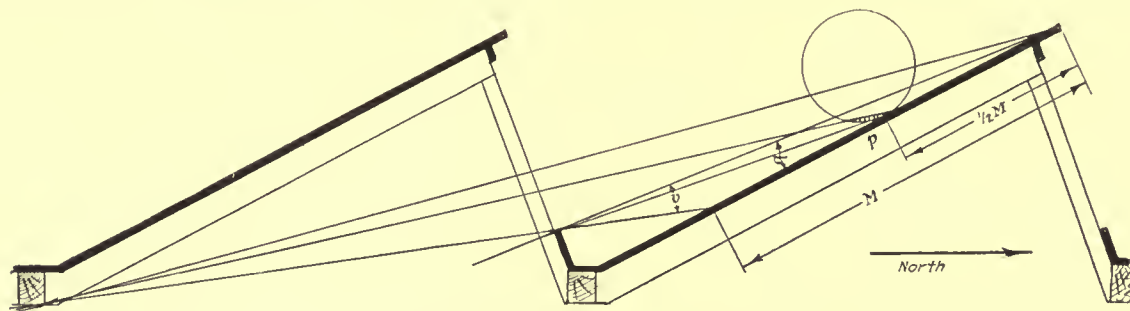

FIG. 4. TO ILLUSTRATE THE AMOUNT OF PURE REFLECTED SUNLIGHT AND SKYLIGHT FROM TOP OF ROOF

dent upon and passing 1 sq. ft. of lighting area  $s_{x,y}$ .

47. The relative intensity  $K$  is present over the roof area within the useful angle  $v$  of the figure. Let  $S_1$  represent the ratio of this effective roof area to the lighting area  $s_{x,y}$ . As before some of this light will be absorbed by the roofing itself, the amount depending upon the color and other surface characteristics of the latter. Let  $R_2$  represent the coefficient of reflection of the roofing material.

48. The reflection of this amount,  $R_2$ , will very closely follow the cosine law of diffuse reflection, the proportional amount included within any vertical angle  $q$  from any point  $p$  being

$$\frac{q}{\pi} - \frac{\sin 2q}{2\pi} \text{ (where } q \text{ is expressed in radians)}$$

and represented graphically by shaded portion of tangent circle (Fig. 4).

49. As the amount of light obtained under this heading is usually relatively insignificant, it will be sufficiently accurate to compute the total proportional amount as

$$P_1 = \frac{q}{\pi} - \frac{\sin 2q}{2\pi}$$

50. Now, since from the previous equations [3]

the building. Let  $K$  and  $S_2$  represent the ratios of light intensity and areas as explained previously, with the exception, however, that (on account of the fact that for a portion of the year the sawtooth valleys may be shaded from the sun's rays and consequently are useful only in reflecting a negligible amount of skylight) the ratio  $S_2$  in this case should be computed for a roof area included between the sawtooth ridge and a horizontal line part way down the roof representing the average shade line on the average day of the year. This may readily be obtained by applying the principles of Part 1.

52. As before, let  $R_1$  and  $R_2$  respectively represent the coefficients of reflection of the ceiling and roofing material. Furthermore, the proportion of reflected light included within any vertical angle  $\alpha$  from any point on the roof equals, according to the cosine law of diffuse reflection,

$$\frac{\alpha}{\pi} - \frac{\sin 2\alpha}{2\pi} \text{ (where } \alpha \text{ is expressed in radians)}$$

and is graphically represented by the shaded portion of the tangent circles (see Fig. 5).

53. The average value for this expression between the limits  $\alpha = 0_2$  and  $\alpha = 0_1$  is therefore

$$P_2 = \frac{\int_{\theta_1}^{\theta_2} \left( \frac{x}{\pi} - \frac{\sin x}{2\pi} \right) dx}{\theta_2 - \theta_1} = \frac{\theta_2 + \theta_1}{2\pi} - \frac{\sin(\theta_2 + \theta_1) \sin(\theta_2 - \theta_1)}{2\pi(\theta_2 - \theta_1)}$$

where  $\theta_2$  and  $\theta_1$  are measured in radians.

54. The above expression may be taken as the proportional amount passing the lighting area since the amount excluded between the limits  $\phi_2$  and  $\phi_1$  is usually relatively insignificant. However, this proportion may be calculated from the same formula if desired and subtracted from  $P_2$ .

55. Since the intensity of light received by the ceiling varies considerably from ridge to valley, the total useful quantity may be obtained accurately only after a more complex operation than that involving  $P_1$  and  $P_2$  above; and for simplicity, therefore, as in computing  $rd$ , this proportion may be taken as  $D = \frac{180^\circ - g^\circ}{180^\circ}$ . It is believed that this assumption is sufficiently accurate for the purposes of the problem,  $D$  usually representing a considerable proportion approximating 70 per cent. Therefore, following out the same reasoning as for Equation [5],

$$r,c \text{ (per sq. ft. of } F) = K S_2 R_1 R_2 P_2 D \left( d + \frac{rd}{R_1 D} \right) \quad [6]$$

57. Let the computations be based on a section of the sawtooth having a length equal to the width of one sash, i.e., 8' 3", the latter having a net width of glass equal to 7' 3". The length of span between valleys is 17' 0". From the foregoing,

$$s_{x,y} = 7.25 \times 5.5 = 39.9 \text{ sq. ft. and } F = 17 \times 8.25 = 140 \text{ sq. ft.}$$

Therefore entering equation [3],

$$d = \frac{80.5 \times 39.9 \times 0.592}{140} = 13.6.$$

To find quantity  $rd$ , Equation [4].

58. From the detailed building sections it is found as before that  $b_1 = 72^\circ 30'$ ;  $x = 44"$ ;  $e = 25^\circ 30'$ ;  $y = 40^\circ$ . Basing the computation on the same length of sawtooth as before,

$$s_x = 7.25 \times 3.66 = 26.5 \text{ sq. ft.} \\ F = 140 \text{ sq. ft.}$$

also,

$$D = \frac{180 - 55}{180} = 0.7$$

59. Assume that ceiling of sawtooth roof is

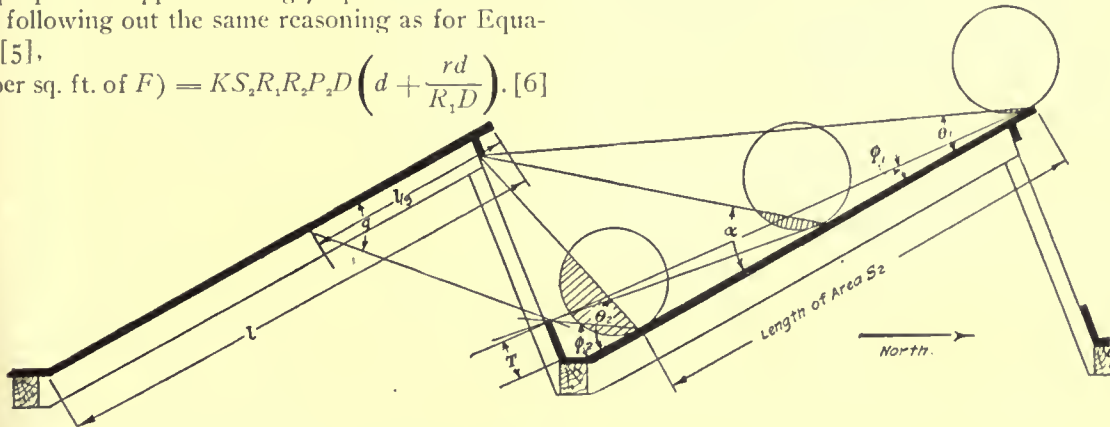

FIG. 5. TO ILLUSTRATE THE AMOUNT OF DOUBLY REFLECTED SUNLIGHT AND SKYLIGHT

56. The following example illustrates the method of procedure.

EXAMPLE 2. Given the same typical sawtooth roof as in Example 1, having angle of glass = 73 deg.: Required to find the total amount of daylight entering — that is, quantity  $L$ , Equation [2].

First to find quantity  $d$ , Equation [3]. From the detailed building sections, it is found that

$$b_1 = 72^\circ 30'; b_2 = 86^\circ; b_3 = 80^\circ; x = 44"; \\ y = 22";$$

whence

$$a = \frac{44 \frac{72.5 + 86}{2} + 22 \frac{86 + 80}{2}}{66} = 80^\circ 30'$$

and

$$\frac{180 \text{ vers } a}{\pi a} = \frac{180 (1 - 0.165)}{80.5 \pi} = 0.592$$

painted white having coefficient of reflection  $R_1 = 0.60$ . Then, entering Equation [4],

$$rd = \frac{0.6 \times 0.7 \times 12.75 \times 26.5 \times \sin(72^\circ 30' + 12^\circ 45')}{140} = 1$$

which is relatively small compared with  $d$ .

To find quantity  $r,c$ , Equation [5].

60. From the detailed building sections, it is found that  $q = 15^\circ = 0.26$  radians, whence

$$P_1 = \frac{0.262}{\pi} - \frac{\sin 30^\circ}{2\pi} = 0.004$$

61. According to a publication entitled *The Sun* by Charles G. Abbott, S.M., Director Smithsonian Astrophysical Observatory, the average intensity of sunlight plus skylight on this sawtooth roof may be deduced as being during working hours, and for ordinary atmospheric conditions, four or five times

that of skylight on the lighting-area plane. Therefore, let  $K = 4$ .

62.  $S_1$  from the detailed sections is found to be 2.3. Assume the roof to be covered with clean white slag having a coefficient of reflection = 0.5. Then, entering Equation [5],

$$r_1c = 4 \times 2.3 \times \frac{1}{0.5 \times 0.004 \left( 14.8 + \frac{1}{0.6 \times 0.7} \right)} = 0.3$$

63. This quantity, represented by Equation [5], is usually so small that it may be omitted entirely from the computations.

To find quantity  $r_2c$ , Equation [6].

64. From the detailed building sections it is found that

$$\theta_2 = 80^\circ = 1.4 \text{ radians}$$

$$\theta_1 = 24^\circ = 0.42 \text{ radian}$$

whence

$$\theta_2 + \theta_1 = 1.82 \text{ radians, and } \sin(\theta_2 + \theta_1) = 0.97$$

$$\theta_2 - \theta_1 = 0.98 \text{ radian, and } \sin(\theta_2 - \theta_1) = 0.829$$

Therefore,

$$P_2 = \frac{1.82}{2\pi} - \frac{0.97 \times 0.829}{2\pi \times 0.98} = 0.16$$

$S_2$  is found to equal in this case 2.7.

$K = 4$ ,  $R_1 = 0.6$ ,  $R_2 = 0.5$ , and  $D = 0.7$ , as before. Therefore, entering Equation [6],

$$r_2c = 4 \times 2.7 \times 0.6 \times 0.5 \times 0.16 \times 0.7 \left( 13.6 + \frac{1}{0.6 \times 0.7} \right) = 5.8,$$

whence, Equation [2]

$$L = 13.6 + 1.0 + 0.3 + 5.8 = 20.7.$$

This total quantity may be compared with a corresponding value computed for a sawtooth building already in service and of known degree of excellence as regards intensity of natural illumination.

65. In case additional illumination is required an alternate design having increased glass area or a flatter slope, or both, might be considered. It is interesting to note that if the pitch is decreased by only  $10^\circ$ , the glass area remaining the same,  $L$  figures out to be increased by about 15 per cent. Assuming the building placed as in Example 1 and applying the principles of Part 2, it is found that considerable sunlight will enter for the entire day. The period of total shade would be decreased on June 10 from over 7 hr. to zero, or a condition of continuous direct sunlight.

66. This information, when extended to comprehend that for other days of the year, including the days of average length, and when used in conjunction with the particular conditions and requirements of the problem in question should facilitate the selection of the most advantageous design.

67. Various means have been adopted to exclude direct sunlight from the interior of such buildings and all of them seem to have the disadvantage of reducing the total illumination. Sawtooth buildings

with glass vertical, that is, with the effective angle of the lighting area actually *overhanging*, are not uncommon; whitewashing the glass results in some protection against direct solar rays and a cooler interior, but also in glare and considerable loss of light, the latter being especially noticeable on dark days and when the sun is not shining in the shed; deeply ribbed glass produces glare.

68. Whatever glass is used, cleanliness is essential; the significance of Equation [6], indicating the possible average relative amount of reflected light, emphasizes the importance of adopting light-colored roofing materials such as white slag, and the use of white dust-resisting, washable paints upon sawtooth ceiling of buildings in which maximum daylight is desired. If either of the above surfaces had been black, the average reduction in daylight for Example 2 would have been equivalent to 30 per cent, or the increased light resulting from their use amounts to over 40 per cent.

Part 2 should be applied with due regard to its practical limitations. It furnishes a means of comparison with known designs, is based on fair-weather conditions and with sunlight on the building as a whole. During cloudy weather the amount of useful light contributed from the top of the sawtooth roof is decreased, but the quantity of direct skylight, which has been found to constitute the major portion of the total, is often considerably increased, depending upon the relative brightness of the clouds.

69. From the foregoing analyses it is evident that the height of valley ( $T$ , Fig. 5) for a given construction should be made as low as consistent with protection against the elements, including snow and ice. It is a coincidence that in the South, where some difficulty is often encountered in obtaining the desired intensity of daylight (on account of the increased slope of the glass which it is felt necessary to adopt), the lighting area may be considerably augmented by using a shallower valley than would be considered advisable in the North.

70. It will be seen that for a given building the use of a *small* number of *large*-scale sawteeth as against a greater number of *smaller* units having the same pitch, results in considerably increased daylight due to fewer number of valleys of height  $T$ , and consequently less proportionate obstruction. This principle should be applied with due regard to structural limitations and architectural consideration which may be involved, together with the important question of evenness of daylight intensity.

71. It is worthy of note that the adoption of flatter saw-teeth with increasing terrestrial latitudes works out well in conjunction with the heating requirements, since it results in less cubage and radiating surface.



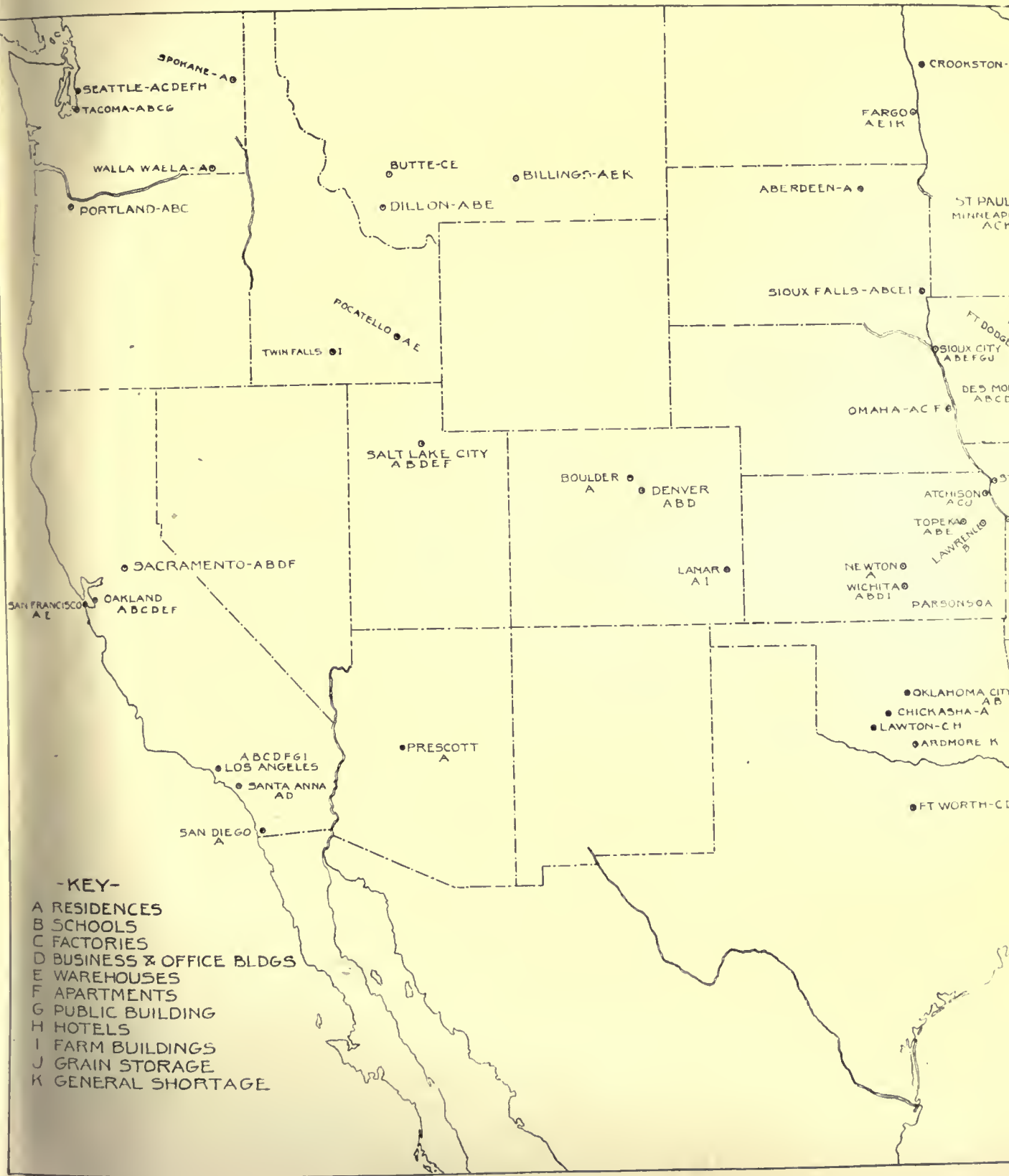

SPOKANE - A B  
 SEATTLE - A C D E F H  
 TACOMA - A B C G  
 WALLA WALLA - A D  
 PORTLAND - A B C  
 BUTTE - C E  
 BILLINGS - A E K  
 DILLON - A B E  
 CROOKSTON - I  
 FARGO - A E I K  
 ABERDEEN - A  
 ST PAUL - M I N L A P O L  
 A C K  
 SIOUX FALLS - A B C E I  
 FT DODGE - E  
 SIOUX CITY - A B E F G J  
 DES MOINES - A B C D E  
 OMAHA - A C F  
 TWIN FALLS - I  
 POCATELLO - A E  
 SALT LAKE CITY - A B D E F  
 BOULDER - A  
 DENVER - A B D  
 ST. A  
 ATCHISON - A C U  
 TOPEKA - A B E  
 LAWRENCE - B  
 NEWTON - A  
 WICHITA - A D I  
 PARSONS - O A  
 SACRAMENTO - A B D F  
 SAN FRANCISCO - A Z  
 OAKLAND - A B C D E F  
 LOS ANGELES - A B C D F G I  
 SANTA ANNA - A D  
 SAN DIEGO - A  
 PRESCOTT - A  
 OKLAHOMA CITY - A B  
 CHICKASHA - A  
 LAWTON - C H  
 ARDMORE - K  
 FT WORTH - C D F

**-KEY-**

- A RESIDENCES
- B SCHOOLS
- C FACTORIES
- D BUSINESS & OFFICE BLDGS
- E WAREHOUSES
- F APARTMENTS
- G PUBLIC BUILDING
- H HOTELS
- I FARM BUILDINGS
- J GRAIN STORAGE
- K GENERAL SHORTAGE



-HIGH-LIGHT-  
 -BUILDING-SURVEY-  
 -OF-  
 -UNITED-STATES-  
 PREPARED BY  
 -ARCHITECTURAL & BUILDING-PRESS, INC.-  
 -243 W. 39 ST-NEW YORK-  
 PUBLISHERS OF  
 -AMERICAN ARCHITECT-BUILDING AGE-  
 -METAL WORKER-PLUMBER & STEAM FITTER-

# Building Construction in the United States

## The Present Needs of the Country

PRIOR to the war, building construction in this country was variously estimated as amounting to between \$2,000,000,000 and \$3,000,000,000 annually. Exactly what building construction amounts to in any one year cannot be definitely determined. One reason for this is that records of building permits are compiled in comparatively few municipalities and no records are kept of farm building construction. Another element of possible error is the fact that while building permits may be issued in a particular year, the actual construction is not completed within that year.

A major proportion of the total building construction is handled in architects' offices and built according to architects' specifications. For this reason architects are vitally interested in the building outlook.

Beginning about the middle of 1914 and continuing up to the time the armistice was signed on November 11th, there was a general diminution of the work in architects' offices, so that the estimated amount of building construction for the year 1918, outside of Governmental construction, amounted only to approximately \$500,000,000. It seems logical, therefore, to assume that during the past four years building construction has lagged behind normal activities to an amount, at a conservative estimate, somewhere between \$3,000,000,000 and \$4,000,000,000. With these figures as a basis and with the expectation that not only will normal building construction equal a pre-war figure but that the shortage created during the war will also be made up, it seems fair to assume that during the next five years building construction will average considerably in excess of \$3,000,000,000 annually.

As an indication of the shortage, it may be pointed out that, according to census figures, the normal residential construction, which includes apartment houses, amounted to 385,000 structures for the year 1913, while in the year 1918 it is estimated that, even with the great industrial housing projects of the Government, only 125,000 residences would be built. Figures show that the country is now short something over 700,000 residences alone.

Realizing the shortage in all types of buildings and desiring to secure an idea of the types of buildings most urgently needed in all parts of the country, the editors of *THE AMERICAN ARCHITECT* sent a questionnaire to architects, bankers, real estate

men and contractors in all parts of the country, asking for information on what types of buildings were most needed in their communities, and what factors might tend to encourage or discourage their construction. This questionnaire was sent out prior to the signing of the armistice and represented conditions existing while war was still being continued. For this reason the answers to some of the questions might be different now than it was in October and early November when replies were received, but the types of buildings needed would be the same.

The results of this investigation are shown on the accompanying pages, on which are given a map of the United States, showing the cities from which replies were received, and giving a key to the types of structures needed. This is followed by a tabulation of the questions asked, together with extracts from letters received in reply. It will be noted that, in some few instances, correspondents from the same city are not entirely in agreement.

Of the 114 cities represented, 84 of them reported a material shortage of residences, 50 of them reported the need of schools, 31 of them require additional business and office buildings, 30 of them could use more factories, 27 of them need warehouse accommodations, 16 should have apartment buildings, and 16 require public buildings of various characters, 8 of them could advantageously have greater hotel accommodations; 13 replies were received showing that there was great need of farm buildings in the agricultural communities surrounding those cities, and two mid-Western cities reported the need of greater grain storage facilities.

These replies have simply indicated the types of buildings actually necessary and no reference has been made in them to libraries, churches, theaters, fraternal buildings, or other structures of a similar character that form a considerable bulk of peacetime construction.

While reports are given from only 114 cities of the country, these are so distributed that they may safely be considered as representing average conditions in every community.

It is evident from the foregoing that architects should be very busy for at least the next five years to come. It seems logical to assume that those offices best fitted to handle the work will reap the greatest reward.



# Information Supplied by Architects

CITY AND STATE	1. WHAT IN YOUR JUDGMENT IS THE PRESENT SHORTAGE OF PUBLIC BUILDINGS, DWELLINGS (CITY AND SUBURBAN), FACTORY BUILDINGS, FARM BUILDINGS, SCHOOLS AND OFFICE BUILDINGS?	2. ARE THERE IN YOUR VICINITY ANY PUBLIC BUILDINGS UNDER-TAKEN, BUT NOT COMPLETED, OWING TO GOVERNMENT RESTRICTIONS?	3. DO YOU ANTICIPATE SPECIAL ACTIVITY IN ANY PARTICULAR BRANCH OF BUILDING AFTER THE WAR?	4. WILL YOU GIVE ME BRIEFLY AN EXPRESSION OF YOUR OPINION AS TO YOUR REASONS FOR ASSUMING THAT THERE WILL BE OR WILL NOT BE UNUSUAL BUILDING ACTIVITY IN YOUR SECTION?	5. DO YOU BELIEVE THAT THE RETURNS IN RENTS OR OTHER INCOME FROM BUILDINGS WILL SERVE TO STIMULATE THEIR ERECTION?	6. ARE THERE IN YOUR JUDGMENT ANY FACTORS IN THE BUILDING SITUATION LIKELY TO OPPOSE A BUILDING REVIVAL? WILL LABOR, MATERIAL COSTS OR FINANCING BE THE IMPORTANT ELEMENT?
SYRACUSE, N. Y. ....	Houses under \$10,000 and schools.	Small schools.	Houses.	House building ceased and population increased.	No answer.	No answer.
ROCHESTER, N. Y. ....	There is a shortage in public buildings, but no apparent shortage in either city or country houses. Some factory buildings needed.	None.	Yes, in all branches.	Many projects have been held up. Think there will be decided era of prosperity after the war.	Yes.	Possibly labor and materials.
ALBANY, N. Y. ....	Municipal building and many schools.	None.	Not to any great extent.	Not until costs of labor and material decrease.	No.	Labor and materials.
PITTSBURGH, PA. ....	There is a shortage of dwellings, city and suburban, schools and office buildings.	None.	Does not anticipate any.	Pittsburgh activity in building entirely due to local industrial prosperity.	Yes.	Labor, material and money.
WILKES-BARRE, PA. ....	None at present.	None.	Indefinite labor problem complicates.	See 3.	No.	Labor shortage.
PITTSBURGH, PA. ....	Schools, apartment houses, dwellings.	Yes.	No.	Owing to action by labor unions and the uncertainty of wage scale only necessary building will be undertaken.	No.	Labor.
NASHVILLE, TENN. ....	Apartments, hotels, dwellings, schools.	None.	Yes, considerable.	Owing to large number of men engaged in Government work plant there will be great building activity.	Cannot give a satisfactory answer.	Scarcity of labor and materials.
FORT WORTH, TEX. ....	Hotel, office buildings, factory buildings.	None.	No.	Look for only normal conditions.	Yes.	Believe these matters will adjust themselves.
BIRMINGHAM, ALA. ....	Houses, schools, factories, office and public buildings and farm buildings.	Yes, U. S. Post Office.	Yes, but mainly in schools.	War time shortage has created big demand.	Yes.	Labor.
BIRMINGHAM, ALA. ....	Houses and schools.	Yes, bond issue \$3,000,000 for public buildings held up.	Yes.	No satisfactory answer.	No.	Labor and materials.
RICHMOND, VA. ....	Schools, apartments, suburban houses, warehouses.	Yes.	Yes, in retail stores.	Return of peace and "flush times" will create demand for stores.	No.	Labor and materials.
NORFOLK, VA. ....	Houses, factories, schools, office buildings.	None.	No.	Reconstruction.	No.	All.
LITTLE ROCK, ARK. ....	Houses, schools.	None.	Yes.	Personal observation while in Government work. Looks for "great revival."	Doubtful.	Labor and materials.
FARGO, N. D. ....	There is a shortage in all.	None of importance.	Yes.	The general need for expansion.	Certainly.	Labor and materials.
DENVER, COL. ....	Houses, schools, office buildings.	None.	Houses, apartment buildings.	There is a dearth of sufficient housing.	Yes.	Labor.
LOS ANGELES, CAL. ....	Public buildings, houses, industrial buildings, farm buildings, schools, office buildings.	None.	Normal.	"The only reason I can give is the condition of my own clientele."	Not just now.	See his letter.
LOS ANGELES, CAL. ....	A new city hall, library, some industrial buildings.	None.	Normal.	Believe there will not be any large increase in population to warrant much building activity.	No.	Labor and materials.
SAN FRANCISCO, CAL. ....	The normal amount over a period of two years.	Bonds voted for schools and state buildings.	Must make up for lost time. Additional foreign trade should produce buildings of every character.	Answered in 3.	Yes, on law of supply and demand. Rents will continue to be higher than before the war.	Plenty of labor and material. Financing will be difficult and expensive.

OAKLAND, CAL. ....	Dwellings costing \$2,000 up to \$20,000. Considerable shortage also in factories. Slight shortage in office buildings. Great shortage in schools.	None.	Yes.	Building activities seriously retarded for four years. Population increased about 30 per cent and more.	Not in office buildings. Schools, department stores, factories, farm buildings, hotels, hospitals will go ahead.	Uncertainty of prices. Delivery of material. Labor market will be home and also due to increased efficiency of women. Financing will be easier as people have been converted to nation of savers.
COLUMBUS, OHIO. ....	Buildings to properly house state institutions. Medium priced dwellings. Factory and commercial buildings.	About 20 per cent.	Public and semi-public buildings.	Believe there will be a strong demand for additional facilities for all lines of business. Activity will be unusual and above the normal.	Yes, decidedly.	Will probably be a number of years before marked decrease in prices of materials. Believes business will adjust itself to new conditions and people will be better able to build even at advanced prices of labor and material owing to the fact that the source from which they derive their benefits will have increased proportionately. Financing will adjust itself.
CINCINNATI, OHIO. ....	Does not know.	No.	No.	Normal amount only.	No.	Labor and high price of materials.
COLUMBUS, OHIO. ....	With exception of schools comparatively few buildings erected in past two years. (A general shortage.	None.	Expect strong activity. Not confined to any particular branch.	Pronounced activity.	No.	Labor and materials.
CINCINNATI, OHIO. ....	School houses. Great shortage of factory buildings. Office space difficult to secure.	None.	See No. 1.	Unusual activity.	Decidedly, yes.	Labor.
DETROIT, MICH. ....	Dwellings, retail stores, schools.	Several planned but none started.	Very great activity.	Industrial buildings have been extended for war work. With peace they will more than take care of demand.	Yes.	No answer.
CHICAGO, ILL. ....	No shortage except small houses in vicinity of large industries.	None.	Schools, better class houses. Speculative building.	Do not believe there will be any unusual activity.	Do not believe income from rents will stimulate building.	Organized labor.
CHICAGO, ILL. ....	Only in the small houses.	None.	Not immediately unless perhaps remodelling.	Do not believe there will be any but normal activity.	No.	Labor and materials.
MILWAUKEE, WIS. ....	10 per cent.	None.	Yes, public buildings.	Yes, based on inquiries by people interested.	No.	Labor.
KANSAS CITY, MO. ....	10 per cent.	Yes.	Expect a gradual resumption.	"Restriction at present means a spasm when removed."	Yes.	Labor.
St. LOUIS, MO. ....	About 70 per cent.	None.	Depends on cost of material.	No answer.	Yes, industrial buildings.	Labor and materials.
St. LOUIS, MO. ....	No shortage.	None.	A fair activity not confined to any special branch.	There is plenty of office and store space available. Possibly some warehouse or loft buildings may be built.	No.	Labor.
PROVIDENCE, R. I. ....	Very great.	None.	No.	Normal resumption.	Yes.	Labor.
PORTLAND, ME. ....	Central fire station, schools. No building of good houses for past two years. Factory buildings.	None.	Yes, considerable.	See No. 1.	In some locations.	Labor and materials.
NEW HAVEN, CONN. ....	Schools, two- and three-family houses.	None.	Yes.	Strong activity.	Yes.	Think conditions will serve to adjust these matters.
BRIDGEPORT, CONN. ....	Industrial housing.	None.	Believes there will be continued depression.	See his letter. A very well expressed opinion why Bridgeport will see no unusual activity.	No.	Labor complications. See letter.
BOSTON, MASS. ....	Equivalent to three years' supply.	Yes, a great many due to Government restrictions.	Looks for great activity in public buildings but little special activity in private work for some time.	See his letter for lengthy expression of views.	Does not look for much advance in this direction.	Division of capital in financing the Government and large corporations. Believes labor will be plenty but high.
BOSTON, MASS. ....	Moderate priced houses and schools.	A considerable number.	Very marked.	No satisfactory answer.	Yes.	Labor and material costs.
SALT LAKE CITY, UTAH. ....	Shortage of most kinds of buildings. No vacant stores; buildings of offices or houses. Slight shortage of schools, some being erected to a limited extent.	No.	Yes, in most branches. Store and office buildings, apartment houses, schools, warehouses, residences.	Think there will be an era of building activity after the war dependent on prevailing conditions then. Many projects held up. Exceedingly prosperous section.	Yes, rents advanced in keeping with other advances all along the line.	Continued high prices of building materials. High wages, aggressive labor unionism. No difficulty in financing.

Information Supplied by Architects—Continued

1. WHAT IN YOUR JUDGMENT IS THE PRESENT SHORTAGE OF PUBLIC ANY BUILDINGS, DWELLINGS (CITY AND SUBURBAN), FACTORY BUILDINGS, FARM BUILDINGS, SCHOOLS AND OFFICE BUILDINGS?	2. ARE THERE IN YOUR VICINITY BUILDINGS, UNDER CONSTRUCTION, BUT NOT COMPLETED DUE TO GOVERNMENT RESTRICTIONS?	3. DO YOU ANTICIPATE SPECIAL ACTIVITY IN ANY PARTICULAR BRANCH OF BUILDING AFTER THE WAR?	4. WILL YOU GIVE ME BRIEFLY AN EXPRESSION OF YOUR OPINION AS TO YOUR REASONS FOR ASSUMING THAT THERE WILL BE OR WILL NOT BE UNUSUAL BUILDING ACTIVITY IN YOUR SECTION?	5. DO YOU BELIEVE THAT THE RETURNS IN RENTS OR OTHER INVESTMENTS FROM BUILDINGS WILL STIMULATE THEIR ERECTION?	6. ARE THERE IN YOUR JUDGMENT ANY FACTORS IN THE BUILDING SITUATION LIKELY TO OPPOSE A BUILDING REVIVAL? WILL LABOR, MATERIAL COSTS OR FINANCING BE THE IMPORTANT ELEMENT?
CITY AND STATE BALTIMORE, MD.....	Nothing of material extent.	Shortage of industrial buildings must be met. People have become rich. Will probably build.	Baltimore is a conservative city.	Buildings after the war will have to meet definite demands and not speculative investments.	High cost of materials and labor.
TACOMA, WASH.....	None of importance.	General commercial, dwellings of better class, schools.	Prosperous conditions. High wages and high cost of materials also building restrictions account of war holding up building.	Not at present time. Building costs too high to get returns.	Price of labor and materials.
SEATTLE, WASH.....	No.	See question 1.	Present demand of buildings of all kinds not equal to supply. Therefore buildings of all kinds to take care of population.	Yes.	Costs of labor and materials.
SIOUX CITY, IOWA.....	Yes, addition to U. S. Post Office.	Yes.	Trade demands of a growing and prosperous territory warrant it. Builders have accumulated wealth. Will influence building industry.	Impossible to put up normal residences, office buildings and stores and receive profitable return from rent except in congested sections. In case of small apartments, rents are abnormally high and therefore satisfactory to owners. People feel this is a temporary condition and do not want to invest on the strength of it.	I. W. W. idea.
NEW ORLEANS, LA.....	Several churches and schools.	All branches.	Actual need exists and must be satisfied.	No.	Labor shortage and congested condition of all manufacturing elements.
CHICAGO, ILL.....	Union Railway Station Terminal.	Perhaps small apartment buildings.	Labor and material costs too high. Impossible to get adequate return for the investment.	No.	Labor, material costs.
LOS ANGELES, CAL.....	Yes, especially schools.	All branches.	Actual shortage of building and good supply of money.	Yes.	Will have to go by higher schedule of costs. Matters will adjust themselves.
PORTLAND, ORE.....	No.	War industries will readjust themselves on a peace basis.	Great activity in residences. Growth of city industrially warrants factories and plants.	Yes.	Believes there should be some Governmental financial aid to spur building.
PORTLAND, ORE.....	Post Office.	Not at present.	Overbuilt before the war especially in office buildings.	No.	Believes people will build regardless of high costs.
OKLAHOMA CITY, OKLA..	School work.	Nothing unusual.	Dependent on labor and material prices and improvement of unsettled conditions.	Yes, providing labor conditions improve.	Labor conditions.
BOSTON, MASS.....	Believe there are.	Factory buildings.	People stimulated by prosecution of successful war will spur building; also requirements of world much depleted in its stocks of manufacturing articles.	Does not care to express opinion.	High prices of labor and material.
St. JOSEPH, MO.....	No.	Yes, in store buildings and residences.	We positively need many buildings so we assume they will be built when conditions are more settled.	Yes.	Possibly high prices. Plenty of money.
CLEVELAND, OHIO.....	Auditorium held up. Jail and public library bonded and ready to let contracts after war.	Yes, in domestic work.	Many people have become wealthy and will desire better homes. Will build regardless of cost to satisfy their desire.	Doubtful.	Labor and material costs.
CHICAGO, ILL.....	Yes, public schools.	Schools first to be built.	Expect considerable building activity.	No.	High cost and labor shortage.
ATLANTA, GA.....	No.	Do not look for special activity.	Building will be resumed in a general and steady way as conditions become normal.	Yes.	These matters will adjust themselves.



# Information Supplied by Bankers, Real Estate Dealers and Contractors

CITY	1. IS THERE ANY SHORTAGE OF DWELLINGS, FACTORY BUILDINGS, WAREHOUSES, FARM BUILDINGS, SCHOOLS OR OFFICE SPACE?	2. DO YOU ANTICIPATE SPECIAL ACTIVITY IN ANY PARTICULAR CLASS OF BUILDING AFTER THE WAR?	3. MAY WE HAVE AN EXPLANATION AS TO THE REASON FOR ASSUMING THAT THERE WILL OR WILL NOT BE UNUSUAL ACTIVITY?	4. DO YOU THINK RENTS AND OTHER RETURNS FROM BUILDING INVESTMENTS DO YOU REGARD AS MOST LIKELY TO OBSERVE A REVIVAL OF BUILDING INVESTMENTS WHEN PEACE COMES?	5. WHAT FACTORS IN THE BUILDING SITUATION DO YOU REGARD AS MOST LIKELY TO OBSERVE A REVIVAL OF BUILDING INVESTMENTS WHEN PEACE COMES?	SPECIAL COMMENT.	6. HOW HEAVILY HAVE RENTALS ADVANCED IN THE LAST YEAR?	7. DO RENTERS EXPERIENCE DIFFICULTIES IN SECURING ANY PARTICULAR ACCOMMODATIONS?
TOPEKA, KAN.	Yes.	Dwellings.	Return of confidence and shortage of dwellings.	Yes.	Labor.		25 per cent.	Yes.
TOPEKA, KAN.	Yes, dwellings and schools.	Railway and warehouse work.	Much needed shortage will have to be filled.	No.	Labor and material costs.		No advance.	Modern houses.
WICHITA, KAN.	Moderate shortage of dwellings and office space.	All buildings, dwellings, farm and school buildings, etc.	Prosperity of agricultural class as the result of market conditions after the war.	Conditional; depends on business activity.	Labor, high prices of building materials and poor agricultural production and low prices of same.	Farmers' prosperity big factor in future building operations.	15 to 30 per cent.	No answer.
WICHITA, KAN.	Yes, dwellings and office space.	Only normal activity expected.	Normal.	Yes.	Labor and material costs.	Normal building operations expected.	10 to 20 per cent.	Dwellings and office space.
WICHITA, KAN.	Yes.	All kinds.	City growing rapidly on account of oil development.	Yes.	Government restrictions only.		Waiting lists for apartments.	Yes.
CARTHAGE, MO.	Yes.	All buildings.	Strong indication of rapid future growth.	Yes.	Labor, material costs.		10 to 25 per cent.	No.
CARTHAGE, MO.	No.	No.	Crop conditions bad; money scarce.	Rents about one-half what they should be to make a paying investment.	Demand and financing.		None.	Small modern houses.
NEVADA, MO.	No.	No.	Country can't support any more. Crop a failure.	No.	Buildings do not pay 10 per cent net for past 5 years. Many vacant. Labor, material costs, etc.		No advance. Decrease noted.	Modern buildings desired but low rents don't warrant construction.
OMAHA, NEB.	Yes.	Dwellings	Stimulation of rentals may serve to spur new building.	Stimulation of rentals (as they are now low) may encourage investment.	Material costs, labor and readjustments, financing.	This city will depend for its future building on the action of rest of the country.	10 to 15 per cent.	Great difficulty experienced in obtaining any dwellings especially with modern conveniences.
CLEVELAND, OHIO	No real shortage. Only war condition.	No special activity.	Future building necessary and will have to be accomplished to house munition workers.	Decrease in rents and returns likely.	Assimilation in commercial buildings. Labor, material costs and financing.	Normal building activity expected to house growth.	20 per cent.	Yes, at this time.
CLEVELAND, OHIO	Yes, dwellings, apartment and tenement houses; office and school buildings.	Dwellings.	Constant growth demands it.	No.	None.	There is sure to be building activity following war because city is crowded.	25 per cent.	Dwellings.
CLEVELAND, OHIO	Yes, dwellings, factories, warehouses.	If conditions are favorable.	Depends on material and labor.	Yes.	Financing.		No answer.	Dwellings.
CLEVELAND, OHIO	Yes, dwellings, factories, warehouses.	All kinds.	Growth of city demands it.	Yes.	Financing.		25 per cent.	Yes.
CHICKASHA, OKLA.	Yes, dwellings.	Dwellings.	No activity unless labor and material costs decrease.	No, not here.	Labor, material costs, financing.	If labor and material prices which are now prohibitive, decrease, future building will be possible.	20 to 30 per cent.	Some difficulty. Good dwellings hard to get and cheap ones to be had.
TEXARKANA, ARK.	No.	No	Plenty of building for present needs.	No.	Labor, material costs, financing.		16 2/3 per cent.	No.
LAWTON, OKLA.	Yes.	Factories and a hotel.	Big gas field opened and factories needed. Good prospects for future building.	Rentals are good.	Financing.	Irrigation plant to be built. More business houses and factories will be built.	No answer.	No answer.

Information Supplied by Bankers, Real Estate Dealers and Contractors—Continued

CITY	1. IS THERE ANY SHORTAGE OF DWELLINGS, FACTORY BUILDINGS, WAREHOUSES, FARM BUILDINGS, SCHOOLS OR OFFICE SPACE?	2. DO YOU ANTICIPATE SPECIAL ACTIVITY IN ANY PARTICULAR CLASS OF BUILDING AFTER THE WAR?	3. MAY WE HAVE AN EXPLANATION AS TO THE REASON FOR ASKING THAT THERE WILL OR WILL NOT BE UNUSUAL ACTIVITY?	4. DO YOU THINK RENTS AND OTHER RETURNS FROM BUILDING INVESTMENTS ARE SUFFICIENTLY HIGH TO STIMULATE SUCH INVESTMENTS WHEN PEACE COMES?	5. WHAT FACTORS IN THE BUILDING SITUATION DO YOU REGARD AS MOST LIKELY TO OBSTRUCT A REVIVAL OF BUILDING? MATERIAL COSTS?	SPECIAL COMMENT.	6. HOW HEAVILY HAVE RENTALS ADVANCED IN THE LAST YEAR?	7. DO RENTERS EXPERIENCE DIFFICULTIES IN SECURING ANY PARTICULAR ACCOMMODATIONS?
NEWTON, KAN	Yes, dwellings.	Dwellings.	Number of families without homes. All dwellings occupied.	Yes.	Material costs.	Spur will come to building dwellings when war is over.	10 per cent.	Difficulty in securing rental in modern building.
St. JOSEPH, Mo.	No.	No.	No building because of there being very little return on money.	No.	Labor, material costs. Returns on investments hardly pay taxes and assessments.	City's charter in relation to real estate investments is very hostile. Land tax is very high and no building is possible.	Slight.	Difficult because no capital will invest in building under present conditions.
St. JOSEPH, Mo.	Yes, dwellings and warehouses.	All kinds.	Curtailment has created the demand.	Yes.	Financing.		Slight.	Dwellings.
St. JOSEPH, Mo.	Yes, dwellings, factories, warehouses.	Dwellings and warehouses.	No vacant houses at present. Some more needed.	Yes.	Labor.		10 per cent.	None.
BLOOMINGTON, ILL.	No.	Dwellings.	Many buildings will be built if war conditions readjust themselves.	No.	Labor, material costs.		None.	To some extent.
AKRON, OHIO	Yes.	Yes.	Considerable activity.	Yes.	Labor, material costs, financing.		10 per cent.	Yes.
MINNEAPOLIS, MINN.	No.	Activity in all kinds of construction expected.	Activity will make up for lost time.	Yes.	Material costs.		None.	No.
WALLA WALLA, WASH.	Yes, dwellings.	Dwellings.	Building will be started after war because it is needed.	No; do not build here for investment; build own homes.	Material costs, financing.		No advance here.	Good homes at a premium; apartment houses wanted but financing lacking.
MONMOUTH, ILL.	No.	No.	Sufficient buildings to meet demands.	No.	No answer.		None.	No.
LOUISVILLE, KY.	Yes, modern residences, warehouses, factories.	Big building activity in all lines including repairs.	Yes, activity is expected.	Yes.	None.	Cessation of government work will lower material costs and labor.	10 to 15 per cent.	Cannot secure modern houses or apartments.
LOUISVILLE, KY.	Yes, dwellings.	All lines of building.	Ban on building stopped much needed building.	No.	Financing, material costs.	Permanent army camps close to this city will spur building.	20 per cent.	Apartments and dwellings.
LOUISVILLE, KY.	None.	Public buildings, residences.	Curtailment of construction has created demand.	No.	Labor, material costs.		No answer.	Apartments.
PARSONS, KAN	Yes, dwellings.	None.	Nothing to cause it.	No.	None.		20 per cent.	Yes.
PARSONS, KAN	Yes, dwellings.	Very little.	Very little more than normal.	Yes.	Labor, material costs.		15 to 100 per cent.	Dwellings.
ELDORA, IOWA	None.	Gradual activity expected.	Nothing unusual expected.	No.	None.		Very little.	More than needed now.
ELDORA, IOWA	No.	None.	Farming community and only normal building expected.	No.	Labor, material costs.		10 to 33½ per cent.	No.
SIXSTON, Mo.	Yes, dwellings and business dwellings.	Yes, dwellings.	Great shortage of business buildings and dwellings that will have to be built.	Yes.	Financing		25 per cent.	Yes.
SANOUSKY, OHIO	Yes.	Dwellings.	No building now and spur after the war is expected.	Yes.	Labor, material costs.		25 per cent.	Yes, small houses.
FORT DODGE, IOWA	Yes.	School buildings and dwellings.	Building will be active after the war.	No vacant houses.	Labor, material costs.		5 to 10 per cent.	Houses well filled up.

	No.	Slight activity in all classes.	Community is prosperous.	Yes.	Labor.	Country desirable and prosperous. Building boom is expected.	No advance.	No.
Fort Dodge, Iowa.....	No.	Business buildings, dwellings.	City will build after the war.	Yes.	Labor, material costs.		10 to 25 per cent.	No.
Santa Ana, Cal.....	Yes, but to no marked extent.	No.	Building boom expected.	Fair.	Material costs.		10 per cent.	Yes.
Fort Madison, Iowa.....	Yes.	All kinds of construction.	Natural shortage will have to be supplied.	Yes.	Labor, material costs.		10 per cent.	Yes, generally and dwellings particularly.
Fort Madison, Iowa.....	Yes, all kinds of buildings.	Factory buildings, school dwellings.	Building factories is urgent and would be done now only Government won't grant permits.	Yes.	None.		10 per cent.	Yes, good class houses.
Durham, N. C.....	Yes, dwellings, school houses.	None.	No answer.	Yes.	Labor, material costs.		20 per cent.	Apartment houses.
Des Moines, Iowa.....	No.	All kinds.	Demand and proximity of cantonment demands new building.	No.	Labor, material costs.		10 per cent.	Dwellings.
Des Moines, Iowa.....	Yes, all kinds of buildings.	Very little; some dwellings.	Normal.	No.	Material costs.		Slight.	Apartment houses.
Des Moines, Iowa.....	None.	No.	Oversupply of dwellings at present. Factories abundant.	No.	Material costs and financing.		20 per cent.	Small dwellings and cottages.
Des Moines, Iowa.....	Dwellings, factory buildings, warehouses, schools.	Curtailment of building will spur activity.	No answer.	No.	Labor, material costs.	City was on verge of building program before war and it is thought this will be resumed.	25 per cent.	Apartment houses.
Waterloo, Iowa.....	Yes, school houses.	Considerable.	Building boom expected in which 400 to 500 dwellings yearly will be built.	Not impressed by rental returns.	Labor, material costs.	Steady volume of farm building continues. Public building construction will be resumed and prosperity will determine extent of activity.	Slightly.	Yes, well located modern houses.
Waterloo, Iowa.....	None.	None.	None, except dwellings.	No.	Labor, material costs.		Declined.	No.
Waterloo, Iowa.....	Yes, small dwellings and a business block.	Small dwellings, tenement houses.	Building demand is there and must be satisfied.	No.	Labor, material costs.	Growth of city and cessation of building will have to be satisfied.	None.	Small houses.
Waterloo, Iowa.....	Yes, warehouses, farm buildings.	No, normal.	Normal building expected.	No.	Labor, material costs.	Bright prospects.	Slight.	Dwellings and apartments.
Iowa City, Iowa.....	No.	None, except apartment buildings.	Very little.	No.	No demand and financing.		No advance but reduction noted.	Yes, heated apartments.
Boulder, Col.....	Yes, dwellings.	Yes.	Yes, people expect lower material prices and labor costs.	No.	Labor, material costs.	When lumber, cement and other materials are lowered in price, building will be boomed.	Yes.	Dwellings.
Chicago, Ill.....	Yes, factory buildings.	All classes except factory buildings. War industries now in operation will provide these.	Building boom expected but depends on the lowering of material costs.	No.	Labor, material costs.	Poregone conclusion that building will boom; depends on labor, material costs and financing.	Factory buildings advanced; office buildings same; dwellings same; and stores slight advance.	Factory buildings especially on track.
Chicago, Ill.....	No, except warehouses.	Dwellings and apartment houses.	Business man will build his own home after war.	No answer.	Labor.	No wonderful building spurt is looked for.	10 per cent.	Apartment houses.
Creston, Iowa.....	No.	Very little until material costs decrease.	Very little.	No.	Material costs and present crop situation.		None.	No.
Elgin, Ill.....	No shortage except for small dwellings.	Very little special activity.	Very little change from normal.	No.	Labor, material costs.	A great number of workmen and families have left to go to cities of war industry.	40 per cent on farm proper.	No.
Macon, Ga.....	Yes, dwellings and farm buildings.	Dwellings.	Considerable demand exists; growth demands a boom.	Yes.	Labor, material costs.		10 per cent.	Small houses, apartments.
Macon, Ga.....	Dwellings, schools.	Industrial buildings and business construction.	Growth of city industrially.	Yes.	Labor, material costs.	Congested because of cantonment near here.	10 to 20 per cent.	Living quarters.



Information Supplied by Bankers, Real Estate Dealers and Contractors—Continued

CITY	1. IS THERE ANY SHORT-AGE OF DWELLINGS, FACTORY BUILDINGS, WAREHOUSE BUILDINGS, FARM BUILDINGS, SCHOOLS OR OFFICE SPACE?	2. DO YOU ANTICIPATE SPECIAL ACTIVITY IN ANY PARTICULAR CLASS OF BUILDING AFTER THE WAR?	3. MAY WE HAVE AN EXPLANATION OF YOUR OPINION AS TO THE REASON FOR ASSUMING THAT THERE WILL OR WILL NOT BE SPECIAL ACTIVITY?	4. DO YOU THINK RENTS AND OTHER FACTORS FROM THE BUILDING SITUATION ARE SUFFICIENTLY HIGH TO STIMULATE THE REBUILOUT OF DWELLINGS OR FACTORY MATERIAL COSTS?	5. WHAT FACTORS IN THE BUILDING SITUATION ARE YOU REGARDING AS MOST LIKELY TO INFLUENCE THE REBUILOUT OF DWELLINGS OR FACTORY MATERIAL COSTS?	SPECIAL COMMENT.	6. HOW HEAVILY HAVE RENTS ADVANCED IN THE LAST YEAR?	7. DO RENTERS EXPERIENCE DIFFICULTIES IN SECURING ANY PARTICULAR ACCOMMODATIONS?
HARTFORD, CONN.	None.	Very little, if any.	If material costs decrease, new building will boom.	Yes.	Material costs.		Slight.	Desirable single houses.
KOKOMO, IND.	Yes.	Yes.	Boom is looked for.	Yes.	Material costs.		Small.	No.
KOKOMO, IND.	No.	Perhaps.	No answer.	No.	Material costs, labor and financing.		Slight.	No.
JOLIET, ILL.	Yes, particularly dwellings.	Yes, dwellings.	Situation demands it.	Rents not high.	None.		Practically none.	Yes.
PONTIAC, ILL.	Yes, dwellings.	Dwellings.	Dwellings will be built as they are necessary.	Yes.	Labor and building costs.		No rise.	Modern houses of 5 to 7 rooms.
PONTIAC, ILL.	Yes, hotel.	No.	No.	No.	Material costs.		None.	High-rises.
WILMINGTON, DEL.	Yes, dwellings and office space.	Dwellings and office buildings.	Demand for building office structures and dwellings must be satisfied.	Yes.	Material costs, labor and financing.		50 to 100 per cent.	Dwellings, rooms or offices.
WILMINGTON, DEL.	Yes.	Dwellings.	Prosperity and lack of building during past year will spur building.	Yes.	Labor, material costs.		20 per cent.	Yes.
ATCHISON, KAN.	Yes, dwellings, factory buildings, grain storage.	Nothing in particular.	Delay building because of costs at present.	Yes.	Material costs, labor.	Reduction of costs is the prime issue in regards to future building.	None.	Yes.
BIRMINGHAM, ALA.	Yes, dwellings, warehouses, farm buildings, schools.	Dwellings.	If costs are reduced, building will boom.	No.	Material costs, labor.		10 per cent.	Suitable residences.
BIRMINGHAM, ALA.	Yes, dwellings, factory buildings, warehouses, farm buildings, schools.	Dwellings, schools.	Normal amount of business expected in all lines.	Yes.	None.		10 to 20 per cent.	Dwellings and apartments.
POCATELLO, IDAHO.	Yes, dwellings and warehouses.	Dwellings and warehouses.	Building of dwellings will resume after the war.	Yes.	Labor.	Hotels are crowded and if dwellings were available they could easily be filled.	No answer.	Apartment houses.
AUSTIN, MISS.	No.	No.	No answer.	No.	Material costs.		Very little.	No.
KANSAS CITY, MO.	None except school buildings.	Dwellings and office buildings.	New building activity if labor and material costs decrease.	Yes.	Labor, material costs, financing.		10 per cent.	Apartments.
KANSAS CITY, MO.	Yes, dwellings, warehouses and factory space.	Dwellings and apartment buildings.	Congestion at present demands new building.	Yes.	Labor, material costs.		7 to 10 per cent.	Apartments.
DUBUQUE, IOWA.	No.	Yes.	Renewed building activity is expected because of curtailment by Government.	No.	Material costs.		No advance.	None.
DUBUQUE, IOWA.	None.	No.	Well supplied at present.	No answer.	No answer.		15 per cent.	None.
STIOUX CITY, IOWA.	Yes, dwellings, apartments, warehouses.	None.	No increase in building activity.	No.	Labor, material costs.	Considerable construction in this city during past year. No great shortage exists.	7 1/2 per cent.	Heated apartments.
STIOUX CITY, IOWA.	Yes, dwellings, warehouses, schools.	Dwellings, warehouses, grain elevators, school buildings.	Growth of the city industrially, commercially, etc., demands building activity.	Yes.	Labor and material shortage.	Building activity is certain as this city is growing in all directions.	Considerable.	Warehouse space and dwellings.
LANSING, MICH.	Yes, dwellings.	Dwellings and factories.	Need of homes and apartments and entrance of large company demand new building activity.	Yes.	Labor.		10 to 15 per cent.	Dwellings and apartments.



Information Supplied by Bankers, Real Estate Dealers and Contractors—Continued

CITY	1. IS THERE ANY SHORTAGE OF DWELLINGS, FACTORY BUILDINGS, WAREHOUSES, FARM BUILDINGS, SCHOOLS OR OFFICE SPACE?	2. DO YOU ANTICIPATE SPECIAL ACTIVITY IN ANY OF THESE CLASSES OF BUILDING AFTER THE WAR?	3. MAY WE HAVE AN EXPOSITION AS TO YOUR OPINION AS TO THE REASON FOR ASSUMING THAT THERE WILL OR WILL NOT BE UNUSUAL ACTIVITY?	4. DO YOU THINK RENTS AND OTHER RETURNS FROM BUILDING INVESTMENTS ARE SUFFICIENTLY HIGH TO STIMULATE SUCH INVESTMENTS WHEN PEACE COMES?	5. WHAT FACTORS IN THE BUILDING SITUATION DO YOU REGARD AS MOST LIKELY TO OBSTRUCT A REVIVAL OF BUILDING? LABOR? MATERIAL COSTS? FINANCING?	SPECIAL COMMENT.	6. HOW HEAVILY HAVE RENTALS ADVANCED IN THE LAST YEAR?	7. DO RENTERS EXPERIENCE DIFFICULTIES IN SECURING ANY PARTICULAR ACCOMMODATIONS?
BOSTON, MASS.	No.	Apartments and residences.	Depends on prices of labor and materials.	No.	Labor, material costs, financing.		5 to 25 per cent.	No answer.
YOUNGSTOWN, OHIO.	Yes, dwellings, apartments, schools.	House building.	Unusual activity expected because of shortage.	Yes.	Labor.		10 per cent.	Dwellings and apartments.
SPRINGFIELD, MASS.	Yes, dwellings and schools.	Dwellings.	Prices of material and labor cause none to be built now.	Yes.	Labor, material costs.		20 to 25 per cent.	Dwellings.
KEOKUK, IOWA.	No.	No.	No.	No.	Labor, material costs.		None.	No.
SEATTLE, WASH.	Yes, dwellings and warehouses.	Dwellings, apartments, business buildings.	Growth in population and industry, demand unusual building activity.	Yes.	Labor, material costs, and financing.	3,500 new dwellings being constructed, this fall to house war workers. Active building expected after war.	33 1/3 per cent.	Dwellings and apartments.
SEATTLE, WASH.	Yes, factory buildings, dwellings, warehouses.	Dwellings, factory buildings, warehouses.	Actual shortage at present.	Yes.	Labor.		33 1/3 per cent.	Dwellings and apartments.
COLUMBUS, OHIO.	Yes, dwellings.	Dwellings and apartment houses.	Long cessation of building created a demand.	Yes.	Labor, material costs.		10 to 15 per cent.	Residences.
SPOKANE, WASH.	Dwellings.	Residence building.	Increase of population and ban on building has created a demand.	No.	Labor.		No answer.	Residences.
SPOKANE, WASH.	No.	Not immediately.	Very little activity expected because of low rents.	No.	Vacant properties, labor and material costs.		No advance.	Up-to-date moderate priced houses.
FORT SMITH, ARK.	Yes, dwellings.	Dwellings and factory buildings.	Ideal manufacturing location and over 100 factories located here, and demands for more dwellings.	Yes.	Labor, material costs.	City is quite a manufacturing town and prosperous conditions demand more dwellings.	8 to 10 per cent.	Dwellings.
ATLANTA, GA.	Yes, dwellings, factory buildings, warehouses, schools and office space.	Great activity expected in all classes.	Restrictions create demand which must be satisfied.	Not at present.	Material costs.		10 per cent up.	Difficulty in securing everything.
ATLANTA, GA.	Yes, dwellings, warehouses, schools.	Dwellings.	Conditions demand an active building season.	No.	Material costs.	Fire recently destroyed \$5,000,000 of buildings, mostly residences.	Same.	Dwellings.
UPLAND, CAL.	None.	No.	Many empty dwellings, stores, etc., small town and nothing more than normal building expected.	Not at present.	Labor, material costs.		Reduced.	None.
LOS ANGELES, CAL.	No shortage.	Dwellings and apartment houses.	No unusual activity expected. Only necessary construction will be made in this city after war.	No.	Labor.		5 to 15 per cent.	None.
LOS ANGELES, CAL.	No shortage.	Not immediately.	If vacant houses are refilled and people return from war industries, there will be activity.	Not at present.	Financing.		Decreased.	None.
MOBILE, ALA.	Yes, medium priced houses.	Dwellings.	Increased population and growth of ship building interests in this city.	Yes.	Vacant buildings.		10 per cent.	Dwellings.
HUNTSVILLE, ARK.	Yes, dwellings, farm buildings, schools.	Yes.	Demand greater than supply at present. Will have to be satisfied.	Yes.	Labor, material costs, financing.		Slight.	Yes



OAKLAND, CAL.	Yes, dwellings, factory buildings, warehouses, office space.	Dwellings, office buildings, apartment houses, etc.	Growth of population and demand of industries urge active building campaign.	Yes.	Labor, material costs, financing.	Oakland population has grown 50 to 75 per cent. in last year and ship building, motor works and other industries have been added.	25 to 100 per cent.	Dwellings, apartment houses and family hotels, office buildings, factory buildings.
SEDALIA, MO.	Yes, schools.	All lines.	Lull in building activity will cause a reaction.	Yes.	Labor, material costs.		No answer.	Public schools.
ARMORE, OKLA.	Yes.	Yes, general growth.	Growth of industries demands activity.	Yes.	Financing.		None.	Modern houses.
BILLINGS, MONT.	Yes.	Yes.	Yes, because city has not the facilities now to handle the business offered it.	Yes.	Labor.		None.	Yes, all kinds.
ABERDEEN, S. D.	Yes, dwellings.	Dwellings.	Yes, shortage at present and general prosperity of the community.	Yes.	Material costs.		Little change if any.	Yes.
FARGO, N. D.	Yes, farm buildings, dwellings.	Farm buildings, dwellings and warehouses.	Curtailed of building has produced need.	Yes.	Labor, material costs, financing.		Very little.	Residences and farm buildings.
PADUCAH, KY.	Yes, factory buildings, warehouses.	Considerable expected if material costs decrease.	Prosperity is one of the greatest factors indicating big activity.	Yes.	None.		No advance.	Apartment houses.
TWIN FALLS, IDAHO.	Yes, farm buildings.	No special activity.	Normal building activity expected.	No.	Material costs.		No answer.	Dwellings.
HELENA, ARK.	Yes, dwellings.	Yes.	Great demand for dwellings at present. Curtailment produced this demand which must be satisfied.	Yes.	Labor, material costs.		25 per cent.	Dwellings and mercantile houses.
HELENA, ARK.	No.	No.	No answer.	No.	None.		None.	No.
OKLAHOMA CITY, OKLA.	Yes, dwellings and school buildings.	Dwellings and schools.	Actual need exists that must be satisfied.	Yes.	Labor, material costs.		25 to 35 per cent.	No buildings of any class for rent.
ANNISTON, ALA.	Yes, dwellings.	No.	Demand was created by proximity of cantonments but now there is an oversupply of some buildings.	No answer.	No answer.		Enormous gain.	No answer.
HOT SPRINGS, ARK.	No.	No.	Present supply seems adequate.	No.	Labor, material costs.	Nothing more than normal building expected as there is no stimulus.	No advance.	No.
DETROIT, MICH.	Yes, schools.	Dwellings.	Unusual growth in population will produce a shortage of dwellings.	No.	Labor, material costs.		No advance.	None.
CROOKSTON, MINN.	None.	None, except farm buildings.	Prosperity of farming community indicates spur in farm building.	No.	No answer.		No advance.	None.
SHREVEPORT, LA.	Great shortage of dwellings.	Dwellings.	Always has been shortage of dwellings and after war is logical time to build.	Yes.	No answer.	Have great oil and gas fields here and natural gas. This naturally increases industries.	Small advance.	Dwellings and all living quarters.
LAWRENCE, KAN.	None, except high school buildings.	No special activity.	Government has built barracks for 5,000 on university grounds. This has produced many vacant houses, while the 3,000 formerly lived.	No.	Labor, material costs.		Decrease.	None.
BUTTE, MONT.	Yes, warehouses and schools.	No.	If price of labor decreases, some building may be expected.	Yes.	Labor.		None.	Storage.
SIoux FALLS, S. D.	Yes, factory buildings, dwellings, warehouses, farm buildings and schools.	Dwellings, warehouses and farm buildings.	In addition to present shortage, a business expansion will take place after the war.	Yes.	Material costs, labor.		No advance.	Dwellings and warehouses.

Information Supplied by Bankers, Real Estate Dealers and Contractors—Continued

CITY	1. IS THERE ANY SHORTAGE OF DWELLINGS, FACTORY BUILDINGS, WAREHOUSES, FARM BUILDINGS, SCHOOLS OR OFFICE SPACE?	2. DO YOU ANTICIPATE SPECIAL ACTIVITY IN ANY PARTICULAR CLASS OF BUILDING AFTER THE WAR?	3. MAY WE HAVE AN EXPRESSION OF YOUR OPINION AS TO THE REASON FOR ASSUMING THAT THERE WILL OR WILL NOT BE UNUSUAL ACTIVITY?	4. DO YOU THINK RENTS AND OTHER RETURNS FROM BUILDING INVESTMENTS ARE SUFFICIENTLY HIGH TO STIMULATE SUCH INVESTMENTS WHEN PEACE COMES?	5. WHAT FACTORS IN THE BUILDING SITUATION DO YOU REGARD AS MOST LIKELY TO OBSTRUCT A REVIVAL OF BUILDING?	SPECIAL COMMENT.	6. HOW HEAVILY HAVE RENTS ADVANCED IN THE LAST YEAR?	7. DO RENTERS EXPERIENCE DIFFICULTIES IN SECURING ANY PARTICULAR ACCOMMODATIONS?
QUINCY, ILL.	No.	No.	Very little activity expected as there has been an abnormal exodus of war workers from this city.	No.	Low rents and present surplus of building.		None.	No.
SAN DIEGO, CAL.	Yes, dwellings.	Dwellings and business buildings.	Needed construction must be made.	No.	Labor, material costs and moderate demand.	If confidence in real estate is restored activity will be spurred.	None.	Dwellings.
WILLISTON, N. D.	No.	No.	Poor crops. No indication of any great activity.	No.	No answer.		Decreased.	No.
MONTGOMERY, ALA.	Yes, dwellings and other buildings.	No special activity.	City has been built up considerably to house visitors to local cantonments. Normal activity expected.	No.	Possibly labor, material costs.		25 per cent.	No.
LAMAR, COL.	No shortage.	Dwellings and farm buildings.	If crops are good and ban is lifted, some activity is expected.	No.	Material costs.		No answer.	No answer.
OGDEN, UTAH.	No.	Only normal.	No unusual demand and therefore do not expect any unusual activity.	No.	Labor and material costs; also demand.		Advanced about one-tenth cost of construction.	Small modern residences.
OMAHA, NEB.	Yes, dwellings, apartment houses, factory buildings.	Dwellings, apartment houses, factory buildings.	Population has steadily increased; investment in real estate is daily becoming a better investment and shortage today demands activity.	Yes.	Labor, material costs.		20 to 25 per cent.	Dwellings and apartments.
PRESCOTT, ARIZ.	Yes, dwellings.	Even greater shortage of dwellings expected.	Growth of population demands new building.	Yes.	Labor, material costs, financing.		10 to 50 per cent.	Dwellings and apartments.
DAVENPORT, IOWA.	Medium priced dwellings for rent.	Medium priced dwellings for rent.	Government closed private construction till close of war.	Yes.	Government buildings as proposed, labor, material costs.		25 to 30 per cent.	Moderate priced houses.
TWIN FALLS, IDAHO.	Dwellings, warehouses and probably one school.	Dwellings, warehouses, school.	Anticipates activity after the war.	No answer.	None.	Knows several buildings that will go up after the war.	No advance.	No answer.
SIOUX FALLS, S. D.	Factory, warehouses and school buildings.	Factory, warehouses and school buildings.	Great demand warrants it.	Yes.	There will be a spark plug factory after war.		No advance.	No.
ARDMORE, OKLA.	No.	Dwellings and factory buildings.	Prosperous community warrants it.	Yes.	None.	Abundance of oil, natural gas and asphalt create activity.	No answer.	No answer.
SEATTLE, WASH.	Shortage in everything mentioned.	Dock, warehouse and office buildings.	Tremendous shipping passes through port of Seattle to Orient, Russia and Siberia.	Yes.	Cost of labor and restrictions on same.		20 to 45 per cent.	Yes.
MINNEAPOLIS, MINN.	No shortage.	Homes, factory buildings.	Cessation of building because of tan will spur activity.	Yes.	Possible labor difficulties, material costs.		Moderate advance.	No marked difficulty.
ST. PAUL, MINN.	Not noticeable except factory buildings.	All lines, especially factory, warehouse and farm buildings.	Anticipate unusual activity in building generally.	Yes.	Shortage of materials, especially steel.		About ten per cent.	Yes, especially high class apartments.
BUTTE, MONT.	No.	No.	300 saloons thrown out of business, most of which will remain idle.	No.	Many vacant stores on account of prohibition.		Slight decrease.	No.

	No.	Doesn't know.	No answer.	Doesn't know.	Doesn't know.	Doesn't know.	Doesn't know.	No.	Not much.	No.
DUBUQUE, IOWA	Factory buildings, rental property, schools.	Doesn't know.	Factories, apartment houses, high class residences, etc.	No answer.	Many buildings already planned were postponed. Expect a good deal of activity.	No answer.	No answer.	Doesn't know.	About 15 per cent.	Modern apartments.
COLUMBUS, OHIO	Dwellings, warehouses, schools.	Warehouse and dwellings.	Warehouse and dwellings.	Yes.	Many building projects stopped. Community prosperous on account of high prices for farm products.	High wages, high cost of materials.	High wages, high cost of materials.	20 per cent except for office space.	20 per cent except for office space.	Residence and warehouse space.
BILLINGS, MONT.	Moderately priced dwellings, warehouses, factories, schools.	Dwellings, warehouses, factories, schools.	Dwellings, warehouses, factories, schools.	No.	Anticipate general building activity. No special activity in any particular class of buildings.	Possible labor shortage and labor unrest.	Possible labor shortage and labor unrest.	About 10 per cent.	About 10 per cent.	Moderately priced dwellings, warehouses.
SIoux FALLS, S. D.	Dwellings, factories, office space.	Yes, more dwellings.	Yes, more dwellings.	Yes.	Demand greater than supply. Prospect of striking oil fields.	Securing land for building, financing.	Securing land for building, financing.	10 per cent.	10 per cent.	Dwellings.
HUNTSVILLE, ARK.	Schools, apartments.	Perhaps schools.	Perhaps schools.	No.	Does not anticipate activity. Not a paying investment for investor.	Financing.	Financing.	No advance; decline noted.	No advance; decline noted.	Apartments.
WATERLOO, IOWA	Buildings of different types needed.	All lines.	All lines.	Cannot give definite reply.	Curtailment has created demand.	Scarcity of skilled labor.	Scarcity of skilled labor.	About 15 per cent.	About 15 per cent.	Apartment houses, bungalows of five and six rooms.
St. LOUIS, MO.	Dwellings.	Dwellings, large hotel.	Dwellings, large hotel.	Yes.	Business activities will scarcely be normal after the war.	Labor, material costs.	Labor, material costs.	Think there has been no advance.	Think there has been no advance.	No.
WHEELING, W. VA.	No.	Yes	Yes	Yes.	A growing town.	No answer	No answer	None	None	No.
MINOT, N. D.	Yes, considerable.	All lines.	All lines.	Yes, first class.	Because it is needed.	None.	None.	30 per cent.	30 per cent.	Yes, very much.
OKLAHOMA CITY, OKLA.	Many buildings going up now will relieve present shortage.	Yes.	Yes.	No.	People have become wealthy. Will want better homes or to improve their present ones.	Labor and material.	Labor and material.	Not much.	Not much.	Small houses for renting.
WILMINGTON, DEL.	No.	Not to amount to much.	Not to amount to much.	Rebates and high taxes will not justify returns.	On account of high prices of materials.	Labor, material costs.	Labor, material costs.	Not more than 7 per cent.	Not more than 7 per cent.	No.
CARTHAGE, MO.	No.	No answer.	No answer.	No.	We depend altogether on visitors. High cost of living cut them down.	Valley Mill Co.	Valley Mill Co.	Decreased.	Decreased.	No.
HOT SPRINGS, ARK.	Modern dwellings, apartment houses, schools, office space.	Dwellings, apartment houses, municipal building.	Dwellings, apartment houses, municipal building.	High enough to stimulate steady growth in building construction, but not sufficiently high to cause sudden expansion in building activities.	Same as previous answer.	None.	None.	No advance.	No advance.	Same as No. 1.
SACRAMENTO, CAL.	Considerable shortage in factory buildings, warehouses and dwellings.	Small residences and apartment houses.	Small residences and apartment houses.	Yes.	Increased population warrants new building.	Securing materials.	Securing materials.	5 to 10 per cent.	5 to 10 per cent.	Two- and three-room apartments.
BOSTON, MASS.	No shortage.	Farm buildings, farmers have had a bumper crop this season	Farm buildings, farmers have had a bumper crop this season	No.	Depend largely on farming industry. Farmers prosperous and will probably build.	Labor and material costs.	Labor and material costs.	Decreased.	Decreased.	None.
CROOKSTON, MINN.										



# Industrial Information

*In this Department there is published each week information as to the development of materials and methods, derived from reliable sources.*

## Improved Methods in Plan Filing

To practice what you preach may not always be convenient, but it is admittedly the way to give strength of your convictions. If an architect can bring his client to an office equipped for his own use with an eye to system and convenience, nothing perhaps would more impress said client with the importance of the architect as a factor in the practical administration of efficiency. Nothing superfluous, but everything, as far as possible, that represents the modern and progressive in equipment should be in use.

Among the many items of interest appropriate for such use the Art Metal Planfile may be mentioned.

The helpful attribute peculiar to this planfile, as manufactured by the Art Metal Construction Co. of Jamestown, New York, is the principle of compression in its construction. By a system of springs on the side edges of each pocket folder, tracings and blueprints can be placed within and held flat and smooth, in a vertical position without the inconvenience of fastening them on the top, and without any crumpling or breaking down of any sheets so filed.

An Art Metal Steel Planfile is built with double wall construction and lined between inner and outer walls with asbestos. It accordingly affords unusual protection against fire and water, as has been showed in many instances where subjected to accidents of this kind.

In capacity a 42 30 "Planfile" holds about 5400 tracings with space for 54 or more folders. It is said to be necessary to stack thirty plan drawers to a height of 9 feet 7 inches, figuring 200 tracings to the drawer, to equal the capacity of one Planfile.

Only 24 inches for aisle space are required to operate Planfiles.

The folders are double folded at top edges for extra strength and are scored for expansion. Heavy durable stock is used exclusively. No climbing or stooping is needed to operate this file, as the operator always stands on the floor.

The index is always in sight when the file is being used.

Locking of one Planfile protects from 4500 to 5000 drawings. It is necessary to lock 25 drawers to accomplish the same purpose.

The Planfile herein described is but one of a number of novel files for plans of different sizes, and, in fact, for filing of any kind. The Art Metal Co. of Jamestown will be pleased to give further information.

---

## For Sliding Doors

The Coburn Trolley Track Mfg. Co. of Holyoke, Mass., has prepared an elaborate catalogue and price list descriptive of its sliding door hardware. Hardware of this kind has an important function to perform, and the illustrations in this catalogue seem to indicate that the sliding door equipment made by this company is effectual and durable in character.

A large variety of accessories are depicted, including hangers, stops and guides, locks, storm shields, etc. The numerous plans presented should be of assistance in specifying sliding door hardware. The makers state that Coburn products are designated to give maximum service at all times and are amply strong to perform their respective functions without undue wear or friction.



14835

# The AMERICAN ARCHITECT



DETAIL, THE ALHAMBRA, GRENADA, SPAIN

PUBLISHED WEDNESDAYS IN NEW YORK—FOUNDED 1876

VOLUME CXV

JANUARY 8, 1919

NUMBER 2246

Entered as second class matter January 6, 1909, at the Post Office at New York, N. Y., under the Act of March 3, 1879. Publication office, 243 West Thirty-ninth Street, New York, N. Y. Subscription price in the United States and Possessions, \$10.



*A form  
for every  
pile—  
A pile  
for every  
purpose*

## Why to Specify Raymond Concrete Piles

Specify Raymond Concrete Piles because that is the simplest, most direct way of automatically making certain that every finished pile will actually be perfect, not only on paper, but in the ground. The reason is simple—each and every standard Raymond Concrete Pile is cast in place in a spirally reinforced steel shell—and this shell is left in the ground. This feature is an exclusive RAYMOND advantage.

### Raymond Concrete Pile Company

NEW YORK: 140 Cedar Street CHICAGO: 111 W. Monroe Street

#### The Method

A collapsible driving core or mandrel is encased in a spirally-reinforced steel shell. Shell and core are driven to refusal—the core is collapsed and withdrawn—the shell is left in the ground. The interior of the driven shell may be inspected, before the concrete is poured into it. Certainty!

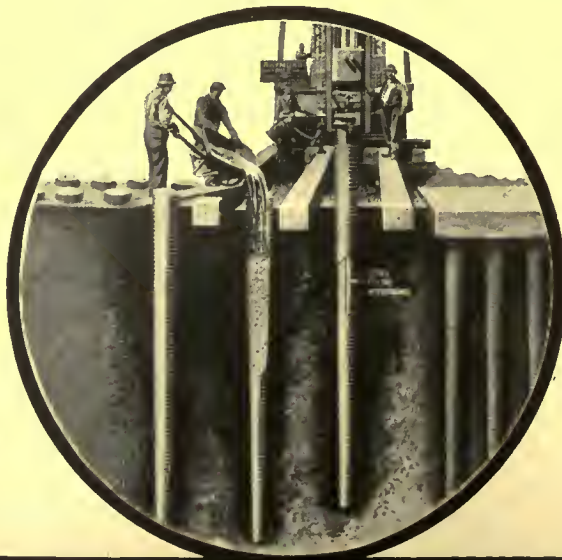

#### And Now—

Peace has come, and with it the added abilities for Service that our War experience has brought us. Bigger and broader than ever before—and with greatly increased efficiency and facilities—this Organization is now in a position to swing its full strength toward the construction work of the reconstruction period.

*The* RAYMOND  
CONCRETE PILE





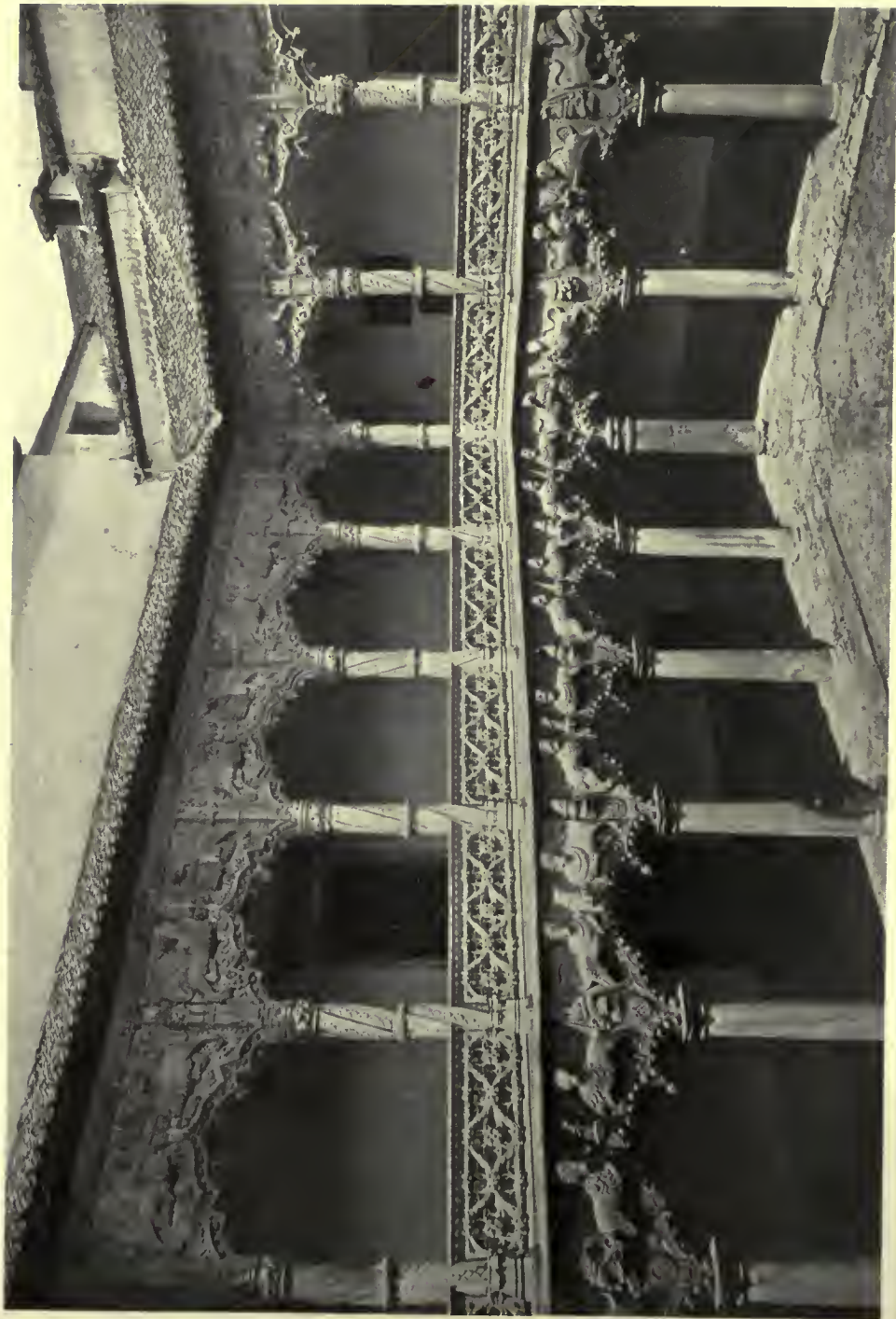

COURTYARD, THE ROYAL PALACE, GUADALAJARA, SPAIN

# THE AMERICAN ARCHITECT

VOL. CXV

WEDNESDAY, JANUARY 8, 1919

NUMBER 2246

## Government Housing: What Will Follow?

By C. GRANT LA FARGE, *F. A. I. A.*

IT is too early to do more than to speculate, however advisedly, upon the effect that the housing for war workers, undertaken by the Government, is to have upon the general question we somewhat vaguely indicate by the term "reconstruction." It were better called "re-adjustment," so far as concerns this country.

Those of our citizens who, as individuals or as associations, have long been concerned with the problems of town planning and housing; who have convened and discussed, preached and toiled in the face of a public mostly blind and indifferent; these have turned eager eyes upon what must have seemed almost a miracle: The actual venturing by the United States Government upon the construction of dwellings for working people, upon a large scale and, so far as the personal characters and abilities of those employed for the task could guarantee, in a manner and upon terms that would be a very long step in advance. Those same eyes had scrutinized the examples furnished overseas, especially, perhaps, the remarkable performance of Great Britain in war time. To thoughtful persons, open-minded students of the subject, the conviction was not new that the living conditions of working people, outside the factories, were at least as important as those surrounding their working hours. They measured the question in terms of citizenship, not satisfied that any purely economic formula was adequate to cover a subject so complex. Not that radicalism should be suspected of dismissing the necessity for a sound economic basis, but rather of believing the commonly accepted one to be unsound. Housing must pay, of course, but must the standard of payment be an irreconcilable incompatibility between the workman's resources and such living conditions as are essential to the health, contentment, efficiency and well-being of himself and his family; yes—let us face it—even to their honorable pride and their opportunity for that "pursuit of happiness" recognized by the founders of this republic?

It would appear to be so, if the solution of the problem of industrial housing were to be left en-

tirely to the laws of supply and demand, as interpreted and made use of by the speculative builder chiefly, with an occasional contribution from some enlightened association (of which New York City affords a notable example), or from industries become aware of the important part to be played by housing in stabilizing labor. The limits of this brief article forbid more than this mere glance at a great and many-sided question, but even the glance may suggest that if any lessons are to be gleaned from governmental entry into the field, they are worth attention.

There are such lessons, many of them, and they will doubtless be elaborated in various ways; one only will be indicated here. It has to do with production. Occupancy and its methods; terms of rental and sale; plan of holding the properties; their management; the effect of the housing—these matters at this writing lie in the lap of the gods, some of whom thunder upon Capitol Hill.

In ordinary circumstances, the great bulk of low-cost housing is a real estate speculation pure and simple; much of it is vicious. The common phenomena are familiar; some land secured at a bargain; cheap houses crowded as close as the law will permit; the minimum of ground improvements; poor plan; no continuing responsibility of the promoters; no decent system of management, probably none at all. The whole thing is unloaded by shrewd advertising methods and is left to take care of itself, which it usually does by becoming a slum. Not that this is universally the story of speculative building; some of it is good in its way, rather limited so far as design of houses and their surroundings goes; or a fair plan of disposal by stable companies. But—and it must be understood that we are not here considering the few exceptional instances—in ascertaining, analyzing and relating the many factors involved in a proper determination of the investment, nowhere is there brought to bear such an assemblage of qualified skill and opinion as the United States Housing Corporation has had at its command.

To set forth these factors it will be well to see how



## THE AMERICAN ARCHITECT

they presented themselves to the Corporation, as the subject of its methods of investigation.

It must be clearly borne in mind—and the fact is all the more illuminating for the relevance of the methods in other circumstances—that the function of the Corporation has not been merely to build homes for industrial workers. Broadly stated, it has been, proof of the need being duly established, to find or to provide housing for the workers essential to munitions production, in whatever manner, building being resorted to when other means were exhausted. Its aim therefore was a war aim: its specific object to reduce a specific labor turnover; it was not a "welfare" organization. But inasmuch as the root of the trouble, no matter what the purpose or range of the remedy, was always the same—congestion; insufficient dwelling-places; living conditions ranging from unsatisfactory to intolerable, it had to take into account every single fact ascertainable, most decidedly including those relating to the communal facilities such as markets, schools, churches, amusements and recreation. This is, or ought to be, self-evident.

So the chief objects of an investigation, in the case of any applicant community, were to discover the number, kind and condition of *all* local industries, engaged wholly, in part, or not at all in war production; the number, classification and earnings of their employees, in war and in normal times, past, present, required, or expected; the rate of labor turnover in each plant, with evidence as to its cause; the residence of employees, local, or at a distance, with schedules, rates of fare and quality of transportation service; whether or not there was housing unavailed of in those other localities, and if so, how much, and of what sort; the quantity and classified quality of local housing, and the extent to which it was occupied; the organized efforts, if any, made to find living quarters for workers and their families; the sanitary conditions and the state of public utilities; average rents and purchase prices; land values; available building sites; facts as to schools, churches, stores, amusements, parks, playgrounds, recreation welfare organizations; amount of house building done or projected; condition of the banks and loaning companies, particularly as to building loans; and any other information that would aid in determining the nature of the community, its present condition, its normal state and, very specially, its quality of industrial prosperity as a stable thing.

Speaking upon personal responsibility, as one who made a considerable number of such investigations, and who is familiar with many made by others, it is not outside the facts to say that conditions disclosed over and over again were such as

in any fair view of human surroundings should be called scandalous and a disgrace to a people claiming the standards of civilization and some measure of idealism. The astonishing, and the degrading, thing is not that they were revealed by inquiry, but that such inquiry should have had to be made in order to disclose them. For they were not due to the war, but had been there for years under our eyes, plain to be seen had we cared to see them. The war pressure accentuated and intensified them, it is true; it was the fierce search-light that so displayed them that we could no longer be blind; it made the poisonous weeds grow so fast in the field from which we had to reap a speedy harvest that we had no choice but to do some clearing—but the weeds were there through our neglect.

The policy being as already stated, to resort to building when other means were exhausted, the obvious first of these means is to make use of all discoverable vacancies of proper character, local or within reasonable reach, by placing workers in those vacancies. This was the function of the Homes Registration Service.

The object toward which it worked was the occupation of all fit living accommodations within reasonable radius of the plants by war-workers up to the point where all were suitably accommodated at prices commensurate with the wage earned. Various considerations enter in to render this a complex problem. One community might show a surplus of lodgings for single men and afford scanty opportunities for workers with families. A locality might supply a thousand rooms suited to the needs of the workers earning three dollars a day, and only a score of the kind sought by the six dollar or more a day artisan, or vice versa. Lodging houses might abound where the demand was heavy for complete boarding or housekeeping conditions; and boarding places be the rule in the vicinity of a plant whose labor, for reasons of overtime, or high pressure work, required the other system.

Vacancy canvasses were made, covering all unoccupied houses, flats, and in the most pressing conditions, even rooms which householders might be induced to rent. Houses and rooms were graded, not only as to convenience and price, but also as to cleanliness and sanitation, and those not up to standard in the latter respects put upon a deferred list. Lists of all available accommodations were maintained in each community at the Homes Registration Office, and checked and kept up to date by daily reports and frequent inspection. Field Agents were appointed who visited and established Homes Registration Bureaus in about seventy cities in the United States, where need for housing existed.

## THE AMERICAN ARCHITECT

Where there is housing saturation in the vicinity of the war work plant, there may yet be, within reasonable distance, some community that offers housing vacancies, or, if not convenient, it may be rendered so by the establishment of new or improved traffic facilities. In such cases, to accomplish these was the object of the Transportation Division; in so doing its function coinciding with that of the Homes Registration Service; viz.: to avoid where possible the expense of constructing special houses for war workers. By special train, trolley and boat service, timed to the schedules of the war factories, and by a simple rearrangement of schedules in some instances, this relief was afforded.

In investigating congestion due to war work, the Corporation received its information as to the importance of the output of the locality in the war program from either the Army or the Navy. The localities were rated "A", "B", and "C", and when it developed that the appropriation from Congress would not adequately take care of all the projects that demanded relief, the Corporation necessarily tried to give relief to those of primary importance. This was the function of the Priorities Section of the Requirements Division. In those communities where funds were not available to give relief, or where projects for house building had been abandoned because the locality expected the Government to build, the Housing Corporation made an effort to stimulate private capital to take care of the housing shortage for industrial workers.

The Corporation indicated to these communities that it would secure for them priorities as to materials, the license to build under proper restrictions, safeguarding the worker as to rental and sale, and that wherever possible the Corporation would secure Government prices for these projects. All plans were passed on by the Corporation before the license was issued, and a sworn statement of stipulations in each case was drawn up and signed by all the parties concerned.

There now remained one step to be taken to bring about a better distribution of labor through its diversion from the less essential industries to those making munitions of war, in conjunction with a redistribution of war contracts by placing them where factories were idle, or partly so, and where there was labor supply and housing. Because there nowhere existed any such industrial survey as gave the requisite information, the Division of Surveys and Statistics was formed, which acted as a very complete investigating Bureau, working with the Regional Advisors and the Labor Control Boards in the various centers of activity.

A complete list of every factory employing over ten men was made in an appreciable number of

cities, including a statement as to the kind of work that the less essential factory could take on as a war measure, and how long it would take that factory to change over. In this way it soon became evident that in many localities no housing would have to be provided if a certain percentage from the less essential factories were diverted to those factories engaged in war work. The redistribution was the work of the War Industries Board, to which body reports were made.

In this cursory fashion are indicated those methods employed other than the construction of housing. The manner of handling that must be as briefly touched upon, because it is not the purpose of this article to describe the workings of the Housing Corporation.

Besides a very expert Real Estate Division, charged with the acquiring of land for sites, there were the technical Divisions of Architecture, Engineering and Town Planning. By these, covering the field of design, a vast amount of valuable information and material was collected and digested, preparatory to the beginning of the projects to be undertaken. Minimum housing standards were prepared; type designs elaborated; standard details and specifications adopted; instructions of all sorts for employed designers worked out. Special researches were made covering schools, hospitals, cafeterias, relations with municipalities as to the installation or extension of public utilities, and the very important matter of varying building codes. Experts of high grade studied in detail questions of heating, plumbing and lighting, and established new devices of economical character. The subject of building materials, a very vexed one under the constantly increasing restrictions of war-time, was under constant scrutiny in active collaboration with the War Industries Board. A corps of skilled estimators, in the Requirements Division, made careful cost analyses and quantity surveys; by a very thorough plan, materials in quantity were allocated, ordered, and arrangements made for their shipment so as to be on hand when required for construction.

The designing of projects was entrusted to Committees of Design, each consisting of Architect, Engineer and Town Planner, selected from among private practitioners of high professional standing. They worked upon a contractual basis founded upon the idea of war service, and affording them a remuneration far below their customary receipts. Needless to say, though not to be described here, very complete arrangements were made as to submission and approval of drawings and specifications and work both in office and field. Every possible emphasis was laid upon two points; that designers



## THE AMERICAN ARCHITECT

were to work as teams, and that their clients were the workers for whom the buildings were to be built.

Closely allied with the work of design was the Operating Division, which would have charge of the properties when created. As managers of these sometimes large communities, their function would be fully as important as that of their creators; hence their oversight was necessary at every stage of the development of each project. Housing is not merely the building of houses; it is the sudden creation of new communities, perhaps villages, perhaps fair-sized towns. Their conduct; the physical up-keep of the dwellings; the maintenance of sanitary conditions; the abatement of nuisances; the adjustment of disputes which unadjusted lead to the police court; the general welfare supervision of the populace; the fixing of rentals and priority of occupancy; the maintenance and establishment of desirable social and recreational activities—these are management. The purpose of the Housing Corporation was far from the irresponsible, get-rich-quick, unload-it-on-'em-anyhow-and-get-out-with-the-profit method of the more disastrous forms of speculation in real estate and human needs.

To the work of the Construction Division only passing references may be made; upon this large and most competent organization devolved the making of contracts and the handling of the work to be done by the contractors in the field. To describe its extensive function and machinery would require an entire article.

What then is the lesson?

To the casual observer the general proposition that houses were to be built for workmen would seem a simple one. But actually it is a large, complex, human and economic problem, with so many sides to it that for its solution there needs be invoked the joint endeavor of those in numerous and greatly varied walks of life, ordinarily thought of as unrelated.

The union of all these forces does not, in ordinary circumstances, occur. It is possible only where the magnitude of operations upon a wholesale scale permits the absorption of the overhead expense it entails. The United States Housing Corporation has worked upon such a scale and has therefore been able to assemble into one closely woven organization these many agencies. Here have been owner, manager, real-estate expert, designers in all branches, constructor, experts in the technicalities of building, of transportation, of schools, hospitals, living conditions, and the law. The special knowledge of all these has been available for exercise at the moment when needed and continu-

ously throughout. The advantage is easily demonstrable; to have, for instance, the advice and co-operation of the builder who will construct, and the manager who will conduct the property, from the very inception of the planning and through all its stages to completion in all its various parts, is obviously beneficial; the same is true of the larger group. It is also a fact that these experts should all be the best in their respective lines. The Corporation, because of the importance of its work and through the patriotic appeal inherent in its objects, has been able to command such talent. The organization has functioned as what may fairly and appropriately be called a Team. In so doing there has been afforded illuminating evidence of the essential inter-dependence of its factors and of the value of so uniting them when the problem of industrial housing, whether for war workers, or those of peace, is to be adequately solved in its many economic and social aspects.

Even so slender an outline as this of the Corporation's activities should not fail to include some word concerning their spirit and quality. The employed designers have shown an enthusiasm and devotion, a glad acceptance of severest toil with only war-time remuneration; have manifested a degree of technical skill and ingenuity, that reflect high credit upon the professions concerned, their mastery of their arts and their characters as loyal citizens. The same thing might truthfully be said about the great team which has served the Government, but perhaps that should not come from one whose privilege it was to be a member. He can, however, say that its leader, Otto M. Eidlitz, has come out of his conduct of an almost inconceivably difficult and trying task, with not merely their respect but their warmest personal affection.

For private enterprises, and in the common run of things, no such uniting of the forces may be anticipated. And yet the problem of industrial housing, still in its infancy, is one that this country has got to solve in its human as well as its financial bearings; in its effect upon a better citizenship; upon the Americanization of both our foreign-born and native populace; upon the rational treatment of labor unrest. Surely we should not sink back into our *laissez-faire* treatment of this, among the other lessons that the war has been supposed to teach us—surely the fruits of the great governmental experiments should be cultivated and ripened.

The country is undoubtedly not ready to accept housing as a Federal enterprise. But it would seem as though a Federal Bureau could exercise a useful function in gathering together, analyzing, digesting, extending, the great mass of relevant facts and experience growing out of the work so



## THE AMERICAN ARCHITECT

far accomplished. This central agency might in many valuable ways make this knowledge available to all those concerned, whether States, municipalities or private organizations. There will long be need for a Homes Registration Service, as well as for Employment Agencies. There is great need for really complete and competent industrial statistics. There is the greatest kind of need for adequate surveys such as Philadelphia, Boston and Chicago have been making, to set forth facts as they are and out of them to make what we so sadly lack—plans. When you say housing and transportation there is but little you leave out of living conditions, industrial distribution, employment, highways and railways and waterways, ports and terminals. In the stimulation and correlation of such surveys, this central Bureau could play a most important part. We need to know far more than we do about the cost of housing, of new methods that will reduce it; of the relation between that cost and the paying power of the wage earner. Here is work for such a Bureau.

We need to work out a system of loans to workers who want homes, at low interest rate and on long-term payments, that will drive the loan shark, on whom that worker now so largely depends, out of existence.

We need a competent, exhaustive, continuing study of a subject that is vital to the well-being of the republic.

We need to realize that the old days of prating about town-planning and the education of popular taste from the top down are gone forever, and that the way to build anything at all is to begin with the foundations.

We need to open our minds to such ideas as are advanced in these extracts from a report to the British Ministry of Education.

"Opportunities for education depend to a considerable degree upon the character of the houses in which the people live. The unsatisfactory condition of working-class housing, as regards both quality and quantity, in town and country alike, is now realized on all hands. This problem, though accentuated by causes arising out of the war, existed even before the war in acute form.

\* \* \* \* \*

"Such conditions, it is only too obvious, militate against the full use and right enjoyment of life. It is difficult often, indeed, impossible, for badly housed men and women to develop intellectual interests, and where such interests have been developed, almost insuperable obstacles are offered to their full realization. The information submitted to the Committee on this question is unanimous in condemning existing housing conditions; and students,

teachers, and social workers are in full agreement as to the very serious handicap imposed on those who would wish, as one puts it, 'to do more than work, eat and sleep.'"

\* \* \* \* \*

"Too little attention has been paid in the past to the reaction of the physical environment upon the aesthetic and moral standards of the people. Contact with ugly and depressing surroundings tends gradually to dull the finer senses, and people who, under more favorable circumstances would shrink from the drab and sordid environment of large areas in all our towns, become, through familiarity, oblivious of its ugliness. It is as important not to overlook the subtle degradation of mean and sordid surroundings as it is to remember the educational influence, none the less real because unconscious, of a clean, healthy, dignified and beautiful environment.

"We have approached the matters dealt with in our present report from the human rather than the economic point of view. If the individual is to make the most of his powers, if the citizen is to be worthy of the responsibilities thrown upon him by the ever-increasing complexity of life in a modern community, in other words if education in any broad meaning of the term is to become a reality, certain definite conditions of life are indispensable. The paramount consideration is that of the individual as a member of society. Material progress is of value only in so far as it assists toward the realization of human possibilities. Industry and commerce and the social conditions which are in a large degree dependent upon them must in our opinion be regarded from this point of view, and if they cramp the life of the individual, no amount of economic argument will suffice to justify them. \* \* \*

"We do not think, however, that there is of necessity a fundamental antagonism between ethics and economics. Adequate pay, reasonable hours of labor, the suppression of heavy, degrading, and monotonous forms of manual labor by machinery and improved processes, the provision of holidays, the introduction of human relations and of the social motive into industry, healthy homes and cheerful environment—these are the indispensable conditions of economic efficiency; they are also among the elementary rights to which the citizen, as such, and in virtue of his responsibilities, is entitled."

We may not all agree with all of this. We should agree that the problem is urgent; that what we have done is but a beginning; that the old methods are insufficient.

# Architectural Office Organization for Post War Conditions

## *Part II*

By DANIEL PAUL HIGGINS

THERE are special reasons why the American architect should be particularly interested in planning for the period after the war. Today he is virtually a stranger in his own domain. Whichever way he turns, whatever phase of building he looks at, all is changed under the strangely pallid mercury lamp of war. Engineers and contractors are in the limelight and hold the center of the stage, in fact, the very atmosphere in which he was accustomed to work seems lurid, hectic, altered. Slowly the architect is becoming aware that business not only will not be, but cannot be, what business was before the war.

Can an architect doubt the necessity for studying and planning concerning the time after the war? The great war time machine swallowed up to a large degree the peace time architect's machine, but having finally put the great war machine into successful and effectual operation, the live architect is thinking of the next big job, which he knows is after-war adjustment—rehabilitation of peace time business machine to cope satisfactorily with the transition from the old to the new demand for architects big enough in organization to manage scientifically and correct the discordant elements that always accompany changes in conditions and methods.

The architect who is on the front line here at home in the industrial part of warfare can see the opportunities the newly made millions will offer to the architects and builders after war, as well as the great need for schools, public buildings, banks, monuments and residences made necessary by the curtailment of all private buildings in the past few years and new conditions and the development caused by the war, all of which will demand efficiency unthought of before by architects.

The first year or perhaps two years after the war are admittedly the critical ones. No one doubts that after several years when demobilization and readjustment will be general and complete, there will be unprecedented building prosperity for America. It is the vital interest between the first authentic hint of peace and the time when the world is in full operation again on a peace basis that gives pause to the thinking architects.

The more analytical, constructive minds wish to

leave nothing to faith or feeling, but are keen for constructive action to be begun at once, aggressively, intelligently, with a sure practical touch and no grumbling log-rolling, or inexpert dallying. They should have that business imagination which has made Americans famous and should forge this imagination into reality. They should apply the tools of organization and analysis to the situation and force the problem to an issue now with definite departmented plans of action to take care of the coming business requirements by men in their organization who are especially trained in their particular function with skill enough to get results.

There is a significant lesson to be drawn from the Government's attitude during the speeding up of the war. The architect or builder who has had an organization to fit the crisis, regardless of a long standing reputation as architect or builder, was given work to be done under strict Governmental surveillance, as to method and speed. Many architects who have felt that their reputation before the war was beyond reproach, when put to a severe test and under the business audit of a Government whose only interest is results, were keen disappointments to the Government and largely the cause of Government recognition of the so-called Modern Building Organization.

The lesson learned by architects who could never associate efficiency with architecture before was that efficiency was first sought by the Government as the best, easiest and most economical means of production.

Some architects hate the word efficiency, regarding an efficiency expert in the same light as a religious crank, never reasoning that without efficiency water and oil would have to be carried on the head by a carrier as of old, instead of flowing through miles of pipe lines to the consumer. That, under the rules of efficiency one man by development of specialization can produce a hundred times as much in eight hours as he formerly could when he was a novice in nearly everything he tried to do and worked sixteen hours per day. Efficiency permits the much condemned meat packer to sell all the meat on a steer for less money than he paid for the steer and yet grow rich on the by-products. Could the country butcher do it? Not any more



## THE AMERICAN ARCHITECT

than the architect without efficiency can make the profit he ought to out of his practice since he has not discovered his by-products.

To do a deed with maximum intelligence using the most highly developed instrumentality possible is efficiency, hence when the architect's practice reaches the point where it is no longer possible to be carried in the mind of one man, there exists a choice between two principal courses. In one, and undoubtedly the exceptional case, the architect can himself continue to oversee and direct the business functions of his office. It is then most essential for him to obtain an able and efficient head for his department of design. The other alternative, and this is undoubtedly the one most architects would prefer to follow—would be to keep in touch with the design and to control its policy, often with the assistance of a qualified designer and who is the nominal head of that department. When the minds at the head of important departments, such as those of design, business and job supervision is of recognized and special ability, they can carry their specialty to maximum efficiency and with a minimum of interruption. This specialization of function by men scientifically trained in their specialties permits the architect to be relieved of actual participation in detail and thereby allows him time to secure and promote new work and properly attend to and supervise its design. With the aid of exact accounting and other statistical information, he is in a position where he can best control his practice with profit to himself and satisfaction to his client.

The welding of these units into a consolidated system by the architect, scientifically assisted by a proper business organization, with all its parts properly co-ordinated, will then be adequately prepared to furnish the most efficient results in the most economical way.

A few progressive architects have recently developed a science of specialization and co-operation in their organization where the individuals are united into a systematic body, purposed to work for a common end, with appointed specialists in authority over divided or sub-divided parts of a whole, so that the duties of each shall correlate and co-operate with all to minimize cost and avoid unnecessary double handling of matters following the order of their function and their relations to one another.

The accompanying chart and key are introduced for the purpose of showing in simplified form the departments of this modern architect's organization. A careful study of the chart and key will convey some idea of the relation of these departments discussed in the foregoing pages and some others of which brief mention is made in the last section of

this text. The square shown under each department indicates the subdivision of the functions which properly comes under the control of that department. The nature of the work which applies to each department will be found upon reference to the key.

### Architect

The principal function of the architect is to find a client, then to find out his requirements or to create in the client a desire and then to design something to fill that want. To find a client and to create a desire can be done more often through the science of promotion, which entails a great amount of missionary work. It requires a comprehensive knowledge of architecture and building in all its phases and an ability to talk forcibly and intelligently not only on design and building construction, but on matters of realty financing, know the conditions of the loaning market, and the extent of the loaning facilities of important institutions. He should be able on examination of data furnished him to make such calculations as to the cost of the building under consideration and to be in a position to speak authoritatively as to the advisability or need of any important items included or omitted. Unlike many architects who take only an apathetic interest in the promotion of a project until they secure the commission the modern architect confers with the principals and when and where necessary advises changes in the financial scheme, or suggests such modifications in the drawings or specifications as will bring the project within the available appropriation and properly eliminate waste and extravagance.

This phase of promotion brings in the necessity of an up-to-date organization along the lines of specification and co-operation to assist the architect with the preparation of business and structural data upon which devolves a large part of the credit for most of the work secured.

### Business

The individual in charge should be a real executive, scientifically trained in modern business methods, with a higher knowledge of accounting. It is hardly expected that he should in the very beginning have a thorough knowledge of architects' and builders' organizations, but in a short time by a continuous specialization of study and the application of his previous training and ability he can make himself proficient in such matters and the motive power of all other forces.

His mind should be garrisoned by a disciplined army of ideas, always alert, marshalled and thoroughly prepared to hurl himself on any important business organization or promotion problem.



## THE AMERICAN ARCHITECT

His department is the central point for all systems and office routine. Correspondence and other matters, incoming or outgoing, are received, checked and distributed by the executives in charge; all matters pertaining to accounts, both as regards office and job, are recorded and supervised. Contracts, extra orders and certificates are audited and signed by him. In the case of orders and certificates, they are first approved by the supervising architect.

The general business policy of the entire organization comes under his control as well as all confidential details of promotion, etc. Clients are first received by him and when necessary he refers them to the proper person directly connected with the matter under discussion. He prepares regularly an adequate system of records which are indispensable to the architect in keeping him in touch with every phase of his practice, providing a constant barometer of conditions, and are the means of enabling the heads of other departments to be familiar automatically with every detail necessary to its more successful operation. In addition to the various financial reports, a general report from each department head is made on the condition of work in his department, wherever important and at least once a week, and all passed to the business department, where they are placed in a loose leaf book always kept before the architect on his desk ready for instant reference in the order of the departments. This method places the architect in a position where he has within reach the detailed conditions of all jobs, etc., should the client unexpectedly call on the phone or meet him to discuss some of them. By his prompt answer to questions and familiarity with such details, which questions ordinarily are referred to others, or are deferred until the architect interviews others who might be out of the office or even out of town, he conveys to a client that he is personally in touch and familiar with all conduct of his work.

He takes an active part in the promotion of new work and is capable of performing many other important functions, perhaps too obvious and numerous to mention here, that under the old system were neglected.

Further to complete the efficiency of this department, an attorney who is a specialist in the law of architecture and building is retained on a reasonable annual basis to confer, advise and direct all legal affairs and to approve all important contracts—a measure that has proved valuable and has often prevented serious legal difficulties.

Under so highly developed a business administration the architect and heads of departments are entirely free to preserve their individual and important specialties with the maximum of efficiency and a minimum of interruption and annoyance.

Before proceeding with a brief description of the function of the designer, supervising architect, interior decorator, and engineer, it would be of considerable value to the reader to refer to a series of articles by Prof. Howard Dwight Smith of the Ohio State University in the numbers of the *Architectural Review* in the departments mentioned above; articles written in co-operation with the writer on the "Business of Architecture." Prof. Smith's training and experience equip him to cover intimately the functions of these departments and their relations to one another. He has dealt thoroughly and helpfully with the problems of these special departments in this same organization as advocated in this article.

### Designer

This department is headed by a clever designer and architectural renderer who works with the architect from the earliest conception of a problem, and after a definite scheme is finally accepted and decided upon the job is turned over to him. He has the ability to improve the design from the varied viewpoints of conception as to use of materials, texture and ultimate effects. He has absolute control of all designs and no work leaves this department without being studied from all angles. Great success can be attributed to the use of models which are very often carried considerably into the selected materials themselves. Under this system which has consistently developed to the point of perfection, the architect himself is seldom required to give any further time to the details of design after a scheme is once finally determined upon.

### Supervising Architect

The head of this department whose ability is exceptional, in the sense that he has been trained and experienced in both design and structural engineering, is regarded as the architect's assistant in matters pertaining to the management of building after they leave the designing department. He possesses rare executive ability and in general he is able to represent the architect in the most desirable manner possible.

He acts as a general superintendent and has direction over engineering and inspection and is held responsible not only for the construction of the work, but also for the artistic character in which the work is executed.

His designing ability and general good taste are most helpful factors, as he is then always in perfect harmony with the designing department, which permits him to visualize the final effect sought by this department. He is fitted to discuss and to decide in a final and satisfactory manner all ques-

tions arising to affect both design and color during the execution and completion of the work. By being able to discuss such points intelligently with clients, he saves the architect many unnecessary interviews and gets in the end the full artistic effect and refinement of detail that is desired.

### Interior Decoration

In this particular organization this department has developed in a few years in the most amazing manner due to the satisfactory results of having a man in charge who has specialized in all phases of interior decorating. In addition to proving exceptionally profitable from a viewpoint of money, it has likewise added to the good reputation of the architect.

Criticism of interior designs, the supervision of construction of special interiors, models, etc., in the shops and on the building are made by him. He is responsible for harmonizing the work of all the many different trades and crafts so necessary to carry out to completion the best grade of interior decorative work.

The architect derives many benefits from the completeness of this department, for, in addition to the profitable monetary returns and the reflection of good credit for the execution of work, he is free to devote his time to carrying his own ideas to perfection, and, furthermore, by the assistance of the head of this department, who is able and qualified to give sufficient time and pains to determining and to carrying on all the fine and complicated minutiae with which the final detail of decorating, furnishing and fitting up the building are ultimately concerned, the architect can assume the credit for the entire project.

The client is better served and everything pertaining to the completion of the building is carried forward hand in hand under the direct influence of the architect, thereby insuring better results than would otherwise be obtained. He exercises control over and makes decisions in the first place as to the kinds of material and how the work is to be done.

### Engineering Department

While engineering may be divided into two departments, structural and mechanical, in this organization they are united under one head. Under the head of structural are included all steel, reinforced concrete and similar work, including the designing and, where work is laid out by contractors, the checking of same. Under mechanical is included the layout of all mechanical plants, including plumbing, lighting, power plants, refrigerators, etc.

The engineer takes care of all draughting and specifications in connection with the above classes

of work, affords general practical guidance for the draughting department, checking all drawings as to their correctness and practicability. He makes estimates on work, and from time to time is called upon to visit the various operations for the purpose of seeing whether the work under his department or the work as a whole, as the case may be, is properly carried out.

All practical work in the draughting room is laid out by the engineer and it is essential for him to be constantly attentive to see that standard practices are developed and after such development are put into service. He also sees that all data are promptly and properly classified as to specification of mechanical equipment, etc.

### Draughting Department

In another and even larger way the same methods used for planning work in the engineering department apply to the draughting department. For example, one job or several jobs are given in charge by the engineer to higher class draughtsmen in the department known as "job captains" who lay out the work ahead of less expensive and less experienced men, applying the principle of the division of functions and dividing each job into parts, so that each part can be done in perfect and harmonious sequence. Here, again, the engineer is of service, for, as has been explained, he possesses the higher technical ability and a keen sense for relative importance of detail.

The difference between a large practice and a small one is largely one of vision. The basis of success is commonly self-made.

The architect who sets definite limitations on his practice by a lack of perfection in method and organization will probably fall short, even of those, but the architect who is big enough to decide that he can improve his organization to handle men and larger work with satisfaction to his modern client fixes limits only as stages in his career.

This wrong point of view hinders the progress of more architects than any other cause. The architect who has a small practice, calls himself a small architect, wants to know only about systems and organization of other small affairs and dismisses the lessons from larger and more successful architects with the remark, "That's all right for his office; he is a big architect, but it won't do for my office or policy" is the architect destined for a small and unremunerative practice.

Let us grant that a small practice does not require and cannot well bear the expense of conducting affairs in the same fashion as a larger one and that it would not be practical to divide the function of the practice among departments, as the architect or someone in his employ must generally be the

# THE AMERICAN ARCHITECT

department heads rolled into one, it would be feasible and economical to have an expert accountant or business man proficient in architecture and building methods look over his affairs and advise him periodically, in the same manner to employ outside practical tabs on all engineering, structural and mechanical equipment, etc., when necessary. The architect will then be applying the principles of organization outlined in the article, profitably and within limits of his business.

In conclusion, this talk is not a plea for any over-

elaborate, expensive, time-consuming, hair-splitting system, which is more apt to throttle than to aid a small practice. It is simply a review of the general principles of organization by which every successful business, large or small, must be conducted. System, if properly understood and not confounded with red tape, is perhaps even more essential to a practice where the architect must carry the whole burden than to a large practice where many contribute their individual talents to the whole.

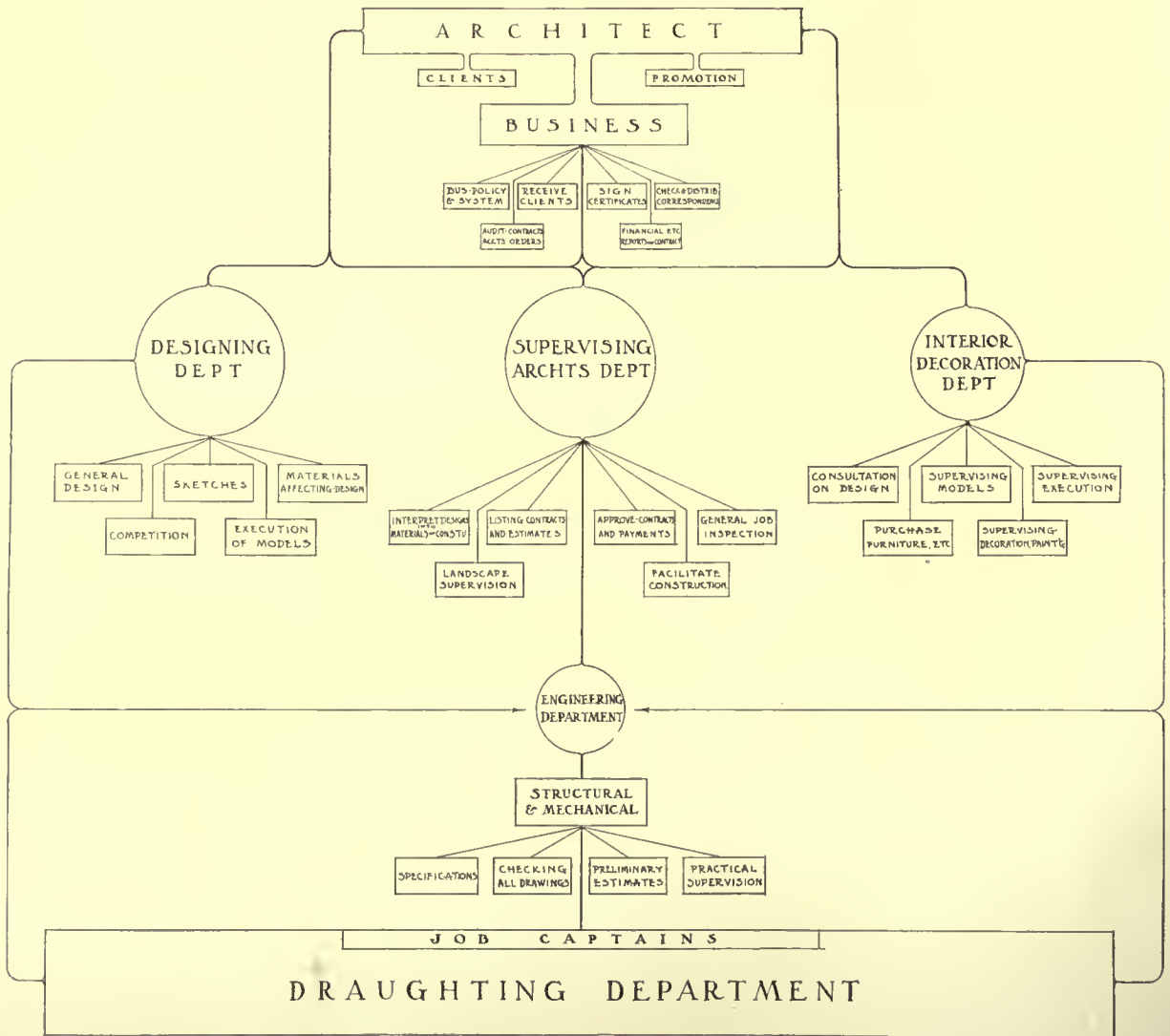



# Report of Sub-committee of the Joint Committee on Reconstruction After War

## Illinois Chapter, A. I. A. and Illinois Society of Architects

J. C. LLEWELLYN, *Chairman*

As chairman of the committee to consider steps to be taken to permit architects to do work on a cost plus fee basis, and still retain professional standing, I submit the following:

As stated in the minutes, the resolution appointing the committee might be interpreted as referring to a scheme of charges, discussed and practically endorsed by the American Institute of Architects in convention a few years ago, when the architect in lieu of a straight percentage on the cost of the work was permitted to charge a fixed sum for his service and add thereto the actual cost of drafting, supervision, expert service and an allowance for office overhead.

The purpose of the motion, however, as I understand it, contemplates a discussion of the question as to whether or not forces are at work which will make it advisable for the architect to assume a larger supervision of the construction of work under his care than formerly, extending even to the purchase of materials and employment of labor, and charging for this service a fixed amount plus the cost of preparation of drawings, supervision, etc., or a percentage on the cost of the work as charges are now made for preparation of drawings and that supervision now recognized as a proper part of the architect's service, and considered professional.

Much depends upon the definition of a profession and the limitations put upon it. In general, the term profession implies an occupation requiring a liberal and special education and discipline, and the practice of the profession implies a personal service employing the knowledge gained by such education and discipline and the experience resulting from practice. This service is rewarded by a fee, supposedly commensurate with the service rendered. Law and medicine are the well-known examples of the professions.

Architecture is no exception to such definition, but in practice the service rendered by the architect often becomes less a personal service, than a use of special knowledge, in directing and guiding the labor of a number of others in performing certain service. I doubt if anyone will claim that the service so rendered is any the less professional, but rather the claim may be made that the architect is filling a larger place in the second instance than when confining himself to his own personal efforts.

Furthermore, it is a matter for debate whether the architect who renders the service to his clients he is supposed to render, will be regarded as a professional man at all by the public, because he must combine with whatever sense of proportion, good taste and beauty he may have acquired by reason of environment or by education or travel, those qualities which in the eyes of those about him, place him in the realms of pure business.

In fact, the methods we employ and include in the term "professional practice," with its governing codes, etc., is being approached steadily by those we have been pleased to call contractors and who have had to do with the actual business of building only. In fact we hear now of "ethics" among builders, as witness the scheme of organization proposed at the convention of general contractors held in Chicago recently. Is it not possible that the chief value of our term "professional" is to furnish a topic for debate or speculation, and has but little to do with the service architects render their clients. The real question is, whether our methods permit us to keep abreast with the rest of the world, and, if not, whether we cannot change them and retain the spirit of what a code of ethics aims at—honorable service to our clients and fair play to all others.

As to changing conditions under which we are working:

First—For a number of years there has been a gradual increase in and instability of prices for material, and also an increasing scarcity of, and a consequent instability in cost of labor, which have rendered the letting of contracts under the old system of lump sum, uncertain and unsatisfactory to contractors, so that they are advocating, in order to eliminate risk of loss to themselves, the adoption of the system known as cost, plus a percentage or fixed fee, in the handling of construction work. The conditions brought about by the war and the fact that the Government placed its stamp of approval on the cost plus fee method in the greater part of its war work, will serve to bring this method of doing construction work into more general use, and contractors will thus approach in methods of charges at least the "professional method" of a fee or percentage on cost.

The system has its faults, which are known to

## THE AMERICAN ARCHITECT

all of us, and is capable of abuse. It depends, more than the lump sum system, upon the integrity of the contractor and a conscientious regard for the interests of an owner, whose interests are likely to be lost sight of in a majority of cases. The attitude of labor toward percentage work is well known, whatever common interest there may have been between contractor and employees to save contractor from loss under lump sum contracts is absent under the cost plus fee system, and the indifference of labor to an owner's interest with resulting decrease in efficiency is well known. Labor is insistent in its demands, and the uncertainty of the character of their demands constitute one of the principal reasons for abandoning the old system. The fact that labor will continue to be an uncertain element of cost in any building project must be taken into account and will have its effect on methods of contracting and our practice as well. The system will impose upon architects the checking and auditing of bills, unknown under the lump sum system, and will greatly increase their work without corresponding recompense.

Second—The work of the war has demonstrated the value of co-ordinated and organized effort in spite of the drawbacks bound to occur because of the circumstances under which the organization was affected. It remains to be seen how far the Government, now that the war is over, will retain control of or will attempt to direct construction or building in those lines which have a direct influence on the welfare of the public. Whether the Government will assume any part of this direction or not, the fact remains that the war has given a great impetus to a movement begun before the war, having for its object the proper housing of people in rapidly growing cities and towns, especially in workmen's communities, and that this work is apt to be done under co-operative or organization methods more than heretofore. To handle this work will call for a fuller co-operation of the architect, town planner, utilities engineer and builder, in which co-operation the directing hand should be that of the architect. This particular class of work will bring us closer to a much larger proportion of our people than our work heretofore has done, and it is worth our while to prepare ourselves to assume a larger responsibility in operations of this character.

Third—The architect cannot be wholly immune from the effect of changes in business methods in other lines of work akin to his own which have to do with construction; neither can he ignore the value of public recognition and approval of his services. The fact that construction companies and engineering corporations are employing designers

and doing all work from the making of plans and specifications to the construction and furnishing of the building, and that this method is increasing along special lines is another element which has the effect of rendering the term architect less known and understood. The prominent part taken by engineering corporations in all Government war work is well known. The reason is evident. The public, even the Government, does not associate the architect with the actual operations of building in the same way they do engineering and construction companies. The element of design is to it an intangible thing and secondary to the building operation, and is considered a part of such operation, if considered at all. The special fields in which these companies operate are those offering the great opportunities to the architect.

These three items, namely:

Instability of prices for material and labor and the consequent rapid change in methods of contractors themselves, by which the contractors are approaching the principal of selling their service, instead of taking a change on profits in the old way, and in which the architect must add greatly to his labor or lose a larger share of control in his work and of the confidence of his client; the impetus given to co-operative and organization methods by war activities; and the assumption by the contracting and engineering organizations of complete control of building from planning to completion and furnishing, are only three items, but sufficient to justify a discussion of our present methods and the advisability of changes in same.

It is the opinion of the chairman of the committee that architects as a class are not assuming the responsibility they should; that there is a wide difference between the appraisal of the service of the architects by themselves and by the general public, and that it is necessary to put a value into their service that will be recognized by a far larger proportion of the general public than obtains at present.

To do this I believe it is necessary for the architect to prepare for and assume a wider responsibility in the actual construction of his building, and a broader initiative in every line of endeavor which has to do with the proper planning and construction of all classes of building, together with the utilities which go to make these buildings complete in service to the community in which they are located. To do this will call for a more complete co-operation of the architects, with specialists in all lines of engineering covering utilities and equipment (and on occasion town planning), required to lay out and equip the work properly. Also, through a department of cost and construction the architect should be prepared to give much closer approxima-



## THE AMERICAN ARCHITECT

tions to cost of buildings than heretofore, and finally he should be prepared to take over the actual erection of the building in those cases where, on account of location, size of work or any other reason, he feels his client's interests are not fully safeguarded by letting of contracts in the usual way, the owners paying bills for material and labor upon properly audited bills instead of by certificate to contractor as at present.

The objection will be raised that this is contracting and unprofessional. I answer that the subdividing of contracts and building without the general contractor is sanctioned, and I may say favored, by architectural societies to-day, and has been the practice of many architects for years, and is not deemed unprofessional. I confess my inability to see why the purchase of materials and employment of labor by the architect for the few trades furnished by the general contractor, and doing this work for an owner on a fee basis and not for a lump sum with an unknown profit should be unprofessional. The service rendered is one in which the architect adds to his ability to design and his sense of fitness and good taste, a knowledge of building construction and construction operations, which enables him to assume a greater control and responsibility in the execution of his work, and for which he receives a predetermined compensation, not a profit representing the difference between cost and contract price. Work done in this manner is not contracting, but is rendering service for a fixed fee or percentage, and is done in a professional way. At the same time it gives the architect an authority and control of his own work which he rarely has at present, and will give him recognition by the public, which goes usually to the construction organization.

Now I am not unmindful of the general contractor in all of this discussion, and believe that we should co-operate with him as far as we can, fully alive to our clients' interests. There are many cases, however, where circumstances will dictate the elimination of the general contractor, and where to obtain the best results unusual methods should be adopted. In these cases I believe the general contractor will recognize the reasoning as sound and will agree with me.

If architects believe that conditions call for change in methods, and an assumption of a wider responsibility, than the means taken to accomplish that purpose will be modified by the viewpoint of the individual, it becomes the individual's problem. No hard and fast method of procedure can be adopted that will apply to all, but each must work out the matter in accord with his own ideas. Architectural societies to-day control members through

rules of practice based on conditions of years ago. They attempt to cover by rule all questions pertaining to practice, but fail for the same reason that the economist fails when he reaches conclusions based on arguments which have not taken into account that element in human nature which seeks change and is not content with things as they are. These rules should be modified and placed on a broader basis, relying more on the individual's sense of honor and fair play.

The State law licensing architects, the revisions of which, in connection with the law licensing structural engineers, is receiving some attention, should be studied with a view to combination. The details of a law which would govern both architects and engineers is a matter for a legislative committee to consider. Under the engineers' law partnerships with architects are permitted. Corporations cannot be licensed, but under the engineers' law corporations are permitted to prepare drawings and specifications for buildings and structures, which are erected, built or their construction supervised by such corporation, provided that the chief executive officer or managing agent of such corporation in Illinois shall be a structural engineer. Architects are barred from incorporating or forming partnerships, except with licensed architects, as far as any provisions to the contrary are found in the architects license law. The legal phases of the question deserve special study. As architects we are barred from doing in a corporate way what we can do as individuals through co-operative methods, as I have tried to suggest. Can we enlarge our sphere of action and be professional? I think we can, as there is not an element of contract in the matter as proposed, except for service rendered in planning and supervising construction of buildings. If the owner desires a guaranteed cost, then the architect must resort to the contractor in the old way, but the architect should employ scientific methods in preparing preliminary costs and make his estimates trustworthy.

My own opinion is that the method outlined is but a modification of methods already employed by architects against whom no charge of non-professionalism has been made. I further believe many cases will be found in practice where better results can be obtained for owner and architect by an adoption of the schemes outlined in lieu of the old.

The details must of necessity be left to the individual architect, but the objective for all can be a larger initiative and control, more co-operation with others working along lines akin to our own, and a more complete service to client and community.





HOUSE OF ARTHUR BADGER, NEWTON CENTER, MASS.  
COOLIDGE & CARLSON, ARCHITECTS



THE AMERICAN ARCHITECT

Founded 1876

PUBLISHED EVERY WEDNESDAY BY

THE ARCHITECTURAL AND BUILDING PRESS, INC.

No. 243 West Thirty-ninth Street, New York

E. J. ROSENCRANS, PRESIDENT AND TREASURER  
WILLARD C. HOWE, VICE-PRESIDENT

WILLIAM H. CROCKER, Editor

ARTHUR T. NORTH, Engineering Editor

Subscriptions in the United States and Possessions,  
Mexico and Cuba, TEN DOLLARS. Other Countries,  
TWELVE DOLLARS.

SINGLE COPIES (Regular Issue) 25 CENTS

CHICAGO OFFICE, Mallery Building

PAGE A. ROBINSON, Western Manager

ST. LOUIS OFFICE, Wright Building

CLEVELAND OFFICE, Guardian Building

SAN FRANCISCO OFFICE, 320 Market Street

Owned by United Publishers Corporation—H. M. Swetland, President;  
Charles G. Phillips, Vice-President; W. H. Taylor, Treasurer;  
A. C. Pearson, Secretary. Entered as second-class matter January  
6, 1909, at the Post Office at New York, New York, under the Act of  
March 3, 1879.

VOL. CXV JANUARY 8, 1919 No. 2246

"Shadows and Straws"

Just at the moment there is some hysteria in the yellow section of the architectural press in the East; there are splenetic outbursts from its fledgling of the Great Lakes. We hear loud calls for the "red-blooded" man, accompanied by frantic appeals for haste, lest the profession be left at the post, in the mad rush, or lest the world take the wrong track through lack of advice from architects. Those who so cry out have no idea of what they wish done, but they insist on the doing of something. "Let us at least make some noise," is the real thought in their minds, for they have observed that most people can be impressed by a drum. But, and very fortunately, these little Hearsts may be dismissed as not counting. To have listened to the discussion in the last meeting of the Board of Directors, when the possibilities ahead of the Post-War Committee were being canvassed, was sufficient evidence to the sixteen men who sat in the room that from one end of this country to the other, thoughtful architects are not jumping to conclusions. Neither are they to be prodded into any futile and hasty action by sneers and snarls. Abundant evidence has accumulated to make it plain that the profession recognizes in the Post-War Committee a serious purpose and a scientific method for the attainment of that purpose.

—From an editorial in the December issue of the *Journal of The American Institute of Architects.*

ALL of the editorial comment in this issue of the *Journal* appears under the heading "Shadows and Straws."

Which are the shadows, and which are the straws?

Rainbow chasing has, until revived by the editor of the *Journal*, been a lost art. From the classic shades of the Octagon where stalk the ghosts of a time that once was, this editor views the field of

architectural practice through glasses dimmed by the accumulated dust of an age that is past and gone. He and only he believes that architects may continue in the future as they did in the past, to pose aesthetically before clients and awe them by the force of their artistic personality.

Apparently it is not known to this Sage of the Octagon that we have been at war, and that we have emerged from it swept clear and clean of all vestiges of feminism. That from now on the practice of architecture will be a man's job. If such a task cannot be visualized by the editor of the *Journal*, perhaps he might find a more congenial field in the pages of the *Ladies' Home Journal*, to which it is known he is a regular contributor.

Naturally a temperament that avoids the rude shocks of actual contact with a man-size job would regard anything so excessively rude as a blunt statement of fact as "yellow journalism." And it is equally true that a mind so delicately poised would shun the vulgar strife of everyday life, and fail to be able to distinguish the real difference between a virile progressive journalism which seeks constructively to bring about needed reforms, and a type of editing whose main distinction is that while it employs many high-sounding words and beautiful metaphors, it says nothing.

If the editor of the *Journal* has specifically in mind a certain "yellow journal in the East, and its fledgling of the Great Lakes" (note the happily turned phrase), why does he not come boldly forth and name these publications? Stalking behind ambiguity is but a certain form of moral cowardice.

State Societies

A MOVEMENT has been set afoot in the Middle West to federate the various state architectural societies which have been so efficiently working for the good of the profession. This is a subject that should receive the favorable consideration of every man affiliated.

In bringing to successful conclusion a matter so important, those engaged in the work—and it will mean an unselfish giving of much valuable time—will be earning the gratitude of their associates and they should receive cordial support and co-operation. There is not, nor can there be, any disloyalty to the American Institute of Architects in favoring the federation of State Societies, or in an effort to secure their formation in every state. There need be no jealousies nor rivalries, except the rivalry in accomplishing the greatest good for the entire profession of architecture.

The Institute does not, as an organized body, represent the entire profession, and in fact does

not number among its members a majority of the practicing architects of this country. It is thus reasonable to assume that the State Societies would secure a sufficient membership in addition, to make the two organizations combined, fully representative.

What we have needed in the past, and have failed to get, is action. We shall need it more in the future. With the friendly but serious competition of two organizations, this action would undoubtedly be forthcoming, and we would witness in our architectural organizations the same conditions that exist in our national politics, the best service by each party as the guarantee of an efficient, result-getting administration.

Sooner or later will the profession of architecture as a complete body be compelled to organize. In its practice it confronts organizations of labor and the various building interests. To assume that it is not necessary to take measures toward its own safety such as are taken by those it is supposed to direct, is to assume a certain dignity which will be the only barrier it can hope to impose between itself and the world.

Certainly we have had sufficient practical illustration as to just what protection this barrier of professional dignity affords, and should take steps to strengthen the profession against the insidious advance of any who would without warrant usurp its functions.

A nation-wide organization of all the profession would secure all of these desirable results, and with the Institute and a group of federated State Societies, we could go steadily forward secure against any encroachment of our prerogatives.

### Safety and Sanity

THE large amount of hysteria and pessimistic foreboding now reported in the daily press accents in the most forceful way the contrast between the theorist and the practical man. Just why, in view of the demonstration on the part of this Government in its conduct of the war that the practical idea is the only sure one, will groups of theoretically trained men rush into print with irresponsible forebodings and unreliable predictions?

Every man trained in methods of business and

finance sees the new problems, has, in fact, through that very training been able to foresee them, and has set the organization over which he presides in preparation successfully to meet them. These facts have no general publicity. This is regrettable, for they would, if known, tend to reassure the timid ones, misled by theorists as to what the business future has in store.

A certain professor in the New York University sends forth word from the scholastic atmosphere of his study that the not distant future will bring a crisis in business—panic, idle labor, bread lines and riot. What will he personally do to avert these things?

With this man the president of the City Bank takes issue. He sums up in a practical, common-sense way the now all-absorbing factors of demobilization and its effects on labor, the question of the stabilization of prices and other important things affecting readjustment. He sees the dangers, but he also is sure he knows their remedy, and he has set all the machinery of his large organization at work efficiently to prevent all that the professor believes inevitable.

Treating the individual economically, what should be the relative value of these two types of men to the nation? The answer is obvious. Howling calamity at this time is, to a certain degree, as seditious as working treasonably during time of war. The panic that this learned professor believes he can foretell would be the result of a state of public mind brought about by just such utterances on the part of men whom an ignorant public clothes with sapience.

The United States, in its composite aspect has always been a practical nation, hence its steady rise to its present eminence. This feature of good, hard sense is to-day further proved. We did not win this war on theory. Every operation after the first few weeks of indecision was successfully carried forward because it was planned and controlled by practical men.

The best authorities see no cause for great uneasiness over the business future. They do see the grave things that will need careful solution, and they are prepared to deal with them efficiently. There does not appear to be any well-grounded fear for our future business stability.



# Criticism and Comment

## The Practice of Architecture

*The Editors, THE AMERICAN ARCHITECT:*

We are in full accord with all five of the paragraphs set forth in the article entitled "The Practice of Architecture" in your issue of Nov. 27. We might add to paragraph 3—"the Architect must be explicit and avoid generalities." This would particularly apply to the specifications where one may frequently see sweeping general clauses requiring the work to be executed by the contractor in a fully complete and finished manner, even though it may not be fully detailed or described in the specifications. Specifications containing such generalities do not indicate thoroughness or efficiency in architectural service, and are not fair either to the contractor, or the client.

SCIENCK & WILLIAMS.

Dayton, Ohio.

*The Editors, THE AMERICAN ARCHITECT:*

The editorial appearing in the November 27th issue of your journal under the caption of "The Practice of Architecture," containing what might be styled five aphorisms, needs only to be reflected upon to convince those who have hitherto followed the well-beaten path of the practice of architecture that it is necessary, due to the rapid advance of civilization in the last generation, which has so dislodged the firmly rooted professional practices, to recast many obsolete methods and adopt a saner and more practical attitude toward the public who is to be benefited by our services. It must be remembered that at the present time there are many more professions dealing with the construction and equipment of buildings than existed a half century or more ago, and the men who make up the other professions have not been following professional practice handed down from a previous civilization; therein lies the fundamental difference between the professional practice of the architect and his contemporary, the engineer. Nor is the architect to be severely censured for following long standing traditions, for it is inherent in well organized society to adhere to precedent. We see this exemplified very strikingly in court procedure, and it is only natural to suppose that like law, architecture, which has co-existed with it from the beginning of civilization, would be slow to make any radical departure from well-established practices. However, the war has made us all think

more intensely, and while some may have foreseen earlier the changes which would inevitably be forced upon the profession as time went on, and ventured to take the initiative even before the war, while the remaining majority adhered to previously established practice, they should not be considered outside the pale of the elect, for as surely as no living thing can persist in the even tenor of its way, while all about it is changing, without suffering from its own inertia, so a profession which is so vitally bound up with the life of a people as is architecture, cannot hope to escape feeling the impress of the age in which it exists.

Hence I am convinced that great good will come out of the criticism and comment regarding the practice of architecture, and that the five points emphasized in your editorial must become the underlying principles for the successful practice of architecture.

EMILE G. PERROT,  
Of Ballinger & Perrot.

Philadelphia.

*The Editors, THE AMERICAN ARCHITECT:*

With reference to the article entitled "The Practice of Architecture," appearing in your issue of November 27, we comment as follows:

So far as paragraph one is concerned, we believe, and have for years, that the business of architecture is inseparable from the profession. Because of our belief that architecture is a business as well as a profession, our firm and other firms have for many years been barred from many architectural societies. It is interesting to us to note that the stars in their courses fight on our side.

So far as paragraph two is concerned, we believe that it is entirely proper for an architect to develop a general demand for his services by reasonable publicity, a practice which we have followed for many years with gratifying results.

As to paragraph three, this firm has for many years given a complete architectural and engineering service, so that we render plans and specifications for everything embraced in the complete equipment and furnishing of industrial enterprises.

We agree to all of paragraph four, except that we doubt the wisdom of holding an architect responsible financially for the cost of an enterprise, since the fee which the architect receives is not large enough to allow him to guarantee his esti-

mates. Should the architect be held financially responsible for the success of an enterprise, he should enter into a contract for carrying it out, and his fee should be large enough to enable him to take financial responsibility. Our firm has never legally agreed that it is financially responsible, but as a matter of practice we have for many years stood behind our enterprises.

Paragraph five has been a cardinal principal of our business for many years. All five of the paragraphs have been endorsed by us and made a part of our business for a long period of time, with the exception of the question of financial responsibility, which we think should only be undertaken by the architect after proper compensation.

Boston.

LOCKWOOD, GREENE & Co.

*The Editors, THE AMERICAN ARCHITECT:*

We appreciate the opportunity to express our opinion as to the statement concerning the practice of architecture appearing in your issue of November 27. Considered as a creed we beg to say that we do not believe in creeds on the average. Creeds breed dogmas and dogmas are time serving and decadence comes after. In this great world of activity the advance guard must be untrammelled of finished things. Leaders of thought must have no creeds to impede their advancement. Creeds are the crucifiers of wisdom. Creeds have only been the formulas for the ignorant by which the hordes are led. Architecture is not a finished article but the most rapidly advancing agency that society has. It would be

stultified if its activities were bound up in formulas. Leave the field open for the architect to pound his way upward with daily vigilance and with each new invention his mind can devise independently.

Those in charge of war industries have not admitted any architect to prominence in the recent unpleasantness in the world, nor the name architect to be put forward as a legitimate evidence of accomplishment to occupy any place greater than the awards to conscripts. "Construction Engineers" seems to have been the pet name and some architects got places as such and served admirably. Your credal expressions apparently admit this error to be a proper idea and would help to abase the name architect. Those of us who know the integrity of our calling do not mind the persecution (or to be more modern, the dirty deal) and are willing to await the consequences with abiding faith undisturbed.

We vastly prefer to see the architectural press turn away from introspection and proceed to fight insults and wrongs committed on the profession, free handed. The field is open now. Our destinies are no longer in the hands of stock brokers and percentage builders. The war is over. The call of patriotism now is not closed lips, but the stroke at those who blaspheme against the institutions of economic industry.

The profession of architecture is the product of necessity and needs no bolster. It is like truth itself—existent—not to be made, but only to be discovered, utilized and amplified.

Atlanta, Ga.

EDWARDS & SAYWARD.

## Recent Legal Decisions

### WORKMEN'S COMPENSATION ACTS—EXTRATERRITORIAL EFFECT

The Colorado Supreme Court holds that where a Colorado contractor employed in Colorado a resident to act as foreman on jobs in a number of states, such employee was protected by the Workmen's Compensation Act while working in another state. This decision is in line with the later opinions of other courts of last resort in states having similarly worded statutes. The facts of this particular case were that a contracting company, organized in Colorado, had a general contract with a telephone and telegraph company for the construction of telephone exchange buildings at different points in the states of Colorado, Wyoming, Idaho, Montana, Utah, Arizona and New

Mexico. The employee injured acted as foreman in connection with the construction of these buildings. The court said, in part: "If we assume that there are no workmen's compensation laws in the states where the deceased was to perform his services outside of Colorado, then there can be no recovery of compensation, notwithstanding all premiums sufficient to maintain the workers' accident insurance had been fully paid. On the other hand, if we are to assume that a workmen's compensation law prevails in each of the seven states of Colorado, Wyoming, Idaho, Montana, Utah, Arizona, and New Mexico, then the employer must be compelled to comply with each statute and to pay the premiums required by the law of each state for the protection of the one employee, or approximately seven times the amount otherwise required. If this were



## THE AMERICAN ARCHITECT

legally permissible, the expense would make it prohibitive. The result in this case must be that: The employer has paid the full premium demanded by the state to insure his employee against accident; the employee has relied on the pledge of his state for the protection of himself and his dependents; his widow and children discover the whole arrangement to be a delusion and a snare, and find themselves without protection." The court refused to assume that the legislature intended such an injustice, in the absence of some clear and express provision in the statute to that effect, which it did not find. It therefore reversed the judgment of the district court vacating the award of compensation of the Industrial Commission, and instructed confirmation of the award.—*Industrial Commission v. Aetna Life Ins. Co. (Colo.)* 174 Pac. 589.

---

### BUILDING RESTRICTION COVENANTS — OPEN PORCHES AND ENCLOSED ROOMS

The titles to several dwelling houses in a row contained a building restriction that the front of each house should not be nearer than 15 ft. from the street. One of the owners was enjoined in a suit in equity brought against him by his neighbors, where it appeared that he built an addition to his house within the prohibited area, described by the court as follows: "The structure consists of three brick piers 18 in. square, extending as high as the building, which is three stories, and on the two upper stories, supported by the piers, are two open balconies or porches, and on the ground floor there is an enclosure of wood and glass, making a permanent room, connected with the main house, and since its completion is and has been used as a part thereof. This room obstructs light, air, and prospect, and mars the appearance and uniformity of the street, and deprives the plaintiffs of the light, air and prospect, theretofore enjoyed by them." In such a case it was held immaterial that the plaintiffs and the defendant had maintained open porches beyond the 15-ft. building line.—*Law v. Weeter*, 68 Pa. Superior Ct. 23.

---

### ACCIDENT NOT COVERED BY CONTRACTOR'S POLICY

An owner's contingent policy insured against injuries resulting from the negligence of any contractor or subcontractor engaged in the work. The policy had a schedule: "All work under

supervision of James A. Wilson, who lets contract and does carpenter and mason work himself. This policy covers contracted work only." The provision was inserted to bring Wilson within the terms of this owner's policy. One of the contracts was let to a construction company. One of that company's employees injured a passer-by by dropping a plank. The injured person sued Wilson. The insurance company refused to defend the action. Wilson paid the judgment obtained against him by default, and sued the insurance company. It was held that the accident was not covered by the policy. Wilson was not in law liable for the construction company's negligence and there was no reason why he should not have defended the action against him. He could not therefore recover against the insurance company.—*Wilson v. London Guarantee & Accident Co. (Cal.)*

---

### RECOVERY ALTHOUGH LIEN DENIED

A mechanic's lien is a cumulative remedy and to deny it does not deprive a party of his right to a recovery upon his contract in the usual way.—*Decatur Bridge Co., v. Standart*, 208 Ill. App. 592.

---

### COLLUSION WITH CONTRACTOR

An architect, like any other professional man, impliedly contracts with his employer that he has the ordinary skill, knowledge and judgment possessed by men of his profession, and that he will use this skill, care and judgment in the interest of his employer and will act with perfect honesty: *Nave v. McGrane*, 19 Idaho 111, 119. He is an expert in carpentry, in cements, in mortar, in the strength of materials, in the art of constructing the walls, the floors, the staircases, the roofs, and in duty bound to possess reasonable skill and knowledge as to all these things: *Hubert v. Aitkin*, 15 Daly 237, 239. He is responsible for collusion to defraud: *Conn v. Huston*, 16 Pa. Superior Ct. 172; and for negligent disregard of his duties; *Lacher v. Colton*, 80 Ill. App. 75; and so an owner may be permitted, in an action for services, to show that the plaintiff through collusion allowed the contractor to depart from the plans without the defendant's knowledge or consent, that a loss had resulted and the amount of such loss.—*Henon v. Vernon*, 68 Pa. Superior Ct., 608.



## Government to Start Campaign to Promote Building

The final step in preparation for the resumption of building throughout the country has been taken in the promulgation of an order from the Priorities Division of the War Industries Board cancelling all reservations restrictive of the production, sale and use in construction work of building materials.

In addition to the removal of embargoes and restrictions essential during the war period the Federal Government is organizing a campaign to have states, counties and municipalities begin all possible construction at once, in order to furnish work for returned soldiers and sailors, through the United States Employment Service.

The campaign for the nation-wide resumption of building operations was inaugurated in an address on Dec. 30, at a conference of state officials and representatives of labor and industry at Boston by Secretary of Labor William B. Wilson. The campaign will urge an expenditure of \$3,000,000,000 for a million new private residences. In addition to private building, Mr. Wilson believes the country will do well to spend \$1,000,000,000 on roads and highways and double that amount on other public works.

Newton D. Baker, Secretary of War and chairman of the Council of National Defense, has asked all state defense councils to advance all public improvements in order to absorb labor as far as possible.

A division for the conservation of building operation has been created by the Labor Department and will soon be in operation.

## Raw Materials Should Not Be Sacrificed

In an address before the Southern Commercial Congress at Baltimore, Burwell S. Cutler, chief of the Bureau of Foreign and Domestic Commerce, referred as follows to possible liquidation in raw materials:

"We must guard ourselves against motives of fear in the business world. At present most of our factories and storerooms are filled with raw materials and commodities which the owners may be tempted to sell at sacrifice prices in order to restore cash balances wholly depleted by war taxes and purchase of Liberty bonds. Precipitate action of this kind, if based on a fear that raw materials will generally decline in value will bring individual and national loss. The most knowing and deliber-

ate business men realize that the available supply of basic materials for human use and consumption is many times less than the world will need for some years to come. This is the inevitable result of four years of systematic destruction without replenishment in every quarter of the globe."

## National Architectural Society Proposed

The President referred to a letter received from Mr. Harry I. Schenck, of the Dayton Chapter, relative to a proposal of the Washington State Society of Architects to call a convention of state societies, not connected with the A. I. A., for the purpose of forming a national body that would be more representative of the profession. Mr. Kohn spoke in favor of a closer affiliation between the Institute and the many loosely organized architectural societies in the country. He said that the four Institute Chapters in New York have considered the formation of a new state association, with a broad membership drawn from the registered architects in the state, who would not necessarily be members of a Chapter or the Institute. It was believed that such an associate class of membership would prove a good recruiting-ground for the Institute. Other directors spoke of the confusion which might arise in the public mind from such a membership and referred to the Chapter associate class which the Institute abolished under its reorganization of two years ago.

*Resolved*, That the correspondence be referred to the Post-War Committee, with the request of the board that the principle of close affiliation between the Institute and the architectural societies, and its application, be carefully considered.—From the *Journal of the A. I. A.*

## Employment of Soldiers

### GOVERNMENT AIDS RETURN TO CIVIL LIFE

The Federal Board for Vocational Education is distributing two series of pamphlets designed to promote the restoration of soldiers and sailors, both sound and disabled, to gainful occupations in civil life. There are separate pamphlets addressed to the men, to their families and to American employers of labor. Some of the pamphlets tell of a plan of Federal vocational education.

Those wishing to receive information regarding this subject should address the board mentioned above, at Washington, D. C.



PLATE 12

OLIVER WENDELL HOLMES SCHOOL, FIFTY-FIFTH AND CHESTNUT STREETS, PHILADELPHIA, PA.

HORACE COOK, ARCHITECT





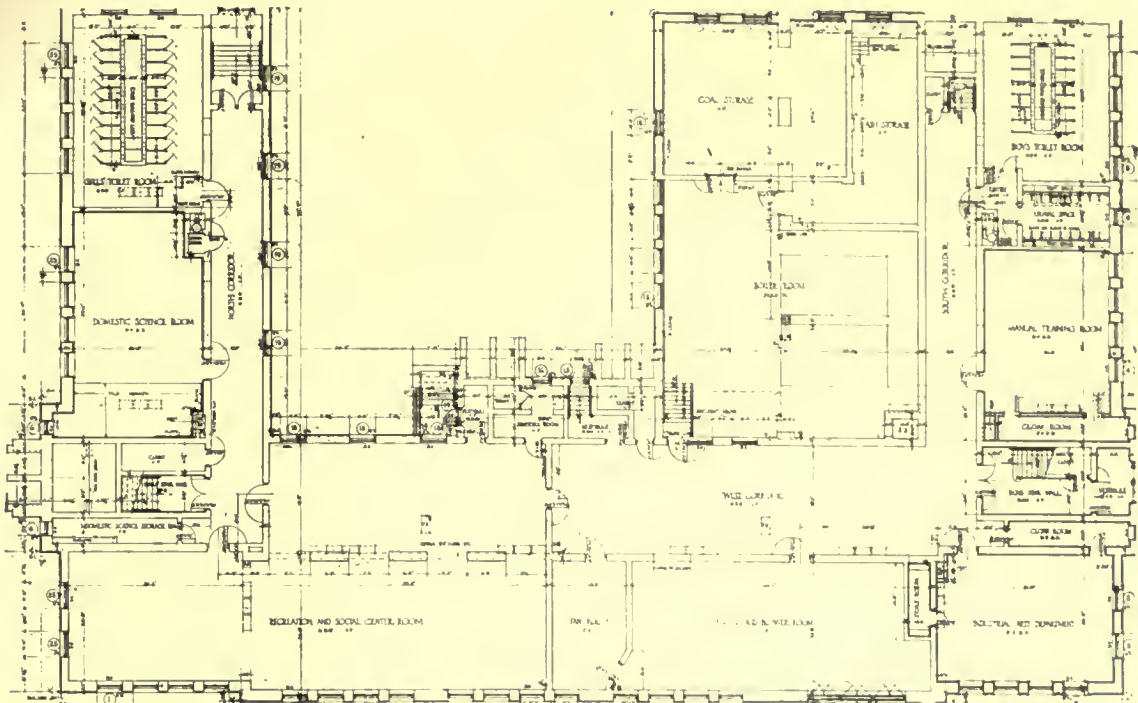

BASEMENT PLAN

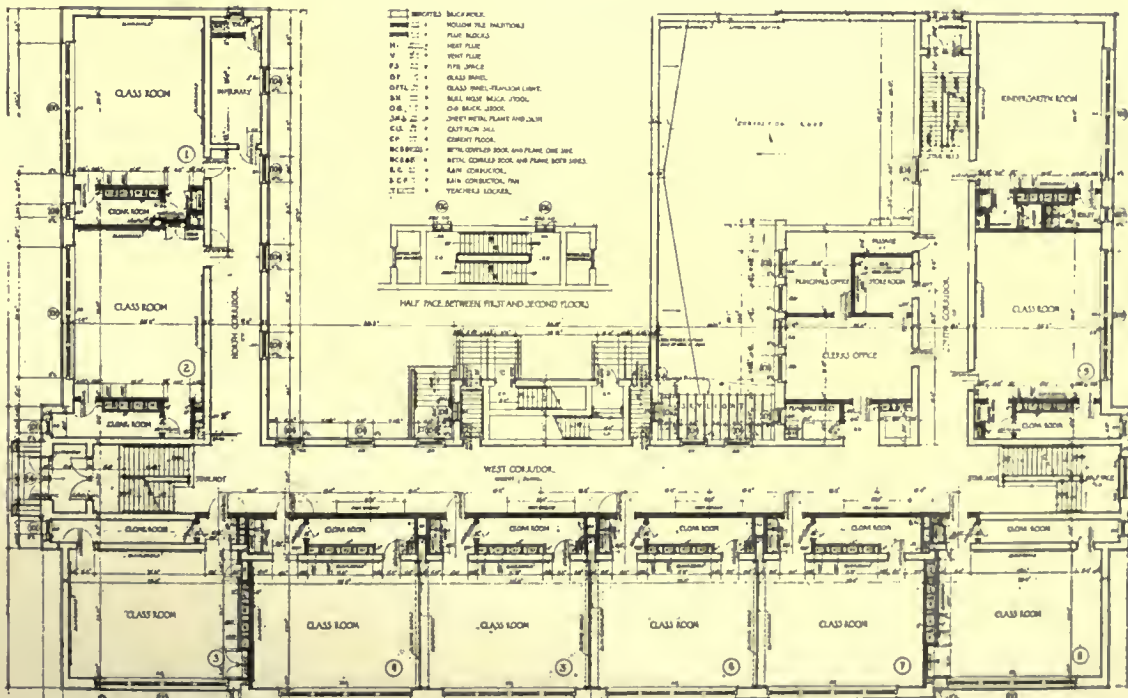

PLATE 13

FIRST FLOOR PLAN

OLIVER WENDELL HOLMES SCHOOL, FIFTY-FIFTH AND CHESTNUT STREETS, PHILADELPHIA, PA.

HORACE COOK, ARCHITECT



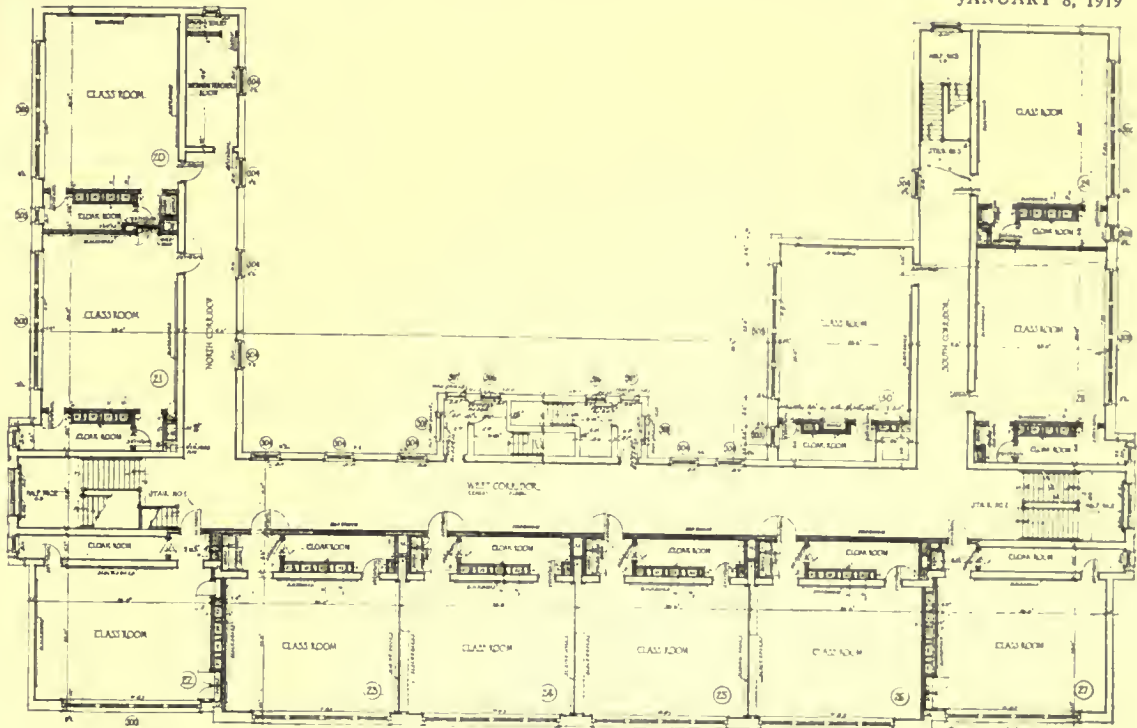

THIRD FLOOR PLAN

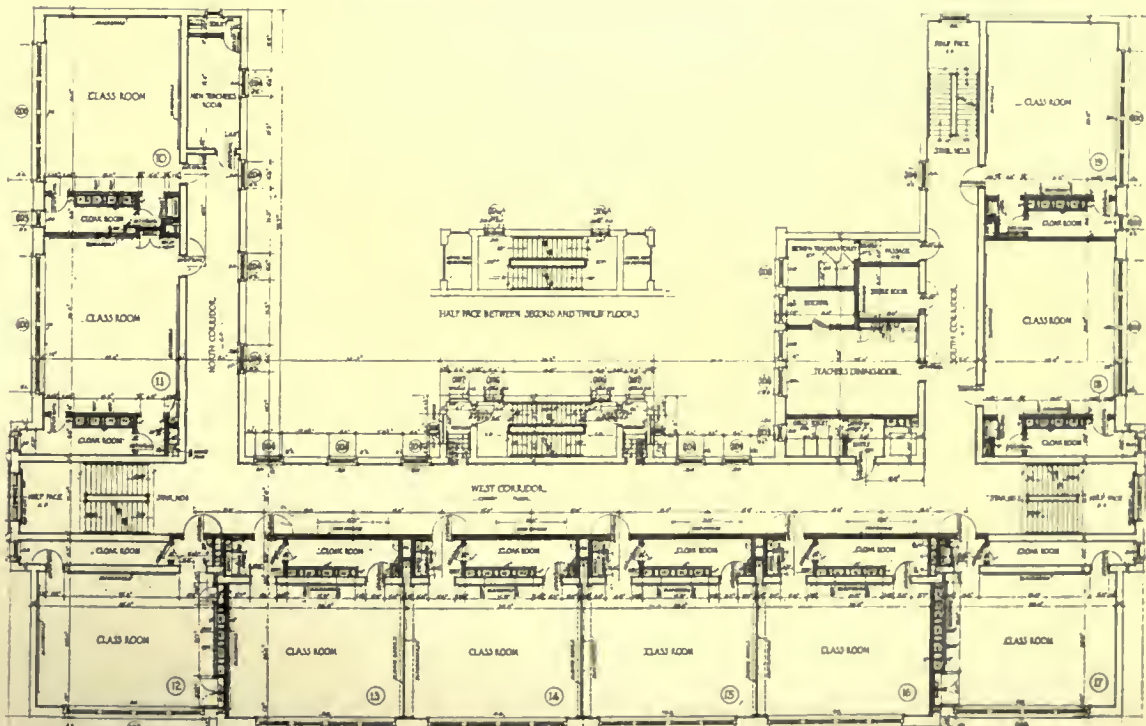

SECOND FLOOR PLAN

PLATE 14  
OLIVER WENDELL HOLMES SCHOOL, FIFTY-FIFTH AND CHESTNUT STREETS,  
PHILADELPHIA, PA.  
HORACE COOK, ARCHITECT







PLATE 15

CULLEN SCHOOL, CARDIFF, CAL.  
JOHN S. SIEBERT, ARCHITECT





THE AMERICAN ARCHITECT

JANUARY 8, 1919

VOL. CXV, NO. 2346



PLATE 16

HIGH SCHOOL, LUCY, TENN.  
JONES & FURBRINGER, ARCHITECTS



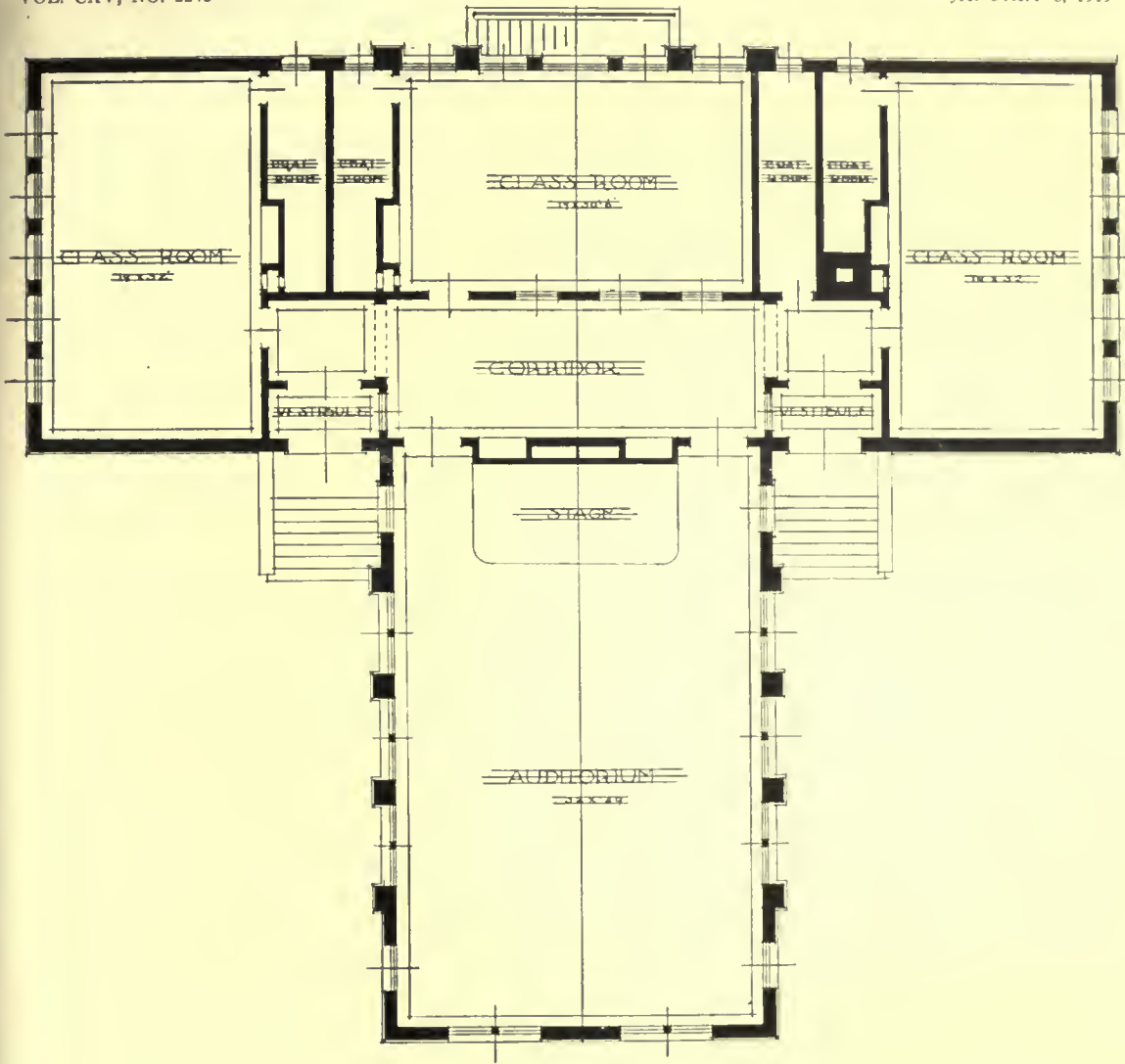

HIGH SCHOOL, LUCY, TENN.

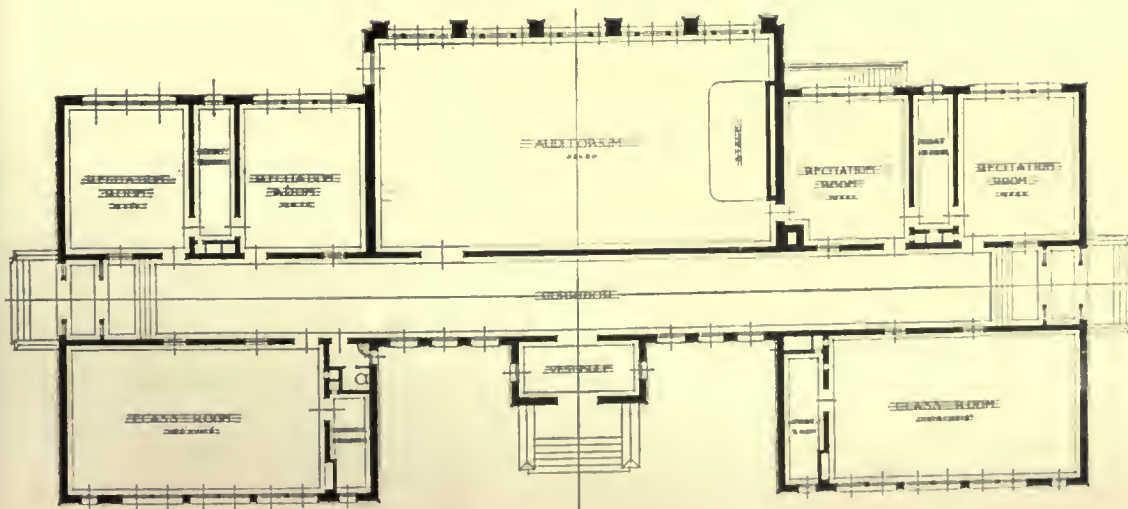

PLATE 17

HIGH SCHOOL, CORDOVA, TENN.

JONES & FURBRINGER, ARCHITECTS





## The Next Convention of the A. I. A.

The next convention of the American Institute of Architects will be held at Nashville, Tenn., April 30 to May 2, 1919.

It might be noted that in the November issue of the *Journal* containing this announcement, also appears the completed committee assignments of the Institute for the Institute year.

Query: If it required seven months to appoint the Institute committees, how much time should they be given to organize and do effective work?—From the December *Bulletin* of the Illinois Society of Architects.

---

## Landscape Architects Hold Reconstruction Meeting

A special meeting of the American Society of Landscape Architects was held in Washington, D. C., Dec. 7, to consider problems affecting the profession in the reconstruction period.

The meeting was called to consider how the society might best be of service in this country and overseas during the period of readjustment.

Better and more economical results, it was believed, would be secured by the co-operation of landscape architects, as they are likely to be called on more than ever before in the solution of city planning problems.

---

## New York State Board of Registration

There will be two opportunities during 1919 for architects to be admitted to practice in New York State by examination. Examinations held in various cities will be open to candidates who shall have previously qualified, on January 29, February 1, and on June 1 and 3.

Candidates should write at once for information to the Examinations Division, Education Building, Albany, New York. Those who wish to take the examinations will be required by the Regents to qualify under the law, which specifies that the applicant shall have "satisfactorily completed the course in high school approved by the Regents of the University or the equivalent thereof and subsequent thereto of having satisfactorily completed such courses in mathematics, history and one modern language, as are included in the first two years in an institution approved by the Regents, conferring the degree of Bachelor of Arts. Such candidate shall in addition submit satisfactory evidence of at least five years' practical experience in the

office or offices of a reputable architect or architects, commencing after the completion of the high school course. \* \* \*"

Candidates may obtain copies of the Registration Law and an outline of the examination by addressing Dr. A. S. Downing, Assistant Commissioner for Higher Education, Education Building, Albany, New York.

Architects who have graduated from certain schools of architecture and those who have practiced ten years in other states may secure certificates of registration without examination. It is illegal for anyone to use the title "architect" in this state without registration unless he actually practiced architecture in New York previous to April 28, 1915. The Board of Examiners and Registration of Architects, Education Building, Albany, N. Y., D. Everett Waid, President; Wm. P. Banister, Secretary.

---

## To Promote Better Relations Between Native and Foreign-Born Workers

The Bureau of Education, Department of the Interior, is engaged in a movement to promote better relations between native and foreign-born workers in industry. Trade publications reaching employers of labor will help in this service by presenting material in such form that employers can pass it on to their workers by means of the bulletin board, pay envelope, house organ or other medium. The plan is to publish brief articles in the trade publications under such a heading as "Put This on Your Bulletin Board" or one of similar meaning.

---

## Imported Labor Barred

No more Federal permits for the importation of Mexican and West Indian labor will be granted, the Department of Labor has announced, and permits already granted will be void after January 15. Aliens permitted to enter temporarily for war work will be repatriated gradually, without interfering with agricultural or other work now in progress.

The admission of semi-skilled laborers from Canada will be discontinued, but present arrangements whereby skilled laborers are admitted only when they cannot be employed in their own country, and when those countries have given consent to their departure, will be continued for the present. Conferences on this subject are under way between the United States and Canadian Governments.

## The Largest Business Unit in the World

Judged by almost any standard the Bureau of War Risk Insurance is probably the largest business unit in the world. In the twelve months just ended the bureau has mailed more than 6,500,000 checks in payment of allowances and allotments, representing a total disbursement of almost \$200,000,000 for the care and maintenance of the families and dependents of our army and navy. During the same period the bureau has written nearly \$35,000,000,000 of this insurance. The army and navy is more than 90 per cent insured and new applications are now being received for more than \$1,000,000,000 of this insurance per week. The bureau has made awards and is paying monthly compensation on more than 5,000 death and disability claims and is paying monthly installments of insurance on more than 9,000 insurance death claims.

In the performance of this threefold task the bureau has within the year handled nearly 3,900,000 insurance applications and more than 3,800,000 allotment and allowance forms, and it has been necessary to prepare and maintain under constant control more than 26,000,000 separate individual card records. The bureau has received and answered more than 3,000,000 letters. From a small organization of twenty persons working in the basement of the Treasury Department, the bureau has grown until now it has a working force of 13,000 employees occupying thirteen buildings in Washington.—*Heating and Ventilating Magazine.*

## Oldest Iron Industry

The Shansi iron industry is claimed by a Chinese writer to be the oldest in the world, says *Domestic Engineering*. Like many others of the great resources of China the country's deposits of iron ore have been but little developed. Dr. H. Foster Bain, assistant director of the United States Bureau of Mines, who spent some time in China investigating its mineral resources, estimates that China has 400,000,000 tons of iron ore available and suitable for modern furnace reaction and an additional 300,000,000 tons that might be treated by native methods.

The iron ore deposits are now controlled by Chinese or Japanese interests, the Chinese Government aiming to control those that are not already mortgaged to Japanese interests. The Penchihu furnaces were producing in 1918 about 75,000 tons of pig iron. The Anshanchan Iron Works, in Manchuria, operated by the South Manchuria Railway, have an annual output of 150,000 tons. The Han-

yhping furnaces are probably producing an equal amount, which will be increased when the company's furnaces are in operation at Tayeh. Thus, a fair estimate of China's production of pig iron (1918) would seem to be about 500,000 tons a year, including the output of numerous crude native furnaces, about 50 per cent of which are said to be in Shansi. The Hanyehping Co. took out, in 1917, 540,000 tons of iron ore.

During 1917 China exported to Japan 170,000 tons of pig iron, valued at 5,300,000 taels, and 303,500 tons of iron ore, valued at 1,000,000 taels. One tael is equal to about \$1 in United States currency.

## Decay in Buildings

Research was recently started by the Forest Products Laboratory to determine the "killing points" in temperature and humidity of common fungi found in American buildings. Field and laboratory studies indicate that much more care should be exercised in the selection of timber and in the construction of buildings to avoid conditions favorable to decay. A number of inspections of buildings which have given trouble on account of decay have shown that any one of the following causes may result in rapid deterioration of the building:

1. The use of green timber.
2. Allowing timber to get wet during construction.
3. Allowing the timber to absorb moisture after the building is finished because of leaks or lack of ventilation.
4. The use of timbers containing too much sapwood.
5. The use of timbers which have already started to decay.

The avoidance of these conditions will, as a rule, it is said, prevent decay. In special cases, however, decay can only be prevented by preservative treatment. It is stated that for this purpose salts, such as zinc chloride and sodium fluoride, are better than creosote for buildings.

## Purple Wood from Panama

Large growths of bright purple nazarene wood are lying idle in Panama, only awaiting development, according to Dr. Henry Pittier, who recently led a botanical expedition to the Darien section of the Isthmus. Before the war this beautiful wood commanded \$125 to \$200 per thousand feet. It is



estimated that there are 40,000,000 feet of wood awaiting use.

This timber has most unusual qualities. The trees reach a large size, sometimes a diameter of three feet, and have very little sap wood. The interior is a rich purple color and the wood is hard, heavy, strong and extremely resistant to water and weather; it contains an essential oil and it takes an excellent polish. When the wood ages, and is at the same time exposed to the sunlight, it turns much darker in color.

---

### Importance of Community Boards

#### GREAT TASK REQUIRES SYSTEMATIZED EFFORT

There is no instrumentality at the Government's disposal so well equipped to help in the process of transition from a war to a peace basis as the Community Labor Board, and at no time since the beginning of the war has the need of such service been more urgent or the duties imposed upon those capable of performing them more imperative.

The country now faces the obligation to return to suitable employment those who, under the stress of war, it has induced to enter its service in the field or in the factory. The demands upon the country since the signing of the armistice are, perhaps, greater than those during the war, and the Community Labor Board will be looked to, largely, for the successful handling of the new problem.

The activities of the Community Board, by means of which workers in non-war work have been recruited for war industry, will now be utilized in the replacement in industry of both soldiers and civilian war workers. The board will be used to gather information in industrial localities necessary to an intelligent demobilization of the army and war industry and the redistribution of workers. A plan has been formulated by the War Department and the War Industries Board whereby the Community Labor Board in the important industrial centers will send weekly reports to the latter indicating the labor conditions in their communities.

Secretary of Labor Wilson has sent an appeal to each of the sixteen hundred boards now in existence urging their members to continue in the work until the last unit of our fighting forces overseas shall have been brought back to appropriate pursuits of peace, and the last man to be withdrawn from war service shall have been given an opportunity of employment where he is best fitted to serve.

### Work of the United States Employment Service

With the co-operation of the national welfare organizations, the Government agencies interested in demobilization, and local community organizations of all kinds, the United States Employment Service is establishing a Bureau for Returning Soldiers, Sailors, and War Workers in every city and town in the United States. It also has stationed qualified representatives in all army camps and posts in this country to acquaint soldiers with the facilities for assisting them to suitable employment after they leave camp.

The reconstruction program of the Employment Service links up all national and local efforts, both governmental and private, and centralizes in every community, through these local bureaus, all information as to proper openings in industry, commerce, and agriculture available to the nation's fighters and war workers. It calls for assisting them to the best work the country can give them, the individual's qualifications being considered, and for sending as many men as possible to the farms.

Since most soldiers are expected to go to their home communities—and should be encouraged to do so—the task of aiding them in finding work is primarily a community responsibility, and the local bureaus enable its discharge.

The program has been approved and adopted by the Secretaries of the War, Navy, Interior, Commerce, Agriculture, and Labor Department, sitting as the members of the Council of National Defense. In the same capacity, those cabinet officials most concerned with demobilization have taken steps to keep intact the field machinery of the defense council so that it may be utilized by the Department of Labor and its Employment Service in carrying out the replacement program. Their action brings to the Employment Service's aid a total of 184,000 local units, among them being the State councils, 4,000 community councils, and 16,000 women's organizations.

---

### County Organizations for Forest Fire Control

Twenty-four counties in California have adopted a plan of organization for rural fire control, states *Engineering News-Record*. In these counties, covering 16,000 square miles, 412 rural fire-fighting companies have been organized and now include about 6,500 men, according to a summary of the situation recently made by the University of California. By the aid of 532 automobile trailers,

which have been purchased and equipped with fire extinguishers and fire-fighting tools at county expense, these companies have kept losses from fire at a remarkably low figure in the past season.

### Results of Daylight Saving Law

According to the United States Fuel Administration's estimates, 1,125,000 tons of coal were saved by turning the clocks ahead one hour for seven months. Definite reports from St. Louis show a saving of 17.5 tons for each thousand of population on the seven months' basis.

The saving in France for a three months' period was 250,000 tons, which would make a saving of 12.5 tons for each thousand of population for a seven months' period.—*Heating and Ventilating Magazine.*

### Her Roads Saved France

And why has it been possible for France to carry on for four years a successful war against the greatest military power that the world has ever seen? Because France had the benefit of the engineering skill and of the foresight of two men who are 1,800 years apart—Napoleon and Caesar. Those men built the roads of France. Without those roads, conceived and built originally by Caesar for the conquest of the Gauls and for the conquest of the Teutons, without the roads built by Napoleon to stand off the enemies of France, and to make aggressions to the eastward, Paris would have fallen at least two years ago. So that you gentlemen who are engaged in the business of developing the highways of the country, and putting them to greater use may properly conceive of yourselves as engaged in a very far-sighted, important bit of statesmanship, work that does not have its only concern as to the farmer of this country, or the helping of freight movement during this winter alone, but may have consequences that will extend throughout the centuries. Take the instance of Verdun. Verdun would have fallen unquestionably if it had not been for the roads that Napoleon constructed and that France has maintained; for all the credit is not to go to the man who conceived and the men who constructed. This is one thing where we have been short always. One thing that the people of the United States do not realize. It is not sufficient to pay \$25,000 a mile for a concrete foundation, but you must put aside 10 cents out of every dollar for the maintenance of these roads, or your money has gone to waste and your conception is idle. And you gentlemen know if you continue, as I hope

you will, after the war you will have not merely a function in the securing of the building of good roads, but will have a very great function in the maintaining of these roads as actual arteries in the system of transportation of the country. You remember that at Verdun the railroad was cut off, and Verdun was supported by the fact that she had trucks which could go 40 feet apart all night long over the great highway that had been built from Paris to the East.—*Franklin K. Lane, Secretary of the Interior, before the conference of regional chairmen, Highways Transport Committee.*

### Professor Goodyear's Research

The Brooklyn Museum recently exhibited two groups of Prof. William H. Goodyear's enlarged photographs of cathedrals in the war zone of Europe. When the photographs were made there was no thought of war. They were made with exceeding care to illustrate deviations from the normal of lines in medieval buildings, to illustrate and prove Professor Goodyear's discoveries that lines assumed to be vertical were not so but were bent from the perpendicular, that lines assumed to be horizontal and straight were bent or curved either in the horizontal or vertical plane. Most of the pictures include simultaneously photographed plumb-lines or stretched lines to show the deviations. As most of the buildings photographed have been in the path of *kultur* to a greater or less degree, and are now either badly damaged or entirely destroyed, these accurate, painstaking photographic records, many of them showing details which the ordinary tourist or even student would probably never even see, form a heritage for which the world, and especially the architects, owe Professor Goodyear the deepest gratitude. To indicate the care and thoroughness with which the work has been done, it is well to note that there are some cases where every pier of the nave has been individually photographed with plumb-line reference. These records are now priceless, for as Professor Goodyear has pointed out, not even elaborate monographs and measured drawings of these buildings have made serious note of the refinements and deviations which exist.

Nor are these enlargements valuable only as records. Many of them are noteworthy pictorially and merely for the sake of having good pictures of the best architecture of the Middle Ages. Pictures taken from the architect's viewpoint, we should be thankful that these splendid Goodyear negatives are in existence and in the care of the Brooklyn Museum.—Ben J. Lubschez in the December *Journal of the A. I. A.*



# Department of Architectural Engineering

## Useless Waste in Concrete Construction Due to Legal Requirements\*

By W. STUART TAIT, Assoc. M. Am. Soc. C. E., Assoc. Mem. Inst. C. E.

### CORRECTNESS OF DESIGN AND ANALYTICAL METHODS

THE second general heading to be considered in arriving at the factor of safety may be roughly classified as correctness of design and analytical methods. The various building codes set down the analytical method to be followed in preparing all designs. In considering beam or one-way slab, for instance, we find that most building codes

cases being the total uniformly distributed load on the beam and  $L$  the center-to-center span. For intermediate spans the bending moments for a uniformly distributed load, both positive and negative, are to be figured as  $WL/12$ . The table (Fig. 4) shows the bending moments for beams having knife edge supports at both the end and intermediate points. These bending moments, of course, are based on all spans being uniformly loaded and upon

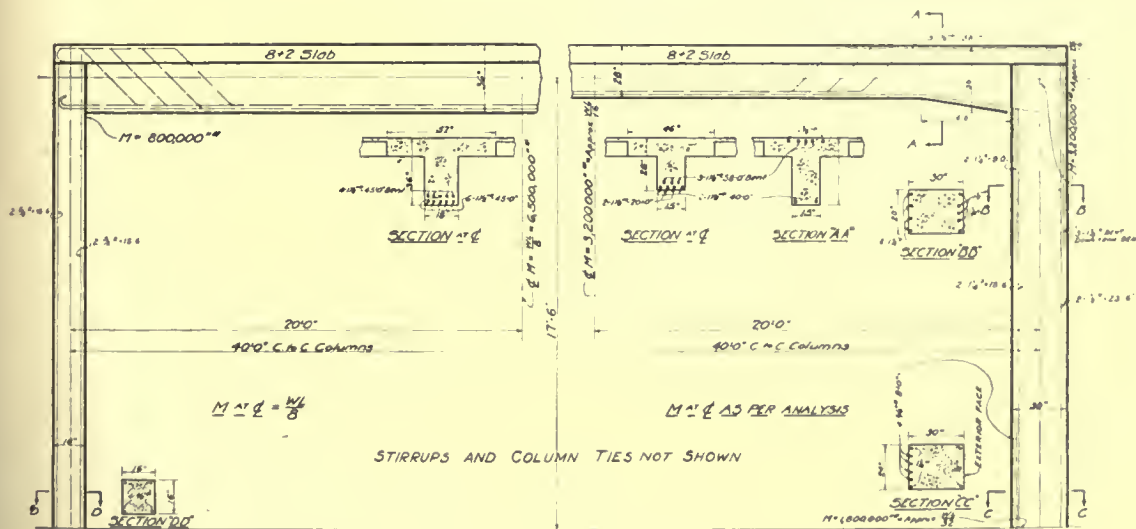

FIG. 1

provide that for uniformly distributed loads the bending moment  $WL/8$  shall be used where the beam is of one span length only. Where a beam is partly continuous, that is to say, more than one span in length, a positive moment of  $WL/10$  is required to be figured at the center of the end spans, and in the Chicago ordinance a moment over the supports is to be taken as not less than  $WL/18$ , and the sum of the moments over one support and the center of the span shall be not less than  $WL/6$ ,  $W$  in all

all spans being equal. The bending moment  $WL/12$  now in general use for intermediate spans was fixed to cover the worst conditions of bending possible, due to some of the spans being loaded while others were not loaded. By comparing the bending moment requirements governed by ordinance and accepted in engineering practice, however, with those shown in the diagram, it will be observed that standard practice lays far greater stress on the positive moment than on the negative moment, while with uniform conditions of loading the negative moment is far greater and more important than the

\*Continued from our issues of December 11 and 18, 1918, pages 718 and 752.



positive moment, and in this respect standard practice and all building codes tend to produce structures which are inclined to be weak in negative bending. Take, for instance, the case of a beam two spans in length resting on brick walls. How many practicing engineers design for a negative moment over the center support of  $WL/8$ ? The Chicago ordinance could be satisfied on this point by providing a bending moment of  $WL/15$ , while

out of place here to also call attention to the fact that the dead and live load moments are always, in American practice, treated together. In some cases this adds a severe and entirely unnecessary burden on the construction.

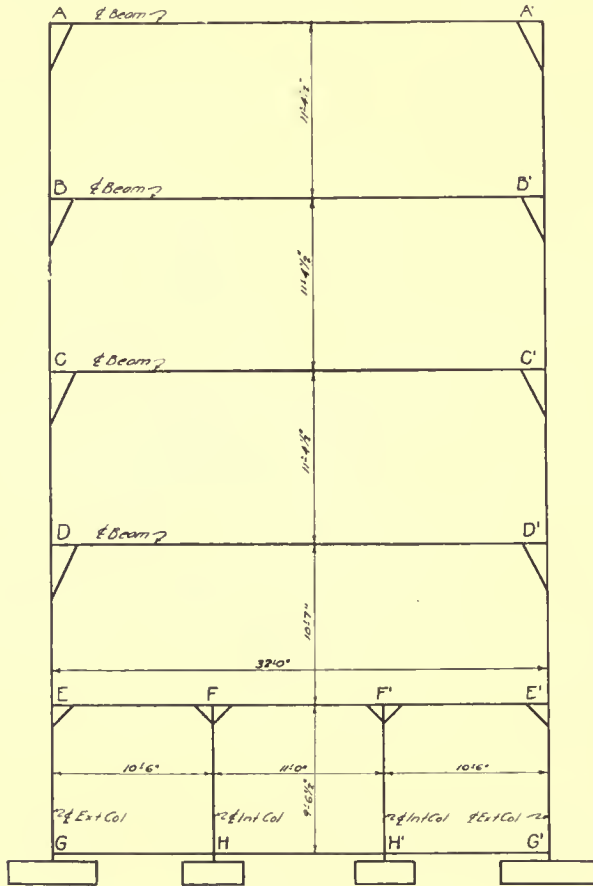

FIG. 2

the positive moment used would have to be  $WL/10$ , against a possible correct value of  $WL/14$ . Some years ago it was the opinion of many engineers that so long as sufficient positive resisting moment was provided that this resisting moment would provide the necessary strength and relieve the negative stresses. More recent experience and investigations, however, have demonstrated that this is not the case. The distribution of the total bending moment between the positive and negative is governed partly by the distribution of load and partly by the relative moments of inertia of the member at the center and at the support. It is also, of course, affected to a marked degree by the condition of fixity of the supports. I feel that it is not

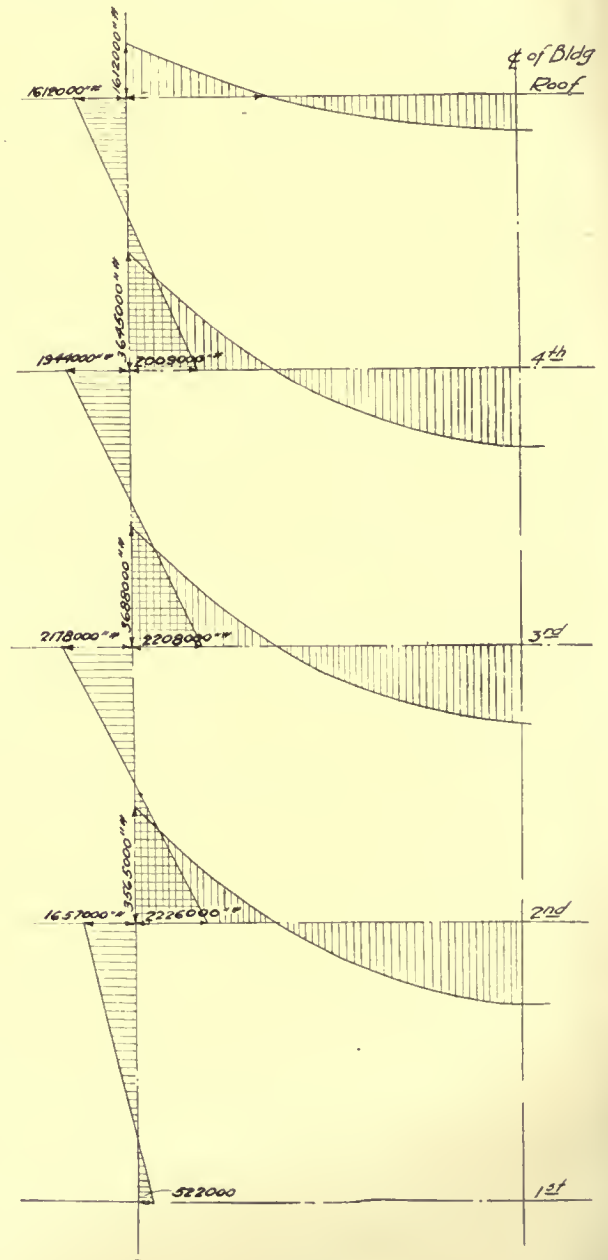

FIG. 3

The rules for figuring the bending moment in beams and slabs as given above were sufficiently accurate for concrete designing as practiced ten or fifteen years ago, but now that we have a large body of trained concrete designers it would appear that this "rule of thumb" method places upon the investor an entirely unnecessary financial burden.

# THE AMERICAN ARCHITECT

while in some points his building is not as strong as he and his designers believe if they follow the building ordinance and accepted practice literally. In arguing for the accepted practice of bending moments mentioned above, their advocates seem to lose sight of the fact that there are a number of actual conditions tending to reduce the maximum bending moment possible due to irregular load. Anyone who has assisted in or witnessed one of the scientific load tests on actual buildings where the stresses were measured by extensometers, have had forcibly brought before them the fact that it is extremely difficult to load a floor to any con-

ing from unequal load, and it would seem only fair to make some allowance for these assisting factors in determining the actual bending moments to be figured.

The bulk of concrete construction is built with exterior columns. Of course, there is a material amount of construction in which brick-bearing walls are used. It would seem incorrect to treat these two classes of construction under precisely the same regulations. Where concrete columns are used in

*SUM OF  
BEAM MOMENTS  
ALL SPANS*

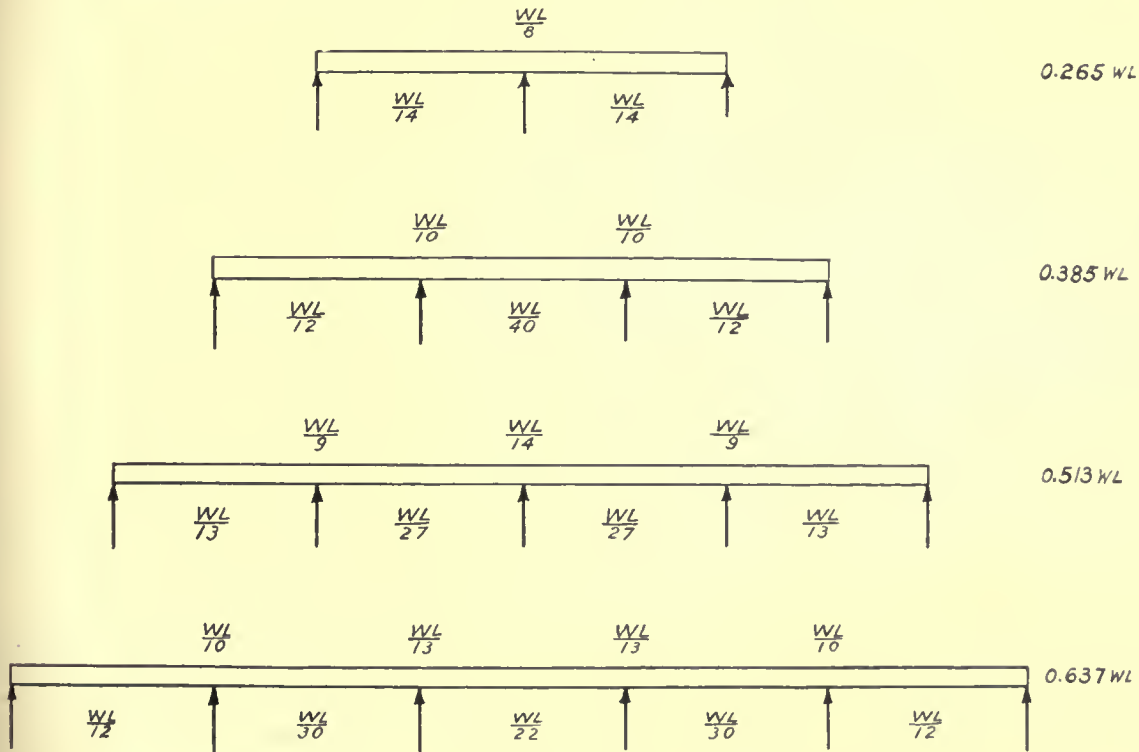

FIG. 4

siderable extent and avoid to any degree arch action in the load itself. This arch action in the load itself, of course, reduces the positive bending moment, but does not affect the shear at the supports. Another factor contributing in beam or slab strength to a marked degree is the arch action in the beam or slab itself. Another fact also contributing is that concrete, while engineering practice does not recognize it, has a material strength in tension. Text books, of course, show that this strength is not a reliable or important item, but actual tests seem to indicate that it contributes materially to the strength of concrete construction. These three strength contributions mentioned all tend to a marked extent to assist the beam or slab in overcoming the extreme bending moments result-

the outside walls the connection between the beam and the column is not hinged, as is assumed in all building regulations, but is rigidly fixed. This fixity causes a negative bending moment in the beam adjacent to the column, and produces a bending moment in the column itself. This negative resisting moment produced by this fixity reduces the positive bending moment in the exterior spans to a very marked degree. The latest text books on reinforced concrete design give clear and correct methods for calculating the bending moment caused by this fixity, and the time has therefore passed when we should, as a matter of convenience, or as an admission of lack of knowledge, treat this end connection as if it was hinged. On account of the erroneous assumption made in the preparation of

# THE AMERICAN ARCHITECT

all building ordinances that the connection between a concrete column and beam is hinged and not fixed, no recognition was given to the fact that the rigidity of the connection between the column and the beam to a marked degree prevents the occurrence of the high positive bending moments we have established to provide for some or all of the spans of a continuous beam being loaded. If one interior span in a beam continuous over a number of supports is loaded and the adjoining spans are not loaded, the rigid connection between the beam and the column brings into play the bending resistance of the column itself, both above and below the

signed as fixed beams and the columns properly proportioned to resist the bending moment actually occurring. The building department ruled that their hands in the matter were entirely tied by the ordinance, since in single span construction, such as this, the ordinance provided that the bending moment at the center of the beam should be figured as  $WL/8$ . The writer then asked if the building department would require the column to be designed for a direct load only. Their decision was

SUM OF  
BEAM MOMENTS  
ALL SPANS  
  
AS REQD  
PROPOSED BY PRESENT  
FIG. 5 CHGO. ORD.  
  
**0.33 WL 0.33 WL**

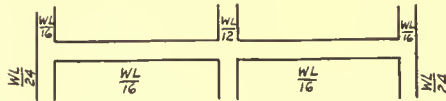

**0.45 WL 0.50 WL**

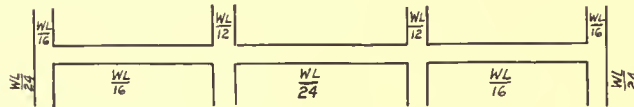

**0.58 WL 0.66 WL**

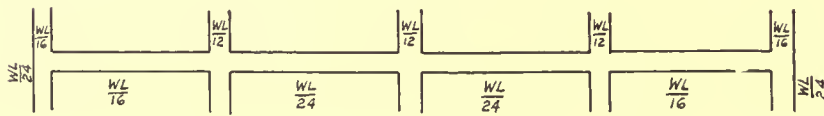

**0.705 WL 0.83 WL**

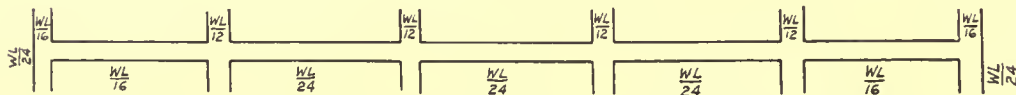

*TOP STORY COLS. TO BE FIGURED FOR A B.M. OF  $\frac{WL}{16}$  INSTEAD OF  $\frac{WL}{24}$*

FIG. 5

beam, with the result that the maximum theoretical bending moment at the center of the loaded span is reduced. In considering a concrete slab continuous over a number of concrete beams a similar resisting strength is contributed by the ability of the concrete beam to resist torsion.

In the long span concrete construction such as is being put into execution in these times serious defects may develop from treating this end connection in the old-fashioned manner. The writer had occasion recently to design some concrete girders having a span of 60 ft. Before doing so he took up with the architectural engineer of the building department in the city where these beams were to be erected the matter of their design. He proposed to the building department that they should be de-

signed as fixed beams and the columns properly proportioned to resist the bending moment actually occurring. Since, in this case, the structure was only one story in height, the columns supporting the end of this beam could be relatively slender, and on account of the fixed condition of the end of the beam the columns would be subjected to a bending moment which would highly overstress the column. The illustration (Fig. 1) shows at the left the half elevation of a long-span concrete beam and column of this class which would satisfy most building codes. At the right on the same illustration is shown the beam and column carefully designed to act as a rigid frame. The cost of these two structures is practically the same, yet in one case we have a properly balanced design and in the other a design which is



# THE AMERICAN ARCHITECT

very weak. It will be noticed that the actual bending moment occurring at the middle of this beam is approximately  $WL/16$  instead of  $WL/8$ , as required by the ordinance, and still the structure which is unacceptable under existing building ordinances is actually stronger than the structure that would receive the approval of most building departments. Some people may ask why it is that this condition has not resulted in serious failures in the past. The answer to this is simply that up to a short time ago, when structural steel became such a scarce and high-priced commodity, for long-span construction the designer naturally turned to

that where the designer of a structure is willing to expend the time and thought necessary to prepare a design in which the actual bending moments are determined by a method such as that known as the method of Slopes and Deflections, that building departments should be in a position to recognize the benefits of having structures erected from properly balanced designs. Their present attitude forces upon the competent and conscientious engineer the necessity of designing as in the case cited for a

SUM OF  
BEAM MOMENTS  
ALL SPANS  
AS AS REQ'D  
PROPOSED BY PRESENT  
FIG 6 CHGO ORD

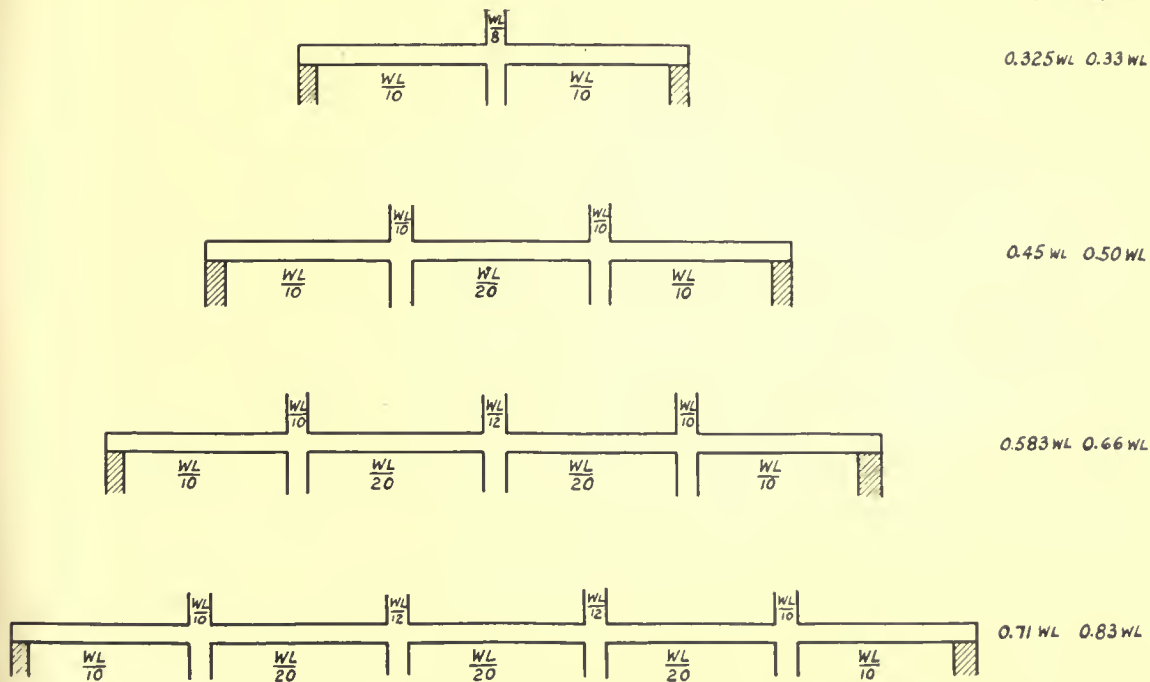

FIG. 6. WALL BEARING

structural steel. In shorter span construction the bending moment occurring in the column was, of course, very materially less numerically in value on account of the fact that it varied with the square of the beam span. The size of column supporting the end of the beam, however, as in the case illustrated in the design above, would be governed by the minimum requirement for column dimension on account of its length. Suppose, for instance, that the span in the example had been 20 ft. instead of 40 ft., the bending moment in the column would have been reduced to about 200,000 in.-lb. instead of 800,000 in.-lb., while the column supporting the end of the beam would remain as shown, 16 in. square, since the minimum dimension of the column was governed by its length, and was thereby fixed at 16 in. It would seem, in view of these facts,

bending moment at the center of the beam of  $WL/8$  instead of  $WL/16$ , while at the same time strengthening the exterior column to resist the actual bending moment determined from the relative stiffnesses of the beam and column which he has found necessary to use.

About a year ago the writer had occasion to design a multiple-story structure, which was to be erected in a small community outside of the jurisdiction of an established building department. This structure was one span only in width, the columns being placed 32 ft. center to center. The diagram (Fig. 2) shows a cross-section of this structure in outline. The diagram (Fig. 3) illustrates the bending moments occurring in the various beams and supporting columns. I would like to draw attention to the fact that the maximum positive bend-

ing moment at the center of this span was  $WL/19$  while the maximum bending moment at the support was  $WL/13.5$ . The largest bending moment found in a column was  $WL/22$ . In all of these bending moment figures  $W$  equals the total distributed load on the beam and  $L$  the center to center span of the same. The maximum bending moments given above were obtained by considering some or all of the floors fully loaded. The erection of this structure, as designed, would not have been possible under existing building codes, and had it been erected in concrete the sizes of the beams spanning across this building would have been increased enormously. As a result this would have added a considerable item of cost to the construction, and the structure would not have been one whit more valuable so far as the manufacturer who occupies it was concerned.

Most engineers and architects recognize that skeleton construction of reinforced concrete in which the exterior columns are replaced by brick walls is very much more uncertain and less satisfactory than where a complete skeleton having exterior columns is used. Few designers proportion their footings on the basis of the dead load or on the dead load plus a small portion of the live load. The general practice is to design the foundation both for outside walls and interior columns for the same bearing pressure, using both the dead and a large proportion of the designed live load occurring in each location. In all foundations, except rock, shale or solid gravel, some settlement is certain to occur, and if the bearing pressure on the underside of footings proportioned as above is taken at the same value for both the exterior walls and the interior columns, a much higher actual pressure will probably be developed at the exterior than at the interior footings. This condition will exist during the period before the building is occupied and loaded, and also at those times when the interior of the structure is not completely loaded to the design strength of the floors. In many cases this has led to a greater settlement of the outside walls than of the interior portions of the structure. This settlement, of course, means that the outside end of the exterior beams will be bent downward, and in concrete construction a high negative bending moment over the first row of interior columns will be produced. In mill construction this is not the case, since the end floor girder resting on the wall and on the first interior column is somewhat free to move. If the exterior supports of the structure are brick-bearing walls, four or five stories in height, they will, of course, be very much heavier than 13-in. spandrel walls and columns, and on the basis of foundation design outlined the tendency of the

walls to settle is intensified. It would appear, therefore, that building ordinances would do well to make more favorable rulings for bending moments in concrete beams supported on exterior columns, with the idea of stimulating designers to use exterior columns. I would suggest that building codes establish two tables of bending moments somewhat similar to those given, Figs. 5 and 6, the former table applying for building skeleton construction where the exterior columns were designed to take bending, and the latter for the case of structures having no exterior columns.

I wish to emphasize the importance of considering and providing properly for the negative bending moment in reinforced concrete construction. Numerous engineers pay little attention to this point, and building departments, many of them, unwittingly approved designs in which the extreme fiber stress in a beam resulting from negative bending may run as high as 1500 lb. per square inch where the ordinance allowance may only be 800 lb., and, as will be observed from the illustrations in this article, the negative bending moment is always more serious than the positive.

With the bulk of reinforced concrete design now being executed by thoroughly competent and experienced professional organizations, it is unnecessary for building codes to carry as high a factor of safety as was necessary under the old régime of ten years ago, when most concrete designing was carried out in commercial offices. Our engineering colleges have, in the past ten years, produced a large number of engineers versed in the theory of concrete design, many of whom, after a few years' experience, develop into excellent designers. Engineers of this class, of course, were practically unobtainable ten years ago, and those practicing and directing the design of concrete construction had neither through experience nor education learned where the danger points lay nor were they in a position to systematize the work of their designing and detailing forces with the object of covering with accuracy the numerous secondary points in concrete designing and detailing which is so essential.

In a later article the writer hopes to propose a method of insuring better concrete construction, and to thereby secure from building departments recognition that good concrete design properly carried out under to-day's standards carries an excessive factor of safety. With the safeguards which the writer hopes to propose later it would be entirely unnecessary to provide any quantity in the factor of safety to allow for incorrect analytical methods or to provide for errors of design.

(To be continued)

# Effect of Time of Mixing on the Strength of Concrete\*

By PROF. DUFF A. ABRAMS

Structural Materials Research Laboratory, Lewis Institute, Chicago

## Part IV

TABLE 4

A STUDY OF THE TIME OF MIXING CONCRETE—(SERIES 80)  
(Effect of Consistency)

Mix 1-4 by volume.  
Aggregate sand and pebbles graded up to 1½ inch in size.  
Compression tests made on 6 by 12-in. cylinders.  
Wear tests made in Talbot-Jones rattler; specimens consisted of concrete blocks 8 by 8 by 5 in. thick; 10 wear blocks in a ring were run for 1800 revolutions at 30 r.p.m., with a charge of 200 lb. cast iron shot.  
Cylinders stored in damp sand; tested damp. Wear blocks stored in damp sand until 2 days prior to test.

Ref. No.	Time of Mixing, Min.	TESTS OF 6 BY 12-IN. CYLINDERS										WEAR TESTS AT 2 MONTHS				
		COMPRESSIVE STRENGTH										Weight, Lb. per Cu. Ft.	Density	Yield	Depth of Wear, Ins.	Mean Error, per Cent
		Lb. per Sq. In.			Mean Error, per Cent											
		7d.	28d.	2m.	7d.	28d.	2m.	Av.								
Relative Consistency 90%—Water .655 of Volume of Cement																
1	10	2510	3370	4660	1.9	2.0	4.1	2.7	158.0	.871	1.036	.46	10.2			
2	5	2230	4020	4520	4.1	7.9	4.0	5.4	158.0	.871	1.036	.48	4.0			
3	2	1740	3440	4060	1.2	9.9	15.3	8.8	157.5	.868	1.040	.56	6.0			
4	1	1840	3750	4130	9.2	5.2	12.5	9.0	157.5	.868	1.040	.60	8.4			
5	1½	1620	3180	4190	8.0	8.6	7.4	8.0	156.0	.860	1.049	.52	7.9			
6	¼	1260	2140	2880	31.4	32.0	20.5	28.0	153.0	.844	1.070	.69	19.9			
Average		1870	3480	4070	9.3	10.9	10.6	10.3	157.0	.864	1.045	.55	9.4			
Relative Consistency 100%—Water .725 of Volume of Cement																
7	10	1640	2930	3960	4.0	3.5	7.5	5.0	156.0	.856	1.055	.49	16.9			
8	5	1750	3520	3810	3.2	4.0	20.4	9.2	156.5	.857	1.052	.57	9.0			
9	2	1460	2800	3500	5.0	4.6	8.2	5.9	156.0	.856	1.055	.53	5.7			
10	1	1380	2780	3620	5.7	4.2	9.8	6.0	156.0	.856	1.055	.53	5.7			
11	1½	1130	2210	3080	5.7	7.6	6.7	6.7	155.0	.851	1.061	.72	8.3			
12	¼	1000	2020	2860	22.6	19.3	9.2	17.0	153.0	.839	1.077	.93	20.2			
Average		1390	2710	3470	7.7	7.2	10.3	8.4	155.4	.852	1.059	.63	11.0			
Relative Consistency 110%—Water .800 of Volume of Cement																
13	10	1520	2860	3640	12.8	12.5	8.5	11.3	156.5	.852	1.062	.60	7.2			
14	5	1500	2900	3550	6.4	3.6	7.8	5.9	156.5	.852	1.062	.64	7.4			
15	2	1090	2300	3070	14.2	11.4	7.2	10.9	155.5	.845	1.068	.60	5.4			
16	1	1160	2520	3350	4.9	8.8	5.9	6.5	155.5	.845	1.068	.66	8.9			
17	1½	880	2060	2620	24.1	16.2	13.0	17.8	154.5	.842	1.074	.76	25.5			
18	¼	1060	2140	2790	21.4	28.0	22.6	24.0	153.0	.834	1.086	.70	16.0			
Average		1200	2460	3170	14.0	13.4	10.8	12.7	155.2	.845	1.070	.66	11.7			
Relative Consistency 125%—Water .910 of Volume of Cement																
19	10	1260	2140	2980	9.9	14.5	13.1	9.5	154.5	.833	1.084	.69	11.6			
20	5	1200	2170	3030	7.6	15.5	4.6	9.2	155.0	.835	1.081	.68	11.5			
21	2	1030	1800	2500	14.1	7.8	12.0	11.3	153.5	.827	1.091	.61	13.0			
22	1	900	1830	2250	9.9	8.6	16.8	11.8	153.5	.827	1.091	.63	4.5			
23	1½	710	1840	2400	17.8	22.9	5.8	15.5	154.0	.830	1.088	.69	8.7			
24	¼	690	1510	2250	25.0	44.6	42.5	37.4	153.0	.825	1.095	.98	27.6			
Average		960	1850	2570	12.6	19.0	15.8	15.8	153.9	.830	1.088	.71	12.8			

\*Continued from our issue of December 25, 1918, page 781.

Relative Consistency 150%—Water 1.080 of Volume of Cement

25	10	690	1240	1820	5.4	9.0	7.4	7.3	153.0	.810	1.115	.85	9.4
26	5	560	1090	1780	12.1	21.6	5.6	13.1	152.5	.808	1.118	.92	12.7
27	2	480	1030	1750	9.3	8.5	6.1	8.0	153.5	.814	1.110	.78	20.5
28	1	500	1090	1740	12.1	9.2	8.8	10.0	152.5	.808	1.118	1.06	17.4
29	1½	500	1120	1690	4.2	17.2	12.9	11.4	152.0	.806	1.120	1.19	8.4
30	¼	340	880	1200	29.0	36.2	21.7	29.0	151.5	.803	1.125	1.46	2.4
Average		510	1080	1660	12.0	17.0	10.4	13.1	152.5	.808	1.118	1.04	11.8

Relative Consistency 200%—Water 1.440 of Volume of Cement

31	10	260	620	1110	26.9	31.8	28.4	29.0	149.0	.764	1.181		
32	5	260	730	1040	18.0	25.4	28.2	23.9	150.0	.768	1.176		
33	2	160	460	720	10.8	15.6	12.1	12.8	148.0	.759	1.190		
34	1	150	510	880	11.5	6.7	5.8	8.0	149.0	.764	1.181		
35	1½	160	509	940	14.0	15.7	4.5	11.4	148.0	.759	1.190		
36	¼	150	460	840	36.0	42.4	29.0	35.8	147.0	.752	1.200		
Average		190	560	920	19.5	22.9	18.0	20.1	148.5	.761	1.186		

Grand Average for All Consistencies

10	1450	2570	3210	7.8	10.9	10.9	155.0	834.1	085	64*	10.1*
5	1280	2470	3040	8.3	11.7	11.2	154.0	835.1	084	66*	8.7*
2	1010	2020	2670	9.8	9.9	9.7	154.0	831.1	089	62*	9.3*
1	1010	2140	2760	8.3	7.4	9.4	154.0	830.1	089	69*	9.0*
1½	840	1820	2500	14.0	11.9	9.1	153.0	827.1	094	77*	14.0*
¼	790	1610	2230	26.7	32.9	27.0	152.0	819.1	106	91*	17.0*

\*Does not include 200% Consistency.

TABLE 6

EXAMPLE OF INFLUENCE OF WATER ON THE STRENGTH OF CONCRETE

Values calculated from equation,

$$S = \frac{A}{Bx} = \frac{14000}{8.2x}$$

Where S=Compressive strength.

x=Water ratio.

A and B are constants whose values depend on quality of cement and other conditions.

The water ratio is equivalent to the cubic feet of water to 1 sack (1 cu. ft.) of cement. The strength values are solely for comparative purposes in showing the influence of changing the water ratio. The table is based on the following assumptions: Mix 1-4 relative consistency 110%, aggregate graded 0-1¼ in., mixed 1 min.

Gallons	Water Ratio (x)	Relative Consistency, per Cent	Compressive Strength of Concrete at 28 Days	
			Lb. per Sq. In (S)	Relative Strength, per Cent
5.75	.77	100	2770	100
6.0	.89	104	2600	94
6.25	.84	109	2400	87
6.5	.87	113	2250	81
7.0	.94	122	1950	70
7.5	1.01	131	1670	60
8.0	1.07	139	1470	53
9.0	1.21	157	1100	40
10.0	1.34	174	830	30
12.0	1.60	208	480	17
15.0	2.00	260	200	7



# THE AMERICAN ARCHITECT

**TABLE 5**  
**A STUDY OF THE TIME OF MIXING CONCRETE—(SERIES 93)**  
 (Effect of Mix and Size of Aggregate)

Compression tests of 6 by 12-in. cylinders.  
 Mix by volume.  
 Concrete in this series was mixed to 110% relative consistency.  
 Aggregates—sand and pebbles from Elgin, Ill.  
 Mixing was begun after all materials were in the drum.  
 Machine mixed cylinders made 16 in a batch; 4 for test at each age. In the order of making No. 1, 5, 9 and 13 were tested at 7 days; No. 2, 6, 10 and 14 at 28 days, etc.  
 Only one batch of machine-mixed concrete was made for each mix, grading and time of mixing. The mixing of the batches for a given mix and grading were distributed over a period of 4 weeks. All the 10-min. batches were mixed first, the 5-min. next, etc.  
 Hand-mixed specimens were made for comparison with machine-mixed concrete.  
 Specimens stored in damp sand; tested damp.  
 The 1-year tests in this series are not yet due.

Ref. No.	Mix by Vol.	Water Ratio to Cement by Vol.	AGGREGATE			Time of Mixing, Min.	CONCRETE					
			Range in Size, Ins.	Weight, Lb. per Cu. Ft.	Density		Compressive Strength, Lb. per Sq. In.			Weight, Lb. per Cu. Ft.	Density	Yield
							7d.	28d.	3m.			
Machine-Mixed Concrete												
1	1-2	.60	0-1 1/4	130.0	.780	10	2440	4410	5960	153.4	.803	1.276
2						5	2420	4080	6220	151.5	.792	1.293
3						2	1760	3550	5180	152.8	.799	1.281
4						1	1330	3400	5060	152.0	.794	1.286
5						1/2	1430	3140	5160	150.0	.784	1.305
6						1/4	1180	2970	4690	150.2	.786	1.303
Average							1760	3600	5380	151.6	.793	1.291
7	1-3	.70	0-1 1/4	130.0	.780	10	2100	3760	4980	154.0	.823	1.143
8						5	1720	3480	5260	153.2	.820	1.148
9						2	1390	3300	4960	152.8	.816	1.152
10						1	980	3000	4760	153.2	.821	1.148
11						1/2	840	2300	4360	152.7	.816	1.153
12						1/4	819	2060	4000	151.2	.809	1.164
Average							1310	2990	4720	152.8	.818	1.151
13	1-4	.81	0-1 1/4	130.0	.780	10	1380	2380	3730	153.2	.831	1.085
14						5	1340	2730	4100	153.2	.831	1.085
15						2	1090	2310	4330	154.0	.835	1.080
16						1	760	2320	3430	153.4	.832	1.083
17						1/2	650	2060	3850	153.5	.833	1.082
18						1/4	600	1820	3240	152.2	.826	1.092
Average							960	2270	3780	153.2	.831	1.084
19	1-5	.91	0-1 1/4	130.0	.780	10	1380	2600	3460	154.1	.830	1.057
20						5	1170	2340	3460	153.5	.826	1.062
21						2	590	1370	2620	153.2	.824	1.064
22						1	490	1670	2620	153.3	.825	1.063
23						1/2	460	1490	2880	152.6	.820	1.060
24						1/4	460	1520	3150	153.0	.823	1.065
Average							760	1830	3030	153.3	.825	1.062
25	1-6	1.01	0-1 1/4	130.0	.780	10	1280	2370	3510	154.4	.849	1.013
26						5	860	1910	3150	153.2	.844	1.020
27						2	760	1910	3040	153.5	.845	1.018
28						1	440	1450	2640	153.1	.843	1.021
29						1/2	450	1340	2270	153.3	.845	1.019
30						1/4	400	1440	2320	153.0	.842	1.022
Average							700	1740	2820	153.4	.845	1.019
31	1-7	1.10	0-1 1/4	130.0	.780	10	1020	1920	2880	154.8	.857	.991
32						5	780	1640	2790	153.1	.847	1.002
33						2	790	1870	3110	153.8	.852	.997
34						1	480	1420	2160	153.0	.847	1.002
35						1/2	440	1240	2280	153.2	.848	1.001
36						1/4	350	1020	1700	152.8	.845	1.004
Average							640	1520	2490	153.4	.849	1.000
37	1-9	1.32	0-1 1/4	130.0	.780	10	650	1240	2040	154.5	.861	.969
38						5	460	1100	1990	153.2	.854	.977
39						2	480	1110	1980	153.9	.859	.972
40						1	220	720	1370	151.3	.844	.989
41						1/2	280	720	1400	149.1	.831	1.003
42						1/4	260	810	1460	150.0	.837	.997
Average							390	950	1710	152.0	.848	.984
43	1-15	1.94	0-1 1/4	130.0	.780	10	320	530	950	150.0	.843	.963
44						5	250	560	970	149.9	.842	.964
45						2	150	360	570	144.7	.814	.998
46						1	140	460	910	143.7	.808	1.005
47						1/2	110	310	470	142.6	.803	1.012
48						1/4	110	240	390	141.8	.797	1.018
Average							180	410	710	145.4	.818	.993

49	1-5	1.57	0-14	104.0	.624	10	240	490	990	131.6	.665	1.084
50						5	160	380	940	129.0	.653	1.105
51						2	130	430	810	129.3	.654	1.102
52						1	110	280	560	128.0	.648	1.112
53						1/2	70	200	400	126.3	.640	1.128
54						1/4	20	50*	110	125.0	.632	1.140
Average							120	310	640	128.2	.649	1.112
55	1-5	1.51	0-8	110.0	.660	10	280	580	1080	134.0	.688	1.101
56						5	230	550	1200	131.8	.677	1.118
57						2	180	480	920	131.1	.672	1.126
58						1	140	470	1060	132.0	.677	1.118
59						1/2	80	250	490	129.5	.665	1.139
60						1/4	30	100*	230	127.5	.654	1.157
Average							160	410	830	131.0	.672	1.126
61	1-5	1.43	0-4	115.0	.690	10	370	760	1400	137.0	.710	1.108
62						5	310	670	1620	133.0	.690	1.140
63						2	180	520	1060	134.9	.700	1.124
64						1	200	650	1630	135.5	.703	1.119
65						1/2	110	220	610	133.2	.691	1.138
66						1/4	50	180	270	131.8	.684	1.150
Average							200	500	1100	134.2	.696	1.130
67	1-5	1.25	0-3/8	122.5	.741	10	500	1020	2030	141.8	.753	1.114
68						5	460	1090	2100	144.5	.767	1.093
69						2	310	1000	1970	143.6	.762	1.100
70						1	280	1000	2200	142.5	.757	1.108
71						1/2	230	760	1590	141.0	.748	1.120
72						1/4	160	500	1090	147.7	.752	1.115
Average							320	890	1830	142.5	.756	1.108
73	1-5	1.08	0-3/4	126.5	.759	10	840	1700	2830	150.8	.812	1.053
74						5	510	1590	3010	149.6	.806	1.062
75						2	460	1390	2900	150.5	.811	1.055
76						1	380	1300	2640	147.9	.796	1.074
77						1/2	360	1000	2400	147.5	.794	1.077
78						1/4	250	840	1840	146.8	.791	1.082
Average							470	1300	2600	146.8	.802	1.067
79	1-5	.82	0-2	128.5	.771	10	1410	2300	3290	157.2	.867	1.002
80						5	980	2260	3540	156.6	.863	1.006
81						2	790	2020	3320	156.7	.864	1.005
82						1	740	2000	3260	155.5	.858	1.012
83						1/2	560	1780	2700	155.0	.855	1.016
84						1/4	600	1560	2810	149.8	.827	1.051
Average							850	1990	3150	155.1	.856	1.051

\*All specimens broken in removing forms; strengths interpolated from other tests.

**TABLE 5A**  
**A STUDY OF THE TIME OF MIXING CONCRETE**  
 A summary of the values given in Table 5.

Reference No. (See Table 5)	Time of Mixing, Min.	Concrete					
		Compressive Strength Lb. per Sq. In.			Weight, Lb. per Cu. Ft.	Density	Yield
		7d.	28d.	3m.			
Grand Average of All Mixes and Aggregates—Machine-Mixed Concrete							
1, 7, 13, 19	10	1010	1860	2800	148.6	.799	1.068
2, 8, 14, 20	5	830	1750	2830	147.5	.794	1.077
3, 9, 15, 21	2	650	1540	2630	147.5	.793	1.077
4, 10, 16, 22	1	480	1440	2450	146.7	.790	1.082
5,							

TABLE 7

EFFECT OF TIME OF MIXING ON THE STRENGTH OF CONCRETE

Based on 28-day compression tests of 6 by 12-in. cylinders.  
 The values given in the table are percentages of the strength of the same concrete mixed for 1 min.  
 These values may be expressed by an equation of the form  $P = k + n \log t$   
 When  $P$  = percentage of strength of 1-min. mix  
 $t$  = time of mixing in seconds.  
 $k$  and  $n$  are constants, which depend on the mix, consistency, age and other conditions of the test.

Mix	Values Based on Series No.	Relative Consistency, per Cent	Size of Aggr.	Strength at Different Mixing Periods as Compared with the Strength at 1 Min. (P)												Comp. Strength 28 Days 1-Min. Mix, lbs. per Sq. In.	Values of Constants in Equation	
				1/2 m. 15s.	1/4 m. 30s.	3/4 m. 45s.	1 m. 60s.	1 1/2 m. 90s.	2 m. 120s.	3 m. 180s.	5 m. 300s.	10 m. 600s.	(k)	(n)				
1-1	89	90	0-1 1/4	77	89	95	100	106	112	127	138	3200	+32	39				
1-1-1	89	100	0-1 1/4	76	88	95	100	107	112	123	141	2650	+28	40				
1-1-1	89	110	0-1 1/4	81	91	97	100	106	110	123	133	2230	+43	32				
1-1-1	89	125	0-1 1/4	87	93	97	100	104	106	115	122	1750	+61	22				
1-1-1	89	150	0-1 1/4	86	93	97	100	104	107	117	124	1600	+58	24				
1-1	89	200	0-1 1/4	90	95	98	100	103	105	112	118	560	+69	17				
1-2	93	110	0-1 1/4	86	93	97	100	104	107	117	124	3450	+57	24				
1-3	93	110	0-1 1/4	76	88	96	100	107	113	129	131	2700	+29	40				
1-4	93	110	0-1 1/4	81	91	97	100	106	110	123	133	2230	+43	32				
1-5	93	110	0-1 1/4	78	89	96	100	107	112	127	138	1800	+33	28				
1-6	93	110	0-1 1/4	78	89	96	100	107	112	127	138	1550	+33	38				
1-7	93	110	0-1 1/4	76	88	95	100	107	113	129	141	1300	+28	41				
1-9	93	110	0-1 1/4	79	89	96	100	106	110	124	135	900	+38	35				
1-15	93	110	0-1 1/4	62	81	92	100	111	119	144	163	350	-12	63				
1-5	93	110	0-1 1/4	28	64	85	100	120	136	184	222	250	-116	122				
1-5	93	110	0-8	39	70	89	100	120	133	176	208	340	-87	107				
1-5	93	110	0-4	50	75	90	100	114	125	159	184	440	-49	100				
1-5	93	110	0-3/4	79	90	96	100	106	110	125	135	840	+38	35				
1-5	93	110	0-3/4	73	87	94	100	108	114	132	146	1200	+20	45				
1-5	93	110	0-1 1/4	78	89	96	100	107	112	127	138	1800	+33	38				
1-5	93	110	0-2	81	91	96	100	106	109	122	131	1900	+44	32				

[The results of the very comprehensive tests recorded by Professor Abrams are well worth several readings and careful study and comparison. They disclose facts of the utmost importance to all who have an interest in the development of the use of concrete. The outstanding points developed are the effect of time of mixing, the effect of the amount of water used and the curing of the concrete after being placed in position.

It is readily seen that a rational enforcement of each of these requirements will meet with opposition on the part of

that class of contractors, architects and engineers who measure construction service in terms of speed rather than quality. It can be readily seen, however, that the expenditure of more time with an added labor cost is more than compensated for in the added strength and durability of the product.

THE AMERICAN ARCHITECT has on several occasions referred to the dangers of excess water in mixing concrete. Every observing person who has passed under a concrete floor, recently poured, has noticed the results of the leakage from above. The floor below is covered with a coating of cement and ridges of cement from 1/4 to 1 in. high under the joints in the forms above indicate a serious washing out of the cement. It is shown by the tests that excess water weakens the concrete where no leakage occurs comparable to that in building construction and it may safely be assumed that the results in actual practice are more disastrous than under test conditions. The reduction in water content of concrete may require a modification of those placing equipments which require the concrete to be "sloppy." When the necessity of less water is appreciated by specification writers and such specifications become common a suitable equipment will be furnished, although the present-day carts or buggies are entirely suitable.

The consistency of concrete based on the volume of water to cement (1 cu. ft. per bag) appears to be the logical terms to employ as they are the only factors entering into concrete that are not variable in character.

By referring to Fig. 23 it appears that a rate of rotation of the mixer of 18 to 20 r.p.m. produces the best results. Fig. 15 clearly indicates the effect of time of mixing for all mixes tested. It shows an added strength of 250 to 300 lb. per square inch in compression by continuing the mixing from one to two minutes and an added strength of about 500 lb. per square inch if continued for a period of three minutes. As 1-2-4 concrete ordinarily runs this is an addition of 15 and 25 per cent respectively. This would require the use of two mixers in many cases, but the results justify the means employed. By reducing the water content to a minimum workable percentage these gains are conserved, and in no other way. The rule given on page 750 should be constantly kept in mind. The statement on page 776 further emphasizes this point. The importance of curing is summarized on page 780.

While Professor Abrams' program of tests is not yet completed, the results so far obtained evidently justify modifications of specifications for concrete along the lines here indicated, with the result that increased fiber stresses can be used with the consequential saving in materials.]

# Industrial Information

In this Department there is published each week information as to the development of materials and methods, derived from reliable sources.

## Corr Plate Floors

In good technical form and with much scientific precision the Corrugated Bar Co., Buffalo, N. Y., presents an analysis of advantages to be derived from the use of Corr Plate Floors.

In perfecting methods of concrete construction, commercial organizations have developed a product which is helping, in a valuable way, to fill the ever present need for economy and good service. Among such organizations the Corrugated Bar Co. has been active in developing concrete and steel in com-

bination. This has involved a practical, scientific analysis of the action of steel and concrete as used together, and has developed certain workable formulas for rectangular and "tee" beams. The principles surrounding the correct type of reinforcement, it would seem, have been given careful research and consideration by this company. The results of their investigations are printed in handbooks which they state are considered standard works of reference and have been translated into six important foreign languages.

The Corr Plate Floor is a flat slab, two-way sys-



tem, characterized, the makers put it, by its particularly efficient method of distribution of the reinforcement so as to conform to a variation in moment that is necessarily gradual in whatever direction this variation may be considered. It combines economy of material with simplicity of construction. It does away with the need for beams and girders. This affords a smooth ceiling and reduces largely the number of sprinkler heads required. Windows can be built clear to the ceiling, admitting more light and affording better ventilation. By its use space is saved. From one to one and a half feet is gained in every story, which may amount to a story in height for about every eight. It can be erected quickly and at low cost, not only because of the simplicity, but also due to the fact that the element of safety is practically uniform throughout, there is saving in the quantity of material used, both in concrete and in reinforcement.

This company offers architects a definite guaranteed service insuring safety, economy and patent protection, without imposing the use of its own materials. Details may be obtained by addressing the Corrugated Bar Co., Buffalo, N. Y.

### Pine and the Architect

The surest way to increase the consumption of any material is through well-directed campaigns of education in its use. A commodity that can be used in any undertaking, from the smallest to the largest, has a universal adaptability. There is often, however, failure to avail of it through ignorance of its application or its adaptability to various purposes.

Take, for example, the propaganda of the Southern Pine Association, sent forth from its head offices in New Orleans. Most men believe they know all about wood. If they desire to test themselves on this subject let them send for one or all of the many pamphlets the Southern Pine Association publishes, and check up their knowledge.

For instance, there is a large and fully illustrated pamphlet on creosoted wood block pavements. How desirable are such pavements, how extensively are

they laid? What is the cost of laying and of upkeep? What are the sanitary advantages? Find the answers to these and other equally pertinent questions in this pamphlet.

Mill construction is coming into its own. Get the pamphlet "Heavy Timber Mill Construction Buildings." It is written by an engineer; full of facts, diagrams and illustrations. It is a guide and handbook to be had for the asking.

How can you most economically and safely use wood in interiors? Two pamphlets answer that question: "The Interior of Your Home" and "Beauty Plus Service in Floors." The first illustrates actual interiors, tells of the best and most artistic finishes and gives colored plates of these finishes. The second is a handbook on floors.

Other equally instructive pamphlets are published by the Yellow Pine Association: "School Architecture" contains many suggestive plans and good elevations. "Implement Sheds"—the farmer no longer leaves his machinery out of doors all winter; he has learned better. "Service and Economy in Building," full of facts and interesting illustrations. And a brochure, "Facts Worth Knowing About Turpentine," which makes good its title.

This series of pamphlets puts the user of pine in full possession of an encyclopaedic knowledge and as there is reliability and a long and honorable reputation back of the company that sends them out, they can be read and digested with much profit and increase of knowledge of a specific material.

### Standard Textile Products Co.

Announcement is made that the corporate name of the Standard Oil Cloth Co. has been changed to the Standard Textile Products Co. The object of the change is to designate more comprehensively the various kinds of products manufactured and marketed by that company. Its organization and management will remain as heretofore and is in no way affected by this action. Headquarters continue at 320 Broadway, New York.





4  
2  
1  
102

# The AMERICAN ARCHITECT



IN THE GARDENS OF THE VILLA D'ESTE



PUBLISHED WEDNESDAYS IN NEW YORK—FOUNDED 1876

VOLUME CXV

JANUARY 15, 1919

NUMBER 2247

Entered as second class matter January 6, 1909, at the Post Office at New York, N. Y., under the Act of March 3, 1879. Publication office, 243 West Thirty-ninth Street, New York, N. Y. Subscription price in the United States and Possessions, \$10.



A Bishopric-Board Home at Stamford, Conn.

Architects, Patterson &amp; Dula, New York City

## "I absolutely guarantee all Stucco Work done by me on Bishopric Board"

So wrote one of St. Paul's prominent contractors. Furthermore, he says, "I consider it the only lath that will stand dampness and changeable weather."

Absolute dependability is the reason why Bishopric Board today is specified and used by architects, contractors and builders all over the country.

It builds reputation, secures confidence, promotes more business. Bishopric Board **makes good.**

The construction of Bishopric Board is simple. Its advantages are obvious. Building principles and materials that have withstood the test of centuries are combined in Bishopric Board.

Creosoted dovetailed lath imbedded under terrific pressure in Asphalt Mastic on a background of heavy fibre-board—that, in brief, is Bishopric Board.

The creosote preserves the lath—the dovetail locks the stucco so it can't let go—the Asphalt Mastic

on the fibre-board deadens sound and is proof against vermin, water, and weather changes.

Bishopric Board can be used with or without sheathing and when nailed securely to framework forms a background that can't sag or break away, causing the stucco to crack and flake off.

Bishopric Board insures satisfaction. Don't be contented with anything less. Use a background you can **guarantee absolutely.**

### The Bishopric Manufacturing Co. 904 Este Ave. Cincinnati, O.



Write for our free book, "Built on the Wisdom of Ages," illustrating homes, apartments, factory and public buildings, finished in stucco on Bishopric Board. It contains letters from architects, builders and users, and extracts from reports of scientific tests. It also gives full instructions for making a stucco mixture that will last. With this book we send free samples of Bishopric Board.

Write today, investigate for yourself, be convinced.









CLOISTER OF THE CATHEDRAL, TARRAGONA, SPAIN

# THE AMERICAN ARCHITECT

VOL. CXV

· WEDNESDAY, JANUARY 15, 1919

NUMBER 2247

## Architecture After the War

### 2. Organization

By C. H. BLACKALL, *F. A. I. A.*

BY organization I mean the association, grouping or incorporating of two or more persons in such way as to produce the best architectural results, considering architecture as a business, an art and a science. The architecture of today has always this triple nature. A failure to recognize this trinity means a limited or imperfect output constituting a restriction not only on the individual but on the profession as a whole and on the public. This triple nature cannot be too strongly emphasized, because in the natural specialization which comes in every business each individual is apt to forget the other's point of view and the exact balance between the three considerations is by no means easy to maintain. It ought to be accepted at the very start that no one man can do it all and do it right. Many single men can assume a leadership, can direct the forces, but in the very nature of things it is possible for one man to do the whole even if only because of the mere physical limitations; and whether the organization consists of one man with a number of hired assistants, whether it is a partnership of two or more, or whether it is a great co-operative enterprise such as has been tried in some instances where everyone down to the office boy shares in returns and responsibility, in any of these cases architecture is not the result of one man's energies or application, but must be considered as a combined output, as a group effort.

I am not assuming that this group effort, this recognition of the three sides of architecture, is a new idea. On the contrary it has been developed and carried to a thoroughly efficient and successfully complete organization by some firms for many years. But the point as I see it which ought to be emphasized is that this triple arrangement has in the past come about as an expedient rather than as a principle and that the great majority of architects are still clinging to the idea that the architect must do it all, that architecture is one, and that therefore an architect who gives up any part of the architectural prerogatives to another is by that degree less faithful to his profession. It seems to

be pretty generally considered that from a business standpoint a division of work means an increase in the profits and a greater share of efficiency, satisfaction and economy, with also much larger profits. But there are still many architects, probably including the majority of the average practitioners, who feel that this is applying shop methods, that this means an architectural mill, that thereby individuality will be sacrificed and the architect will be degraded by seeking the level of the commercial man. I cannot feel any sympathy with this attitude. If there was any man who believed in co-operative, co-ordinated effort it was Mr. McKim, and his spirit of co-ordination was so strong that years after his death the school of architecture which was represented by his office and business associates is still able to keep up the high standard of work which he set, notwithstanding the fact that he was not at all what would be called a clever draughtsman or designer, nor a remarkable business man, and certainly not an engineer. But he recognized in advance of these times that the best result is obtained by co-operation, by several individuals pulling together and by a certain surrender of one's self to the group. There was also the case of Mr. Burnham, who was eminently a business man, but he, too, recognized the triple nature of architecture, and the organization which he effected was able to turn out a very high grade of work and turn it out in a very businesslike, practical, scientific, as well as artistic manner. The example might be multiplied indefinitely, and yet notwithstanding the manifest successes of men like McKim or Burnham we are constantly meeting the architect who denies that architecture produced by an organization can be a fine art, that the practice of architecture can be good and at the same time businesslike, that a man can be professional and at the same time be a business man and a poet. So what we need to-day is the awakening of the average practitioner. The big firms will take care of themselves. They will gravitate of necessity to an efficiency in organization, but after all it is the average man that makes the senti-



## THE AMERICAN ARCHITECT

ment of the community, and it is this average architect that needs to appreciate the false position in which the profession has put itself in the past as well as the opportunities for a rebirth and a recount of possibilities to-day.

When I say that it is the average man we wish to influence, the answer will naturally be that the average man has not a sufficiently large practice to be able to share it with two or more others, that very many of our architects who are strong in design never have more than one or two jobs at a time, and that it does not call for sub-division of responsibility and effort. I am not so sure about that. One architect comes to my mind now who has never had a large business and it is doubtful if he has ever been upon more than three jobs at any one time with an aggregate cost of over \$75,000, and yet I was interested to see how he recognized and wrought out this triple side. The getting of the job, the talking with the client and the talking with the contractors on general matters he did himself. He had one draughtsman whom he held responsible for the entire running of his office and the business end of his affairs, and then he depended entirely, and very wisely, upon the builder for the scientific side, calling in an engineer for special occasions. He frankly admitted his personal job was the artistic and the directing, and his work always went smoothly, his clients were satisfied and his buildings never fell down. Incidentally, he made a comfortable living every year. Now I claim that any man with a business of \$100,000 a year or more ought to organize in this triple capacity even if it is only to share responsibility with a typewriter and an office boy, but recognize that there is this triple side, to be prepared to treat the practice of architecture accordingly, and if the man has any real ability at all his practice will not stay down to \$100,000 a year very long.

I believe that the very mental attitude which will prompt an architect to say: "I do not know all the details about this, see Mr. So and So, my assistant, or my partner"—is one which would inspire confidence in builders and owners, for it would show a recognition of the necessity for care in decisions and a willingness to acknowledge limitations. It would not be a derogation of an architect's professional capacity in the slightest degree and I cannot believe that there is any architect so stuck on himself that he would not take more comfort and more pride in being an important factor in large results than he would in being monarch of all he surveyed on a small island. I think in the past architecture has sometimes suffered by a species of what the builders are apt to term "swellheadedness" on the part of the individual who tries to do it all and that attitude is one of the worst that could

happen because it offers a bar right at the very start between the men who carry out our ideas and ourselves, and surely no one who has ever had any experience with co-operative effort and will honestly look on it as a question of efficiency would ever want to go back to doing it all himself.

In fact, it is the man in business for himself without associates, who cannot do everything himself, but has to try to do it, who is responsible to a very large degree for the present public point of view toward architecture and architects. There are many architects who can devise excellent color schemes, are connoisseurs of a bit of wrought iron or an architectural ensemble, who have unwittingly spread the idea that that is real architecture and that the real architect is above anything else. Again there is the other kind who has a real scorn of all things artistic, who prides himself on his engineering or business ability and thinks he has compassed the range of architectural possibilities when he has built his buildings securely and so that they will make money, even though they may be architectural atrocities. Neither of this kind ought to be in business for himself. They should in each case be joined with others who would supplement their own lack and would enable them to be part of an organization rather than to act as an individual. Everybody cannot be an architect and the quicker we recognize that fact the better, but the number who can take an honorable and very important part in an architectural organization is growing larger each year and there is no lack of good material right at our hand if we once get away from the foolish idea that architecture is nothing but a fine art.

I purposely avoid personal details of how to run an office. A lot might be said on that score, some of which I propose to take up later. They are largely personal matters and do not affect the general proposition of architecture after the war, which is increasingly a matter of group treatment and involves the three-sidedness of our calling which must be carried out to the full limit if we are to hold our own in the very exacting conditions of today. As I said before, many of the large offices are already recognizing and carrying out these very principles. It is for the profession as a whole not only to carry them out but to admit by word, by precept and practice that the individuals are a part of an organization which shall always be a business concern first, a scientific construction firm second and a poet and architect last, not that these always have the same relative importance because that varies nearly with every kind of building.

The third element is the one which makes the others worth while; the second is what makes it possible; and the first is what put the whole into logical, efficient execution.



# The Architect of Tomorrow

By ALFRED H. GRANGER, *Captain of Engineers, U. S. A.*

ONE evening, quite recently, four men were dining together at the Shoreham Hotel in Washington. All are in the service of the Government, having been drawn in by the emergency of the great war. One was a professor of one of our largest universities, now acting as an assistant secretary of the Treasury; one a noted Boston architect, acting as a vice-president of the United States Housing Corporation; the third, a civil engineer of more than national reputation, now a major in the Engineer Corps, serving on the staff of the Chief of Engineers, and the fourth a Chicago architect, serving with troops as a Captain of Engineers; thus New York, Philadelphia, Chicago and Boston were gathered together. The armistice had just been signed, and men everywhere had begun to talk of readjustment—the getting back to normal civil life. As, with the exception of the assistant secretary of the Treasury, all were vitally interested in building and construction, the main topic of conversation was the future of the building industries in America. The Boston architect started the discussion by saying to the secretary, "Do you think, sir, there will be any use for architects in the immediate new world?" This question acted almost like a bombshell upon the minds of the engineer and the other architect; the discussion was long and earnest, and the conclusions arrived at were so interesting and so pertinent to the very life of the architectural profession that they should be openly discussed now before it is too late.

At the very beginning of their talk these four men, from the four most important centers of America, found themselves in absolute agreement on the fact that architecture, as a profession, does not stand in high repute with the heads of the various departments of the Government. This is a most unfortunate state of affairs, but it is none the less true, as many of us who have been working in Washington for the past fifteen months have found out to our sorrow. Why is it? That is the question which must be satisfactorily answered if architecture as a profession is to take the place in the new world which is rightfully its own. We all know, we architects, that there is no one body of men more whole-heartedly devoted to public service. When we entered the war architects from all over the country, individually and as a body, gave up all thought of private work and came forward to enlist in the great cause for which the country was fighting. After the passage of the draft law one of the first problems facing the War Depart-

ment was how to provide for the training of the great army. Up to that time the constructive operations of the army had been handled by two divisions—fortifications, roads, etc., by the Engineer Corps, and such purely building operations as were needed by the Quartermaster Corps. It is not my intention here to go into the story of the development of one section of the Quartermaster Corps, first into the Cantonment Division, Q. M. C., and later into the Construction Division of the United States Army, which has successfully carried on a building operation involving the expenditure of almost one billion dollars without waste, without any excess profit, and, which is paramount in war times, without delay.

On the staff of the Construction Division are architects from almost every section of the country, serving because the commanding general could not carry on his work without their services, while the Committee on Emergency Construction, which has borne the responsibility of selecting contractors for all this work, has been under the chairmanship of Col. William A. Starrett, of the architectural firm of Starrett & Van Vleck, who had serving with him all last winter Capts. K. M. Murchison and A. H. Granger, both architects. During the winter of 1917-18 Colonel Starrett, working with a committee of the American Institute of Architects, drew up a form of contract between the United States Government and ———, architect, by which the services of the architect could be used in preparing plans for the various types of buildings needed to carry on the war. This contract was submitted to the Secretary of War, but was never adopted. Why? Another question to be answered. One would naturally think that the Government would be eager, in such an emergency as then existed, to avail itself of the services of such a body of technically trained men as the architects of America, but, alas! it was not and is not so. Members of the various engineering societies offered themselves and were eagerly accepted; oftentimes the Government did not wait for them to offer, but summoned them from civil life, commissioned them without delay and put them to work. There is no single instance of an architect's having been specially sent for.

It might be said that most of the building problems were straight engineer's work and not architect's. There we near the root of the question which we all must face if we are to meet the problems of the immediate future. The engineer today

## THE AMERICAN ARCHITECT

is in demand because he is practical, he is economical and he is honest, and by honest I mean that he tells his client the truth. I do not for one second imply that the architect has not these qualities when I say the engineer tells his client the truth. I simply mean he estimates properly because he knows actual costs, which 85 per cent of the architects today do not. Another reason why greater dependence has been placed upon the individual engineer than upon the architect in the more recent Government operations is because he seems to be in closer touch with the contractor, the actual builder, who, after all, in the mind of the man or corporation or government who is to spend the money, is the man who counts.

Properly to house the great national army during its period of preliminary training, it was necessary for the War Department to build thirty-two cities, each with a population of approximately forty thousand people, and to build these cities in the short period of three months—and it was done. It is obvious that work must have been begun before any plans could be developed far enough for even tentative bids to be made. How this was done has been graphically described in a series of articles by Colonel Starrett in the *Scientific American* for Sept. 7, 14 and 28, 1917, but in these articles the point of most vital importance to the architect has not been touched upon, and that is that from the very beginning the architect, the engineer and the contractor have worked together as one man, a veritable trinity. I believe that this union of the three types necessary for the solving of modern architectural problems has shown us the path we must follow if we are to continue to exist as a great and vital profession.

For the past twenty-five years the architects have devoted themselves more and more to the single problem of design, and of late years the problem of design has largely developed into the preparation of beautiful, elaborate and extremely costly drawings. The system of competitive bidding has been largely responsible for the elaboration and cost of these drawings, because the architect, in order to save his client the danger of expensive extras and yet preserve the, to him, essential beauty and integrity of his design, has been compelled to show every little detail of ornament and construction by carefully prepared drawings so that the contractor cannot by any chance omit from his estimate any of these details.

The preparation of such complete drawings involves so much time and study and thought that their prime purpose, to act as guides to the building of a building, has gradually been lost sight of, and that is why so many of us suffer such keen disap-

pointment when we make a pilgrimage to see a building or group of buildings of which we have seen the preliminary or competitive drawings.

Before the Renaissance, during the Gothic period, buildings were erected which stand to-day as examples of wondrous beauty, but the names of the men who designed these buildings are unknown. With the advent of the Renaissance came the birth of the individual architect who created the profession of architecture as a profession apart from that of builder.

"In the elder days of art  
Builders wrought with greatest care  
Each remote and unseen part  
For the Gods see everywhere."

Today we face the dawn of a new world. The hordes of autocracy have been beaten to their knees and mankind at last faces freedom. This is what we believe; it is for this that the civilized nations of the world have so freely offered up their dearest and their best. A witty Senator recently remarked, "Now the war is over, real trouble begins."

Had he said, "Now the war is over, real work begins," he would have been nearer the truth. Real work is before us, work calling for the best in every one of us, and in this work of construction and reconstruction no man has a more vital or more splendid part to play than the architect. Will he do it? I firmly believe that he will, but to go back to the discussion at the Shoreham and the conclusions there arrived at, there are certain things that must be done, certain new relationships to be arranged before the best results can be achieved. The architect must not consider himself like a Brahmin, a sect apart, but must draw to himself his two brothers, the engineer and the contractor in the closest possible association. The American Institute of Architects, the American Societies of Civil, Mechanical and Electrical Engineers and the American Contractors' Association should unite into some sort of federation somewhat on the League of Nations idea. All three are primarily builders because the supreme function of each is to produce buildings that shall show to future generations what our civilization stands for. We study human history by means of the buildings of past ages, and we want the ages to come to understand the efficiency, integrity and beauty of our age by the buildings we leave behind us.

I have not in this paper attempted to suggest the type of association to be formed among the three great building professions, but only pointed out one fundamental fact, which the architect must bear in mind, if he is to function properly in this new era of the world, and that is that he is primarily a



## THE AMERICAN ARCHITECT

builder of buildings, and by those buildings he must be judged.

Two names stand out as creators of buildings in the annals of our great profession in America, and those names are H. H. Richardson and McKim, Meade and White, and I believe one reason of their pre-eminence is due to the fact that their buildings today possess distinction, not only because they were so carefully and so lovingly designed, but because they were so supremely well builded. Let us cease to be artists and become builders, losing our desire for individual fame in the greater desire of perfect production and our future in the new world is assured.

---

### Reconstructing Architectural Practice in England

The following extract from the address of Mr. Henry T. Hare, president of the R. I. B. A., will undoubtedly be read with interest by architects in this country.

Mr. Hare stated in part:

We stand today at the threshold of a new era. Our whole system and scheme of life has been dislocated and virtually destroyed. Industry, commerce and society must be reconstructed and reconstituted on a new plan to meet the altered conditions. We have the opportunity of making a new beginning, and it is for us to approach the complex problems which face us, with open minds.

Reconstruction is the comprehensive word which expresses the problem which faces our country in every industry, calling and profession. In our own case the practice of our art during these years of war has been almost entirely in abeyance. We have had to submit to restrictions—and we have done so cheerfully and willingly—greater than those imposed upon any other profession. Our younger members have with one accord diverted their energies from the arts of peace to those of war, and while we are proud of what they have accomplished, we remember sadly and gratefully those who have fallen in the struggle. We shall welcome those who come back to us and endeavor to make their return to peaceful occupations as easy as may be.

I have alluded to the restrictions which have been placed upon our work, which have borne very hardly on most of us. We have submitted without complaint because we knew that it was necessary and essential to divert the whole energy and resources of the Empire to the one purpose of defeating a thoroughly organized and well-prepared enemy. With the restoration of peace that neces-

sity will exist no longer, and we feel that we should not be asked to bear longer than is vitally necessary a special burden which other members of the community do not share. \* \* \*

During the period of inactivity in the legitimate exercise of our profession, we are taking the opportunity of inquiring into the status of the architect. It is felt that, although the course of study and attainment required to equip an architect to carry out his duties efficiently is at least as severe as that required for other professions, from many causes the general public do not appreciate his position adequately. A very large amount of building is carried on either without an architect or under an entirely unqualified practitioner, thus bringing the entire profession into disrepute and leading to many abuses.

Is there any means by which the building public may be enabled to distinguish between the qualified and the unqualified?

Is it practicable, short of actual compulsion, to insure that every man who seeks to enter the profession shall be properly qualified by education and training to carry out the duties of his position to the satisfaction of his client and the benefit of the community?

Have we, hitherto, properly correlated and adjusted the relative importance of the practical business and scientific side of our work with the historical and artistic aspects?

Can any steps be usefully taken to organize and unify the profession?

These and kindred questions are now being carefully considered, and the views of those competent to give opinions are being collected and noted with a view to so ordering the policy of the Institute as to lead to a general improvement in the position of the profession.

In this connection it is felt that architects have not hitherto adequately taken their part in public affairs, on many aspects of which they are peculiarly qualified to speak. We ought to have our representative in Parliament, and there are few local bodies which would not be strengthened by the addition of an architect member, who would concern himself with the building projects of the district and its amenities.

I would have every new building or public improvement subject to the criticism and to some extent to the control of such a body. Here is a wide field for the activity of architects, and one which would enable us to forward the education of the public in artistic questions which are generally lost sight of and submerged in the purely practical and utilitarian aspect.



# The Arch of Democracy

## Brooklyn, New York

By FRANK J. HELMLE OF HELMLE & CORBETT, *Architects*

“OUR men will give a good account of themselves,” declared General Pershing to Clemenceau just before their appearance on European soil. “Your men fight like veterans,” exclaimed Marshall Foch after the first American advance. Our 200,000 boys from Brooklyn and Long Island have earned this praise by nobly doing their part in winning the great war. These boys—our boys—are coming home to us, some of them maimed and blinded, and bearing the



THE ARCH OF DEMOCRACY TO BE ERECTED IN BROOKLYN, N. Y.  
HELMLE & CORBETT, ARCHITECTS

## THE AMERICAN ARCHITECT

marks of privation, yet joyful that they have done their share for humanity and democracy. Are we going to do our part fittingly to receive the living heroes, and pay our reverent tribute to the memory of the dead? Never before in the history of the world has there been a war like this, and never before has there been presented to the citizens of Brooklyn and Long Island such a splendid opportunity to do a fine thing in a magnificent way.

Traditions have been overturned, old modes of

standing columns surmounted by statues of the eight great military leaders of the war, Foch, Joffre, Petain, Haig, French, Diaz, Albert of Belgium, and our own Pershing.

The frieze presents various military scenes and incidents and the entablature bears appropriate inscriptions. Below the richly ornate cornice are six circular medallions bearing the portraits of the great statesmen of the war, Lloyd George, Clemenceau, Poincaré, Orlando, Ishii, and Wilson. The



PLOT PLAN SHOWING LOCATION OF ARCH OF DEMOCRACY

thought become obsolete, social lines and standards deleted and utterly destroyed. Out of this conflict has been born the triumph of Democracy, and a monument to commemorate the event should fittingly tell the story.

The arch, as designed by Helmle & Corbett, is a structure of magnificent proportions, 40 feet in span and 70 feet in the clear, springing from two huge pylons 36 by 36. The entire structure will have a height of 130 feet. The top will be crowned by a colossal group typifying the Triumph of Democracy. It will be represented by a figure of Victory driving a chariot drawn by six superb horses.

Flanking the central structure are eight free

spandrels bear symbolic representations of the military forces of land, sea and air.

There are six huge niches on the faces of the pylons which will contain heroic figures of soldiers, sailors, marines, engineers and others on whom the real burden of the war has rested. Within the arch upon two panels will be reliefs, the one representing the industries which have so admirably contributed to the success of our army, the other representing all those forces and agencies which have ministered to the comfort of the victims of the war. Here will be a tribute to the Red Cross, Young Men's Christian Association, Knights of Columbus, Salvation Army and the other similar organizations.





# An Honor Roll Memorial in Chicago

THE background wall of this memorial will carry tablets arranged to receive the names of the sons of Chicago fallen in the war, placed in general accord with the main organization of the

this shaft is to be a figure of Chicago, symbolic of the purpose of the city in the dedication of her energies to the war.

At the base of the obelisk, to the right, there will

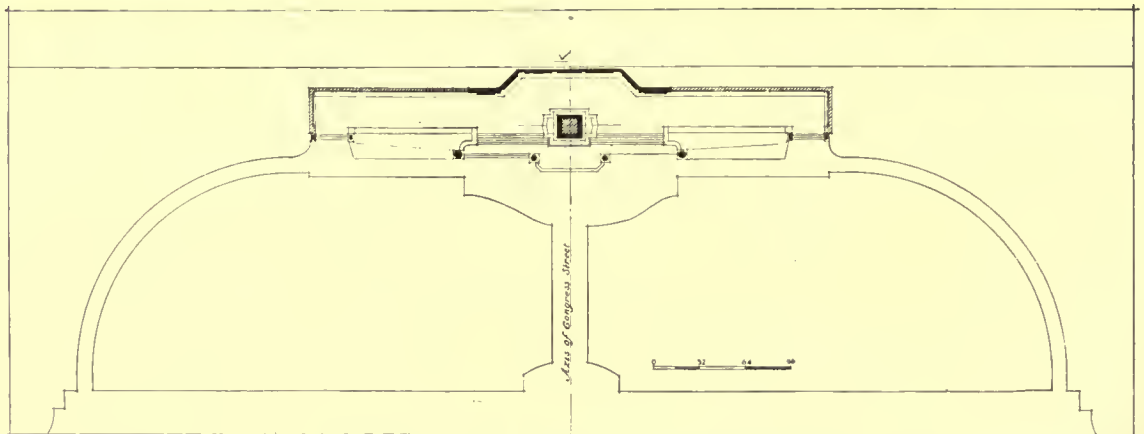

HONOR ROLL MEMORIAL, CHICAGO, ILL.

EDWARD H. BENNETT, *Consulting Architect*  
CHICAGO PLAN COMMISSION

Army and Navy, the tablets to be separated by sculptural decorations of symbolic character. In front of these tablets there will be a space about twenty feet deep to serve as a walk for the visitors.

In the center will be a shaft or obelisk form 65 feet in height emblematic of the city. In front of

be a group representing the Army and to the left one representing the Navy. The lighting will be a special feature.

The monument and its grounds, although temporary, will help in the determination of any future scheme of improvement of Grant Park extending the work already begun north of the Art Institute.



THE AMERICAN ARCHITECT

Founded 1876

PUBLISHED EVERY WEDNESDAY BY

THE ARCHITECTURAL AND BUILDING PRESS, INC.

No. 243 West Thirty-ninth Street, New York

E. J. ROSENCRANS, PRESIDENT AND TREASURER  
WILLARD C. HOWE, VICE-PRESIDENT

WILLIAM H. CROCKER, Editor

ARTHUR T. NORTH, Engineering Editor

Subscriptions in the United States and Possessions,  
Mexico and Cuba, TEN DOLLARS. Other Countries,  
TWELVE DOLLARS.

SINGLE COPIES (Regular Issue) 25 CENTS

CHICAGO OFFICE, Malters Building

PAGE A. ROBINSON, Western Manager

ST. LOUIS OFFICE, Wright Building

CLEVELAND OFFICE, Guardian Building

SAN FRANCISCO OFFICE, 320 Market Street

Owned by United Publishers Corporation—H. M. Swetland, President;  
Charles G. Phillips, Vice-President; W. H. Taylor, Treasurer;  
A. C. Pearson, Secretary. Entered as second-class matter January  
6, 1909, at the Post Office at New York, New York, under the Act of  
March 3, 1879.

VOL. CXV JANUARY 15, 1919 No. 2247

The Architect of Tomorrow

“WILL there be any use for architects in the immediate new world?”

In the article by Capt. Granger, “The Architect of Tomorrow,” on page 91 of this issue, will be found this question, asked of an Assistant Secretary of the Treasury by a Boston architect and followed by an account of the discussion that this “bombshell” of a query provided. It is an accurate and profound presentation of an important matter.

No man intimately acquainted with conditions affecting the practice of architecture in the past or present, or with their probable effect on the future, will disagree with the arguments set forth. Nor, if he is thoroughly alive to the importance of these matters, will he fail to approve of the remedies proposed.

Here we have four men, from the four most important centers of the United States, each in accord with the opinion that architecture as a profession does not stand in high repute with the heads of the Government. Just why this is so is very clearly set forth, and the remedy for such a condition is as lucidly presented.

Why was the contract agreement between the Institute and the United States Government never brought to adoption? Why were engineers in such great demand that no time was lost in searching them out from civil life and offering them attractive

opportunities? The answer undoubtedly is that engineers have always been closely identified with their work, have shown either as an organized body or as individuals that they were practical men. They did not rest in the seclusion of professional dignity at the time we entered this war, nor had they failed in the period before we commenced hostilities to show their ability to carry forward everything they undertook.

There is no blame that can be laid on individual architects, as there can be no individual claims by engineers for this state of affairs. The whole fault is one of organization and lack of proper representation.

AS shown by Colonel Starrett in the article referred to, from the very beginning when the architect, the engineer and the contractor “worked together as one man, a veritable trinity,” they achieved the greatest and most successful results. All of which points directly to the contentions made in these columns now more than a year ago, that the architect is primarily a builder of buildings, and that if he is to function properly he must have, either of his own knowledge, or lacking that, by partnership with other men, the ability to render clients every service that will efficiently originate and carry to completion the work undertaken.

This is rapidly becoming an age of alliances, a period where men working toward a common purpose will find in a federation of interests the only successful solution of their many problems. The seclusion of professional dignity, the assumption of an autocracy of occupation no longer awes a world that is to-day more practical than ever. Now, as never before, will there be a survival of the fittest, and the fittest will be those who will have been willing to see the unmistakable trend of public opinion and so conform with it as to ride on the high wave of a demonstrated adaptability to a station of professional success. A federation of the architects, engineers and contractors, such as is proposed, is one that should receive the most thoughtful consideration.

There will be no diminution of dignity on the part of architects in such an alliance, but, on the contrary, there will be a very large accession of respect from the lay world for a profession that will, thus organized, combine in itself every element making for the highest efficiency and the most practical and valuable results.

ASK any one of that large and important body of architects who during the time that we were at war served in the various departments in Washington where their abilities were in demand,

## THE AMERICAN ARCHITECT

and we think it will be disclosed that with scarcely any exception none of them were at any time engaged in either planning or designing of structures; their activities were directed wholly along lines of the most practical executive work. They were engaged in research into every phase of building construction. They were occupied with the questions of cost and the location of materials and the quickest and surest methods of their assembling. Ask them if they considered that they were practicing their profession, and it is believed that they will tell you, and with considerable emphasis, that it is their opinion that they have not only been practicing the profession of architecture, but that they have been engaged in the highest development of that profession, and in a method that will in the future guide and control all their activities as architects.

These men have been really practicing architecture for the Government, and it is not to be supposed that the practice of architecture for the individual client will in the future be very greatly different. None of the men who have filled these important positions have become any less artistic, but, retaining all those fine appreciations for the artistic side of their profession, they have added under the most rigorous training a post-graduate course of the highest efficiency. It will be to this type of man that the profession may look for the best and wisest counsel when the subject of the readjustment of architectural education is to be considered, and it will be a serious error if their words of wisdom are not hearkened to and their counsel followed.

### Improving Farm Buildings

LETTERS received from almost every state, each one expressing warm endorsement of the proposal to make well organized effort to improve the character of farm buildings, indicate that this subject is one of nation-wide interest.

In a few states, action looking toward reforms has been taken at one time or another, but these movements, like many another, have been suspended for war activities. At the present time when the whole world is actively preparing for readjustment to normal conditions, there may well be included in the general program some provision for a reform which, with industrial housing, is among the most important we now have to consider.

The proposal that each state appoint a commission to be composed of architects, agriculturists, builders and realty men, is meeting with general approval. A commission so constituted could

work intelligently and to some purpose. Formed at this time, it would have ample opportunity to organize, outline a program and be ready for a practical demonstration of its work by Spring.

The effort necessary to set afoot such a reform is so small that it is to be hoped there will be no further delay on the part of the various states, particularly those wherein agriculture plays a prominent part.

### War Memorials

THE subject of permanent war memorials is being considered in the artistic press, and it is encouraging to those who seek the best expression in these things to learn that the preponderance of opinion is strongly in favor of memorials which combine utilitarian features with artistic merit:

The types range from the usual memorial museum and library, of which we have many—good, bad, and indifferent—to community buildings, town halls, out-of-doors theaters, swimming pools and recreation centers. All of these have features that will commend them to different communities.

One encouraging indication is the general disfavor into which the Civil War iron statue atrocity has fallen. There is small danger that the country will again suffer such an affliction. If those who have stayed at home have no better artistic perception than to favor this type, it is very certain that the men who went to France and have returned have imbibed ideas of good art that will safeguard us from these "memorial monuments."

The temporary memorial such as the larger cities will build to serve during the occasions when returning troops are welcomed will not be considered in the same way as those built for permanency. Many of these so far built do not commend themselves to good artistic taste, but they will serve their purpose, disappear and be forgotten.

A memorial poorly designed and lacking in the essentials of good art is really a slight put upon the memory of the men it seeks to honor. Everywhere in this country where it is proposed to erect such a thing there should be some competent authority to pass judgment on its merits. As these memorials are in honor of soldiers and sailors, why, then, should not the Army and Navy Departments have some voice in approval? In case of doubt, we have a competent National Art Commission as a court of final decision.

Let us be slow and sure with our memorials, and not leave to posterity examples of our bad taste in these matters.



# Criticism and Comment

*The Editors, THE AMERICAN ARCHITECT:*

I regard the suggestion of an allied conference very timely and agree with you that the architects of the country should be willing to assist in every way possible in the reconstruction work abroad. An allied conference of architects, such as you suggest, would, I believe, be productive of inestimable good for all concerned. To assist with practical suggestions having in view the requirements abroad, also what this country is best equipped to help with, should prove of real assistance to architects in Europe. The engineers, I believe, have already had a meeting of the kind; surely the architects ought to do their share.

Perhaps the question could be put to some of the foreign architects whether or not such help from this side would be welcome. I dare say they would accept with alacrity. At any rate, I think your suggestion should be acted upon with energy.

ALBERT KAHN.

Detroit, Mich.

*The Editors, THE AMERICAN ARCHITECT:*

We approve the principles set forth in "The Practice of Architecture" appearing in your issue of November 27. These principles, in the main, have always been the practice in our office.

We believe our service to the owner required us to prepare complete plans, drawings, details and specifications, including structural and heating plans of the proposed building, and to be morally and financially responsible for the completeness and accuracy of these drawings and specifications.

We think you will find upon investigation that there are many offices in which the preparation of complete and accurate drawings and specifications is the rule, and that these offices acknowledge and feel their responsibility. We also know there are many offices in which the rule seems to be to prepare as few, and to assume as little responsibility, as possible, and often the more careful and accurate architect does less business than the careless and incompetent one. The public has had really no opportunity to distinguish between the accurate and inaccurate architect. The explanation for this lack of real knowledge and appreciation of the skill and business ability of the careful and conscientious architect can be found, we believe, in the present methods of carrying out the work after the drawings and specifications are prepared—the practical separation of all that relates to the preparation of

the drawings and specifications from the actual construction and erection of the building. The owner sees and knows but little, and the public not at all, of the days and nights of concentrated study required in the preparation of the drawings and specifications. They do see, however, the construction of the building as it goes up, how nicely each unit or part members with its neighbor, how smoothly and systematically the work progresses, and a sign with large letters, fastened to a prominent part of the building, giving the name of a contractor and engineer. True, the architect visits the building regularly, but he is practically a stranger. He probably does not know the name of a single mechanic engaged upon the work. Indeed, he may not even know the name of the foreman, as all of his instructions in regard to the work are given to the contractor in writing. And so the author of all of this great work, in whose brain the building originated and who carefully and accurately illustrated it so that the contractor could properly carry out the work is known appreciatively to only a few, while the contractor and engineer is known to every one because they see his sign on the building and because they see him "doing things."

The architect conducts his business in accordance with the present code of ethics, but this code does not bring a just reward to the able and conscientious architect, nor does it prevent the incompetent architect from often securing the greater rewards.

The solution of the problem, it seems to us, requires that the architect shall be intimately connected with the construction of the building. It must be in a way so that the public must know that he not only prepared the drawings and specifications, but that he also built the building. His name must be the principal one associated with its construction. We can then trust the public quickly to separate the competent from the incompetent.

If we understand it, the fourth and fifth paragraphs under discussion contemplate this closer connection with the construction of the building.

Pardon this quite lengthy letter, but we desire not only to approve these principles of architectural practice, but to also urge, as we see it, a closer practice, but also to urge, as we see it, a closer construction of the building. Just how this is to be accomplished, whether the office of the architect should be organized so as to take over the work of the builder, we are not prepared at this moment to say, although we cannot but believe it is the sensible and logical thing to do. MORGAN & DILLON.

Atlanta, Ga.



# Recent Legal Decisions

## EXTRA WORK AND ADDITIONAL WORK

In an action against a city for amounts alleged to be due for extra labor and materials furnished in the construction and completion of a reservoir for the defendant the question was whether or not the plaintiff was entitled to recover the reasonable value of extra labor improperly and unnecessarily required of him to be performed, under protest, by direction of the city's duly authorized agents and officials. The extra labor was caused by the fact that the city engineer required the plaintiff, when the work was suspended in 1914, to put earth on the slopes of the excavation and embankment of the reservoir to protect them during the winter season, and until the work of construction might be resumed, in 1915. The trial court found that this extra work was wholly unnecessary and without the contract, and not contemplated by the parties. On appeal from a judgment for the plaintiff the Utah Supreme Court thinks that, while the authorities and decisions are not uniform, the best considered cases hold, and the great weight of authority is to the effect, that the contractor may recover the reasonable value of extra materials and labor regardless of the provisions of the contract.

There seems to be a distinction made under the authorities between extra work and additional work in cases of this kind. The term "extra work" applies when the work is of such a character that it cannot be said to have been in contemplation by the contracting parties, while "additional work" may be said to be that class of work that may fairly be presumed to arise in the course of a proper construction of the improvement, although not included by the plans and specifications or specifically mentioned or referred to in the contract. Judgment for the plaintiff was affirmed.—*Wilson v. Salt Lake City, Utah Supreme Court, 174 Pac. 847.*

## GOVERNMENT CONTRACTOR'S BOND

In an action by materialmen on a government contractor's bond the sureties claimed that it was impossible for them to pay the respective sums for which they were liable because of the danger of double liability; and the further fact that they did not know, and could not ascertain, what proportion of their liability was due to the individual creditors. On this point the Colorado Supreme Court says that the bond performs a double function. It is intended to secure to the United States the faithful performance of the contract, and to protect persons from

whom the contractor obtained labor or materials in the prosecution of the work. As said in *United States v. National Surety Co., 192 Fed. 551*, approved in *Equitable Surety Co. v. United States, 234 U. S. 448*: "The two agreements which the bond contains, the one for the benefit of the government, and the one for the benefit of third persons, are as distinct as if they were contained in separate instruments." The act does not postpone the right to have payment because it may be that a cause of action had also arisen, or may arise, against the sureties in favor of another party for whose benefit the bond was likewise given. If one so entitled is paid, the surety's obligation is discharged to the extent of the payment.

Where materialmen and laborers have a right to sue on a government contractor's bond immediately on the failure of the contractor to pay them, and the government had no right to sue until the completion of the work, materialmen and laborers who had sued years before the right of the government against the bond had matured are entitled to their money, and need not await the outcome of litigation pending between the sureties and the United States.

Under a bond executed under the act of Congress of 1894, undertaking that a government contractor should promptly make payment to all persons supplying him with labor and materials in the prosecution of the work provided for in a certain contract to which reference was made, it is held that the surety is liable for supplies for buildings, dining rooms, furniture, and means of provisioning workers, where the work (a tunnel) which would take months to complete, was to be performed many miles from any town.—*McPhee v. United States to use of Montrose Hardware Co. (Colo.), 174 Pac. 808.*

## MECHANICS' LIENS—PROOF OF TIME OF FURNISHING MATERIALS

In a suit to enforce mechanics' liens, the plaintiff has the burden of proving that the last materials were furnished within the statutory time of filing the statement of a lien. Care should therefore be taken in regard to the dates of delivery slips, and in copying the receipted slips by a bookkeeper. An error in copying a date, as, for example, the substitution of February 2nd for February 21th, might involve the loss of the lien.—*F. M. Sibley Lumber Co. v. Doran, Michigan Supreme Court, 168 N. W. 957.*

# Financial and Commercial Digest

## As Affecting the Practice of Architecture

### Bright Future for Building Activity

Declaring that although large loaning institutions such as life insurance companies were out of the market for the present on account of the heavy Liberty Bond purchases there will be a gradual rather than sudden revival in building activity, Walter Stabler, comptroller of the Metropolitan Life Insurance Company, expressed the opinion that this resumption of work depends upon financial arrangements that can be made. He suggests the bond issue, popular in other cities, as a possible solution. Mr. Stabler views the future as most promising and feels that the many problems to be faced will be easier of solution on account of the improved standing of real estate holdings, largely due to the increase in rent.

"Before there can be a resumption of building activities," Mr. Stabler says, "we must adopt some new plan of finance, and I can suggest one plan seldom used in New York City which has been extensively employed in other cities—the bond issue. I am familiar with conditions existing in many parts of the country, where new construction has been financed through bonds and notes issued in small amounts, even as low as ten and fifteen thousand dollars divided into small units. If such a plan could be practiced in New York nothing would produce better results. No railroad or any similar project is financed on any other plan, and it has worked out satisfactorily. Such issues should be made for long terms, and above all, arrangements made for an amortization every year or six months so that the debt is greatly reduced and the loan made safe. The owner would be benefited by a reduction of his obligation and the entire situation would lead toward a more conservative loan and greater confidence for lenders."

"Moderation will make for safety," Mr. Stabler continued, "and I hope that we never reach the point touched eight years ago when so many lenders encouraged builders too liberally and permitted entirely too many structures to be erected. But we all learned our lesson. The moderate resumption of building will work great advantage to the city without working to the disadvantage of the present favorable condition. As far as mortgages in general are concerned we have all been too careless in the way we borrow and the way we lend. Speculators have had in mind one idea, and that is to attain as near the expense of operation as they could. I do

not blame them, but I blame the lenders because this is bad principle and is productive of bad results.

"A policy which requires a reduction on the principal of mortgages of 2 per cent every year should be strongly urged. This is now becoming the rule with most institutions and is based on a sound foundation. It is as much to the interest of the owner as it is to the lender because it enables him to pay all his debt in installments instead of being faced with the situation that he must meet his entire obligation. I predict that this rule will eventually be the plan of all mortgage institutions in New York City, and I hope to see it the universal practice."

### Prices and Wages to Continue High

Describing the outlook as "auspicious" and remarking that the war has not impaired the resources of the country, the National City Bank of New York, in a statement issued this week, declares that instead of a period of exhaustion the future is looked forward to with both confidence and ambition. The question of prices and wages is referred to as follows:

"The indications are that wages and prices are going to stay up, for a time at least, all over the world, which will do much to simplify the situation in every country. The general state of credit expansion over the world will sustain, and naturally cause, a higher level of prices than prevailed before the war, and there will not be the same pressure to lower wages and prices in this country that there would be if the level were falling in other countries. It does not follow, of course, that wages and prices at the higher level will yield any better net results to producers and wage earners than at the old level, or that the new level will be permanent, but business is favored by stable conditions, and, with all the world subject to the same general influence, changes are likely to be gradual rather than abrupt. If all wages and prices in this country could be brought back at one stroke to the old level, it doubtless would be advantageous to have it done, but it is impossible, and if accomplished there is no probability that they could be held there with the present stock of gold in the country and the existing state of inflation abroad."



## “Rehabilitation Bonds”

A suggestion that the United States Government might provide credit for financing foreign trade by an issue of “rehabilitation bonds” and practically force our industrial activities to concentrate their energies upon European restoration through control of exports, is made by the National City Bank of New York in a statement just issued. The opinion of the bank that the raising of credit by a “process of commandeering” like this would receive, in time of peace, the support of both the people and business organizations that raised the four Liberty Loans, is regarded by some with doubt. However, the argument is advanced that there is little question that if the restoration of Europe is put upon a business basis, with responsible financial and able business leaders in charge, several billions will be available in the form of popular investment in the securities of foreign governments, bonds of foreign municipalities, securities of sound foreign corporations, or mortgages of individual foreign manufacturers, with the guarantee of responsible governments or institutions.

The situation as interpreted by the bank shows that financial organization is ready to accomplish this. “Our banks have built up a great international banking machinery,” the statement points out, “for doing foreign business right, and we can create these foreign enterprises, whether by financing reliable foreigners in their localities, or by financing enterprises to be founded and conducted abroad by Americans. This would at once create a great outward movement of supplies, building up the prosperity, consumptive demand and ability to buy in foreign regions that will steadily support an export trade from America in the future.”

## Rents Likely to Increase

Arthur W. Warner of the Executive Committee of New York Building Managers' Association believes that rents in many parts of New York are likely to increase before active building operations get under way. “Fixing criminal responsibility upon owners,” says Mr. Warner, “for happenings on their property while it is under lease to others, or under the control of employees who may neglect to do what they are told to, shuts out those who would be willing to invest money in buildings. This leaves the market to persons willing to take some risk but who exact a premium for so doing. Money is

worth more than it was, for building as well as other purpose. These elements make for rents before any great building movement b

## Estimating Recession of Prices

Considerable estimating as to the amount of recession from war-time levels that prices and rents will take in the near future is being done in architectural and building circles. Conservative estimates put the drop at about 10 per cent, while some few put it as high as 25 per cent as the maximum. And while the pessimists among property owners are marking time on the construction projects. That the drop will be small and will come before Spring is well understood and is generally conceded. Although the urgent demand is absent, there will still continue to be a normal call with man-power considerably less. There are cities without number short of housing and where office building space is at a premium.

## Financing Foreign Readjustment

A survey of the question “Are American engineers and contractors wanted in France and Belgium?” made by the *Engineering News-Record* conclusively shows a negative answer. Apparently in this country of these two nations feel confident that their own engineers and contractors are fully able to cope with the situation. To America the British and Belgians are turning for construction machinery only, as materials will be largely of European origin. It is further brought out that the country must await the decision of the two foreign governments upon the method of financing the work of restoration before action is taken on our part and that what seems more likely than the granting of extensive government credits is the probability that strong financial groups here will undertake the financing of projects abroad, and will in some cases select large contracting organizations to do the work.

Apart from the vital reconstruction projects abroad the most important situation before the United States today is what will result from the commercial and financial unrest that threatens industrial chaos. Our readjustment differs in many aspects from that of our Allies. Although a large age of labor in this country has been marked by some time, a gradual demobilization of our surplus is to be attempted so that the men may be absorbed into commercial activity.



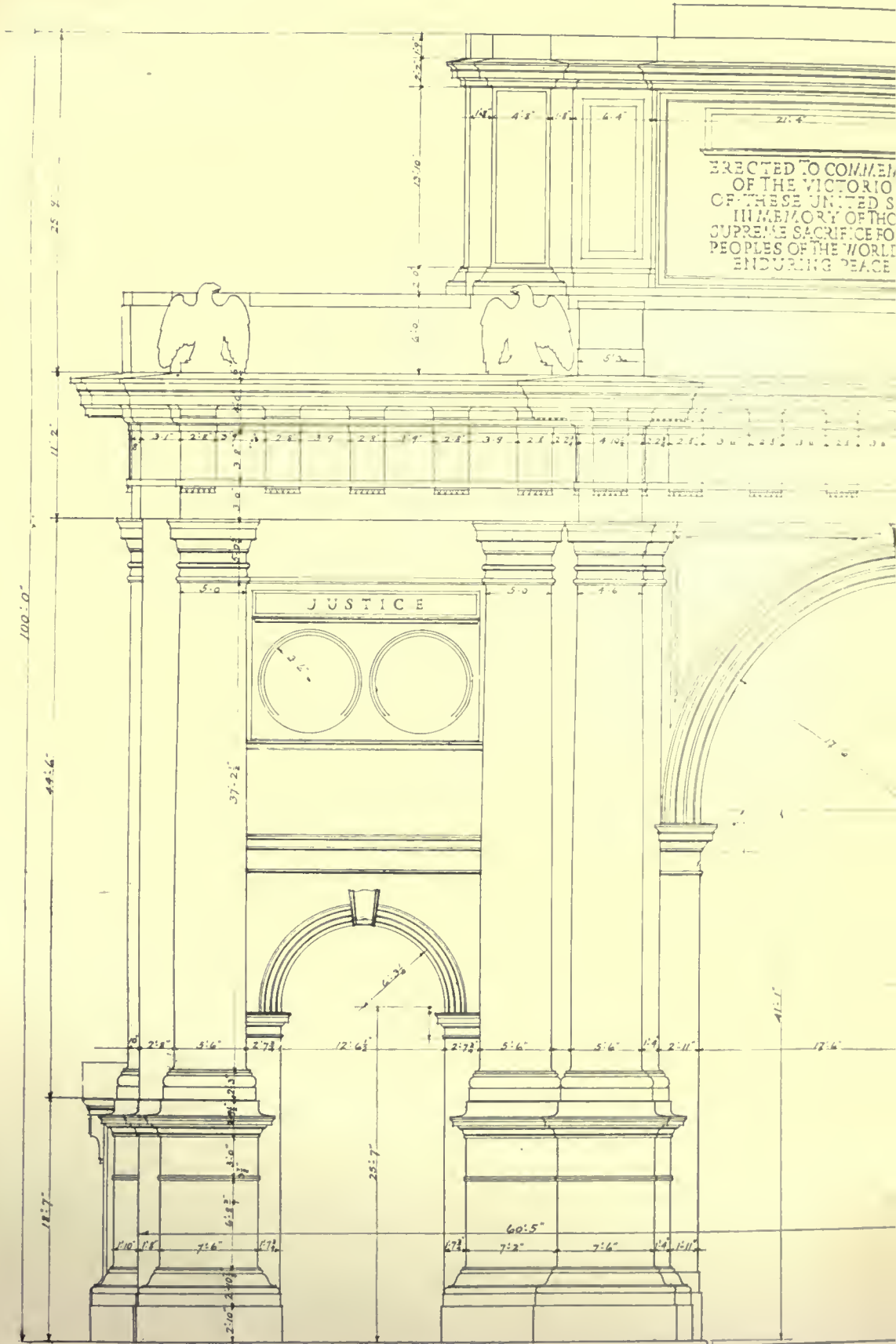

PLATE 18

ARCH OF FREEDOM, MADISON, WIS.

THOMAS HASTING



ON SQUARE, NEW YORK

ARCHITECT



PLATE 19

GROUND PLAN, SHOWING LOCATION OF ARCH OF FREEDOM AND ALTAR OF LIBERTY, MADISON SQUARE, NEW YORK

THOMAS HASTINGS, ARCHITECT





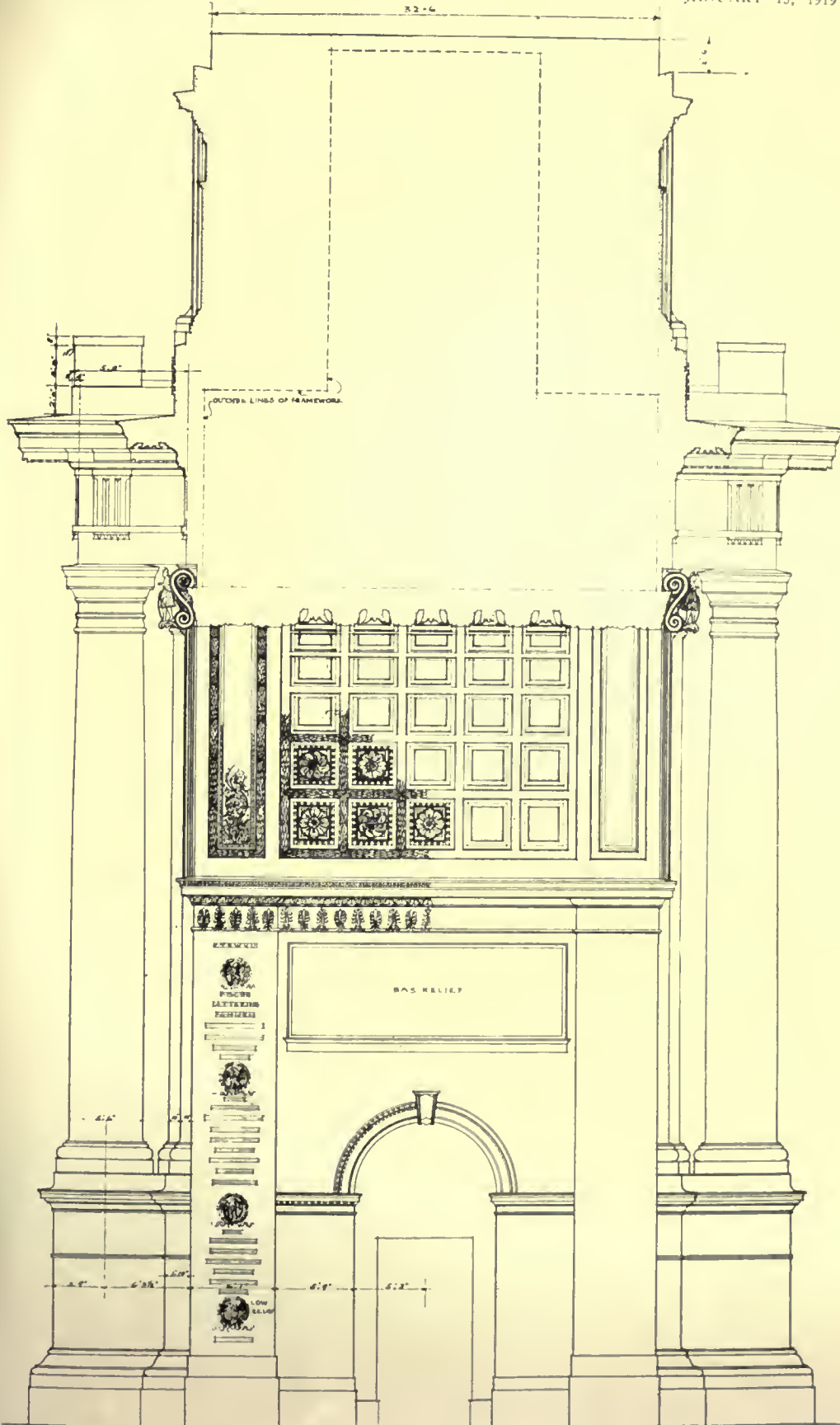

PLATE 20

ARCH OF FREEDOM, MADISON SQUARE, NEW YORK

THOMAS HASTINGS, ARCHITECT





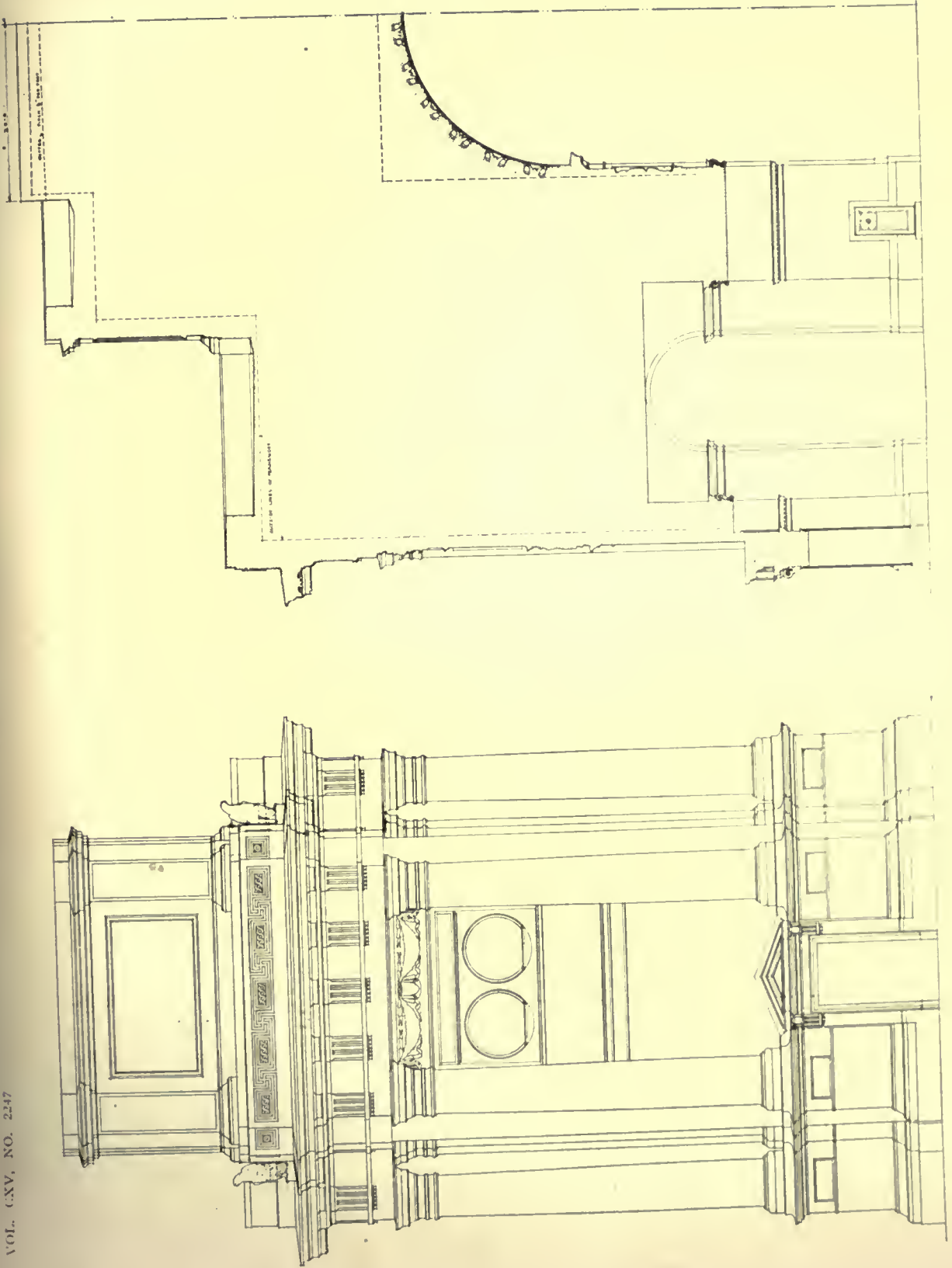



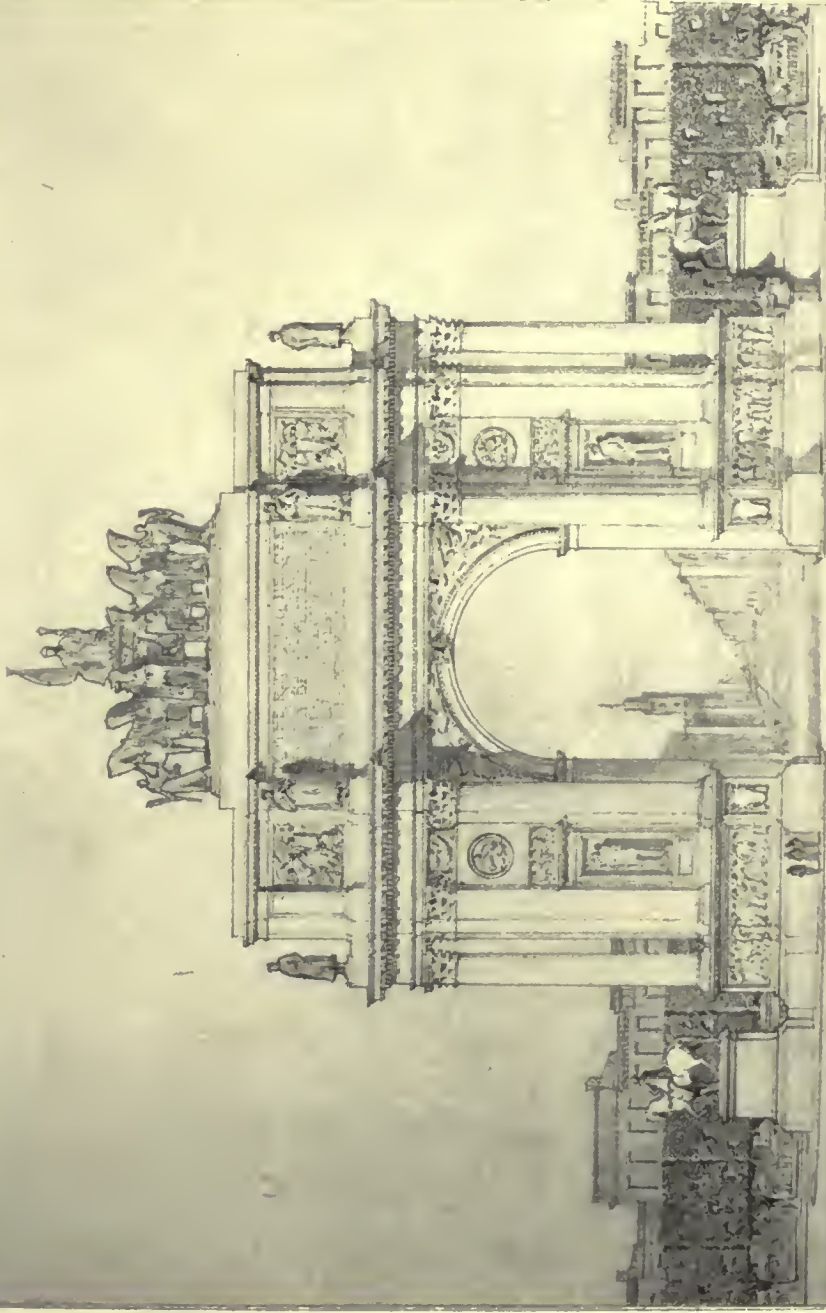

THE ARCH OF DEMOCRACY IN BROOKLYN





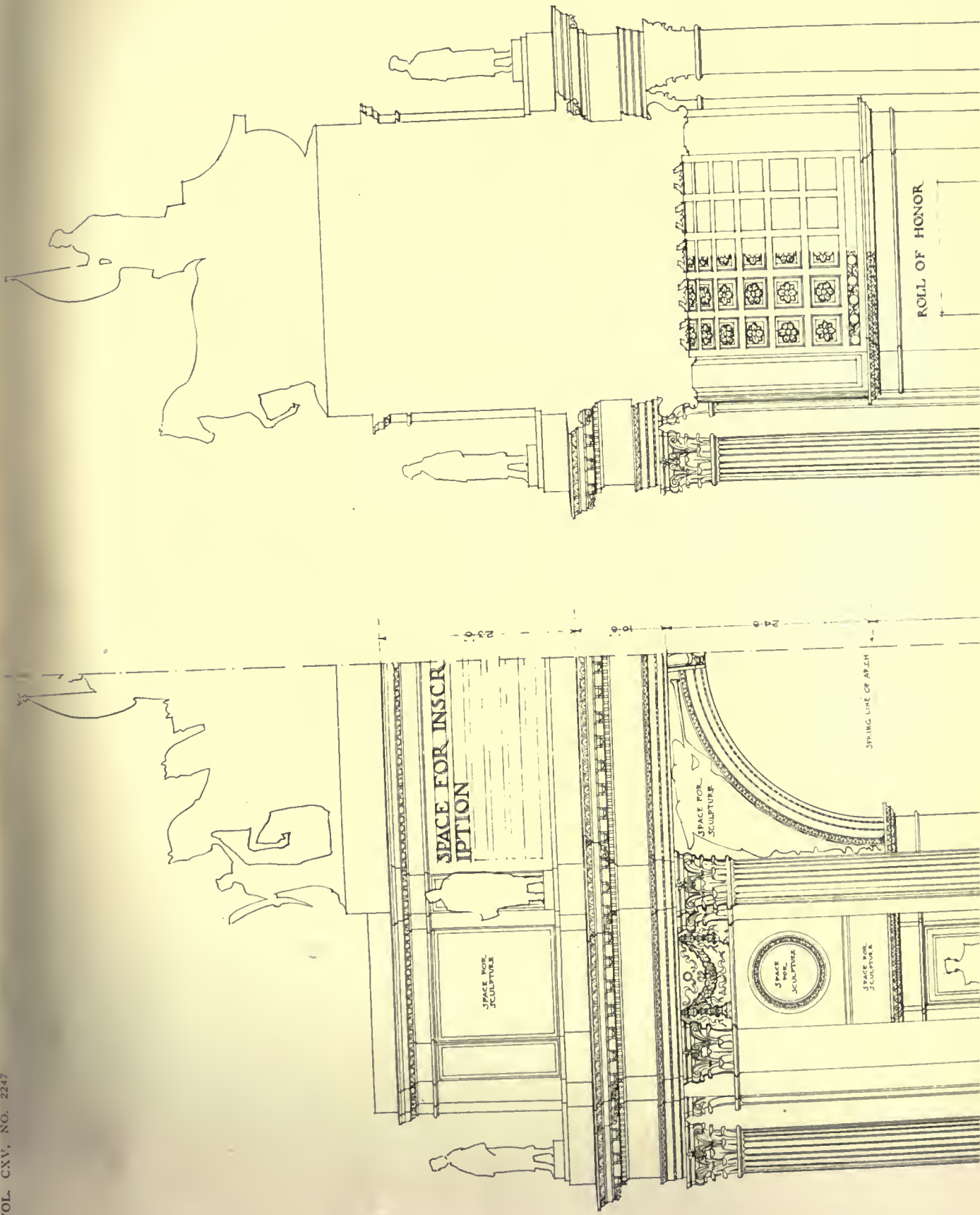

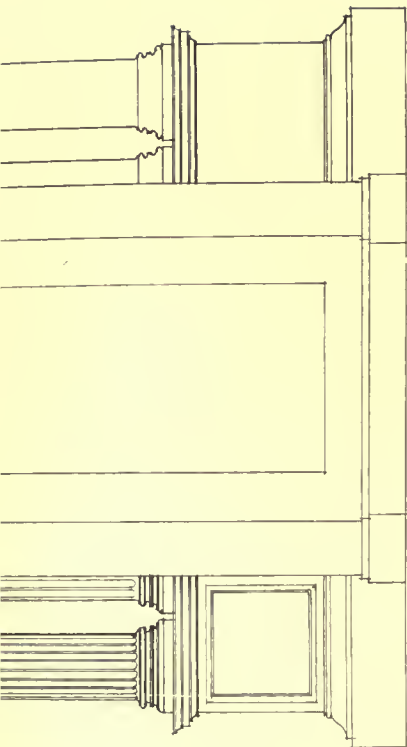

SECTION

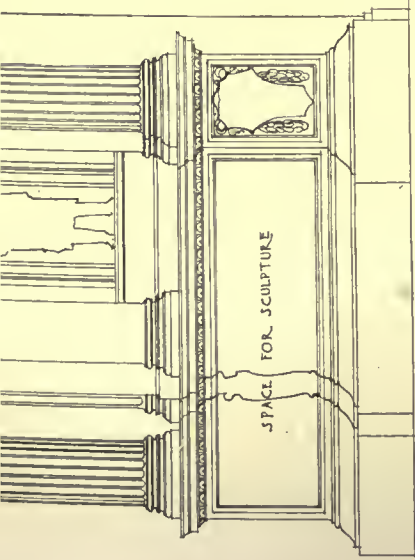

HALF • ELEVATION

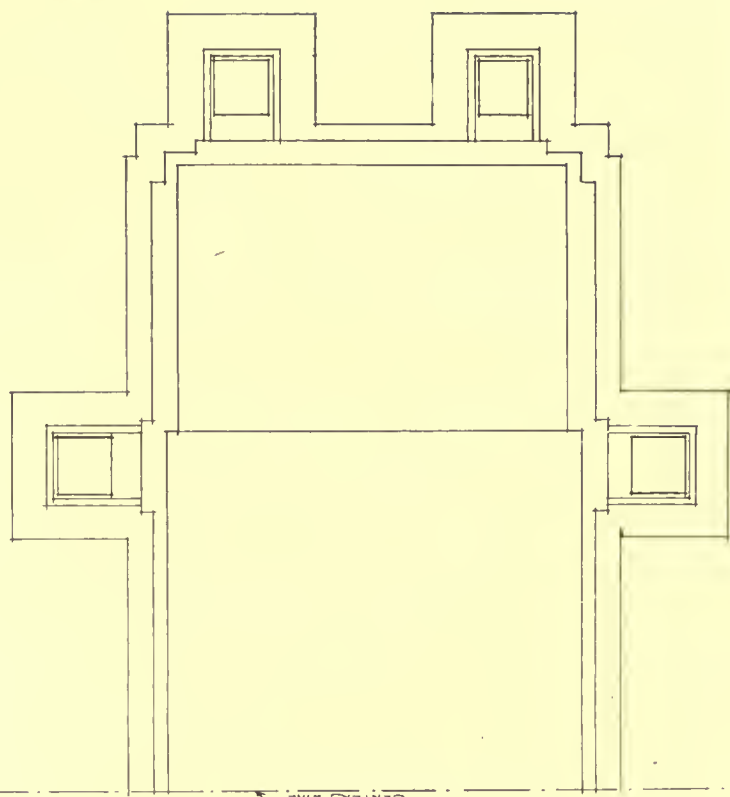

PLAN

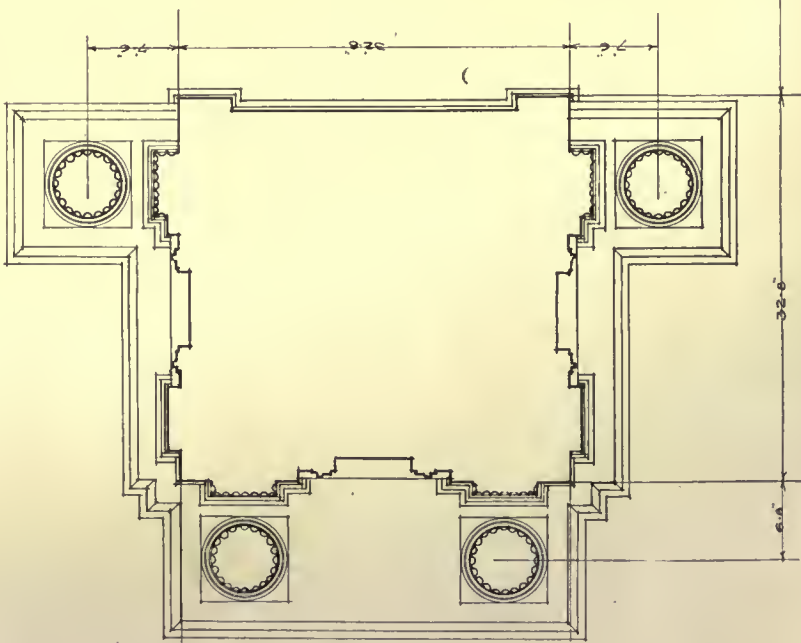



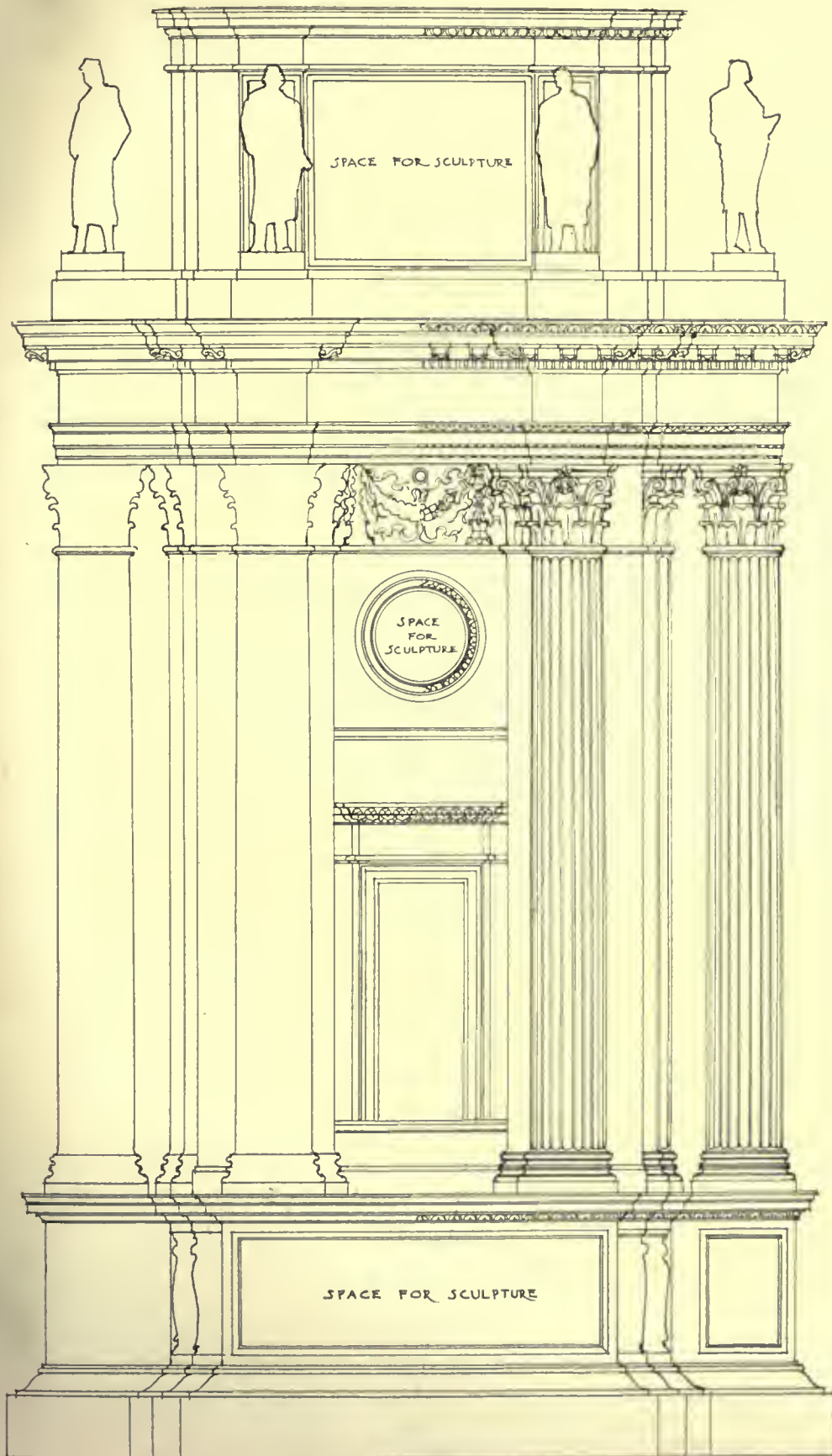

PLATE 24

END ELEVATION

THE ARCH OF DEMOCRACY, BROOKLYN, N. Y.

HELMLE & CORBETT, ARCHITECTS



## Form New Bureau to Secure Construction Data

The new division created in the Department of Labor to interest the nation in public works and private construction is now in operation. Secretary Wilson announces that the new service will gather and distribute information which will enable private initiative to make the transition from a war to a peace basis without serious interruption due to lack of data on which business judgment must depend. The new organization is called the Division of Public Works and Construction Development.

A survey of business conditions will be made with a view to learning how labor and capital may be profitably employed during the critical period when factories are being made over for peace production and markets are being canvassed for future outputs.

The particular objective of the bureau's research will be to secure data for the use of the construction industry, but the material to be collected will be so varied that the information will be of value to industry generally. The facts made available will be of help to any community or investor in determining whether it is advisable to undertake public or private building at present. When circumstances unfavorable to construction are discovered, an attempt may be made to correct them, but there will be no stimulation of economically unsound enterprise.

The general purpose of the work of this division is expressed in Secretary Wilson's statement:

"Building construction will help to provide employment for returning soldiers and for workmen dismissed from war industries. One of the largest sources of prospective employment is the building trade and its allied factory industries.

"In the case of private construction, a resumption of activity will also lessen the congestion of population, improve conditions affecting public health and convert inactive property into active property—which supplies the means that enable communities to support the functions of governments.

"During the war the nation practically concentrated all its efforts on the production of goods for immediate consumption—war materials, food, clothes. The failure to produce the normal quota of goods for future consumption has made these scarce and high priced, and as they are essential to further production they affect the cost of production and, consequently, the cost of living. Chief among such goods are building and other real estate improvements, including public works, as roads,

bridges, etc. The scarcity of buildings, for example, creates high rents."

The inquiry will be under the direction of business men of wide practical experience who are serving without pay. The actual investigation will be conducted by a group of economists and special agents supplied by the Department of Labor and other Government departments or by the universities. The field will include the cost and supply of building materials, the amount of labor available and its cost, the values of land, prevailing rents, the supply of capital, the amount of construction held up by the war and the demand for building in all parts of the country.

Mr. F. T. Miller, director of this new division, referring to the inter-relation of the construction industry with the general welfare of the country, makes the following statement: This is a question that goes beyond the interests of the construction industry. It is fundamental to our entire program of reconstruction and affects society as a whole. After all, reconstruction must be literal as well as metaphorical; the way to bring about reconstruction is to reconstruct. Successful construction depends upon proper teamwork between the employer and employee; therefore, the work undertaken by this division falls under the activities of the Labor Department, and under those of the Information and Education Service, which already possesses a nucleus of the necessary organization and important data.

Secretary Wilson's effort is toward interesting the nation in public and private construction. This end cannot be attained unless the work is based on facts. Facts when verified and surveys when completed, as proposed by the new division, will be made known to the public and to the members of this great composite industry. The service is one of information and education.

The co-operation of other governmental departments, the State Councils of Defense, etc., is assured. Time can be saved and correctness of viewpoint gained by such co-operation.

The following telegram from the Secretary of War, approved by the Secretary of Labor, has been sent out to forty-eight State Councils of National Defense and 4000 County Councils of National Defense:

Re-employment of discharged soldiers, sailors and war workers released from war industries is one of the most important tasks now before the country. We strongly urge that in sections where there is a surplus of labor all public improvement be advanced in order to absorb labor. We ask that you use all influence with state, county and municipal authorities to this end. Preliminary steps should be taken immediately in order that neces-



## THE AMERICAN ARCHITECT

sary authority may be secured in time for operations upon opening of construction season.

(Sgd.) Newton D. Baker, Secretary of War and Chairman of Council of National Defense.

Approved by Secretary of Labor.

The construction industry—a composite industry—is one of the nation's largest. Its successful functioning is most necessary for the public welfare. It now needs and merits governmental support more than any other great industry, for the reason that it has necessarily been embargoed by the Government during the war.

Deferred building construction is one of the first portions of our war debt which must be met, for it provides facilities for paying the remaining portion of the war debt and also decreases the cost of living. It is an economic waste to allow labor and materials to remain even temporarily in idleness when they might in the meantime be put into wealth and tax-producing structures.

Money is not consumed in building operations, but passes from one hand to another, and still remains in the National banking system, yet leaves on its way a permanent evidence of wealth—such as water-power, a highway, a railroad, a sewer or other necessity to the earning power of society.

Since the beginning of the European War, construction has decreased, until now it is quite at a standstill. There is, therefore, an accumulated need for building. The shortage of construction is indicated by high rents. The increased cost of building materials is only about half that of other commodities, and this cost is offset in some localities by decreased cost of land.

The country is probably a full year behind in its civic construction program, amounting to at least three billion dollars. This amount must be caught up and normal building continued; a condition of permanently arrested development of the country is inconceivable.

There is a growing understanding between the building employer and the employee of their co-operative relationship, and together they have every incentive for rendering the public efficient service. Co-operation of the architectural and engineering professions, of the practical contractors, and of the two hundred odd national associations of manufacturers, in the practical application of these facts may be assumed as assured.

---

### New School for Industrial Art Opens

To supply the demand for artisans trained in drawing, color and designing, the New York Evening School of Industrial Art opened sessions on January 6th, with a student roll from art schools

and art industries. It is the aim of the school to enable artists to become better craftsmen. Exhibitions of the students' work will be held several times a year. The Museum of Art and the American Museum of Natural History will, it is stated, co-operate to carry out the work of instruction which will be offered in the following subjects: book illustration, costume design, advanced drawing, interior decoration, jewelry design, modeling and sculpture, mural decoration, poster and advertising design, principles of design (craft and novelty work) and textile design.

---

### Construction Projects Stopped by War Department

The War Department through the Director of Operations has ordered the construction division to abandon many proposed building operations. The order covers the stopping of all hospital extension work at Rochester, N. Y.; Cincinnati, Ohio; Chicago, Ill.; Milwaukee, Wis.; Cleveland, Ohio; Camp Shelby, Miss.; Des Moines, Iowa, and Nashville, Tenn. Projects in these cities were for alterations to make buildings suitable for hospitals containing 1000 to 4000 beds. Other work stopped includes work at the American University, Washington, D. C.; new barracks and additional roads at Florence Field, Fort Omaha, Neb.; quartermaster's supply buildings at Chapman Field, Fla., and the construction of an officers' training school at Camp Pike, Ark.

---

### Production of Coal Decreases

The production of bituminous coal in the last week of the year just passed shows a decrease of nearly 500,000 tons compared with the previous week, according to the report compiled by the Geological Survey, Department of the Interior. The estimated average daily output decreased from 1,831,000 tons in the week ended Dec. 14 to 1,689,000 tons in the week ended Dec. 21. Production in the week of Dec. 21, 1917, was greater by about 800,000 tons than that recorded in the corresponding week of 1918.

The production of anthracite in the week ended Dec. 21 is estimated at 1,839,000 net tons, a decrease compared with 1,924,000 tons the previous week, but a gain compared with the corresponding week of 1917. The total production from April 1 to date is estimated at 72,541,000 net tons, about 1,400,000 tons less than in the corresponding period of 1917.

## Report on Housing

By THE

JOINT COMMITTEE ON RECONSTRUCTION AFTER  
WAR, ILLINOIS CHAPTER, A. I. A., AND  
ILLINOIS SOCIETY OF ARCHITECTS

**Y**OUR Committee on Housing has been asked to study questions of means and methods to be used to keep the matter of proper housing before the United States and State authorities and to present a plan for carrying on better housing and propagating the idea.

Proper housing means better sanitary and living conditions for workmen and the elimination of the slums. The direct result of improving housing conditions will be to develop a higher type of citizenship and to create more healthful and more attractive communities in which to live.

The proper development of housing is of such vital importance to the state and nation, and the need for promptly remedying the conditions of congestion and housing shortage is so great that we believe the best results cannot be obtained without the active aid of the state and government authorities.

The present state laws prevent a company or corporation from erecting houses to be sold to or to serve as homes for their employees. This provision of the law is undoubtedly to prevent corporations from gaining too great a control over real estate, or over their employees, but to meet the great need for extensive housing development throughout the state it would seem that a careful study should be made of the existing state laws governing housing to determine whether or not they permit, to the fullest extent desirable, the various types of collective participation in community housing that have been employed successfully elsewhere.

We respectfully recommend the establishment by the government of a permanent Bureau of Housing to assist in an advisory capacity in improving housing conditions throughout the country.

We recommend the appointment of a State Commission of Housing to study the subject of housing in a broad way and under the guidance of expert advice to determine:

- 1st. The advisability of changing the present state laws restricting housing to permit freer housing development.
- 2nd. To determine the proper financial requirements needed in connection with housing developments for the protection of the investor to be enforced by state supervision.
- 3rd. To determine what changes, if any, in the State Constitution will be needed to give to the State authority to require the approval of all plans

for housing development by a permanent State Housing Bureau. This bureau to be given the power to not only enforce the laws in regard to safety and sanitation, but to pass upon the planning of the houses and grounds for group housing projects to insure the development of housing along lines that will provide healthful living conditions and attractive homes and environment for workmen.

We believe that the establishment of a State Housing Bureau or Commission under the direction of an expert in city planning and housing development, and given the authority suggested, would do more to prevent the undesirable features of present housing development of the speculative type than could be accomplished in any other manner.

As a suggestion for propagating the idea of better housing we believe there is the need for educating the public to what better housing means.

This educational work could be carried on by lantern slides showing some of the best types of community housing, and if the slides were furnished by the various groups and men and women who are working for better housing conditions, without selfish motives, we feel sure that the managers of the moving picture theaters could be induced to show them to the public without charge.

## The Industrial Readjustment of the Liberated Regions of France

The United States Commercial Attaché at Paris reports:

Roughly speaking, a seventh of the total area of France has at one time or another during the last four and a half years been in the occupation of the Germans. This so-called invaded region, now liberated, comprised the following territory:

Department of Nord—All, excepting a small area along the coast.

Department of Pas-de-Calais.—The eastern third, comprising an important part of the coal-mining basin.

Department of Somme.—The eastern half, which suffered damage as a result of the German thrust toward Amiens in the spring of 1918.

Department of Aisne.—The northern half was in German occupation for four years. The area of invasion covered all of the Department after the German push toward Paris in the spring of this year, and until the recent retreat.

Department of Ardennes.—All of this Department was in German occupation from the early days of the war.

Department of Marne.—The northern fringe only.

Department of Meuse.—The portion north and east of Verdun, comprising about one-half of the total area.

Department of Meurthe-et-Moselle.—The strip stretching northward from Nancy to Luxembourg, in which are situated the iron-ore beds of Briey and Longwy.

All of this invaded region has suffered damage, though the extent and character of the destruction varies greatly in different sections. The region in



## THE AMERICAN ARCHITECT

the north which has suffered most constitutes the richest industrial section of France, and the task of restoration will be herculean. The aid of American manufacturers will be essential, and it is therefore important for them to know something of the industrial activities of the various departments as they existed before August, 1914. With the object of furnishing a few of the facts needed to gain an idea of the size and nature of the task of industrial reconstitution, the office of the commercial attaché has in preparation a series of articles giving the salient facts regarding the industries of the departments named. The first of these articles will deal with the Department of Nord, one of the most important industrial regions of France.

### Reserve Officers to Be Trained in All Branches of Service by Colleges

An important change in organization will be worked out in the new Reserve Officers' Training Corps, which has taken the place of the demobilized Students' Army Training Corps in various colleges of the country. Thereby units will be allowed to specialize in training officer candidates for field artillery, engineer, signal, coast artillery, ordnance, and military aeronautics corps, instead of training for infantry alone, which was the rule before the war. Applications have been received by Secretary of War Baker for the formation of about 200 new units in addition to about 100 of the old units which will be re-established.

The Committee on Education and Special Training has in hand the administration of the Reserve Officers' Training Corps and will attempt to make available a large amount of scientific and technical material, which has been developed by the experience of the war. In all units special attention will be paid to physical training and athletic contests.

### Wants More Trade Agents Abroad

Burwell S. Cutler, Chief of the Bureau of Foreign and Domestic Commerce, in his annual report just made public, recommends that the scope of the Government's facilities for increasing foreign trade be widely expanded. A resident trade commissioner abroad is needed, the report states, who can travel from place to place and send his views to American business men so that they can successfully do business with those countries. Mr. Cutler urges appropriations to pay larger salaries so that valuable men may be retained, unhampered in their work by lack of funds, and to provide for

new posts. Attachés are asked for for Rome, Madrid, Ottawa, Mexico City, Santiago, Chile, Athens and other places.

### Harbor and River Bill Carries Many Important Improvements

The harbor and river bill for 1920, which was completed last week by the House Committee of Congress, includes more than forty new improvement projects. The measure carries appropriations totaling \$26,935,000. The principal new project is the purchase of the Chesapeake & Delaware Canal and its dredging to 12 feet.

### United States to Supply Vast Quantities of Copper to Europe

Vast quantities of copper will be required for use in the rebuilding of devastated Europe. Stocks of this metal both here and abroad have been greatly reduced during the war, and a general survey induces the conclusion that there are no indications of a sharp decline in prices. There is no immediate prospect of a drop, although it is to be expected that there will be a gradual recession from the present level. Miners and other large interests still assert that copper cannot be produced for less than eighteen cents a pound.

### Personal

Harry Marshak, formerly with the Navy Department at Washington, D. C., and Joseph A. Hickey, formerly construction engineer for the Revere Rubber Co. Plant 2 at Providence, have formed a partnership under the firm name of Marshak & Hickey, for the practice of architecture. They will open offices at 310 Strand Building, Providence, R. I. They will be pleased to receive catalogues and manufacturers' samples.

Blaney & Blaney have reopened offices for the practice of landscape architecture and town planning in the Brattle Building, Harvard Square, Cambridge, Mass., according to cards of announcement just received. During the war the firm's offices were closed owing to the fact that both partners had entered war service. Herbert W. Blaney, a member of the American Society of Landscape Architects, was engaged with the Town Planning Division of the U. S. Housing Corporation.



## Obituary

### Capt. E. L. Satterlee

Capt. Edward Lansing Satterlee, U. S. R. S. C., of the architectural firm of Satterlee & Boyd, New York, died of typhoid fever at Clermont Ferrance, France, on Dec. 4. Captain Satterlee was born at Dobbs Ferry, N. Y., and received his early education at St. Paul's School, Concord, N. H., later graduating from the Columbia University School of Architecture, class of 1899. He also studied architecture at the École Nationale et Speciale des Beaux-Arts.

Captain Satterlee specialized in ecclesiastical and memorial structures and residence buildings, and designed the Zion Church and the memorial to President McKinley at Hamburg, N. Y.; the Little Sanctuary and All Hallows Gate on the cathedral at Washington, and the residence of Admiral A. T. Mahan at Quogue, L. I.

### C. Y. Turner, N. A.

Charles Yardley Turner, architect, painter and mural decorator, died of influenza on Jan. 1 at the Presbyterian Hospital, New York, after a two days' illness. Mr. Turner lived in Baltimore, and was visiting friends in New York City when taken ill.

Mr. Turner was a National Academician, elected in 1886. While the earlier years of his career were devoted to architecture, Mr. Turner was perhaps better known both as an easel painter and as a mural decorator. He painted the large panels for the new Essex County Court House in Newark, and also distinguished himself by his coloring and harmonizing the mural "The Burning of Peggy Stuart" to the architecture of the Baltimore Court House. He was director of color and decorations for the Chicago Exhibition in 1893, and director of color at the Buffalo Exhibition in 1901.

Born in Baltimore, Nov. 25, 1850, of Quaker parents, Mr. Turner graduated from the Art School of the Maryland Institute in 1870. Shortly after this he came to New York and founded the Art Students' League, of which he afterwards became president. Mr. Turner was vice-president of the Architectural League of New York, and for one year held a like office in the National Academy of Design. He had been awarded a number of medals at expositions here and abroad.

### Offers Plans for "World Capitol"

A dispatch from Rome states that Henrik Andersen, American sculptor, will present to the peace conference, drawings for a capitol for the proposed League of Nations. It is proposed that the "world capitol" be built in either France or Belgium.

### Growth of World Trade in Century

Growth in population, cheapening in transportation and a division of labor among groups of men the world over are, according to the statement of the National City Bank of New York, the chief causes of the growth from less than \$2,000,000,000 in 1818 to approximately \$50,000,000,000 in 1918. By 1850 world international trade had grown to \$4,000,000,000; by 1900 it was \$20,000,000,000; 1913 \$40,000,000,000, and in the year just ending aggregated probably \$50,000,000,000, when measured in the inflated currency of the present period. The bank's statement pointed out that with the rapid increase in gold production in the last quarter century the money of the world has grown from \$10,000,000,000, in 1800, to about \$15,000,000,000 at the beginning of the European war. During the century of power transportation, 1818 to 1918, the world's greatest steamships grew to about 30,000,000 net tons, with a value at the beginning of the late war of about \$2,000,000,000, while the world's railroads had grown to 725,000 miles, with a value, probably, of \$70,000,000,000.

### Urges Plan for a Federal Body to Supervise Industry

A plan that calls for a body to counsel and regulate industry that closely parallels our present Supreme Court in its manner of appointment is being launched by M. L. Requa, head of the Oil Division of the Fuel Administration. It will be presented in the form of a bill to be introduced in Congress.

The fundamental idea, that supervision and regulation of industry by the Government must develop to a greater degree, embodies the placing on a sort of board of trade certain selected captains of industry who have reached the highest pinnacle of success in business life. Members elected to the body would necessarily have to give up all private business ventures and take up a position aloof, where, using their wisdom and experience, they could counsel and aid business generally and guide it in its relations with this and other governments.

It is Mr. Requa's idea that a chair in the proposed body should be cherished and striven for by

## THE AMERICAN ARCHITECT

a business leader just as a lawyer sees the Supreme Court bench as the goal of a highly successful legal career. It is planned that this supervisory and regulative body, with powers sufficiently broad to allow it actually to function, would have its personnel so protected and guaranteed that business interests could put the fullest confidence in it.

---

### Decided Progress Toward Resumption of Normal Conditions

Attributed chiefly to a drop in the prices of raw materials, the Federal Reserve Board reports a decrease in prices between September and October, the first during the present year. Steel prices have lowered, with foreign inquiries for the product strong. There is a real demand for copper, but buyers are generally waiting for prices below 23 cents fixed upon as an export price. The genuine belief is that much progress has been made toward the resumption of normal conditions where supply and demand are the controlling factors.

Building is being restricted on account of the uncertainty of the price situation in spite of appeals from the Government to promote such enterprises as a solution of the problem of demobilization.

---

### Labor Readjustment Calls for Americanization

That only a thorough-going campaign of Americanization can solve the problem of labor readjustment which is now taking place is the decided opinion of many close followers of the subject. Just whether it will end with employers calling for help or with workers begging for jobs is not clear, but reports from widely separated sections indicate that the surplus labor may be absorbed. Some dispatches even intimate that an actual scarcity of labor may follow a brief period of readjustment.

Among the many plans suggested is the organization of Americanization committees in industrial plants to improve racial relationships and give the men something besides a wage stake in America. If they cannot get representation, self-expression and participation, it is said that many will return to their home lands, and their labor and savings will be lost to this country. The plan is to get them genuinely and voluntarily interested in free education, American investments, Liberty Loan, Red Cross and other American advantages which give new ties in our country.

With the coming of peace it is therefore neces-

sary that the far-seeing employer will do everything in his power to make and retain the good will of his workers, just as the sales manager tries to gain and hold the good will of the buying public.

---

### The Question of Advertising

The following wording, as to advertising by architects, has been accepted by the Board of Directors of the American Institute of Architects and ordered published as a part of the circular of advice:

"Publicity of the standards, aims and progress of the profession, both in general and as exemplified by individual achievement, is essential. Advertising of the individual, meaning self-laudatory publicity procured by the person advertised or with his consent, tends to defeat its own ends as to the individual as well as to lower the dignity of the profession, and is to be deplored."

---

### Form Decorative Arts and Industries Association

The Decorative Arts and Industries Association, a new organization to encourage higher standards in home furnishing, has been formed. The executive committee has decided to hold a convention in New York City early this year in order to bring together those interested in developing better taste in the home. It is proposed to secure a membership distributed through the art trades and societies, and to have a mutual understanding and common aim between the trade and artists working for the trade which does not now exist.

The officers of the new association are: James P. Haney, president; Henry W. Frohne, vice-president; William Laurel Harris, secretary, and Chandler R. Clifford, treasurer.

---

### Municipal Reconstruction in America

For those interested in a reconstruction program for American cities, a valuable bibliography on the subject, including titles of magazine articles, British literature on reconstruction, and French books on reconstruction, has been prepared by the New York Public Library and published in Municipal Reference Library Notes for Nov. 13, 1918. Copies may be obtained by writing the librarian, Room 512, Municipal Building, New York.



# Department of Architectural Engineering



CABINET FACTORY, VICTOR TALKING MACHINE COMPANY, CAMDEN, N. J.  
View looking east on Market Street, showing bridge over Front Street, Building 17C, water tower and Building 17D beyond.

## Cabinet Factory, Victor Talking Machine Company Camden, N. J.

BALLINGER & PERROT, *Architects and Engineers*

WHEN men achieve a certain degree of notoriety their portraits are published, illustrating all the seven stages of their lives. The student of human nature is able to trace the development of the character and explain the effects of employment and environment on the physical aspect of the person. Even as this applies to persons, it applies also to manufacturing plants that expand beyond their initial size.

The person who is versed in the development of building construction can easily determine the decade in which each unit of the plant was constructed.

Every element of the building indicates the progress made in architectural design, structural design, the mechanical equipment consisting of the heating and ventilating plant, lighting system and sanitary arrangements. A change in the architect is also readily noticeable in the architectural and engineering treatment and also in the degree of the completeness of the structure and its equipment—the element of completeness being a measure of the work and care devoted to the project.

An interesting industrial development is that of the cabinet factory department of the Victor Talk-



## THE AMERICAN ARCHITECT

ing Machine Company at Camden, N. J. This department consists of five units known as Buildings 17, 17A, 17B, 17C and 17D. These buildings are located on a plot of ground having a frontage on the north side of Market Street of 443 ft. and having a depth of 270 ft. with Delaware Avenue on the west and Front Street on the east. As will be seen from the block plan, the Buildings 17, 17A and 17B are located within 27 ft. of the north lot line and

on the river bank west of Delaware Avenue. Under flood conditions and high tide in the Delaware River the water level is about two feet below the street level at Building 17D. The basement of this building is successfully waterproofed by finishing the floor and plastering the inside of the walls with a one inch covering of waterproof cement plaster. The original mechanical plant included a main steam service line supported on steel towers. As



Site of Building 17D, with Buildings 17, 17A at left and center with 17C back of water tower. Building No. 1 at extreme right. Old water tower being wrecked. Note elevated steam main entering at the left and later placed in tunnel.

constitute one group which is separated from Buildings 17C and 17D by a court yard 38 ft. wide. This court yard is traversed by a railroad track and has entrances on Delaware Avenue and Front Street and also through Building 17D midway in the Market Street frontage.

All of these units are of fireproof construction, six stories high, with Building 17D only having a basement throughout except under the driveway. A veneer cellar is placed in Buildings 17B and 17C. A system of tunnels extends from the old power house, located east of Front Street on Cooper Street, through Building No. 1. Crossing Front Street the tunnel enters Building 17C and connects with the basement of Building 17D and with Buildings 17, 17A and 17B by traversing the court as shown. On the west end of Building 17 is a shipping platform, under which is a basement from which a tunnel, passing through the kiln building, connects with the new power house which is located

this line ran through the extensive lumber storage yards of the company it was apparent to the architects that a moderate fire would destroy the steam

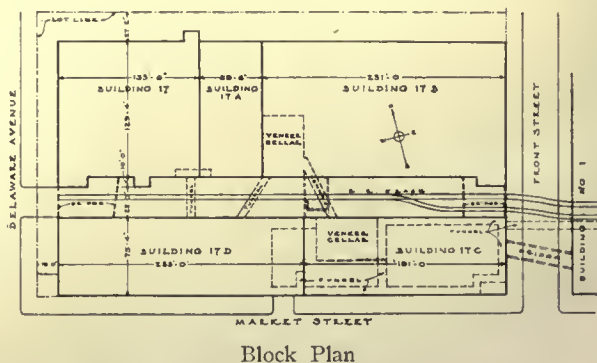

supply system and on their recommendation this steam service was placed in the tunnels which have been described.

## THE AMERICAN ARCHITECT



View of a partially poured concrete floor, showing the four-way reinforcing rods in place

Three bridges, five stories high, cross the court and connect the two groups of buildings. A bridge in the 4th, 5th and 6th stories over Front Street

As Building 17D is the last one constructed, it naturally has some features of construction and equipment that are improvements over the previously erected buildings. Among these are described the features of building construction, heating and ventilation and water supply with a description of the ramps in Building 17C which are used as means of ingress and egress, in lieu of stairways.



Basement column in position, showing brackets for supporting the floor slab and openings for hot air registers



Basement columns in position with slab form material ready for erection

connects Building 17C with Building No. 1. These bridges are closed at each end with automatic rolling steel shutters.

Building 17D is constructed of reinforced concrete of the type known as "flat slab" construction. The typical floor panel is 23 ft. x 24 ft. 10 in. in size designed for a live load of 150 lb. per sq. ft. The slabs are 8½ in. thick reinforced with a 4 way system, the diagonal bands consisting of 12 ½-in. square twisted bars and the rectangular bands of 30 bars of the same size. The drop panel is 9 ft. 6 in. square and 4 in. deep. The cap at top is 5 ft. 7 in. in diameter and 2 in. deep. The floor strips, fill, under and top floor of wood have depth



## THE AMERICAN ARCHITECT

of  $5\frac{1}{8}$  in. The spandrel girders extend from the plane of the underside of the drop panel to a variable height above the floor, permitting the steel sash to extend practically to the ceiling line.

The exterior columns are of reinforced concrete,

and the heavy cast iron brackets support the conical concrete cap. The columns have a 2 in. covering of metal lath and cement plaster, serving as fire protection. The vent openings in general are four in number 8 in. wide and 24 in. high, surround-

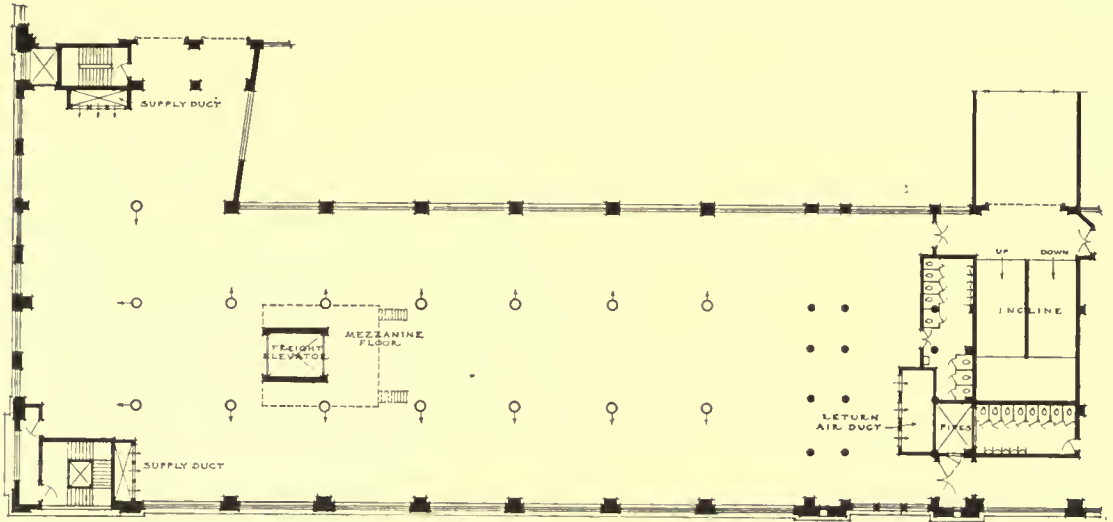

Building 17D, Typical Floor Plan

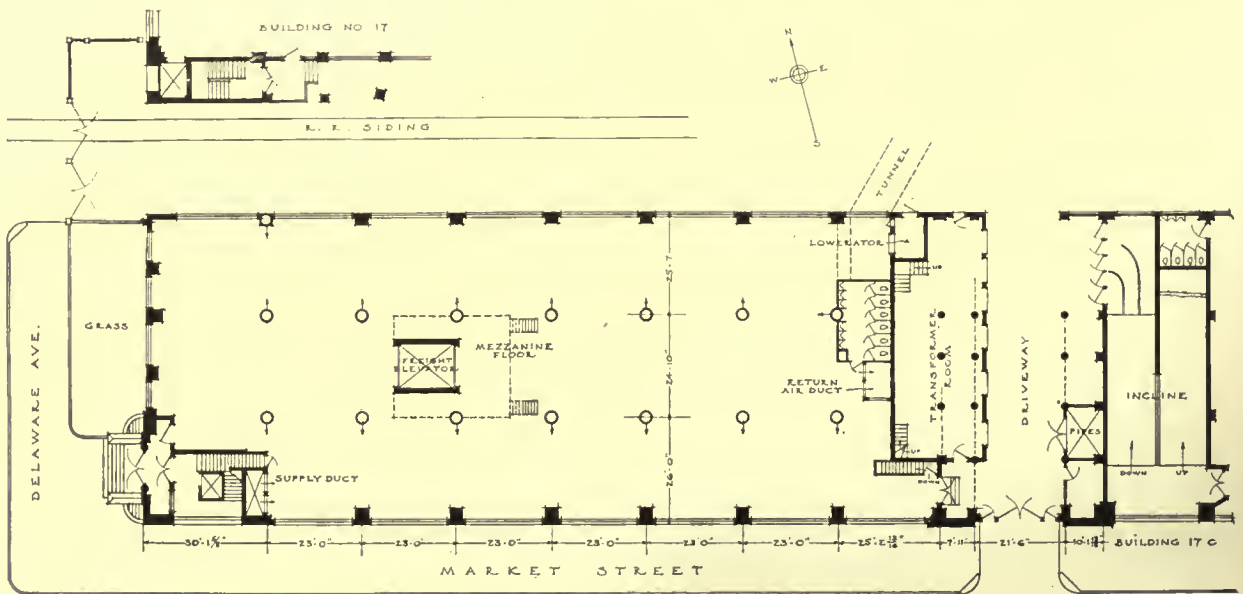

Building 17D, First Floor Plan

rectangular in section. The columns supporting the tower are of structural steel, encased in concrete and except for these the interior columns are of cast iron, cylindrical in section. These columns serve as structural columns and as vertical ventilating ducts. They all have an outside diameter of  $27\frac{3}{8}$  in. and the typical column has a metal thickness in the basement of  $1\frac{11}{16}$  in., first story  $1\frac{1}{2}$  in., second story  $1\frac{1}{4}$  in., third to six stories inclu-

ed by ribs of 2 in. metal 6 in. deep. The construction of these columns is clearly shown in the detail drawing and the photographic illustrations. The basement is 11 ft. 4 in. high from floor to floor, the first to fifth stories 15 ft. and the sixth story 17 ft. 2 in. to top of roof slab. The roof slab is covered with 2 in. of cork on which is placed the cinder concrete roof filling for drainage, over which is placed the slag roofing. The 2-inch cork



insulation was used not only to facilitate maintaining a uniform temperature in winter weather, but to prevent any condensation forming on the ceiling due to the humidity in the air. The south, east and west elevations are faced with brick, the north

by thermostats. In Building 17C (not illustrated) the fan is located in a pent house on the roof and is of the double inlet, multiblade type, having a capacity of 200,000 cu. ft. per minute, operated by a chain driven motor of 150 hp. The pre-heater con-

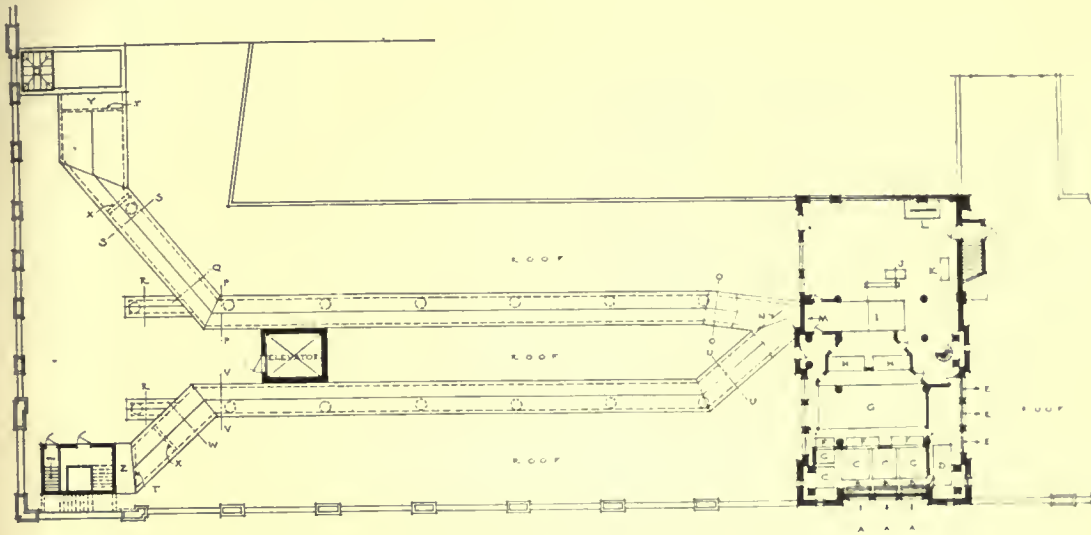

Building 17D, Seventh Floor and Roof Plan

- A—Fresh air inlet.
- B—Regulated fresh air louvres.
- C—Return air opening in floor with regulated louvres.
- D—Return air opening in floor to atmosphere.
- E—Return air openings to atmosphere.

- F—Pre-heaters.
- G—Air washer.
- H—Re-heaters.
- I—Fan.
- J—Fan motor.
- K—Vacuum pump and trap.
- L—Switchboard.
- M—Outlet to air duct on roof.
- N—Adjustable deflector.

- O—Duct 7 ft. wide, 5 ft. 6 in. high.
- P—Duct 6 ft. 6 in. wide, 5 ft. 6 in. high.
- Q—Duct 6 ft. wide, 5 ft. 6 in. high.
- R—Duct 3 ft. by 3 ft. high.
- S—Duct 6 ft. wide, 5 ft. 6 in. high.
- T—Pipe rail in duct.
- U—Duct 7 ft. by 7 ft.
- V—Duct 6 ft. 6 in. wide, 7 ft. high.
- W—Duct 9 ft. wide, 7 ft. high.
- X—Regulating dampers in duct.
- Y—Vertical air duct.
- Z—Vertical air duct.

or court elevation has brick spandrel panels only, the concrete girders and columns being exposed. The four faces of the tower are faced with brick.

The tower is 40 ft. 6 in. square from the ninth to eleventh stories inclusive. At the seventh floor or main roof level the tower is the full depth of the building, the eighth floor being practically a mezzanine story as shown in the section.

This tower is a notable example of the use of such an architectural feature to house the water supply tanks and other utilities. If such structures were universally used the skyline of our cities would be relieved of the hideous tanks that so often appear as suspended in the air or resting on plain brick walls. In this particular case the tower is an interesting and well designed architectural feature which supplanted the concrete covered steel tower shown in the progress photograph which was in the same plan location as the brick tower in Building 17D.

The heating of Buildings 17D and 17C is accomplished by hot blast systems of sufficient capacity to maintain an internal temperature of 70 deg. Fahr. throughout, with external temperature of zero, the room temperatures being automatically controlled

sists of two groups of regular vento sections, two tiers high and two rows deep, containing 2,560 sq. ft. of radiation. The re-heater is composed of two groups of regular vento sections, three tiers

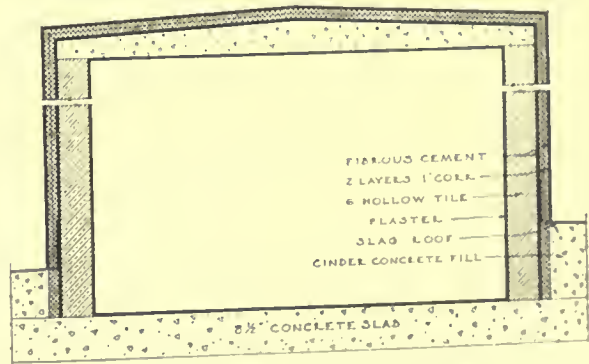

Section through Air Duct on Roof

high, one group being three rows deep and the other group four rows deep, containing a total of 8,778 sq. ft. of radiation. The air washer has a capacity of 200,000 cu. ft. per minute and is provided with a system of humidity control.

In Building 17D, see seventh floor and roof plan,

# THE AMERICAN ARCHITECT

the fan is of the single inlet, multi-blade type, with a capacity of 225,000 cu. ft. per minute, operated by a chain driven motor of 150 hp. The pre-heater consists of three groups of regular vento sections, three tiers high and two rows deep, containing 4,224 sq. ft. of radiation. The re-heater is made up of two groups of regular vento sections, three tiers high and four rows deep, containing 8,448 sq. ft. of radiation. The air washer is of 225,000 cu. ft. per minute capacity and provided with a system of humidity control. These air washers eliminate 98 per cent of the solid matter in suspension before being delivered to the fan.

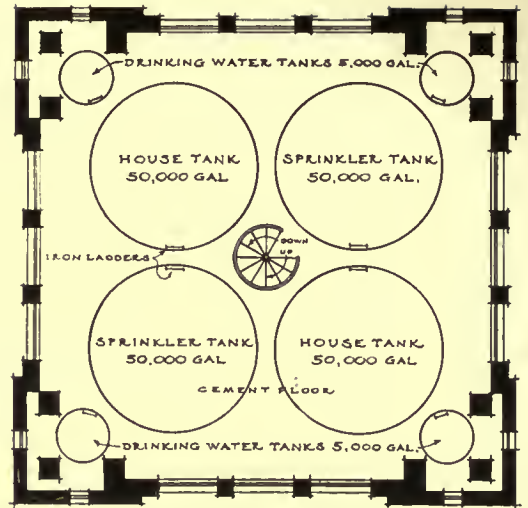

Ninth Floor Plan

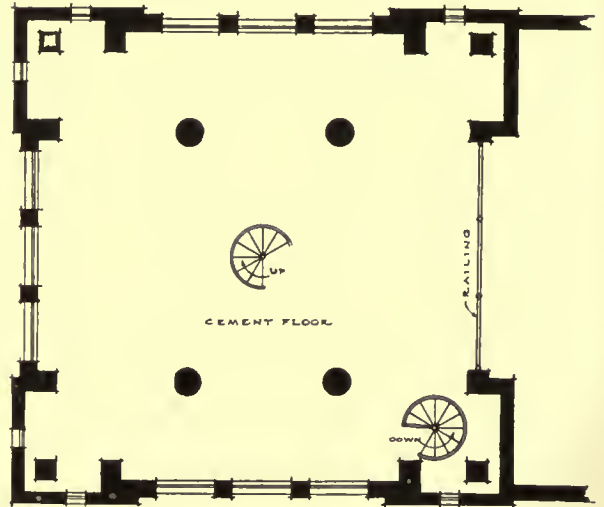

Eighth Floor Plan

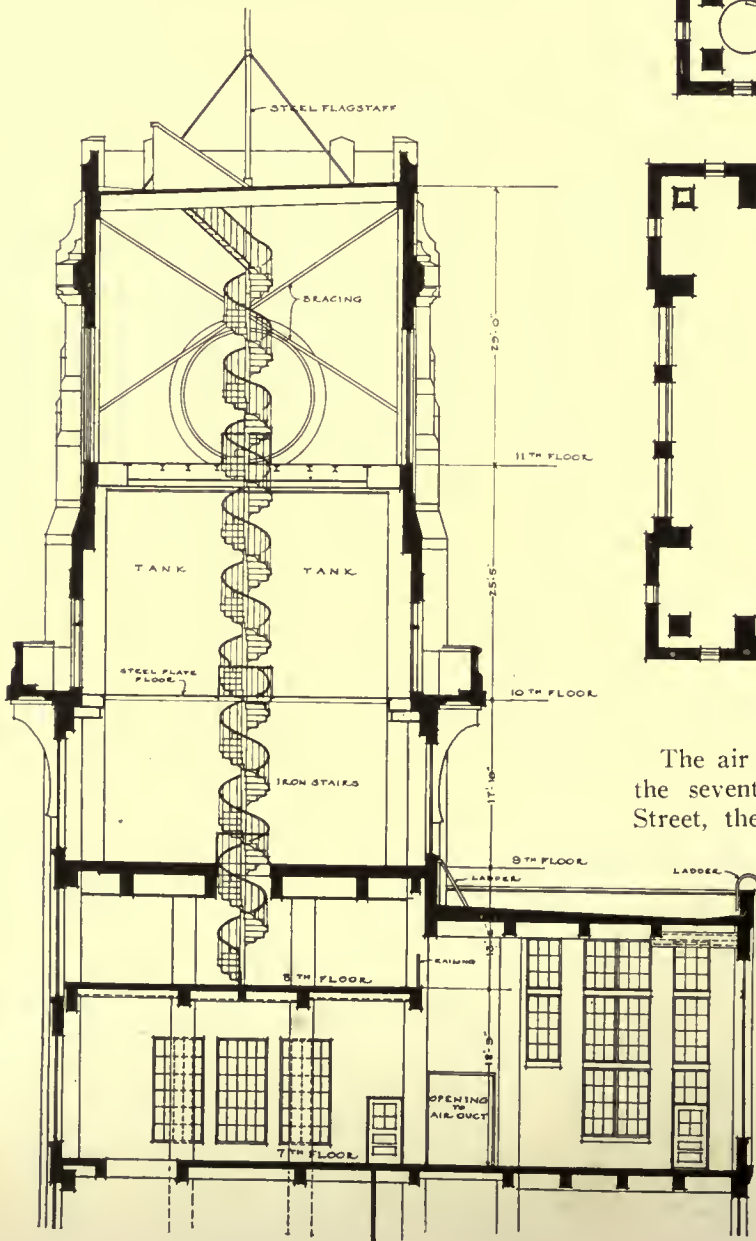

Section of Tower, looking west

The air intake is through the three openings in the seventh story of the tower, facing Market Street, the louvres immediately back of these openings are automatically controlled by thermostats and arranged so that the air may be taken entirely from the exterior, from the re-circulating ducts or a combination of fresh and return air. This arrangement is shown in the seventh floor and roof plan.

In the seventh floor are return air openings, with louvres which are controlled by thermostats. The return air duct is brought to this position below the sixth story ceiling. One such opening, to the east, is separated from the main air chamber



# THE AMERICAN ARCHITECT

by a partition and this return air escapes to the atmosphere through the three window openings to the east as indicated.

The air, either fresh or return, passes through the pre-heaters, the air washer and the re-heaters

ment. By this construction the duct is insulated against heat loss. Immediately after the duct

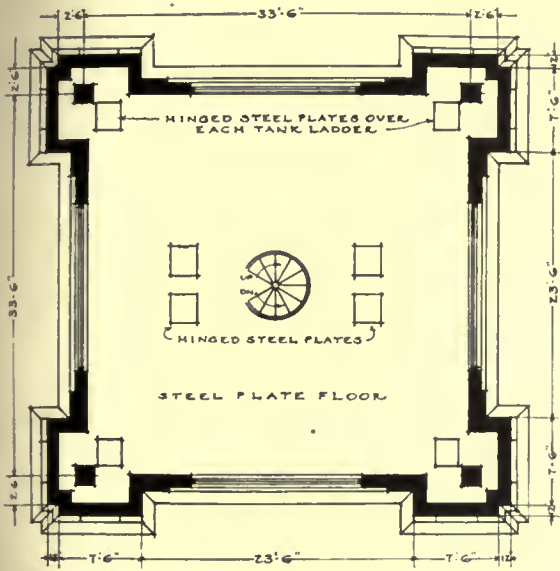

Eleventh Floor Plan

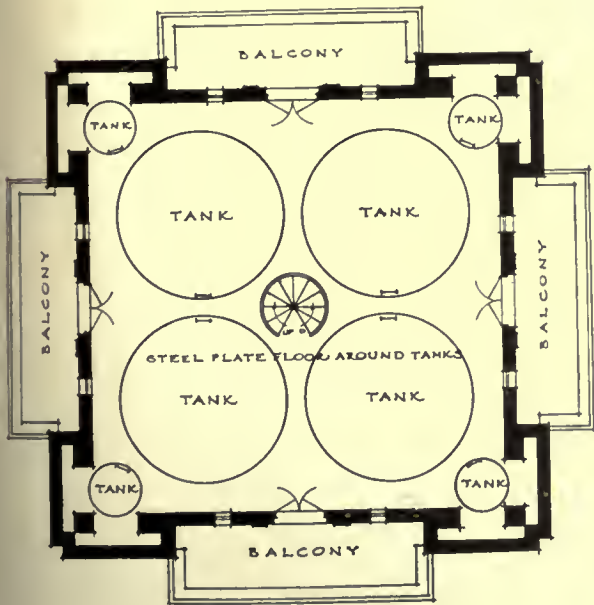

Tenth Floor Plan

to the fan from which it is sent to the roof ducts. These roof ducts have side walls of 6 in. hollow tile and roofs of reinforced concrete. The entire interior is plastered. The exterior of the tile walls and concrete roof is plastered with a fibrous cement, to which is applied two layers of one inch thick cork to which is applied another coating of fibrous ce-

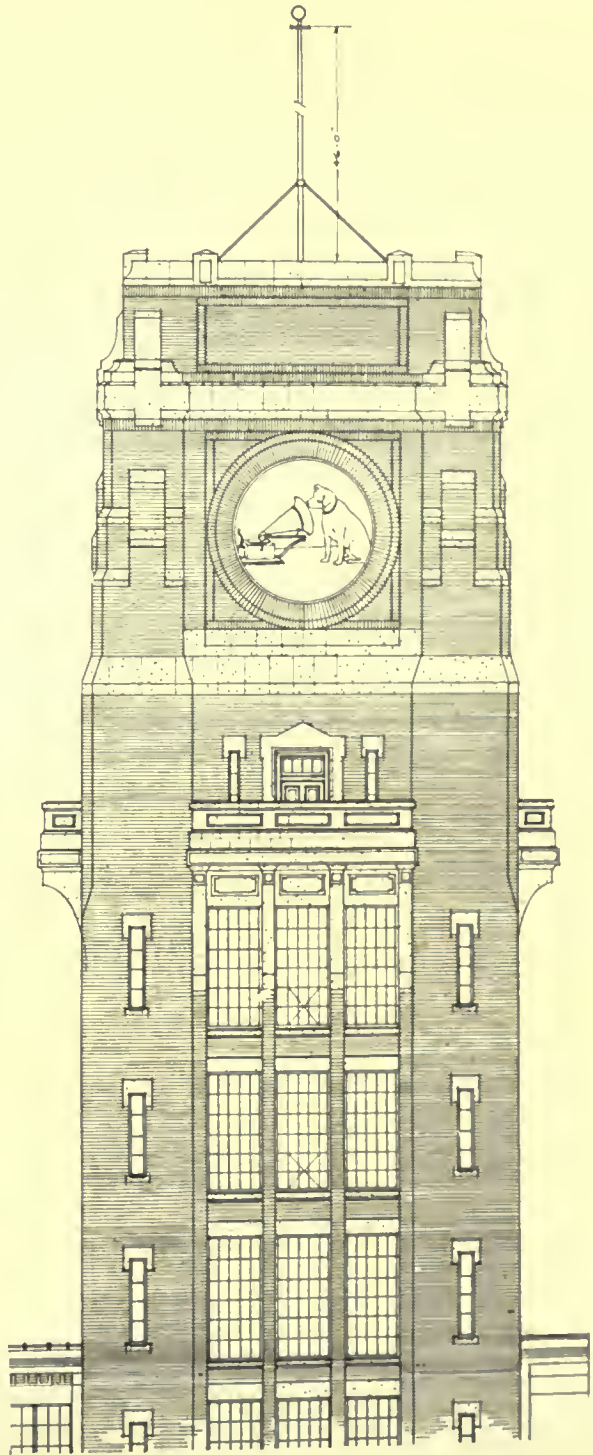

South Elevation of Tower

emerges from the tower, it divides into two lines and at the junction is placed on adjustable deflector to regulate the air supply to these ducts.



## THE AMERICAN ARCHITECT

In the bottom of these ducts are openings into the tops of the fifteen stacks of cast iron columns, previously mentioned, which also serve as vertical air ducts. The air is diverted into these columns by specially designed deflectors which are adjusted from the outside of the horizontal duct. These horizontal ducts terminate over two vertical rectangular air supply ducts, the one on the north extending down to the second floor and the south duct to the basement. Before entering these vertical rectangular ducts there is placed in the horizontal

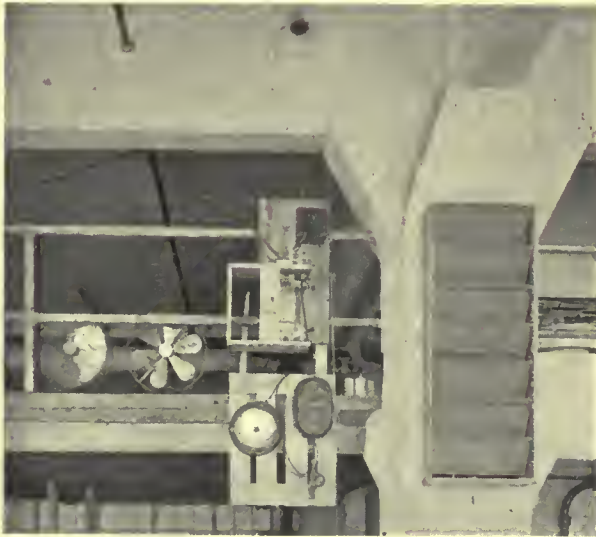

Test of automatic register release apparatus. Actuating apparatus at ceiling with air line connection to operating device which is connected with the ventilating louvres. For a test purpose the apparatus, on release closes the registers, stops one fan and starts another, rings a gong, turns in a fire alarm and causes a talking machine to say "This is a fire drill; form in line two abreast, and move out quietly."

ducts a regulating damper and a pipe railing to prevent persons from walking into these vertical ducts.

The air passing through the cylindrical cast iron columns is deflected through the openings at each story by adjustable galvanized iron deflectors as shown in the detail drawing. A register casing, made of galvanized iron, is placed on the front of the opening. In this casing is placed louvres which are hinged at the side. Their normal position is, of course, open and are held in this position by a simple chain mechanism, which in case of fire is automatically released and causes the louvres to drop into a position that closes the opening. These registers, as well as all of the automatic fire doors and rolling steel shutters, are actuated by an automatic release. This release operates when the rate of temperature increase is abnormal, as in fire conditions, or at a rate of 15 deg. or more per minute.

When the rate of temperature increase is less than 15 deg. per minute the release does not operate. It will be seen that this device operates by the rate of increase in temperature regardless of the temperature itself. This is directly contrary to the action

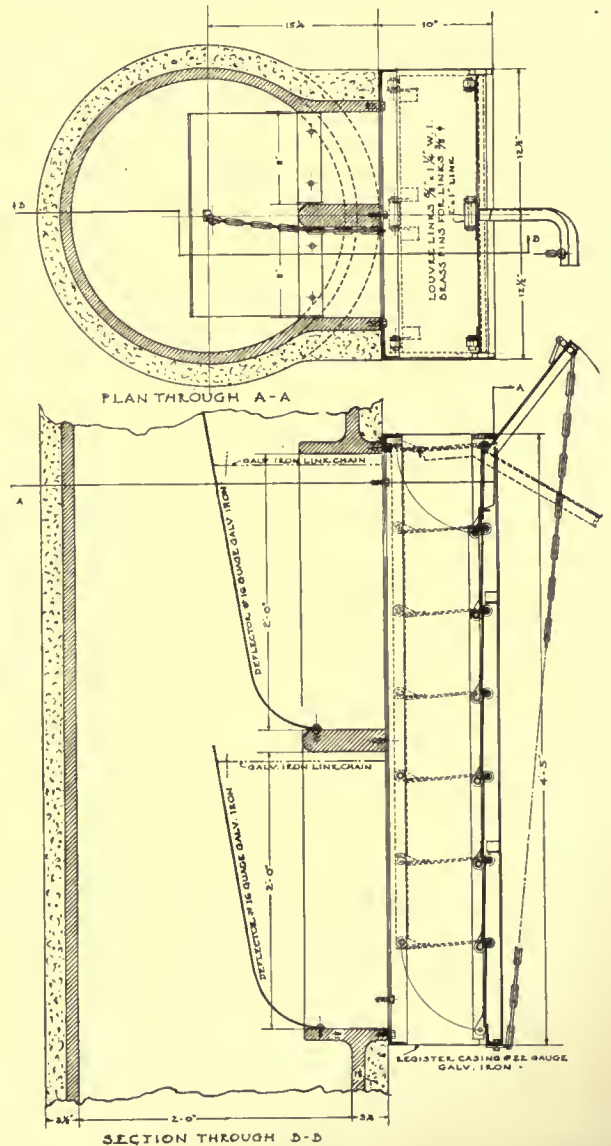

Detail of register on cast iron column showing the louvres closed. Open position indicated by dotted lines. Note adjustable deflectors inside the column

of the ordinary fusible link which can operate only at a fixed temperature. The release here used would operate in a cold storage house, provided the temperature increased 15 or more degrees per minute and well illustrates its value for universal applications.

The incoming air at each story causes the air to travel to the return air duct located at the east end of the building and extending vertically to the

## THE AMERICAN ARCHITECT

chamber under the sixth story ceiling, where it passes through the louvred openings in the seventh floor and is disposed of as previously described. On one floor there is operated planing machines at which there are placed an exhaust apparatus for the removal of sawdust and shavings. This draws a considerable amount of air out of the room and one of the problems that the architect had to solve was to put in as much air as was taken out by this exhaust system and maintain temperature of the rooms; this was done successfully.

During the summer season, the fans and air

midway in the height of the tanks is placed a steel plate floor for utility purposes only. The eleventh floor above the tanks is also made of steel plates, in which doors are placed over each tank.

The tanks consist of two sprinkler system and two house tanks for sanitary purposes, each of these four tanks are 14 ft. 6 in. in diameter and 40 ft. 6 in. high, with a capacity of 50,000 gallons each and also four drinking water tanks, 4 ft. 8 in. in diameter and 40 ft. 6 in. high with a capacity of 5,000 gallons each. The total tank capacity is 220,000 gallons of water.



View of a finished story, except that the hot air registers are not yet in place.

washers are used for cooling purposes. The windows in this building in all seasons are kept closed.

Exhaust steam is used for heating. A 24-in. main supply originates at the old power house on Cooper Street and from this main a 14-in. vertical supply, with a 10-in. branch to the pre-heaters, supplies steam to this apparatus. A 6-in. return line carries the condensation to the basement of Building 17D at which point it connects with a 10-in. main return running to the power house. Vacuum pumps and return traps insure the circulation of the steam.

The water supply tanks for the group of buildings are placed on the ninth floor of the tower and extend through the ninth and tenth stories. They rest on a concrete slab which is supported by a heavy structural steel frame. Gutters are placed in this concrete slab, about the eight steel water tanks, to remove the condensation which accumulates on their outer surface. At the tenth floor,

The water for sprinkler and sanitary purposes is taken direct from the river, the pumps being located in the basement of the Power House which is built on the river front. The water is pumped through filters which have a capacity of 5,000,000 gallons per 24 hours. This water is pumped to the four large tanks located on the ninth floor of the tower, which are located about 1500 feet from the Power House and about the central in the group of buildings. The elevation of these tanks is sufficient to give the required head for this group of buildings.

The piping to these tanks is run in the pipe shaft from the basement to the eighth floor, where all of the control valves for the tanks are located, the entire space on that floor being utilized for that purpose insuring easy access to all valves. This centralized control and the fact that the piping is painted in colors to designate the contents of the same,



## THE AMERICAN ARCHITECT

gives a system that is easily understood and convenient to operate. The drinking water tanks are supplied with city water from a 6 in. main riser with a 4 in. branch to each tank. Two 12 in. risers supply the sprinkler and house tanks, from which a 6 in. branch supplies each tank through the 8 in. sprinkler and house service pipe which connects with the bottom of the tank. The large tanks have 8 in. overflows, the small tanks 4 in. overflows, into which are connected the 4 in. drains from the bottom of all tanks. These drains and overflows unite in a 12 in. vertical drain in the pipe shaft. From the 12 in. sanitary or house tank riser is taken a 10 in. service to the air washing plant. The sprinkler and house tank service is cross-connected at the eighth floor for emergency use.



Entrance to ramp showing hand rails for preventing congestion.

The discharge line from the sprinkler tanks is run to a manifold in the basement of the tower. The discharge line from the house tanks is connected with a loop line in the basement which serves all the buildings in the group, and to the sprinkler manifold, which makes the contents of the four large tanks available in case of emergency. The distribution of the drinking water is also accomplished by a loop line in the basement.

The inclined planes or ramps at the west end of Building 17C are worthy of especial attention. They are 11 ft. wide and have a pitch of  $1\frac{3}{4}$  in. per foot. The concrete floor has an ordinary float finish. Two pipe rails are placed at the bottom of the incline to prevent congestion at the five exit doors. At a fire drill test 4850 men passed out of these buildings through this exit in  $13\frac{1}{2}$  minutes. This

is a very impressive demonstration of the efficiency of this type of means of egress and is well worthy of careful consideration by architects and owners. Objection may be made by some to the amount of



View of ramp midway between first and second floors, showing entrance at the left.

space occupied by such a construction but its advantages in safety to life will far outweigh any reasons brought against its use. The other means of egress are fireproof stairs enclosed in brick walls and access thereto only being by passing through an exterior balcony; in other words, no stairway opens directly into the building.

This entire group presents many interesting features and is well worth a careful inspection. This article is confined to Building 17D, the last constructed, as containing all of the desirable features developed during the growth of this great industrial plant. Every feature of this building and its mechanical equipment was designed and specified within the organization of Ballinger and Perrot, Architects, and is an excellent example of the product of the modern architects' organization, so formed as to render complete service to the client. The plant also evidences the intelligent liberality of the Victor Talking Machine Company in providing such quarters for the production of their wares.



# Industrial Information

*In this Department there is published each week information as to the development of materials and methods, derived from reliable sources.*

## Changing Times

A twelve-page calendar measuring 20 x 27 inches will be sent on request to architects addressing John Boyle & Co., 70 Reade Street, New York. Each page bears a fine, colored map, representing first the world, then this country, Europe, the chief European countries, Asia, Africa and Australia in succession. In view of the imminent changes in the aspect of a world map now for so many years familiar, and the constant references that doubtless will be necessary in the near future, a calendar so illustrated will be a useful adjunct in every office.

John Boyle & Co., Inc., have been for nearly sixty years manufacturers and exporters of cotton duck and awning materials. They have a branch office in St. Louis, Mo.

---

## Vacuum Heating

The valuable exposition of vacuum heating contained in a booklet on heating equipment prepared by the Bishop-Babcock-Becker Co. gives another outlook on a topic whose ramifications have not all yet been explored. This company has headquarters and factories in Cleveland, Ohio, and eleven other offices in principal cities throughout the country.

Considerable misapprehension exists on the meaning of "vacuum heating." The term naturally implies that vacuum is used as a heating medium, but this is actually not the case. It is generally conceded that steam is at present a satisfactory and economical heating medium, but it is also recognized that air accumulates in radiators, pipes and boilers, preventing the free circulation of steam and reducing the effectiveness of the system.

In the ordinary steam plant, the only way to get rid of the air is to force it out with steam pressure through vent valves on radiators. As the openings in these valves are very small, this procedure frequently requires considerable time, during which the occupants have to suffer from cold. In addition, a large amount of fuel is burned to produce the steam pressure necessary to force air out of the system and keep it out.

Vacuum heating equipment will, it is claimed, overcome these difficulties. Vacuum in a steam-heating plant eliminates air resistance by exhaust-

ing air from the radiators, piping and boiler; after this is done, it pulls steam into the radiators on the same principle as a vacuum cleaner sucks in dirt. The result is quick, thorough and even heating, as steam reaches all radiators instantly and each one is entirely filled with steam.

It has been found that with two pipe gravity return plants, the vacuum would eliminate the water due to condensation, thereby assuring thorough drainage and preventing freezing and hammering in the pipes.

Another point in favor of vacuum heating is that vacuum in the boiler permits of boiling below the 212 F. required in air. This means that steam is produced and transmitted to radiators at a lower temperature than is otherwise possible, and results in an appreciable saving in fuel.

The booklet describes three different kinds of heating equipment made by the Bishop-Babcock-Becker Co., to cover every requirement. They are claimed to be efficient in any structure, whether small residence or tall skyscraper. Diagrams and plans are interspersed throughout the pages, helping to form a complete and valuable book.

---

## Globe Ventilators

Good ventilation is inseparable from health and vigor. Every element favorable to good health may be present and yet made impotent by bad air. Manufacturers have devoted much time and effort to the perfection of apparatus which will purify the air and maintain it in constantly wholesome condition.

Notable among devices with this aim is a widely used and effective instrument manufactured by the Globe Ventilator Co. of Troy, N. Y.

In a booklet published by this company there is printed a simple discussion of ventilation in its various aspects, together with a thorough description of how the Globe ventilator fills the needs of a reliable system. The illustrations have been selected with a view of showing the variety of structures in which Globe ventilators have been installed.

The design of the Globe ventilator, with its curved inner and outer surfaces, induces, it is said, a rapid movement of the air outward, at the same time offering the minimum resistance to flow. It produces a powerful upward current of air, draw-

ing out all trace of dust, steam, smoke and gas-laden air. Wind cannot enter the throat of the ventilating pipe, therefore there is never a downward draft. The makers state that every inch of its opening is effective in creating efficient, positive ventilation; that it utilizes all wind currents, thereby creating vacuum—a vital principle of ventilation—and works without wind by natural suction.

The Globe ventilator is made of heavy gauges of galvanized iron of the best quality obtainable. The construction is described as firm and substantial, carefully executed by skilled workmen. An interesting result in the operation of this device is that nothing moves but the air, so there are no parts to creak or get out of order.

A small model demonstrating the operation of this ventilator will be mailed on request of architects.

### Electric Equipment

The Hart & Hegeman Mfg. Co., of Hartford, Conn., has united with the H. T. Paiste Co., of Philadelphia. Both are now under one management in Hartford. The consolidation secures to architects a complete line of wiring devices of high quality, made under one supervision.

In manufacturing and developing its line of wiring material, the H. T. Paiste Co. has aimed to make every new addition to its line a standardized interchangeable device, thus avoiding duplication and multiplication of ineffective designs.

The reputation attained by Hart & Hegeman switches is, they claim, due to the fixed purpose of producing the most durable and serviceable switches possible. This company for twenty-six years has specialized exclusively in the manufacture of switches, and success of results is to be expected. If a switch proves unsatisfactory and causes inconvenience to the householder, the whole installation is apt to be condemned. In any case, it tends to

makes the use of the system unreliable and troublesome. It is the switch with which the user comes in daily contact, and this makes it to him a feature of considerable prominence as part of the equipment. It is therefore a matter of importance to the architect to select a dependable and durable switch. The makers believe they have this kind to offer.

They state that all the raw materials used in the manufacture of "H. & H." switches are given laboratory tests before being made up, and further, that every part of the finished switch is tested and gauged. Most of the moving parts need to be so accurately made that there is not a variation of one-thousandth of an inch. In addition, severe mechanical and electrical tests are given.

A book of 181 pages may be secured from these people in which will be found illustrations and description of the wide variety of electrical devices and materials they produce.

### The Shingle Roof

The possibilities of shingle roofs are persuasively presented in a pamphlet printed by the H. W. Johns-Manville Co. of New York.

Chief among the drawbacks in the use of shingles has been the matter of their susceptibility to fire. In this instance, however, the shingles are made of asbestos, so that by their use fire hazard is reduced to a minimum. Combine this attribute with a good assortment of rich and appropriate color and you have a material which has earned for itself considerable esteem and appreciation.

The brochure referred to is colorfully illustrated by pictures of country cottages and other rural structures where roofs of this type may be used, and covers an able and readable talk on the evolution and development of shingle roofing here and abroad.

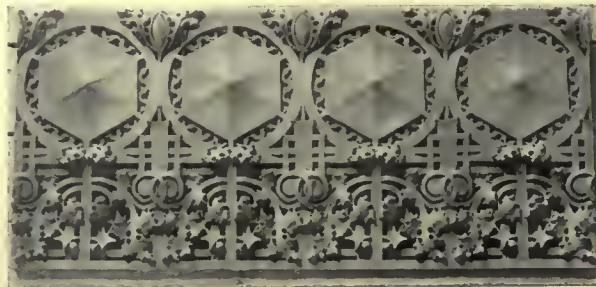

14 134

# The AMERICAN ARCHITECT



PATIO OF THE LIONS, THE ALHAMBRA, GRENADA

PUBLISHED WEDNESDAYS IN NEW YORK—FOUNDED 1876

VOLUME CXV

JANUARY 22, 1919

NUMBER 2248

Entered as second class matter January 6, 1909, at the Post Office at New York, N. Y., under the Act of March 3, 1879. Publication office, 243 West Thirty-ninth Street, New York, N. Y. Subscription price in the United States and Possessions, \$10.





The Name **ARMCO** is a  
synonym for

**HIGH QUALITY IRON**

in the minds of all men

*The Builders' Trade is especially interested in the economy of its use*

**The American Rolling Mill Co., Middletown, Ohio**

Licensed Manufacturers Under Patents Granted to The International Metal Products Co.

Branch Offices at New York, Washington, Pittsburgh, Chicago, Cincinnati, Cleveland,  
Detroit, St. Louis, Atlanta, San Francisco and Buffalo



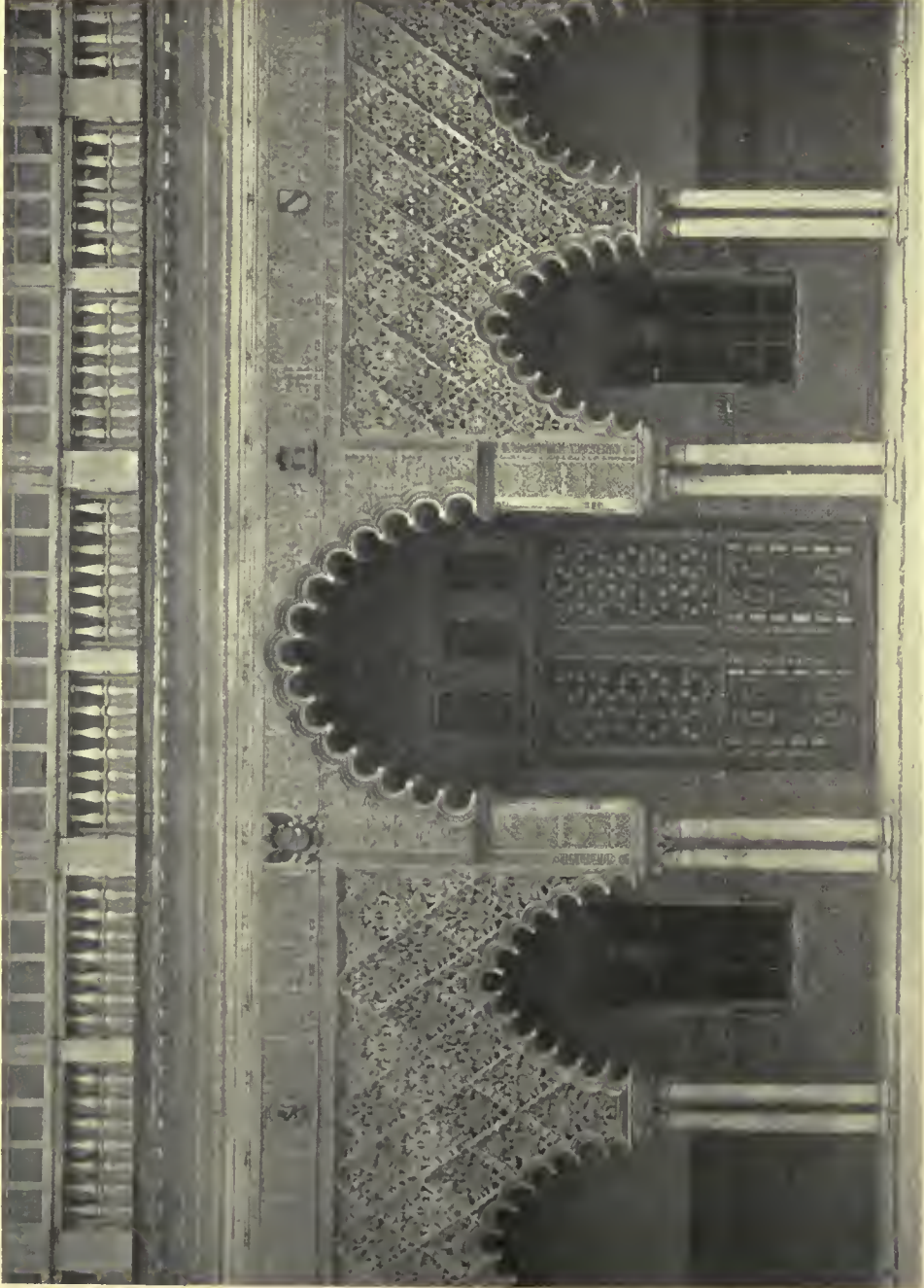

DETAIL, THE ALCAZAR, SEVILLE, SPAIN



# THE AMERICAN ARCHITECT

VOL. CXV

WEDNESDAY, JANUARY 22, 1919

NUMBER 2248

## Building for Health

### A House Should Fit Its Owner Like His Skin

By WOODS HUTCHINSON, A. M., M. D.

HOUSES are built for everything except for the comfort of those who live in them. Originally they were tombs for the dead and most houses more than one hundred years old are much better adapted for this class of tenant than they are for the living. No wonder so many old houses are haunted and that to move into one of them is a sure sign of a death in the family within a year.

Next, the house was a fortress, or an appendage to a fort, and a painful majority of houses over fifty years old show unmistakable traces of this origin, in darkness, smelliness, stupidity of plan, and utter lack of ventilation. An Englishman's house is still his castle in a number of most uncomfortable and inconvenient senses, cold, dark, damp, drafty. The worst fault that a house can possibly have from a health point of view is that it is old.

In recent times the majority of places in which people have to live—it would be an undeserved compliment to call them homes or even houses—are built to return a good income on the investment, the next largest moiety to form a monument for the architect, and the third most important fraction to prove publicly and inescapably that the owner "has the price." Building for the health and comfort of the occupant, or for the pleasure and welfare of the community has only just begun, and most of the best and most convenient sites are already occupied by rack-rented barracks, or misfits, or calamities in brick or stone.

For the sake of health there should therefore be passed a law fixing a term of life for houses used for dwellings and this term should be in the neighborhood of fifty years. The Almighty in His wisdom has fixed the term of human life at three score years and ten, which is often a great mercy for the rest of the community, and we should imitate Him by fixing a life-time for houses one-third shorter than this, because we cannot yet build as well as He.

Every house still used for human habitation and dwelling should be automatically burnt or pulled

down when it has stood for fifty years, unless it can be clearly shown to be thoroughly sanitary, up to date and fit for human habitation according to modern standards, or can be readily altered to make it so. Exceptions of course could be made for building of historical interest, birthplaces of famous men, specimens of periods of architecture, etc., but these should be turned into public museums and no longer lived in.

This would involve no real injustice to the owners of the property, because most rented houses are let so as to return about ten per cent on the original investment to cover repairs, dilapidation, etc., consequently the house pays for itself every ten years, or four or five times over in the fifty years. The greatest obstacle we have to fight, five times as serious as any other, in attempts at, and schemes for housing reform, is the old house, utterly incapable of being made sanitary and decent for human habitation, and yet too tough and strong to allow us to get it condemned on the ground of being unsafe to live in.

Our heathenish and outrageous old building laws in most states and cities permit the condemnation of a house only on the grounds that its walls are liable to collapse, or its floors to give way or its roof to fall in, even though it be a perfect breeding ground for bugs and hot-house of disease and death. If we had power to pull down these wretched old baby stifiers and consumption breeders, the owners of the property would have no difficulty in borrowing money enough on the land to erect in their place modern sanitary model tenements or apartment houses.

But these would return them only five or six per cent on the investment, while the existing old rookeries and barracks pay anywhere from ten to thirty per cent on the original cost. So that as long as our brutal and antiquated laws protect them they will go on callously coining money out of the blood and sufferings of the poor, and turning over one or two per cent of it to the support of the church and

## THE AMERICAN ARCHITECT

schemes of Christian charity, as an opiate for their conscience.

Just think of the splendid field for architectural accomplishment, of scope for the new school of building which is eager to plan and construct for the service of the community and the public welfare and pleasure, if the hundreds of acres now cumbered and blighted in every large town by slums and stews and germ-cages could be swept clear and clean for the rebuilding of the city on broad and beautiful and healthful lines for the comfort and shelter and enjoyment of its citizens!

In "remoulding nearer to our heart's desire" the condemned old parts of our cities and towns and the growing new ones, it must be clearly recognized that the day of the single and separate house is over and gone. Houses in the new and open parts of the cities must be built in groups around parks and gardens. In the down town, denser regions they must also be built in groups called apartments, around spacious central courts, and receded sufficiently from the street line to make each one, so to speak, provide its own air and light. If they are more than four stories high the upper stories must recede still farther from the lot line and the highest assume the character of towers.

Each individual house or apartment should be considered and planned as merely a unit in the group, and, far from being in any way "self-contained," dependent absolutely upon the rest of its fellows and neighbors. It should give certain concessions in regard to air, light and view to its neighbors, both lateral and vertical, and receive from them other similar concessions in return.

Each group whether down town in a tenement or out in a suburban garden court should have a central system of heating, lighting and gas supply and of air or power for cleaning and domestic labor-saving purposes. These need not be operated by or dependent upon the skill of the individual tenants, but be attended to by groups or teams of experts who would visit the building so many times a day for heating or lighting service and so many times a week for cleaning, window washing, laundry and heavy cooking work.

Even where central heating or city electric and water and gas supply are not yet available, all modern group-buildings should be provided with flues, wires, pipes, etc., for all these services, so that whenever the city can give them these privileges they can be utilized to the best advantage. In the meantime most house groups except the very smallest would find it a distinct economy and advantage in every way to have one central furnace instead of a dozen or fifteen separate ones, one central lighting system, where possible electric, and where not, acetylene or other inexpensive form of private

gas-installation, and a central water supply from well or spring, pumped and distributed by gasoline engine or windmill.

It is also very convenient in most house-groups whether above and below or side by side, to have a central kitchen and a central café or dining room on the cafeteria plan. Here the heaviest, most laborious and heating forms of the cooking, the joints, the vegetables, the breads and biscuits, the pies and cakes can be carried out by an expert cook, paid by all the tenants in common. Then such families as wish can have their meals served in the dining room, cafeteria fashion, or bring them up to their rooms on the same plan and dine at home.

This would save much space and stuffiness and greasy odors and cooking smells in the separate houses and apartments, as well as much discomfort and dirt from ashes, coal, slops and garbage. Each individual house or apartment need only be provided with a small, well lighted and ventilated kitchen, equipped with a gas stove, sink, cabinet, glass or enamel-top tables, refrigerator and electric ironing table.

The modern kitchen should in any case be small, compact, with the stove in the centre of the room, the mixing table next to it, the sink and dish closets in easy reach from one side of the stove and the refrigerator and cabinet from the other. It should be a laboratory, not a living room, so arranged that one or at most two individuals can stand or sit on a high stool in the middle of it and reach everything they require for food and mixing and preparing on one side, and for serving, washing and distributing by wheeled table or carrier, on the other, without moving from where they stand or rising from where they sit. Any more space than this in a kitchen "cometh of evil," causing unnecessary trotting about and lost motion generally as well as wastage of valuable floor space.

The floor of the kitchen should be either of hard wood, or, better still, of concrete, or one of the tough wood-pulp mixtures, or, failing this, linoleum covered. Its walls should be not merely painted but enameled; its tables, sinks and drainage boards, either glass or enamel or heavily paraffined wood, so that every surface of tables, walls and floor can be sluiced down or wiped clean with a wet cloth. The stove should, of course, be either gas or electric, as a good and economical private "gas-works," or electric dynamo for ten or more houses can be easily constructed, where there is no city service of either gas or electricity.

In addition to this the up-to-date kitchen will be supplied with cold air pipes from a central cooling plant, so as to prevent cooking the cook with the roast when the weather is too warm, to permit the room being cooled by its numerous windows.



## THE AMERICAN ARCHITECT

Of course every kitchen ought to have windows at least on two sides and preferably on three, so as to allow for both proper cross ventilation and cooling. And a hood over the stove to carry away any possible odors of cooking.

A central heating plant is absolutely indispensable for the proper and healthful use of the bathroom, as a bathroom, without an abundance of hot water day and night is little better than none at all. Without continuous hot water it is simply a temple of discomfort and mortification of the flesh. It was the omission of this vital factor which gave rise to the chief of the daring and delighted jeers and cheap flings of the superior classes at the inborn shiftlessness and dirtiness of the poor. Namely, the story of the model tenement built by the benevolent rich for the deserving "pooah," in which after six months' occupancy the bathrooms were found

turned into storerooms and the bathtubs used for the storage of coal. Nothing of that sort ever happens when hot water is provided.

Incidentally, this famous and favorite story of vestrymen, heavy taxpayers, or rather tax dodgers, supercilious lady visitors, Lady Bountifuls and the charitable rich generally can be matched and bettered by the story of the family of the Italian nobility which rented for a season the remodelled villa of an American in Rome, and who were found on a visit of the owner keeping butter and melons and green vegetables in the bathroom and live ducks in the bathtub! So that it is not merely the poor and lowly who have a prejudice against cleanliness by the cold tub route. Like Mrs. Partington, while some people can bathe in water as cold as Greenland's icy mountains or India's coral strand with perfect impunity, they prefer a bath slightly tepid.



NORTH FRONT, GREAT CHATFIELD MANOR HOUSE



# The Sacramento State Buildings Competition

WILLIAM C. HAYS, *A. I. A.*, discussing in a recent issue of *The Architect and Engineer of California* the various designs submitted in the Sacramento State Buildings Competition illustrated in this issue of the AMERICAN ARCHITECT, refers to what he considers "well warranted criticism of the Institute Code" governing competitions. Specifically, and with reference to this competition, he states in part:

"This was a 'two-stage' competition, with ostensible 'preliminary' and 'final' stages. Actually, the 'preliminary' nature of the first stage was a farce—with such tragic results, from the economic standpoint, that architects, as a class, must appear to intelligent laymen to be fit subjects for immediate investigation, either by alienists on behalf of the Lunacy Commission or by the Board of Charities—both of which State bodies, by the way, are to be housed in one of the new buildings.

"In effect, the competitors (sixty-four of them, we are told, from Sacramento—by men who should 'admit' and not rejoice in it) were by those same 'authorities' caused to spend not less than fifty or sixty thousand dollars, where three-fourths of that waste could, and should, have been avoided.

"The 'Code' of the American Institute of Architects recognizes both 'open' and 'limited' competitions, but deprecates the former. It also provides for two classes of 'limited competitions,' in one type of which (b) the participants are chosen 'from among architects who make application accompanied by evidence of their education and experience.' In the 'open' form the Code contains a very serious fault in that this 'evidence of education and experience' shall be offered by all competitors *after* incurring the expense of the preliminary stage.

"The Code, by the way, states that the first stage of an 'open' competition is 'open to all.' Such was not the case here, for it was 'closed' to those Americans who could not qualify, under certain restrictions, as well as to all foreigners. In essence, would it have been less 'open to all' in the first stage, once any limitation is established, if the geographical limitation had been the State of California, or Modoc County—or if the 'training and experience' qualification had been 'a previous condition of servitude in the office of Smith, Jones and Black'? Furthermore, the Code never, either by word or spirit, countenances such a 'preliminary' stage as this one was; on the contrary explicitly stating

that 'the competitive drawings are of the slightest nature, involving only the fundamental ideas of the solution.'

"In this case, the officials, against the urgent representations of the Chapter Committees, insisted on a first stage in which, with the exception that no 'sections' were called for (or allowed), there were required complete 'final' scale drawings (even including basement plans) of both buildings, rendered on Whatman paper in India ink and identical with the final stage. The omitted sections, by the way, could easily have been done in *three or four days*. But their omission, far from being a help, was a positive handicap to competitors—a section being quite as essential as either plan or elevation in studying as well as in 'setting forth the fundamental ideas of the solution.' There was allowed more than *five months'* time for this 'preliminary' stage.

"That the 'preliminary' stage was a mockery at the plain intent of the Code is evident. What then, may the words 'least possible' in the Code mean? One may venture a specific suggestion that, in this case, the spirit and the letter of this phrase would have been properly met if there had been required, say, two principal floor plans of the Library and a plan of the Court floor, one elevation, one section (or two) of the Library and Courts building, at 1/16 inch scale and a block plan at 1/50 inch scale—all on white tracing paper, rendered only in sketch form and mounted at the corners or edges. With a time limit of, say, ten days, each set of drawings might be accompanied by an affidavit to the effect that they had been produced personally by the competitor, with no help other than one assistant, who had been regularly and exclusively in the employ of the principal for the continuous period of six months immediately preceding the issuance of the program. The drawings here described would be full and sufficient for any intelligent juror (and none other is qualified to serve, under any conditions) to make selection. Some worthy scheme might be overlooked? Doubtless—as worthy schemes *were* overlooked, even with the conditions as they existed.

"Another potential fault: the architects in the jury formed a minority, contrary to the Institute Code, and, while the geographical distribution was wise, in general the method of final choice was fundamentally wrong, as all final selections should have been made by the competitors concerned—not

THE AMERICAN ARCHITECT



FRONT ELEVATION, OFFICE BUILDING

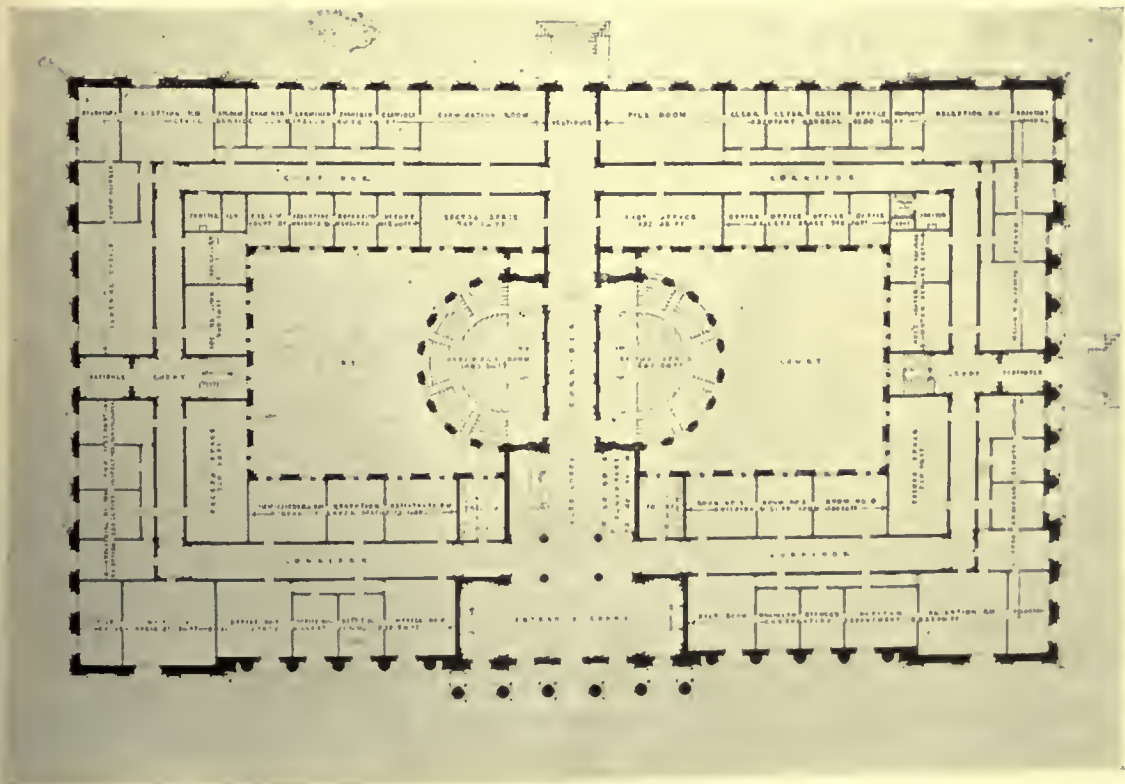

FIRST FLOOR PLAN, OFFICE BUILDING

BLISS & FAVILLE, ARCHITECTS

SACRAMENTO, CAL., STATE BUILDINGS COMPETITION



## THE AMERICAN ARCHITECT

by uninformed laymen—even when professionally advised. Furthermore, it was unjust that the making of nominations for the California juror should be by general vote of the local A. I. A. Chapters, whose members have only the indirect interest of a million other citizens of the State; it was no con-

cern of anyone's, save of the avowed competitors. That the jury, as finally selected, was most excellent and efficient and made an unimpeachable choice among the 'finals' has no bearing on the *principles* involved, but only proves that good frequently comes *in spite* of adverse conditions."

---

# Report On Labor Conditions

*By the Sub-Committee of the Joint Committee of The Illinois Chapter, A.I.A., and The Illinois Society of Architects*

**A**S precedent to readjustment of labor conditions in any scheme of general reorganization, the sub-committee on labor reorganization of this joint committee believes:

First: That the language of this country (that is the English language) shall be used in all industries and that language alone. That no notice or instructions shall be posted in any foreign language, and that after a specified period no one shall be employed outside the ranks of common labor, and then only under abnormal conditions, who does not have a fair command of English, written and spoken. The reasons for this are too obvious to need elucidation.

Second: That for a period of years (five at least) foreign immigration shall be restricted to the most enlightened and sturdiest elements and that a national effort be made to assimilate the foreign elements of our population. That when immigration shall again be permitted, any and every immigrant who cannot read and write English at the end of six months from the date of his entry into the United States shall be deported immediately.

Third: The sub-committee believes that all means of transportation, all waterways and water courses furnishing power, fuel, forests and mines, and the disposal of raw materials be placed under the supervision of the Government to be employed to the highest advantage of the greatest number of people. These fundamentals being accepted, the program of reorganization or reconstruction may be attempted with promise of success. As to details of that program, we hold among others the following principles to be indispensable in the field of universal labor of hand and brain, and essential to peaceful, progressive democracy:

1. *Minimum Standard of Wages* in industries, trades and professions, in accord with inherent quality or hazard and the cost of preparation and apprenticeship.

2. *Educational Training for All*, in observation, memory, will and expression as well as mechanics of equipment and skill of performance.

3. *Employment for All* and all employed, in necessities or amenities only, and the establishment of government labor allocation and employment bureaus.

4. *Freedom of Trade* and employment between states, cities and places—no discriminations except in quality, fitness and efficiency, and national control of capital issues.

5. *Standards of Labor* and labor conditions and housing, the elimination of child labor and the equalization of male and female labor. Standardization of and improvements in materials and methods and cost saving devices for the benefit of all, without detriment to labor and the free and unprejudicial application of new methods and devices. Enforced truthful and authoritative statements in negotiation and vending.

6. *Safeguards Against Waste* and detriment of the third party in labor disputes, price fixing and profit taking, with collective bargaining, representative negotiation and open prices; no secret treaties or secret rebates; no strikes or lockouts, except the individual right to quit or the individual liability to discharge.

7. *State Councils* for the authoritative propagation and adjudication of these principles, in each group of related industries, trades and professions, and free courts of appeal and final resort, with power to enforce decisions.





# The Elimination of Waste Due to Building Codes

**A** BETTER appreciation of the building industry, with its multitudinous alliances, is had today than ever before. Measured as an essential for human existence, it is on equality with the production of food and clothing and its importance in the realm of finance is second to none. In supplying its demands, a greater number of different productive activities are employed than in any other industry.

As this industry seeks the avenues that lead to the resumption of normal activity, a study must be made of the conditions that obstruct. Of these, the first that occurs is the cost of materials and labor. While these costs will probably never fall to the levels of 1914, they will approach the future normal conditions as rapidly as they can be brought about through adjustments of conditions that are now abnormal.

The cost of labor and materials, of acknowledged great importance, has but little more influence on the total costs of building construction than the wastes that afflict the industry. Many of these wastes are voluntary, being in the form of misapplication of labor, inadequate or unsuitable equipment and other conditions that can be the resultant of carelessness or ignorance. By correcting these conditions, labor is made more productive or effective and consequently its cost is reduced. This, with the reductions in labor scales that in many instances will follow, disposes of that factor.

The cost of materials will naturally fall with the return of labor that was required in war work, the reduction in the cost of fuel and in many cases the cost of raw materials.

The voluntary wastes of material are due to the manner of designing and specifying their uses. These will be overcome by more intelligent effort on the part of architects and engineers and by the competition of the intelligent buyer of such service employing the most economical designer. The architects, engineers, contractors and material producers who do not take advantage of their opportunity to eliminate the voluntary wastes will naturally be driven out of business by the force of competition.

Probably the most tremendous waste in building construction is involuntary and due to laws regulating building construction, existing in the form of state and municipal codes, regulations of factory and labor commissions and in some cases fire prevention bureaus. All persons who are interested in building construction, must exert their utmost

efforts to correct, at this present time, these involuntary wastes.

The preparation and enactment of building codes is generally a slow process, being usually in the hands of commissions or committees appointed for that purpose. The personnel of these committees is often unfortunate, being dictated by political or private interests or composed of too many honest and well intentioned persons whose competency, based on broad experience and real practical knowledge, is questionable. Observation shows that the enacting bodies are always ready to adopt the conclusions of such committees promptly and expeditiously and without question. It then follows that such committees should be composed of a limited number of active and successful men who are compelled, by the demands of their other activities, to work quickly and reduce the code to a minimum in scope and size. With the experience in these matters which has been had, there is no reason why such a committee should not formulate a code in three months if the work was handled with the same expedition that obtains in any successful private enterprise. These things can be done if the desire so to do is present.

The code should contain only the minimum requirements that are necessary to insure that a building is structurally safe and sanitary, with adequate provision for fire-prevention and safety to life. Following antiquated precedents, most codes are specifications in effect, long winded and often contradictory in their provisions. It seems ridiculous that a law should describe, in minute and verbose detail, how mortar should be mixed or shingles laid. These things are within the province of the architect's activities and belong in his plans and specifications which are always subject to the approval of the building departments.

A doctor studies medicine, serves as an interne and is finally licensed to practice in a legal manner—but the law does not state in detail just how he shall perform an operation or write a prescription. Note the rapid advances in the practice of medicine and surgery. On the other hand, building codes apparently are made on the hypothesis that architects and engineers are absolutely incompetent to direct their work without minute legal restrictions covering every detail of a structure. And this in the face of the inspection of plans and specification by building departments and inspection of the work as it is constructed.



## THE AMERICAN ARCHITECT

A code should be so made that it can be revised as fast as progress in building construction takes place. This is best accomplished by a body authorized to perform this function, similar to the Board of Standards and Appeals in New York City or the Commissions that govern many American cities.

When the art of constructing with reinforced concrete was in its infancy in this country, there were no codes regulating such undertakings. Under these conditions many buildings were erected two and three stories high and were later increased to five and six stories in height. The initial designs were made in the light of the then available knowledge and the buildings were well built. The cities in which these buildings stand have since adopted reinforced concrete codes, the provisions of which indicate that many of these magnificent and amply safe buildings should be unsafe and should have collapsed the moment the laws became effective. Such is *law*. Why?

Codes are generally made for the worst conditions of incompetent architectural and engineering designing and inspection and bad construction by dishonest and incompetent contractors. This is a sad commentary on the efficiency of the administrative ability of American cities and the standing of the related professions. This theory of law-making is entirely wrong.

Laws should be made for the best conditions and *effectively administered*. It does not speak well for the architects, engineers and contractors that they have quietly labored under these false assumptions of the building codes and it is now time that they should assert their true place in the political economy of this country as competent and honest men. A building department of any American city which thus admits its inability properly to enforce the law and conserve the interests of the citizens should be dismissed at once and replaced by those who can effectively administer wise and proper laws.

A city which has an improper building code is handicapped and its growth hindered by the burden of useless costs incorporated in building construction. The intelligent investor in such projects will locate in such cities that make it possible for him to secure an adequate return for his investments to which every investor is entitled. It needs no argument to substantiate the fact that the state of the building industry in any community is the index

of its prosperity. It then behooves those who have the interests of the industry at heart, architects, engineers, contractors, material producers, realtors and citizens generally, to make the proper revision of building codes now the first order of business.

---

### The Hazard of Film Exchanges

**I**N urging upon architects that it was part of their duty as citizens and particularly within the legitimate activities of their profession to become identified with movements that conserved public health and insured safety, THE AMERICAN ARCHITECT believed it was consistently carrying forward its efforts toward a proper readjustment of architectural practice.

A concrete instance may be found in our issue of July 17, 1918, wherein were discussed and described the hazards due to the use of buildings not properly safeguarded, such, for example, as film exchanges. The essential features of the new code adopted by the City of Chicago to regulate the construction and equipment of buildings occupied as film exchanges were presented, and it was pointed out that these hazards existed in all cities of any considerable size throughout the United States.

Press reports of a film exchange fire in Pittsburgh state that nine persons lost their lives and a score of others received serious injuries. It develops that several exchanges were housed in the destroyed building through which the fire spread, accompanied by many explosions peculiar to this class of fires.

It is again suggested that architects, particularly in locations where there are organized bodies of the profession, should by united effort secure competent survey of every building used as a film exchange, and see to it that the general safety is assured by such municipal action as will reduce the hazard to its lowest possibility of damage, not only to the occupants of these buildings but to the entire community.

Architects with supersensitive attitude toward professional advertising might find a good method of acquainting the public with their existence by actively forwarding a reform that is so absolutely necessary.



# Re-education of Disabled Soldiers and Sailors

**E**MLOYERS of labor are to have a most important part in the rehabilitation of two hundred thousand American men disabled in the war. According to a monograph, "What the Employers of America Can Do for the Disabled Soldier and Sailor," recently issued by the Federal Board for Vocational Education, the success of the Government's big program dealing with the men who have borne the brunt of battle, to a great extent, depends upon the attitude and co-operation of the employer.

It is the intention of the Government to assist in replacing each man, regardless of his handicap, in suitable civil employment. The men are not to be dealt with from the viewpoint of giving them special "soft" jobs. Sympathy and charity are neither needed nor desired. On the other hand, the employers of America are requested to consider the employment as a business proposition. More harm than good will be done to the disabled man if he is merely "taken care of" in a job in which he cannot make good and earn advancement.

The Government has provided that its disabled man may be retrained in order that he may overcome his handicaps and be re-established as an efficient worker. Through the co-operation of the employers definite jobs will be made available. The training of each individual will be made thoroughly practical and pointed toward a specific occupation to which he may go when he is industrially fit to do so.

The utmost care is to be taken that each man is trained for and placed in a job in which he can make good. Each case will be considered individually on its merits by experts of the Federal Board and by a physician, an employer and a representative of labor in the home district of the man who is to be trained. An effort will be made to place each man in the occupation in which he is most interested, provided it is neither waning nor overcrowded. While it is the policy of the Federal Board to return the man to his former occupation, it can if deemed advisable train him for an entirely new trade. In each case the previous education and experience and the nature of the man's handicaps will be given full consideration in determining a suitable occupation.

Courses of instruction in all agricultural, industrial, commercial and professional occupations are being provided under the jurisdiction of the Federal Board.

No attempt is being made by the Government to establish special schools for the training of disabled men. The most reputable trade and vocational schools, colleges and other well-organized institutions will be utilized. In many cases the training will be given in the factory, shop or office in which the disabled man will be employed after he has finished his course of instruction, and is competent to do the work.

All expenses of course of training, the personal living expenses of the disabled man, and in the case of one who could not successfully follow an occupation without retraining, allowances will be paid to his dependents by the Federal Government.

After the man goes to work his interests and those of his employer will be safeguarded by a follow-up system of supervision established by the Federal Board. While each man will be free to do as he chooses, the policy of the Board will be to see that he makes good, and if he is unable to do so he may receive additional training in the chosen occupation or in some other pursuit in which he is more likely to become efficient. This additional training, when found necessary, will be given entirely at the expense of the Government and on the same basis as the previous course.

Though he may be handicapped in body, the disabled man who carries on through a proper course of training and is placed in a real job will have the satisfaction of feeling that he is doing a man's work. He will be independent and will be able to retain his self-respect.

The employer who thinks he is doing a patriotic duty by giving the disabled man a temporary soft job at high wages is only helping to make one of America's brave soldiers dissatisfied and dependent in future years of his life.

Co-operation of the right kind is sought. Every employer will do well to learn his part in this great work for the disabled soldier and sailor. Action should be taken in this matter. Inquiries should be addressed to the Federal Board for Vocational Education, Washington, D. C.

THE AMERICAN ARCHITECT

Founded 1876

PUBLISHED EVERY WEDNESDAY BY  
THE ARCHITECTURAL AND BUILDING  
PRESS, INC.

No. 243 West Thirty-ninth Street, New York  
E. J. ROSENCRANS, PRESIDENT AND TREASURER  
WILLARD C. HOWE, VICE-PRESIDENT

WILLIAM H. CROCKER, Editor  
ARTHUR T. NORTH, Engineering Editor

Subscriptions in the United States and Possessions,  
Mexico and Cuba, TEN DOLLARS. Other Countries,  
TWELVE DOLLARS.

SINGLE COPIES (Regular Issue) 25 CENTS

CHICAGO OFFICE, Mallery Building  
PAGE A. ROBINSON, Western Manager

ST. LOUIS OFFICE, Wright Building

CLEVELAND OFFICE, Guardian Building

SAN FRANCISCO OFFICE, 320 Market Street

Owned by United Publishers Corporation—H. M. Swetland, President;  
Charles G. Phillips, Vice-President; W. H. Taylor, Treasurer;  
A. C. Pearson, Secretary. Entered as second-class matter January  
6, 1909, at the Post Office at New York, New York, under the Act of  
March 3, 1879.

VOL. CXV JANUARY 22, 1919 No 2248

## The Definite Specification

IT will probably be admitted that the physician who made a practice of prescribing certain drugs—"or others whose pharmacodynamic properties were similar"—would soon lose the confidence of his patients, and yet that is in effect what the architect is doing who persists in the outworn and discredited practice of writing "or equal" after the specification of a given material or equipment.

Unless he entirely neglects to perform his function and leaves the decision to the builder, he must sooner or later determine what is to be used and, considered both from the standpoint of the client's interest and his own reputation, it would seem to be desirable that he inform himself and make his decision when the specification is written rather than after the contract is let.

The old argument to the effect that a definite specification fosters high prices has been effectually disposed of by leading architects who have for years been specifying the materials and equipment that their experience and investigations have shown were best suited to meet the particular requirements of the occasion, without alternative. It is evident that no manufacturer of standing and responsibility would take advantage of a definite specification to increase his price. To do so as a policy would be business suicide. Without doubt, any attempt that

has ever been made to profit unduly by reason of being favored by a definite specification was the result of a mistaken effort of some subordinate in a manufacturer's organization to improve his balance sheet. Such a circumstance needs only to be brought to the attention of the heads of the concern to be corrected.

A definite specification does not necessarily mean that choice is limited to a single article. Where there are two or more of equal merit and suitability the specification is no less definite if both or all are mentioned. If there is a difference in price, the contractor should include a bid on each. In this way, really competitive figures are secured. On the other hand, if there is but one article or material that will, in the opinion of the architect, give better results than any other, he should have the moral courage to specify it outright.

A client who lacked confidence in the architect's competence or integrity in the matter of specifications should obviously bestow his commissions elsewhere. When the indefinite specification containing ambiguous provisions, so called "grandfather" clauses attempting to put all responsibility on the contractor, and the iniquitous "or equal" phrase disappears entirely from architectural practice, the public confidence in architects will unquestionably be greatly increased. Fortunately progress is being made and comparatively few architects worthy of the name are now in practice who cling to the old forms.

## Memorials in New York

THE daily press in New York has printed communications, offering what the writers believe to be the most appropriate forms for memorials. The majority of these suggestions are so impractical and visionary as to be unworthy of serious consideration. For this reason it appears to be a proper time to discuss the subject of memorials in New York and endeavor so to act as to prevent grave errors and the perpetration of artistic blunders.

THE AMERICAN ARCHITECT has in the past maintained and is yet of the opinion that any permanent memorial involving the expenditure of a considerable sum of money should be utilitarian in character, always designed and built with every dignification of good artistic expression.

In a previous issue of THE AMERICAN ARCHITECT there was presented a design for a landing stage and stadium on Riverside Drive at Grant's Tomb. The necessity for a properly designed and constructed permanent landing stage where the nation's guests might be received and welcomed in



## THE AMERICAN ARCHITECT

a dignified manner has been many times stated, and action that would lead to results urged.

We have an excellent opportunity to combine the utility of a much needed civic feature with the best element of artistic design. It will be a comparatively easy matter so to arrange the plan for the Riverside Drive improvement as to provide for this landing stage and stadium, which could be made a joint memorial to our soldiers and sailors.

**I**F this plan should not meet approval, we have another excellent choice in the decorative treatment at 110th Street and Riverside Drive that was proposed during the Hudson-Fulton celebration. This design also contemplated a landing stage and a dependent decorative landscape treatment of that neighborhood, to be crowned by a temple. There might also be considered the admirable design for a victory memorial, published in *THE AMERICAN ARCHITECT* of Dec. 4, which includes a landing stage feature. The temporary arch now being erected in Union Square will undoubtedly be favorably considered by a great number of citizens, although its permanent location on its present site may not be as generally approved.

In addition and at different times during the past ten years various artistic societies have presented splendidly conceived projects, all of them containing germs of ideas that at this time will be worth careful consideration. All of these schemes have been evolved as the result of the application of the highest artistic effort. They have received endorsement by the best judges, and they have lapsed to obscurity. It is now time for action. It will be no time for a purely academic discussion and ineptness. Such a course will be one of the utmost ingratitude and one we shall not be able calmly to contemplate in the future.

**A** COMMITTEE composed of members of our leading architectural organizations with power to select and present a plan should be immediately formed. A second committee whose duties should be solely to provide the necessary money should also be formed. On this committee the city government should be fully represented, and the committee start on its work with the assurance that the city will contribute a certain amount, the remainder to be raised by public subscription.

The criticism made with reference to the proposed stadium and landing stage at Grant's Tomb,

that it might be regarded as purely a naval memorial, does not hold good. A landing stage for distinguished guests, whose mission to this country will be for many and different purposes, none perhaps naval, could in no sense be considered as solely a naval memorial. As we now conduct these matters, there is probably no maritime city which is so poorly equipped to receive its guests in fitting manner. The ramshackle emergency landing places that have been erected in the past, for the accommodation of the city's guests, have been a reproach to our civic pride and a source of regret to every patriotic citizen. No better scheme can be devised, now that we are determined that the broad expanse of Riverside Drive shall be returned to its rightful owners, the people of New York, and properly laid out and cared for, than to provide a memorial feature to our soldiers and sailors which will fittingly express in dignity and artistic conception the very large debt of gratitude we owe them.

**A** FURTHER scheme for memorials, and one that would be more local, is suggested by our celebration of the Fourth of July and other holidays. During the past four years, perhaps even earlier, we have throughout the country conducted these occasions in what has been well described as a "safe and sane" manner. In place of all the noise and dangerous elements, a very much more dignified program is now carried forward. Its best performance, and its ability to teach valuable lessons of patriotism and civic pride, is marred by the makeshifts of temporary rostrums and decorative features. Why not lay out the city into certain areas, or sub-civic centers, and in each one provide a memorial rostrum, after the manner, perhaps, of The Altar of Liberty, now in Madison Square? On the tablets of these rostrums could be placed the names of men who were in service from each particular section. These structures could be surrounded with such architectural and landscape effects as would make them beauty spots. The many recreation centers about the city would offer sites for these rostrums, while our recreation piers might be dignified as memorials to our sailors of the naval reserve who have served in these wars.

These things, while purely suggestive, are the basis of a scheme that is believed to be entirely feasible, well considered, and to afford the utilitarian aspect that should be a part of all well-considered memorials.



# Beaux-Arts Institute of Design

DIRECTOR OF THE INSTITUTE, LLOYD WARREN

ARCHITECTURE, WILLIAM F. LAMB

SCULPTURE, JOHN GREGORY

MURAL PAINTING, ARTHUR CRISP

INTERIOR DECORATION AND INDUSTRIAL ART DESIGN, ERNEST F. TYLER

## Official Notification of Awards— Judgment of December 17th, 1918

### PROGRAM

#### CLASS "B"—I ANALYTIQUE

The Committee on Architecture proposes as subject for this Competition:

"A DOORWAY."

#### INTRODUCTION:

An architectural feature should not only be in scale with the whole building of which it forms a part, but also be in scale with human beings. This human scale is given by means of certain elements that are so intimately related to man's use that they should not vary much—such as steps, balustrades, the leaves of doors, etc. In addition to this means of giving human scale, there are more subtle means, such as size of stone courses, number of members in a cornice, etc.

#### THE PROBLEM:

The subject of this projet is the appropriate architectural treatment of the main entrance to a large city club for men. The building is of stone, 6 stories high. The first floor is 4 feet above the level of the sidewalk. From first floor to second floor is 20 feet. There should be a balcony over the entrance where the members may view parades—reached through a second story window. This window, however, need not be shown in this projet, except the window sill in the section. None of the treatment, not even the steps, shall project more than 6 feet beyond the main face of the façade, but the treatment may be recessed into the building as far as 6 feet within the façade. One of the classic orders should be used.

JURY OF AWARD: R. M. Hood, J. W. O'Connor, J. F. Harbeson, D. J. Baum, C. Ewing, L. E. Smith and B. W. Morris.

This Jury also served as Jury of Award for Class "B"—I Projet, Class "A"—I Esquisse-Esquisse and Class "B"—I Esquisse-Esquisse.

Number of drawings submitted: 29

### AWARDS

FIRST MENTION PLACED: W. Ulrich, Atelier Hirons, N. Y.

FIRST MENTION: H. V. Murphy, Beaux-Arts Atelier, Wash., D. C.; S. M. Jokel, John Huntington Polytechnic Institute, Cleveland.

MENTION: W. F. Frederick and A. N. Schaeffer, Beaux-Arts Atelier, Wash., D. C.; F. Galante, Atcher Brazer, Chester; L. T. Obel, Helen M. Gail, A. T. Terrell, W. D. Moyle and S. Oxhandler, Columbia University, N. Y.; E. Babitsky, John Huntington Polytechnic Institute, Cleveland; J. W. Meyer, Jr., care of Warren & Clark, N. Y.; W. R. Shirley, Syracuse University, Syracuse; L. C. Neilson, Atelier Treganza, Salt Lake City; J. L. Fleming and E. M. Moore, University of Kansas, Lawrence; A. C. Weatherhead, University of Oregon, Eugene; T. J. Rowland and H. Bradley, George Washington University, Wash., D. C.

### PROGRAM

#### CLASS "B"—I PROJET

The Committee on Architecture proposes as subject for this Competition:

#### A YACHT CLUB

Upon an embankment sloping steeply down to the shores of a lake, it is proposed to build a small yacht club, the members of which are devoted to the sailing of small boats, rowing and canoeing. The nature of the ground is such that there is comparatively level space of about 100 feet between the water's edge and the embankment, while above it the ground is also fairly level. This embankment is about 15 feet high. These conditions will give an opportunity to provide, in the basement of the club-house, storage space for canoes and shells which can be very easily run up from the water. The basement will also contain locker rooms and showers for the club members.

The main floor will provide a club or lounge-room, a restaurant, a kitchen and serving pantry (the kitchen may, if desired, be placed in the basement, in which case there should be provided a service stairway and a small pantry on the main floor).

Above, will be arranged several rooms and baths for guests.

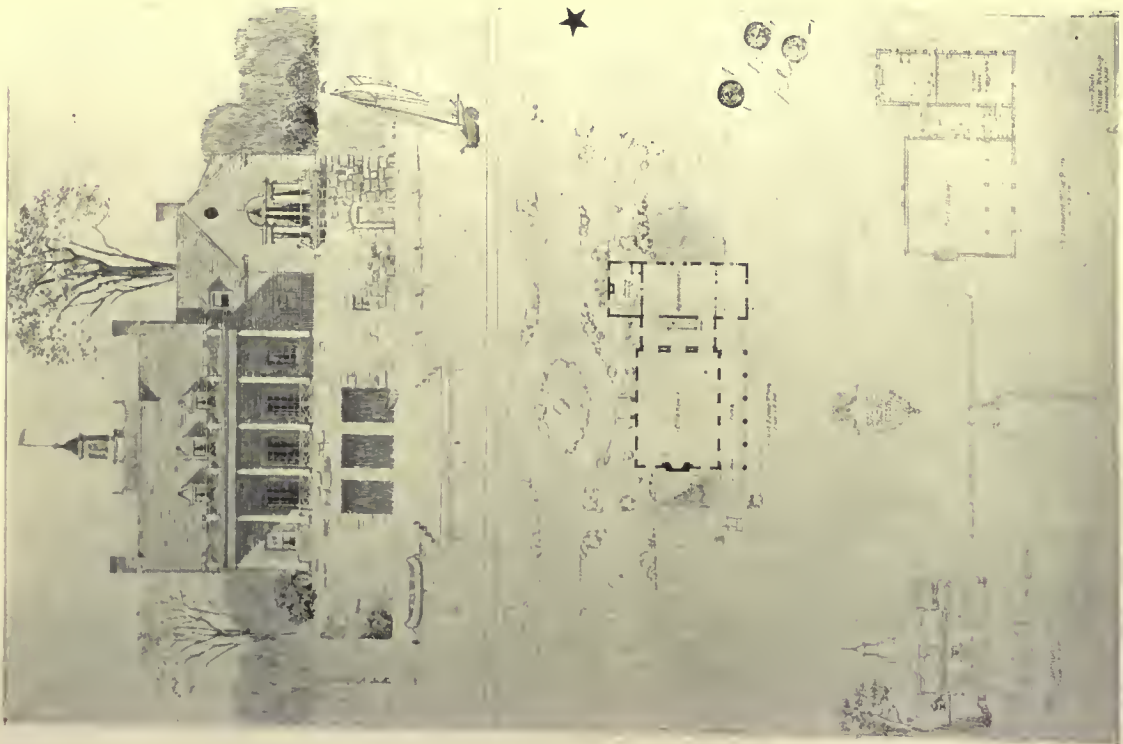

LOUIS KURTZ 1ST MENTION, PLACED ATELIER WYNKOOP  
CLASS B. I PROJET—A YACHT CLUB

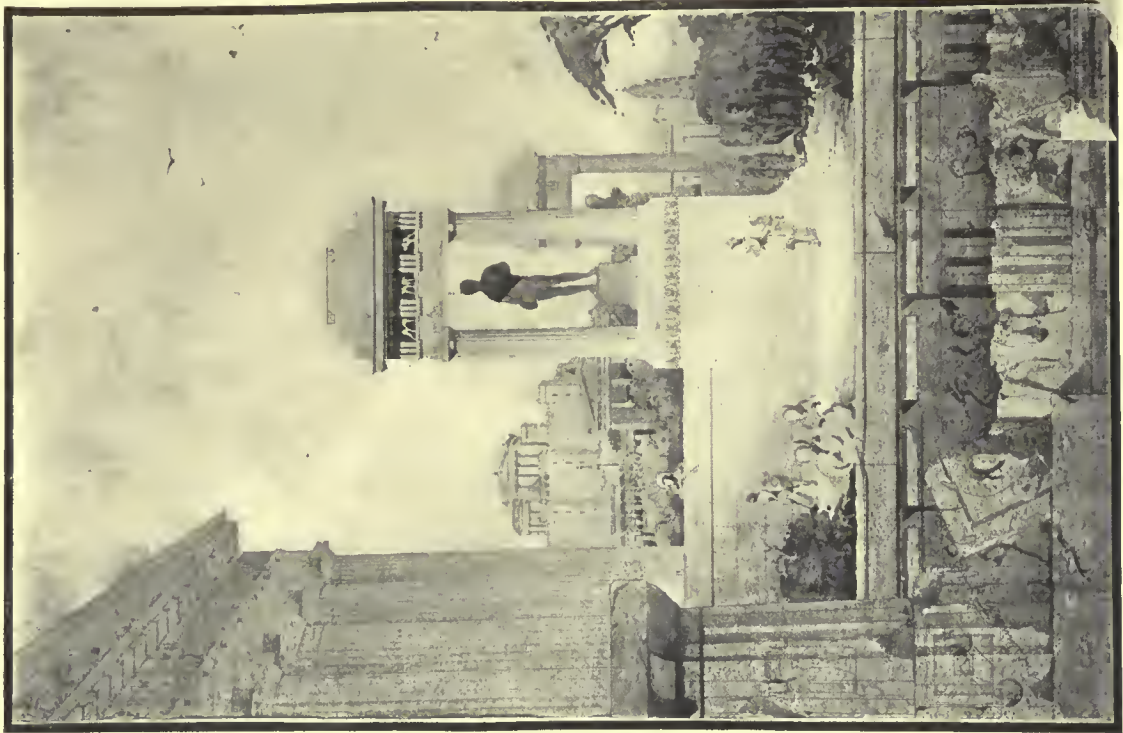

J. W. HERSHEY 3D MEDAL JOHN HUNTINGTON POLYTEC. INST.  
CLASS A AND B, ARCHAEOLOGY. I PROJET

STUDENT WORK, BEAUX-ARTS INSTITUTE OF DESIGN





SOUTH ELEVATION



PLATE 25

OFFICE BUILDING

PRIZE WINNING DESIGN

WEEKS & DAY, ARCHITECTS

SACRAMENTO, CAL., STATE BUILDINGS COMPETITION





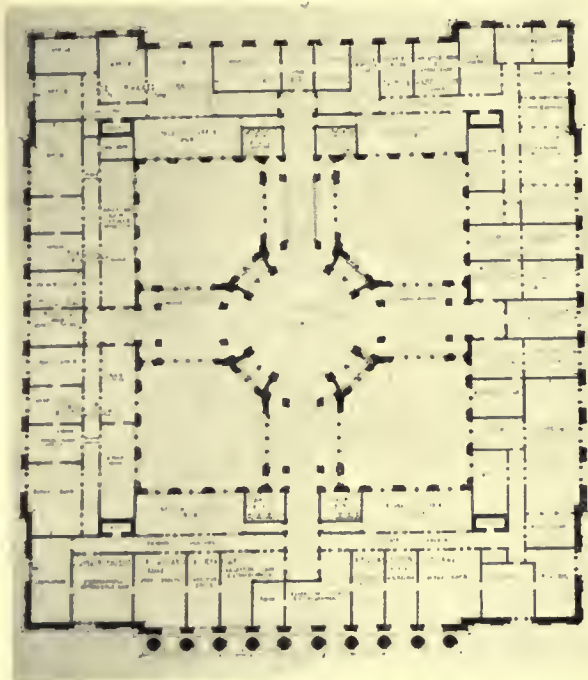

SECOND FLOOR PLAN

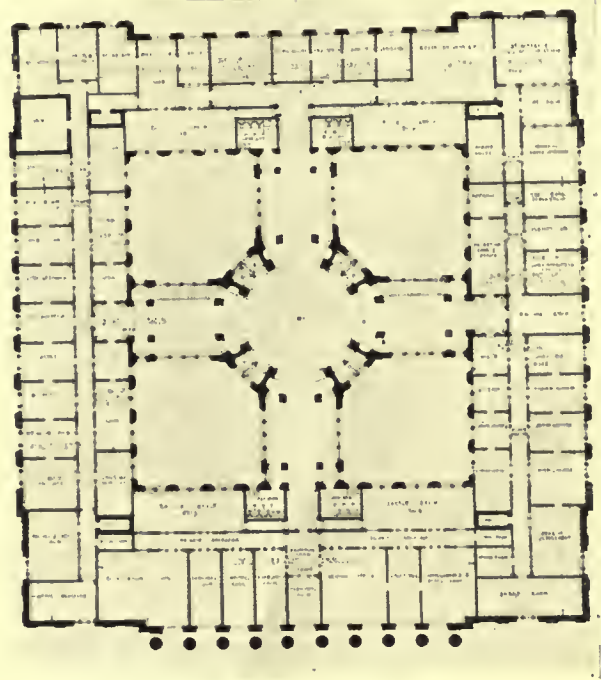

THIRD FLOOR PLAN

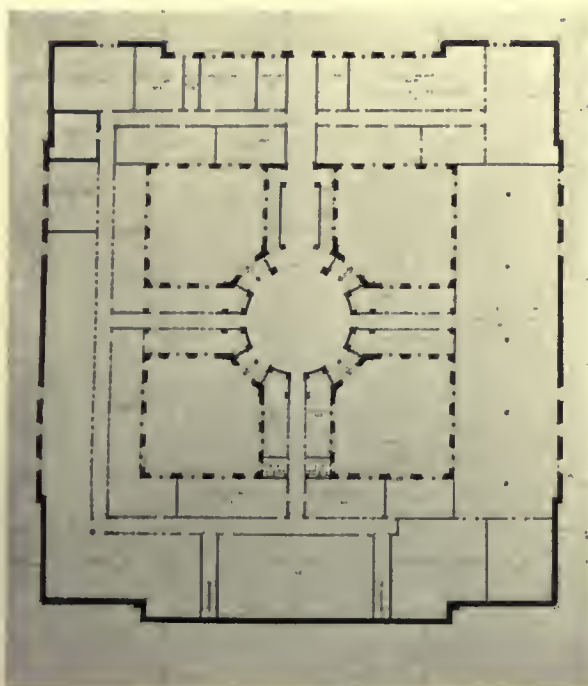
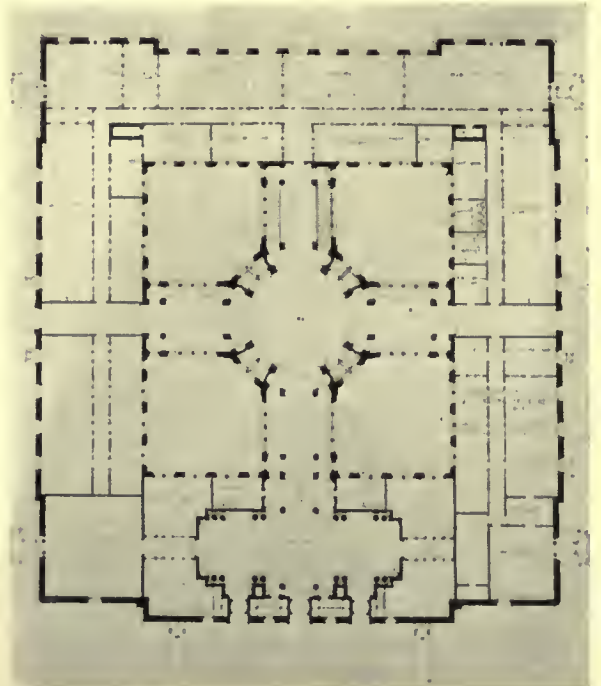

PLATE 26

BASEMENT FLOOR PLAN



FIRST FLOOR PLAN

FLOOR PLANS, OFFICE BUILDING

PRIZE WINNING DESIGN

WEEKS & DAY, ARCHITECTS

SACRAMENTO, CAL., STATE BUILDINGS COMPETITION







THE LIBRARY

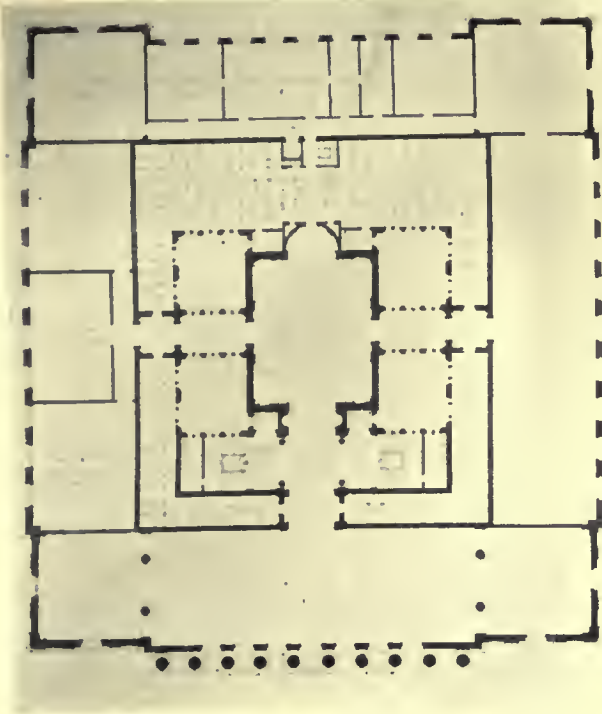

PLATE 27

LIBRARY BUILDING  
PRIZE WINNING DESIGN  
WEEKS & DAY, ARCHITECTS

SACRAMENTO, CAL., STATE BUILDINGS COMPETITION





SECOND FLOOR PLAN

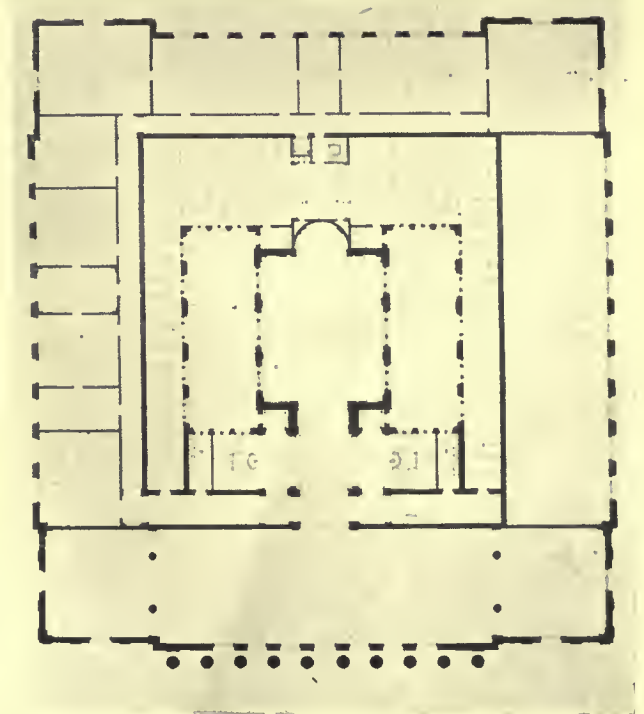

SECOND FLOOR MEZZANINE

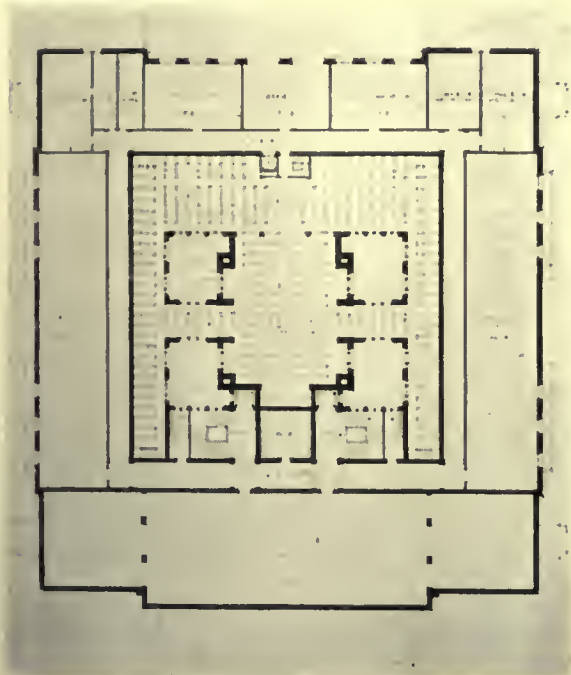

BASEMENT PLAN

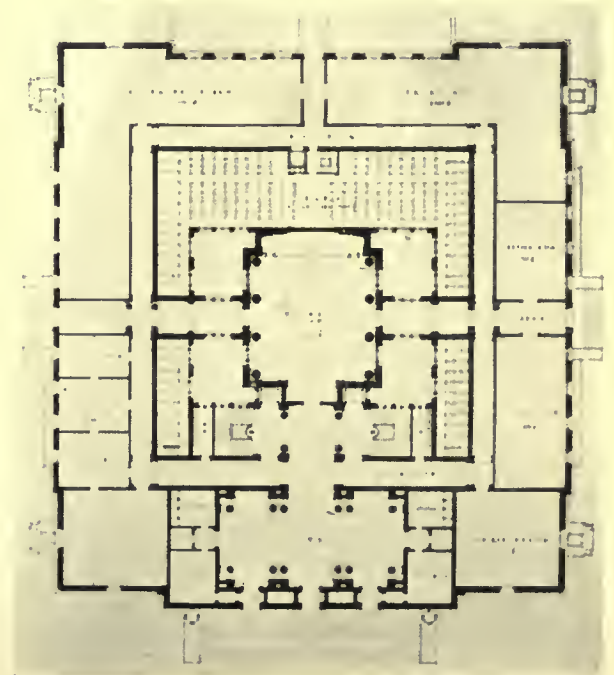

FIRST FLOOR PLAN

PLATE 28

FLOOR PLANS, LIBRARY BUILDING

PRIZE WINNING DESIGN

WEEKS & DAY, ARCHITECTS

SACRAMENTO, CAL., STATE BUILDINGS COMPETITION





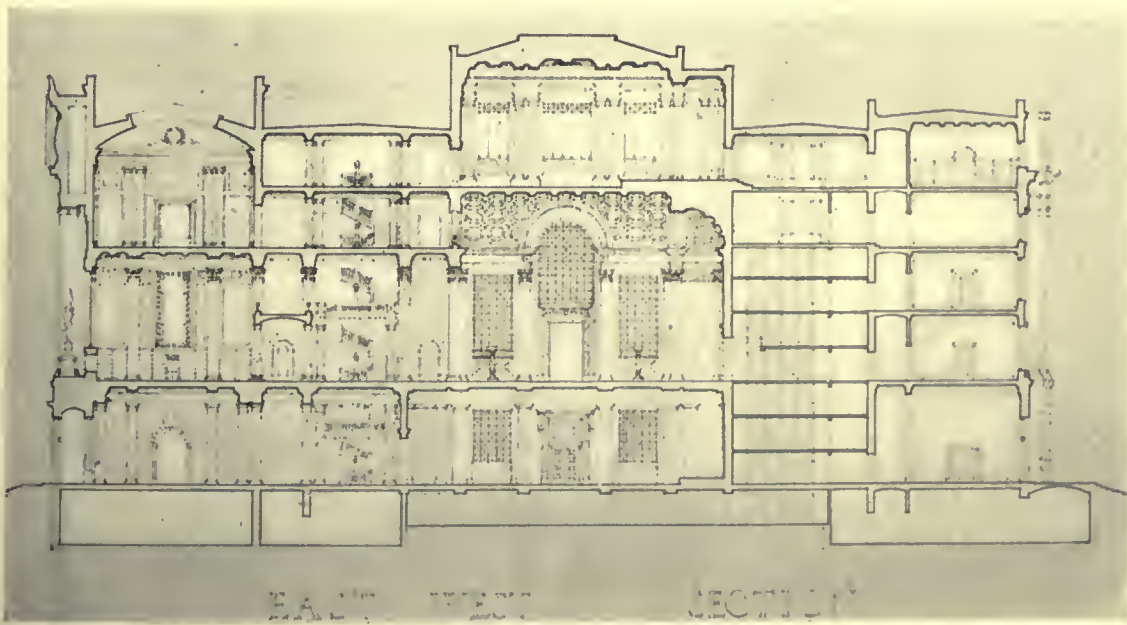
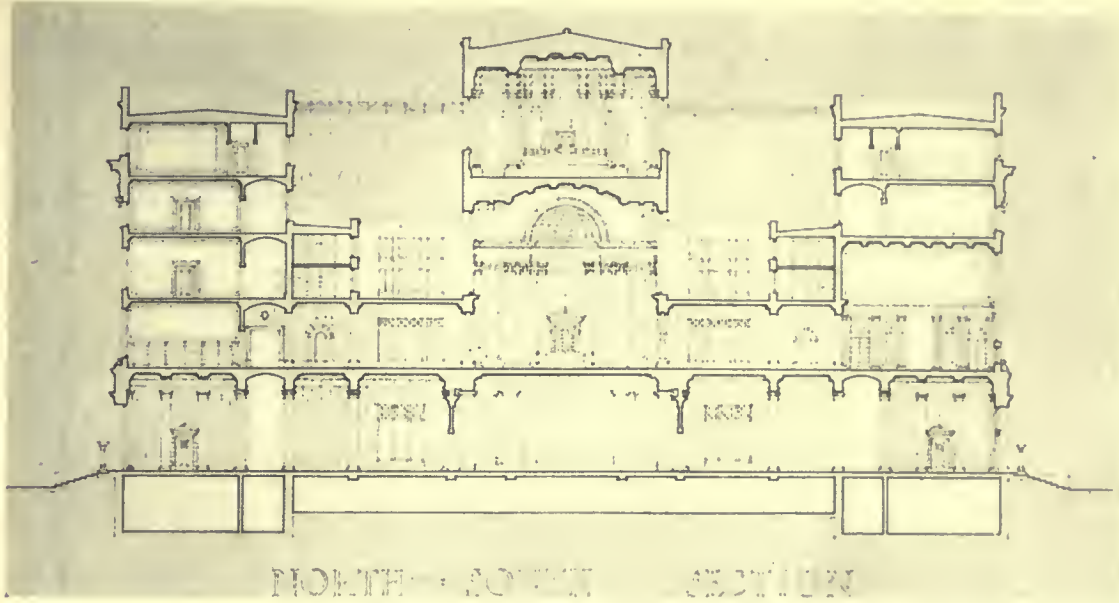

PLATE 29

SECTIONS, LIBRARY AND COURTS BUILDING

PRIZE WINNING DESIGN

WEEKS & DAY, ARCHITECTS

SACRAMENTO, CAL., STATE BUILDINGS COMPETITION





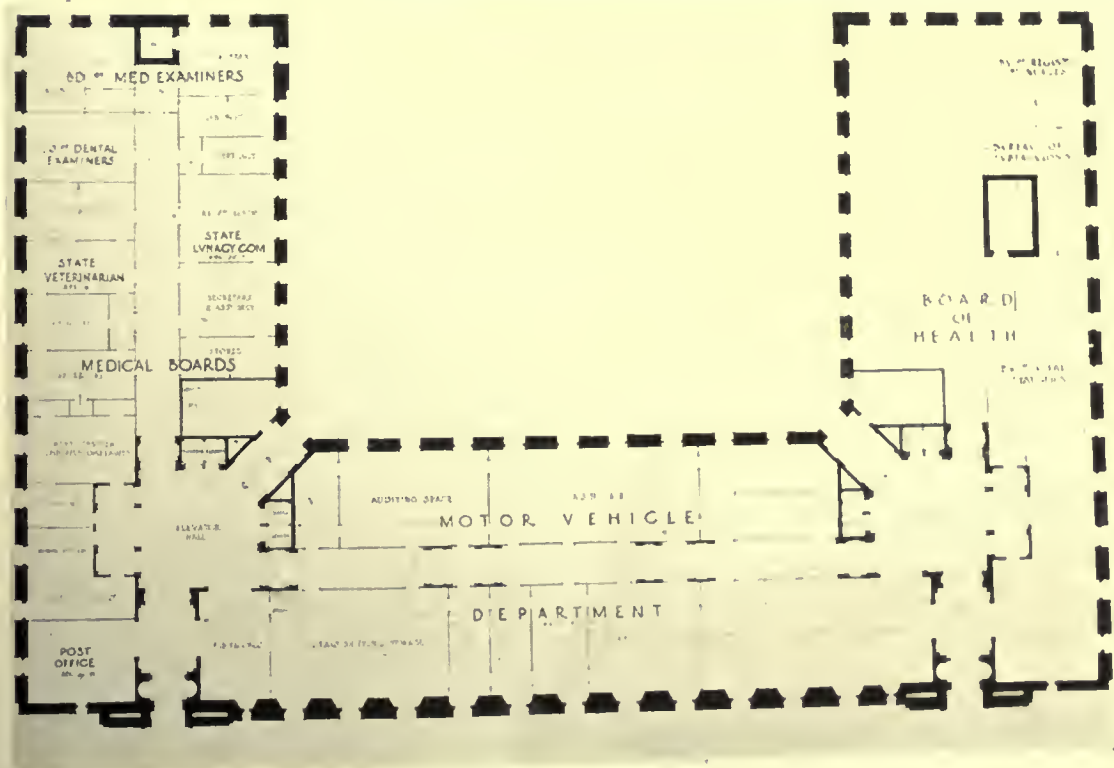
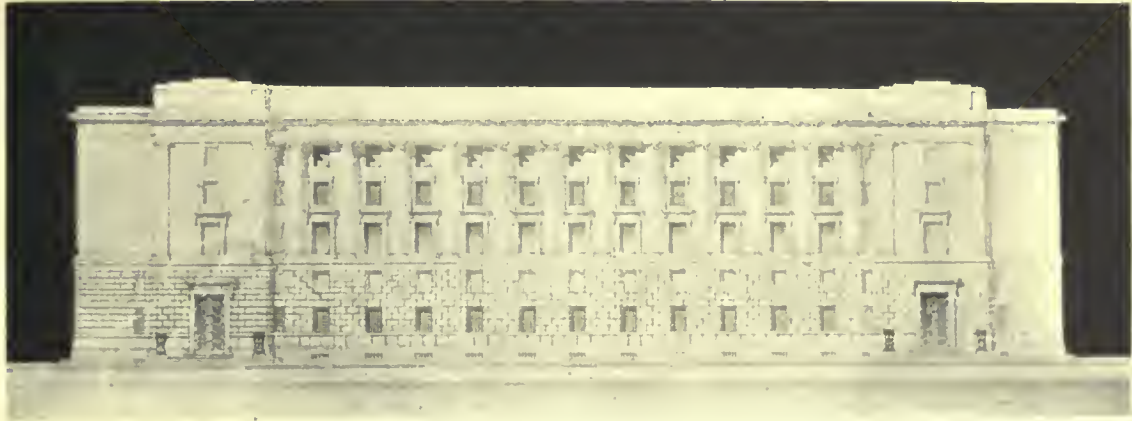

PLATE 30

OFFICE BUILDING

DENNISON & HIRONS, ARCHITECTS

SACRAMENTO, CAL., STATE BUILDINGS COMPETITION









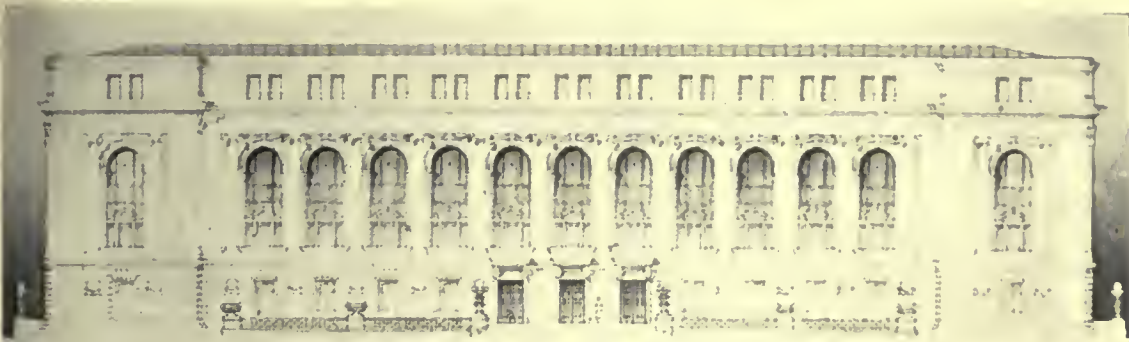

UNIT ELEVATION OF FRONT FACADE

**CUBAGE**  
 1st Floor  
 47,742 sq. ft. (48 ft. high) = 2,298,636 cu. ft.  
 2nd Floor  
 47,742 sq. ft. (48 ft. high) = 2,298,636 cu. ft.  
 3rd Floor  
 47,742 sq. ft. (48 ft. high) = 2,298,636 cu. ft.  
 4th Floor  
 47,742 sq. ft. (48 ft. high) = 2,298,636 cu. ft.  
 5th Floor  
 47,742 sq. ft. (48 ft. high) = 2,298,636 cu. ft.  
 6th Floor  
 47,742 sq. ft. (48 ft. high) = 2,298,636 cu. ft.  
 7th Floor  
 47,742 sq. ft. (48 ft. high) = 2,298,636 cu. ft.  
 8th Floor  
 47,742 sq. ft. (48 ft. high) = 2,298,636 cu. ft.  
 9th Floor  
 47,742 sq. ft. (48 ft. high) = 2,298,636 cu. ft.  
 10th Floor  
 47,742 sq. ft. (48 ft. high) = 2,298,636 cu. ft.  
 11th Floor  
 47,742 sq. ft. (48 ft. high) = 2,298,636 cu. ft.  
 12th Floor  
 47,742 sq. ft. (48 ft. high) = 2,298,636 cu. ft.  
 13th Floor  
 47,742 sq. ft. (48 ft. high) = 2,298,636 cu. ft.  
 14th Floor  
 47,742 sq. ft. (48 ft. high) = 2,298,636 cu. ft.  
 15th Floor  
 47,742 sq. ft. (48 ft. high) = 2,298,636 cu. ft.  
 16th Floor  
 47,742 sq. ft. (48 ft. high) = 2,298,636 cu. ft.  
 17th Floor  
 47,742 sq. ft. (48 ft. high) = 2,298,636 cu. ft.  
 18th Floor  
 47,742 sq. ft. (48 ft. high) = 2,298,636 cu. ft.  
 19th Floor  
 47,742 sq. ft. (48 ft. high) = 2,298,636 cu. ft.  
 20th Floor  
 47,742 sq. ft. (48 ft. high) = 2,298,636 cu. ft.

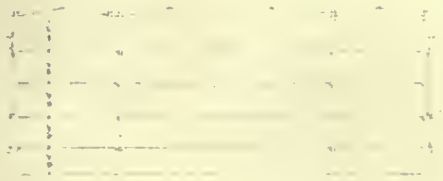

**CUBAGE**  
 21st Floor  
 47,742 sq. ft. (48 ft. high) = 2,298,636 cu. ft.  
 22nd Floor  
 47,742 sq. ft. (48 ft. high) = 2,298,636 cu. ft.  
 23rd Floor  
 47,742 sq. ft. (48 ft. high) = 2,298,636 cu. ft.  
 24th Floor  
 47,742 sq. ft. (48 ft. high) = 2,298,636 cu. ft.  
 25th Floor  
 47,742 sq. ft. (48 ft. high) = 2,298,636 cu. ft.  
 26th Floor  
 47,742 sq. ft. (48 ft. high) = 2,298,636 cu. ft.  
 27th Floor  
 47,742 sq. ft. (48 ft. high) = 2,298,636 cu. ft.  
 28th Floor  
 47,742 sq. ft. (48 ft. high) = 2,298,636 cu. ft.  
 29th Floor  
 47,742 sq. ft. (48 ft. high) = 2,298,636 cu. ft.  
 30th Floor  
 47,742 sq. ft. (48 ft. high) = 2,298,636 cu. ft.  
 31st Floor  
 47,742 sq. ft. (48 ft. high) = 2,298,636 cu. ft.  
 32nd Floor  
 47,742 sq. ft. (48 ft. high) = 2,298,636 cu. ft.  
 33rd Floor  
 47,742 sq. ft. (48 ft. high) = 2,298,636 cu. ft.  
 34th Floor  
 47,742 sq. ft. (48 ft. high) = 2,298,636 cu. ft.  
 35th Floor  
 47,742 sq. ft. (48 ft. high) = 2,298,636 cu. ft.  
 36th Floor  
 47,742 sq. ft. (48 ft. high) = 2,298,636 cu. ft.  
 37th Floor  
 47,742 sq. ft. (48 ft. high) = 2,298,636 cu. ft.  
 38th Floor  
 47,742 sq. ft. (48 ft. high) = 2,298,636 cu. ft.  
 39th Floor  
 47,742 sq. ft. (48 ft. high) = 2,298,636 cu. ft.  
 40th Floor  
 47,742 sq. ft. (48 ft. high) = 2,298,636 cu. ft.

CLACK SECTION  
 SCALE - ONE INCH = THIRTY-TWO FEET

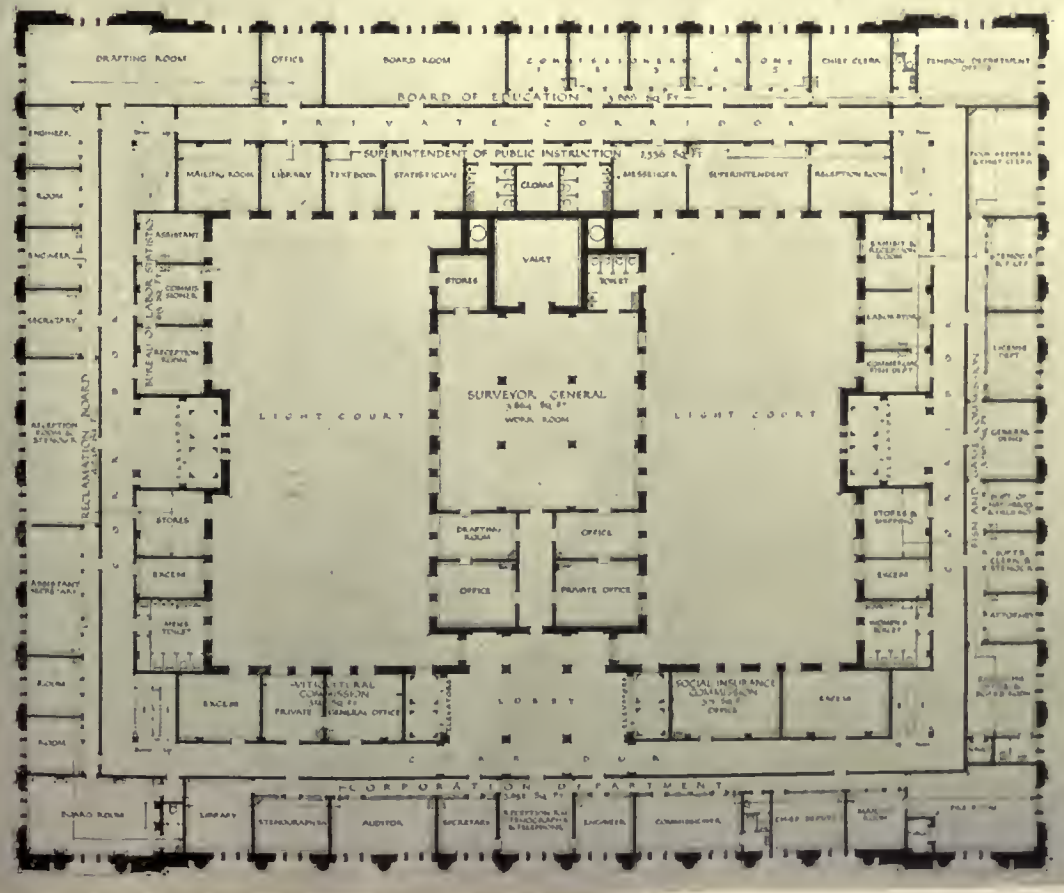

PLATE 32

LIBRARY

HEWITT, ASH & CURTIS, ARCHITECTS

SACRAMENTO, CAL., STATE BUILDINGS COMPETITION





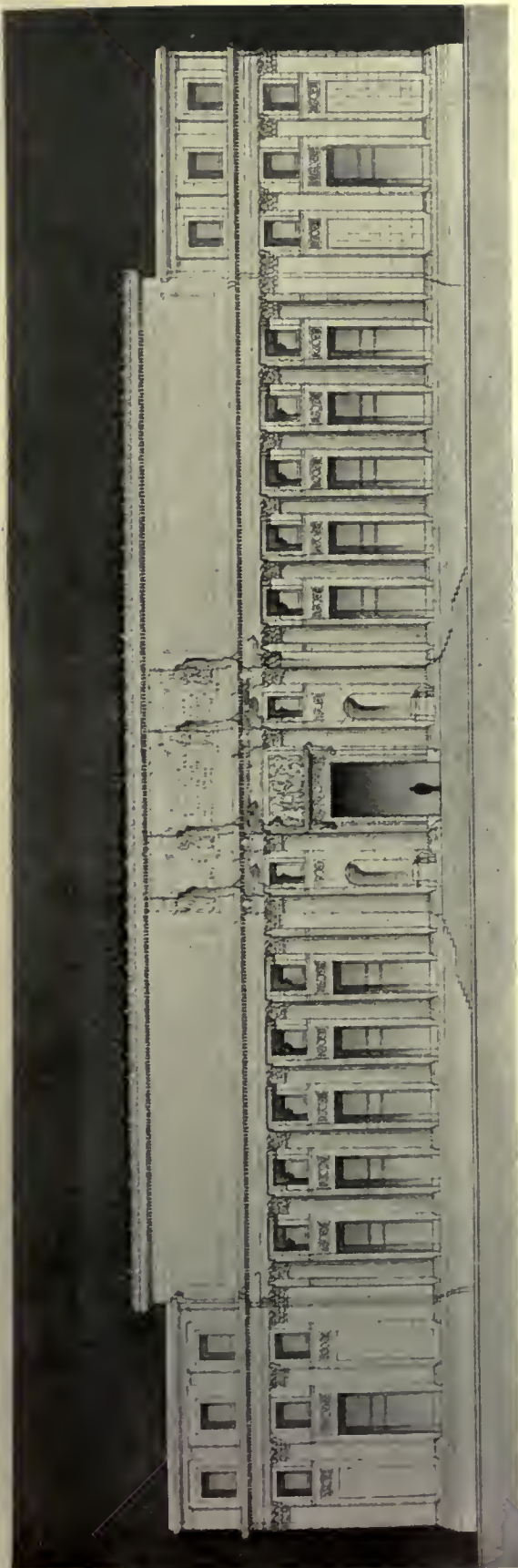

FRONT ELEVATION

LIBRARY BUILDING

BLISS & FAVILLE, ARCHITECTS

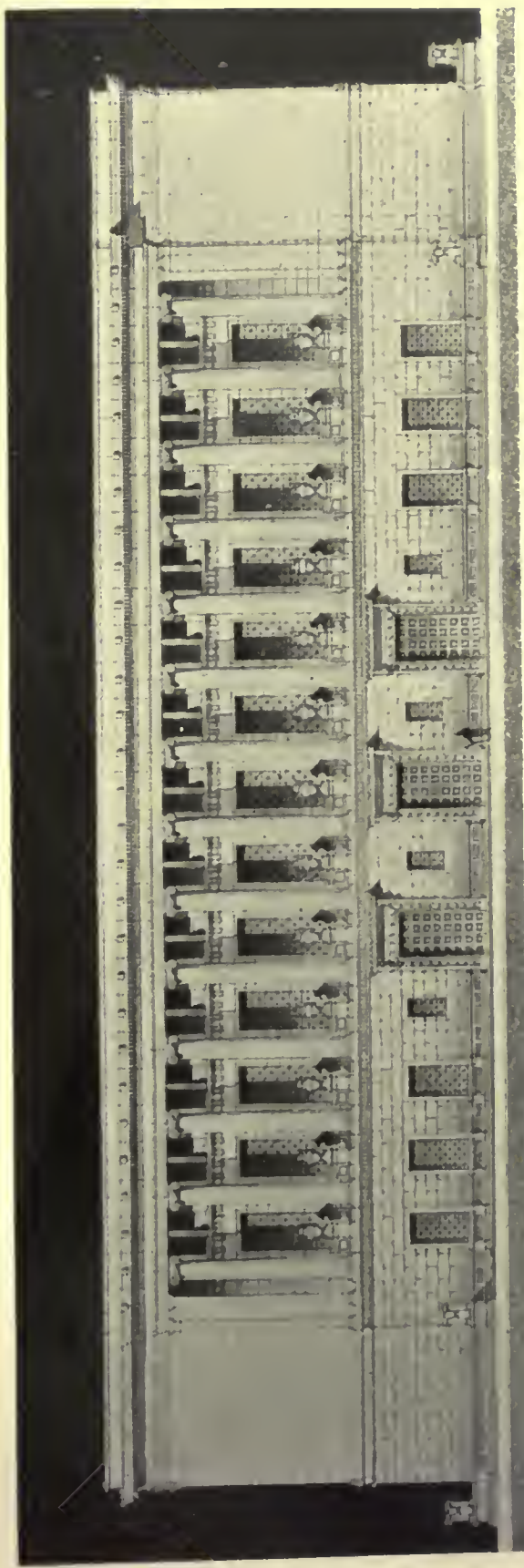

NORTH ELEVATION

PLATE 33

LIBRARY BUILDING

SACRAMENTO, CAL., STATE BUILDINGS COMPETITION

ADOLF SHERRER, ARCHITECT







LIBRARY BUILDING

TRACY & SWARTWOUT, ARCHITECTS

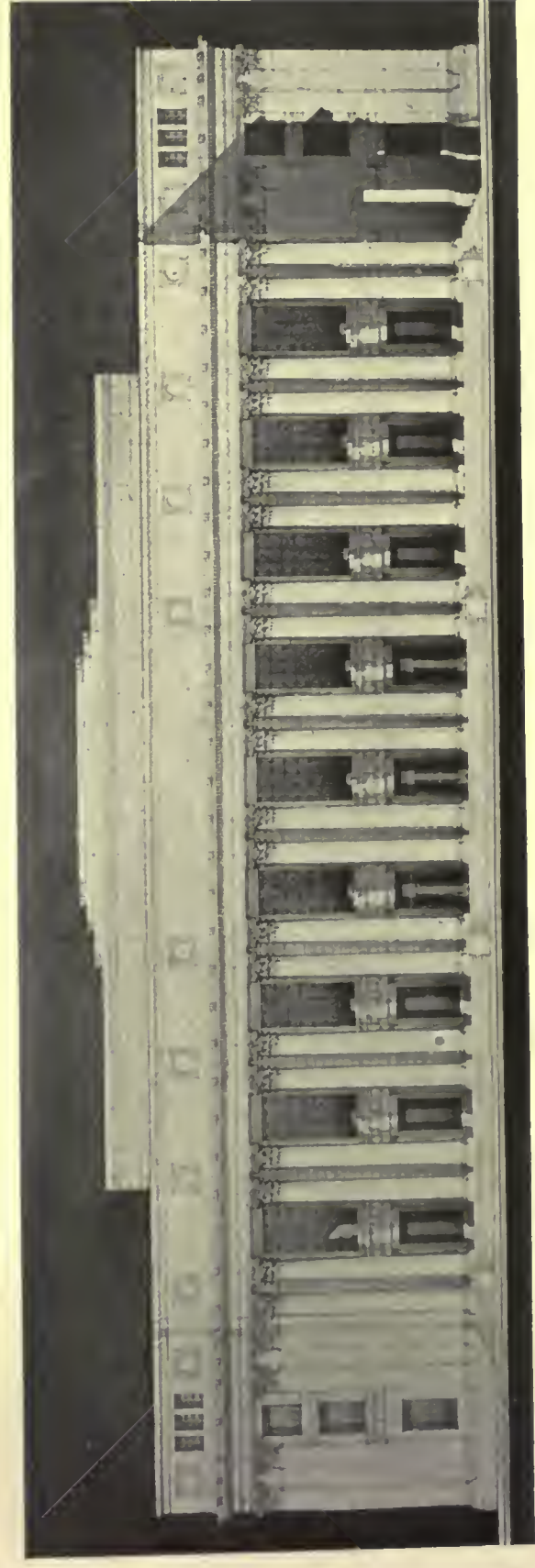

PLATE 34

LIBRARY BUILDING

WARD & BLOIME, ARCHITECTS

SACRAMENTO, CAL., STATE BUILDINGS COMPETITION





## THE AMERICAN ARCHITECT



WM. ULLRICH FIRST MENTION PLACED, ATELIER  
HIRONS

### CLASS B—I ANALYTIQUE—A DOORWAY

Beside the necessary interior staircases there should be provided, by means of terraces and stairs or in some other way, exterior communication from the top of the embankment to the lower level.

The greatest dimension in plan of the ground floor must not exceed 75'-0" in either direction.

Number of drawings submitted: 30.

### AWARDS

FIRST MENTION PLACED: L. Kurtz, Atelier Wynkoop, N. Y.

FIRST MENTION: W. J. Richards, Beaux-Arts Atelier, Wash., D. C.; G. H. Van Anda, 530 Manhattan Avenue, N. Y.; R. S. McCauley, Stony Point, N. Y.

MENTION: H. T. Bell, Beaux-Arts Atelier, Wash., D. C.; B. Hill, Cornell University, Ithaca; F. R. Schreyer, K. C. Chang, F. Wingate and J. Y. Moo, Columbia University, N. Y.; H. I. Hirsch, W. A. Rutherford, Jr., W. R. Reece and C. L. Armsby, Georgia School of Technology, Atlanta; B. Laub and E. C. K. Schmidt, "T" Square Club, Philadelphia; P. W. Strickland and E. Pickering, University of Kansas, Lawrence; L. J. Ellis, University of Oregon, Eugene; T. F. Price, Atelier Wynkoop, N. Y.; H. Legemann, Atelier DeGelleke, Milwaukee.

H. C.: E. N. Damon, Atelier Schadler, Reno; G. A. Yeomans, Cornell University, Ithaca.

### PROGRAM

#### CLASS "B"—I ESQUISSE—ESQUISSE

The Committee on Architecture proposes as subject for this Competition:

#### "A WALL FOUNTAIN"

A retaining wall 15' 0" high has been built along one side of a park, separating it from a public thoroughfare. It is proposed to build, on the axis of an abutting street a fountain applied to this wall which will serve as an architectural feature as well as a place where the public may obtain water to drink. There should therefore be provided continuously flowing jets as is the modern practice for public drinking fountains arranged at the proper height. The decorative features of the fountain are left to the competitor, the only requirement being that composition should not exceed the height of the retaining wall.

Number of drawings submitted: 3.

### AWARDS

MENTION: H. T. Bell, Beaux-Arts Atelier, Wash., D. C.



A. C. BIEBER—3D MEDAL, UNIV. OF PENNA.

### CLASS A AND B ARCHAEOLOGY. I PROJET—A MONUMENT TO A GREEK ATHLETE

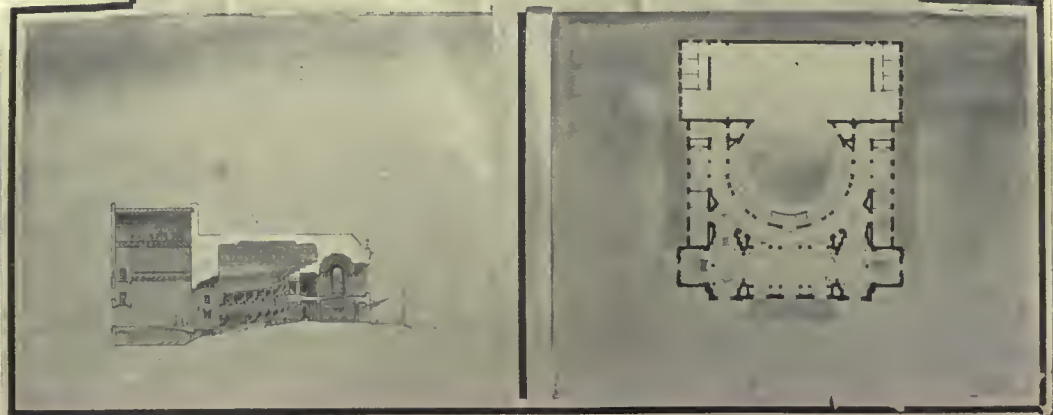
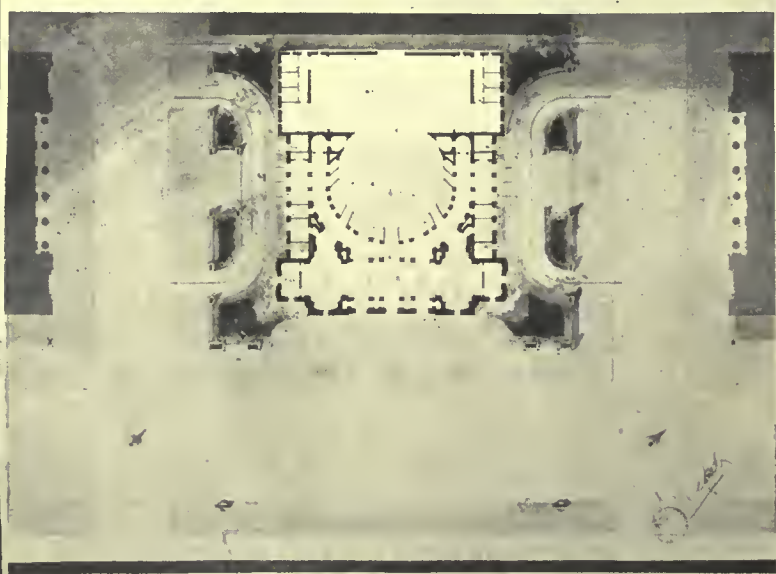

F. VON OSTHOFF—1ST MEDAL, ATELIER HIRONS  
CLASS A—I PROJET—A THEATER  
STUDENT WORK, BEAUX-ARTS INSTITUTE OF DESIGN



# THE AMERICAN ARCHITECT

## PROGRAM

### CLASS "A"—I ESQUISSE—ESQUISSE

The Committee on Architecture proposes as subject for this Competition:

#### "A BATTLE MONUMENT"

The first engagement of any importance in which the American Army took part in the present war was at Belleau Wood. While this battle was in no sense a major operation, yet it had a great importance in that it was the first real check to the German offensive on the Marne Salient, and gave to the French a new hope and an increased courage which enabled them to turn that offensive into a retreat. It has, therefore, been proposed to erect in the wood a monument to this battle. For this purpose a clearing has been made in the center and two roads at right angles to each other cut through, branching from the main highways. The monument will be erected in the clearing, and on the axis of the roads, and will commemorate the valor of the United States Marines who took part in the engagement. This monument should not exceed 50'-0" in height.

Number of drawings submitted: 11.

#### AWARDS

MENTION: E. E. Weihe, Atelier A. Brown, Jr., S. F. A. C., San Francisco; J. C. Janney, University of Pennsylvania, Philadelphia.

## PROGRAM

### CLASS "A"—I PROJET

The Committee on Architecture proposes as subject for this Competition:

#### "A THEATER"

A group of wealthy patrons of the drama propose to build a theater, the purpose of which, while not entirely uncommercial, is to provide an opportunity for the development of the highest forms of dramatic art. The project in conception is, therefore, similar to that of the municipal, subsidized theaters in Europe, and, taking on in part the character of an institution, its architecture should express this, although at the same time no sacrifice should be made of the practical elements of the problem. The foyer and circulations should be more ample than is ordinarily the case, and on the exterior, carriage entrances, low terraces and balustrades may be developed, provided they are found within the limits of the site. All such expressions should not, however, be exaggerated.

The site is a rectangular plot 200 by 170 feet, the longer side facing a public square in a large city, and the shorter sides facing two avenues. The building proper shall be placed in the center of the plot, and shall not exceed 120 feet in width. A

service passage of 10 ft. in width shall be kept at the back of the plot.

#### AUDITORIUM:

The auditorium consists of a main floor, no part of which shall be more than 5 feet above the level of the street, a balcony, and an orchestra pit. Proscenium boxes, or loges, either on the floor or in the balcony, may be used, although this is optional.

#### STAGE:

The stage shall have minimum dimensions of 32 feet in depth by 70 feet in width, and shall have a clear height up to the under side of the gridiron of at least twice the height of the proscenium arch; the stage shall be fully equipped with a gridiron, fly galleries, electrician's gallery, switchboards, etc. Private dressing rooms for six stars, several larger dressing rooms for the secondary actors, one large room for the male chorus, and one large room for the female chorus shall be provided above the stage level, although two of the stars' dressing rooms shall be arranged on the stage level. A property room and an orchestra room shall be provided in the space below the stage.

#### GENERAL:

- Entrance lobby with tickets booths.
- Offices for the manager.
- Coat rooms for men and women.
- Men's smoking and retiring rooms.
- Women's retiring rooms.
- Large foyer for promenading during the entre-acts.
- The men's rooms may be in the basement.
- The balconies shall be reached by at least two broad ramps or stairs, placed either in the auditorium or in the lobby. Additional stairs for exits from the balcony shall be arranged, widely separated from main stairs. No curved stairs or winders are permitted. Exits from the main floor shall be as ample as possible.

JURY OF AWARD: F. A. Godley, W. A. Bottomley, H. W. Corbett, F. C. Hiron, A. M. Brown, L. H. Burnham, J. Wynkoop, and M. B. Stout.

This Jury also served as Jury of Award for Class "A"-II Esquisse-Esquisse, Class "B"-II Esquisse-Esquisse, and Class "A" and "B" Archaeology-I Projet.

Number of drawings submitted: 23.

#### AWARDS

FIRST MEDAL: F. von Osthoff and T. Shimura, Atelier Hiron, N. Y.

SECOND MEDAL: Charlotte Knapp, Columbia University, N. Y.; P. B. Oteiza, Cornell University, Ithaca; S. H. Brown, "T" Square Club, Philadelphia; A. C. Bieber and J. C. Janney, University of Pennsylvania, Philadelphia; L. Fentnor, Atelier Wynkoop, N. Y.

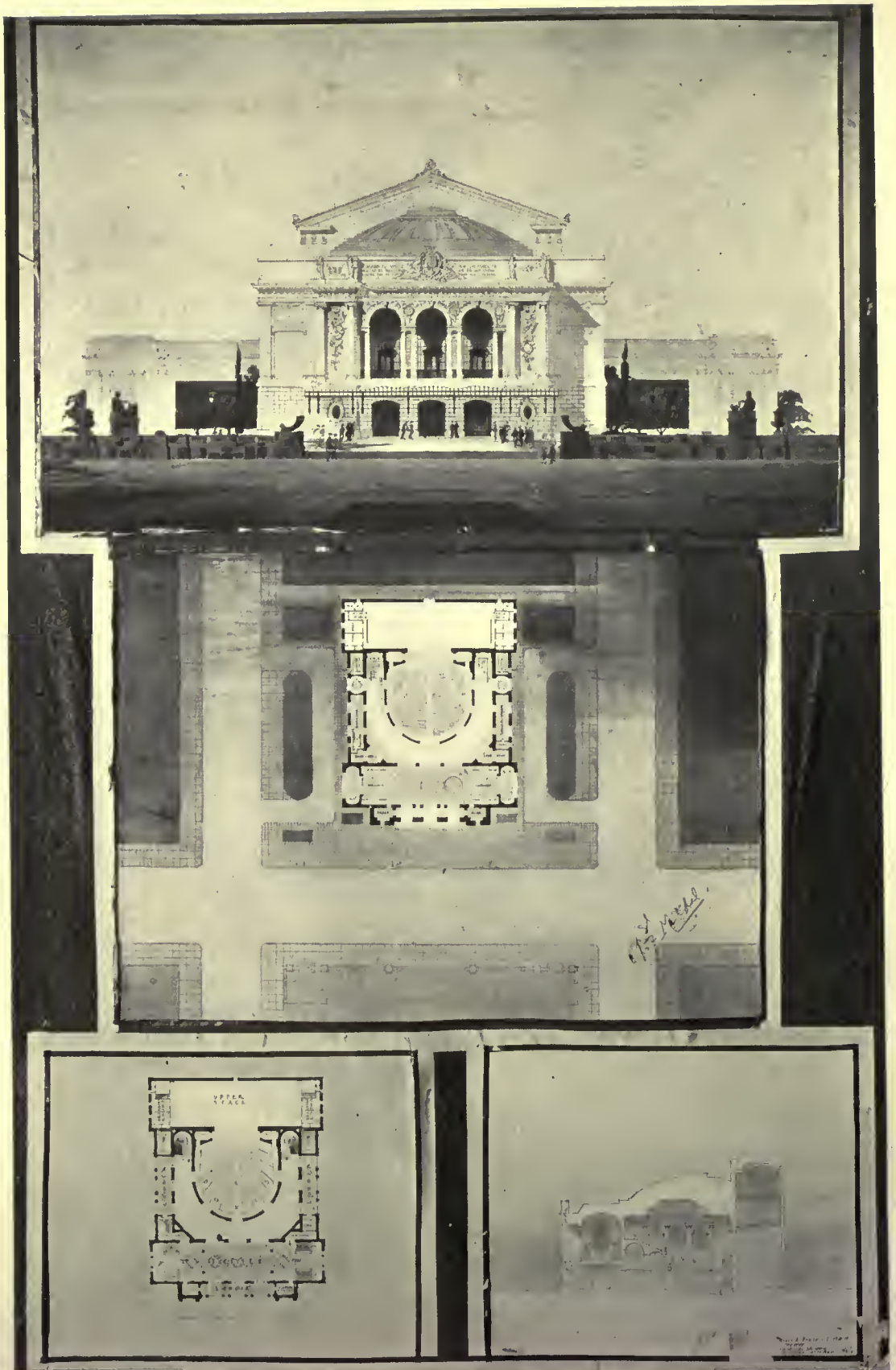

A. SHIMURA—1ST MEDAL, ATELIER HIRONS  
CLASS A—I PROJET—A THEATER  
STUDENT WORK, BEAUX-ARTS INSTITUTE OF DESIGN

## THE AMERICAN ARCHITECT

MENTION: L. Williams, W. L. Uhl and E. Rabasa, Jr., Columbia University, N. Y.; E. L. Howard, Y. C. Lu, N. W. Duncan, R. E. de Wolfe and Dorothy F. Levy, Cornell University, Ithaca; R. E. Martins and L. Yu, Syracuse University, Syracuse; J. P. Roberts, G. F. Lafferty, G. A. Anderson, S. H. Gordon and L. D. Cook, University of Pennsylvania, Philadelphia.

---

### PROGRAM

#### CLASS "B"—II ESQUISSE—ESQUISSE

The Committee on Architecture proposes as subject of this Competition:

#### "A LOGGIA"

At one end of a public square, devoted on certain days of the week to public markets, is a small public building. Projecting from the lower floor of this building, and raised a few steps above the street level, is a covered space or loggia where the people may find some protection from the sun and rain.

Number of drawings submitted: 2.

AWARDS: No mentions.

---

### PROGRAM

#### CLASS "A"—II ESQUISSE—ESQUISSE

The Committee on Architecture proposes as subject for this Competition:

#### "A LIFE-SAVING STATION"

#### THE PROBLEM:

On a rocky point of the New England coast within which is a tiny protected beach is built a group consisting of a lighthouse, the helper's cottage and a life-saving station, consisting of the boat house and the dormitory and living room of its crew.

Number of drawings submitted: 8.

### AWARDS

THIRD MEDAL: D. McLachlan, Jr., Atelier Hirons, N. Y.; J. W. Hershey, John Huntington Polytechnic Institute, Cleveland.

MENTION: E. H. Knight, Atelier Birmingham, Birmingham; E. Hayward and W. C. Stanton, "T" Square Club, Philadelphia.

---

### PROGRAM

#### CLASS "A" and "B" ARCHAEOLOGY— I PROJET

The Committee on Architecture proposes as subject of this Competition:

#### "A MONUMENT TO A GREEK ATHLETE"

The devotion of the Greeks to the various forms of athletics is a well-known fact. The Olympic games, which brought together the great athletes of their time were considered so important that very often the successful competitors were immortalized by having monuments erected in their honor. Usually these took the form of a statue, but occasionally an architectural monument was built. The choragic monument to Lysicrates—although erected in honor of a singer—is an example of the type of monument which forms the subject of this program. Sculpture either free-standing or in relief, representing the victory of the athlete, may be employed, but it should be borne in mind that the monument should be architectural in conception. The only dimension given is the height, which should not exceed 30 feet.

Number of drawings submitted: 4.

### AWARDS

THIRD MEDAL: J. W. Hershey and S. M. Jokel, John Huntington Polytechnic Institute, Cleveland; A. C. Bieber, University of Pennsylvania, Philadelphia; E. C. K. Schmidt, "T" Square Club, Philadelphia.



# Awarding School Building Contracts by Group Method

Plan Just Approved by New York City Board of Education, Whereby  
Many More Buildings Will Be Erected Within a Year, Closely  
Watched by Other Municipalities

A PLAN which, if successful, will doubtless be put into execution by municipalities all over the country, has just been adopted by the Board of Education in New York City, whereby the awarding of contracts for the erection of new school buildings will be done by a group method, in the belief that the actual time of construction will be materially shortened. The new method for the letting of contracts was suggested in a report made by C. B. J. Snyder, superintendent of buildings for the Board of Education, and was at once adopted. This body was quick to see that by grouping two or three buildings in one section of the city, and awarding the contract to the lowest bidder in the aggregate, the construction of buildings will be hastened. This for the reason that the contractor will be able to purchase materials more economically and to attract more reliable sub-contractors.

If the scheme is brought to successful conclusion, and there apparently is no reason why it cannot be, other cities are as sure to approve the idea as is the superintendent of buildings for the New York City Board of Education. In the New York situation Mr. Snyder has two buildings, one of which he hopes to complete in ten and the other in six months. Heretofore, the contract time for the erection of a forty-eight room building has been three hundred consecutive working days, but delays due to trouble with sub-contractors or strikes has carried the time of construction well beyond that limit.

In the group plan of Mr. Snyder these delays, caused by the award of sub-contracts to unreliable firms, it is expected, will be done away with. Contracts to put up a number of new buildings in the same neighborhood at the same time will attract more reliable bidders. Under these circumstances it will be possible to complete the contract within eight months. Included in the report is another proposal expected to aid in the rapid completion of the buildings. That is the awarding of equipment contracts at the same time as the general construction is awarded, thereby utilizing every possible idea that will help shorten the time of building.

In discussing the methods of letting contracts, Mr. Snyder states that the plan of letting a contract to include more than one building represents certain distinct advantages over the only remaining one—that of letting contracts for each building separately to the lowest bidder—with the award to be made

on the basis of the lowest aggregate bid. He believes that these large contracts, presenting as they do greater opportunity for the economical purchasing of materials, would attract a number of strong, reliable contractors, who might be depended upon to employ first-class sub-contractors, something which is of the utmost importance, since it is through the sub-contractors that most of the delays occur.

The viewpoint of many of the contractors, as seen by the building superintendent, is that inasmuch as they know they cannot secure a contract unless they are actually the lowest bidder, they must make every effort to secure the lowest bid possible for all of the various trades or work which they do not actually perform with their own organizations. This leads them sometimes to accept estimates from sub-contractors whom they know to be inexperienced, or who have limited capital or facilities. This results, more often than otherwise, in delays, but where there are so many trades at work, as well as independent contracts under way, the contractor may be held liable.

The report to the Board is made so that the building of schools may proceed with the minimum of delay, and it is of the utmost importance that sub-contractors of sound qualifications with adequate facilities for doing the work properly be engaged.

A possible need of increasing the amount required as security on contracts is mentioned by Mr. Snyder. The amount of this security or bond has usually been fixed at a sum that is about 40 per cent of the estimated cost of the work, while the certified check or cash deposited with the bid must be 8 per cent of such sum. If the estimated cost of the work is \$400,000, the security or bond would be fixed in the advertisement at \$160,000, which would require a certified check or cash to the amount of \$8,000, which is returned to the contractor upon the execution and approval of the contract. The fixing of the percentage for estimating the security is based upon a minimum allowance of 10 per cent to cover errors in contractors' estimates and 15 per cent for possible rise in markets, a total of 25 per cent. Experience has indicated the wisdom of increasing this arbitrarily to 40 per cent.

The present form of contract meets all of Mr. Snyder's requirements, except that it does not provide for the making of the surety company a party of the third part. The United States Government

## THE AMERICAN ARCHITECT

found it necessary to adopt this measure as the only possible guarantee against the delays experienced with contractors with insufficient capital.

In the recommendation of the building bureau that the group method be adopted it is stated that the bids received will undoubtedly be high when tested by those of any previous contracts, but that, on the other hand, the need for providing additional school accommodations is very great and the period of time required for construction will be shortened. Consequently the main causes of delays, which had heretofore prevented the early completion of buildings, will be done away with. The various methods employed in making contracts are each taken into consideration by Mr. Snyder.

Of the cost-plus method Mr. Snyder says that it will secure the completion in the shortest space of time, but not at the least cost. This method can also be used with a fixed compensation for the contractor, which removes some of the objections inherent in the first plan, but does not remove them entirely as far as public work is concerned.

Letting contracts to include the construction of the building, together with its equipment, to one man, frequently done in private work, should not, Mr. Snyder avers, be applied to school construction. Another method brought out is the awarding of the

contract to that bidder who will guarantee to do the work within the shortest time, under a very heavy sum for liquidated damages in the event of his failure to live up to the terms of the agreement. When this system was tried out a few years ago one of the arguments against it was that if the contract was awarded for the shorter period at the larger amount there might be delays from any one of a number of causes over which it would be claimed that the contractor had no control, so that the time finally consumed would be equal to the longer period for which the lower estimate had been submitted, while the contractor would be actually receiving the larger compensation.

Another plan discussed, but which was found not to work well unless the contractor can have complete control of the entire work, was the payment of a bonus or premium by the owner of a given amount for each day the contractor may have completed his work within the time limit fixed in the contract.

In order to carry forward as rapidly as possible the program for the relief of congestion the group method was adopted and the Board of Education will select sites for a number of buildings that are to be included in the first two years of its three-year program.

# Financial and Commercial Digest

As Affecting the Practice of Architecture

---

## Our Bank Loans Abroad

It is of noteworthy interest in financial circles that since shortly before the outbreak of the European war there has been a gradual but steady unloading of American securities on the market by their European holders, until, it is estimated, the liquidation has reached \$8,000,000,000. The result of this, consequently, is that when these nations wish to borrow they cannot hypothecate these securities as they formerly did.

Furthermore, this means that the reconstruction needs of the Allies can be taken care of only by educating American investors to take European securities. So, while McAdoo's statement to the Finance Committee was that in his judgment the needs of the Allies would be taken care of "through ordinary banking methods," it is believed by many that Mr. Glass will be confronted with the necessity of advancing further funds to the European governments.

That the United States may continue to hold its position as the leading creditor nation of the world it is necessary that American banking houses make a thorough survey of foreign investment securities so that they will be able to recommend foreign opportunities with the same degree of intelligence that marks their handling of domestic securities.

---

## Should Take Up Public Improvements

Assistant Secretary of Labor Louis F. Post does not look forward to any unemployment crisis. "There is no reason," he states, "why either business men or wage-earners should be apprehensive with regard to commercial stagnation. The war has on the whole increased the purchasing power of the masses and has created new markets. America must assist in the rebuilding of Europe, and avenues for foreign trade hitherto closed to us are now open. Raw materials which were denied to private and non-essential industry during the war are now accessible to the manufacturers of America through their release by the War Industries Board. Credits which were similarly denied to private concerns because they were needed for Government use have also been released by the Capital Issues Committee. There is no reason for anyone to be alarmed over the future.

"We must remember, however, that we have large numbers of men under arms who must be transferred to industry as rapidly as possible and that this number is many times larger than that which we have been accustomed to absorbing. Industries cannot be resumed overnight. Consequently there will be for some months to come the necessity for providing some form of employment for our demobilized soldiers and war workers, pending the resumption of normal activities. We must stimulate work which is valuable for peace-time purposes. Many municipalities throughout the country, and many states as well, have during the war either abandoned or suspended considerable amounts of public improvements. The Federal Government itself has practically abandoned its building program for the past two years. This accumulation of work should be undertaken at once as a means of providing buffer employment to carry us beyond the transition period and take up such unemployment slack as may result not so much from the inability of the industries to eventually absorb demobilized soldiers and war workers as to the rapidity with which they will be required to absorb them."

---

## More Certificates for Treasury Requirements

Announcement has just been made by the Treasury Department of the issuance of two new certificates of indebtedness, one for \$600,000,000 in anticipation of Fifth Liberty Loan receipts, and the other for an indefinite amount in anticipation of tax collections in June. This raised the aggregate of certificates, outstanding or offered, to approximately \$4,500,000,000 and represents the current debt of the Government, most of which will be refunded in Liberty bonds.

About \$3,000,000,000 of certificates have been offered since the Fourth Liberty Loan, including \$794,000,000 of tax certificates, but not making allowance for the issue of the indefinite amount just announced. In addition \$1,200,000,000 of certificates issued in anticipation of Fourth Liberty Loan receipts are outstanding.

The Government's cash requirements are now at their maximum, ordinary disbursements having reached \$125,900,000, the largest in the nation's history. By reducing the minimum amount of bond



## THE AMERICAN ARCHITECT

certificates offered from \$750,000,000 to \$600,000,000, and at the same time offering an indefinite amount of tax certificates, the Treasury hopes to meet its cash requirements and also reduce the amount of certificates sold directly to banks.

Reports from 102 banks operating the Morris plan of industrial loans show that \$34,500,000 was lent to some 212,500 small borrowers during 1918. Up to Dec. 31 of last year the total number of loans made under this plan exceeded 600,000, the amount lent being approximately \$87,500,000.

### The Fire Loss

Eighty per cent of America's fires are due to carelessness, says J. P. Heynes in the *Efficiency Magazine*. Statistics are presented showing that in 1917 America burned up \$268,000,000 worth of goods. Carelessness with matches in that year caused a loss of \$7,000,000, and smoking stumps destroyed \$9,000,000 worth of property. New York City's fire losses are about four and one-half times as heavy as those of London, while a comparison of Vienna and Chicago, cities of about the same size, shows that Vienna's fire losses amounted to \$303,000, while Chicago's were \$5,500,000.

During the year 1913, which is the last upon which reliable statistics can be had, the average fire loss for each man, woman and child in France was 49c; in England, 33c; in Germany, 28c; in Holland, 11c; in Austria, 25c; in Italy, 25c; in Switzerland, 15c; in the United States, \$2.10. Our record, therefore, was four times as bad as that of France and nearly twenty times as bad as Holland.

### Meeting the Peace-Time Problems

William B. Dickinson, vice-president of the Midvale Steel & Ordnance Company, New York, discussing recently the problems of industry, labor and government which must be solved with the return to a peace-time basis, said that the situation should be approached, not in the spirit of class prejudice, but in that of the great-hearted Lincoln, "with malice toward none, with charity toward all." He cited the following: "Many years ago a noted steel man was asked which was the most important factor in his business—labor, capital or management. His reply was in the form of a question: 'Which is the most important leg on a stool with three legs?' While this conclusion as to the equality and interdependence of these three factors has been generally accepted as a theory, in very few instances has it been given practical application."

## Current News

### Soldiers Trade School at Camp Dix

The organization of a Government trade school for soldiers crippled in battle, in connection with the overseas convalescent center, has been started at Camp Dix, New Jersey, under command of Major Harry L. Twaddell. Camp headquarters has announced plans greatly to increase the size of the convalescent center in order to relieve congestion among patients now under treatment in other camps in New Jersey and eastern Pennsylvania. The school will be an experiment in development work for wounded men, and if it proves a success, similar courses of instruction will be established elsewhere.

Government officials will inspect the Camp Dix school shortly in view of the proposed extension of the system to other convalescent stations. The aim of the school will be to provide wounded and crippled men with new occupations, if war has unfitted them for their old work, and many of the methods that have proven most successful will be incorporated in the system of training. The War Depart-

ment has announced that a soldier may return after he is actually discharged from the service and take the school course.

Lieutenant Carl Lellmaker of Buffalo, N. Y., who is in charge of the organization, has arranged that initial courses will include stenography, typewriting, auto repairing, shoe repairing, tailoring, printing, telegraphy and wireless. Instructors will be furnished by the Quartermaster's Department and the army Y. M. C. A.

### Building Boom Hits Midwestern States

Architects and contractors in the larger cities of Minnesota and Wisconsin are anticipating a general revival of building operations within the next few months. Enthusiastic reports from these sections claim that building records will surely be broken in 1919. One dispatch from the city of Wausau, Wis., a live paper manufacturing community, states that

citizens there have already planned \$350,000 worth of new construction.

The construction of St. Paul's new Union Depot will be speeded to the limit from now on. This is insured by the recent sale of an \$8,000,000 bond issue. One-half of the issue will be utilized for construction work in 1919. In the expectation that steel prices and labor will drop shortly, the new street lighting enterprises of that city are being held temporarily in abeyance by Commissioner Keller. The cost of lighted ways provided for amounts to \$85,000, estimated on a pre-war basis.

St. Paul hopes to surpass all previous building programs by completing \$4,196,000 worth of new projects. It is the biggest building program ever prepared by that city and officials are confident that it will be carried out.

---

### U. S. Selling Agency to Market Timber

A special agency, with a director of sales, to dispose of vast quantities of timbers and other wood products on hand at various cantonments and building projects throughout the United States at the time the armistice was signed has been created by the War Department. The sudden ending of the war, with all this great construction work for the Government under way, for a time threatened to make a serious problem.

It was at first feared that millions of feet of lumber not consumed on the Government contracts would be thrown back on the market and that chaotic conditions might result. The director of sales, whose office will be in the Munitions Building at Washington, will confer with committees representing industries affected by disposal of different kinds of supplies in order that business conditions may be disturbed as little as possible.

---

### Forest Reserve in New York Big

A summary just compiled by Conservation Commissioner George D. Pratt shows that a forest reserve of over 2,000,000 acres is assured to the people of New York State, with the purchase of more than 200,000 additional acres now under negotiation with owners. Statistics of the commissioner show that since the approval of the bond issue for the acquisition of lands in the Adirondacks and Catskills for State park purposes, 460,731 acres of forest land have been offered for sale to the State. After deducting such tracts as by their location were manifestly unsuitable for forest preserve pur-

poses, 411,650 acres have already been examined and appraised by the commission's foresters, which is nearly a quarter of the size of the entire preserve owned by the State previous to the bond issue, which had gradually been accumulated since the year 1883.

The lands purchased in the Adirondacks average \$5.79 per acre, and those in the Catskill \$7.10 per acre. A total expenditure of \$900,000 is involved.

---

### Urges Planting of Trees

Practical consideration of the value of tree planting is urged by John Y. Cuyler in a letter to the *New York Sun*, who writes that it should be treated as a matter of common interest, as are other necessities upon which health, comfort and happiness depend. Not far removed in its dreadful significance from the appalling destruction of human life abroad is the devastation, and in many instances the complete destruction, of the woods and forests, the parks and gardens of France, Belgium and other fields of the sanguinary conflict just ended.

In our own country we can no longer delude ourselves with the boastful claim of an exhaustless timber supply. The shifting scenes of the lumber interests, the story of which is so startling as evidencing the magnitude of such inroads upon this once incomparable resource, forced upon us the widespread need of reproduction and the unremitting service of wiser conservation. Great areas of our Middle Western States once invested with dense forests of valuable timber are now so bare as scarcely to yield a local supply of firewood.

---

### Model Towns in British Problem

With the announcement of the British Local Government Board that 100,000 houses will be erected by the Government without delay, plans are well under way in London for a great building boom when demobilization is further advanced.

The Essex County Council has decided to purchase 400 acres near Colchester for settlement by farmer soldiers. Model towns are being built at many centers, including Avonmouth, Swansea and Barry.

---

### British Suburban Development

The British Ministry of Reconstruction is embarking upon a great scheme of rural development by the construction of a large number of light railways to connect the country districts with the main



railways, according to the *London Daily Mail*. The cost will be borne in part by the county authorities and part by the Government. Upon completion the lines will be leased to the operating companies under adequate guarantees.

Enormous quantities of material used by the British army in France will be utilized, reducing the cost of construction to about \$12,000 per mile. The rails are of the narrow gage type and were used by the British army mostly for transporting light munitions from the ordnance bases to the battle front.

The first rural railway has been begun at Giggleswick, Yorkshire.

---

### Fire Protection Furthered by Concrete Roads

By the construction of fifty-five miles of concrete roads radiating from Appleton, Wis., fire protection has been extended a distance of ten to fifteen miles into rural districts around that community. When the entire system of permanent roads is completed, the Appleton Fire Department will be able to respond to fire calls in the most remote part of the county within thirty minutes. A fee for this service, according to the distance of the run, will be levied by the city. This means that the insurance rates of the farmer will, in many cases, be reduced.

---

### New Branch for Steel Society

An Indianapolis section of the Steel Treating Research Society, which numbers some 1200 members throughout the United States, Canada and England, is being organized under the direction of J. Weaver Smith of that city. At the first meeting Prof. John F. Keller of Purdue University gave an illustrated lecture on the subject "Steels—From Ore to Finished Heat-Treated Products." William R. Chapin outlined the plans for the future of the Indianapolis society.

---

### Montana Has World's Tallest Chimney

There are but two buildings among New York City's skyscrapers, the Metropolitan building—700 ft. 3 in.—and the Woolworth building—750 ft. high—that are taller than the new brick stack of the Anaconda Copper Mining Co., in Montana. It is 585 ft. and 1½ in. in height and is twelve feet taller than any chimney in the world. According to the engineer's estimates the capacity per minute of the smoke treater and stack will be three million cubic feet of hot gas with one million cubic

feet of cooling air. The stack was built in 142 working days and consists of an octagonal base 86 ft. in height. It has a taper of 64 per cent.

---

### Large Purchases of Copper by Italian Government

Italy has been the only one of the large allied powers to be a large purchaser of copper in the American market. The Italian Government has just placed an order for 5,000,000 lb., while not long ago an order for 10,000,000 lb. was negotiated. The price is supposed to be 23 cents a pound, which was the figure announced for export recently. England has not been in the market for some time, it being said that the government has 62,000,000 lb. of the metal on hand.

---

### Note Rise in Steel Trade

Little significance is attached to the slightly increased business activity in the iron and steel industry since the first of the year by *The Iron Age*, which believes that as yet there are no real signs of a big buying movement. Some steel plants are said to be operating about 85 per cent of their capacity, but the general average is placed at nearer 65 per cent, which is equivalent to about 90 per cent of the capacity attained during the four years before the war.

---

### Personal

The office of Frederick A. Schweiger, architect, has been moved from Romer, Minn., to Moose Lake, Minn., where he requests manufacturers' samples and pamphlets be sent.

The firm of Bleckley & Irvin, architects of Augusta, Ga., has been succeeded by Willis Irvin, who will continue the practice of architecture at 1404 Lamar Building, that city. Mr. Irvin desires manufacturers' catalogues and samples sent to him.

The firm of Eckland, Fugard & Knapp, architects, formerly located in the Harris Trust Building, Chicago, Ill., has been dissolved. Messrs. Fugard and Knapp have secured quarters in the Recor Building, 79 W. Monroe St., that city. Mr. Eckland has established a new office in the Old Colony Building, East Jackson Boulevard, Chicago, under the name of Henry C. Eckland & Co., architects. James N. Hatch, civil and structural engineer, of Chicago, will be connected with the Eckland company.



## Late News from Architectural Fields

### NEW YORK CHAPTER, A. I. A., URGES COMPETITION FOR PERMANENT WAR MEMORIAL

A definite plan, and one that embodies a competition of ideas and suggestions for a proposed permanent war memorial in New York City, outlined in the form of a resolution to the Fine Arts Federation, was adopted by the New York Chapter of the American Institute of Architects at a meeting held Friday evening, January 17, in the rooms of the Architectural League in the Fine Arts Building, West Fifty-seventh Street, New York.

The program agreed upon by the thirty members present at the meeting after a lengthy discussion urged that "all citizens residing or maintaining an established place of business in Greater New York" be given a chance to present their ideas for the memorial in either letter, sketch or plastic form in exhibition. It was suggested that a jury of award of fifteen members, including representatives of the New York Chamber of Commerce, the Merchants' Association, the Fine Arts Association, the Society of Arts and Letters, and other organizations, judge the work entered in the competition. The idea awarded first place will be made the subject of a final competition, the winner of which will be awarded the commission to execute the memorial.

The resolution adopted by the New York Chapter follows:

"Whereas, The Fine Arts Federation is about to appoint a committee to consider the form to be taken by a permanent memorial in New York City to commemorate the valor of the American soldiers and sailors in the world war, and

"Whereas, The realization of such a memorial, of whatever nature, is of vital importance to the community in that it should be a true expression of the sentiment of the citizens of New York as to form of memorial deemed most appropriate; be it

"Resolved, That the New York Chapter of the American Institute of Architects present to the Fine Arts Federation, for its earnest consideration, the following program and plan of procedure:

"That a committee be appointed to institute a preliminary competition of ideas or suggestions to be open to all citizens residing or maintaining an established place of business in Greater New York.

"That their ideas or suggestions be presented in one of the following mediums:

"A—In letter form;

"B—In sketch form, a perspective and plan;

"C—In plastic form, a model and plan.

"A location or plot plan to be submitted if the idea be in the form of a structure.

"As an essential part of this preliminary competition, a first prize with possibly secondary prizes should be awarded.

"That the judgment of this competition of ideas be rendered, after public exhibition, by a jury composed of representative citizens. It is suggested that the jury of award be composed of fifteen members, three members appointed by each of such organizations as the New York Chamber of Commerce, the Merchants' Association, the Fine Arts Federation, the Society of Arts and Letters, etc.

"That the idea awarded the first prize in this preliminary competition be made the subject of a final competition.

"That the winner of this final competition be awarded the commission to execute the memorial.

"In conclusion, the New York Chapter feels that in this manner can best be obtained the opinion and the sentiment of the citizens of New York as to the form of the memorial."

At this meeting members of the the institute listened to a talk by Thomas Hastings on the Victory Arch now being erected across Fifth Avenue at Madison Square. Mr. Hastings is one of the designers, and he assured the architects that the arch was a temporary one, but that he personally favored the site and the design for the permanent memorial.

The question of "post-war activity" was also brought up for full discussion at the meeting. It was decided that a definite program should be worked up by the committee in charge of this subject and sent to every architect in the country, with a request for an expression of opinion.

## Again, "Shadows and Straws"

In the December issue of *The Journal* of the A. I. A., received on Jan. 2, the following appears: "Authorities seem to agree that no immediate decline in the cost of materials is to be looked for, while the price of labor is, of course, shrouded with considerable doubt."

It is interesting to note that the following reductions in prices were all made prior to Jan. 7: Pig iron 10 per cent, finished iron and steel 15 per cent, copper and tinplate 20 per cent, sanitary earthenware 25 per cent, enameled iron goods 20 per cent, boilers, radiators and furnaces 10 per cent, iron pipes and fittings 5 per cent.

# Department of Architectural Engineering

## Useless Waste in Concrete Construction Due to Legal Requirements\*

By W. STUART TART, *Assoc. M. Am. Soc. C. E., Assoc. Mem. Inst. C. E.*

### UNIFORMITY OF MATERIAL STRENGTH AND WORK- MANSHIP

TEN or fifteen years ago the Portland cement used in America was a somewhat uncertain and variable material, and the reinforcing steel was in little if any better position. Both of these materials are to-day, however, manufactured to standard specifications and under the control of skilled chemists. In consequence of this, and due also to the fact that the standard specifications referred to are reasonable and can be lived up to by the manufacturers with ease, these materials are to-day highly uniform and reliable. As an additional safeguard and guarantee of this, most building specifications to-day require that these materials be tested by an engineering laboratory. There are in existence a large number of such laboratories which are thoroughly competent and whose charges for inspection are really an insignificant item. If, therefore, this inspection is required and carried out, we have a double check on the cement and steel, and may therefore classify these two materials as approaching 100 per cent of what is required as their characteristics.

Torpedo sand and either gravel or crushed stone vary somewhat in different localities, but competition being keen in these materials, clean and thoroughly satisfactory aggregate is now available throughout the country at little if any increase in cost over material of a lower grade. The inspection of concrete aggregate is a very small matter, and in consequence obtaining aggregate that will class as entirely satisfactory is a relatively easy matter to provide for. With proper inspection, therefore, it is entirely unnecessary to provide in the factor of safety any quantity to cover the possibility of the materials themselves falling short of the standards upon which our assumed concrete strength is based. The mixing and placing of concrete as practiced

to-day leaves a lot to be desired. With the knowledge, however, that has been gained in the past few years we are now in position to determine in a fairly definite manner what must and what must not be done in the proportioning of, the mixing of, and the placing of concrete in order to assure the desired strengths. Engineers have always striven to obtain better concrete by insisting on certain principles which had been established in a more or less indefinite manner, but up to the present time building ordinances in general will not recognize that 1-2-4 concrete has a greater strength at 28 days than 2000 lb. per square inch in compression. The most recent tests show that with a 1-2-4 concrete, in which the aggregate has been properly graded and sufficient water only used to make the mass workable, and in which the mixing has been carried on for a period of about 1½ minutes, that a strength of 2600 lb. per square inch at 28 days is easily obtainable. Engineers who are in close touch with reinforced concrete construction as practiced by some contractors, will agree that in many cases the concrete resulting from the poorly graded aggregate mixed with an excess of water and mixed only for a period of about 45 seconds, has resulted in many cases in concrete which would not come up to the 2000 lb. crushing strength value assumed in the building ordinance. Many of us have seen concrete which would fall below this to the extent of 10 or even 15 per cent, but this, as in the case of the materials themselves, can all be overcome by proper inspection, particularly as we now have a real definite knowledge of what must be done in these three respects. One inspector to each mixing plant on any construction work could easily, during the course of the day and without interfering with his other duties, make about four tests on the fine and coarse aggregate and determine in a few minutes the proportion of each to be used in the normal 1-2-4 concrete. Proper measuring devices can easily be provided on any hopper for charging the

\*Continued from our issues of December 11-18, 1918, and January 8, 1919.



## THE AMERICAN ARCHITECT

mixer, and it would consequently appear that the control of the mixture itself can easily be regulated to the desired degree. Continuing the period of mixing of a batch from about 45 seconds to one minute would necessitate the use of the two mixers where one mixer is now used and worked to capacity. Since on all concrete work of any extent an inspector is stationed constantly at the mixing plant, the only added expense necessary to obtain a 30 per cent increase in the assumed strength of concrete is the installation of two concrete mixers where one is at present used, and this only where the mixer referred to would be employed to its entire capacity with the rapid mixing now practiced.

In the past six years we have seen the spouting of concrete carried to a point which many of us feel resulted in an expense rather than in a reduction in the cost of placing concrete. A few years ago on building construction work, one could even see a swinging spout used to deposit concrete directly upon the forms. Contractors have, however, found that in the ordinary building construction this method was more expensive than using fixed spouts and distributing by buggies from temporary hoppers placed on the formwork. It is the opinion of many to-day that the construction of high temporary towers and the carrying of concrete through long chutes is not as economical as had been thought a few years ago. Conveying concrete from one hopper to another through a long run of spout always tends to separate the aggregate from the mortar and also creates a tendency among the construction forces to use a greater quantity of water than is really desirable. Some people who have studied this matter have reached the conclusion that the difference in cost between transporting concrete by buggies direct from the mixer tower to its final position in the forms is very little more expensive than transporting the material in the same way from the distributing hoppers placed throughout the structure, and in few cases is this added expense great enough to offset the cost of constructing a high wooden tower and of providing and rigging the distributing spout. In some plant layouts the towers and spouting are made use of to bridge the gap between the point of delivery of the aggregate and the point where the finished concrete is to be deposited. In few cases is it more economical to elevate all of the materials to a considerable extra height instead of transporting the materials by horizontal conveyor to a location for the mixing plant, based upon the economical distribution of concrete direct from this mixing plant. Good concrete can be obtained by spouting, but the temptation to use an excessive amount of water in the mixture, in order to facili-

tate spouting, is so great that it would appear that better concrete could be ensured by entirely prohibiting the transportation of concrete in this manner. It would seem also that the difference in cost resulting from these requirements would not be material.

One of the duties of the inspector supervising the placing of the concrete should be to take samples from the buggies or from the mass as placed in its position at various times throughout the day, and I feel that fully six or even twelve standard test pieces should be made up from each day's run, properly marked and stored in a bed of damp sand at the building site. Testing these cylinders would demonstrate from time to time just what the condition of the structure was, and would provide a reliable basis for determining upon the removal of formwork. In the construction of reinforced concrete skeletons for hotels, apartment buildings, and other structures designed for a light live load, one of the most important features insuring good construction is to determine definitely that the various floors in the structure shall not be overloaded due to a premature removal of the formwork. Under ordinary construction conditions it is usual to have about three or four stories of formwork in place. The writer has never come in contact with any engineer or inspector who has known how to make fairly definite figures as to how much load was carried on the various floors while several stories of formwork were in place. In considering this subject it will be apparent that the amount of load carried by each of the floor slabs bears a definite relation to the relative deflections of these floors. The deflection of any construction varies directly as the bending moment and inversely as the modulus of elasticity and the moment of inertia of the member considered. Now, in most cases, the moment of inertia of the construction is the same for each story but the modulus of elasticity of the concrete will vary with its age. Taylor and Thompson state that the modulus of elasticity of concrete seems to bear a fairly direct ratio to its strength; assuming this to be the case, we may, with a fair degree of accuracy, arrive at the proportion of the total load occurring in the three or four stories by proportioning the total load between the various floors in a direct ratio to the crushing strength of the concrete existing in the various floors at the time the calculation is made. The test data now in existence show the normal development of the strength of concrete under laboratory conditions, and, excepting under extreme summer and extreme winter conditions, these strengths could be used to determine the load carried by each floor when several floors of formwork were in position. If there was any doubt in



## THE AMERICAN ARCHITECT

the chief inspector's mind as to whether the concrete was not developing in strength normally, it would be a very simple matter to have one or more cylinders from each of the various floors tested before making his decision as to the removal of the formwork. With these safeguards, and with a reasonable inspection control at the building to see that construction materials were not piled too high on any of the finished floors, we can be reasonably secure in the assumption that the floor construction will not be overloaded and thereby damaged during construction.

The placing of reinforcing steel is to-day so thoroughly well understood by construction foremen that the inspection of this feature to assure our obtaining construction according to our design is a relatively easy matter. If specifications require the use of mechanical spacing and supporting bars for the reinforcement, we can also be sure that the steel is held securely in its correct position while the concrete is being placed. There are to-day on the market a number of mechanical supporting and spacing bars, and many engineers now require the use of them in their specifications. By these safeguards we can be assured that the placing of the reinforcing steel is such that little allowance is necessary to provide for its deviation from the assumptions made in the design.

Some engineers and architects to-day are in the habit of requiring the formwork design prepared by the contractor to be approved. While the formwork designs used by our most experienced contractors are entirely satisfactory, the architect or engineer should insist on examining this design. All formwork which is not rigid and stiff enough to prevent sagging may result in a material reduction in the strength of the construction, and this must be guarded against. Formwork designs, too, should be made so that repropping after the formwork has been wrecked is not practiced. If the whole of a formwork under a floor is once removed, no material benefit can be gained by repropping. If the load coming on a floor is going to overstress the construction this overstressing will occur immediately the formwork is removed, and nothing is gained by later inserting temporary props. This is a matter which should receive considerable attention, and is one which can easily be provided for in the formwork design.

With proper inspection control it is noted, therefore, that the item of material strength may be controlled within a very small margin. The only factor which may appear on casual examination to be hard to control would be the cleanliness of concrete aggregate. Under existing conditions of competition in the sale of concrete aggregates, it would

be a fairly simple matter to enforce specifications covering the cleanliness and character of the aggregate. The sales forces of progressive companies would soon, under these conditions, offer, when recommending their aggregate, test data showing what strengths had been developed on certain recent work where their aggregate was used, and it is the writer's opinion that they would be willing to guarantee to deliver aggregate in which the percentage of loam and foreign material was controlled to below a certain percentage. The inspection of a car of aggregate to see that it came up to this specification requirement would be a very simple matter, and it is the writer's opinion that jobbers of sand and crushed stone would take the necessary steps to insure that none of their material was rejected, provided they knew that this requirement of the specifications was going to be enforced. By the added safeguards suggested above, little, if any, extra expense is placed on the construction, but the engineer would be in position to know definitely that he was going to get 2600-lb. concrete at an age of 28 days, instead of under some conditions wondering whether his concrete was going to deliver a strength of 1800 or 2500 lb.

I would like to add that the figure of 2600 lb. per square inch for 1-2-4 concrete at 28 days is one that can easily be obtained under the methods of inspection, mixing, and placing outlined above.

*(To be continued)*

### Important Code Revision

THE first gun in the campaign against the antiquated and wasteful requirements of building codes, has been fired by the Board of Standards and Appeals of New York City, John P. Leo, Chairman.

Exhaustive tests were made, by duly authorized persons, to determine the efficiency of certain anti-siphon traps. The conditions of test were standardized and were as near actual conditions in practice as it was possible to make them. Based on the results as observed, a ruling was adopted by a vote of twelve in favor and one negative. Such a radical departure from the usual plumbing regulations aroused considerable opposition from those interested in the purely monetary aspect of the proposition. The reasonableness of the proposal was apparent to the Board, resulting in the vote mentioned above.

The result of the application of this ruling will be to decrease the cost of plumbing installations under certain conditions, which will naturally stimulate the more extensive use of plumbing equipment and relieve the building industry of one use-

## THE AMERICAN ARCHITECT

less burden. If entire codes could be revised with the view of eliminating useless requirements the effect on building enterprise would be noticeable within a very short time. Our codes have been formulated, in many instances, with the apparent intention to aid certain manufacturing and trade interests rather than the owner. Codes should be made with one object only in view; to permit the construction of structurally safe, fire-resisting and sanitary buildings in the most simple and inexpensive manner.

This ruling by the Board of Standards and Appeals, under the aggressive leadership of its chairman, is but a fore-runner of other revisions in the interests of the owner. Other cities may well follow this example for the elimination of waste due to building code requirements.

Rules 91, 95, 98, 99, 111, 113, 114 and 116 of the Rules and Regulations for Plumbing and Drainage, Water Supply, Gas Piping and Ventilation of Buildings, as amended by the Board of Standards and Appeals, December 27, 1918; effective January 16, 1919.

RESOLVED, that rules 91, 95, 98, 99, 111, 113, 114 and 116 of the Rules and Regulations for Plumbing and Drainage, Water Supply, Gas Piping and Ventilation of Buildings, adopted by the Superintendents of Buildings of the City of New York, effective April 23, 1912, be and they hereby are amended, effective January 16, 1919, to read as follows:

### Vent Pipes.

Rule 91. All traps, except approved anti-siphon traps connected to main waste or soil lines or to the house drain by branch piping not over seven (7) feet in length with a fall not exceeding two (2) inches per foot, shall be protected from siphonage and back-pressure by special lines of vent pipes; provided that where approved deep-seal siphon-jet water-closet or slop sink fixtures are installed with branch piping not over five (5) feet in length from fixture to main soil or waste line, the vent pipe may be omitted for such fixtures in buildings not over eight (8) stories in height, and where the main soil or waste line is made one inch larger in diameter than required by these rules, the vent pipe may also be omitted for such fixtures in buildings over eight (8) stories in height.

Rule 95. Except where "yoke type" ventilation is installed, vent connections for water-closets and slop sinks must be made from the branch soil or waste-pipe just below the trap of the fixture, and this branch vent pipe must be so connected as to prevent obstruction, and no waste-pipe connected between it and the fixture. Earthenware traps must have no vent horns.

"Yoke type" ventilation shall be taken to mean a cross connection, by means of a horizontal branch soil or waste-pipe, between the main soil or waste line and the vent line, and in which the connection between the branch pipe and the vent line is made at least six (6) inches above the line of fixtures discharging into such branch pipe.

Rule 98. When the plumbing fixtures installed in any building are arranged in groups or batteries, "yoke type" ventilation may be installed, provided that for batteries of water-closets each fixture shall be set not more than two (2) feet distant from the horizontal branch soil pipe into which it discharges, and for batteries of fixtures other than water-closets each fixture shall be so located that its trap will be not more than two (2) feet distant from the horizontal branch waste line into which it discharges. When the ordinary type of venting is installed and the number of branch or back vents from the traps of fixtures connecting to any main branch vent exceeds the number

and size given in the following table, a 3-inch main branch vent must be provided for the additional vent connections.

2-1½ inch branches on a 1½ inch main branch.	
4-2 inch branches on a 2 inch main branch.	
7-1½ inch branches on a 2 inch main branch.	
2-2 } 4-1½ }	inch branches on a 2 inch main branch.
1-2 } 5-1½ }	

### Traps.

Rule 99. No form of trap will be permitted to be used unless it has been approved by the Superintendent of Buildings or the Board of Standards and Appeals.

No anti-siphon trap or deep-seal siphon-jet fixture shall be approved until it has successfully passed such test as may be prescribed by the Board of Standards and Appeals.

Rule 111. Every plunge bath shall be provided with a trap at least four inches in diameter, the waste from trap to bath to be reduced two diameters and this waste to be controlled by a gate valve. Overflow pipes, if provided, must be connected on inlet side of trap. Except where an approved anti-siphon trap is installed in the manner specified in Rule 91, such trap must be ventilated by a separate vent line extended above the roof, of the same size as trap and water connection.

Rule 113. Every dental cuspidor must be separately trapped by a trap of at least one and one-half (1½) inches in diameter, which shall be vented except where an approved anti-siphon trap is installed in the manner specified in Rule 91, and placed as close to the fixture as possible. The connection between trap and cuspidor may be three-quarters (¾) of an inch in diameter.

Rule 114. No plumbing fixtures, except bar sinks, soda fountains or drinking fountains, shall be installed with an indirect waste connection to the plumbing and drainage system. The waste of every bar sink, soda fountain and drinking fountain, if not directly connected, must discharge over a properly water-supplied, trapped sink, with trap vented, unless an approved anti-siphon trap is installed in the manner specified in Rule 91. The main waste lines shall be two (2) inches in diameter, and the branches to fixtures at least one and one-half (1½) inches in diameter. Drinking fountains must be trapped and the waste line extended through the roof. No vent connections need be provided.

Rule 116. Safe and refrigerator waste-pipes shall not be trapped. They must discharge over a properly water-supplied, trapped sink, with trap vented unless an approved anti-siphon trap is installed in the manner specified in Rule 91, such sink to be publicly placed, and not more than 4 feet above the floor. In no case shall any refrigerator or safe waste-pipe discharge over a sink located in a room used for living purposes.

## Friendly Possibilities of Engineering Societies\*

By PHILIP N. MOORE

*Past President, American Institute of Mining Engineers*

ENGINEERS and masters of enterprise are waking fast to the realization that there is something more in the relations of employer and employee than mechanical output, which can be measured mathematically, and that the human side of service must receive greater consideration for

\*From the Bulletin of the American Institute of Mining Engineers, January, 1918.



## THE AMERICAN ARCHITECT

the future. So much has been said and written on this subject that it has passed into a truism.

Should not the same element, long neglected, be considered as of even greater importance than questions of administration and membership, in the plans of engineering societies? Should mutual service and interest end with mere technical output by members and the rendering of care and management by officers?

The world is recognizing, as never before, obligations for service to fellowmen due from all, high or low, in rank or wealth. Our technical societies, organized for professional protection and advancement, are, insensibly to themselves, almost without conscious intent, widening their field of service to members and dealing heartily with questions broader than technique. Those who are doing such service find unconsciously more and more satisfaction in work so rendered.

The growth of knowledge that comes to subaltern engineers or veterans by converse and contact with their fellows, working along and versed in the same subjects, brings interest and friendship. In this way are built some of the warmest friendships of life, coming as incidental and pleasurable results of meetings undertaken for other purposes. Should not the friendly purpose, the desire for service one to another, and especially the wish on the part of the established man and organizations to help their young fellows, be felt to demand attention as an issue of its own rather than as a by-product?

The thought that such service should be an essential part of society life and obligation is strong and growing. It has shown itself in criticism from time to time against hard and indifferent attitudes and routine, as well as by protests that have taken form in the founding of new societies having the social and the service feature for their reason.

In our Institute, not only has the friendly spirit been growing but the call for service was recognized long since by the establishment of an employment department. With the nation at war, more engineers than ever before were demanded quickly. The task of finding them was assumed by Engineering Service, whose mission was a patriotic attempt to give the Government the right engineer for the right place and, incidentally, to help the right man to find it. This service has now, under a changed name, been placed by the Engineering Council under the secretaries of the four Founder Societies. As the Engineering Societies' Employment Bureau, it possesses the largest cataloged body of information in existence regarding engineers of the country and will, without doubt, grow into a department of increasing value that will carry on

its files the records of the great majority of engineers of the country. To young engineers, members or not, it will offer services, practically free, for placement in positions; for employers, it will carry a body of men from which can be drawn capacity for almost any task.

This is a forward step of great value, which will be welcomed, especially by the younger men of our societies. There are those who believe it is but the beginning and that the societies should increase their points of social contact. Elder men who have achieved their place in the world owe cordiality and acquaintance toward the younger engineers; on the other hand, the younger men should not conceal their vanity or awkwardness under the cloak of modesty, but should show themselves at all times ready to meet, greet, and show interest in the elders, who are far more desirous of knowing and welcoming them than they know.

Further, with such increase of friendly meetings will come not only greater value to the members from their society connection, but there must and will grow a feeling on the part of such members, especially those who are younger, that they have obligations of service, as well as privileges, when they join a national society. All these organizations suffer from the fact that too few members take the trouble even to vote at an annual election and but a small proportion at any time attend the meetings. If each member living within the country should make it a rigid item of his annual schedule to attend at least one meeting of the national society to which he belongs, not only would he benefit greatly thereby through coming to know face to face the men who are doing the bigger things in the profession and the society, but he would find his own powers of influencing other men growing proportionately. The obligation of cordiality is on everyone.

### Engineering Societies Employment Bureau

The American Institute of Mining Engineers, the American Society of Civil Engineers, the American Society of Mechanical Engineers, and the American Institute of Electrical Engineers have established the Engineering Societies Employment Bureau under the management of their secretaries. One of the purposes of the Bureau is to keep in touch with all engineering firms with a view to supplying them with desirable men. Plans are under way to assist in placing men who are retiring from the Government service. The Bureau is not intended to be exclusively for the benefit of mem-



ployed members of the Founder Societies; non-members who are introduced properly will be registered. Information, registration forms, etc., may be obtained from the office of the Bureau, Engineering Societies Building, 29 West Thirty-ninth Street, New York, Room 903.

### The Effect of Lime on Strength of Cement Mortar

THE effect of hydrated lime on cement mortar has been investigated by means of a series of tests and are reported by M. O. Fuller.\* These tests supplement a series previously made and reported in 1916, which showed that the addition of hydrated lime up to 10 per cent not only increased

not present. Longer storage periods showed results in favor of the addition of lime.

The tests here reported were made to determine the percentage of hydrated lime that was best to increase the plasticity and impermeability of the mortar and not affect its strength. The storage conditions were three, outdoor air, water and soil and the test periods 7, 14, 28 and 56 days. In addition

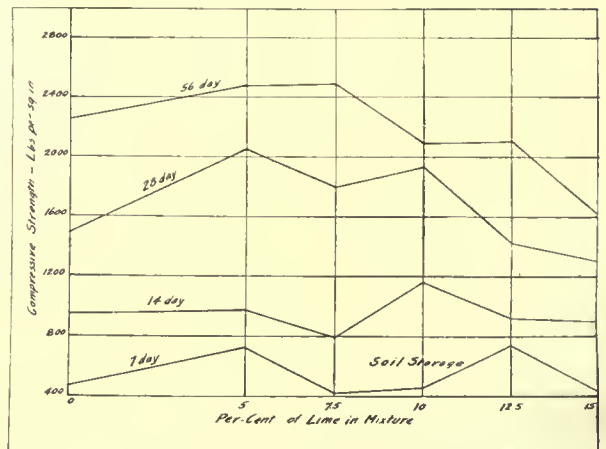
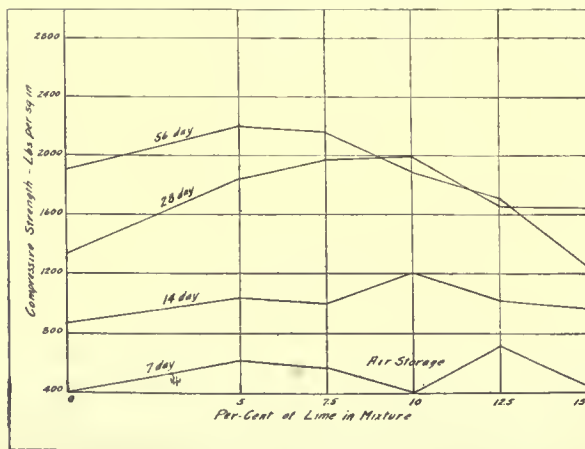
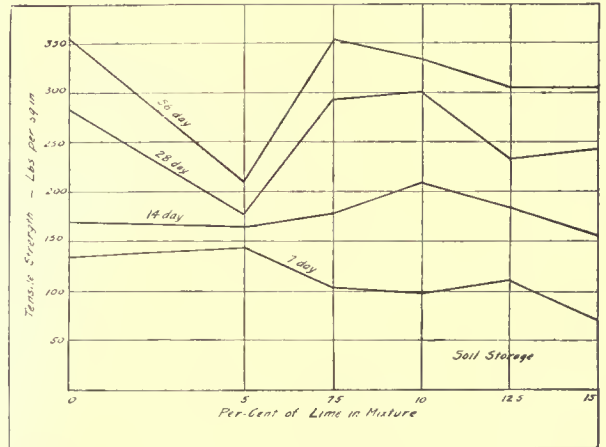
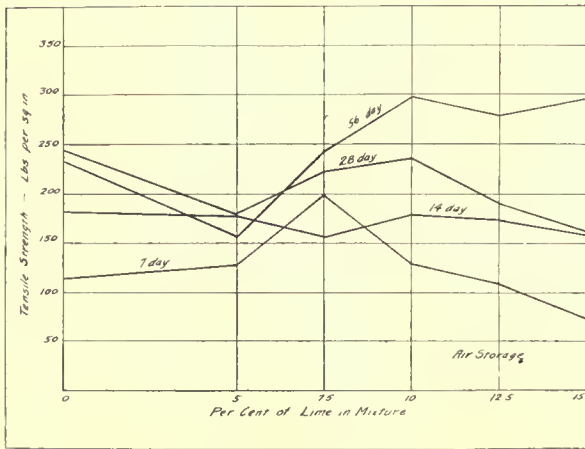

Tensile and Compressive Tests on Samples Stored in Air

Tensile and Compressive Tests on Samples Stored in Soil

the plasticity but also in some degree the tensile strength of specimens stored in water and in earth. The stored specimens showed greater gain in strength up to the ten-day period when lime was

to the tensile briquettes, 2-in. cubes were made and tested in compression on a Universal testing machine.

The cement had the following physical properties: specific gravity 3.08, fineness 18 per cent retained on 200-mesh sieve, normal consistency 25 per cent water. Tensile strength neat cement, 7 days, 454 lb. per sq. in., and 28 days, 753 lb. per sq. in. Compressive strength neat cement, 7 days, 4701 lb. per sq. in., and 28 days, 6737 lb. per sq. in. Tensile strength 1-3 mortar, 7 days, 188 lb. per sq. in., and 28 days, 326 lb. per sq. in. Compressive strength 1-3 mortar, 7 days, 1130 lb. per sq. in., and 28 days, 1997 lb. per sq. in.

The proportions of sand and cement were taken

\*Asst. Professor Civil Engineering, Lehigh University, Bethlehem, Pa.

by weight, the percentage of the total weight of the mixture being added to give what is known as working consistency, i.e., normal consistency plus 50 per cent. The hydrated lime was added to the dry cement and thoroughly mixed before adding the sand and water. Test pieces were stored, one-third in water, one-third buried in moist clayey soil, and one-third outdoors subject to the elements.

The plotted results are given for various per-

esting, although such conditions do not obtain in building constructions except in underground foundation work. They do, however, emphasize the value of keeping concrete in as moist a condition as possible and corroborate the results of the tests made by Prof. Duff A. Abrams which were published recently in THE AMERICAN ARCHITECT. An important result of using hydrated lime, in addition to the increased impermeability of the concrete, is the increased plasticity, which will aid the placing of concrete without the use of excess water. This is well worth considering, as the time of mixing and the percentage of water used are the two most important factors that affect the making of concrete, materials not considered.

### A Duty to Your Profession

“ENGINEERS who are not given to writing articles on technical and practical subjects should bear in mind that to-day, experiences are not handed down from one generation to the next by tradition, but by written books and magazines; that they have received their own knowledge from this source and therefore are in duty bound to reciprocate.”

This is true also as to architects, for the day of the apprenticed draftsman is over, many of them in these days coming from technical and architectural schools. In any event, the architect of to-day has such a remote contact with his drafting forces that he does not have the opportunity to give them the benefits of his experiences even were he so disposed. The teacher or professor in the technical school is, unfortunately too often, a person without practical experience and one whose knowledge is limited to that available in text books and technical journals.

Quoting further from Albert M. Wolf, Assoc. M. Am. Soc. C.E., in *The Wisconsin Engineer*, he states that: “An engineer often has to solve problems regarding which little direct information can be found. In such cases he must draw upon his technical and practical knowledge for the solution. If, after the work is completed, he will write a description of it, and the methods employed in design, with some comments as to whether the design has proven satisfactory in all respects or not, and send it to one of the technical papers for publication, other engineers looking for light on the same subject will be rewarded for their search. They will be able to profit by his contribution to the literature, and undoubtedly will make improvements in their design, suggested by his experience. Then, if they in turn would write up their experience along this particular line, soon we would have mate-

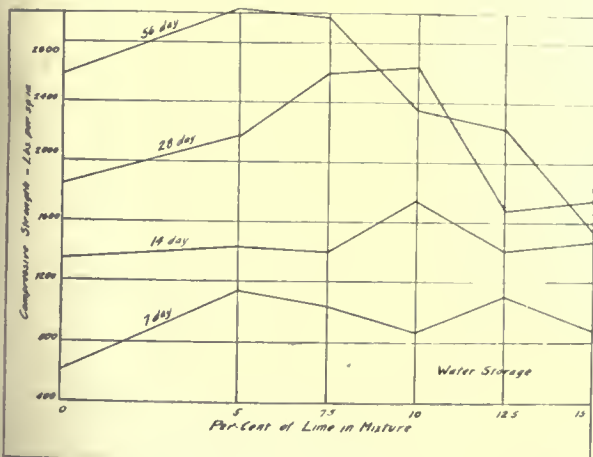
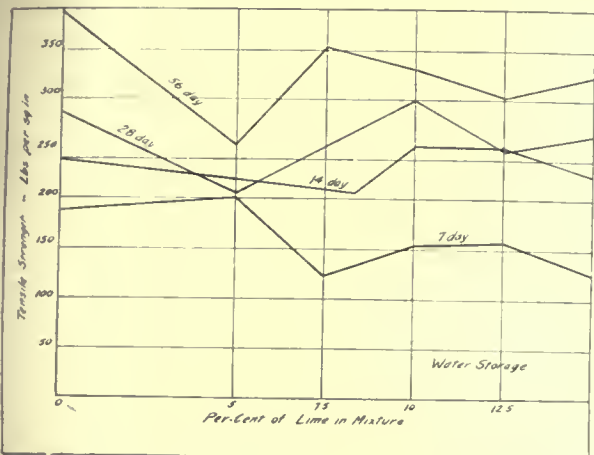

Tensile and Compressive Tests on Samples Stored in Water

centages of hydrated lime up to 15 per cent. As applied to building construction, architects will be more interested in the air storage tests as more closely approximating field conditions. Reinforced concrete design is based on the compressive strength and these tests show that from 5 to 7.5 per cent of hydrated lime apparently improves the strength and this appears to be the safe limits. In tensile strength tests it develops that 10 per cent of hydrated lime gives the best results, but as resistance to tension is negligible in concrete design, this percentage should not be used accepting these tests as a basis for specifications.

The effects of soil and water storage are inter-



## THE AMERICAN ARCHITECT

rial enough at hand to allow someone to set forth clearly that which can be considered good practice."

This can apply equally as well to the architect. A comparison of engineering and architectural journals discloses the fact that the former publications contain many practical observations based on experience, contributed by practising engineers. Without considering the efforts of the able editors of engineering journals to secure this class of material, there is always a stronger feeling of fellowship among engineers and contractors than between architects. This fellowship is based on the fact that they have to combat floods, quicksands and all the efforts of the elements to destroy property and life. These common dangers so humanize them that they willingly yield the results of all their experiences to help their professional brethren.

The absence of such data from architectural journals may be entirely the fault of their editors, who may not have a keen appreciation of the value of such information to the architect. It is true, however, that architects do not contribute such data to these journals. There can be but two reasons, either architectural publications are not considered to be mediums for the dissemination of such knowledge, or architects lack that unselfish human desire to help their fellows. In extenuation of the latter hypothesis, if it be correct, it might be assumed that the practice of architecture is such a placid and cold-blooded procedure that it has not occurred to the average practitioner of the art that he has a duty to perform in aiding the profession and his fellows in this respect.

Every project in building construction has its story and lessons, practical and many times romantic. Sometimes the solution of the unexpected or ordinary problem may appear to be too simple to justify its telling, but it should be kept in mind that the younger ones are reading and coming on and that some of the older ones may not know. Everyone has made mistakes and generally has corrected them successfully, and that correction is to their credit. This knowledge, even if anonymously given, may save another from the same or similar troubles. *THE AMERICAN ARCHITECT* will be pleased to publish any practical solutions of the many difficult problems that confront the architect in his work.

---

### Book Review

A SCHOOL BUILDING PROGRAM FOR CITIES. By N. L. Engelhardt, Ph. D., 6½ x 9½, tables and diagrams, 130 pages. Teachers College, Columbia University, New York. Cloth \$1.60. Paper \$1.20.

This book is in three parts. Part one is devoted to studies in population, measurement of school

population and the geographical distribution of population. Part two treats of the factors that enter into the school building plant. Part three is devoted to the financing of a building program, considering the ability to pay for the necessary additions to a school building plant and the payment for new school buildings.

The unfortunate conditions that affect the public school system of this country are due mainly to the fact that the boards of directors are either elected or appointed, which results in such frequent changes of personnel that a well-conceived program is seldom formulated. There is also little incentive for a member of a school board to become thoroughly informed of the various elements that are involved in the construction and operation of the system. These conditions also affect the school superintendent in a similar manner.

It then follows that any addition to the literature pertaining to the determination of true requirements on which an intelligent building program can be constructed is of value and importance. In many cases the development of school building programs are the result of haphazard consideration, too often influenced by political or private realty interests.

Fundamentally, the program must be based on a measurement resulting from a survey of the controlling factors, which are the measurements of the population, the plant and the ability of the community to finance the program. Such a procedure is similar to that which is required to design a sewerage and drainage system or a transportation system. All intelligent designing must be based on the real requirements.

An architect who has occasion to design school houses either enters into a competition for the work or is awarded the commission outright. The program is generally formulated before he comes in contact with the project. In that case it is simply an order to design a building of a certain capacity. As a practitioner of an essentially constructive profession, there should be no one better qualified to measure and formulate the requirements for school buildings than the architect. Certainly he should be better qualified than the members of the average school board, consisting of merchants, professional men and ladies serving by virtue of their interest in "mothers'" or other clubs. The average school superintendent is a well-qualified pedagogue but too often lacking in the business ability required to solve these problems.

The architect should broaden his knowledge of the basic requirements that underlie the proper solution of these problems and thus be enabled to better serve his clients, the community in which he lives, and himself. To those having such an ambition the reading of this book will be of assistance.



# Industrial Information

*In this Department there is published each week information as to the development of materials and methods, derived from reliable sources.*

## The Art of Stippling

Conspicuous both for clarity of discussion and artistic merit of its illustration is a valuable booklet issued by the Western Brick Co. of Danville, Ill., on *The Art of Stippling*. Herein the reader is carried through a concise history of the subject in its original and artistic aspect. Its definition and early application are illustrated by several ably reproduced stipple engravings done by great engravers famous for this class of technique.

The practice of stippling in painting, we learn, is chiefly confined to miniature water color work where delicacy requires the use of small dots, almost microscopic in size, for producing softly shaded effects. To obtain the exact degree of color, surfaces are frequently stippled more than once, each time with a different tint.

While dotting or stippling was present in the work of the earliest engravers, a mechanical process to overcome the arduous work involved in hand methods was not perfected until 1885. At that time an American inventor, Benjamin Day, made public a machine for producing stipple effects on the negatives used for making line engravings by the photographic process. This, of course, widely increases its use.

Architecture also has come into its share of benefit from the art of stippling, for it is now being employed in building materials to produce beauty of surface, color and texture. The use of the mallet and chisel to soften the appearance of stone has been a custom for long years. Recent adaptation of stippling to the treatment of burnt clay substances has resulted in the production of a stippled brick for use in building construction which opens up wholly new possibilities for face or exterior brick as a building material.

The effect of stippling brick as done by the Western Brick Co. is to produce a surface beautifully soft in texture and sufficiently rough to give depth and richness. By the use of stippled brick an effect is produced at once which for mellowness of tone and blending of color can be compared only with the master brick work of past centuries, and which ordinarily would take decades to mature.

Stippled brick have been produced in a variety of pleasing colors. The heads as well as the faces of the brick are stippled so that any desired bond or method of laying may be used. To meet the demand for brick of which to construct buildings

suitable for all purposes, stippled brick are offered of two wholly different mixtures of clay and two entirely different color ranges. These may all be studied from samples sent free upon request directed either to the general office and factories of the Western Brick Co. in Danville, or to the branch sales offices and exhibit rooms in Indianapolis, Peoria, Grand Rapids and Fort Wayne.

## Standardized Metal Caging

The advantages of wire as used in wire glass have frequently been discussed in these columns; the advantages of "S. M. C." as manufactured by the Mitchell-Tappen Co., 50 Broad St., New York, perform a similar function in soffit protection.

Standardized Metal Caging is a continuous metal cage, made of specially drawn wires electrically welded, to avoid all danger of the material disintegrating after it is in place. When it is applied, it automatically grips and locks on to the projecting rims of steel parts, and will hold the concrete in place regardless, it is claimed, of heat, vibration, knocks or cracks.

An important point is that this caging extends out into the lower corners of the soffit, thus preventing the crumbling of these corners when subjected to intense heat. There is a distinct and valuable asset in the use of standardized metal caging resulting from its fire resistant qualities, regardless of its strengthening attributes. It is also claimed to be immune to the usual causes of corrosion.

It is well known by architects and engineers that steel construction is not fire resisting unless protected by concrete. Steel in buildings is not ordinarily worn out in structures for long periods of time. It is incorporated as a material which assures strength and unusual durability. Therefore in protecting steel from fire or corrosion, the concrete, should, it is urged, be locked to the steel with proper soffit metal. "S. M. C.," it is claimed, produces this result, and adds the advantage of ease and economy in handling. A four-foot collapsed length of this material is sufficient when pulled out to cover about eighty feet of beam.

Typical structures, designed by leading architects and protected with the Mitchell-Tappen product, are illustrated in their bulletin No. 14, together with diagrams of its construction.

## Philadelphia Branch for Walworth Mfg. Co.

The Walworth Mfg. Co., with general offices at Boston, and works at Boston and Kewanee, Ill., and with branches in New York, Chicago and Seattle, has recently purchased the business of Hunter & Dickson, at 241-247 Arch St., Philadelphia. The Walworth Mfg. Co. is a pioneer in the steam supply line of this country. The purchase of the Kewanee works of the National Tube Co. in 1917 by the Walworth Mfg. Co. so increased their production of valves and fittings for steam, water and gas work, that they expect to enter the Philadelphia field well prepared to take care of the growing trade sure to come with the rapid expansion of after war activities in that section.

## A Standardized Truss Unit System

Although architects may cherish certain prejudices as to the standardized building this should not deter them from getting a thorough acquaintance with what has been done with this principle in modern structures to serve as a further basis upon which to expand their ingenuity.

In accomplishing rapidity of construction, so important in the face of the present dearth of necessary buildings, standardization has certain unsailable advantages. These are made clear in a pamphlet published by Milliken Bros. Mfg. Co., Woolworth Building, New York, and active in this field. For the best results to obtain, it would seem desirable for the architect to accept the engineer's contribution toward effecting speed, avail himself of its best features, and continue from that point to a development whose architectural merit shall be only enhanced thereby.

Worth-while results depend upon elemental factors; standardized building depends upon standardized units. Through such an agency, the result should not be confused with a ready-built structure which must be confined rigidly to a predetermined size and shape. The small common unit which makes this course feasible is possible of endless combinations and permutations and makes variety and novelty in design as easy of attainment as it is in any other form of construction.

Noteworthy among systems of this kind is that evolved by Milliken Bros. Mfg. Co., and referred to above. Here the trusses and columns of their Standardized Truss Unit System are composed of a series of triangular units, easily and quickly coupled together in many different forms. A typical unit

measures 10 feet by 3 feet 4 inches, and weighs 200 pounds. It is built up with standard structural steel shapes and plates complete in itself. The method of fabrication insures the accuracy of the units, and whether they are used as parts of columns or trusses, will be found alike and interchangeable. The completed structure, it will be seen, can be extended, modified, or even removed to another site, without injuring the component parts or impairing their durability.

This type of construction is used with particular success in mills, warehouses, garages, machine shops and power houses, general manufacturing buildings and structures for commercial purposes. Interesting diagrams are presented in the literature of the Milliken Bros. Mfg. Co. on this subject. One graphic comment appears in a photograph therein which shows that a single carload of knocked down material is equivalent in weight and function to a fifteen car trainload of riveted trusses in the back-ground, thus demonstrating compactness in packing and economy in transportation.

## Color of Surroundings

As a result of a campaign of education on the part of certain paint manufacturers, the industries now realize that natural light is greatly aided if the interior surfaces (walls and ceilings) are white in color. Any light striking these parts of the room is reflected in a degree, depending upon the color. If dark brown or smoke covered, possibly only five per cent will be reflected. If pure white the reflection co-efficient may be as high as seventy per cent.

If this feature is of importance in the daytime, when intensities run far above those ordinarily supplied artificially, how much more essential is it at night? Even the color of the floor affects the resultant illumination, for part of the light which strikes it goes back to the ceiling and then again down. It takes considerably more power to give the same illumination on the loom or other work place if the ceiling and walls are dark rather than white. It is a real paying investment to keep these light in color.

The lower part of the side walls is of less importance in reflecting light, and for purposes of appearance it is often desirable to have a dado of dark green or some neutral color, as finger marks and other disfigurements are not so noticeable. This treatment of the walls reduces the brightness in the field of view, a desirable feature.—From a bulletin issued by the Edison Lamp Works, General Electric Co., Harrison, N. J.



17 m  
33-4-16 p 15  
5-8

# The AMERICAN ARCHITECT



PATIO, CONVENT OF MONTESION, BARCELONA, SPAIN

PUBLISHED WEDNESDAYS IN NEW YORK—FOUNDED 1876  
VOLUME CXV                      JANUARY 29, 1919                      NUMBER 2249

Entered as second class matter January 6, 1909, at the Post Office at New York, N. Y., under the Act of March 3, 1879. Publication office, 243 West Thirty-ninth Street, New York, N. Y. Subscription price in the United States and Possessions, \$10.





A Bishopric-Board Home at Stamford, Conn.

Architects, Patterson &amp; Dula, New York City

## "I absolutely guarantee all Stucco Work done by me on Bishopric Board"

So wrote one of St. Paul's prominent contractors. Furthermore, he says, "I consider it the only lath that will stand dampness and changeable weather."

Absolute dependability is the reason why Bishopric Board today is specified and used by architects, contractors and builders all over the country.

It builds reputation, secures confidence, promotes more business. Bishopric Board **makes good.**

The construction of Bishopric Board is simple. Its advantages are obvious. Building principles and materials that have withstood the test of centuries are combined in Bishopric Board.

Creosoted dovetailed lath imbedded under terrific pressure in Asphalt Mastic on a background of heavy fibre-board—that, in brief, is Bishopric Board.

The creosote preserves the lath—the dovetail locks the stucco so it can't let go—the Asphalt Mastic

on the fibre-board deadens sound and is proof against vermin, water, and weather changes.

Bishopric Board can be used with or without sheathing and when nailed securely to framework forms a background that can't sag or break away, causing the stucco to crack and flake off.

Bishopric Board insures satisfaction. Don't be contented with anything less. Use a background you can guarantee absolutely.

## The Bishopric Manufacturing Co.

904 Este Ave.

Cincinnati, O.

Write for our free book, "Built on the Wisdom of Ages," illustrating homes, apartments, factory and public buildings, finished in stucco on Bishopric Board. It contains letters from architects, builders and users, and extracts from reports of scientific tests. It also gives full instructions for making a stucco mixture that will last. With this book we send free samples of Bishopric Board.

Write today, investigate for yourself, be convinced.

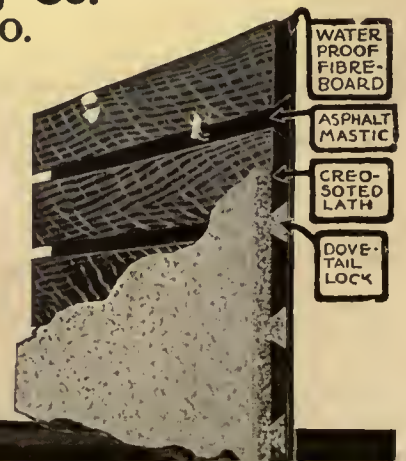





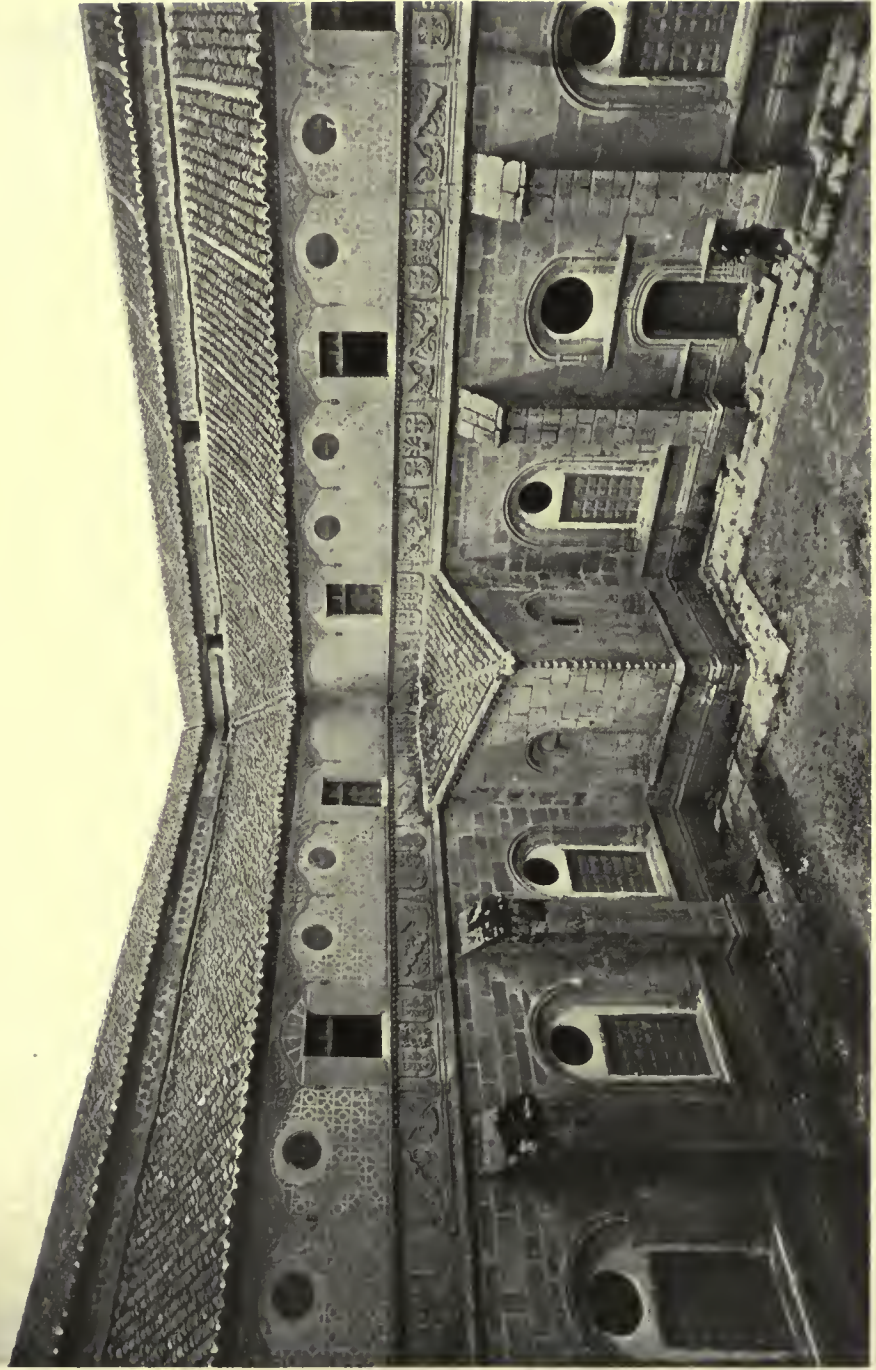

COURTYARD, CONVENT OF ST. THOMAS, AVILA, SPAIN

THE AMERICAN ARCHITECT



# THE AMERICAN ARCHITECT

VOL. CXV

WEDNESDAY, JANUARY 29, 1919

NUMBER 2249

## The New Architectural Education

Report of Sub-Committee on Education of the Reconstruction Committee of the Illinois Chapter, A. I. A. and the Illinois Society of Architects

**L**EADERS in architectural education should not be behind those in other lines of endeavor in realizing the necessity for reconstructive measures, even though they be revolutionary in character. The student of the architectural schools has always been educated to look to the past. A large part of his time has been misspent in the study of subjects of which he is never called upon to make use, and which he soon absolutely forgets. Many subjects, the knowledge of which is necessary in the pursuit of his profession, are not touched upon, to his everlasting detriment and regret. After graduation, the first two years or so of his experience are taken up with the most elementary work, such as tracing, etc., under an assumption of his employer that he knows nothing, and its tacit admission by himself.

Our educational system should be reorganized so that the graduate can become of immediate value to his employer and his services a source of income to himself. It also should aim to cast off in some fashion the shackles of the past and help architecture to take a more honorable part in the destiny of this nation.

The practicing architect, which it is assumed the student intends to become, functions in three entirely diverse directions—the aesthetic, in which he designs his buildings in plan and elevation; the practical, in which he constructs them; and the social, in which he deals with those consummating his plans, and with his clients, present and prospective. These obvious divisions of an architect's practice are, to a greater or less extent, recognized by all the architectural schools, and special studies are provided in their curriculum, intended to prepare the student for these diverse demands.

Your committee is of the opinion that while the program or the ideal toward which the schools work is excellent, yet great improvement could be wrought in the subjects selected for this chosen purpose, and also in the manner in which they are

taught. We believe that some should be omitted, and others now untaught should also be included.

We believe, furthermore, that there is a fatal lack of correlation in the subdivision of the aesthetic, practical and social studies, and that it is both unnecessary and unwise to leave such correlation to the architect after he has left school.

At present the courses of instruction in the principal architectural schools are almost identical, and are all founded on that of the *École des Beaux Arts*, with which they still agree in general in subject but from which they differ widely in administration. These subjects, taken from one of our best architectural schools, and accomplished within the hours of school work and preparation required for the entire course, which covers four years, are substantially as follows:

*Aesthetic*—Architectural design, 1555; Free-hand Drawing, 510; Shades and Shadows, 45; Perspective, 120; Watercolor, 70; History of Architecture, 305; History of Ornament, 45; Total, 2650.

*Practical*—College Algebra, 90; Plain Trigonometry, 90; Analytical Geometry and Calculus (elements), 180; Descriptive Geometry, 240; Applied Mechanics, 200; Physics, 270; Chemistry (inorganic), 180; Design, 120; Sanitary Engineering, 30; Steel Construction, 145; Acoustics, 5; Total, 1550.

*Social*—History of Civilization, 330; English, 210; French, 105; History of Sculpture and History of Painting, included in History of Civilization and Art; Arch. Prac. & Bldg. Law, 45; Philosophy of Arch., 15; Political Economy, 90; Office Practice, 60; Military Science, 90; Total, 945.

This curriculum seems to be comprehensive, and the hours required are certainly as many as the student will stand. Criticisms and suggestions for improving such a course to meet post-war conditions will be taken up in order as follows:

1. Obtain a better correlation of subjects in the curriculum.

## THE AMERICAN ARCHITECT

2. Omit or shorten the courses in certain subjects and add certain other subjects.

3. Inculcate by actual experience a better knowledge of architectural practice and of building practice.

4. Make a decided effort to stimulate the creative and not the imitative instinct of the student.

5. Lengthen the course for a degree in architecture to five years.

1. *Correlation.* To the student in architecture, and to the student in liberal arts as well, the subjects of the curriculum are separate and distinct—gems of different water and of various colors, if you please, which he is to assort and string into a beautiful harmony or odd-shaped pieces of a picture puzzle, which, if he can find time to fit them together in the strenuous battle of life, will surely result in a beautiful, harmonious and complete ensemble. Of the aesthetic subjects, Architectural Design is rightly the most important, requiring in a typical course 1555 hours of a total of 5145. In the ordinary course this subject is correlated only with Shades and Shadows, Water Color, and, to a small extent, with Perspective. It ought, in our opinion, to have in addition close union with Construction, Specifications and Ornament. The subject of Architectural History, perhaps the second in importance to that of Architectural Design, should go hand in hand with the History of Civilization, the History of Sculpture and Painting, Modeling and Ornament. The course should be arranged so that contemporary epochs in these varied courses are studied simultaneously, and, in general, in regard to all of the courses in the curriculum their intimate relationship to each other and to subsequent office practice should be taken advantage of wherever possible.

2. *Curriculum.* Architectural Design, pointed out above as the most important subject in the course, should maintain its supremacy, but should undergo revolutionary changes in the direction of correlation and modernization. The Beaux Arts method of presentation at present in vogue has been practically unchanged since the time of Napoleon, and its modus operandi need not be here described.

We suggest that the student should begin the study of Architectural Design in the second year. Instead of drawing minutely and in ink, mathematically casting the shadows, and painstakingly rendering the elevation with graded washes, he should draw at as large a scale as possible with pencil, sketching on tracing paper and consulting the library, as at present. Every drawing should be annotated, showing the principal materials, and should be figured in its principal dimensions. In connection with each design, besides plan, elevation,

and section, a large size detail or section (if possible, full size) should be made of some important feature, or of some bit of ornament, and a sketch in perspective be made of the ensemble. The student, at least once during the term, should publicly explain and defend his project either before the jury or his classmates. This procedure should be followed in the second, third and fourth years, the problems becoming larger and more complicated as the student progresses from year to year. By this means we believe a better correlation could be obtained between the aesthetic, practical and social functions, and a sense of scale and a knowledge of material so necessary to rational design be obtained early in the course. The large size details and the perspective sketch would acquaint the student with the real function and form of mouldings and a conception of the design in three dimensions.

The last term of the fourth year should be devoted to the thesis, which should consist of working drawings and specifications of a small building complete in all details, including plumbing, heating and ventilation.

At the end of the fourth year the student should be able to go forth and qualify as a competent draughtsman, and, if he so elects to do, he should be given a certificate to that effect.

For the man who elects to remain for the fifth year and receive a diploma and his degree as an architect, he would find his last year taken up with the design of large theoretical projects, which would be elaborately rendered and presented without the notations, figures and details characterizing his earlier studies.

A great defect in the present system of education is the idea that the orders and the various motives appertaining to the historic styles furnish to the architect a stock in trade, or a bag of tricks which he may use at random, and to the use of which he is limited. In some schools, particularly in the East, originality and creative design are frowned upon and discouraged, and the student is told that these may be developed in actual practice.

The instinct of creation may be cultivated in two ways—first, by the method of teaching Architectural Design, and second, by a proper method of studying ornament. Architectural History should be taught, as its name implies, as History, and this should include all exercises in drawing the orders. The course should begin in the freshman year and continue through four years, the last year being devoted to the study of the History of Architecture in America. It should go hand in hand with the course in the History of Civilization, and careful drawings should be made showing the varying manifestations of architecture as influenced by climate, materials, society and history. The student



## THE AMERICAN ARCHITECT

should be made to understand that this knowledge is part of his cultural foundation, and not material to be used irresponsibly in modern building. He should be told that the "styles" in the present century have no longer any chronological or structural significance; they merely refer to the *type* of ornament with which the structure is decorated. No one can prophesy in the presence of a skeleton steel frame whether the building, when hatched, may be Classic, Romanesque, Gothic, or one of the 57 varieties of the Renaissance. For this reason it seems to us that possibly in the proper study of ornament lies the solution of the whole problem of creative design.

A knowledge of historical ornament is a necessary cultural acquisition, but the hand of the architect trained exclusively in the tracing of historical ornament can only with the greatest difficulty guide his pencil to new forms, and in the stress of office practice he will ever find his hand mechanically reverting to the familiar acanthus, the unending fret, the Renaissance arabesque, or the Adam festoons. Therefore, great stress and much time should be spent in considering the purpose of ornament, and in learning to design living ornament. Actual leaves, flowers, fruits, animals, and geometrical shapes should be brought into the classrooms, and the student should be taught to arrange and conventionalize these to apply for beautification to such parts of his building as are suitable for ornamentation. Furthermore, the function of ornament in relation to repose and stress should be carefully brought out.

Other subjects in the curriculum can only be touched upon. Already great improvement has been effected by eliminating waste of time in the study of Calculus beyond its elements, and we believe that Physics and Inorganic Chemistry could be required for admission, and could be eliminated from the curriculum. The subject of Applied Mechanics could be restricted to Statics. This would clear the way for the introduction of other subjects for which the architect has crying need in the practical pursuit of his profession. Simple-Surveying with field work should be included, and a course in Interior Decorating, to consist of the study of textiles, marbles, metals, glass, tiles, etc. This could well come in the fifth year, in which year should also be included a course in the Business of architecture, with examination of the accepted methods of promotion and soliciting business. No man is better fitted than the architect to handle and direct the complex problems arising in the design of industrial buildings, and unless the student is prepared in his college course to solve the problems he, individually, and the profession in general, will see this lucrative and important branch of work en-

tirely slip through their fingers to repose in the grasp of the engineers and the contractors. The greatest improvements already effected in industrial plants, such as the saw-tooth roof, have been made by architects. Industrial design should be taught as a combined engineering, social and aesthetic problem. The student should be shown that industrial buildings can and should be made beautiful, and that in this branch of work he is, if he is doing his work well, rendering a great service to society. With the design of industrial plants is collaborated the science of housing, and lectures and reference reading, at least, should be given, preferably in the fifth year, covering this most important matter. A very necessary part of industrial design and housing is the actual visiting and study of the best examples in the locality.

For advanced students courses should be included in city planning and in landscape gardening. In connection with the latter, practical courses in Applied Botany and Arboriculture should be given.

3. *Experience.* After graduation, under the present system, two or three years in actual office work are often wasted years for the young architect. In these years he is supposed to learn the practical side of architectural practice. This the faculty has told him it is impossible to acquire at college. Months spent in the drudgery of tracing full-size details and other work better suited to the intellectual level of the office-boy spell low wages, and often discouragement to the young architect. More serious yet, during this same time he is apt to forget a great deal of the theoretical knowledge that he has so laboriously acquired through lack of opportunity to apply it. There should, therefore, be inducted into the course actual experience in an architect's office. This should be required work, extending through the major part of two of the long vacations. The architectural offices where this experience is to be acquired should be accredited offices, with their names printed in the college catalogues. We believe this experience most important, not only for the success of the student after graduation, but also for his better comprehension of his undergraduate work.

The class of individuals with whom the architect in his practice is in the most constant and intimate connection is the contractor. Under the present system of education, this personage and his organization, who consummate the architect's plans, is never mentioned, nor is any study made of his relationship. Largely in consequence of this ignorance, the relationship, which should be one of sympathy, becomes one of distrust and often open hostility. Furthermore, the architect, through his ignorance of the business, or, as it is rapidly becoming, the profession of contracting, is placed at a



## THE AMERICAN ARCHITECT

disadvantage in regard to questions of cost, quantities, extras, etc. We therefore believe that there should be an accredited list of building contractors whose names should be published in a college catalogue. Then the student should, at some period of his college course, spend the major part of one summer vacation in a contractor's office.

4. *Originality.* The matter of creative work has already been mentioned, in connection with the study of architectural design and ornament. We believe that the development of a truly American expression in architecture can only be achieved through an evolution of forms, reflecting the manners and culture of the people, and influenced by matters of environment, climate, material, etc. We do believe, however, that this natural feeling for free and independent expression, which exists with every people, should not be stultified and warded off by the insistence of perpetuating archaeological forms. We think the spirit, therefore, of the entire curriculum should be that of a new country and a new epoch, instead of the past and the ancient or modern European world.

5. *Extension of Course.* We suggest that the course for a diploma in Architecture should be lengthened to five years for the regular student, and that a certificate as a draughtsman may be given at the end of the fourth year. This is in order that the name "architect" shall become a more honored one, for the profession can only acquire honor through the individual performances of its members. We do not believe it is possible for the architect of tomorrow, with his added responsibilities and duties, to receive fit cultural and technical preparations in four years. An examination of the curriculum which we have suggested makes this obvious. The extra year also gives added maturity to the student, fitting him for an earlier individual practice, and it will also, we hope, deter him from the procedure of preparing himself for practice in America by a course in a foreign country.

The above suggestions may be epitomized as follows:

1. Affiliation with architects' offices, students to spend four months in accredited offices in superintendence and draughting.

2. Affiliation with accredited construction companies, students to spend two months in estimating and superintendence.

3. Extension of course to five years for archi-

tectural diploma; draughtsman's diploma may be given at the end of four years.

4. Present so-called Beaux Arts system of elaborately rendered plans and elevations to be changed.

5. The orders and details to be studied full-size in pencil.

6. All problems in design to be studied in perspective, as well as elevation, and presented in pencil with little rendering.

7. Problems in design to be small and practical for the first four years, and studied in relationship to the materials used.

8. All problems in design to be roughly dimensioned and annotated.

9. The thesis to be a small practical problem, worked out in a complete set of working drawings with specifications attached, and to be presented in the second half of the fourth year.

10. Antique, Mediæval, and Renaissance decorated forms to be studied only in connection with the History of Architecture.

11. The subjects of Chemistry, Calculus beyond the elements, Physics, Applied Mechanics beyond Statics, Spherical Trigonometry, Analytical Geometry to be omitted.

12. Shade and Shadows as a science to be omitted, students to get their knowledge largely from nature.

13. Study of ornament to be based on a study of nature and indigenous and geometric forms.

14. Interior Decorating to be taught, with instruction in the nature of textiles, glass, ornamental iron, tiles, etc.

15. Practical elementary Surveying to be taught, with simple field work.

16. The design of industrial plants, with modern method of unit multiplication, and factory construction to be taught.

17. A course in housing, with its social relationships, to be taught through lectures and reference reading.

18. The science and history of City Planning to be given as an elective study.

19. A course to be given in business promotion, showing sound methods of promoting and financing building operations.

20. Extemporaneous speaking to be taught through practice in presenting building projects.

21. Last, a general change in spirit to be awakened in the schools to the ultimate end of modernizing and Americanizing the education of the architect.

# Architectural Education

The present war times have demonstrated to us beyond reasonable doubt that, as architects, we are considered by the public at large as a body of visionaries, theorists and occasionally beautiful picture makers, and our ability and celebrity, with rare exceptions, ends there. At present most of the architects are perplexed as to their future *modus operandi*, hoping for the unexpected to happen.

There is still a very great percentage of architects who have lulled themselves to sleep with the idea that the pre-war times and conditions will again prevail. This is not surprising to anyone conversant with the training of the present day architect. We have our architectural colleges to blame for this condition, chiefly.

When architectural schools were unknown, there lived then the real architect—whose work we only poorly imitate to-day. The original schools of architecture were established, no doubt, to give the future architect a broader and universal culture in subjects which he could not acquire in the shop or in the field. This was inspired by the then practicing architects who, although finding themselves a directing force in the community by the very nature of their work, were nevertheless very much deficient in the knowledge of other subjects expected of a man of their standing. It was the realization of their shortcomings, no doubt, that led them to supply this deficiency to the future architect.

In time it was also discovered that the principles underlying the stability of the structure could be taught better in the school room by the development of formulae and thereby save time and eliminate to considerable degree of guesswork regarding this particular branch of the work.

Later on, as science progressed and inventions multiplied, it was found not only very desirable but very essential to know the chemical properties of the material with which they worked, and this branch was also incorporated in the curriculum of the schools. And so, as the world progressed in science, our schools gradually assimilated the new inventions and discoveries and made it a part of their course, and thus eventually they assumed the entire training of the architects.

While this was very creditable to the schools it was very unfortunate for the architect. The practical training he received in the shop and field under his master we see disappearing altogether and architects have ceased to be operative and have become speculative.

Outside of the laboratory tests the student of architecture acquires only a bookish knowledge of

the actual operations on the building. His time is spent—I am almost tempted to say wasted—on a lot of copying, water coloring, sketching and picture making, which, altogether a very good accomplishment to have, nevertheless does not tend to make him a real architect and adds very little to his knowledge as a business man. And business man he has to be to-day if he is to be successful at all.

Our schools of architecture are more or less working under false pretenses though their honesty is not questioned—because of lack of foresight and general inertia on the part of our directors and professors. The world has moved faster than our schools. This is a very strong statement to make, nevertheless it is true, and this is so of nearly all our colleges with the exception of probably medicine and chemistry. Schools turn out the graduate—give him a beautiful diploma—and presto, he considers himself a full-fledged product.

His disillusionment comes when he tackles the real problem. I again repeat, the fault lies mostly with our teachers. We have too many bookish teachers, people who are out of joint with the outside world and consequently adhere to methods long obsolete in every-day practice. We place more value on diplomas than on the man's experience. This is demonstrated in nearly all our civil service examinations.

I realize that the duty of the school is not to turn out men practically equipped for their vocation. I realize that the schools serve as implements by which the intellect of man is cultivated so that he may be more fully prepared intelligently and effectively to grapple with life's problems. However, this method of education, as it pertains to the architect, makes him a mere copyist, theorist, and very often a "swell head" who possesses a vague idea of the responsibility and duty of a real architect. This kind of training fills him with intricate theories on which he often places too much importance and from which he is helpless to extricate himself. His profession and ethics constantly battle in his brain, while in the meantime the practical, often looked-down-upon contractor, gets ahead of him.

It is a conundrum to me how such educated youngster essaying the practice of architecture can judge the character of the work performed when he is absolutely deficient in the practical knowledge of laying brick, even to hold correctly a saw, knows nothing of how to make a miter, properly drive a nail, or tell the difference between slacked and burned lime. We can fool some people sometimes,



## THE AMERICAN ARCHITECT

etc. However, I think we have been fooling ourselves the most.

Nowadays, we hear much talk about reconstruction. Would it not be a good policy to start at the source of this trouble? Some years ago, when a member of the Chicago School Board, I advocated the adoption of a system whereby every teacher in the system would be compelled to spend a year at some work outside of the school every five years. This would not be a vacation by any means for the teacher. During this period, such teachers would draw no salary from the board and would depend upon that which they earn at their outside employment. In this manner teachers would bring back to the class room invaluable experience and knowledge of the present day method in the business world. To accomplish this result the salaries of all the teachers would necessarily have to be raised so that it could be possible for a teacher to accept a position during that period regardless of the pay attached to it.

The salary of a college professor is a very meager one, indeed. We are pursuing here a policy of penny wise and pound foolish. How can we expect to have the best talent of our profession in the colleges, where we ought to have it, when a mediocre architect earns as much and sometimes more than the average professor? I have known the best teachers forsaking school rooms for other more remunerative calling, and this is true not only of architects but in other branches as well. Nowadays a person must be possessed with extraordinary love for teaching, or else is lacking in initiative, to spend his lifetime teaching. This is not meant as any criticism on the teaching profession but rather on the system. When a young man spends his entire time in the school room between the ages of 25 and 35, what chance is there for him to quit it after that and start on his own resources?

If he does, he starts with a handicap of ten years to overcome. Let us make it an object for a person to become a teacher and we may then expect the right material for our teaching force.

Now, as to the course of training architects. Almost every college or university is continually planning some improvement on the campus or in planning new buildings. Why cannot all this work be performed by the junior and senior students in the architectural and engineering colleges under the direction of their professors? This is not only possible but absolutely feasible!

We have positive demonstration of this at the Tuskegee Institute for colored students now in Alabama. This, in my opinion, is the most practical school of architecture in the United States, and possibly in the world. It was left to Booker T. Washington to show us how. Here the student not only prepares the drawings but he actually lays the brick, pours the concrete, does carpenter work, plumbing, painting, plastering—in short, everything that enters into the building to make it complete. There are now in the neighborhood of some sixty buildings on the campus, and these buildings as a whole will compare very favorably in architecture and workmanship with most of our State University buildings. It follows that graduates of such schools are not only competent intelligently to design a building but they are supplied with the necessary business knowledge which most of our graduates absolutely lack. Had such methods been in vogue in our universities we would have now more intelligent contractors and possibly less mediocre architects, who not only are a hindrance to themselves but to the whole profession at large.

Will our university directors consider this necessary change in their school curriculum?—James B. Dibelka in the December issue of *The Bulletin* of the Illinois Society of Architects.





# The Group House—Its Advantages and Possibilities

By RICHARD HENRY DANA, JR.

*An address delivered at the Seventh Annual Conference on Housing in America,  
held in Boston, Nov. 25-27.*

**I**N most parts of America, there is a mania for the single house. Regardless of the size of the house or the lot or other circumstances, the cry is always "let each family have a separate house to itself. What applies to the ten-room house should apply to the four-room house. What is good on the lot of 10,000 sq. ft. should also be good on the lot of 2,500 sq. ft., one-quarter the size. Why discriminate against the small wage earner?"

After thirteen years of sympathetic study of the matter, I feel more convinced than ever that the single house is *not* the best type for the small wage earner, and I should be interested to see if you do not feel that my reasoning in the matter is sound. I felt it instinctively in July, 1905, when I was at the opening of the first Garden City at Letchworth, England, and have ever since been trying to prove it logically, and think I have at last.

Is not this mania for the single house peculiarly American? Do the English or the French, for instance, have this same feeling? Even though they may not have as many radiators or bath tubs per family as we do in America, yet they certainly know how to live healthily and attractively. After two years living in France and three summers in England, I felt convinced that those two countries are as domestic as we are in America, and care even more about privacy than we do. Have we not something quite vital to learn from the grouping of their houses over there? Is not the American mania for the single house perhaps a prejudice coming down to us from the pioneer days, when a man had to battle with nature on a large scale, and had little or no time for community or social life? Other men were either his enemies, rivals, or at best "strangers." His one idea was to live independently, off by himself. The fact that the mania for the single house in the West is stronger than in the East would seem to bear this out. But just because the single house is the American solution for the small wage earner, is it, therefore, the best? Because it was the best for yesterday, is it necessarily the best for to-morrow?

"But," you protest, "you surely do not favor tenement houses—either the crowded city kind or the proposed zig-zag type with finger tips touching around a playground in the full country! You do not approve surely of the double deckers or triple

deckers, or those monotonous row houses where a man can't distinguish his own front door from a hundred others when he comes home late at night." No, by no means, I am opposed to those types of dwellings as much as anyone; but I would have the small wage earners, for their own good, live in group houses; that is, two or more families living side by side with party walls between, but under one roof.

The basis of our discussion must surely be the rent of the houses we are talking about. The *maximum* rent in question is \$35 a month. This, at the high price of building to-day, means six rooms at \$5 a room, plus \$5 for conveniences, such as modern plumbing, electric lighting and heating. The tendency to-day is for smaller and more comfortable houses than formerly. Therefore, I do not think anyone would question that six rooms, plus these conveniences, is better than seven rooms without them. This rent means a two-story house, with cellar, of about 500 sq. ft. area per floor, or 20 x 25 ft. in plan. Above this rent, the problem is quite different and does not concern us in this discussion.

The minimum rent would be \$25 a month, or four rooms at \$5 a room, plus \$5 for conveniences. This means a two-story house and cellar, of about 350 sq. ft. area, per floor, or 16 x 23. Below this rent, tenants must not expect to obtain a new model house, but will have to live in houses built a few years ago when construction was cheaper.

Because the single house is good for a small house on a lot of 100 ft. wide, it does not follow that it is good for a medium sized house on a 50 ft. lot or a small house on a 25 ft. lot. Land cheap enough for large lots can only be found in outlying regions reached by doubtful trolley service. The worker very justly prefers to be within *walking distance* of his work, as this saves him from sixty to eighty-four cents a week, or from thirty to forty-two dollars a year, which is enough to keep him in clothing for a year. Furthermore, it is unquestionably more healthy to *walk* to and from one's work rather than breathe the bad air of over-crowded cars. Land within walking distance of factories is usually held so high that the lots for the rents under \$35 a month would have to be as small as 250 sq. ft. in area. The shape of this area is flexible, no matter what the real estate men have said to the contrary in the past! The suggested shape, 50 x 50 ft., leaves no decent space anywhere outside the single

## THE AMERICAN ARCHITECT

house. The usual shape, 25 x 100 ft. gives a fair front yard and back yard, but side yards are objectionably narrow between the single houses.

If the side yards are wide and planted, they are a separation between houses; but if narrow they are less private than no side yard. The windows of the middle rooms of two adjoining houses look across at each other only a few feet apart, with no more privacy than in a narrow city court. This can be avoided by having the houses only two rooms deep, with the windows facing chiefly the front yard and the back yard. Still these windows into the side yards are a doubtful addition to the rooms and, personally, I feel it would be better to concentrate the windows on the front and back yards, and to omit the side windows entirely, thereby giving much needed unbroken wall space in the rooms.

Because these side yards are so narrow, the sunlight does not dry them out. The snow lies there long in winter, and the grass won't grow there in summer, so that they are always damp, muddy and unsanitary.

Furthermore, these narrow side yards cannot be used for anything. The front yards can be used for lawn flower gardens and the back yards for drying clothes and vegetable gardens, but the side yards are not needed.

Some people claim that these side yards are needed in warm weather for ventilation, but let us look at the facts closely. Is it not much more important to have ventilation *through* the house than *around* the house in warm weather? In cold winter weather the wind draws through these narrow slits between the houses, so that there is no side of the house protected from the wind, where a small baby in its carriage could get an airing. The family never sits out of doors in the spring and autumn, simply because there is no sunny place out of the wind where they can sit comfortably.

It is also claimed that the side yard is needed as a passage to the back yard from the street. The back yards, however, can be reached conveniently by a community path connecting the back doors, with access to the street about every hundred feet or more. Therefore, since the narrow side yards are unnecessary and undesirable, let us omit them as much as we can and make the houses adjoin each other. At intervals, where we must have side yards, let us concentrate the space of the many narrow side yards omitted, into decently wide side yards, each 20 ft. wide at least.

Let us first look at the usual objections to the group house, and see if they are really valid. The real estate men object that they are difficult to sell. Is this not pure prejudice based on the usual poor construction of the row houses that look as if they would not stand up alone. One real estate agent

even told me that 20 ft. lots the width of the units would involve half numbers to the houses, because the numbers were laid out in the basis of 25 ft. lots. When I explained to him that a four-family group house 80 ft. long was located on a 100 ft. lot, and we, therefore, only had four families to the 100 ft., the same as his custom, he still was unconvinced.

Another claim is that these group houses are noisy and that you can hear your neighbor change his mind in the next house. This may have been true in some old fashioned bad examples, but the brick party wall from cellar to roof, now required by law, is as soundproof as it is fireproof.

Another objection is that the middle rooms of these group houses are stuffy without the cross-ventilation of the corner rooms. But all well-designed group houses are only two rooms deep, and have connecting doors between the front and back rooms purposely for this cross-ventilation, which is certainly more thorough than just across the corner of a room.

Another objection is that there is no privacy on the front porches, based on the bad custom of adjoining piazzas. By good planning, the porches can be kept separate, and even recessed so that you cannot look across from one to the other.

Another objection is that these group houses are monotonous looking, owing to the fact that some of the first of these were poorly designed. There is in reality much more variety of design possible in the group house than in the single house; a variety that we architects have hardly begun to discover. In short, are not all these objections to the group house based on poor examples, and would not the answer to them be "go to a good architect?"

The advantages of the group house are quite obvious. It is cheaper to excavate, build and maintain than several single houses, on account of fewer outside walls, and one chimney and one line of plumbing serving two families. This means that the tenant gets the same house for less rent, or a larger house for the same rent, than he would if he rented a single house.

The units of the group house are cheaper to heat than single houses, as they keep each other warm. We have always found in a group that the middle units rented before the end houses for this very reason, and that the canny tenants of the middle units did not light their furnaces in the fall until several weeks later than their neighbors at the end of the group.

The group house has greater privacy on the interior than single houses, as the neighbors at the side cannot see or be seen from the rooms. All the views are across broad, open spaces; either the broad back yards or the front lawns and street.

The chief advantage, however, is that the group



## THE AMERICAN ARCHITECT

houses have so much better proportions on the exterior than the single houses. They present a better front. This is not only of interest to the architect, but to the community as a whole. The economic single house has to be two stories high, with air space above the second floor rooms, so that it is difficult to make the total height from the grade to the ridge less than 25 ft. The width of the single house, of course, is limited by the rent to 16 or 20 ft. The result is that the single house is necessarily higher than it is wide, and stands up in a restless, perky way. The height may be disguised by bringing the roof down to the first floor ceiling, but this spoils the headroom in the second floor bedrooms, and adds greatly to the cost of the house, owing to the necessary dormers and complicated roof construction. A whole town of such single houses close together seems to me to present a very unfortunate pill-box effect, that we, as architects, cannot approve of as the final word in the matter. The group house, on the other hand, is necessarily longer than it is high, and gives the feeling of a house sitting comfortably on the ground. These group houses certainly look like bigger and nicer houses than the small single house, and from the real estate point of view can be made to look like a better class development.

If the group house is to be the happy medium between the jerky single houses and the monotonous row houses, we must take care in the group house to avoid either of these extremes. We have tried group houses of eight families, but I confess that these are a bit too long, unless broken up by more architecture than can usually be afforded. Certainly group houses should never be more than eight units long, on account of easy access to the back doors. An even number of units is advisable for the using of one chimney and one line of plumbing for each two units. A group of four units seems to give the best proportion. This would be 64 to 80 ft. long by about 25 to 30 ft. high. Groups of two units and six units are also good. Here is chance for real architectural composition, and interest, with long roof lines, occasional gables, recessed and projecting porches, etc. The 20 ft. space between these groups breaks the monotony of the row and alternating long and short groups give still further variety.

A full architectural study of the problem demands that we compose these groups as well as the individual façades. A group of three or five houses has more possibilities for architectural composition than a single group house. This grouping of the

groups gives variety and interest to a town. It brings out the design of each type of house by contrast with the right sort of houses next to it. It "pushes" the feeling of the town plan by houses especially designed for corners, ends and vistas, etc. It gives contrast between groups of houses and open spaces by concentrating each in large masses. The group houses only 20 ft. apart give a sense of continuity that is pleasing. The open space would be concentrated into large playgrounds, allotment gardens, etc. This gives much more quality and scale to a development than the old method of small dabs of land cut up by dots of houses. Is not the unbroken lawn with groups of trees at the side more pleasant than the lawn dotted all over with single trees?

Although our study is by no means complete, we have reached the following conclusions: Alternating long four-family houses with shorter two-family houses give a pleasant rhythm, and relieves any possibility of monotony. It looks better not to mix hipped and gabled groups, but to have one group of gabled houses with ridges and gables carefully composed, and another group of all hipped roof houses. Group houses more than 20 ft. apart look scattered, and a 20 ft. distance between gives them a pleasant feeling of continuity and mass. Broad front lawns make the street far too wide for the height of the buildings, and, therefore, except around the community greens, it looks best to have the houses only 20 to 25 ft. back from the sidewalk. It accordingly would seem to be better to concentrate the biggest open spaces at the back of the houses rather than in front.

To sum up the matter briefly: A home for the small wage earner within walking distance of his work, means today a small house on a lot so restricted that the side yards are objectionably narrow and had better be omitted as much as possible. This results logically in the group house. The objections to the group house are based on old badly planned and badly constructed examples. These objections would be entirely eliminated in the new group houses, designed by sympathetic architects. The advantages of the group house over the single house are chiefly economy of construction and heating, greater privacy inside and better looks outside. A development of such group houses, of different sizes, grouped with relation to each other and to the town plan, would be much more varied and pleasing than a village all of single houses, crowded together to give the same number of families per acre.



# Recent Legal Decisions

## MECHANICS' LIENS—WHAT CONSTITUTES CONSENT BY LESSOR

Where lessors had no knowledge of and did not consent to improvements, a complaint in an action to foreclose a mechanics' lien will be dismissed as to them. A requirement that the lessee may or shall at his own expense make alterations does not constitute consent within the New York Lien Law. But where, although contracts for improvements were made with the lessee, the lessor's acting president, who signed the lease, was present on the premises daily while the work was progressing, and all the transactions which he conducted with the architect and builders, and approval of the plans, took place in the office of the lessor, there would be a consent by the lessor, within the Lien Law, although the acting president was also attorney for the lessee.—*H. A. Berger's Metal Ceiling, Etc., Co. v. Farmers' Loan & Trust Co.*, 170 N. Y. Supp. 934.

## CONSTRUCTION CONTRACT AND BOND

In an action on a bond for the faithful performance of a construction contract, where there is sufficient evidence that certain items are lienable, the liens are admissible in evidence. A provision in such a contract (in this case for the construction of

a water system) "that the contractor agrees to pay all expenses, such as engineering, supervision, and inspection, that the village or its engineer may be put to by reason of the work not being completed at the time specified in the contract," does not contemplate any liability on the part of the construction company or the bonding company for engineering services rendered prior to breach of the contract. In such an action testimony showing clearly that certain sums were expended by the obligee in completing the contract in accordance with the plans and specifications is sufficient to make a prima facie case against the bonding company.—*Village of Council v. United States Fidelity, etc., Co.*, Idaho Supreme Court, 175 Pac. 44.

## MECHANIC'S LIEN—FARM DEVELOPMENT

It is held that farm development, consisting of ditches, drains, embankments, and roads, so correlated as to form one harmonious entity, designed to convey water to and constituting a permanent improvement to the land, increasing its value, is a "structure," within California Code Civ. Proc. §1183, providing for a mechanic's lien on specified improvements "or other structures."—*Mendoza v. Central Forest Co. (Cal.)* 174 Pac. 359.



THE PRIOR'S HOUSE, MUCH WENLOCK

THE AMERICAN ARCHITECT

Founded 1876

PUBLISHED EVERY WEDNESDAY BY

THE ARCHITECTURAL AND BUILDING PRESS, INC.

No. 243 West Thirty-ninth Street, New York

E. J. ROSENCRANS, PRESIDENT AND TREASURER

WILLARD C. HOWE, VICE-PRESIDENT

WILLIAM H. CROCKER, Editor

ARTHUR T. NORTH, Engineering Editor

Subscriptions in the United States and Possessions,  
Mexico and Cuba, TEN DOLLARS. Other Countries,

TWELVE DOLLARS.

SINGLE COPIES (Regular Issue) 25 CENTS

CHICAGO OFFICE, Mallery Building

PAGE A. ROBINSON, Western Manager

ST. LOUIS OFFICE, Wright Building

CLEVELAND OFFICE, Guardian Building

SAN FRANCISCO OFFICE, 320 Market Street

Owned by United Publishers Corporation—H. M. Swetland, President;  
Charles G. Phillips, Vice-President; W. H. Taylor, Treasurer;  
A. C. Pearson, Secretary. Entered as second-class matter January  
6, 1909, at the Post Office at New York, New York, under the Act of  
March 3, 1879.

VOL. CXV JANUARY 29, 1919 No. 2249

A Report on Education

THE report of the Sub-committee on Education of the Joint Reconstruction Committee of the Illinois Chapter, A. I. A., and the Illinois Society of Architects, printed in this issue, makes two commendable statements when it says that "our educational systems should be reorganized so that the graduate may become of immediate value to his employer and his services a source of income to himself," and later on where it urges a "decided effort to stimulate the creative and not the imaginative instinct of the student."

These two points are no more fundamental today than they have been in the past. They must be kept in mind in any efforts toward reorganization of architectural educational methods.

From the crucible of the past two years there has emerged a better realization of our needs in education, and in any work that is undertaken to revise present methods it will be well to entrust it to groups of men actively engaged in professional work, eliminating the theoretical elements that have controlled architectural education in the past.

While there will not be unanimous concurrence with all of the things proposed in this report, it will probably be conceded that it contains the germ of a system which must ultimately be adopted if the student of the future is to become fitted for the conditions that will from now on control the practice of architecture.

Critical examination of this report may suggest that it might well be more drastic, as it undertakes only the improvement of existing courses, rather than the substitution of new points of view, based on the new order and the changing conditions of practice.

What is really needed is a complete reversal of our educational system—one that will eliminate every non-essential thing, supplying in its place the practical development of the student who seeks a living in a profession that will, if it is to endure, become more practical than ever before.

In its general direction the report may be commended. It is the result of close study on the part of groups of men who are in the highest degree qualified to advise in these matters. Similar reports on the part of other organized bodies in the profession should lead to a reorganization of our methods of education that will be of the utmost value.

A Leadership in Art Needed

JUST at this time when the matter of memorials is being very widely discussed and the opinion generally expressed that if we are not to become afflicted with a great many inartistic examples we should be guided by expert counsel, it may be pertinent to inquire exactly what are the real relations of the National Academy toward these and other questions which refer to art.

As the representative organization in the field of the fine arts, and as one that includes a majority of distinguished American artists in its membership, it is logical to expect that at such times when questions affecting the present and future of art in this country are being discussed, the influence of this dignified organization should become evident.

Twice a year the Academy holds exhibitions which, while not always representative of all the phases of art in this country, are conceded to be representative of Academy membership. Having opened its doors for certain periods, it closes them for the rest of the time, and the silence between these recurrent picture shows becomes profound.

During the period when we were at war the Academy as the Academy was not in evidence. Artists everywhere gave the best they had in war work, and considerable of this work was not only highly artistic in its result, but also possessed of a utilitarian purpose. The successful artistic exploitation of our various Liberty Loans, the preparation of essential "range-finding" pictures, were due to the unselfish work of artists either as individuals or through organizations of illustrators. In all of these very important movements the



## THE AMERICAN ARCHITECT

Academy as the national and properly ruling organization was not officially present.

If in France, for instance, any one of the Academicians had publicly painted a large canvas in order to promote patriotism and serve a very important end, his relationship to the Academy would have been as insistently set forth as the artist's name and the title of his picture.

In this country, many National Academicians forsook the privacy of their studios, set aside a natural modesty and stood up before vast crowds of people to paint the canvasses they patriotically agreed to. As far as any special significance as to their prominence in the field of art was shown, or their relation to the Academy as distinguished artists, they might as well have been commercial sign painters, placing on some hoarding an announcement of a loudly heralded nostrum. They do things differently in Europe, where art is regarded as a more dignified and serious effort. Just why it is not so considered in this country may possibly be due to the lack of public activity and a truly representative policy on the part of our National Academy.

It is not possible that a group of men so highly educated as the members of the Academy can be lacking in appreciation of the many and important matters in art with which they could very properly become associated. It is possible, however, that there may exist a certain apathy that needs the spur of sharp but well-meant criticism to awaken this organization to a full sense of responsibility and the great opportunities which are presented for a useful activity. Every field of industry is now actively engaged either in evolving a plan for readjustment or is steadily working out the details of a scheme which had with commendable foresight been prepared. We hear much lamentation over the

apathetic attitude toward art in this country. If as a nation we are to become awakened to the dignities of art and the value of its correct interpretation to all the people, should we not consistently look to the National Academy for direction and leadership in these matters?

There are many directions in which the Academy might lead and encourage such popular demonstrations in the field of art. First, however, it would be necessary for a more widespread knowledge that there is a National Academy, national in the true sense of the word, and that it is not merely an organization for the holding of two exhibitions a year.

Its officers might become more actively identified with national movements in art. Its councils might discuss important art matters and give widespread publicity to their conclusions affecting these things. By this means it could, as it should, take the initiative in important matters and become the arbiter in every discussion affecting the more widespread knowledge of artistic matters.

There have been organized in many cities, municipal art commissions whose duty it becomes to watch over the integrity of the artistic property of the city. These commissions have been organized as the result of public sentiment that there should be proper control of matters pertaining to art, and in the lack of interest shown by previously organized artistic bodies, it has been felt necessary to form these commissions.

Why not a bureau of the Academy whose duties would be the dissemination of the opinions as reached in its councils? In public life the services of many men are valued because of the fact that they are regarded as moulders and leaders of public opinion. Why should not the Academy take the lead as moulders of opinion in all matters relating to art?

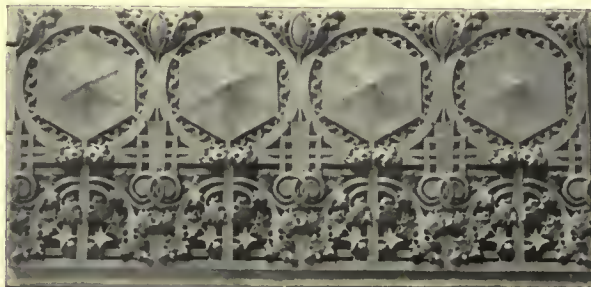



# Criticism and Comment

## The Practice of Architecture

*The Editor, THE AMERICAN ARCHITECT:*

It is with great interest we have followed the discussion in your valuable journal as to what properly constitutes "The Practice of Architecture" and the means whereby the profession might be made more useful to, and given a better appreciation by the public in general. The article composing a five point analysis, published in the November 27th issue, is interesting and instructive and should be read by every architect.

It is to be regretted, however, that up to this time there appears to have been no concentrated effort in bringing before the public at large (the people who it is desired should understand) the need of master builders, by means of suitable and timely articles published in the daily press. Granting that the great majority of the architects of to-day are able to qualify according to the standard set by the leaders in the profession, it is, after all has been said and done, a matter of making the public understand the true meaning of architecture, and that the name signifies not only an art, but also a business. We would suggest that a press committee be selected by the A. I. A., or some other body, whose duty would be to originate timely and interesting short articles for our daily press and popular magazines along this line. Call this propaganda if you like, but we believe this would be a factor in making the issue, "Why Employ an Architect," a live one. Articles of this sort, no matter how good, published in our architectural journals, we believe will fail to bring the required results, because they are not read by a sufficient number of people outside the profession.

One requisite for a better and more thorough appreciation of building as an art and as a business by the public, we believe, is that the architect himself must be in possession of the highest artistic ability, a technical and business training, and training as a mechanic. The man who cannot qualify on the following four points should not in our opinion practice by himself, but should work with or for another so qualified:

1. The inborn quality of true artist.
2. A thorough technical training, including designing, mathematics, history of architecture, etc.
3. Adaptability, experience and business training.
4. Last, but not least, a thorough training as a building mechanic in one or more branches.

The architect of to-day must be a master builder

in the highest sense of the word, or he cannot consistently be called a worthy representative of the profession.

We sincerely hope that out of the many theories and fine suggestions there will soon come a practical application, such as will give representative men and women of our nation a true perspective, and a more thorough appreciation of the greatest and most important of all arts, "Architecture."

The thought that an architect, in order to be successful, must be a skilled mechanic, may be new to many, but we are fully convinced that this fact must be recognized by the profession sooner or later. It does not mean that he must be skilled in all the different trades, but the fact that he is skilled in one trade will add tremendously in his efficiency, both in the planning and supervision of the work in charge.

HENRY C. ECKLAND & Co.

Moline, Ill.

*The Editor, THE AMERICAN ARCHITECT:*

To condense within the limits of five paragraphs the essentials of the practice of architecture is quite an undertaking, and yet as far as that is possible you seem to have accomplished this in your article of November 27th issue. In fact, our own practice is conducted largely along the lines stated in your "five principles of practice," and whatever success we may have had is due to this. Therefore, we can recommend to the careful consideration of every architect the article mentioned.

JONES & FERBRINGER.

Memphis, Tenn.

*The Editor, THE AMERICAN ARCHITECT:*

In the January 1st issue of your paper I ran across a sentence in Mr. Corbett's article which, as an advocate of the Quantity System, I must comment on. In the third paragraph from the end he says, "but he (architect) need not assume responsibility in the sense in which a contractor does, for the simple reason that he is not obliged to take a gambler's chance nor permitted to share in the gambler's profits."

I would like to ask what it is that obliges a contractor to become a gambler. An analysis of the conditions that have prevailed will show that all bidding has been speculative. Not only the contractor, but the building owner, and one could al-

## THE AMERICAN ARCHITECT

most say, the architect has speculated on the kind of workmanship and material that would go into a building under the so-called competitive bidding plan of taking contracts. Contractors have been forced to gamble on both the kind and quality of work to be required under a contract. No two contractors would have the same data on which to base their bets.

There can be no true competition until the exact requirements are known to all. Put competition on the basis of constructive ability and management and the contractor will cease to be a gambler. You cannot get the benefits of competition until uniform guaranteed quantities are made the basis of bids.

Another question I would like to ask is, What is the moral justification of an architect who allows his client to become a party to a speculation when there is a way to provide equitably for the protection of both the contractor and his client?

WM. GRAVES SMITH,  
President, The Quantity Survey Co.  
New York.

*The Editor, THE AMERICAN ARCHITECT:*

Referring to your editorial dealing with an International Federation of Architects, it is an interesting appeal and we sympathize with the idea of a closer union among architects of all nations.

The questions which are being put to architects now involve so much of town and city planning in addition to our old fashioned architectural problems that your proposition for a federation seems all the more important.

We, therefore, concur with you in your wish for a conference at an early date.

Boston. KILHAM & HOPKINS.

*The Editor, THE AMERICAN ARCHITECT:*

I am very much in sympathy with the idea of an international architectural conference which you have brought forward at a very opportune time. Great changes appear to be at hand for the individual and for the organization for the conduct of architectural practice. I would like to join in working along the lines that you express. In my own business, I am already reorganizing.

Pittsburgh. EDWARD B. LEE.

*The Editor, THE AMERICAN ARCHITECT:*

The three things necessary to make an architect are, correct design, correct administration and correct construction. There is no success in the practice of the profession unless these three things are well done and these three things must be recognized

by architects as their duty and demanded of them before the profession will be well balanced. We have to deal with a constructive art which is an applied art and the art depends on good construction and depends on good administration for its crystallization and consummation. W. A. EDWARDS.

Atlanta, Ga.

*The Editor, THE AMERICAN ARCHITECT:*

I regard the idea of an international architectural conference a capital one and should like to see it carried out. ELMER GREY.

Los Angeles, Cal.

### Personal

J. G. Ralston, architect, has moved his office from the Syndicate Building to the L. & J. Bank Building at Waterloo, Iowa.

A. G. Zimmermann, architect, announces the removal of his offices from 10 South La Salle Street, Chicago, to 85 Ninth Avenue, near Sixteenth Street, New York City.

Magney & Tusler, architects, formerly of the Metropolitan Bank Building, Minneapolis, Minn., have moved into new offices at the Builders' Exchange Building.

H. W. Buehning and Alexander C. Guth, heretofore practicing architecture independently, have formed a partnership and will have their offices at 521 Jackson Street, Milwaukee, Wis.

The entrance into the architectural profession of the new firm of Burge & Stevens at 802-3 Atlanta Trust Building, Atlanta, Ga., has been announced by Flippen D. Burge and Preston S. Stevens.

Andrew O'Connor, Jr., of Worcester, Mass., has been one of the sculptors commissioned to make the allegorical figures for the spandrels of the Arch of Triumph which New York is to erect for the return of its victorious soldiers.

It is announced that Mr. Willis Irvin will succeed the firm of Bleckley & Irvin, Architects, and will continue the practice of architecture at 1404 Lamar Bldg., Augusta, Ga. Mr. Irvin desires that manufacturers' catalogues and samples be sent to him.

The firm of Lang and Witchell, architects, at Dallas, Tex., has consolidated with the firm of B. F. and C. M. Davis, construction engineers. Otto H. Lang, who is also Street Commissioner of Dallas, is to be the senior member of the firm. The office of B. F. and C. M. Davis has heretofore been located at Fort Worth. The consolidated firm will have offices in Dallas and Fort Worth.





PLATE 35

WAREHOUSE BUILDING FOR WASHINGTON UNIVERSITY, ST. LOUIS, MO.

EAMES & YOUNG, ARCHITECTS







PLATE 36

HOUSE OF J. W. WYATT, MEMPHIS, TENN.

JONES & FURBRINGER, ARCHITECTS





THE AMERICAN ARCHITECT

JANUARY 29, 1919

VOL. CXV, NO. 2249

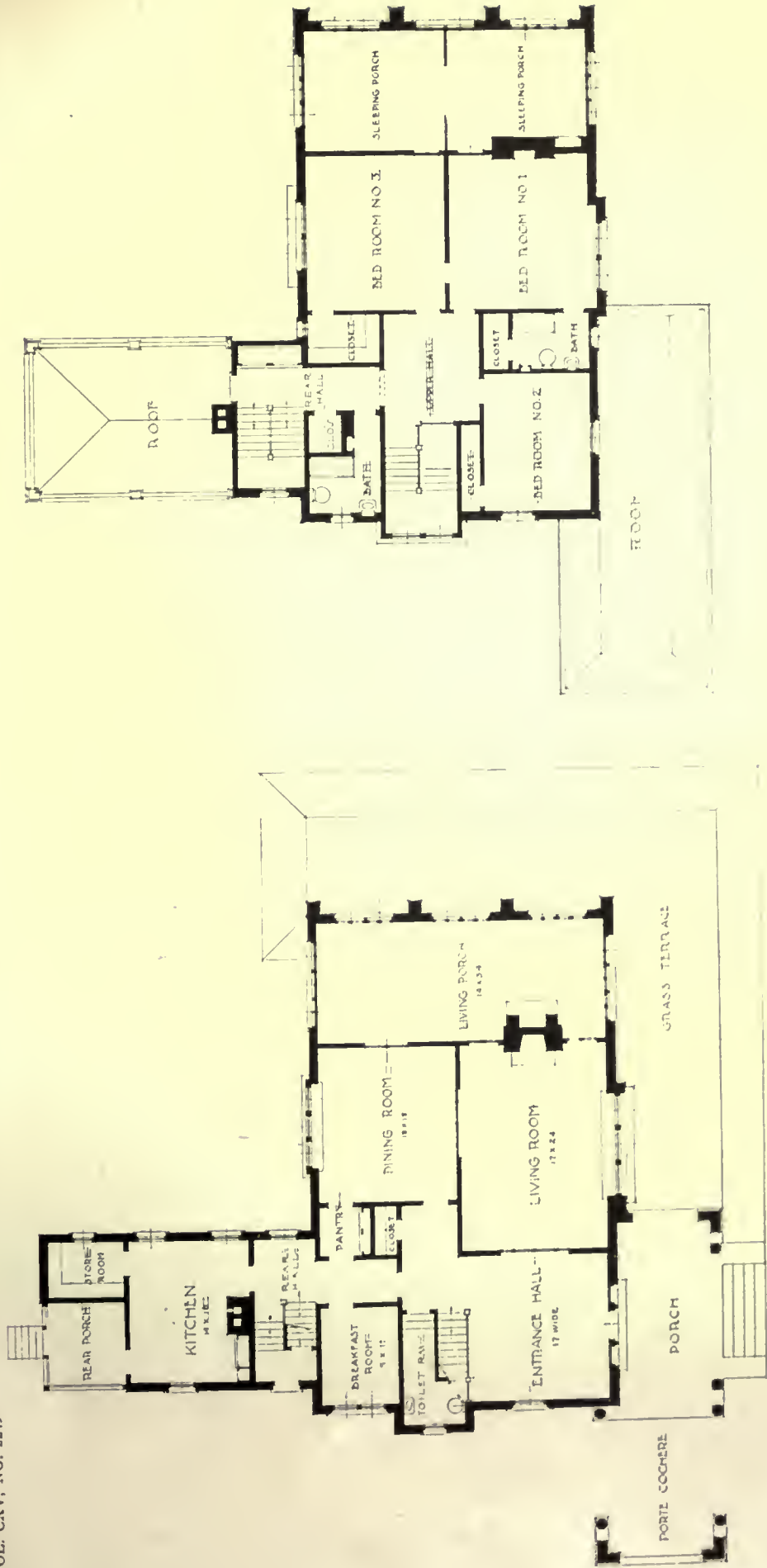

PLATE 37

HOUSE OF J. W. WYATT, MEMPHIS, TENN.  
JONES & FURBRINGER, ARCHITECTS





LIVING PORCH



PLATE 38

LIVING ROOM

HOUSE OF J. W. WYATT, MEMPHIS, TENN.

JONES & FURBRINGER, ARCHITECTS







PLATE 39

FIRST NATIONAL BANK, ST. JOHNSVILLE, NEW YORK

DENNISON & HIRONS, ARCHITECTS





THE AMERICAN ARCHITECT

VOL. CXV, NO. 2249

JANUARY 29, 1919



PLATE 40

FIRST NATIONAL BANK, ST. JOHNSTOWN, NEW YORK  
DENNISON & HIRONS, ARCHITECTS



# 3/4 SCALE DETAIL OF FRONT ELEVATION

*NOTE -  
 EXE. DICKING 1/2" x 3/8" x 1/8" -  
 JOINT -  
 ALL VERTICAL LINES ARE CENTRE  
 TO CENTRE OF JOINTS -*

**DENNISON & HIRONS**  
 ARCHITECTS  
 67-4th AVE. N. Y. CITY  
 Drawing No. 12 Job No. 157  
 Made by H. B. H. Checked by  
 Date No. 20 1919  
 Scale 3/4" = 1'-0"

*Model to be submitted  
 for architect approval*

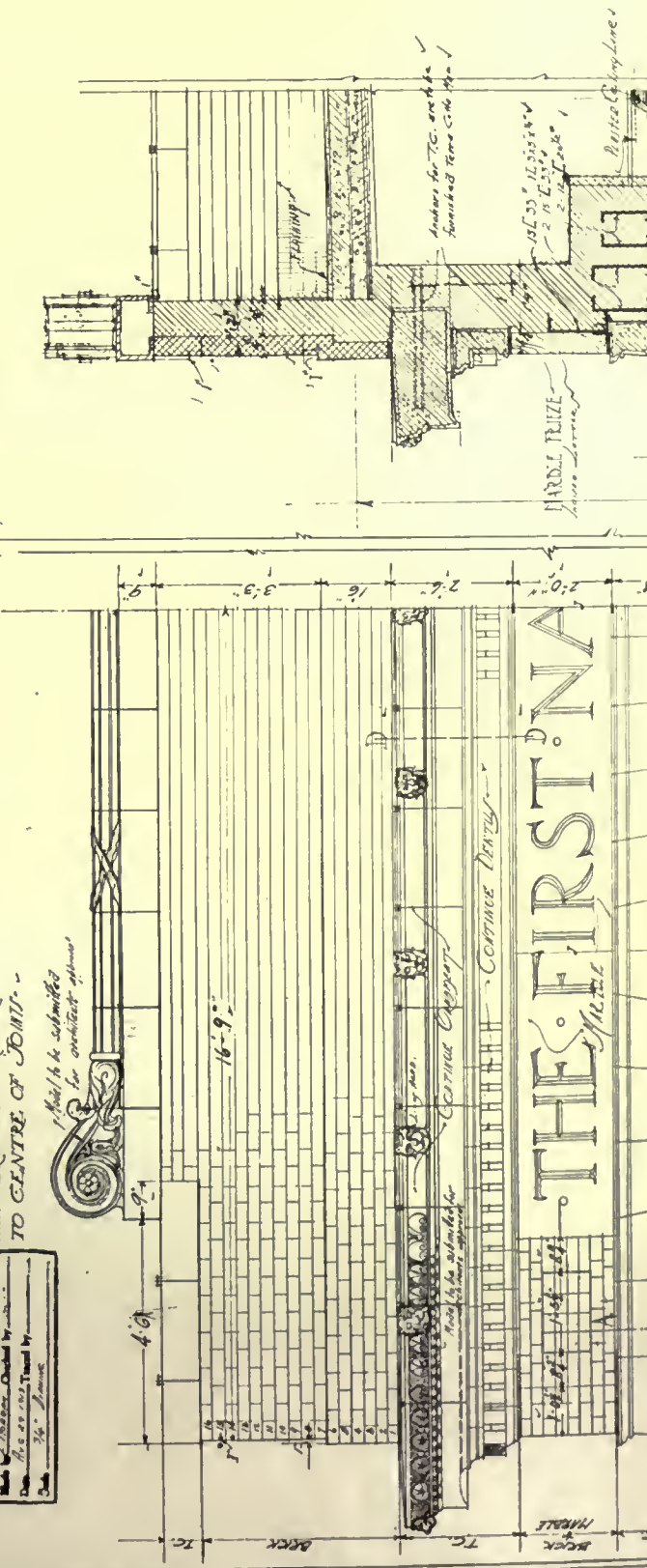











# Financing the Expected Boom in Building

A Digest of Opinion Gleaned by 'THE AMERICAN ARCHITECT' Conclusively Proving that with the Readjustment of Wage Scales and the Lowering of Material Values Construction Will Have a Marked Impetus

**L**ARGE loaning interests have entered the new year in a very optimistic frame of mind, confident that the financial problems brought about by the transition period will be met just as successfully as those induced by the war. While readjustment from a war to a peace basis may take longer than at first supposed and unsettlement in finance and the building trade may be expected to continue for some time, confidence is expressed generally among banking institutions that all situations will be satisfactorily handled. A thorough canvass of both banking and building circles unequivocally reflects the determined attitude of business leaders that, with the readjustment of wage scales and reduction in the cost of materials, there is bound to be great building activity and that it will come by Spring.

Undertakings that will call for construction, building and enlargements which have been held up during the war, will be launched as soon as the factors of price, labor and materials have become more stabilized. While it is true that many of the large loaning institutions are out of the market for the present on account of the heavy Liberty Bond purchases, it is generally realized that the financial and industrial condition of our country is fundamentally strong, and that after a short period of readjustment the building industry will prosper. The necessity of another Liberty Loan is the only thing that will prevent readjustment from taking place more quickly, and, while banks will give all possible aid to industry, capital will be conserved for the next Loan. However, these two seemingly opposed conditions will soon be welded together for the benefit of the Nation.

While the builder must be patient a little longer, as the readjustment will be gradual, he can clearly see the country looking forward to the biggest construction era in its history. As yet the effect of lifting the Government's restriction on building has not been felt. But he knows full well that there is an immense amount of necessary construction which must be taken care of as soon as the financing can be arranged. When this is under way the industry will be kept busy until labor and price conditions have again become more stabilized.

Realizing that the mortgage market is the main

factor and influence in bringing about this expected boom in construction activity, the attitude of the banks and other large loaning institutions must be watched closely. During the war these interests naturally withheld loans for new building because many depositors withheld their surplus earnings from the banks in order to buy Liberty bonds in response to the call from the Government. But since the armistice was signed, these institutions are all issuing statements showing their deposits to be doubled and in some instances to exceed the past withdrawals. This points absolutely to prosperity, and the financial situation in this direction is most reassuring.

E. M. Treat, president of the American Credit Indemnity Co., when asked what would be the consequences of the restoration of peace, replied:

"There is everything in the present situation to encourage and inspire the intelligent preparation for future conditions, to take every precaution against loss of every species, and thus avert serious harm to business."

Banking interests generally feel that the first construction to be taken up will be the care of the housing of commercial enterprises, which have become unduly crowded and congested during the war, and naturally mortgage loans for such projects will be considered most desirable. They feel that there should be little money loaned for the construction of apartment buildings for some time. The feature of this, they assert, is that it will have a strong tendency to hold values up in increased rentals in certain sections, which in turn will create more confidence generally and tone up the strength of the market.

There is a strong feeling that of the money to be loaned for building operations in the near future a large part must be held out for the improvement of the country's industrial facilities, and the further development of suburban housing improvements which are in dire need of expansion.

Take the case of New York City, for instance. Every builder knows only too well the shortage of business space of every character in that vicinity. Experts have declared that the city is several years under-built. The floor space of over a million square feet taken over by the Government for

## THE AMERICAN ARCHITECT

war needs will easily be absorbed when it is released from its present use, as the demand for it is great. It is only to be hoped, however, that all the space will not be released for commercial purposes at once, so that it may be taken care of without undue loss to the property owners.

But the question of most import at this moment is just what financial arrangements can be made to take care of this revival in building activity. One of the most practical suggestions so far advanced, in view of the present financial condition of the banks and loaning institutions, is that of Walter Stabler, comptroller of the Metropolitan Life Insurance Company, and outlined in a previous issue of *THE AMERICAN ARCHITECT*, who suggests as a possible solution the bond issue, which has been successfully tried out in other municipalities.

Close followers of the mortgage situation today see in this suggestion the only means by which new money will steadily flow into the market for reinvestment. The plan is certainly worthy of trial, for the placing of long-term mortgages, to be reduced gradually through the serial payment system, has advantages that are needed to aid in the solution of the present situation. With a sound demand that is sure to come, and with satisfactory basic conditions, in less than two months after the signing of the armistice, there is nothing in the way of a satisfactory solution of the situation. Reports from commercial centers all over the country are evidence that the gradual upward movement has started in force.

The situation is decidedly aided by the attitude of the Government, which, according to despatches in the daily press, announces the formation of a new bureau to conduct an organized campaign to encourage new building projects in order to give employment to men just leaving military service and to thwart any business depression. In answer to the argument of high prices, records show that in the past almost all big construction projects have been launched at times when values were high, rather than when building activity was at a low ebb and prices resultantly off.

That the revival of building will be well under way by Spring is evinced by the fact that various states all over the country are planning a resumption of their building programs, interrupted for three years by the war ruling restricting construction. In New York State a sub-committee on housing has been appointed with the following personnel: John Alan Hamilton, chairman; Dr. Felix Adler, Mrs. William Good, Henry Evans, Peter A. Brady, Mrs. Lewis S. Chanler, V. Everit Macy, Arthur Williams, Alfred E. Marling, and M. Samuel Stern.

It is explained by those in authority in regard to

the state's building program that there is no intention on the part of the Legislature to appropriate vast sums of money for either new buildings or highway purposes. The leaders declare, however, that certain work must be done, and that although materials and labor are high, it is essential for the state to furnish employment for its discharged service men on needed improvements.

A brief outline of what new construction is necessary in New York state may not be amiss, for in other states work of similar character must necessarily be done. It is expected, news despatches from Albany state, that work on the new state office building, which is to occupy two city blocks in the rear of the capitol, will be begun shortly. Salvage from the present buildings will more than pay the cost of demolition. The new building, which is to house all state departments that cannot be accommodated in the capitol, will cost more than \$2,000,000. It is to be a memorial to the soldiers, sailors and marines who served in the world war.

A decided impetus will be given hospital construction. In his message to the Legislature Governor Smith directed attention to the fact that hundreds of returned soldiers suffering from shell shock and other mental afflictions must be cared for in state institutions, which are already overcrowded. On September 1st of last year the overcrowding in state hospitals amounted to 22.6 per cent, or 6546 patients in excess of the total certified capacity of the thirteen institutions, figures compiled by the state commission show.

And this state of affairs in institutions brings all the more forcibly to our attention the belief that conditions would have been bettered, in view of the demand for material and labor abroad for reconstruction purposes, had more attention been paid to the movement to alter and remodel older buildings and fit them for occupancy in order to meet the change in conditions. For there is no question but that there is a certain class of buildings—all substantial structures—which are of no use as they stand, but which could be changed into either business or dwelling places if properly altered. Then, instead of being a drug on the market, they would be revenue producing as well as an aid in the solution of the housing problem.

One of the valuable lessons taught by the war and one that is bound to make itself deeply felt during our period of readjustment is offered by the city of St. Louis, where, it may be recalled, enterprising citizens after making a survey of the city and finding that there were numerous ramshackle structures that could well be spared, tore them down, salvaged the material, and built new ones on their sites. The St. Louis Chamber of Commerce pushed this movement to make the city a better, healthier



## THE AMERICAN ARCHITECT

and more attractive place in which to live, even while building was necessarily at a standstill on account of the war. This organization is now behind a movement to pass laws that would give the building commissioner power to remove all useless and undesirable buildings.

Not only are the banking interests enthusiastic over the revival of great building activity by Spring, but the larger construction firms also feel that much big work is to be brought to them. G. Edward Escher, president of the White Fireproof Construction Co., New York, whose words of counsel are always looked up to by the trade, believes that if a reasonable readjustment of conditions can be made during this winter, considerable building activity may be anticipated during the Spring and Summer months. He feels that the proposition will be largely guided by the cost of materials and commodities entering into building construction not actually under Federal regulation and control, which have advanced to a figure prohibitive for work not

absolutely essential and for which cost is no object.

The question now is whether or not the high prices caused by an abnormal demand of the past few years, before the entry of the United States into the war, will be helped by the likelihood of a demand for materials in the rebuilding of devastated Europe. It is known that already there has been some export call for both manufactured articles and raw materials and this business is likely to be a feature in the manufacture of building materials in this country for some time to come.

On the other hand, the enormous demand for supplies, as well as for labor in many lines, ceased on the signing of the armistice. The return of competition as a result of the lessening of activity in munition plants may turn the trick and cause a recession in prices. This slackening in the demand for labor can only result in the further lowering of the cost of manufacture of supplies for building construction.

*(To be concluded)*

### The Law of Supply and Demand

Business Conditions After the War is the mooted question of the moment. In connection with which there seems to be in the air an indefinable dread of the Bolshevik, the I. W. W. and the revolutionist. Such revolutionists should no longer inspire fear. The war itself has been the greatest revolution in history—a revolution against autocracy, tyranny and kaiserism—a revolution against the very things that the little revolutionists, sincerely or insincerely, have always relied upon as a justification for their propaganda. The revolution has succeeded. The world is free. Long live the revolution.

But, queries Mr. Capital Investment, can we build now? What about the cost of labor? What about the high price of material?

Some employers yearn for a decrease in wages. They hope that the eight-hour day will be abolished and that wages will recede from their present level; but labor contends that its motive is not to destroy but to construct, and that all may just as well understand now as at any other time that the advantages which the workers of America and the allied countries have gained, and which may even extend to

the peoples of the conquered countries, shall not be taken away.

It might appear that this sharp divergence of opinion would be irreconcilable. But if we stop to consider, the most potent and really determining factor in the situation, namely, the basic law of supply and demand, is the only point in question.

Increased production and competition will regulate prices. Under any other course employers would suffer as much as employees, and capital suffer as much as labor.

In the meantime the great investing public twirls its thumbs. It waits, it hopes, it studies, it will (the smartest of them) be quick to seize the opportunities of the moment.

The pending organization of the next Congress, if it leads to stability and definiteness of policy (no matter what kind) will open the flood gates of investment. Prosperity, activity, employment, contentment and happiness will follow, and be the reward of the industrious, the serious minded and the upright; these in the individual, if coupled with capability, will spell success.

WILLIS POLK.

San Francisco.





# Financial and Commercial Digest

## As Affecting the Practice of Architecture

### Housing Appropriation Not All Used

Not more than \$45,000,000 of Congress' appropriation of \$75,000,000 to provide housing accommodations for workers in war munition plants will be spent, according to Otto M. Eidlitz, director of the United States Housing Corporation. The amount of contracts outstanding, Mr. Eidlitz's statement shows, is \$63,491,146.65. The director said that it is proposed to proceed and complete contracts amounting to \$23,073,961.11. Contracts amounting to \$17,330,957.29 will be reduced to \$11,297,471. Projects that have been contracted for to the amount of \$17,627,952.50 will be canceled, at a loss of \$4,053,483 to the Government. Contracts to the amount of \$5,458,275.75 will be canceled without financial loss.

Contracts that will be completed are for housing projects in districts where housing facilities are greatly needed, and this work is nearing completion. The largest single contract for a project that will be completed is for the housing of war workers, other than shipyard employees, in Philadelphia. This contract is for \$2,612,270. The large housing projects at Bethlehem, Pa., have been reduced one-half, while projects for the Pittsburgh district, including a \$5,673,354 one for Neville Island and building operation at Eddystone, will be canceled.

The final cost to the Government of the contracts for work the housing commission will proceed with and the loss to the Government through the abrogation of contracts amounts to \$38,429,915.11, leaving a net saving of \$25,061,231.54 on contracts awarded.

### Favor Coal Export Co-operation

The Foreign Trade Committee of the National Coal Association in a report just issued recommends the establishment of an export coal association under the Webb-Pomerene Law, open to all bituminous coal exporters in the United States and designed to work as a medium through which the country's foreign trade may be handled. It is understood that the proposal has met with the favor of leading bituminous coal exporters of the United States.

"The problem of supplying at the present time American coal where it is most needed abroad,"

says the report, "is almost wholly one of obtaining the necessary vessel tonnage. Indications are that in the near future an increasing number of vessels will be available for the transportation of this tonnage. The desire to use economically whatever ocean transportation is available, coupled with the desire to maintain in foreign markets a high standard of product, is another factor upon which the recommendations that an export association be formed are based."

### Mineral Products Score Record

Preliminary estimates of the United States Geological Survey, Department of the Interior, for 1918, combined with the known figures for 1917, show the remarkable record of over \$10,000,000,000 in mineral production. The total estimate for 1918, including unspecified products, is \$5,160,000,000, a goodly increase over the total of nearly \$5,011,000,000 for 1917 and a vast increase over \$3,513,972,000 in 1916.

The output of metallic products, chief of which are pig iron, copper, ferro-alloys, lead, zinc, gold, silver and aluminum, are estimated at \$1,895,000,000 for 1918, as again \$2,091,825,000 in 1917. The non-metallic products, principal of which are coal, petroleum, clay products, cement and natural gas, were placed at over \$3,265,000,000 in 1918, against about \$2,889,000,000 in 1917.

### Building Manager Condemns Tax

Declaring that the 10 per cent so-called "war tax" on fire insurance policies was costing the owners of buildings and of their contents in New York City alone about \$2,000,000 annually in extra premiums, Arthur W. Warner, chairman of the insurance committee, New York Building Managers' Association, has come forth with a protest, urging that a discontinuance of the tax should now be considered.

"The flat extra charge was never justified by loss experience in New York and is not a tax at all," Mr. Warner added, "but a war profit for the insurance companies, which was levied under cover of the Black Tom explosion, while public imagination was aflame with the incendiary threats and doings of spies and other German sympathizers.

"Whatever merit may have existed in the plea that the additional 10 per cent was needed to strengthen the resources of these companies to meet unknown wartime risks, the occasion for the fear is now happily over. The fire insur-

## THE AMERICAN ARCHITECT

ance business is unique in that it enjoys the protection virtually of the State against any competition to reduce selling prices, and for that reason it is particularly unfair for the fire insurance companies to sit tight and keep on collecting their toll of extra profit masquerading as a war tax, while all other business and building owners are straining to make ends meet.

"Another phase of the situation is that some insurance companies are willing—although naturally not anxious—to forego making this charge, but dare not do so for fear of punishment by the New York Fire Insurance Exchange, of which all insurance companies are members, and which fixes all rates in New York City, with the more or less complete approval of the State Superintendent of Insurance. Before the war there was some talk of generally reducing fire insurance rates in view of the city's fire record, and it is to be hoped that this too may now get the consideration it deserves by the Exchange, its members, the premium payers, and the proper public officials."

### A Note of Optimism Predominates

The expected foreign demand for certain American products is already manifesting itself and this is one of the main factors in locating the note of optimism that dominates business conditions. Another big factor is that conditions are fundamentally favorable. Crops of all kinds are uniformly reported good. An earnest effort is being made by the large employers of labor to maintain wages. Factors not on the boom side of the ledger include the prospect for long drawn-out peace negotiations with the certainty that business will be affected thereby and the quandary that war work industries are still in as to the status of their contracts.

A review of last year by the Federal Reserve Board shows that concentration of the country's monetary stock of gold held at Federal Reserve Banks amounted to \$2,090,300,000 as against \$1,671,100,000 at the close of 1917. Much of this was taken in exchange for Federal Reserve notes, which increased from \$1,246,500,000 to \$2,685,200,000 during the year and at the close represented about 70 per cent of the total paper circulation of the country, not counting gold and silver certificates, as compared with 54 per cent at the close of 1917. The paid-in capital of banks increased from \$70,-

142,000 to \$80,681,000, representing an increase of \$341,300,000 in the aggregate capital and surplus of member banks. Gross deposits of the Reserve Banks show an increase from \$1,771,000,000 to \$2,312,500,000.

### World's War Debt a Vast Sum

A review of the war obligations of Europe made by the Mechanics and Metals National Bank shows that the total indebtedness of the seven great nations chiefly engaged in carrying on the world war was increased in four years from \$27,000,000,000 to more than \$104,000,000,000, while the total indebtedness of the nations of the world has increased to more than \$200,000,000,000. The bank's compilations show that Great Britain and Germany have the heaviest debts of any of the belligerents, that France comes third, and Austria-Hungary, Russia, the United States and Italy follow in order.

The bank's estimates show securities now outstanding against the seven chief nations which were in the conflict are greater than the developed wealth of any single nation of the world, other than the United States. These securities represent a sum six times as large as all of the bank deposits of the United States, twelve times as large as all the gold and silver mined since the beginning of the world and twenty times as large as the value of the annual foreign trade of this country.

### Steel Industry Slowing Down

As further evidence that the steel industry is slowing down, reports from the Youngstown section show that many large plants are halting production and working at 80 per cent capacity. This is the first recession from high production which has been forthcoming from this iron and steel section since early in the war. Generally speaking, Southern plants seem to be holding nearer to capacity than those of other sections of the country.

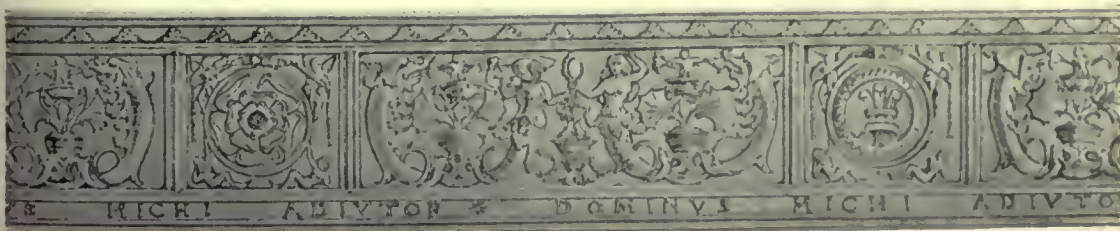



## Cities Deciding on War Memorials

While cities and towns all over the country are considering the erection of memorials to those who have served in the war, very few municipalities have as yet decided just what form their tributes will take. Buildings, arches, sculpture and tablets are being discussed, but public sentiment generally seems still to be in an uncertain stage, the daily press in most cases urging that "haste be made slowly" and that mature and deliberate discussion be given suggested projects.

There is a remarkable similarity in the plans under consideration in most cities, each one including in its possibilities a public building, a park or memorial arch. In the smaller towns which would be unable to finance expensive undertakings, sentiment seems to favor bronze or steel tablets which would bear the names of the men and women who have been in the service for any period during the war. Public buildings seem to be leading in point of popularity.

Various cities in New England have been active in formulating plans. Worcester, Mass., has definitely decided to build an auditorium. It seems probable that Lynn, Lowell, Pittsfield and Brockton will also erect public buildings. Lowell and Lynn have prepared committee bills for the Legislature which strongly intimate the trend of the public building idea. The Lowell bill has been prepared to get legislation to remove its old public hall and erect a new one as a memorial. One of the Lynn representatives will place a bill asking for the right of cities and towns to erect memorial halls.

The proposal of Pittsfield, approved heartily by its citizens, is for a Liberty building to be erected by popular subscription. The building would include an assembly hall, quarters for military organizations, and would be a center of community activity. One feature of the interior would be a set of bronze tablets giving the name and record of the 2,700 Pittsfield men in the service. Brockton, Mass., would spend \$100,000 on a memorial building. Manchester, N. H., has also selected an auditorium, although public sentiment strongly favored an artistic stone bridge over the Merrimac River at a point made historic in the early days of the city. The idea was voted down, however, because of remoteness of the bridge from the city and the limited number of people who would see it daily.

In Waterbury sentiment favors waiting until the boys return and letting them have a voice in what they would like to have done for them. Bronze tablets, however, have been placed in the Waterbury City Hall.

Two architects, Charles W. Oakley and Stockton B. Colt, have submitted designs to the City Council of Elizabeth, N. J., for proposed memorials to soldier and sailor heroes of that city. Mr. Oakley's idea was for a permanent memorial arch, while Mr. Colt suggested that the memorial for the fighting men take the form of a "Temple of Love."

The principal speaker before the Municipal League of Seattle, Wash., when the proposition of erecting a suitable war memorial was taken up at this organization's weekly meeting, was Carl F. Gould of the architectural firm of Bebb & Gould. Mr. Gould's address was on the great war memorials of Europe and was illustrated with stereopticon views. The suggestion to erect a great public hall was decided to be most suitable. The will of the late James Osborne provides \$85,000 for use in building such a structure, and trustees of the estate stated that the city might use this amount, together with other funds, should this type of structure be decided upon.

The Des Moines, Iowa, City Council has purchased a site on West First Street, that city, for the erection of the new municipal museum and memorial. It is planned to erect a \$500,000 museum, with a \$200,000 endowment for the maintenance of the structure.

Following the indorsement of the committee of one hundred and of the trustees of the Rhode Island School of Design, similar action has been taken by the Rhode Island Chapter of American Institute of Architects on the proposal to build an auditorium in memory of heroes of that State in the world war.

Speaking of war memorials that are worth while, the *Philadelphia Public Ledger* says:

"The artificers of Ephesus who made the little images of Diana were not more wroth with St. Paul, whose new-fangled doctrines threatened to ruin their very lucrative business, than are the stone-cutters of New Jersey, who are furious because Governor Edge has suggested that the war memorials that are planned might as well take on a practical form. And it does not call for any deeper insight than that afforded by their outburst to assume that Governor Sproul has been similarly chided in Pennsylvania because he believes in memorial bridges, and supervised by competent art experts at that; or that, in general, all over the country the minor craftsmen are rallying to oppose any "interference" with the home-made memorials which will bring shekels to their pockets, if not artistic fame to their home town.

"Well, as the phrase goes, we shall see what we shall see. A good deal of water, however, has run under the bridge since the crop of Civil War memorials and the Spanish-American War monuments



were set up. We do know that most of these local monuments are an indictment of good taste and are absolutely without inspiration. And, despite the outcry of the craftsmen, who are ready to fight the artists, architects, engineers and the civic experts, the country as a whole will not return to the inertistic wallow of other days. For when it is remembered that the walls of the humblest public schools, in print and photograph, now reveal those things that are glorious for all time in art, and, too, when it is also recalled that the moving picture theatre shows daily in its instantaneous and universal views, the country over, interiors that are beautiful, gardens that are magnificent, and public and private art that delights and transports, it is certain that the mass of the people have no such gradgrind attitude toward the artistic memorial as the objecting statuaries and stone-masons would suggest.

"And the absurdity of these protests is that the business of all artificers will be increased, not diminished, if the plans of the specialists succeed. At all events, it is to be hoped that both the State and local authorities will not rush permanent memorials into execution until the question of their artistic value is threshed out. The American Federation of Arts, for instance, has called a convention for May to discuss this war memorial problem, and in the meantime it is advising all its members to see to it that any question of a war memorial be taken up judiciously and that all aspects of the problem be studied out before any community is committed to any given project. In fact, in this issue, the best rule for all communities is to make haste slowly."

The Boston *Transcript* voices a similar sentiment in urging communities to make haste slowly in selecting permanent memorials as follows:

"It would be much better to wait for years for our memorial to the soldiers who have died for us in this great war than hastily to erect one which afterward we should desire to see removed. The finest existing sculptured tribute to heroes of the Civil War, the Shaw Memorial, was not dedicated until the year 1897, thirty-four years after the heroic assault on Fort Wagner, which it commemorates. It was assuredly worth waiting for. 'You can hear them breathing as they march,' said William James, of the bronze figures in relief. If haste had been made to raise this memorial in the days or years immediately following 1863, the beauty and distinction of the present Shaw memorial would never have been attained, for the work absolutely awaited the genius and the leisure of Saint-Gaudens for its accomplishment."

The building of "Liberty Halls" throughout the country instead of monuments of stone or metal to the soldiers who gave their lives in the war, is urged by George W. Coleman of the Department of Labor.

### U. S. Engineers Build World's Biggest Dam

American engineers are responsible for the construction of the largest dam in Europe, just completed in the Barcelona consular district of Spain. *Scientific American* describes how the concrete dam, which is built across the chasm through which the Noguera Pallaresa River flows, is 330 ft. in height and 700 ft. in length, and abuts almost perpendicular cliffs. The thickness is 230 ft. at the base, gradually decreasing to 14 ft. at the top. The dam has a twofold object, to produce electric power and use in irrigation. The water passing through the power house yields an electric current of 40,000 horsepower. The water is carried by a system of canals into an arid district, where it irrigates a surface of nearly 100 square miles. The cement-making apparatus was brought from the United States, while the cement used in the construction was made on the spot from limestone and marl found within a short distance and transported by a temporary railroad.

### Immigration at a Low Mark

Statistics announced by the Bureau of Immigration at Washington show that immigration almost ceased during the war. From April 1, 1917, to Sept. 30, 1918, a total of 178,362 immigrants arrived in the United States and 123,676 departed.

### Resolution of the Illinois Chapter of the American Institute of Architects, Passed Jan. 14, 1919

"Whereas, It is the sense of the Illinois Chapter of the American Institute of Architects, in regular meeting assembled, that the successful inauguration and consummation of a war memorial will call for the highest character of architectural service and advice; therefore, be it

"Resolved, That, in his appointment of the commission provided for in the resolution of Alderman Joseph O. Kostner and ratified by the City Council, the Mayor of the City of Chicago be, and hereby is, requested to include in the personnel of this commission five practicing architects, of whom not less than three shall be members of the American Institute of Architects; and be it further

"Resolved, That it is the sense of this meeting that the memorial should be located in conformity with the 'Plan of Chicago,' and that its principal

functions should be to keep green the memory of those in whose honor it is dedicated, to inspire our people with the spirit of patriotism and sacrifice, and to be an everlasting and worthy addition to our heritage of beauty and art."

---

### Seattle Builders Elect Officers

Officers and trustees of the Seattle Master Builders' Association have been elected for the ensuing year. They are: Charles W. Carkeek, president; P. A. Harrington, vice-president; J. E. Shoemaker, secretary, and E. J. Rounds, treasurer. The newly elected trustees in addition to the officers are: James Murdock, M. Arveson and C. C. Cawsey. The auditing committee will consist of O. N. Finne, C. W. Clist and C. A. Lohman.

Mr. Carkeek succeeds E. S. Booker as president, who was presented an engraved clock as a memento of his services and a mark of appreciation.

---

### Montana Architects Hold Convention

An interesting convention was held by the Montana Association of Architects at Helena, Mont., last week, which featured short talks and reading of addresses of topics of the day by members. Thirty members were in attendance and elected O. S. Wasmandorf of Lewiston, president, and Frank Bossout of Harve, secretary. No proposed legislation was brought up for discussion.

---

### Rhode Island Chapter, A. I. A. Elects Officers

At the annual meeting the Rhode Island Chapter of the American Institute of Architects elected the following officers: President, George Frederick Hall; vice-president, F. Ellis Jackson; secretary, Norman M. Isham; treasurer, Robert C. N. Menahan; executive committee, in addition to officers, Prescott O. Clarke and Eleazer B. Homer.

The committees appointed included: Admissions—president, secretary and Messrs. Clarke, Robertson and Jackson. Entertainment—Messrs. Adams, Henshaw and Burleigh. Competitions—president and Messrs. Hoppin and Isham. Public Information—Messrs. Cady, Hill and Fontaine. Civic Improvements—Messrs. Homer, Jackson, DuFais, Burlingame and Burleigh. Education—Messrs. Howe, Jackson and Hoppin. Auditor, Mr. Almy.

### \$2,000,000 for Extensions Is Asked

Senator Lester of San Francisco has introduced in the Senate a bill asking for an appropriation of \$2,000,000 with which to erect buildings in San Francisco and Los Angeles (\$1,000,000 each) for use of the University of California extension classes and administrative use. The text of the measure refers to the fact that inside of four years, starting with a class of fifteen, the work has grown to 15,000 persons who take the various extension courses.

---

### Heating and Ventilating Engineers to Meet

The annual meeting of the American Society of Heating and Ventilating Engineers, which will be held at the Engineers Building, New York City, on January 28-30, will constitute a celebration of four events in the development of the society, namely, the twenty-fifth anniversary, the attainment of 1000 members, the success of the research bureau, and the organization of two new chapters.

The sessions will include discussions on mechanical ventilation, the boiler testing code, and automatic heat control.

---

### Redwood District to be Known as Roosevelt National Park

The Senate Public Lands Committee has unanimously approved Senator Phelan's bill designating the Giant Redwood District at the crest of the Sierras in California as the Roosevelt National Park. Director Mather of the National Park Service and others indorsed the plan to create the new National Park and give it the name of Roosevelt instead of Sequoia.

---

### Pope's Statuette for Pershing

Alexander Pope, the Boston sculptor, has produced a spirited equestrian work of General John J. Pershing. General Crozier assisted Mr. Pope by "sitting" for the figure on the horse. The statuette is 18 inches high.

---

### Many Cities Adopt Zoning System

The lead of New York City in establishing a building zone system is being followed with success by other cities all over the country. The three phases of restriction, including height, area and use, are becoming quite generally accepted as stand-



ard, and guide municipalities in the drafting of their codes. St. Louis has just prepared and adopted a zone system, which in many respects follows the New York system that has been in operation for more than two years.

Philadelphia has nearly completed a zoning plan, while Cleveland has appointed a commission to zone the city and has secured the services of Robert H. Whitten, who helped prepare the New York system, to oversee the work there. All cities taking the matter in hand are using the two voluminous reports of the New York City Building Heights Commission as the basis of their work.

### Waste Reclamation Section Made Permanent

The work done by the National Waste Reclamation Section of the War Industries Board in the salvaging of materials needed by the Government in the prosecution of the war has been taken over by the Department of Commerce, which will direct its work to the end of saving the wastes of material in the industries of the country in time of peace. This was found to be the logical move following the presentation of statistics in *The Waste Trade Journal* estimating the values of the waste materials reclaimed during the year as follows: Scrap iron, \$600,000,000; scrap metal, \$300,000,000; old waste paper and rags, \$200,000,000; woolen rags, \$75,000,000; cotton and wool waste, \$100,000,000; old rubber, \$300,000,000; second-hand bags, \$25,000,000; and cotton linters, \$50,000,000.

### Soldiers for Suburban Development

The co-operation of New York State with the National Government has been urged by Governor Smith in his message to the State Legislature to create farm land for soldier farmers. *The Engineer News-Record* sees in this war reconstruction plan the nucleus of a peace-time measure that would give impetus to better agricultural conditions through the East and calls attention to the remarkable development at Durham, Cal., of the State Settlement Board that can be duplicated if existing agencies are called upon for help.

Governor Smith in outlining his plan said:

"It is becoming more and more apparent that the ability and the experience of our agricultural leaders should be mobilized to create a planned rural development which will include co-operative organization for buying and selling, a system of credit that will give broader opportunities for men of small capital to become farm owners, and a better social life."

### Report of Royal Commission on Housing in Scotland

A copy of the special report, with relative specifications and plans, prepared by John Wilson, F.R.I.B.A., on the design, construction and materials of various types of small dwelling houses in Scotland, has been received.

These matters are considered and presented in Great Britain with such complete thoroughness as to make reports a source of the most valuable information. While of necessity this report has special reference to specific housing problems, it nevertheless contains suggestive matter of the utmost value to every architect making a study of these important problems.

The findings in this report refer particularly to post-war housing schemes, and as the question of housing in England is just now, owing to a pronounced shortage, one of first importance, a document so filled with the most valuable matter, all based on far-reaching investigation, is helpful in the highest degree.

The report can be secured by addressing H. M. Stationery Office, 23 Forth Street, Edinburgh, Scotland, or through any international book seller in this country.

The price is one shilling net.

### Airplane Boxes Big as Cottages

Boxes used for overseas shipments of United States Navy seaplanes require enough lumber to build a small cottage. The packing box for the hull usually is 8½ x 10 x 46 ft. and 3620 ft. of lumber are necessary to build it. Except for windows and doors, which would have to be added, that lumber would build a comfortable little house. The Navy Department in a recent statement emphasized the importance of the "wooden packing box," and went into detail as to the manner of its construction.

### Weight of New York Skyscrapers

The combined weight of three of New York City's largest office buildings, the Equitable, Woolworth and Municipal, totals 1,086,800,000 pounds, or 490,000 tons. The heaviest structure is the Equitable, which is also the world's largest office building, its weight being 203,000 tons. The Municipal Building is the next heaviest, totaling 188,000 tons, while the Woolworth, which ranks as the tallest skyscraper in the world, weighs 103,000 tons.



## Loans Sought Here by Other Nations

Views now being exchanged by bankers indicate that serious consideration is being given the floating of foreign Government bonds in this country in the near future. It is reported that both Belgium and Chile have felt out the investment situation here, and it is admitted that there has been some discussion on the question of a substantial loan to China.

Carter Glass, Secretary of the Treasury, has verified the proposal of the Belgian Government that a loan be launched, either by means of a public offering through bonds or through banking channels. He has also confirmed the report that a public offering of the British and French obligations held by the Treasury as security for loans advanced by the United States Government might be made. Both propositions were still in a tentative stage, he said.

It is generally conceded in banking circles that no further loans to Great Britain and France will be attempted until after the Fifth Liberty Loan in April. It is understood that when Belgian representatives were engaged in the preliminary discussions looking toward a loan, the indemnities owed to that country by Germany were considered as collateral.

Considerable speculation as to the amount of the next Government loan has been occasioned by the reference made by Secretary of the Treasury Glass in a recent address that the interest rate would be higher than  $4\frac{1}{4}$  per cent. Banking firms closely allied in floating previous loans believe that the forthcoming loan can be floated at  $4\frac{1}{4}$  per cent, a belief based on the assumption that the offering will be of not more than five years' maturity, and will be prepared so as to offer particular attraction to banks as a desirable bank investment. If this is the case it might reduce the appeal to the buying public. This is just what the Treasury Department does not want to do.

---

## Reviving the Industries of Belgium

To assist in the reconstruction of trade and industry in Belgium, the Comptoir National pour la Reprise de l'Activite Economique en Belgique, has been organized under the form of a commercial organization, aided by the Government. The initial capital of the bureau, limited to 1,000 francs per stockholder, amounts to 519,200 francs, and is contributed by Belgian manufacturers just outside of invaded Belgium.

The income of the Comptoir National will consist of a commission sufficient to cover its general

expenses and insure an interest of five per cent on the capital paid in. Profits over this will be distributed among the buyers in proportion to the amount of their purchases. The Belgian Government will render aid other than financial by putting the bureau's purchasing plan before the inter-allied commissions in order to obtain for Belgium her share of the raw material coming under the control of these commissions. The organization will also purchase for account of individuals who do not require State financial aid.

---

## Club House for Discharged Officers

A million-dollar club house, to serve as a home for discharged commissioned officers of the United States Army temporarily sojourning in New York City, will be erected at a central location in Manhattan within a short time, according to Capt. George Aitken of 1881 Broadway. The proposed club will be one of the largest in the city and will contain all conceivable conveniences and attractions, including a gymnasium, convention hall and theater. Many wealthy New Yorkers who served in the army during the war are said to be behind the project. While the new building is being constructed temporary quarters will be provided for the officers.

---

## Baling Saves 50 Millions in Shipments

By the substitution of baling for casing or boxing in the shipment of clothing and equipment for the use of the American Expeditionary Forces savings amounting to \$51,678,000 have been effected, according to statistics furnished by the Packing Service Branch of the Domestic Operations Division. The savings include material, labor in packing, handling and cargo space. Since October, 1917, when baling was begun in the New York depot, there have been over 1,000,000 bales made.

---

## Los Angeles' Area Now 337.92 Square Miles

Since the annexation of Westgate and Occidental, the city of Los Angeles, Cal., is now the largest city in the United States in point of area, forcing New York City to second place. Los Angeles' area is 337.92 square miles and New York City's, 314.75. Chicago is third with 198; Philadelphia fourth with 129.

# Department of Architectural Engineering

## Roof Construction for Factories with Excessive Moisture

By FREDERICK J. HOXIE, *Mem. Am. Soc. M.E.\**

THE wooden roofs of highly humidified weave sheds, paper mills and bleacheries, filled with steam, are prone to rot rapidly and therefore special consideration should be given to their design with a view to preventing this trouble. In addition to the expensive up-keep resulting from the rot, there is damage to goods and machinery, caused by water dripping from cold roofs, which is the more troublesome feature and causing the greater damage.

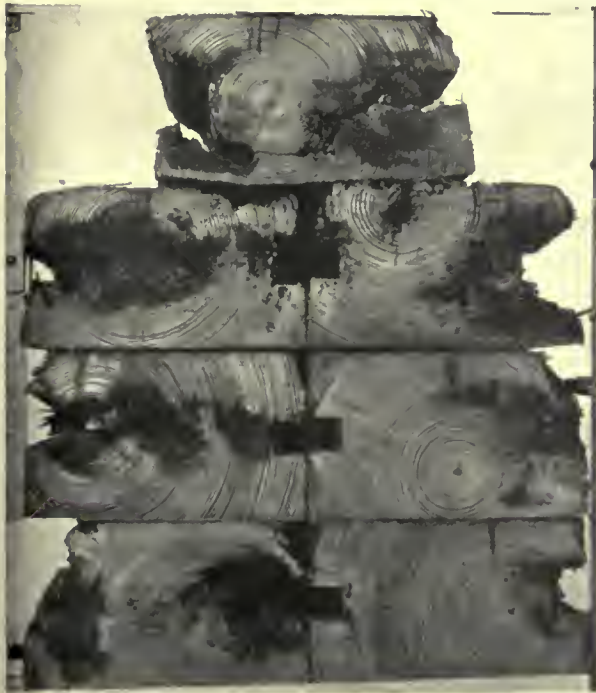

Fig. 1. Four inch longleaf pine roof planks, rotted through the centre, taken from a paper mill in Maine.

Both the rotting and the sweating are caused by the same conditions, and they can be prevented by the same remedy. This remedy is found in the reduction of the relative humidity of the air at the roof, to be accomplished by the most practicable

\*Engineer and Special Inspector, Associated Factory Mutual Fire Insurance Companies, 31 Milk St., Boston.

means available. This can be brought about by designing for increased temperature, either by putting more heating pipes near the roof or by preventing the escape of heat through thin and poorly insulated roof planks, the ventilators, skylights,

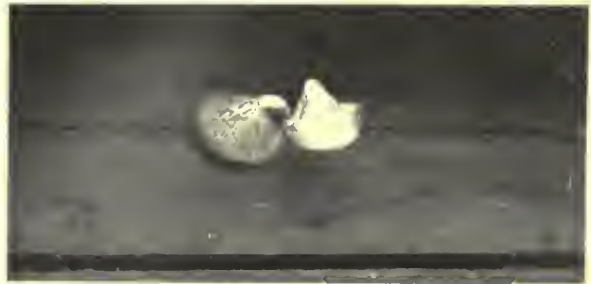

Fig. 2. A normal fruiting plant of *Lentimus Lepedius* growing on the roof planks at the valley of the saw-tooth skylight in a cotton weave-shed, from which the sheathing has been removed.

roof drains, etc., care being taken to prevent the penetration of moisture into and its precipitation within or above the roof planks. The fungus plant, which causes the rot to start in the center of the plank, grows where sufficient moisture has penetrated to make this possible, as shown in Fig. 1.

Three or four varieties of the wood destroying fungi appear to be most active in the destruction of roofs. The true dry rot fungus or *Merulius Lachrymans* is not among these, doubtless owing to the fact that it cannot live in the high temperature to which roofs are commonly subjected. This fungus and its frequent associate, the *Coniophora Cerebella*, while very destructive, generally confine their ravages to basements, bottoms of lumber piles and new buildings into which they have been introduced with the lumber.

The varieties of fungus found in factory roofs fortunately have moisture requirements which limit the field of their ravages quite narrowly to the parts of the roof which are practically at the dew point. Slight variations in the moisture and temperature favor one or another variety. The *Len-*



## THE AMERICAN ARCHITECT



Fig. 3. Abnormal fruiting plants of *Lentimus Lepedius*, two feet long, which grew between the roof planks and sheathing of a cotton mill weave-shed. This abnormal form is probably due to excessive moisture, and darkness may be also a factor.

*timus Lepedius*, shown in Figs. 2 and 3, when fruiting normally has gills and looks very much like a common toadstool and is generally found in the more moist locations at the base of the sawtooth skylights or near humidifiers. The *Leucisites*, shown in Figs. 4 and 5, is the most common and destruc-

tive of the roof destroyers. They grow through a wider range of moisture than some of the others and can withstand a comparatively high temperature. The *Fomes Officianais*, shown in Fig. 6, appears to be more exacting in its requirements than the others and is not as common. It is found more often on the beams than on the roof plank.

All of the wood destroying fungi require conditions very near if not quite at the dew point or

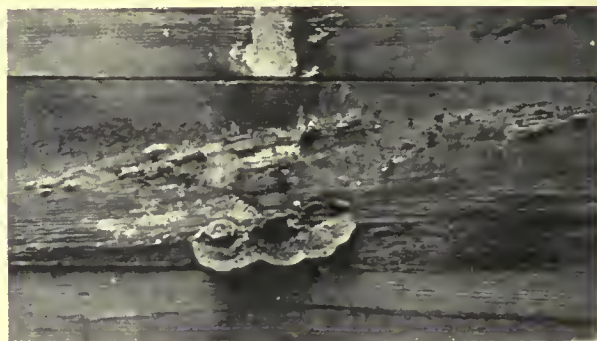

Fig. 4. Fruiting plants of *Leucisites Seperia* growing on southern pine roof planks of a cotton mill weave-shed after the sheathing was removed for some time. They are of a brown color.

atmospheric saturation for their best growth, and this limit may be inside the roof plank, as shown in Fig. 1. Upon this most important fact is based several essential details in the design of roofs. It is always to be noted, in removing a rotted roof, that the destruction is more complete over the beams than elsewhere. At these points the rot frequently has not only destroyed the entire plank, as shown in Fig. 9, but it has extended some distance into the beam. This clearly indicates that the above mentioned moisture limit, or point at which the water is absorbed by the wood, is the place that is in the condition most favorable to fungus growth. This can probably be more clearly shown by an example of conditions commonly found in weaving mills. The room temperature is 70 deg., the outside temperature 30 deg. and the dew point of the air in the room 60 deg. Assuming a uniform heat conductivity for the roof material, it would be expected that the dew point, that is 60 deg., would be found one-quarter through the roof plank however thick it is. If rotting begins at the dew point, that is where the moisture is first precipitated, it will begin somewhere between one inch from the inner surface and the outside of a four-inch plank, following an irregular line dependent upon the thickness or insulating power of the roof, and, therefore, when a thick supporting beam is encountered the rot line will be brought down below the lower surface of the plank and into the beam itself, often entirely



rotting off the planks at their bearing ends as shown in Fig. 9.

That the actual limit is followed with definiteness is demonstrated in Figs. 11 and 12, showing sec-

end of the plank, thus completely destroying the supports before the remainder of the plank is deeply affected, as shown in Fig. 14. Sheathing acts in a similar manner by keeping the heat of the room

away from the plank and bringing the rot line down below its lower surface, thereby causing the rapid destruction of the entire roof plank as shown in Fig. 15. It would be logically concluded from this that the place for the insulation is on the outside of the roof instead of the inside. Anything which would prevent the penetration of aqueous vapor into the roof plank or remove this vapor from the interior of the roof more rapidly than it could penetrate would increase the life of the roof, therefore a double roof suggests itself. The outer part of such a roof to be of rot-resisting materials and the inner part having sufficient strength to support the load as well as having the necessary qualities for the finished ceiling as shown in Fig. 16.

Between the two roof planks there should be a layer, impervious to aqueous vapor, to prevent moisture from penetrating the outer plank and

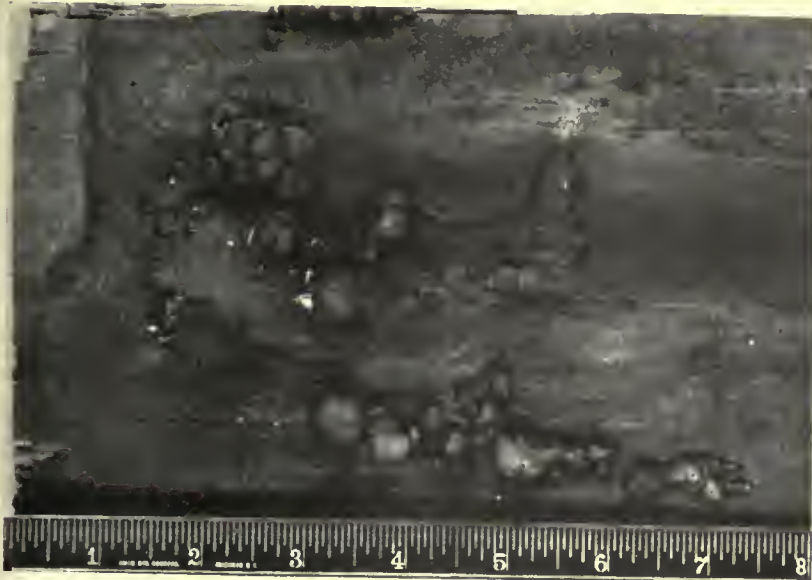

Fig. 5. Abnormal *Lenzites* plants growing on roof planks under sheathing of a worsted spinning mill. This abnormal form is probably due to excess of moisture, and light may be also a factor. They are of a brown color.

tions of roof planks removed from two Massachusetts factories.

The obvious remedy is to make the bearing no wider than the thickness of the plank. This can be accomplished, when wide beams are required, by chamfering off their upper corners as shown in Fig. 13. This should increase the life of the roof



Fig. 6. *Fomes Officinalis* plants growing on the side of a beam under a weave-shed roof from which the sheathing has been removed for some time.

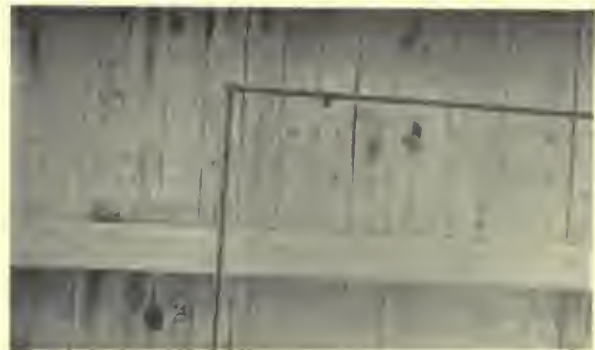

Fig. 7. Roof of a weave-shed destroyed in 9 years by *Trametes Seralis*.

reducing its heat insulating power. The outer part could consist of partially rotted planks removed from a previous roof or low grade new lumber. The more sap wood it contains the better, as this absorbs antiseptics better than heart wood. Of whatever kind of wood the outer part of the roof is, it should be completely penetrated with hot creosote so as to sterilize it and prevent the de-

plank and protect the beams. The not infrequent custom of placing ornamental mouldings at the upper edge of the beam, accelerates the destruction by bringing the rot line entirely outside the bearing

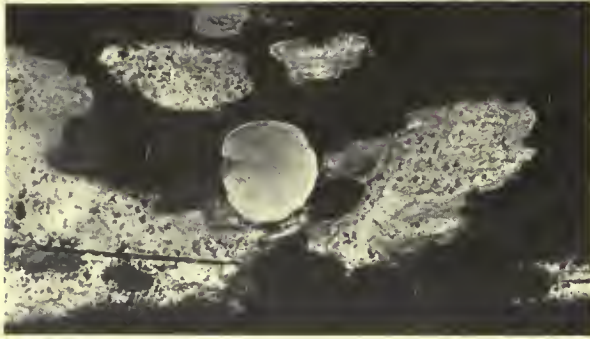

Fig. 8. Normal fruiting plant of *Trametes Seralis* growing in a weave-shed basement. This fungus is found both in basements and on roofs, although rather more frequently in basements.

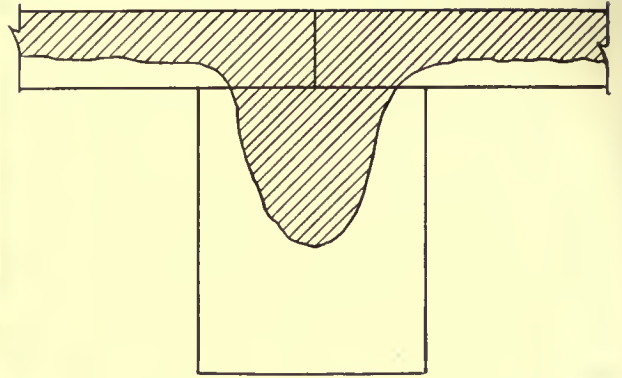

Fig. 10. Section of roof plank and supporting beam showing the line of moisture limit at which fungus growth will stop.



Fig. 9. Ends of roof planks rotted over the supporting beam. The rot has also extended three or four inches into the beam.

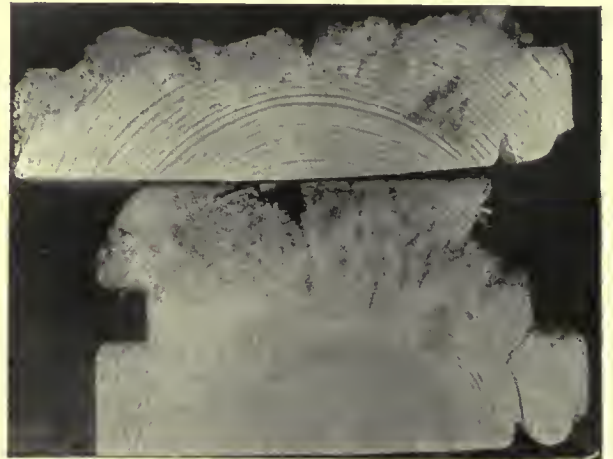

Fig. 11. Section of roof plank from a highly humidified Massachusetts spinning factory, showing definite line of limit of fungus growth.

velopment of fungus. Such an outer insulating covering will be found as practicable for a concrete roof as for a wood roof. The poor heat insulating power of concrete makes it necessary to thoroughly insulate it to prevent sweating in moist occupancies. In some cases rotting has been discovered, in its

early stages, in sawtooth weave shed roofs, sheathed underneath. Experiments are now under way with

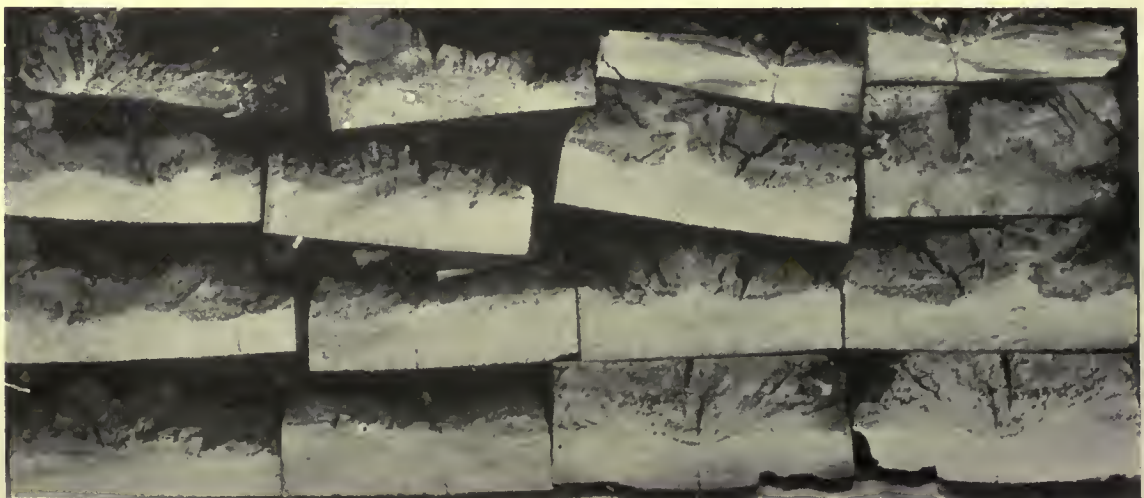

Fig. 12. Roof planks from a bleachery roof, showing definite moisture line limiting fungus growth.



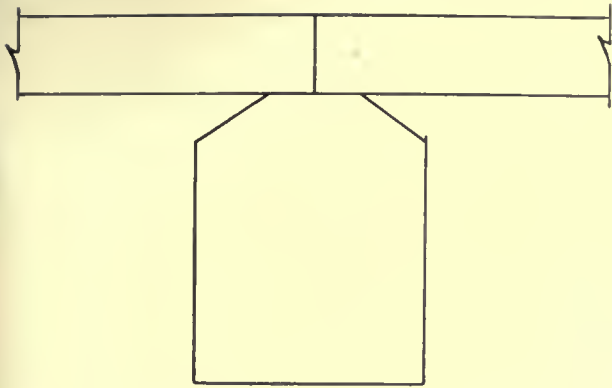

Fig. 13. Section through roof plank and beam showing a method for retarding rotting over beams.

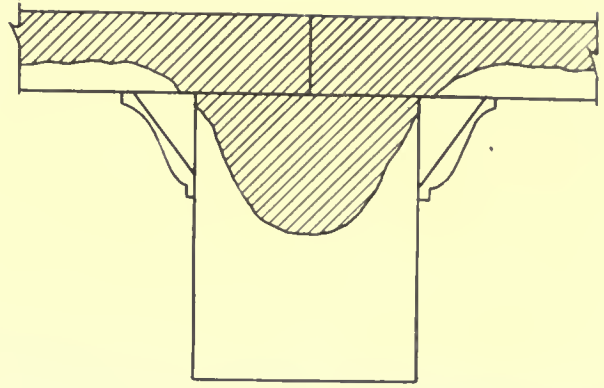

Fig. 14. Section through roof plank showing effect of a moulding in bringing the moisture line, limiting fungus growth, outside the edges of the supports, resulting in the rotting off of the ends of the planks.

a view to removing the moisture from the space between the sheathing and roof plank of such a roof, by making small holes from this space to the outside air. The idea is to allow the aqueous vapor in this space to escape by the breathing caused by variations in temperature and barometrical pressure as recommended by Mr. Arthur N.

Sheldon\* for double factory windows. These experiments have not been under way long enough to warrant any positive conclusions. There seems to be no reason why they should not, somewhat at least, increase the life of the roof.

\*See THE AMERICAN ARCHITECT of June 5, 1918, page 777.



Fig. 15. Roof planks of a New Bedford weave-shed from which the sheathing has been removed. The planks were destroyed in nine years.



## THE AMERICAN ARCHITECT

It is evident that if the wood-destroying fungi require a certain amount of moisture for active growth they may be as effectively killed, or at least put into a harmless resting state, by depriving them of this moisture as by poisoning them with antisept-

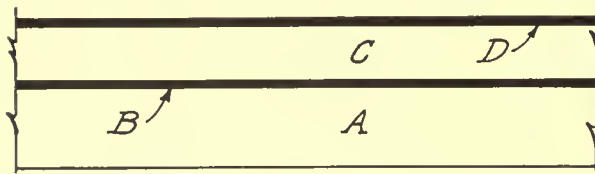

Fig. 16. A—Good plank suitable for carrying the load and forming the finished ceiling. B—Three thicknesses of tarred paper saturated with tar. C—Thoroughly creosoted low grade plank. D—Tar and gravel roofing or equivalent.

tic mixtures. Experiments are in progress with a view to testing the practical application of this theory by placing a heat insulating roof, similar to that previously described, over an old roof in which rot has already made considerable progress, although it still has sufficient strength to carry the additional covering. If this method proves effective it will be simply necessary to apply such an insulating outer covering to a roof, in which rot has been discovered in its early stages, while there is still sufficient strength in the old roof to carry



Fig. 17. This iron pipe, for carrying away rain water from the roof, has absorbed sufficient heat to precipitate water on the nearby roof, causing the roof to rot.

itself and the added load. This insulating covering can be applied much more cheaply and conveniently than the old roof can be removed and replaced, the old roof still retaining its original usefulness.

Some of the most serious cases of dry rot have occurred in comparatively new mills, doubtless due to the fact that the new lumber was infected throughout with living plants of actively growing fungus, which had entered it at the saw-mill or lumber yard. In many cases, but for such previous infection, the conditions in the building were not

such as to have caused fungus growth. In new buildings *Lachrymans* and *Coniofora* have been more frequently the cause of damage than the rotting fungi previously mentioned. These fungi can be destroyed by heating the building a few days to about 115 deg. and this procedure is undoubtedly worth its small cost in any new building in which



Fig. 18. Cast iron columns used as a drain pipe for rain water has precipitated water on and seriously rotted the beams which enclose it.

lumber more than two inches thick has been used. Heating, however, will have little or no value in saving roofs of buildings in which high humidities are to be used.

An important cause of local rotting in roofs is ventilating pipes, roof drains and skylights or parts which radiate heat more rapidly than other parts of the building, thereby keeping the nearby lumber



Fig. 19. Beam rotted for some distance from column, serving as rain water conductor, which it enclosed.

at the dew point. An example of this is shown in Fig. 17 in which a roof drain has absorbed sufficient heat to rot the roof for some distance. This is much more serious when columns are used for



Fig. 20. Roof rotted for 10 or 15 feet from a ventilator, owing to the escape of heat, reducing the temperature and causing moisture to precipitate on the roof planks.

conducting rain water from the roof and the main supporting timbers surround them at their bearing ends. In this case the water precipitated on the cold pipe is absorbed by the beam, which is rapidly rotted, thereby weakening an important support of the structure. Such a case is shown in Fig. 18. Sometimes this water is conducted through season

cracks the entire length of the beam, weakening it for 20 or 30 feet, as shown in Fig. 19.

Ventilators or skylights are particularly pernicious in this respect, almost always rapidly rotting the roof for 10 or 15 feet from them, as shown in Fig. 20.

The remedy for this defect in design is to provide sufficient heat insulation to reduce the escape of heat to that of other parts of the building. Roof drains and closet vent pipes can be covered with insulating coverings such as are commonly used on heating pipes. Drain pipes should be kept separate from important structural supporting beams of wood. Ventilators should be protected by heavy wooden covers in cold weather when not in use, and double windows should be used. Near skylights and other windows, where it is impracticable to reduce the radiation, additional heating pipes should be provided to compensate for the excessive transmission of heat. Such heating pipes should be carefully arranged to avoid setting up air currents which will continuously deposit moisture on the ceiling or windows.

## Useless Waste in Concrete Construction Due to Legal Requirements\*

By W. STUART TAIT, *Assoc. M. Am. Soc. C. E., Assoc. Mem. Inst. C. E.*

### The Strength of Materials

IT was pointed out in a previous article that laboratory tests and investigations have shown that with reasonable care and proper supervision we now know what steps it is necessary to take in order to produce a concrete which can be relied upon for a crushing strength of 2,600 lb. per sq. in. at 28 days. It is also known that this material will develop a strength of approximately 3,900 lb. at 90 days. Existing design methods are all based on a strength for 1-2-4 concrete at 28 days of 2,000 lb. per sq. in. These design methods take no account whatever of the increase of strength developing in the concrete with additional ageing. Now, in few cases is a floor subjected to any other load than construction loads before the concrete in it is 90 days old, and, with careful supervision, as outlined in a previous article, the loading of floors with materials for construction can be held down to a point which would be well within the safe carrying strength of the partially developed concrete. It seems to the writer, therefore, that engineers should

consider the construction as it exists when occupied rather than at an age of 28 days. In establishing design methods and stresses it also would seem that the designer should develop his design on the basis of the strength of the materials which can be expected at a period of 90 days after the concrete is placed. In doing this, due account should be taken of the ratio of moduli of elasticity of the steel to the concrete at these stresses.

Design methods in use at present, covering 1-2-4 concrete, provide that the ratio of moduli of elasticity be taken as 15, and it appears from the limited data of this nature available that this ratio is approximately correct if we consider only developing a stress in the concrete of 2,000 lb. per sq. in. The stress strain diagram for 1-2-4 concrete, shown in Fig. 7, shows clearly the change in the value of  $E$  for concrete, as the stress on the concrete is increased up to 2,800 lb. per sq. in. It will be noted that at a stress of 2,600 lb. per sq. in. on the same concrete  $E$  becomes 1,300,000 and that in consequence  $N$  would become 23. In Table 1 is given the percentages of steel resulting from the use of certain values of  $f_s$ ,  $f_c$  and  $N$ . In the third row the stresses developed at the bending moment used in

\*Continued from our issues of December 11-18, 1918, and January 8-22, 1919.



the design are given in case  $N=10$  instead of the values given at the head of the various columns. In the fourth and fifth rows will be found the stresses developed in the concrete where  $f_s$  is limited to 60,000 lb. per sq. in. and  $N$  has values of 20 and 25 respectively. In these columns will also be found the values of  $R$  which, being equal to  $M/bd^2$ ,

$N$  changes to 25, then, from the fixed percentage of steel in the member,  $f_c$  becomes 1,930 lb. per sq. in.

In the sixth row is given the values of "d" for a bending moment of 86,500 in. lb. obtained by using the various stresses and values of  $N$  given at the head of each column. The seventh row shows the number of pounds of steel per square foot required in these slabs for the same bending moment. The eighth and ninth rows give the cost per square foot of a concrete slab of the thickness shown in the sixth row and containing the amount of steel shown in the seventh row. In the eighth row the cost of steel in place is taken at 3c per lb., while in the ninth row it is taken at 4c per lb. The concrete in each case is taken at 30c per cu. ft. While these steel costs do not directly apply at the time this article is written, it is probable that, in a short period of time, the cost of steel in place will lie between these two figures. The cost per square foot, of course, takes no account of all the constant items such as formwork, finishing and fireproofing. In the tenth row is given the factor of safety, considering stresses only, and obtained by limiting the steel stress to 60,000 lb. per sq. in. and assuming that at the concrete stresses developed and shown in the fourth and fifth rows that the value of  $N$  lies between 20 and 25 when the concrete is 90 days old. Since the factor of safety does not vary much as  $N$  changes from 20 to 25, average values are given. It will be observed that with the concrete stress in the design ranging from 700 lb. per sq. in. to 1,600 lb. per sq. in. and the value of  $N$  varying between 8 and 15 that the factor of safety based on a limiting steel stress of 60,000 lb. per sq. in. varies only between 2.82 and 3.25. It also will be observed that using stresses of either 1,200 or 1,600 lb. per sq. in. on the concrete and 20,000 on the steel has little effect on the cost of the construction. Of course, if a value of  $N=15$  were used with these concrete stresses, slightly more concrete would be used and a little less steel. The factor of safety, however, would be reduced and the cost of the construction again would not be materially changed. It is not believed that sufficient data has been published at this time to allow a determination of the combination of stresses and value of  $N$  which would give us a reasonable factor of safety and at the same time produce the most economical structure. It would appear, however, that the present concrete stress used is too low, provided, of course, we have reasonably good supervision. An examination of this table would seem to indicate that the use of  $f_s=20,000$ ,  $f_c=1,200$  and  $N=10$  would result in concrete stresses well within the strength of the construction at an age of 90 days. A design made on this basis, with the bending moments suggested in a previous

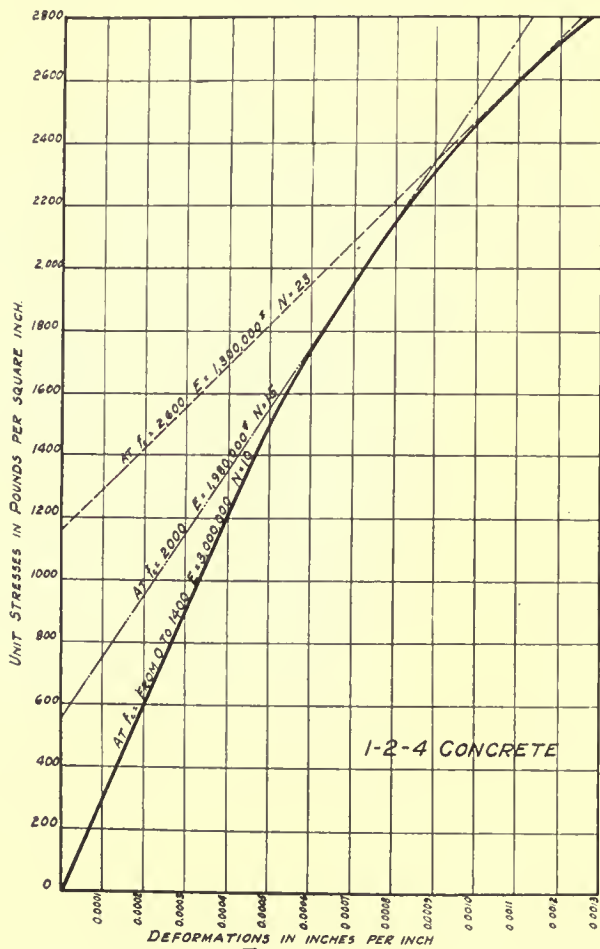

FIG. 7.

are the measures of the resisting moment of the construction at or about its elastic limit. The writer decided to use  $f_s=60,000$  lb. per sq. in. for the reason that the tensile resistance of the concrete below the neutral axis would probably have the approximate effect of raising the elastic limit of the reinforcing steel generally used from 50,000 to about 60,000.

Attention is called to the fact that the relations between the concrete stress and the steel stress developed by any given bending moment depends entirely upon the percentage of steel used and upon  $N$ , thus, as in the case of a design prepared using  $f_s=18,000$ ,  $f_c=700$  and  $N=15$ , we obtain a percentage of steel of 0.716. Now, if the bending moment is increased so that  $f_s$  becomes 60,000 and



# THE AMERICAN ARCHITECT

article, would make a sufficient saving in the cost of the construction to largely offset the increased cost of materials, and this construction would have a theoretical factor of safety of about 3, and an actual factor of safety of more than this. The stresses shown in Table 1 are all calculated on the basis of the straight-line formula. While this formula is not strictly correct, the use of it tends slightly to

days, or to a value of 120 lb. per sq. in. Provision is also made that two-thirds of the total shear be provided for by the introduction of stirrups. Tests now being carried on by the Emergency Fleet Corporation in the development of concrete ship design show that this limitation is unreasonable, provided the diagonal tension is properly provided for by reinforcement. In the design of concrete ships,

TABLE 1

Case		1	2	3	4	5	6	
1	Design stresses	$f_c$	18,000	18,000	20,000	20,000	20,000	20,000
		$f_s$	700	1,200	1,200	1,600	1,200	1,600
		N	15	10	10	10	8	8
		R	113	208	197	340	174	271
2	Per cent of steel	0.716	1.34	1.13	1.79	0.975	1.56	
3	If N = 10 For B. M. figured in design	$f_c = 800$ $f_s = 17,600$ R = 113	$f_c = 1,200$ $f_s = 18,000$ R = 208	$f_c = 1,200$ $f_s = 20,000$ R = 197	$f_c = 1,600$ $f_s = 20,000$ R = 304	$f_c = 1,100$ $f_s = 20,200$ R = 174	$f_c = 1,490$ $f_s = 20,200$ R = 271	
4	If N = 20	$f_c = 2,100$ $f_s = 60,000$ R = 372	$f_c = 3,140$ $f_s = 60,000$ R = 665	$f_c = 2,800$ $f_s = 60,000$ R = 570	$f_c = 3,850$ $f_s = 60,000$ R = 880	$f_c = 2,540$ $f_s = 60,000$ R = 493	$f_c = 3,480$ $f_s = 60,000$ R = 766	
5	If N = 25	$f_c = 1,930$ $f_s = 60,000$ R = 369	$f_c = 2,930$ $f_s = 60,000$ R = 665	$f_c = 2,600$ $f_s = 60,000$ R = 560	$f_c = 3,590$ $f_s = 60,000$ R = 862	$f_c = 2,350$ $f_s = 60,000$ R = 490	$f_c = 3,250$ $f_s = 60,000$ R = 753	
6	d =	8 in.	5.9 in.	6 in.	4.85 in.	6.45 in.	5.17 in.	
7	Steel per sq. ft.	2.34 lb.	3.22 lb.	2.76 lb.	3.55 lb.	2.56 lb.	3.29 lb.	
8	Cost per sq. ft. conc. 30c per cu. ft. steel 3c per lb.	27c	24 $\frac{1}{2}$ c	23 $\frac{1}{4}$ c	22 $\frac{3}{4}$ c	23 $\frac{3}{4}$ c	22 $\frac{3}{4}$ c	
9	Cost per sq. ft. conc. 30c per cu. ft. steel 4c per lb.	29 $\frac{1}{3}$ c	27 $\frac{2}{3}$ c	26c	26 $\frac{1}{4}$ c	26 $\frac{1}{4}$ c	26c	
10	Factor of safety	3.25	3.2	2.87	2.85	2.82	2.82	

increase the factor of safety, and the writer feels that, since the results obtained from it would not vary materially from those obtained by the use of the parabolic formula, the straight-line method of analysis should be retained.

Under the various building ordinances and committee rulings now in existence, 1-2-4 concrete is considered in the design as safely resisting an extreme fiber stress of from 500 to 800 lb. per sq. in. Many entirely satisfactory buildings are in existence to-day where the actual extreme fiber stress, occurring when the building is subjected to its design load, exceeds materially the 1,200 lb. per sq. in. stress developed under the method of design suggested. These stresses are generally those resulting from negative bending and occur simply as a result of engineers having become accustomed to providing more carefully for the positive bending moments than for the negative.

Most ordinances limit the shear in a reinforced concrete beam to 6 per cent of its strength at 28

shear as a measure of diagonal tension is limited to 500 lb. per sq. in. on concrete having a crushing strength of twice that assumed in building construction. This would seem to indicate that with correct diagonal tension reinforcement the shear limitation might be increased to about 12 per cent of the strength of the concrete.

The floor constructions now in general use have been developed to produce economical structures conforming to the design methods and stresses now required. The revised methods of design suggested in these articles and the increased stresses would, of course, result in modifications of our present more or less standard forms of construction to meet the new conditions involved. Paying more attention to negative bending moments and reducing the positive bending moments would, for instance, lead designers to use haunches on beams instead of the flat bottom beams now in general use. The same remark might apply also to concrete slabs.

(To be continued)

# Industrial Information

*In this Department there is published each week information as to the development of materials and methods derived from reliable sources.*

## Pee Gee Paints

A volume of comprehensive and convincing character has been prepared by the Peaslee-Gaulbert Co., Louisville, Ky., describing "Pee Gee" paints, stains and varnishes.

The many common uses of paint and paint products are discussed in distinct departments. In each instance exact color charts accompany the text, from which architects may select exactly what they require, with the assurance that that and nothing else will be obtained. Directions for using and price schedules make this book of particular value in permitting intelligent specification.

Under each division, helpful suggestions are given as to the proper functions of paints, stains and varnishes and analyses of the elements which make one kind of product superior to others for the accomplishment of a particular purpose.

Mastic paint as made by the Peaslee-Gaulbert Co., it is stated, is used with great success on the exteriors of suburban houses. Many effective examples of these are carefully illustrated in typical colors, each with proper identification.

For wall covering, "Pee Gee" Flatkoatt has a wide range of possibilities; these are also illustrated in the original colors, and suggestive stencil borders are added. A logical and interesting exposition of the advantages obtainable by paint as a wall decoration is also presented. Many well-designed interiors, both of dwellings and public buildings, are reproduced in colors prepared by this company.

Pee Gee Dyestain makes possible practically every color or combination of colors known in finishing modern interior woodwork, floors, or furniture. Its use does not raise the grain of the wood, but strikes into and brings out its natural beauty, leaving a perfectly smooth surface for finishing. This material contains depth of tone and richness, covers a large surface, dries quickly, and will not rub up. The results of its use are again illustrated by color charts of excellent quality.

Several pages are devoted to Pee Gee wood fillers and varnishes for both interior and exterior use. Pee Gee China enamel for interior wood, plaster, brick or metal work, and Adamant floor paint, which apparently fills every requirement for such an article are also produced by this company.

Porch paint, furniture paint, roof paint, galvanite for use on galvanized iron, flat brick colors, Pee

Gee Portlanite for concrete surfaces, Pee Gee black insulating paint, a product for sub-surfaces, said to be waterproof, acid and alkali-proof and not affected by steam or gaseous fumes; Pee Gee Ferronite, a rust preventive for structural metal—these are some of the materials furnished by the Peaslee-Gaulbert Co. and shown in this book.

Architects are commended to the acquaintance of a volume so complete in its discussion of one of the commonest needs and best assets of any building.

## Self-Sentering

"Self-Sentering" is a type of expanded metal reinforced for concrete construction, which is in itself a combined reinforcing and centering—a one-piece steel lath and stud. In describing this, The General Fireproofing Co., Youngstown, Ohio, who manufacture it, state that the heavy ribs of Self-Sentering are cold drawn, a process which increases tensile strength and elasticity. The diamond mesh used is an efficient form of expanded metal reinforcement, the parallel sides make for maximum rigidity, and the beaded edge, where rib and diamond mesh are joined, still further stiffens the whole sheet. It is stated in the folder on Self-Sentering, issued by this company, that the diamond mesh fabric gives an excellent bond for concrete and plaster. At the same time its peculiar construction provides great reinforcing value, diffusing strain from concentrated loads, and by its perfect continuity insuring that every ounce of metal is in tension. There are no breaks at right angles to the line of stress.

Self-Sentering may be used advantageously for concrete roofs, floors, walls, ceilings, partitions, columns and beam protection.

Reinforced concrete, at once fire resisting and enduring, makes an estimable roof. The only hindrance in its wider use for roofing purposes has been its comparatively high cost and weight. Self-Sentering, the makers claim, overcomes both these obstacles, first, because no forms are required, the heavy ribs giving ample rigidity to support the weight of the wet concrete; second, because the large sheets permit rapid erection with minimum labor; third, because the slabs need be but 2 in. thick, thus reducing the dead load, and not only saving material and labor on the roof itself, but permitting the use of lighter supporting members.



12  
42-5046 20

# The AMERICAN ARCHITECT

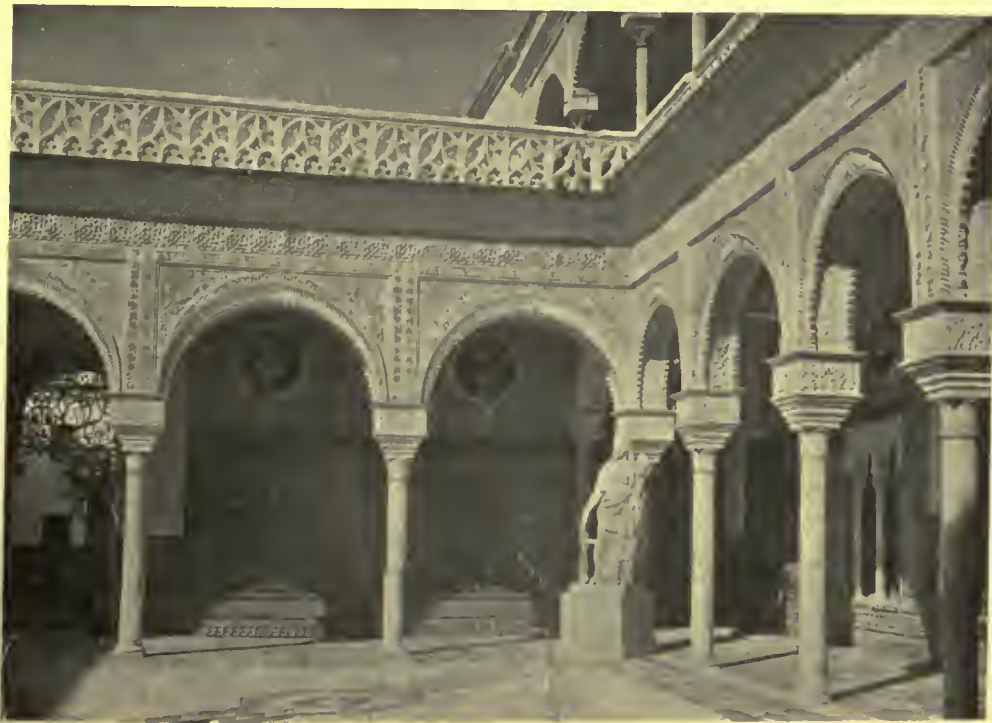

PATIO, CASE DE PILATOS, SEVILLE, SPAIN

PUBLISHED WEDNESDAYS IN NEW YORK—FOUNDED 1876  
VOLUME CXV                      FEBRUARY 5, 1919                      NUMBER 2250

Entered as second class matter January 6, 1909, at the Post Office at New York, N. Y., under the Act of March 3, 1879. Publication office, 243 West Thirty-ninth Street, New York, N. Y. Subscription price in the United States and Possessions, \$10.



# RAYMOND

It is as though a searchlight played upon every step in the making of a Raymond Concrete Pile, so free from doubt does this method render perfect concrete pile construction. An expanded core or mandrel is encased in a spirally reinforced steel shell.

The combination of core and shell is driven to proper refusal. *You can see it.*

The core is collapsed and withdrawn, leaving the shell in the ground. *You can inspect the shell interior.*

The shell is then filled with concrete. The shell remains in the ground. Simple and CERTAIN isn't it?

A Form for  
Every Pile

A Pile for  
Every Purpose

Raymond Concrete Pile Company

New York: 146 Cedar Street

Chicago: 111 West Monroe Street

Montreal, Canada: Raymond Concrete Pile Co., Ltd.

Branches in Principal Cities









BRAMANTE DA VRBINO ARCHITETTO

*J. Vasari T. II.*

*J. Batt. Cecchi Sc.*  
53



# THE AMERICAN ARCHITECT

VOL. CXV

WEDNESDAY, FEBRUARY 5, 1919

NUMBER 2250



## House of Allan S. Lehman

Tarrytown-on-the-Hudson, New York

JOHN RUSSELL POPE, *Architect*

**J**UST what service means in the correct practice of architecture can in no better way be demonstrated than by reference to a work in architecture such as Elmbrook, the house of Allan S. Lehman, at Tarrytown, N. Y., designed by John Russell Pope, and fully illustrated in this issue.

Will a man be known as any less of an artist because, having beautifully designed a stately country house with all its furnishings and many accessories, he has also, through a large and efficient organization of which he is the dominating spirit, brought to successful completion every detail? It is

with considerable satisfaction that THE AMERICAN ARCHITECT has received permission to present this example of domestic architecture to its readers.

The accusation which has been made and patiently borne, that in claiming architecture is a business the profession has been denied the right to the title of artist, could be no better refuted than by reference to Mr. Pope's work. The contention recently stated in an architectural journal that architects could with propriety ignore most of the often monotonous and commonplace phases of the superintendence of their work, contenting themselves with the perfection of

## THE AMERICAN ARCHITECT

the design and plan, does not hold good. Taking a job such as this dignified example of the best Tudor traditions, let us analyze just what has taken place—not from a purely suppositional viewpoint, but one that is based on actual investigation. First a perfectly equipped organization takes the client in hand at a time when the only well-defined purpose he has in mind is that he wants to build a house on which he will only expend a determined sum of money. There is a certain mental equipment that the archi-

bies, his temperamental habits, even his daily occupation must be considered.

All these things having been fully learned, then the architect becomes an artist, and with his client as the model, he designs a house to fit him. The artist-architect is now fully in evidence. At last the final conference has been held, the last major change made, and the work goes forward.

Just here enters the business man. Certainly it is a business to co-ordinate all the trades and crafts



PLOT PLAN

tect must possess in a case like the present one, where an expenditure bordering on a quarter of a million dollars will represent the total investment.

Before he places in evidence his ability as an artist he must prove his competency as a student of character. The architect must study his client in the same way that he will next have to study his plan. Ready-made houses, like ready-made clothes, seldom perfectly fit. So, then, the architect must study all the "mental contours" of his client, so as to give him a most accurate fit. His fads and hob-

bies, which combine to bring this artistic creation to perfection. Let no one contend that at this point the architect may turn over to a well-drilled organization all the many and complex things; any one of which means, as it is handled, either waste or saving to his client. He may, of course, delegate to others certain details and routine, but he must be constantly in touch with every phase, quick to detect error of business acumen, in order to direct and control every phase of the work.

Personally will he give service, standing before



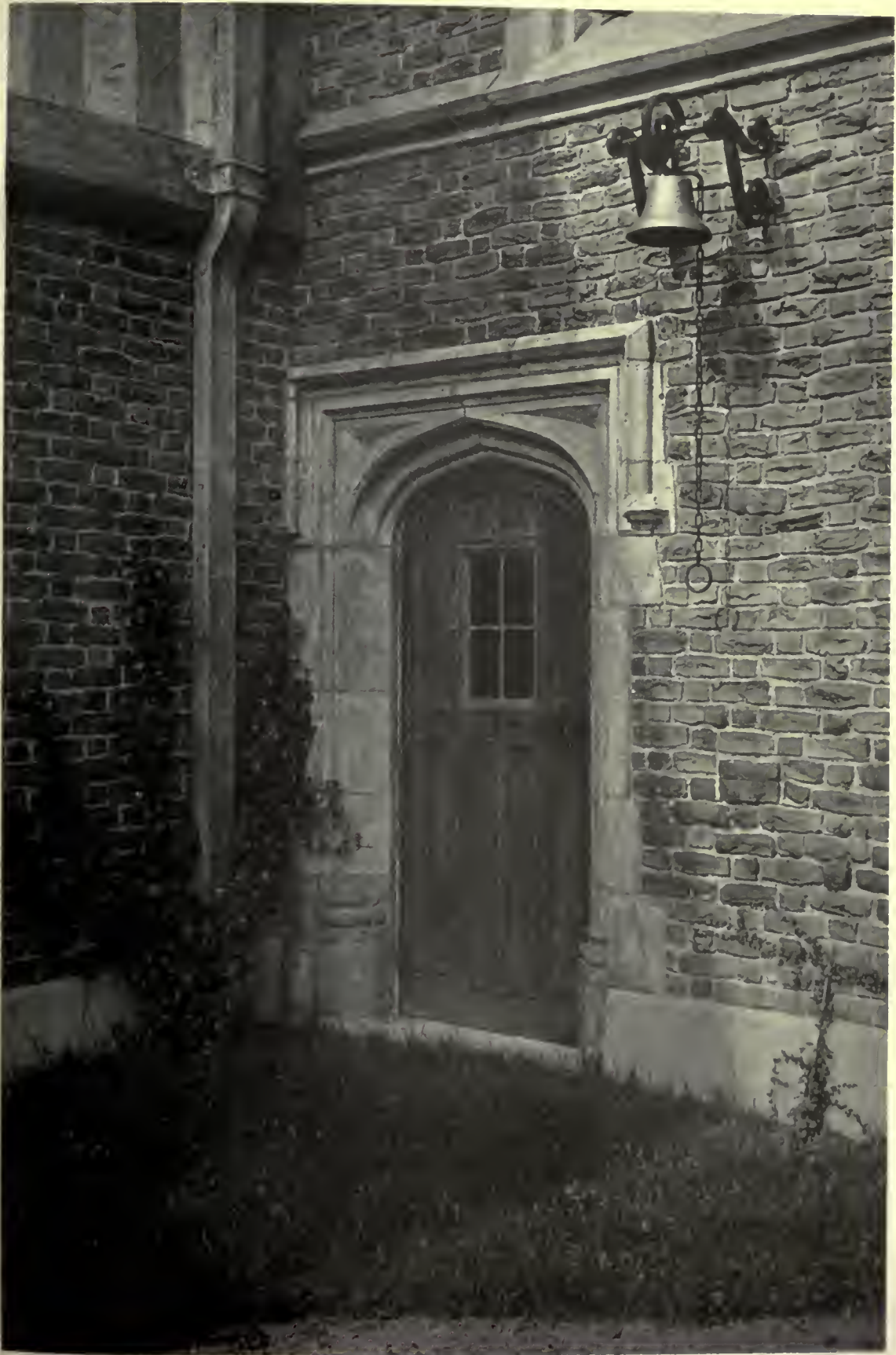

STAIRHALL ENTRANCE  
HOUSE OF ALLAN S. LEHMAN, TARRYTOWN-ON-THE-HUDSON, NEW YORK  
JOHN RUSSELL POPE, ARCHITECT



## THE AMERICAN ARCHITECT

the structure at each critical period. Visualizing the thing as he created it in his mind's eye, he makes it grow in harmony with his artistic perception. These things can, of course, be turned completed over subordinates. When they are, the difference is as between the *average* house and one like this.

Clients differ. Some will not quietly stand hitched. When the building is completed, they may therefore discharge their architect and deliberately proceed to mar his work by atrocious decoration and poorly selected furniture. But as we had occa-

tion, to divorce his artistic activities from his well-trained business abilities. Now, knowing as in this instance, that a house has been built within the limits of the original appropriation, here again the business man appears. All the wonderful refinement which has been displayed in this building, all the many contingencies which may at any time appear, have all been foreseen and met. This is simply the practice of architecture in this twentieth century. Can it be successfully denied?

Perhaps some will point to an organization of skilled assistants of keen estimators and specifica-



SOUTHWEST VIEW

sion to remark when we previously illustrated a house by Mr. Pope, he is able so to impress upon his client the need of consistency to the last detail, that in this house, as in many others, he has selected or designed every important element that constitutes its interior fitting.

Here we have another phase of the architect's many-sided activities, and here again, starting with the most correctly trained artistic ideals, he becomes the man of business. In fact, it does not seem possible in following an architect in the progress of an important job from its inception to its comple-

tion writers, of a routine business organization that is a model. All of these things are conceded, but must it not also be conceded that they have been assembled, organized, drilled and perfected in every detail by the controlling mind of the artist whose work they are carrying forward, by the architect who of necessity is a business man and the head of an organization whose watchword is Service?

These things, it would seem, can be logically claimed as the correct attitude of the modern architect toward his work. If it is necessary, as it seems to be to many, to assume a "pose" toward profes-



SERVICE GATE



MAIN ENTRANCE

HOUSE OF ALLAN S. LEHMAN, TARRYTOWN-ON-THE-HUDSON, NEW YORK  
JOHN RUSSELL POPE, ARCHITECT



## THE AMERICAN ARCHITECT

sional practice, how much more to the material advantage will it be, not omitting the result toward one's own self-respect, to affect a pose of absolute practical competency, than that of an ultra aestheticism where every studio gesture and affected mannerism suggests a cloak to hide the lack of ability.

The end crowns the work. The completed house, as herein illustrated, needs little, if any, description to enable the technical observer to realize its dominating style, its features of design, or the many

ture and successful planning. Can any profession seek a higher reward?

Less than a quarter of a century ago the houses of our rich men shouted aloud in the garishness of their new paint and gilding, inside and out, to every beholder. All of this is now changed. Here we have a modern house with all the outward aspect of a venerable, well-spent number of years. It commands respect, and to every intelligent onlooker there is a deep-seated admiration for a result



LIBRARY

attractive accessories that have been selected and installed by the architect. This house is one of a constantly increasing number which are being erected by men of wealth, wherein they may find opportunities far from the scenes of commercial activity for domestic relaxation and the pleasing company of chosen associates. Amidst such surroundings, shorn by the artistic skill of the architect of all the elements of the vulgarity of recent construction, a man may carry on his life, rear his children and find growing contentment. And all of these things are the direct result of good architec-

that, founded on the most thoroughly trained artistic knowledge, has, by a perfectly co-ordinated organization, created a thing of beauty and a joy as long as it shall exist.

To the technical man there is a certain dramatic appeal to this house, and it lies in the selection of the brick, stone and slate used, and its treatment to simulate the weathering effects of time. These effects are accented by the grey timbered gables, the quaintly patterned brick with its wonderful textures and the towering chimneys. Naturally a structure so correctly designed in form would also have





GREAT HALL

HOUSE OF ALLAN S. LEHMAN, TARRYTOWN-ON-THE-HUDSON, NEW YORK  
JOHN RUSSELL POPE, ARCHITECT

## THE AMERICAN ARCHITECT

equally well placed color. This effect cannot, of course, be shown in the illustration so as to give the reader an approximate idea; it may be set down that the color ranges from a greyed burnt Sienna and brown-grey timbering to a yellow-grey stone with the added effect of warm-toned stucco. The advantage that has been taken of a most favorable natural setting is apparent. The location on the site of timber of many years' growth has contributed very largely to the effect of age in the general ensemble.

The plan is so simple and direct as to require but brief allusion. Following the precedent of the Tudor mansion, the Great Hall is the point or place about which are grouped the various rooms which constitute the entire plan. The early usage of the Great Hall as a place of circulation and assembly is retained, and it is here that centers the domestic life of the household. The magnificent proportions of this hall are well shown in the illustrations, as is also the Great



BOUDOIR



DINING ROOM





DINING ROOM  
HOUSE OF ALLAN S. LEHMAN, TARRYTOWN-ON-THE-HUDSON, NEW YORK  
JOHN RUSSELL POPE, ARCHITECT



## THE AMERICAN ARCHITECT

Hall window, which faces the west. This window is fourteen feet wide and extends to nineteen feet above the floor. Opposite the window, and in what is in a certain sense an angle-nook, is the large stone mantelpiece.

The living room, next to the hall in importance, is marked by austere simplicity and the refinement of good taste. The stair hall, extending through two stories, is open and well lighted. It conserves all the dignities of the major subdivisions of the plan and has been so placed as to solve successfully

the problems in planning on the second floor that a feature of this sort always presents.

It is scarcely necessary to refer further in description to a house that is herein so fully illustrated. It undoubtedly presents in all its various aspects the most valuable opportunity to study the evolution in this country of a dignified and fitting country residence of large cost, and at the same time it affords an opportunity to observe by a concrete example the many-sided aspects of successful modern architectural practice.



DETAIL OF GABLE OVER ENTRANCE

THE AMERICAN ARCHITECT

Founded 1876

PUBLISHED EVERY WEDNESDAY BY

THE ARCHITECTURAL AND BUILDING PRESS, INC.

No. 243 West Thirty-ninth Street, New York

E. J. ROSENCRANS, PRESIDENT AND TREASURER

WILLARD C. HOWE, VICE-PRESIDENT

WILLIAM H. CROCKER, Editor

ARTHUR T. NORTH, Engineering Editor

Subscriptions in the United States and Possessions,  
Mexico and Cuba, TEN DOLLARS. Other Countries,  
TWELVE DOLLARS.

SINGLE COPIES (Regular Issue) 25 CENTS

CHICAGO OFFICE, Mallery Building

PAGE A. ROBINSON, Western Manager

ST. LOUIS OFFICE, Wright Building

CLEVELAND OFFICE, Guardian Building

SAN FRANCISCO OFFICE, 320 Market Street

Owned by United Publishers Corporation—H. M. Swetland, President;  
Charles G. Phillips, Vice-President; W. H. Taylor, Treasurer;  
A. C. Pearson, Secretary. Entered as second-class matter January  
6, 1909, at the Post Office at New York, New York, under the Act of  
March 3, 1879.

VOL. CXV FEBRUARY 5, 1919 No. 2250

## Psychological Test in Student Examinations

"HAVING conquered the army," says the *New York Sun*, "the psychologist now storms the University." This remark is suggested by the statement from the authorities of Columbia University that it believes there is large waste in the use of its expensive plant and operating force on great numbers of students who are incapable of profiting seriously by higher education.

It will therefore be the policy of this University to weed out its students by a psychological and physiological inquiry. The customary entrance examinations will not be dispensed with but candidates for admission who are able to present the usual certificates that they have done the required preliminary work may elect to take the new test instead of the examinations. "In this action," comments the *New York Times*, "there seems to lie a weakness, for the student of subnormal mentality who might be coached to pass the entrance examinations but would be of no use thereafter, is likely to elect the test which he can pass by cramming rather than the psychological inquiry which would reveal his unfitness. But whatever the defects of the plan, its

very adoption is an indication of the tendency of educational authorities to revolt at the hampering of able and willing students, and the waste of the teacher's time, which comes from the prevalence in past years of the notion that college was a convenient, if temporary, asylum for harmless morons."

This blunt statement of a past condition accents the necessity for a reform in the selection or rejection of students who apply in the future for admission to all of our colleges and universities. It is not fair to that class of able men who conscientiously pursue work in our universities that they should be hampered in their progress by students whose right to enter classes may be very properly questioned.

There is also danger that in the effort to secure just the type of student who will be best fitted to receive the benefits of university courses, the system may be carried by too academic measures to a point where there would be set up an aristocracy of education. If the college is to be regarded as of service to the nation, it becomes a debatable question whether such service will best be rendered by the intensive cultivation of a carefully selected few or by the present open method that admits without question any candidate who may successfully qualify for admission.

The point is well presented in the article in the *Times* above referred to, wherein it is stated:

"In the newer parts of the country the universities, and even more, the small colleges, perform a very considerable service by their effect upon men who may never graduate, but who still leave college better equipped for life than when they entered. Students from rural or semi-rural environment who leave college without a degree but with better standards of taste or deportment, with business experience such as might come from managing the football team or the glee club, with ability to talk, to 'mix,' to reason on problems for practical decision—even with such minor bits of knowledge as what fork to use—they may not have got all that college has to offer, but they have got a good deal that will be useful in their future life."

A very valuable service that could be given by a university psychologically administered as is proposed at Columbia, would be in the determination along what lines each student might most advantageously pursue his studies.

The present method wherein the student may personally select the course of study he desires to follow, leads to many errors. The world is full today of these "misfits" and no profession suffers more from their presence than does architecture.

If the student cannot be denied a college training once he has passed the necessary entrance examinations, he might be denied the privilege of self-determination as to the exact course he will pursue. He should go in right and continue right, else he should not go in at all.



## American Academy of Arts and Letters, and the Matter of Memorials

IT is reassuring to learn that the American Academy of Arts and Letters, of which the venerable William Dean Howells is president, has issued a public statement and appeal that all memorials to the valor of American soldiers, sailors and marines in the great war be of the highest artistic merit.

Action of this nature by a leading art society has become imperative, for, judging by the hysterical and ill-advised letters published in the daily press, there is grave danger of the commission of many artistic errors. In its statement the Academy endeavors to impress the fact that these memorials should express the best in art that we have in this country, and that the best is none too good for even the smallest village. Reference is further made by the Academy to the National Commission of Fine Arts created by act of Congress, and the admirable effect that this commission has had upon the character of the national memorials.

Similar commissions in states and municipalities have been doing good work, but it is necessary that the supervision of the memorials to be erected everywhere be undertaken by equally artistically competent authority.

THE suggestion that trees when well planted would serve as fitting memorials in small communities where the question of expense must be carefully considered, is one to be highly commended.

A cluster of oaks or elms, surrounded by a well-designed fence with stone seats and appropriate tablets would beautifully commemorate the valor of a town's heroes. It would be impossible in the future to divert the significance of such a memorial, and the trees would necessarily receive the care that would result in their well developed growth.

The Washington Elm, on Cambridge Common, is an example of what the tree as a memorial means. This historic spot, marking the place where Washington assumed command of the American Colonial Army, is visited annually by thousands of people, and as a memorial to a great American is no less im-

pressive than the many hundreds throughout the country, erected at great expense, in honor of our first president and distinguished soldier.

## A Movement to License the Engineering Profession

AT the recent meeting of the Ohio Engineering Society held in Columbus, the principle of licensing engineers was approved by a unanimous vote and a plan outlined for a study of the subject by all engineering organizations in the State of Ohio, in order that a generally acceptable bill might be drafted. This action on the part of Ohio engineers was taken as the result of an address by Mr. C. E. Drayer, secretary of the American Association of Engineers.

There is undoubtedly a necessity for the licensing of the engineering professions for the reasons that it would provide additional safety to the general public, that it would insure an increased efficiency and thus would effect a very considerable saving.

An interesting feature of Mr. Drayer's remarks before the meeting was his insistence that any licensing law should not only include civil engineers and surveyors, but all branches of the engineering profession, civil, mechanical, electrical, and mining. This inclusion of all branches would seem to be logical, as the line dividing them in almost every phase of professional work is more imaginary than real.

Reasoning from analogy, one may ask the proponents of licensing all branches of the profession, why are not doctors examined only on the basis of the branch of the profession they practice instead of in medicine and anatomy, or why are not lawyers who will practice corporation law alone examined only in that branch instead of all the principles of the practice of law? It is but common sense to urge the examination of all engineers in the fundamental elements common to all branches particularly with reference to actual practice. This covering of the entire profession would very much simplify the drafting of a law that would receive general acceptance. In any event, the movement is one of particular importance and its progress will be watched with considerable interest not only by engineers but by architects as well.





# Criticism and Comment

## Federating State Societies

*The Editors, THE AMERICAN ARCHITECT:*

Your editorial on State Societies in the issue of January 8 reminds me of an altogether unintentional remissness on my part toward certain communications which have come to me during this past season from your sanctum. These letters, bearing upon architectural practice, possible post-war conditions surrounding the building industry, and certain internal policies of your own, came to me while my mind was engaged on problems as remote as possible from the contemplation of such subjects.

For six months beginning in May, 1918, I was engaged as "Assistant Examiner" for the District of the Great Lakes in smoothing labor conditions in the shipyards and in interpreting and administering the award of "The United States Shipbuilding Labor Adjustment Board." You may easily imagine that this strenuous work, involving travel, conferences and judicial hearings, left little time or inclination for architecture, at that time a dormant issue to which I am but now free to turn. Of one thing I have been certain, and of which my recent experience has made me more certain: that the war has not changed human nature; certainly not in this country, where the lessons have been but superficially impressed upon us. There will still be ethical and unethical, dignified and undignified, practitioners in all the professions, including architecture. The nature of "democracy" will continue slowly and painfully to reveal itself, and with that revelation will come a fuller understanding of the value and necessity of high leadership; an appreciation of the function of leadership in leavening the mass. As I review the immediate past it seems to me that there has been present too potent an element of hysteria and confusion; hysteria as to the outcome of conditions, confusion as to leadership and the mass. Personally, though, I refuse to be one of the mass, that is, to sink my ideals to the level of the mass; I am content to let the mass move in its own way, trusting that sooner or later it will yield to the influence of high leadership. As one of the paths toward the higher plane, I regard State Societies of professional bodies; and as ministering to the general unification of ideals I welcome an affiliation of such societies.

But to be specific, when all has been accomplished in the way of forming and amalgamating State So-

cieties of Architects, there will always be an idealism a little in advance; there will always be a need of the leader, the one to whom all must look for the expression and interpretation of the finer professionalism. The American Institute of Architects holds that place to-day and will continue to hold it if it does not yield to clamor from without and debasing elements within. An amalgamation of State Societies has its place and the Institute has its, and the place of the Institute is that of professional leadership which can be abandoned only at the expense of the highest good. It is only as a moralist that I am concerned with the ethics and antics of architectural practitioners outside the Institute. They will "compete" all they please and as they please; they will "advertise" all they please and as they please; they will many of them "graft" all they can, but let them not force the Institute to formulate a code of their unprofessionalism.

The Institute has never directly interfered with the outsider's practice, has never assumed to dictate to the outsider or to those who employ him; and if the outsider thinks it has it is but the stirring of his own guilty conscience. If the Institute has any standing before the public and in the profession, it is because a loyal, far-sighted, ethical body of men have sought to uphold its standard—to set its standard—and the public and the profession recognize the validity of that standard, whether they follow it or not. Let the State Societies organize and let the Institute join in the good work, not as a camp follower, but as a leader; not lowering its own standard, but helping to raise the standard of the others. Let not the Institute, nor any organization of architects outside, conceive that it is its function to build up the profession as a profession at the expense of the public. Let architects recognize the value and service of engineers and contractors and their rights and obligations, and differentiate only as to how far the architect may be of higher service and fulfill deeper obligations. In the end the differentiation will come from the outside; for eventually an enlightened public—enlightened by high leadership—will determine who shall build its buildings and furnish the material covering and expression of its social and industrial spirit. That leadership today, in the elements of culture, ethics, force and economic penetration and spiritual illumination, will fall to the architect—naturally to the Institute as fostering the architect's ideals—but the architect should make good, demonstrate his

## THE AMERICAN ARCHITECT

capacity for leadership, and cease the whinings in the architectural press which of late have arisen almost as a chorus.

IRVING K. POND.

Chicago, Ill.

*The Editors, THE AMERICAN ARCHITECT:*

The articles by Mr. Daniel Paul Higgins in the Jan. 1 and Jan. 8 issues on Architectural Office Organization indicate that Mr. Higgins has no place for the Quantity Surveyor, although he recognizes that the Quantity Survey methods followed in England do protect a building owner's financial interest. This is necessary there, Mr. Higgins would seem to have us believe, because of the English architect's lack of structural or business knowledge.

I am not competent to draw comparisons between the architects of various countries, but I know that the architects of England and other European countries who use the Quantity Survey methods do thereby exhibit sound business sense and appreciation of the interests of the building public. They use methods to keep down cost, to supply a basis upon which true competition can flourish, as compared with the speculative bidding in this country, and thereby protect both the owner and contractor by a contract based on known requirements.

Mr. Higgins approves of efficient methods, but some prejudice apparently founded on fear that Quantity Surveyors would take away some of the architect's prestige or dignity obscures for him the fact that the Quantity System is the most efficient way of doing one of the necessary parts of the routine work of a building project. Speaking for my company as representing American Quantity Surveyors, we do not seek any of the architect's prerogatives, either architectural or engineering.

A Quantity Surveyor is fundamentally a measurer or computer of quantities. Whatever else he represents to individual architects is only incidental to that function. When the Quantity Surveyor becomes an organization of specialized experts, it usually does suggest matters in the course of its work by queries as to structural or other details which an architect will wish to consider or even incorporate in his drawings and specifications. The analysis such an organization makes of the drawings and specifications to determine the architect's intent is valuable to the best architect and a great assistance to a novice.

To quote from Mr. Higgins' article, "in these days of business efficiency, what is not good busi-

ness for the owner certainly in the end will not be good business for the architect." And again, "to do a deed with maximum intelligence using the most highly developed instrumentality possible is efficiency."

The above quotations are strong arguments for the Quantity System.

It is not good business or efficiency to waste money, but it is variously estimated that from 3 to 7 per cent of the cost of buildings is wasted in payment of unnecessary expense in quantity estimating. Applied to the country at large, this means a waste of from fifty to one hundred million dollars yearly. It comes about through the cumulative estimating expense that contractors carry. On an average, contractors estimate fifteen times as many jobs as they win. Therefore, from the money a contractor receives for any job, he pays for estimating on fifteen jobs that he bid on and lost. This necessarily increases the cost of buildings. Another way to appreciate this wasted effort is by considering the multiplicity of quantities prepared for a single job. For example, say ten general contractors bid. They make ten separate lists of quantities. For the sub-trades, about twenty in number, each general contractor will get say ten bids each. That makes 200 sets of quantities by sub-contractors to a single general contractor. For the ten general contractors, this might demand the preparation of 2000 separate sets of quantities by sub-contractors. Of course, some sub-contractors will make bids to all the general contractors. Allowing for this, it seems conservative to say that on a good-sized job at least 500 separate quantity estimates will be made.

The Quantity System corrects this condition. It provides that the necessary quantities for use as a basis for bids shall be determined accurately by a responsible firm composed of specialists in all trades and distributed without charge to all contractors asked to bid. Instead of multiplying the labor of quantity preparation, it is done once only and made available to all interested parties.

I have only tried to allay any fear among architects as to the purposes and aims of Quantity Surveyors and to point out that it is in line with good business and efforts to increase efficiency. There is much besides to be said in favor of the Quantity System which should suggest itself to any thinking man.

WILLIAM GRAVES SMITH,  
President, The Quantity Survey Co.  
New York.





PLATE 42

SOUTHWEST VIEW

HOUSE OF ALLAN S. LEHMAN, TARRYTOWN, ON THE HUDSON, NEW YORK

JOHN RUSSELL POPE, ARCHITECT





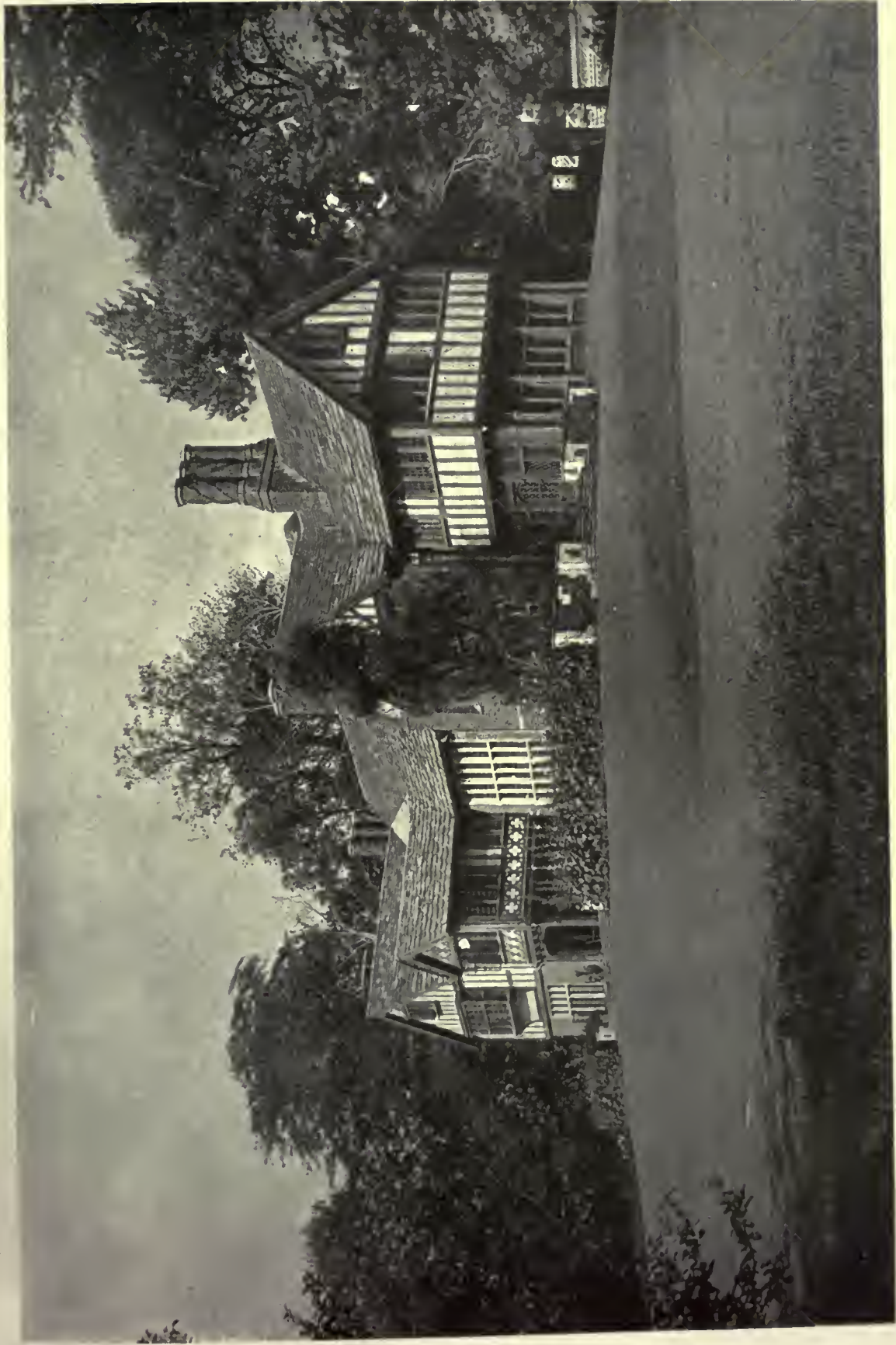

PLATE 43

NORTHEAST VIEW

HOUSE OF ALLAN S. LEHMAN, TARRYTOWN-ON-THE-HUDSON, NEW YORK

JOHN RUSSELL POPE, ARCHITECT







PLATE 44

MAIN ENTRANCE

HOUSE OF ALLAN S. LEHMAN, TARRYTOWN-ON-THE-HUDSON, NEW YORK

JOHN RUSSELL POPE, ARCHITECT







PLATE 45

DETAIL OF SOUTHEAST ELEVATION

HOUSE OF ALLAN S. LEHMAN, TARRYTOWN-ON-THE-HUDSON, NEW YORK

JOHN RUSSELL POPE, ARCHITECT







PLATE 46

DETAIL OF SOUTH ELEVATION

HOUSE OF ALLAN S. LEHMAN, TARRYTOWN-ON-THE-HUDSON, NEW YORK

JOHN RUSSELL POPE, ARCHITECT







PLATE 47

DETAIL OF NORTHWEST ELEVATION



DETAIL OF STAIR HALL BAY

HOUSE OF ALLAN S. LEHMAN, TARRYTOWN-ON-THE-HUDSON, NEW YORK

JOHN RUSSELL POPE, ARCHITECT





PLATE 48

STAIR HALL

HOUSE OF ALLAN S. LEHMAN, TARRYTOWN-ON-THE-HUDSON, NEW YORK

JOHN RUSSELL POPE, ARCHITECT







PLATE 49

GREAT HALL

HOUSE OF ALLAN S. LEHMAN, TARRYTOWN-ON-THE-HUDSON, NEW YORK

JOHN RUSSELL POPE, ARCHITECT







PLATE 50

LIBRARY

HOUSE OF ALLAN S. LEHMAN, TARRYTOWN-ON-THE-HUDSON, NEW YORK

JOHN RUSSELL POPE, ARCHITECT



# Financing the Expected Boom in the Building Trade—Part II

With the Stabilization of Prices for Material and Labor, Builders Now Put It Up to Lending Institutions to Reform Methods of Making Mortgage Loans. So Construction Can Proceed—Big Price Cuts Made—What Investors May Expect In Costs

**D**ESPITE views held by some of the leading members of widely known loaning institutions that only by the flotation of bond issues would the problem of financing mortgage loans for big construction projects be solved, a thorough survey of the situation brings out the general opinion that the best method is for lending companies to adopt the amortized mortgage system. The consensus of opinion in the building trade is that these institutions should insist upon a 25 per cent instead of the usual 10 to 15 per cent "upset equity" of the borrower, and upon a million dollar investment lend the usual 60 per cent of value, but by applying the principle of amortization gradually reduce the amount of excess loan to meet the assured lowering of war-time construction prices as reconstruction is gradually worked out. This, it is claimed in responsible quarters, will stabilize the construction market, prevent overbuilding, and at the same time have a tendency to relieve the "high cost of living" that keeps wage prices high.

Secretary Wilson of the Department of Labor has announced the Federal Government's policy of liberal construction, which is understood in the trade to mean that with everything else ready for a great construction market, including general price reductions on heretofore excessively costly equipments and materials, money also should be made as free.

Under this plan the borrower on a million-dollar building operation three years ago, under the present permanent plan of making mortgage loans, would be told that although the cost today would be a million dollars, the lender would only consider the cost equal to that of the same type of building erected five years ago, which would be around \$700,000. Therefore 60 per cent of that cost would be \$420,000, representing a permanent loan which is seldom paid off.

If the amortization plan were adopted, however, the loan would be made on the full value of a million dollars, which would represent a six hundred thousand dollar loan. In the course of five years, when, it is expected, building costs will

approximate normal, the lending interest will have been reduced to the basis upon which the borrower would have made the engagement.

A majority of the members of the American Institute of Architects, most of the prominent members of the Building Trades Employers' Association, practically all of the building material and distributing associations, as well as building investors, endorse the plan. When banking institutions were asked what they thought of the amortization method they gave out the statement that they had been asked by the Government not to make any big building commitments until after the Fifth Liberty Loan in April. To this, in an effort to start a nation-wide building revival at once, Secretary of Labor Wilson at Washington, co-operating with Roger W. Babson and Franklin T. Miller, replied:

"Inasmuch as the building industry is regarded by many as the means of facilitating the general industrial transition to a peace basis, it should have the encouragement of all interests. . . . Public construction will be helpful in mitigating conditions, therefore it is evident that private as well as public construction must be resumed before the country returns to normal conditions. Next to placing private funds in Government securities it is desirable that they be invested in enduring wealth, like construction. The accumulated earnings of the country should not be diverted into forms of wealth easily consumed and without earning power. Permanent investments of wealth will stabilize the moral and financial conditions of the country as a whole, as well as benefit the individual investor and his dependents. To bring this about all factors interested in construction must co-operate."

The situation seems to have boiled itself down to a case of what in the army is called "passing the buck" by the loaning interests. First they announced to the building and material interests that as soon as prices had been lowered and stabilized loans would be forthcoming. The material men co-operated, but no loans were made. So now the building trade has "passed the buck" back again with the rejoinder that the loaning interests change



## THE AMERICAN ARCHITECT

their methods of making mortgage loans so construction work can proceed.

To relieve the tension incident to the deplorable lack of building space many firms dropped their prices at once. Reports show that radiator prices were lowered 25 per cent; pipe fittings, 5 per cent; porcelain knobs, from 5 to 25 per cent; weather-proof wire, 3-4 per cent a pound; friction tapes, 2 per cent per pound; brass butts, 25 per cent; limoleums, 5 to 25 per cent; tools, 10 to 20 per cent. Considerable drops in prices are also contemplated by soil pipe interests and conduit manufacturers within a short period.

With regard to New York building, the labor situation is improving, the stabilized basis of 1918 instead of the sought for 1919 basis is apparently proving acceptable, with some modifications. These modifications have been at the request of the loaning institutions, and it was hoped that with the lower prices for materials, mortgage money would be released so that building construction could accept the new price basis and give the men employment.

That immediate action to prevent disastrous results is necessary is shown by the strangulation of demand, which has caused the complete closing down of the Eastern Portland cement industry, while the brick situation is so acute that Hudson river plants, closed for the winter, probably will not be opened until late in the spring. Other basic commodity plants are also either shut down or running at greatly reduced capacities. Reduced prices, therefore, are not just baits for the building investor, but acts of desperation. Authorities assert that if the reduced prices are not accepted now while the market needs support, when the Spring movement gets under way prices will be forced to much higher levels, and builders then will have to take their chance on supply.

The situation as to labor has materially changed in many sections in the past week. Twelve states report a surplus, as against seven the previous week. The country's surpluses seem to belt across country from Connecticut to Minneapolis. Weather conditions as affecting lake navigation are said, in a measure, to be responsible for this.

It is the duty of business to go right ahead and not wait for a bigger decline in prices, and the tendency on the part of business men to hold back new enterprises, in the expectation of lower commodity prices and wages, is a mistake, in the opinion of Joseph E. Otis, vice-president and acting head of the Central Trust Company of Illinois.

Mr. Otis says that he has no sympathy for the man who is sitting back, awaiting still lower prices.

"The people who are awaiting a drastic decline in prices,"

continues Mr. Otis, "aren't going to get it. They are going to get left. In other words, I do not believe we are going to see any immediate and drastic decline in commodity prices. There is a world-wide scarcity of many materials, and production costs are going to continue abnormally high.

"We have had perhaps a certain amount of inflation. To the extent that present high prices are due to that cause, moreover, we can expect no immediate decline. The process of deflation will be gradual.

"If we were all to hold back, awaiting lower prices we should produce conditions of a sort that would benefit no one. It is the duty of business to go ahead and seize the opportunities now awaiting. If a manufacturer were to defer building needed additions to his plant, in the hope of securing a lower construction cost at some indefinite time in the future, he probably would lose more profits on goods which he might have been producing and selling in the meantime than he will save on cheaper construction costs."

Frank W. Thomas of A. O. Slaughter & Co., stated:

"In considering the outlook for commodity prices, we must bear in mind that wages are going to continue high for an indefinite time, and that European competition, formerly so keenly felt in our markets, is not going to be so severe as it was before the war. Wages have been advanced abroad with no immediate prospect of their return to pre-war basis."

Frank A. Vanderlip, president of the National City Bank of New York, declares that it is possible to transfer 15,000,000 men now engaged in war activities to works of peace without greatly disturbing conditions.

"I would not argue that we can make this transition without any jolt," he said. "There will be some. But I believe that the demand for labor is so great that it is possible to make the transition without disaster.

"We may make a cushion of public works. That is possible. But there are really tremendous orders that may now be executed, and on the whole I would not be surprised to find that we shall see no surpluses of labor, providing labor and the employer of labor each does his best to help in this readjustment."

John N. Willys, president of Willys-Overland Company, says:

"Material prices and wages are not likely to come down in a hurry. With the passing of the first flurry of unsettlement of prices which followed the signing of the armistice there is now a noticeable steadying of the market."

In order to interest the public in building during the transition period from war to peace, an aid to home builders on a national scale has been suggested to the Division of Public Works and Construction Development of the Department of Labor by President Kessler of the United States League of Building and Loan Association. It is similar to the method used by the Federal Farm Loan Banks to aid agriculture.

According to the plan, building loan associations of this country would perform the same service for working men as performed for farmers by Farm Loan Banks. In order that the loan associations may render the most effective service, mortgages made over to building and loan organizations, it is suggested, should be rediscountable at Federal Reserve Banks.

Two difficulties stand in the way at present. First, the associations are not members of the Federal Reserve Bank system, and have no capital stock and reserve therein. Second, the Reserve

Banks are designed for handling commercial paper and not mortgages. Solutions offered for meeting these two problems are that, first, special measures be taken to protect the Reserve Banks, and that the second be met by limiting the amount of mortgages rediscounted. Perhaps, as an alternative, the Farm Loan Banks might be authorized to accept mortgages on homes, as well as on farm lands, but either method would be preferable to the creation of new organizations.

Building loan associations are admirably equipped to take care of the financing of home building, and it is believed that in view of the necessity for obtaining immediate relief from the congestion in the private home situation, they can be of great assistance. The restrictions on buildings due to the war and the gradual decline in building for some

years preceding the war have reduced the amount of housing per capita in the United States to figures below the normal for a number of years.

President Kessler has been in conference with Franklin T. Miller, director, and other officers of the Division of Public Works and Construction Development in the Department of Labor. The building and loan associations for the country number 7,269, with a total membership of 3,838,612. Their total assets exceed \$1,750,000,000. Their receipts from all sources in 1917 were \$1,220,000,000 and their cost of doing business \$9,800,000, amounting to only eight-tenths of one per cent. Losses are light, because of the conservative method on which loans are made. Ordinarily, if a man owns a lot of ground he may immediately obtain a loan for two-thirds of the land and buildings.

## Current News

### An International Federation of Architecture

Commenting on the editorial, *Federating Architecture among the Allies*, in *THE AMERICAN ARCHITECT*, issue of November 27, *The Building News* of London reprints the entire editorial and states:

"Let us by all means, say we, and let it be followed by yearly gatherings in the capitals of all countries successively, at which the principles and practice of our art may be discussed in similar fraternal fashion to that which prevails in regard to science at the meeting of the British Association."

### Washington State Chapter Elects Officers

Officers elected at the twenty-fourth annual meeting of the Washington State Chapter of the American Institute of Architects, held at Seattle, Wash., were: President, D. R. Huntington; first vice-president, Carl Gould; second vice-president, George Gove; third vice-president, Albert Held; secretary, L. Baeder; and treasurer, F. L. Baker.

### Deposits in Postal Savings

The total deposits in the Postal Savings Department of the New York City Post Office, covering the Boroughs of the Manhattan and the Bronx, on Dec. 31, 1918, was \$36,138,861, an increase of \$6,253,209 during the year.

### Debt Comparisons and Obligations

The belligerent nations owe about six times the amount of all the gold and silver produced in all time, \$30,000,000,000. Incidentally, Austria owed \$2,736,000,000 at the beginning of the war, which had increased by June, 1917, to \$11,573,000,000.

### To Study Post-War Problems

Post-war problems, which include housing conditions of the state and the necessity of speeding up public works to meet employment conditions, will be taken up by a reconstruction committee of thirty-six members just named by Governor Smith of New York, which includes some of the most influential men and women in the State. Abram I. Elkus of New York, who served as counsel to the New York State Factory Investigation Commission, Ambassador to Turkey, and a member of the State Board of Regents, will act as chairman of committee.

Co-ordination of State resources with Federal, municipal and private resources is most important, the governor urges, in the solution of the employment problem. The public is requested to apprise the commission of unemployment that may come to its attention. The commission also is committed to dealing with any labor crisis which may arise during the period of readjustment.

The Federal proposal, as embodied in what is known as the "Soldiers' Settlement Act," will be considered by the commission, as will the suggestion of Secretary of Labor Wilson, that necessary public



works be speeded up to meet unemployment conditions.

In concluding his message the governor said:

"More than all I enjoin upon the commission such speed as may be consistent with thoroughness, in order that situations demanding immediate relief be remedied as soon as possible. The commission is directed to utilize all available material in the possession of special agencies or state departments to this end. I shall rely upon the commission for advice and counsel in all of the matters mentioned, and shall hope to receive early reports of progress and recommendations for action."

---

## Structural Steel

George E. Gifford, secretary of the Bridge Builders and Structural Society, has announced that the bridge and structural shops of the country contracted during the year 1918 for about 1,210,000 tons of steel work, or 56 per cent of their entire shop capacity. This compares with 1,285,000 tons in 1917 and 1,500,000 tons each for both 1916 and 1915, and 1,080,000 tons the amount for each year 1914 and 1913. The new contracts taken on December, 1918, amounted to about 52,000 tons or 29 per cent of capacity.

---

## Will Not Cut Steel Workers' Wages

There is a uniformity of opinion among iron and steel producers that no general reduction in wages should be attempted now or in the near future, despite the fact that the daily earnings of the men are from two to two and a half times greater than they were before the war. What employers do seek, however, is a restoration of the labor performance of before the war. They expect men to render a standard day's service, and as there is no opportunity now to make selections, the men who are willing to do a full day's work will receive the preference.

---

## To Extend Banking Affiliations

For personal conferences with foreign bankers as to the needs of their countries during the readjustment period, many representatives of American banking interests either have sailed or are about to sail for Europe, with a view of largely extending American banking affiliations. That this country has become a heavy creditor nation means the absorption here of large amounts of foreign securities.

John J. Arnold, vice-president and head of the foreign department of the First National Bank of Chicago, speaking of a trip which he is about to take to Europe, is quoted as saying:

"The bankers are undertaking a vast task. We hope a preliminary peace treaty will be signed soon,

and when that is done many barriers to active work will be lifted and we can start our operations. I personally shall visit all of the countries of Europe. We have two fundamental tasks: to lay the foundation for financing the rehabilitation of the war-wrecked cities and towns in allied territory and to restore bank connections with countries where they have been broken off by the war, and to form new connections where needed. This work will probably require three or four months.

"In devastated regions our energies will be chiefly devoted to arranging for financing the restoration of public utilities and to investigate and report on industrial needs as well."

---

## The World's Largest Office Building

Larger than the Woolworth, Whitehall and Flat-iron Buildings combined, is the Equitable Building, New York. It comprises a floor area of 1,227,000 square feet, equalling the area of a 28-acre farm, which makes it the largest office building in the world. Making a round trip in each of its sixty-one elevators would provide a seven-mile ride, and one walking its corridors would cover 5.8 miles. To build it 20,000,000 bricks were used.

---

## Partnership Discrimination in Income Tax Bill

Prominent business men at a conference between the Senate and the House at Washington last week pointed out one of the inequalities in the pending \$6,000,000,000 War Revenue Bill, which, it was argued, if not corrected, would result in discrimination against partnership as against corporations in the operation of the income tax section. The delegation argued that the bill was so drawn that it did not carry out the expressed intent of both committees which had charge of the original drafting of the bill, which was that it would put corporations and partnerships on a parity of taxation.

As the bill stands, the corporations are subject to the payment of an excess profits tax and the payment of a war profits tax, and then, if they have not paid dividends, they would be subject to an income tax of 12 per cent on the amount of their profits undistributed and left in the business. But in case of partnerships the profits would be divided among the partners and each partner would be subject, first to a normal income tax and then to a surtax increasing in proportion to the extent of the profits divided.

Consequently, it had been discovered that in the case of a very large partnership, the amount of the



surtax would exceed the aggregate of the taxes imposed upon corporations, in cases where corporations and partnerships were of like size and similar conditions, so that the intent of the committee in such cases would not be carried out in the plan of the bill as drafted and under consideration in conference. The fact was brought out that one of the large partnerships represented at the informal conference would, unless the bill were modified so as to remove this inequality, have to pay a difference as a partnership amounting to \$175,000 in excess to what it would pay if it were a corporation of like size and equal number of partners.

As a remedy an amendment has been suggested providing that in such cases of discrimination a partnership might elect, subject to suitable regulations to be framed by the Treasury Department, to be taxed under the provisions applying to corporations. The only question after the conference appeared to be the application of the form of the remedy proposed and the effect it might have on other parts of the schedule considered.

### Canal Tonnage Shows Decline

In his annual report General W. W. Wother- spoon, State Superintendent of Public Works, reports that the total canal tonnage for the season was 1,159,270 tons, distributed as follows: Erie Canal, 667,374; Champlain Canal, 434,784; Oswego Canal, 44,661; Cayuga and Seneca Canal, 7,509, and Black River Canal, 4,932.

### France's Coal Shortage Will Boom Industry

Large distributors of bituminous coal in Pennsylvania predict that a great stimulus will be given the coal situation in this country for several years due to the wrecking of the rich coal mines of northern France. American engineers who have inspected the mines in the Lens section of northern France estimate that it will be at least two years before the mines will be in full operation again. Many of the mines are flooded and conditions in that region are generally bad.

### Will Recommend Continuance of Housing Projects

Completion of twenty-two Government war housing projects, costing \$48,000,000, will be recommended by the House Public Buildings Committee, which has decided to amend to this end the Senate bill calling for the discontinuance on work on all projects not seventy-five per cent completed.

The projects for completion are at the following places: Aberdeen, Md.; Alliance, Ohio; Bath, Me.; Bridgeport, Conn.; Charleston, W. Va.; Davenport, Iowa, and Rock Island, Ill.; Erie, Pa.; Hammond, Ind.; Indian Head, Md.; Mare Island, Cal.; New Brunswick, N. J.; New London, Conn.; Newport, R. I.; Niagara Falls, N. Y.; Watertown, N. Y.; Niles, Ohio; Norfolk and Portsmouth, Va.; Philadelphia, Pa.; Puget Sound, Wash.; Quincy, Mass.; Waterbury, Conn., and Washington, D. C.

### New York Apartments to Cost, with Land, \$2,000,000

In the heart of the Fifth Avenue residential district and next door to the Astor family mansion at Sixty-fifth Street and Fifth Avenue, New York, will be erected a twelve-story apartment house of the superluxurious type. Preliminary architectural details for the building, which it is estimated will cost over \$1,000,000 and outstrip anything of its kind in point of artistic effect and conveniences offered tenants, are being drawn by J. E. R. Carpenter in association with Cross and Cross. Several new methods of apartment house construction will be featured in the building, which is expected to be ready for occupancy early in the summer of 1920. The building will be erected on the site owned by the estate of the late Grant B. Schley.

The apartment house will have but one suite to a floor, the idea being to make each floor as much like a separate dwelling as possible, so that the structure will be more in the nature of twelve superimposed dwellings than a mere apartment house. Each suite will have a floor area of about 11,000 sq. ft. and a main living room extending across the entire frontage of Fifth Avenue. This feature alone, it is said, has already brought applications for the renting of several of the floors. There will be twenty rooms to a suite.

In addition to the Astor mansion, it will have distinguished neighbors, for other properties in the immediate vicinity are owned by Thomas F. Ryan, Mrs. H. O. Havemeyer, Frederick Lewisohn, Mrs. James B. Haggin, William Guggenheim, Henry C. Frick and Mrs. E. H. Harriman. The invasion of this district by apartment houses has made some interesting history. It precipitated a crusade by the Fifth Avenue Association in which the Real Estate Board of New York participated. The amendment of the zoning resolution to prevent the construction of any building over 100 ft. in height on the avenue, between Sixtieth and Ninety-sixth Streets, was proposed, but failed of adoption.

The entire property has a frontage of 50.6 ft. on the avenue and 160 ft. on Sixty-sixth Street.

Posters Issued by the Department of Labor to Stimulate Building

The Department of Labor, through its Information and Education Service, is doing a useful and constructive work in stimulating the building industry to a resumption of pre-war activity. One



of the means employed is a series of posters, supplied free of charge to contractors and builders. These posters are of inspirational character and aim to bring home to employer and employee the thought that they are both selling their services to the public, and if the building in hand is well and quickly completed, another, figuratively speaking, is likely to be built across the street.

The posters, 10 x 15 inches in size, have each a direct appeal, officially made by the Department of Labor to all the people to co-operate in a general movement in building construction. From a large collection of these posters, all signed by Secretary

Wilson, we reproduce a typical example. Others read:

"I want to see every wage-worker own his own home."

Construction adds to the wealth of the country—build now.

Build now that city hall, court house, school house, church, factory, memorial.

Let this building be built so well and so quickly that the owner will be encouraged to build another.

Own a home for your children's sake.

Every architect and builder by liberal use of these posters can aid in this campaign. They may be had by addressing Roger W. Babson, chief, Information and Education Service, 1706 G Street, N. W., Washington D. C.

Prof. Rolla Clinton Carpenter

Rolla Clinton Carpenter, professor emeritus of experimental engineering at Cornell University, and widely known by construction engineers for his book on heating and ventilating, which was the first practical treatise of the subject ever written and which has been used extensively as a text book, died last week at his Ithaca, N. Y., home. He was sixty-six years old.

As every Cornell trained architect knows, Prof. Carpenter was also on the faculty of the college of architects, teaching the subject of heating and ventilation. His research in this line has never been surpassed, while his "formula" has for many years been considered by heating experts as the standard where accuracy is essential. The Carpenter formula, it will be recalled by many, was tested out in a full-sized building over a period of months during the winter and proved to be 98 per cent accurate. He wrote numerous important works on engineering.

Professor Carpenter was born in Orion, Mich., and was graduated from the Michigan Agricultural College in 1873 and later took a course in engineering at the University of Michigan. From 1875 to 1890 he was instructor and professor of mathematics in the Michigan Agricultural College. He went to Cornell as associate professor of engineering, and in 1895 was made professor of experimental engineering, holding the chair until 1917, when he was made professor emeritus.

He had been engaged in many important commercial enterprises. He was engineer for the construction of high power pumping stations in New York City and Brooklyn, and constructed the high pressure fire system of Baltimore.



# Department of Architectural Engineering

## Useless Waste in Concrete Construction Due to Legal Requirements\*

By W. STUART TAIT, *Assoc. M. Am. Soc. C. E., Assoc. Mem. Inst. C. E.*

WE have on record a mass of tests on reinforced concrete columns both spirally reinforced and otherwise. In practically all of these tests, however, no records were made of the amount of water used in the concrete and the nature of the mixing was not recorded. One of the most recent series of tests, and one which represents average building construction results, was the series re-recorded in the proceedings of the American Concrete Institute in 1915. The columns for this test were made by construction forces at a building under construction, and represent the results which can be expected from fairly good concrete. In the report of the committee conducting this test a formula is given by which the ultimate strength of the columns covered by this test can be obtained. This formula shows that, for a concrete column of 1-1½-3 concrete with 1½ per cent of spiral and 2 per cent of vertical steel, the ultimate strength is 5,660 lb. per sq. in. The ruling for column design adopted by the American Concrete Institute would credit this column with a working stress of 1,340 lb. per sq. in. These figures, of course, refer to the average stress per square inch considering the concrete only and adding together the resistance of the concrete, the vertical and the spiral steel. These figures indicate a factor of safety of 4 in this rule. In all spiral column design the area of the concrete outside the spiral reinforcement is not considered as contributing to the strength of the column and is treated as fireproofing material only. The series of tests referred to seem to indicate that the concrete placed outside the spiral reinforcement actually contributes to the strength of this column in much the same way as the concrete within the spiral. This concrete appears to be restrained in a similar manner to the concrete within the core through the tensile strength of the concrete and also by shear. This seems to indicate that the material lying outside of the spiral can be relied upon to provide the

additional strength necessary to overcome a reasonable bending moment in the column resulting either from eccentricity or unequal loading of panels adjoining the column. It would appear, therefore that a factor of safety of 4 was somewhat severe provided we have proper supervision, as previously outlined. The Table II shows the working strength of a certain column according to a few building ordinances now in force. Those who are conversant with designing of concrete construction throughout the United States have found, to their

TABLE II.

Strength of a 30-inch concrete column of 1-2-4 concrete reinforced with 1½ per cent of spiral, 26-inch diameter and 2 per cent of vertical steel, according to various city ordinances:

Chicago .....	525,000 pounds
Cincinnati .....	620,000 pounds
Cleveland .....	620,000 pounds
Detroit (1-1½-3) .....	565,000 pounds
Minneapolis .....	825,000 pounds
St. Louis .....	850,000 pounds
Am. Concrete Inst. ....	640,000 pounds

sorrow, that practically every city which boasts a building code, has a different method of figuring the column strength and uses different stresses in its steel reinforcement. This lack of uniformity is clearly brought out in Table II, and we see that a column constructed in Chicago is credited only with about 60 per cent of the strength of the same column constructed in St. Louis. There is no material difference in the construction methods and inspection in force in these two cities, and it would therefore seem unreasonable that the manufacturers of Chicago, Detroit, Cincinnati, Cleveland and numerous other cities should have this apparently unnecessary burden placed upon them. According to the tests referred to above, a concrete column in St. Louis has a factor of safety of 3.

\*Continued from our issues of December 11-18, 1918, and January 8, 22 and 29, 1919.



The dead load on a concrete column is a larger portion of the total load than in the case of a concrete slab, consequently the probability of column overloading is less than in the case of a floor. In a previous article the overloading of a floor in warehouse construction was shown to be limited to approximately  $1\frac{1}{2}$  times the design load, and it is the writer's opinion that the use of a factor of safety of 3 in concrete columns provides amply for the existing conditions.

In factory construction, engineers are practically compelled by many building ordinances to allow the same floor load as coming upon the columns as is used in designing the floor construction. An engineer may design the floor construction with an equivalent live load considerably in excess of the actual load occurring, to provide for concentration of load and for impact from machinery. Many building ordinances, however, would not recognize the right of an engineer to design the floor for one uniformly distributed load and the columns for a less load. Most building ordinances make some allowance for the floors of a building not all being loaded at one and the same time by permitting a reduction in the live load figured in the columns from that for which the floors are designed. This is a reasonable allowance but is, of course, entirely independent of the point just referred to above.

Some building departments rule that the column stresses specified in the ordinance must be used in designing a column for combined bending and direct load, while other cities, where columns are designed for this condition, permit the use of the extreme fiber stress governing beam design. The writer can see no reason whatever in the former stand for the reason that in a column subjected both to bending and direct load we have an extreme fiber stress on one side of the column which, in the case of a circular column, diminishes very rapidly. In the same way many building departments require that, under the same condition of column loading, the concrete outside of the spiral reinforcement shall not be considered as contributing to the resisting strength of the column in bending. This ruling appears to be far from logical. One argument presented by a building inspector in support of this requirement was that the material outside of the spiral was simply fireproofing. When this argument was brought up the writer did not consider it advisable to argue further and to compare this case with that of a concrete beam. In the case of the concrete beam all of the concrete above the neutral axis is counted as acting in compression, and it therefore always appeared to him that, since the same conditions applied in a concrete column subjected to bending, the concrete outside of the spiral should be considered as contributing to the column

strength in bending. In fact, from an observation of fire tests it would appear that a circular concrete column was less liable to damage from fire than the corners of a concrete beam, and these corners are vital in providing the necessary resisting strength for negative moment.

In a previous article the bending moment occurring in exterior columns was discussed. To provide against possible overstressing resulting from the bending moment caused by the fixed end condition of the beam, a limit for the dimension of the columns should be set which is based on the span of the girder resting on the column as well as a limit based on the column length. The writer feels that in this respect a limitation of about  $1/18$  of the span of the girder is reasonable and would, to a large extent, prevent the possibility of overstressing developed by a condition as illustrated in Fig. 1 in a previous article.\*

The factor of safety used in columns of steel construction is very little in excess of 2, based on the elastic limit. These columns, just as in the case of concrete columns, may be subjected to bending moment. It is true that this may not be as great in value as that occurring in the concrete column, still in a steel column we have a much more slender member than in the case of a concrete column and, as a result, the effect of a bending moment is more severe in the steel column. In a building in which steel columns are used the floor construction is usually also of structural steel and, as a consequence, the dead load on the steel column is a smaller percentage of the total load than in the case of the concrete column. The possibility, therefore, of overloading a steel column is generally greater than in the case of a concrete column. With proper supervision, it appears unreasonable to use a factor of safety of more than 3 in concrete column design.

*(To be continued)*

## The A. S. M. E. Code for Low-Pressure Boilers

IN THE AMERICAN ARCHITECT of April 10, 1918, page 446, was printed the code for testing low pressure heating boilers as presented to the American Society of Heating and Ventilating Engineers by its committee. The purpose of this code is to establish a uniform method of testing low pressure heating boilers in order to determine the ability of the boiler to heat or evaporate water; in other words, to measure its power to render service.

The Boiler Code Committee of The American Society of Mechanical Engineers submitted its re-

\*See THE AMERICAN ARCHITECT of January 9, 1918, page 79.

port to the council of that society in December, 1918, in which it embodies a code regulating the *construction* of low pressure heating boilers. The reports of this committee are almost universally accepted as the standard for this country, and some states have embodied its recommendations in their laws pertaining to such matters. That portion of the report covering the construction of low pressure heating boilers is entirely new and it is the first recommendation of any kind for the standardization of that very important factor in building construction. The growth of low pressure heating boiler manufacturing has been along individual lines and has resulted in a great variety of designs, more particularly in cast iron boilers. Too often their design has been dictated by the requirements of foundry practice and manufacturing profits rather than a scientific analysis of the problem. The application of this code will necessitate the revision of some types now on the market and in the interest of safety to the user. This, with the application of the code above referred to, will result in boilers uniform as to performance as well as to construction.

The architect can, with safety, specify that the boilers used for this purpose shall comply in all respects to the two codes.

## A. S. M. E. Boiler Code

### Part I—Section II

#### BOILERS USED EXCLUSIVELY FOR LOW PRESSURE STEAM AND FOR HOT WATER HEATING AND HOT WATER SUPPLY

(This does not apply to Economizers or Feed Water Heaters.)

#### GENERAL

- 335 The Rules for power boilers shall apply:
- a To all steel plate *hot-water* boilers over 60 in. in diameter.
  - b To all steel plate *hot-water* boilers where the grate area exceeds 10 sq. ft. and the maximum allowable working pressure exceeds 50 lb. per sq. in.
  - c Under other conditions, the following rules shall apply.

#### MATERIALS

336 Specifications are given in these Rules, Pars. 23 to 178, for the important materials used in the construction of boilers, and where given, the materials shall conform thereto.

337 Flange steel may be used entirely for the construction of steam heating boilers covered in this section, but in no case shall steel of less than  $\frac{1}{4}$  in. in thickness, nor tube sheets or heads of less than  $\frac{5}{16}$  in. in thickness be used.

#### MAXIMUM ALLOWABLE WORKING PRESSURE

338 The maximum allowable working pressure shall not exceed 15 lb. per sq. in. on a boiler built under these Rules to be used exclusively for low-pressure steam heating.

The maximum allowable working pressure for a hot-water boiler or heater used on a closed system shall be one-half of the maximum allowable working pressure for the same hot-water boiler or heater when used on an open system.

Hot-water systems shall be designated as either open or closed systems. Open systems are those in which the pressure is balanced by a fluid column, the cross sectional area of which is at least equal to the cross sectional area of the water supply pipe, or where the system is freely connected to the street supply. All other systems are classed as closed systems.

Open systems shall be so installed that there will be no opportunity for the fluid column to freeze or to be accidentally shut off. If a valve is used in the supply line, it shall be locked and sealed open and bear a tag stating that the system shall be relieved of pressure whenever the valve is closed.

339 A boiler to be used exclusively for low-pressure steam heating may be constructed either of cast-iron, steel cast, or wrought iron or steel, or any combination of these, but in all cases the connecting rods and bolts shall be wrought iron or steel.

340 All steel-plate *hot-water* and *steam-heating* boilers shall have a factor of safety of not less than five.

#### BOILER JOINTS

341 Longitudinal lap joints will be allowed on boilers to be used exclusively for low-pressure *steam* heating, when the maximum allowable working pressure does not exceed 15 lb. per sq. in., and the diameter of the boiler shell does not exceed 60 in.

342 The longitudinal joints of a horizontal return-tubular boiler if of the lap type, shall be not over 12 ft. in length.

343 In a *hot-water* boiler to be used exclusively for heating buildings or hot-water supply, when the diameter does not exceed 60 in. and the grate area does not exceed 10 sq. ft., or equivalent as defined in Pars. 359 and 360, longitudinal lap joints will be allowed. When the grate area exceeds 10 sq. ft., or equivalent as defined in Pars. 359 and 360, and the diameter of the boiler does not exceed 60 in., longitudinal lap joints will be allowed provided the maximum allowable working pressure does not exceed 50 lb. per sq. in.

344 *Protection of Joints.* When a boiler is built wholly or partially of steel and is used exclusively



## THE AMERICAN ARCHITECT

for low-pressure *steam* heating, or when a *hot-water* boiler is used exclusively for heating buildings or for hot-water supply, it shall not be necessary to water jacket the rivets in the fire-box where one end of each rivet is exposed to the fire or direct radiant heat from the fire, provided any one of the following conditions is fulfilled:

- a Where the ends of the rivets away from the fire are protected by means of natural drafts of cold air induced in the regular operation of the boiler.
- b Where the ends of the rivets away from the fire are in the open air.
- c Where the rivets are protected by the usual charges of fresh fuel, which is not burned in contact with the rivets.

### WASHOUT HOLES

345 A boiler used for low-pressure steam or hot-water heating or for hot-water supply shall be provided with washout holes to permit the removal of any sediment that may accumulate therein. Steel shell boilers of the locomotive or vertical fire-tube type shall conform to the requirements of Pars. 265 and 266 for washout holes.

### BOILER OPENINGS

346 *Flanged Connections.* Openings in boilers having flanged connections shall have the flanges conform to the American Standard given in Tables 16 or 17 of the Appendix, for the corresponding pipe size, and shall have the corresponding drilling for bolts or studs.

### SAFETY VALVES

347 *Outlet Connections for Safety and Water Relief Valves.* Every boiler shall have proper outlet connections for the required safety, or water-relief valve or valves, independent of any other connection outside of the boiler, the area of the opening to be at least equal to the aggregate area of all of the safety valves with which it connects. A screwed connection may be used for attaching a safety valve to a heating boiler. This rule applies to all sizes of safety valves.

348 *Safety Valves.* Each *steam* boiler shall be provided with one or more safety valves of the spring-pop type which cannot be adjusted to a higher pressure than 15 lb. per sq. in.

349 *Water Relief Valves.* Water relief valves shall be placed on all hot-water heating and supply systems and be connected to the boiler or heater. The valve shall be of the diaphragm-opening type set to open at or below the maximum allowable working pressure, the diaphragm being so designed that, if the valve fails to open, the diaphragm will rupture at a pressure not exceeding 50 per cent above the maximum allowable working pressure.

350 The outlets of water relief valves shall have open discharges in plain sight.

351 No safety valve for a steam boiler shall be smaller than 1 in. nor greater than 4½ in. standard pipe size. No water relief valve shall be smaller than ¾ in. nor greater than 2 in. standard pipe size.

352 When two or more safety or water relief valves are used on a boiler or heating system, they may be single, twin or duplex valves.

353 Safety or water-relief valves shall be connected to the boilers or heating systems independent of other connections and be attached directly, or as close as possible, to the boiler or heater without any intervening pipe or fittings, except the Y-base forming a part of the twin valve or the shortest possible connection. A safety valve or water-relief valve shall not be connected to an internal pipe in the boiler or heater. Safety valves shall be connected so as to stand upright with the spindle vertical when possible.

TABLE 9—ALLOWABLE SIZES OF SAFETY VALVES FOR STEAM HEATING BOILERS

(Maximum Allowable Working Pressure, 15 lb. per sq. in.)

Water Evaporated per Sq. Ft. of Grate Surface per Hr., Lb.		50	75	100	125
Diameter of Valve, In.	Area of Valve, Sq. In.	Area of Grate, Sq. Ft.			
1	0.7854	2.25	1.50	1.00	1.00
1¼	1.2272	3.50	2.25	1.75	1.50
1½	1.7671	5.00	3.25	2.50	2.00
2	3.1416	8.75	6.00	4.25	3.50
2½	4.9087	13.75	9.25	7.00	5.50
3	7.0686	20.00	13.25	10.00	8.00
3½	9.6211	27.25	18.00	13.50	10.75
4	12.5660	35.50	23.50	17.75	14.25
4½	15.9040	44.75	30.00	22.50	18.00

TABLE 9a—ALLOWABLE SIZES OF WATER RELIEF VALVES FOR WATER HEATING BOILERS AND FOR HOT WATER SUPPLY BOILERS

Diameter of Valve, In.	Area of Grate, Sq. Ft.
1	Not exceeding 8
1¼	Over 8 and not exceeding 13
1½	Over 13 and not exceeding 18
2	Over 18 and not exceeding 28

Above 28 sq. ft. of grate area, more than one valve shall be used, the sum of the areas handled by the valves as given in the Table to be equal to or greater than the grate area.

354 No shut-off of any description shall be placed between the safety or water-relief valves and boilers or heaters, nor on discharge pipes between such valves and the atmosphere.

355 When a discharge pipe is used its area shall be not less than the area of the valve or aggregate area of the valves with which it connects, and the discharge pipe shall be fitted with an open drain to prevent water from lodging in the upper part of the valve or in the pipe. When an elbow is placed on a safety or water relief valve discharge pipe, it



STEAM AND WATER GAGES

shall be located close to the valve outlet or the pipe shall be securely anchored and supported. The safety or water-relief valves shall be so located and piped that there will be no danger of scalding attendants.

356 Each safety valve used on a *steam* heating boiler shall have a substantial lifting device by which the valve may be raised from its seat at least 1/16 in. when there is no pressure on the boiler. A relief valve used on a hot-water heating system need not have a lifting device.

357 Every safety valve or water-relief valve shall have plainly stamped on the body or cast thereon the manufacturer's name or trade mark and the pressure at which it is set to blow. The seats and discs of safety or water-relief valves shall be made of nonferrous material.

358 The minimum size of safety or water-relief valve or valves for each boiler or heater shall be governed by the grate area as shown by Table 9 or 9a. The equivalent grate area for oil or gas fired boilers or water heaters heated by steam shall be used as specified under Par. 360.

When the conditions exceed those on which Table 9 is based, the following formula for bevel and flat seated valves shall be used:

$$A = \frac{W}{4.7P}$$

in which

*A* = area of direct spring-loaded safety valve per square foot of grate surface, sq. in.

*W* = weight of water evaporated per square foot of grate surface per hour, lb.

*P* = pressure (absolute) at which the safety valve is set to blow, lb. per sq. in.

GRATE AREA

359 *Double-Grate Down-Draft Boilers.* In boilers of this type the grate area shall be taken as the area of the lower grate plus one-quarter of the area of the upper grate.

360 *Boilers or Heaters Fired with Oil or Gas or Heated with Steam.* In determining the number and size of safety or water-relief valve or valves for a boiler using gas or liquid fuel, 15 sq. ft. of heating surface shall be equivalent to one square foot of grate area. If the size of grate for use of coal is evident from the boiler design, such size may be the basis for the determination of the safety-valve capacity.

For a heater heated with steam the maximum amount of steam that can be condensed per hour shall be determined and the equivalent grate surface taken as the maximum weight of steam condensed in pounds per hour divided by fifty.

361 *Steam Gages.* Each *steam* boiler shall have a steam gage connected to the steam space or to the water column, or its steam connection, by means of a syphon or equivalent device of sufficient capacity to keep the gage tube filled with water and so arranged that the gage cannot be shut off from the boiler except by a cock placed near the gage and provided with a tee or lever handle arranged to be parallel with the pipe in which it is located when the cock is open. Pipe connections to steam gages less than 1 in. pipe size, shall be of brass, copper or bronze composition when the distance between the gage and point of attachment of pipe is over 5 ft. If less than 5 ft., the connections shall be of brass, copper or bronze composition if less than 1/2 in. pipe size. The dial of a steam gage for a *steam* heating boiler shall be graduated to not less than 30 lb.

362 *Pressure or Altitude Gages.* Each *hot-water* boiler or heater shall have a gage connected in such a manner that it cannot be shut off from the boiler or heater except by a cock with tee or lever handle, placed on the pipe near the gage. The handle of the cock shall be parallel to the pipe in which it is located when the cock is opened. Pipe connections to gages less than 1 in. pipe size, shall be made of brass, copper or bronze composition when the distance between the gage and point of attachment of pipe is over 5 ft. If less than 5 ft., the connections shall be of brass, copper or bronze composition if less than 1/2 in. pipe size. The dial of the pressure or altitude gage shall be graduated to not less than 1 1/2 times the maximum allowable working pressure.

363 *Thermometers.* Each *hot-water* boiler or heater shall have a thermometer so located and connected that it shall be easily readable when observing the water pressure or altitude. The thermometer shall be so located that it shall at all times indicate the temperature in degrees fahrenheit of the water in the boiler or heater.

*Temperature Regulators.* A temperature regulator which will operate to prevent the temperature of the water from rising above 200 degrees fahr. shall be used on all hot-water supply and hot-water heating systems in which the working pressure exceeds 30 lb. per sq. in. It shall also be used on all closed systems irrespective of the working pressure.

FITTINGS AND APPLIANCES

364 *Bottom Blow-off Pipes.* Each boiler or heater shall have a blow-off pipe, fitted with a valve or cock, in direct connection with the lowest water space practicable.

## THE AMERICAN ARCHITECT

365 *Damper Regulators.* When a pressure damper regulator is used, it shall be connected to the steam space of the boiler.

366 *Water Glasses.* Each *steam* boiler shall have one or more water glasses.

367 *Gage Cocks.* Each *steam* boiler shall have two or more gage cocks located within the range of the visible length of the water glass.

368 *Water Column Pipes.* The minimum size of pipes connecting the water column of a boiler shall be 1 in. Water-glass fittings or gage cocks may be connected direct to the boiler. The steam connection to the water column of a horizontal return tubular boiler shall be taken from the top of shell or the upper part of the head; the water connection shall be taken from a point not less than 6 in. below the center line of the shell. No connections, except for damper regulator, drains or steam gages, shall be placed on the pipes connecting a water column to a boiler.

### METHODS OF SETTING

369 Wet-bottom steel-plate boilers shall have a space of not less than 12 in. between the bottom of the boiler and the floor line with access for inspection.

370 *Access Doors.* The minimum size of access door used in boiler settings shall be 12 by 16 in. or equivalent area, the least dimension being 11 in.

371 The longitudinal joints of a horizontal return-tubular boiler shall be located above the fire-line.

### HYDROSTATIC TESTS

372 A shop test of 60 lb. per sq. in. hydrostatic pressure shall be applied to steel or cast-iron boilers or to the sections of cast-iron boilers which are used exclusively for low-pressure *steam* heating.

373 *Hot-water* boilers for a maximum allowable working pressure not exceeding 30 lb. per sq. in. used exclusively for heating buildings or for hot-water supply, when constructed of cast-iron, steel cast, or wrought iron or plate steel or any combination of these, shall be subjected to a shop test of 60 lb. per sq. in. hydrostatic pressure applied to the boiler or, at the option of the manufacturer, to the sections thereof.

374 A maximum allowable working pressure in excess of 30 lb. per sq. in., but not exceeding 160 lb. per sq. in., will be allowed on hot-water boilers

or heaters constructed of cast iron, or of cast iron excepting the connecting nipples and bolts, used exclusively for heating buildings, or for hot-water supply, provided they are subjected as a whole or, at the manufacturer's option, in sections, to a shop hydrostatic test of  $2\frac{1}{2}$  times the maximum allowable working pressure for an open system and 5 times the maximum allowable working pressure for a closed system.

All hot-water boilers or heaters that are to be used for a working pressure in excess of 50 lb. per sq. in. on open systems, or for a working pressure in excess of 25 lb. per sq. in. on closed systems, are to be subjected to a field hydrostatic test upon the boiler after it is installed. The boiler is not to be tested at a pressure in excess of the shop test required to be made by the manufacturer. For hot-water boilers or heaters constructed of cast-iron, or of cast iron excepting the connecting nipples and bolts, used exclusively for heating buildings or for hot-water supply, the hydrostatic pressure for the field test shall be  $2\frac{1}{2}$  times the maximum allowable working pressure for open systems and 5 times the maximum allowable working pressure for closed systems. For steel plate boilers or heaters, the hydrostatic test pressure shall be  $1\frac{1}{2}$  times the maximum allowable working pressure for open systems and 3 times the maximum allowable working pressure for closed systems.

375 Individual shop inspection shall be required only for boilers which come under the rules for power boilers.

### STAMPING

376 Each plate of a completed boiler shall show a sufficient portion of the plate maker's stamp for identification.

377 *Name.* All boilers referred to in this section shall be plainly and permanently marked with the manufacturer's name and the maximum allowable working pressure, this to be indicated in Arabic numerals, followed by the letters "Lb."

All hot-water boilers or heaters are to bear a manufacturer's label, that is irremovably attached to the front section, stating the maximum allowable working pressure for which the boiler is allowed to be used on "open systems" and on "closed systems."

All heating boilers built according to these rules should be marked A.S.M.E. standard.



# Industrial Information

*In this Department there is published each week information as to the development of materials and methods, derived from reliable sources.*

## The Safe Stairway

Despite the constantly increasing dependence of man upon elevators in public buildings, the importance of the stairway does not decrease proportionately. In fact, the sense of the necessity for speed which elevators have augmented, makes him heedless of his step when elevator service is inadequate and he resorts to stairways. Particularly in times of danger, when fire or other cause demands a hasty egress, safety in stairways looms up as an element of considerable importance. In subways, where no artificial urging is needed to encourage such hasty egress, in schools or lecture halls, the test of a good stairway is made. And what is a good stairway but a safe one?

Several predominating factors commend the use of Universal Safety Tread, made by the company of that name, at 40 Court Street, Boston, for stairways, indoor and out.

The factor of safety in a stair tread depends on the non-slip character of the surface material used, and the absence of any hard supporting metal which in a short time become very slippery and dangerous. The wearing surface of the Universal Safety Tread is composed entirely of the mineral abrasive known in the trade as Alundum. This is an artificial preparation of corundum, the hardest material known next to the diamond. Alundum grains give this tread the highest efficiency as a non-slipping surface, while at the same time its extraordinary hardness insures permanence and durability to a very high degree. Thus perfect safety is combined with a maximum length of service.

As a stiffening element, a baseplate of light steel is used to which the abrasive composition is securely attached. In the process of manufacture this baseplate is coated on all sides with lead, making the finished product absolutely rustproof.

On all treads exposed to severe usage, especially on down-traffic stairways, the edges get the brunt of the wear. To meet this condition, reinforced nosings have been worked out, and a thick body of the abrasive material is presented where it is most needed.

It can be furnished, with or without nosing, in one piece, in any width up to 12 inches, thereby avoiding unnecessary joints.

The Universal Safety Tread is particularly well adapted to cement stairs, as it not only prevents slipping, but also acts as a metal guard to the edges of the concrete, thus preventing them from becoming chipped or otherwise defaced. Safety Tread also protects the stair itself from wearing out if it be made of wood. On iron stairs protection of some kind is very necessary, as they rapidly become slippery, and unless some measures are taken to prevent, many accidents result. The Universal Safety Tread has been made with a view to eliminating all these difficulties and to giving service of the right sort.

## A Matter of Life and Death

A fire escape that will serve its purpose simply and surely, that will give confidence to its users and dissipate the fear and panic generally incident to a quick fire, needs no comment. Everyone wants one like this. An introduction is all that is necessary for architects to profit by the acquaintance.

The fire escape referred to is a device manufactured by the Davy Automatic Fire Escape Co., Syracuse, N. Y. It is a machine controlling a steel cable, to the end of which is fastened a life belt, and, the makers claim, is so positive and sensitive in its construction and operation that it will lower a small child or a heavy adult with equal safety. It is used only for descending, and has a carrying capacity of three persons per minute, one at a time, from a third or fourth floor, or one per minute from a twentieth floor. It is a pulley arrangement, the mechanism of which is simple and dependable.

A number of statements are set down by the makers to demonstrate its superiority and reliability. Enough of these machines are installed to empty the building of all occupants in less than four minutes. They are never provided except throughout an entire building and in numbers adequate for all the people, and including an allowance for the loss of the use of escapes on the side where the fire is located. They require no adjustment or manipulation by the user for varying weights. Automatically they lower a small child or a helpless person as safely as a trained fireman. If the belt is placed around such a person and he is



## THE AMERICAN ARCHITECT

put out of the window, the Davy will do the rest, and more safely and gently than can human hands. Its use in hospitals and schools is therefore particularly apparent. Finally they are low in cost and require no attention after they have been installed.

### Concrete Reinforcement

In the large variety of wire products made by the American Steel & Wire Co. their triangle mesh concrete reinforcement is of particular value to architects and engineers. This company has sales offices in the eighteen chief cities in the United States, beginning at 208 S. La Salle Street, Chicago. Here they may be addressed for a small technical pamphlet on the present subject. This pamphlet sets forth the essentials of concrete reinforcement and shows how triangle mesh steel wire reinforcement fulfills the conditions. It is stated that this material, providing even distribution of the steel, reinforces in every direction. The tension or carrying members are accurately spaced. A reliable mechanical bond is obtainable. A sufficient area of steel is provided in the cross wires of the triangle mesh reinforcement to prevent temperature cracks, thereby eliminating the necessity of laying additional reinforcement at right angles to the longitudinal or tension members. In this material the diagonal wires assist the longitudinal wires in carrying the load. This the makers claim as a unique feature of their product.

Ungalvanized reinforcing fabrics are recommended for the reason that both greater strength and better adhesive bond are provided. By the use of galvanized wire, on the other hand, the adhesion is to the coating on the steel and not to the steel itself. Furthermore, in the process of galvanizing, the steel is annealed or softened, thus reducing its elastic limit and ultimate strength.

A curious statement based on the assumption that concrete embedded in steel does not rust is made in the discussion of this material. The makers state that in the case of a smooth round rod used as reinforcement, it is more desirable to have a thin surface coat of rust than a perfectly bright and smooth one, provided the rust has not penetrated sufficiently to pit the steel and produce a scale. Such a slight coating of rust, they maintain, provides a rougher surface and hence a better bond.

Right here is reprinted a short paragraph from the *Scientific American* explaining the action of cement on rusted steel, and showing how rust disappears from iron bars, etc., in the process of erecting reinforced concrete structures.

Certain valuable formulae and tables are presented in the booklet which give further information on this important topic.

### The Effect of Good Illumination on Surroundings and Morale

If a mill is well lighted throughout, it will be tidy, for litter and refuse will not be permitted to accumulate, if it is clearly visible to the superintendent. Waste material always tends to gather in dark corners. Shop sanitation is an important element. A well-lighted shop is pleasant to work in. It attracts and holds employees. In view of the possibilities of even greater labor shortages this feature is of much importance, for contented employees certainly constitute an essential asset. Cases are on record where one mill in a section has been markedly better illuminated and has actually, through this means, obtained the very pick of the hands in the surrounding country.

Good lighting is also reflected in faces of the operators, in the form of healthful, buoyant spirits. Bad lighting is irritating because it makes it difficult to see, and strain is involved in the efforts of workers to adapt themselves to unnatural conditions. The mind, unconsciously perhaps, becomes obsessed with the idea that it is being imposed upon. Everyone has seen this condition evident in employees, possibly the reader himself has experienced this feeling of resentment. Bad lighting will react to produce nervous, irritable, discontented employees.

Any plant manager knows that the experienced or trained man is an asset not easily replaced. If this man has been working continuously under insufficient illumination, its detrimental effect will eventually show up in his failing eyesight. He becomes incapacitated at the very time when he should be yielding the biggest return on the investment made in training.—*From a bulletin issued by the Edison Lamp Works, General Electric Co., Harrison, N. J.*

31-10-1919 after page 240

# The AMERICAN ARCHITECT



CHURCH OF S. MARIA NOVELLA, FLORENCE, ITALY

PUBLISHED WEDNESDAYS IN NEW YORK—FOUNDED 1876  
VOLUME CXV      FEBRUARY 12, 1919      NUMBER 2251

Entered as second class matter January 6, 1909, at the Post Office at New York, N. Y., under the Act of March 3, 1879. Publication office, 243 West Thirty-ninth Street, New York, N. Y. Subscription price in the United States and Possessions, \$10.



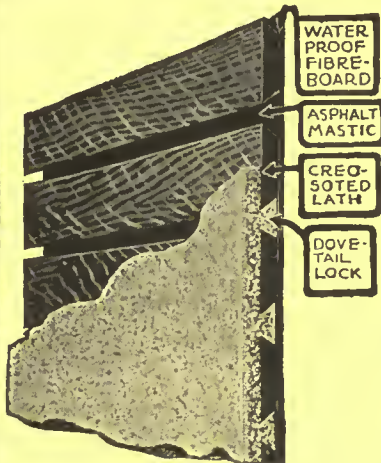

**A**MONG them are nationally known firms who do not compromise on doubtful construction; state architects; architects of schools, churches, clubs, public buildings, fine residences and popularly-priced homes.

The use of Bishopric Board for Stucco construction has increased 1000 per cent in six years. For these reasons: Wherever the right Stucco mixture has been applied to a Bishopric background the walls have remained rigidly intact—crackless, unsagging; there has been no rusting—no pulling away from the supports—because first, there is nothing in Bishopric Board to disintegrate; and second, it is nailed securely to studding or sheathing; it provides effective insulation; deadens sound; and often the saving it makes possible solves an economic problem for Architect and Builder.



The "lock-in-the-plaster" principle has made good in a big way. Architects have seen it hold Stucco with a bulldog grip through severe winter and hot summer. They have watched Bishopric Board stand all winter and be in perfect condition for Spring Stuccoing.

Stucco clings vise-tight to the dovetailed, heavy-wood strips which are creosoted against swelling, shrinking, warping, and weather change. These strips are imbedded, under terrific pressure, in a layer of tough Asphalt Mastic—a wonderful preservative and moisture-proof and fire-resisting. The heavy fibreboard backing is weather-proofed against heat and cold and it retards sound. Nailed as a unit to the building with joints broken every four feet for added rigidity, with the proper mixture of stucco applied to Bishopric Board how can the walls crack or crumble or the building be anything but comfortable, well-insulated, and sound free?

For interior use in place of ordinary lath, Bishopric Board makes sound-retarding walls, ceilings, and partitions, and saves plaster, time, and labor.

Bishopric Sheathing saves about 40 per cent as compared with  $\frac{7}{8}$ -inch wood sheathing. Makes a compact, damp-proof, sound-proof wall. No joints or knot holes. Ask about it.

Note the absolute rigidity of construction of this 3-family apartment house in Utica, N. Y., built for John J. Doyle. This building stood through the winter before being stuccoed. Bishopric Board was nailed direct to studding, no wood sheathing being used. Bishopric Board was also used on interior.

All Architects and Builders should have our book, "Built on the Wisdom of the Ages." It describes and details the use of Bishopric Board; illustrates homes and institutions on which it has been used; tells how to get perfect Stucco work. It contains reports of scientific tests and letters from engineers, architects, builders and home owners. Get it—and samples of Bishopric Board and Bishopric Sheathing.



**The Bishopric Manufacturing Company**  
904-Este Avenue,  
CINCINNATI, OHIO







MAIN ENTRANCE

HOUSE OF ALLAN S. LEHMAN, TARRYTOWN-ON-THE-HUDSON, N. Y.  
JOHN RUSSELL POPE, ARCHITECT

# THE AMERICAN ARCHITECT

VOL. CXV

WEDNESDAY, FEBRUARY 12, 1919

NUMBER 2251

## The Future of Government Villages

By CLARENCE WILSON BRAZER

WITH every newspaper containing reports of the proposed action of the Government as to housing operations, and articles inspired by the recent Senate Joint Resolution 194, constructive discussion as to the disposition of these villages becomes more pertinent. This resolution, which would require the cessation of all building not over 70 per cent completed and the cancellation of contracts for furnishings, is particularly aimed at the temporary dormitories and apartments being constructed in the City of Washington between the Capitol and the Union Station Plaza (expected to have been completed last December), as well as those proposed for 2800 Government employees at Twenty-third and B Streets. As temporary accommodations with their furnishings will not much longer be required, it may be wise to cancel such contracts and to scrap the houses not roofed and enclosed. This has generally already been done as we will see later.

When, however, we consider permanent housing an entirely different situation is involved, and radical amendments should be adopted before enacting any such law as the previously mentioned resolution. Should unenclosed buildings not be scrapped and the site be not restored "without trace," these deteriorating skeletons would become a serious detriment to adjoining Government investments. If outsiders were to buy and complete these houses they would reap the advantages of utilities provided, and such breaking into the development by newcomers would greatly handicap good management of the community as a whole. Work which has progressed even 50 per cent could probably be completed for less than it could be demolished and scrapped, including just compensation for cancellation of materials ordered and manufactured.

The well organized and managed U. S. Housing Corporation received its appropriation too late for many of its houses to be occupied before the armistice was signed. At that time, upon interpretation of the law, 55 of its villages were abandoned and contracts were terminated or curtailed wherever there was thought to be no permanent demand for

houses in normal times. Over 30 of the corporation's beautiful plans will probably never be undertaken, and the real estate purchased or condemned will probably be sold. In some instances, within a week of the cessation of hostilities, rafters of unroofed buildings were torn down. Over \$23,000,000 worth of contracts were cancelled with a loss of \$4,000,000, while 14 other housing contracts aggregating \$17,000,000 were curtailed to \$11,000,000. Twenty operations are, unless stopped by the proposed law, to be completed at a cost of \$23,000,000. These are generally of a permanent character and located in cities such as Philadelphia, Erie, Bethlehem and Elizabeth, where there is demand for permanent houses to fill the gap in normal production caused by cessation of private building during the war. Before appropriations were made all these projects were exhaustively investigated and permanent housing only granted where such an investment seemed desirable, therefore the expert judgment of this Corporation, as shown by its voluntary cancellations, should not be lightly cast aside for the purpose of enabling political recompense for other extravagances. The work under the Housing Corporation awarded upon competitive bids in lump sum contracts, probably will be found to be more economical than the "cost plus" contracts let by other branches of the Government, and with their land, being owned outright by the Government, thus most concern us.

The appropriations for the Emergency Fleet Corporation buildings, on the other hand, were granted earlier and the villages were largely completed under "cost plus" contracts. Few of these have been cancelled, although extensions have been curtailed. The houses are mainly of permanent construction and were financed by Government ten-year, or less, mortgage loans for local housing corporations largely owned by shipbuilders. The land and public utilities are generally owned by the Local Housing Corporation, but the Fleet Corporation agreements provide that it may fix the rental and selling price as long as the mortgage remains unpaid, except that the rents need not be



less than 10 per cent of the cost of land with improvements, less depreciation. These agreements also require the Local Housing Corporation to sell (subject to 30 per cent or over mortgage to cover excess war cost) to officers or employees of the shipbuilder desiring to purchase lots improved with buildings as herein contemplated, but not more than one lot to any one purchaser except with the approval of the Fleet Corporation. During the mortgage term the Fleet Corporation also has the right to regulate policies determining the health, welfare and housing conditions, and upon release, the public dedication of public buildings, streets and improvements.

Provision is also made for assumption by the Government of losses due to excess war cost "*in no event exceeding 30 per cent*" of appraised value of the property at a period between 2 and 5 years after peace is declared. In such an appraisal it is conceivable that the increased value of land might offset the decreased value of the building. While authentic figures are not available, it is possible that original appropriations, based on estimates necessarily higher than normal, will be exceeded by from 30 to 60 per cent! Must the worker forever pay rent based on the excess war cost over and above the 30 per cent maximum to be written off by the Government? Failing to collect such high rents, will the village become deserted or the Local Housing Corporation bankrupt?

This matter of normal cost is of prime importance. Until the whole excess cost is written off by the Government, the properties cannot become stabilized so that the worker will know the price he must pay to own his home, or upon which his rent must be based to produce the normal income and maintenance charges. This will have a most important bearing on readjustment, and should not be delayed any longer than necessary.

In Philadelphia over 2000 houses of the commonplace two-story box row type were built for the Fleet Corporation by lump sum contract and occupied by Hog Island war workers. Soon after the armistice was signed and the draft cancelled, men previously exempt because of war work suddenly vacated hundreds of these houses as well as others of the less desirable type or location. Rents which have averaged \$5 per room per month have begun to drop, but have not yet reached the pre-war average of \$3. A "Buy Your Home" campaign has been started in the city, and it is now announced that these houses are to be sold immediately at their market value, which is less than cost. First choice is to be given Hog Island workers, and the remainder to any others who wish to buy! These buildings probably met a temporary urgent need of the Government at a comparatively small loss, but the city

has gained nothing over its usual type of commonplace housing. Due to the cessation of the usual operative building, these houses will probably be in some demand so long as the shipyard is operated, but should this now called "temporary shipyard" be abandoned, it is quite possible that, due to the location of some of these houses, present values will shrink considerably, and the "deserted house" be at the loss of the present-day purchaser on whom the Government is about to unload. Such houses in metropolitan districts are, however, much less likely to be deserted than those in more isolated villages.

Activity in seaboard shipyards and accessory manufactories has greatly decreased, causing cessation of overtime and dropping of the double shifts of labor. Most of these plants are, however, planning to continue not only the completion of present Government contracts, but also new private orders, which are expected as necessary to replete the world loss of tonnage. Annual repairs to ships built in these plants will also require a large regular force. The men attracted from the interior by high weekly wages have naturally cut the extra expense of living away from home, and have vacated, mainly, the boarding or lodging houses. Large numbers of workers were also attracted from the interior to build the housing, thus temporarily increasing the already acutely crowded communities. Many of these workers have returned to their home cities. The acute demand for housing has, therefore, even in metropolitan districts, greatly subsided. Also the total number, probably not over 30,000, permanent houses recently erected will accommodate such a small proportion of the total normal labor force of these new plants (generally less than 10 per cent) that from present indications there will be few deserted houses in metropolitan industrial districts adjacent to these plants. During the war transportation was improved, and many workers have daily traveled "on a strap" distances up to 40 miles to and from their work, at a cost of from 20 to 40 cents per day. Probably at least 50 per cent have traveled over 5 miles each day. With the return to normal wages men cannot afford this time, money and lost energy, and should welcome an opportunity to obtain new and attractive homes within walking distance of the plant.

Whether these villages will or will not be "deserted" is largely dependent upon the early completion of the necessary amenities. Good shops, schools, churches, amusements and recreational attractions must be provided, as well as good walks, well planted and paved streets and parks, or the worker will prefer to live and work where these are to be had. These are most vital to the isolated industrial community, located near munition or

## THE AMERICAN ARCHITECT

other strictly war necessity plants which are most likely to become "Government Deserted Villages." Even should these plants be turned into active peace industries, they will, without all these necessities, experience difficulty in attracting and holding a labor reservoir far from the city with its attractions and many opportunities for securing work. Practically none of these necessary amenities have yet been provided and it is essential that permanent Government investments should not be endangered by their noncompletion.

It would seem, therefore, that the Senate Resolution requiring abandonment is unwise. Private building will not be likely to proceed to any extent on a falling market, and, until labor and material values are stabilized and Victory Loans are over, money will not be largely loaned for investment in building. Until Government standard prices, such as even now maintain on brick in some districts, are removed, prices cannot be fully adjusted. In the meantime many men are being discharged from service, and with cessation of this housing work more men are thrown out of employment. Would it not be wise, therefore, for the Government, not only in order to provide employment but to protect its own investments, to continue at once the completion of the necessary amenities that will make the isolated industrial village attractive to the working man?

The temporary housing should, in order to reduce competition with permanent housing and prevent deteriorative slum conditions, be scrapped at once and charged to war cost and the sites restored immediately upon evacuation. As to the permanent housing, the national emergency is past, and we do not like to think of Uncle Sam as our landlord, troubled with maintenance and administration of properties erected, to say the least, in great haste. As soon as guarantees of proper standards for administration and maintenance can be established, which should be six months after peace is declared as provided by the Emergency Fleet Corporation agreements, the Government should sell its property or its mortgages at normal cost and retire.

It is essential, however, that beyond the limits of organized municipalities some good organization, political or non-paternal, be established to maintain and manage the buildings, streets and parks, provide fire and police protection and in some cases to maintain the utilities, collect garbage and ashes and perform other municipal duties, which some of these suburban districts are not now allowed by law to do. Where the property is owned by a Local Housing Corporation, this problem of maintenance should properly be its duty, and for the good of the whole community the ownership of the entire property should remain

in the Local Housing Corporation. The owners of the plants are anxious that the houses be not sold in fee again to have title transferred to a worker in a competing plant, or to an objectionable neighbor. They are now protected by cancellation clauses in the Fleet Corporation Village leases, upon termination of employment in the plant. For the plant to retain or acquire ownership might require more capital investment for housing of labor than for housing of machinery, and besides the advantage gained of renting direct, to employees only, is too paternal to be popular with labor.

The American workman now understands the buying of Bonds on installments, but is apt to be suspicious of a "copartnership" as practiced in England. Why not, therefore, instead of selling the houses, sell the workman on partial payments from his wages, a rent paying first mortgage bond secured by the normal value of his home, and carrying the privilege of occupancy while employed at the plant with the first option for repurchase reserved to the Local Housing Corporation upon his removal or desire to sell. As his investment increased his rent would decrease, and if arranged to cover all costs, taxes, etc., he would be likely to appreciate the advantage, and become settled. By thus preventing profiteering on resale, the unearned increment should redound to the credit of the Housing Corporation.

There is a growing tendency in the locality of these new communities to question whether it is altogether politic to segregate so many workers of one class, sometimes with peculiar national traits, without admitting to residence some of the best elements of our citizenship which would leaven the thought and action of the community. It would seem wise, therefore, to encourage the dwelling within the village of the school teachers, clerks, shopkeepers and professional men required by the community.

These war villages should not establish our highest ideal for the future, for it must be remembered they were designed and erected under tremendous pressure. Much better results should be obtained under normal conditions, when responsibility is centralized in a single head. The Government has withal raised the general standard for real estate development to a level where all future developments should start, and the future industrial villages to be erected after reconstruction should be so controlled by City of State Planning Commissions as never to fall below the level thus established. The architects should help the general improvement by establishing and making known a new schedule of charges proper for this class of work, including town planning services.





PRELIMINARY TOWN PLAN OF SOUTH PHILADELPHIA, PA.

(Location plan inserted in upper corner)

CLARENCE WILSON BRAZER, TOWN PLANNING ARCHITECT



## Westinghouse Village at South Philadelphia, Pa.

**S**OUTH PHILADELPHIA lies between the towns of Lester and Essington on the Delaware River, about three miles north of Chester, Pa. The large new marine turbine plant of the Westinghouse Electric & Mfg. Co., for whose employees the town was projected, extends from the water front to the railroad on the watershed, as shown on the small insert plan. The inland side is the village site, approached from the plant by a viaduct over the railroad tracks as well as over the tracks of the Chester Short Line trolley from Philadelphia. The viaduct is also planned to serve a railroad station and a trolley loading loop.

glorious old oak tree some six feet in diameter still remains, however, carefully "courted" to preserve its roots. About 20 acres in the center of the tract are richly wooded, while stretching across the fields were groves of gum trees, very colorful in the Fall.

The Westinghouse Company has more than twenty other housing developments, but this is the largest of them all, and as planned it will eventually provide homes for over 6000 people. Long before America entered the war this scheme had been projected as a permanent part of their plant, and the company's town planning architect, Clarence Wilson Brazier, was commissioned to study and report a complete



*Drawn by E. D. Robb*

GROUPS OF SIX-ROOM HOUSES AT SAUDE AVENUE AND SENECA STREET

The tract set aside for housing contains about 90 acres of comparatively high land, sloping gently north with a fall of 30 ft. toward Long Hook and Darby Creeks, which are surrounded by marsh land. The portion nearest the trolley tracks was formerly a cornfield surrounding one of the first built houses on the Delaware River. Essington, on Tinneconk Island, was the first permanent settlement in Pennsylvania, having been colonized by the Swedes in 1642. Its streets were named for prominent Swedish settlers. The old manor house had been burned out many years ago, and the first act of the workmen, before they could be stopped, was to use it as a quarry for foundation stones. A

and comprehensive town planning development for the site, with plans of all buildings and municipal engineering suited to the needs of the locality and the company's employees.

After several months spent in survey and study of surrounding towns he submitted the accompanying plans with a comprehensive report. The latter discusses all phases of town planning, taking the open land, its subdivision, plotting, installation of all streets and public utilities, housing for different classes and the necessary number and kind of shops required to provide their needs, and churches which the population could support. A complete census of probable male, female and child



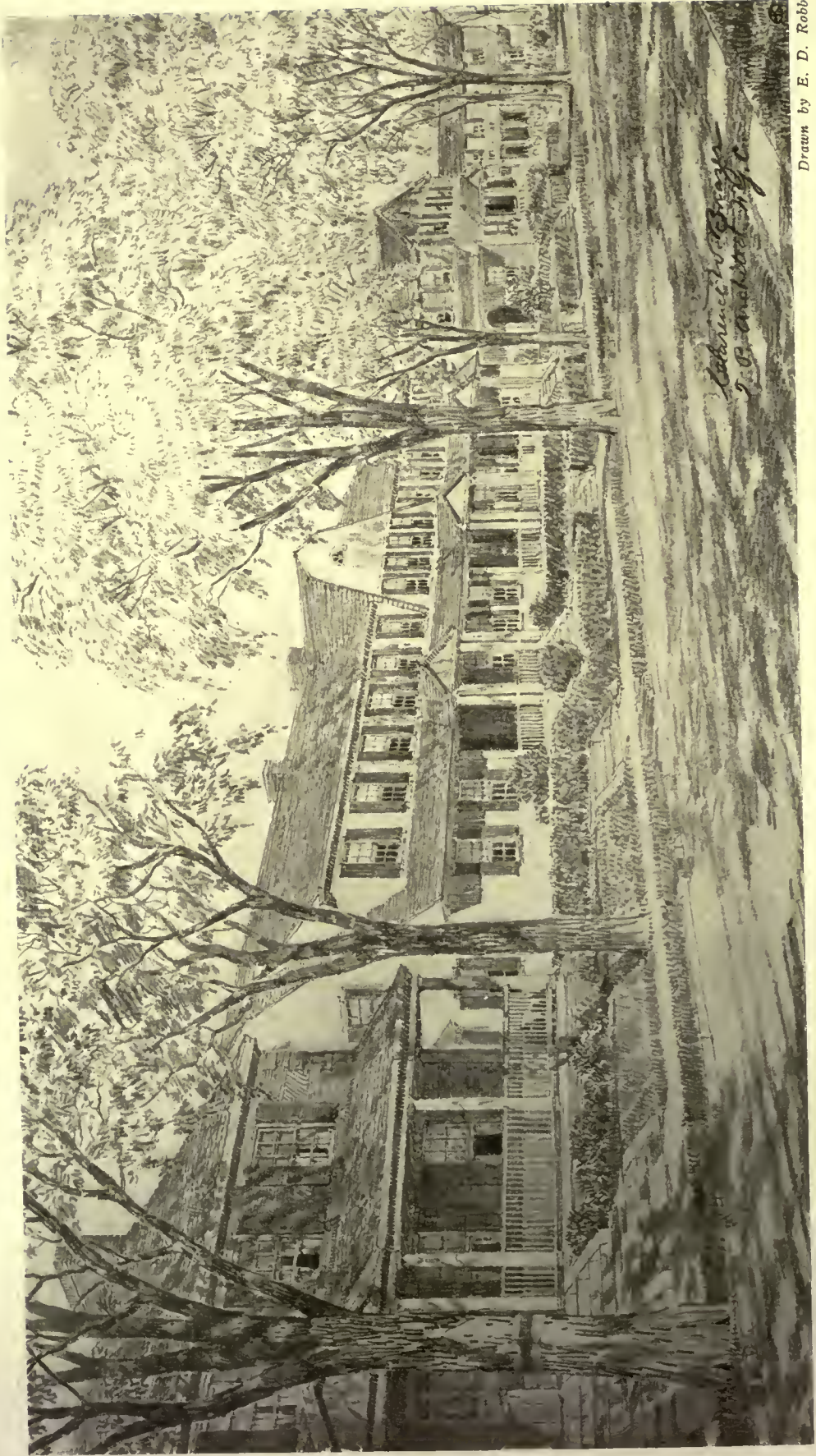

GROUPS OF FIVE AND SIX-ROOM HOUSES ON JANSEN AVENUE, SOUTH PHILADELPHIA, PA.  
CLARENCE WILSON BRAZER, TOWN PLANNING ARCHITECT



## THE AMERICAN ARCHITECT

occupants of the bedrooms contained in the typical plans of the buildings designed also gave data for school population and playgrounds as well as the possible number of male employees, single and married, that could be housed. This was accompanied by the usual percentage tables to prove the proper proportioning of the land area, and detailed estimates of cost of full land and utility development, as well as detailed builders' estimates on the build-

on the gross cost of building and lot average only 9 per cent, including water rent, interest and all the above-mentioned charges. Recommendations for restrictions to be placed on the land, administration and disposal of privileges terminate the preliminary report.

When Mr. Brazer first studied the site, the factory buildings were nearing completion, and their septic tank was being erected upon the lowest land

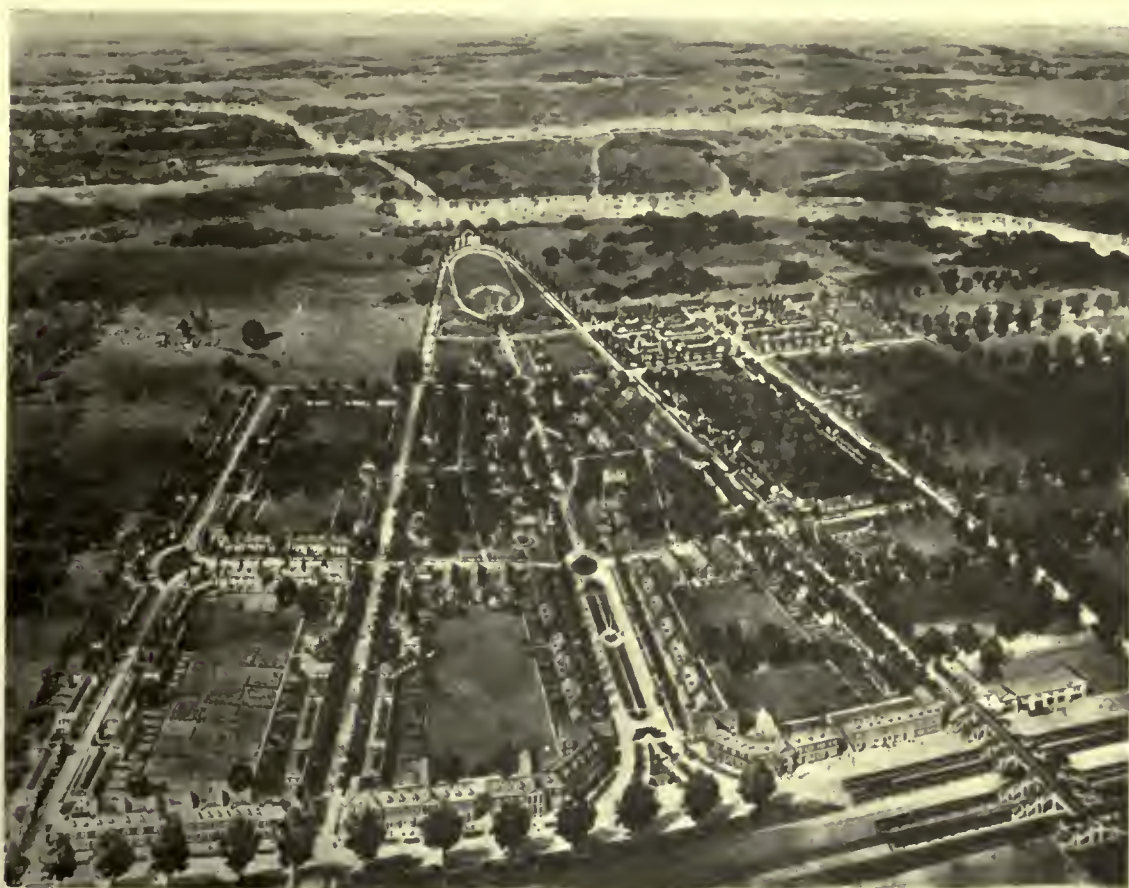

PRELIMINARY AEROPLANE PERSPECTIVE OF SOUTH PHILADELPHIA, PA.

ings, thus giving a grand total of eventual expenditure required. The public improvement costs were assessed against the lots, according to area, to which were added the cost of the buildings. Tables of each of the 15 classes of buildings were prepared, and on these total costs for each class were ascertained the taxes, insurance, water rent, 5 per cent interest on the investment, maintenance and repairs for streets, parks, lights, fire protection and buildings, as well as costs for collection of ashes, garbage and rents. These tables thus gave the amount of rent required from each house or building to pay all these charges, and the proof of good design is shown by the fact that the yearly rentals

adjoining Long Hook Creek. Extensions of the septic system had been planned to provide for the future village. This, therefore, became one of the determining factors in the town plan, as the natural fall of the land from the railroad gave just about the proper grade for sanitary sewers. Then, too, the surface drainage could be handled most economically by the same route to Long Hook Creek. The Swedish named streets of Essington and the Indian named streets of Lester had already been plotted, and were in part cut through in typical gridiron fashion. As the distance between these two towns was only 1800 feet, a system of curved streets would not only have been incongruous, but unsuit-



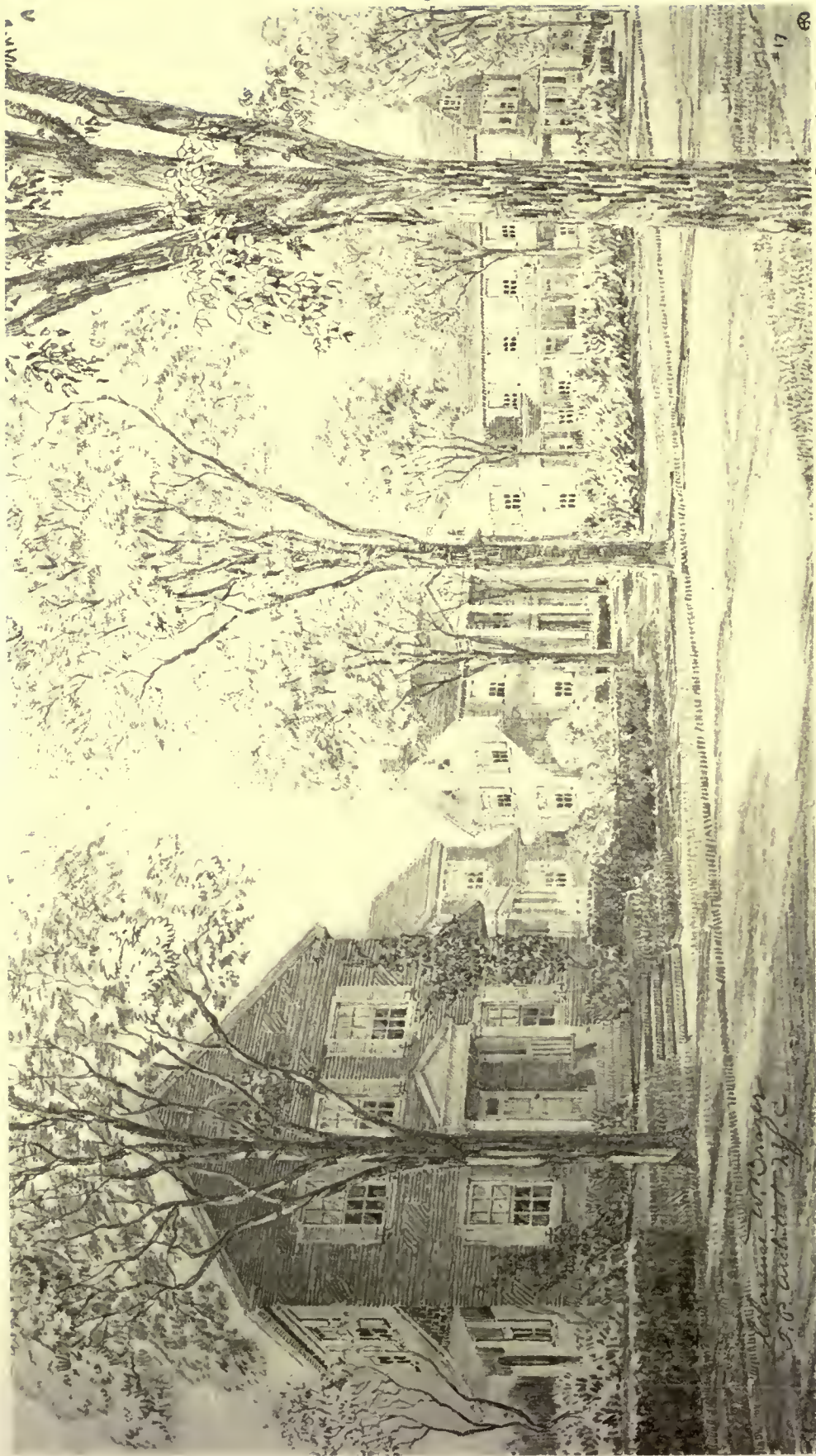

Drawn by E. D. Robb

GROUPS OF FIVE, SIX AND SEVEN-ROOM HOUSES ON JANSEN AVENUE, SOUTH PHILADELPHIA, PA.

CLARENCE WILSON BRAZER, TOWN PLANNING ARCHITECT

able to the economical straight-forward plotting of flat land for the row type housing preferred by workmen in this locality. In order to fuse simply and directly with these towns some of the adjoining streets were continued into the property, and those running north and south were chosen for residences, so that practically every room in the village gets direct sunlight some time during the day.

The frontage on the trolley line naturally was reserved for stores, banks, movies, etc., with apart-

located the school, Y. M. C. A., recreation field and boathouse; the latter on filled land. The lowest corner, on the east side nearest the viaduct to the plant, was reserved for the laborers' section, and the higher land to the west for homes of mechanics and foremen.

The blocks have been planned with alternate streets temporarily omitted until full development requires their being cut through, so that in the intervening years children will have the use of these

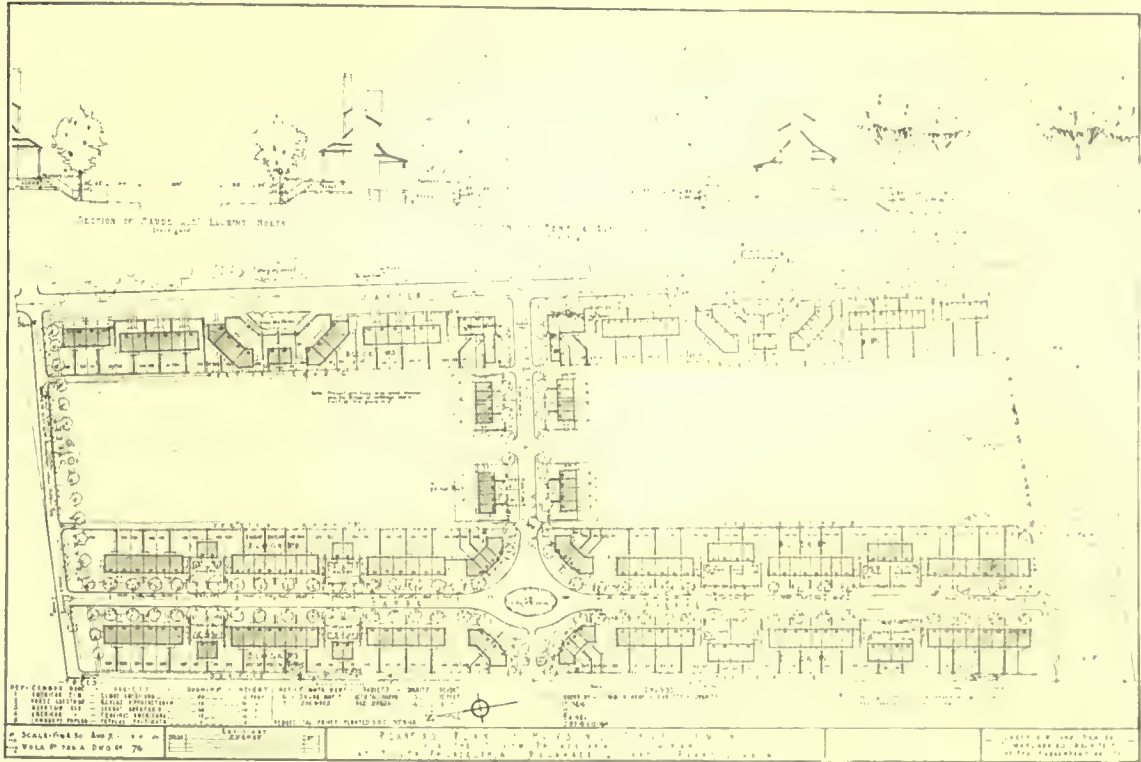

PLANTING PLAN OF FIRST FIFTH PORTION OF DEVELOPMENT

ments for the shopkeepers, and offices for the professional men, placed in two stories above to shield the housing district and give more privacy from the smoke and noise of the manufacturing plant and railroads. These higher buildings are broken by Central Parkway, 150 ft. wide, on which are placed boarding houses of similar height, leading to the Protestant and Catholic churches on the edge of the woods. In order best to preserve this wooded section, twin and single houses were plotted for the executive force of the plant, each with its garage on a minor service road. Service roads were also introduced to serve all houses and to permit most of them to have private garages. The sanitary sewers are placed here most economically. At the far end of Central Parkway, where the noise of organized play would least disturb the villagers, are centrally

protected open lots for play or gardens at will. All necessary connections have been made to the sewers and other utilities, of size amply to serve the future houses, which are located as shown by dotted lines on the town plan. Thus the first development will retain all the openness of the surrounding unplotted country at very little additional first cost.

Upon America's entry into the war prices so advanced that private financing became undesirable, and Fleet Corporation financial assistance was accepted for a sixth section of 200 houses only. This portion is shown on the accompanying detail planting plan, and the houses thereon have now all been plastered and over half of them are occupied. The unfinished condition of the surroundings which, with the planting, cannot now be done until Spring, makes it more desirable to publish the beautiful



# THE AMERICAN ARCHITECT



Drawn by E. D. Robb



FIRST FLOOR PLAN

SECOND FLOOR PLAN

REVERSE PLANS.

GROUP OF FOUR SIX-ROOM HOUSES AT SENECA STREET AND JANSEN AVENUE  
CLARENCE WILSON BRAZER, TOWN PLANNING ARCHITECT



## THE AMERICAN ARCHITECT

perspective drawings by E. Donald Robb than any photographs which could be taken at this time. In the war haste with which these houses were designed and erected, many of the detail drawings

were not followed on the job. Ill-advised changes were also quickly made by rough work pushers, so that better results are anticipated in the larger number of buildings still to be erected.



GROUPS OF FIVE AND SIX-ROOM HOUSES ON SAUDE AVENUE, SOUTH PHILADELPHIA, PA.

CLARENCE WILSON BRAZER, TOWN PLANNING ARCHITECT

### Massachusetts' Building Program

A building program involving the expenditure of \$200,000,000 in Massachusetts, \$64,000,000 of which should be expended in Boston, is urged upon Governor Coolidge by Henry N. Teague, associate director of construction for the United States Department of Labor. The plan proposed by the Federal Labor Department calls for spending \$300,000,000 throughout the country. The Department of Labor is seeking to gain the co-operation of each municipality and State in the hope of getting legislators to appropriate abnormally large sums for building and highway improvements.

"The Highway Department has nearly \$5,000,000 which has been accumulated from appropriations for road work during the past two or three years," he said. "The commissioners are planning on spending this in addition to their appropriation for the current year, and the amount asked for is larger than usual. I believe there will be a considerable amount of money spent for State buildings,

especially those devoted to educational purposes.

"Private interests are holding off as the majority of business men expect a depreciation in wages and cost of materials. The Secretary of Labor has stated that he does not expect any marked decrease in wages or materials for several years to come. It is up to the city, state and national governments to lead the way by starting elaborate building and improvement programs and then the private interests will follow."

Mr. Teague feels confident that building will boom everywhere. Prior to reaching Boston he conferred with the Governors of twelve States and the mayors of the leading Middle Western cities. Practically all the officials he met indorsed his plan.

Partly because of the reception he has met and partly on account of department investigations, Mr. Teague is optimistic regarding readjustment of labor conditions. According to his figures labor shortage exists in a number of States. These are mostly big manufacturing centers, which have attracted returning soldiers from other localities.





Drawn by E. D. Robb

GROUPS OF FIVE AND SIX-ROOM HOUSES AT OAK TREE COURT, SAUDE AVENUE, SOUTH PHILADELPHIA, PA.

CLARENCE WILSON BRAZER, TOWN PLANNING ARCHITECT



THE AMERICAN ARCHITECT

Founded 1876

PUBLISHED EVERY WEDNESDAY BY

THE ARCHITECTURAL AND BUILDING PRESS, INC.

No. 243 West Thirty-ninth Street, New York  
E. J. ROSENCRANS, PRESIDENT AND TREASURER  
WILLARD C. HOWE, VICE-PRESIDENT

WILLIAM H. CROCKER, Editor  
ARTHUR T. NORTH, Engineering Editor

Subscriptions in the United States and Possessions,  
Mexico and Cuba, TEN DOLLARS. Other Countries,  
TWELVE DOLLARS.

SINGLE COPIES (Regular Issue) 25 CENTS

CHICAGO OFFICE, Mallery Building  
PAGE A. ROBINSON, Western Manager  
ST. LOUIS OFFICE, Wright Building  
CLEVELAND OFFICE, Guardian Building  
SAN FRANCISCO OFFICE, 320 Market Street

Owned by United Publishers Corporation—H. M. Swetland, President;  
Charles G. Phillips, Vice-President; W. H. Taylor, Treasurer;  
A. C. Pearson, Secretary. Entered as second-class matter January  
6, 1909, at the Post Office at New York, New York, under the Act of  
March 3, 1879.

VOL. CXV FEBRUARY 12, 1919 No. 2251

The Sport of Chance or The Master of Destiny

AFTER the Civil War, when the question was widely debated as to the best methods that would effect a resumption of specie payments, a certain statesman advanced the opinion that "the way to resume specie payments was to resume."

This will also be the best method with reference to building operations halted by the present war. We have but to resume, at once to take up the work where of necessity we laid it down, and go forward with our building operations, adapting ourselves to present conditions.

While there will probably be some further reduction in prices, and, possibly owing to the large number of unemployed, some cheapening in certain directions of labor costs, it would be unwise to defer operations suggested by present necessities in the hope for radical cheapening of labor and materials in the near future.

The way to resume building operations is to resume. Secretary of Labor Wilson has recently addressed a letter to the Governors of all the States, urging action in the stimulation of interest in public works and civic construction. In response, the Governors of many of the States have appointed special commissions and the impetus due to this action is already apparent.

Governor Coolidge of Massachusetts has issued an inspiring address to the people of his State, in which he says: "Instead of being the sport of chance, Massachusetts ought to be the master of destiny. Instead of waiting we should act."

This is exactly the right spirit and one that should be shared by all of the people. We should act, and now. There is little if any material result to be gained by a policy of procrastination.

UNDOUBTEDLY the first important movement toward the resumption of our normal building conditions will result from a well directed leadership on the part of the various agencies of the Government. The national Government and those of all states and communities should start this movement. There is today a pressing need for many types of public buildings. It is claimed that the contracts for more than eight hundred schoolhouses were held up during the war, and it is estimated that these represent a building cost of eighty million dollars. *The American Contractor*, commenting on this one item of construction, school buildings, states:

"Assuming that a decrease of 20 per cent in construction costs might develop during the next four or five years (and this is regarded by many as a maximum decrease) the immediate completion of the nation's school program would involve an excess of only 1 per cent per capita per year over the per capita cost, even if construction were delayed for several years. The educators of the country ask, shall the country have its schools now at five cents per capita per year, or delay having them for four or five years in order to buy them at four cents per capita per year?"

A POLICY that seeks to provide employment for men for the simple purpose of giving them something to do is not founded on sound economic principles. It is a wasteful proceeding. The program as outlined by the Department of Labor is one based on well considered effort looking to the sound and safe resumption of our building activity. It seeks to repair in a practical manner the deterioration of the past two years, to provide for the logical needs due to our unusual growth during that period. The same safe and sane program may be, with the necessary adjustment, applied to civic building. The way we shall resume our building operations will be—to resume them.

Architects may by well-directed, logical arguments make clear to their clients the exact situation as it stands to-day and demonstrate the "penny wise and pound foolish" attitude of procrastination. There should be no slackening now in any measures



that look to securing the rapid return to normal conditions, and the influence of the architect on the subject of a speedy resumption of building can at no time be better exerted.

### A Comprehensive Educational Measure

PROBABLY the most comprehensive and important educational measure ever put before Congress is the bill introduced by Senator Smith of Georgia. Its main provisions make appropriations for the removal of illiteracy, the Americanization of the alien, the equalization of educational opportunities within the several States, co-operation for the promotion of physical and health education and of recreation.

A further important feature is the creation of an executive department, known as the Department of Education, with a Secretary in the President's cabinet.

The fact disclosed during the first selective draft that there were in this country 700,000 illiterates between 21 and 31 years of age, was a surprise to most citizens. It was not conceivable that in a nation where educational facilities were so generally supplied there could be so large a number of citizens in this class. The bill introduced by Senator Smith allots \$7,500,000 to be used for the removal of illiteracy.

The matter of the Americanization of the alien has now become one of large importance. The conditions disclosed in this country during the progress of the war unmistakably pointed out the fact that if we are successfully to eliminate the hyphenate we must set about the education of the alien and enact such laws as will quickly mould these people to the better forms of conditions in America. For this worthy purpose the bill provides \$50,000,000.

Our population has been made up largely of immigrants. In 1910 there were in the United States 13,515,886 persons of foreign birth out of a total population of 91,972,266; or, roughly speaking, every seventh person of the entire population was born in a foreign land. The foreign born population in our Atlantic Coast States and in our industrial States increased rapidly from 1900 to 1910. Large numbers of these were illiterates. In New York alone there were, in 1910, 406,020 foreign born illiterates—a number probably greatly in-

creased before the outbreak of the war. The total number of foreign born illiterates in 1910 was 1,650,361.

If these immigrants are to be more than just so much productive power, they must become Americanized. The first step in this process is acquiring the ability to speak and read English. Those under ten years of age should go to the public schools regularly. Other provisions must be made for the adults.

The matter of the equalization of educational opportunities within the States is one of very great importance. The success of an effort in this direction would undoubtedly be largely influenced by the creation of a National Department of Education, presided over by a Secretary with Cabinet rank. As the matter now stands the educational opportunities are largely controlled by the per capita wealth in the various States. This is very uneven. In North Carolina, for example, it is \$726.35, in Nevada \$4,135.35, and in the country as a whole it is \$1,712.77 per capita. Further, the population back of each teacher employed in the public schools is also uneven. In Iowa there is one teacher for a population of 81.52 persons, in Louisiana there is one teacher for a population of 240.01; in the country as a whole there is one teacher for a population of 163.91.

The bill before Congress provides \$50,000,000 annually "for the improvement of public schools of less than college grade, with the definite aim of extending school terms and of stimulating State and local interest in improving, through better instruction and gradation and through consolidation and supervision, the rural schools and the schools in sparsely settled localities." An equal amount by the States would provide \$100,000,000 annually. The fund is to be distributed on the per teacher basis, and amounts to \$80.34 for each public school teacher employed.

The bill provides that no State shall share in this fund unless it has at least twenty-four weeks of school in each district, unless it enforces an adequate compulsory school attendance law, and unless it provides that "the basic language of instruction in the common school branches in all schools, public and private, shall be the English language only."

This bill is one that should receive the active support of every citizen. It is undoubtedly the most important educational measure ever considered by Congress.

# Structural Service

## Impromptu Remarks by D. Knickerbacker Boyd at the 57th Annual Convention of The American Institute of Architects

I WELCOME this opportunity to add for consideration certain suggestions concerning the services of architects as applied to practical matters. I hope you all realize that Structural Service does not concern itself solely with matters considered to be structural in the ordinary sense of the word. The intention has been by combining with it the word service to include and describe all forms of the architect's service exclusive of those pertaining to design. From that point of view the field would be divided into design on the one hand and what we choose to call "structural service" on the other. As stated in the resolution of the board in proposing a committee which is now to be inaugurated, the subjects covered by the field of structural service would be all those relating to "the improvement of building materials, their safe and efficient application and use, and to providing for the safety, health and comfort of the occupants of all buildings."

I would like to point out a few of the opportunities which I see before us for service in connection with other organizations to render the broadest kind of a national service. Take, for instance, the formation of this body just mentioned as a federation of the building industries (later organized as the National Federation of Construction Industries by the Chamber of Commerce of the United States in co-operation with the National Association of Builders' Exchanges, the Associated General Contractors of America and other bodies). I would like especially to urge that in associating with us the various organizations of the country we should include all of those which concern themselves with any phase of the sheltering of humanity in its broadest aspect. We should, in this connection, not think in terms of materials alone, but consider them as but mediums with which to provide the best and safest kinds of habitations for mankind, and include in such federation all those who would welcome the opportunity to contribute to improvements in the character of such habitations.

But, instead, I will merely call your attention to that fact and mention a few of the opportunities as I see them for us to render the kind of national service to which I refer.

Mention has already been made in the report of the board and on this floor of some of the activities of the American Society for Testing Materials, the

National Fire Protection Association, the Underwriters' Laboratories, the United States Bureau of Standards and of some of the departments of the United States Government.

Various departments of the Government, as well as these, and other organizations throughout the country, are performing services at all times and issuing publications that are of the greatest interest and usefulness to the architectural profession and other interested citizens—and yet how few of us, comparatively speaking, realize what is being done in this direction and how we are being benefited. The point is, that being the case, should it not create a reciprocal obligation on our part to co-operate with these agencies, not alone by availing ourselves of the information which can be obtained through publications issued by them, but by participating as fully as possible in their activities and contributing to the results which make these publications possible? Should we not, as many of us as can, be members of the National Fire Protection Association, the American Society for Testing Materials, and some of the other national organizations which are working for the good of us all in the various problems connected with the sheltering of humanity?

And yet there are only about fifty members of the Institute who are members of the National Fire Protection Association. This association, originally created as an agency for the protection of property against loss by fire, has long since become one of the most potent in this country for the protection of life against loss by fire, panic and other causes inseparable from mere property considerations.

I believe that there are only three who are members of the American Society for Testing Materials. At the convention in Atlantic City last June of this society, which I attended with Professor Nolan, chairman of our Committee on Materials and Methods, there was a report submitted from the Committee on Fireproof Construction, and on the front page it was stated that the report had been prepared in collaboration with representatives from eleven important national organizations, which were listed, and in the list was not included the name of the American Institute of Architects.

Upon calling the attention of the convention to this fact, it was pointed out that Mr. Daniel Everett Waid was a member of the committee, but that he represented the National Fire Protection Asso-



## THE AMERICAN ARCHITECT

ciation and not the American Institute of Architects, because he had not been officially asked to participate. In view, however, of his being an officer of the Institute, as well as prominently identified with technical phases of our practice, the Executive Committee of the society added the Institute's name.

Surely such a society is one which our members should join in force and in which we should make our influence felt by serving, not alone on that committee, but on the many others concerned with building materials and methods.

It seems to me that we have ourselves largely to blame that we are not more generally asked to participate in these and other public service movements, for we have not heretofore made sufficiently apparent to the inclination to do so. So I am going to urge upon you all to seek the opportunity to extend the architect's service by collaborating with these important agencies throughout the country which are doing work of so much benefit to us, individually as well as collectively.

Mr. Jensen very ably pointed out what we might do to assist the United States Department of Agriculture in respect to what we have heretofore denominated minor structures of the country—farm houses and groups of farm buildings. How few of us are aware that the Department of Agriculture will provide information and furnish publications to any architect or citizen of the United States who asks for either. Many of the excellent publications are absolutely free and others may be had at merely nominal prices. It seems to me we should acquaint ourselves with the service which this department renders and the publications which it issues, and that in the case of the latter we should use as many of them as we can, should review them, and wherever possible, offer suggestions for their amplification, improvement or greater distribution and utilization.

The same department has prepared an elaborate and most interesting model of a farmstead, showing all the buildings of such a group as well as the layout of the grounds. Why should we not get in touch with the Department of Agriculture and offer our services in further developments of this idea and see that such models are given the widest circulation and recognition possible?

The same thing applies to the Bureau of Education in the Department of the Interior. That Bureau not only issues comprehensive publications relating to schoolhouses and all educational matters, but has prepared drawings for schools for the smaller communities of the country. I wonder how many of the architects know that such drawings have been prepared, that they are available to and are secured and used by school boards and communities? Why should we not co-operate with the

Government in the issuance of such drawings, if they need improvement, and, if not, at least let the department know that we are with it in this movement? It also has prepared a model for a schoolhouse for a small community, and that model is being asked for by school boards in various parts of the country and has doubtless proved very helpful to them in arriving at conclusions.

The United States Department of Labor and the Bureau of Mines have both made investigations into the subject of the housing of employees for many kinds of industry, and they have issued valuable publications relating to this subject which includes a monthly bulletin of the Bureau of Labor Statistics. I do not know how many architects are aware of these facts, or whether they have applied for any of those publications, but, if not, they should.

The Navy Department issues specifications for materials that are used in many features of building construction. These we should know of and benefit by the results of these investigations.

In these and many other ways we should recognize what is being done for us by the various departments of our own Government, and afford them the realization that, as citizens, we are utilizing the results of their endeavors and are willing also to assist them in every way we can.

Among other things we should, it seems to me, co-operate with the American Society of Civil Engineers and other great engineering societies far more than we have ever done. In recognition of the important developments in materials and appliances which they have brought about we should voice our desire and willingness to take a more active part in such work.

We should also maintain a more cordial contact with, and give encouragement and assistance to, such organizations of producers and manufacturers as are constantly and conscientiously endeavoring to improve materials and processes and bring about a better understanding of their varied characteristics.

And, at the same time, I want particularly to mention the necessity for correcting the lack of cooperation on our part with the craftsmen, mechanics and others employed upon buildings. In this connection the American Federation of Labor maintains a Building Trades Department, composed of nineteen organizations known as "Internationals," with local branches, in different parts of the country, covering the various industries that pertain to building construction. These concern themselves, among other things that we ought to know more about, with methods of safety in construction and the use of building materials.

Other organizations exist whose chief functions are to make for safety in all the industries and in all walks of life. Among these are the National



## THE AMERICAN ARCHITECT

Safety Council, the American Museum of Safety, the Workmen's Compensation Service Bureau, with the valuable work and publications of all of which we would do well to familiarize ourselves.

The National Education Association is another one of the bodies which is working for the safety of occupants in buildings and is one which has a Committee on Standardization of School House Construction and Planning.

It seems to me we should follow up this work and find what is possible for our members to do in co-operating with that committee, as its intention is, I know, to provide for the safety of the occupants of all school buildings by causing buildings to be fire resistive in construction and by seeing that adequate exits are provided, so that everyone may get out in case of panic as well as in case of fire.

The same thing applies in the matter of co-operating with the Public Health Association and with the American Hospital Association, the latter of which has a Committee on Standardization of Hospitals. No architect is on that committee, and, doubtless, but few know of its existence.

We should, it seems to me, co-operate with the American Medical Society as so effectively pointed out by Mr. Medary. There must be many opportunities for us to offer the services of the American Institute of Architects to this and other important bodies, and we should at least make the effort to find out what they are doing and determine the possibilities for collective or individual participation.

The same thing applies to the Chamber of Commerce of the United States, the national organization representing all local groups. Heretofore we have seemed to avoid connection with anything which implied a contract with commerce, but the times are changing and we must change with them.

As an instance of the lack of co-ordination in lines of similar endeavor, take the case of the conference recently called by the American Civic Association and the American Housing Association.

Certainly none ought to be more interested than architects in those allied activities, and yet these conferences were held in Philadelphia recently and they both covered ground already covered by the American Institute of Architects and by its Journal.

These associations, apparently without notice or conference, were the initiators of a movement which should have been initiated by the architects and carried out in co-operation with these associations.

Another organization with which we have interest in common is the National Association of Real Estate Boards, and there are still many others which I can not attempt to recall in the course of an impromptu summing up of such an important sphere of activities. In concluding this outline sketch, however, I would like to make mention among them of the Illuminating Engineering Society. That organization has prepared a code for the adequate illumination of industrial buildings, and is now working on other codes, one of them being for the proper illumination of school buildings. These codes concern themselves, as is perhaps not so generally understood, with the proper day lighting of interiors, as well as with their artificial illumination by various methods. Certainly the architects of the country should be more familiar with these works and become, in large numbers, affiliated with that society. This, like several of those of which I have mentioned, is not subject to any restriction as to membership except the indication of a reasonable degree of interest and the payment of nominal dues.

In suggesting these as a few possibilities in the way of an extended national service, let me emphasize once more the impression which such service would be bound to create upon other groups and upon the public at large. It would convince them that we are persons interested, not alone in matters of design, of ethics and of pleasing disposition of materials employed in construction, but that we are also essentially interested in all matters which make for the health, the safety and the comfort of the occupants of all buildings. That we are concerned with the width and arrangement of streets, the light and air admitted to buildings, their sound and fire-safe construction, ample exits for safety from fire and panic, matters of proper sanitation, and with everything else which makes for decent places in which to live and work and such facilities for play, recreation and enjoyment as shall make life worth the living.

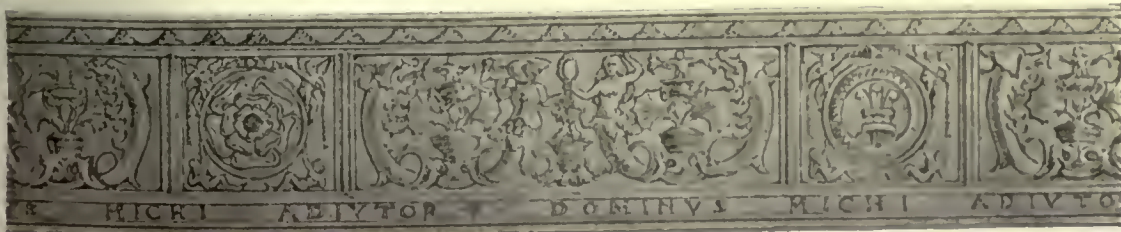

# Some Aspects of Modern Contracting

Remarks of F. E. DAVIDSON, *A. I. A.* Before the Master Builders of Wisconsin at Green Bay, Wis.

**T**HE business mortality of contractors is said to be the highest of any business, and approaches the mortality of the battlefields of Europe.

I am going to assume that a twenty-five years' active experience in the construction field, first as draftsman, then building superintendent, afterward estimator, then contractor, and for the past fifteen years as architect and engineer, has offered me an opportunity of observing some of the shortcomings of my friends, the contractors, and if perchance I may offer a single suggestion that will react on their brains as a thought, which if acted on should result in conserving any part of their time or resources and at the same time conserve any part of our labor resources for the general good of society, then I shall feel that my trip to this wonderful City of Green Bay will have been of some avail.

Based upon observation, it is my firm belief that the average contractor is ill-equipped successfully or efficiently to perform his functions in our business world. His training has not been sufficient. We have no colleges or schools of contracting. The average contractor enters business, not only with insufficient training and preparation, but with inadequate capital, and often the only asset he has when entering business life is an acquaintance with some architect's superintendent, which permits him to secure a set of plans and specifications and submit a bid as a full-fledged, financially responsible and experienced contractor; and he has been able to get away with it. Why? Because the average owner will usually consider only the lowest bid, because forsooth the bonding companies are ever ready to write a bond on anything and for any purpose.

Everyone knows that contractors and material dealers are children in arms when considered as business men. Else why should our State legislatures provide lien laws to protect their credits, a protection not given to any other business on earth?

I will make the positive statement that our lien laws and our custom of exacting surety bonds has done more injury to the building business as a business than all other things combined. I have often condemned the system of surety bonds as a species of organized legal graft. The price of a bond is fixed by the mortuary business tables of the insurance companies and anyone with the price to pay can secure a bond for any purpose and for any amount.

As to our lien laws, every mechanic's and material man's lien law should be wiped off our statute books and the building business put on the same footing of common honesty and fair dealing that is the rule of conduct in any other successful business.

Is it not time that you as contractors ceased to be regarded as wards of the State and unable to conduct your own business? Today the law views you as a class of men unable to judge credits, or even able to collect your own accounts or to pay your own bills, and to aid the great gamble allows the bonding companies to speculate on your ability to conduct even a simple financial transaction.

One of the vital questions which our nation must answer and which you individually and as an organization may do your part in answering, a question that is now and in the next few years will be one of the most important that any people have ever been called upon to face, is the great problem of conserving the man power of the nation.

Human life has always been considered a cheap commodity, and during the years when the tide of immigration set to our shores, but little regard was paid by industry to safeguarding human life and limb. Society overlooked the fact that the maiming or killing of an industrial worker was a crime and that it must thereby carry an additional burden for every worker that was killed or injured. It also overlooked the fact that every worker injured or killed reduced the available man power of the nation and directly decreased our capacity for production and added as well a further burden on society for caring for the injured and for the support of the family of the one injured. But again the State has recognized that what is particularly true in the building industry is true to an extent in all industry, that industry and society were not adequately and directly caring for those injured and for the families of those killed. Therefore the bonding companies were permitted to gamble on the chances of your employees being killed or injured and on your inability so to manage your building operations as to prevent the loss of life and limb. And what is the result? In many States we find compulsory liability insurance laws, and the rates charged by the liability insurance companies for insurance in the field of building is higher than for any other industry, proving conclusively that contractors as a class are less able to protect their own interests, as well as the interests of the community, than any other class of men. Every preventable accident is a



## THE AMERICAN ARCHITECT

direct loss not only to society, but to the employer. The expense of the labor turn-over is increased, the loss or damage of materials, the cost of reorganizing the working force, the expense of replacing and training of men to replace those injured, on the occasion of a serious accident, all represent a financial loss to the contractor that is not covered by his insurance policy and that is a factor of cost not usually considered in preparing estimates on work.

Why is the percentage of accidents, and the corresponding cost of insurance, higher in the building industry than in any other? In Wisconsin the ratio is about four to one and varies but little in the other States. It cannot be that our building mechanics are less intelligent or less skillful than the workers in the railroad yards or the mechanics in a rolling mill. The human element will be found the same whatever the line of work considered. Therefore, why the four to one ratio of accidents on your work as compared with all others? I will venture the suggestion that the average contractor was improperly trained for his calling. He is perhaps an ex-carpenter boss, or a bricklayer, or a plumbing foreman whose wife has inherited a little money and he concludes to become over night a full-fledged contractor; and if he is lucky, he gets away with it. He is starting his business life, no better equipped than the very great majority of his competitors. By the law of averages, a few at least succeed in making money, but he continues to conduct his business along the lines of the same old gamble, instead of organizing to reduce costs and increase efficiency; he continues to gamble on the chance of a profit on work in which to him there are so many unknown quantities that the loss of a few lives is too small a matter to be considered; for has he not done his duty to society by buying liability insurance? He overlooks the fact that his neglect in doing all that might be done to prevent accident is not only a direct loss to himself and to the community, but affects the insurance rates placed on his class of work, which every man in a similar capacity is compelled to pay.

No man can live by and for himself alone. Our each and every act affects the lives of all our fellows. It is the duty of every contractor to do all possible to conserve man power. Let each member of this society read the astonishing results secured by some of the largest contractors in reducing the number of accidents on their work.

The contractor who is able to maintain a high morale in his organization is able to do work cheaper and better than the contractor who takes no interest in his workmen. The really successful contractor is he who knows men, who knows their problems and can sympathize with them in their troubles, who

considers even the laborer on the job as his partner in business, and recognizes that the time has arrived when it is better to consider labor as a comrade than as an enemy. A contractors' association such as yours will do well if it heeds the "handwriting on the wall" that labor has the right to participate in the management of construction and that the right of organized and collective bargaining has been established for all time, as one result of the world's war. Co-operation was the great lesson taught by the war. You as contractors and we as architects must recognize that the co-operation of contractors, workmen and architects is necessary to give perfect service to those who employ us. Let me say further that the contractors of the future will be compelled to give a service not dreamed of in your philosophy. I expect to see the day when contracting, instead of being a matter of barter and exchange, will develop professional aspects and that when you sign a contract you will be expected and compelled to furnish service to the owner in addition to delivering to him so many carloads of brick or so many feet of lumber assembled in a certain way.

The successful contractor of the future will be a better business man than he is to-day. He will not only know how to keep cost accounts, progress reports, etc., but he will also learn how to reduce the labor turn-over and prevent 85 per cent of the accidents now chargeable to building operations.

In conclusion let me say that if you have no brains, hire some. Brains are the poorest paid and the scarcest commodity in the world today. Organize your work, give your employees an interest with you or at least see to it that they are interested in your welfare. Prove to them that their best interests are also your own. Increase the morale of your working force. Don't regard your competitor as an enemy but as your brother. Talk over your problems with him. Remember that your calling in life is an honorable one. Jesus Christ was a carpenter. Remember that he who can devise a means of reducing costs is a benefactor of his race. Remember that every preventable loss, whether in materials or man power, is a national loss, and above all, remember that whatever you may do affects your neighbor, that in the end his interests are your interests, and that as an organization you can have no ideals not possessed by you and your associates as individuals. Let your association set its standard so high that you as an individual will ever be compelled to look up to the standard you as an association may set, and bring to your business an idealism and an expression from the innermost heart of life. Bring to your association the best that is in you; ever remembering that the good of one is the good of all.



# Hotel Lincoln, Indianapolis, Ind.

RUBUSH & HUNTER, *Architects, Owners and Operators*

**H**OTEL LINCOLN, illustrated in this issue, is situated at the juncture of Washington Street and Kentucky Avenue, in Indianapolis, on a lot triangular in shape, measuring 150 ft. on Washington Street and 187 ft. on Kentucky Avenue. Since this location is in the very business center of the city, it was imperative that the design and plan should be one wherein there might be

low granite base carrying ivory terra cotta up to and including the third story. Above this story there is used a rough textured brick in variegated buff and light brown tones laid in brown mortar with raked joints. The result of this happy combination of materials has been to produce an extremely soft and pleasing texture.

As it is intended to extend this hotel an additional



INTERSECTION OF CORRIDOR ON LOUNGE FLOOR

located upon the ground floor a maximum number of shops in order that the income-bearing possibilities of the project might be realized to the fullest extent. This location of the business premises necessarily curtailed the size of the lobby, café and other features usually to be found on the ground or entrance floor of the modern hotel, but, as will be seen in the illustration, in no wise retarded the opportunity for making these features architecturally attractive. As will be noted, the exterior is one of the simple Adam design with a

eight stories at some time in the future, the present cornice is but temporary.

The lobby, as will be noted in the plan, may be approached from both Washington Street and Kentucky Avenue through vestibules whose walls and arched ceilings are of the same terra cotta as used on the exterior, decorated in low relief. The warm tones produced are of a most satisfying nature and accent the domestic atmosphere that is a pronounced feature of the interior of this hotel throughout. The same general treatment is to be

seen in the café and coffee shop. An unusual feature in the lobby is the admission of daylight through a skylight through an open court extending up through the lounge on the second floor. It materially emphasizes the size and dignity of this important space.

The lounge on the second floor extending entirely around this open space has many unusual features of planning to allow social intercourse either in small groups or to avail of the entire space. This room has a vaulted ceiling decorated in the Adam style. This decorative treatment, in fact, is to be found throughout all the public rooms of the building, and has been successfully carried forward by the introduction of well selected delicate greys without accenting the high lights which emphasize in the most satisfactory way the numerous Wedgwood effects that are introduced.

The upper floors have been planned to meet the requirements of the usual social and business activities and each room has been especially planned for the arrangement of the necessary furniture and the avoidance of crowding so often to be noticed in hotel sleeping rooms.

The following description of the interior fittings of this hotel is taken from a communication received from the architects and indicates the very large amount of thought and personal supervision that has been given to produce a result in which the city of Indianapolis very properly takes a considerable pride.

This description is of interest in view of the fact that Messrs. Rubush and Hunter are not only the architects of the hotel, but also the owners and control its management. They state:

Each bedroom has its accompanying bathroom. Solid porcelain recess bath tubs, vitreous china lavatories, flushometer water closets, solid porcelain

recessed shelf over the lavatory, enameled rod towel shelf, recessed grab rail and soap dish over the bath tub, recessed white glass toilet paper holder, plate glass mirror, white porcelain shaded light, tile floor and wainscot, circulating ice water, ventilation and last, but not least, a radiator to keep the room warm for the man who likes to sleep in a cold, well ventilated bedroom.

The basement is taken up with the public toilet room, barber shop, tailor, carpenter shop, store rooms, boiler room, engine room, helps' dining rooms, and the inevitable kitchen with its many ramifications little thought of by the public, but a composition of mad detail to the architect in its layout and proper equipment. After you get it all complete and view the results with satisfaction, you are thrown to the depths of despair when you turn loose the steward, French chef and bakers and the thousand and one experts who are to occupy this space, and learn that absolutely nothing is right and that only a first-class bonehead could make such a mess of a kitchen. But you regain some of your courage when you lose your first chef and his corps



BUST OF LINCOLN IN LOBBY

of experts and find that the new gang would have planned the whole thing in a manner entirely different from the original chef. After you recover from the onslaught of the kitchen dignitaries and breathe a sigh of relief, you find you have only jumped from the frying pan into the fire when you come in contact with the housekeeper. Then you find how little you know and how poorly informed the sources are from which you obtained your information as how to furnish a hotel bedroom, but thank goodness all of these are only made up of the personal equation and your real happiness comes when you hear the expressions of delight and satisfaction of the guest which more than repays you



## THE AMERICAN ARCHITECT

for the untiring efforts and hard work you have injected into the enterprise.

The furniture throughout the public portion of the house was selected not only to meet the severe service but to harmonize with the architecture in both design and color and at the same time furnish these portions in an inviting and homelike manner.

The bedroom furniture was made in black walnut from our own designs, harmonious with the style used throughout the hotel. The dressers have one panel fronts with the veneer laid at an angle of about 60 degrees, running from the lower corners meeting in the center. This lends a very attractive feeling and refinement. The mirrors are large and stationary. The drawers are provided with wood knobs, mahogany bottoms and all corners are slightly rounded to prevent splintering caused by the rough service they are required to withstand. All beds are veneered in the same manner as the dresser fronts and the footboards are low, being but two inches above the top of the dressing of the bed. The chiffoniers are designed to match the dressers and have the customary sliding drawers, etc. The desks are provided with a drawer with a drop front, thus providing writing space without removing anything from the desk top. Desks, chiffoniers, dressers and night stands have glass tops. The grip or handbag stands have been uphol-

stered with carpet of the same material and design used on the floor. This makes it possible to use it as a stool in case the room is temporarily crowded, thus avoiding the delay caused in sending for an extra chair.

The rooms commonly used by male transients are equipped with a chiffonier and desk combined, a drawer being provided to serve as a desk, the front dropping down as on the regular desks. This makes it possible to dispense with a regular desk in these rooms.

Each room is amply provided with chairs, including the destructive, yet necessary, rocker; also the little things to complete the furnishings, and sanitary drinking cups; in fact, nothing is left undone to make the rooms complete and homelike, even to the use of light figured wall papers, tinted ceilings and pictures which are different.

Now, if you haven't had experience sufficiently varied to satisfy you in the planning, designing and furnishing of the hotel, become interested in its operation and you will no doubt fill your cup to running over in endeavoring to satisfy those of the traveling public who own the room, as well as the entire hotel, as soon as they register. But you will also find there is another portion of the traveling public who appreciate your efforts and do not hesitate in expressing their pleasure.



SOUTH WRAXALL MANOR HOUSE





PLATE 51

HOTEL LINCOLN, INDIANAPOLIS, IND.  
RUBUSH & HUNTER, ARCHITECTS, OWNERS & OPERATORS









THE AMERICAN ARCHITECT

FEBRUARY 12, 1919

VOL CXV, NO. 2251

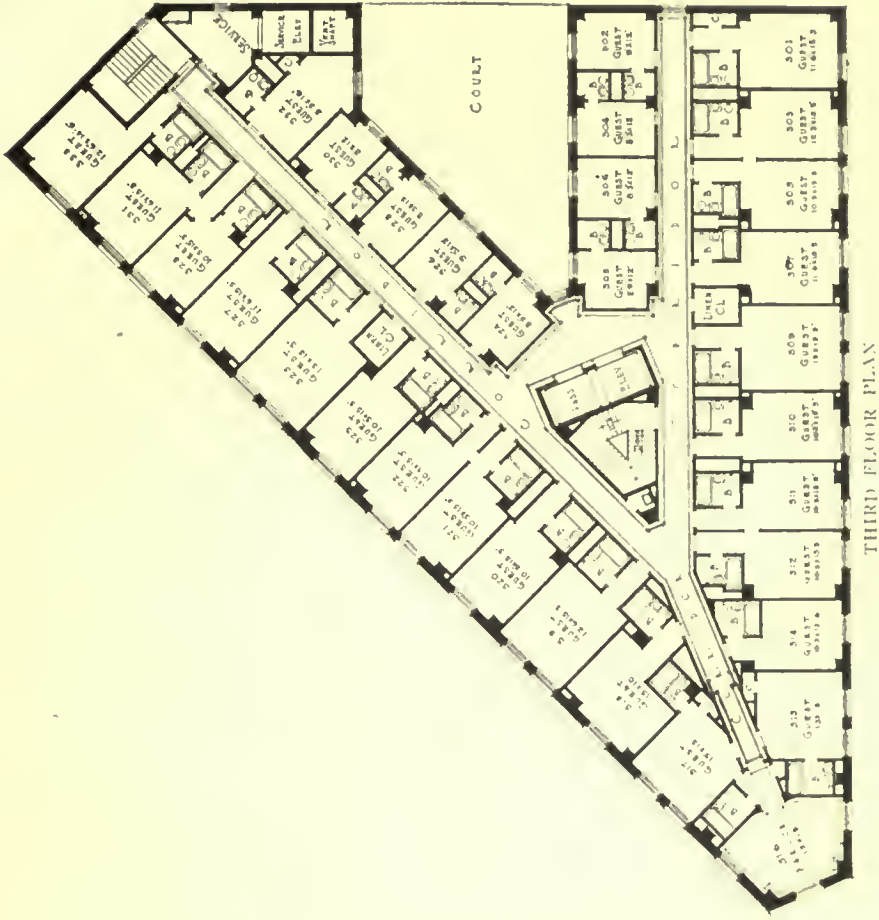

THIRD FLOOR PLAN



SECOND FLOOR PLAN

PLATE 53

HOTEL LINCOLN, INDIANAPOLIS, IND.

RUBUSH & HUNTER, ARCHITECTS, OWNERS & OPERATORS







THE LOUNGE



PLATE 54

BANQUET ROOM

HOTEL LINCOLN, INDIANAPOLIS, IND.  
RUBUSH & HUNTER, ARCHITECTS, OWNERS & OPERATORS





THE LOBBY



MAIN CAFE

PLATE 55

HOTEL LINCOLN, INDIANAPOLIS, IND.  
RUBUSH & HUNTER, ARCHITECTS, OWNERS & OPERATORS





# Financing the Expected Boom in the Building Industry

Starting of-First Apartment House Project in New York City in Many Months Indicates Absence of Any Federal Bar to Building Loans and Encouragement of Widespread Construction—Mortgage Money for New Buildings Becoming Easier with Stabilizing of Material Prices at Lower Levels

## *Part III*

With the announcement that the first apartment house project to be undertaken in New York City in many months is to be started shortly, evidence is making itself strongly felt that the hesitancy heretofore held by mortgage interests and lending institutions in freely loaning money for construction work has been removed. This release of loans by the banks is due mainly, it is believed, to the statement made by Carter Glass, Secretary of the Treasury, who, when he learned that money from the loaning interests was not forthcoming because they were saving it for the Victory Loan in April, as they would be the primary source of flotation, said that the public will be just as ready patriotically to absorb that loan as it was to subscribe to the others.

All Government authorities are bending every effort to encourage building construction, including the flotation of loans on both public and private construction. Other factors that have put the banks and larger insurance companies at ease, are statements from the Department of Labor. One was from the Assistant Secretary, Felix Frankfurter, which said:

"As far as the Department of Labor is concerned, we are making every effort to stimulate the development of necessary public works by the States and cities during 1919. We shall shortly know the programs of 500 cities. We can already estimate that the amount of public work will be valued well above the normal amount of \$600,000,000 per annum, and we have every confidence that both public and private work will go forward in large volume.

"Furthermore, it is the definite policy of the Government, as announced in the President's message and as followed by all departments, to set in motion all the necessary public work in order to supply some substitute for the large Government orders which have been cancelled.

"On behalf of the Secretary of Labor, I hope you will bring home to the building trade his desire to assist it in any way in his power, and that the industry will feel able to do its part in providing employment for large numbers of returning soldiers and former war workers in 1919."

Acting at the request of the Secretary of Labor, who urged governors in every state in the Union

to stimulate interest in public works and civil construction, Governor Calvin Coolidge of Massachusetts has announced the appointment of a special committee composed of representatives of labor and capital to forward this purpose. In a statement issued to the people of Massachusetts advising them that the State does not intend to be the "sport of chance," but the "master of her destiny," Governor Coolidge said:

"The material resources of the community must be used for the benefit of the people of the community. Such use is the only thing that gives them value, and the only warrant for their existence. Unless this is done by private enterprise it will have to be done through the taxing power and otherwise, for the purpose of relieving the suffering caused by unemployment. Every facility is at hand for an era of great prosperity. What is needed is the courage to act. In the exhibition of that courage the Government agencies must take the lead."

Further evidence of the spirit of co-operation that alone can result in a widespread construction movement all over the country, on the part of the building interests, has been shown in the voluntary cutting by New York material men of the price of Portland cement. The new level shows a lowering of 20 cents a barrel, delivered on the job, although no cut whatever was made in the wholesale quotations. Brick interests, with no stocks on hand and an increased demand, resisted pressure to raise prices from the present \$15 level. Roof slate manufacturers have adopted a stabilizing scale of prices to conform to the new schedule. Other material prices showed hot air registers to drop 25 per cent; tarred felt showed a 50 per cent per hundred weight concession; electrical porcelains face another drop of from 5 to 10 per cent; rubber-covered wire is obtainable at lower levels. Changes have been made in pipe discounts in favor of the consumer.

The removal of another factor instrumental in holding back building projects came in the announcement from Washington that the quantities of available building materials on hand, due to the cancellation of war construction contracts, are not to be distributed so as to upset market conditions. Many

## THE AMERICAN ARCHITECT

were expecting that vast quantities of materials would be dumped on the market at below market prices, but the official statement was that the stock, with the exception of lumber, was very small indeed. So instead of being able to pick up supplies cheap, as many had hoped, what stocks there are will be rapidly absorbed into other Federal departments for Government construction work.

Stabilization of lumber prices, too, may be expected, even at the cost of a decided shrinkage of profits, for there is a distinct tendency to give equilibrium to the consumer. To-day \$50 buys \$20 of lumber at ante-war prices, but until the cost of labor for handling at the mill is made lower than \$10 per 1000 ft.; until the lighterage charge of \$2 to \$3 is removed by restoring the free lighterage system prevailing in this harbor before the war; until the high freight rates of \$3 to \$7 per 1000 ft. is reduced by supplementing war time rates for peace time tariffs; and until the cost of handling at retail yards is returned to the pre-war levels instead of the \$12 to \$15 per 1000 ft. costs now prevailing, any reduction in price to the consumer must come out of the profits of the dealer, who, in order to co-operate in the general price conciliation that is being made in every department so as to get construction work started, is now operating at cost and in some cases below cost.

A new plan by which delivery cost is covered in the revised schedules for the New York district upsets a custom more than half a century old—one that had originated back in the days before the telephone was developed, when it was necessary to have a general meeting place where dealers could gather and buy and sell according to prices posted for the day. Heretofore, all prices have been based upon a wholesale scale, but in the future all building material prices will cover delivery at the job, if it is located in any of the boroughs of New York, with the exception of Richmond. It is planned to bring Newark and Jersey City within the zone of unification, so that contemplated building operations can be estimated with greater uniformity.

The new plan facilitates new construction projects at a time when many owners of real estate contemplate improvements, provided they can be assured of a reasonably regular market. It will be necessary for the present, however, to quote common brick from the Hudson, Raritan and Hackensack at the wholesale price. Street traffic congestion is such an item in the cost of the brick in building as to make it impossible to change the plan.

It is possible to figure the delivered quotations for any particular site by adding to the wholesale price, which today is \$15 a thousand, dock New York, cost of carting and handling 10 per cent; the "cost of carting" depending upon which zone the job is

located in and the distance of the site from the unloading piers that are available. Traffic conditions in certain parts of lower New York and Brooklyn are such as to make it more costly to cart a thousand brick across Manhattan Island at any point below Canal Street than it costs to bring the brick a hundred miles down the Hudson River.

As a part of the preparation being made for building distributors of Portland cement, plaster, plaster-board, plaster block, second hand brick, and hollow tile have already listed their materials under the new price quotation system. There are cases where slight advances over listed quotations have to be made from time to time where the job site is remote or the hauling conditions particularly bad.

The building material situation this winter has been given a new aspect because of the long period of open weather. This has affected conditions by allowing the brick plants to continue operations, and the crushed stone quarries are expecting the biggest winter's business on record. Glass production has been resumed and the Hudson River is open for navigation once more. All of which goes to make the probability of higher prices more remote.

At the same time, a leading contracting firm of Philadelphia, with nearly a century's experience in the sale of building materials in that city, brings forth statistics from its business records showing that not within fifty years—in fact it is almost safe to say one hundred years—have material prices reached the figures obtaining at present. It is very interesting to note from the records that in 1866, immediately after the close of the Civil War, cement was worth \$2.00 a barrel, calcinated plaster \$2.50 a barrel, Roman cement \$6 a barrel, fire clay \$2.50 a barrel, lime 30 cents a bushel, plaster hair 30 cents a bushel and fire brick \$48 a thousand.

Current prices for similar materials prevailing throughout 1918 and largely at the present time are: \$3.27 a barrel for cement, \$4 a barrel for calcinated plaster, \$3 a barrel for fire clay, 44 cents a bushel for lime, 30 cents a bushel for plastering hair, and \$47 a thousand for fire brick. In 1916 cement sold for \$1.65 a barrel, calcined plaster at \$2.05 a barrel, fire clay at \$1.50 a barrel, lime at 20 cents a bushel and plastering hair at 28 cents a bushel.

It will be noted that 1918's prices are in many instances from about 30 to 60 per cent higher than those prevailing in 1866, and in some cases 100 per cent above those for 1916, the year before the entry of the United States into the world war.

It is a curious coincidence, however, that plastering hair sells to-day at the exact figure prevailing in 1866—30 cents a bushel.

The fact that prices to-day are higher than at any time in the past fifty years is traceable, no doubt, to the increased cost of labor and production. While



it is true that labor-saving devices have been perfected and new sources of raw materials opened, still the greatly increased demand and amount of production bring with them an increased amount of labor, which is not as cheap as it was in the days following the Civil War.

An optimistic outline anticipating a healthy revival of building by early spring has been given by O. W. Ketcham, president of the Philadelphia Master Builders' Exchange, in his report to the association which discusses future business and prospects for 1919. In substance he said:

"Already there exists strong indications in this direction. Many inquiries are being made for materials for structures of different types.

"While the prices of building materials have as yet shown no material decrease nor can such be expected for some time to come, there nevertheless seems to prevail among the builders a strong desire to start operating. The percentage of advance in

pricing building materials with few exceptions has been so slight as to permit of very little, if any, reduction for the coming season.

"Many plants making bricks and other materials closed during the war period will, as soon as conditions warrant, resume again. As yet there appears to be very little common brick or face brick piled for future deliveries, but with the resumption of business, there will, no doubt, be a plentiful supply on hand to care for any early demands. But as this stock will have to be accumulated under present conditions which have not materially changed from that of two months ago, the selling conditions must remain about as at present.

"Building materials in comparison with other materials of different kinds have shown a lower percentage of increase in selling prices than any other. No reduction can be expected with prices fixed for future deliveries. It seems to be an opportune time to develop plans and prepare for spring operation."

## Current News

### Treasury Department Calls for Money

A large oversubscription of a new issue of Treasury certificates of indebtedness is necessary in view of the fact that banks have been informed that Government expenditures are still running at an extraordinarily heavy rate.

The Government's outlay in December was in excess of \$2,000,000,000, and is said to be continuing at this rate, although signs are not wanting that the pressure is gradually easing. The matter of financing the Government's immediate requirements was understood to be the subject of a lengthy session of the Money Committee of the banks of the Federal Reserve Bank recently.

### Italians Place Big Southern Pine Order

The purchase by commissioners representing the Italian Government of 3,500,000 ft. of yellow pine timber is an interesting and highly significant feature of the export lumber market that has developed recently. It is noteworthy not only because of the size of the order but because of its indication that post-war lumber buying for European countries may be handled largely by government commissions which may deal with organized central agencies in

preference to making purchases direct from individual mills.

It is not officially settled that this method will be adopted, but in addition to the Italian transaction with the Southern Pine Emergency Bureau, there have been intimations that France and England will buy lumber in this country through the "high commissions" which handled their war-time purchases. The important question of ocean tonnage, which has troubled students of the export market more than a little, may be disposed of if the business is handled upon the lines indicated, sellers making delivery at American ports and buyers providing cargo space.

### U. S. to Finish Philadelphia Houses

Appeals from Philadelphia have resulted in the Government's decision to complete the construction of the 700 houses adjacent to Thirteenth Street and Oregon Avenue, that city. The operation is now about 50 per cent completed. Reports that the Government would not finish the operation because of the end of the war caused the Philadelphia Housing Association and other bodies to protest to Washington. It was argued that the completion of the houses would alleviate the lack of housing facilities. The dwellings, which are being erected under the direction of the United States Housing Corporation, will be leased to navy yard employees when completed.

## Results of Fuel Saving by Restricted Industries

Statistics of the United States Fuel Administration from reports made by 4,000 clay products companies, representing practically the entire industry, of what each one actually saved during the first six months of 1918 show:

	Net tons
Fifty per cent curtailment—Brick, terra cotta, roofing, floor and wall tile, and sanitary ware..	1,218,000
Twenty-five per cent curtailment—Hollow tile, drain tile, and sewer pipe.....	603,000
Fifteen per cent curtailment—Stoneware (except chemical) .....	25,000
	1,486,000

Letters received by the administration tell of the lessons of economy through more efficient methods learned by the companies, which will be continued in most cases, although restrictions have been lifted.

## Engineering Societies Employment Bureau

The employment bureau maintained by the four national Societies of Civil, Mining, Mechanical and Electrical Engineers has issued a statement to state and municipal authorities, corporations and individuals, who have need now or expect to have in the near future, for the services of professional engineers, asking them to communicate their wants.

As many engineers who have been serving in army or Government capacities during the war are about to be released and returned to civil life, it is the desire of this bureau to place such men in touch with contemplated projects as early as possible. In the present emergency the demand for engineering services and the supply has not as yet been so thoroughly co-ordinated as to afford the best results. It is with a view to meeting these conditions and laboring to correct them that this very useful bureau has been formed.

The bureau may be addressed at the Engineering Societies Building, 33 West 39th Street, New York.

## Labor Takes a Reasonable View

According to advices that have reached the Department of Labor the attitude of labor toward new building projects is thoroughly reasonable and conciliatory. An instance has just come to light at Atlantic City, where a \$3,000,000 hotel is under construction, which is encouraging for builders. It seems that electrical workers employed elsewhere in Atlantic City were receiving 87½ cents an hour, but the rate of pay on the hotel was only 75 cents.

The men felt that they should receive the prevailing wage, and notified the construction company to that effect.

For a time the controversy threatened to halt work, but when the men understood that the company had taken the contract based on less than 75 cents an hour for electrical workers, and would lose heavily if they insisted on the 87½-cent rate, the men willingly returned to their jobs and agreed to stick to the 75-cent-an-hour rate.

## Proposes \$1,000,000 Bridge as Memorial in Maine

Legislation to provide for the erection of a \$1,000,000 bridge on the site of Martin's Point Bridge at Portland, Me., on the State highway leading to Brunswick, to be known as Maine's Memorial Bridge, has been introduced in the Maine Legislature by Senator Howard Davies of Yarmouth. The purpose of the measure is to commemorate the "mighty work of the men and women who went from Maine and participated in the world war." It is proposed that the Federal Government appropriate \$600,000 toward the expense and the State \$400,000.

## Frank Duveneck

Frank Duveneck, for fully forty years regarded as one of the most gifted artists of the world, died last week at his home in Cincinnati, Ohio. He was seventy-one years of age. Until the past six months, when he was stricken with illness, he had always been an active figure in both American and European art.

It was John Singer Sargent who said at a dinner in London more than twenty years ago that "after all is said, Frank Duveneck is the greatest genius of the brush of this generation."

Duveneck was a Kentuckian, born in Covington in 1848, of Dutch ancestry. Since the death of his wife, Elizabeth Booth Duveneck, several years ago in Florence, Italy, Duveneck has been an instructor in the art school at Cincinnati. He first studied art in Munich under Wilhelm Van Diez. His exhibition at the Panama-Pacific Exposition three years ago won for him a special gold medal, in recognition of the great influence he had exerted in the modern development of American painting. When he first came back to this country on completing his studies abroad he startled New Yorkers by his broad and bold technique, which was at direct variance with the detailed motif of the Dueseldorf school, after which the early Americans patterned their efforts.



## Iron Exports Held Up

Pending action by the United States Shipping Board on the question of cutting ocean freight rates to a level where offerings may be made in foreign markets which will be at actual competitive figures, iron men report that export of their product is being held up. There have been some tonnages shipped where the demand had been for immediate delivery regardless of price, but this has been in the minority. The trade is reported to be in a splendid position to sell iron just as soon as the foreign rates are cut so that the foreign market prices may be scaled.

## Southern California Chapter, A. I. A.

The one hundred and twenty-second regular meeting of the Southern California Chapter A. I. A. was held Jan. 14, 1919.

As guests of the Chapter were present: Lieut. W. H. Perdue, of the U. S. Engineering Corps, and Mr. John Bowler of the *Southwest Builder and Contractor*.

Under "Communications" the following letters were read:

From Mr. E. C. Kemper, executive secretary of the Institute, stating that Mr. Robert D. Farquhar of this Chapter had been selected for fellowship in the Institute, requesting that the Chapter confirm the nomination. It was moved by Mr. Krempel, duly seconded and carried, that Mr. Farquhar's name be ratified, and the secretary of the Institute be notified accordingly.

From the secretary of the Municipal League, Los Angeles, to the effect that the League had addressed a resolution to the City Council relative to the Hancock Grant of the La Brea Oil Fields to the County, copy of which resolution accompanied the letter. Summarized, the paper stated that the League took the stand of approving the retaining of the Hancock gift by the county, but suggesting that new conditions be mutually agreed upon by Mr. Hancock and the Board of Supervisors relative to the investment of a sum for improvements to the said oil fields, with the appointment of a commission to supervise the work. It was moved and duly carried that the Chapter endorse the resolution, notifying the Municipal League to that effect.

The secretary read the recommendation of the executive committee that the Medal of Award for Meritorious Architectural Work for the past year be passed by owing to the war and the general dullness in building. The recommendation was accepted.

Under the head of "Papers and Discussions" the president introduced Lieut. W. H. Perdue, who addressed the members on his experiences in France during the war, at the conclusion of which the Chapter's thanks and appreciation were expressed.

## New York Society of Architects

The New York Society of Architects held its regular monthly meeting Jan. 21, 1919.

The meeting was well attended, several new members were elected, and applications for membership received.

It was brought before the meeting that persons are making unlawful use of the title of Architect. The names of these persons were referred to the Committee on Registration of Architects, with instructions to investigate, and if the facts warranted to lay the matter before the proper authorities for prosecution.

A paper by Mr. F. C. Zobel was read disapproving of the proposed method of stimulating the building industry by encouraging the construction of public buildings, and asking that means be adopted to revive private construction of buildings which will produce revenue rather than buildings which are an expense to the community. After considerable discussion it was decided, on motion of Mr. John P. Leo, to bring the matter before the next meeting for further discussion.

## Is Willis Polk An Architect?

Is Mr. Willis Polk really and legally an architect?

This problem is liable to become an acute bone of contention between Willis and the State authorities at an early date.

There is a State law which compels every practicing architect to pay a license fee of \$15 a year, or describe himself as an unlicensed architect.

When the tax collector went to Willis Polk's office for his license money, Mr. Polk received him and said:

"Why do you tax me? All the architects here say I am not an architect. What is my word against theirs? Let the matter go!"

The tax collector, peeved and astonished, picked up one of the Polk letterheads.

"What do you call yourself here?" he snapped, adjusting his glasses.

"Willis Polk & Co., Builders," replied Mr. Polk. "There's no architect about that!"

The collector departed without collecting the \$15 fee. He says that he will yet prove Mr. Polk is an architect, or eat the license.—*San Francisco Chronicle*.



## Oyster Bay Plans a Roosevelt Park

A large waterfront park as a memorial to Colonel Roosevelt will be established at Oyster Bay, L. I., if the prevailing sentiment in the home town of the former President materializes. A citizens' committee under the leadership of William Loeb, Jr., who was at one time the colonel's private secretary, has been formed.

Colonel Roosevelt believed in parks for the people, and Oyster Bay has none. Situated near the railroad station is a vast area facing the bay which has never been improved and has been considered a detriment to the beauty of the village. If this is secured it is proposed to fill in many places and erect bulkheads. It will have some suitably inscribed memorial, such as a rostrum, and will be named Roosevelt Memorial Park. Several thousand dollars have already been contributed toward the fund.

## Copper Men Go Abroad

A committee representing the Copper Export Association has gone to Europe, accompanied by S. R. Guggenheim, a director of the American Smelting & Refining Company, for the purpose, it is said, of perfecting plans for the extension of the Copper Export Association.

## Washington Hears of Much Building

News has reached Washington of many building projects, which will not only give employment to a large number of returned soldiers and enable the transition of industry from a war to a peace basis to be made with a minimum of friction, but will also increase the wealth of the country and its resources for the foreign trade campaign that will soon begin. The readiness of States and municipalities to do their part in construction development is illustrated by the attitude of Maine and New Hampshire, which stand ready to contribute a large sum for the building of a bridge from Kittery to Portsmouth.

Secretary Daniels, it is understood, favors a Federal appropriation to aid these States, on the grounds that the project is rather too large for their resources and that the Federal Government, through the Portsmouth Navy Yard, will benefit greatly from the work.

Building loan associations throughout the country have manifested much interest in the plan of the Division of Public Works to assist home building at this time, and co-operation on a national scale has been suggested at conference be-

tween the building loan representatives and officials of the division. There are certain technical difficulties in the way of most effective co-operation, but it is anticipated that these will shortly be cleared up or circumvented, and that builders may be assured aid in the same way farmers are assisted by farm bank loans.

## Won't Discharge Soldier Against His Will

To solve the problem of unemployed discharged soldiers, the War Department has ordered that no man be discharged from the army against his desire until such time as he can obtain employment in civil life. Orders have been telegraphed all department commanders to retain all men who desired to remain temporarily in the service without prejudice to their subsequent discharge to take employment.

Governor Coolidge of Massachusetts will send to the State Legislature shortly a bill authorizing an appropriation of \$10,000 to aid and find employment for returned and returning soldiers, sailors and marines.

## Cleveland Building Figures Show Gain

If building construction figures for January are an indication of Cleveland's volume for 1919, this year's total will show a decided gain. The figures for the first month this year, according to tabulations made by H. H. Uthoff, statistician, show a gain of \$579,990 over those for January, 1918. The total building volume for the month just ended was \$927,900, against \$347,910 for the corresponding month last year.

## \$10,000 Building 10-Day Record

Building permits totalling around \$10,000 were issued for the first ten days in January at Fort Worth, Tex., which is considered a remarkable record for this time of the year, January being considered one of the poorest building months of the twelve.

## Personal

Reopening of the offices of P. Tillion & Sons in the Terminal Building, 103 Park Avenue, New York City, is announced. Clement V. Tillion has returned after two and a half years' service with a New York Division, but Philip G. Tillion is still with the American Expeditionary Forces in France.

## Wage Standardization and Administration

Standardization, which is rapidly increasing in the larger industrial institutions, with the determination of wages, hours and conditions of work according to general principles, the justice of which is universally acknowledged, is the subject of a joint paper by Earl Dean Howard and Henry P. Kendall read at the recent annual meeting of the American Society of Mechanical Engineers. The paper first gives particulars of the administrative machinery available before the war for dealing with industrial relations, and then of the governmental agencies since developed for that purpose. The authors say:

"The regulation of industrial standards by joint boards as suggested has the great advantage over the present system in that it eliminates at least three-fourths of the cost of friction between the particular employer and his employees. Each employer then adopts the standards which are current in his trade and knows that all his competitors are on the same basis and have no advantage over him. Even under our present system, the chief objection to any one employer's increasing wages lies in the fact that it comes out of the profits unless the increase is general among his competitors, when it is shifted to the consumer of the product. It is easy to foresee a time when the public and not the employers will have the chief interest in opposing wage advances."

## England is Short 500,000 Houses

In the opinion of Sir J. Tudor Walters, M. P., who has given much thought and time to the question of housing, England faces a shortage of 500,000 houses in addition to her normal requirements of 100,000 new ones annually. Consequently England is wrestling with many housing schemes. One of the unusual plans suggested for bridging the transition period while England is being changed from a war to a peace basis, is a proposal that the Government should build houses and either sell them on long-time payments or furnish them outright, particularly to soldiers.

Reports from Great Britain show that thousands in the building trades have gone into other work, as all building operations ceased when the war started. Materials there are at exorbitant figures or unobtainable. It is much more difficult for prospective small-house owners to finance construction than it was four and one-half years ago. One of the plans suggested is that the Government pay the

householder the difference between what his house will cost to construct immediately after peace terms have been arranged and its estimated value five years hence.

Any plan that will result in large expenditure of public money will be met with considerable opposition among members of the Government. This was made very clear when a statement was made in the House of Commons that the Government should give all war workers a six months' holiday with full pay as one means of solving the tremendous problem of changing England from a war to a peace basis. At least one member of the Government, referring to that statement, said that the Government could not undertake any gigantic financial obligation in its effort to bridge the transition period as quickly and efficiently as possible.

## To Study British Labor Situation

An employers' commission, designated by William B. Wilson, Secretary of Labor, to study labor conditions and governmental labor policies in Great Britain and report thereon to the department, has sailed for England, expecting to spend several months in its investigations. R. R. Otis of Atlanta, Ga., represents the building industry. Others include Dorr E. Felt of Chicago, connected with the machinery industry; R. J. Caldwell of New York, the textile industry; W. H. Ingersoll of New York, the watch industry; Eldon B. Keith of Boston, the shoe industry, and E. T. Gundlach of Chicago, the publishing industry.

## Support Lane's Land Plan

The Women's National Committee of the American Defense Society, of which Miss Elizabeth Marbury is chairman, has announced that it has telegraphed to the members of the Appropriations Committee of the House urging a favorable report on Secretary Lane's Land Settlement Bill. The measure aims to provide land for returned soldiers, and is said to have the approval of President Wilson.

## Exports from France to U. S.

The total declared value of the exports from France to the United States and possessions during 1918 was \$57,048,499, against \$94,561,318 for 1917. The exports to Continental United States were valued at \$55,688,490, against \$93,462,780 in 1917; to the Philippines, \$1,273,724, against \$955,074.



# Late News in the Financial Field

## Guarantee of Labor Stability Urged to Aid Building

Assurance has been given the building trade that efforts will be made before the next Congress to have an appropriation set aside as a sort of building subsidy fund, to be operated on an amortization plan to make it possible to cover the high cost of labor until the law of supply and demand of man power has been met by returning service men.

A term probably extending over the period covered by the measure to shut out immigration for approximately four years is proposed. In other words, Federal farm loan principles applied to a form of Government building subsidy will probably be used as a means of releasing the millions of dollars' worth of construction that is being held up pending the adjustment of wage scales in a great many cities in the country.

The opening of the general construction season is but little over a month away and the building industry is still stagnated because of its inability to make mill alterations, enlargements and repairs to meet the greatly enlarged demands upon their capacities, much less to the staggering demand for new construction of various kinds that is booming all over the country. A total lack of what is termed "wheelbarrow" labor, which in the production of building materials is a very important factor, is one of the causes of the difficulty in the construction business at present. The supply of labor promises to be still further depleted by thousands of foreign-born men clamoring for passage back to Europe.

Building material and equipment prices are continuing to drop to attractive levels and the scarcity of rentable space makes it imperative to build at once. All building materials, with hardly an exception, may be accepted as being at practically the lowest ebb, which is only a temporary level. Prices will have a distinct tendency to advance, even if only twenty per cent of normal building is attempted this year, because of the heavy tax upon available supplies of construction material. Notable downward movements include a drop on lead of \$5.50 a ton; stove pipe, sash cord, cast iron sash weights, insulated wire, electric pole line material, malleable iron fittings, electric lamps, and there are immediate prospects of reductions in plumbers' earthenware, wire products and a few other lines.

## Urges Public Work to Avert Idleness

That there is immediate need of co-operation throughout the country to forestall the threatened danger of unemployment and that efforts should be concentrated to support the efforts of Secretaries Lane, Wilson and Redfield favoring public building as the medium, is the opinion of officials of the National City Bank in a survey of economic conditions just given out. The fact that costs are still high should be no deterrent, it is maintained, to the undertaking of improvements, otherwise labor will be idle and its "potential value totally lost to the country." In an analysis of conditions the bank statement says:

"The idea that the Government might promptly adopt a constructive policy for dealing with the danger of widespread unemployment has had as yet no adequate development. Secretary Wilson has established in his department a bureau for the encouragement of public construction by municipalities and other public bodies, and Secretary Redfield has written letters giving public indorsement to the policy of liberal expenditures of this character, but the executive officials can do little themselves without action by Congress.

"There is greatly needed at this time a large and enterprising public policy which would organize and co-ordinate the activities of national, state and local governments, so as to create a large amount of construction work for the coming spring and summer. After that it is safe to say that the situation will take care of itself, provided unemployment can be averted in the meantime. The prestige and co-operation of the national government is required to develop such a movement, and the good efforts of Secretaries Lane, Wilson and Redfield should be not only supported but enlarged and made a national policy. The railroad and utility companies should be enabled and encouraged to make improvements now, when labor will otherwise be idle and its potential value totally lost to the country. Extra costs are nothing compared with total losses and little compared with war expenditures, and this is the view that communities should take of the proposal. Of course the program should be elastic, so that no more work would be undertaken than necessary for the purpose, but unemployment should be prevented by a public-spirited, nation-wide movement.

"The policy of heavy taxation upon business profits begins now to show its repressive and unfortunate influence. There was never a time when the spirit of courage and enterprise was more needed than now. Secretary Wilson made a strong plea at a New York meeting a few days ago for business men to go ahead with resolution and public spirit to set the wheels of industry turning and provide employment to the wage-earning population. All who heard him realized the force of his arguments and the truth of his warning against the dangers which might develop from widespread idleness and distress. But these are times when serious risks attach to individual policies."



# Department of Architectural Engineering

## A Structural Material Made of Thin Sheet Steel

A NEW structural material, or the new use of an old material, is always of interest. This interest, however, is influenced largely by the manner of its first presentation to the public. If it is represented as a substitute for a known and tried material it is immediately placed on such a basis

ilar parts made of incombustible material. While the initial intention was to make the buildings that usually are constructed with wooden joists and studs more fire-resisting, it has developed that in



A store and office building, the floor and partitions of which are constructed of formed metal joists and studs.

and is not liable to be accepted on its true merits. To properly gauge the value of such products, it is necessary to consider them in relation to their actual uses. On this basis is here discussed some structural shapes which are coming rapidly into general use.

These structural shapes are fabricated from rolled sheets and, generally, in forms similar to rolled structural shapes. Primarily they were designed to replace wooden joists and studs with sim-



A floor with metal joists, structural steel girders and columns. Concrete floor slab in place. View from below.

a greater field, this material has been found entirely suitable. Like all other materials and constructions, it has limitations of use which are determined by its physical properties and economic considerations. To better appreciate these limitations, a general description is here given.

The basic section is that of a channel beam, from which I-beam sections are made by riveting the channels together back to back. The studs are of channel, U and T shapes. These sections were first formed on a brake, each separate bend being a distinct operation. The length of the section, without splices, was controlled by the length of the brake. This length was generally 16 ft. 8 in. Sections were spliced in such a manner as to provide any length for which the cross-section was suitable. These splices were designed in such a manner as to develop 25 per cent more strength than the balance of the section. A later development in the fabrication of these sections is in making the splices by electric welding.

It is understood that all rolled steel sections are subject to internal stresses which are inherent from the nature of the production process. Some engi-

neers attribute the comparatively easy destruction of rolled structural shapes, under comparatively low temperatures, to these internal stresses. The correctness of this theory is debatable. Rolled sheets have these same internal stresses in some degree, and also the usual distinct grain parallel to the rolling. When such a sheet is fabricated in a brake there is a weakening of the material at the bends: this is also the case when the shaping of

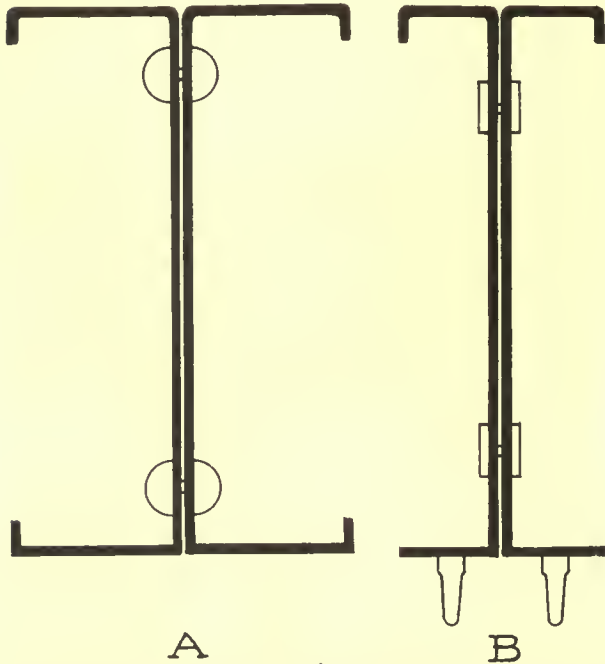

Typical sections of formed metal joists, made by riveting two channels back to back.

the material is done by forming rolls, which are now used for this purpose to a large extent. To overcome this difficulty the sheets are cut to suitable lengths and re-rolled in a direction at right angles to the original rolling. The result is a fine double grain material. The material, re-rolled and annealed, is uniform in texture and in repose from internal stresses. The sheets used for this purpose are not ordinary commercial sheets, but those made to special specification requirements. Fire tests indicate some greater resistance to the effects of high temperatures than is found in the rolled structural shapes, but this does not absolve this material from the necessity for adequate protection from fire.

Referring to the cross-section diagrams, sections A and B are typical I-beam sections made by different producers. It is noted that they are formed by riveting two channel beams back to back. Type A is made of 14 and 16 U. S. Standard steel gauge sheets. The dimensions, reading the breadth

first and depth second as in wood joists, are in inches 3 x 3, 3 x 4, 4 x 5, 6 and 7, 5 x 8 and 9, 6 x 10 and 12. The 10 and 12 in. beams are made of 14 gauge steel only. In this type the breadth of the flange increases by groups, as the depth increases. Type B is made of 12 and 15 U. S. Standard steel gauge. The flanges are all 3 in. wide and the depths are 4, 5, 6, 7, 8, 9, 10 and 12 in.

In both of these types prongs can be provided for the attaching of metal lath to the top or bottom flanges or both, as shown in the illustrations. When beveled wood floor strips are used for the attachment of finished wood floors, these strips are attached by nailing through the strip into the space between the channel sections.

Metal studs are made in several forms. The

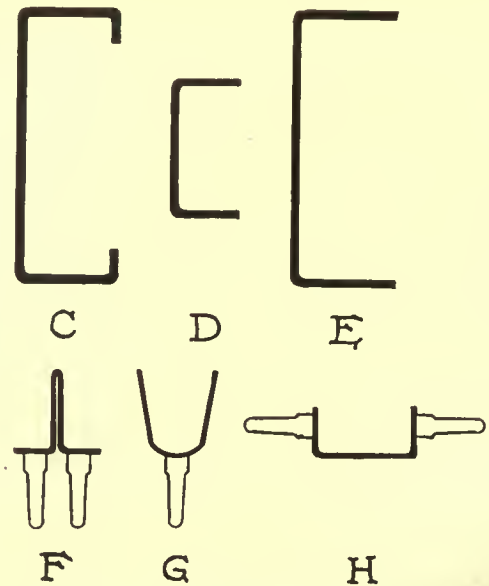

Typical sections of formed metal studs, sills and caps. Channel studs riveted back to back to form H-studs for bearing partitions.

channel studs of type C are made in sizes of 1½ x 3 and 4, and 2 x 5 and 6 in. of 14 and 16 U. S. Standard steel gauge, type D is 1 x 2 in. in size and made of 16 gauge steel only. These studs, excepting the 1 x 2-in. size, have prongs on both flanges for the attachment of metal lath. H-studs are made by assembling type C back to back with the prongs staggered on the flange. These studs are used for bearing partitions and where additional strength is required to support concentrated loads. Type H studs are made with flanges 1½ in. wide and depths from 2 to 6 in. inclusive, increasing the depth by ½ in. These sections are made of 12, 14, 15 and 16 gauge steel. They are assembled in the shape of I-studs by riveting together back to back. These stud sections are used



## THE AMERICAN ARCHITECT

for bearing partitions, and where partitions do not carry any load such types as F, G and H are used and made of 16, 18 and 20 gauge material. Type F, called the T-stud, varies in depth from  $\frac{3}{4}$  to  $1\frac{1}{4}$  in., increasing by  $\frac{1}{8}$  in. Type G is made in depths from  $\frac{1}{2}$  to  $\frac{3}{4}$  in., increasing by  $\frac{1}{8}$  in., and



Placing the metal lath over metal floor joists. The white strips are galvanized iron bands used as bridging to keep the joists in position until the concrete slab is placed.

from 1 to 2 in., increasing by  $\frac{1}{4}$  in. Type H, in addition to sizes already noted, is made of these lighter gauges with  $\frac{3}{4}$ -in. flanges and depths from  $\frac{3}{4}$  to  $1\frac{1}{4}$  in., increasing by  $\frac{1}{4}$  in., and from  $1\frac{1}{2}$  to 4 in., increasing by  $\frac{1}{2}$  in. In these lighter stud sections prongs are provided as shown.

Type E is used for sills and caps, which are laid horizontally and between the flanges of which the vertical studs are placed. They vary in width to accommodate the various depths of the studs and the width of the flanges varies to afford such beam strength as may be required.

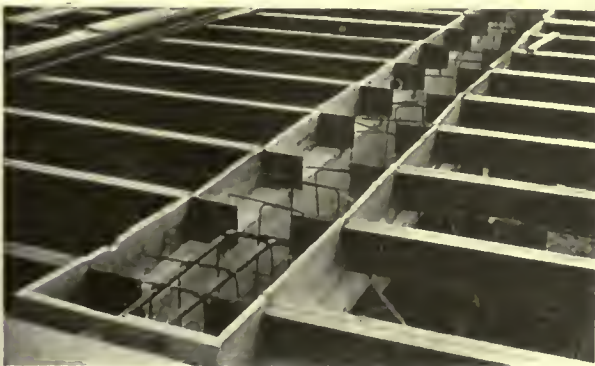

Metal floor joists embedded in the flanges of an unpoured reinforced concrete T-beam girder.

These sections are the basis of this type of construction and are so designed as to be quite elastic in their application. The result is that any condition of plan for which this material is adapted can easily be provided for. In other words, any construction that is made of wooden joists and studs can be duplicated in this material.

This material is assembled in two ways. One is by riveting the members together with small rivets, cold driven, and angles, straps and other connecting members. The other form of assembling is made by using a mortise and tenon connection. The mortise is made by punching a slot hole or by depressing a portion of the sheet metal, which allows the tenon to pass between the depressed part and the main sheet. In the tenon is provided a hole into which is driven a metal wedge. By driving the wedge home a close contact is made, resulting in a rigid connection. No special equipment is necessary to assemble this material in place other than that used in ordinary carpenter work.



Apartment house construction, showing metal floor joists, studs, cap and sill plates.

To give an idea of the properties of this material, a comparison will be made with yellow pine dimension lumber. A 2 x 10 yellow pine joist dressed to  $1\frac{5}{8}$  x  $9\frac{1}{2}$  in. weighs 4.3 lb. per lineal foot and a 10-in. metal joist of type B weighs 6.3 and 9.8 lb. per lineal foot when made of 15 and 12 U. S. Standard gauge steel respectively. The section modulus of the 2 x 10 wood joist is 24.44 and for the 15 and 12 gauge steel joists it is 4.45 and 6.8 respectively. It will be seen that the metal joist is the heavier, but yet within a weight which is easily handled by one man. The comparative



## THE AMERICAN ARCHITECT

strength or resisting moment is found by substituting in the well-known formula:

$$M_R = fS$$

in which

$M_R$  = the resisting moment.

$f$  = the extreme fiber stress in pounds per sq. in.

$S$  = section modulus.

Then we have for the long leaf yellow pine beam:

$$M_R = 1,600 \times 24.44 = 39,104;$$

for the steel beams of 15 and 12 U. S. Standard steel gage:

$$M_R = 16,000 \times 4.45 = 71,200,$$

$$M_R = 16,000 \times 6.80 = 108,800.$$

From these results it is seen that the 2 x 10 wood joist has but 55 per cent of the strength of the 15 gauge metal joist and but 36 per cent of the strength of the 12 gauge joist, based on the fiber stresses assumed.



Floor construction in a large apartment house, metal joists supported on structural steel girders, galvanized iron bridging strips in place.

In calculating the moment of resistance of these beams this formula can be used:

$$M_R = fd \left( A_s + \frac{dt}{6} \right)$$

in which

$M_R$  = moment of resistance in in.-lb.

$f$  = extreme fiber stress in pounds per sq. in.

$d$  = height of beam in in.

$A_s$  = net flange area in sq. in., or the gross flange area minus the area of holes punched out for prongs.

$t$  = thickness of web in in.

In tests where the loading is increased to destruction it is found that the lower or tension flange is not injured, but that it is the upper or compression



Reinforced concrete T-beam girder with metal floor joists in place and anchored together, ready to be poured.

flange that is affected. When several joists are tested together, in a panel with the concrete floor slab in place, the ultimate strength of the beam is very materially increased. This is due to the lateral support afforded the upper or compression flanges by their embedment in the concrete slab.

The floor is constructed by first placing a layer of metal lath on top of the joists and attaching it thereto by means of the prongs in the top flange. On the lath is placed the 1½ or 2 in. concrete slab and finished in the usual manner. When a wood-finished floor is provided, 1½ or 2 in. wood strips are laid along the tops of the joists and nailed thereto, after which the concrete filling is placed



A reinforced concrete T-beam girder the forms of which are filled, the concrete enclosing the ends of the metal floor joists.

and struck off level with the strips. The finished wood flooring is then placed as usual. Where thin hardwood floors are used an ordinary underfloor is first laid on the strips. The ceiling is made by attaching the metal lath to the under side of the joists by use of the prongs and plastered. The spacing of the joists varies from 16 to 24 in., according to the kind of metal lath used, and the joists are designed to comply with the conditions

## THE AMERICAN ARCHITECT

thus imposed. For this reason these joists are not readily adapted to spacings wider than those for which they are designed.

This system of construction is fire-resisting for the reason that primarily the material is metal, and therefore incombustible. With its greater strength, these two qualities are the main advantages over wood construction. It is necessary, however, to protect the metal from high temperatures resulting from the burning contents of the building. This protection is provided by the concrete floor construction and the metal lath and plaster ceiling.



An apartment house, the floors and partitions of which are constructed of formed metal joists and studs.

The ceiling is naturally the most vulnerable point and the protection is limited by the fire-resisting ability of the plastering.

The fire tests of this construction indicate that it will withstand a temperature of 1700 deg. Fahr. maintained for four hours. Naturally this result is obtained only by virtue of the plastering on the ceiling, as without this protection the construction would fail. It is unfortunate that in these tests temperatures of the steel joists and the air space between the ceiling and floor construction were not

obtained. This data would be a valuable aid in forming conclusions for conditions other than those under which the tests were made. In this case the cement plastering was 1 in. thick and made of a 1-2½ mix. Its insulating value would vary directly as its thickness. As before stated, the quality of the plastering is a very important element in the fire-resisting ability of this type of construction.

The fire-resisting ability of this type of construction limits its use, except in sprinklered buildings, to those that do not contain large amounts of combustible contents, such as residences, school houses, apartments, hotels, office buildings and some classes of mercantile occupancy. The mercantile occupancies would be those in which the stocks were of fairly incombustible goods and of light weight.

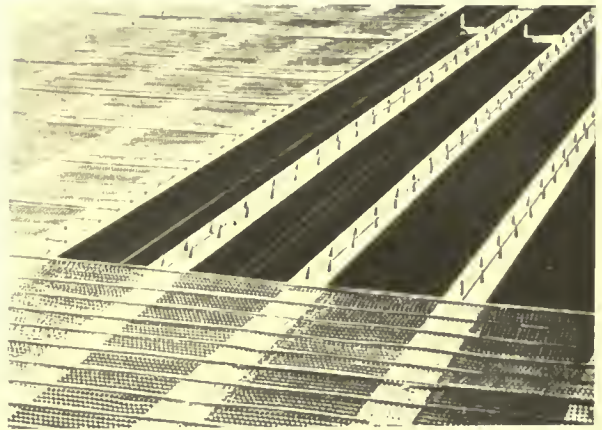

A school house floor under construction, the metal lath being placed on top of the metal floor joists. Note the prongs for attaching the metal lath.

It is apparent that these floors are not adapted for what is known as "heavy duty" floors, but are commercially possible for light live loads such as are found in the kinds of buildings mentioned above. The structural, fire-resisting and economic limitations are light live loads, medium spans and minimum fire temperatures due to the burning of combustible contents.

One of the great economies in the use of this material is due to the lightness of the material and the construction. With few exceptions, fire-resisting floors have a dead weight of from 70 to 125 pounds per square foot. This type of construction weighs from 32 to 40 pounds per square foot and is one of the few fire-resisting constructions in which the live and dead loads are approximately equal in the class of buildings above mentioned.

This element of lightness permits of the use of lighter girders, columns and foundations and is one of the principal factors in the cost savings effected by the use of this material. The supporting girders



and columns can be made of reinforced concrete or structural steel. In case concrete girders are used, they are T shaped and into the flanges of which the ends of the metal joists are incorporated and anchored, either into the girder or the opposite joist when there is one. When structural steel girders are used, the joists bear on angle iron seats or are hung in stirrups and anchored to the girder. When the joists rest on top of the girders a sheet metal seat is provided which clips on to the joist and the girder.

It is unfortunate that the production of this material is not standardized in the same manner that structural steel shapes are standardized. As it is, each manufacturer has his own standards and the differences are not of sufficient importance to preclude the possibility of uniform standards. Designing data is furnished by the manufacturers which enables architects and engineers to design

for the use of the material. For competitive purposes, the architect who produces his own structural designs will be compelled to make two or more designs or accept those provided by the manufacturer. Many architects and engineers prefer to have entire control of the design, and rightly so, and this condition of non-standardization hinders the use of this material, in the same manner that the use of structural wrought iron was affected when each rolling mill had its own individual shapes.

The use of this material is becoming more common as its availability from a structural and economic viewpoint is better known. It is found that its cost very closely approximates that of wood construction, giving the added and desirable quality of great resistance to destruction by fire. In these times, when justifiable economies are sought and studied, this material is well worthy of careful consideration.

---

### Useless Waste in Concrete Construction Due to Legal Requirements\*

By W. STUART TAIT, *Assoc. M. Am. Soc. C. E., Assoc. Mem. Inst. C. E.*

**M**OST of us have at times used the expression "It is A1" when wishing to state that something is highly satisfactory. Few of us, however, know how the expression originated. The term "A1" is an abbreviation of the phrase used in connection with shipping, "A1 from Lloyds." Lloyds refers to Lloyds Register of Shipping, and A1 is the highest classification made by that society. It means that the vessel referred to has been thoroughly well built and is entitled to receive the best rate of insurance quoted. Lloyds Register of Shipping was founded in 1760, and their book of rules and tables is the principal naval architect's handbook covering the design of a ship's structure. In the past hundred years the word "Lloyds" has gradually become linked in people's minds with things highly safe and sound, until to-day the phrase "A1 from Lloyds" has world-wide use.

Structural engineers engaged in the design of buildings and bridges would pass many sleepless nights if they were called upon to design a steel ship, and instead of following the beaten path blindly made an analysis of the structure which they had developed from Lloyds tables. They

would find a factor of safety of considerably less than 2 and probably not over  $1\frac{1}{2}$ , and in spite of this Lloyds Bureau is to-day considered throughout the world as being the criterion of safe and conservative design. Until comparatively recent years no engineer has been able to analyze the structure of a ship, and as a result Lloyds rules and tables were practically all developed from experiment and experience. Mankind can be truly thankful that ship design was not hampered by ultra conservatism in a manner similar to concrete building construction. A ship with a factor of safety of 6 or 8, which is approximately what we really have in most concrete buildings, would have to be several times as heavy as the ship built under the present standards, and, in consequence, vastly higher carrying rates would have to be charged. A ship is subjected in a storm to far greater strains of an indeterminable nature than any possible overloading or the most severe impact in a building could produce. Then again, let a failure take place and the ship, her passengers and crew, are at the mercy of the waves. In a concrete building which is severely overloaded a failure would never be sudden, and, looking at the factor of safety as a protection for human life, the ship should be far more conservatively de-

\*Continued from our issues of December 11-18, 1918, January 8-22 and 29, 1919.



## THE AMERICAN ARCHITECT

signed than the concrete building. The reverse, however, is true.

In the preceding articles I have shown how we may, by making better designs and executing better work, produce concrete buildings with greatly reduced costs. In order, however, to make possible the use of the more reasonable design methods outlined, one of two things must happen. Either all building ordinances must be entirely revised or the building departments must recognize a board of engineers created to make a detailed examination of concrete building plans and to practically take charge of the superintendence of the construction, in a manner similar to the operation of Lloyds Bureau of Shipping. I feel that the latter method would produce better and more immediate results. This engineering board would be recognized by the building department of each city and permitted to formulate its own code of structural design. Each city would retain its present building code, but would accept also concrete structures in which the design was approved by the proposed engineering board and the construction executed under the supervision of that board. The board would charge a fee for the examination of building plans, and the fee would be sufficiently large to permit them to examine the design in the most complete detail. The board would also charge for and furnish sufficient inspectors to insure the highest class of work and the exact adherence to the plans. The fees charged by the board for inspection could not be furnished on small structures for a percentage charge which would be adequate on large work. This feature would tend to force small work, which is that usually executed by the less competent designers and contractors, through the usual channels, and this work would be carried out under the existing building codes. The board would recognize and examine designs prepared only by architects and engineers who had proved by their past work that they were competent and conscientious and that they understood concrete design thoroughly. The board would not only check the main features of the design, but would also examine all details with care. The board would have in its employ, as chief executive, a competent engineer at a salary sufficient to insure obtaining one of the best men in the district. He would have entire charge of the operations of the board. The board that I suggest would be made up of two structural engineers, two architects, and the architectural engineer of the building department. The two structural engineers would be appointed by the local engineering society, the two architects by the local chapter of the American Institute of Architects or the State Society of Architects. These four mem-

bers would serve for relatively small compensation and would act in about the same manner as the board of directors of a corporation. The board would prepare its own code of rules governing concrete design, and any plans approved by them would be accepted by the building department. In a previous article I cited a case, and not by any means an exaggerated one, in which an engineer who followed the building ordinance of most cities would produce a structure which would be decidedly weak. I also showed the correct design for the same structure and showed how, under present conditions, a building department could not approve the correct design. In cases of this kind, a board such as suggested in this article would have a most desirable effect. The board, having power to decide these matters, would assist in obtaining better structures and in all cases would be free to approve a design upon its merits without being bound by the technicalities of the city building code. I think that most engineers will agree that it is almost an impossibility to prepare any building ordinance which can be followed literally and produce good and reasonable results in all cases. New conditions develop which lead to new methods of construction, and it is hardly reasonable to hamper and retard these developments as a result of the technicalities of the ordinance. I will cite an example of this. During the development of concrete ship design it was found that concrete weighing about 140 to 150 lb. per cu. ft. could not be used with real success. As a result, a concrete aggregate of such weight that 100 lb. concrete can be obtained has been produced, and with a 1-1-2 mixture of this material a strength of 4000 lb. per sq. in. at 28 days is obtained. Now, according to existing ordinances, concrete is to be taken to weigh 150 lb. per cu. ft., and 1-1-2 concrete cannot be considered as having an ultimate strength at 28 days of over 2900 lb. per sq. in. Therefore this new concrete aggregate could not be used under existing building codes, and it would take two years or more to obtain revisions to the code which would permit of its use.

After a building was completed the necessary load cards for the floors would be issued by the board and approved by the building departments. The annual inspection of the building would then be carried on by the building department just as at present. It is the writer's opinion that in a short time after one board, such as suggested, was in operation other cities would see the advantages of this procedure and allow similar boards to be created. It would then be only a short step to associate all such boards and to standardize all the codes of these boards on concrete design throughout the country. Concrete engineers and

architects doing business in a number of cities will all admit the great advantages of a uniform code in concrete design and one in which a more logical and reasonable factor of safety is provided.

In the first article of this series the conditions to be allowed for by the factor of safety were stated as follows:

1. Use of the structure under consideration.
2. Correctness of design and analytical methods.
3. Uniformity of material strength and workmanship.
4. Knowledge of material strengths.
5. Possible deterioration of structural members.

Providing for item 1, it has been shown in factory and warehouse construction that a factor of safety of  $1\frac{1}{2}$  is sufficient to cover possible overloading. In discussing item 2 it has been shown that the "rule of thumb" design moments now in use are in some cases twice as great as the correct value, while in others these moments are only about one-half of the correct value. Attention was also drawn to the fact that there is now in existence a large body of highly trained concrete designers. Note that the use of these incorrect moments often results in stresses highly in excess of the more reasonable stresses suggested in this article. Under the supervision of the board suggested in this article, the factor of safety to provide for item 2 would approach unity.

Dealing with item 3, it was stated that as a result of scientific control and inspection the materials themselves approach very closely to 100 per cent perfect upon their assumed characteristics. The matter of uniformity in workmanship is purely a matter of careful and conscientious inspection. Under the inspection methods outlined in this article there would be little chance of a material deviation from the standards assumed. Let us, however, assume a factor of safety of 1.3 to cover item 3.

Considering item 4, it was stated that 1-2-4 concrete, properly prepared and placed, could be definitely counted upon for a crushing strength of 2600 lb. per sq. in. at 28 days, where standard practice recognizes only 2000 lb. Attention was also called to the fact that the strength of concrete increases 50 per cent. between 28 days and 90 days, making the crushing strength at 90 days for good concrete 3900 lb. per sq. in. As a result of our extensive series of tests we now know fairly accurately the strengths which we can rely upon obtaining, and even under the method of design and stresses proposed in this article we have an actual factor of safety of over 3 without approaching the ultimate strength of the concrete at 90 days. But let us assume an increment in the factor of safety to cover item 4 of  $1\frac{1}{2}$ .

Item 5 is one which our experience has shown does not exist in reference to concrete buildings. The total factor of safety to be applied is the factor obtained by multiplying the increments necessary under items 1 to 5. The factor therefore becomes:

$$1.5 \times 1 \times 1.3 \times 1.5 = 2.95$$

Under the design methods for beams suggested we have a theoretical factor of safety approximating this and an actual factor of safety in excess of 3. Furthermore, the actual concrete stress developed to produce this factor is materially less than the ultimate strength of the concrete at 90 days old.

In the matter of column design the tests upon which the recommendation of this paper were based were actual size field specimens and were constructed under ordinary conditions of building construction. It would therefore seem that the factor of safety of 3 recommended in the method of design referred to is more conservative than the same factor for floor construction.

In closing, I wish to express a hope that these articles may help to create some new thought in concrete design regulations and also lead to the closer co-operation of the various bodies controlling building construction, so that before long we may be permitted to produce permanent, safe concrete structures for our manufacturers at a far lower cost than now prevails.

### An Important Code Committee Meeting

The Fire Marshals' Association of North America has appointed a Committee on Uniform State Building Codes, which held an organization meeting in Chicago on January 21, 1918, and which will hold a meeting in Chicago on February 18. This meeting will be in session for some days.

John G. Gamber, State Fire Marshal of Illinois, Springfield, is Secretary-Treasurer of the Association and writes that a number of architects and engineers will be invited to assist in the work. It should be kept in mind that the State Fire Marshals are in close touch with the executive branch of the various States and in more close touch with the legislative branches than are architects and engineers, either individually or collectively. The importance of this meeting is then apparent.

Code building is in the air, and its importance has been fully set forth in THE AMERICAN ARCHITECT of January 22, 1919, on page 128. Code building is not entirely within the province of any special class of men, but the architect and engineer is vitally interested. What will they do and who will build the codes?



# Industrial Information

*In this Department there is published each week information as to the development of materials and methods, derived from reliable sources.*

## Fuel Facts

If to be successful the architect is obliged to be alive to the business issues of the day, perhaps one of the most valuable means of gathering important information in a condensed and reliable form is through the medium of government publications.

In a desultory, casual manner, for the most part, the people have gleaned that coal shortage here and abroad was a serious matter, widely affecting their normal activities. By certain enforced sacrifices they have been made to recognize the existence of a fuel administration whose business was to prevent a crisis and its attendant consequences.

How far have these sacrifices accomplished their purpose? What is the status of the fuel problem to-day? Which methods, tried in wartime and found "not wanting," may be pursued in peace with advantage? What experiences, in other words, may we learn to incorporate which in the future will make for the highest economy of our resources?

These questions are suggested by a booklet issued by the United States Fuel Administration which discusses chronologically and with considerable interest, the whole course of procedure followed by that administration since its organization in August, 1917.

The average reader of newspapers cannot form any conception of the magnitude of this problem with all its ramifications. This booklet, known as "Fuel Facts," contains so fine a summary of an important subject, so many interesting sidelights on the business of war and peace, and so much valuable advice and general information of one sort and another, that the professional man with an eye for practical knowledge will welcome an opportunity to read it.

## Interlocked Steel Gratings

It is frequently necessary or desirable to use grating about a building. As window and vault guards, and registers, for instance, architects will recognize in the interlocked steel gratings herein discussed a medium for the accomplishment of these aims which promises satisfaction. Mitchell-Tappen Co., 15 John Street, New York, are the manufacturers.

These gratings were originally designed for sidewalk openings over subways, and for power plants

and places where walkway gratings are generally used to admit light and air below. Their use, however, has been extended, and some of the structural features accounting for this wider use follow: All intersections are absolutely interlocked by dovetail joints. This dispenses with the need for bolts, rivets and screws which tend to loosen or rust out. The spaces, as will be seen in the accompanying photograph, are all rectangular, providing maximum openings for light and air, and eliminating acute angles which may catch disease-breeding dirt or prevent proper painting. These things make for service. The gratings are made of varying weights and sizes to meet requirements.



The grating herein described has been widely used in navy and marine work where requirements are of the most exacting kind. It has been found to give maximum light and ventilation, and also great rigidity, due to the absolute interlocking above referred to, and the fact that members run continuously in both directions. In many instances the gratings are used without any grating framing for spans up to ten or twelve feet.

The illustration shows the interlocked type of grating protecting the first story of the Winchester Repeating Arms Co., New Haven, Conn., and gives an idea of the substantial character of the material. Further information may be obtained by a perusal of Bulletin G-2, sent on request by Mitchell-Tappen Co., 15 John Street, New York.



## Ventilating for Results

In any building, provision for adequate ventilation is an essential. Too much stress cannot be laid upon it as a guard to health and an incentive to energetic attention to the activities within.

A roof ventilator which has received both the official award ribbon at the Panama-Pacific International Exposition and the gold medal of the Department of Agriculture, is "Alpina," made by the Milwaukee Corrugating Co., Milwaukee, Wis.

It is appreciated that perfect ventilation means a constant circulation of adequate fresh air without draft. The logical outlet for foul air is the roof, the place to which it naturally ascends. A system which attempts to draw the foul air out where the fresh air should come in, is one which fails to take advantage of the assistance obviously available.

Alpina roof ventilators exhaust the foul air from the building at a point where no counter currents of fresh air can hinder their operation. At the same time, windows or other fresh air intakes are left free to accomplish this special purpose.

Fresh air, though admitted in abundance, is rapidly contaminated by the foul air present unless this is systematically and forcibly carried off. Public buildings are often overcrowded. In theaters, schools or churches, for instance, the problem is not so much how to admit fresh air supply as it is to take away the used air as fast as it is expelled from the lungs of the occupants.

The Alpina Syphon Revolving Ventilator placed at the highest point of a roof intercepts and takes advantage of the slightest breeze from any direction. A vacuum caused by the passage of air currents produces a suction which draws out the foul air through the stock of the ventilator. This influence strengthens the natural tendency of the warm, impure air to rise to the highest point in the interior of the building.

The Alpina has a large capacity due to the fact that it is not stationary, but revolving. It is said to cost nothing to operate and to be easy and inexpensive to install. Technical details are printed in a booklet published by the Milwaukee Corrugating Co. The company conducts an engineering department for the benefit of architects who have unusual conditions to meet in the matter of ventilating.

## Tempting People to Paint

It is well said that there is a mesmeric fascination in watching paint transform an old shabby surface into something bright and attractive.

We stand and watch the painter applying his brush even at the risk of paint spots on our outer garments or on our observing heads.

That there is an irresistible itching to apply the paint ourselves is shown by Mark Twain in his story of "Tom Sawyer." It will be remembered that Tom capitalized on this tendency by selling the boys the privilege of painting Aunt Polly's fence. His profits were an apple, a kite, a dead rat and a string to swing it with, twelve marbles, part of a jew's-harp, a piece of blue bottle-glass, a spool cannon, a key, a fragment of chalk, a glass stopper for a decanter, a tin soldier, a couple of tadpoles, six fire-crackers, a kitten with only one eye, a brass doorknob, a dog collar, the handle of a knife, four pieces of orange peel, and a dilapidated window sash.

The profit of the man who applies Dixon's Silica-Graphite Paint to his smokestack or roof or boiler-front, or any other surface requiring protective paint, is the satisfaction that comes in a coating of paint that is good to look upon, with a choice of four colors any one of which can be used as a trimming if desired, and a knowledge based on the experience of others for over fifty years that he will not need to repaint for perhaps many years to come.

Sometimes repainting has been done, not for greater durability, but simply through a desire for a change of color.

Dixon's Silica-Graphite Paint is a paint that is not affected by heat or cold, acids or alkalies, and is one that is not affected by sunlight and therefore never fades. The only change that can come to it is the natural discoloration which comes from dust and smoke and to which all paints are subject.

Now that the stress of war is over, houses and iron work of all kinds should be brightened up and better protected with a coat of Dixon's Silica-Graphite Paint.—From "Graphite," published monthly by Joseph Dixon Crucible Co., Jersey City, N. J.

58-62  
646 0 272

# The AMERICAN ARCHITECT



PULPIT IN A FLORENTINE CHURCH

PUBLISHED WEDNESDAYS IN NEW YORK—FOUNDED 1876

VOLUME CXV

FEBRUARY 19, 1919

NUMBER 2252

Entered as second class matter January 6, 1909, at the Post Office at New York, N. Y., under the Act of March 3, 1879. Publication office, 243 West Thirty-ninth Street, New York, N. Y. Subscription price in the United States and Possessions, \$10.





# ARMCO IRON

## For Safe, Sound, and Profitable Building Construction

TO tear down is the business of war; to build up is the business of peace. Razed and ravaged Europe must be restored, and great and busy America must continue to grow and expand. It is absurd to think that the next decade will see otherwise than a colossal building boom in every part of the world.

With the world demanding construction of a permanent nature, metal will be used for building as never before. We expect every available pound of our product, Armco (American Ingot) Iron, to be used for such purposes as fast as we can supply it. In every phase of its manufacture, Armco Iron is subjected to scientific and never-ending care and inspection. It combines purity, evenness, density and other qualities that make for durability.

### Building Uses for Armco Iron

In every kind of building, new or altered, residential, industrial, public, or office, Armco Iron can be most profitably employed for all exposed metal parts such as roofing, coping, pent houses, skylights, water tanks, ventilators, window frames and sashes, and for such purposes as metal lath where durability is a factor even though the metal is not directly exposed.

Every architect, builder and property owner or investor who is interested in safe, sound, and profitable building construction, should write us for information specifically applied to his building problems.

The trade-mark ARMCO carries the assurance that iron bearing that mark is manufactured by The American Rolling Mill Company with the skill



intelligence and fidelity associated with its products, and hence can be depended upon to possess in the highest degree the merit claimed for it.

## THE AMERICAN ROLLING MILL CO. MIDDLETOWN, OHIO

Licensed Manufacturers Under Patents Granted to  
The International Metal Products Co.

Branch Offices at New York, Washington, Pittsburgh,  
Chicago, Cincinnati, Cleveland, Detroit, St. Louis,  
Atlanta, San Francisco and Buffalo



# ARMCO IRON Resists Rust







PULPIT BY GIOVANNI PISANO IN THE CATHEDRAL OF PIZA

*THE AMERICAN ARCHITECT*

# THE AMERICAN ARCHITECT

VOL. CXV

WEDNESDAY, FEBRUARY 19, 1919

NUMBER 2252

## A Civic Type of War Memorial

Proposed for the City of Boston

By M. S. FRANKLIN

**A**LREADY there has been a general movement throughout the country to cause the memorials of the present war to take on a practical value to the community, incorporating the idea of their use as community centers, or including halls for public forums and meetings, or auditoriums that will also be available for use for dramatic and musical occasions. So far, however, the structures that have been actually proposed along these lines have been exclusively for the smaller cities and towns. Boston is, perhaps, the first of the larger American cities to shape definite plans for a structure that amplifies the "Community Center" idea to truly metropolitan proportions.

The large city, of course, must have many "Community Centers" scattered throughout its area, and the public school is coming into very general use for such purposes. The up-to-date American city, however, requires some large central structure which will fulfill similar purposes on the scale necessary for the large community. As this plan has been visualized in Boston it includes not only all the attributes usually found in the smaller community center—of course on the larger scale—but also other elements intended to make the building the educational, recreational, and social headquarters for city and state—and the actual plan has been so developed that these uses in no way detract from the dignity and character of its memorial expression.

To consider the latter first, the central feature of the plan—forming the entrance to the great Auditorium, opening on to the communicating cross Corridor of the Allies, terminating at one end in the



Hall of the Army and at the other in the Hall of the Navy—is the Memorial Pantheon, reproduced at a smaller yet dignified scale from the Roman original, which is probably universally regarded as the most impressive and commanding architectural structure in the world. Located in this position, it would be visited and used daily by thousands of citizens, thus serving its purpose far better than could be the case with any isolated arch or any other purely memorial structure.

Opening from the Corridor of the Allies are



THE AMERICAN ARCHITECT

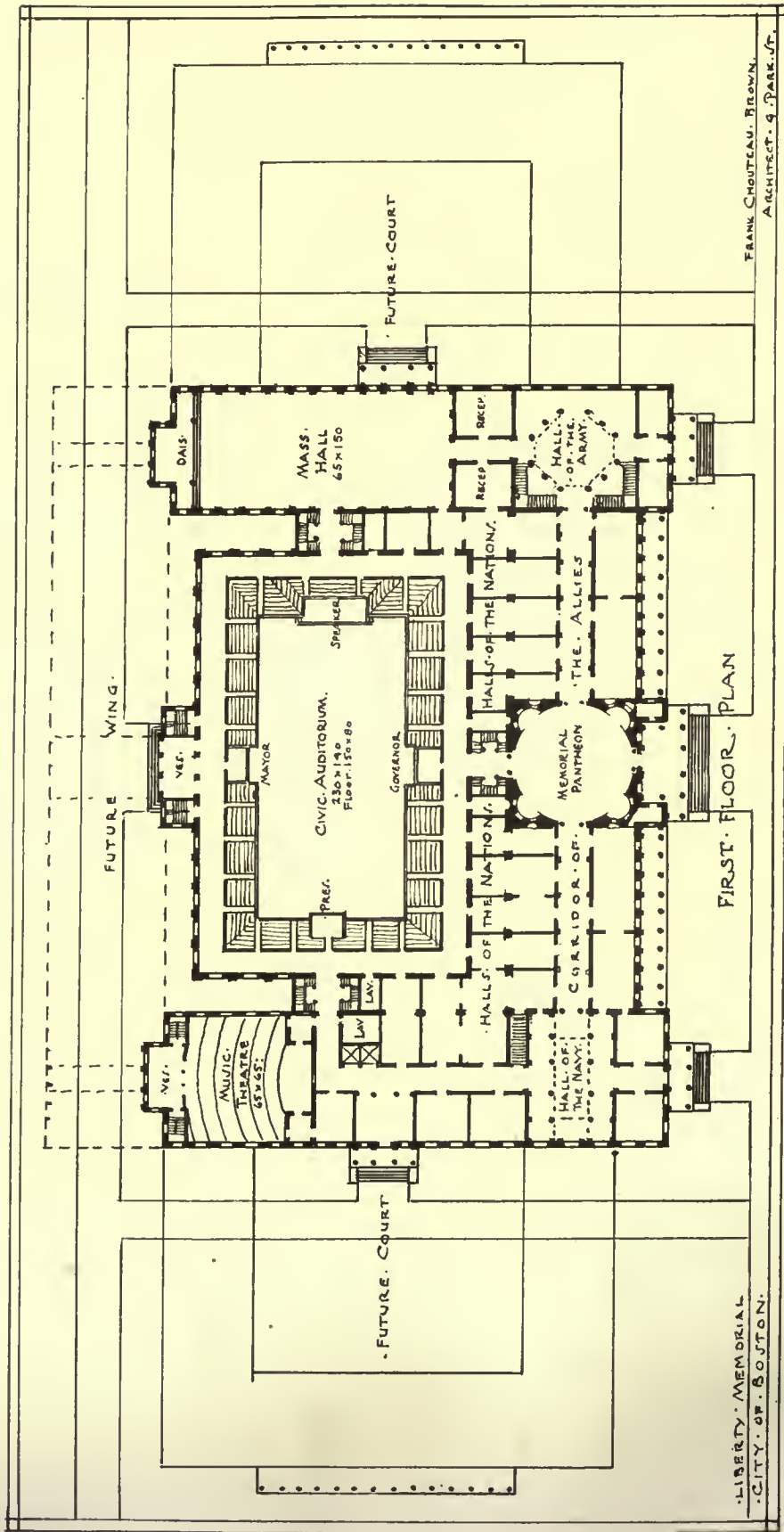

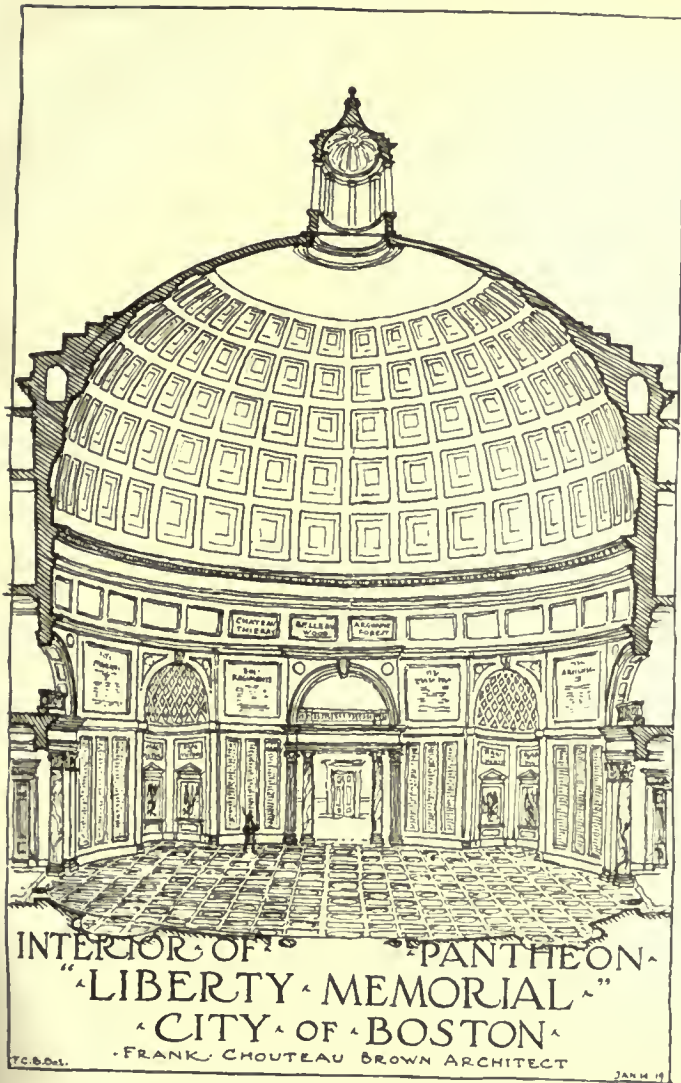

and naval organizations. The wing at the right is especially intended to be used for large city receptions and other municipal gatherings, the Hall of the Army providing a dignified meeting place, and Massachusetts Hall beyond (65 by 150 ft. in size) being available for large banquets, military dances, or gatherings of the war veterans, or for convention purposes. This banquet hall communicates directly with the speaker's platform in the large Civic Auditorium, which will make it possible for the city to entertain visiting notables with a banquet in Massachusetts Hall, taking them afterwards into the Civic Auditorium, where a larger public meeting might have been arranged.

The purpose of the building is expressed on the exterior main façade by a colonnade, each column of which would represent one of the allied nations and support a figure symbolic of that nation or representing its national hero, while the frieze of the entablature would be carved with the nations' names. At the rear of the Memorial Pantheon is the large auditorium, also approached from the street at the back, which is an important thoroughfare traversed by street car lines. The auditorium has a floor 80 ft. wide by 150 ft. long, from which rise tiers of seats on all four sides, reached from outer circulatory corridors entirely surrounding the hall. A similar arrangement occurs on each floor, serving convenience of access and insulating the auditorium from outer noise, the seats being continued in a deeply pitched balcony above, ending at the back in a colonnade

rooms, lighted from above, each of which is to be allotted to a racial group of foreign-born Americans within the community, and their individual hall is to be used by them both as a meeting place and headquarters at all times, as well as for the exhibition of their national art and other features, thus providing graphic reproductions of their historic background and culture for the benefit of any visitor. The rooms will be open at all times to the general public as an educational feature, and will also serve as passages and exits from the circulatory corridor surrounding the large auditorium in the rear to the memorial corridor at the front of the building.

Other rooms opening from the corridor and halls at each end would provide simple yet dignified meeting places, accommodating twenty-five to three hundred people, for public committees, or for convention purposes, or for the headquarters of military

that is carried entirely around the top of the auditorium, which is 150 by 250 ft. in size. The seating capacity of the auditorium is about 6000 people, with an opportunity for six hundred to eight hundred more to stand in the colonnaded gallery behind the balcony seats. Besides the speaker's stand at one end, opposite which is a "Presidential Box," intended for use on national occasions, there are two other permanent boxes, one for the Mayor and one for the Governor, located in the center of the auditorium on each side, connected with retiring rooms beneath by a private staircase.

The street at the rear is at a lower level, so that it is also possible to approach or empty the floor directly from a corridor on a lower story than that shown at the back of the seating tier on the principal floor plan. Some idea of the general arrangement can best be obtained from the sections appearing at each side of the view of the auditorium in



## THE AMERICAN ARCHITECT

which the hydraulic stage is shown raised into place from its position in the smaller theater auditorium in the space below.

This drawing indicates the spaces available under the inclined seats which are utilized for cloak rooms, smoking rooms, dressing rooms, storage and other purposes, the relation of the outer corridors to the main memorial floor at each story, and illustrates how the spectators can enter and leave the seat locations by various levels. The auditorium staircases are arranged in four stair wells, separated both from the auditorium and the enclosing building, but available for use from both, thus making for economy in construction and safety in case of panic or fire. The entire construction, of course, would only be undertaken on the most permanent and indestruct-

raised above the floor level, bringing up from its position in a smaller theater auditorium beneath a completely equipped and permanently constructed stage, with proscenium, boxes and fly gallery, all ready for large operatic and dramatic performances. The seats in front of the stage when at the lower level would accommodate about fifteen hundred spectators, and while the gallery would be entered from the lower street level, the lower floor would be—as in English theaters—below the level of the street.

Situated at the rear of the left wing is a smaller music theater, similarly entered from the rear street, which, with its balcony, would seat between nine hundred and one thousand people. This auditorium could be used by singers and other soloists,

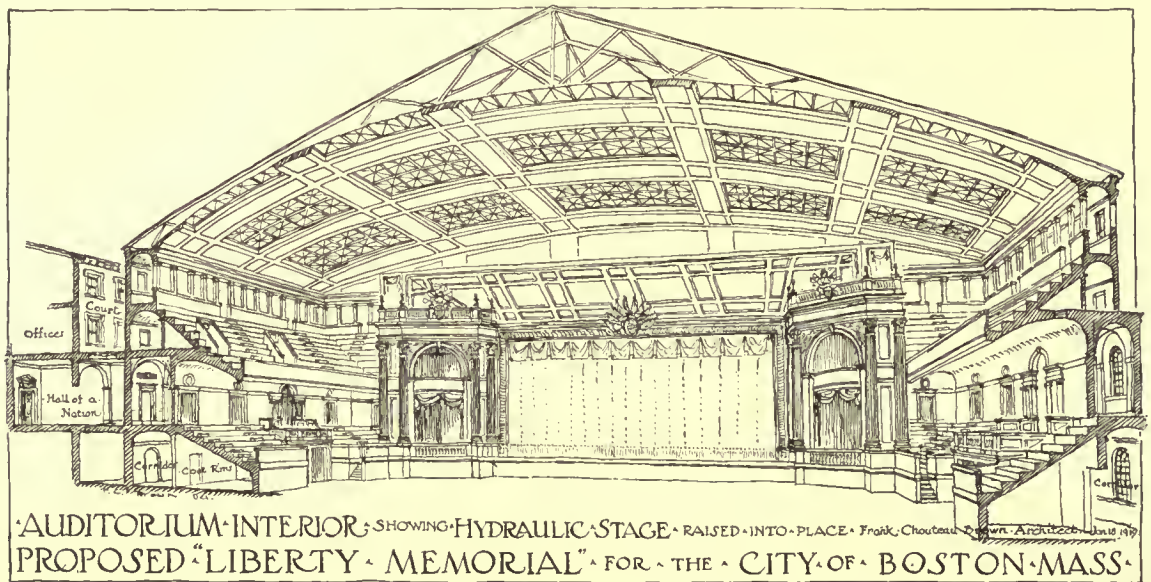

ible basis, and the treatment of the auditorium itself would be simple yet dignified, adapted to supply appropriate surroundings for important civic meetings and the best acoustic results.

Such an auditorium as is here described should become an important element in the development of a city and in the lives of its future citizens. It provides a place for important conventions; for large choral entertainments and concerts, a space in which reunions or reviews of soldiers and sailors could be held, with ample room remaining for spectators. The floor, eighty by one hundred and fifty feet, could be used for dancing, for large pageants, and for many other purposes. Its level could be made to change easily so as to help sight lines for public meetings or dramatic performances. One end, including the speaker's rostrum and a portion of the floor is arranged as the roof of a huge elevator car, 90 feet wide and 40 feet deep, which can be

and for chamber music, for Greek plays and graduation exercises. It should also be noted that all three of these elements, the auditorium, music theater and banquet hall, will help provide the material income necessary to maintain and make freer public use of the structure.

The remainder of the basement space, extending partly beneath the floor of the main auditorium, is given to swimming pools, shower baths, bowling alleys, and certain exercise rooms and courts for recreation purposes, available for the Service Club in the evenings and for students in the daytime. A restaurant is also provided in connection with the kitchen in the basement, which is also used to serve the banquets given in the large ballroom on the floor above.

The Memorial Pantheon is actually intended for the State Memorial—being essentially a "Hall of Flags"—and it is intended to be kept entirely free



## THE AMERICAN ARCHITECT

from superfluous sculpture or decoration, these adornments being relegated to the Memorial Halls of the Army and Navy, which, with the walls of the Corridor and the principal memorial rooms on the front of the building provide ample wall space for tablets, busts and other commemorative memorials. It is indeed intended that these rooms would be furnished by the friends of different military units or organizations, each room thus becoming a perma-

under the one roof would not be required for other community purposes.

There are also other interests, such as the various racial groups who would accept and make use of the "Halls of the Nations," that could be counted upon to contribute directly part of the expense of providing a memorial of this kind and size. There are, besides, many business organizations which would be especially interested in a civic auditorium.

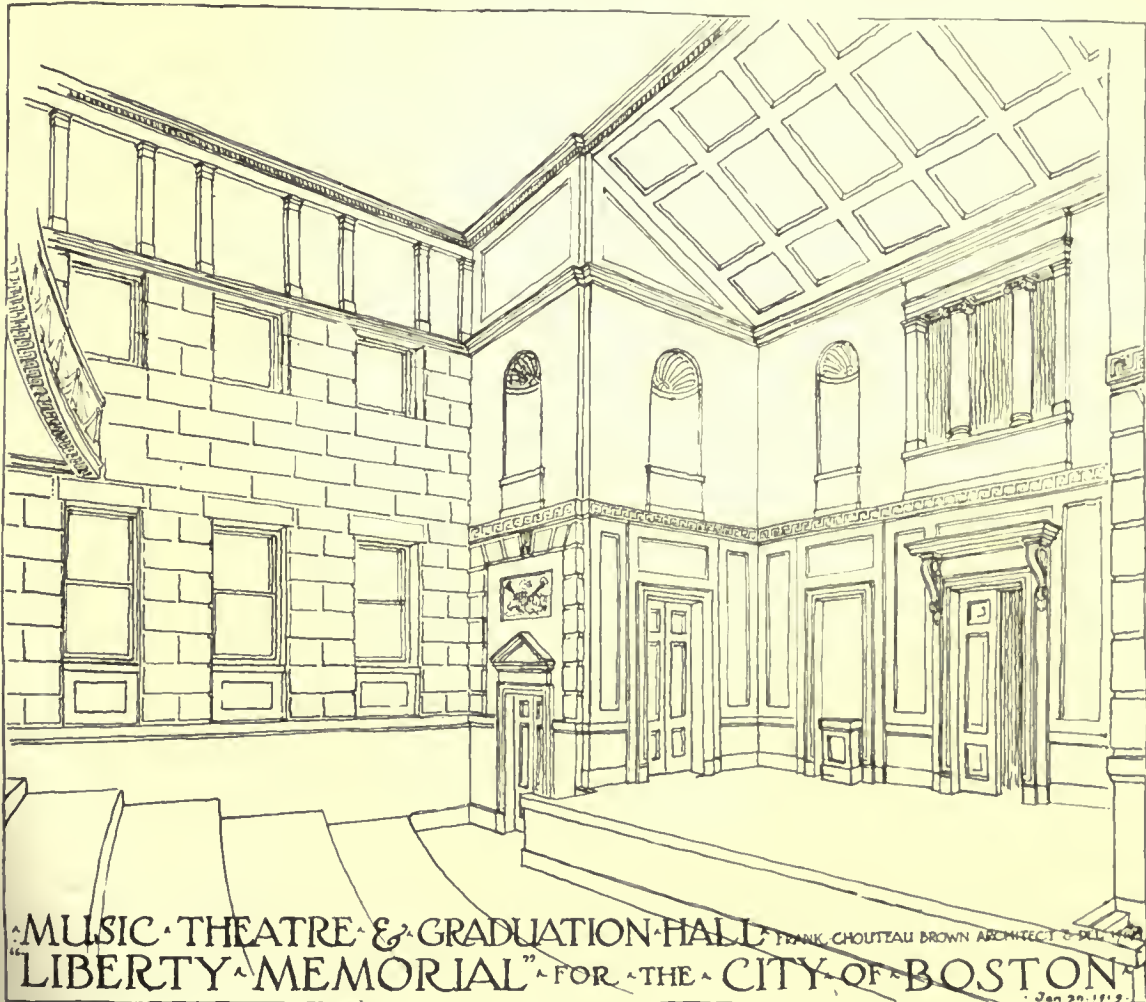

nent feature of the state or city's memorial record.

Not only could especial contributions be obtained in this way, but much of the helpful interest that would thus be raised should undoubtedly aid in obtaining public contributions to the whole Memorial structure—just as the School Committee has already expressed its willingness to contribute the half million dollars it has available in order to obtain headquarters in a building so much of which could be utilized by the School Committee between those times when the various different functions included

Those interested in that part of the memorial which best symbolizes the current idea of the "League of Nations" would find that expression in the harmonious colonnade of the façade, indicating the equally closely related groups of halls of the same nations which are provided on the plan of the principal floor. This floor, throughout its entire area, is intended to be maintained on a commemorative scale of simple yet dignified beauty, which could be counted upon to impress all those entering the structure, for whatever purposes they may first have come to the building.

THE AMERICAN ARCHITECT

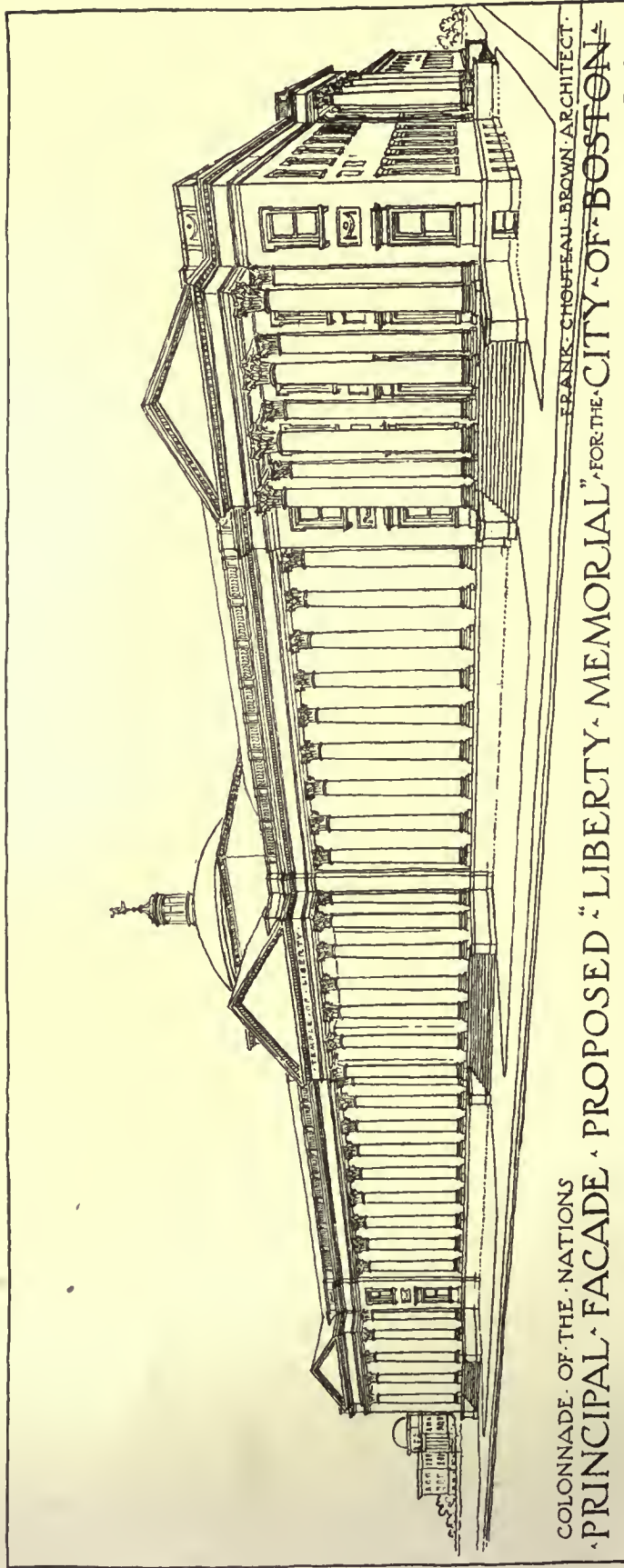

COLONNADE OF THE NATIONS

PRINCIPAL FACADE PROPOSED "LIBERTY MEMORIAL" FOR THE CITY OF BOSTON

FRANK CHOUTEAU BROWN ARCHITECT

JAN. 15 1917

FROM THE ORIGINAL DESIGN BY FRANK CHOUTEAU BROWN, ARCHITECT



THE AMERICAN ARCHITECT

REAR & AUDITORIUM FACADE SHOWING FUTURE WING  
FRANK CHOUTEAU BROWN ARCHITECT BOSTON

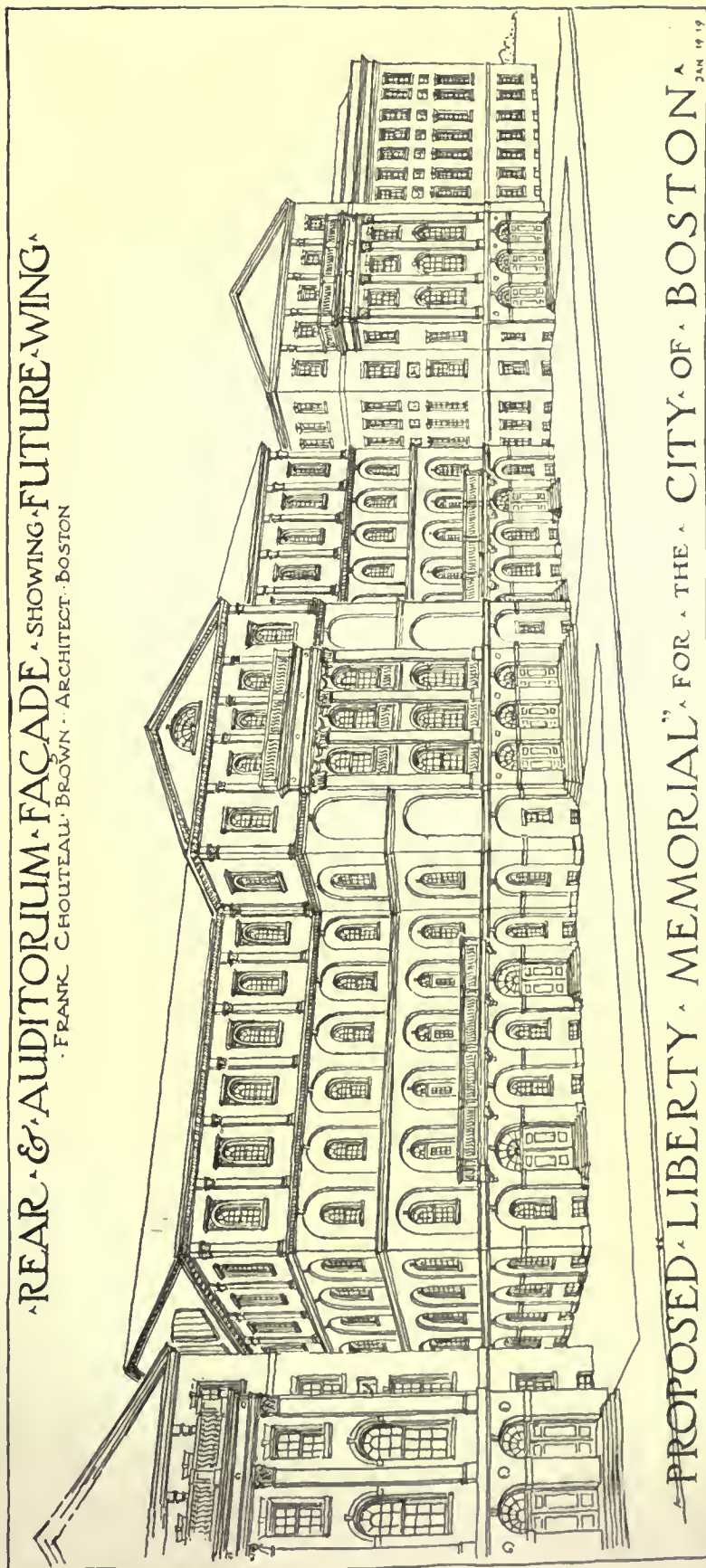

PROPOSED LIBERTY MEMORIAL FOR THE CITY OF BOSTON  
JAN 19 19

FROM THE ORIGINAL DESIGN BY FRANK CHOUTEAU BROWN ARCHITECT



## THE AMERICAN ARCHITECT

The "Halls of the Nations" should be interesting enough to draw, in the daytime, groups of school children and others into the Pantheon on their way to study this visualization of European civilization, just as in the evening they should draw to themselves the racial groups for which they would provide a headquarters, all by their very juxtaposition and inclusion in the Civic Memorial, expressive of their common part in the war and the harmonious fusion of these nations into our democratic American city organism.

It is neither contemplated, nor is it considered as altogether desirable, that this structure should all be undertaken at one time, although it is necessary to have the complete scheme definitely in mind, a scheme so complete that it even would provide for remote future additions—so that a site originally can be provided of sufficient capacity for the extension of the building to meet the demands that always eventually arise. And, although the structure is illustrated in a reasonably complete form, it would be an entirely possible and probably the most practical thing to start out by building—as soon as a sufficient amount of funds appears to be in sight—the Memorial Pantheon, which provides the central element, and then later continue to build the two front wings, which would make the front Memorial Façade complete. This would also provide sufficient area for the school headquarters and, as the wings extending to the rear could be added later, the other interests involved could be taken care of, one after the other, leaving only the Civic Auditorium to be finally built into the court of the completed scheme. On the other hand, if the Civic Auditorium were the immediate need, that could be built following the Pantheon—or, if it was

desired, in advance of any remaining portions of the structure.

Finally there remain a few words to be said about the drawings. Because of the fact that almost as soon as the scheme was presented to the architect, Mr. Frank Chouteau Brown, it became necessary to meet the ideas and suggestions of a number of individuals or organizations interested in the five or six different principal elements comprising the problem, and then arranging those ideas in a form available

for quick presentation to committees and others already endeavoring to determine the type of memorial to be built in the community, it became necessary to turn almost immediately to the graphic presentation of the scheme by means of simply arranged perspectives.

Once the arrangement of the plan, the scheme for the elevation and the principal section had established the relation of the individual parts the perspectives were started, much of the detail and actual design being worked out on the perspectives and checked back to plan and elevation. In order to make the perspectives available for purposes of newspaper reproduction—and, incidentally, to simplify their rendering and reduce the amount of time neces-

sary to their presentation to the absolute minimum—the adoption of the type of straight "line rendering" carried more or less consistently through all these illustrations was determined upon; and, that convention once adopted, it was adapted to meet the various problems encountered in the presentation of the structure as they were met from time to time.

The result is submitted for what interest of rendering or of design it may possess. At the moment the matter of a War Memorial is directly before

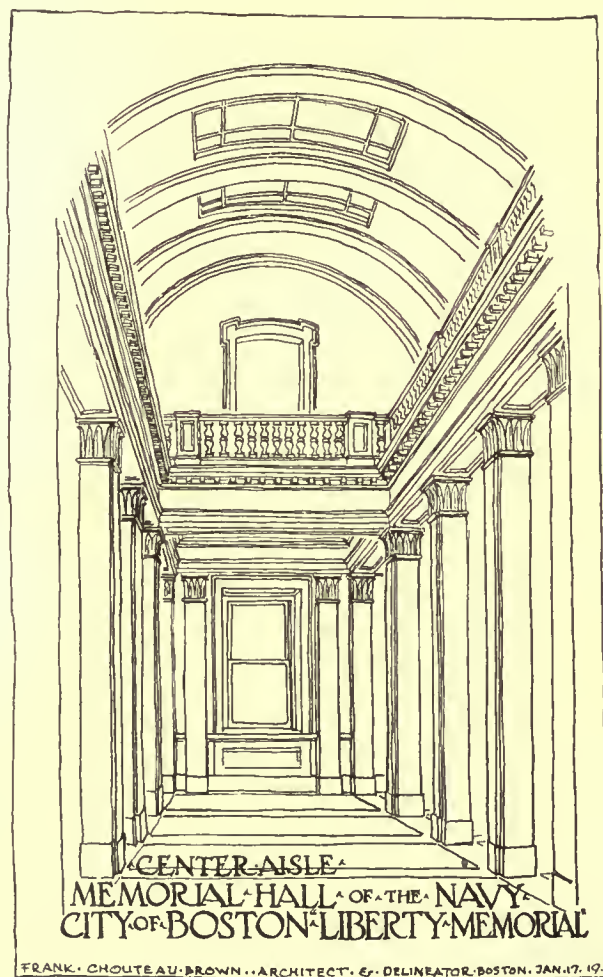

THE AMERICAN ARCHITECT

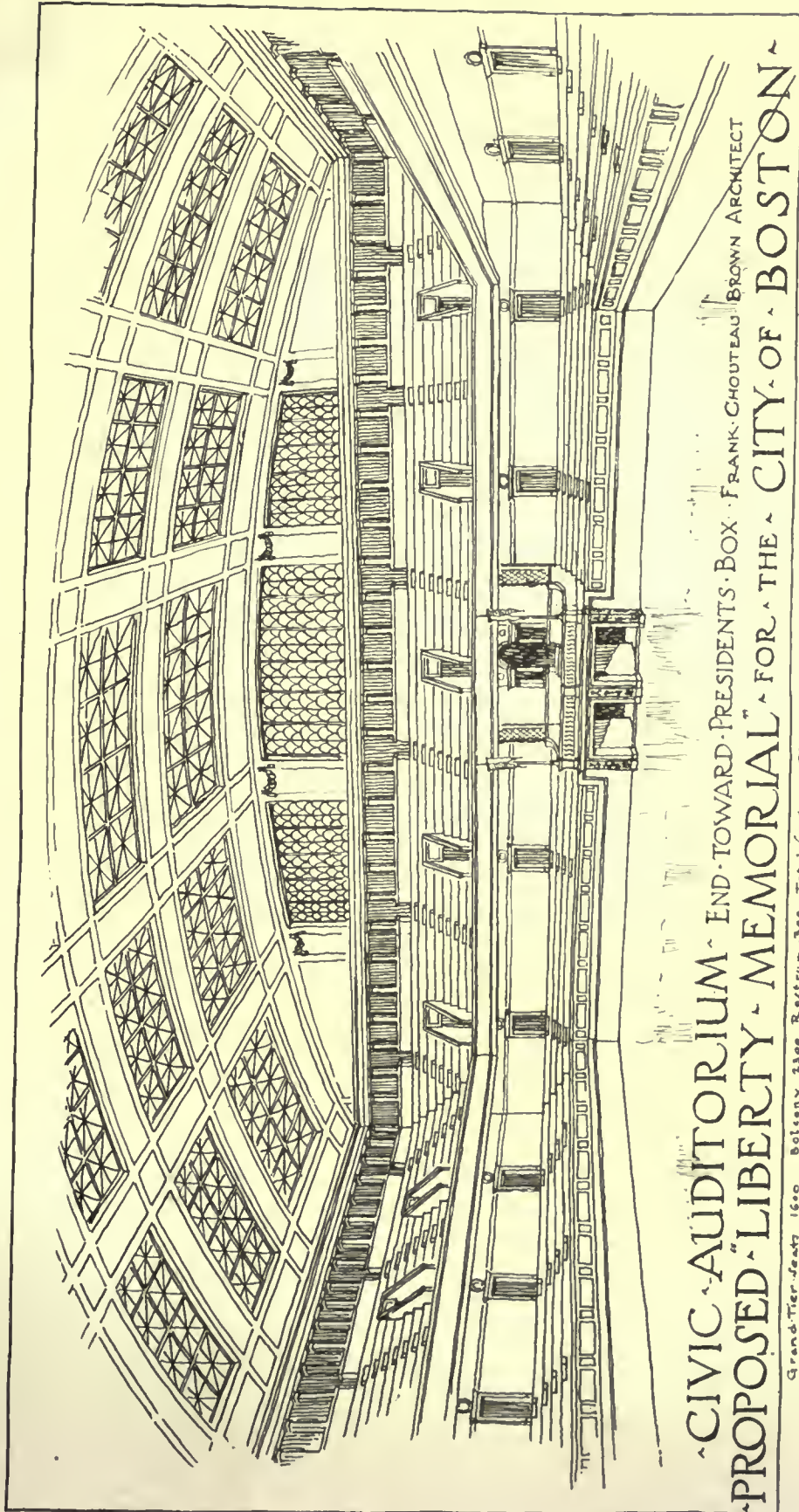

CIVIC AUDITORIUM - END TOWARD PRESIDENTS BOX - FRANK CHOUTEAU BROWN ARCHITECT  
PROPOSED LIBERTY MEMORIAL FOR THE CITY OF BOSTON

Grand Tier Seats 1600    Balcony 1300    Refectum 300    Total (outside Floor) 4200    Floor Seats 1486    Grand Total 5686 Capacity    Jan. 1911

FROM THE ORIGINAL DESIGN BY FRANK CHOUTEAU BROWN, ARCHITECT



## THE AMERICAN ARCHITECT

the larger American public for consideration in one form or another. A memorial of some sort or other will be built in thousands of American towns and cities. Thus far the ideal here proposed has met with a wide and general local acceptance that seems to indicate that these plans combine to meet

the wishes of nearly every element existing in one of our larger American cities. It remains for other communities to determine upon some type of memorial that will be an equally wise and judicious investment intended to aid in the maintenance and perpetuation of a future democracy in America!

---

### An American Memorial to Theodore Roosevelt\*

By GEORGE W. MAHER, *F. A. I. A., President, Illinois Chapter, American Institute of Architects*

CHICAGO is known the world over as a city typical of America. Here, perhaps, more than in any other city, all the races of the earth are blended together into a unit, a citizenship expressive of our nationality, or a democratic ideal.

Here is the universal melting pot, which is producing a new and dominant race that will express the true aspirations of America.

It is therefore fitting that the proposed memorial to be erected in Chicago to Theodore Roosevelt should typify the life and character of a man who responded in a marked degree to the virile life that is centered in this great metropolis. Therefore it should be beyond all peradventure American in inception, design and execution; otherwise it will be unworthy of Chicago and the nation.

Roosevelt has been universally termed the great American. The press in editorials throughout the length and breadth of this country, as also abroad, has unanimously accredited him this distinction.

Hence the purpose of our text: It is unfortunate that the art world in this country has not always responded or comprehended the fundamental principles that lie back of great historic events, such as, for instance, the potential significance of the world war just ended. The designs thus far produced in the majority of cases are conclusive evidence of this assertion. Too often we erect memorials and monuments, camouflaged with precedent types of architecture and sculpture, which seldom bespeak the reason for their existence or the purpose for which they have been erected.

These monuments become in time mere passing phases of interest in the eye and mind of the public and possess little intrinsic or historic value.

Above all, they portray a sterility of the creative faculty and are unworthy of the spirit and ideals of our great country.

There are many reasons that could be enu-

merated emphasizing the lack of understanding on the part of the public, the architect and the artist, who are responsible for such evidences of a flagrant sacrilege in the realm of art. It seems, therefore, that this national defect should be recognized and clearly understood by those who are now entrusted with the responsibility of erecting a worthy memorial to Theodore Roosevelt.

It is an axiom that no country is really great that cannot create or possess an indigenous art and architecture, as well, indeed, as poetry, literature and music.

The difficulty in America thus far in its history is that there has been little sincere attempt to encourage the native qualities of genius in our midst, to produce a creative art, especially in the art of architecture.

There has been no insistent demand or support for it either in the educational world or in public press or magazine. There has been no propaganda for a national architecture indigenous to this country. It was said before the war that America was a country without ideals, but this assertion has been overwhelmingly disapproved. America is now recognized as the greatest idealistic nation. As a people we have been prone to lean upon the art achievements of Europe for all that we have accomplished, and indeed one of our greatest hindrances to a national art is that many of our prominent and influential artists and architects have been educated in ateliers abroad and are as a result of training and impression not in intimate touch or sympathy with American inspiration and development. This fact is evidenced by the actual work produced, notably in architecture, and travelers from abroad have repeatedly commented on this anomaly.

However, it can be stated with truth that cannot be contradicted that successful efforts pertaining to a creative building art has been produced in this country and has proved conclusively that there are

---

\*Reprinted from the January Bulletin of the Illinois Society of Architects.

(Continued on page 272)



THE AMERICAN ARCHITECT

Founded 1876

PUBLISHED EVERY WEDNESDAY BY

THE ARCHITECTURAL AND BUILDING PRESS, INC.

No. 243 West Thirty-ninth Street, New York

E. J. ROSENCRANS, PRESIDENT AND TREASURER

WILLARD C. HOWE, VICE-PRESIDENT

WILLIAM H. CROCKER, Editor

ARTHUR T. NORTH, Engineering Editor

Subscriptions in the United States and Possessions,  
Mexico and Cuba, TEN DOLLARS. Other Countries,  
TWELVE DOLLARS.

SINGLE COPIES (Regular Issue) 25 CENTS

CHICAGO OFFICE, Mallery Building  
PAGE A. ROBINSON, Western Manager  
ST. LOUIS OFFICE, Wright Building  
CLEVELAND OFFICE, Guardian Building  
SAN FRANCISCO OFFICE, 320 Market Street

Owned by United Publishers Corporation—H. M. Swetland, President;  
Charles G. Phillips, Vice-President; W. H. Taylor, Treasurer;  
A. C. Pearson, Secretary. Entered as second-class matter January  
6, 1909, at the Post Office at New York, New York, under the Act of  
March 3, 1879.

VOL. CXV FEBRUARY 19, 1919 No. 2252

Build Now

“THIS country is confronted with a peculiar condition,” states C. H. Blackall in the course of an article contributed to the *Banker and Tradesman*. “We all feel the necessity for building and building now, but there is a curious reluctance to get started.”

In view of facts that are or should be apparent to everyone who contemplates undertaking a building operation, the real cause for this tardiness is difficult to understand. Mr. Blackall in this article directs attention to the almost exact stabilization of building prices during the past ten years, and as verification gives specifically the result of bids on certain contemplated building. A project begun but abandoned in 1917 is now again under contract, and the bids received disclose that identically the same work without any change can be built at an average advance of but 10 per cent. Inasmuch as the rentals obtainable from these buildings will exceed that percentage, the operation presents a concrete example of the folly of further hesitancy.

There has been a decided rearrangement in the prices of building materials during the past two months. Steel to-day is lower in price than it was in 1898, although it still rules higher than it did in 1915, which was the period of the lowest price for many years. The same conditions affect the price of cement.

The war has taught many and valuable lessons, particularly with reference to the substitution of materials. This substitution has during the period of the war, and will for the future, work toward a decided cheapening of the total costs of buildings while in no way impairing their efficiency. In fact we have but only learned the elementary principles as to what may be accomplished by a well studied substitution of materials and their efficient use, and it is in this very interesting phase of practice that architects may be able to work out and set in motion operations that would otherwise be held in abeyance.

THE question of labor presents the only uncertain factor in building operations. No one can foretell just what the future attitude of organized labor will be. It would seem reasonable to assume that with the supply even now far in excess of the demand it will not be possible to insist on the present high scale of prices that prevailed during the war. But those who have given this matter the closest study are firmly of the belief that there will be no material reduction in wages for some time. In fact with the present ruling prices of material, the large number of unemployed, the steady increase in rentals, and the shortage occasioned by the cessation of building, there is every good reason to regard the timidity to resume building as merely temporary.

The educational work being carried forward by the Department of Labor is already bearing fruit. It must be considered that the conditions produced during the war, and which were the result of almost two years of abnormality, cannot be at once overcome. But with our increased public wealth, the fairly free supply of loaning capital, each day now more freely released, it will soon become apparent that further cautiousness is not only unwise, but that it is, as affecting the individual, poor business policy.

We have two hundred and sixty-five billion dollars of wealth. We are to-day wealthier than four of the wealthiest nations of the world combined. We have \$2,500,000,000 worth of gold, the greatest amount ever in the possession of this country, and more than half the gold in the world.

WITH the war over, all danger of hostile attack from any other nation passed, we are still cautiously looking ahead, trying to pierce the veil of the future, yet, because of a certain psychological status, we are waiting, vainly hoping that prices of labor and material will be considerably reduced.

Such supercautionsness it is hard to understand. We have been as a nation known abroad as always

## THE AMERICAN ARCHITECT

ready to take a "sporting chance." Such a chance presupposes a certain gamble. With all the tangible evidences of our present and future prosperity before us we now hesitate to build. In the name of common sense, why?

With the approach of the spring months we shall have reached the time when the lowest bids are generally offered. Referring to this period, Mr. Blackall states: "The contracting firms are always anxious to place their orders for the year, labor is less apt to complicate the matter and the supply of materials generally is such that prices are at a low level. Furthermore, if building initiative is postponed beyond these three months we would then be in the midst of the building boom which is sure to come before very long, when prices may advance and it may be more difficult to enlist either capital or labor."

Those who followed the often repeated injunction during the war, to plan then, should be in the very best position to build now. To defer doing so is to become unmindful of their best interests, and to be perhaps as unpatriotic by inaction as they would have been to have undertaken to evade the Government's restriction of six months ago.

### An Efficiency Test

**T**HERE are many men in the profession of architecture who have demonstrated in the most forceful way the shortsighted policy of the national Government in its relations to architecture.

For many long and wearying months these men toiled in departmental positions. Their duties of a most arduous nature, their working hours long and filled with responsibilities, they freely gave to the service of their country all they had. And this all was a measure of performance the result of years of active practice of the real profession of architecture.

The majority of the men thus employed spent but little time in the practice of their profession, as it is mistakenly understood by the general public, and also, most unfortunately, by many men in high and responsible Government positions. They were not crouched over drawing boards creating beautiful designs, evolving æsthetic details, or sitting in conferences in which the principal topic was Art.

But what they were really doing was no different, except perhaps in the magnitude of the operations, from the work they had been quietly pursuing when

they set it aside to serve their country. All of these men were practicing architecture in its highest development, in its ultra-administrative phases. They were conducting investigations as to the supply and sources of material; they were devising schemes for its routing and prompt delivery. They were investigating the labor and social conditions of the vast numbers of working people who at a high speed were striving to make us fit and ready for our big task of winning the war. None of these men was compelled to serve an apprenticeship in these things. They came to their tasks master builders, master organizers, master workmen.

**W**HEN the fleet came out of Santiago, Admiral Evans signaled, "Steady, men, this is what we have been educated for." The architects who took up their work in Washington and at other points where the Government was conducting vast operations had been educated and perfected through long experience for just the thing they were doing. It is too early now for the profession to receive the recognition that it deserves for these services, but when the facts are known it is certain that the profession of architecture will reap the reward that is its due for its wonderfully efficient co-operation during the war.

Another class which has also helped to set public opinion straight is composed of those men who either individually or as working partners have during a period of cessation of building operations efficiently maintained their organizations at a considerable loss, so now that the time has arrived when the best interests of the Government demand a return to normal building conditions, they stand ready, fully equipped, for the work before them. Many of these firms had maintained their equipment and at the same time had relinquished for important Government work many men in their organizations.

Most of the professions have profited materially as the result of this war. There have been to them many avenues for advancement, for substantial and remunerative service. In the profession of architecture the record has been a spirit of self-sacrifice. Architects have been forced to contemplate what has been practically a ban on professional activities. That they have survived this crisis, have emerged at this time equipped to take up their work efficiently, is a triumph of the profession.



## A Coming Extension of Architectural Service

IT is obvious that the successful execution of a building contract must satisfy the owner, the contractor and the architect. This condition is affected by numerous elements that enter into such an undertaking. Some of these elements have a greater influence on the contract than others, but all require careful attention.

The essential elements of the execution of a building contract are the furnishing of materials and labor by the contractor for a compensation provided by the owner. The fundamental factor of a contract is the materials, and their quantity and quality governs the extent of the labor involved. The quantity of material and its attendant labor must be correctly estimated as the basis of the contract, for no transaction which includes an error can be satisfactory or just. Error may vary in degree and importance, but if the fundamental factor is in error the whole transaction is vitally affected. Hence it follows that a satisfactory contractual relationship must be free from fundamental errors.

The plan and specification are the directions that guide the furnishing of materials and labor on the part of the contractor, subject to interpretation, and are ordinarily thought to be a sufficient basis for such a contract. The plan and specification, by line and word, only indicate the limits of each particular factor which enters into the completed whole. They cannot and they do not indicate *directly* the volume or measure of these factors. To complete the presentation of the project to the contractor, as a basis for a contract and its execution, the measure of the volume and quality of the material must be included. In other words the *complete* interpretation of the architect's conception of the building must include the plan, the specification and the measure of the materials involved.

The custom of requiring the contractor to estimate the quantities is a delegating of the architect's function of interpreting his conception of the projected building. Modern building undertakings bulk in such a degree of magnitude that individual estimates of quantities of all kinds may be made by one hundred or more persons, translating the plan into quantity according to the variable ability of the estimators. Every plan and specification requires a uniform reading and it is manifestly impossible for the architect to have a direct contact with each estimator. To conserve the architect's time and make the basis of cost estimating uniform and truly comparable necessitates the furnishing of the

quantity schedules along with the plan and specification.

The cost of estimating these quantities is now paid by the contractor in the first instance, incorporated in the contract price and ultimately paid by the owner. By deducting the cost of a quantity survey from the payments to the contractor and reimbursing the surveyor, the owner's estimator instead of the contractor's estimator is paid. The ultimate cost of the project is not adversely affected and is very often cheapened by the elimination of error in quantity estimating.

In making the measure of the quantities, the surveyor in no manner interferes with the design or construction of the building nor does he encroach on any prerogative of the architect—the surveyor is simply the means of interpreting the plans and specifications in terms of materials.

In the new order of things, the elimination of waste and indefiniteness is demanded in every activity and the readjustment of routine practice will surely come about. In this case, there is no doubt but that the errors of quantity estimating on the part of the contractor and the cost of the tremendous duplication of this work, will be done away with. Being the proper function of the architect to control this work, as completing his service to the owner and the contractor, it is his duty to comply with the demand. Should he not do so, it will then inevitably be done by the owner and the architect will surrender that control which he must maintain to make his position secure. This rendering of complete architectural service cannot long be delayed.

## Criticism and Comment

*The Editors, THE AMERICAN ARCHITECT:*

Paragraphs Nos. 1, 2, 3, 4 and 5 of the article on "The Practice of Architecture" in your issue of Nov. 27, I fully endorse. If we have had a measure of success as architects it is because we have made these principles govern our practice. Few are really successful architects unless they have governed their practice as therein set forth. The measure of an architect's success is largely governed by how nearly he follows this as outlined in the above mentioned paragraphs.

I have in my forty-five years' practice had as clients the sons, the fathers and the grandfathers, in a number of instances, by taking care of everything.

OCTAVIUS MORGAN,  
of Morgan, Walls & Morgan.

Los Angeles, Cal.



## THE AMERICAN ARCHITECT

### An American Memorial to Theodore Roosevelt

(Continued from page 268)

men of vision and ability in our midst, who, if given the opportunity, can create in marble and bronze a result that is worthy of our aspirations and an honest effort to express our life.

Chicago has already produced a type of architecture which has been given more recognition abroad—in London and Paris—than near its native prairie soil which gave it birth.

This theme or type of art has not been fully developed nor yet officially recognized by our art or technical schools, but the movement is under way and is virile and is gaining momentum and recruits and will be fostered in time by the country. It will be encouraged by the masses of people who by instinct will ever call for their own.

The memorial to Theodore Roosevelt will be un-

worthy if it is a replica of any Greek, Roman or European model or precedent. Pericles and the Cæsars inspired the artists of their country and age and the temples and monuments erected through their inspiration typify their civilizations.

If this great American, now silent in speech, could express to us his ideals in regard to an American effort as he has upon many auspicious occasions, notably before the convention of the American Institute of Architects at Minneapolis in the year 1917, this argument would be unnecessary. His plea was for an American art and architecture.

The great public will hail with emotion and grateful appreciation a theme that is consistent with his ideals, which he proclaimed in precept and example during the extent of his useful life.

Let no man or influence divert the great spirit of his aspirations in any memorial monument to be erected to his life, otherwise it will be a false note, a discordant attempt and nonexpressive of the character and life of this great American.

---

### Furness House, Baltimore

By EDWARD HUGHES GLIDDEN, *A. I. A.*

(See plate section for illustration)

**F**URNESS WITHY & CO., LTD., steamship owners and agents, one of the great corporations of Great Britain and Ireland, with offices located in many of the seaports of the world, decided some time since to erect their own personal office buildings in certain of the cities of this country.

The port of Baltimore was the first to be considered, and the architect was requested to design a small building which would be of a dignified and pleasing type, without being at all over-ornate or in the slightest degree bizarre. In addition they desired a building of a traditional English type.

It was decided to adopt the style shown by the accompanying photographs, and the clients have felt the type so appropriate that they have since used it in another city.

The plans of the building have little of interest, as in the lower story there is merely a corridor running from street to street, flanked with offices on either side, and the upper story is one large skylit counting room with private offices at the east end. The plans

and details have therefore not been reproduced.

As to the exterior, which is of red brick and limestone, the relative proportions of the fronts were determined to a greater or lesser degree by the existence of old pile foundations which could not be removed and replaced without great delay, owing to the lack of labor caused by the war.

A greater projection of the central feature in each front would have probably been advisable.

The carved ornament of the east front was purposely executed in higher relief than that of the west by reason of the fact that a large building throws its shadow over the east façade throughout the morning with the exception of a period of about an hour.

A greater freedom was used in the design of the west front than in that of the east, and it is questionable if the results are as good.

The private office of the manager of the Baltimore division is shown. This is a simple room, but it is unfortunate that the furniture and lighting fixtures were not selected in better accord with the small amount of decoration and that the trim of the room was not painted rather than executed in mahogany. The distortion caused by the wide angle lens of the camera of course does not exist.

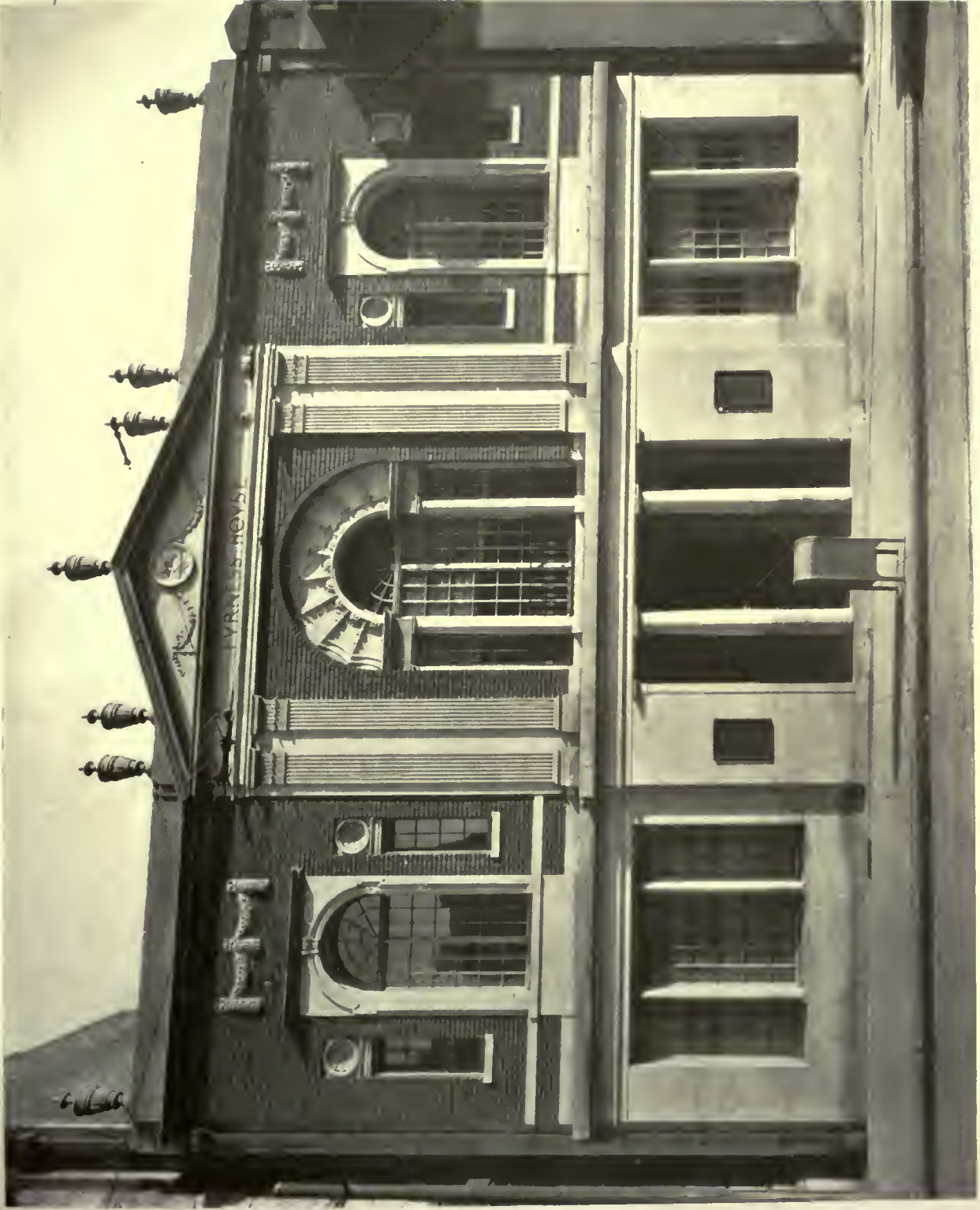

PLATE 56

"FURNESS HOUSE," BALTIMORE, MD., OFFICES OF FURNESS, WITHEY & CO., LTD.,

EDWARD HUGHES GLIDDEN, ARCHITECT







PLATE 57

"FURNESS HOUSE," BALTIMORE, MD., OFFICES OF  
FURNESS, WITHEY & CO., LTD.

EDWARD HUGHES GLIDDEN, ARCHITECT





PLATE 58

"FURNESS HOUSE," BALTIMORE, MD., OFFICES OF  
FURNESS, WITHEY & CO., LTD.

EDWARD HUGHES GLIDDEN, ARCHITECT







PLATE 59

"FURNESS HOUSE," BALTIMORE, MD., OFFICES OF  
FURNESS, WITHEY & CO., LTD.

EDWARD HUGHES GLIDDEN, ARCHITECT









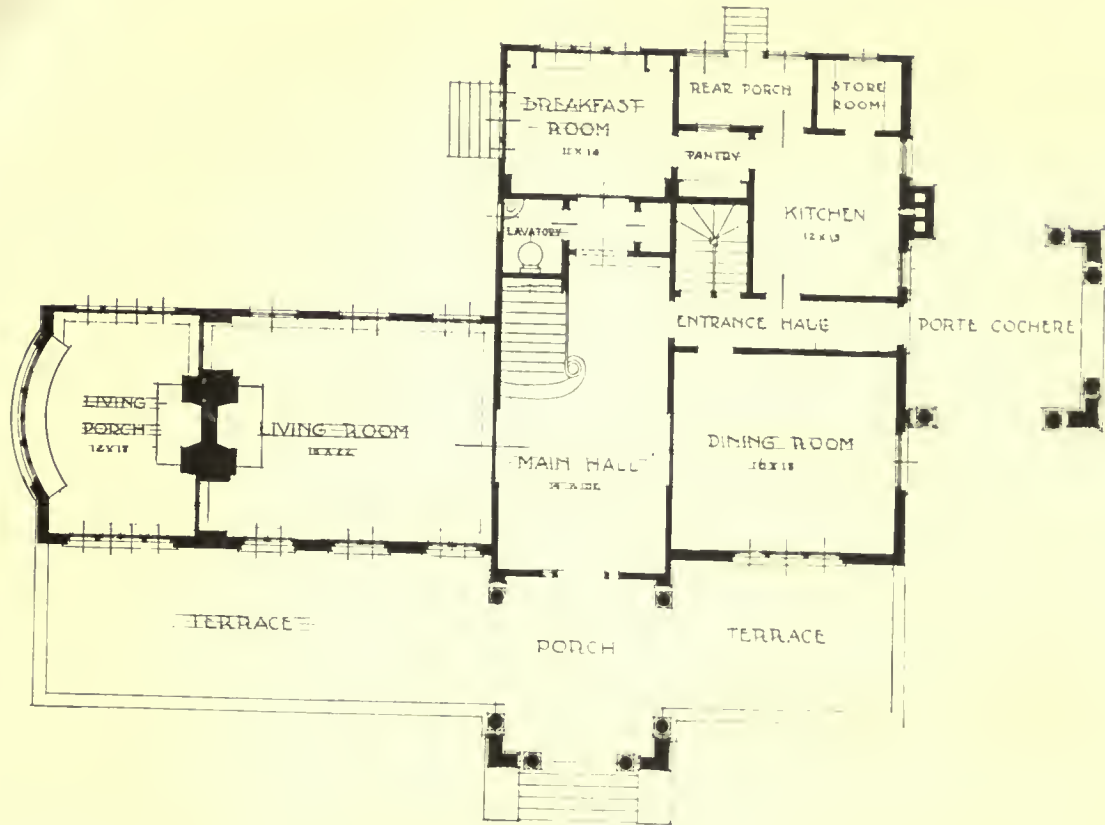

PLATE 61

HOUSE OF DR. ROBERT FAGIN, MEMPHIS, TENN.

JONES & FURBRINGER, ARCHITECTS







LIVING ROOM



PLATE 62

MAIN HALL

HOUSE OF DR. ROBERT FAGIN, MEMPHIS, TENN.

JONES & FURBRINGER, ARCHITECTS





# Financial and Commercial Digest

As Affecting the Practice of Architecture

## Construction Codes for Safety Uniformity

To effect a similarity of safety codes so that construction interests may not be so hampered in their work, a plan which includes a tentative list of codes in no less than fifty-five lines, is being formulated by the Department of Labor working in co-operation with the Bureau of Standards. It is the idea of the two departments to draft codes covering all trades in order that injury to employees and economic loss to the nation may both be prevented as far as possible. One of the safety codes will deal with construction, including demolition work, retaining walls, masonry, concrete and steel ladders, stairways, runways; another code will deal with elevators, escalators, in which particular attention will be paid to shaftways, counterweights, guide rails, landings, cars, safety device controls and signals.

Codes already drawn up by states and private institutions will be carefully examined and the best features of each will be incorporated in the new codes. Some of the other subjects to be considered call for the investigation of plant arrangement as might affect the routing of materials, the design of the buildings, clearances and illumination, also fire hazards, the spacing between buildings, and material as relating to the occupancy of the buildings.

## Plan Solves Dust and Fumes Problem

Dust and fumes, which have always presented a perplexing industrial problem, are the subject of an article by William H. Easton of the Westinghouse Company in *Industrial Management*, in which he shows how to make these injurious substances useful by merely pressing a button. In Mr. Easton's electrostatic process the dust particles are charged with electricity so that they fly to the sides of a tube oppositely charged and cling there until dislodged by jarring. Thus valuable material that otherwise would be lost is saved, and according to Mr. Easton a smelting company collected copper-dust in this way which netted the firm \$180,000 a year more than the cost of its precipitating plant.

The electrostatic method of dust precipitation embodies an old underlying principle, that of rub-

bing a rubber comb against a woolen garment, and the comb becoming electrified can attract and hold scraps of paper or other small particles. A treater for precipitating the dust consists of two large horizontal pipes connected by means of a large number of small vertical tubes, inside of which hang fine wire, which is charged by means of direct current to a potential of from 50,000 to 100,000 volts. The tubes are grounded so that a strong electrostatic field exists inside the tubes.

## War Boomed Building

The monetary value of the war boom in building and engineering operations in the nation is shown in statistics compiled and set forth in a recent bank statement. Contracts aggregating \$1,689,242,000 were awarded in 1918, the largest amount on record. Thirty-two per cent of this sum is represented by Government work. The contracts were let in twenty-five States.

## Public Contracts Executed in Year

Expenditures for work performed under the supervision of the Bureau of Yards and Docks during the fiscal year 1918 totaled \$193,164,458.24, according to the report of C. W. Parks, chief of bureau. Six hundred and eighty-two public works contracts were executed during the year. Since July 1 of last year 224 public works contracts were executed.

For the fiscal years 1917, 1918 and 1919 to date, there has been appropriated for work over which this bureau has cognizance a total of \$263,446,575.53. Of this amount \$27,509,000 was for maintenance and contingent expenses of yards and stations and \$235,937,576.53 for public works. To date, out of the total amount appropriated, there is unobligated \$35,814,709.80.

## Plan Model Farm Dwellings

The Department of Agriculture has developed plans for model structures to help meet the demand for tenant farm homes. It is believed by the department that better houses and an offer of permanent employment are needed to get large numbers of men to work on farms.

## Steel Orders Smallest Since October, 1915

A decline of 694,884 tons in unfilled orders for January is reported by the United States Steel Corporation. The total on Jan. 31 was 6,684,268 tons, the smallest since Oct. 31, 1915, when 6,165,000 tons were reported. A shrinkage which the industry considers as emphasizing the slackening of commercial purchases of steel after the armistice was signed caused the decline of advance business in December and January together of more than 1,400,000 tons.

The current bookings compare with 12,183,083 tons on April 30, 1917, the maximum total reported by the corporation, with 11,474,054 tons on Jan. 31, 1917, and 9,477,853 tons on Jan. 31 last year. From Jan. 31, 1917, to the end of August that year orders on hand did not fall below 10,400,000 tons at any time and were not below 8,000,000 tons last year in any month except December.

While new orders have fallen away rapidly since Dec. 1 last the corporation's mills have been working above 75 per cent of capacity, with some around 85 per cent, according to estimates heard in the trade. The output has been partly for customers who have specified against contracts placed prior to the absorption of production by the Government and also for the corporation's warehouses. It is estimated that between 25 and 30 per cent of current production is going into stocks which were greatly depleted during the period when war demands were requiring almost all the mill outturn.

---

## Improved Roads and Congress

Of the many measures before Congress to improve highways and create a national interstate system, two have the backing of the Administration, having been formally approved by the Secretary of Agriculture. The first, introduced by Senator Bankhead, who fathered the present Goods Roads Act, would amend that law by making available, in addition to funds already appropriated, \$600,000,000, to be expended over a period of seven years. The second, presented by Senator Swanson, directs the Postmaster General to set aside, at the end of each fiscal year, 60 per cent of the net proceeds derived from the operation of motor trucks engaged in carrying parcel post. This money would be used in repair work on the roads where the trucks travel.

Senator Chamberlain, chairman of the Committee on Military Affairs, is the author of another measure that outlines a plan for an initial appropriation of \$100,000,000 to establish and develop a

system of military roads under military control. The Secretary of Agriculture, under another plan, can lay out national highways that meet all needs, and he can use the Good Roads Act to put it into effect.

---

## Co-operation Against Fire Loss

In view of the fact that in ten months of 1918, with the United States at war, the fire loss was greater by a hundred million dollars than in the corresponding period of 1916, the major part of which was strictly preventable, the resolutions recently adopted by the committee on co-operation with the National Board of Fire Underwriters of the Fire Marshals' Association of North America, are of particular import. The committee advocated, among other things, compulsory fire prevention education in schools; the adoption of uniform records, greater fire protection for Federal, State and municipal buildings which house priceless historic records and documents; the adoption of the recommendations resulting from the municipal surveys of the National Board engineers and the acceptance of the offer of the New York City Fire College to extend the privileges of this institution to the firemen of other states.

---

## British Architects Exhibit American Timber

As a step in the British reconstruction program, the first exhibition of American timber in England has just been held under the direction of the Royal Institution of British Architects. Housing forms a big part in the British reconstruction plan, and many enterprises are projected in which timber will be required to a large extent. The exhibit was prepared through the assistance of American Trade Commissioner J. W. Walker.

---

## Collecting War Medals and Relics

A collection of material relating to the world war which will form one of the most important ever shown, is now being assembled for the United States National Museum at Washington. The purpose is to preserve and exhibit a series of objects vividly illustrating the military and naval activities of all countries engaged in the war. The collection will consist of commemorative medals, military and naval service insignia, mementos and relics of special note gathered during the war.



# Current News

## Cady Architectural Library Goes to Trinity College

Mr. J. Cleveland Cady, for many years senior member of the firm of Cady & Gregory of Hartford, Conn., has presented to the Trinity College Library his valuable collection of books. Some 375 volumes and nearly 2000 photographs are included in the collection which Mr. Cady assembled at great expense and over a period of forty years. The library is notable for its completeness and wide scope of subjects and is considered one of the most important gifts ever received by the college.

Among the handsomely bound volumes in the collection are Fletcher's "Andrew Palladio and His Works," Pugin's "Specimens of Gothic Architecture," Street's "Gothic Architecture in Spain," Hill's "Organ Cases and Organs of the Middle Ages and the Renaissance," Gotch's "Architecture of the Renaissance in England," Brindley and Weatherby's "Ancient Sepulchral Monuments," Viollet Le Duc's "Dictionnaire de l'Architecture," Uhde's "Baudenkmaler in Gross Britanien," Stuart and Revett's "Les Antiquites d'Athenes," and Revolt's "Architecture of the Renaissance in England." A series of books on Colonial architecture in this country includes some of the best known volumes on the subject, which could be duplicated, if at all, only at great expense.

The collection of photographs is also unique and extensive and includes selections made by Mr. Cady because of some peculiar excellence, eliminating any prints that might be insignificant or commonplace. Cathedrals as well as parish churches of England, France, Italy and Spain are included in the number, as are noteworthy cottages of England and chateaux of France.

Mr. Cady has not been actively identified with the profession for the past several years, but is perhaps best remembered for his designing of the Metropolitan Opera House and the American Museum of Natural History in New York, some fifteen buildings at Yale University and a smaller number at Williams, Wesleyan and Trinity.

## Ask for New Naval Medal Designs

Secretary of the Navy Daniels has directed Rear-Admiral Victor Blue, chief of the Bureau of Navigation, to ask a number of artists to prepare new designs for naval distinguished service medals or crosses, the ones submitted by the Artists' Association having been rejected. Secretary Daniels has announced that he would wait until a satisfactory design could be obtained, and indicated that he might make public the citations upon which awards will be based before the decorations themselves were ready for distribution.

The Artists' Association had protested against the decoration adopted by the army.

## Short Notes of News Interest

A Federal Victory Building is proposed by the Springfield, Mass., Citizens' Improvement League for housing the post office, custom house, federal land bank, and federal district court, with various supplementary offices. The design of the building includes a war memorial symbolic of the heroic victory achieved by our forces. This memorial feature is in the grand stairway and fore-hall of the district federal court, where naturalizations will be held, thus constituting appeal to patriotism for new made citizens. The principal facade also has panels giving titles of the battles of the war engaged in by the 104th Regiment.

Twenty-five million dollars will be invested in private building enterprises in Cleveland, Ohio, during the present year, in addition to approximately \$80,000,000 in public improvements, Building Commissioner Cunningham has estimated. He further estimated 3000 new homes will be constructed.

Agreement to launch immediately all possible construction of public improvements and to urge private activities of a similar nature, notwithstanding existing high prices for materials, has been reached by Governor Cox of Ohio, mayors, county commissioners and other public officials.

Representative Clarence B. Miller of Minnesota has made a strong appeal for favorable action on his bill for the appropriation of \$1,150,000 for the construction of a public building in Duluth. It is proposed that the building house not only the post office and federal courts, but the land office, the steamboat inspection office and the Indian office.

One of the most serious problems now confronting the city of Sacramento, Cal., is the proper housing of people establishing their homes there. This point has been brought out fully in a report just prepared by the housing committee of the Consolidated Chamber of Commerce.



## Would Create State Board of Architecture

A bill which has for its purpose the creation of a state board of architecture has been introduced before the West Virginia legislature by Senator H. W. Harmer of Clarksburg. The measure is now before the judiciary committee of the senate for consideration.

The bill provides that within sixty days after its passage, the governor shall appoint five persons, who must be, at the time of their appointments, architects residing in the state, and who have been engaged in the practice of their profession for at least five years. These men shall constitute the West Virginia Board of Architecture, two of whom shall be appointed for one year and three for two years.

The measure also provides that the board shall adopt all necessary regulations and by-laws to govern its proceedings and rules and regulations for the examination and registration of applicants desiring to practice architecture in accordance with the provisions of the act.

---

## May Make Contracts Public

War contractors in every industry are affected by the announcement of the War Department that it has ordered the revocation of the clause or clauses in its contract prohibiting the publication in respect to such contracts. Contractors are therefore authorized and permitted to furnish the public information concerning War Department contracts and orders received by them.

---

## Commission Appointed to Study Farm Conditions Abroad

A commission of ten members of the Agricultural Reconstruction Committee of the National Board of Farm Organizations has been appointed to visit Europe, to study conditions and represent the association at the peace conference. A program is being worked out by the committee studying reconstruction based on the fundamental principle affecting labor and capital. It is of special significance to builders because agricultural prosperity is a barometer of general business prosperity and because this year promises special activity in the field of farm construction.

The great farming sections have increased considerably in wealth during the past year as is shown by the remarkable totals of crop values during the

past two years. The figures, which show a per cent change up to as high as plus 60 per cent for wheat for 1918 over 1917, indicate that the money returned to the great farming sections of the middle west and south from the bumper crops surpasses all previous records. In fact all of the chief agricultural sections of the country give an impetus to building and construction work as well as to general business activity. Good business can be expected by contractors and builders in farming regions especially and they must be prepared to take care of whatever opportunities arise.

---

## England's War Memorials on Large Scale

If plans so far made can be taken as an indication of the general program, war memorials in England will take the form largely of spacious buildings. The most ambitious project yet proposed is that of the Veterans' Association, which is planning a building of 1000 bedrooms and a convalescent home for discharged men. At least £1,000,000 will be required to carry out the project on adequate preliminary lines. Another important plan calls for an "Overseas Memorial," a vast hotel for use of all men and women from overseas possessions. It will be built in the heart of London. Glasgow University purposes to erect a chapel on the west side of its present buildings.

The Leys School Memorial Fund now exceeds £32,000, on which a first charge of £20,000 has been laid for the foundation of entrance and leaving scholarships in memory of those who have fallen in the war. It is now proposed to secure additional support to provide for the erection of a memorial hall in honor of the part played in the war by the old boys of Leys. Designs for the hall have already been drawn by Sir Aston Webb. It would front on Trumpington Road and would be a striking architectural landmark on the entrance into Cambridge.

---

## Plan Monument to America's Womanhood

A movement to erect in Washington a monument to "American womanhood in commemoration of her loyalty, sacrifices and devotion to the American expeditionary forces" has been started by the Third American Army. Letters suggesting the idea were written recently to all the commanding officers of the Third Army by Colonel E. St. J. Grebel, Jr., commanding the Seventy-sixth Field Artillery. It

is proposed that General Pershing appoint a committee to take up the work and that only members of the American Expeditionary forces, the navy and the merchant marine be permitted to contribute to the fund, enlisted men giving \$1 and officers \$3 each.

---

### New Orleans Architects Elect Officers

At the annual meeting of the Louisiana Chapter of the American Institute of Architects, recently held, the following officers for the year were elected: M. H. Goldstein, president; Leon C. Weiss, vice-president; William R. Burk, secretary, and Victor Wogan, treasurer. Resolutions were adopted on the death of Samuel Labouisse.

---

### New Chapter of Engineers Elects Officers

Over one hundred and fifty members have been enrolled in the new St. Louis chapter of the American Association of Engineers. The following officers have been elected:

Lef Winship, president; F. L. Flynt, first vice-president; C. G. Harrington, second vice-president; R. B. Kerr, secretary; Geo. Grimm, Jr., assistant secretary; C. P. Calvert, treasurer. Directors: J. F. Peters, W. E. Playter, E. F. Collins, Prof. E. J. McCaustland, University of Missouri; L. T. Maenner, H. L. Hopper.

---

### New York City's Waterfront

New York has 578 miles of waterfront, of which 450 miles are available for pier construction. The harbor is far superior to that of London or Liverpool. The Thames is a brook beside the Hudson, and requires constant dredging. Liverpool has a tide of 30 feet range, with enormous watergate construction required to overcome it, while New York Harbor is practically tide free. In so far as docking space is concerned, New York can expand her harbor to a capacity equalling the combined dockage space of any five of the main ports of Europe.

On the Manhattan shore of North River, between Thirty-sixth and Thirty-ninth streets, the city has begun the construction of a series of gigantic piers for modern leviathans. These piers are 1,050 feet long, with slips 350 feet wide, having a depth of 44 feet at mean low water.

### England's Housing Appropriation \$600,000,000

To take care of housing conditions for a period of three years after the war England will spend over \$600,000,000 on new houses. The state will also meet 75 per cent of the loss due to expected fall in material prices and labor during the coming years. This means a national contribution of about \$188,000,000 and a local contribution of about \$47,000,000. Incidentally, England will insist that the standards of construction be raised and that the work of demolishing the slum sections of the larger communities continue to be done away with.

The density of the house building will be governed by town planning schemes, fixing twelve houses to the acre in towns and eight to the acre in cities. Land purchase, house building and local transit will be taken care of together. The housing policy of England is an integral part of the town planning policy, according to Thomas Adams, town planning adviser and Commissioner of Conservation, Ottawa, Canada, who writes that it is "recognized as a result of long experience that you cannot deal successfully with housing unless you deal at the same time with the proper and economic development of the land—which is town planning.

"Good housing connotes adequate light and air, restriction of density on the building lot, improvement of sanitation and street surfaces around the dwelling, healthy and agreeable environment, and all these things can only be secured by proper planning of the land, and not by mere planning of the dwelling itself. A good housing policy as far as reconstruction is concerned means therefore one which takes care of building the houses, planning the sites, planning and constructing the local improvements, and dealing with questions of local transit. You must deal with all these questions simultaneously, if you are to make new housing measures successful. The United States Steel Corporation and other companies recognize that by buying and planning whole town sites for housing their employees. But there must also be a simultaneous policy of improving the dwellings that exist and a courageous policy of demolishing those that are unhealthy.

"You cannot deal with the housing problem by public enterprise unless you control the land and local means of transportation. It is even more important to buy the land and provide it with local improvements and transit, under a proper town planning scheme, than to build the houses. The latter is the field that can be best left to private enterprise, and \$1 spent on land and land development goes as far as \$7 spent on building."



## Big Lumber Demand Arises in London

The possibility of a large lumber export business in the near future to take care of a sudden demand rising in England is the report from manufacturers and dealers in the Chicago district, who hope to supply a large portion of the demand from the middle west.

According to reports from England, the housing of the transient or floating population made up of soldiers and sailors on leave, is one of the chief factors which is causing concern to the English authorities. Hundreds of thousands of people have been attracted to London by positions in connection with the huge demobilization program of Great Britain and the United States. In a good many instances these workers have taken their families with them, thus causing such a demand for small flats and houses, that the result has been extreme congestion and insanitation.

It is declared that at least 100,000 new houses are needed in London alone. During the war 1500 houses were condemned as insanitary and should not have been used, but under the circumstances they had to be occupied.

The London County Council has 106 acres on which houses are to be built at once which can accommodate 17,000 persons. It is proposed to spend \$17,032,750 on this program. The London Government Board has planned for erecting 300,000 houses, but the procuring of the material required is the great problem. It is estimated that fully 94,000,000 cubic feet of timber, 2,500,000 windows, and 3,000,000 doors are needed for these houses.

## American Building Materials for Norway

The first shipment of American house-building materials ever sent direct to Norway has recently gone forward, and a trade that was started with the help of the Bureau of Foreign and Domestic Commerce now promises to develop into one of important dimensions. A self-explanatory letter from the New York representative of the company chiefly concerned in the transaction follows:

"A couple of weeks ago I went to Louisiana and purchased about 120,000 feet of yellow pine in the different dimensions suitable for wooden buildings, which was shipped from New Orleans within a few days direct to Norway. We have since placed an order about half that size, and we now expect that other orders will follow right along.

"We also shipped from New York some 17,000

pounds of American tile and ceramic flooring and some deadening quilt for walls and floors, and have placed orders for high-class and, in part, carved interiors in quartered oak, mahogany, and satin-wood, for a certain brand of special-type panels, for ornamental compo ceilings, for plumbing fixtures, water filters, metal roofing, and a number of other building materials for the houses to be erected by a company in Christiania as samples of American building materials and appliances. The company is being organized to carry a stock of such materials at Christiania, Bergen, and Trondhjem."

## British to Provide Cottage and Farm Acre for Each Soldier

A bill to be presented at the coming Parliamentary session embodies the scheme of settling former service men on land in large numbers, giving each a cottage and an acre of land, which will be partly garden and fruit growing land. The owner will make the main part of his living by work either in a neighboring town or on the land. It is also desired to have farms on each of which will be a manager, and will be cultivated by men who are not agricultural laborers, although they will get the agricultural wage of the district. They will be partners in the concern and benefit by its progress, getting their share of the surplus profits, as the farm will be cultivated extensively.

## To Master Foreign Trade

Courses of study to meet the requirements of those who must learn the practical aspects of the fundamentals of overseas commerce within a short time have been outlined in a bulletin issued by the Federal Board of Vocational Education at Washington. It contains short unit courses in foreign trade technique, on common selling methods and practices, the mechanism of foreign trade, exchange, credit, banking, ocean transportation, marine insurance, trade routes, foreign tariffs, and commercial policies. The bulletin is prepared by Dr. R. S. MacElwee, agent for commercial education in the board.

## Preserve Belgian Ruins

Hearty endorsement by the press follows the decision of the Belgian Government to maintain Ypres in its present condition as a permanent war memorial.

"Ypres will be a memorial," says the *Westminster*



*Gazette* of London, "in which future generations may learn the horrors of war. There is nothing more impressive than the sight of the stricken city with the skeletons of its once wonderful buildings rising gaunt into the sky.

"In a sense there are few things more beautiful. To patch it up would be impossible. Every one, therefore, will welcome the decision that the remains of the old city shall be left intact instead of being cleared away.

"The East abounds in the ruins of the last vestiges of once glorious civilizations which have been overthrown. Ypres will stand for centuries as a reminder that civilization itself cannot be overthrown, and as a monument to a generation sacrificed in its defense."

### National Highways Proposed at Convention

The first nation-wide conference called to prepare plans for a system of national highways that will be continuous trunk lines connecting all important parts of the United States was held last week at Kansas City, with every State except Massachusetts represented. Thirty-three organizations were represented by more than three hundred delegates.

The purpose of the convention was to band all the active highway associations of America together into one national organization. With all of the good roads associations unified, it is hoped to induce Congress to pass legislation providing for a complete system of national roads.

### Capital in American Railways

Capital invested in American railroads at the end of 1917, when the roads were taken over by the Government, totaled \$20,543,389,571, the Interstate Commerce Commission reports. The gross receipts for their operation during the year were \$3,596,865,766, while the total expenses of operation were \$2,357,398,412, leaving a net railroad operating income, after certain taxes and rentals were subtracted, of \$1,081,556,496.

### Personal

By the adding of an engineering partner, Frank A. Randall, the old firm of Berlin & Swern, 19 S. LaSalle Street, Chicago, Ill., has been changed to Berlin, Swern & Randall. Members of the new firm now are Robert C. Berlin, Perry W. Swern and Frank A. Randall.

## Surplus Government Supplies of Building Materials

Estimates regarding the building materials which the War Department now holds in excess of its present needs have been placed before the Committee of the Chamber of Commerce of the United States of America by Mr. C. W. Hare, the Director of Sales. The Director of Sales expresses a belief from his present knowledge that the War Department's surplus building materials will not cause any serious inconvenience to the building materials trade when it comes to be disposed of. Accuracy in these estimates is not yet possible, but there is reason to believe that the figures presented below cannot contain an error larger than 25 per cent. The estimates are as follows:

Commodity	Quantity
Brick .....	14,516,000
Hollow Tile .....	2,235,403 pcs.
Lumber Ft. B. M. Veneers and Plywood .....	350,000,000
Cement .....	115,523 bbls.
Lime .....	77,560 bbls.
Flue Linings (Lin. Ft.).....	20,226
Metal Lath (Sq. Ft.).....	1,122,313
Wood Lath .....	2,695 M
Wall board (All kinds).....	5,406,429
Roofing—Rolls .....	202,208
Building Papers—Rolls.....	52,377
Nails—Asst. Sizes.....	159,622 kegs
Reinforcing Steel .....	3,000 tons
Sewer Pipe—Asst. Sizes (Lin. Ft.) .....	577,497
Wood Shingles .....	908 M

### Discuss Disposal of Surplus Building Materials

The uniform plan of procedure for the disposal of Government surplus stocks of building materials, which was approved by the representatives of the several building material industries present at a recent conference, is being rapidly worked out. In the case of lumber a plan will be submitted in final form for approval shortly.

The United States Housing Corporation is now engaged in the liquidation of a large volume of furniture and cafeteria equipment which was purchased for the munition towns which it was engaged in building and which have been discontinued since the armistice. In order to facilitate the disposal of this material it has opened a display wareroom in New York City.

# Late News in Architectural Fields

---

## To Be Steady Growth in Building

William B. King, general counsel of the National Association of Builders Exchanges, expresses optimism and confidence and states that "this is a great country which cannot be kept down," and that while there may be no "boom" in building, the outlook is bright "for good steady progress and growth, which is better than any modern 'boom,' which often collapses even more rapidly than it expanded."

A difficult obstacle to resumption of activity in building, he says, is the feeling among investors that war prices must shortly come down. They are wrong in this assumption, he outlines, and must be convinced that prices are not going to be lower for six months or a year. When so convinced he feels sure people will go ahead and build, for there is a great demand for buildings in spite of high prices.

Speaking of the vast power of the United States, the States and municipalities in helping toward the rehabilitation of building industries, Mr. King says that the city, state and nation can better afford to pay 10 to 20 per cent more for a building now than it might cost at a year hence, than they can to have idle workmen.

---

## Brooklyn Architects Hold Monthly Dinner

The Brooklyn Chapter of the American Institute of Architects held its last regular monthly dinner which was largely attended. The main topic of the evening's discussion was city housing conditions. Several speakers deplored the fact that the present tenement house laws in New York State were not elastic enough to permit of improved or advanced construction, which, for instance, would not allow the building of a four-story block of houses with a wide courtyard and flower beds between each house.

It was pointed out that while ordinances and regulations are designed to protect the tenement house dweller, they frequently prevent radical improvements which builders of this type of house are willing to incorporate in the new structures. It was urged that revisions of the tenement house regulations be made so that city housing conditions can be improved.

Robert D. Kohn, of the New York Chapter, spoke on the desirability of the graduate of an in-

stitute or school teaching architecture, serving a course of apprenticeship with some architect of wide experience, instead of gaining his experience as is so often the case at the expense of his first clients. The average college, he said, does not turn out a competent graduate. Mr. Kohn spoke of the questionnaire to be sent out to each of the 80,000 architects throughout the country for the purpose of gaining data for formulating reconstruction plans.

Frederick L. Ackerman, formerly supervisor of design of the Emergency Fleet Corporation, gave an interesting talk on how the housing problem for shipyard workers was solved.

Among those who took part in the discussions were: Carroll H. Pratt, president of the Chapter; Alexander McIntosh, secretary; Benjamin Driesler, George Kiese, William A. Parfitt, A. C. Koch, Edward Snook, Frank Quinby and Stephen W. Dodge.

---

## Price Concessions Aid Building Market

A greater volume of building materials moved to actual construction work and more building operations were reported for estimate in New York City last week than at any time in almost two years. This, with lowering prices, has done much to discontinue the unsettled labor conditions.

The barometer of the present building material market as to inquiries, shipment and production is Portland cement. Inquiries in January were three times as strong as in December, while in December there were twice as many as in November. This healthy tone of the market is strengthened by the opinion of leading operators that 10 per cent more business moved in January this year than in January, 1918, despite the fact that there are now no Government orders that would require shipments. In this section of the country more mills ran in January, 1919, than in January a year ago.

Leading price concessions of the past few days have been in the equipment and supplemental building material lines, which show insulated wire to have declined half a cent, making annunciator base 28½ cents and weatherproof 23 1/3 cent base. Flush and supply pipe manufacturers have been offering concession from 10 to 15 per cent below the recently printed schedule. No drop in lumber is anticipated before summer.



# Department of Architectural Engineering



View of the S. E. corner of State Street and Social Hall Avenue, showing a portion of Social Hall at the extreme left. The three-story building on the corner is used on the first floor as a display and sales room, the second floor for the display of used cars and trucks and the third floor as a repair shop. The service room in the rear has a clear span of 50 feet.

## The New Automobile Center, Social Hall Avenue Salt Lake City

By MILLER, WOOLLEY & EVANS, *Architects*

A NEW article, which is produced and used on an extensive scale, requires satisfactory housing and architecture responds quickly to the demand, because a building, when properly planned, is so constructed as to serve a specific purpose. The introduction of the automobile, and the great increase in its use, has been followed by the development of a type of factory, sales and storage buildings. Sales and storage buildings for automobiles have been described in *THE AMERICAN ARCHITECT*\* in which the requirements of individual buildings are dis-

cussed and illustrated. These buildings are more or less scattered about a city, although in many cities the tendency to group them in one locality is apparent. The latest development in housing the sales and storage of automobiles *en bloc* is in Salt Lake City. In this case an unusual feature is that the entire development was planned and executed under the supervision of one firm of architects. This resulted in that co-ordination of planning and designing which satisfies the demands in the greatest measure.

The automobile industry in Salt Lake City, up to this time, was housed in cheaply constructed, one-

\*See *THE AMERICAN ARCHITECT* of March 6, 1918, page 305; March 20, 1918, page 361; September 4, 1918, pages 296 and 301.





## THE AMERICAN ARCHITECT



View of the N. W. corner of Second East Street and Social Hall Avenue. The first floor used as a display room, a used car room and service station. The second floor is used as a motor truck room.

story buildings, widely scattered. To concentrate the industry and better house it an important realty and construction project has been successfully concluded.

Salt Lake City is laid out with city blocks 660 ft. square, very wide streets and sidewalks. This plan

and a street 66 ft. wide, broadened to 86 ft. at the State Street end, was opened and improved. The name of Social Hall Avenue was given to the street. In the center of this new street, facing State Street, is one of the oldest landmarks of Salt Lake City, "The Social Hall," built by Brigham Young in 1852



An interior view of the Social Hall Avenue Garage, showing the rigid frame type of reinforced concrete construction.

leaves large areas of unused ground in the center of the blocks, and to make these areas available for use, to some extent, alleys have been cut through. In most instances these alleys have been built up with undesirable structures.

Immediately south of the Public Library, the property adjoining one of these alleys was acquired

as a place of assembly for the Utah Pioneers. This building was used as the first theatre in Utah, balls and banquets were held in the ground floor. Church Councils, political conventions, territorial legislatures and U. S. District Courts have convened in this building. Owing to its historical interest the owners wished to preserve this building, so the



## THE AMERICAN ARCHITECT



The second floor of the building on the N. W. corner of Second East Street and Social Hall Avenue. This floor is designed for the storage of motor trucks. The construction is of the rigid frame type discussed in the text.

street was widened around it, the building was restored and is now used at a "Little Theatre," endowed by the State University.

In designing the buildings a type of exterior design was adopted and used throughout, the walls being faced with dull glazed buff terra-cotta and a

variety of woods, finishes and decorative treatments were used in these spaces. Office spaces were arranged to suit the occupant, and often on mezzanine floors, from which a good viewpoint can be had of the display room. The buildings are equipped with electric elevators, with platforms 10 x 20 and 10 x 24 ft. in size. They have a capacity of 10,000 lb. each, with 10 hp., three-phase motors, hand rope control, and a car speed of 20 ft. per minute. The openings are protected with automatic gates. Hand



Detail of the exterior walls, faced with dull glazed buff terra cotta with ornaments in white.

granite base. Panels are provided with electric outlets in each panel for electric signs but there are restrictions as to the placing and size of the signs. Uniform street lighting is provided from brackets on the buildings, thus keeping the avenue free from lamp posts. Being essentially sales, service and work buildings, a large proportion of glass surface is used in the walls, the elevations clearly indicating the uses to which the buildings are put.

The buildings are planned to suit the individual needs of the occupants and in some cases economy in construction was waived to some extent to accomplish this end. Dividing walls are very largely made of hollow blocks, enabling the floor areas to be modified with a limited cost. The display rooms are designed to give variety and individuality, floors



A stock room for automobile parts and repairs.

and electrically operated dumbwaiters serve the different floors. Shower bath, locker and toilet rooms are provided for the employees.

All of the buildings have reinforced concrete frames with brick curtain walls. The floor slabs range in size from 20 x 20 ft. to 12 x 18 ft., with thickness, including toppings, of  $6\frac{3}{4}$  in. for the largest panels and  $6\frac{1}{4}$  in. elsewhere. The reinforcement is laid in two directions, and brought up over the beams to provide for the negative moments.



## THE AMERICAN ARCHITECT

Rigid frame construction was used wherever possible, on account of its economy and appearance. In a reinforced concrete building the entire structure is rigid to a certain extent, but for simplicity in design calculations, advantage usually is not taken

economy is obtained by taking account of the rigidity and continuity of joints. It is well suited for girder bridges, power houses, machine shops, train sheds, churches, and many other structures or parts of structures. Rigid frames are not, as such, being



Interior view of the shop on the third floor of the building on the S. E. corner of State Street and Social Hall Avenue.

used in America to a very great extent, while in Europe they form the standard practice. A partial reason for this is found in the fact that many engineers do not believe in continuity, and doubt the effect of rigidity. They do not hesitate to figure on concrete resisting positive bending moments in the span center, nor do they object to using cantilever construction and providing for the resulting negative moments, but they are timid about combining the two.

In the Anderson garage roof, as well as in some other parts of the Social Avenue buildings, full advantage is taken of the rigidity of the frame, and the bending moment at the end of the beam is assumed to be transmitted

of it. Frequently, in both building and bridge construction, the bending moment is taken as an assumed fraction of  $WI^2$ , while the bending moments at the ends and in the columns are disre-

garded entirely. The exact solution of the moments is developed from Castigliano's "theory of least work."

Frequent compression tests were made on 6-in.

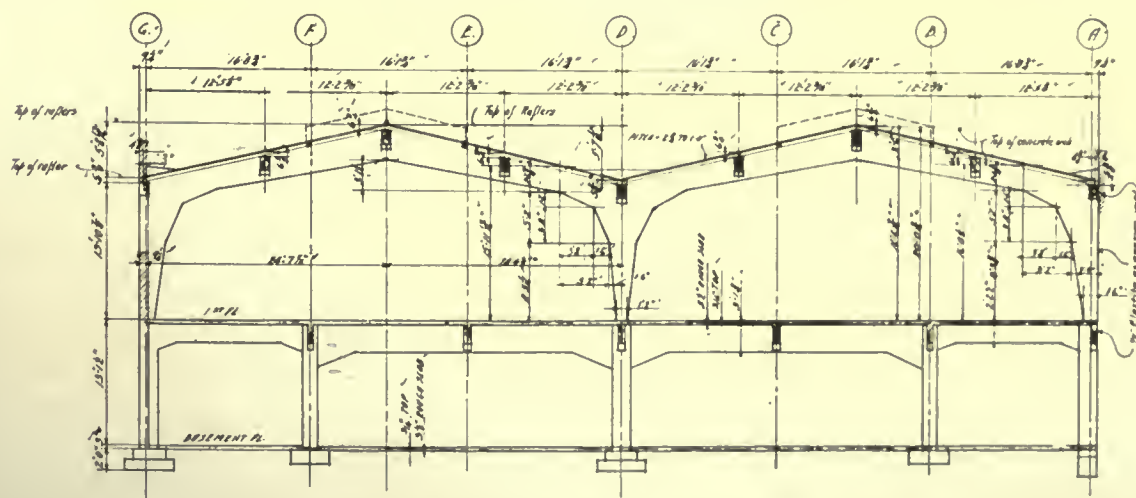

Section through Social Hall Garage, showing the rigid frame construction.

garded entirely. The effect of this is to make one part too strong at the expense of another.

The rigid frame is, in other words, the exact opposite of the pin-connected frame, and while it is usually safe enough to figure concrete as if it were pin-connected, there are many cases where

concrete cubes at the University of Utah, and the results consulted to gauge the safety of the structure under construction loads.

The property has a grade of about 5 per cent from the north to the south, which presented some difficulties in arranging floor levels and other details.

The street improvements were planned by the architect and the city engineer. The cross section of the street shows the sidewalks and the concrete street pavement joining without any abrupt curbs, the storm water draining to the south side of the street

The coal is received in a 5-ton automatic scale with a 6 x 11-ft. hopper. A steel pan conveyor acts as a feeder from the weighing hopper to a 12-in. bucket elevator. By means of a turn-head spout on the weighing hopper coal may be diverted through a coal crusher, which reduces lump coal to proper size when slack coal is not available. The coal is elevated by a 12-in. bucket elevator through a height



A sales room for automobile accessories.

into a shallow gutter. The transverse grade is 4 per cent, and the absence of any crown is necessary to permit of the drainage scheme. A tunnel is provided under the sidewalk on the south side of the street, in which is placed the steam, hot water, compressed air and gas mains. In this space is also placed the plumbing pipes and drainage.

All of these buildings, as well as the Public Library, University and Alta Clubs, Elks Building, City Public Safety Building and two apartment houses, are heated from a central power station located in the center of the block and south of the avenue. This plant is so constructed that it can, at some future time, be operated as a unit of the municipal heating plant.

This plant, which for the present will be used for heating only, is equipped with six 150-hp. boilers operated at 70 lb. pressure, which is reduced before entering the heating mains. The boilers are equipped with underfeed steam-driven stokers. The reinforced concrete stack is 6 ft.

6 in. inside diameter and 155 ft. high above the boiler-room floor. This stack was built in cold weather, and a frost casing was carried up as a part of the scaffolding, in which kerosene jet burners were used to prevent the freezing of the concrete.

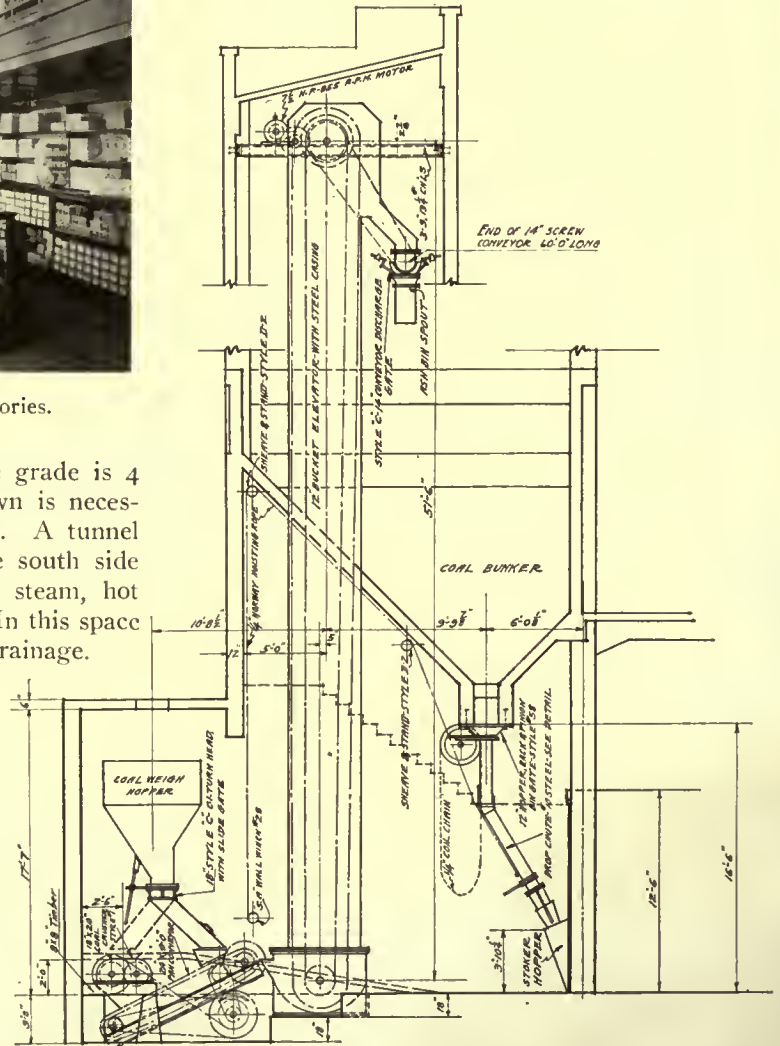

Section through the coal handling plant, showing the weighing hopper with turn-head spout delivering either to a coal crusher or to the elevator boot direct. The 12-in. bucket elevator conveys the coal to a head 52 ft. above the boot and delivers the coal to a 14-in. screw conveyor, 60 ft. long, over the coal bunkers and ash bin. From the reinforced concrete bunkers the coal is spouted to the stoker hoppers.

of 52 ft., delivering into a 14-in. screw conveyor 60 ft. long over coal bunkers and ash bin. By this arrangement the ashes are handled and deposited into the ash bin by the coal-handling machinery. About 30 tons of coal per hour can be handled. The bunkers are of reinforced concrete, with a capacity



## THE AMERICAN ARCHITECT

of 400 tons. The coal is spouted from the hopper bottoms of the bunkers to the automatic stokers.

The heating mains are carried through the tunnel, the pipes resting on ball-bearing brackets. They supply the cast-iron radiators in the buildings, which

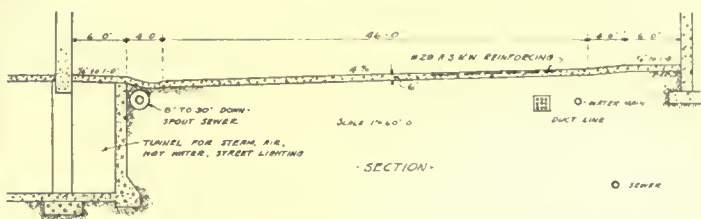

Cross section through Social Hall Avenue, looking west. Note the 4 per cent pitch in the section due to the pitch of the ground from north to south, directing the surface water to the shallow gutter on the south side. There are no curbs or crown in this street.

discharge the condensation through a trap, and each tenant has a condensation meter. From the meters the condensation returns by gravity through a common return main to the vacuum pumps and thence to the steam-driven boiler feed pumps. All boiler-room heating equipment is in duplicate to permit of repairs without closing down the plant.

Hot water is supplied from the boiler plant for the entire block. It is heated by steam passing



Display room in the building on the S. E. corner of State Street and Social Hall Avenue.

through a feed-water heater, and goes into a 1000-gal. tank. All of the hot water is under city pressure, and its circulation is boosted by a slow-acting reciprocating pump. A large amount of hot water is required to temper the water used for washing automobiles, and special hot and cold water connections are made at each wash rack for this purpose.

Compressed air at 150 lb. pressure is supplied for the whole block by a single stage air compressor rated at 182 cu. ft. free air per minute, driven by a 30-hp. induction motor. It is also piped through the tunnel and is used for inflating tires,

cleaning cars, blowing soldering furnaces, and driving small repair-shop machines.

A project of this kind presents several interesting aspects. To the architects it presented an opportunity to design and construct buildings for one specific use having a frontage of one-third of a mile, and which included one central mechanical plant for providing the heat, compressed air and hot water. It also offered as equally attractive and interesting a problem to the contractors, Villadsen Brothers, Inc., who solved problems of equipment and procedure in a highly satisfactory manner, and all carried on with close co-operation with the architects. To the owners it was a project involving the segregation of an industry with specially prepared housing and facilities. The project is also worthy of consideration from the viewpoint of rehabilitating old and dilapidated sections of cities and increasing property values. There is scarcely a city in this country that does not have such neighborhoods that could be remade for this or some other industry. The success of this particular project demonstrates that a broad-gauge consideration of its possibilities is well worth careful study.

### Research Graduate Assistantships

To assist in the conduct of engineering research and to extend and strengthen the field of its graduate work in engineering, the University of Illinois maintains fourteen Research Graduate Assistantships in the Engineering Experiment Station. Two other such assistantships have been established under the patronage of the Illinois Gas Association. These assistantships, for each of which there is an annual stipend of \$500 and freedom from all fees except the matriculation and diploma fees, are open to graduates of approved American and foreign universities and technical schools who are prepared to undertake graduate study in engineering, physics, or applied chemistry.

An appointment to the position of Research Graduate Assistant is made and must be accepted for two consecutive collegiate years, at the expiration of which period, if all requirements have been met, the degree of Master of Science will be conferred.

Nominations to these positions, accompanied by assignments to special departments of the Engineering Experiment Station, are made from applications received by the Director of the Station each year not later than the first day of March. Preference is given those applicants who have had some practical engineering experience following the completion of their undergraduate work. Appointments are made in the spring, and they become effective the first day of the following September.

Research work and graduate study may be undertaken in architecture, architectural engineering, ceramic engineering, chemistry, civil engineering, electrical engineering, mechanical engineering, mining engineering, municipal and sanitary engineering, physics, railway engineering, and theoretical and applied mechanics.

Additional information may be obtained by addressing  
**THE DIRECTOR,**  
 Engineering Experiment Station,  
 University of Illinois,  
 Urbana, Illinois.



## Zoning the Billboard in New York\*

By HERBERT S. SWAN, *Secretary, Zoning Committee, New York*

PRIOR to the adoption of the zoning resolution there existed in New York absolutely no safeguards to protect residential districts against billboards. Advertisers were free to erect huge signs wherever they wished—whether the site chosen was opposite a church or a warehouse, a park or a railroad yard, a home or a gas house. No locality had any amenities which the billboard was bound to respect—it could go anywhere. A private dwelling had no more rights in a residential district than fences featuring Ziegfeld's Follies, Haig & Haig or Bull Durham.

All this has been changed by the zoning resolution which prohibits property situated in residential districts from being put to any but the following uses and the accessory uses customarily incident to these uses:

1. Dwellings, including dwellings for one or more families, boarding houses, and hotels having thirty or more sleeping rooms.
2. Clubs, excepting clubs the chief activity of which is a service customarily carried on as a business.
3. Churches.
4. Schools, libraries or public museums.
5. Philanthropic or eleemosynary uses or institutions, other than correctional institutions.
6. Hospitals and sanitariums.
7. Railroad passenger stations.
8. Farming, truck gardening, nurseries or green-houses.

The term "accessory use" does not include any building or use not located on the same lot with the building or use to which it is accessory. A private garage for more than five motor vehicles is not deemed an accessory use. Presumably the only kind of signboard constituting an accessory use is the ordinary "to let" or "for sale" sign affecting the premises on which it is located.

Commercial advertising can in no sense be deemed accessory to any of the uses specifically permitted in residential districts. The erection of signs in the future will therefore be confined to such sections of the city as are situated in business districts or unrestricted districts.

The city's determination to enforce this provision of the zoning resolution has been demonstrated in several instances by the revocation of permits mistakenly issued for the erection of billboards in residence districts.

\*Copyright 1919, by Herbert S. Swan.

The zoning law, it must be remembered, is not retroactive in any of its provisions. Uses not conforming to the restrictions imposed on the districts in which they are situated are allowed to continue, provided they existed in the district previous to July 25, 1916, the day the law was passed. Hurtful or harmful uses, which have invaded residential neighborhoods since that date, unless authorized by the Board of Appeals after a public hearing at which all property owners immediately affected by the proposed use were notified to appear and have their objections heard, are in the nature of violations.

The zoning resolution has at one stroke done more to remedy the billboard evil in the residence districts of the city than all the laws and ordinances previously passed on this subject put together. Instead of merely regulating the height, size and construction of signs, it frankly recognizes the fact that there is no such thing as a billboard respectable enough to rub elbows with churches, schools and private homes. When hereafter erected the billboard must go where it will cause a minimum of harm—alongside business buildings and industrial establishments.

## Important Test Data on Flat Slate Construction

Bulletin 106 of the Engineering Experiment Station of the University of Illinois gives the results of tests on a four-way reinforced concrete flat slab floor of the Western Newspaper Union Building in Chicago, Illinois, just before it was razed in 1917 to secure space for the present Union Passenger Station.

The floor construction used in the first five floors of the building was slab and girder type while that of the upper three floors was Turner mush-room flat slab type with four-way reinforcement. The tests were made on the sixth floor. A test load of 913 lbs. per square foot, was applied over four panels each 17 ft., 5½ in. by 19 ft., 4½ in. This load was considerably greater in proportion to the design load than had ever been used in previous tests of buildings. The information secured, therefore, which shows the action of the slab in its various parts given by the strain measurements has an important bearing on the design of the flat slab structure. The text of Bulletin 106 is adequately illustrated by means of photographs and diagrams.

Copies of Bulletin 106 may be had gratis by addressing the Engineering Experiment Station, University of Illinois, Urbana, Illinois.

# Industrial Information

*In this Department there is published each week information as to the development of materials and methods derived from reliable sources.*

## Lengthening the Building Season

That winter weather need not preclude the possibility of successful construction is a truth bearing in its wake many advantages which every observer will appreciate. By exercising certain comparatively simple precautions, building can be carried forward during months when labor is more available, and during which transportation congestion may be lessened by distributing over the year work heretofore necessarily confined to a short period.

The North Western Expanded Metal Co., 37 West Van Buren Street, Chicago, sends forth a monthly publication issued in the interest of better buildings. It will be sent without cost to those interested in good design and construction. In the January number of this publication may be found an account of how an important concrete structure was erected in northern Michigan during zero weather.

Concrete is so important a medium for the construction of the modern building that it may be time well spent to give quite fully the experiences which made it possible to evolve a successful method for proceeding with its outdoor use under adverse weather conditions.

In answer to the natural query, what precautions were taken to make cold weather concreting safe, we are told merely some hot water for surface thawing and well warmed concrete.

The frost-fighting apparatus used was simple even to elemental—two small steam boilers to supply coils to the water tank and material bins. A tower 135 feet high and chutes with a maximum run of perhaps 200 feet distributed the concrete.

The work was left exposed over night to the elements. But before beginning operations in the morning the top "skin" of ice and laitance—sometimes nearly 2 inches deep—was thawed out by running hot water over the surface and letting it stand a few minutes—the necessary water pressure being obtained from a small feed pump connected to the hot water tank. The fresh, warm concrete heated to a temperature of about 50° was then placed and the warm mass completely finished thawing out the frozen layer so that a good bond resulted.

When the spring thawing was complete it was found that only on the work placed during the very coldest weather was there any evidence of scaling and this only in occasional spots and to a depth not exceeding  $\frac{3}{8}$  inch, and in July absolutely no signs of leaks have been found.

It is a recognized fact that warmth and moisture hasten, while cold retards the hardening of concrete. If therefore the mixing water and aggregates are heated and due precautions taken to protect the working during the first 48 hours there is apparently little danger of ill after-effects.

On large jobs the water is usually heated by steam, and since a boiler pressure of 25 pounds suffices, it is often possible to use an old steam boiler that is no longer safe for

high pressure. Heating the water alone is insufficient. The aggregates must also be warmed and the necessary heat may be obtained by piling them over and around a "stove" frequently made from sheet iron cylinders or an old smoke stack, etc., or from steam heated pipe coils. Care, however, should be used to keep the materials separate (otherwise there is liability of the "batch" being incorrectly proportioned) and to turn them frequently that they may not become so hot as to impair the strength of the concrete. By further covering the work with tarpaulins and using open fire pots or salamanders in the interior the hardening process will be facilitated and greater comfort for the workmen assured. It is not necessary to add that the sand and broken stone to be used later should be kept indoors if possible and carefully covered. The steel reinforcing should also preferably be warmed.

Salt, which was at first commonly used in cold weather concreting, is now considered undesirable, since no more than 10 per cent can be used without danger of affecting the final strength of the concrete, which amount is insufficient to afford protection. Furthermore it tends to corrode the reinforcing steel and even spoils the appearance of the finished work by causing the whitish deposit called "efflorescence" to appear later.

It is highly important that sufficient time be allowed for the concrete thoroughly to harden before forms are removed. To determine whether the work has hardened or is simply frozen, pour hot water on the concrete or turn the flame of a plumber's blow torch on it under which it will quickly soften if merely frozen.

The additional cost should not exceed 10 per cent and may even be as low as only 6 per cent above that of summer concreting—a difference more than offset by the advantages of having the building ready for use at the beginning instead of at the end of the season.

This whole subject is one of particular suggestive value to architects, and may serve as a point of departure for very efficient and expeditious work in the winter months.

## Todhunter Mantels

In the large reception room or the many other places where wall space is not at a premium, a mantelpiece will lend more of dignity, stateliness and atmosphere, perhaps, than any other one feature of design.

Many beautifully executed reproductions of Colonial and early English mantels, together with appropriate fireplace accessories, have been created by Arthur Todhunter, craftsman, who maintains showrooms at 101 Park Avenue, New York. These mantels are made in both wood and marble, with consummate care and artistic ability.

Among the numerous illustrations submitted in the unusually attractive literature which Mr. Todhunter has prepared for circulation, replicas are presented which one feels instinctively to correspond exactly with their 18th century prototypes.



## THE AMERICAN ARCHITECT

One commendable reproduction is that of a Jacobean oak panelled room whose mantelpiece, ornamented with rich carving and inlaid panels, is of exceptional interest.

Reproductions of old English and Colonial wrought-iron work, fireplace furnishings, and distinctive metal work of the most varied and attractive kind are another feature of this man's activity. Architects are invited to watch his blacksmiths at their forges at 326 East Thirty-eighth Street, New York, where these things first are made.

Mr. Todhunter appears to be fully equipped to render service of the desired character. He maintains a London office constantly co-operating in revealing rare pieces and getting them over here, where skilled artisans may reproduce them. There is also a drafting department to co-operate with the architect who desires to avail himself of this opportunity.

### An Expansion Joint

For construction work where it is necessary to provide for expansion of materials, The Philip Carey Co., Lockland, Cincinnati, Ohio, have placed on the market what they call the Elastite Expansion Joint. This consists of a heavy body of special asphalt compound sandwiched between two layers of a high grade of asphalt-saturated wool felt, the whole being firmly bonded together by an improved process. This results in several special advantages. It insures full depth of joints. The compound is evenly distributed from top to bottom and from end to end of the joint, so its uniform thickness as well as its high melting point make it respond readily to expansion without damage. It requires no investment for equipment. The expenditure is for the joint itself. It is easy to place, and therefore reduces labor cost. No waste occurs in application.

The makers claim Elastite does away with all danger of imperfect joints and prevents a faulty job either from carelessness of installation or other causes. The Philip Carey Co. manufactures a large variety of important building materials. They may be addressed for further information on Elastite at branches in the chief cities in America.

### The Science of Illumination

Most people really know very little about good light. Illumination is a science, and as yet we have not been educated to understand this fact and act upon it.

This important matter of illumination has been left to manufacturers of chandeliers—successors to gas fixture makers—who depend upon design of fixtures instead of quality of light. They have largely failed to keep pace with the development of the lighting unit from gas and the first carbon filament electric lamps to the modern incandescent lighting unit of a thousand times the brilliancy.

The two standards by which the average person judges lighting are brilliancy of illumination or beauty of fixtures. These two false standards are the basis of the condition which now confronts us—the alarming increase in the wearing of glasses and the prevalence of headaches, 60 per cent of which specialists say are due to poor light. *There* is the big cause—wrong illumination. When people know that the only real standard for judging light is its effect upon the eyes, then we will have *right illumination*. When they understand that the eye is an exceedingly delicate organ, that its nerves are so sensitive that even a small amount of excessive light will injure them or a few hours of work under inadequate light do great damage, all illumination will be based primarily upon the eye and its needs.—*National X-Ray Reflector Co., 235 West Jackson Boulevard.*





1-68 4/20

# The AMERICAN ARCHITECT



INTERIOR OF THE CAMPO SANTO, PISA, ITALY

PUBLISHED WEDNESDAYS IN NEW YORK—FOUNDED 1876  
VOLUME CXV      FEBRUARY 26, 1919      NUMBER 2253

Entered as second class matter January 6, 1909, at the Post Office at New York, N. Y., under the Act of March 3, 1879. Publication office, 243 West Thirty-ninth Street, New York, N. Y. Subscription price in the United States and Possessions, \$10.

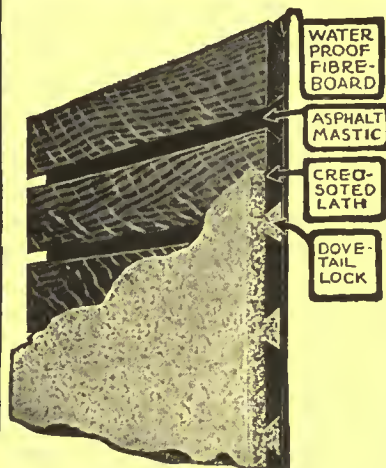

**MORE THAN 2000  
ARCHITECTS AND BUILDERS  
NOW SPECIFY IT**

**A**MONG them are nationally known firms who do not compromise on doubtful construction; state architects; architects of schools, churches, clubs, public buildings, fine residences and popularly-priced homes.

The use of Bishopric Board for Stucco construction has increased 1000 per cent in six years. For these reasons: Wherever the right Stucco mixture has been applied to a Bishopric background the walls have remained rigidly intact—crackless, unsagging; there has been no rusting—no pulling away from the supports—because first, there is nothing in Bishopric Board to disintegrate; and second, it is nailed securely to studding or sheathing; it provides effective insulation; deadens sound; and often the saving it makes possible solves an economic problem for Architect and Builder.

**FOR  
EXTERIORS**

THE DOVETAILED KEY  
"LOCKS THE PLASTER"  
**BISHOPRIC  
STUCCO AND PLASTER  
BOARD**  
TRADE-MARK REGISTERED

**FOR  
INTERIORS**

The "lock-in-the-plaster" principle has made good in a big way. Architects have seen it hold Stucco with a bulldog grip through severe winter and hot summer. They have watched Bishopric Board stand all winter and be in perfect condition for Spring Stuccoing.

Stucco clings vise-tight to the dovetailed, heavy-wood strips which are creosoted against swelling, shrinking, warping, and weather change. These strips are imbedded, under terrific pressure, in a layer of tough Asphalt Mastic—a wonderful preservative and moisture-proof and fire-resisting. The heavy fibreboard backing is weather-proofed against heat and cold and it retards sound. Nailed as a unit to the building with joints broken every four feet for added rigidity, with the proper mixture of stucco applied to Bishopric Board how can the walls crack or crumble or the building be anything but comfortable, well-insulated, and sound free?

For interior use in place of ordinary lath, Bishopric Board makes sound-retarding walls, ceilings, and partitions, and saves plaster, time, and labor.

Bishopric Sheathing saves about 40 per cent as compared with  $\frac{7}{8}$ -inch wood sheathing. Makes a compact, damp-proof, sound-proof wall. No joints or knot holes. Ask about it.

Note the absolute rigidity of construction of this 3-family apartment house in Utica, N. Y., built for John J. Doyle. This building stood through the winter before being stuccoed. Bishopric Board was nailed direct to studding, no wood sheathing being used. Bishopric Board was also used on interior.

All Architects and Builders should have our book, "Built on the Wisdom of the Ages." It describes and details the use of Bishopric Board; illustrates homes and institutions on which it has been used; tells how to get perfect Stucco work. It contains reports of scientific tests and letters from engineers, architects, builders and home owners. Get it—and samples of Bishopric Board and Bishopric Sheathing.

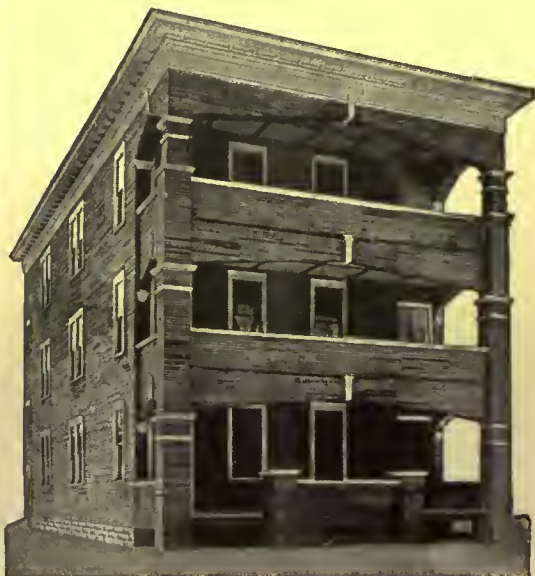

**The Bishopric Manufacturing Company**  
904-Este Avenue, CINCINNATI, OHIO

210





CITADEL OF PISA, ITALY

# THE AMERICAN ARCHITECT

VOL. CXV

WEDNESDAY, FEBRUARY 26, 1919

NUMBER 2253

## Does the Architect Function as He Should?

A Resume of the Program of the Post-War Committee on Architectural Practice of The American Institute of Architects

By ROBERT D. KOHN

[The preliminary draft of the program of the Post-War Committee, as quoted, summarized and discussed in this article by Mr. Kohn, was published in the January number of the *Journal* of the American Institute of Architects. Inasmuch, however, as the Post-War Committee is seeking the co-operation of the entire profession, including a majority who are not affiliated with the Institute, THE AMERICAN ARCHITECT is pleased to give the project the fullest publicity.—THE EDITORS.]

THE leaders in every trade and profession, the thinking men in education, in the law, in engineering and architecture, in the trade unions and in all the manifold industries of the country are giving consideration to the changes that will certainly take place in those industries and professions by reason of the war. There are, to be sure, a great many people who think that the United States is not to be materially affected nor radically changed as are the countries of Europe. Whether this be so or not, even if the direct effect of the war produces no marked changes here, it is certain that eventually the reflex of changed conditions in Europe is bound to require profound modifications in our industrial system. In addition to this, we are moving through a time of searching inquiry into the relation between industry and labor and between the various industries. It behooves the men in every vocation, therefore, not only to study the forces already rising to power before the war and more in evidence since the armistice, but also to inquire into the great question of their own relationship to others while there is still time to avoid even greater evils than those of the existing order of affairs.

It is interesting to note that the new spirit of the time has affected even the conservative religious leaders of the world. Mr. Ackerman recently illustrated this point at a meeting of Brooklyn architects by quoting from reports adopted by the Methodist Church of Canada at a general conference held at Hamilton (printed in full in the *New Republic* of February 8th). This he read in part as follows:

*"The war has made more clearly manifest the moral perils inherent in the system of production*

*for profits. Condemnation of special individuals seems often unjust and always futile. The system rather than the individual calls for change."*

\* \* \* \* \*

*"The triumph of democracy, the demand of the educated workers for human conditions of life, the deep condemnation this war has passed on the competitive struggle, the revelation of the superior efficiency of rational organization and co-operation, combine with the unfulfilled, the oft-forgotten but the undying ethics of Jesus, to demand nothing less than a transference of the whole economic life from a basis of competition and profits to one of co-operation and service."*

\* \* \* \* \*

*"We declare all special privilege, not based on useful service to the community, to be a violation of justice, which is the foundation of democracy."*

When a Church Association thus faces the questions of the day, is it not time that every profession inquire searchingly into its activities and relations to the public, taking nothing for granted, reviewing every one of its accepted standards? We cannot stand aside as if we were antiquarians always to live in the past. We must apply the test through our vocations.

The keynote of any such investigation must be the words "right relationship." As architects we should inquire whether or not we are in right relationship with the public—with those whom we would serve. Secondly, are we in right relationship with those with whom we would co-operate, with the other professions, the engineers, the craftsmen, the industries connected with building and the trade organizations; and thirdly, are we in right relation-



## THE AMERICAN ARCHITECT

ship to our fellow professionals and the younger architects who are studying to enter the profession?

Within a few weeks the newly organized Post War Committee on Architectural Practice will send out its preliminary program to every architect in the country, whether a member of an existing architectural organization or not. The committee is not a committee of the Institute. It was appointed by the directors of the Institute, but is expected to add to its membership from the profession at large, and has been directed to try to reach every architect of the country who is qualified to practice his profession. It hopes to get information from the individual and then to report back to the individual from time to time the results of its investigations, so that eventually the whole profession may be made aware of and may develop a guiding public opinion. We may in the end thus define the ways in which the profession should be advancing in order to achieve its highest purpose.

During the past few weeks messages have been received from all over the country indicating that the building fraternity generally considers the committee to have before it possibilities for the greatest good, and welcoming its appointment with enthusiasm. Already architectural organizations in a number of cities have held meetings to discuss the program.

What, then, is this program? In its details it will shortly be sent to many thousand members of the profession (others who are interested may secure copies on application). In general it starts with a declaration of purpose which the committee considers to be "to study and suggest improvements which will affect the conditions and increase the efficiency and adequacy of architectural practice throughout the United States. The desire is to make the study cover the whole country and to reach every qualified person practicing the profession of architecture, irrespective of whether or not that person be a member of one of the established professional organizations." It then goes on to say that "the experience of the war has bared the weakness of long established methods of performance until institutions of every kind, hitherto thought to be effective, have been found wanting. The conditions affecting the building arts at this time, therefore, not only suggest but demand that they be given the same searching analysis that is being given to every human activity."

After citing the three main divisions of the investigation which have already been referred to, the program proceeds to outline fourteen main topics on which the committee invites comment and suggestion. The point is clearly made that each of these subjects as stated is not intended to indicate an opinion held by the committee or to signify an

implied criticism of present methods. Persons interested in any branch of the building profession are urged to study the existing procedure with regard to each of these items and to express an opinion as to whether or not these are at present what they should be. The test of right relationship is to be applied to each. Is it what it should be? Should it be bettered? Can it be bettered? How are we to go about it? In considering each item (as far as humanly possible) self-interest is to be set aside, because of the conviction that eventually the best interest of the individual in any vocation will be attained through his rendering the greatest possible service to society as a whole through that vocation.

The subjects of investigation are to be presented under the three categories already referred to and will at the beginning include the following:

### I. THE RELATIONSHIP OF THE ARCHITECT TO THE PUBLIC

*a. Extension of the service that the architect may render:* All the professions have been criticized for having worked primarily in the interest of one class to the neglect of others; for the rich or moderately wealthy, and to a lesser degree, or not at all, for the poor. We know that a large majority of all building work is carried on without the services of a competent architect. It is one of our most important problems to discover where lies the responsibility for this condition; with the architect's training and practice, or with the public? Has the architect laid too much stress on the æsthetic and too little on the business value of his functions? Has he kept in touch with the new developments in industrial methods, the ever-growing demand for better human relations within industry, the new desire for better ways of living, each one of which justifies and requires an environment which will further its development? Is the cost of the architect's service so great as to make it generally unavailable for the solution of such problems? Does the public consider the architects' service as a luxury mainly reserved for the wealthy? Granting that it is essential to attempt to secure a solution of every building problem that shall be æsthetically satisfactory, should not the architect none the less urge the importance of his knowledge of wise economy, adequate and practical planning, safety, and the most advanced building methods? Assuming that the profession as a whole will have acquired the knowledge that justifies these claims, what educational work can it undertake to make the public generally aware of them?

*b. Responsibility of the Architect:* A large proportion of building is carried on with borrowed funds. A reliable estimate of the cost of the com-



## THE AMERICAN ARCHITECT

pleted structure is necessary as a prerequisite in arranging any scheme for financing its cost. Individuals are entitled to know in advance, approximately, what obligations they are entering into. Too many architects have been slow in realizing how vital is a reliable preliminary estimate to the success of a building undertaking.

An architect's estimate, even though correct, carries with it no financial guarantee that protects the owners or lenders in the amount of money they may be called upon to spend. The architect's status as agent of the owner imposes upon the owner full financial responsibility for all errors of judgment or defects growing out of lack of experience or ability on the part of the architect, except in such remote cases where it can be proved that the architect had failed to exercise due diligence and care. The architect's status is said to be not clearly enough professional, in the lay mind, to make apparent the reasonableness of this relation.

How shall the architect supplement his work, if at all, so as to overcome these apparent deficiencies? Is it true that there is inherent danger in a financial guarantee given by a person or firm engaged to render both professional and commercial service, that in the performance of this service their judgment may be prejudiced as to the quality of workmanship and materials entering into the construction of a building by the possibility of a financial loss under their guarantee? Is there any other way out of the difficulty? As the English system of Quantity Surveys seems to afford an economical basis for estimates, would its general adoption help in the solution of this problem?

*c. The Architect as a Citizen:* The architect, it is said, does not understand or sympathize with the viewpoint of business, nor does business understand the professional ideals of the architect. The architect does not take sufficient interest in business, political, or civic organizations. His ability, through his peculiar training and experience, to render service in these fields is little understood. Other more aggressive interests are therefore more closely identified in the public mind with the building world. While the architect may render an excellent service to an individual client, is it not true that he has failed signally to render the equally necessary service for which his training has fitted him to the community in which he lives? Is there not conspicuous evidence of this in the formation of organizations which deal with matters lying well within the domain of architecture and yet which are promoted and financed by laymen? Architects have looked on these various usurpations of their functions without protest, with the result that they are quite generally excluded from participation in many plans for improvement and amelioration of living and other con-

ditions. What are the particular functions of government in which the architect can be of special service by reason of his technical knowledge? How can he make the public realize the importance of his aid in these particulars?

*d. Percentage Remuneration:* It is commonly said that the theory of charging for professional service on the basis of a percentage on the cost is unsound. While the cost of two buildings may be the same, the cost of rendering the architectural service for the two buildings would never be the same. A given percentage in one case might be too low and in another too high; further, the public cannot disabuse its mind of the notion that where a man's remuneration is based upon a percentage of cost, there will be a tendency, if not actually, to attempt to increase the cost, at least to refrain from making an effort to reduce it. Has the present practice a marked influence on the extent to which the architect's service is used? Are the substitutes satisfactory that have been suggested and are actually, to a certain extent, in practice (the cost plus fee system)? Is there any other practical suggestion?

*e. Supervision of Construction:* Architects are said to devote themselves too exclusively to the study and preparation of drawings, specifications, and contract documents, and to entrust the supervision of the works too largely to salaried employees. The owner's active interest is in the actual construction, not in the drawing. In watching the progress of the work he is thrown into closer contact with the contractor and the salaried employee, with the result that the value of the architect's service in connection with the actual construction seems unimportant to him. As the busy architect is already very heavily burdened, is there any practical solution of this difficulty? Would his position be better and his services more adequate if those to whom supervision of construction is entrusted were his associates or partners, rather than employees?

*f. The Status of the Architect; art, profession or business?* To the vast majority of people the construction of a building is distinctly a business undertaking, and the men they associate with the building business are the ones they have learned to identify with the actual operation. The public—including its governmental officials—does not associate the architect with the actual operation of building construction with the same understanding they give to engineering and construction companies. The elements of conception, study, and design are regarded as intangible and secondary things and are considered only in this light—if considered at all. Yet the architect is unwilling to diminish in any degree that part of his professional effort which makes for the æsthetic ideal. Need it

## THE AMERICAN ARCHITECT

be diminished in order to develop the business side of the profession? If he develops along the line of making his work of greater social service, will he not find the right ratio between art and efficiency?

*g. Advertising:* Without going into the controversial question of whether advertising of a certain kind is or is not proper for professional men, or dwelling on its potential abuses or advantages, the fact seems undeniable that of all the agencies interested in a building project, the architect's function is the least understood by the lay public.

Advertising seeks to accomplish a greater use or sale of any article or service. Such a result is attained in the business world by means of a liberal expenditure of money along recognized lines of publicity. The architect does not advertise. Between these two opposites, however, there must lie a fruitful field for study, to the end that architecture may be given a wider application and serve society in a fuller measure. It is a great pity that the architect has no way to make known to others who might need it the technical experience which he acquires in the execution of his work. Do we need to find some dignified form of publicity which would not be open to criticism as blatant and immodest? If the architect can help in so many ways to the solution of our social problem, is there a better way to make it known?

### II. THE ARCHITECT'S RELATIONSHIP TO THOSE WITH WHOM HE WOULD CO-OPERATE

*h. The Contractor's Function:* Great changes have taken place, in recent years, in the status of the contractor in relation to building enterprises. In important work the contractor now, generally, sells his services on a professional basis. His remuneration is understood to be for the use of his organization and its knowledge of the building business. This changes the relation of the architect to the whole building procedure.

Some of the contractors have been quick to realize changed conditions and the desire of modern business to deal with one organization equipped to handle all phases of a building problem. There are, to be sure, some so-called "general contractors" who do nothing but trade on a name, have no technical knowledge of building, and live on the skill and credit of their sub-contractors. But there are also general contractors and construction companies which are composed of able men and which employ able designers and do all work from the making of drawings and specifications to the financing, building and furnishing of the structure. As against such a system, the average architectural organization dwindles in impressiveness. The services of an

architect, where a really competent contractor is selected on the basis of "confidence," is not required in the same degree as in the older method, to watch the performance of the contractor or to safeguard the expenditures of the owner. Nor is he so frequently called upon to adjudicate disputes that may arise between the owner and the contractor over interpretations of the contract obligations. On the other hand, with incompetent so-called general contractors who sub-let everything and know nothing of building, the work and responsibility of the architect is greatly increased.

While the architect has been criticized for not giving reliable estimates backed by a responsible guarantee, the tendency in part of the contracting field is growing away from the giving of such guarantees by the contractor. The willingness of the public to accept unguaranteed estimates from a contractor while questioning the estimate from an architect, seems to indicate a far greater reliance is placed on the contractor's judgment as to the cost than in that of an architect. May it not be reasonable to assume that contractors, through their new conception, will do more to bring about an understanding of the professional viewpoint than architects have been able to do? Does this not also suggest a vital reason for establishing a closer co-operation and understanding between architects, consulting specialists, and contractors, and indicate a community of interest that has hitherto been unapparent?

Must not the architect encourage every valuable outside aid to efficiency and yet clarify his own function as an element in building production? Can the man who creates the design also be the director or manager of the whole procedure of building or shall he primarily be the designer?

*i. The Need for a More Comprehensive Service:* The modern tendency of business, accentuated by the experience of the war, is to deal with larger organizations with one responsible head rather than with the several contributing factors that go to make up an organization to produce a material result. It is said that the architect has done nothing to meet this demand, but that engineers have, to an extent, done so.

The war has brought the whole world face to face with a situation which demands that production be increased and that resources and facilities be developed to an extent far exceeding the pre-war volume. The architect is said to have done nothing to co-ordinate his work with the movement for efficiency in production. The experience of the Construction Division, the Emergency Fleet Housing Division, and the Housing Corporation have demonstrated the great advantage of intimate organized co-operation of all the factors in building



## THE AMERICAN ARCHITECT

production in meeting the exigencies of a war emergency.

Should there not be a closer co-operation between the engineers, the architects, and the construction men (the builders)? Should not all these qualities be integrated; should not all be present at each stage of the procedure? Does this point toward larger organizations in which men of varying qualifications co-operate figuratively as equals rather than the present plan whereby one man—the architect—employs others to work under his direction?

*j. Organized Industry:* The architect is said to have ignored or neglected his relationship to one great element of the building world: organized and unorganized labor. He is said to consider that skilled and unskilled labor is troublesome, unreliable and uninterested in good workmanship, in the advance of the art of building and in efficiency. Has the architect done anything to find out if there is another side to the question? Is the architect convinced that the average builder is so wise a guide to labor that no better condition of employment could be devised? Should not the architect as representative of the owner (the public) be a party to the agreements made between employers and employees in the building trades? Could he not co-operate in their relationship so as to place it on a higher plane, make it more human and tend toward better craftsmanship?

*k. Standardization of Building Products:* Although efforts have been made in the past toward standardization of building materials of minor importance, it is said that the high cost of building is due in a measure to the great variety and detail of materials demanded by architects' plans and specifications. Is this not a field for co-operation between "material men" and architects that offers a wide field of usefulness? This subject has been elsewhere discussed at length (in *THE AMERICAN ARCHITECT*) and need only be mentioned to suggest its potentialities of economy and efficiency.

### III. THE RELATION OF THE ARCHITECT TO HIS FELLOW ARCHITECTS AND THE MEN PREPARING FOR THE PRACTICE OF THE PROFESSION

*l. Architectural Societies:* Only a small percentage of all the practicing architects of the country are members of any professional organization. There must be a reason for this aside from the proverbial indifference of the human species to matters not patently connected with getting along in the world. Our professional organizations have been accused of devoting too much time to discussions on the art of architecture. They are said to have occupied their energies in the past in prescribing the exact terms upon which an architect may seek or accept employment and have not taken into account

sufficiently the kind and quality of service the public demands and is willing to pay for, or the terms upon which the public is willing to engage such service under the ever changing economic conditions that govern all business operations.

Without expressing any opinion as to the justice of these accusations, can we not consider anew what kinds of organizations are needed in order that through association and conference between architects the practice of architecture may be advanced and the extent and value of the service it may render to society thus be increased? Is the cost of membership in existing societies prohibitive? Do we need regional organizations of architects distinct from or as an adjunct to a national organization? Shall we have organization for so-called business and technical purposes only with no attempt to enforce an ethical code? It has been said that we should have an organization of architects for the sole purpose of bettering the financial standing of the architect. Is there any such demand?

*m. Competitions:* The architectural profession is possibly suffering the consequences of having encouraged, or at least officially countenanced, a questionable method of selection—the competition. The efforts made to regulate its conduct and minimize its pernicious effects are merely superficial remedies applied to a condition that is fundamentally unsound. The selection of an architect by the comparison of his usually hastily prepared and inadequately considered drawings with those of others in the same boat, without any of them having the benefit of personal consultation or co-operation with the interests that are to use the building when built, puts a premium on deceit and meretriciousness, and confirms the all too common belief that architects are primarily picture makers and neglect the considerations of good construction within or approaching the approximate cost, and the management of all the business details attendant upon such an undertaking.

As part of this question, the methods by which architects are employed need study. There seem to be three ways by which they may solicit a commission: By the competition, as above described; by the social method of utilizing friends and acquaintances; and by the direct business method of soliciting employment, by making sketches gratis. Then, too, the schedule of professional charges has been supposed to be mandatory, or has been used by architects to indicate a compulsory fee to which they are bound, thus setting up an anomalous condition whereby the public is led to believe that all architects possess equal ability because they are entitled to equal payment.

The younger men have said that only through competitions can they hope to get a chance at im-



## THE AMERICAN ARCHITECT

portant work. Even if this is true, is it a desirable way? Does it lead to progress? Could not a better way be found to achieve this and the purposes generally subserved by competitions?

*n. Education:* Our architectural schools, in emphasizing with more or less success, the important features of design, science, and culture, have apparently neglected to train the students in practical business methods or practical building knowledge, with the result that a large proportion of graduate architects are utterly unprepared to render skilled service. Thus it would seem to be true that many young men gain their experience at the expense of their first clients. There is a large question as to whether the practical application of scholastic training can be taught in schools or whether it must be gained by a system of apprenticeship or responsible association with more experienced architects.

What can be done to make our schools more responsive to the practical needs of the world in which we live? Have not architectural schools been woefully at fault in neglecting to instruct their students in their obligations as citizens qualified to render a great and needed service in every community? What can we do to bring this viewpoint to the fore?

There is also a great problem before us in the frequently discussed question of new forms of architectural design appropriate to the new ways of living, the new ways of industrial production, and the new social forces everywhere in evidence. Does not this problem require an entirely new kind of training for the young student and continuous study

on the part of the practising architect to keep in touch with reality?

\* \* \* \* \*

These, then, roughly stated, are the main items in the program of inquiry about to be issued by the committee. None of the paragraphs as printed are intended to state conclusions, nor indeed are any of the arguments advanced necessarily valid. They are merely outlined so as to provide a basis for helpful discussion. The committee will be glad to receive from anyone suggestions of topics to be added to the program, provided that these are pertinent to the purpose of the proposed investigation as outlined in the foreword. (Address Post-War Committee on Architectural Practice, the Octagon, Eighteenth Street and New York Avenue, N. W., Washington, D. C.).

\* \* \* \* \*

A speaker said at a recent meeting in New York that he considered the program of this committee to be the most promising sign of vitality and progressive spirit ever seen in the building world of America. The writer believes that this is true and believes also that the outcome of the inquiry will in the course of the next few years prove to be helpful not only to the members of the profession, but what is more important, make the architect's service more worth while to the community in which he lives. In order to approach this desirable end it is necessary, however, that architects generally recognize the importance of the move and participate whole-heartedly in this effort at enlightenment of their profession and the public.



# The Hotel Pennsylvania, New York

McKIM, MEAD & WHITE, Architects

*This Last Addition to a Chain of Hotels Operated by the Statler Company, is Not Only the Largest Hotel Structure in New York City, But is Also the Commanding Feature of the New Civic Center Created by the Pennsylvania Terminal, opposite, and United States Post Office Building on Eighth Avenue, of which McKim, Mead & White were also the architects.*

**T**HE problem confronting the designers of the new Hotel Pennsylvania in New York City was to produce the largest hotel building in the world in the greatest hotel city and in so doing to translate into concrete expression the ideals and

Streets. It has 22 floors from street level to roof, inclusive, and three levels in the pent house.

The entire area is covered with solid building for four stories above the street level to the approximate height of the Pennsylvania Station opposite.



SOUTH, OR THIRTY-SECOND STREET FRONT

enthusiasm of the great railway system as owner and the Statler Company as lessee and operator.

The building has been erected on a plot of ground 200 x 400 feet, bounded on the west by Seventh Avenue, on the north and south by 33d and 32d

This solid base is faced with Indiana limestone and treated with an order of Roman Ionic pilasters with lightly rusticated walls between, and a story of plain ashlar. This treatment relates the building in design and scale with the station. In the center of



## THE AMERICAN ARCHITECT

the Seventh Avenue façade is a portico of six Ionic columns marking the main entrance. The building line has been set back fifteen feet on Seventh Avenue to assist in the scheme of producing a plaza in front of the station.

These lower floors contain most of the public rooms. On the street level are the main lobby, office, dining room, tea room, men's café, bar, main serving pantry and shops of various kinds with entrances from street and hotel and also the customary

hair dresser shop and the maître d'hôtel's office. On the ballroom floor is a very complete and extensive entertaining area of great flexibility. This is divided into grand foyer and ballroom, two large parlors, banquet room and foyer, and three smaller dining rooms arranged en suite. All of the above have their necessary auxiliary spaces and in addition to having private elevator service from the ground floor are arranged for direct service from the large banquet kitchen. The arrangement permits of one



MAIN DINING ROOM

florist shop, telegraph office, public telephones and checking accommodations.

In a half story above the ground floor are housed the hotel executives' offices, baggage and parcel rooms, print shop and help's dining rooms. The baggage room is connected by a conveyor to the service driveway through the easterly end of the building, avoiding any reversal of direction of incoming or outgoing baggage.

On the mezzanine are the lounging and writing rooms and library and also a large exhibition space,

or two large or several smaller parties being accommodated at the same time. The second mezzanine, a part floor, and the entire second floor, are devoted to service bedrooms, storerooms, sewing and linen rooms, and the telephone exchange, which latter is the largest of its kind ever built.

Above this lower area the shape of the building has been dictated by the typical bedroom floor plan. After much study a plan of alternate wings with wide courts opening to the south was adopted. There are four bedroom wings each 54 feet wide









## THE AMERICAN ARCHITECT

The easterly 50 feet of the first floor area under the easterly court is occupied by two parallel drive-ways, a service drive for the hotel with its loading platforms, elevators to workshops above and storage rooms and kitchen below, and conveyor to baggage storage on the mezzanine over; and at the extreme east a service drive for the Gimbel store with elevators and loading platform to care for the store deliveries which are now crowding the 33d Street pavements.

lobby. A well-lighted underground passage under the 33d Street sidewalk will lead past the hotel to the concourse connecting the Hudson & Manhattan Railway and the Broadway subway and to Sixth Avenue.

The sub-basement mezzanine, a part floor, contains shops and service dining rooms and locker rooms. The sub-basement houses the house and guest laundries and extensive refrigerating, pumping and filtering plants and the machine rooms. The



MAIN ENTRANCE LOBBY

There are three floor levels below the street. The basement contains main kitchen and auxiliaries, grill room, lunch room, barber shop and wash room. This floor has direct entrances from the platform of the 34th Street express station of the Seventh Avenue subway. At the 33d Street side of the hotel there is a wide passage under Seventh Avenue connecting directly with the Long Island Railroad station. At the 32d Street side is a similar passage for Pennsylvania Railroad passengers. The latter passage can also be reached by elevators from the hotel

electric power and steam service is supplied by the Pennsylvania Station Power House.

The ground floor has been designed with a view to meeting the problems of circulation presented by the throngs of people which the great metropolitan hotels are called upon to handle, and to produce effect of spaciousness in scale with the magnitude of the structure, which will not be disassociated from the simple dignity of form and harmony of color which the American people demand in their own homes. The classic architecture of Italy has been





# THE AMERICAN ARCHITECT

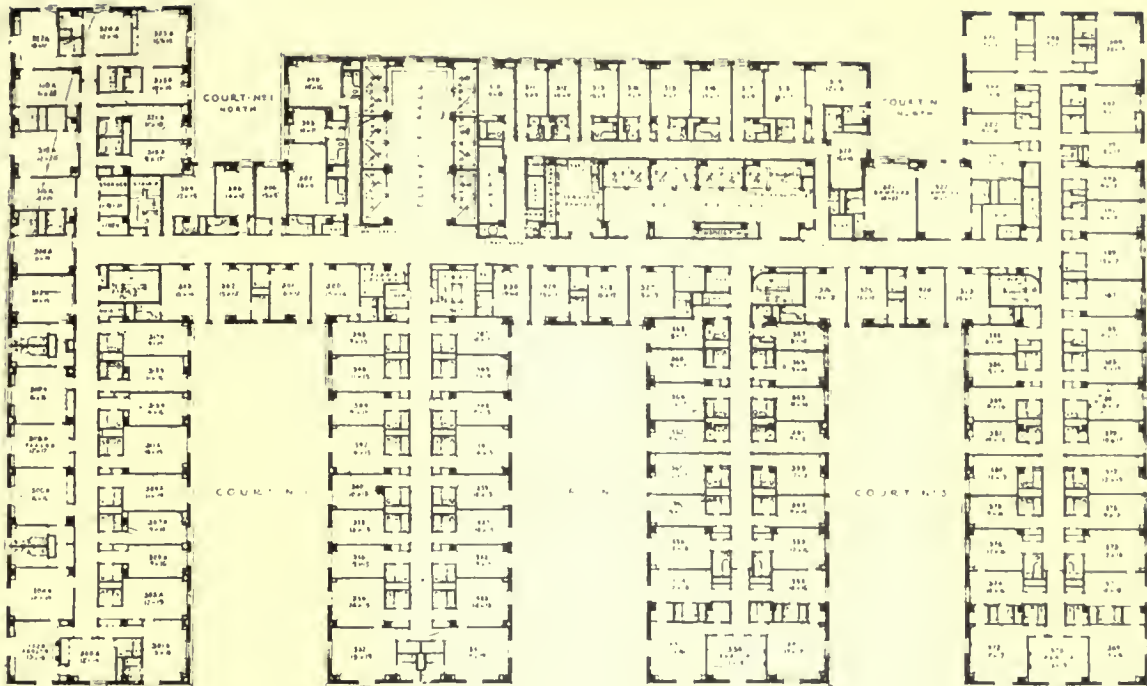

TYPICAL FLOOR PLAN

the inspiration for the decorative treatment for all the public rooms.

The architectural feature of the main lobby is a colonnade of Doric columns producing the effect of a great atrium in the Roman style. Above is a metal and translucent glass ceiling thirty-five feet from the floor, from which a glow of golden light descends. A mezzanine gallery forms a promenade

and lounging space entirely around the colonnade. On the ground floor there are two direct entrances each from 32d and 33d Streets to the lobby and a special entrance on the 33d Street side for the ballroom, with direct stair and elevators to the ballroom floor.

On the right of the main entrance, with a direct entrance from the street, is the men's café. It is

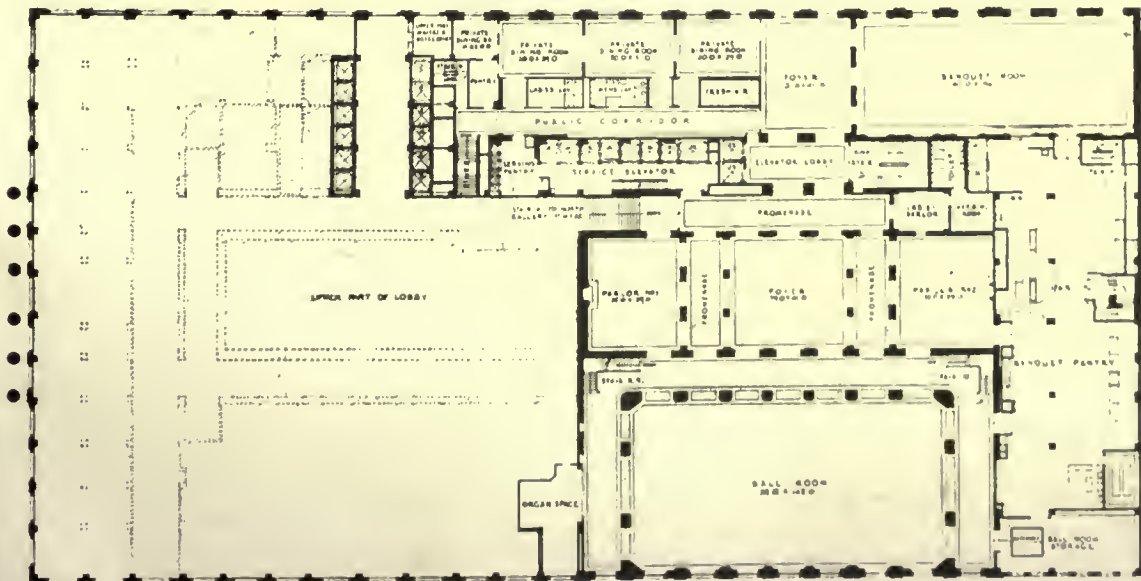

BALLROOM FLOOR PLAN

# THE AMERICAN ARCHITECT

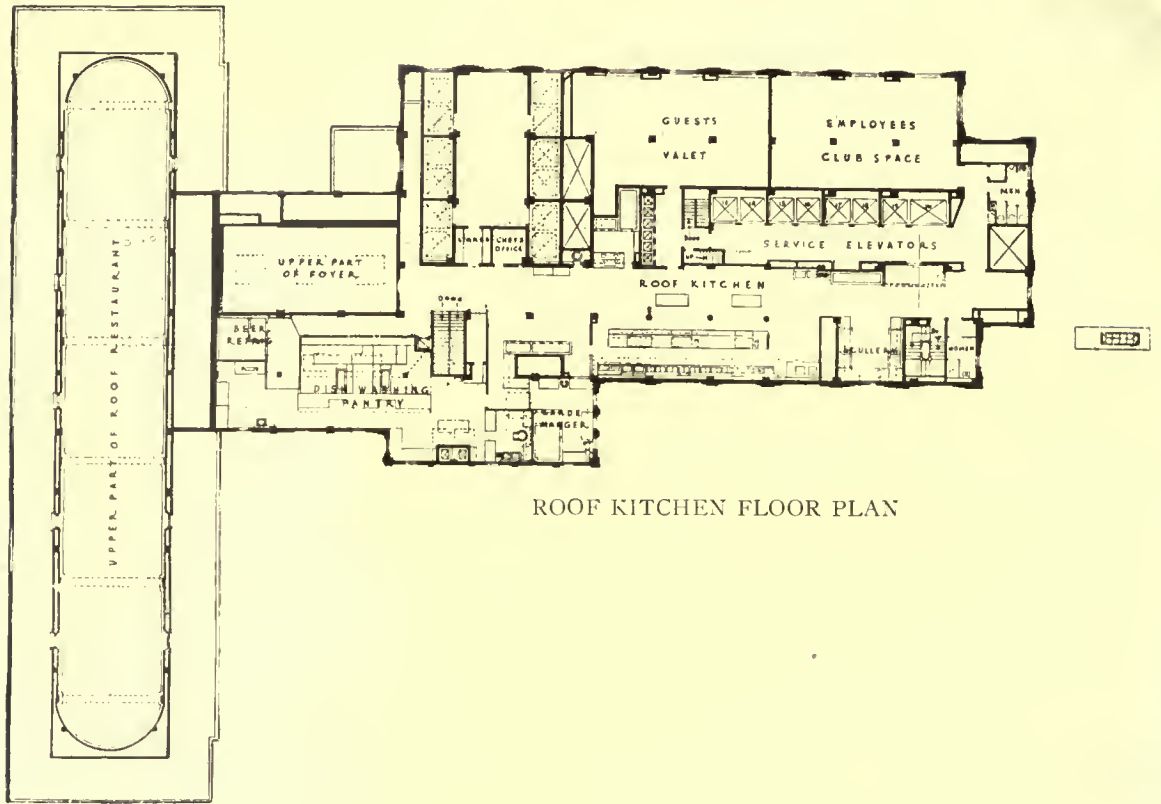

ROOF KITCHEN FLOOR PLAN

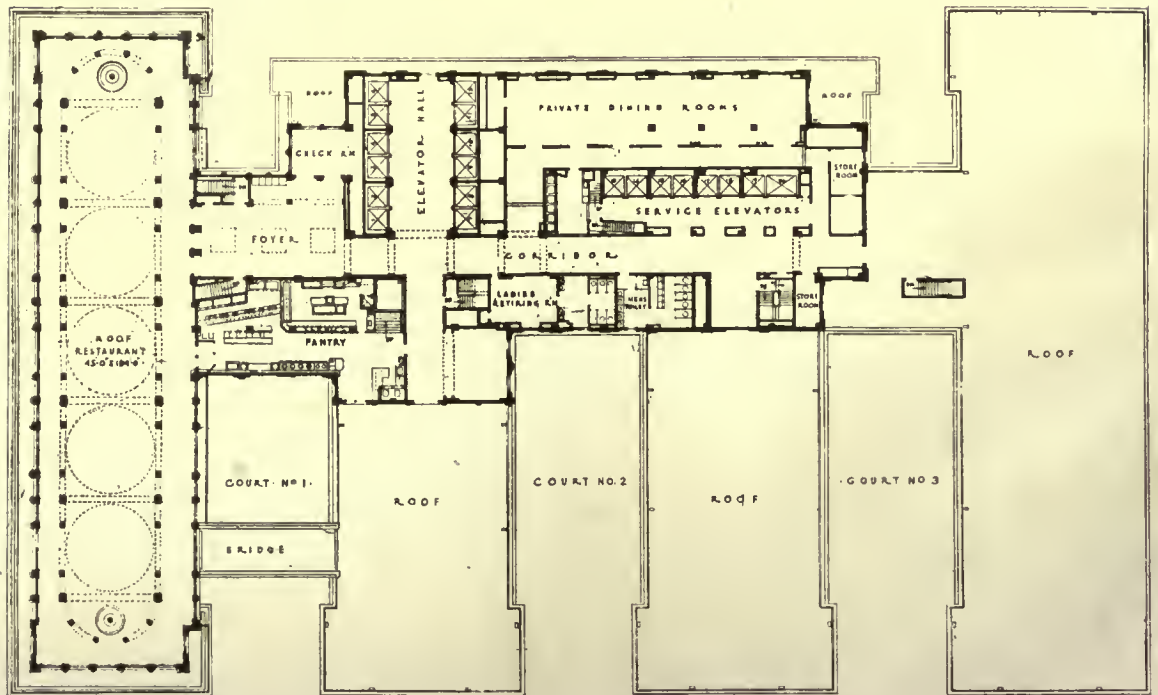

MAIN ROOF PLAN



## THE AMERICAN ARCHITECT

panelled to the ceiling in a natural finished chestnut. The floor is of imported quarry tiles. The lighting fixtures of pewter and brass are a development of the Georgian and Flemish chandeliers.

On the left of the main entrance is the bar. The stone walls, vaulted ceiling, leaded windows and mosaic tile floor give the atmosphere of Tuscany of the Early Renaissance or Quattrocento, where every hill town had its world-famous product of the fruitful vine.

opens the main restaurant. This vast room measures 60 x 140 feet and is over 20 feet in height. At each end is a terrace or dais raised above the floor level of the central portion so that those seated at the end tables may include the entire room in their field of vision. At the edge of each dais a light screen of four columns adds scale and architectural interest to the great space. The walls are of artificial limestone, with a base and window and door trims of terra cotta decorated with delicate Italian



GRILL ROOM

Opening from the east end of the main lobby is the tea room, the design of which suggests the Adam period of English decorative art, with a close relation to the Italian Renaissance rather than to the severer classic forms which the Scottish architects used as their inspiration. The walls present an alternate composition of arched openings with mural decorations in the tympanums and wall surfaces with magnificent mirror scones.

A promenade which forms an extension of the aisles of the main lobby colonnade makes a complete circuit of the tea room, from the south arm of which

arabesque ornament. The beamed ceiling is richly decorated in the style of the Italian and French ceilings of Renaissance times, yet with colors so soft and harmonious that they increase the apparent height of the ceiling in spite of its enormous span.

Opening from the south colonnade of the mezzanine level is the writing room, which in turn opens to the library. The latter room is a study in the English Jacobean period, panelled in oak to the ceiling. The centerpieces in the modeled plaster ceiling are representations of the old printers' marks of the sixteenth century, which were used by the

## THE AMERICAN ARCHITECT

first masters of the printers' craft in Italy, France, Flanders, Germany and England.

From the mezzanine gallery of the main lobby a short flight of steps leads to the ballroom floor. A grand foyer, with its aisles and parlors on either side, opens into the ballroom. These rooms are carried out in the spirit of the Italian Renaissance as it is typified in the palaces of the sixteenth century.

The ballroom itself, on the south side of the building directly over the main dining room, is some 12 feet wider than the latter, and has a ceiling height of 30 feet. The gallery of boxes extends around three sides of the room. The vaulted ceiling is delicately modeled with Italian arabesque ornament decorated in color on an ivory toned ground in a manner suggestive of the fresco decorations of Raphael and Giovanni da Udine in the Vatican and the Villa Madama in Rome. Two great crystal and silk chandeliers are the main illuminating features.

The banquet room, on the north side of the same floor, is panelled in white oak to the ceiling, while its foyer—like the grand foyer—has walls of artificial stone.

The private dining rooms, which can be used singly or en suite, suggest in their decorative treatment the styles of the early Georgian period in England, which borrowed its motifs from the Palladian architecture of Italy.

The roof restaurant occupies the entire roof of the Seventh Avenue wing. From its many windows and from the open promenade outside, over the main cornice of the building, an uninterrupted view is possible of the entire city and its environs. The harbor and North River are in view from the Narrows to Hastings. This room has been designed on simple architectural lines conveying an impression of lightness and openness. A vaulted plaster ceiling is supported by a colonnade, forming a great central hall with aisles. The walls are of plaster above a tile wainscot, and the details are of the utmost simplicity with a view to forming a background for the changes in decorative scheme which will be made from season to season.

In the grill room in the basement the effect has been made to escape entirely from the dungeon-like quality of most below-grade rooms. The guest enters the grottoes and orangeries of an Italian villa garden, surrounded by warm and happy colors reminiscent of Mediterranean shores. The columns and wall arcades are executed in sgraffito, the etched plaster work of the Italian Renaissance, all of which has been executed in place by Italian artisans. The sgraffito is bound by terra cotta to structural lines and a base of the same material affords protection to the lower part of the wall. The tile floor has been made specially to harmonize in color with its surroundings.





## The Long Case ("Grandfather") Clock

An interesting article, contributed to a recent issue of *The Architect* of London, refers to certain interesting collections in England of long case clocks. This dignified and well proportioned detail of furnishing has, it is believed, never received the consideration in this country to which it is entitled as an extremely useful and decorative item of interior furnishing. Replicas of foreign examples have been made in this country, but at a cost that makes them available only to the well-to-do.

The "*veritable antique*," routed from years of quiet rest in New England houses, has found lodgment in the homes of those fortunate enough to "pick them up" at bargains. Copies of these old clocks, with modern movements, are sold at prices as high and often higher than English replicas.

It has seemed that among the details of built-in furniture the tall clock might with good decorative results be included. There is a certain sense of companionship in the slow swinging pendulum of the tall clock and also in its rich, deep-toned gong that strikes every half hour.

In a "short chat," as the article is called, on the long case clock, *The Architect* states:

The long case or grandfather succeeds the brass lantern or bird cage clock about 1670, and at the same time replaces a mechanical instrument of metal by a piece of furniture made principally from wood. The long clock, in consequence, obtains a predominance and importance not possessed by its smaller predecessor. It must be remembered that at this period instruments of timekeeping were rare, and confined to the upper classes almost exclusively. The bulk of the English nation arose with the sun and went to bed with the dusk. Appetite regulated the hours of meals. The portable timekeeper was the pocket watch or the lantern—the true "bracket-clock," as a bracket for its support and to allow of the fall of the weights or the swing of a long pendulum was a logical necessity.

It is easy to understand the popularity of the long case clock. It was an important and decorative piece of furniture; it required no defacing of walls by the fixing of a bracket; it could be placed in any position, and, above all, it was a novelty.

It is a curious point with regard to furniture (and the same is probably true of many other things) that new types are always logical and fitted for the purpose for which they were made. It is only in the later stages of development that the decorative begins to override the utilitarian. Thus the early Stuart oak chairs are nearly always ideal, sturdy and comfortable. The Restoration chair is lighter, but

still constructional. The type degenerates with the later Jacobean period into the flimsy and badly designed Flemish models, with front legs doweled into seat frames and back crestings attached to the outer uprights by wooden pins. New life is introduced during the first years of the eighteenth century, and the evolution begins again to culminate in the Chinese and Rococo absurdities of Chippendale. This rhythm may be noticed, at more or less definite intervals, up to the present day. The early cabinets fulfill the cabinet function—to hold things; the early tables are rigid and were made to support weights. An apparent contradiction of this rule is the sideboard, which, at first, has neither cupboards nor drawers, yet in the hands of the Heppelwhite and Sheraton schools becomes a repository for wine, napery, cutlery and glass. This contradiction is more apparent than real, however. The sideboard is, as its name implies, a side-table; it changes at a later date to a combination of cupboard and chest of drawers, the functions of neither of which properly belong to it.

The development of decorative type with concomitant loss of utility and purpose is very evident when we trace the rise and decline of the grandfather or long case clocks from about 1670 (the dawn of the type) to 1800 or later. The function of a clock is, primarily, to show the time, and to do this in the most legible fashion. For this reason, a clockmaker does not put his dial at the bottom of the case, but many of the later makers did things nearly as bad. Dials 8 feet in the air, minute and hour hands identical but for a trifling difference in length, hour numerals of insignificant size and a general blurred type of dial are all characteristics of many of the late long case clocks. With the work of the renowned makers, such as Tompion, Knibb, East, Gould, Gretton and Quare—to name only six from a host—it is a pleasure to note how everything is subordinated to the one function of a clock—to show the time—without deteriorating in any way from its decorative value; in fact, the latter is cleverly enhanced by the obvious purpose of each detail. The early long case clocks are never assertive, therefore as furnishing pieces they never disturb a harmonious decorative scheme. The cases, although good, are usually plain, thereby not detracting from the focus point of the clock itself, the dial, where fine workmanship and choice detail was expended. Above all, these early clocks are refined; there is no hint of the vulgarly ornate.

Clock collecting is a fascinating pursuit. Although, broadly, these long cases can be resolved into certain types, yet in points of detail nearly every fine example is in a class by itself. Within the last seven or eight years only have they appreciated to anything like their proper value. Con-



sidering their original cost—the early examples were only made for the very wealthy—and the time and care lavished on their manufacture, it is only bare justice that they should have come into their own, and that the most individual craft which Eng-

land has known, one which reflects the pride and skill of the craftsman in the greatest degree, should be treasured and conserved by its cultured collection in these days of commercialism and machine-made production.

## Recent Legal Decisions

### EXTRA WORK—WARRANTY AS TO WATER-TIGHT WALLS

The ultimate guide in determining whether or not there can be a recovery for the extra cost of doing work under a contract is the contract itself. It is always a question of the intention of the parties, and it is this fact which makes it difficult to reconcile some of the cases. No two contracts are exactly alike, and a difference in the language may make inapplicable a decision under some other contract. It may be said, however, that if there are positive representations in a contract as to the conditions or character of the work amounting substantially to a warranty, there may be a recovery based upon such representations; and this may be true even though the contractor was required to make investigations and satisfy himself upon these matters. On the other hand, the representations may be such that it was clearly the intention of the parties that the contractor should rely upon his own investigations and examinations, and in such cases he cannot recover upon the representations. There may be representations and still the contractor will be denied a recovery because his bid was a gross bid for the entire work. *Lentilbron v. City of New York*, 102 App. Div. 548, 92 N. Y. Supp. 897. A recovery may be had where the representations are fraudulent even though the contractor is required by the contract to make independent investigations; but by far the greater bulk of the cases upon this subject fall under the head of work or material furnished outside of the contract. A recovery may be had in this line of cases where the work was to be carried to bedrock, for instance, and the contractor was made to carry it below that point; where there was an erroneous direction of an engineer which required extra work; where there were unauthorized changes in plans which required extra work; and generally where the contractor was required to do work which did not come within the scope of that called for by the contract.

In an action to foreclose a mechanic's lien by a subcontractor for masonwork, the plaintiff claimed that he found hardpan in the excavation to be done

under the contract, and that it was represented that the soil was made up of earth and gravel, and that there was sufficient gravel in the excavation and on the premises for use in making concrete, which was not the case. The owner claimed that the foundation walls of the building were not made water-tight as required by the contract, because of which he was entitled to damages.

The specifications provided that good gravel would be found in the excavation or on the premises, but further provided that if sufficient gravel was not found the subcontractor should furnish equally good gravel. He was required by the contract to make a careful examination of the premises and to note existing conditions; and he had ample opportunity to do so. The contract was for a gross sum. It was held that he could not recover for extra cost in excavating hardpan or for gravel purchased in connection with the performance of the contract.

The owner's claim was disallowed because, though the contract provided the walls should be water-tight, the specifications provided how the walls should be built and how the waterproofing should be done, and the subcontractor was required to build them in that manner. If they proved not to be water-tight it was no fault of his. An owner under a building contract cannot recover damages for failure to produce a given result where he has specified the manner in which the work shall be done to accomplish that result.—*Kuhs v. Flower City Tissue Mills Co.*, 171 N. Y. Supp. 688.

### ARCHITECT'S APPROVAL OF MATERIALS.

ing contract required the contractor to remove from the premises, within 24 hours after receiving written notice from the architect, all materials condemned by him. This necessarily involved the use of materials which had the approval of the architect, and, when the words "approved brand of lime" were used, they necessarily meant approved by the architect, who had the power to condemn.—*Drummond v. Hughes (N. J.)* 104 Atl. 137.

## THE AMERICAN ARCHITECT

# THE AMERICAN ARCHITECT

Founded 1876

PUBLISHED EVERY WEDNESDAY BY

THE ARCHITECTURAL AND BUILDING  
PRESS, INC.

No. 243 West Thirty-ninth Street, New York

E. J. ROSENCRANS, PRESIDENT AND TREASURER  
WILLARD C. HOWE, VICE-PRESIDENT

WILLIAM H. CROCKER, Editor  
ARTHUR T. NORTH, Engineering Editor

Subscriptions in the United States and Possessions,  
Mexico and Cuba, TEN DOLLARS. Other Countries,  
TWELVE DOLLARS.

SINGLE COPIES (Regular Issue) 25 CENTS

CHICAGO OFFICE, Mallery Building  
PAGE A. ROBINSON, Western Manager  
ST. LOUIS OFFICE, Wright Building  
CLEVELAND OFFICE, Guardian Building  
SAN FRANCISCO OFFICE, 320 Market Street

Owned by United Publishers Corporation—H. M. Swetland, President;  
Charles G. Phillips, Vice-President; W. H. Taylor, Treasurer;  
A. C. Pearson, Secretary. Entered as second-class matter January  
6, 1909, at the Post Office at New York, New York, under the Act of  
March 3, 1879.

VOL. CXV FEBRUARY 26, 1919 No. 2253

### Conserving an Architectural Opportunity

THE new Hotel Pennsylvania, fully described and illustrated in this issue, presents an opportunity to direct attention to an example of a very well carried forward conservation of an architectural opportunity. The growth of important centers in New York, and in fact in most of our large cities, has been as a rule marked by an utter disregard of the architectural proprieties. In too many cases no serious effort has been made to harmonize the architecture of the various groups of buildings, and the result has been just as it may be everywhere seen, an architectural hodge-podge, a jumble of conflicting styles, and faulty skylines.

The Hotel Pennsylvania stands directly across Seventh Avenue from the Pennsylvania Railway Terminal. The rare artistic excellence of this terminal, if past methods had been pursued, would have been seriously menaced by the placing of a towering structure in such close proximity. The architects of the hotel, McKim, Mead & White, have by rare good judgment and a highly developed artistic perception, added to what will undoubtedly become one of the greatest, if not the greatest civic

center in New York, a building that so thoroughly supplements the dominating structure as to set an example, not only to those in New York, but in every large city, of the importance of a carefully studied development of large areas. It is fortunate that this has happened. There has been much ink spilled in directing attention to the haphazard architectural development of large areas. A concrete example, so excellently carried forward, will do more than anything else to influence future operations of this kind.

THE addition of the Hotel Pennsylvania and the Hotel Commodore to the already large number of hotels in New York, an addition that totals almost five thousand rooms, does not, as has been conclusively proven since these hotels opened their doors, solve completely the question of accommodation for New York's immensely large transient population. It relieves in a certain sense what was a very serious shortage of hotel accommodations, but observation discloses the fact that both of these hotels are daily compelled to turn away applicants for rooms and that a similar condition exists in every hotel in the city. New York's transient population has been estimated at more than five hundred thousand. Whatever the figures may be cannot be accurately determined, but the fact remains the city's transient population is so rapidly increasing that we have not built hotels fast enough adequately to provide for it.

### An Industrial Welfare Bill

SENATOR KENYON of Iowa has introduced a bill providing for the study of and a report to Congress on a plan that will enable every American worker to own his own home. This bill creates a commission of six members, which is directed to study existing methods in the United States of financing the building and buying of low-cost houses, and the effect of present methods on investing capital. The commission will also study the methods followed in other countries. The report is to be submitted to Congress by Jan. 1, 1920.

The idea is really an extension or application of the measures of the Farm Loan Act. This legislation should be approved. The passage of a well-prepared bill for the purposes set forth would materially aid the solution of a problem that lies at the roots of our national prosperity.

In the formation of the proposed commission the value of the service of architects should not be overlooked. In fact, many men in the profession who have been engaged in housing investigations by the Government are valuably equipped for



work of this character, and it is to be hoped that the American Institute of Architects and the various State Societies will use every effort to secure a place on this commission for a representative of the profession of architecture.

### Teaching History by Pictures

EVERY man in the A. E. F. in France who had opportunity to watch the work of the artists appointed by this Government to draw in black and white or paint in colors the vivid scenes of actual warfare became impressed with the value of work of this sort in teaching a history of the war. It may be some time before these drawings and pictures will be available for exhibition and reproduction. When they are they will supplement if not equal in value the well-written reports of many extraordinarily capable newspaper correspondents and equally capable men who have been detailed to the Military Intelligence Department.

When General Perry, a Civil War veteran, was recently appointed superintendent of the Indiana Soldiers' and Sailors' Monument, he set about the task of clearing away the mass of accumulated debris that encumbered the basement of the structure. It was discovered that this large space could be readily prepared and utilized for exhibition purposes. A collection of war pictures of early wars was already at hand, and when supplemented by those that will soon be available illustrating the recent war, there will be secured an exhibition of large historic value, and one whose educational possibilities are unlimited.

In this instance there is to be found a suggestion that might very well receive the close attention of all those who shall design and plan our future war memorials. Provision should be made for adequate space for well selected collections of war pictures. The interest in such an exhibition never palls, and as an aid to the visualization of just what war really is, there is no means yet found equally good.

### An Architect President of the Royal Academy

THE architectural press of England is elated over the election of Sir Aston Webb, a past-president of the Royal Institute of British Architects, and an architect of wide reputation, to the presidency of the Royal Academy. In expressing its satisfaction over this event, *The Building News*, of London, declares that it was "certainly high time that architects should receive some more emphatic recognition that our art is not merely one of, but the chiefest among, those included in the Academy's title."

All of which is absolutely true, and for such very good reasons architects in this country may unite with their brethren of England in a deep sense of satisfaction over the election of Sir Aston.

In our own National Academy there is shown to be a very decided need for some more energetic and representative action than is at present to be found. As there are many distinguished architects members of the National Academy, it might be pertinent to inquire if their selection for important executive positions in that body would not materially quicken what is at present a very inactive organization, and at the same time accord a proper recognition to architecture.

The general feeling in the English press is that Sir Aston Webb's selection for this important office was due to the fact that in addition to his commanding position as an architect, he combined executive and administrative abilities in a high degree and that the brilliant story of his past record bears witness to persistence in the face of difficulties that converts obstacles into stepping stones.

The lesson to be learned by all this is that in any profession success can only be achieved by the absolute demonstration of a positive ability, and that in art a man to forge ahead must be something more than a dreamer—he must be an active and aggressive element in every phase of his professional work.







PLATE 63

HOTEL PENNSYLVANIA, SEVENTH AVENUE, NEW YORK

McKIM, MEAD & WHITE, ARCHITECTS





MAIN ENTRANCE DETAIL

HOTEL PENNSYLVANIA, SEVENTH AVENUE, NEW YORK

McKIM, MEAD & WHITE, ARCHITECTS







PLATE 65

LOWER STORIES, THIRTY-SECOND STREET FACADE

HOTEL PENNSYLVANIA, SEVENTH AVENUE, NEW YORK

MCKIM, MEAD & WHITE, ARCHITECTS







PLATE 66

THE LOBBY

HOTEL PENNSYLVANIA, SEVENTH AVENUE, NEW YORK

MCKIM, MEAD & WHITE, ARCHITECTS







PLATE 67

MAIN DINING ROOM

HOTEL PENNSYLVANIA, SEVENTH AVENUE, NEW YORK

McKIM, MEAD & WHITE, ARCHITECTS







TEA ROOM

HOTEL PENNSYLVANIA, SEVENTH AVENUE, NEW YORK

MCKIM, MEAD & WHITE, ARCHITECTS





# Architectural Competitions

By THOMAS CRANE YOUNG

IF the architectural profession is ever to place itself on an equality with other established professions in standing and dignity before the public, it will be necessary to purge from itself some of its inherited practices and customs which serve no proper purpose in the conduct of the business of building under modern conditions. Probably the so-called Architectural Competition, whether of the illegitimate "wild cat" variety or as conducted by orthodox methods under the Code of the American Institute of Architects, has had greater effect in preventing a unity of effort in the professional ranks, and perhaps has done more to create an unfavorable public opinion than any other traditional custom.

It would seem quite ridiculous to request a dozen or so of lawyers to prepare a brief in a given case at law, or a like number of physicians to diagnose a disease and outline a course of treatment and then to submit the same for judgment to another practitioner, who might perhaps be no better qualified to decide on their respective merits than any of the contestants.

The actual cost of producing conventional competition drawings is very great and out of all proportion to their usefulness. The aggregate of expense in a single competition often reaches into tens of thousands of dollars and assumes enormous proportions when one considers the amount so spent annually by the entire profession. All this is pure waste for the many who lose and largely so for the few who win, as equally effective results might be obtained by less expensive methods. While in other professions and lines of business every effort is being made to eliminate unnecessary waste, architecture seems to be the only one which deliberately permits and encourages it.

The object of a competition, according to the Code, is the selection of an architect, not a plan. In theory each competitor is selected because of his proved ability to conduct the work should the choice fall on him. It should be unnecessary that the problem be worked out ten or twelve different ways in order to effect a final choice. It would save the futile effort of the unsuccessful and in view of the original selection, accomplish the purpose equally well were the final choice to be decided by lot.

Quite recently the practice has been defended by one high in the councils of the Institute as a regret-

table, though necessary, concession to the gamoting spirit inherent in the human race. His designation of the practice is unquestionably correct, though why a dignified professional body should find it necessary to condone this or any other vice is difficult to understand. In most straight gambling games the chances of gain or loss are supposed to be equal, but in the competition game, even of the most orthodox variety, this proportion is seldom reached. Let us take, for example, one in which ten contestants are selected, presumably of equal standing and ability, the chance of success can only be as one to ten, and with a larger number of competitors the proportion must be correspondingly decreased. Nor are the stakes inconsiderable, for even in the respectable "paid" competition the individual cash investment often runs into thousands of dollars. As a sporting proposition, it is about on a level with shooting loaded dice, and, of course, as a conservative business venture it can have no standing at all. The feuds and rivalries so frequently engendered by competitions can only spread demoralization among architects and the business world can have but little respect for a "profession" where employment in a serious task may be determined by the issue of a game of chance.

A more serious matter is the effect of this unfortunate custom upon the young, for in them it encourages the idea that sudden fame and fortune may easily be attained through a brilliant architectural *tour de force* or stroke of genius as a substitute for the slower processes involving continuous study and work, which is usually the price of success in other walks of life.

Our system of education may be somewhat at fault, the schools having (unconsciously, no doubt) fostered a false idea of the purpose for training and the ends to be attained thereby. They have, as it were, cultivated an elaborate and ornate handwriting with too little regard for the thought to be expressed. Neither has the atelier system borrowed from France been more successful in the improvement of American architecture because it encourages imitation of French forms without adaptation to American conditions. Thus architectural "rendering," so expensive and so useless, has become the goal of effort for the student architect instead of the physical substance of the completed building which is the architectural idea expressed through the refractory medium of steel and brick or stone.

These elaborate architectural drawings, often exhibiting wonderful workmanship, cost thousands of dollars but have no value as works of art, for they cannot be sold in any market for the price of a song. In contrast with this, the "artist" may take a dime's worth of paper and a pencil and, perhaps, produce a picture worth a substantial fortune. A better instance of misdirected energy than the former case presents could scarcely be devised.

Quite recently an eminent architect, in a public address, defended the Architectural Competition as a means of injecting a little excitement and zest into an otherwise hum-drum existence. One can scarcely think that any of the champions of the ancient Code who have yet spoken have been sincere or themselves shown a high degree of respect for their chosen calling or of the "high ideals" of which they prate so much.

# Financial and Commercial Digest

As Affecting the Practice of Architecture

## Amortization Committee is Named

The American Bankers' Association has announced that the following men have been appointed a committee on loans held by savings banks: James H. Manning, President of the National Savings Bank of Albany; Samuel H. Beach, President of the Rome Savings Bank, Rome, N. Y.; Edwin P. Maynard, President of the Brooklyn Trust Company; Russell S. Walker, President of the Dime Savings Bank of Brooklyn; C. H. Kelsey, President of the Bond and Mortgage Guarantee Company of New York, and Frederick H. Ecker, Treasurer of the Metropolitan Life Insurance Company.

## Steel Price Lowering Looked For

Producers are beginning to admit that the cutting of prices in the iron market is necessary to liven the interest of buyers and that the maintaining of prices at too high a level in past weeks has effectually discouraged trading, the *Iron Age* states. Summarizing the situation it continues:

"The low total of the present inflow of emergency orders points to shutdowns here and there in two or three months' time. In the activity of such happenings, a rewriting of costs would be possible. Whether the trade conferences proposed by the Secretary of Commerce could before then develop understandings looking to establishing prices likely to attract depends largely on securing official sanction and the broad co-operation of the manufacturers and the steel workers.

Meanwhile the buying elements need to remember that the country is proceeding on the theory that it is no longer an isolated nation. Fixed iron

and steel export prices of England, its chief competitor for the world's markets, are anywhere up to 40 per cent higher than its own, and only relatively slight shifts in ocean freight charges will serve to throw the advantage to these shores. Foreign trade requires little concession, so long as England's costs do not come down."

## Coal Production Decreases

According to the report of the United States Geological Survey a considerable decrease in the production of bituminous coal occurred during the last week in January, the output declining to the low level of 9,159,000 net tons. This production, which falls approximately three-quarters of a million net tons below the preceding week, and approximately 1,000,000 net tons below the corresponding week of last year, is at the rate of 475,000,000 net tons per annum, and is considerably below present consumption.

Many consumers are now using coal accumulated during last summer, and the present good weather enables certain consumers to await the outcome of the raising of the zone and price restrictions by the United States Fuel Administration before placing their orders. The daily production of bituminous coal during the past week, estimated at 1,526,000 net tons, is 19 per cent below the daily average for the coal year to date and 13 per cent behind the daily average for the same period of last year. The production of anthracite increased considerably during the week ending Jan. 25, and was slightly in excess of the average weekly production for the coal year to date.



## Place Responsibility for Safe Building Construction

At the fifth annual meeting of the Building Officials' Conference, just held at Pittsburgh, the chief topic of discussion was the placing of responsibility for safe building construction and a proper compliance with laws and ordinances. Agreement that effort should be made to place that responsibility took the form of a resolution, which follows:

"That it is the sense of the Building Officials' Conference that for the better protection of the public against unsafe and illegal building construction suitable legislation should be enacted by which building operations shall be restricted to architects, engineers, builders, superintendents of construction or others who have by proper evidence shown their ability or capacity for undertaking such building operations, and on whom individual responsibility for the safe prosecution of the work and a compliance with the laws relating to buildings can be placed.

"It was further resolved, that the secretary of this organization be directed to furnish, at the request of any member, copies of this resolution for presentation to legislative bodies in support of such legislation."

A joint session of the Conference and the National Brick Manufacturers' Association met in Pittsburgh at the same time. The topic of discussion was brick work, and centered about papers presented by W. W. Pearse, superintendent of buildings, Toronto, Canada, on certain tests of bricks and brick piers, and by Edward Stotz, architect, of Pittsburgh, on brick work. Other interesting features of the meeting were a fire test on a concrete column made at the Bureau of Standards.

The present officers of the Conference were continued for another year: Rudolph P. Miller, New York City, chairman; James G. Houghton, inspector of buildings, Minneapolis, Minn., vice-chairman; Fred W. Lumis, superintendent of buildings, Springfield, Mass., secretary; Walter R. Forbush, public buildings commissioner, Newton, Mass.; George Rendigs, commissioner of buildings, Cincinnati, Ohio, members of the executive committee.

## Atlantic City Architects Organize

The Society of Registered Architects of Atlantic City, N. J., has been organized for social and professional affiliation. Temporary officers have been elected as follows: William B. Riebenack, chairman, and Bertram Ireland, secretary.

## Great Britain's Fuel Problem

A memorandum supplemental to the general report made by the commission sent abroad by Harry A. Garfield, Federal Fuel Administrator, sets forth the British Government's fuel problem as presented by the war.

In the first year of the war 191,170 British miners enlisted in the army, and in June, 1918, the total had risen to 285,000. On the latter date the net loss of mine labor had been reduced to 133,000 men through extraordinary efforts to return soldiers to the mines, but this program was interrupted early in 1918 by the necessity of returning 75,000 miners to the battle lines.

Where the United States was able to increase its coal production, Great Britain suffered a loss of approximately 185,000,000 tons mined, using the 1913 production figures as a basis for computation.

The report of the commission also shows that Italy, whose population as a whole was without coal for heating and in large part without gas for cooking, for many months of the war period, was the worst sufferer from fuel shortage among the allied nations. Switzerland now faces a severe shortage, but Belgium, it was found, should be able immediately to produce more coal than needed for its own consumption.

## Good Roads and Merchandise Traffic

Among the many valuable lessons the war has taught is that our improved highways can be used to advantage for the transportation of merchandise by motor trucks, even for long distances.

During that period when our railroad lines were exclusively occupied in serving Government needs, it was demonstrated that freight communication could, in sections where the highways had been sufficiently improved, be economically maintained, and routes of service were set up that prevented what would otherwise have been real hardship.

Attention will not have to be directed to the necessity for a widespread good road movement in this country. Not good roads such as may be considered as fitting the ordinary motor pleasure traffic, but roads built to withstand the heaviest wear.

The traffic bureau of the Merchants' Association of New York has actively taken up this matter of motor routes for freight traffic, and it is proposed to start a movement that will bring into close relations both shippers and truck owners with a view to continuing a service that has demonstrated its efficiency.



# Current News

---

## Hotels Pennsylvania and Commodore Rentals Set New Mark

Hotel rents in New York rose to new heights in the leases affecting the Pennsylvania and Commodore hotels, reflecting graphically, says *Record and Guide*, the remarkable hotel development and expansion which has characterized the city's growth within recent years. Aside from the general interest which attaches to the opening of these two giant structures, as a result of their successful completion during war times, their architectural distinction and their concrete representation of the genius and enterprise of the American hotel business, special interest on the part of real estate men can be centered upon the huge rentals involved and the terms of the leases.

In the instances of both the Pennsylvania and Commodore, the exact rentals to be paid are not ascertainable because they depend upon the final cost of the completed structures. Both leases, however, call for the payment of large ground rentals.

The Pennsylvania Hotel lease, recorded last week, was made by the Pennsylvania Terminal Real Estate Company to Franklin J. Machette, who assigned it to the New York Hotel Statler Company. It runs for twenty-one years from thirty days after the completion of the building and calls for the payment of a ground rent of five per cent a year of \$4,000,000, which would be \$200,000 plus taxes and other charges. The lessee will pay in addition an annual rental of six per cent of the cost of construction of the building, less a deduction of \$250,000 the first year, \$175,000 the second year, and \$100,000 the third year; for each of the remaining eighteen years the lessee will pay \$200,000 a year ground rent and six per cent of the cost of the building plus one-eighteenth of the sum of \$525,000, this being the amount deducted from the rent as above.

Real estate men see in the lease clauses calling for rent payments based upon the cost of construction a reflection of the war-time building situation, when construction costs mounted almost daily and builders were liable to meet tremendous advances in material prices over night. As a result in a project of such magnitude, whenever the time of completion was uncertain and estimates of final building costs were impossible, it is not surprising that builders asked the lessees to share with them the risk of rising building costs; hence a rental based upon aggregate building cost rather than a fixed amount.

A similar arrangement was made in the case of the Hotel Commodore, where the lessee, the Bowman Hotel Corporation, will pay a ground rental of \$175,000 a year plus 91 per cent of the taxes plus six per cent per annum on the total cost of construction. There is an additional payment to be paid, consisting of two per cent more on the total cost of construction, according to the lease filed in the Register's office. The lease is for twenty-one years from June 1, 1916, with renewal privileges.

---

## Cut Out Parks' Dead Trees

The Park Department of the City of New York is doing a good work in the concentrating of all its forces on the removal of a large amount of dead wood which had accumulated in the parks during the last few years. Already 3,000 dead trees have been removed, but not until a very careful examination was made of each individual one to ascertain whether the tree was beyond saving. Some of the wood will be distributed with the consent of the mayor to poor people through the Fuel Committee of the Mayor's Committee on National Defense.

---

## New York's Hotel Resources Added to by 4,500 Rooms

Although a total of 4,500 rooms and as many baths have been added to New York City's hard-pressed hotel resources within the past month, adequate relief has not arrived to take care of the greatly increasing transient trade. It is still necessary in some instances for out-of-town guests to go to Brooklyn, Newark, and in some cases as far as Philadelphia, to get overnight accommodations. However, the Hotel Pennsylvania, just opened, which has 2200 rooms and 2200 baths, is the largest hotel in the world by 200 rooms and 200 baths. Second to it in size is the new Hotel Commodore, also just opened, which has a round 2000 rooms and an equal number of baths. The Hotel McAlpin has just opened its addition of 300 rooms, giving it a total of 1500 rooms.

There are twenty-seven floor levels from the lowest sub-basement to the top floor in the Hotel Pennsylvania. The hotel is set back several feet from the property line, increasing the width of Seventh Avenue until in this block it is slightly

wider than Fifth Avenue. This valuable real estate was sacrificed to give a larger setting of open space for the hotel and the station for the sake of the architectural effect. The first four floors of the hotel are built in a style to harmonize with the massiveness and dignity of the great railroad building. On these floors are the offices, lobbies, dining rooms, cafés, galleries, and most of the public rooms. Above these floors the structure is cut into by four deep courts, which give light and air to all the rooms.

### War Contract Adjustments Recommended

A statement given out by the Department of Labor showing the labor surplus in many industrial centers has increased rapidly in the last few weeks, urges that early action on legislation to adjust war contract controversies be taken. The cancellation of war contracts with no provision for an early financial adjustment of the investment in war machinery, materials and partly completed products, was blamed for plunging some concerns into a state bordering on stagnation.

The Department of Labor's investigation of ways and means to stimulate building and improvements and augment the absorption of labor industry disclosed these two important ways of getting results. The statement says:

"One—Legislation enabling the building and loan associations of the country to use their real estate mortgages for collateral in a system of federal home loan banks.

"Two—Legislation to authorize immediate adjustment and payment by the Government of reasonable claims growing out of the summary rescinding of war contracts.

"The former would permit home builders to avail themselves of almost two billion dollars in loans; the latter would provide much needed immediate capital for manufacturing."

### Restoring the Orchards of France

With thousands of square miles utterly denuded of trees, the war demanding every foot of lumber available for military purposes, France now faces a serious condition, with one quarter of her trees gone and many orchards non-existent. A survey has shown that only 925,270 fruit trees, located in 125 nurseries, are available. Consequently, it is proposed to establish a central nursery, where trees from other nurseries will be stored, at Noisy-le-Roi.

Prisoners of war will be employed, until the peace treaty is signed, for labor purposes, and it is estimated that one hundred men can plant 30,000 trees within three months at minimum cost. Germany in 1915 planted 20,000,000 fruit trees.

The French Government has already placed at the disposal of the minister of the liberated districts 300,000,000 francs, but this money will be used to purchase trees for devastated districts only. The planting of 2,000,000 trees will cost about eight million francs. The American Red Cross has not only given \$10,000 but has aided in the actual labor of reconstruction in devastated districts.

The Boston *Transcript* in an editorial captioned "Transplanting Our Forests to France," comments on the fine sentiment in the gift of 3,000,000 pine seedlings that Pennsylvania is to send to France as a contribution toward the restoration of the war riddled forests. It continues:

"Now that our forest regiments are to be withdrawn as rapidly as transport facilities will permit it will be the handsome thing for the United States to do what it can toward aiding in the repair of the damage that was permitted in its interest. There will still remain a million or more acres in northern France from which the axes and the guns of the enemy stripped the once thrifty forests and in the restoration of which Germany and her henchmen should be made to toil. What France really would be glad to have from this country in this reclamation work is not seedling trees, however good, but seed. This country has just now closed its own doors against foreign-grown nursery stock of all kinds in fear of the pestilences that the plants may carry. It would not be strange, therefore, if France felt a similar reluctance to accept our trees, not in retaliation for our prohibition but because of a justifiable dread of the possible consequences."

### Hospital Construction in the Future

Any consideration of hospital building projects must be based upon the new conditions that have followed in the wake of the war and not by comparison with buildings erected before the war. *Modern Hospital* traces how the expense of building hospitals is bound to be greater than in the past, as follows:

"Owing to the suppression by the Government of all private building during the war, a great amount of construction will be necessary, at practically any cost, as soon as the restrictions on building are removed, and this necessary construction will keep the cost of building high for many years. Investigations show that building to the value of over \$200,000,000 has been held up during the war in the cities of New York and Chicago alone. The total in the whole country reaches an enormous sum.

"The reconstruction work abroad will draw heavily upon our production of building materials and will further tend to keep prices high. It is thought by many well-informed authorities that



## THE AMERICAN ARCHITECT

these influences will remain for as much as ten years, and that a recession to pre-war prices may never be expected.

"No effort should be made to offset the higher costs by using cheap materials and finish, for a hospital, more than any other building, should be built well if for no other reason than to keep down the burden of maintenance charges, which will become larger and larger each year in a poorly constructed building. If a compromise is necessary, let it be in the size of the building rather than in its quality.

"In planning, constructing, and furnishing the hospital, do not emphasize too strongly all of the well-known 'sanitary' features, such as white woodwork, flush-panel doors, round corners, etc. Use these and all similar precautions where they count, as in the operating and other workrooms; but don't overdo it, and thereby eliminate all possible attractiveness from the patients' rooms and similar portions of the building. Someone has said that a hospital is a factory for making well people; that is not true. A hospital is, or should be, a home on a large scale, where the institutional atmosphere has been eliminated as far as possible. Surround your patients with things that are comfortable, attractive and beautiful, to the end that their thoughts may be directed away from their troubles. Risk the remote chance of a few lurking germs in pictures and books, and other things that are not smooth-faced, round-cornered and white, in order to gain the immense advantage of the greatly improved 'morale' which brings with it power of resistance to the progress of disease."

### Organization Aids Business and Technical Workers

For the first time in the history of America's development employers have an opportunity of selecting from a large and varied list of highly educated and experienced men those individuals especially equipped to meet their particular requirements. The professional and special section of the U. S. Employment Service, a branch of the Department of Labor, has been organized for the benefit of employers in need of engineers, executives, men of college training and practical experience in business and technical fields now being released from the Government service.

Two zone offices, one in New York and the central zone at Chicago, have been opened as clearing houses where returning men are classified in accordance with their qualifications and where the requisitions of employers are matched against them. So complete is the system of classification and so diverse the qualifications of the thousands of

applicants that the most exacting requirements of an employer, as stated in his requisition, can be met in each detail. When the qualifications of a man and the specifications for a position are accurately matched, the man and employer are immediately placed in touch with each other by the professional and special section.

### Art in Trades Shown in Museum Exhibition

An exhibition of unusual interest, the work of commercial firms or individuals who have found inspiration for their designs, colors, or decorations in objects from many parts of the museum, has been opened to the public at the Metropolitan Museum of Art. For many years the authorities have been endeavoring to prove that the wonderful collections on exhibit there were not only valuable for their aesthetic worth, for the high place that they held as objects of art, but that there was in them a practical value to meet the everyday needs of the people.

Visitors to the exhibition will see that it is conducted on a much larger scale than the two previous ones. Occupying two large galleries on the second floor, it is staged with all the care and skill given exhibitions of its own collections, and will astonish the public with its dignity, beauty and comprehensiveness.

The work of more than one hundred of the largest firms in the city and people working along the finest lines in art are represented, their efforts being classified under nineteen different heads. There are twenty-one exhibitors of furniture and seventeen of textiles. Other exhibitors come under the heads of decorative accessories, frames and mirrors, glass, gold and silversmiths' work, jewelry, laces, lamps, mantels, metal work, models, painted panels, photographs, pottery, rugs, mosaics, wall paper, and there is a large collection of designs and drawings.

Treasures of the museum which have been the inspiration for the finished products now shown are often strangely unrelated to them. The museum director tells how a twenty-century-old Athenian vessel suggested an effective shape for a modern cosmetic jar; a modern tapestry manufacturer found a design on an old Italian-painted picture frame; a design for a dress fabric was discovered in the armor collection; ecclesiastical vestments inspired a wall paper design, and old Chinese designs are reproduced charmingly on modern painted furniture.

The work is so entirely practical that the pieces



## THE AMERICAN ARCHITECT

shown were taken, many of them, from the show-rooms of shops, and some of them were already sold and were taken to the exhibition with the permission of the owner.

The museum has practical accessories for this laboratory work, study rooms where there are stored objects which may be of use to the workers or where may be taken objects from other parts of the museum for close observation. It has lantern slides and photograph and lending collections, and its docents and members of the staff are ready to give their assistance in bringing the designer and the museum collections into comfortable relationship. In addition, there is a field worker who knows a shop and workrooms as well as the museum, and whose business it is to introduce the workers to the museum and show them its possibilities. There has been a greatly increased demand upon the museum's resources by manufacturers and designers the last five months, and a large number of these for the first time saw and recognized the museum values as related to business.

---

### Historic Salt Lake Residence to Be Razed

Amelia Palace, pretentious residence built by Brigham Young for Amelia Folsom Young, reputed "favorite wife" of the pioneer Mormon leader, is to be razed and upon the lot it now occupies will be erected a modern structure. Announcement to this effect has been made by J. T. Keith, architect for the owner of the property.

Amelia Palace was known for years as "Gardo House." It is said one of the workmen was responsible for the name, it being due to an Italian mansion which had that name. The mansion was planned and building commenced by Brigham Young in 1876, and during 1877 a portion was completed and occupied by Mrs. Amelia Folsom Young. Amelia Palace has been one of the historic places pointed out to tourists who visited Salt Lake City. It is just across the street from the famous Beehive and Lion houses, and the Eagle Gate, notable relics of the days of Brigham Young.

---

### Easier Money Rates Noted in Federal Report

The Federal Reserve Board, in reviewing financial conditions for the past month, says as to public and private financing that in spite of the beginning of industrial demands at banks and the requirements of the last instalments of the Fourth Liberty loans,

there has been an increase of bank balances at financial centers.

"Easier rates for money," the review continues, "have accompanied this inward movement of funds, although the price paid for the longer term capital for industrial use has not been lowered, while rate for call loans and other prime commercial paper have fallen but slightly. The tendency, however, has been downward and may be taken as indicative of distinct recuperative power on the part of the financial community."

---

### Personals

The Dwight P. Robinson Co., Inc., constructing and consulting engineers, have opened offices at 61 Broadway, New York City.

The state architect of New Jersey, Frances H. Bent, has moved his office from the State House to 142 West State Street, Trenton, N. J.

George Awsumb, formerly practicing architecture at 189 W. Madison Street, Chicago, has moved his offices to 104 S. Michigan Avenue, where he will resume his work.

W. F. Brooks, architect, Hartford, Conn., announces that he has succeeded to the architectural practice of Davis & Brooks. He will continue the offices at Lewis and Gold Streets.

Following his return from military service Herbert A. Willcox has opened offices for the practice of architecture at 205 Commerce Building, Miami, Oklahoma. Mr. Willcox desires to receive manufacturers' samples and catalogs.

Announcement has been made of the incorporation of Rossel Edward Mitchell & Co., Ltd., architects, engineers and town planners, with main offices at 604-8 Paul-Gale-Greenwood Building, Norfolk, Va. The officers of the new company are Rossel Edward Mitchell, president; Gilbert Stanley Underwood, vice-president, and Bernard Stebbins Alves, manager.

The firm of Wallis & Goodwillie, architects, 56 West Forty-fifth Street, New York City, has been dissolved by mutual agreement and Frank E. Wallis, senior member of the firm, has taken his son, Richard P. Wallis, into partnership. The firm will be known as Frank E. Wallis & Son, architects and engineers, and will be located at the same address.

Richard P. Wallis is a graduate of Massachusetts Institute of Technology, class of 1912, and has been engaged in engineering work in Albany, Cleveland, Minneapolis and in the U. S. War Department, Construction Division.

# Late News from Architectural Fields

---

## Vote to Support Tenement House Bill

Whole-hearted support of a bill now before the New York State Legislature introduced by Senator Dodge relative to remodeling three and four-family tenement houses was voted at the regular monthly meeting of the New York Society of Architects held at the Engineering Societies Building, 29 West Thirty-ninth Street, New York, Tuesday evening, Feb. 17. A delegate was appointed to represent the society at Albany on the matter.

The Committee on City Departments having reported favorably on the appointment of a Board of Appeals against rulings of the Tenement House Department, the membership voted unanimously in favor of such proposed board. It was also decided that the society become a member of the National Housing Association.

The question of the best means to be adopted to bring about a revival of building construction was discussed, arguments alternating between an advocacy of governmental intervention and individual initiative.

In the absence of the president and vice-president of the society, John P. Leo, of the board of directors, occupied the chair. He reminded the meeting that this country owed its wealth and advancement to individual enterprise, and that to allow a system of governmental paternalism to supersede individual thrift and private enterprise would be disastrous for the future of the United States.

---

## Urge Award of Post Office Building Contracts

An effort to bring about the passage of legislation relative to the deficiency appropriation requested by the Treasury Department as necessary to permit the award of post office construction contracts is being made by the Indiana Limestone Quarrymen's Association. This organization at a meeting held last week telegraphed members of the Senate and House of Representatives the following resolution adopted at the meeting:

"At general membership meeting this association unanimously resolved that one of the most important pieces of legislation before the present Congress is the deficiency appropriation requested by the Treasury Department as necessary to permit award of post office construction contracts. These

new buildings were originally appropriated before the war period. Naturally today's conditions as to labor and other costs result in a range of bids exceeding the original appropriations. The Government urges that buildings be commenced everywhere in order to stabilize conditions, and Congress should make it possible for the authorities themselves to initiate this commendable movement. It is the one practical way of counteracting unrest and disturbance, while the price is cheap, considering everything that has been and is being done. We respectfully ask your whole-hearted effort to bring about passage of this deficiency legislation."

---

## Northeast Building Shortage 50 Per Cent

Revised statistics on the building deficiency, issued this week by United States Department of Labor through the Division of Public Works and Construction Developments, indicate a shortage in building in the North Atlantic States in the sum of \$538,430,000.

This estimate is based on a study of building permits issued in the larger cities prior to and during the war. The estimated building deficiency by states is as follows:

Maine, \$8,300,000; New Hampshire, \$7,870,000; Vermont, \$4,960,000; Massachusetts, \$153,000,000; Rhode Island, \$8,000,000; New York, \$236,000,000; New Jersey, \$27,500,000; Pennsylvania, \$92,800,000; total, \$538,430,000.

The building deficiency in these states during 1917 and 1918 is approximately 50 per cent of the average of 1915 and 1916, indicating that the district is one year behind normal development in building projects. This in addition to the normal current demand for 1920.

---

## Schilling Again Heads Michigan Architects

Edward A. Schilling of Detroit was re-elected president of the Michigan Society of Architects at the annual three days' convention of that body, just held at Lansing, Mich. A. E. Munger, Bay City, was named first vice-president; J. N. Churchill, Lansing, second vice-president; C. J. J. Barnes, Detroit, secretary, and Alvin E. Harley, Detroit, treasurer.



# Department of Architectural Engineering

## Swimming Pools for Public Schools

By C. E. DOBBIN

*Architect, Deputy Superintendent of School Buildings, New York City*

THE engineering problems of swimming-pool construction which a few years ago engaged the serious attention of architects, engineers and sanitary experts, may now be considered as having been solved. This does not imply that perfection has been attained, but the great number of well-constructed and excellently appointed pools scattered throughout the country are evidence of the fact that a high degree of proficiency has been reached.

Incidentally, there have been developed excellent plans of pools, together with their appurtenances—showers, dressing accommodations, toilet facilities, etc.—to meet the special needs of clubs, Turkish baths, Christian Associations and public baths.

But swimming as a part of the curriculum in public schools is of such recent origin that there seems to be no fixed, nor even commonly accepted, course of instruction for this activity. Instructors have usually been obliged to formulate their own methods, and those without previous experience in administering swimming pools have sometimes underestimated the magnitude of the problem in schools of considerable size.

The author believes that there is no justification for the existence of a pool in any public school unless the work is conducted with the degree of formality common in gymnasium work, and unless the instruction is sufficiently frequent to give it educational value. Desultory use of the pool, as in clubs, Turkish baths or associations, cannot be permitted. The various accessories must be so arranged that the squads into which the pupils must be divided as in gymnasium work can be conducted promptly through the various stages of undressing, body inspection, use of toilets, showers, swimming and dressing, without retracing steps or crossing other lines of travel.

In many instances pools are nearly completed before those in charge begin to consider how they are to be administered. In such cases it can hardly be

expected that the equipment will perfectly meet the requirements, however expert and faithful the architect.

Architectural planning, to be successful, must be predicated upon full and definite knowledge of the precise use for which the structure or feature is intended. Since this kind of knowledge regarding swimming pools is not yet available, no attempt can be made at this time to offer a full solution of the problem of swimming pool planning for schools.

The suggestions here presented are not therefore offered as standards applicable to all schools, but rather as a compilation of experiences and conclusions resulting from the planning of these facilities for large public schools in New York City, where intensive use is a matter of necessity. It is hoped that they will be of assistance to those who find themselves confronted with this problem for the first time, and also that they will direct the attention of school authorities to certain questions that must be considered and answered by them before any standards can be set up.

### GENERAL ARRANGEMENT

Before the architect can begin to plan intelligently he must have definite instructions on the following points:

1. Is the pool to be used by boys, by girls or by both at different times?

The entire plan will be determined largely by this consideration. For girls, bathing suits and separate bathing and dressing compartments are necessary, while for boys these are not required. Some authorities claim that privacy in these respects is not only unnecessary but undesirable for boys. One pool may be used alternately by both sexes if the needed accessories are available. There are two ways of accomplishing this double use of the pool:

(a) By having one set of showers, lockers and dressing compartments for alternate use by both, with separate toilets when possible.



(b) By placing the accessories for boys on one side or end of the pool and those for girls on the opposite side, with folding partitions, by means of which either set of accessories may be disconnected from the pool. With this arrangement one sex may use its showers or prepare for the pool while the other sex is using the pool.

2. Does the school program call for intensive and continuous use of the pool? If so, is a class of 40 or 50 to be handled as a unit or divided into two or more squads?

The size of the squad will determine the number of dressing stalls and showers required. If the school program requires rapid operation, there should be as many showers and dressing stalls as there are pupils in the squad and two or three times as many clothing lockers. If rapidity is not essential, one-half the number of each may be sufficient.

It seems to be the consensus of opinion that the squad shall number about twenty, and that the period of instruction shall be twenty minutes. On this basis a school numbering 1800 can be given instruction once a week with one pool, if it is kept in constant use.

For such use of the pool there must be in attendance at all times a swimming instructor and also an assistant to supervise the preliminaries and the expeditious movement of the squads. It is doubtful whether one such set of instructors can conduct this work continuously.

The showers, dressing quarters and pool must be in one open room, and so arranged that those in charge may observe all that is going on from any position.

Personal cleanliness is imperative before entering the water. Entrance to the pool space for pupils should therefore be only through the showers or past the shower stalls, and exit from the pool only to the dressing space. Baffle gates at entrance and exit prevent passage in the wrong direction.

3. Are pupils of all grades to use the pool, or only those in the higher grades?

Water depths must be regulated accordingly, and

also the area of shallow water if the pool is intended for very small children.

There seems to be a difference of opinion as to the value of swimming instruction for pupils in the lowest grades. This is worthy of careful considera-

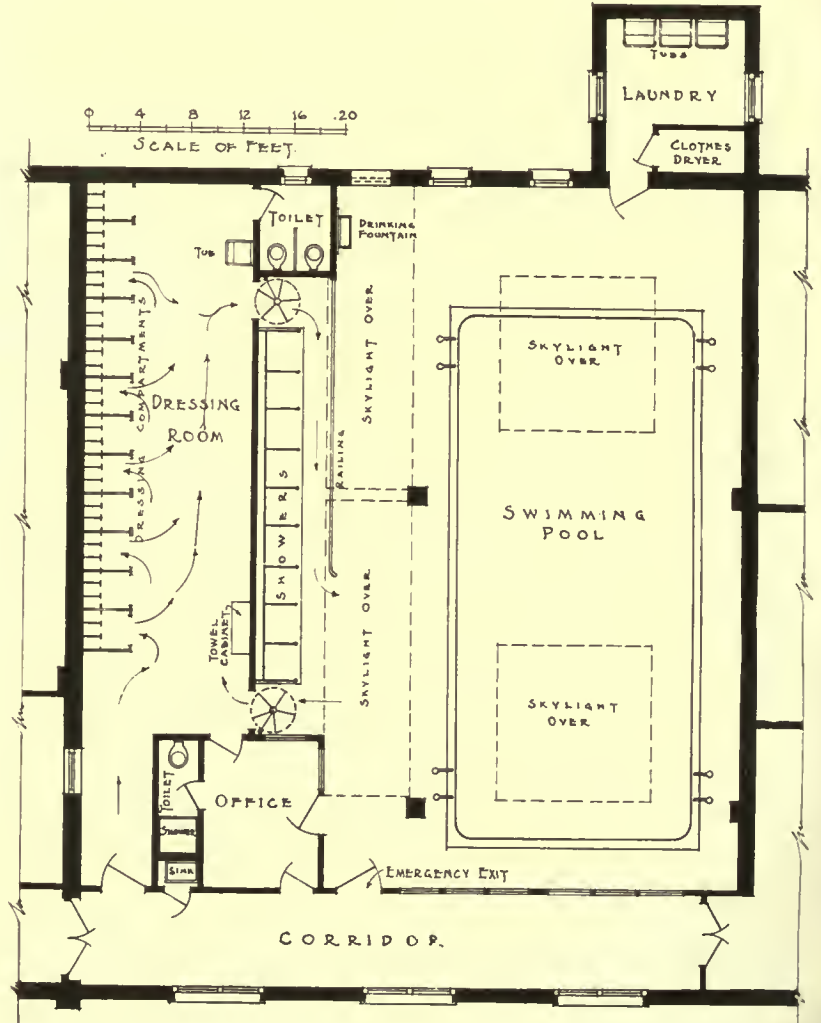

Fig. 1. Natatorium in Public School No. 32, The Bronx. Owing to lack of space only one small pool was possible. The arrangement, however, is such as to facilitate the rapid handling of squads. Note the lines of travel, also the excellent natural lighting by means of skylights. Each dressing stall contains three steel clothing lockers, which permits one squad to dress or undress, while another squad is using the showers, and a third squad is in the pool.

tion, for the problem is greatly simplified if the use of the pool is limited to the older pupils.

4. What provision is to be made for furnishing and laundering towels, and how are the bathing suits for girls to be cleaned, dried and stored?

If the program calls for intensive work it seems almost imperative that these articles be furnished and cared for by the school, as pupils cannot give them the necessary attention. For this there will

## THE AMERICAN ARCHITECT

be needed a small laundry equipped with tubs and a steam dryer. There must also be suitable receptacles, placed at the proper points, for collecting and dispensing the towels and suits.

### CONSTRUCTION

It is scarcely necessary to emphasize the importance of sanitary construction throughout, but it is equally essential that the whole effect be spotless and pleasing. Nothing is more distasteful than the thought of entering a bath that shows any lack of cleanliness, and particularly one that is used by great numbers. This must be kept in mind in the

be of sufficient thickness, so that the total weight, exclusive of the water to be contained in the pool, be not less than the weight of the water displaced. Otherwise, with a high ground water level, the emptying of the pool may cause the floor to be forced up or the entire structure to be lifted from its bed. Such problems require special study by experts.

The following construction has been found both economical and satisfactory:

*Outer Shell.*—Concrete with reinforcing bars of steel properly designed and placed is by far the best method of construction, insuring as it does a

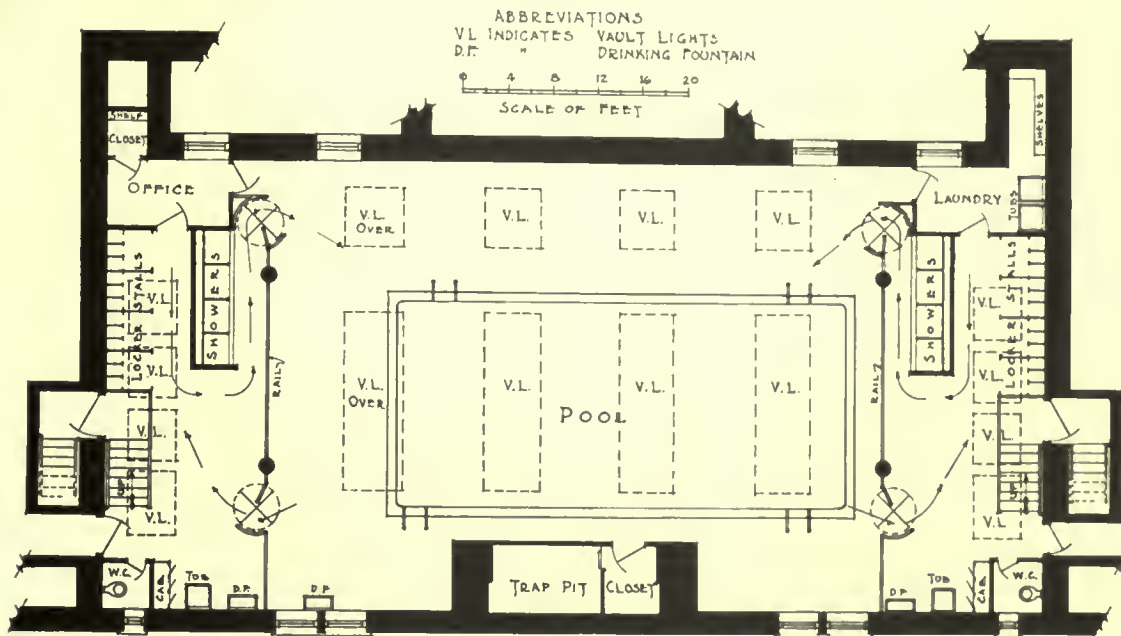

Fig. 2. Natatorium under the paved court yard of Public School No. 66, Borough of Brooklyn. Another pool in a very limited space, yet capable of intensive use by reason of the carefully planned lines of travel. By the substitution of folding partitions in place of the railings at the ends of the pool room, either set of showers and dressing quarters could be disconnected from the pool for independent use.

selection of materials and colors. Cement and other materials that absorb oils and dirt must be avoided. The predominant colors should be white or very pale tints. An abundance of natural light, *sunlight*, if possible, and an ample supply of pure, fresh, tempered air are indispensable.

The pool should consist of an outer shell, designed to withstand the necessary water pressure from within, and possibly from without; an inner shell to which the finish is applied, or which in itself provides the finished surface; and waterproofing, either as a membrane between the two shells or integral in the outer one.

In the event of there being ground water present at any or all times at the location of a proposed pool, care must be taken that the walls and floors

unity throughout the entire fabric with a minimum quantity of material.

Under ordinary conditions this outer shell can be made sufficiently water tight by careful mixing of the concrete, or by adding integral waterproofing to the mixture; but when there is water pressure from without, or when the pool is located on an upper floor of the building, the membrane system of waterproofing should be used.

Wall ties built into this concrete with ends turned up against the inner forms serve to bond the inner wall to the outer shell. Pipes passing through the outer wall are made water tight by means of flange connections, gaskets and lock nuts.

*Inner Shell.*—The floors and walls may be lined with ceramic tiling with the life rail and cove base



## THE AMERICAN ARCHITECT

formed of the same material. This material is impervious and easily cleaned, but the great number of cement joints are a detriment. White glazed brick is excellent for this purpose, particularly the English size, which presents fewer joints than the ordinary size. Glazed terra cotta is an equally

21 ft. in width, as the side rails should be within easy reach.

Depth of water depends on the use of the pool. For adults the shallow end may be about 4 ft., for children about 3 ft. If high diving is to be indulged in, the deepest water should be at least 9 ft.; but

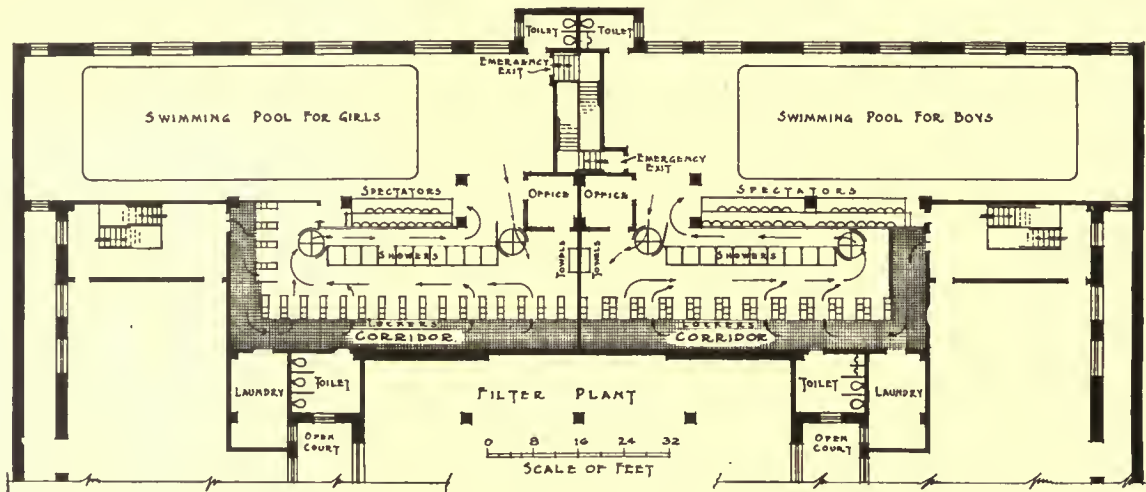

Fig. 3. Double natatorium for a proposed elementary school in New York City. The clothing lockers are so grouped so as to form dressing stalls. In Fig. 4 this is shown more clearly. By this arrangement it is possible to keep shoes with their attendant street dirt away from all portions of the floor likely to become wet, a matter of great importance to the cleanliness of the pool. The wearing of shoes should be confined to the space marked "corridor." Seats for spectators have been provided on raised steps. Note the toilet facilities. The toilets opening on the corridors are for compulsory use before entering the pool, while those opening on the pool room are for emergency use while bathing.

good material, and if the blocks are about 4 x 12 in. on the face, the number of joints is still further reduced. White glazed tile is sometimes used, but it is rather fragile and requires special care in laying. It should not be "buttered on" in the usual manner, as voids behind the tiles would fill with water, and this, being under pressure, would force off the tiling when the pool was quickly emptied.

Several lines of dark colored tiles or bricks should extend lengthwise on the floor of the pool, the outer lines being placed 3 ft. from the side wall to assist swimmers in maintaining straight courses when under water. There should be two similar lines across the pool, placed 3 ft. from the ends, to warn contestants of their approach to the walls.

Pools for racing should, if possible, be 75 ft. or more in length and 21 ft. or more in width. When racing is not an important consideration, the length may be 60 ft., 45 ft., or even less. In any event the length should be a multiple of 3 ft., as racing distances are measured in yards.

Pools for children should not be more than 20 or

if only the low spring board is to be used this may be reduced to 6 ft. 6 in.

One of the problems in pool design is the adjustment of water depths where the pool is to be used by both adults and children. If the pool is less than 60 ft. in length, there is a real difficulty because of an even incline of the floor from the shallow end to the deepest point (which should be 10 ft. from the deeper end of the pool) because too steep for safety. The best way to avoid this is to incline the floor about one foot from the shallow end to the middle and from there pitch it as sharply as may be necessary to the deepest water, placing a removable barrier across the middle to prevent inexperienced bathers from going beyond their depth. This barrier will be described later under "Safeguards."

The words "DEEP WATER" should be moulded in the life rail at the deep end, "SHALLOW WATER" at the shallow end and the actual depths in ft., as "4 FEET," "5 FEET," etc., at the proper locations along both sides.

Depth is measured from a line 3 in. below the

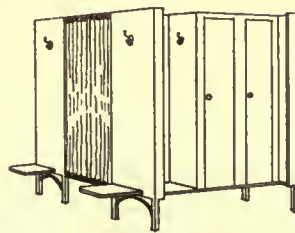

Fig. 4a. Perspective sketch of the lockers shown in plan in Fig. 4.



overflow gutter or life rail, as the water is reduced to about this level by surging and splashing when the pool is in use.

*Combination Life Rail and Overflow Gutter.*—Whatever the construction of the pool, there should

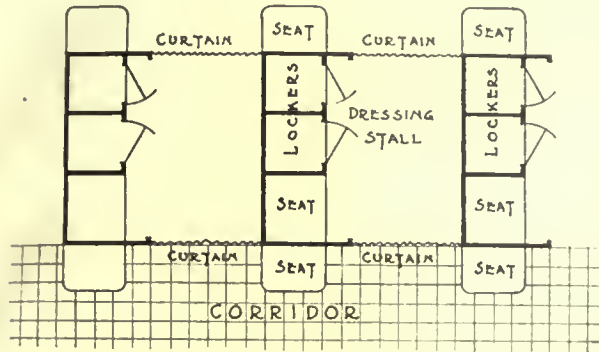

Fig. 4. Metal clothing lockers, so arranged as to form dressing stalls. Shoes should be removed in the corridor and immediately placed in the locker without touching the floor of the dressing stall. After dressing has been completed, except as to shoes, they should be taken from the locker and put on in the corridor space.

be a continuous overflow gutter around all sides, with drainage outlets about 20 ft. apart. Floating impurities are washed into the gutter by the surging of the water. The lip of the gutter is so shaped as to form a good hand grip, thus providing a continuous life rail about the whole pool.

The top surface of the life rail member, which forms the floor at the edge of the pool, should be roughened to prevent slipping. If of terra cotta, this may be best accomplished by applying the glaze over a light sprinkling of sand, which will render it both non-slipping and non-absorbent. Care must be taken that the sand be of the proper size and quantity and that it be covered with a full glaze so as to avoid all possibility of injury to bare feet. This method when properly applied produces a surface of the required roughness, but which nevertheless is non-absorbent and easily cleaned. When the life rail is of tile or mosaic, non-slip tiles may be used for the top surface.

*Ladders.*—Any form of steps or ladders placed within the pool or in recesses in the walls of same, is objectionable. The sides of the pool must be free from obstructions and entanglements.

The most satisfactory ladder is of terra cotta units built into the wall, so formed as to provide a good foothold and at the same time a good handhold. Above each ladder there is a double pipe hand rail, which, however, does not project over the edge of the pool. Four such ladders are placed, two on each side of the pool, near the ends. No ladders occur on the ends of the pool as the recesses interfere with racing contestants, who in making the turns, push against the end walls with the feet.

Single ladder units, placed at several points along the sides of the pool about 4 ft. below the life rail, serve as foot rests.

*Floor of Pool Room.*—Ceramic tiling is one of the most satisfactory materials for this purpose as it is impervious, non-slippy and easily cleaned. Marble mosaic and terrazzo are somewhat more slippy and more absorbent. Cement is probably the cheapest available material. It can be made impervious by the introduction of a "hardener" in the mix, but the color and appearance are not pleasing.

The floor should be sloped away from the pool and floor drains provided at points remote from the lines of travel.

*Walls and Ceilings.*—The walls, or at least the lower portion forming a wainscot should be of white glazed tile or ceramic tile. If the room is

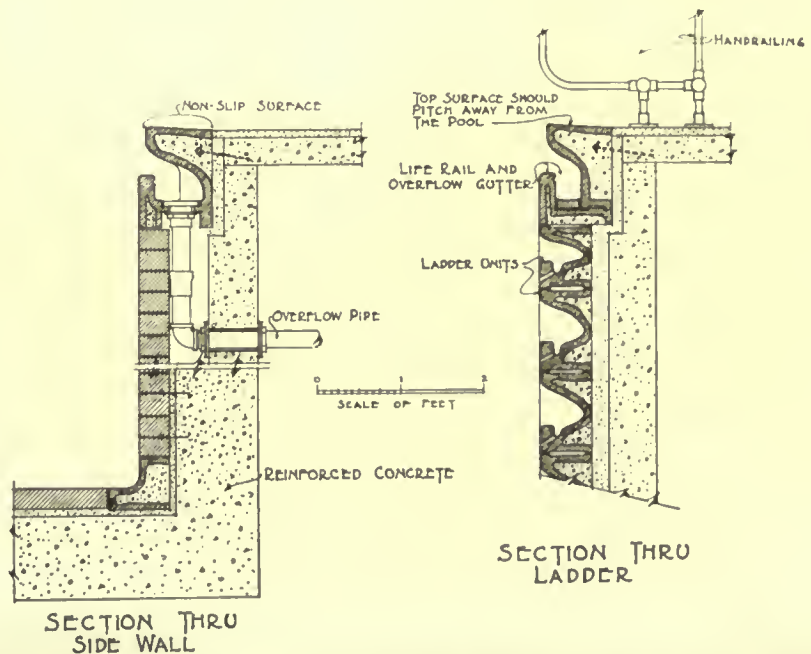

Fig. 5a. Details of the swimming pool shown in Fig. 5.

small and low, it may be advisable to use ceramic tile for the ceiling as plaster is softened by the vapor; but if the room is large and airy, painted plaster will prove satisfactory.

# THE AMERICAN ARCHITECT

*Shower Stalls.*—One of the best materials for these is enameled pressed steel. White marble discolors in time and colored marbles do not harmonize with the other appointments. The partitions

laundry fitted with porcelain tubs, wringers, and a small steam dryer; a porcelain tub and wringer convenient to the dressing quarters and a store closet for cleaning implements and other paraphernalia.

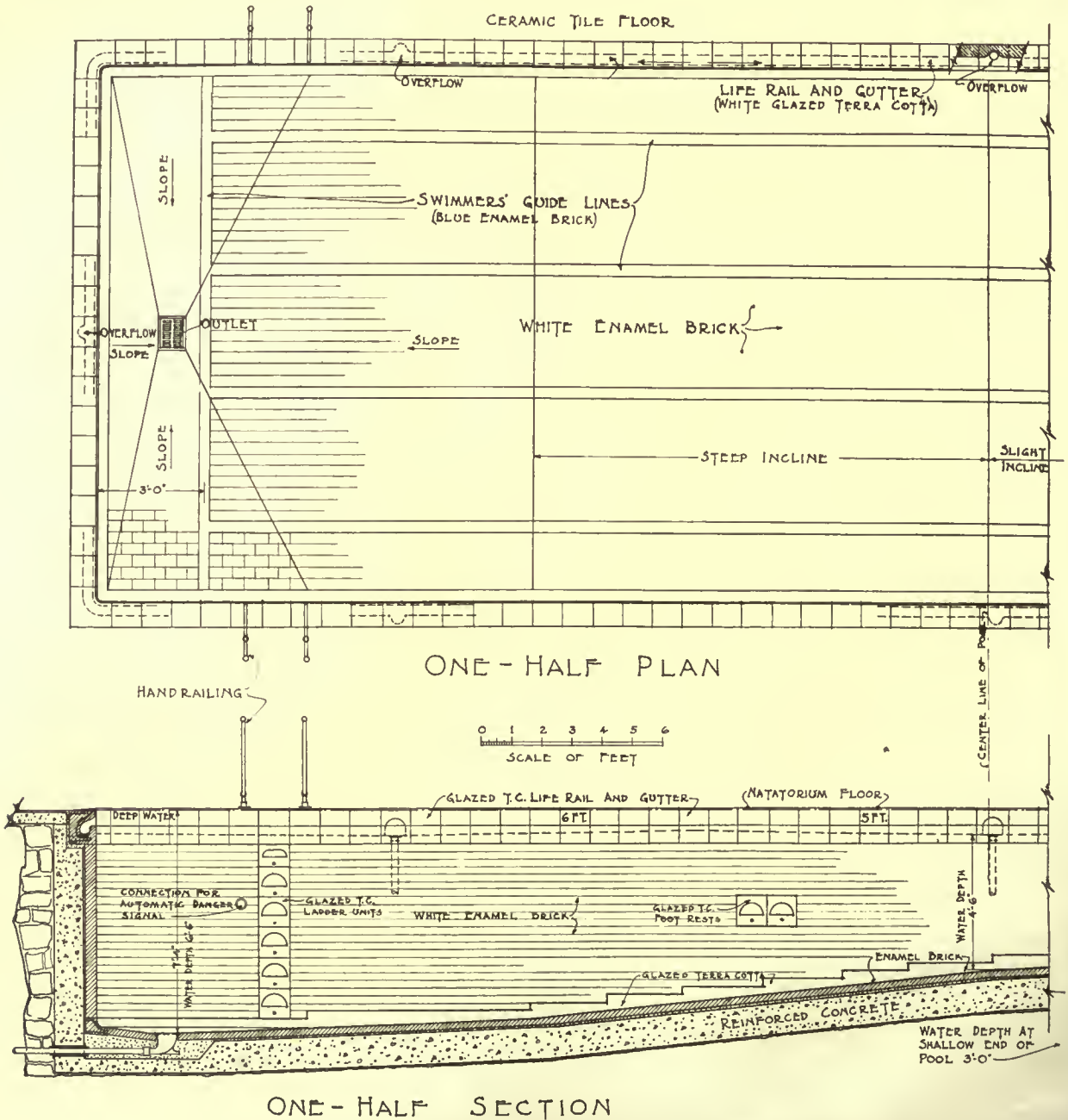

Fig. 5. Half plan and longitudinal section of a typical swimming pool.

should be supported on legs 12 to 18 in. high to facilitate cleaning. In order to insure easy supervision, the tops of the stalls should be low enough to expose the heads of the occupants.

*Lockers* should be of steel with legs.

*Other Accessories.*—There should be a small

## SAFEGUARDS

There are at present in every swimming pool, potential possibilities for accidents of the most serious and distressing nature. When the pool is used by small children, these dangers assume such proportions as to place a heavy responsibility upon de-



signer and administrator. It is imperative therefore that all the appointments be made as fool-proof as is humanly possible.

Long experience in schoolhouse construction and maintenance is likely to instill a due sense of responsibility for the safety of the pupils, and Mr. C. B. J. Snyder, Architect of the Public School Buildings in New York City, is one of those in

schools, a large curtain which drops automatically across the deep end as soon as the water is lowered to a certain level. On this curtain there is the inscription in large letters: "DANGER—LOW WATER."

The crank used to raise the curtain is detachable and is kept in the attendant's locker so that the curtain cannot be raised by any unauthorized person

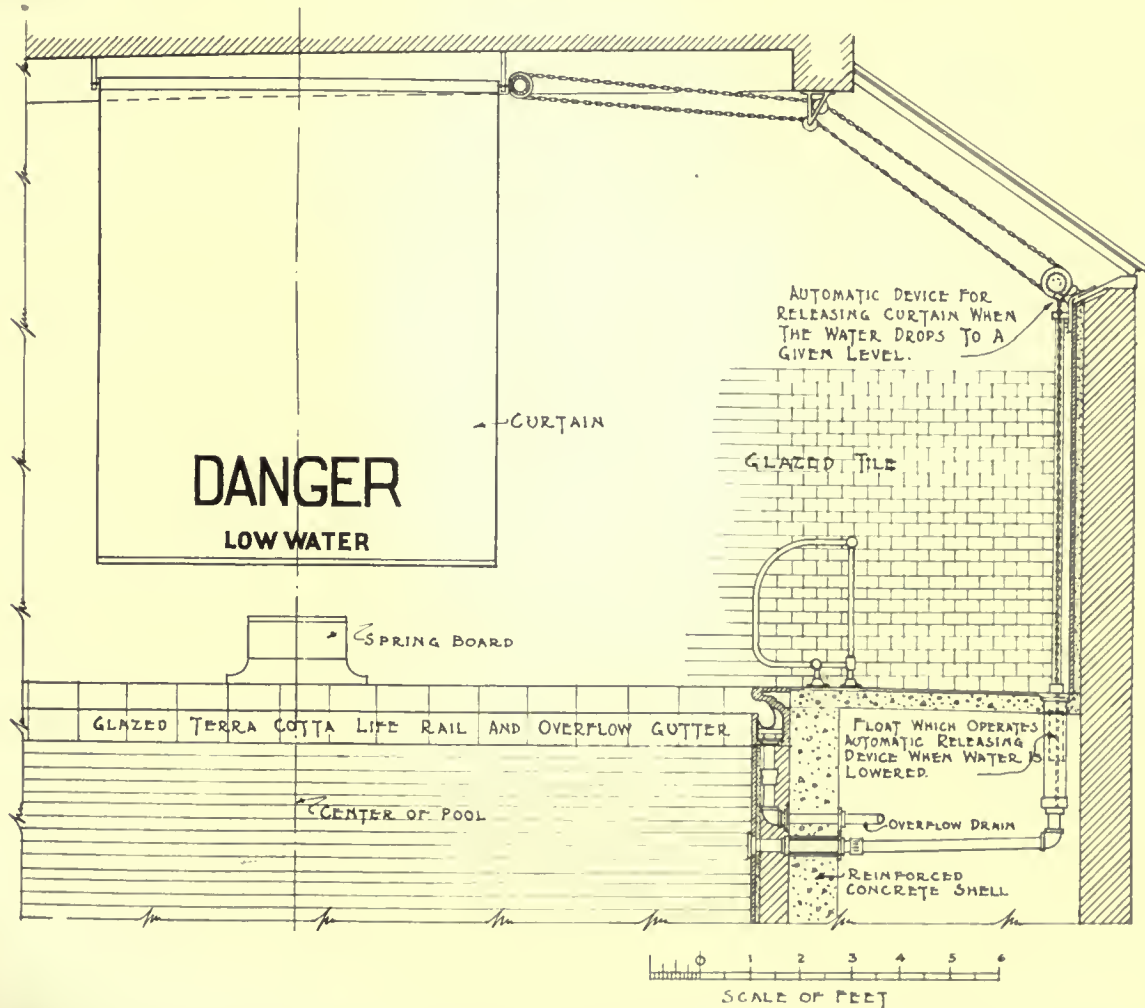

Fig. 6. Automatic danger signal, developed from the suggestion of C. B. J. Snyder, Architect of the Public School Buildings in New York City, to give warning when the water in the pool recedes to a level below which diving is unsafe. The curtain bearing the danger sign, drops of its own weight when released by the automatic device which is put in operation by the lowering of the water level. It cannot be returned to position until the water level has been raised above the danger point, and then only by an authorized attendant.

whom this attribute is ever present. Particular mention should be made of two excellent safety devices that have been developed for the pools in New York schools, from suggestions made by him.

*Danger Signal.*—It is not uncommon for persons to dive into empty pools, owing to the difficulty of detecting by sight whether the water is actually there. To avoid such an unfortunate occurrence, there has been devised for pools in New York City

This device has been developed to the point where the curtain cannot be lifted until the pool has risen to a safe level, but this need only be applied in exceptional cases.

*Barrier Between Deep and Shallow Water.*—Protection for the smaller children or those who do not swim, is essential; but the usual method of putting a so-called life-rope across the pool to prevent them from getting into deep water, only increases the



## THE AMERICAN ARCHITECT

danger which it is intended to avert. Such a rope to be of value should be just above the surface of the water and sufficiently taut to properly support the weight of two or three children. Even if the practical difficulties of affording proper fastening are overcome, there remains the lack of protection beneath the rope. The buoyancy of the water tends to make the foothold insecure, and there is nothing to prevent the body from slipping under the rope even though the hands are grasping it. The sensation produced upon one not accustomed to deep water is unpleasant and perhaps terrifying.

Water depth is sometimes adjusted to the smaller children through the lowering of the water level; but this does not work out well in actual use, as it prevents the proper and legitimate use of the life rail and gutter, which is so essential to the safe use and cleanliness of a pool. A secondary overflow gutter may be placed below the usual one, for use when shallow water is desired, but this introduces an objectionable recess in the otherwise unbroken wall surface and adds a considerable item of expense.

Alternate lowering and raising of the water level



Fig. 7. General view of the pool and natatorium facilities in Public School No. 66, Borough of Brooklyn. The plan of this pool is shown in Fig. 2. Note the guide lines on the floor of the pool, also the generous register openings for fresh air supply and ventilation.

Both protection and flexibility as to depths of water may be best obtained by means of a boom resting on the water and extending all the way across. This should consist of a 4-inch round stick of a light, buoyant wood, to which three or more coats of good white lead paint have been applied. The ends are supported in place either by ropes carried up over the edge of the pool and secured to suitable weighted stanchions, or by stirrups of suitable design resting on the life rail.

From the boom a sheet of striped canvas is suspended, with the lower edge held in place upon the floor of the pool by means of a galvanized iron rod or pipe let into the hem or through loops. The striped canvas not only indicates plainly the limit of safe depth, but also serves as a barrier to prevent accidental overstepping of the bounds.

involves unnecessary administrative attention. Orders must be given to the engineer whenever a change of level is desired and time must be lost while the change is being made. When the level is raised, a large volume of water must be drawn from the mains and heated to the desired temperature within a short space of time. This requires a larger heater, more water and more fuel than would otherwise be necessary.

### SANITATION

For many years the only known method of purifying the water in swimming pools was by emptying and refilling and there was no assurance of purity except immediately after refilling. Water from most city mains, although pure enough to be safe for drinking purposes, contained enough sedi-

ment to make it uninviting. Unless such pools were constantly emptied and refilled, the danger of infection from disease germs rendered them a positive menace to health.

There was thus created in the minds of the people, both lay and professional, a prejudice against the use of swimming pools, except by lim-

the same water continuously without any danger of infection, the small quantity of water lost through the overflow gutter being replaced by water from the mains.

Toilet accommodations should be provided convenient to the dressing quarters and their use insisted upon before entering the water. There should

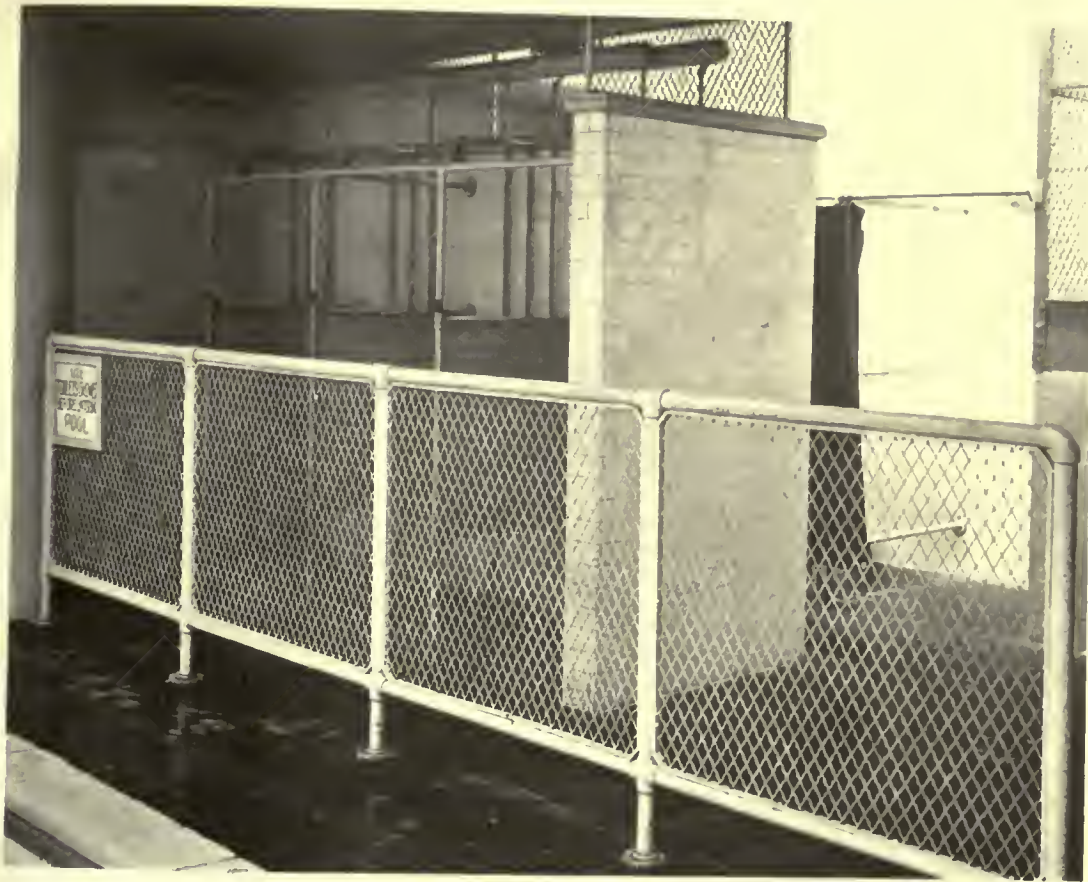

Fig. 8. A close-in view of the showers shown in Fig. 7, also showing a partial view of the locker stalls in rear of same.

ited numbers, or when there was a practically unlimited and constant supply of fresh water.

Recently, however, there have been developed methods of re-purifying so positive as to eliminate this danger, where proper precautions have been taken for the health and cleanliness of those using the pool. At the same time, the attractiveness has been greatly enhanced by the crystal clearness of the water.

Pumps are provided of sufficient capacity to recirculate the entire volume of water at least once during the working day, and at the same time pass it through mechanical filters and re-heaters. Before its return to the pool it is sterilized by the automatic injection of the proper quantity of hypochlorite or ozone. By this method it becomes possible to use

also be other toilets adjacent to the pool for emergency use while bathing.

#### COST

The initial cost of pools and appurtenances of the kind described, is not such as to prohibit their use in public schools.

Prior to the war a 60-foot pool, together with its appurtenances, could be secured for about \$10,000. The provision of additional space for the pool adds also to the cost of the building. The chief item of expense, however, is for maintenance and administration and this fact is sometimes lost sight of, when the requirements for a new building are under discussion.

Swimming instruction, when developed to the



## THE AMERICAN ARCHITECT

limit of its possibilities, provides much more than a pleasant, healthful exercise. To a greater degree than most courses of study, it can be made to extend its benefits beyond the individual pupil and to exert a powerful influence on the health, mental attitude and morals of the community.

"Cleanliness is next to Godliness," is more than a trite expression, it is an indisputable and well recognized fact. Where personal cleanliness is at a discount, one cannot expect to find clean homes, clean streets or clean morals. A great uplifting force would be brought to bear on such a community if all the schools were provided with well equipped pools; if all the school children were taught by competent instructors, not only swimming but cleanliness; and if these advantages were also made available for adults when not in use for school purposes.

A prominent New York physician has assured the

author that these incidental benefits arising from the proper use of pool facilities constitute the strongest possible arguments in their favor. To secure them it is absolutely essential that both the architectural plan and the administrative program be conceived and executed along correct lines.

### ACKNOWLEDGMENTS

Mention has been made of certain devices that have been developed from suggestions made by Mr. C. B. J. Snyder, Architect of the Public Schools in New York City. Grateful acknowledgement is also made of many other helpful suggestions from the same source, in connection with the planning of pools for the New York schools and the preparation of this article. Information has been drawn from many other sources, and to all of these the author wishes to give full credit.

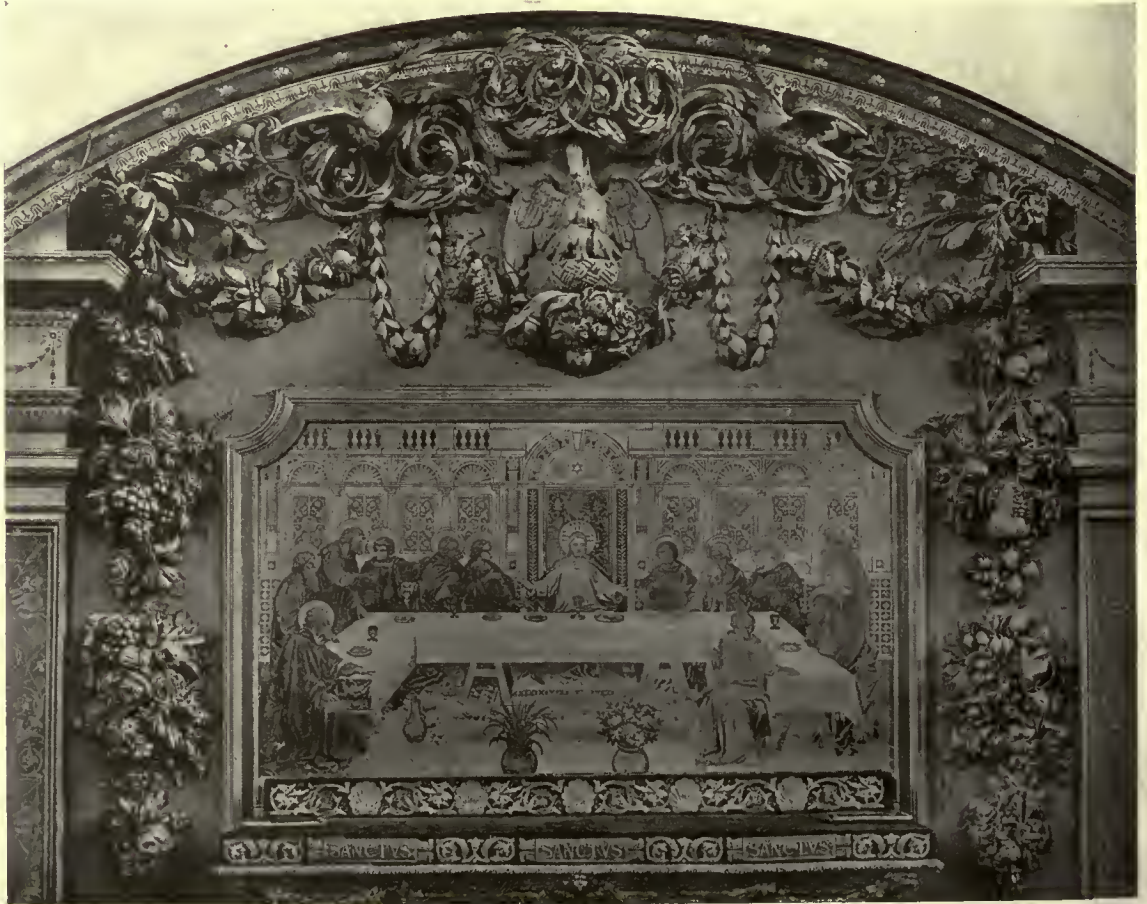

CARVED REREDOS—TUDOR PERIOD



# Industrial Information

*In this Department there is published each week information as to the development of materials and methods, derived from reliable sources.*

## Waterproofing Methods and Materials

To make a structure proof against injury from water is but one way of taking the obvious precautions that will assure its long continued usefulness. That this is an important subject to the architect and engineer is borne home in a valuable booklet prepared by the General Fireproofing Company, Youngstown, Ohio. The adequate waterproofing of a building is as much dependent upon proper methods of application as upon quality of materials. This handbook is accordingly offered both as a description of a very complete line of materials and as a guide to their correct use. The methods of application recommended are based on successfully used specifications and cover almost every conceivable waterproofing problem. A valuable feature of this book is a specification guide which gives in four parallel columns typical problems and conditions, methods for meeting them, materials best for the purpose, and finally a cross reference to the page giving complete specifications for the work. These are of very distinct value, for from each page may be obtained information of the most pointed importance and interest in dealing with this subject. Diagrams and other illustrations are interspersed throughout.

There are two general methods of waterproofing: integral, by which is meant the incorporation of a waterproofing material into the mortar or concrete during the process of mixing; and membrane, which is a surface treatment over a completed structure. The uses of each are fully developed in what is a book of considerable reference value. Included in the exposition are methods of acidproofing, floor coating, steel coating, concrete hardening, brick and cement coating, and many other specialties, accurate knowledge of which will be of benefit to the architect.

## Sanitary Window Shades

With several good features to commend it, Draper's Sanitary Roller Shade is widely used in schools and office buildings. It is manufactured by the Luther O. Draper Shade Co., Spiceland, Ind., and its advantages are enumerated as follows:

The materials and construction are of the best,

so that operation is simple and quick and accompanied with so little resistance that little can wear out even with constant use. It can be raised at the bottom and lowered at the top at the same time. This is particularly an asset in ventilation. Most windows may be lowered from the top and if the shade cannot, either the passage of air is obstructed or the shade flaps in a manner which injures it and is very annoying. Further details may be had on request from the makers.

## Deming Pumps

Unless it flows by gravity, water must be pumped either by hand, windmill, electricity, gas, steam or other power. A very readable booklet called "A Generation of Progress" has been prepared by the Deming Co. of Salem, Ohio, showing graphically the wide application of the Deming product for every purpose where water is to be transported from one place to another. In large variety, for the house, the farm, the factory, for general water supply, boiler feeding, fire protection, drinking purposes, Deming pumps have been used with successful results.

An interesting insight into the value of pumps in carrying on modern progress, whether in the mountains, the desert, or the mines, is presented in this booklet. In addition is given practical information on pump facts which the many-sided architect will be glad to review.

## Drying Clothes

Whether we like to admit it or not, we are all closely related to the washerwoman and bound up in her affairs. "Clothes and the man," one of the long-favored debating society topics, is given a new angle in the discussion of scientific clothes dryers, an angle in which the emphasis is on scientific dryers, and not on scientific clothes.

A Cleveland concern, the Scientific Heater Co., 1065-1125 East 152d Street, that city, has prepared a manual for salesmen to show just in what respects the Scientific Clothes Dryer which it manufactures is an accessory worthy of a place in every household. This manual has a two-fold appeal—to the seller and through him to the buyer. Since

the architect may in this instance be the one or the other, the book has interest.

The makers have summarized very concisely and comprehensively the advantages resulting from the installation of their Scientific Clothes Dryer. First, wash day is made independent of the weather. The thing further eliminates tearing of fabrics caused by clamping with clothes pins, by flapping in the wind, and by folding frozen clothes. It avoids soot spots, dust and other outdoor dirt. It does away with the discomforts of cold winds and hot sun, and reduces the chances of colds, rheumatism and other ills. It eliminates the useless backbreaking labor of handling heavy clothes baskets and pinning clothes on the line. It takes the place of all the unsightly clothes lines. It, finally, shortens the process of drying, and reduces the time required for completing the week's laundry.

### Hendricks' Register a Voluminous Work

The twenty-seventh annual edition of Hendricks' Commercial Register of the United States for buyers and sellers, with which has been incorporated "The Assistant Buyer," has just made its appearance in the trade. It is especially devoted to the interests of the architectural, contracting, electrical, engineering, hardware, iron, mechanical, mill, mining, quarrying, chemical, railroad, steel, and kindred industries. Products are listed from the raw material to the finished product, with the concerns handling them from the producer to the consumer, corrected and revised up to the latest possible moment. The volume contains 2384 pages. It may be obtained from the publishers at 2 West Thirteenth Street, New York, for the sum of \$10.

### Permanence the Unwritten Law of Church Building

Some of the greatest triumphs of the world's master builders have been achieved in the creation of religious edifices. Century-old structures of transcending beauty attest how limitless are the possibilities of genius when inspired by religious fervor.

That time has but added to the beauty of Europe's wondrous cathedrals—so truly "poems in stone"—is due to the fact that in their construction only materials offering the greatest resistance to the action of time and weather were employed.

Down through the years this same fundamental principle has obtained and in the church construction of today endurance is a deciding factor in the selection of the building materials.

That metal lath is now universally recognized as meeting every construction requirement, both as to permanence and fire resistance, is proven by the increasingly large number of churches and other public buildings in which it is now specified.—*From Expanded Metal Construction, Published by the Northwestern Expanded Metal Co., 37 West Van Buren Street, Chicago.*

### Personal

Zenas W. Carter, chairman of the War Service Committee on Metal Lath, with offices in the Woodward Building, Washington, D. C., has resigned to become managing executive of the Material Handling Machinery Manufacturers. He will take up his new duties on March 1, with headquarters in New York City. Before entering the War Service Committee, Mr. Carter was secretary of the Associated Metal Lath Manufacturers.





344  
100-77 / 100-344

# The AMERICAN ARCHITECT



DOORWAY—CHURCH OF S. PRASSEDE, ROME

PUBLISHED WEDNESDAYS IN NEW YORK—FOUNDED 1876  
VOLUME CXV                      MARCH 5, 1919                      NUMBER 2254

Entered as second class matter January 6, 1909, at the Post Office at New York, N. Y., under the Act of March 3, 1879. Publication office, 243 West Thirty-ninth Street, New York, N. Y. Subscription price in the United States and Possessions, \$10.





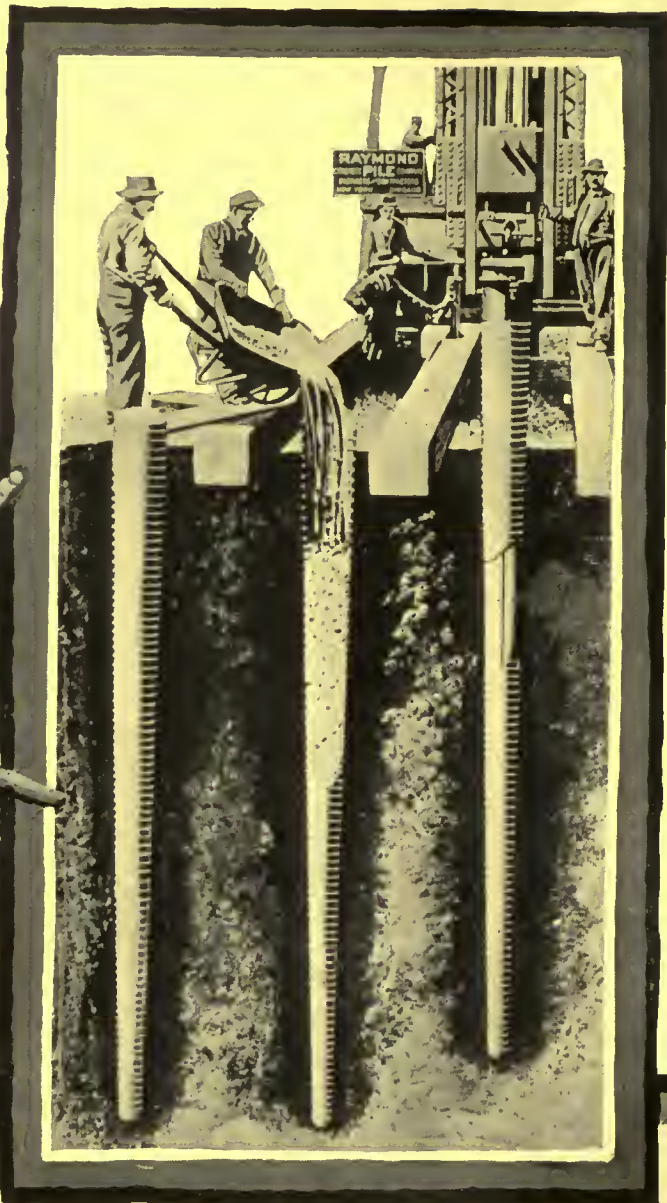

## The Shell is in its place— The Core will be withdrawn—

Then the interior of the driven shell may be inspected down to the very tip so that you have ocular proof that back-pressure of soil, pressure of adjacent pile driving or foreign materials will not weaken nor distort the concrete pile. Finally, the concrete is poured—and the shell left in the ground. There is only one type of cast-in-place concrete piles formed in this manner—RAYMOND. They make certain—and also reduce incidental expenses, such as excavation, sheeting, shoring and pumping.

**Raymond Concrete Pile Company**

NEW YORK: 140 Cedar Street CHICAGO: 111 W. Monroe Street

*"A Form for Every Pile—A Pile for Every Purpose"*





PALAZZA BONIN, VICENZA, ITALY  
BY PALLADIO

*THE AMERICAN ARCHITECT*



# THE AMERICAN ARCHITECT

VOL. CXV

WEDNESDAY, MARCH 5, 1919

NUMBER 2254

## Architecture After the War

### III. Efficiency

By C. H. BLACKALL, F. A. I. A.

IF there is one word I detest it is *efficiency*, for it has been worked to death during the past few years and has come to indicate pretty nearly the elimination of everything that makes architecture worth while and a substitution therefor of a classified, indexed, mechanical something which has been imposed upon architecture and called practical when it is really the essence of impracticability if we consider the true results which we know are such as will endure. But there is no other one word which expresses just the thought I have in mind, namely, the process of correlating the forces which, when properly united, will produce true architecture. Efficiency in its proper sense does not mean an engineering structure, nor does it mean a fantastic dream of a genius, nor the plodding evolution of a business man, but it means just that balance of art, business and science toward which we are all really working.

For the purpose of this paper, in developing and carrying out this efficiency, we need consider only three relations of the architect: First, his relations to the owner, the one who makes it possible for him to build; second, his relations to the contractor, who makes it possible for his ideals to be realized; and third, his relations to the public, from whom he must draw his inspirations. It is the failure to properly recognize and consistently and fairly carry out all these relations that is due a considerable measure of the failure and loss of prestige which the architectural profession has suffered during the war, and it is the proper recognition and application of these relations which will go a long way toward reinstating the architect in the position which he would most wish to occupy.

The relation of the architect to the owner is primarily and fundamentally that of a business man, except that not having a commodity for sale he can sell only his brains and the results of his experiences. It is wholly a matter of service, and, assuming that the architect's organization is properly

balanced, without taking up the question of how the work is divided among the individual members of the organization, there are a few things which must be insisted upon from the very start if we propose to give our client a square deal. When we have a building to do we should know our job thoroughly, not having a general, hazy idea that it will look so and so, or that it will involve such and such problems of construction, or that the book-keeping may be worked out in a particular line, but we must know the details of what is set before us so thoroughly that we cannot be caught tripping by an inquisitive builder or make mistakes which an indignant agent or owner may call upon us to rectify. If it is an office building we should know everything that is to be known about office buildings. If it is a church we should know just what kind of church is wanted in that particular place and not try to impose a ritualistic design on a Methodist Meetinghouse, nor a pagan temple on a lot which admits only of perpendicular treatment. We should know the details down to the last screw and bolt; know what is the best thing to do and what has been done in other cases. This is not an impossible condition, given the right organization; and when we do not know a thing we should go to work and dig it out at once. There ought to be no such thing as a specialist in architecture. Every problem should be treated as calling for the utmost architectural care in the initial steps as well as in the final elaboration of beautiful design, and it is not enough to toss off some sketches, but even from the very first an architectural job should be treated as something that must be mastered in advance; the program must be worked out so we know what we are doing and have a thorough reason for what we do. It may be stated as a general condition that few men are ever able to do their best all the time. Some of us can put on a spurt in one direction. Many of us can keep on a low level indefinitely, but the ideal organization which is to

## THE AMERICAN ARCHITECT

be of the most service to its clients is one which does its best all the time, which is always up to concert pitch, which does not admit such a thing as lack of preparation or specific knowledge, and which is always ready to deliver the goods it is paid for. I repeat this is not an impossible condition for a group, however much an individual architect might fail therein, and the great motto which ought to be over the door of every architect's office is, "Whatsoever thy hand findeth to do, that do with thy might," and one might add for a postscript, "Do it now." There is hardly any one attitude which will do more than this to restore the status of the architectural profession. Do it right and do it now. This really sums up the gist of the architect's relation to the client.

The relation to the builder is considerably more uncertain. Are we paid to help the owner beat the builder, force him to an impossible contract, incite him thereby to scamp work, or are we to play safe with the builder, whom we want to use many times, and help him out when he gets in a tight hole, "co-operate with the builder," as one general contractor has expressed it? Are we to consider ourselves the owner's agent in dealing with the contractor, or are we to take the point of view that we are an arbitrator between the two? Are we to encourage the master builder at the expense of the subcontractor, or develop the subcontractor at the expense of the builder? These are pretty vital questions, and they will not be answered in this generation. The owner hires us as his representative. The builder trusts us to a square deal. That much we know anyway, and I believe, speaking from personal experience, that the architect's function is neither as arbitrator nor agent, but that he should take a position that he is the virtual builder of the structure; that it is his job to see that the contract is carried out as an entity and in a proper manner, and that the co-operation which is so essential in the architect's own organization is fostered, developed and maintained in the organization of the builder. It is not enough to let a contract to a general contractor and then sit back and see him race to a finish. We must stand over that contract with even more care and foresight than the builder is called upon to exercise. We have more at stake than the builder, and his interests as well as our own are so involved in having the building carried out right from every standpoint that we cannot afford to leave such carrying out for one moment in the hands of anyone but ourselves. We must not allow a clerk of the works to come between us and the owner. We must not allow a foreman, however clever, to come between us and the actual workers, and we must

even guard us from ourselves, that in our perfectly natural desire to do things right and truly we do not overstep our rights and either ask more from the contractors than they ought to give, or take less than we know should be required. We must make the building and the builder right. Never for a moment lend ourselves to any emergency, artistic, business or structural, which would detract from doing the thing just right, but at the same time we must give the builder and all his associates and subordinates the very thing we should promise the owner, namely, first, last and always a square deal.

If we question what constitutes a square deal and try to decide in advance for every case that might arise, we would get nowhere; but we do not have to decide all questions in advance, and there are very few times when we do not know what constitutes a square deal to a contractor. It is the suppositional cases, the cases which never arise, or which may never come before us, which cause us to doubt, but I think every architect in practice knows perfectly well when he is not giving a builder a square deal, and if he lends himself to that kind of business transaction he has nobody but himself to blame if he gets a bad reputation. Carelessness, oversight and haste may land someone sometime in an equivocal position, but some of the procedures fundamentally essential to keeping the relations clear between the architect and the builder are, first, never trust to memory or to hearsay; second, never to give indefinite instructions or even instructions which are not based upon a specification or a document; and, third, never put off until to-morrow what ought to be done to-day. Remember all the time that the architect really owes more to the builder than the builder does to the architect; that the builder should be our best business friend and our best recommendation; that he is really doing a part of our work, and we owe it to ourselves and to him to recognize that he is a part of us, and not an opponent or competitor.

The architect's relation to the public is very easily lost sight of. We work for our individual clients and with our builders. We must not lose sight of the fact that we are able to practice our calling because of the attitude of the general public toward us. The best architect in the world, if unsupported by local, public appreciation and sympathy, would have but a sorry success. There never was a work of art yet built without its public. We must not be intolerant of the man in the street who passes our work by and puts forth an offhand criticism which we may resent but which may be altogether salutary for us and for our pride.



## THE AMERICAN ARCHITECT

We indeed build for our employers, but we draw our inspirations in last analysis from the consensus of opinion of the great public who sits in cold, impartial judgment upon our product. We must give the public what it wants. Of course there is room for a great variety in methods and means and some phases of the results, but we have only to compare the architecture of different cities in different parts of the country, for instance, to appreciate that architecture is not a transplanted, exotic production but must be indigenous. The function of the architect to the public is, therefore, to a very definite degree to study his public, to see what the trend of public thought is, keeping not so far ahead of public thought that he will be a mere crank, nor so far behind that he will be a fossil. Let his make his work as it truly should be, typical of his times, his country and his local audience. This point ought to be very strongly insisted upon. A recognition of this local influence was largely responsible for the individuality of the Italian work during the early renaissance. It is the recognition of this which contributes unquestionably to the success of such structures as the Woolworth Building in New York, or the Temple of the Scottish Rites in Washington. And with our service

to those who pay our bills we must include service to the public which tolerates, judges and approves or casts us out. We have done all too little of this in the last few years. We have been too prone to tell people what they should accept as good, and then find fault if they do not take our say so; but the war has shaken some of that out of us, and I believe the near future will show a closer approach to the ideal conditions of the great building periods of the past when architecture was truly a reflection of the sentiment, the growth, the history, the aspirations, the successes and the failures of the civic and national life.

And, finally, we must be proud of our three-sided profession, so proud that we set it above everything else on earth and give our life and our strength days, nights and Sundays, if necessary, to make it the very biggest thing on earth. Our calling is one which awakens the imagination and arouses enthusiasm if we will but open our minds to its possibilities and its whole meaning. We need imagination in our business, we need enthusiasm in our art, and, above all, we need firm convictions and high ideals which will lead us to be worthy of the great opportunities which we believe are coming.

## An American Architect in France

*A Communication from* LIEUTENANT ALFRED P. SILAW, *H. Q. Air Service*

*Illustrated by Sketches by the Author*

**T**HIS leaves me in Tours, my "station" for almost a year, although I have been absent from it as much as I have been present. When I left the front I had the very natural feeling that I'd never miss it, but I was wrong. Here in our S. O. S. Headquarters the streets of the town are heavily sprinkled with khaki (the U. S. A. kind), the amount of khaki being directly proportionate to the hour of the evening, as the French population has a way of staying indoors after dinner. (Is this a war-time habit or not?)

The Americans are in general more efficient "promenaders" and sightseers by day as well as by night, and take advantage of the opportunities to study, among other things, the beauties of French architecture. On Sundays up and down the spiral stone staircase, which leads to the top of the cathedral towers here, there is a constant procession of doughboys, with and without W. A. A. C.'s, or "mademoiselles"; the chateaux of the Loire were never so much visited by Americans, and many an

overseas cap has slipped off backward while its owner admired a gargoyle or a cornice. There is now at Loches an old guide and caretaker who has interested himself in researches and excavations at the old "donjon," in recognition for which service he has received the ribbon of the "Academie Française." You may have seen him yourself; he has been there a long time, and is most interesting and dramatic. In the dark dungeons of the old "Chateau fort" he turns down his lamp to a mere flicker, and after slamming a tremendous wooden door, solemnly explains: "*Chene mes amis, cinq centimeters d'epaisseur!*" or, clutching at an iron grating, shakes it and cries, "*Fer solide. Impossible de sortir! C'etait terrible, mes amis, terrible!*" He so impressed us with the genius of Louis XI. for cruelty that our chauffeur, who used to haul up shells to the artillery on the French front, was heard to remark that he hoped "the old guy wouldn't lose his way out." He didn't, fortunately.



## THE AMERICAN ARCHITECT

In getting around from place to place we have found ourselves stopping over night in towns which are miniature paradises for architects or archeologists. At Sancerre, where my "side kick" managed to clamp onto an American Army dentist long enough to cure his aching jaw, we could sit out on the old ramparts and see a whole department below us. The town, after the fashion of feudal days, is built on a good-sized hill, and if one could hang a swing from a tree on the neighboring slope, put

the properly attired boy in it, give him a push across the picture and look at Sancerre behind such a foreground, there would be no difficulty

in realizing that Maxfield Parrish was the municipal architect. We happened in there during the hottest days of the summer and expected to have cool nights, soft moon, gentle breezes and all that business, but instead the cool air manufactured in the valley stayed there and sent us only the accumulated warmth of noonday to remain at our higher strata. Every available billet for miles was taken by the division which had just moved in, and it took two days to get beds for the three of us. Just the other side of Clamecy, where our 3rd Corps School was located, and quite off the beaten path, is the splendid old abbey of Vezelay; we were obliged one day to climb over the hill on which it lies, and, passing at its very gate, could not resist an inspection. For once I was glad of my ignorance, as Vezelay was like a bolt from the blue. I had forgotten even

the name of the place, and to step, without warning, from the burning, dusty heat of midsummer into the vast, cool, dignified nave of the abbey church and feast my eyes on the beauties of its vaulting, the mellow tones of the masonry, the delicacies of the carving in capitals and tympana was reward enough for former hardships. The abbey and the town around it, like Sancerre, cut up into the sky and seemed to be sitting there that day, baking in the sun, left alone by the world and

perfectly contented. What is now hardly more than a village was once a town of 10,000 people, and it was here that Philippe Auguste and Richard the Lion Hearted met to make plans for their crusade.

For a short while we worked out from Auxerre, which, in spite of its location, had at that time only an occasional American.



## THE AMERICAN ARCHITECT

At the hotel we nearly passed out with joy upon being shown to the comforts and luxuries of the bridal suite, which included a bath, where the "chaude" on the faucets meant something. From the top of the same establishment there is a fine view of the rich red tile roofs of the town, the two very similar and perfectly beautiful late Gothic towers of the Cathedral and St. Pierre rising about the sea of roofs and chimneys, and behind the whole the ring of cool green hills.

My duties as a member of a division which had

tion to the French of the meaning of and the energy behind the U. S. A. To see a whole railway carriage full of French officers and civilians flock to the windows as we pass alongside one of our vast depots and to watch them bob their heads up and down as only the Frenchman does in exclaiming, "Incroyable!" is a stimulus for the sleepest kind of national pride. One old commandant seemed to think that if he could conduct the German General Staff on a tour, including a few large American depots, that they would return sadder



THE CATHEDRAL OF ST. ETIENNE, AUXERRE

activities in every corner of France, namely, helping to locate sites for air service projects and then getting them built, have given me disgracefully excellent opportunities to see things; sometimes where an American uniform creates a surprise, and at others in those places where the American invasion has been complete. You have heard much already of the work of Americans as engineers in France, and it is invigorating to see their marvelous desire and ability to accomplish their tasks—whether it be at Buzancy or Bordeaux—and the feeling of satisfaction for simply having done it.

One of the good results of the war is the revela-

but wiser. (The same result was very likely obtained by proxy.)

It goes without saying that there are no fine æsthetic qualities embodied in the designs of these A. E. F. projects. But the spectacle of a vast storage depot or of a great prairie manicured into a flying field by draining, scraping—sometimes ploughing—and rolling it, with rows of barracks and the gaping holes of the hangar entrances at the fringes, and planes taxi'ng around, taking off and landing in all directions—all this is not without its charm. We have seen these airdromes grow out of fields which since the days of the Gauls have been



producing the fruits of the farmers' toil, and we realize that we are watching and assistant at the solution of a new architectural problem which is bound to equal if not surpass that of the railroad station in importance. The Wrights will be as much to blame for the crimes committed against architecture in the designs of airdromes as is the inventor of the locomotive for those in railroad stations. It is easy to picture every large city with one or more municipal airdromes, not only showing conspicuously from the air, but having

and an architectural student in 1999 will only have to press a button in the library in order to have laid upon his desk Woodrow Pershing Clemenceau's Treatise on "Early American Airdromes" (illustrated, 8vo. photographs from 10,000 feet). By a coincidence I left, on my first leave in six-



THE CHATEAU LOUNES

its own particular "merk," made by the placing of buildings or by designs in the turf, so that a pilot could orient himself by simply memorizing or referring to these marks. Up to date most of our airdromes in France have been the products of military necessity and are intentionally free from any sense of show or beauty of design. We are bound, however, to have some real "swank" ones very soon,



TOURS

teen months, on the day of the signing of the armistice. Marshal Foch said that he thought he could keep things going for a while and for me to get away for a bit of rest. So I did. Paris was wild with delight, whether the cause was my arrival or the signing of the armistice I cannot say, but the most extreme press dispatches were mere echoes of the joy of the boulevards. The enthusiasm of the moment has quieted down, and we are all sitting with our ears cocked for the communiques from the Peace Conference.

Keep your eyes open for bargains in tweed suits with open collars and long trousers—I've never been as proud of my clothes in my life as I am of my uniform, but—I have been more comfortable in others.



# The Commodore—A New Hotel on Pershing Square New York

WARREN & WETMORE, *Architects*

**N**EW YORK'S hotel famine, while not entirely relieved, has been largely checked by the simultaneous opening of two hotels, each greater in size than any others in this country.

The Commodore, on Pershing Square and adjoining the Grand Central Station, adds a very important architectural feature to a location that is

area of the plot occupied is 275 x 208 feet, equivalent to a square block. The building rises twenty-six stories above the sidewalk level, with five stories below the street. Part of the structure stands over the subway extension which curves at this point from Park Avenue and under Pershing Square to Lexington Avenue.

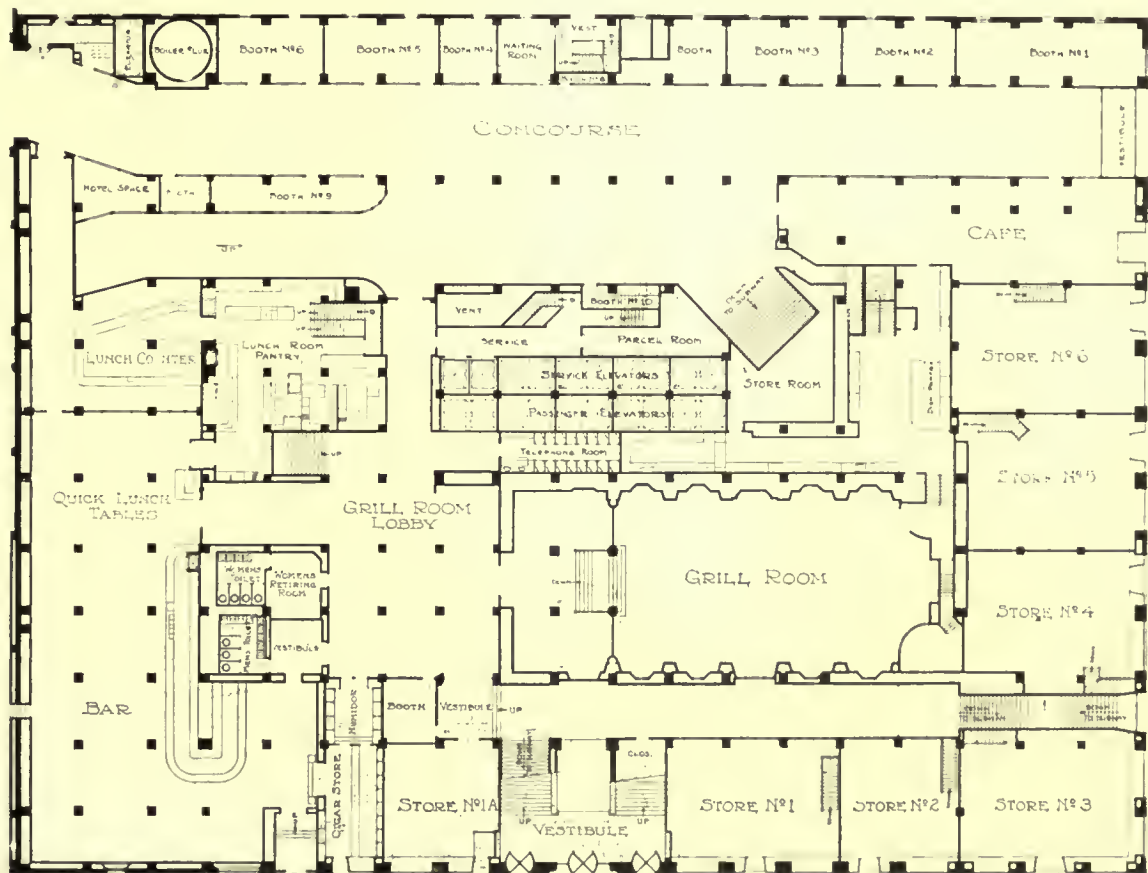

STREET LEVEL PLAN

bound to become one of New York's busiest civic centers. The completion of the Park Avenue extension to connect by a well designed viaduct with the terminal, and the laying out of the adjacent grounds, to be known as Pershing Square, will create an architectural feature that will become one of the most attractive parts of this city.

The Commodore, designed by Warren & Wetmore, stands on the northwest corner of Forty-second Street and Lexington Avenue. The ground

The building, in addition to the many rooms usual to the social, executive and administrative necessities of the modern hotel, all shown on the accompanying plans, contains 2000 outside guests' rooms. There is a bathroom with each guest room.

The lobby of the hotel, claimed to cover the largest floor space of any similar room in the world, has been treated with originality and presents the aspect of an Italian courtyard or garden. This creates an atmosphere of intimacy with the foyer,

## THE AMERICAN ARCHITECT

and the result has been admirably achieved by means of a low ceiling of translucent white glass, all supported by beams decoratively treated. Here the walls are of rough plaster, above a wainscoting of soft Italian stone, the panelling on the walls is set with blue Italian tiling.

The garden effect is further carried out by the introduction of many large vases on the floor and

smaller dining rooms and the men's café on the same level, and by two short runs of steps the street level bar and the lunch rooms. The grand ball room is unusually large. It is 180 feet long by 78 feet wide, with a gallery completely encircling the room and divided into fifty-six boxes.

The ventilation of this room is on the level with the boxes, while the vents are in the ceiling. The

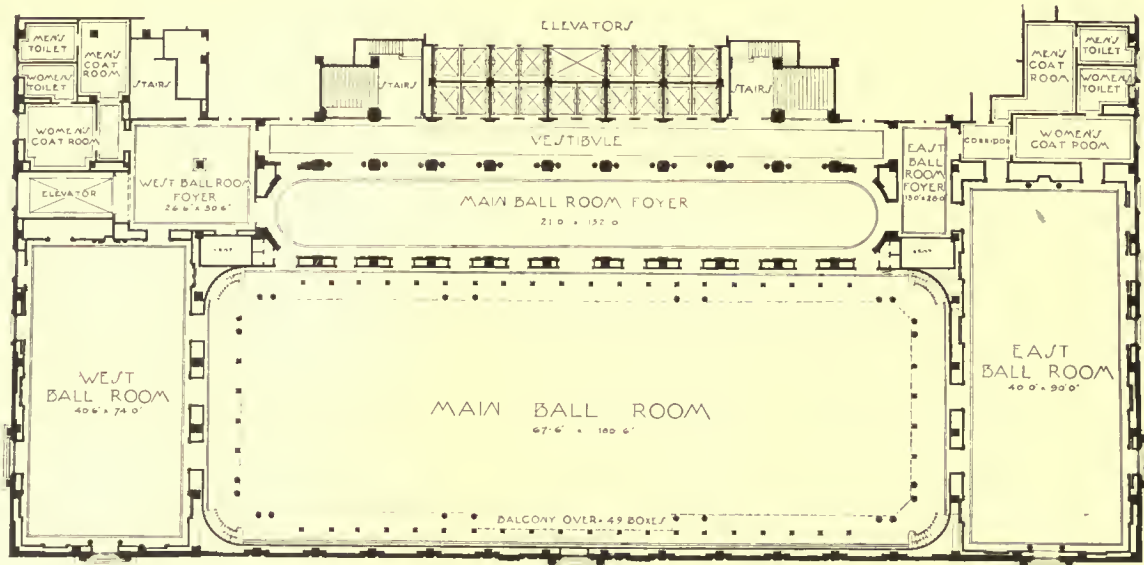

BALLROOM FLOOR PLAN

decorated boxes along the gallery railing, containing palms and other green plants. The mezzanine floor serves as a lounge, from which there is access to many well-appointed writing rooms.

The arrangement of the lobby provides opposite sides for men and women. At the right of main entrance are located the public rooms for men, the main offices, café and other utilities, while at the left are grouped the women's rooms, florist stands and other conveniences.

An unusual feature in the location of the kitchen is that four rooms are directly served from one kitchen. This kitchen is above the street level and is daylighted. It serves the main dining room, the

lighting is by an indirect system. The decorative scheme is made up of an admirable arrangement of orchid purple, white and gold, with a base of emerald green.

The foyer extends the entire length of the ball room, while the entrance is in Depew Place above the Forty-second Street level, obviating the necessity for guests passing through the main hotel lobby.

Owing to the elevated railway tracks along Forty-second Street, soon to be removed, it is not possible to secure satisfactory exterior photographs of the Commodore, as there is no location for a camera that will avoid the interposition of the elevated tracks.

THE AMERICAN ARCHITECT

Founded 1876

PUBLISHED EVERY WEDNESDAY BY

THE ARCHITECTURAL AND BUILDING  
PRESS, INC.

No. 243 West Thirty-ninth Street, New York

E. J. ROSENCRANS, PRESIDENT AND TREASURER  
WILLARD C. HOWE, VICE-PRESIDENT

WILLIAM H. CROCKER, Editor  
ARTHUR T. NORTH, Engineering Editor

Subscriptions in the United States and Possessions,  
Mexico and Cuba, TEN DOLLARS. Other Countries,  
TWELVE DOLLARS.

SINGLE COPIES (Regular Issue) 25 CENTS

CHICAGO OFFICE, Mallery Building  
PAGE A. ROBINSON, Western Manager  
ST. LOUIS OFFICE, Wright Building  
CLEVELAND OFFICE, Guardian Building  
SAN FRANCISCO OFFICE, 320 Market Street

Owned by United Publishers Corporation—H. M. Swetland, President;  
Charles G. Phillips, Vice-President; W. H. Taylor, Treasurer;  
A. C. Pearson, Secretary. Entered as second-class matter January  
6, 1909, at the Post Office at New York, New York, under the Act of  
March 3, 1879.

VOL. CXV      MARCH 5, 1919      No. 2254

Program of the Post-War Committee

THE preliminary program of the Post-War Committee as outlined in a résumé prepared by Mr. Robert D. Kohn and printed in our issue of Feb. 26, presents a comprehensive study of existing conditions in the field of architectural practice and certain axiomatic conclusions of which a profession-wide criticism is asked.

It is urgently desirable that an objective so very commendable, one that will favorably affect in its ultimate conclusions every architect irrespective of affiliation, should receive the whole-hearted co-operation of the entire profession.

When the last word of counsel and advice has been received and digested, the work before this committee will be the task of putting into concrete form such measures as will secure every desirable end. This whole matter can only be regarded with enthusiasm and satisfaction, but it may be well to add that any plan, however admirably conceived, has no value unless it is relentlessly pushed to a practical conclusion. It will require an unselfish giving of much valuable time by many men, and as for this reason it may become handicapped, it would seem wise for the profession to provide a fund that would enable the committee freely to employ the clerical labor that will undoubtedly be required.

As the committee is not one purely of the Insti-

tute but of the profession as a whole, the matter becomes one of interest to every man who practices architecture or whose work is dependent on architects for support. Such a fund could be readily raised and would put the whole matter on a basis of such practical method as greatly to aid in its successful outcome.

The whole question involved in this proposed reorganization of the profession is one of right relationship—architects, one to another, to their clients, to the contractor, to labor and to the world at large. Most of the things about which complaint has been made in the past have been caused by a lack of proper relation such as other professions hold toward their field and toward the world. This brings up many questions: ethics, the true function of the architect, the exact relation of the architect's work to the arts and to commercial activity. The architect's relation in the past, or what he has incorrectly supposed to be his relation toward his work, cannot today be taken as a starting point from which to plot a diagram of his newer tasks. We have in two years entirely rewritten the laws regulating not only our professional but also our daily lives. We shall have to take as our rule and guide the conditions that surround us, and so govern our rebuilding as to have for the newer structure we shall erect, a firm foundation.

That the proposed program largely works toward this end is its greatest strength.

It would have been inconceivable three years ago that any proposal to regulate the practice of architecture could have been so drastic in its provisions and so radical in its recommendations. If, during the convention held three years ago, a member of the Institute had asked if it was not necessary for architects to become better known as business men and not entirely as artists, he would not have been taken seriously. Yet this program proposes to discuss and finally declare just exactly whether the practice of architecture is an art or a business.

It is a source of satisfaction to learn that the main points of this well-prepared program are in their essence identical with the very reforms which THE AMERICAN ARCHITECT has proposed during the past eighteen months.

THE AMERICAN ARCHITECT, in holding out for a better interpretation of relationship, early advanced the opinion that architecture while always an art was equally a business. It has been adversely criticized for what it was charged was a deliberate attempt to deprive the practice of architecture of its high dignities. Its retort was that the assumption of these dignities, often without due qualifications, was the main reason why architects did not receive recognition.

The program of the Post-War Committee, while



merely referring to this phase of relationship, asks that a very full expression of opinion be made. It is safe to assume that there will be a large sentiment endorsing the contention made in these pages and set forth in its declaration as to what constitutes the real practice of architecture.

The work is but begun and the road is long and beset with many difficulties. Every man who practices architecture should give his earnest support to the Post-War Committee which in its present attitude is the most democratic and therefore the most American that has ever been shown by the profession of architecture.

### State Societies

ARCHITECTS will generally agree with the statement made by Irving K. Pond, past president of the American Institute of Architects, in a letter addressed to *THE AMERICAN ARCHITECT*, and printed in the issue of February 5.

Writing on the subject of the formation of State Societies of Architects in all of the States, and more particularly in those where licensing laws are now in force, Mr. Pond stated:

"As one of the paths toward the higher plane, I regard State societies of professional bodies; and as ministering to the general unification of ideals I welcome an affiliation of such societies.

"But to be specific, when all has been accomplished in the way of forming and amalgamating State societies of architects there will always be an idealism a little in advance; there will always be a need of the leader, the one to whom all must look for the expression and interpretation of the finer professionalism. The American Institute of

Architects holds that place to-day, and will continue to hold it if it does not yield to clamor from without and debasing elements within. An amalgamation of State societies has its place and the Institute has its, and the place of the Institute is that of professional leadership which can be abandoned only at the expense of the highest good."

The American Institute of Architects, as the ranking national organization, and the various State societies, each working for the common good in their respective States, would correspond to our Congress and its two legislative subdivisions. There is every reason to believe that an organization of this sort would not only represent the entire profession of architecture, but in the striving to secure the most desirable results, show to all the world the true meaning of the practice of architecture.

The initiative in this matter will largely rest with the State societies, and it would seem logical to expect those already organized to exert by well-conducted propaganda an influence on the men practicing in States where no society now exists and at once to set about the necessary preliminaries looking to a State organization.

In the federation of such societies—and why not as an initial movement to federate those already in existence—we would have in this country two working bodies whose influence for good and whose opportunities for performance would be the liveliest factor in architectural organization.

The Institute, in the work outlined in its admirable post-war program, will be so busily engaged in carrying it forward to successful conclusion that the matter of the further organization of State societies and their ultimate federation can well be assumed by the State societies without calling on the Institute to interrupt the work now in hand.



# Criticism and Comment

## A Leadership in Art

AN INTERESTING COMMUNICATION FROM THE VICE-PRESIDENT OF THE NATIONAL ACADEMY OF DESIGN.

*The Editors, THE AMERICAN ARCHITECT:*

I have read with interest the editorial in *THE AMERICAN ARCHITECT* for January 29, entitled "A Leadership in Art Needed," and I feel that the inquiry made in it, as to what are the relations of the National Academy of Design toward the matter of memorials and other questions which refer to art, deserves answer.

The article is somewhat of an arraignment of the Academy for inaction and indifference. It states that the "silence between its recurrent picture shows is profound"; that "when we were at war, the Academy as *the* Academy was not in evidence." It expresses the fear that apathy exists in the Academy "that needs the spur of sharp but well-meant criticism to awaken this organization to a full sense of its responsibilities and the great opportunities which are presented for a useful activity." It is not so much, however, against the Academicians themselves, whose services are generously acknowledged, as against the Academy as an institution that the criticism is directed.

As an officer of the Academy, permit me to thank you for the concern felt and the advice offered, especially for the suggestion that "its officers might become more actively identified with national movements in art" and "that its councils might discuss important art matters, etc."

With you I deeply regret the fact that the voice of the Academy is not louder. I acknowledge that its activities beyond its exhibitions are not so much in the limelight as should be those of a body enjoying its inheritance; and that this fact certainly justifies inquiry if not criticism. But however non-apparent it may be, the fact remains that a vast amount of good work has been accomplished for which the Academy should receive credit. It has not been blazoned forth because of existing conditions confronting the Academy and against which it has long contended. It has felt it could accomplish the most good for art by co-operation with the other art organizations, and it has consistently followed this policy even in the recent war work, where, through its officers, it has taken its part in organizing and directing the work of the Division of Pictorial Publicity and of the Art Advisory

Committee of the Liberty Loan Committee. Furthermore, at the present moment it is actively at work in co-operation with the Architectural League and a group of manufacturers in establishing student workrooms for practical industrial art study.

Of course, its New York exhibitions *are* its main performances, although the importance of its schools for drawing and painting, where instruction is given to over three hundred pupils annually, should not be overlooked. It has also furnished from forty to sixty per cent of the annual and special exhibitions in other large centers. But in addition to its exhibitions, important civic and national questions have crowded upon the Academy which it has not ignored. It has, on the contrary, devised efficient methods of dealing with them. Take civic art questions for example. In 1895 the Academy and the Society of American Artists—now happily united—led in the creation of the Fine Arts Federation of New York, a body devoting itself exclusively to such questions. Other organizations were asked to co-operate in order to avail of all the best talent in the city whether in or out of the Academy. Thirty of its present members are and six of its seven presidents have been Academicians. The standing committees of this Federation have dealt with innumerable questions from lamp-posts to Soldiers' and Sailors' Monuments, and on these committees the Academy has always placed its most qualified representatives. The debt which New York owes to this organization is largely a debt to the Academy, though its actions are not proclaimed directly from its council room.

Again, your editorial speaks of the Art Commissions of cities and holds them up as models for the Academy. It asks, "Why not a bureau of the Academy equally advantageous to the community?" But, I ask, would any of these art commissions be in existence to-day if it were not for the Academy? Certainly the first one—the Art Commission of New York City—owes its origin to the Academy, acting again through the Federation; and as to the source of its power for artistic effort and judgment, will you kindly look at its personnel—even its lay-members are nominated by the Federation. The example has been followed in other cities. A grand achievement—largely brought about by the Academy.

It played its part also in the conception of a United States Art Commission to be located at Washington and to deal with national questions related to the fine arts, as it did last November with



## THE AMERICAN ARCHITECT

the question of what monument of Lincoln should be presented to London. The National Academy in this case furnished from its council room the data clarifying the situation. This National Commission owes its existence to much the same source and has drawn its professional members almost entirely from the ranks of the Academy.

And now let me tell you that the movement on which we must count for better memorials is well in the hands of Academicians. It was initiated by eight members of the Academy, assisted by a few others, including three laymen. These again found it better to operate, not directly, but through the organization having the most widespread membership, viz.: the American Federation of Arts. Even the Fine Arts Federation of New York, which immediately took up the question, agreed to this. In this decision you will see the kernel of the whole matter.

Your comparison of our problem with that of France, to the detriment of the Academy, takes no account of the difference in the situations. In France, Paris is the center of all radiation. New York does not hold the same relation to this country. A National Art Commission should be located at Washington. This was a necessity, and the Academy has lent all its efforts to its establishment and effectiveness. In France the Government stands behind art—acknowledging its worth as an enormous national asset. We are not so enlightened here, where art must take care of itself. The burden on the Academy is therefore a heavy one. We are still in the stage where American art patrons prefer to build up museums of past art—indispensable in their way. Until American patrons begin to stand behind the living art of their own nation, so long will the Academy be kept out of its own.

The National Academy will have to continue in this course for the present and do all the good it can by the means which it has provided and which are the best now at its disposal. The great thing is not publicity, it is accomplishment. And if journalists would inform themselves and would offer help instead of criticism the results would be more easily achieved.

The Academy looks forward to the day when its position as the source of sound effort throughout the nation will be more easily understood and acknowledged. That day will come when the Academy is properly housed in a building adequate to its own needs and to the needs of all other forces for good art in this city. The National Academy Association has been organized to erect such a building and to manage it. It would be the center of all current art activity. It would be known as the National Academy Building, and not only would it enable the Academy to make its exhibitions cover

every branch of art and welcome all artistic design but it would centralize all the scattered forces that make their appeal to the country, enormously increasing their influence and the prestige of the National Academy itself. The questions of site and financial support have thus far prevented the consummation of this ideal.

In saying what I have about the work accomplished and under way by the Academy I do not wish to underestimate the share done by others associated with it. That is one reason why the Academy has not proclaimed results more loudly. It believes that actions speak louder than words, and let me, in closing, call your attention to a list of only a few of the artists who, in our own day, have stood for good art in this community, serving as representatives of the Academy in the channels pointed out above: Francis D. Millet, John LaFarge, Chas. F. McKim, Augustus St. Gaudens, John W. Alexander, John M. Carrere, Herbert Adams, Edwin H. Blashfield, Kenyon Cox, Frederick Dielman, Daniel Chester French, Francis C. Jones, Thomas Hastings, Douglas Volk, H. W. Watrous, and a host of others. These have lifted art in the community, working for the public good. Of course there are many members whose work lies in the studio and not in the forum, but the Academy has not been lacking in men willing to sacrifice time and energy outside of the studio. I wonder whether any other profession gives itself so ungrudgingly and without compensation in public sacrifice. The lament goes up from many studios—Oh, for time to work; and the pleasantries go around, "The American Artist does not work, he serves on Committees."

HOWARD RUSSELL BUTLER,  
Vice-President National Academy of Design.

---

### The Quantity System

*The Editors*, THE AMERICAN ARCHITECT:

The quantity system as a means of eliminating the factor of doubt in the predetermination of cost seems to me entirely without merit. In the affairs of the contractor and the owner there will continue to exist a gamble on the final outcome. And this whether the contract sum be arrived at by the contractor through the exercise of his own skill or by calculations based upon a bill of quantities furnished by one called a quantity surveyor, who claims to know better than the contractor how to prepare such a schedule.

Mr. Wm. Graves Smith, in his letter appearing in your January 29 issue, asks what it is that obliges a contractor to become a gambler. An-



## THE AMERICAN ARCHITECT

swered in the same sense as propounded, the answer to this query is: Nothing at all, provided he understands his business. Answered in another sense, however, it seems proper to remind Mr. Smith that nothing does or can prevent the contractor being a gambler. If he does not play the game a winner he should, and generally does, return to the ranks of the journeyman, where he more properly belongs.

We all gamble who are ambitious and seek to better our condition. We always will until we have individually outlived our usefulness. Life without the speculative factor does not, in the nature of the case, look attractive to red-blooded men living under conditions peculiar to democracies.

Mr. Smith evidently thinks that the only element of gambling in contracting is that associated with the taking off of quantities, and in this I do not agree with him. His conclusion that if competition be put on the basis of constructive ability and management the contractor will cease to be a gambler (the natural inference being that the general adoption of the quantity system would bring about that condition) seems wholly unjustified by facts. Quality is not measured by quantity and cannot be fixed by mere listing.

FRANCIS W. GRANT.

Seattle Washington.

*The Editors, THE AMERICAN ARCHITECT:*

The engineering articles published in AMERICAN ARCHITECT have been read with interest, as our firm is endeavoring to keep up with the latest developments along the line of scientific construction and equipment of buildings.

In this connection, I cannot refrain from commenting upon the published letter in issue of Dec. 4, 1918, entitled, "Skin Specialists," in which it is charged that architects are in general ignorant of engineering and devoid of interest in the structural necessities of the buildings they design. The writer must be very unfortunate in his acquaintance among those who claim to be architects, to have arrived at such conclusions. In fact, it would seem that his acquaintances are not architects at all.

An architect must approach his building problem with an all around comprehension of its needs, and while he is modelling the exterior he must also be arranging consciously or sub-consciously the skeleton of its inner construction and utilities. He may be expressing himself in advance structurally without calculation of weights or stability just as a writer expresses himself grammatically, without diagramming his sentences, because like the writer, he has been trained in structure until his natural artistic

expression is necessarily correct in structure. No man is entitled to the name of architect who does not work in this way and the writer is not acquainted with any architects who work any other way.

The "Skin Specialists" described in the letter referred to must be examples of training in which too much emphasis is placed upon specialization. There is enough tendency toward specializing in the business of architecture. The term should not be carried into the education of the architect.

HOLMES & FLINN,

Chicago.

*The Editors, THE AMERICAN ARCHITECT:*

In your issue of Jan. 22, 1919, there is a reference to some comments by William C. Hays of San Francisco in *The Architect and Engineer of California*, on the recent competition for some State buildings in Sacramento, Cal. I have not seen the original article, but it seems to me that your abstract is somewhat misleading.

In the first part reference is made to "well-warranted criticism of the Institute code," and the balance of the article proceeds to point out various unsatisfactory features of the competition, because, in the instances complained of, the spirit of the code was violated. It seems scarcely necessary to suggest that a competition code cannot be held responsible for unsatisfactory conditions arising from a failure to follow the letter or spirit of the code.

The only specific criticism of the code I observe is in the fourth paragraph, which says, "In the 'open' form the code contains a very serious fault in that this 'evidence of education and experience' shall be offered by all competitors *after* incurring the expense of the preliminary stage." I do not understand the point in this comment. The first stage in an open competition as contemplated by the code is merely for the qualification of competitors in the second stage, and the latter is the real competition. In almost any conceivable circumstances the submission of evidence of education and experience fills every requirement for qualification, and where, for any extraordinary reason, drawings are found necessary they should be of the "slightest nature," as the code plainly states, and the evidence accompanies them. The obvious intent of the code in respect to the first stage is to limit to the minimum the burden of labor and expense required of the architects desiring to qualify for the final competition.

The extravagant and burdensome requirements of the first stage of the Sacramento competition seem to me to have been wholly unnecessary, although unfortunately the response of the profession appears to have justified the demands of those

in charge of the competition, if it be true that sixty-five competitors submitted designs. Why should not the commissioners have asked for whatever they thought they wanted when so many architects proved themselves willing to undertake such an excessive amount of work and expense merely for a chance to compete further? I quite agree with Mr. Hays's comment in this regard.

The code no doubt has its defects, but I cannot see that any have been developed by this competition. No code will work by itself or without the intelligent and sympathetic co-operation of the architects themselves. The Sacramento program was approved by the San Francisco sub-committee, although this committee had power under the code to refuse approval. None of the architects who

were in touch with the situation during the time the program was under consideration appealed from the approval of the local sub-committee to the Institute Committee on Competitions, as they were warranted in doing within a reasonable time after the program was issued. If they had made such an appeal, it is quite possible that the profession would have been saved many thousands of dollars. When members of the Institute do not insist that the spirit of the code be carried out in competitive programs, or fail to avail themselves of the remedy it provides in cases where that spirit is violated, a situation is created, it seems to me, that reflects elsewhere than upon the code.

JOHN HALL RANKIN.

Philadelphia, Pa.

## Recent Legal Decisions

### STATEMENTS IN STOP NOTICE TO OWNER

Prior to its amendment in 1910, under the New Jersey Mechanic's Lien Law, section 3, the failure of a materialman to state in his stop notice with absolute accuracy the amount of the debt due to him was fatal to his right to recover under that section. And this was true even where the variation between the amount actually due and that claimed was slight, and had resulted from an honest mistake. To relieve to some extent the burden resting upon the materialman, the amendment provided that he should specify in the stop notice the amount due to him "as nearly as possible." But it is held that, in order to take advantage of the statute, when it appears that the amount specified in the stop notice is in excess of the amount actually due, the burden rests upon the materialman to show that the excessive claim was not the result of carelessness, and that the mistake had been made notwithstanding the fact that he had used every reasonable effort to ascertain with exactness the amount which he was entitled to impound in the hands of the owner.—*Tuttle v Cadwell, New Jersey Supreme Court, 105 Atl. 11.*

### MATERIALS FURNISHED SUBCONTRACTORS ON PUBLIC WORKS

A statute was passed by the Legislature of Washington in 1915 providing that those furnishing materials to subcontractors for public work should give written notice thereof to the principal contractor within ten days of commencing to deliver the materials as a precedent to suit against the con-

tractor or his surety. A company who delivered gravel to a subcontractor for county work failed to give this notice, relying solely upon the notice and claim which it filed with the county auditor within thirty days after the completion and acceptance of the work. Under the contract the county retained a reserve fund. It was held that the materialman was not entitled to participate in this reserve fund. Prior to the enactment of this statute, the creditors of a subcontractor were without recourse against either the property or bond of the principal contractor, and the only creditors who could participate in the reserve fund, which was considered a trust fund, were those of the principal contractor. The effect of the act was that the creditors of a subcontractor, on complying with the conditions therein stated, might become creditors of the principal contractor and recover on his bond, and consequently from the trust fund. But to have this effect, they must qualify themselves by complying with the statute.—*Denham v Pioneer Sand & Gravel Co., Washington Supreme Court, 176 Pac. 333.*

### SURETY BONDS—EXISTING DEFAULT

While there is some lack of uniformity in the cases in different jurisdictions, the rule seems to be that, where the principal is in default and the surety executed the bond in ignorance thereof, he will not be bound, where knowledge of such default was withheld from him by the obligee; but where the surety has knowledge of it, he will be bound.—*Park Paving Co. v Kraft, Pennsylvania Supreme Court, 105 Atl. 39.*





PLATE 69

THE COMMODORE—A NEW HOTEL ON PERSHING SQUARE, NEW YORK  
WARREN & WETMORE, ARCHITECTS







PLATE 70

LOBBY

THE COMMODORE—A NEW HOTEL, ON PERSHING SQUARE, NEW YORK

WARREN & WETMORE, ARCHITECTS







PLATE 71

MAIN DINING ROOM

THE COMMODORE, A NEW HOTEL ON PERSHING SQUARE, NEW YORK  
WARREN & WETMORE, ARCHITECTS





PLATE 72

THE GRILL

THE COMMODORE—A NEW HOTEL ON PERSHING SQUARE, NEW YORK

WARREN & WETMORE, ARCHITECTS







ENTRANCE TO MAIN DINING ROOM FROM LOBBY



PLATE 73

MEN'S LOUNGE

THE COMMODORE—A NEW HOTEL ON PERSHING SQUARE, NEW YORK  
WARREN & WETMORE, ARCHITECTS







BALL ROOM



PLATE 74

BALL ROOM LOBBY

THE COMMODORE—A NEW HOTEL ON PERSHING SQUARE, NEW YORK  
WARREN & WETMORE, ARCHITECTS



THE AMERICAN ARCHITECT

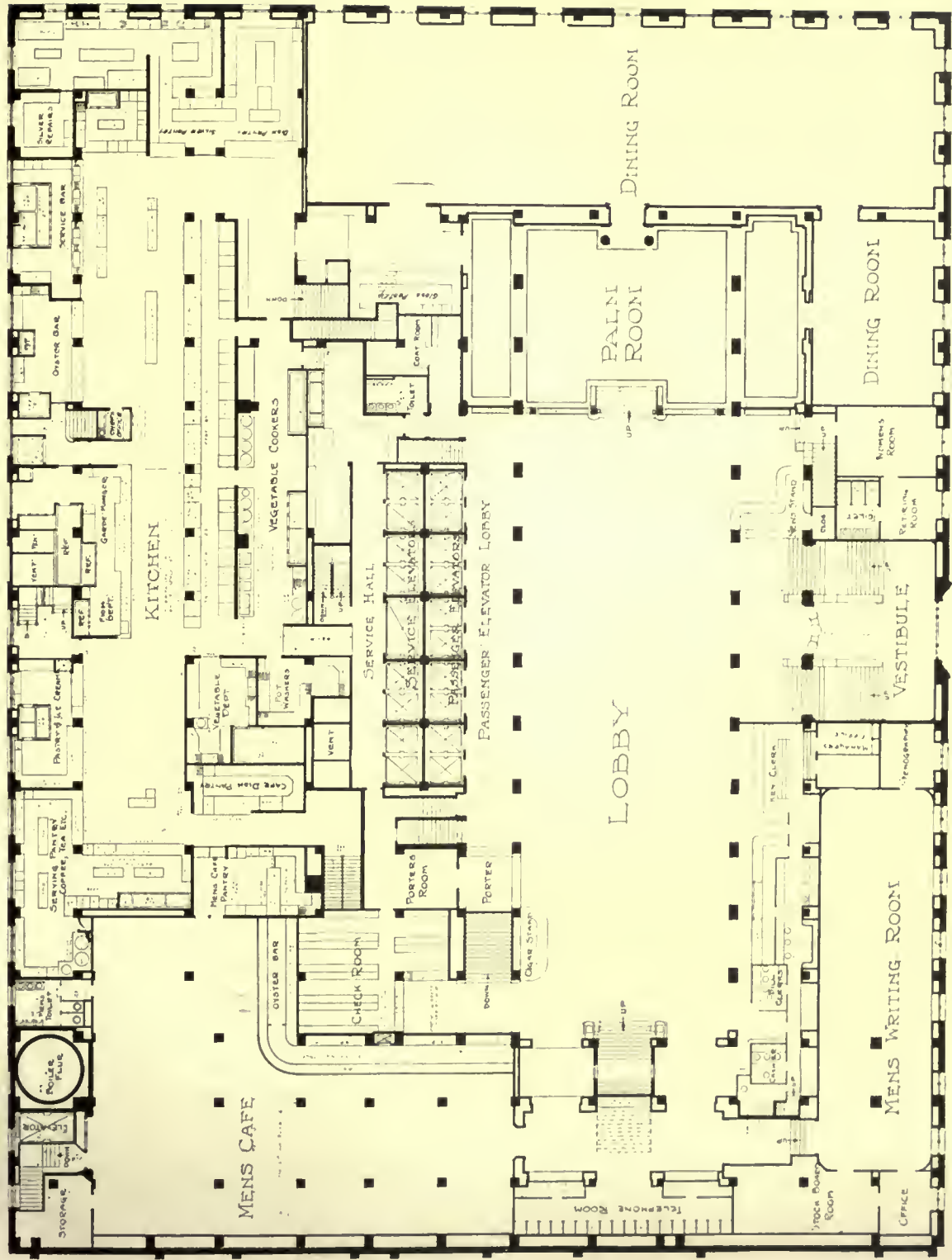

THE COMMODORE—A NEW HOTEL ON PERSHING SQUARE, NEW YORK

WARREN & WETMORE, ARCHITECTS





40 - THIRD ST

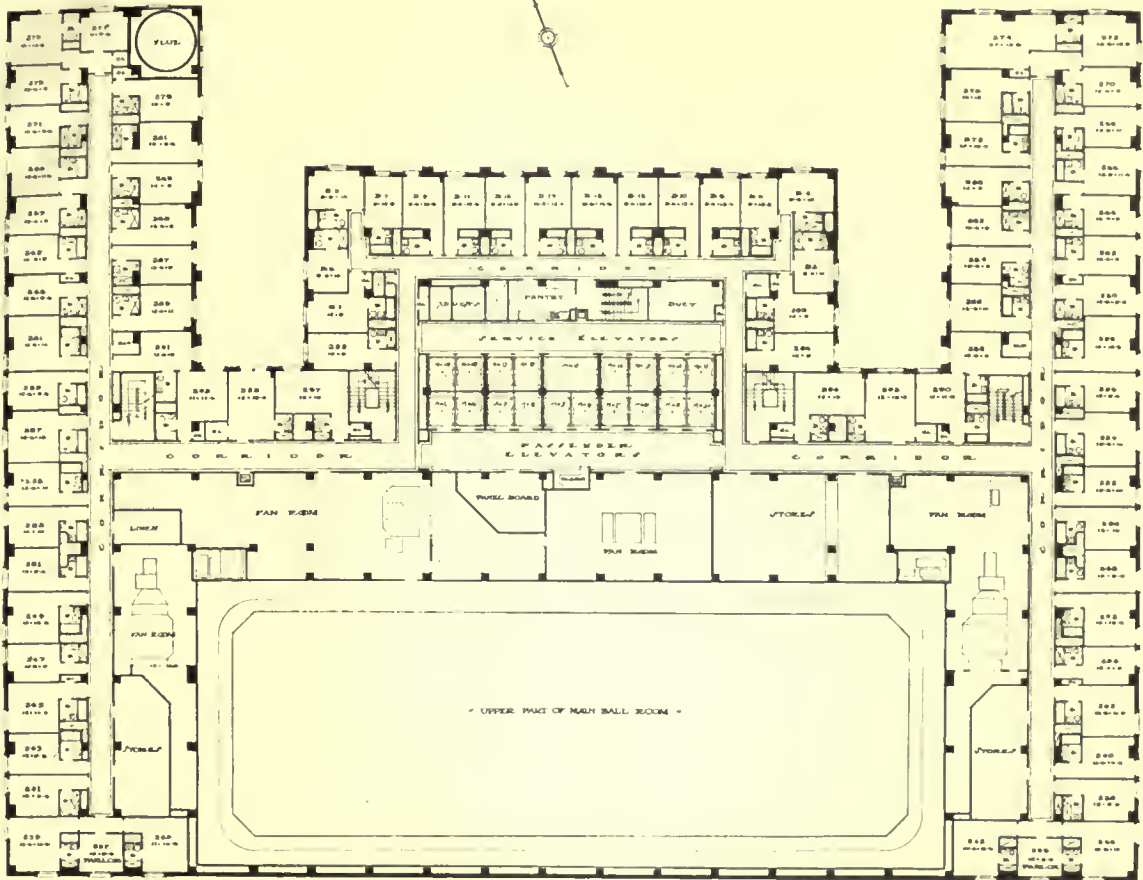

SECOND BEDROOM FLOOR

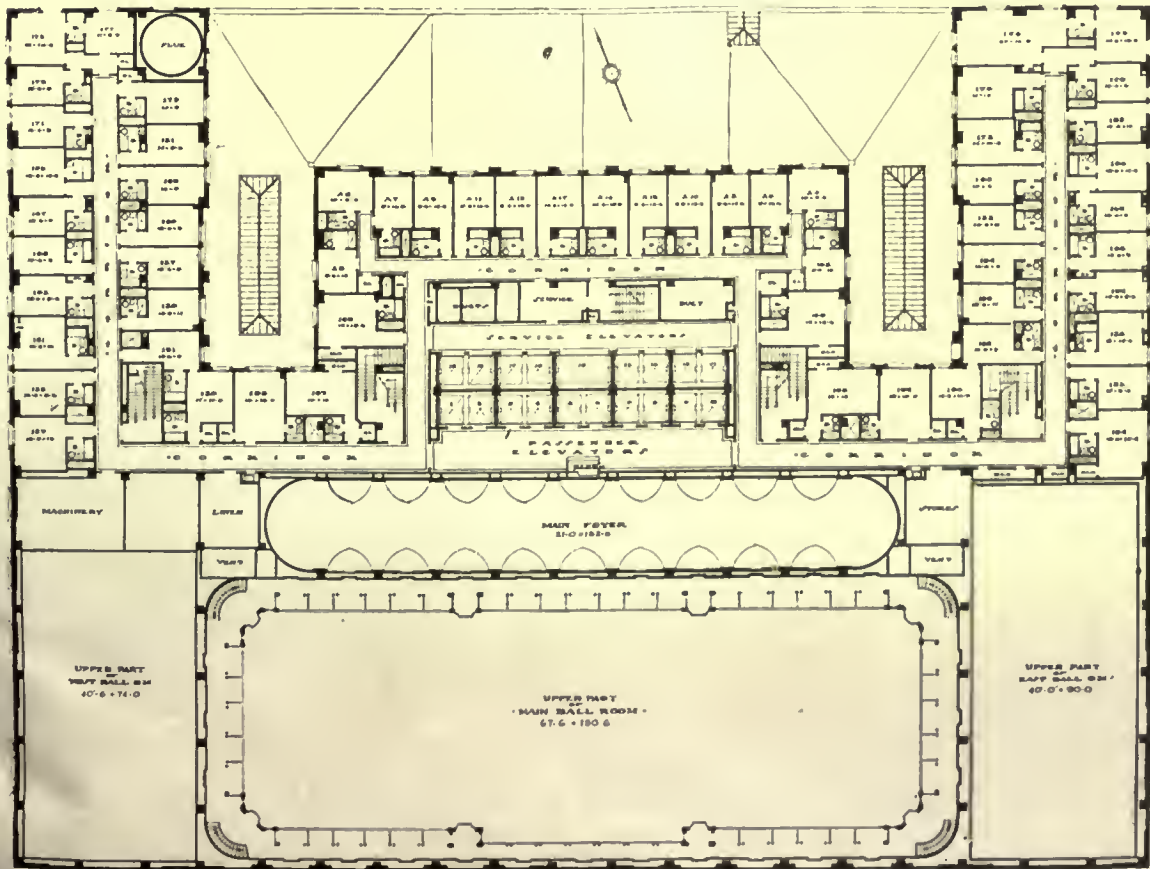

FIRST BEDROOM FLOOR





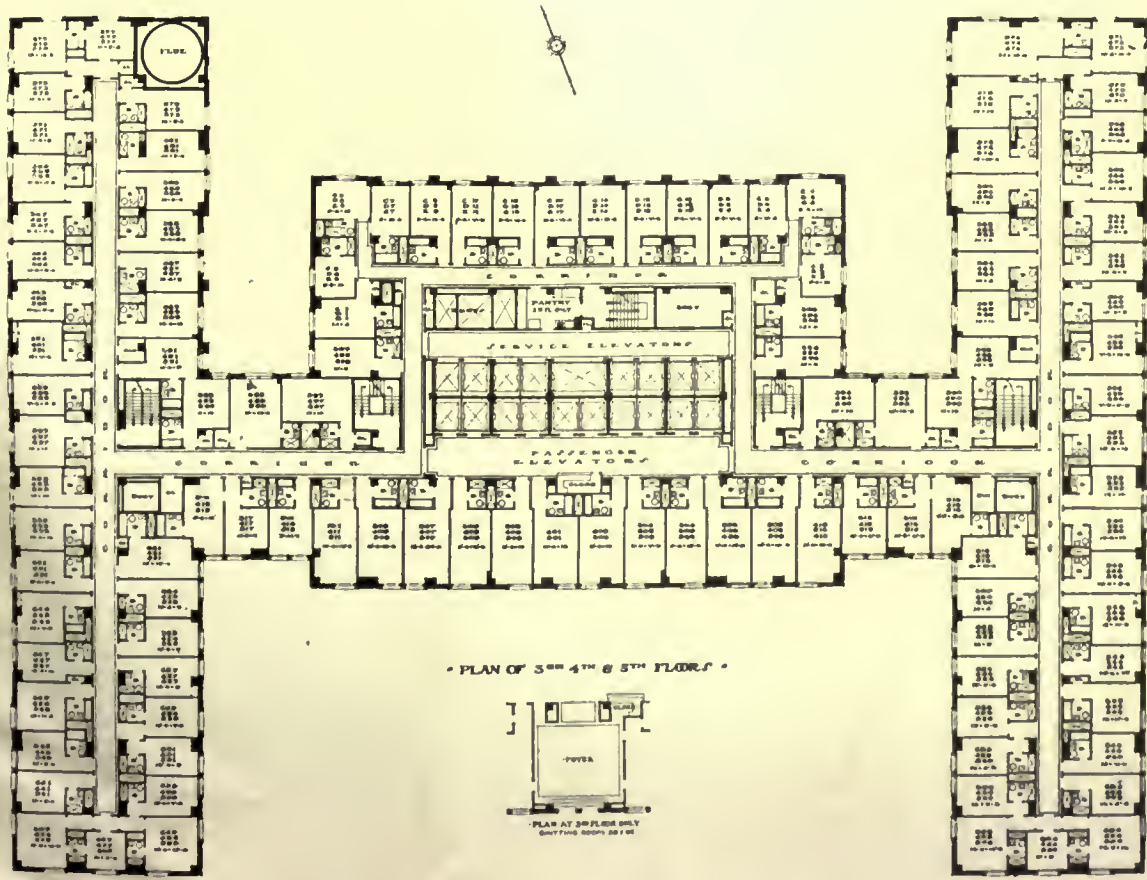
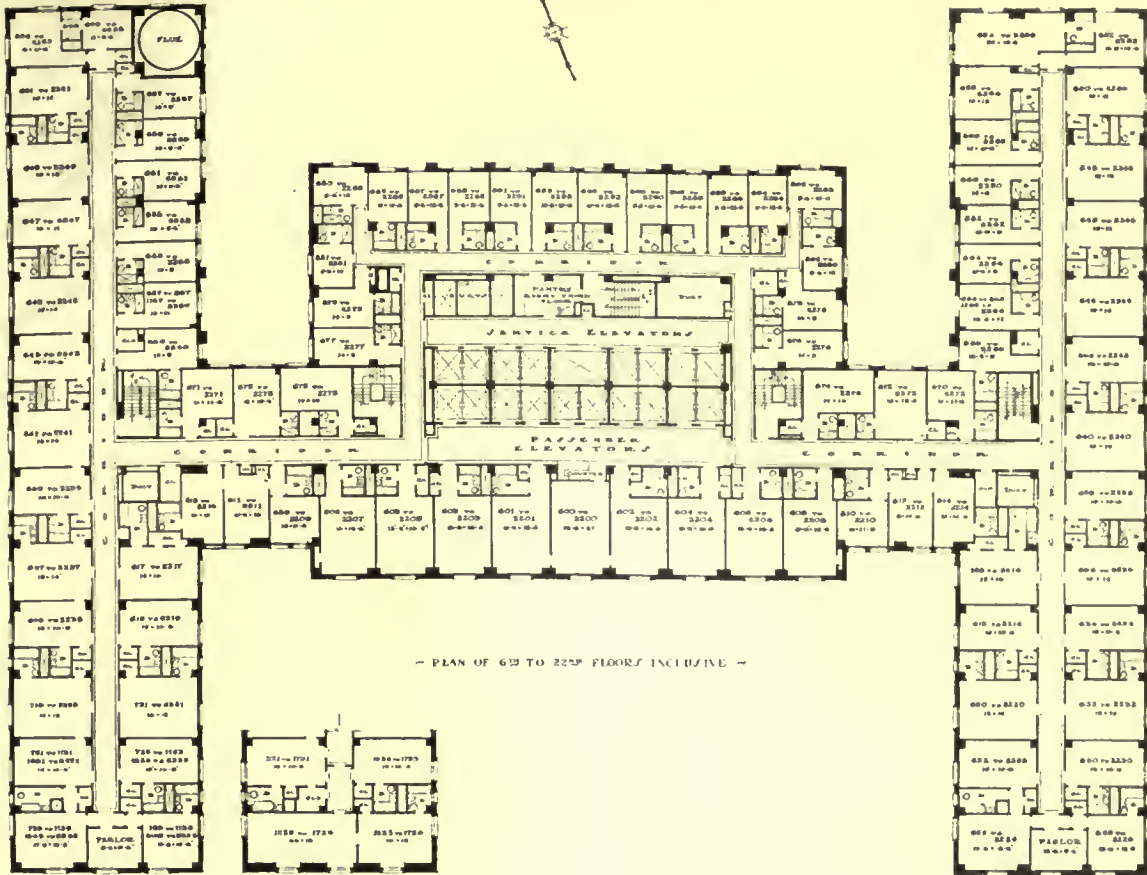

PLATE 77

THE COMMODORE—A NEW HOTEL ON PERSHING SQUARE, NEW YORK

WARREN & WETMORE, ARCHITECTS



# Financial and Commercial Digest

As Affecting the Practice of Architecture

## Scores Business Timidity

Charles T. Clayton, director of the Training Service of the Department of Labor, who is in touch with business enterprises in all parts of the United States, describes the present business situation as nothing more serious than a psychological state that has induced timidity.

"Business is positively going ahead," Mr. Clayton says, "and the biggest men of the country know it. I know that one of the largest railroad companies in the United States has been advertising for weeks trying to get machinists. At the same time, there are thousands of machinists out of work. The explanation is that most of these men are really not machinists at all, but machine operators. They haven't the real knowledge of machine work that they absolutely must have to make good. It is a fact, too, that the Employment Service recently examined a number of machinists for 156 jobs open to qualified men. Of about the same number of applicants, only three were found competent. In one community where there were 9000 alleged machinists, only 211 were qualified for real machine work.

"A great many industries in the United States at this minute are running under-manned because skilled help cannot be had. There are jobs enough, and men enough, but the men need training to hold the jobs.

"Business is slack because it is turning the corner; because there is uncertainty about future prices, and because a great many people are taking stock. The most far-seeing business men in America, I know from personal experience, are not delaying their plans for any one of these considerations, and the man who waits is almost certain to get 'stung.'"

## War Trade Balances

The great excess of exports over imports during the war period occurred almost exclusively in the trade with Europe while in the trade with other parts of the world, notably Asia and South America, there was a large excess of imports over exports, says the National City Bank.

In the fiscal year 1915, practically all of which fell within the war period, the excess of exports to Europe over the imports from that continent

amounted to \$1,357,000,000; in 1916, \$2,383,000,000; in 1917, \$3,714,000,000, and in the fiscal year 1918, \$3,326,000,000, while the excess during the months of July, August, September and October, 1918, was \$1,267,000,000, making the excess of exports to Europe during the entire war period more than \$12,000,000,000; and even this does not tell the full story, since over \$1,000,000,000 worth of merchandise for European Russia was sent during the war to her Asiatic ports and recorded by our Government figures as exports to Asia when in fact their final destination was Europe.

## Saving During the War

The savings made during the war were greater than for any other four-year period in the history of the United States. The per capita of savings in banks, trust companies and war savings was \$89.11 in 1914, and \$113.45 in 1918, an increase of 27.3 per cent.

The net earnings of the National Banks of the United States during the last fiscal year were \$212,332,000, the largest on record.

## The War Cost of Food

Figures of food costs obtained by the Federal Bureau of Labor Statistics from more than 2000 retail stores in forty-five cities show an increase of 83 per cent since the beginning of the war.

## Railroad Income Short One-Fourth

The financial results of Government operation of railroads, disclosed by Director-General Hines, show that the new Federal railroad income for the year fell short of the standard return by \$202,135,602. The standard return for the year is given as \$890,385,685. The net Federal income was \$688,200,083.

Operating revenue increased \$853,868,213, or 21.4 per cent. Operating expenses increased \$1,130,770,166, or 40.3 per cent. Net operating expenses decreased \$276,901,953, or 23.5 per cent. Net Federal income corresponding to standard return guaranteed by the Government decreased \$272,292,028 under Government control and operation of the roads, or 28.3 per cent.



The statement points out that wage increases had the effect of increasing the 1918 operating expenses by \$583,000,000. The full effect of the wage increase was not felt in 1918, as some of the higher wages did not go into effect until late in the year, and the effect of these increased wages for a full year could not be shown by the 1918 figures. There are some who believe these wage increases for the full year 1919 will reach \$900,000,000.

### Standardization as Aid to Price Reduction

Speaking on the immediate resumption of building activities as a national asset, F. T. Miller, of the U. S. Department of Labor, said that it is probable that the cost per cubic foot of modern fireproof buildings, up to three years ago, at least, was less than the cost per cubic foot of the old six-story, non-elevator, non-fireproof building of thirty years ago.

This is because of the rapid advance in the art, the manufacture of materials in large quantities, and the more ready assembling of the component

parts through standardization of forms. In the assembling of these materials there are one to two hundred skilled artisans. As inventions and improvements occur—as metal lath is substituted for the wooden, reinforced concrete for brick, the kalamein doors for wooden doors, etc., these trades suffer successively and yet the public is benefited.

In the adjustment of the incidental trade disputes over such matters occurs our greatest trouble, yet this is just the same kind of trouble which occurred in Manchester, England, on the introduction of the textile machinery, and as has occurred in every great industrial center upon the introduction of the labor-saving devices and improvements, each temporarily injuring one trade yet benefiting society as a whole. Less than 10 per cent of our labor difficulties in the building line are due to contests for wages.

Home building and home owning is the basis of the strength of the nation. While the home is not a negotiable investment, history has shown that it pays very large financial returns in the increased efficiency of the family. The home-owning spirit is awakened in about 120 cities throughout the United States for which end agitation is now active.

## Current News

### Secretary Creates Claims Board

To supervise and co-ordinate the work of the various War Department agencies engaged in the settlement of claims resulting from the termination of contracts or other procurement obligations made necessary by the suspension of hostilities, and to authorize and approve such settlements, a claims board has been created by the Secretary of War.

The members of the War Department Claims Board are: Benedict Crowell, Assistant Secretary of War and director of munitions, president; G. H. Dorr, assistant director of munitions; Brig. Gen. George W. Burr, assistant director of purchase, storage, and traffic; Brig. Gen. Herbert M. Lord, director of finance; Lieut. Col. Herbert H. Lehman, assistant to the director of purchase, storage, and traffic.

Special members of the board are W. H. Davis, for Ordnance Department contracts and obligations; Col. C. A. McKenney, for contracts and obligations of the purchase and storage division; Major H. L. Goodhart, for contracts and obligations of the Chemical Warfare Service, Medical

Corps and Signal Corps. Other special members may be appointed by the president of the board when necessary for duty in connection with other procurement bureaus or agencies of the War Department.

### Formulate Plans to Urge Construction Work

With a view of supplying work for surplus labor the Division of Public Works and Construction Development of the Department of Labor last week met with twenty-five representatives of building and loan associations from almost every section of the United States, to formulate plans for necessary construction and obtaining assistance to this end.

In normal times, it was developed during the meeting, ordinary construction work each year aggregated approximately 600,000 homes built to take care of the normal growth of the country and to replace the losses occasioned by fire and other destructive agencies. During the past two years this class of construction work has ceased almost

entirely. Conservative figures furnished by the representatives of the associations indicated that more than 1,000,000 homes are needed to take care of the normal growth and destruction during the past two years. The major portion of this construction, it is believed, has not been abandoned, but rather delayed, and it is with this idea in mind that a way to make liquid the associations' assets is being worked out so as to provide more money to float home-building loans.

Seriousness of the labor situation in Montana has resulted in action being taken, at the instance of Scott Leavitt, Federal director of Montana, by the State County Commissioners' Association, which has passed a resolution urging legislation to increase the powers of county commissioners so that they may undertake construction of public works on a large scale.

Approval of early legislation to broaden the scope of the commissioners' authority, it is believed, will be met promptly, as members of both House and Senate who have been interviewed on the matter have expressed themselves as heartily in accord with the plan.

### The Future of Jerusalem's Architecture

Jerusalem's architectural, political, economic and social future is outlined in the *Spectator*, London. As a result of the great change which has put new life in its veins, it is written:

"The Moslems find comfort in the British assurance that the town planning scheme now afoot will not touch the ancient city within the walls. This scheme does not altogether please the Jews, for it involves the destruction of hundreds of the hideous erections which have arisen outside the walls of late years—shops and dwellings which have ruined the approach to Jerusalem. For the Jew, with all his artistic temperament, is not studious of architectural symmetry, and centuries of Ghetto life have not inspired him with much domiciling taste.

"The plans for the new city have been drawn by Mr. McLean, chief engineer of Alexandria, who was responsible for the Khartoum improvements. Among the chief features of the Jerusalem plans is a splendid boulevard running from the southwest toward the old city, intersected by an arboreous rond-point containing the British War Memorial. In future all buildings are to be in keeping with the local character; no more red roofs, no more flaunting gilded domes and other Neo-Byzantine atrocities. That eyesore, the Kaiser's clock tower, is to come down. The Holy City is hereafter to preserve her architectural soul secure from outside violation, and

with this security, may become one of the most beautiful, as it is the holiest, the most ancient, and the most interesting, city in the world.

"Jerusalem is giddy with prosperity. The British 'Tommy' is here, and a Pactolian stream of piastres floods the shops, bazaars, the very gutters. None so meek, so dull, so unenterprising but can divert some of this torrent; and Turk, Jew, and Gentile, shopmen, curio-sellers, restaurateurs, cabmen, guides, photographers, artisans, hucksters, barbers, shoeblacks, and beggars, are enjoying an affluence they have never known or dreamt of since King Solomon's day. Jerusalem in war time has become very much like one of the numerous febrile, army-infested towns of Northern France, and in her streets a thousand allurements, from cheap jewelry to pink ice cream, appeal irresistibly to the passing thousands of dust-covered soldiers."

### Plans Burial Ground for Our Men in France

A bill has been introduced in the Congress by Representative S. D. Fess, of Ohio, to incorporate the American Field of Honor Association, consisting of prominent and patriotic people throughout the country, to co-operate in selecting and beautifying an estate in France as a final resting place of all Americans who died in battle abroad. The plan is to have a sort of Arlington Cemetery somewhere in France for the American heroes.

### American Art In Luxembourg Museum

An official exhibition of American paintings and sculpture will be held in the Luxembourg Museum in Paris during May and June, it has been definitely decided. The plan was under consideration before the war, but only since the ending of hostilities have definite arrangements for the project been effected.

About one hundred paintings and about twenty small bronzes, busts and reliefs and a few other pieces in marble will be sent abroad, while it is possible that a small number of works in black and white, drawings, etchings and lithographs will be added to the collection. No large sculpture will be taken on account of the limited transportation facilities.

A committee, representative of all phases of present-day art in the United States, and comprising three or four corresponding members who will be professional artists of high standing in other cities, such as Boston, Philadelphia and Chicago, will vote



in the selection of exhibitors. Exhibition will be solely by invitation and the collection will include works of living artists only. It was decided by the committee, working in harmony with the plans of the Paris authorities, that if works of dead artists were considered it would require as much space as is to be accorded living artists, and the purpose of the exhibition is to place before the European world of art a carefully selected collection of representative American art of the present day.

It is also contemplated that a return exhibition of French art in New York will be held next winter.

---

### Salt Lake Predicts Building Boom

Salt Lake City, Utah, expects a building boom in the Spring that will necessitate the services of every workingman in that city. An industrial survey made recently by the labor federation disclosed the fact that many of the leading concerns have already completed plans for construction activities. Records of the federation show that in the past the prosperity of the city has always been assured when the city's financial interests have thrown their resources into buildings and real estate. Many private owners of property in the city have declared their intentions of building homes and making improvements on property.

---

### Colleges to Admit "War Special" Students

The Bureau of Education of the United States is securing for returning soldiers and sailors admission to colleges, which under ordinary circumstances would not be possible because of lack of qualifications and standards. There are many men now awaiting discharge who are not regularly or formally prepared for college, but who are especially intelligent, and, as a result of their army contacts, aspire to have a more advanced training.

The Bureau of Education has obtained the aid of 87 of the best universities in America, who have consented to admit those who do not quite conform to their regulations as "war specials."

Certain qualifications, however, will be necessary, but a lower standard will be made in "war special" matriculants, and in each case where candidates desire to enter courses of study which by their professional nature require advanced and technical preparation, the giving of such examinations as will satisfy the institutional officers of the applicants' fitness to pursue such courses will be had.

### Push Public Undertakings to Completion

Three things may be done in every community in the United States to speed readjustment in industry, prevent suffering and lack of employment, and bring to an end the period of uncertainty between the signing of the armistice and the treaty of peace, according to Geo. W. Coleman of the U. S. Department of Labor. Mr. Coleman has sent to business organizations throughout the country a letter in which he has outlined the things to be done to help aid the new era born amid the wreckage of war.

"See that your town starts at once and pushes to completion schoolhouses and other public undertakings halted by the war," he says. "Projects involving at least \$80,000,000 in schools were postponed last year through military necessity. Even if the country puts \$200,000,000 into schoolhouses this year we would not catch up with the needs of our children.

"The best antidote to the growth of elements of discontent and violence lies in each man owning his own home. The man who is building or in process of paying for a home, which he can call his own, is rarely, if ever, an anarchist. England alone is planning the building of 1,000,000 houses needed to-day, and we are advised that hundreds of thousands of new houses should be put up in America the present year. The citizen who builds a home this Spring will increase the social efficiency of his family and be a public benefactor as well.

"Individually and as a society, work toward the co-operative ideal in community life. Co-operation is to-day succeeding competition as the keynote of modern life and thought."

---

### Raise Fund for National Cathedral

More than \$2,500,000 has already been raised for the building of a National Episcopal cathedral in Washington. Announcement was made this week that the National Cathedral Association is enlarging the organization, begun in 1907, to resume building operations this spring. The cathedral can be completed in three years.

---

### Paint Peace Conference Scenes

The British artists Orpen and St. John have started work painting scenes from the Peace Conference. Both recently returned from the British front, where they have been painting war scenes.



## Making Prosperity Permanent

Temporary and even make-shift buildings are justifiable only when the worth of the things what are housed or to be housed in them are cheap. In countries where life is cheap the places where men live by labor are cheap.

In America cheap livestock, and cheap hay and grain, produced on cheap land, produced conditions where sometimes no buildings at all were provided to house them, and what buildings were erected were of a temporary character.

These conditions are only traditions to the present generation. But they teach a lesson of relative values.

Our fathers measured the cost of building against the value of the grain or livestock the buildings would house, and felt that it was cheaper to spend their time and energy in growing more livestock and grain than in building substantially.

Even if the land became worn out by repeated croppings, it was not worth while to spend time in fertilizing it. It was cheaper to take on more land, or move if the situation was not convenient. The low prices received for farm products in those days nevertheless gave profits from one year's operation of a quarter section of land to buy another quarter section of equally good land. This land was bound to rise in price and rise rapidly. The best interest of the farmers therefore was to put every dollar into more land, rather than into buildings.

They served themselves best by farming as much acreage as possible even though they farmed it inefficiently; and piled grain on the ground until they could find time to haul it to market, and let their livestock take care of themselves by the shelter of a straw stack, or under sheds made of poles covered thatched with straw.

Those days are gone. There were plenty of "land poor" men in the past. They put up with hardships and discomforts. Their belief in the future sustained them, but there was often a woeful waste and an unnecessary waste. The method of operating was unthinkingly followed just because it was "the way everyone did."

While the man of to-day who would allow his machinery, stock and farm products to suffer the onslaughts of wet, heat and cold, without the protection of good buildings, would fail in a short time, there is still a number who have not awakened to the change of conditions—who do not realize the value of permanent building.

The practice of wastefulness survived the economic reason for it. The economic reason we have described. The practice is rapidly disappearing.

The wasteful saving that made farming laborious and colorless drove the younger generation away from the farm. There were none of the graces of life, of the things to satisfy the desire to live and enjoy. The future was always being discounted by the present—putting up with hard labor and inconvenience for good times to come.

Nowhere to-day is there greater opportunity to live normally and enjoy life as on the modern farm. The time when nature was continually lending without interest has passed. We worked Nature to the limit. Now we realize what it is to work with Nature, and get bigger dividends than we got loans from Nature's surplus.

The average price received for stock, hay and grain is so high that we must save every bit of them we possibly can. We cannot afford to let any of our stock die, or any of our hay or grain be destroyed.

Builders have contrived all sorts of structures suited to the farmer's needs. There used to be only one material that could be used—lumber. Now, lumber is being more intelligently used, for we have discovered the uses of other materials for permanent buildings. The farm is now a permanent manufactory of foodstuffs. It can never become "worn out" under modern management. Its buildings must have all the permanence of the modern factory, sanitary, fireproof, sightly.—*The National Builder*.

## Inter-Racial Council Formed

That an active Americanization of our foreign population is necessary in order to eliminate conflicting attitudes and intentions in our readjustment is penetrating the ranks of our people. The subject, with its close alliance to our many problems, has evoked the interest of prominent citizens who have now organized better to help foreigners, and, of course, their chosen country.

The direct aims of the organization are three-fold: First, the education of the immigrant in the language, principles and ideals of the American people; second, industrial co-operation, whereby foreign laborers arriving here may be made to realize their opportunities and the desire of their employers for fair play; third, providing for the various groups, opportunity for association and other national groups, that racial aspirations may be brought into harmony.

The council has been established as a permanent organization, with Gen. T. Coleman du Pont as chairman. Representative men of the principal races from which our immigrants come are in process of being selected for work in this organization.

## THE AMERICAN ARCHITECT

Labor will be represented, and Arthur E. Holder, of the Vocational Education Board, Washington, is also one of the members.

Discussing the objects of the council, Alexander J. Hemphill, chairman of the board of directors of the Guaranty Trust Co., said:

"The first purpose is to create a better understanding and better feeling among the races in America, to the end that not only shall those who constitute our foreign-born population merge themselves effectively into our political and social structure, but that the countries from which they sprang may have a better and more complete understanding of America and its ideals."

---

### Lumber Course Proves of Wide Value

The correspondence course in lumber and its uses, announced some time ago by the School of Forestry, University of Idaho, at Moscow, Idaho, has met with a ready acceptance the enrollment exceeding expectations. The course was offered in response to a demand for information in convenient form, regarding the properties of wood and the adaptability of different woods to different uses.

The topics treated include the structure of woods, physical properties of wood, standard grades and sizes, structural timbers, seasoning and preservation of woods, lumber prices, lumber production and the war-time use of wood.

The course is designed to be of special value to lumber dealers, lumber salesmen, contractors or builders, carpenters, manual training teachers, and others connected with the woodworking industries.

---

### France Offers U. S. Monument Site

France has offered to present to the United States the site for a monument on French soil to American soldiers who died "on the field of honor." Edouard de Billy, of the French High Commission, has sent to Secretary of War Baker the following translation of a cablegram received from Andrew Tardieu, head of the commission, who is now in Paris:

"I am informed by Mr. de Billy that it is proposed to erect in France a monument to the American soldiers who have died on the field of honor. Mr. Clemenceau begs me to advise you that France wishes to offer the ground for the erection of this monument."

In acknowledging receipt of this message, Mr. Baker expressed deep appreciation and added that

upon the passage of legislation pending in Congress he would be happy to take up with the French authorities the question of co-operation from the French Government.

---

### Great Britain Allows Trade in Hardwood

A British order effective March 1 has abolished restrictions on dealings in hardwood timber outside the United Kingdom. A cablegram from the consul general at London states that existing stocks in that country will be sold at public auction. Stocks are approximately as follows: Cypress, 220 carloads; gum, 183; cottonwood, 81; chestnut, 13; ash, 40; walnut, 40; oak, 176; birch, 62; poplar, 525; various other wood, 20; in addition there are about 300 carloads still to arrive.

---

### A Roosevelt Memorial Bird Fountain

Announcement has been made that the National Association of Audubon Societies and affiliated organizations would begin work at once for the erection in New York City or Washington of a Roosevelt memorial bird fountain. Eminent American sculptors will be asked to present plans, it was said, and a national committee of nature lovers and sportsmen would soon be formed to advance the project.

---

### Comparative Cost of a Quarter Century of Building

Shall contractors combine in a State organization to maintain the high cost of building and at the same time reduce labor to pre-war wage conditions?

That was the proposal of Ralph McLeran at the annual banquet of the Sacramento Builders' Exchange.

Mayor Carmichael congratulated about 125 builders present on the fact that the war being over building would resume. McLeran did not think it would unless he could form a combination of contractors and get wages back to "normal." He wanted a State organization of builders' exchanges similar to the State Building Trades Council. He stated that many of the trades had recently demanded and been granted an increase of one dollar a day, some trades now receiving \$9.00 per day. These wages, he said, could not prevail if building was to resume. Furthermore, contractors would have to get together and insist upon the acceptance



by the owners and architects of the lowest bids received.

The acceptance of lowest bids is all very fine in theory and would be ideal from the contractor's point of view, but incidentally I have closed contracts on over twelve million dollars of work during the last twelve years at prices \$1,364,375.21 less than the lowest bids, or approximately 13 per cent of the total cost of the work. Whereas an equal amount of work oftentimes costs more where the lowest bidder must get the job. In other words, the compulsory acceptance of lowest bids is a temptation to bidders to fix prices.

But to reduce wages is not necessary, and I don't think it can be done. If it can, why stop at pre-war conditions? Why not go back twenty-five years and reduce labor to \$1.00 per day?

We can build better buildings to-day with high wages than we could twenty-five years ago with low wages.

The modern printing press turns out fifty thousand papers in an hour, while the old Franklin press could print but 500 an hour.

The tractor to-day can do the work of fifty horses in cultivating our fields. The hoist, the concrete mixer and numberless labor-saving devices and improved methods can do the work that formerly required expensive man power.

Mr. McLeran is wrong.

The following comparative costs during the past twenty-five years is the answer:

	Cu. Ft. Cost
Chronicle Building, 1890.....	.40
Mills Building, 1891.....	.40
Merchants' Exchange, 1903.....	.34
Chronicle, 16-story, 1905.....	.3472
Mills Annex, 1908.....	.26
First National Bank, 1908.....	.44
Insurance Exchange, 1912.....	.282
Mills Addition, 1913.....	.2404
Hobart Building, 1914.....	.3447
Hallidie (glass front), 1917.....	.1513
	WILLIS POLK.

Jan. 17, 1919.

### Detroit's First Builders Show

The first annual Detroit Builders Show will be held during the week of March 15 to 23 at the Wayne Gardens, Detroit, Mich. The exhibition will include a complete display of building products and equipments. It is expected, in view of the present state of the building trade, that there will be a large number of builders present and that the proceedings will have more than usual interest.

### Personals

After serving in the Army Y. M. C. A. for some time, Lee Black, architect, of Lansing, Mich., has reopened his offices at 517 Oakland Building, that city.

A partnership has been formed by H. W. Bueming and Alexander C. Guth, architects. Their offices will be located at 521 Jackson Street, Chicago, Ill.

A partnership for the practice of architecture has been formed by M. B. Rissman and Leo S. Hirschfeld, with offices in the City Hall Square Building, Chicago, Ill.

The firm of Hitchings & Hutchings, architects, has been formed at 176 Federal Street, Boston, Mass. They will be pleased to receive manufacturers' samples and catalogs.

D. C. Newman Collins, architect and engineer, having completed his duties with the Government, has returned to the practice of his profession. His offices will be at 14 John Street, New York.

A partnership to practice architecture has been formed by Edward H. Bennett and William E. Parsons, with offices at 1800 Railway Exchange Building, Chicago, Ill. Mr. Parsons will act as consulting architect for the firm.

The Building Trades Employers' Association of New Rochelle, N. Y., has inaugurated a movement officially endorsing the U. S. Government slogan "Build Now," in the direction of meeting the demand for new houses in that community.

Lieut. Edwin Kopf of the architectural firm of McGuire & Shook, Indianapolis, has been mustered out from service in England and will return to his practice. The office of his firm has been moved to the Indiana Pythian Building, that city.

Harry Marshak, recently with the architectural department of the U. S. Navy at Washington, D. C., and Joseph A. Hickey, formerly connected with the engineering department of the U. S. Rubber Co. at Providence, have formed a partnership for the practice of architecture, and have opened offices in the Strand Building at Providence, R. I. They would be pleased to receive manufacturers' catalogs and samples.

The firm of Whitsitt & Schulzke, architects, has reopened offices at 610 Peoples Bank Building, Moline, Ill., following the discharge from the service of Captain H. W. Whitsitt, of the construction division of the Ordnance Department, who entered the army immediately upon the declaration of war, and Captain W. H. Schulzke, who entered the air service in December, 1917. The firm desires to receive manufacturers' samples and catalogs.



# Late News in Architectural Fields

---

## Lumbermen Confer with Government Officials

Representatives of the Government and the hardwoods and black walnut industries met last week at Washington to give further discussion to the method of procedure for the disposal of Government surplus stocks of hardwoods and walnut lumber that would be for the best interests of the administration and at the same time meet with the approval of the industry.

In the case of hardwoods, those present at the conference agreed that the quantity, less than 9,000,000 feet, was too small to be even a factor in the market. A plan was agreed to by which a committee representing the producers is to act in an advisory capacity to the Director of Sales of the War Department in the disposition of the small amounts of surplus hardwoods not absorbed by the construction bureaus of the Government or by the industry; this committee to advise as to market conditions and to assist in securing purchasers for the stocks as rapidly as they become available. It was agreed by those present that this action on the part of the Government removes these small surplus stocks as a disturbing factor in the hardwood market.

The conference in regard to walnut lumber brought out the fact that the Government representatives having these stocks in charge would so dispose of the stocks as not to in any way adversely affect the market. The plan is under consideration by which these stocks will be disposed of in cooperation with the industry, and the representatives of the walnut industry agreed to submit a proposal for the purchase of these stocks.

---

## French Sand Breaks Commodity Prices

Prices for ordinary building sand, which have been held at practically war levels, were broken this week when dealers flooded the market with French sand which has been brought here in large quantities since the close of the war as ballast in troop ships. Contractors, since the armistice was signed, have been forced to meet the Government fixed price in the neighborhood of \$2.25 delivered, representing a wholesale price of approximately \$1.25 a cubic yard. The price was maintained en-

tirely according to the supply here in the market prior to the movement of troops back to home ports. It was expected that there would be an automatic drop back to proportionately pre-war levels when building sand in this market was 50 cents a cubic yard.

For the past month or so sand from Belgium and France has been dumped on the New York piers in such quantities as to be a menace. When the larger contracting firms found that there was to be no return to lower prices they took the step to force the commodity lower on delivery price in this market. A new material delivery company was organized, and announced a price for ballast sand at \$1.85, or 40 cents below the former delivered market price.

The price of broken stone in New York has also dropped 25 cents a cubic yard, making the quotation to-day \$3.25 for inch and a half and three-quarter-inch stone. The expected \$4 drop in the price of structural steel, the belief that lumber has touched its lowest level, with the rigidity of cement and brick prices, has tended to support the belief in the building construction field that everything is being cleared for the immediate resumption of building construction.

Meetings were held this week by both tile and brick manufacturers to readjust the situation to the best possible position with relation to the builder this spring. The ceramic tile interests met in New York City, while the brick manufacturers convened at Newburgh, both with the idea of putting the market in attractive shape for the prospective builder before the season starts next month.

---

## New Housing Bureau Director Named

The appointment has been announced by Secretary of Labor Wilson of L. K. Sherman, chief engineer of the housing corporation, to succeed Otto M. Eidlitz as director of the Bureau of Industrial Housing and Transportation, the United States Department of Labor, who recently resigned to resume his private business. Mr. Sherman is 49 years old, a native of Massachusetts, and was graduated from the Massachusetts Institute of Technology as a civil engineer in 1892. His experience for the last 27 years has been as an engineer or executive on construction. His offices are in Chicago.

# Department of Architectural Engineering



Port Jefferson, Long Island, N. Y. Alfred C. Bossom, Architect. Started Aug. 1, 1918; photograph taken Dec. 1, 1918. Ready for occupancy.

## Quantity House Production Methods, Construction Branch, Emergency Fleet Corporation

**T**HAT the impossible of yesterday is the possible of to-day has been evidenced in many ways within the past two years. These achievements have demonstrated the ability of this country to satisfy the most onerous demands and the methods by which these things have been done are worthy of study. The knowledge thus gained will exert a powerful influence on future undertakings and can be adapted to many problems not yet solved. Construction projects, on a scale of magnitude heretofore not undertaken, will become comparatively common. This enlargement of such enterprise will be a resultant of increased demands, of a knowledge of our actual abilities and from having accomplished great things.

Construction projects require the employment of two factors, the plan of the architect and engineer

and the construction organization. It is the accomplishment of construction organization that will be here described.

The imperative need of ships made necessary the establishment of a large number of shipyards. As these yards were located near cities already congested the housing of these additional workmen was urgent. The increase in number of the workmen employed in shipbuilding from 120,000 on Nov. 15, 1917, to 384,850 on Nov. 15, 1918, indicates the need of the housing work which was undertaken and carried to completion in record-breaking time. This work was done for the United States Shipping Board Emergency Fleet Corporation as an activity of the Division of Passenger Transportation and Housing. The Production Bureau of the Housing Department had charge of the production of build-



## THE AMERICAN ARCHITECT

ings and the installation of public utilities. This bureau was directed by a chief and a deputy chief of administration, R. D. Kohn and E. J. Russell, architects, of New York and St. Louis respectively. This bureau included the Architectural Branch, in

9 hotels and a number of miscellaneous structures. The buildings are of permanent construction, being of brick, frame, hollow tile and stucco. They are equipped with basements, heating plants, hot and cold water, gas ranges, laundry tubs, kitchen cabi-



Wyandotte, Mich. Branch of Design, Housing Department, Architects. 78 houses, started Sept. 1, 1918; photograph taken Dec. 16, 1918. Houses occupied.

charge of F. L. Ackerman, architect, Chief of Design; the Engineering Branch, in charge of Morris Knowles, Chief Engineer; the Construction Branch, in charge of W. G. Luce, Chief of Construction.

The work of these three branches was of great importance and the co-operation between them was

nets, fully equipped bath rooms with tub, water closet and lavatory, electric lights and fixtures. They were completely finished and decorated includ-



Jacksonville, Fla. H. J. Klutho, Architect. 158 houses. Work started Aug. 28, 1918; photograph taken Dec. 16, 1918.



Lorain, Ohio. Abram Garfield, Architect. 232 houses and 2 apartment buildings.

very effective. The Construction Branch was inaugurated on March 1, 1918, and on Jan. 1, 1919, the work of construction was practically completed on 26 projects, extended along the Atlantic Coast from Florida to Maine and as far inland as Wisconsin.

The work involved included the building of 8949 individual homes, 1119 apartments, 21 dormitories.



Lorain, Ohio. Abram Garfield, Architect. 232 houses and 2 apartment buildings.

ing the wall paper. The work of this branch also included the grading of streets and lots, the building of pavements, curbs and sidewalks, the installation of sewers, gas and water mains, the planting of trees, shrubs, hedges and grass plots. They took



## THE AMERICAN ARCHITECT



Buckman Village, Chester, Pa. G. Edwin Brumbaugh, Simon & Bassett, Architects. Photograph taken Dec. 16, 1918. Houses completed, tree planting in streets under way.

the bare ground and on it constructed complete towns, having every modern improvement.

Practically all materials used in this work were purchased through the Construction Division of the War Department. This was the better method.



Buckman Village, Chester, Pa. G. Edwin Brumbaugh, Simon & Bassett, Architects. 278 houses, 21 apartment houses, 1 boarding house and 1 waiting station. Work started July 1, 1918. Photograph taken Aug. 1, 1918.



Buckman Village, Chester, Pa. G. Edwin Brumbaugh, Simon & Bassett, Architects. Photograph taken Dec. 16, 1918. Many houses occupied.

although it worked hardships in some instances, as it enabled the War Industries Board, who passed on all material requirements in conjunction with the Purchasing Department of the Division, to make surveys of the various material productions in all parts of the country. These surveys embraced the

kind and adaptability of materials, quantity of production, transportation facilities, cost and other factors. These items had to be considered, not only from the standpoint of the project needing these materials immediately, but also with reference to possible developments in the vicinity of the producing locality. It can readily be seen that it would be poor management to make a long haul of materials for one project and deplete the stocks, when



Buckman Village, Chester, Pa. G. Edwin Brumbaugh, Simon & Bassett, Architects. Photograph taken Dec. 16, 1918. Rear yards and service alley at the left, street at the right. Houses occupied.

the same kind of material would later be needed in the production vicinity and thus require another long haul to supply the need.

It was also found that many materials ordinarily used in construction must be conserved for use in the direct prosecution of war. This applied more particularly to copper, cast iron, various oils, lead, bituminous products and other things used in the manufacture of munitions. The serious shortage of fuel made it necessary to use materials, as much

## THE AMERICAN ARCHITECT

as possible, which did not require the use of fuel in their production.

The scarcity of freight cars, the shortage of fuel and motive power to move them and the congestion of the railroads on our Eastern seaboard, made the

is a most notable achievement. The problem was to construct these buildings out of materials, the use of which would least interfere with the vigorous prosecution of the war and on which there were no restrictions and to get them in the shortest possible



South Philadelphia houses, Essington, Pa. Dubring, Okie & Ziegler, Architects. 200 houses and 1 store building. Work started July 10, 1918; photograph taken Dec. 16, 1918.

problem of transportation one of grave importance. This necessitated the elimination of long hauls where possible. It was also found advisable to bring the materials to the seaboard, when possible, at a right angle to the coast line in order to avoid

time so as to not conflict with the Government transportation program, also to carry on the work expeditiously regardless of the serious labor shortage.



Chester Hotel, Chester, Pa. G. Edwin Brumbaugh, Simon & Bassett, Architects. Started July 1, 1918. Photograph taken Dec. 12, 1918.



Dundalk, Md. E. L. Palmer, Jr., Architect. 529 houses, 2 boarding houses, stores and athletic field. Started June 15, 1918; photograph taken Dec. 1, 1918.

transportation through the congested area. It will be readily seen that the selection of the materials, their purchase, transportation and expediting presented an important and complicated problem.

Until the work of the Housing Department of the Emergency Fleet Corporation was undertaken, no development of that kind had ever been attempted on a scale of such magnitude even under normal conditions. When the abnormal conditions that affected every element of such a project are considered and the fact that the work was accomplished with the record-breaking speed that was absolutely necessary in order not to disrupt the Government war program, the work of the Construction Branch



Hog Island Dormitories, Philadelphia, Pa. G. M. Bartlett, Architect. 4 group hotels with dining halls, store building, heating plant, laundry, pump house, bakery and warehouse.

A large proportion of the labor was inexperienced in this class of work and recruited from all parts of the country.



## THE AMERICAN ARCHITECT

It was not necessary for the contractors to devote weeks estimating the quantities and ordering the materials as the Construction Branch was responsible for their purchase and delivery, including the equipment when required. Only contractors of



Union Park Gardens, Wilmington, Del. Ballinger & Perrot, Architects. 510 houses, 1 apartment house and 4 store buildings. Work started July 1, 1918; photograph taken Dec. 21, 1918.

known ability were selected and the work was awarded on a lump-sum fee basis; the Construction Branch furnished the lists of materials, attended to their purchase, quality, transportation and delivery; took care of the funds and payrolls and the adjust-



Yorkship Village, West Collingswood, N. J. Electus D. Litchfield, Architect. 907 houses and 1 schoolhouse. Started May 15, 1918; photograph taken Dec. 16, 1918. Houses completed, road-making delayed by lack of materials for public utilities.



Washington Avenue Apartments, Newport News, Va. Francis Y. Joannes, Architect. 4 apartment buildings with 323 apartments and dormitory rooms. Started June 1, 1918; photograph taken Dec. 15, 1918, occupied.

ment of all labor disputes, the United States Employment Bureau assisting with the recruiting of labor. This procedure left the contractor free to devote his entire time to the work of actual construction.

Mr. M. M. Dyer, of Boston, Supervisor of Estimates of Materials, had charge of making all material lists and quantity surveys. This was a very

complicated problem owing to the fact that the lists had to be made in conjunction with the War Industries Board and subject to their approval. This was necessary in order not to interfere with the general war program. Another factor in this work



St. Helena, Md. E. L. Palmer, Jr., Architect. 206 houses, mess hall and kitchen and power house. Started May 15, 1918; photograph taken Nov. 15, 1918.

was the constant substitution of materials which were, on a moment's notice, withdrawn from use owing to their scarcity or other requirements of the Government. Transportation difficulties also, at times, made substitutions necessary. It was under these conditions that Mr. Dyer was compelled to



Sun Village, Chester, Pa. Branch of Design, Department of Housing, Architects. 430 houses, 18 apartment buildings with stores under 8. Work started July 12, 1918; photograph taken Dec. 17, 1918. Houses occupied.



Hilton Village, Newport News, Va. Francis Y. Joannes, Architect. 501 houses, 2 apartment buildings with stores under, fire house and incinerator.

labor in furnishing the lists which controlled the supply of material to the project.

In order to save time the materials often had to be listed from pencil sketches, and, on many occasions, the materials which it was known would be required, were ordered before any drawings were prepared. They were in transit in such quantities as to be delivered at the site of the project almost coincident with the arrival of the drawings and the contractors with their outfits and equipment.



## THE AMERICAN ARCHITECT

The material lists, when completed, were given to Mr. H. W. Jensen, a contractor of Pittsburgh, Supervisor of Materials Procurement. He had charge of the purchasing and procuring of all materials. These purchases were made through the Construction Division of the War Department by

the kind, quality and quantity of available materials as well as the ability of the various vendors to furnish them. Only in emergencies were materials purchased in the open markets for immediate use, pending the arrival of materials through the regular channels.



Dormitories, Essington, Pa. Duhring, Okie & Ziegler, Architects. 2 dormitories for 614 men, 1 dormitory for 27 women, mess hall and kitchen and boiler house. Started June 22, 1918, completed Aug. 24, 1918.

Mr. James Albro, who maintained an office with the Construction Division at Washington, representing the Construction Branch of the Housing Department as Supervisor of Material Purchases and reporting to Mr. Jensen.

Purchasing in this way simplified the problem and the close contact with the War Department resulted in the elimination of red-tape and delays, permitting of maximum speed in the work. The Governmental purchases of material tended toward doing away with competition, control of the market and enabled the Construction Branch to be always familiar with

The use of standardized products was adopted as far as possible. The Architectural Branch adopted certain standard units, such as windows, doors, trim, plumbing and lighting fixtures. These standards were furnished to the project architects and were incorporated into their designs with the most satisfactory results. Economy in cost and time, with no lessening of architectural effect were gained by the use of these standards, and it is one of the valuable lessons taught by the work of the Housing Department.

*(To be continued)*

---

## Equivalent Temperature of Guaranteed Steam and Hot Water Heat

By HENRY N. DIX, M. E.

NINETY-NINE times out of a hundred, when a heating plant is tested, the temperature outdoors is not that which the specification or contract states to be the temperature when a certain indoor temperature is to be obtained. In other words, the contract may call for a temperature of 70 deg. in zero weather, but on the day of the test the outdoor temperature is not zero but some other, usually higher. The question then arises, what is the temperature to which the building should heat under these conditions in order to fulfill the guarantee?

For the use of the architect, engineer, contractor and the trade this article has been prepared with the hope that it may prove of interest and value to

them. The formula and charts apply equally well to buildings heated by direct or indirect radiation, and hot blast.

There have been published, from time to time, tables which have purported to give the temperature to which a building should heat, with different outdoor temperatures, when the quantity of radiation installed is correct to heat the building to 70 deg. with an outdoor temperature of zero. These tables have usually been satisfactory for the heating of residences in the so-called 70-0 region. However, there are many buildings where they cannot be used because many combinations of indoor and outdoor temperatures are required. Again, these tables have been made applicable to steam-heated

## THE AMERICAN ARCHITECT

buildings. A large percentage of modern buildings are heated by gravity hot water systems and these tables do not apply, owing to a difference between steam and hot water heating.

For these conditions the following formula will hold good with internal temperatures varying from 40 deg. to 100 deg. F. Outside of these limits the coefficient of transmission of the radiators and building materials will have changed enough to cause this formula to be inexact. For all practical purposes it is sufficiently accurate to be used even with the higher temperatures that result from testing in summer weather.

$$C = \frac{T(A - B) + D(T - A)}{T - B}$$

in which

$T$  = Internal temp. of radiator.

$A$  = Guaranteed room temp. with outdoor temp.  $B$ .

$B$  = Outdoor temp. on the day temp.  $A$  is to be maintained.

$C$  = Indoor temp. to which building will heat when

$D$  = Outdoor temp. on the day of test.

For example:

A heating plant is installed in a building and guaranteed to heat the building to 60 deg. with an outdoor temperature of minus 10 deg. with steam at five pounds gauge pressure. The day the test is to be run off the outdoor temperature is 15 deg. above zero. What temperature of the room should be obtained in order to fulfill the guarantee?

Substituting in the formula we have

$$A = 60, B = -10, D = 15, T = 225.$$

then

$$C = \frac{225(60 - (-10)) + 15(225 - 60)}{225 - (-10)}$$

$$= \frac{225 \times 70 + 15 \times 165}{235} = 77.5 \text{ deg. F.}$$

The objection to using this formula, however, is that it requires considerable computation to arrive at your result. With this in mind the accompanying charts have been prepared. These charts have been made by using the above formula.

Charts Nos. 1, 2 and 3 are for use with low pressure steam and will be found sufficiently accurate to give satisfactory results where the steam pressures vary from atmosphere to 10 lbs. gauge. The charts themselves were plotted using a steam temperature of 220 deg. F.

Charts Nos. 4, 5 and 6 are for use with open tank, gravity hot water systems, and although plotted for an average temperature in radiators of 165 deg. F. will be found sufficiently accurate with

a temperature variation of 10 deg. each way of this figure.

Although the charts themselves are almost self-explanatory, an example showing their use will perhaps make them clearer.

A building has been guaranteed to heat to 65 deg. when the outdoor temperature is zero, steam at 2 lb. pressure. However, on the day of the test the temperature outdoors registers 35 deg. and the indoor temperature is maintained at 92 deg. Is the quantity of radiation as installed sufficient to satisfy the guarantee? What temperature will probably be maintained indoors with the radiation installed when the temperature is zero? What temperature should have been reached at the test?

Outdoor Temp. Day of Test, F.°	EQUIVALENT INDOOR TEMPERATURE DAY OF TEST					
	GUARANTEED TEMPERATURE RANGE					
	70° & +10°		70° & 0°		70° & -10°	
	S.	W.	S.	W.	S.	W.
-10	56	58	63	64	70	70
-5	59	61	67	67	73	73
0	63	64	70	70	77	75
5	66	67	73	73	80	78
10	70	70	77	76	83	81
15	74	73	80	79	86	84
20	77	76	84	82	90	86
25	81	79	87	84	93	89
30	84	82	90	87	96	92
35	88	85	94	90	99	94
40	91	88	97	93	103	97
45	95	91	101	96	106	100
50	99	95	104	99	109	103
55	102	98	107	102	112	105
60	106	101	111	105	116	108
65	109	104	114	108	119	111
70	113	107	118	110	122	113

Referring to chart No. 2, we find that the horizontal line through 65 deg. on the left-hand scale intersects the diagonal line marked 35 deg. at a point corresponding to 89 deg. on the lower scale. Therefore, inasmuch as 92 deg. was obtained at the test, the radiation as installed is more than ample to fulfill the guarantee, as we found from the chart that 89 deg. was all that was required. To find the temperature which will be obtained in zero weather, we find that the vertical line through 92 deg. on the lower scale intersects the 35 deg. diagonal line at a little over 68 deg. on the side scale, which is the temperature it will be possible to heat the building in zero weather.



# THE AMERICAN ARCHITECT

The same method of procedure should be followed with the other charts.

For the convenience of those whose business consists largely of residence heating, where the desired temperature is usually 70 deg., the table has been compiled with the resulting temperature given to the nearest degree.

It is hardly necessary to say that this table and

charts only hold good when the test is run under conditions identical with those in winter, *i. e.*, all windows, doors, fireplace flues, etc., must be kept closed, the pressure or temperature of the boiler must be that figured for winter and everything approaching as nearly as possible actual winter working conditions. Thus applied this data will serve its purpose.

## LOW PRESSURE STEAM

Chart 1. Outdoor Temperature +10°

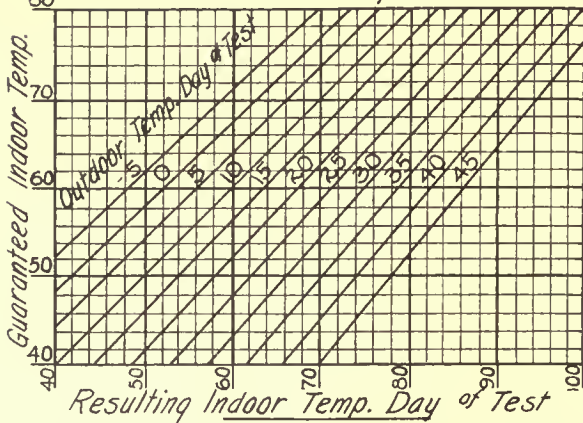

Chart 2. Outdoor Temperature 0°

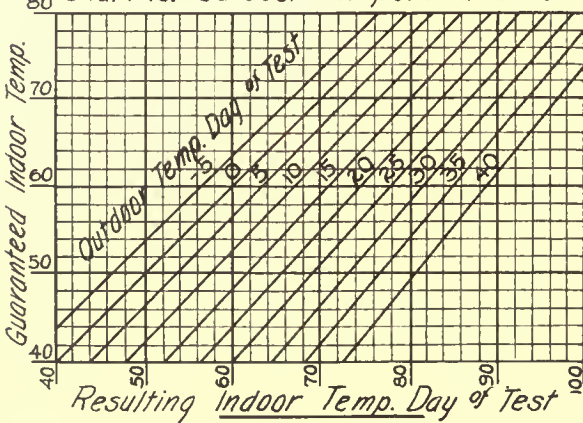
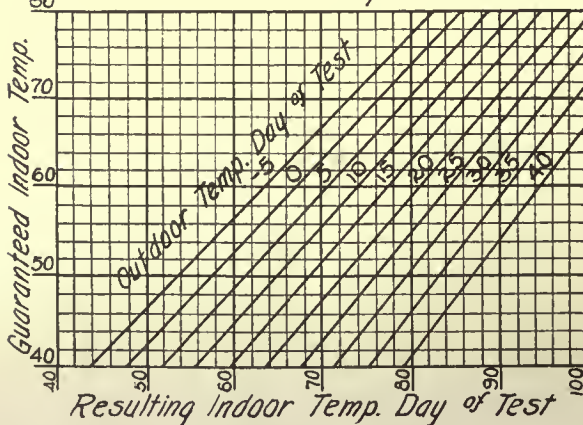

Chart 3. Outdoor Temperature -10°



## GRAVITY HOT WATER

Chart 4. Outdoor Temperature +10°

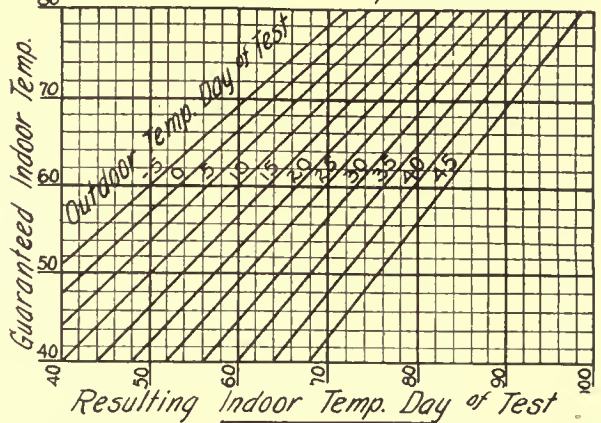

Chart 5. Outdoor Temperature 0°

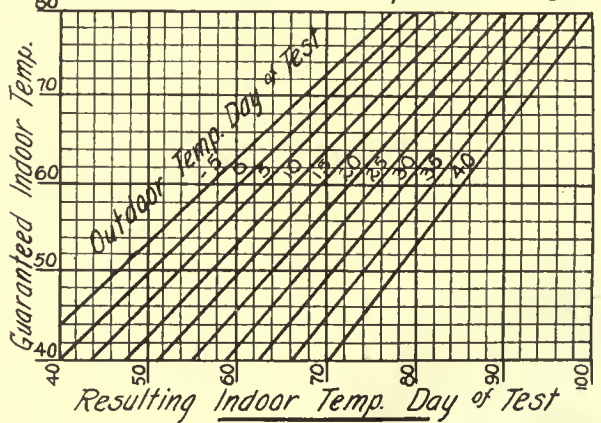
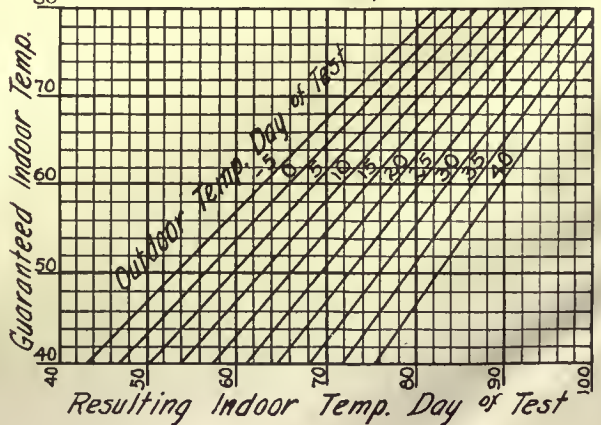

Chart 6. Outdoor Temperature -10°





# Industrial Information

*In this Department there is published each week information as to the development of materials and methods, derived from reliable sources.*

## Stucco vs. Fate

"Man builds, time decays, the elements destroy, flame consumes, man builds."

This constant round of labor on the part of man, to counteract the forces of nature, is brought to attention by the above quotation printed in a description of "Rocbond," an exterior stucco, made in Van Wert, Ohio, by the Rocbond Co., Inc.

In our efficient age, this does not proceed unchallenged, for in use of the product mentioned the heretofore relentless destiny shall be mollified and her efforts directed elsewhere to teach further valuable lessons.

The use of stucco generally has so much to commend it with which the architect is already familiar that a review of these things need not be set down at this time. But Rocbond Stucco offers certain advantages which are not so commonly appreciated.

The particular service which Rocbond renders is due to the fact that it is prepared at the factory and not by an indifferent or unskilled workman on the job. It is made in one grade only, and is mixed with a non-freezing mixing liquid which can be applied in any temperature. The dry material is shipped in paper and cloth bags; the mixing liquid is shipped in steel drums. Rocbond is delivered to the job in fixed proportions ready to use. Nothing is added or taken from it. To add sand or water would make it unfit for use. Thus the vagaries of human nature are as far as possible eliminated from its application, and the result is claimed to be uniformly good.

Rocbond may be applied to any building base, brick, hollow tile, wood or metal lath, and adheres as an integral part to such base. It is applied in two coats. The principal ingredient is Magnesite, so that it is fire-resisting, waterproof and a non-conductor of heat. It may be used instead of repainting, and once so used maintains the building on which it is applied in a waterproof, fire-resisting and slightly condition. It is on this account widely employed for remodelling.

It is possible to obtain large color variety in Rocbond Stucco. What is known as "dash finish" provides many unique color effects, which are stated not to fade or deteriorate, but to yield in a desirable manner to the effects of weathering.

Architects interested in this subject may write the Rocbond Co. in Van Wert, Ohio, for their literature.

## Metal Lath

Just at a time when the use of concrete is so prominently identified with important building projects, its association with metal lath for permanence and safety is of special interest.

Metal lath is a base and reinforcement for plaster and stucco. It is made from flat sheets of metal expanded into an open mesh and so formed that the plaster imbeds the lath, making a solid unit wall.

The Associated Metal Lath Manufacturers, 813 Woodward Building, Washington, D. C., comprises ten nationally known manufacturers and metal supply companies, all united in their endorsement and exploitation of metal lath. The architect should be impressed with the economy, beauty and variety of construction which for thirty years has been made possible by the use of metal lath. He should be convinced that metal lath insures the duration of the decorative scheme by holding the walls and ceilings fast and rigid, thus obviating cracks and falling plaster and the need for constant redecoration.

It is stated by the members of this association that metal lath walls and ceilings are sound proof, and that for dividing partitions, a thin solid wall of plastered metal lath gains floor space and effects substantial saving in weight over other types of fire-resistant walls.

The decorator and plasterer like metal lath because of its adaptability and because they know their workmanship will last. For the architect, the use of metal lath and stucco offers unlimited possibilities for individual treatment, and creates that sense of security in a building which is so important to the comfort of the occupants.

The method of construction herein discussed carries with it a promise of beauty and a pledge of permanence. The association assures the architect that his responsibility will be fulfilled in every sense if metal lath construction is employed, and the joy in the completed building will be enhanced by the knowledge that it will endure.

---

## Congoleum

Congoleum is a material from which has been made a sanitary, low-priced floor covering which comes in styles appropriate for any room. These are produced by the Congoleum Co., a subdivision

## THE AMERICAN ARCHITECT

of the Barrett Co., Philadelphia, Pa., in imitations of wood or carpet. They combine the elements of good design and coloring with superior qualities of sanitation, durability and economy. They are claimed to be absolutely unaffected by constant washing, as no material is used which can rot from dampness, and they are accordingly guaranteed as waterproof and easy to keep clean and wholesome. They have a firm, durable surface that does not gather dust and dirt and therefore do not require sweeping or beating; they may be kept clean and bright with simply a damp mop. The makers say, further, that Congoleum "art rugs" lie flat without fastening. They "hug the floor" so that dust cannot accumulate underneath. They remain perfectly flat after being unrolled, without any tendency to "kick up" or curl at the edges or corners. They will not slide out of place or interfere with swinging doors.

---

### McCray Refrigerators

Sufficient recognition is not always given by the busy architect to the importance of a sanitary refrigerator. If it is damp, foul smelling and germ producing, it may cause serious illness.

McCray ice chests have proved their sanitary qualities and superiority under the most exacting tests of food experts. They are used in the Government pure food laboratories at Washington and in the diet kitchens of the leading hospitals, clubs, public institutions and residences.

The system of refrigeration followed in these installations is based on the application of all the natural laws known to relate to this large subject. Advantage is taken of every principle which physics and experience have evolved. The hardware and materials used are of the most substantial and serviceable kind. Every accessory has been incorporated with a thought for convenience and efficacy in achieving its purpose.

In considering the subject of refrigerators, the

construction of the walls is of prime importance, for it is the insulation which determines whether the refrigerator shall be an ice-waster or an ice-saver.

It has been stated by a well-known physician in an address to the American Medical Association that the average refrigerator is only 30 per cent efficient and that 70 per cent of the ice power is used up in overcoming heat which percolates in from without. Wasted ice in a hot spell means not only wasted food but often wasted lives from spoiled food. This is all guarded against in the McCray product.

One model of the McCray is so designed that it may be placed near the street entrance of the kitchen when this is on the ground floor. The ice-man may have access to it without entering the room and without walking off with the other contents.

Other models may be built into the house and finished to harmonize with the surrounding wood-work. They are made in numerous sizes. The McCray Refrigerator Co. may be addressed at Kendallville, Ind., for further information on a valuable and important product.

---

### Graphite Products

"Dixon's Graphite Products" is the title of a new pocket catalog issued by the Joseph Dixon Crucible Company of Jersey City. While not so complete as the large general catalog, it furnishes a comprehensive idea of the variety of products made by this long established concern.

Pages have been devoted to lists of articles especially for mills, railroads, automobiles, etc. The descriptions are brief, but the company will gladly send pamphlets dealing in detail with any of the individual members of the line. This new catalog will be found useful to all users of lubricants, paints or pencils. Ask for Booklet No. 14-KP.

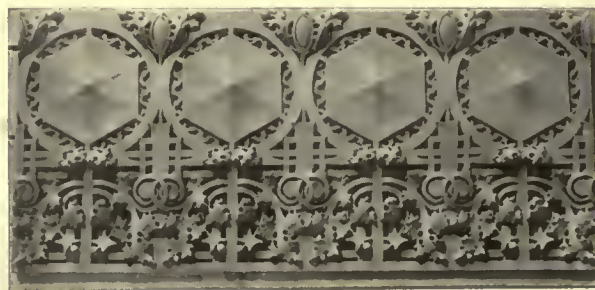

212



Floruit et obiit apud Leodienses anno 1560.

18.



18 LAMBERTO LOMBARDO, LEODIENSI,  
PICTORI ET ARCHITECTO.

Elogium, ex merito quod te, Lombarde, decebat,  
Non libet hic paucis texere versiculis:  
Continet hoc ea charta (legi si nostra merentur)  
De te quam fecit Lampsoniana graphis.

Vitam eius descripsit Dominicus Lampsonius,  
Brugis ab Hub. Goltzio 1565. editam.

H. Goltz.

# THE AMERICAN ARCHITECT

VOL. CXV

WEDNESDAY, MARCH 12, 1919

NUMBER 2255

## Build Now!

### A Symposium on the Necessity for an Immediate Resumption of Building and the Method of Financing as Expressed by Leading Authorities in Banking, Real Estate, Building, Engineering, Supply and Architectural Fields

**H**OW will the expected boom in building be financed? In order that readers of THE AMERICAN ARCHITECT may have a more comprehensive understanding of a question of such timely interest, a symposium of interviews with leaders in the field of architecture, finance, real estate, building and material supplies has been carefully prepared, with a result that more than a hundred opinions on the topic have been received. While these opinions vary, the majority of statements hold that the conditions affecting an exceptionally active building season are steadily improving.

Although in the main the high costs of materials are held to be the chief obstacle, it is noted that many of the writers express the belief that the public should be willing to pay the price and reap the benefit in the reduction of unemployment, the absorption of the products of many industries, and the forwarding of many public works, of which there is great need. The increased revenue on the investment is also a big factor in starting new work quickly. As several executives consider it—"What can I do with my building after I get it?"—and not "What is going to be the first cost of the building?"

One of the most interesting views on this point is that of Samuel H. Beach, president of the Savings Banks Association of the State of New York, in which he says that "a strong feeling is prevailing in financial circles that small annual payments of principal should be required on all mortgage loans and under such a plan of loaning money the lender would be safe in making a fairly liberal loan even based on prevailing high costs, for the gradual reduction of the principal would counterbalance the possible eventual fall in values to a lower level."

According to the survey of the situation made by THE AMERICAN ARCHITECT all sections of the country report that despite the immediate factors

that might operate to hinder construction, the great need for additional buildings of every description and the growing feeling that nothing can be gained by waiting longer for reduced material prices and construction costs, will cause a resumption of building as soon as the weather permits.

Several of the larger financial institutions comment on what may be a difficulty in some quarters in securing loans for building on bonds and mortgage on account of probable heavy participation in the next Victory loan and also the fact that there are many attractive investments in the market that have the advantage of liquidity. Others are only too eager to lend money on good sound investments. That large loaning interests are going to do their share in the big construction movement may be judged from the view of Festus J. Wade, president of the Mercantile Trust Company of St. Louis, Mo., a well-known banker in the Central West, who says that the organization which he heads has been unable to secure enough loans to meet the requirements of its business. He says: "We are to-day ready and willing to finance any legitimate real estate enterprise where the property is improved with substantial buildings of the character that can be utilized for the benefit of the industrial, commercial and manufacturing interests of the country."

As to how the boom will be financed, Gerald R. Brown, comptroller of the Equitable Life Assurance Society of the United States, believes that "operations of any size in the near future will have to be accomplished by serial bond issues underwritten by investment bankers and title and trust companies who have a large clientele seeking investments of this character."

Within the last month new building projects have been announced which in number and importance



## THE AMERICAN ARCHITECT

exceed any structural operations, excepting only Government work, brought out since the early months of the world war. Plans for many of these projects are now complete, and work will undoubtedly be started as soon as labor troubles have been adjusted and contracts awarded. From the architect's viewpoint, D. Everett Waid, *F. A. I. A.*, states that there appears to him to be plenty of building work to do and that there will be a good volume of building, if not a boom, provided labor difficulties show some sign of early solution. He believes the problems of financing operations and even high prices are minor ones in comparison with the importance of some stability in labor conditions.

The prevailing opinion is that material prices will lower somewhat and that labor will work for a lower wage, due to the law of supply and demand. A prominent engineering firm of Boston favors maintaining labor prices at the highest possible point, but not even labor can go counter to the laws that control prices.

Among the many statements received by *THE AMERICAN ARCHITECT*, the following conclusively show the trend of opinion on the necessity for an immediate resumption of building and the method of financing:

\* \* \*

From Samuel H. Beach, president, the Savings Banks Association of the State of New York:

"The slowing down on building was undoubtedly owing to the reluctance of real estate men and owners to start new projects during the uncertainties of a world war; to the steadily mounting prices of labor and materials and to the difficulty of financing ordinary building operations when every nation on earth was calling for money on an unprecedented scale and every manufacturing corporation was stretching its credit to the limit.

"But now, with war practically ended, with skilled carpenters and mechanics daily being released from cantonment erection, ship building and other war construction, coupled with the return of thousands of soldiers and sailors to their usual occupations, there is bound to be a strong reaction along all ordinary building lines.

"Farmers have prospered and are seeing the need of more properly housing their crops, tools, machinery and live stock. Fire from lightning and other causes every year plays havoc with buildings all over the land, and the reconstruction of the barns, houses and sheds which have thus been destroyed in the five-year war period will form no small part in the building demand.

"In the cities, with their constantly growing population, the housing need is especially pressing. The building of apartment houses, which in normal times goes steadily forward, has, with everything else, been at a standstill and the need along this line is particularly in evidence.

"Owing to the drastic changes which the going into effect of the recent prohibition legislation will cause, the demand for new stores will for some time not be urgent, but the remodeling and making suitable for other lines of business the places now occupied by the liquor trade will in itself be a great consumer of both labor and materials.

"The question naturally arises, 'How will all this work be financed?' And if conditions, such as have in the near past prevailed, should continue, this would be a difficult

question to answer: but conditions are changing; they have in fact already changed. Thousands, yes even millions of dollars, since the armistice was signed, have been steadily flowing into the savings banks, and while these institutions in common with the other banks in the country will have to do their full share in subscribing for the fifth Liberty loan, they will undoubtedly endeavor to supply the necessary building demand for money in their several localities.

"In making loans on new work not only savings banks but life insurance companies and building and loan associations must take into consideration the higher values now ruling. Many years must elapse before a building can be constructed at anything like the costs prevailing in the pre-war period. Lumber, a large factor in nearly every building, is just now seemingly very high in price; but lumber is a crop not produced in an ordinary human lifetime and, while the production of copper, concrete, iron and steel is limited only by the amount of labor employed, the production of lumber is not only limited by the scarcity of labor and the lack of sufficient snow this winter to render logging operations in the northern latitudes normally productive, but is every year having to be hauled from longer distances and obtained in less and less accessible places owing to the constant and rapid disappearance of our forests; and the present high level of prices must necessarily continue over a considerable period.

"A strong feeling is prevailing in financial circles that small annual payments of principal should be required on all mortgage loans, and under such a plan of loaning money the lender would be safe in making a fairly liberal loan even based on prevailing high costs, for the gradual reduction of the principal would counterbalance the possible eventual fall of values to a lower level."

\* \* \*

From Ernest K. Satterlee, president, the Franklin Savings Bank, New York City:

"Just what may be expected to occur does not always occur as expected. Since the signing of the armistice the keen minds of the country have engaged the reconstruction problems and are endeavoring to wrest from them signs indicating how and when and in what manner men taken from productive industrial pursuits to defend the cause of the nation can be returned to their several occupations at a minimum expense of efficiency. At the moment they ceased to be 'producers' in the economic sense they became totally dependent upon the power of production of their fellow citizens for their means of support, together with those who in turn were totally dependent upon them. The manner in which the nation has shouldered the burden beggars description. Letting the burden down after the emergency has passed—and doing it without shock and strain—is the question which is stirring legislative bodies, newspapers, organizations and the multitudes of individuals whose forceful personalities always bring them to the forefront of any great agitation into the arena of opinionative conflict out of which will presently emerge 'the plan.' This is the American way—direct, blunt, courageous and ultimately sound. The Babel of conflicting ideas is after all healthy, because utterance has been given to every extreme and the fittest essentially will survive.

"Among the vitally important considerations we find the problem of housing a population which, in New York City, is increasing approximately twenty-five souls an hour, night and day. Try to find a suitable apartment, flat, hotel suite or lodging room in New York City today and you will gather rich material for a thesis on the subject of domestic surroundings.

"If we probe the subject, even to no great extent, we very shortly find ourselves staring straight at the principal reasons: (1) Shortage of space; (2) no new building, and (3) high rents.



## THE AMERICAN ARCHITECT

"It would appear to be a bit paradoxical that the complete stalling of building operations should continue when it is generally known that the deposits of all our banks are growing by leaps and bounds, but let us examine this point a little. It is not probable that all people understand that the enormous part played by banking and business corporations in absorbing the four Liberty loans was not entirely accomplished by the use of available cash but that these corporate bodies mortgaged their income for, in many instances, a year in advance, and until their cash equilibrium has been re-established the builder will continue to be deprived of one of his principal necessities—mortgage money—at least in the quantity needed to finance his operations. This, however, is not his only difficulty. Material and labor conditions finish brilliantly with the lack of money in the race to devalue our most potent economic factor—the home builder. We are all, undoubtedly, on the side of the argument which espouses union labor in its general, broad principles, but it is probable that our espousal is tempered with the belief that there is a sparking point between the dollar and the man beyond which neither may venture without completely stalling our productive machine. Just now the dollar will not buy all the man needs and he calls into action the faculties at his command in order to obtain an additional dollar. The said additional dollar not answering to his summons, he proceeds to make war upon the dollar which is already serving as faithfully as a dollar can in the circumstances. Often he will contrive to get his dollar by giving less of his labor for it. The result is the same. Meanwhile the necessities of life—food, clothing and other vitally important things—move further and further out of his reach. Truly the dollar and the man should become better allies.

"This is a little beside the subject, but we all want, in our heart of hearts, to create and develop an American trait—the ability to bring our warring elements into harmony and apply the result to our general good.

"Savings banks are in generally the same position toward the building situation that other leading institutions are, with this possible difference—the necessity of restricting the loan to 60 per cent of the value as determined by the trustees. At once the present cost of building as against the estimate of actual value from the standpoint of the lending institution come into conflict and the desire of the borrower cannot be met unless he is in a position to meet the difference in building values out of his own resources. By this it may be readily seen that even if the savings banks felt entirely free to enter the mortgage market to any great extent the costs of material and labor exercise a controlling influence. There is in prospect further Government financing which will necessitate large participation by the banks, and this, for the present, serves to make a proportionate amount of money unavailable for the financing of building operations even in the face of the constant desire to supply our natural allies, the builders, with the money to conduct their operations.

"It is satisfying to note the improved feeling among savings bankers and the increased optimism that the conditions so briefly discussed here may, and probably will, improve to a point where there will be relief and the resumption of the relations between banks and builders so mutually helpful in the past."

\* \* \*

From Festus J. Wade, president, Mercantile Trust Company, St. Louis, Mo.:

"Every reputable financial institution that usually loans money on real estate security is, in my judgment, perfectly willing to continue to make such loans when the security is adequate.

"We have never ceased to make loans on real estate since the war began. In fact, we have been unable to secure enough real estate loans to meet the requirements

of our business and we are today ready and willing to finance any legitimate real estate enterprise where the property is improved with substantial buildings of the character that can be utilized for the benefit of the industrial, commercial and manufacturing interests of the country."

\* \* \*

From Gerald R. Brown, comptroller, the Equitable Life Assurance Society of the United States, New York City:

"It seems to us that the financing of real estate operations of any size in the near future will have to be accomplished by serial bond issues underwritten by investment bankers and title and trust companies who have a large clientele seeking investments of this character."

\* \* \*

From Alex. P. W. Kimman, president, Union Dime Savings Bank, New York City:

"There has been a large increase for the past three months in the deposits of savings institutions, and the banks are now loaning on bond and mortgage, and expect, after the placement of the next Liberty loan, to be in funds to take a large line of mortgage loans.

"Personally, I do not expect to see a large boom in building this Spring. While land can be bought upon favorable terms, the present price of building material and labor makes it almost impossible for a contemplating builder to figure out a successful termination of his venture, and unless the price of building material and labor arrive at a solution of the problem, I do not look for any real boom in building until the Spring of 1920."

\* \* \*

From Albert L. Scott, treasurer, Lockwood, Greene & Co., architects and builders, Boston, Mass.:

"While it is true that material prices are high and labor is also high, yet these features are not, we feel confident, going to weigh too greatly with the concern which requires new buildings and equipment in order to maintain its position in the market, or to enter new fields. The important thing for every manufacturing executive to consider is, 'What can I do with my building after I get it?' and not 'What is going to be the first cost of the building?'

"Our opinion is that material prices are going to soften materially and that labor will work for a lower wage due to the inevitable law of supply and demand. We are in favor of maintaining labor prices at the highest possible point, but not even labor can go counter to the laws which control prices."

\* \* \*

From D. Everett Waid, *F. A. I. A.*, president of the State Board of Examiners and Registration of Architects, New York City:

"There appears to be plenty of building work to do and there will be a good volume of building, if not a boom, provided labor difficulties show some sign of an early solution. The problems of financing operations and even high prices are, I believe, minor ones in comparison with the importance of some stability in labor conditions. Owners will not willingly proceed so long as they fear a fluctuation in prices and a complete tie-up when a building is half constructed."

\* \* \*

From Robert Willison, architect, Denver, Col.:

"What is the outlook for building? The outlook in Colorado never looked better. Inquiries show that the sentiment of our people is to get busy and make up for

## THE AMERICAN ARCHITECT

lost time. Among projects on which plans have been completed are: A hospital ambulatory ward building to cost \$75,000; a hospital medical building, \$25,000; hospital utility building with superintendent's and doctor's quarters, \$50,000; Home for Aged, \$50,000; hotels and theater buildings to cost \$250,000; many residences costing from \$5,000 to \$10,000, and a bridge across the Grand River in Mesa County. In Denver the School Board will have a vote on an \$8,000,000 bond issue for new high and grade school buildings; the City Council will call for a \$3,000,000 bond issue for a new city and county building and a criminal court building in connection with the county jail.

"There is also a half million dollar bank building to be erected as well as many apartment houses, as soon as conditions will permit, and investors now feel that the cost of construction has reached the limit of decrease, which is the all-absorbing factor in present proposed building operations in this section.

"Among other buildings to be constructed in the West are a twelve-story bank and office building in Salt Lake City; a large auditorium in Spokane, Wash.; a similar building in Sterling, Col., and there will be a large amount of school building put up throughout the West this year."

\* \* \*

From John A. Murray, merchant and bank director, New York City:

"We have just emerged from a world war, in high spirits but very tired, physically. I believe business is relaxing from the tremendous nervous strain it has been under for the past two years. We are putting our house in order to prepare for business on a peace basis. We are going to have business and have it abundantly. The brains and wealth of the country cannot stand idle. We are built in this country.

"The serious problem before us today is the housing proposition. The solution of it is more buildings, and we are going to build. Supply and demand is the panacea which is going to light the discussion today of cheap labor, cheap material and the unemployed. Money lenders are eager to lend money on safe and sound investments.

"When we start in, it will be gradual, and develop as we proceed. I view in the months before us good business. And why not? We have the great need, the brains and the desire to go forward. We are all eager to get started. We have the money and our money-lending institutions are eager to get their money working. I view with alarm what may happen when we do start, owing to the diminished stocks on hand. It will be doubtful if the demand can promptly be supplied.

William M. Beebe, manager of the Long-Bell Lumber Company, St. Louis:

"It is evident that concerns that loan money on residences and flats in the city and prospective builders do not understand the underlying principles that are causing building material to maintain a very strong market, and even advance, when all other commodities show a decline from week to week.

"The reason for this is that building has been practically stopped for nearly two years. In the meantime lumber was in great demand for cantonments, so that it was almost impossible to produce enough lumber to keep pace with the demand. The stocks in the hands of manufacturers are not over 60 per cent of normal. A high level of lumber values will be maintained for two or three years.

"I predict that as soon as these conditions are thoroughly understood by prospective builders and concerns that loan money on new buildings, the building boom will start and will be the greatest ever known."

\* \* \*

From Charles Hill, general manager, Southern Pine Sales Corporation, New York City:

"A satisfactory thing to do is to establish a banking arrangement for building purposes on the lines of the Federal Farm Loan Banks. I do not think that borrowers or lenders can expect to do business under present conditions on old methods. Possibly some arrangement could be made of the suggestion to the effect that loans made for buildings at the present time should be amortized to the extent of about 25 per cent within three years, which would protect the loaning institution on any fall in value, and as the builder will during the next three years receive high rentals, perhaps something can be done along this line.

"The manufacturing industry is perhaps in a rather unfortunate situation. There is a public demand for lower prices on basic materials. Unfortunately, the lumber manufacturing industry is not in a position to meet these demands."

A further large number of opinions which, unfortunately, space does not permit of presentation in this symposium, are along lines as set forth in the above communications. The necessity for an immediate resumption of building operations has never been more clearly demonstrated, nor the methods of financing more accurately set forth.

### The Post-War Committee

Every architect should support the work of this committee. It is not one of the Institute alone, but representative of the entire profession in this country.

Send your suggestions promptly to the Committee at the Octagon, Washington, D. C.



# A Circular of Advice

[The following amendments, eliminations and additions to the Circular of Advice and Code of Ethics of The American Institute of Architects are proposed by Henry K. Holsman, secretary of the Illinois Chapter of the Institute and Chairman of a Joint Committee on Reconstruction of the Illinois Chapter and The Illinois State Society of Architects.

The provisions as now constituted are printed in the left hand column with the new wording as proposed on the right. In the opening paragraphs, the italics indicate changes from the original reading.]

THE AMERICAN INSTITUTE OF ARCHITECTS, seeking to maintain a high standard of practice and conduct on the part of its members as a safeguard of the important financial, technical and aesthetic interests entrusted to them, offers the following advice relative to professional practice:

The profession of architecture *co-ordinates inventive, aesthetic, and mechanical design, specifications and execution in the creation of buildings*, and calls for men of the highest integrity, business capacity, *mechanical judgment* and artistic ability. The architect is entrusted with financial undertakings in which his honesty of purpose must be above suspicion; he acts as professional adviser to his client and his advice must be absolutely disinterested; he is charged with the exercise of judicial functions as between client and contractors and must act with entire impartiality; he has moral responsibilities to his professional associates and subordinates; finally, he is engaged in a profession which carries with it grave responsibility to the public. These duties and responsibilities cannot be properly discharged unless his motives, conduct, and ability are such as to command respect and confidence.

No set of rules can be framed which will particularize all the duties of the architect in his various relations to his clients, to contractors, to his professional brethren, and to the public. The following principles should, however, govern the conduct of members of the profession and should serve as a guide in circumstances other than those enumerated.

## 1. On the Architect's Status.

The architect's relation to his client is primarily that of professional adviser; this relation continues throughout the entire course of his service. When, however, a contract has been executed between his client and a contractor by the terms of which the architect becomes the official interpreter of its conditions and the judge of its performance, an additional relation is created under which it is incumbent upon the architect to side neither with client nor contractor, but to use his powers under the contract to enforce its faithful performance by both parties. The fact that the architect's payment comes from the client does not invalidate his obligation to act with impartiality to both parties.

The architect's relation to his client is primarily that of professional adviser; this relation continues throughout the entire course of his service. He may also execute the work he plans, as a builder, on a fixed or percentage fee basis, in lieu of a contractor, but not as a contractor on a lump-sum basis. When, however, a contract has been executed between his client and a contractor by the terms of which the architect becomes the official interpreter of its conditions and the judge of its performance, an additional relation is created under which it is incumbent upon the architect to side neither with client nor contractor, but to use his powers under the contract to enforce its faithful performance by both parties. The fact that the architect's payment comes from the client does not invalidate his obligation to act with impartiality to both parties.

## 2. On Preliminary Drawings and Estimates.

The architect at the outset should impress upon the client the importance of sufficient time for the preparation of drawings and specifications. It is the duty of the architect to make or se-

The architect at the outset should impress upon the client the importance of sufficient time for the preparation of drawings and specifications. It is the duty of the architect to make or

cure preliminary estimates when requested, but he should acquaint the client with their conditional character and inform him that complete and final figures can be had only from complete and final drawings and specifications. If an unconditional limit of cost be imposed before such drawings are made and estimated, the architect must be free to make such adjustments as seem to him necessary. The architect should assume no responsibility that may prevent him from giving his client disinterested advice; he should not, by bond or otherwise, guarantee any estimate or contract.

secure preliminary estimates when requested, but he should acquaint the client with their conditional character and inform him that complete and final figures can be had only from complete and final drawings and specifications. If an unconditional limit of cost be imposed before such drawings are made and estimated, the architect must be free to make such adjustments as seem to him necessary. The architect should assume no responsibility that may prevent him from giving his client disinterested advice.

## 3. On Superintendence and Expert Services.

On all work except the simplest, it is to the interest of the owner to employ a superintendent or clerk of the work. In many engineering problems and in certain specialized aesthetic problems, it is to his interest to have the services of special experts, and the architect should so inform him. The experience and special knowledge of the architect make it to the advantage of the owner that these persons, although paid by the owner, should be selected by the architect under whose direction they are to work.

On all work except the simplest, it is to the interest of the owner that the architect should take entire charge of the execution of the work, employ a superintendent or clerk of the works, and in many engineering problems and in certain specialized aesthetic problems, engage the services of special experts.



# THE AMERICAN ARCHITECT

## 4. On the Architect's Charges.

The Schedule of Charges of the American Institute of Architects is recognized as a proper minimum of payment. The locality or the nature of the work, the quality of services to be rendered, the skill of the practitioner or other circumstances frequently justify a higher charge than that indicated by the Schedule.

The Schedule of Charges of the American Institute of Architects is recognized as a proper minimum of payment for architectural services, without executive services as a builder. Circumstances frequently justify a higher charge than that indicated by the Schedule. The architect should fix for himself a scale of charges commensurate with his skill and ability and in accordance with the nature of the work and quality and quantity of service to be rendered and never cut his fee to secure work by competitive bidding against a fellow architect.

## 5. On Payment for Expert Service.

The architect, when retained as an expert, whether in connection with competitions or otherwise, should receive a compensation proportionate to the responsibility and difficulty of the service. No duty of the architect is more exacting than such service, and the honor of the profession is involved in it. Under no circumstances should experts knowingly name prices in competition with each other.

The architect, when retained as an expert, whether in connection with competitions or otherwise, should receive a compensation proportionate to the responsibility and difficulty of the service. No duty of the architect is more exacting than such service, and the honor of the profession is involved in it.

## 6. On Selection of Bidders or Contractors.

The architect should advise the client in the selection of bidders and in the award of the contract. In advising that none but trustworthy bidders be invited and that the award be made only to contractors who are reliable and competent, the architect protects the interests of his client.

The architect should advise the client that none but trustworthy bidders be invited and that the award be made only to contractors who are reliable and competent.

## 7. On Duties to the Contractor.

As the architect decides whether or not the intent of his plans and specifications is properly carried out, he should take special care to see that these drawings and specifications are complete and accurate, and he should never call upon the contractor to make good oversights or errors in them nor attempt to shirk responsibility by indefinite clauses in the contract or specifications.

As the architect decides whether or not his plans and specifications are properly carried out, he should take special care to see that these drawings and specifications are complete, clear and accurate, and he should never attempt to shirk responsibility by inadequate drawings or indefinite clauses in the contract or specifications.

## 8. On Engaging in the Building Trades.

The architect should not directly or indirectly engage in any of the building trades. If he has any financial interest in any building material or device, he should

The architect should not engage in any of the building, decorating or furnishing trades except for the execution of his own designs on a fixed or percent-

age fee. If he has any financial interest in any building material or device, he should not specify or use it without the knowledge and approval of his client.

age fee. If he has any financial interest in any building material or device, he should not specify or use it without the knowledge and approval of his client.

## 9. On Accepting Commissions or Favors.

The architect should not receive any commission or any substantial service from a contractor or from any interested person other than his client.

The architect should not receive any commission or any substantial service or payment from a contractor or from any interested person other than a fee from his client.

## 10. On Encouraging Good Workmanship.

The large powers with which the architect is invested should be used with judgment. While he must condemn bad work, he should commend good work. Intelligent initiative on the part of craftsmen and workmen should be recognized and encouraged and the architect should make evident his appreciation of the dignity of the artisan's function.

The large powers with which the architect is invested should be used with judgment. While he must condemn bad work, he should commend good work. Intelligent initiative on the part of craftsmen and workmen should be recognized and encouraged and the architect should make evident the services supplied by other experts and his appreciation of the dignity of the artisan's function.

## 11. On Offering Services Gratuitously.

The seeking out of a possible client and the offering to him of professional services on approval and without compensation, unless warranted by personal or previous business relations, tends to lower the dignity and standing of the profession, and is to be condemned.

The offering to a possible client of professional services on approval and without compensation tends to lower the dignity and standing of the profession, and is unethical and unbusinesslike.

## 12. On Advertising.

Advertising tends to lower the dignity of the profession and is therefore condemned.

Injudicious, laudatory or extravagant advertising tends to lower the dignity of the profession and is unethical.

## 13. On Signing Buildings and Use of Titles.

The display of the architect's name upon a building under construction is condemned, but the unobtrusive signature of buildings after completion has the approval of the Institute. The use of initials designating membership in the Institute is proper in connection with any professional service and is to be encouraged as helping to make known the nature of the honor they imply.

Placing the name of the architect and his expert assistants upon a building under construction and the signature of buildings after completion, if done in an unobtrusive manner, are commendable means of advertising. The use of initials designating membership in the Institute is proper in connection with the architect's name and is to be encouraged as helping to make known the nature of the honor they imply.

## 14. On Competitions.

An architect should not take part in a competition as a competitor or juror unless the competition is to be conducted according to the

A formal competition is one in which two or more architects knowingly submit special designs for the solution of the same problem

## THE AMERICAN ARCHITECT

best practice and usage of the profession, as evidenced by its having received the approval of the Institute, nor should he continue to act as professional adviser after it has been determined that the program cannot be so drawn as to receive such approval. When an architect has been authorized to submit sketches for a given project, no other architect should submit sketches for it until the owner has taken definite action on the first sketches, since, as far as the second architect is concerned, a competition is thus established. Except as an authorized competitor, an architect may not attempt to secure work for which a competition has been instituted. He may not attempt to influence the award in a competition in which he has submitted drawings. He may not accept the commission to do the work for which a competition has been instituted if he has acted in an advisory capacity either in drawing the program or in making the award.

### 15. On Undertaking the Work of Others.

An architect should not undertake a commission while the claim for compensation or damages, or both, of an architect previously employed and whose employment has been terminated, remains unsatisfied, unless such claim has been referred to arbitration or issue has been joined at law; or unless the architect previously employed neglects to press his claim legally; nor should he attempt to supplant a fellow architect after definite steps have been taken toward his employment.

### 16. On Injuring Others.

An architect should not falsely or maliciously injure, directly or indirectly, the professional reputation, prospects or business of a fellow architect.

without adequate compensation for the work involved and service rendered. An architect should not take part in a formal competition as a competitor or juror unless the competition is to be conducted according to the best practice and usage of the profession, as evidenced by its having received the approval of the Institute, nor should he continue to act as professional adviser after it has been determined that the program cannot be so drawn as to receive such approval. An architect should not attempt to secure work for which a competition has been instituted, in any manner except by the terms of the competition and as an authorized competitor. He should not attempt to influence the award in a competition in which he has submitted drawings. He should not accept the commission to do the work for which a competition has been instituted if he has acted in an advisory capacity either in drawing the program or in making the award.

An architect should not accept nor attempt to secure a commission while the service of an architect previously employed has not been legally terminated, nor should he attempt to supplant a fellow architect after definite steps have been taken toward his employment.

An architect should not falsely or maliciously attempt to injure, directly or indirectly, the professional reputation, prospects or business of a fellow architect, or other person. The architect should be free to ask and be prepared at all times freely to give, friendly and constructive advice and criticism to a fellow architect on work in progress, to the end that every building erected may be the best possible.

### 17. On Duties to Students and Draughtsmen.

The architect should advise and assist those who intend making architecture their career. If the beginner must get his training solely in the office of an architect, the latter should assist him to the best of his ability by instruction and advice. An architect should urge his draughtsmen to avail themselves of educational opportunities. He should, as far as practicable, give encouragement to all worthy agencies and institutions for architectural education. While a thorough technical preparation is essential for the practice of architecture, architects cannot too strongly insist that it should rest upon a broad foundation of general culture.

The architect should advise and assist those who intend making architecture their career. An architect should urge and assist his draughtsmen to avail themselves of educational opportunities. He should give encouragement to all worthy agencies and institutions for architectural education. While a thorough preparation is essential for the practice of architecture, architects cannot too strongly insist that it should rest upon a broad foundation of general culture.

### 18. On Duties to the Public and to Building Authorities.

An architect should be mindful of the public welfare and should participate in those movements for public betterment in which his special training and experience qualify him to act. He should not, even under his client's instructions, engage in or encourage any practices contrary to law or hostile to the public interest, for as he is not obliged to accept a given piece of work, he cannot, by urging that he has but followed his client's instructions, escape the condemnation attaching to his acts. An architect should support all public officials who have charge of building in the rightful performance of their legal duties. He should carefully comply with all building laws and regulations, and if any such appear to him unwise or unfair, he should endeavor to have them altered.

An architect should be mindful of the public welfare and should participate in those movements for public betterment in which his special training and experience qualify him to act. He should not, even under his client's instructions, or the risk of being discharged, engage in or encourage any practices contrary to law or hostile to the public interest. An architect should support all public officials who have charge of building in the rightful performance of their legal duties. He should carefully comply with all building laws and regulations, and if any such appear to him unwise or unfair, he should endeavor to have them altered.

### 19. On Professional Qualifications.

The public has the right to expect that he who bears the title of architect has the knowledge and ability needed for the proper invention, illustration, and supervision of all building operations which he may undertake. Such qualifications alone justify the assumption of the title of architect.

The public has a right to expect that he who bears the title of architect has the knowledge and ability needed for the proper invention, illustration, supervision and co-ordination of all expert and trade services and the execution of all building commissions he may undertake. Such qualifications alone justify the assumption of the title of architect.



## The Canons of Ethics

The following Canons are adopted by the American Institute of Architects as a general guide, yet the enumeration of particular duties should not be construed as a denial of the existence of others equally important although not specially mentioned. It should also be noted that the several sections indicate offenses of greatly varying degrees of gravity.

It is unprofessional for an architect—

1. To engage directly or indirectly in any of the building trades.

2. To guarantee an estimate or contract by bond or otherwise.

3. To accept any commission or substantial service from a contractor or from any interested party other than the owner.

4. To advertise.

5. To take part in any competition which has not received the approval of the Institute or to continue to act as professional adviser after it has been determined that the program cannot be so drawn as to receive such approval.

6. To attempt in any way, except as a duly authorized competitor, to secure work for which a competition is in progress.

The following Canons are adopted by the American Institute of Architects as a general guide, and the violation of any of them by a member of the American Institute of Architects or by an associate member or member of any chapter of the American Institute of Architects subjects him to liability of discipline or discharge from the Institute and chapter.

It is unprofessional for an architect—

1. To engage directly or indirectly in any of the building or decorative trades, except for the execution of his own designs for a fixed or percentage fee.

2. To accept any commission or substantial service from a contractor or from any interested party other than the owner.

3. To take part in any formal competition which has not received the approval of the Institute or to continue to act as professional adviser after it has been determined that the program cannot be so drawn as to receive such approval.

4. To attempt in any way, except as a duly authorized competitor, to secure work for which a formal, approved competition is in progress.

7. To attempt to influence, either directly or indirectly, the award of a competition in which he is a competitor.

8. To accept the commission to do the work for which a competition has been instituted if he has acted in an advisory capacity, either in drawing the program or in making the award.

9. To injure falsely or maliciously, directly or indirectly, the professional reputation, prospects or business of a fellow architect.

10. To undertake a commission while the claim for compensation, or damages, or both, of an architect previously employed and whose employment has been terminated, remains unsatisfied, until such claim had been referred to arbitration or issue has been joined at law, or unless the architect previously employed neglects to press his claim legally.

11. To attempt to supplant a fellow architect after definite steps have been taken toward his employment, *e.g.*, by submitting sketches for a project for which another architect has been authorized to submit sketches.

12. To compete knowingly with a fellow architect for employment on the basis of professional charges.

Adopted December 14-16, 1909.

Revised December 10-12, 1912.

5. To attempt to influence, either directly or indirectly, the award of a competition in which he is a competitor.

6. To accept the commission to do the work for which a formal competition has been instituted if he has acted in an advisory capacity, either in drawing the program or in making the award.

7. To injure falsely or maliciously, directly or indirectly, the professional reputation, prospects or business of a fellow architect.

8. To undertake a commission while the service of an architect previously employed has not been legally terminated.

9. To attempt to supplant a fellow architect after definite steps have been taken toward his employment.

10. To compete with a fellow architect for employment by cutting established fees for professional services.

## Comments on a Proposed Revision of a Circular of Advice and Code of Ethics

By HENRY K. HOLSMAN

(a) The Circular of Advice is intended to advise both the architects and the public. The italicized definitive terms are inserted in the preamble to indicate that the architect is and should be responsible for the invention and business-like execution of not only the aesthetic elements but of all the varied mechanical and sociological elements of a building design.

(b) The added sentence in Article 1 advises how an architect may keep in close touch and control of his work without usurping the legitimate field of the general contractor. So long as he builds for a known fee, not for an unknown profit, he acts in a professional and proper ad-

visory capacity and holds his rightful power of execution for the benefit of the building and the client.

(c) The last clause is omitted from Article 2 because the architect in his business capacity and knowledge of the perfection of his drawings and specifications should be able to give his client at some stage in the progress of his work a responsible guarantee of the cost. Not to be able to do so propagates a disastrous lack of confidence in the architect's business and executive ability and this provision invites the incompetent and ill-equipped architect into practice which only a competent architect should undertake.

(d) The present form of Article 3 invites the owner to



## THE AMERICAN ARCHITECT

suspect that if his architect is not competent to handle certain vital engineering and aesthetic problems and not willing to be responsible for the payment of the necessary expert advice, he is not competent to select an expert for the owner to pay. It is better for both parties if the architect selects and pays for such assistance and charges the owner according to necessities and thus avoids a division of responsibility for the finished whole.

(e) Three alterations are suggested in Article 4. The Institute schedule of 6 per cent is probably proper for competent, experienced architects, but to imply that the incompetent and inexperienced may properly make the same charge as the gifted and well-equipped destroys confidence in the value of the entire profession.

When an architect is equipped to execute his design in detail without the intervention of another builder or general contractor he should charge for expert services rendered.

That each architect should fix his charges according to the services he can render and stick to his schedule is only good ethical and business device.

(f) The last clause of Article 5 is transferred to the last clause of Article 4 for the sake of better classification, and the revisions of Articles 6, 7, 17 and 18 are only for the sake of brevity and clarity.

(g) Article 8 is misleading. Many interpret this to mean that an architect should not buy materials or labor for his client, even on a known fee basis. The American Institute of Architects is on record in favor of the architect dealing directly with the several trades, without restricting the degree of subdividing the work. Some architects, and the public, have come to believe that the architect may only make the pictures and leave the general contractor to be known as the builder, even when he only sublets the work to the several trades, just as the architect might have done with much more grace and with much benefit to himself, the builder and his client. This function of the truly competent architect should be emphasized and encouraged.

(h) If the architect would give his expert advisers and assistants due credit for their work, as suggested in Article 10, he would have less trouble with the engineers and secure better service and more interest in his work from the allied arts and professions.

(i) The tone of Article 2 is altered. Surely the "seeking out of a possible client" is not "condemned." Offering services on approval and without compensation may not be unethical, but is certainly not good business. If it is not good in case of a possible new client, how can it be justified by "personal or previous business relations?" In fact, the practice seems to be that the friend is charged for sketches and the prospect gets plenty of worthless ones free. Moreover, in a "Circular of Advice," who "condemns?"

(j) Article 12 is revised to suggest that not all forms of advertising are ill-advised. If so, how does it happen that we all know so much about the works of a few illustrious and estimable architects?

(k) The suggested revision of Article 13 is to indicate that the Institute should advise what is good advertising. It is imperative that the architect should in some manner let the public know what he can do. This is but common justice to both parties. If the architect permits the public to get the impression that only the builder or the engineer has any responsible connection with the erection of a building, it will not occur to the public to go to the architect even when most in need of his services.

(l) Much confusion and trouble has arisen over Article 14 on "Competition." The Institute enjoins its members from taking part in competitions, except under certain conditions, in the first sentence, and in the second sentence gives a definition of "competition" that is wholly absurd and im-

possible of observance, thus nullifying the whole matter. The suggested definition is necessarily broad. It will be objected that the word "knowingly" leaves a loophole, but it is necessary; for a man cannot be censured formally or informally for not knowing what some other fellow has done. Competition in a real and ethical sense is essential to our economical welfare. So long as two or more architects are paid what is just for their labor in submitting sketches for the same project, it is wholesome for the profession and the public and should not be called a prohibitive "competition." Only those competitions wherein the services called for are not paid for should there be regulation and safeguards provided for the protection of the competitor and the owner.

(m) Much trouble has come to architects and much injustice has been done to owners on account of the complicated proscription on the ethical method of discharging an incompetent and securing a competent architect as set forth in Article 15. The first two clauses of this article have the effect of giving the unethical architect the advantage of the so-called "ethics" of the situation to the great disadvantage of the ethical successor and the injured owner.

(n) Article 16 might properly be omitted as being well-known common law and ethics. If it be deemed necessary to give advice on this subject the corollary suggested in a second sentence would seem to be germane and sometimes practical advice.

(o) In Article 19 the sense of executive ability should be added to the definite classifications intended to describe a thoroughly equipped architect.

(p) The Code of Ethics is intended to be a compilation of definite laws by which every member of the American Institute of Architects agrees to be governed under penalty of discipline of discharge for infractions thereof. The suggestion that there are other items "equally important," and the implication that one may be punished for the infraction of an "equally important" unexpressed code is quite untenable, either in law or ethics. Moreover, associate chapter members are subject to the same discipline, and this should be stated as in the revision suggested as indicating how important the canons are held to be.

Article 1 is revised to clear the existing status of the architect as a builder, as set forth under paragraphs a, b and g.

Article 2 should be omitted if the argument in paragraph c is valid and the architect may at all assume and charge for executive building responsibility.

Article 4 has already been stricken from the code.

In Article 5 the word "formal" is inserted to comply with the revised Article 14 of the Circular of Advice as set forth in paragraph l.

Article 10 is revised to clear up the troubles indicated in paragraph m.

Article 11 is impractical as an enforceable canon. It deals with the business prerogatives of the architect. No business man can reasonably be expected to know whether "definite steps have been taken" by his prospective customer toward the employment of another. The example is superfluous and has to do with competitions, which is even more untenable.

In Article 12 the word "knowingly" nullifies the code. Moreover, a young architect, for example, has the right to compete with a fellow architect "on the basis of charges," whether he knows what the older architect charges or not, which of course in practice he cannot know, and the owner has the right to pay in proportion to the value of services he may expect to get. Architects are not of equal ability. This article of the code is wholly adverse to ethical business principles and subversive of progress in architecture.

The Wentworth-Gardner House  
Portsmouth, N. H.

**T**O the man hurried and overworked in his machine-made surroundings, buried in a mass of tyrannical efficiency, few things contribute more to a reposeful and steadying reaction than the quiet study of a Colonial house.

That the City of New York presents abundant opportunity for such study is to be expected, and the appreciation with which visitors avail themselves thereof is manifested by the esteem in which old landmarks are preserved and the solicitous interest with which they are regarded. Fraunces Tavern, Jumel Mansion, the Van Cortlandt Manor House, the New York Historical Society's build-



THE WENTWORTH-GARDNER HOUSE, PORTSMOUTH, NEW HAMPSHIRE

ings, these are but a few of the places where one may thrill to the charm and beauty of old times, where one may trace in each detail the gradual changes which time has wrought since our fathers fought for freedom.

The Metropolitan Museum of Art, always in the front lines of progress toward the attainment of the proper admixture of art and utility, has recently purchased in toto the furnishings of a Colonial dwelling for installation at the Museum in its original state and in its original arrangement. This is the Wentworth-Gardner House erected in 1761 at Portsmouth, New Hampshire. It is obviously desirable that this property should be in the possession of a public institution where the skill of the eighteenth century craftsman may be preserved as

an inspiration to his descendants of the present day.

The house is built on a rectangular plan similar in the two main floors and follows the usual two-chimney type. It is divided symmetrically by the hallway upon which open the doors of the four rooms on each floor. The house faces the water, and in its original estate a large garden was laid out in the rear. The wooden exterior is typical of its period, well proportioned and symmetrical.

The chief interest centers in the interior. The front door opens directly into the entrance hallway, which is marked off from the stair hall by an elliptical arch spanning its width and growing out of a group of three fluted Doric pilasters at each end. A wainscot 38 inches high appears in both entrance and stair hall, where it follows up to the second floor. The great panel along the first flight of stairs is of a single piece of wood.

The stairway is of unusual excellence of design. The spindles of the rail are of three types, three to the tread, and take in succession the form of a thin Doric colonnette, a spirally turned column and a graceful gourd-shaped baluster. The newel post is in design a composite of these spindles. The hand-rail is broad and heavy.

In the eight rooms of the first and second floors the conspicuous feature is the fireplace walls which are panelled in wood from floor to ceiling. The upper hall is also panelled from top to bottom. The wall is separated into corresponding bays on either side by fluted Ionic pilaster strips which carry the cornice and coved ceiling. The symmetrically placed doors to the rooms are flanked by pilasters and the space between the two doors on each side is divided into six panels. The rooms present simplicity of design yet amplitude of decoration.

The whole house exemplifies in its plan and decorative treatment the restraint so characteristic of the New England Colonial building. Whatever the decoration may lack in imagination is gained in consistency of scale and motif. Throughout the house, the woodwork, the wall panelling, the stair landings and all the numberless other details are designed to give interest and are executed with considerable skill.

That the Museum has taken steps to make all of this excellent material available for a wider acquaintance with an always interesting phase of architectural development is one instance more of its important function in education and its valuable promotion of better execution in modern craftsmanship.



THE AMERICAN ARCHITECT

Founded 1876

PUBLISHED EVERY WEDNESDAY BY

THE ARCHITECTURAL AND BUILDING  
PRESS, INC.

No. 243 West Thirty-ninth Street, New York

E. J. ROSENCRANS, PRESIDENT AND TREASURER  
WILLARD C. HOWE, VICE-PRESIDENT

WILLIAM H. CROCKER, Editor  
ARTHUR T. NORTH, Engineering Editor

Subscriptions in the United States and Possessions,  
Mexico and Cuba, TEN DOLLARS. Other Countries,  
TWELVE DOLLARS.

SINGLE COPIES (Regular Issue) 25 CENTS

CHICAGO OFFICE, Mallers Building  
PAGE A. ROBINSON, Western Manager  
ST. LOUIS OFFICE, Wright Building  
CLEVELAND OFFICE, Guardian Building  
SAN FRANCISCO OFFICE, 320 Market Street

Owned by United Publishers Corporation—H. M. Swetland, President;  
Charles G. Phillips, Vice-President; W. H. Taylor, Treasurer;  
A. C. Pearson, Secretary. Entered as second-class matter January  
6, 1909, at the Post Office at New York, New York, under the Act of  
March 3, 1879.

Vol. CXV MARCH 12, 1919 No. 2255

The Architectural Improvement of  
Farm Buildings

THE movement to improve the architectural treatment of farm buildings inaugurated by George W. Maher, president of the Illinois Chapter of the American Institute of Architects, is rapidly growing in favor. There are printed in this issue, on pages 377-379 inclusive, extracts from a few of the large number of communications relating to this important matter which have been received from officers of agricultural colleges and schools. It will be seen that there is an absolute unanimity of opinion as to the necessity for a reform such as Mr. Maher has suggested, and there is general concurrence as to just how the result desired might best be attained.

Probably the least cumbersome and most effective manner would be through commissions appointed by the Governors of the various States. Of course, these commissions, to be effective, would necessarily be absolutely non-political, and their personnel comprised of representative men in banking, real estate, engineering and architectural fields, always including a certain number practically engaged in farming.

To get the matter under way as speedily as possible, and to avoid further loss of time, it would be well if the various agricultural colleges so keenly in sympathy with the movement would promptly consult with the State Chapters of the American Institute of Architects and the State Societies of Architects, and in co-operation bring the whole thing up with the various State governments.

The object to be attained is so very desirable, and its accomplishment something which all of the people would so quickly approve, that the appointment of a commission in one State would undoubtedly be followed by a nation-wide movement.

It will not be necessary to state that THE AMERICAN ARCHITECT will give the most serious support to a movement which so largely contributes to the moral, social and artistic welfare of workers whose industry is the largest in this country.

A Revision of the Circular of Advice

ON another page in this issue there is printed a proposed revision of the Circular of Advice, and the Canon of Ethics of the American Institute of Architects, submitted by Henry K. Holsman, secretary of the Illinois Chapter of the American Institute of Architects and chairman of a joint committee of the Chapter and the Illinois Society of Architects.

This revision has been made with the purpose of clarifying the status of the architect and consistently answering the criticisms that have in the past been aimed at the profession. It is now printed that it may stimulate discussion not only among Institute members but generally throughout the profession.

An expression of opinion on the part of readers of THE AMERICAN ARCHITECT is invited.

Build Now

IF, as has been maintained in these columns, architecture, while first of all an art is none the less a business, it is essential that any publication in the field of architecture should lay before its readers such important matters as vitally effect the executive aspects of practice.

With this belief, THE AMERICAN ARCHITECT has, after a careful inspection of the present conditions affecting building, secured from groups of men of high authority expressions of opinion on this now all-important question. These are presented in this issue.

If, during the progress of the war, it was patriotic to heed the Government's instructions in the matter of building, it is no less patriotic now to uphold the well-directed efforts of the Department of Labor in encouraging as far as may be possible



a speedy return to normal building conditions. To build now, to set afoot every operation of building that possibly can be undertaken, becomes an actual and a patriotic duty.

The questions of supply and demand of material, the all-important one of labor, are in their solution bound up in the attitude of those who have building needs. To fail to proceed in these matters is only to retard the stabilization of prices of all the elements which go to produce a building.

**W**ITH so large an amount of investment capital temporarily unavailable, it is important that new ways of securing money should be given careful consideration.

Building and real estate development are so closely related to the financial community that any serious setback reacts equally. Those with money to lend will, of course, require exact stability of collateral, and it is probable that the solution of the problem lies in a more general issuance of bonds guaranteed by well-placed mortgages. Investors have in such a method a perfectly safe and lucrative form of investment, and the opportunity at this time is so very favorable for investment capital that we may, perhaps, with confidence find that this will be the speediest and most logical solution to the questions involving building loans.

**A**LARMISTS who loudly proclaim pessimistic views as to the building outlook, and who counsel postponement of building operations, have somewhat dishonestly claimed that the correctness of their views is shown in what they state is the unwillingness of large insurance corporations to loan money on building projects.

As a matter of fact, any reluctance to finance building on the part of these corporations is not due to any mistrust as to the value of the collateral, but actually to the fact that they are not prepared, owing to shortage of loaning funds, to undertake business they would if they could, gladly accept.

The truth of this statement was very clearly shown by Walter Stabler, comptroller of the Metropolitan Life Insurance Company, in a recent address before the Real Estate Board. Mr. Stabler stated that it was authoritatively known that the drafts on the five largest insurance companies by the various Liberty Loans amounted to \$240,000,000, which, he further adds, equals the amount

these companies have had at their disposal in normal years for investment purposes.

Further, it was pointed out that the deaths during the epidemic of influenza had occasioned a heavy drain on these companies, one of which had been compelled to pay out for this cause alone no less than \$18,000,000.

These facts indicate that the present policy of insurance companies to invest in building loans is actually due to their inability, and not to their disinclination to enter this field of investment.

### Definite Specifications

**W**HILE the concise, definite specification is now generally conceded in principle, "habits are stubborn things," and a specification writer who for years has masked his ignorance or indolence behind general terms, and has attempted to cover up omissions by "grandfather" clauses, experiences some difficulty in preparing an instrument that contains no ambiguities or uncertainties.

Probably the average practitioner does not realize just how susceptible of more than one interpretation his specifications are until they are put to the test. A case in point was that of a leading firm of architects in an Eastern city who recently submitted a set of plans and specifications for a project of some size to a Quantity Surveyor for the purpose of securing an accurate list of required quantities of materials, equipment, etc. Before the Quantity Surveyor could render his report he was obliged to ask for further or more accurate information concerning more than fifty items. This was a revelation to the architects, for it not only demonstrated the value of the survey in furnishing an exact basis for figures sought from building contractors, but it apprised them of the degree of indefiniteness which, without their full realization, had pervaded their specifications.

Perhaps this was an exceptional case, but the suspicion is strong that there are other offices in which conditions are not very different, and where only a test as noted above would convince the members of the firm of the actual situation.

Accepting the theory of the definite specification is only the first step toward the reform that is being made in this branch of architectural practice. Seeing that the theory is put into actual practice by testing the product of the specification department is no less necessary to real accomplishment.

# Criticism and Comment

---

## The Practice of Architecture

*The Editors, THE AMERICAN ARCHITECT:*

We have read your "Practice of Architecture" with interest and we do not see anything very revolutionary in it. Our business policy, in fact, has followed pretty closely the lines as laid down by you. In many cases promoting is not necessary, but we see no reason why it should not enter into the business end of an architectural office. Our office organization takes care of all service—architectural, civil, mechanical, heating and ventilating and lighting engineering. We give service in industrial layouts for manufacturing plants. We always consider our firm responsible for accuracy of plans, etc. We make a condition that superintendence for our building plans must be furnished by our office. We control business affairs as relating to construction of building. We have followed the plan as outlined above for the past fifteen years and find it works satisfactorily.

SMITH, HINCHMAN & GRYLIS.

Detroit.

---

## The Post War Committee

*The Editors, THE AMERICAN ARCHITECT:*

Will you permit me to make a few comments on the publication in your edition of the 26th of the Program of the Post War Committee on Architectural Practice:

In the first place, I very much regret that the title placed at the head of my article referred to the committee as being "of the American Institute of Architects." To be sure, the committee was appointed by the board of directors of the Institute, but it was definitely instructed to consider itself in all its actions quite free of control by the institute. It was specifically instructed to add to its members from the profession at large, and more than that, it was suggested that the committee might well take in persons who were not architects, but who might contribute valuable aid in the discussion of the problems facing the building world.

The editorial note following the title may lead some of your readers to think that the article had already been published elsewhere. This is not the case. Not only the foreword is entirely different from that prepared by the committee, but the 14 items had been in a great part recast, and put into my own language, besides being supplemented by additional paragraphs. The committee as such is in

no way responsible for the article. It has decided, however, that the draft as published in *THE AMERICAN ARCHITECT* is a considerable step in advance of the original program published in the *Journal of the Institute*, and proposes to use the article published by you as the basis of its final program which is to be sent out in a few weeks.

The committee is unquestionably indebted to the editors of *THE AMERICAN ARCHITECT* for the interest they have shown in this most important move. Your paper can greatly assist this work by opening its columns to the discussion of various points of the program, particularly if your readers will keep clearly in mind that the committee is in no way interested in criticising the practices of the building world. Its sole purpose is to elicit constructive suggestions towards betterments where such are desirable. It merely repeats comments made from time to time by various persons with regard not only to the architectural profession, but to the practice of engineers, builders, contractors, etc. In the course of the next few months we expect to issue supplementary documents which will perhaps be equally provocative of discussion and which will more directly dwell on conditions in other parts of the building world.

ROBERT D. KOHN,

Executive Member Post War Committee  
on Architectural Practice.

---

## Waste Due to Building Codes

*The Editors, THE AMERICAN ARCHITECT:*

Reference is made to the article entitled "The Elimination of Waste Due to Building Codes," in *THE AMERICAN ARCHITECT* of Jan. 22, 1919. This is an excellent article—true right down to the last word. What are we going to do about it? Already my copy, like thousands of others, is laid aside.

The subject is a matter of the first importance. I believe that there should be a national code, just as there are national laws. The terms of this code should be such that they would be applicable to any part of the country. Should any state or municipality consider the national code insufficient to cover their requirements they could adopt a sub-code with additional requirements to meet their individual needs. The sub-codes would conform to the several state laws or municipal ordinances, and not conflict with the requirements of the national code.

As the matter stands, I must first digest the



## THE AMERICAN ARCHITECT

Illinois code before I can safely make even a sketch for an Illinois building, and so it is with the other states or cities. Having a national code and a local sub-code, being already familiar with the national code, I only need to glance over the local sub-code.

A commission should be created to establish such a code. This commission should appoint individuals expert in the several branches, each individual to make up a code for his special branch of the work. The commission should then correlate the work of the individuals. The result should be a national code. This could be made a law by Congress, or could be left for the several states to adopt at their option.

It seems to me that the American Institute of Architects should be a proper body to push this through. The men doing the work should be adequately paid for their services so that the work would be well done. I believe that *THE AMERICAN ARCHITECT*, as the foremost architectural publication, should be able to bring about the required action. Possibly the Government could be induced to take up this matter. I trust that something more substantial than the mere spreading on of printer's ink will come of this.

ELMORE R. DUNLAP.

Detroit.

### The Art of Planning

*The Editors, THE AMERICAN ARCHITECT:*

There is bound up in the daily practice of architectural design an art so subtle that few laymen realize its existence, and indeed few architects themselves accord it a position which its importance should demand. Its practice is based upon information of such an exact nature that it might almost claim a place among the sciences as well as among the arts. We refer to the art of planning.

About all we get from the professional magazines bearing upon this most essential department of architectural practice exists in the reproduction of plans without any analysis or comment as to the principles from which they were evolved, or of the data upon which these principles were based.

Your analysis of schoolhouse standards, recently published, we believe is a step in the right direction, but only a step into what may be an inexhaustible field of valuable research. Gaudet is the only author whom we know to have gone into this very thoroughly or satisfactorily, but inasmuch as there has never been, to our knowledge at least, a translation of his work into English, what he has done is presumably beyond the reach of ninety per cent of American practitioners. Even were his work to be translated we doubt if it would have the full value of similar study made from the American viewpoint and under existing conditions. We believe the profession at large would appreciate immensely any effort undertaken in this direction, and we would appreciate at least your consideration as to its wisdom and feasibility.

EDWARDS & SAYWARD.

Atlanta.

### A Correction

A correspondent advises that in the announcement published in the February 19th issue of the donation by J. Cleveland Cady of his architectural library to Trinity College at Hartford, Conn., it referred, in error, to Mr. Cady as being the senior member of the firm of Cady & Gregory "of Hartford." Mr. Cady has practiced the profession for nearly fifty years in New York City, with Mr. Gregory associated with him for the past thirty-five years. The firm's offices are at 40 West Thirty-second Street, New York.







PLATE 78

FORD BUILDING, 54TH STREET AND BROADWAY, NEW YORK

ALBERT KAHN, ARCHITECT, ERNEST WILBY, ASSOCIATE











PLATE 80

MAIN STAIRWAY

FORD BUILDING, 54TH STREET AND BROADWAY, NEW YORK

ALBERT KAHN, ARCHITECT, ERNEST WILBY, ASSOCIATE







PLATE 81

FORD BUILDING, 54TH STREET AND BROADWAY, NEW YORK

ALBERT KAHN, ARCHITECT, ERNEST WILBY, ASSOCIATE



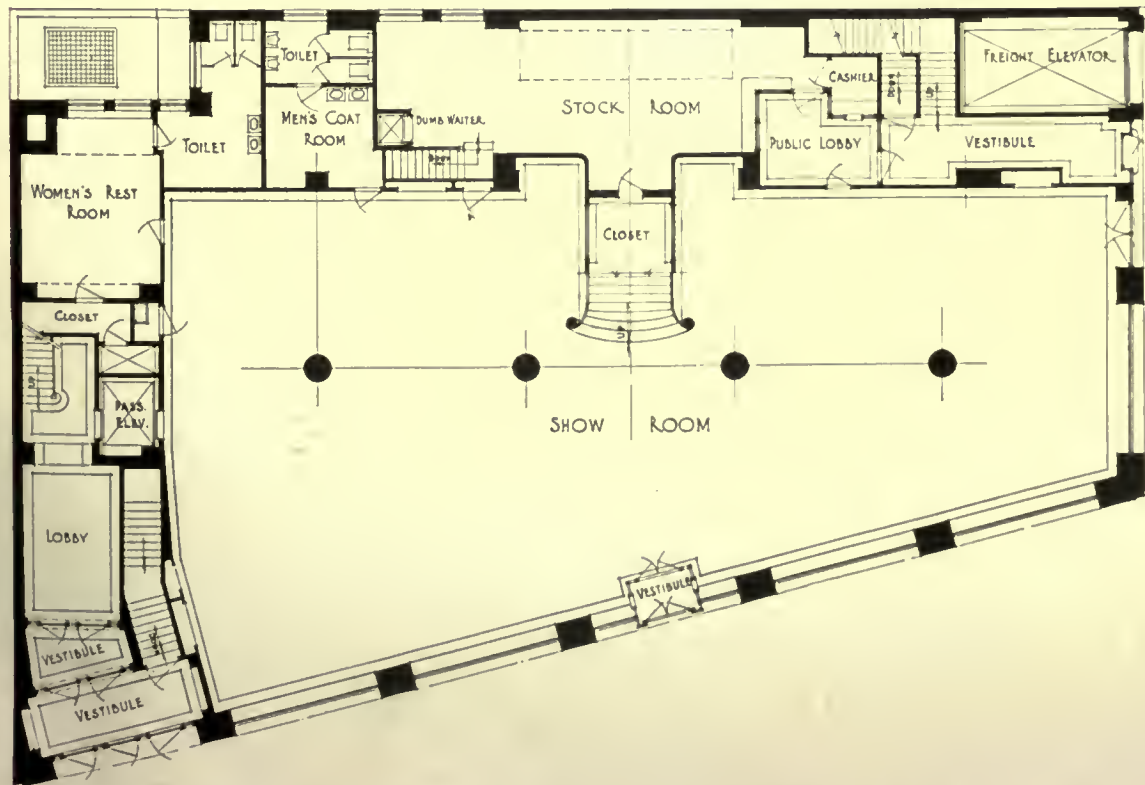
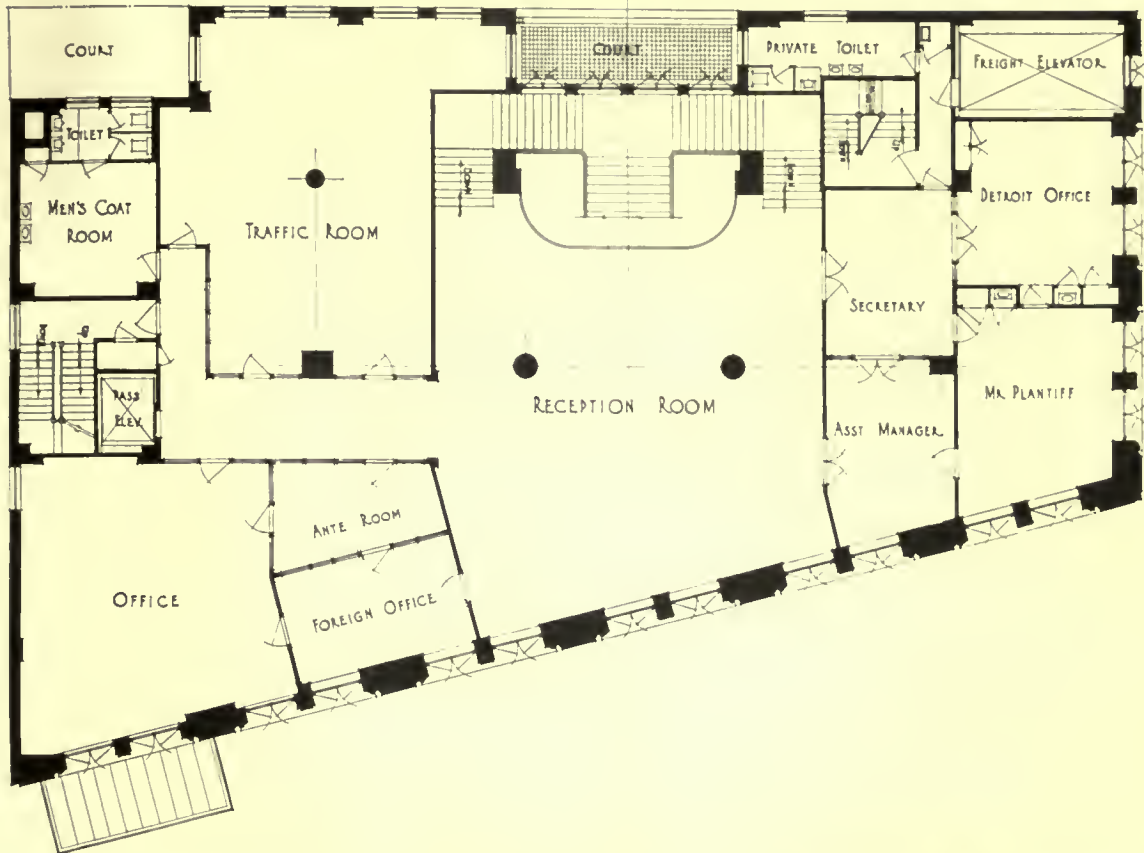

PLATE 82

FORD BUILDING, 54TH STREET AND BROADWAY, NEW YORK

ALBERT KAHN, ARCHITECT, ERNEST WILBY, ASSOCIATE







J. P. ROBERTS, UNIVERSITY OF  
PENNSYLVANIA  
FIRST PRIZE AND FIRST MEDAL

CLASS A. II. PROJET  
SPECIAL BOOK PRIZE  
COMPETITION

AN ISLAND OF FREEDOM

STUDENT WORK  
BEAUX-ARTS INSTITUTE  
OF DESIGN





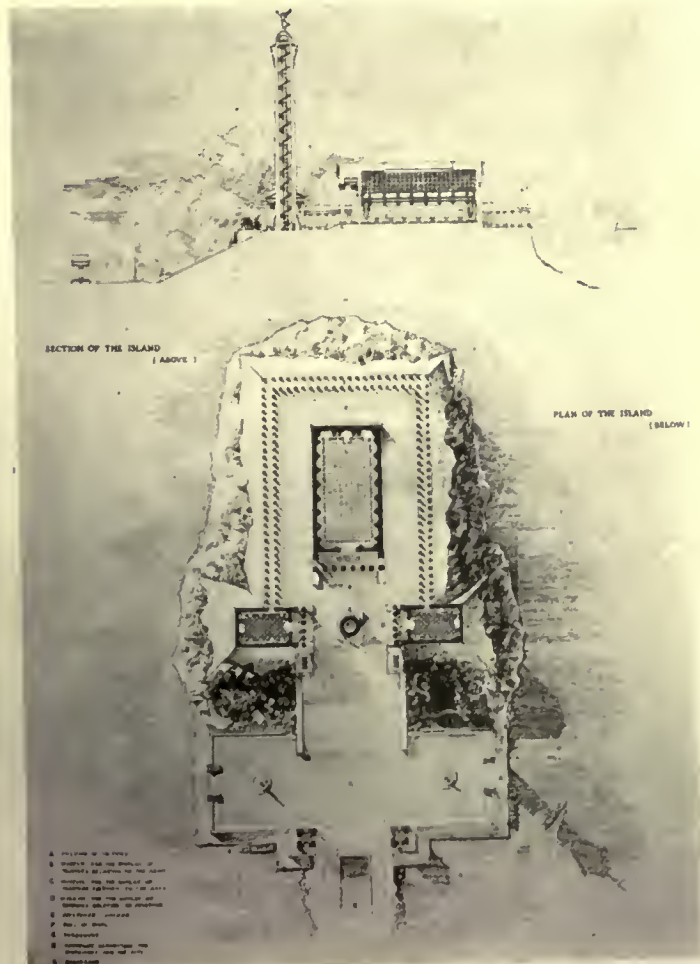
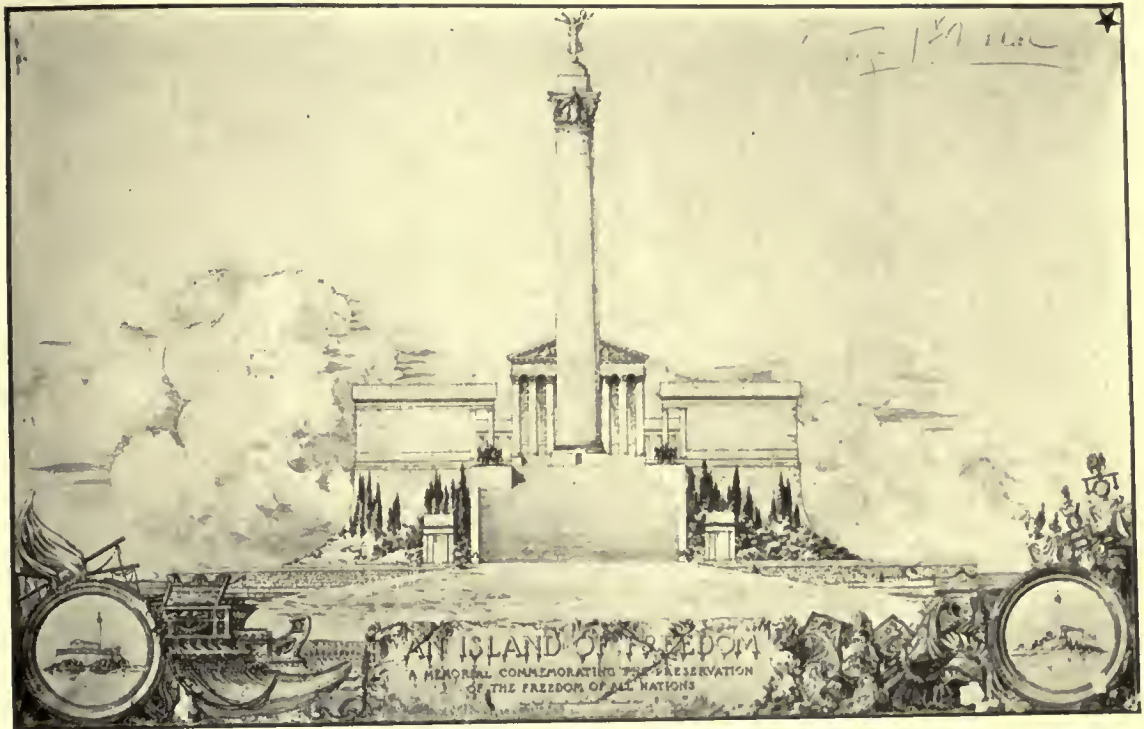

L. WILLIAMS, COLUMBIA UNIVERSITY  
—SECOND PRIZE AND FIRST MEDAL

CLASS A. II. PROJET  
SPECIAL BOOK PRIZE  
COMPETITION

AN ISLAND OF FREEDOM

STUDENT WORK  
BEAUX-ARTS INSTITUTE  
OF DESIGN





*1st Medal* ★

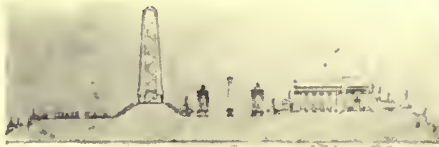

A. E. MIDDLEHURST, CORNELL UNIVERSITY—THIRD PRIZE AND FIRST MEDAL

CLASS A. II. PROJET  
SPECIAL BOOK PRIZE  
COMPETITION

AN ISLAND OF FREEDOM

STUDENT WORK  
BEAUX-ARTS INSTITUTE  
OF DESIGN

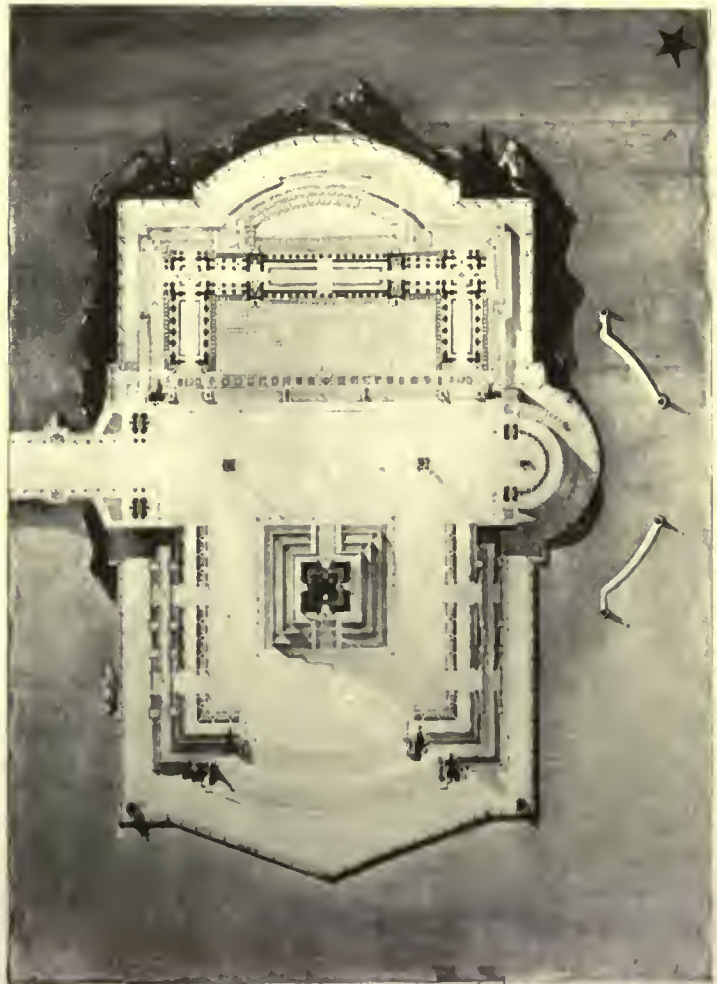

★





THE AMERICAN ARCHITECT

MARCH 12, 1919

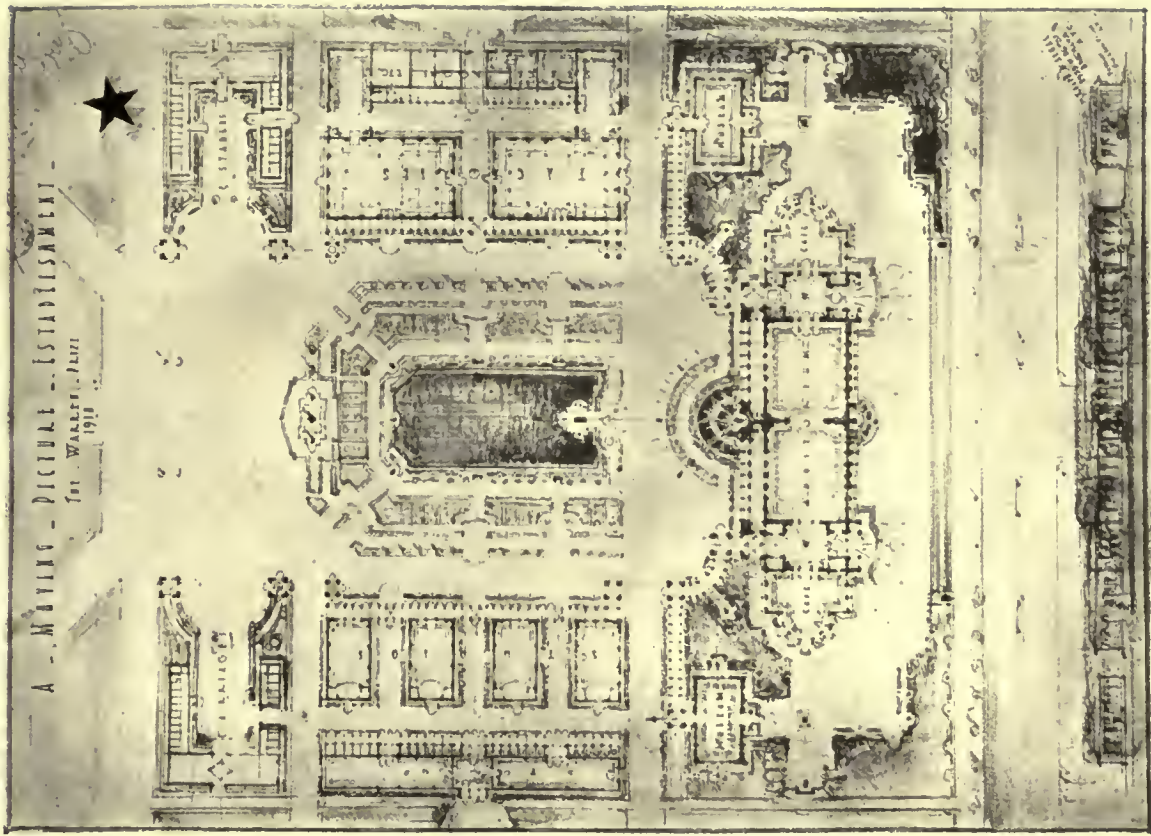
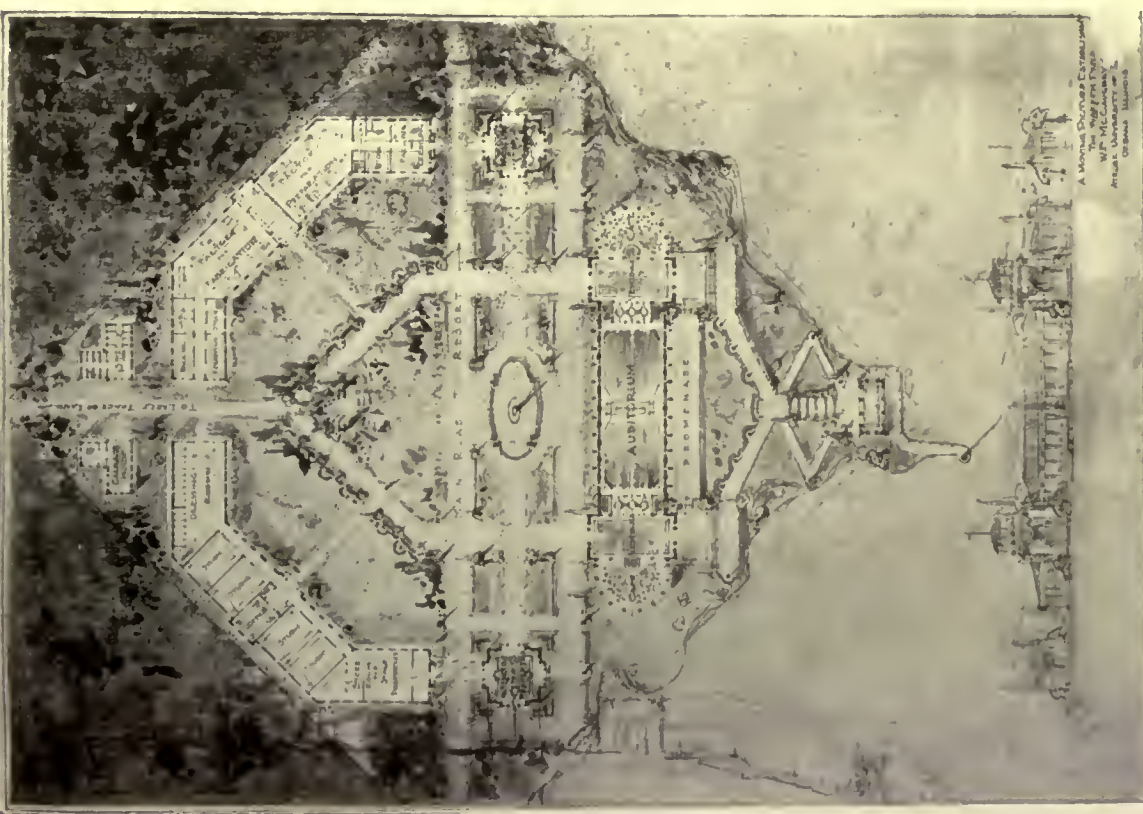

W. F. McCAUGHEY, UNIVERSITY OF ILLINOIS

R. H. SEGAL—SECOND PRIZE, PATRONS G. & E. BLUM

WARREN PRIZE COMPETITION—A MOVING PICTURE ESTABLISHMENT  
STUDENT WORK, BEAUX-ARTS INSTITUTE OF DESIGN





# The Architectural Improvement of Farm Buildings

A Series of Communications from Various Agricultural Colleges Endorsing the Movement Inaugurated by George W. Maher, President of the Illinois Chapter, A. I. A.

*The Editors, THE AMERICAN ARCHITECT:*

Your valued article regarding the suggestion of Mr. George W. Maher, Chairman of the Illinois Chapter of the American Institute of Architects, that various states vigorously take up the subject of the improvement in design and plan of farm buildings, has been read with unusual interest. As a citizen of the State of Illinois, I am very proud of the fact that this suggestion came from an Illinois architect and wish to assure you that I am willing to do all within my power to assist in furthering the work of which you write.

My experience has brought me in contact with the farmers of Illinois and other states and I have found that these men are much interested in securing properly designed and constructed buildings at a reasonable price. Here at the University we have a large number of inquiries every year from the farmers of this and other states asking for information regarding farm buildings. With our present facilities the service which we can render is very limited.

There are a number of ways in which interest in farm building problems could be stimulated and assistance given to farmers who are desirous of erecting new buildings or remodeling old ones.

In the first place the State Commission which you suggest, could render a very valuable service by carefully investigating the conditions as they exist today and by making some broad, far-reaching recommendations regarding the importance of farm building work, and the influence which properly designed buildings may have in making farm life more attractive, and could offer suggestions regarding the desirable lines for future work. Such a report, if well done, would serve to bring the importance of the farm building problem to the attention of the public and furnish a basis for further development which does not exist at the present time. Such a commission should be very carefully selected. If it is to enjoy the support of the agricultural interest which it must have in order to make its work effective, its membership should be representative of the interests involved.

Such a commission should contain architects who have been born and brought up on a farm and who still have a genuine interest in things of the country.

Such men would bring to a work of this nature not only great technical skill in their professions, but also an understanding of and a sympathy for the things of the country.

This commission should have a number of representative farmers as members. These men should not merely own land, but should be living on it and operating it during the time which they serve upon such a commission. As our agricultural colleges and extension service materially assist in disseminating the information to the farmers, I believe it would be well to have them represented, as they would not only assist in carrying on the good work regarding farm buildings, but they would also bring to the commission the services of men who know farm problems and look at them from a scientific viewpoint.

Another important step which might be taken for the improvement of farm buildings is to enlarge the work of the farm building departments of our State Universities and strengthen the extension work relating to the same. Practically all of our land grant colleges have men who are devoting part or all of their time to the subject of farm buildings. Unfortunately some of the men engaged in this work are not well-trained architects, and in practically every case with which I am familiar the amount of money which the state is appropriating for this work is entirely out of keeping with its importance. No greater service could be rendered to the agricultural interests of our country than to bring about the appointment of well-trained architects, who understand country problems, to the faculties of our agricultural colleges and then to see that their work receives the needed financial support.

This work in our colleges should furnish instructions to students regarding farm building problems, take up investigation work relating to the arrangement, design, and construction of farm buildings, and then organize the extension work which will give the message to the farmers.

At the present time we are entering a new era in farm building construction. We are just now passing out of the pioneer stage. Today the farmers are looking for permanence in construction, convenient economical arrangement, and the artistic

## THE AMERICAN ARCHITECT

design and grouping of farm buildings. There never has been a more appropriate time for taking up the work such as you suggest.

E. A. WHITE,  
Division of Farm Mechanics,  
University of Illinois.

---

*The Editors, THE AMERICAN ARCHITECT:*

Your article with reference to encouraging the farmers in the improvement of design and planning of their buildings, I consider a very worthy step, because there is, no doubt, a great need for better farm buildings throughout the country. Most of the state agricultural colleges are doing some work along this line. This department, at least, is urging better farm buildings and is furnishing plans through the Extension Service.

In connection with improving the conditions that now exist, I believe it would be wise to put on a vigorous campaign to create a greater interest along this line, and along with this campaign we should have something to offer the farmer. The special commission which you suggest might take this matter in hand and investigate to find out what material is now available for the farmer along this line, and also get this information before the public.

E. W. LEHMANN,  
Associate Professor of Agricultural  
Engineering, University of Missouri.

---

*The Editors, THE AMERICAN ARCHITECT:*

In taking up the subject of the improvement in design and plan of farm buildings, you have struck a very important and practical line of development for the entire rural population of America.

I have said frequently that from an economic standpoint there has been an immense amount of money wasted because of the crude building done on the farms of this country. I have also campaigned somewhat against the crude stuff in the small towns in the United States. There is no question but that the taste of the people must be appealed to and trained in order to prevent this enormous loss. We ought somehow to make it clear to the head of the family that to carry on a saving and industrious career for ten or fifteen years and to spend this savings in some unattractive sort of building is a pitiable dissipation of wealth. It seems that we might be able to impress this thought, that after these savings have been expended in this way the buildings soon become almost worthless because of their ugliness and because of their lack of plans suitable to the needs of a well-ordered home.

J. W. CANTWELL, President,  
Oklahoma Agricultural and Mechanical College.

*The Editors, THE AMERICAN ARCHITECT:*

I am interested to note that you are beginning a campaign looking to the improvement in designing and planning of farm buildings. I am strongly of the opinion that such a measure is designed to be of great value because of the great backwardness in the matter of planning farm structures, not only as regards their utility, but as regards their beauty. This institution is greatly interested in the matter, and is using its Art Department, as well as its Mechanic Arts Department, in the furtherance of desirable plans.

Very truly yours,  
E. G. PETERSON, President,  
Agricultural College of Utah.

---

*The Editors, THE AMERICAN ARCHITECT:*

There are three important factors involved in the construction of farm buildings:

- (1) *Cost*, for farm buildings are built primarily for the purpose of earning dividends on the investment.
- (2) *Practicability*. The building must conserve the purpose for which it is built—housing animals properly and conserving labor.
- (3) *Beauty*.

We believe that these factors, although each is important, should rank in the order suggested. Advancement or progress in rural architecture, or the subject of "Farm Structures" as we prefer to call it, is something that must come about through public or co-operative effort.

J. B. DAVIDSON,  
Professor of Agricultural Engineering,  
University of California.

---

*The Editors, THE AMERICAN ARCHITECT:*

It is very true that the buildings found on the farms are mostly unsightly as well as unsuited for the purposes for which they are used. There is much evidence of a lack of plan or sense in the planning and construction of these buildings. However, those of us who are of the city life will have a difficult subject to handle in attempting to introduce any desirable changes into the life of our rural communities. The people of such are wedded to their own way of doing things and look with grave suspicion upon any movement inaugurated by outsiders.

The movement suggested in your letter, and in the printed matter accompanying it, is one worthy of consideration and support.

ALSTON ELLIS,  
Ohio University.



## THE AMERICAN ARCHITECT

*The Editors, THE AMERICAN ARCHITECT:*

The movement which you are fostering is in every way timely and imperative, in order to attract and hold the large numbers of people who will more and more be necessarily drawn to the farms during this period of readjustment.

This institution has for many years interested itself in helping the farmers of this section in the matter of improving their school houses and grounds, their churches and grounds, as well as their dwellings and surroundings. We have from time to time been glad to furnish, free of charge, such advice and plans from our specialists, as well as shrubbery and the personal supervision of our instructors as were necessary in the proper working out of their problems.

We shall of course be glad to co-operate in every possible way in furthering the work.

ROBERT R. MOTON,

The Tuskegee Normal and Industrial Institute.

*The Editors, THE AMERICAN ARCHITECT:*

This Division has been particularly interested in rural civic improvement with special reference to the improvement of rural school grounds. In many instances we have also taken up the designing and construction of rural parks and playgrounds, and everywhere over the state we have found a most general spirit of co-operation.

With reference to the designing and laying out of farm grounds and farm buildings, I may further advise that we have acted in a consulting capacity to the California Land Settlement Board along these lines and believe that results are beginning to show to advantage.

This Division will be particularly glad to associate itself with any movement along these lines.

J. W. GREGG,

Professor of Landscape Gardening and  
Floriculture, University of California.



SQUASH COURT AND GARAGE OF ROGER B. MERRIMAN, CAMBRIDGE, MASS.  
COOLIDGE & CARLSON, ARCHITECTS



# Recent Legal Decisions

## FAILURE TO REQUIRE CONTRACTOR'S BOND—TIME FOR BRINGING ACTION

A county contracted with a construction company for the erection of a courthouse. A materialman delivered material to the contractor which entered into the construction of the building. The bond furnished by the contractor did not contain the clause providing for the payment of labor and material required by the statute. When the building was partially completed the contractor abandoned the work, and the county took over the job. Section 2 of the statute provides a liability on the part of the county for its failure to require the proper bond. The materialman brought action to enforce this liability. Section 3 of the act limits the time within which an action may be brought to "ninety days from the acceptance of the work for which the same shall be claimed." The decision of the case depended upon the meaning of this section. The court said: "When we consider that the county is not immediately concerned with the relations between the principal contractor and subcontractors, and that the declared purpose of the act is to provide a remedy to laborers and materialmen who might otherwise be deprived of a remedy, and that none of the parties to the principal contract or subcontracts may be in position to know the outcome of the job within ninety days from the acceptance of a particular piece of work or material by the principal contractor, and that it is the ultimate outcome that is clearly aimed at in the act, it is not difficult to arrive at the meaning of said section three. It is clear to us that the word 'work' is used to comprehend and embrace the words 'erection, alteration, repair, or improvement,' found in the preceding section, and that it was so used to obviate the necessity of their repetition in section three. Or, in other words, it refers to the job to be performed under the contract between the public corporation and the contractor under and for whom the laborer or materialman furnished his labor or wares. The word is commonly so used in reference to building contracts."—*Gold Bros. Brick Co. v. Grant County, South Dakota Supreme Court*, 168 N. W. 855.

## LEVY ON BUILDING MATERIALS

A written agreement between a building contractor and an owner provided that building materials delivered to the operation should be the property of the owner, and that after the operation was completed, the buildings should be sold, and the balance of the proceeds after payment of the

liens and claims should be paid to the contractor. The owner incurred obligations on the faith of this agreement. It was held that a judgment creditor of the contractor could not levy on building materials (consisting of brick, lumber, and structural iron) delivered to the operation; and especially was this the case where the judgment was for materials furnished to another operation. The contractor had no control over the materials except for the purpose of erecting the houses; and his sole interest was a right to an accounting after the houses were sold.—*Evans v. Champion*, 68 Pa. Superior Ct. 522.

## MECHANICS' LIENS—TIME FOR FILING CLAIMS

A materialman's delivery of 30 cents' worth of material at the premises, not by order of the contractor to be used in the building, but solely to extend the time in which to file a lien claim, is held not good faith delivery under a contract causing the time for filing claim of lien to run from its date.—*Lee Canfield Lumber Co. v. Heinbaugh*, Iowa Supreme Court, 168 N. W. 776.

## CONTRACTS FOR ARCHITECT'S SERVICES

It is a common rule that a cashier of a bank has the apparent power to bind the bank in the bank's usual financial business. But it is held, in an action for the agreed price stipulated in an oral contract for architect's service, that the building of a two-story brick building for the use of the bank is not the ordinary financial business of a bank, nor is the making of a special contract for the professional services of an architect within the above rule.—*Reuter v. Utica State Bank*, Texas Court of Civil Appeals, 206 S. W. 715.

## AGREEMENTS TO OBTAIN GOVERNMENT CONTRACTS

While public policy condemns agreements which tend injuriously to affect the public service, it is held in an action to enforce a contract between plaintiffs and defendant, that an agreement between the parties to use joint efforts to obtain from the United States Government a contract for the construction of a military camp, and to contribute to services and share in profits, is not against public policy. But if such an agreement tended, by necessary implication, to bring to bear upon officers of the Government secret or improper influences in awarding the contract, it would be condemned by the courts.—*Anderson v. Blair*, Alabama Supreme Court, 80 So. 31.

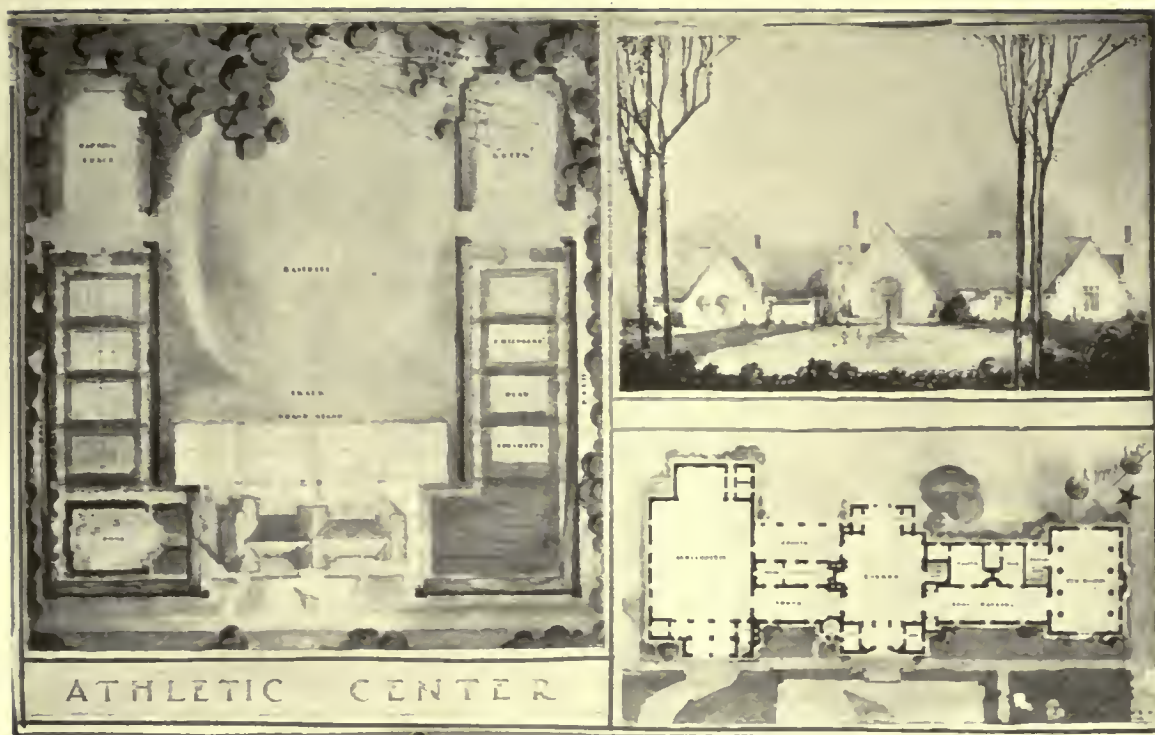

R. D. McPHERSON—FIRST MENTION, CORNELL UNIV.  
CLASS B. II. PROJ. AN ATHLETIC CENTER

## Beaux-Arts Institute of Design

DIRECTOR OF THE INSTITUTE, LLOYD WARREN

ARCHITECTURE, WILLIAM F. LAMB

SCULPTURE, JOHN GREGORY

INTERIOR DECORATION AND INDUSTRIAL ART DESIGN, ERNEST F. TYLER

MURAL PAINTING, ARTHUR CRISP

### Official Notification of Awards— Judgment of December 30th, 1918

#### THE WARREN PRIZE

The gift of Messrs. Whitney Warren and Lloyd Warren offered for excellence in planning a group of buildings.

FIRST PRIZE—\$50.00. SECOND PRIZE—  
\$25.00.

(For conditions governing this Prize Competition, see Circular of Information, Article VIII—Par. 2 and 3.)

#### PROGRAM

The Committee on Architecture proposes as subject for this Competition:

### "A MOVING PICTURE ESTABLISHMENT" INTRODUCTION:

Near a large seaside resort it is proposed to establish a manufacturing plant for moving picture machines and films, and to have in connection with this plant museums, cafés, and a theater for the entertainment of the residents and visitors to the resort. A plot of ground 600 ft. x 600 ft. adjacent to a large tract owned by the company and used by it for experiments and special settings, has been arranged to receive the buildings required. These buildings with their approximate areas are:—(as stated below)

#### PROVISION MUST BE MADE FOR:

1st—A large rectangular auditorium 65 ft. x 160 ft. arranged with a transparent curtain hung in the



center of the long dimension for the purpose of subdividing the audience into two classes—each of which views the pictures from the correct distance. That half of the audience viewing the pictures in the reverse pay less for admission than that half who see the pictures from the side of the operator.

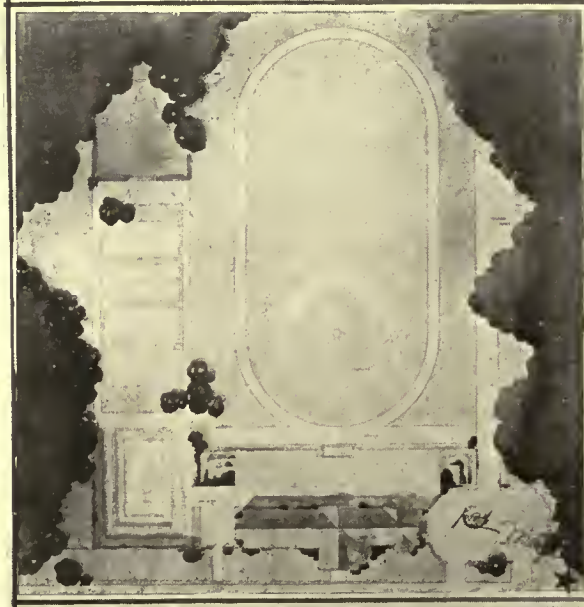

F. R. STEFFENS, JR.—FIRST MENTION, CORNELL UNIV.  
CLASS B. II. PROJET. AN ATHLETIC CENTER  
FOR AN INDUSTRIAL TOWN

2nd—A vestibule and café with toilets, retiring rooms, etc., form an additional part of each half of the large auditorium.

3rd—A public museum of stage furniture and properties—2500 sq. ft.

4th—A public museum of photography and appliances—2500 sq. ft.



A. C. WEATHERHEAD—FIRST MENTION, PLACED, UNIV.  
OF OREGON

CLASS B. II. ANALYTIQUE

5th—A factory for the fabrication of moving picture machines—6000 sq. ft.

6th—A factory for the preparation of moving picture films—6000 sq. ft.

7th—Stock rooms, two (2) packing and receiving rooms, dark rooms, several small laboratories, etc., in connection with these factories.

8th—Four studios arranged with a stage, drop and movable scenery, each having an area of 2000 sq. ft. Access between these studios and the museum of properties is obligatory.

9th—Thirty (30) dressing rooms or booths for actors. A storage room for movable scenery having an area of 4000 sq. ft. should be arranged for near the above studios.

10th—A stable and carriage house near the large tract of land, referred to in the introduction, for special settings. This large tract of land may be on all sides of or on any one side of the plot of



R. L. GALBRAITH—MENTION—BEAUX-ARTS ATELIER  
WASHINGTON, D. C.

CLASS A. III. ESQUISSE-ESQUISSE. A SODA  
FOUNTAIN



## THE AMERICAN ARCHITECT

ground set aside for buildings. It should be indicated in part on the plan to show its relation to the general scheme.

11th—Such vestibules, corridors, service, etc., and gardens, fountains, and pergolas as will unite all parts of the composition and add to its attraction are permissible.

### DIMENSIONS:

The plot of ground to be used for the buildings shall be 600 ft. x 600 ft.

JURY OF AWARD: F. A. Godley, W. L. Bottomley and H. P. Pennington.

Number of drawings submitted: 13.

### AWARDS

FIRST PRIZE, \$50: W. F. McCaughey, University of Illinois, Urbana.

SECOND PRIZE, \$25: R. H. Segal, Patrons—G. & E. Blum, New York.

PLACED THIRD: D. McLachlan, Jr., Atelier Hirons, N. Y.

PLACED FOURTH: L. Fentnor, Atelier Wynkoop, N. Y.

PLACED FIFTH: L. KURTZ, Atelier Wynkoop, N. Y.

### OFFICIAL NOTIFICATION OF AWARDS— JUDGMENT OF FEBRUARY 11th, 1919

#### PROGRAM

#### CLASS "B"—II. ANALYTIQUE

The Committee on Architecture proposes as subject for this Competition:

#### "AN EXEDRA"

#### INTRODUCTION:

The term "Exedra" is applied usually to an important raised semi-circular seat with a high back; it is applied in the present case to a semi-circular colonnade under which there are seats. Such colonnades or porticos are most appropriate to formal gardens, where they may be used to end a vista, forming a setting to a statue, fountain or some other point of interest, or serving some other decorative purpose.

#### THE PROBLEM:

The Exedra in question will be situated at the end of a formal garden, overlooking beds of flowers above which it will be slightly raised. It will consist of a row of Ionic columns, which may be treated as a covered portico or as a vine covered pergola, the only dimension given being the radius from the center to the axis of the columns which is 20 feet. The back of the colonnade may be a high or low wall, or another row of columns.

JURY OF AWARD: R. M. Hood, H. R. Sedgwick, H. M. Woolsey, G. H. Bickley, M. B. Stout, F. C. Hirons and E. V. Meeks.

This Jury also served as Jury of Award for Class "B"—II Projet, Class "A"—III Esquisse-Esquisse and Class "A" & "B" Archaeology-II Projet.

Number of drawings submitted: 26.

### AWARDS

FIRST MENTION PLACED: A. C. Weatherhead, University of Oregon, Eugene.

FIRST MENTION: E. F. Biresak, J. L. Fleming, H. Machamer and D. K. Frohwerk, University of Kansas, Lawrence; R. B. Thomas, Yale University School of Fine Arts, New Haven.

MENTION: A. N. Schaeffer and H. V. Murphy, Beaux-Arts Atelier, Washington, D. C.; A. F. Keymar, Atelier DeGelleke, Milwaukee; H. Bradley and T. S. Rowland, George Washington University, Washington, D. C.; E. L. Babitsky, John Huntington Poly. Institute, Cleveland; C. Davidson, 434 West 125th Street, New York; C. S. Thalheimer and F. M. Manker, "T" Square Club, Philadelphia; E. W. Moore and Julia Carman, University of Kansas, Lawrence.

### PROGRAM

#### CLASS "B"—II. PROJET

The Committee on Architecture proposes as subject for this Competition:

#### AN ATHLETIC CENTER FOR AN INDUSTRIAL TOWN

A new industrial town, similar to "Yorkship Village" in New Jersey, or the one at Bethlehem, Pennsylvania, comprising a well planned community of fifteen hundred houses, has just been completed. The new town is a permanent one, and the houses are not only of permanent construction but also well designed and well grouped.

A tract of land six hundred feet square, situated on the outskirts of the town and bordering on the main highway leading to a nearby large city, has been set aside for recreational and athletic purposes. While the main portion of this ground is flat, that side of it along which runs the highway is considerably raised above the level of the rest of the property, and the highway itself is approximately, therefore, eighteen feet above the general level of most of the tract.

It is proposed to plan the property so that it shall be of the best possible use for the recreational activities of the town, both outdoor and indoor. To that end a building combining the features of a "social center" and "athletic clubhouse," including dressing and bathing facilities, is to be erected on the portion of the property adjoining the highway. This building must be of appropriate architectural character in keeping with an up-to-date, modern town of which it is one of the chief structures.

## THE AMERICAN ARCHITECT

Incorporated into the plan of the building or closely adjacent thereto there must be a "Grand Stand" or bank of seats accommodating approximately fifteen hundred people, overlooking a baseball diamond, which diamond, from its very size, will form the principal feature of the general layout in plan.

The property must be so planned as to include:

1. A baseball field.
2. Four tennis courts.
3. An outdoor swimming pool.
4. A children's playground with apparatus.



J. F. COOK—FIRST MENTION, ATELIER WYNKOOP, NEW YORK

### CLASS B. III. ESQUISSE-ESQUISSE. AN ENTRANCE TO A SAFE DEPOSIT VAULT

5. A running track as long and as conveniently arranged as possible.

The building proper in addition to the above mentioned "Grand Stand" or "Tribune" for fifteen hundred people, must contain:

1. Entrance or lounge hall with a small office and counter opening off it.
2. Auditorium with moderate sized stage and two dressing rooms with a balcony at the rear to accommodate moving picture apparatus.
3. Tea room with pantry and direct service to a

small kitchen, which may be placed in the basement.

4. Coat room and toilet arrangements for men and women.
5. Two bowling alleys.
6. Billiard room for two tables.



D. W. ORR—THIRD MEDAL, YALE UNIVERSITY. (SCHOOL OF FINE-ARTS)

### CLASS A AND B—ARCHAEOLOGY. II. PROJET. A ROMAN TRIUMPHAL ARCH

7. Locker room containing three hundred lockers, and dressing and shower accommodation for men.

8. Locker room containing three hundred lockers, and dressing and shower accommodations for women.

9. Apartment for steward, to consist of two rooms and a bath.

10. Two small rooms to be used for card or committee rooms.

Besides the kitchen in the basement, the bowling alleys, billiard room and locker rooms may be placed there, as well as the furnace room.

Number of drawings submitted: 25.

#### AWARDS

FIRST MENTION: F. R. Steffens, Jr., R. D. McPherson and K. Carver, Cornell University, Ithaca; K. K. Stowell, Atelier Hiron, N. Y.

MENTION: T. Yokogawa, E. B. Mason and F. H. Robinson, Cornell University, Ithaca; R. Mackey, John Huntington, Poly. Institute, Cleveland; H. B. Preston, Syracuse University, Syracuse; R. L. Goldberg and E. Schmidt, "T" Square Club, Philadelphia; W. M. Icenhower, E. Pickering, J. L. Benson and L. F. Soxman, University of Kansas, Lawrence; L. J. Ellis and H. Johnston, University of Oregon, Eugene.

#### PROGRAM

### CLASS "A"—III. ESQUISSE-ESQUISSE

The Committee on Architecture proposes as subject for this Competition:

"A SODA FOUNTAIN."

As a result of prohibition and the demand for a service for women corresponding to the bars and



# THE AMERICAN ARCHITECT

smoking rooms usually restricted to the use of men, some hotels include as one of their features a Soda Fountain or "Ladies' Bar." This is a combination of stand-up bar and table service of soft drinks and sweets and the sale of confections.

The subject of this problem is the design of such a room featuring the counter and its immediate surroundings. It should be borne in mind that space economy is a usual requisite while combining serviceability with effective display of the articles for sale. The use of rich materials, with ornament and color, is desirable to express the character of the place and of its customers.

Number of drawings submitted: 21.

## AWARDS

MENTION: R. K. Galbraith, Beaux-Arts Atelier, Washington, D. C.; J. K. Smith and W. H. Livingston, University of Pennsylvania, Philadelphia; D. M. Allison, University of Illinois, Urbana.

## PROGRAM

### CLASS "A" AND "B" ARCHEOLOGY—II. PROJET

The Committee on Architecture proposes as subject for this Competition:

#### ROMAN TRIUMPHAL ARCH

The Romans, especially during the Empire, commemorated their victories by the erection of Triumphal Columns and Arches, a great many of which exist to this day. The Triumphal Arch, which forms the subject of this program, was perhaps more widely used, at least, there are many which still exist not only in Rome but in other parts of Europe and Asia Minor. In and near the Roman Forum are three of the best known and best preserved; the Arch of Septimus Severus, the Arch of Titus, which commemorated the capture of Jerusalem, and the Arch of Constantine. These express to a great degree by the richness of carving and sculpture the magnificence of the Roman civilization at that time.

The tradition of the Triumphal Arch has continued to the present day. The Portes St. Denis and St. Martins, the Arc de Triomphe, and the Arc de Carrousel in Paris, the Marble Arch in London, several arches about the Palace Stanilas in Nancy and some in our own country all show the influence of the great Arches of ancient Rome.

The subject of this problem is a Triumphal Arch of the Roman Empire, erected to commemorate a great victory. The only dimension given is the height, which, exclusive of any sculpture surmounting the arch should not exceed 60 ft. 0 in.

Number of Drawings submitted: 7.

## AWARDS

THIRD MEDAL: S. B. Brown, "T" Square Club, Philadelphia; D. W. Orr, Yale University School of Fine Arts, New Haven.

MENTION: L. T. Obel, Columbia University, N. Y.; J. Lucchesi and M. Jaeger, Jr., Atelier Hiron, N. Y.; F. Martinelli, Patron—P. J. Rucker, N. Y.

## PROGRAM

### SPECIAL PRIZE COMPETITION

Special Prize offered by the Paris Prize Fund of the Society of Beaux-Arts Architects.

1st prize, Architectural books to the value of \$200

2nd prize, Architectural books to the value of 100

3rd prize, Architectural books to the value of 50

### CLASS "A"—II. PROJET

The Committee on Architecture proposes as subject for this Competition:

#### AN ISLAND OF FREEDOM

It is proposed that an island situated in the harbor of an important seaport is to be dedicated to the ideals of liberty and freedom for the preservation of which the world has been fighting and has at last achieved.

The dominating feature of the composition should be a monument to Freedom which may take any form the competitors desire—a shaft, a column, a colossal statue or any other suitable interpretation of the idea. Placed about this monument should be three museums, one larger one for the display of trophies relating to the army and two smaller ones for those of the navy and aviation respectively. These three buildings should be suitably monumental in character and may be arranged upon terraces and connected if desired by colonnades or any other architectural motifs. The island is to be connected to the city by a long causeway.

In general, it is important to achieve an impressive ensemble, appropriate in character, and inspired by the idea that this island is to be for all time a memorial commemorating the preservation of the freedom of all nations.

The Island should not exceed 400 feet by 600 feet in its greatest dimensions.

JURY OF AWARD: F. A. Godley, A. Ware, R. H. Dana, Jr., H. Daveuport, L. H. Burnham, J. Wynkoop, J. F. Harbeson, L. Ayers, F. H. Bosworth, Jr., and H. P. Pennington.

This Jury also served as Jury of Award for Class "B"-III Esquisse-Esquisse.

Jury of Award for Special Book Prize: F. A.



## THE AMERICAN ARCHITECT

Godley, R. H. Dana, Jr., H. P. Pennington, H. R. Sedgwick, F. H. Bosworth, Jr., L. Ayers, R. M. Hood and H. Davenport.

Number of drawings submitted: 29.

### AWARDS

FIRST PRIZE (\$200 Architectural Books): J. P. Roberts, University of Pennsylvania, Philadelphia.

SECOND PRIZE (\$100 Architectural Books); L. Williams, Columbia University, N. Y.

THIRD PRIZE (\$50 Architectural Books): A. E. Middlehurst, Cornell University, Ithaca.

FIRST MEDAL: L. Williams, Columbia University, N. Y.; A. E. Middlehurst, Cornell University, Ithaca; J. P. Roberts, University of Pennsylvania, Philadelphia.

SECOND MEDAL: Charlotte Knapp, Columbia University, N. Y.; R. P. Raseman, Cornell University, Ithaca, G. A. Anderson and A. C. Bieber, University of Pennsylvania, Philadelphia.

MENTION: R. K. Galbraith, Beaux-Arts Atelier, Washington, D. C.; R. H. Segal, Patron—Blum, N. Y.; D. A. Fletcher, Columbia University, N. Y.; G. A. Yeomans, A. F. Darrin, E. Purdy, E. L. Howard and Y. C. Lu, Cornell University, Ithaca; J. W. Hershey, John Huntington Poly. Institute, Cleveland; D. R. Wilkinson, Los Angeles Architectural Club, Los Angeles; E. Hayward, "T" Square Club, Philadelphia; P. F. Taylor, L. D. Cook and J. C. Jenney, University of Pennsylvania, Philadelphia; L. Fentnor, Atelier Wynkoop, N. Y.

H. C.: W. F. Leppin, care of Satterlee & Boyd, N. Y.; M. C. Beebe, Atelier Hiron, N. Y.; R. E. DeWolfe, Cornell University, Ithaca.

### PROGRAM

#### CLASS "B"—III. ESQUISSE-ESQUISSE

The Committee on Architecture proposes as subject for this Competition:

#### "THE ENTRANCE TO A SAFE DEPOSIT VAULT"

The safe deposit vaults for large banks are located in the basement below the main banking floor. The entrance to the stairway leading to their vaults is arranged in the marble and bronze banking screen separating the public space from the working space.

This entrance is the subject of the program. The door itself should be 3 ft. 0 in. x 7 ft. 6 in. and the banking screen 8 ft. 6 in. high. The entrance should be suitably accented in a decorative manner to give prominence to this important department of the bank.

Number of drawings submitted: 11.

### AWARDS

FIRST MENTION: J. F. Cook, Atelier Wynkoop, N. Y.

MENTION: A. P. Herrmann, Carnegie Institute of Technology, Pittsburgh; H. T. Bell, Beaux-Arts Atelier, Washington, D. C.; E. F. Bircsak, University of Kansas, Lawrence.

H. C.: B. Hill, Cornell University, Ithaca.

### The Post-War Committee

This Committee asks advice and co-operation not only from every architect, but also from those men engaged in occupations allied to architecture and building.

Write your views to the Committee at the Octagon, Washington, D. C.

# Late News from Architectural Fields

Special Correspondence to THE AMERICAN ARCHITECT

## A Price History of the War

Washington, D. C., March 5.—The price section of the War Trade Board, under the direction of Wesley C. Mitchell, is starting on the last lap of the colossal task that it assumed about six weeks ago, namely, the writing of a price history of the war, including a systematic record of the fluctuation of prices and analytical studies of various phases of these fluctuations, their causes and consequences. Data on upward of fifty different commodities have been compiled and are now being prepared for publication, so that a record of the effect of the war on prices of the different materials may be available for interested business men. One division of the work undertaken will be devoted entirely to building materials, comprising ten separate bulletins under the following topics: sand and gravel, quarry products, brick and tile, cement, lumber, glass, paints, naval stores, gums and varnishes and waxes.

The purpose of the study is to lend such aid as may be rendered by accurate information toward an equitable solution of the difficult problem of readjustment that now confronts the entire nation. The prices of materials and their inevitable relationship to the scale of wages, the causes of the rise in prices the relation of fixed prices to prices formerly prevailing, taxation and other forms of government control over business, are merely a few of the many problems upon which these bulletins will furnish enlightening data. Adequate readjustment and resumption of normal business activity can best be brought about by reference to price and wage conditions during and before the war.

In this connection, Homer Hoyt, of the War Trade Board, in an interview with a representative of THE AMERICAN ARCHITECT, described two methods of regaining business equilibrium and dispelling the "watchful waiting" attitude toward building activities. First, a continuation of the present status of business and hesitancy to take on new projects would sooner or later result in a period of depression, which, in turn, would mean a greater supply of labor, lower wages, and, consequently, lower prices and a lower price level. Second an artificial stimulation by the Government and municipalities of business activity in the form of public works construction at high wages would supply a source of employment to hosts of workers, and thereby tide business over, on a high price level, this time of uncertainty. Either process, however, would mean that wages and prices would keep step with each other, and the only hope for a reduction in the prices of materials would be a fall in wages.

"Lumber and cement," declared Mr. Hoyt, "were used more during the war than brick or stone, chiefly because the former were more readily adapted to rapid construction. The production of lumber imposed no burden on fuel regulations, because its own waste was used as fuel in its manufacture. In addition, lumber was a side cut of the military program of the war; for instance, in the Douglas fir regions, it was necessary to cut ten times as much lumber used for direct war purposes in order to get certain desired cuts. This excess was easily manufactured without imposing an added burden on the plant capacity, and was available for use in the construction of cantonments and the building of homes for war workers in munition plants and shipyards.

"The output of lumber during the war was only about 75 per cent of the normal production, while the average price of all kinds of lumber increased about double what it was before the war. The decreased production and the rise in prices may largely be attributed to the shortage of labor and the advance in wages.

"The advance in prices on building materials was about as

fast as the advance on other commodities, most of which increase can directly be credited to the high wages paid during the war. The chief item of cost in the production of most building materials is labor, being two-thirds of the expense in the manufacture of bricks, and one-third in the manufacture of cement. In the production of the latter material, however, fuel comprises one-third of the cost, which may explain why cement advanced only 70 per cent during the war period, price of fuel having lagged behind wages."

The output of cement during the war, like that of lumber, was about 75 per cent normal production, but due to restrictions of the fuel administration, cement companies had to operate on 75 per cent of their normal fuel supply. Cement found many uses in the war in the building of bridges, barracks, roads, coast and interior fortifications, bombproof shelters, tunnels, retaining walls, sewers, trenches, ships, etc. Reinforced concrete construction was greatly in demand during the war, because of the restrictions placed on structural steel. Approximately 11,000,000 barrels of cement were used for government purposes, while the normal export trade in cement kept up, and the stocks on hand at the end of last year were about equal to that of previous years.

The cement problem is less grave than that of brick, because the tremendous cost of machinery in the manufacture of cement will enable production on a large scale without an increase in the cost of production. And there is a likelihood, according to Mr. Hoyt, that large scale production may tend to lower the price of cement.

"The brick and hollow-tile business suffered greatly because of the war. In normal times, brick was manufactured under conditions of keen competition and small profits, and war measures restricted the use of these materials to about 50 per cent of their normal consumption. There was not a great demand for their use in necessary enterprises due to the shortage of skilled labor. Despite this lessened consumption, the price of common bricks doubled in the last eighteen months.

"The rise in prices in building materials may be attributed to three main causes: (1) higher wages; (2) increased cost of fuel; (3) diminished production at higher costs brought about higher per unit cost of production."

## An Advisory Committee on War Memorials

Washington, D. C., March 5.—The American Federation of Arts has recently appointed an advisory committee to deal with the entire subject of war memorials in such a way as to afford assistance to officials, commissions and committees who are earnestly endeavoring to make the memorials of the war express in a permanently satisfactory manner feelings of honor, sacrifice and patriotism.

It is the opinion of the Federation that the American artist should be called on to design and to execute all structural memorials of the war, and that in every community the memorial should be an individual, artistic creation. The committee is not interested in any particular form of memorial, or any particular artist or group of artists, the only end in view being a memorial worthy of the community and the cause.

Among the many suggestions made by the committee is that of "a building, devoted to high purposes, educational or humanitarian, that whether large or small, costly or inexpensive, would through excellence of design be an example and inspiration to present and future generations,



## THE AMERICAN ARCHITECT

expressive of the refinement and culture which mark the highest order of civilization. It should, however, be understood that a building entirely utilitarian can not altogether satisfy the desire for a commemorative work of art. The transept of Memorial Hall at Harvard University is an example of the triumph of memorial feeling over utility and even architecture."

In describing the character of the memorial, the committee continues to suggest: "The most impressive monument is one which appeals to the imagination alone, which rests not upon its material use but upon its idealism. From such a monument flows the impulse for great and heroic action, for devotion to duty and love of country. The Arch of Triumph in Paris, the Washington Monument and the Lincoln Memorial are examples of such monuments. They are devoid of practical utility, but they minister to a much higher use; they compel contemplation of the great men and ideals which they commemorate; they elevate the thoughts of the beholder; they arouse and make effective the finest impulses of humanity. They are the visible symbols of the aspirations of the race. The spirit may be the same whether the monument is large or small; a little roadside shrine or cross, a village fountain or a memorial tablet, speaks the same message as the majestic arch, shaft or temple, and both messages will be pure, line and perhaps equally far-reaching, if the form of that message is appealing and beautiful. Display of wealth, ostentation and over-elaborateness are unbecoming and vulgar. Elegant simplicity, strength with refinement, and a grace of handling that imparts charm are the ends to be sought. These ends require, on the part of everybody connected with the enterprise—committee, adviser and artist—familiarity with the standards of art, and above all, good taste. Only by a combination of all these elements can a really satisfactory result be obtained."

The annual meeting of the American Federation of Arts, which will be held May 15, 16, 17 at the Metropolitan Museum of Art, New York, will be devoted to a discussion of the various phases of war memorials, with illustrations taken from past and present successes and failures in this country and other countries.

### Building Revival in Small Projects

Washington, D. C., March 8.—Reports from various parts of the Middle West, received this week by the U. S. Department of Labor, show a decided revival in building, where small projects are concerned. While this may indicate to a certain extent the patriotic response of the individual or the urge of necessity at a time when the lack of housing is causing a serious problem in many communities, it is also in line with good business judgment, according to data gathered by the department's information and education service, through the division of public works and construction development.

Instead of surplus of labor in the United States, there is in reality a shortage when compared with demands during normal times. If the war had not destroyed the old order of things, approximately 2,000,000 immigrants would have come into this country in the last four years, and industry would not have lost the labor of 2,800,000 soldiers. The country thus has been deprived of the labor of several million men. For this reason it would seem that present-day demobilization problems are those of maladjustment.

The wealth of the nation is approximately two hundred and sixty-five billion dollars, which is greater than the wealth of four of the wealthiest nations in the world. It is estimated that nearly three-fourths of the world's tools of industry are here in this country. It is our problem to put these tools of industry into the best working condition and to place every specialized worker in his own particular groove. The nation invested a large amount of labor in the rearrangement of its industry for the increased production imperative during the war. It is necessary again to invest a large amount in a second rearrangement to meet

the demands of peace production, which are now measured by the high selling prices of commodities—prices that indicate reduced production.

A number of notable building projects are now under way throughout the country, involving the utilization of large quantities of building materials and employing a considerable number of workers.

South Bend, Indiana, has under consideration the development of a model industrial residence section. This will comprise at least 4,000 new homes for 12,000 additional employees of the Studebaker Corporation, which contemplates an investment of \$8,000,000 in a new factory. Other important projects include a department store, \$3,000,000, at Newark, N. J.; interurban station, \$2,000,000, Kansas City, Mo.; head house and six grain elevators, \$2,000,000, Sioux City, Iowa; Hotels and department store, \$2,000,000, Milwaukee, Wis.; office building and theatre, \$500,000, Allentown, Pa.

A force of men is working on the new \$4,500,000 railway station in Chicago. The contractors report that as the building progresses 5,000 men will be employed, preference being given to soldiers.

### The Post-War Committee

Washington, D. C., March 5.—The executive council of the Post-War Committee on Architectural Practice, appointed by the American Institute of Architects, is arranging regional meetings through the medium of which members of the executive council and others intimately familiar with the work of the Post-War Committee as designated by the council will be brought in personal touch with all members of the Post-War Committee.

Replies to the announcement of the Committee's tentative program from Chapters and individuals indicate that architects and organizations appreciate the value of the investigation now being undertaken and are lending their support actively to forward its purposes.

Several Chapters of the Institute have already held or are planning to hold meetings especially for the discussion of the questions suggested by the Committee. The New York and Brooklyn Chapters held enthusiastic meetings recently, at which members of the Committee's executive council were present. At the New York Chapter meeting it was decided to arrange a regular program for future meetings, providing for discussion and debate, one by one, of the numerous questions to be studied by the Post-War Committee.

### To Stabilize Price of Basic Materials

Washington, D. C., March 8.—A board to stabilize the prices of basic materials in such a fashion as to create a firm foundation on which the consumer can base his future purchases and the producer can form necessary production cost estimates has just been created by Secretary Redfield of the Department of Commerce. The full personnel of this board to consist of six carefully chosen men, has not been announced yet, but it has been assured that the chairman will be George N. Peek of Moline, Ill., former vice-chairman of the War Industries Board. The official representative of the Government on the new organization will be Thomas C. Powell, director of capital expenditures of the railroad administration.

"It cannot be too strongly emphasized," declared Secretary Redfield, "that the proposal that the Government shall co-operate in determining fair prices on basic commodities and in stabilizing these prices through government purchases is in no sense a price-fixing program. No one will be under any sort of compulsion to adhere to the price schedule arrived at. If a producer can find a market for his wares at a higher price no one can prevent his being free to avail himself. If a consumer is able to buy below these prices, it will be his privilege to do it.



## THE AMERICAN ARCHITECT

"In substance, we propose to bring capital, labor and the Government into common counsel together around one table and with one purpose—to do the best possible for the country."

One of the striking features of the present situation is the high prices demanded for practically all articles and commodities of trade and commerce. This high price condition is undoubtedly the cause of most of the business inactivity and, therefore, also is the cause of the widespread unemployment of labor.

### Prices Reduced to Aid Building

Cleveland, Ohio, March 8.—Radical reductions in prices of building material in this city have been announced as part of the program of Mayor Davis' building committee, which has been at work several weeks in an effort to change building conditions from a war to a peace basis and to arrange material, labor, and financial conditions that there may be an early start in the 1919 building program.

Substantial reductions in tile, common and shale brick are announced. Building tile, sizes 5 x 4 x 12 inches, was reduced from \$41.25 a thousand to \$26. Other sizes were reduced from \$68.50 to \$109.75 a thousand to \$50 and \$76 respectively. Lime was dropped from 75 cents to 68 cents a hundred pounds and sand from \$2.75 to \$2.25. Brick and drain tile prices were reduced as follows: Common brick—Kiln run, old price \$14; new price \$12.50. Hard brick, old price \$16, new price \$14. Selected face, old price \$20, new price \$18. Shale brick—No. 1, old price \$18, new price \$16; No. 2, old price \$16, new price \$14; selected, old price \$22, new price \$20. Drain tile—3-inch size, old price \$31, new price \$23; 4-inch size, old price \$43, new price \$33; 6-inch, old price \$69, new price \$55.

### Convention Backs "Build Now" Campaign

Milwaukee, Wis., March 8.—A forward push was given to the building industry of the country at a representative assembly of men from all lines of the building business in this city last week in attendance at the eighth annual convention of the National Association of Builders' Exchanges. The spirit of the convention was altogether optimistic.

Steps were taken at the convention to promote two specific movements with a view to stimulating the industry. Both movements will be backed by the government. One of these is a "Build Now" and the other is known as "Own Your Own Home" campaign. Prominent Washington offi-

cialists gave the convention assurances that the government would use all possible efforts, even to the expenditure of large sums of money to advance both of these movements.

While the primary object of all the agitation will be to restore normal conditions in the building industry, second only in its importance to agriculture as a national industry, further and by no means unimportant aim will be to promote work for returning soldiers, sailors and marines.

Resolutions were adopted recommending that all possible repair work on buildings as well as alterations and remodeling be done during the next month or two, the present being considered especially opportune for this class of work. It was suggested that public bodies, boards of education and other authorities having to do with public and semi-public buildings proceed with the same without further delay.

Banks and building and loan companies were appealed to in the matter of building loans. The co-operation of the government in this matter was urged. These resolutions will be taken by delegates back to their different localities and local movements will be started in harmony therewith.

A significant action was taken in the approval of a movement to organize Building Trades Employers' Associations under the auspices of Building Exchanges as a means of bringing employers more directly into an effective organization to deal with the problems now confronting them.

A resolution calling for the return of the railroads to stockholders under private management under government supervision was adopted by unanimous vote. This resolution recommended that great care should be taken in any revision of freight rates so as not to place any additional burden upon the building industry, but rather that any revision should be in harmony with the government's undertakings to encourage building in all possible ways.

The convention sent a protest by wire to Washington against the rider in the agricultural bill doing away with the daylight saving plan. This action was by unanimous vote, indicating that daylight saving is in high favor with the builders in all parts of the United States.

An interesting feature of the convention was an address by George A. Rutherford of Cleveland on "Business Methods for Contractors." Mr. Rutherford illustrated his talk with a series of charts on estimating and cost keeping which enlisted keen interest. As a result of his address a movement was started for a nation wide campaign to improve the business methods of contractors. A committee was placed in charge of this movement, the object being to prepare standard forms so as to place the business upon a higher plane than heretofore.

The sessions of the convention were presided over by Col. John R. Wiggins of Philadelphia, who retired as the executive officer at the close of the meeting and was succeeded by Charles W. Bernhardt of Atlanta, Ga. Mr. Bernhardt appointed as his secretary Dan Carey, secretary of the Atlanta Exchange. The next convention will be held at Columbus, Ohio.

### Personals

An office has been opened at Gaspar, Wyoming, by W. M. Green, architect. Mr. Green desires samples and manufacturers' descriptive literature.

Wilson Potter, architect, on March 1st moved his office from 3 Union Square to larger quarters at 22 East Seventeenth Street, New York City.

A new office has been opened for the practice of architecture by R. R. Markley in the Spooner Building, Harrisburg, Pa. Mr. Markley wishes to receive manufacturers' samples and catalogues.

After ten months devoted to war work, G. A. Fairchild, architect, has resumed his practice, and has opened a new office at 808 West Kalamazoo Avenue, Kalamazoo, Mich. Mr. Fairchild desires catalogues and manufacturers' samples.

The firm of Wilson & Sompayrac, architects at Columbia, S. C., has been dissolved, the practice being continued by Charles C. Wilson individually. Mr. Wilson has changed his address to 804-7 Palmetto Building, Columbia, S. C. Mr. Sompayrac is now located with the United States Shipping Board, in New York City.

# The Responsibilities of Victory

**S**PEAKING of the responsibilities of victory, Francis H. Sisson, vice-president of the Guaranty Trust Company of New York, says it is of the greatest importance in working out this country's problems that there should be the closest co-operation between the financial, industrial and agricultural sections of the country, each of which is dependent upon the others for a large portion of its prosperity, and each in part serving the others.

Mr. Sisson believes that in the working out of our problems, no part of the country will have greater influence than the West—the granary of the world—where such a large portion of the nation's wealth is created, and whose spirit of enterprise and freedom of thought and action have given it a vast and proper power in our national affairs. In this land of far horizons and broad outlook, says Mr. Sisson, lies much of the hope for the nation's future, and upon its business men, the leaders of its thought and action, rests a great responsibility not only for the future of their own section, but for the future of the entire country.

“When the responsibilities imposed upon us by victory shall have been discharged, then,” he continued, “and not until then, the United States will fulfill its manifest destiny and render the world-wide economic and practical humanitarian service of which we are so abundantly capable, and to which we aspire with the same splendid idealism that led us into the greatest of all wars.

“The last important responsibility of victory and of peace to which I would direct attention is that of establishing new relations between the Government and business. The critical railroad situation and other complications have made patent the necessity for mutual co-operation between these two vital elements of our economic life. The Government should learn that ‘all great offices of state are occupied with commercial affairs,’ and that ‘commerce is the greatest of all political interests.’ Great Britain, France, Italy and Japan have evidenced due appreciation of these axioms of statesmanship in their reconstruction programs.

“The peace plans of England, carefully worked out by the Government in co-operation with the country's varied interests, include the lowering of the costs of production of its manufactories; the speeding up of labor; the cheapening of raw materials by buying in enormous quantities; the abolition of wasteful competition among manufacturers;

the placing of Government funds at the disposal of producers who co-operate; the formation of big and influential associations of business men; the establishment of a commercial intelligence bureau of world-wide scope; the subsidizing of research bureaus for the benefit of manufacturers; the development of the inner arteries of the empire; the lowering of costs of transportation, and the granting of preferential rates to British goods.

“France proposes to lower the costs of production through standardization and modern methods; to effect an improvement in relations between capital and labor; to purchase raw materials, cultivate new markets, and ship finished products at common expense; to provide assistance to production; to enact liberal legislation in abolishing administrative restrictions; to initiate vast public works, such as road-building, railroad extensions, dredging rivers and harbors, and building a merchant marine.

“Italy's after-war program calls for a protective tariff; the establishment of credit arrangements for foreign business; for the liberation of new industries from taxation; for the construction of canals to convert Rome into a first-class port; for the abolition of taxation on certain essential industries, and on capital while it is producing for consular agents to act as the ‘economic eyes’ of the nation, and for the co-operation between financial interests and industry.

“Japan is preparing to give Government subsidies; immunity from taxation of certain industries; guaranteed dividends to certain subsidized industries; Government co-operation with big business interests; large Government appropriations for the developing of essential industries; the service of trade commissions to make detailed investigations and reports; the services of a commercial intelligence system, and the Japanese Government will insist that trades build for the future.

“In noting this world-wide trend toward combination, it is not surprising that the United States Chamber of Commerce should refer to its members for vote proposals to amend the Sherman and Clayton anti-trust laws. Unless we properly repeal or amend these statutes, and the La Follette Seamen's Act, we cannot hope to compete successfully for foreign trade. And we should awake to the fact that we have outgrown our home markets, so that foreign trade on a large scale is absolutely essential for the continuance of our prosperity.”



## A National Apprentice School of Design

As a result of a series of meetings held in New York during the past month, by various societies and associations interested in the development of the arts and crafts, there will soon be opened in New York the first unit of the National Apprentice School of Design. This movement, which is one to be very strongly commended, and also one that should receive the support and co-operation of architects, has taken definite form in the appointment of an executive committee of which H. Van Buren Magonigle, architect, is chairman, and William Laurel Harris, mural painter, is secretary. The committee includes representatives from the National Academy, the Architectural League, the American Institute of Architects, and a representation from the manufacturers directly interested in the development of American craftsmanship.

A teaching staff for the New York school has been recruited, and as soon as the school can be thoroughly organized, instruction will begin. The main subjects to be covered in the curriculum are furniture, tapestries, textiles, wrought metals and ornamental glass. It is the purpose to establish schools in other cities, each to have its governing body, but all under supervision of the national body.

In a statement prepared by Mr. Magonigle, the chairman of the joint committee, it is set forth that the three basic principles of instruction are: 1. The simultaneous instruction of students in craftsmanship and in design. 2. A method of teaching that shall be ruled only by actual practitioners of the crafts. 3. That design must be based upon historic precedent and not merely upon suggestions from nature. It is further stated that it is desired to accomplish two purposes in the one effort: To train designers to know intimately by actual work, the technical processes of the crafts for which they are designers and to train competent craftsmen who can make their own designs and not merely execute the designs of others.

## Need for Housing Workers Still Great

In spite of the shift in population which is attending the change back to peace time industry, the need for housing accommodations for workers on Government projects continues pressing in many of the cities in which the United States Bureau of Industrial Housing and Transportation, Department of Labor, has undertaken construction. Proof of this need, according to officials of the bureau, is

afforded by the fact that practically all houses now under construction in these industrial centers are spoken for long in advance of their completion.

From Aberdeen, Md., word has just reached the bureau that "all houses have been allotted to tenants; also the dormitories, as soon as finished, will be occupied." Similar statements have come from Quincy, Mass. The dormitories erected in the latter city by the housing corporation are running to their full capacity—about 925 people being accommodated nightly. In the restaurants connected with this project about 2000 meals are being served to the workers each day.

Reports received from the ship equipment project at Bath, Me., indicate that all houses will be filled as soon as completed. Sixty-six are now under roof. The 170 houses which have been nearly finished at Hammond, Ind., will be in demand at once. In Philadelphia 150 houses are reported this week as lathed and plastered. Already it is indicated that all of these will be taken as soon as they can be made ready for occupancy.

## Urge Building of Houses by State to Limit Cost

A plan whereby New York State would take up a new line of activity—the building of houses—has been outlined by Frank B. Williams to the members of the housing committee of the State Reconstruction Commission. Mr. Williams said:

"The state should be authorized to undertake and empowered to authorize its agencies to undertake housing enterprises on a large scale and in all their branches, in order to realize the resulting gains and make the incidental economies essential to adequate housing at low cost and to the safety of the investments of the state," he said.

"This would include power to purchase large tracts by the acre, provide transportation and develop and plan the tracts, imposing proper planning restrictions, including simple but adequate zoning regulations."

Mr. Williams, with others, favored the establishment of a permanent state housing commission or a similar organization to lay down and enforce the conditions needed to secure the state from financial loss. It was also suggested that the state might furnish financial aid to enhance the construction of much-needed dwellings. On this score he said:

"The state loans, for the most part at least, should not be made directly to individuals, but to municipalities and corporations with limited dividends. In this way, also, the state would secure the advantage of individual enterprise and initiative. Another



method of accomplishing this result would be the purchase by the state, under proper safeguards, of the stock of housing corporations, or the guarantee of its bonds."

Clarence S. Stein, architect, representing the City Club; Robert D. Kohn, former chief of production in the housing department of the United States Shipping Board, and Richard S. Childs were among the speakers at the meeting.

Lawson W. Purdy, former head of the Department of Taxes and Assessments, declared that as long as the building costs are high there seems to be no hope for the erection of suitable buildings to rent for \$4 a room or less.

"The erection of such buildings on suitable plans might well be encouraged by a remission of taxes on such buildings for a sufficient term of years," he said. "With the tax rate over 2 per cent, the remission of the tax would be at least equivalent to a reduction of one-third in building cost. This would nearly compensate for the present increased cost of building."

---

### Government May Dispose of 5,000 Acres of Land

If Congress accepts the suggestion of William E. Shannon, manager of the Real Estate and Commandeering Bureau of Industrial Housing and Transportation of the Department of Labor, opportunity to buy well-built, well-planned and attractively placed homes will be given to the public. Now that the war is over the need for certain industrial communities no longer exists. Mr. Shannon's idea is that the properties should be disposed of in the same manner in which they were bought, and that is through the whole-hearted co-operation of the leading citizens in the places where these properties are located.

In his report Mr. Shannon says:

"It would seem entirely feasible to dispose of the holdings upon such terms of partial payment and interest as shall encourage people of modest means to acquire homes and home sites in the communities where opportunity may permit them to settle."

Mr. Shannon in his report disclosed some statistics which are indeed interesting if not startling. He says that his commission bought more than 5000 acres of property for the Labor Department's use in fifty separate communities in twenty-one states. Of the 5000 acres 4460 were unplotted. The plotted area taken contained 16,766,300 square feet. It might be interesting to real estate men to know that the Government bought this property cheaply.

The report shows that these acres were secured for \$870,000 less than the valuation placed upon the land by conservative experts who held before their minds the needs of the Government and at the same time the welfare of property-owning interests. It is estimated that \$5,600,000 was

invested in real estate for the especial needs of the Labor Department. The 4466 acres were secured at a valuation of \$555 an acre and the plotted property was purchased for 16 cents a square foot.

---

### Building Plans Show Decided Gain

A decided upward bound from December, 1918, to January, 1919, was taken by building activity in New York State. The increased expenditures for this period, as reported by the building departments of the first and second-class cities to the State Industrial Commission, amounted to 123 per cent. The only cities that failed to share in this rise were Albany, Troy and Utica, where the amounts expended for building declined 20, 1 and 50 per cent respectively.

This is the first time there has been a decided revival in building activities so early in the season, as this tendency is not usually manifest until late in March, says a commission statement on the subject.

The total amount for January was \$5,645,329, which is 9 per cent less than a similar sum reported in January, 1918. Building costs reported in January, 1918, 1917 and 1916 were, respectively, \$6,000,000, \$12,000,000 and \$15,000,000. The Boroughs of Brooklyn and Queens and the cities of Binghamton, Schenectady and Syracuse made larger expenditures for building in January, 1919, than in January, 1918. The Boroughs of Manhattan, Brooklyn, Bronx, Queens and Richmond, and the cities of Binghamton, Buffalo, Rochester, Schenectady, Syracuse and Yonkers reported larger expenditure in January, 1919, than in December.

---

### Suggests Cemetery in France

Colonel William Boyce Thompson, chairman of the Roosevelt Permanent Memorial National Committee, has announced that one of the suggestions being considered as one of the memorials to Theodore Roosevelt was that an American National Cemetery be established in France in Belleau Wood, now called the Wood of the Marine Brigade. It was there that the American marines, fighting with other American troops, turned back the attack of the Prussian Guard regiments in the last German offensive on July 15th last.

The suggestion came from Miss Agnes Shufeldt of Johnson City, N. Y., who suggested that in this cemetery should be buried all the American soldier dead whose families wished them to remain where they fell in France. Not far from the spot suggested Quentin Roosevelt was buried when he fell in aerial combat with German aviators.

# Department of Architectural Engineering



Buckman Village, Chester, Pa. G. Edwin Brumbaugh, Simon & Bassett, Architects. Photograph taken Dec. 16, 1918. Houses completed and street shrubs planted.

## Quantity House Production Methods, Construction Branch, Emergency Fleet Corporation\*

**T**RANSPORTATION of materials was in charge of Mr. R. D. Williams, Supervisor of Traffic. Mr. Williams, of San Francisco, was manager of Pacific Coast Traffic for the Erie Railroad and was loaned to the Emergency Fleet Corporation to do this work.

This department supervised the movement of about 25,000 cars. The material was unloaded so expeditiously and the cars so released, that the demurrage charges amounted to but a few cents per car. A traffic assistant was placed on each project who, in most instances, was an experienced railroad man. His duties were to handle the local problems in conjunction with the main office. The car tracing, except locally, was done by telegraph or long-distance telephone. It was found that this method of tracing and expediting was very successful and avoided the confusion incident to the

usual method of sending expeditors to the various yards and terminals.

A comprehensive system of daily reports kept the Traffic Department advised, at all times, of the shipments, location and condition of unloading of the cars. This greatly facilitated the handling of materials and assisted the Railroad Administration in conserving their facilities by the quick release of the cars and for this reason no embargoes were placed on any of the housing projects of the Emergency Fleet Corporation.

Mr. H. G. Coutts, an experienced building constructor, of Chicago, had charge of all the field work as General Superintendent, under whose direction were the local project superintendents. Working in close co-operation with Mr. Coutts and in charge of the construction problems in the main office, was Mr. Robert Glenn of New York.

Absolute co-operation in field and office work was

\*Continued from our issue of February 5, 1919.





Manitowoc, Wis. E. F. Miller, Architect. 100 houses and 1 dormitory. Started Aug. 1, 1918; photograph taken Dec. 15, 1918. Houses completed.

essential and this was successfully maintained. It was the duty of the General Superintendent to see that the contractor "got on the job" with an efficient organization and produced results according to a

the "plant," such as railroad sidings, temporary roads and water service, warehouses, offices, bunk houses, commissary, hospital, saw mill, tool house, stables and time keeping, checking and paying

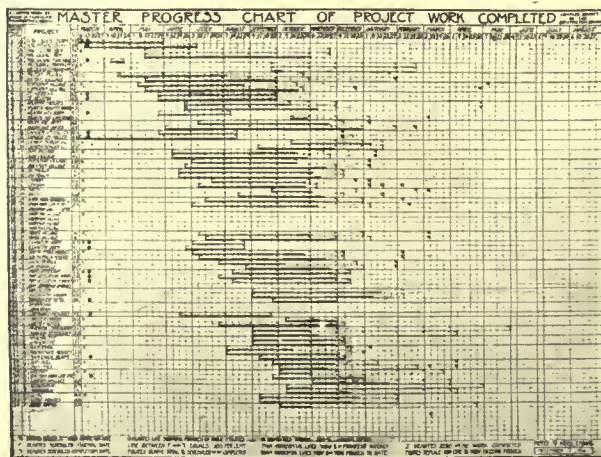

Master progress chart of project work completed. On this chart all of the projects are represented. The lower heavy horizontal lines show the per cent of total progress to date. The upper horizontal lines denote the progress of public utilities. Compiled weekly by Construction Branch.

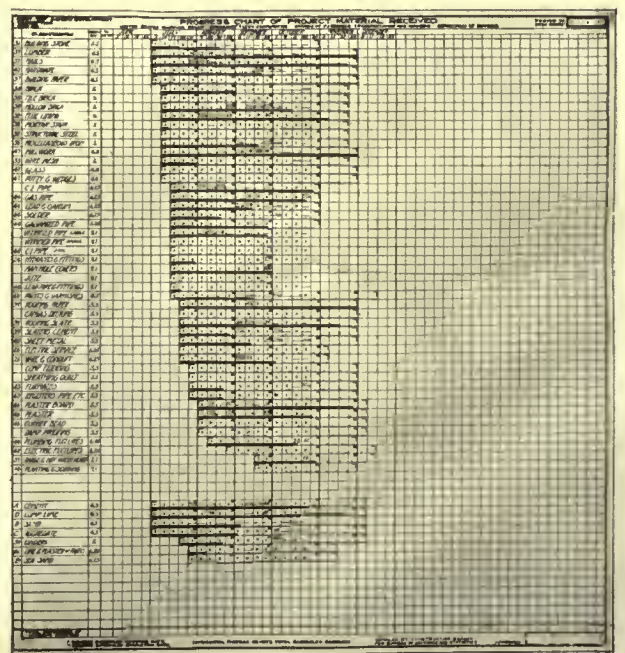

Progress chart of project material received. On this chart the material received for one project is noted. Each kind of material is represented by a heavy horizontal line and the progress of receipt so noted. Compiled weekly by the Construction Branch.

definite time schedule; that he was instructed as to the established procedure and the requirements of the Construction Branch as to the handling of the details of the work. This included the lay-out of all preliminary and temporary work commonly called









# THE AMERICAN ARCHITECT



Newburgh, N. Y. Branch of Design, Housing Department and Ludlow & Peabody, Architects. 127 houses, 70 apartments and 2 stores in 13 apartment buildings. Work started Oct. 9, 1918; photograph taken Dec. 1, 1918.

means of these charts the main office was able to detect unsatisfactory progress and take immediate steps for its correction.

The effective co-operation of labor made possible

WAGE SCHEDULE FOR														
CLASS OF LABOR					CLASS OF LABOR					RATE				
Blacksmiths					Motor Truck Drivers									
" Helper					Painters									
Boiler Maker					" Foreman									
" Helper					Pipe Fitter									
Brick Layer					Plasterer									
" Foreman					" Foreman									
" Mortar Mix					" Rod Carrier									
Carpenter					Plumber									
" Helper					" Helper									
" Foreman					" Foreman									
Cement Finisher					Pipe Layer									
" Foreman					" Helper									
" Laborer					Pile Driver									
" Worker					" Foreman									
Chauffeur					" Helper									
Dock Builder					Pump Man (Gas Engine)									
" Foreman					Rigger									
Electricians					" Foreman									
" Helper					Roofer									
" Foreman					" Foreman									
Engineers					Law Filer									
High Machinery					Lead Metal Worker									
Locomotive					" Foreman									
Crane					" Helper									
Stationary					Sewer Pipe Layer									
Steam Boiler					" Foreman									
Steam Shovel					Stone Masons									
Stiff Leg Derrick					Steam Fitters									
Pile Driver					" Foreman									
Concrete Mixer					" Helper									
Fireman					Sprinkler Fitter									
Fireman NY					" Foreman									
Glazier					" Helper									
" Foreman					Steam Shovel Operator									
Rod Carrier					Sign Painter									
Iron worker					Teamster									
" Foreman					Time Keeper									
Laborer - Common					Water Boys									
" Concrete					Watchman									
Labor Foreman														
Material Clerk														
Machinist														
" Helper														
Metal Lathers														

Wage schedule for each project. This schedule is based on local wage scales and is agreed upon between the contractor and the Construction Branch at the time the work starts.

the execution of the program and this satisfactory relationship with labor was due largely to the work of the Supervisor of Labor, Mr. R. E. Pingrey, architect, of Chicago. The duties of this department included the dealings with the United States Employment Bureau for the supply of labor and with various other branches of the Government in regard to labor policies. Mr. Pingrey settled all labor disputes by direct dealings with labor representatives and the basis of all adjustments, rates and conditions being the Baker-Gompers agreement, entered into by the Secretary of War and Samuel



Noreg Village, Gloucester, N. J. Bissell & Sinkler, Architects. 457 houses and 1 apartment building. Started July 15, 1918; photograph taken Dec. 17, 1918.

Gompers, president of the American Federation of Labor.

Mr. Pingrey's duties were of great importance, and that his efforts were productive of very satisfactory results is evidenced by the fact that the work on all projects was executed with practically no strikes or labor troubles of any kind. This was due largely to the hearty co-operation of the Construction Branch and the representatives of organized labor, who realized their responsibilities to the Government and made every effort to avoid any stoppage of the war program.



## THE AMERICAN ARCHITECT

The plans, as the fundamental factor of all construction work, must always be effectively handled, and when such a tremendous volume of work is under way, it requires an effective organization to prevent no delays due to them. The Supervisor of Plans was Mr. W. S. Church, architect, of Chicago. It was his duty to take charge of and settle all matters pertaining to information between the Architectural and Construction Branches; to receive and distribute all plans, specifications and details; to keep a complete record of all changes and see that proper notice and data concerning them were furnished to all interested parties and acting as a general bureau of information on all matters pertaining to architectural requirements.

The enormous amount of detail work in connection with the office routine was in charge of Mr. G. R. McEldowney, a building constructor from Chicago, who took charge of all correspondence, applications, service records, data on personnel, and many other things. This work is of great importance in a large organization, and must be effectively done in order to secure harmonious and prompt operation.

The accomplishment of such vast undertakings in construction, or any other activity, depends on the character of the organization directing the work. As clearly indicated, the local organization on each project consisted of a superintendent, traffic man, cost clerk and progress engineer. The lack of large and complicated organizations in both field and office made possible that close co-operation which resulted

in great speed of operation through the elimination of red-tape. On March 1, 1918, Mr. W. G. Luce, Chief of Construction, a desk and a chair constituted the Construction Branch. Mr. Luce, of Chicago, a general contractor of large experience, proceeded at once to build up an organization to carry on the work. Between the time the Construction Branch was inaugurated and Jan. 1, 1919, the buildings constructed would, if placed against each other, cover entirely a tract of 140 acres, with miles of streets, sewers, and water and gas mains.

Of this tremendous amount of work 35 per cent of the buildings were started within a week of June 1 and 40 per cent within a week of July 1, 1918. It can be seen that no extended period of time was

available to build up a complete organization before actual work began, but the making of the Construction Branch organization was, of necessity, done under stress of high-speed production. Due to Mr. Luce's long experience with large operations, his wide acquaintance among architects, contractors, engineers and labor representatives, together with his judgment, far-sightedness and executive ability, made the success of this work possible. The results obtained are due to complete harmony, from which came quick decisions and quick action which made results possible.

In this way, towns complete to the minutest detail, were quickly built, including the temporary structures needed to house the construction forces, hospitals and commissaries.



From the menu of the banquet of the Division of Housing and Transportation, U. S. Emergency Fleet. Dec. 6, 1918.

## The Code, the Building Department and the Architect

**N**O law should be enacted which is not susceptible of enforcement. It is equally true that no law should be written based on the hypothesis that the citizens are too ignorant or dishonest to comply with or enforce it. With special reference to building codes, it can be said that whatever man can build, its construction can be governed by a law which can be adequately enforced.

The widespread opinion among American municipal building departments is that the laws must be ultra-conservative. This is a tacit acknowledgment of their inability to properly render the service that they engage to do by virtue of their accepting their official positions. Their theory is that the law must be framed for a condition of incompetent

designing, and incompetent, with possibly dishonest, execution on the part of the contractor.

Designing is to-day an exact science, known to competent architects and engineers. The competency of architects and engineers is not guaranteed at the present time owing to totally inadequate restrictions governing the practice of those professions. It is true that the tendency is toward regulating the practice of these professions, but as yet the results are not of great importance. To safeguard the public against improper designing, building departments have been instituted whose function it is to check the designs as to their compliance with the building code and to inspect the work as it progresses. In other words, the municipality has

## THE AMERICAN ARCHITECT

very properly undertaken to safeguard the public against the erection of buildings that are unsafe structurally, inadequate as to fire resistance, and unsanitary. This is a proper function for a municipal government to undertake. In formulating these codes, however, they are premised on the assumed characteristics of the designer and contractor, as before stated. In doing this they so restrict the designing that a real burden of waste is imposed on those who invest in buildings.

A railroad company is not amenable to law in regard to the bridges that they erect, in so far as the structural design is concerned. Their designs are the best and most economical that they can produce. The shop and field inspection is carefully and accurately made. Their work is made to conform to the requirement that the structure shall be safe for the public and for themselves. They do take the benefit of all of the advantages of scientific progress in design and manufacturing because they only render an accounting to themselves rather than to municipal governments.

The construction of buildings is not entirely analogous to the work of the railroads. The motive of the railroad is safety with economy. The motive of many owners of buildings is, unfortunately, too often that of revenue based on the least possible cost. In striving to attain this objective they resort to employing architects and engineers who compete for their work on the basis of cheapness of building construction regardless of the demands of safe construction. Until this condition is overcome by raising the standard of all those engaged in the practice of architecture and engineering the public must depend on the ability of the building department for protection.

The large majority of owners, except in some localities, desire safe and permanent structures, and aim to employ competent designers. At the same time they have a perfect right to take advantage of scientific developments properly incorporated in design, first-class fabrication of materials and thoroughly good construction. No law should deny such rights, for such denial, through ultra-conservative code regulations, is simple confiscation of property through the waste of labor and materials.

This situation can be improved.

The fault is charged to the public in some instances. This is notably a result of a recent occurrence in Boston. The disastrous collapse of a 2,379,000-gal. molasses tank, which resulted in fourteen persons losing their lives, sixty persons injured, and a very large adjacent property damage, caused Judge Bolster to so place the blame. In this investigation it appeared that the building department engineer approved the plans for the reason that the plans were assumed to be adequate because

the application and plans bore the name of a civil engineer. The testimony also disclosed the fact that he was unable to compute the static pressure in a container of this kind. The honorable court found that:

"The chief blame rests upon the public itself. This single accident has cost more in material damage alone than all the supposed economies in the building department. Laws are cheap of passage, costly of enforcement. They do not execute themselves. A good law poorly administered is worse than a poor law well administered. A public, which, with one eye on its tax rate, provides itself with an administrative equipment 50 per cent qualified, has no right to complain that it does not get a 100 per cent product, and so long as it accepts political influence as the equivalent of scientific attainment in positions which demand such attainment in a high degree, so long it must expect breakdowns in its machinery."

\* \* \* \* \*

"It is no part of the business of this court to find a scape-goat to order for an indifferent or niggardly public on the demand of the inevitable prophet after the event. The only assignable crime involved is manslaughter, through negligence. But error of judgment is not negligence, and if the public is content to buy a mere draftsman for a position demanding a high degree of technical training and skill, it can hardly complain that he is negligent in not exercising a skill which he confessedly does not have, and in view of his compensation cannot be expected to have."

\* \* \* \* \*

"The men who failed are entitled to be judged to their lights."

\* \* \* \* \*

"In short, these steel plans passed through a department created for the primary purpose of safeguarding life, without any checking up of the all-essential matter of structural sufficiency. So far as that department is concerned the plans licensed themselves."

\* \* \* \* \*

"The only excuses offered were extreme rush of business in an undermanned department, which is probably true, and that such a tank was not a building or structure within the meaning of this law. The latter plea will hardly serve, considering that the department in fact took jurisdiction. But I am clear that the tank was a structure within both the letter and the spirit of the law. In justice to the present department it should be kept in mind that this occurred in 1915."

Fortunately, the conditions found by the honorable court do not obtain, as a rule, in American municipal building departments in the measure that they obtained in this case. The keynote of the whole proposition is found in the first quoted paragraph. To enforce a highly technical law requires honest and technically trained brains, and brains cost money. "Laws do not execute themselves," but they are necessary, and require building departments to administer them. "A good law poorly administered is worse than a poor law well administered." This is true. THE AMERICAN ARCHITECT, however, has always contended that we should have *good laws well administered*, and that it is entirely within the ability of the American people to accomplish this thing. It defines "good laws" to be those which permit the use of the higher fiber stresses that have



## THE AMERICAN ARCHITECT

been proved to be safe in connection with proper design and high-grade construction, the elimination of useless requirements that are the heritage of former and existing laws, precedents accepted "as is."

THE AMERICAN ARCHITECT has recently published articles by Mr. W. Stuart Tait advocating the increase in fiber stresses in reinforced-concrete work and changes in methods of computation, all tending to lessen the cost of construction without loss of structural safety. He proposed a method of supervising the design of such work, providing an elastic scheme of administration, which is really necessitated by the rapid advances in engineering knowledge, especially in relation to reinforced-concrete construction. Our present inelastic regulations tax the building industry during periods of the several years required to alter a building code and keep it abreast of scientific developments adequately demonstrated.

Considering the administering of a law controlling the use of reinforced-concrete construction, it is well to take cognizance of the Cleveland method. From the Cleveland code we quote:

### SEC. 173-11. SPECIAL INSPECTOR ON CONCRETE CONSTRUCTION

(a) When reinforced concrete is used in construction, the owner shall provide a special inspector, who shall be satisfactory at all times to the Inspector of Buildings, and who shall be on the work continually during the mixing and placing of concrete and steel and the removal of forms. Such special inspector shall make daily written reports to the Inspector of Buildings on the progress of the work. Before placing concrete, the owner or contractor shall notify in writing the Inspector of Buildings the time at which he intends to begin the placing of concrete.

(b) Before the reinforced concrete work is started the owner shall name in writing the special inspector, who shall pass such examination as may be required by the Inspector of Buildings to determine his competency.

(c) When reinforced concrete is used in construction, the owner shall provide for and have made such tests and inspection of cement, inerts and steel as is required by the Inspector of Buildings.

The City of Cleveland also provides inspectors of concrete work, whose duty it is to see that the special inspectors, provided as above described, perform their work in a proper manner. In reference to this work, Mr. E. W. Cunningham, Commissioner of Building, city of Cleveland, writes:

"In this particular instance it may be of advantage to know that Cleveland has successfully carried out the policy of special inspection for concrete

work, and I feel that a great deal would be accomplished in the way of successful construction if such a policy were followed out in all large cities.

The results obtained under these provisions have been quite satisfactory, and architects, contractors and owners have come to appreciate the value of this work, and we very seldom have any complaint on the basis of added expense on this account.

We have had a number of concrete tests made during the past year (1918), the samples being taken from concrete being placed in the field, and in most cases these tests have shown a concrete better than 2000 lb. per square inch in compression, the poorest samples obtained showing a very wet concrete with a very material reduction in strength, apparently on this account. I believe that both engineers and contractors are beginning to realize that the regulation of the amount of water used in concrete is quite as essential as the amount of the other materials."

Thus the very admirable Division of Buildings in the city of Cleveland has taken a step in advance toward the proper administration of building laws, and has shown one method of enforcing good laws. Undoubtedly, Mr. Cunningham can, as a result of his experience, suggest other methods for increasing the efficiency of municipal building departments.

The desirable things, good laws well administered, have a tremendous influence on the prosperity of every community, and they must be brought about. The architect, engineer and contractor are vitally interested, as these laws regulate the conduct of their business. This being true, they should be the controlling factor in the writing and administering of them. If they do not assume this control, either individually or through their professional organizations, they have failed in their duty to themselves and to the public, and the public must look for relief from other sources.

The revival and maintenance of the building industry is adversely affected by the present conditions, and now is the time to act. This necessitates that the architect, engineer and contractor, the realtor and investor, should make every possible effort to completely function as a professional and business man and as a true citizen. This involves political action and contact with politics, but without assuming these conditions any effort will fail, as it should.



# Industrial Information

*In this Department there is published each week information as to the development of materials and methods, derived from reliable sources.*

## Portable Ozonators

In a leaflet printed for the Sprague Electric Works, 527 West Thirty-fourth Street, New York, a summary of the value of ozone in the maintenance of fresh, breathable, odorless air is set down.

The main source of physical discomfort existing in the air are excessive heat, moisture and unpleasant odors. Engineers have given considerable attention to the first two factors, and the heat and moisture of rooms may now accordingly be controlled by suitable methods of heating and ventilating.

Although the subject of objectionable odors has been somewhat minimized, it is also one of importance. While the presence of such odors is not necessarily nor even generally indicative of poison in the air, its result is to restrain the normal breathing and tend to lessen physical vitality and efficiency. These odors may be caused by cooking, smoking, trade processes or uncleanness. Ventilation may considerably assist in reducing annoyance and depression by diluting these odors with fresh air, but their complete removal may best be accomplished by other means.

Ozone is known to be a form of oxygen which is so extremely unstable as rapidly to oxidize or burn up any organic matter with which it comes in contact. It is formed from the oxygen of the air as it passes through an electrical discharge, and its presence is often noticed after a severe thunder storm, this being one of nature's ways of purifying the atmosphere. In practical work, the electrical discharge is produced between two concentric tubes, between which a flow of air is maintained.

In buildings where for any reason a ventilating system cannot be installed, Portable Ozonators may be employed. These ozonators are provided with fans which by keeping the air in motion insure a thorough distribution of the ozone produced. Portable Ozonators are built by the Sprague Electric Works in two sizes, the Household and the Universal. These are practically identical except as to capacity. These ozonators are approved by the National Board of Fire Underwriters. The Household Ozonator is used mainly in the home for destroying kitchen and other household odors. This type is especially suited to keeping the air fresh during the winter when windows and doors

may be tightly closed. It is also used in offices, small theaters, restaurants, toilet rooms, etc., to aid in the general purification of the air and counteract the effects of tobacco smoke and body odors. The Universal has four times the ozone capacity of the household type, and may be used in large offices, cold storage rooms, factories, hospitals and moving picture houses for similar purposes.

---

## Atwood Vacuum Cleaner

Quite apart from the appeal that the "nothingness" in a vacuum cleaner is a power to be counted on for active service, the conservation of energy resulting from its use is something to be reckoned with in any household.

Having placed on the market a vacuum cleaner of wide adaptability and effectiveness in performing its functions, the Atwood Vacuum Machine Co., Rockford, Ill., has proceeded to tell why and how in a catalog recently received. Herein it is stated that the Atwood is of great durability and operates with the least possible noise. These qualities are obtained by the use of a large, slow-speed pump rather than a small, high-speed one. Any form of power will run this machine—electric motor, gasoline engine or any other available. This machine has an endless belt drive. An Atwood Gravity Idler is incorporated in each machine and always maintains the belt at correct tension. The belt may be instantly removed and the motor used for any other machine. All shaft bearings are unusually large and automatically lubricated by ring oilers. Oil reservoirs are generous in size and fitted with dustproof hinged plates. Motor and exhauster are mounted on a heavy cast-iron base, giving the machine a solid foundation. A valuable feature is the fact that the vacuum is under control. The Atwood Automatic Unloading Valve is set and locked at the factory to operate at the correct vacuum. This valve is so designed as to relieve the motor when the cleaner is started or run with all the inlets closed, but instantly brings the machine to full capacity as soon as any tool is put in use. Tools cover a wide variety for all the general and specific needs.

The average vacuum cleaning system is called upon to do a varied work. It is put on heavy rugs which require relatively high vacuum and small volume of air, and also on bare floors and walls where the conditions are reversed. The Atwood type of ex-

hauster automatically makes possible these nice combinations. Various sizes are made providing for the whole range of buildings, from small bungalows to large hotels and public buildings.

### The Ja-Nar'

To be able to conceal the usually unsightly radiator and at the same time automatically regulate the warmth of the room to an even and constant temperature is the twofold function of the Ja-Nar'. The Fulton Company, Knoxville, Tenn., issues a booklet on this subject of more than usual interest.

From the description presented, the Ja-Nar' has much to commend it. First, there is the element of comfort and health. A room constantly too hot or too cold cannot be comfortable. A room that is spasmodically hot and then cold is still worse. The repeated necessity for opening and closing the window or regulating the valve of the radiator dissipates the comfort of a restful evening. The Ja-Nar', we are told, does away with this inconvenience. It brings two kinds of comforts: the physical comfort of always having the desired temperature in the room, and the mental ease of knowing it in advance.

To architects the exposed radiator has always been disconcerting. When, with the comfort assured by the Fulton Company, there may be had a distinct addition to the artistic aspect of the room, one is justified in seeking acquaintance with a cabinet which achieves these desired results.

The Ja-Nar' is a piece of furniture which fits over the radiator, and is finished to match mahogany, oak, walnut and white or tinted enamel. It makes, it is claimed, a better use of the heat than the naked radiator; it prevents the streaky, faded spots on the wall above, and the warping of woodwork around; it provides an appropriate place for flowers, books and statuary, and contributes another decorative touch to the intimacy and personality of the room.

The working of the Ja-Nar' is extremely simple. Its installation requires no change of a single detail in the heating system; no connections of pipes or tearing up of floors are required. The thing works on tried and known principles. It operates without any outside interference, and conserves fuel in the process.

Ja-Nar' is fully guaranteed as to workmanship, material and operation. The Fulton Company will send further details upon request.

### Fires and Flues

"Clay Products for Building Construction" is the title of a booklet printed by the Sewer Pipe Manufacturers' Association, Akron, Ohio. The recommendations for the safe and sanitary construction of buildings made therein are founded on statistics compiled as the result of investigations of losses caused by unsafe and unsanitary construction of various types of buildings. These recommendations embrace the suggestions of architects, health officers, fire engineers, city building commissioners and others with related interests.

Buildings are no longer constructed where the use of inferior materials is sanctioned for the sake of restricting costs. Societies are being formed everywhere to instil the need of safe and sanitary construction in the minds of the public. This education, valuable as it is, must be followed by action. It will not do tacitly to admit the importance of a certain policy only to pursue one diametrically opposed.

What is called "the wooden-house habit" is traced from its earliest development in this booklet, and its relation to fire hazard is clearly set forth. The part of the flue in spreading or limiting a fire once under way is emphatically disclosed. The necessity for proper flue construction cannot be overlooked.

It is not, perhaps, generally appreciated that the expenditure of only a few dollars will permit of lining chimneys and flues with a fire-resisting material which will prevent the collection of soot and reduce the danger of fires from sparks; that will, further, prevent gases, sulphur, etc., from disintegrating the mortar in the chimney, dissolving out the lime, making it crumbly, and weakening the structure of the flue.

It is reasonable to believe that if the building public would more carefully scan the facts governing the origin of fires, many unsafe construction customs, notably that of leaving a chimney unlined, would be abandoned, not from compulsory legislation, but from choice.

Architects might well follow their impulse to send for this booklet and trace the matter to its source



27-93 4/16 410

# The AMERICAN ARCHITECT



LIBRARY  
MAR 27 1919  
UNIVERSITY OF TORONTO



PALAZZO CHIEREGATI, VICENZA, ITALY

PUBLISHED WEDNESDAYS IN NEW YORK—FOUNDED 1876  
VOLUME CXV                      MARCH 19, 1919                      NUMBER 2256

Entered as second class matter January 6, 1909, at the Post Office at New York, N. Y., under the Act of March 3, 1879. Publication office, 243 West Thirty-ninth Street, New York, N. Y. Subscription price in the United States and Possessions, \$10.



# ARMCO IRON

**ENAMELED  
PRODUCTS**

## In The Home

Armco Iron makes its appeal to the women of America in the way of enameled refrigerators, stoves, table-tops, and other enameled kitchen products.

It is a pleasure to feel we have a part in bringing about this great "Enamel Age" for the American kitchen. Our message to the home makers of the land is that they can expect the best products when they know the enameling is done on a pure Armco Iron base.

Its evenness and freedom from occluded gases, seams, scars, cracks, spots, pin-holes and other defects are what make possible the polished perfection of Armco Iron Enameled Products. They don't show ugly spots or rough places.

Many leading manufacturers are using Armco Iron exclusively for all enameled parts in the manufacture of their kitchen cabinets, stoves and table tops.

**THE AMERICAN ROLLING  
MILL CO.**

MIDDLETOWN, OHIO.



**Purity**

**ARMCO IRON**

**Durability**





A GARDEN IN JAPAN



# THE AMERICAN ARCHITECT

VOL. CXV

WEDNESDAY, MARCH 19, 1919

NUMBER 2256

## Architecture and Engineering

By THOMAS CRANE YOUNG

THE preference given by the United States Government to the engineer and contractor over the architect in the conduct of building operations for war was perhaps natural, considering the necessity for haste and the fact that the army officials in charge of the preliminary organization were themselves primarily engineers. It must be admitted that in regard to rapid construction surprising results were obtained, although without the usual necessity for any consideration of cost. Whether architects could have done better or as well must always remain an open question in the absence of a comparative test under like conditions. There is, unfortunately, some ground for the criticism that the architectural profession has not kept pace with modern business developments and has given an unwise prominence to that portion of the business of building which has been designated by the critics as "Art."

The American Institute of Architects remains today practically as organized about fifty years ago, when living conditions and business methods were as different from the present as day and night. It still attempts to govern through an inflexible Code of Ethics based upon archaic practices which are unworkable today, and, consequently, seldom closely followed.

The modern practice of engineering as applied to buildings is largely a development of the last fifteen or twenty years, and its national association is organized on a more liberal basis. Broadly speaking, it is governed from the bottom up and, is, therefore, democratic and more in harmony with the times.

The regulations established by the Institute are largely responsible for any misunderstandings regarding the position of the engineer in relation to building. The Schedule of Charges states that the architect is to be reimbursed for "the costs of the services of heating, ventilating, mechanical and electrical engineers. Although this wording is a recent modification, the code still implies as general custom permits, the separation of these engineering activities from the services to be performed by the

architect. All, or nearly all, of these specialties are necessary to any building operation of magnitude and their work must be incorporated in the general architectural plans. It is small wonder then that the owner should question the constructive ability of the architect and consider himself subject to imposition through the multiplication of fees. If the owner deals with each specialist separately he is subject to an added inconvenience and the architect loses a part of the control which he should properly exercise himself. The same may be said for continuous superintendence which also is excluded by the code from the service properly performed by the architect. The total expense for professional services often amounts to a considerable sum and forms a part of the cost of the building which must be provided for. It is unbusinesslike to leave the matter in doubt.

To avoid explanation and perhaps a disagreeable argument with an owner, or the alternative of paying for this technical advice from his own pocket, the architect in some cases seeks to cover the matter up by inserting a clause in his specifications requiring the contractor to include in his proposal an amount sufficient for the purpose, but disguised as "payment for shop drawings" or some similar expedient. To say the least, it is an unbusinesslike shifting on to the owner or contractor of responsibility which should properly be assumed by the architect. The disinclination on the part of architects frankly to face the situation has led to still worse abuses. In some cases manufacturers of building material offer to supply engineering service gratis, provided their material is specified or purchased. Of course, the cost is added to the manufacturer's price, but the service so obtained is not likely to be the best. It is, of course, proper that the owner should pay for any necessary technical services, but it certainly would be more dignified and businesslike for it all to be included in the architect's fee, which should be correspondingly increased.

There are always two sides to any controversy, but it is difficult to formulate a defense until a criti-

## THE AMERICAN ARCHITECT

cism has been expressed in concrete form. Something of this sort appears in the *Journal of the Institute* for November, 1918, in an article by V. A. Matteson, of the Construction Division of the Army, a part of which we quote:

"By a sort of process of disintegration, various fields of endeavor have been started in the past half-century which we have been responsible for saying were not architecture but engineering in some form. The result is that the term "engineering" covers a multitude of activities, but the term "architecture," which should be the broader term, has been confined to very narrow limits. It has been decreed by ourselves that, in order to be architecture at all, our work must have some claim to relationship with "art." Science has been used in connection with the work of the Construction Division, but not much, if any, of what is commonly called "Art" (with a capital A). Therefore, by our own definition, by the limitations we have ourselves set, by public opinion which we have molded, and by our own narrow conception of what a "master builder" should be, architects, according to popular definition, have not been of much service to the Construction Division, as compared with those who are commonly called engineers. On the other hand, if we consider that any man who has knowledge of the art and science of building, and puts that knowledge to practical, professional service as a master builder, is an architect, then we may say that the Construction Division is almost entirely composed of the most able architects that the world has produced."

This appears to be a fair indication of the attitude of Government officials and coincides in the main with similar views heard in conversation and expressed in certain writings appearing in engineering publications not now at hand from which to quote.

Aside from the assumption of the rôle of "artist" in place of "master builder" the gist of the accusations against the architect is that he is often visionary, unbusinesslike, and incompetent to design in detail whatever work of engineering is required in his building. These faults are frequent enough, but neither architects nor engineers are always perfect. Our critics lose sight of the fact that in laying out the general plans, the architect provides for and solves the main features of each engineering problem involved in construction, leaving the details of these and many other parts of the construction for subsequent elaboration.

It is his function to incorporate with his own work that of each of the various technical experts so that in the completed building the parts which each provides will fit in and work together as the parts of a single machine. He must do this in such

a manner as to satisfy the financial requirements of the owner, the physical needs of the tenant and the aesthetic sense of the community.

The training of the architect usually includes a study of the fundamental principles of engineering, but it is true that he is not often an expert in the sense applied to the engineer, nor is this necessary. It must be remembered that there are often eight or nine distinct phases of engineering necessary in modern buildings of any magnitude, each of which requires a preparatory period of four years to qualify as an expert, and experts in one branch are seldom similarly qualified in another. It would manifestly be impossible for any one man, either architect or engineer, to qualify as an expert in all branches during the span of a single life. Besides a certain knowledge of engineering an architect must have a working familiarity with a dozen or two of the building and industrial trades, to say nothing of decorative painting and sculpture. If not a universal expert himself, he can co-operate with other specialists, and this co-ordination of effort is absolutely necessary in the conduct of modern building operations, whether under the direction of the engineer or architect. If by the former, he will find it necessary himself to depend in equal degree upon the assistance of experts in other lines of work.

Engineering has a better standing as a profession because it has established a definite standard of education for those who practice it. It is much more difficult to do this for the architect, owing to the great diversity of information he must acquire, but a similar definite standard of education must be required before architecture can be maintained as a profession at all. Facts brought out by the war have, however, caused an almost universal doubt as to the efficacy of present methods of education in many other branches of human endeavor as well, and probably much study and effort will be necessary before our educational institutions can be made properly to fulfill the requirements of modern life.

At the present time the education of the engineer, whether military or civil, includes no study of the aesthetics of construction, and this probably accounts for the extreme ugliness of most structures purely utilitarian in character and especially of most buildings designed by engineers.

It has recently become fashionable to minimize the value of the aesthetic element in a structure and yet at the present time the whole world bewails the destruction of thousands of buildings throughout Europe because of the loss of their acknowledged beauty which has for long been a prolific source of income to the countries possessing them. Beauty



## THE AMERICAN ARCHITECT

and ornament are not synonymous terms by any means, though frequently so misused. Nor does the element of beauty in a structure bear any special relation to cost. But when it does exist, it appears as the result of the exercise of some mental quality which, for the want of a better term, may be designated as skill, or may be what is meant by "Art."

At the close of the Civil War, as now, the engineer was in the ascendancy, and for the ten years following, national architecture as to merit was at its lowest stage since the inception of our government. The next twenty-five years, partly due to the workings of the "Tarsney Act," saw an enormous improvement in American architecture until it equalled perhaps the product of any of the modern nations. That this work should be attributed to the engineer rather than to the architect, many of whom

attained world-wide eminence during this period, is a claim which borders somewhat on the ridiculous.

After all it seems rather futile to dispute over the relative importance of architecture and engineering. The functions exercised by each are necessary in any construction and neither can obtain results without the co-operation of the manufacturer, the contractor, and not least, of labor, each contributing to the finished product in his own manner of work and degree of skill.

Co-operation must be the key word for building in the future, and whether this may best be obtained through organization as had in the past, or in modified form, perhaps in larger units combining and exercising under one head all of the functions necessary to building, from finance to labor, is one of the new problems of peace yet to be solved.

---

### Analyzing the Development in American Architecture

By DAVID J. VARON

THE military achievement of our nation in this great war has been far reaching. It has revealed our country to the world at large, and where we were thought of as a conglomeration of materialists, we have suddenly shown that we were as truly idealistic as any older nation. Our devotion to the highest ideals was sealed by the death of thousands of our best men on the Altar of Liberty. When our forces at Chateau-Thierry opposed an iron wall to the foe, it was in a new garb. It was the heroes of the War of Independence who reappeared. This revelation of real humanity in the nation once upon a time known as "the nation of business" is fraught with consequences. We might inquire how should we stand a world investigation about our achievements in fields other than military. I leave it to others to speak for agriculture, industry and commerce, contenting myself with an analysis of American endeavor in the architectural field and from the artistic standpoint. That field is vast and ought to be subdivided into at least three big parts: industrial, commercial, and civil architecture.

About twelve years ago, in a conversation with a friend, I expressed the opinion that one of the great problems we had to solve was the industrial plant, feeling that if the Greek genius were still at work, the goddesses Electricity, Steam, etc., would be glorified in the beautiful and powerful temples of labor. Today this dream is beginning to materialize. If you have never ventured out of your

office for the last decade there are great surprises in store for you. The Larkin plant in Buffalo, the Sears-Roebuck plant in Chicago, and many others of similar type would show you what tremendous strides we have made along this line. Things are looking more human, an air of courtesy is pervading the organizations all through. Architects and owners have vied with each other in the attainment of an ideal and have succeeded. We may be proud of their success, because upon it is based that of the whole nation. Our business men have come to understand that it pays to shed beauty over an industrial structure. In the long run it is repaid by the superior quality of the product and the reduction of labor turnover.

In the labor housing, which is an industrial collateral question, the improvements have also been great, especially since the Government took the matter up. We have understood that a good man needs to be well housed. The foundation of a nation has to be well seated, well cared for, if it has to be relied on for the support of the whole structure. Let us hope that what we have achieved along this line is only a start, a beautiful one, full of hope for the future, to the advantage of the laboring class and to the credit of the Government.

It would require several articles to put in its true light our civic architecture. Suffice it to say that we are in the ascendancy.

Commercially we have had to cope with our typically American problem, and this is the sky-



## THE AMERICAN ARCHITECT

scraper. How interesting is the history of the development of this class of building! At the time of its birth the skyscraper was surely not intended for a parading feature along our thoroughfares, but as a necessity dictated by the imperious demands of the rapidly developing business in our congested cities. Room in the business centers was growing scarce and rent ran high. There was only one logical solution at a time when locomotion was not so easy as to-day, and that was the superimposition of a new city over the old. Buildings were doubled and trebled in height. The strides, as far as engineering was concerned, were huge. There was no limit to the possibilities offered by the steel frame. But the men of the architectural profession were taken aback. It was all so sudden that the first solution which offered itself was the actual multiplication of elements: if an office building was to be three or four times higher than usual, then the basements must be accentuated three or four times and three orders would in turn superimpose each other, etc. In other examples, three or four regular six-floor-high buildings climbed upon each other with remarkable nimbleness. They made you think of very skillful acrobats.

Meanwhile cultured people began to take the matter to heart. Our schools of architecture were just beginning to bloom. As classic architecture began with worshipping Vignola, the latter's book was taxed for the solution of this most modern of all problems. One solution—if not the best—was offered, which took hold of all the mechanically inclined minds: the same divisions of the classic order, base, shaft, and entablature, were to find their counterpart in the design of the new type of office building. Soon there were to be seen elaborate bases whose height was determined by the formula: then practically barren shafts, and, at the height prescribed by the teachings of Vignola, came another elaborate part corresponding to the entablature. The easy so-called solution spread like wild-fire from coast to coast and from North to South. All these new structures "meant business."

Now, at best, these giants were mere masks. They could not stand the slightest test of rationalism. What relation was there between the appearance and the reality? None. Huge columns and portals adorned the entrance, and you supposed that they ushered you to equally important quarters. Great was to be your disappointment. For the inside had nothing to do with the front. In fact, one man studied the equipment of the building, its plan, etc., and another, possibly ignoring all the requirements of the program, took care of the front, the main part of the study of which was to conform to the formula and yet make it different from that of a neighboring giant building. It was for the solu-

tion of such difficulty that the ingenuity of the designer was to be taxed. But the matter, thank heaven, was comparatively easy, owing to the multiplicity of orders, of borrowed styles, of an infinite variety of materials, etc.

There were some who did not grasp at once the "high" significance of such combinations. Well, a more learned friend explained the matter in a very simple manner. The base, which usually reached the height of the heretofore six-floor building, was kept elaborate because people walking in the street could see the ornaments without difficulty. The shaft was barren, precisely because you could not try to see any detail without getting a sprained neck; as to the gorgeous decorations of the top, they were reserved by the kindly artist for those who looked on the new Babylon from across the river or a few miles off. They were to greet the newcomers to our shores.

But, somehow, this mechanical, camouflaged solution did not and could not take hold of all architects. This sort of dress or veneer applied without any plausible reason on the most interesting achievements of the builder-engineer was something decidedly wrong. As to the theory of its proposed solution, it was altogether false. There was no relation of organ to function in its subdivisions, as in those of the orders. Here the base spreads out in order to carry the upper weight on a wider area, and so forth. The cap spreads also in order to relieve the stress of the architrave as far as possible. Hence there is in the order that peculiar charm which accompanies truth.

Meanwhile the best minds of the country were at work trying to live up to the very definition of art which must be a combination of service, truth and beauty. Observing everything in nature, following in this the very same methods of old, they found there must be on the outside at least a suggestion of the inside. Once more those judicious minds contrived to make architecture abide by the simple definition beautiful construction, whereas it has been heretofore an effort to the contrary, "beauty made constructible." How could they reach a solution? Here is where the survey of our achievements becomes very interesting, the more so that the next proposed solution is very rational and thereby points to a change brought or to be brought into methods of teaching in all our schools.

The successful architect started by analyzing the very skeleton proposed by the engineer, and he saw at once that the one important element in it was the pier, whose office it is to carry down to the rock all the weight with which succeeding floors loaded it. In such a system no wall supports itself, but its weight is shifted on every floor on the pier. Hence the latter element must needs become the dominant

## THE AMERICAN ARCHITECT

one. This is what our architects grasped at once and affirmed with the utmost conviction on their work. They had the courage to do away with the obsolete formula teachings and assert their new conception. It proved to be full of life. The metallic pier was accentuated outwardly without any fear and without desire to abide by any so-called symbolic principle that the vertical points to heaven, which is good enough teaching up to a certain age. Verticality emphasizes gravity, and it is therefore a good enough item to be accentuated. It is service and truth combined. No longer the acrobatic climbing up of one building on the top of another, no matter how great the respective merit of each be, but the vertical pier dares to defy the very clouds. This is what gave us buildings of the Woolworth type. That there are some mediaeval details in them is due to the purpose of conciliating to some extent the new creations with the spirit of tradition which for centuries has associated Gothic with any comparatively tall structure. The first step in the right direction, and the most difficult, is made. More power to the daring minds who undertook to open new possibilities!

Our commercial structures begin to be useful and truthful, and to some extent beautiful. The question is to make them altogether so. That is the next step. While comparatively easier, it entails some academic reforms. We may pride ourselves on having the richest and most costly museums in the world. They will help us immensely in our endeavor. But they should serve us only as an inspiration if we wish to create not necessarily an American art but any art at all. Art is not created with models, but with a keen appreciation of life itself, of its poetry, the appreciation of the contemporary events, as well as the aspirations of the nation. Now, if our desire were to revert to the absolute form of polytheism then we should with all freedom let run on our friezes all the themes of Greek and Roman mythology. It would prove our consistency. But as we profess to have altogether a different creed, what can such ornaments as an ox skull beautifully adorned with garlands mean to the man in the street? It is, indeed, "Greek" to him. But as we are anxious to revive the very principle which guided the ancients in their expressions we shall find in our modern life enough material and symbols to give our creations an expressive beauty. The church is right when it commends the praying in the current language, which one understands, no matter how fine a Latin word may sound. To be a living, a lasting, art, ours must appeal to the great number, as did the old. That composition will be classic, whether or not there be any classic details in it, which will

be beautifully representative of the present tendencies of the masses and not only of the few versed in the finenesses of the Iliad and the Odyssey. For the latter our museums will always supply plenty for their want. But the man behind the plough, or even behind the desk, needs an art which breathes in the same atmosphere as he does. As the common people in the Middle Ages found in every pinnacle or gargoyle something reminding them of their folk-lore or an expression of their creeds and legends, so we ought to foster an art which would be comprehensible to the street cleaner as well as to the college graduate.

It requires merely a change in the attitude of our academic heads with regard to the teachings of poetry and life to make these things possible.

Opportunity is now rapping at our door. As a result of our great military victory, which helped make the world safe for democracy, this country is contemplating the erection of hundreds of liberty memorials, Temples of Liberty, as it were. The whole nation is already keenly interested in the proposition. We may expect the co-operation of all the enthusiastic citizens. This is the surest warrant of the coming of a new era in art. The Greeks and the Middle Ages gave us such examples of national enthusiasm, and this is precisely the reason for their being able to hand down to us works of art on which we can see the image of their very lives. If we are to succeed—and we must—it will not be on account of our using this or that style, borrowed from this or that period, but simply because we will have developed more poetry; we will have learned better to appreciate the events of our own time. The symbols we are to use will be representative of our modern aspirations and activities. Humanity of today does not have to blush before its ancestors. The democratizing of the whole planet is as worthy a reality as was poetic or romantic any Herculean deed or myth. The laws of creation are still at work in our midst, but their expression is not quite adequate.

That teaching I deem to be a failure which does not kindle a sacred fire in the bosom of our youth, a desire to feel before Nature and the scenes of the everyday life the same feelings as the poets who put them into verse for them. Art is an expression. One could not expect any expression where there is no impression.

The whole matter of our art lies at the very foundation of society, at school. In the proportion of our making the methods of teaching more imbued with admiration for modern life, and heaving with aspiration toward an ideal, we will have an art worthy of ranking with that of any other period or country in history. And we will have it.



# Recent Books

## The Formal Garden\*

**T**HE formal garden in England, as we know it today, was, up to the beginning of the Tudor period, non-existent. Europe, and particularly England, had been ruled by that good old plan of "he may take who hath the power, and he may keep who can." The English house, as referring to the seat of the lord of the manor, was a feudal edifice, surrounded by moats and defended by strong masonry walls. To venture from even the safe shade of these walls was to risk the marauding bands of some neighboring lord. Even the land that it was necessary to till to afford subsistence was worked under the protection of armed guards whose constant vigilance during the period between seed time and harvest was necessary to insure the garnering of the crops.

By the middle of the sixteenth century, rural England had assumed a more peaceful state, and there existed conditions of personal security which

\*Garden Ornament, by Gertrude Jekyll, full cloth, 11 x 17 inches, with over six hundred illustrations. Price, \$28.00. New York: Charles Scribner's Sons.

permitted a freer going about. These peaceful conditions at once affected every phase of the domestic life of a people whose martial equipment had been laid aside and who began freely and safely to practice agriculture. Henry VIII and later Elizabeth used their influence toward the general reorganization on higher planes of the entire scheme of domestic life.

The architecture of the period also began to assume the characteristics with which we are familiar. Whereas in earlier days the windows of these huge castles were small in size, and mostly on the open courts, the new buildings were fenestrated in such a way that the interiors were flooded with light and air and afforded a wide view of the surrounding country. The bowling greens previously confined to the inner courts were now removed to well selected locations. The "dipping wells" that necessity in the past demanded should be easily accessible, were rebuilt outside the walls of the "tower," and the gardens where were raised the vegetables to supply the table were largely expanded and located further afield.



STAIRWAY IN THE GARDEN AT BOXWOOD, WILTSHIRE, ENGLAND



## THE AMERICAN ARCHITECT

Among the nobility and gentry there was large riches, and the rivalry to improve the house and its surroundings led to the encouragement freely given to architects, craftsmen and gardeners in Europe to visit England, where their services were always in demand and their opportunities for profitable employment very great.

This influence of the artist and artisan of the Continent is everywhere discernible in Tudor houses, but in no direction more strongly than in the stately English formal garden. From its origin principally

have been developed results the fame of which has traveled to the four quarters of the world.

What has been accomplished in England and Italy in the development of the formal garden has been a source of the most beautiful inspiration to men in this country whose clients of large wealth have made it possible to set about a series of important undertakings in garden making. While these are today, in most instances, but the crude skeleton of a real garden, the developing and artistic hand of time will eventually transform them into the same effec-



FLATFORD BRIDGE, ENGLAND. AN EXCELLENT TYPE OF SIMPLE WOODEN BRIDGE

as a utilitarian location where might be raised the necessary vegetables to supply the table, and those essential medicinal herbs that formed the pharmacopia of the time, there developed, under the influence of Italian and French men, the highly decorative and supremely beautiful English formal garden. And to this development there was given the skill of the architect, the sculptor, the craftsman, and what we now designate as the landscape gardener.

Successive generations of reverential hands have builded and led the original schemes until after, in some cases almost four centuries of growth, there

tive results that are to be found abroad. These results will only be attained in this country by the application of the artistic knowledge of successive generations of rich owners and skilled landscape gardeners, but it is quite certain that we shall at some future time have in the United States equally excellent results, as their building will in its inception and development have been controlled by the examples of centuries of growth of the foreign garden.

Many books have been written as to the formal gardens of Europe, each profusely illustrated. These have served to make us familiar as far as



ARCHED TRELLIS, WITH DOMED CENTER, AT EATON LODGE, ESSEX, ENGLAND



A GARDEN SEAT AT HINTON ADMIRAL, HAMPSHIRE, ENGLAND



## THE AMERICAN ARCHITECT

pictures ever will, with the general effect of gardens that have become famous in song and history. It has remained, however, for Charles Scribners' Sons to produce jointly with George Newnes of London a work on gardens that is so markedly in advance of anything attempted along this line in the past, that any reference to the bibliography of the European gardens omitting this important work would be incomplete.

While the title of this large volume (it measures eleven by seventeen inches) is *Garden Ornament*, it would more clearly indicate the character of its

classification of the illustrations. These are divided into seventeen sections. They include gateways, steps, balustrades, paved courts, loggias and orangeries, garden houses, pergolas and bridges. Other classifications of accessories present sundials, fountains and garden ornaments.

The volume is a sumptuous one, and without it the architect's library will, as far as garden making is concerned, be incomplete.

We are indebted to Messrs. Charles Scribners' Sons for permission to reproduce from *Garden Ornament* illustrations accompanying this article.



IN A JAPANESE GARDEN

contents had it been called *Garden Detail*. There is a wealth of six hundred illustrations, carefully made from unusually well taken photographs. Each plate is a storehouse of good suggestion, and many of them possess an artistic quality that is not always present in framed pictures.

As a guide and inspiration to garden planning and designing, this book has the utmost value. The text is brief and only sufficient to introduce the large number of illustrations, each clearly telling its own story.

A helpful feature of this book is the well studied

### Architecture and Democracy\*

**J**UST to what extent the spirit of democracy has and will make itself felt in architecture—a subject which, on account of the war, has had such an extraordinary intensification of interest that no one in the habit of observing the shifting currents of art can have failed to perceive it—is most interestingly traced in Mr. Bragdon's latest work. The book will be found to be well-reasoned

\**Architecture and Democracy*, by Claude Bragdon, F. II. I. A., 213 pages, price \$2.00. New York: Alfred A. Knopf, Inc.





GARDEN TEMPLE, VILLA BORGHESE, ROME

and convincing, with a logical and forceful plea to the architect not to revert to the old feudalism from which the war has set him free, but to seek for the self-expression that will create the new, the true democracy in art.

Written, of course, before the ending of hostilities, it does not for that reason lose either its cogency or timeliness. The fact that our participation in the war has resulted so splendidly for the progress and furthering of the democratic spirit through beauty, is taken due note of by the author. He calls particular attention to one conspicuous example—the Red Cross Community Club House at Camp Sherman, Ohio—which stands as a symbol of the architecture of Need, in contradistinction to the architecture of Greed, and is an oasis in the “Euclidian nightmare of bare board and black roofs of the cantonment.”

Mr. Bragdon logically and forcefully presents his views, which in reality hit at the architect who must have a precedent for all his work. No sympathy is spared on the man who in designing a city bank goes back into history's pages and picks out a

yellow-stoned arsenal of old Spain and uses that for the shell of his new structure. There is none of the spirit of democracy in that, according to Mr. Bragdon, who holds that democracy can not be interpreted in terms of existing idioms, be they classic or romantic, but must come from the heart of the architect, where they will create new forms through him.

The architect who is at a loss to know where to go and what to do in order to be played upon by these emotions is referred to the army and navy camps, where the spirit of democracy is incarnate. There, men stripped of all but the elemental necessities of life, have dreamed the dreams and seen the visions that form the new democracy. The Red Cross building just referred to, which attained its final synthesis through the collaboration of a Cleveland architect and a National Army captain of engineers, is given as an example of the ideal relation between architect and engineer—that of a happily wedded pair—strength and beauty. There was no deliberation as to the relative merits of Gothic and Classic, but the appearance and atmosphere of the

## THE AMERICAN ARCHITECT

structure are inspiring, in symbolic relation to the times. To Mr. Bragdon it represents what may be called the architecture of Service, "a temple of the new democracy, dedicated to the uses of simple, rational social life."

Speaking of the classification of the expression of the building impulse from what may perhaps be called the psychological point of view, Mr. Bragdon says:

Broadly speaking, there are not five orders of architecture—nor fifty—but only two: *Arranged* and *Organic*. These correspond to the two terms of that "inevitable duality" which bisects life. Talent and genius, reason and intuition, bromide and sulphite are some of the names we know them by. Arranged architecture in its finest manifestation is the product of pride, a knowledge, a competence—a competence staggering to behold. It seems to say of the works of Nature, "I'll show you a trick worth two of that." It is created but not creative; it is imagined but not imaginative. Organic architecture is both creative and imaginative.

To make the whole thing clearer it may be said that arranged and organic architecture bear much the same relation to one another that a piano bears to a violin. A piano is an instrument which does not give forth discords if one follows the rules. A violin requires absolutely an ear—an inner rectitude. It has a way of betraying the man of talent and glorifying the genius, becoming one with his body and soul.

Mr. Bragdon deplors the fact that the architects of today, especially those of the East, are so imbued with the classic which they have had drummed into

them in their early training that it has cast a spell over their imagination, and their efforts can never become truly creative. They have merely become reconstructive archæologists, he asserts. His plea is that they deal more simply and directly with the immediate problem to emancipate them from absurd and impossible convention. In the problem of the office building, democracy, he points out, has been afflicted with the attempt to inflict upon the living present a moribund and alien order.

It is the author's belief that in whatever way the war may complicate the architect's personal problem, it should simplify and clarify his attitude toward art and destroy the evil spell of materialism, which is the very negation of democracy. One step toward the solution of the problem has come, through the war, in the attitude of the profession toward the general housing problem.

Besides Mr. Bragdon's interesting treatment of the advent of the new democratic spirit in architecture, his book contains several of his essays heretofore published in various architectural publications, including one on Ornament through Mathematics, Color and Ceramics, and Symbols and Sacraments. Altogether it is a very readable book that Mr. Bragdon has given us, full of interest to those educated in all architectural schools. The book is copiously illustrated with excellent photographs.

### The Post-War Committee

Every architect should support the work of this committee. It is not one of the Institute alone, but representative of the entire profession in this country.

Send your suggestions promptly to the Committee at the Octagon, Washington, D. C.



# Recent Legal Decisions

## EFFECT OF OWNER'S PROMISE TO SEE SUBCONTRACTOR PAID

A lumberman sued an owner for the price of materials and to impress a lien on the property on the theory that the owner, to induce him to furnish the lumber to the contractor promised to see that he was paid for it. Evidence that the value of the house would have been greatly in excess of the contract price was held competent to show the promise, and that the owner practically assumed control of the work. The personal benefit to the owner by reason of the fact that the contract with the builder was very advantageous—was sufficient to remove the promise from the statute of frauds. The lumberman had a lien, under the New Hampshire statute, notwithstanding he gave no notice in writing of his intention to claim a lien. The provisions of the statute requiring a subcontractor to give notice to the owner of such intention are solely for the benefit of the owner, and the notice may be waived by him.—*Janvriu v. Powers* (N. H.) 104 Atl. 252.

## ATTEMPT TO DEFEAT MECHANIC'S LIEN

In an action to foreclose a mechanic's lien for lumber and materials to erect a building, against a husband and wife, the wife's sister claimed the land as hers. It appeared that just before the building of the house, the wife deeded the land to her sister for an express consideration. In the contract for the material it was agreed by the husband and wife that a mechanic's lien should be filed as security for the price thereof, and they gave a note therefor. It was held that the deed to the sister was a manifest sham and that judgment for the plaintiff was clearly right.—*McCaul-Webster Elevator Co. v. Stiles*, North Dakota Supreme Court, 169 N. W. 577.

## FOLLOWING PLANS AND SPECIFICATIONS

The New Jersey Court of Errors and Appeals has approved of the following charge: "If the sagging of the walls and the falling of the plaster were due to insufficient support through joists or timbers, even though the defendant (contractor) put them in, but if the specifications called for them, this defendant cannot be held responsible in this case. In other words, if the defendant simply complied with the terms of the specifications, and the architect, through a mistake, provided for timbers in the specifications which were insufficient to properly carry the weight of this building where it was necessary

to have such support, and as a result, the natural and proximate cause of those insufficient timbers, the cracks occurred and the plaster fell, then this defendant is not responsible." In short, the plaintiff owner was entitled to the house he bargained for, and not a better one. If the contract and specifications are not to be the builder's guide, he has none, and the owner may contract for a \$1,000 house and demand a \$10,000 house. A good workmanlike job is a job properly executed; whether the result is what it should be depends on the plans and specifications.—*Drummond v. Hughes* (N. J.) 104 Atl. 137.



OLD BUILDINGS IN BOURGES

From the original sketch by Captain Harry Lane, 519th Engineers, A. E. F.



THE AMERICAN ARCHITECT

Founded 1876

PUBLISHED EVERY WEDNESDAY BY

THE ARCHITECTURAL AND BUILDING PRESS, INC.

No. 243 West Thirty-ninth Street, New York

E. J. ROSENCRANS, PRESIDENT AND TREASURER  
WILLARD C. HOWE, VICE-PRESIDENT

WILLIAM H. CROCKER, Editor  
ARTHUR T. NORTH, Engineering Editor

Subscriptions in the United States and Possessions,  
Mexico and Cuba, TEN DOLLARS. Other Countries,  
TWELVE DOLLARS.

SINGLE COPIES (Regular Issue) 25 CENTS

CHICAGO OFFICE, Mallery Building  
PAGE A. ROBINSON, Western Manager  
ST. LOUIS OFFICE, Wright Building  
CLEVELAND OFFICE, Guardian Building  
SAN FRANCISCO OFFICE, 320 Market Street

Owned by United Publishers Corporation—H. M. Swetland, President;  
Charles G. Phillips, Vice-President; W. H. Taylor, Treasurer;  
A. C. Pearson, Secretary. Entered as second-class matter January  
6, 1909, at the Post Office at New York, New York, under the Act of  
March 3, 1879.

VOL. CXV      MARCH 19, 1919      No. 2256

Co-operating With the Post-War  
Committee  
Architectural Education

THE Post-War Committee on Architectural Practice, in its admirably conceived program, does not stress with the accent that conditions warrant, the subject of architectural education. It refers to this important matter to the extent of a dozen or more lines, declares that our architectural schools "have apparently neglected to train the students in practical business," and reaches the conclusion that "many young men gain their experience at the expense of their first clients."

These conditions would seem sufficient to indicate that there is something radically wrong with our architectural educational methods. In fact, a large majority of the thoughtful men in the profession believe that much of our trouble in the past has been due to the accent that our architectural schools have given to the less essential features of the student's training and to similar faulty practices.

To go even further into this matter, it may be said that almost all of the queries set down in the program of the Post-War Committee, or the state-

ments made as to present conditions of practice, have their origin in the subject of architectural education. The present relationship of the architect to the public results from a system of education that has tended to give the young architect the idea that his position demands aloofness and that he should acquire the highest development of an ultra-professional attitude and at all costs maintain his dignity as an artist. This point of view has dulled his proper appreciation of his responsibilities as a citizen, and has caused him to ignore those particular functions of the Government in the co-operation with which he could be of great value. It has served to give him an exaggerated idea of his own importance, and caused him to avoid the giving of personal service in the progress of his buildings.

These things are all set down in the Post-War Committee's program and the profession at large is invited to discuss them with the committee. It is urged that every architect accept this invitation, and it is also recommended that in stating reasons for past errors and in suggesting methods for their correction, the matter of architectural educational methods as affecting professional practice, past and future, be carefully considered.

ANY future regulation of architectural education should be the work of the practical men of the profession. Any revision should be based on the experience of actual practice. It should be in the hands of men so sure of themselves, so certain of their knowledge of all the relations of the profession, to one another individually, to their clients, to other professions and to the general public, as to cast fearlessly aside all useless impedimenta to correct practice, and adopt measures that to many, wedded to old and obsolete methods, may seem revolutionary.

C. H. Blackall has stated in his admirable article on Architectural Education, printed in these pages, that necessary changes will not come from the free initiative of the schools, but that they must be evolved in the profession itself. That architects have a manifest duty in this respect is certain. This duty has now been squarely put up to the profession by the Post-War Committee.

Further, Mr. Blackall asserts: "There has been altogether too much separation between the profession and the school; too much treating the profession of architecture as if it were an end in itself rather than the preparation of a life work, and as if the academic successes were tangible achievements rather than mere groundings."

The suggestion of Frederic W. Garber, contained in a communication to THE AMERICAN ARCHITECT, offers a solution for the conditions described by Mr. Blackall. Mr. Garber states: "If architectural

## THE AMERICAN ARCHITECT

education could be divided into two large groups, first, building, and second, architecture, the two factions could be united."

**I**T is not the purpose to set down here any suggestions as to just how or how not to revise our educational methods. What is desired is to accent the influence on practice in the past, of certain methods of education now not generally believed up to the times. Further, it is desired to direct attention to the seemingly ill effect of these methods on practice, and to urge upon those who should with a proper regard to their professional responsibilities uphold the work of the Post-War Committee, carefully to consider whether the matter of architectural education is not after all the one big thing which needs to undergo improvement.

### Illegitimate Publicity Methods

**T**HE American Institute of Architects at the last convention held in Philadelphia, so amended the code of practice as to permit members of the profession to advertise, but it was tacitly understood that any advertising by the profession should be ruled by that unwritten code of ethics which would govern any legitimate business enterprise.

Many firms have since been reorganized on the basis of a closer co-operation with the engineering profession, and a number of these have through technical and other publications set forth by dignified advertisement the completeness of their organizations and their ability to handle every phase of a building operation from the early one dealing with the problem of financing through all details to the completely furnished structure. All of which is quite right and proper and shows a most commendable business spirit on the part of men who

at one time, and not so long ago, were accused of lack of business ability.

It is unfortunate, however, that this removal of the ban on advertising in connection with architectural practice should have given impetus to a certain class of advertising agents, and it is much more to be deplored that there should be found in the profession individuals and firms who have allowed themselves to be cajoled into certain undertakings. It now appears that many firms of architects have been approached by advertising solicitors who offer to get up, free of all expense, a certain limited edition of the architect's work in book form, provided that they may be permitted to solicit and print in each volume such advertising as they may be able to secure. Were it not that facts have been learned as to the success of these schemes and definite knowledge that certain important firms have lent acquiescence to them, the idea would seem incredible. Naturally an advertising solicitor engaged in such work will not be slow to assure those upon whom he calls for advertising that the architect whose work will be illustrated in the volume would be disposed to look with especial favor upon the goods of those who contribute to the success of his published work.

A more reprehensible proceeding it would be difficult to imagine. A method that would tend more to lessen the dignity of architects could not be devised. If these schemes are carried forward, the harm is serious. It would seem as if here was a matter that the Post-War Committee might with propriety early consider, and that the Institute at its convention in April could investigate with a view to such action as would make clear its attitude toward a practice that if persisted in not only discredits its authors, but casts a cloud on the good name of the profession as a body.

### The Post-War Committee

This Committee asks advice and co-operation not only from every architect, but also from those men engaged in occupations allied to architecture and building.

Write your views to the Committee at the Octagon, Washington, D. C.





PLATE 87

CHURCH OF THE HOLY ROSARY, DAYTON, OHIO

W. L. JAEKLE, ARCHITECT





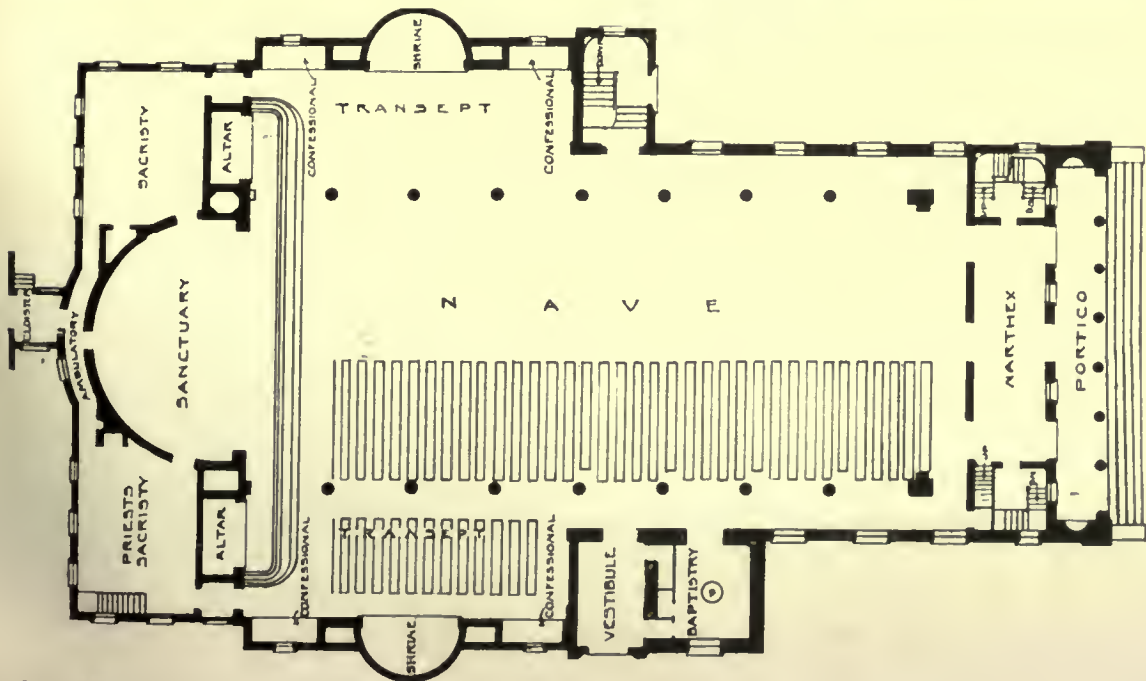

PLATE 88

CHURCH OF THE HOLY ROSARY, DAYTON, OHIO

W. L. JAEKLE, ARCHITECT







PLATE 89

INTERIOR LOOKING TOWARD GALLERY

CHURCH OF THE HOLY ROSARY, DAYTON, OHIO

W. L. JAEKLE, ARCHITECT







DETAILS OF TRANSEPT



CLERESTORY DECORATION

PLATE 90

CHURCH OF THE HOLY ROSARY, DAYTON, OHIO

W. L. JAEKLE, ARCHITECT







BAPTISTRY DOORWAY

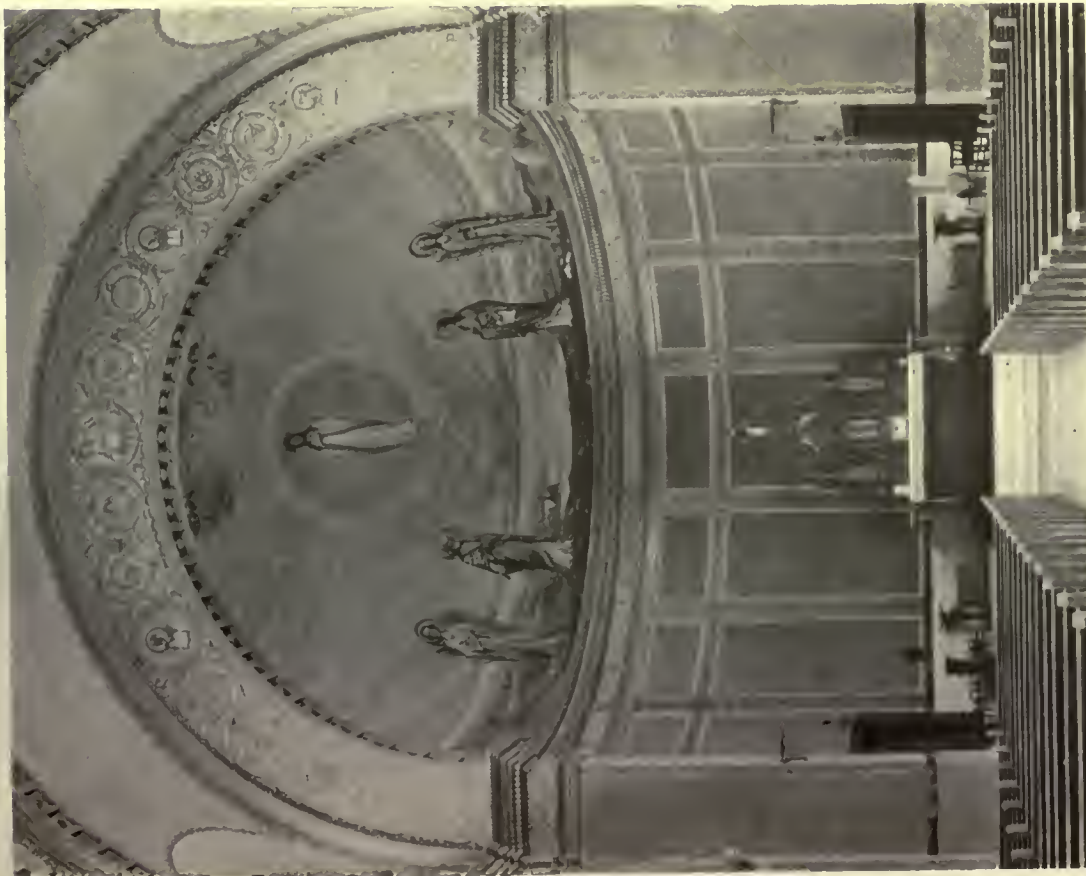

DETAIL OF SANCTUARY

CHURCH OF THE HOLY ROSARY, DAYTON, OHIO

W. L. JAEKLE, ARCHITECT







PLATE 92

ALLIES' SHOP, ST. LOUIS, MO., MAINTAINED FOR BENEFIT OF  
THE AMERICAN FUND FOR FRENCH WOUNDED

GUY STUDY, ARCHITECT

ON entering this café, one finds himself transplanted into a different world. Here is the picturesque quaintness of a village street "somewhere in France": in the center are spreading trees, real trees; at one side, a lovely little 17th century house painted saffron red, is built up against the ruin of a 13th century church, of which only the doorways and the shrine remain; across the way is the village inn, with thatched roof, green shutters, and laurel trees before the door; at one end of the street is a high wall topped with broken bottles, beyond which a scene in the Vosges mountains has been painted, giving the effect of great distance and reality.

No papier-mâché nor imitated construction has been used. All of the houses are built of permanent materials. The architect, Mr. Guy Study, has given care and thought to every detail, such as hand-forged hardware, frames of heavy solid timbers mortised and tenoned and tied with oak pins, and hand-split shingles laid irregularly.

The artists working with Mr. Study, Mr. Frederick Carpenter and Mr. Joseph Adamak, have reproduced the gray, mauve, and those tints of plaster mellowed by time; these soft tones harmonize exquisitely with the apple-green of chairs and tables spread fête-like into the street. Quaint lanterns made of wrought iron enhance the twilight feeling of late afternoon. The very necessary touch of life is supplied by young girls, who serve as waitresses, dressed in peasant costumes of blue with flaring headdresses of white organdie.







PLATE 93

ALLIES' SHOP, ST. LOUIS, MO., MAINTAINED FOR BENEFIT OF  
THE AMERICAN FUND FOR FRENCH WOUNDED

GUY STUDY, ARCHITECT





# Financial and Commercial Digest

As Affecting the Practice of Architecture

---

## False Economy to Await Lower Prices

That the manufacturer, jobber, retailer and consumer will have to realize and convince each other that they cannot stop buying if business is to keep its nose above water during the reconstruction period, is the opinion of T. E. O'Brien, president of the Leader Iron Works, Decatur, Ill. "All of these factors," he states, "are so closely linked together that one must depend upon the other. If the man who contemplated building a \$40,000 home delays operation because of high cost of material, then he must expect his employee who intended building a \$3,000 home to do likewise.

"If the farmer waits for lower prices he must expect the city folks who consume his product to cut down their purchases. In fact, if the implement or pump factory employee is out of work, his purchases from all classes of merchants are of necessity cut down to the lowest point which will allow himself and family to exist.

"So isn't it a fact that we are playing a game of false economy when we wait for lower prices? Won't we suffer more in the long run because of this hesitancy than if we would take the other view and not only encourage our customers to buy, but practice what we preach by buying the things we need ourselves?

"Where do people get the idea that prices to be normal must be pre-war prices? There is no logical reason to believe that prices will reach that level for a long time. Taxes will be extremely high for years to come and 'labor' has no intention of living under the same wage and conditions as existed before the war, 'so whither are we drifting'?

"If prices were to start a sudden decline now, by the time a pre-war basis prevailed business would have reached the worst stage of stagnation this country ever saw and every shred of confidence would be destroyed, and confidence is the one and only thing that will restore the proper balance to business.

"The man with money to do things and who hangs back now is the slacker. This is the time for the manufacturer, jobber and dealer to utilize personal salesmanship and advertising space in a big way just as the Government did to mobilize our resources to win the war. Of what good will his money be if this country is thrown into chaos, due

to millions of men being out of work? Idleness causes unrest and often leads to riots and destruction of property which will mean losses a hundred-fold greater than the difference between prices now and lower ones later. Wouldn't it be much better to try and strike a happy medium and adopt a live-and-let-live program?"

---

## Sees Loan Market Improving

Lewis H. Losee, vice-president of the Lawyers' Title and Trust Company of Brooklyn, believes that the situation in the building loan market created by the high cost of material and the cost of labor may be remedied in the near future. "There is a big improvement," he said, "but it has not taken as yet the shape of a boom. There is an encouraging sign in the transactions during the past few months and an indication of the revival of confidence in building. The demand for apartment buildings is to be expected at this time when the adjustment of living conditions is in progress following the disturbance of the war."

---

## Report on Jobs for Unemployed

Within the last two months the United States Employment Service in New York state has placed 50 per cent of the male civilians who have applied for employment and 38 per cent of the soldier and sailor applicants. The report of activities of the service has been made public by Director Dr. George W. Kirchwey.

Speaking of the discrepancy between the percentage of civilians placed and soldiers and sailors sent to positions Dr. Kirchwey said it was due to the fact that men discharged from the service are particular about the job in which they settle after their experiences abroad, a condition which, he thought, natural. To many the opportunity is now presented to look about for better work than that in which they were employed before the war. They now seek opportunity for advancement in various lines of endeavor.

"Another thing," continued Dr. Kirchwey, "which is making the placement of soldiers difficult is their tendency to overestimate their own abilities. We have had men apply to our offices and rate them-



selves as expert machinists, on the ground that they had become highly skilled in one of the technical units of the army. After referring them to a machine shop we have found that they were unacquainted with even the simplest types of machinery. I have in mind one man who wanted a job as instructor of French in a school or college, whose only knowledge of the language was gained from six months' contact with the inhabitants of the villages where he was quartered.

"To overcome this tendency we are working out a system of simple questions which will enable our examiners to determine whether an applicant is really qualified for the position which he desires."

---

### January Exports Set Record

January exports exceeded in value the total for any previous month in the history of American commerce, according to a statement issued by the Bureau of Foreign and Domestic Commerce, Department of Commerce.

The export figure announced for January is \$623,000,000 as against a total of \$566,000,000 for December, and \$505,000,000 for January of last year. Only twice before have exports reached the \$600,000,000 mark. During the seven months of the fiscal year ended with January the exports totaled \$3,798,000,000, as compared with \$3,450,000,000 for the corresponding period of the previous year.

The value of imports in January was \$213,000,000, as compared with \$211,000,000 in December and \$234,000,000 in January, 1918. For the seven

months ended with January imports totaled \$1,698,000,000, which is a slight gain over the \$1,634,000,000 for the similar period of the previous year.

The excess of exports over imports in January was \$410,000,000, an impressive total when it is remembered that the excess of exports for the entire fiscal year 1914, the last normal year, was only \$470,000,000.

---

### Testing Structural Materials

In commenting upon the needs for an appropriation of \$175,000 by Congress to be used by the Bureau of Standards in its work of investigating stone, clay, cement and other structural materials, Director Stratton states that building needs throughout the country are based upon the most unreliable data. He says there is great need for floor and partition tests, and that the increase of \$50,000 over last year's appropriation is asked for that purpose. An appropriation of \$60,000 is also asked for the investigation of fire-resisting properties of building materials. The sum of \$15,000 has been asked for an investigation of the effect of sea water on concrete.

The director states that there has been an entire change in the floor industry in recent years and it has been necessary to develop new refractories. He referred to the linings of the furnaces on battleships, which are now made of a light brick of very high heat-resisting power.

With the present appropriation the bureau has been conducting some column tests, with some good results from brick, cement and steel protected columns under temperate conditions.

---

## Current News

### New Jersey Architects Organize Memorial Committee

With the view of co-operating with the various communities of the State, the advisory committee on war memorials of the New Jersey Society of Architects organized last week, with James O. Betelle as chairman, Captain Shiras of Elizabeth as vice-chairman, and Hugh Roberts of Jersey City as secretary. The other members of the committee appointed by President Gilbert C. Higby are John F. Capon and Henry Baechlin of Newark, Stockton B. Colt of Elizabeth, C. W. Fairweather of Grantwood, Fred W. Wentworth and Harry T. Stephens

of Paterson, Arnold H. Moses of Merchantville, and William W. Slack of Trenton.

It is the plan of the committee to prepare a communication for submission to all of the municipalities of the State, offering its services in an advisory capacity. Feeling that the question of memorials should be approached with the fullest consideration, the hope was expressed by the members at the organization meeting that the municipalities would feel free to call upon the committee for advice. The belief prevailed that time should be taken to obtain the ideas of citizens and representative bodies, as well as to ascertain the views of the returning soldiers.

## THE AMERICAN ARCHITECT

It was reported to the committee that Governor Edge had been apprised of its formation and had given his hearty sanction, saying that he would be glad to take official cognizance of the organization.

Consideration was also given by the committee to the subject of expediting construction work, and the opinion prevailed that a concerted effort on the part of all interested bodies should be made to induce the Federal Government, the State and the various municipalities to start necessary operations under their respective jurisdictions as soon as possible. It was felt that the increase in costs would be counteracted by the general satisfaction resulting from employment.

---

### League Dines French Commissioner

The Architectural League of New York gave a dinner Thursday evening, March 13, in the Fine Arts Building, West Fifty-seventh Street, New York, to Lieut. Seymour de Ricci of the French High Mission, now in the United States.

The subject for discussion was "Art in French Homes in the 18th Century." Lantern slides were shown illustrating the history of the home-furnishing crafts in the days of Louis XV and Louis XVI, including the most characteristic examples of French craftsmanship as applied to the making of furniture, textiles, porcelain and metal work. These landmarks in the history of the eighteenth century were selected from some of the most artistic homes in Europe.

Lieut. de Ricci is a student of industrial arts in France and has an intimate knowledge of the history of Gallic home making.

---

### Building Industry Asks Lower Freight Rates

Agitation for an immediate lifting of restrictive freight rates on building materials has been most determined. Representatives of the sand, gravel, stone and slag industries, and the cement manufacturers, have appealed to the Division of Public Works and Construction Development of the Department of Labor for assistance in the presentation of their case before the railroad administration.

Many of the contractors and builders reporting to the Department of Labor insist that freight rates, more than any other factor, are holding back the more extensive building projects, especially in the Central West. They submit that if there is to be

an early resumption of general building and construction work, freight rates on sand, gravel, stone, slag and cement must be reduced, and such shipping restrictions as were inaugurated to prevent the diversions from war uses of building materials, must be withdrawn.

---

### Building Zones Planned for Ohio

Senator William Agnew has introduced a bill in the Ohio Senate to authorize adoption of building-zone plans for a half dozen cities having City Planning Commissions. The bill authorizes the Council of any city having such a commission to enact an ordinance regulating the height and bulk of buildings, the area and dimensions of yards, courts, and other open spaces in connection with buildings and the location of trades, of industries and other uses of property. Councils, however, shall not adopt a building-zone plan until a general plan shall have been prepared by the City Planning Commission and submitted to Council.

---

### Fight Unemployment by Constructing Homes

Indiana is preparing to fight both unemployment and radicalism through a campaign of home building and home owning. In his address before the annual convention of the Indiana League of Savings and Loan Association in Indianapolis, President W. B. Reed insisted that the cure for both these menaces was homes and more homes. Mr. Reed's appeal for a state-wide campaign for home building met with an enthusiastic response and out of it is expected to come a drive that has the encouragement and backing of state and municipal officials. The effect of such a campaign is bound to be beneficial for the home owning man if every community takes the responsibilities of citizenship seriously and is not prone quickly to take up untried social and political theories and experiments.

While the figures are by no means complete, data obtained by the division of public works and construction development clearly indicate a revival of home building in Illinois, Indiana, Iowa and Ohio. Activities in this field are not yet normal but from week to week an increase is shown indicating a growing confidence on the part of the private building interests. All authorities in the building industries agree there is a pressing demand for residential buildings.



## Canada Pushes Housing Bill

The Government housing bill will have the right of way over the legislative track. Ontario's premier, Sir William Hearst, in introducing the measure, said he wished it to go through the various stages quickly and get royal assent without delay. The bill offers loans to cities.

A loan of \$2,000,000 was offered at 5 per cent by the province to municipalities provided the latter put up 25 per cent of the amount loaned to builders. Subsequently the Dominion government set aside \$25,000,000 for the purpose and of this sum about \$8,500,000 was available for Ontario. Should a larger amount be required, it likely would be forthcoming. It was estimated, Sir William said, that a \$3,000 home would cost the purchaser \$20 a month if payment were spread over a period of 20 years.

Sudbury was the first place to pass the necessary by-law to comply with the act. Windsor and Sandwich since had taken similar action. About 20 municipalities had intimated their intention of coming under the act, and about 20 more were considering the matter.

It was expected that 60 municipalities would this year avail themselves of the machinery provided under the act.

---

## Our Immediate Responsibility

"We must not overlook the fact," states Mayor Jewett of Indianapolis, in an interview published by the Department of Labor, "that our immediate responsibility is to discharge the cost of peace." Continuing, he says:

"There is hesitation on the part of some in extending business enterprises on account of the prevailing high prices of labor and material. This is evidenced in the building industry. This line of business activity has been at a standstill for two years. A revival of building enterprises will reach into the industrial field a very great distance. It involves setting into motion the wheels of industry which manufacture and produce steel, lumber, brick, cement and all other building material and building equipment which goes into the construction of such work. This means opening up employment for thousands of men in these various manufacturing plants.

"The cost of labor and material is higher than before the war, but there is no reason to believe that these costs will be subject to a perpendicular reduction. It is more reasonable to believe that any decline in these costs will be gradual and not abrupt. The war raised greatly the plane of costs. Wages

are higher, materials are higher and living necessities are correspondingly higher. These increased costs are all relative. Therefore, a gradual reduction of the entire cost plane is to be expected rather than an abrupt decline in any line of costs. This being true, the chance of investors and builders suffering financial loss because of building at prevailing prices, is remote.

"A stimulation in the building industry and in public improvements will be of immeasurable benefit to every city. It will absorb the unemployed and keep the community in an active, healthy state. In the war business concerns felt a responsibility to the nation and the city to hold their business organizations together, even at a sacrifice. This was a part of the cost of war. Now that we have peace the same policy can be applied with the same excellent results and may well be considered as a part of the cost of peace. If we hold back and wait for low prices before we again become active, we shall defeat the very object we seek to attain. We shall lose the money we sought to save."

---

## Says Unemployment is Exaggerated

Judge Elbert H. Gary, chairman of the Board of the United States Steel Corporation, has declared as "exaggerated" the reports of unemployment in the steel industry. Speaking at a meeting of the Directors of the American Iron and Steel Institute he said that the industry is in better condition than it has been reported to be. "So far as our information goes," he said, "there is less unemployment than we would have been led to believe through some publications."

The meeting was called to consider general conditions in the steel industry, and to consider the so-called Redfield plan for the lowering of prices by an agreement among the interests in the different industries. Asked as to prices, Judge Gary said that as far as he knew they were being well maintained.

---

## Memorial to Dead U. S. Fliers

The Aero Club of America has announced plans for the erection of a monument to commemorate the American airmen who made the supreme sacrifice in the war. It is planned to place the memorial in the famous cemetery at Toul, France, where are buried Major Raoul Lufberry, Lieut. Hobey Baker, Blair Thaw, and other American aces, the plan to mark the memory of the nation's dead pilots having been suggested by Captain Eddie Rickenbacker at the Aero Club's recent annual dinner.



## Building Lime in 1918

War restrictions on the building trades greatly reduced the demand for building lime, the production of which in 1917 amounted to one-third of the total lime output, according to the United States Geological Survey. Manufacturers of building lime, except those who supplied Government contractors, reported decreases in demand ranging from 5 to 90 per cent in 1918, and some plants that supply only building lime were closed throughout the year.

A number of Government building projects, most of them in the East, had called for, or were likely to call for, lime during the last two months of the year, but some of these projects may have been abandoned after the armistice was signed on November 11. All restrictions placed by the War Industries Board on the production and transportation of lime were removed on November 12, too late to have any appreciable effect on the recovery of the industry before the end of the year. In view of these conditions it will not be surprising if building lime sold in 1918 has fallen to about 900,000 short tons, and that building lime has for the first time lost to chemical lime its lead among the lime products.

The general curtailment of building operations since the spring of 1917, however, implies that greatly increased activity is necessary to restore the country to normal conditions in this respect, and the Federal Government is already taking steps to stimulate building. Doubtless many prospective builders are inclined to wait for a decrease in costs, but although the cost of some necessary commodities and of labor may decrease slightly, the great demand for buildings will probably maintain the prices of building materials in general at a high level.

## Inscription for Lafayette's Statue

The text of the French inscription for the equestrian statue of Lafayette, to be erected in Mount Vernon Square, Baltimore, Md., has been received by Mayor Preston of that city. It was written by President Poincaré at the request of the mayor, who asked that it be in French. A translation follows:

"In 1777 Lafayette, crossing the seas with French volunteers, came to bring brotherly help to the American people who were fighting for their national liberty.

"In 1917 France was fighting, in her turn, to defend her life and the liberty of the world. America, who had never forgotten Lafayette, crossed the seas to help France, and the world was saved."

## Helping France in Reforestation

An offer to help France in its work of reforestation in the devastated regions has been made by the American Forestry Association, whose representative, Percival S. Ridsdale, is now in Paris. During his stay he will confer with the French Government foresters, and will submit his plan to aid in furnishing the seed necessary for replanting the trees in the territory where they have been destroyed by the ravages of war or cut for war purposes.

To carry out planting experiments, Mr. Ridsdale took to France with him a quantity of Douglas pine seed, all that he has been able to procure at present. French foresters have expressed a desire to obtain the seed of this variety of pine, as they believe it will be successful in certain parts of the country.

In case the offer of the American Forestry Association is accepted, a systematic effort will be made to gather all the seed needed for reforestation in France. After a meeting in Paris, Mr. Ridsdale will make a trip through the wooded regions of France, Belgium and Italy to investigate the damage in the theaters of war, as well as the quantity of wood cut in the forests behind the lines for the needs of the Allies.

## North Dakota Legalizes Home Building Plan

North Dakota has entered upon a program of state activity in industry unparalleled in its own history or in the history of any other state in the Union, by the signing by Governor Frazier of several bills which had their foundation in the Farmers' Non-Partisan League. By these bills the state will now establish and operate the North Dakota Home Builders' Association for the purpose of enabling inhabitants of the state to build and operate their own homes, to build and operate terminal grain elevators and flour mills, and to set up an industrial commission to manage these and other industries that the state may decide to embark upon under the unlimited power granted by new amendments to the state constitution.

## Co-operate With Building Campaign

Ten thousand members of the National Association of Real Estate Boards are pledged to co-operate with the own-your-own-home branch of the building campaign now being carried on by the U. S. Department of Labor. Assurance of this aid has been given by Tom S. Ingersoll, secretary

## THE AMERICAN ARCHITECT

of the association, which has lent Paul C. Murphy, the chairman of its own-your-own-home committee, to the department's information and education service for work with the public works and construction development division.

Since the first of the year the Department of Labor has been making a survey of building conditions, and the most conservative estimates place the shortage of homes in the United States as not less than half a million. In order to stimulate building construction as a means of employing returning soldiers and encouraging general business activity, the department has enlisted the aid of the banks in every state in solving one of the principal after-the-war industrial problems.

---

### Bronze Button for Discharged Soldiers

The "honorable discharge" emblem to be issued by the War Department will be a bronze lapel button somewhat similar to the G. A. R. button of like significance. It is the intention of the Government to distribute the button free of charge to all entitled to it.

Of appropriate and artistic design, the button is the result of a competition among American artists and sculptors, conducted by the Commission of Fine Arts, of which Charles Moore is chairman, and the following are members: Herbert Adams, sculptor; J. Alden Weir, painter; Charles A. Platt, William Mitchell Kendall, John Russell Pope and James L. Greenleaf, architects; and Col. C. S. Ridley, secretary. Fifteen designs were submitted by the commission for final selection by the Chief of Staff.

The buttons will be manufactured only by concerns chosen by the Government, which will furnish the dies for their manufacture and purchase the buttons, thus obviating any possible variance from the approved pattern in design, color or material.

---

### Urge Comprehensive Highway Building

In addressing a recent convention of the American Road Builders' Association, General T. Coleman du Pont spoke of the need of a comprehensive national highway system. As chairman of the Board of National Councilors of the National Highways Association, General du Pont said he had noted that the people of the United States are just waking up to the importance of good roads as the basis of national highways.

"The efficiency of the political units now in general charge of the work," said General du Pont, "as the states, towns and counties, can only be synchronized through an organization that is national, and such a Federal organization should have the power to correlate the work of political divisions to the end that hereafter we may have a system of national highways intelligently laid out and maintained in the most economical manner. If Federal aid is given to road building, regardless of whether such roads are a part of the national system of highways, it is not good political economy.

"The most essential item of road engineering is location. It is the only thing about a road that can be absolutely permanent. All Americans who got to France and beyond a port of embarkation will, I am sure, be the strongest advocates of good roads when they get home."

A resolution was presented at the meeting by E. J. Mehren suggesting the appointment of a committee from the association to lay before the Secretary of War the urgency of returning to this country at an early date a large proportion of the highway engineers now with the army in France. This resolution, as well as another one toward fixing uniform regulations for truck weights and sizes on the highways, was referred to the resolution committee for action.

---

### Placing Disabled Soldiers

Figures indicating progress in re-educating and placing disabled soldiers, sailors and marines show that the work is going forward at a satisfying pace. It has been stated that the total number of cases with which the Federal Board for vocational education was in contact was 22,851. Of these 6552 were reported from the war risk insurance bureau; 9020 from hospitals; 4494 from the Red Cross; 73 from the United States Department of Labor; 1652 from the men direct, and from other sources 1060.

Not every wounded man is entitled to retraining. First, under the law, he must have been awarded compensation by the war risk insurance bureau, and thus far 3655 have been awarded compensation, 79 having been denied it, and 19,117 are cases in process of determination.

It is necessary to have the war risk insurance bureau pass upon a case as the essential preliminary, and the agents of the Federal Board assist all disabled men to make their applications to the war risk insurance bureau. In the last thirty days 2855 men have been assisted in filing their applications. Nine thousand four hundred and twenty-five men have been interviewed by the various agents of the Federal Board and 9162 were awaiting interview.



There were 6286 prospectives for retraining. During the last month 490 cases have been awarded training and entered upon the various lines of study fitting them for useful work in the skilled trades, occupations, professions and other callings, the total available to be selected from being about 500.

---

## Naturalization for 151,449 Granted in Year

Approximately 9 per cent of the applications for naturalization made during the fiscal year of 1918 were rejected, according to the report of the Commissioner of Naturalization to the Secretary of Labor. There were 151,449 petitions granted and 12,182 denied.

Of the petitions denied, 486 were rejected on account of bad character, 1234 for ignorance of American institutions, and the largest number for any cause, 3800, for want of prosecution. The number rejected because of invalid declarations was 2303, as against 766 the year before, the large increase explained by a Supreme Court decision during the year, which makes declarations invalid after a lapse of seven years.

The number of petitions continued was 46,519, as against 31,210 in the preceding year, an increase of 50 per cent. This indicates an attitude on the part of the judges strongly supporting the aim of the bureau, acting with the public schools, to have every citizen fully equipped for citizenship duties.

---

## Hines to Address Lumber Congress

Walker D. Hines, director general of railroads, will address the American Lumber Congress to be held in Chicago April 14-15-16. It is expected that the congress will result in the formation of a national policy for the lumber industry.

---

## Eliminating Fire Hazards

The Board of Fire Examiners of the city of Ottawa, Ill., has taken its duties seriously and is doing much to eliminate fire hazard in that section. The board has secured the co-operation of school children who are reporting all dangerous conditions in their homes. Blanks for the purpose are distributed with the result that many conditions that might have escaped unchallenged are brought to light. The firemen then check up reports of hazards and the knowledge they gain of buildings as they do this is likely to be of value to them in case fire breaks out in any of them. The board is not content to have merely one report, but carries

on a follow-up system, reminding the children that new hazards may have developed since the last report and getting them to disclose new conditions that may require attention.

---

## To Hasten Canal Terminals

Construction of \$400,000 worth of terminals in New York City for canal purposes will be completed as early as possible, according to Lewis Nixon, State Superintendent of Public Works. Contracts are to be signed early in the Spring.

---

## Asks Data for Compiling War History

The Secretary of War has directed that a bulletin be published to the army to provide that officers and other persons who have been in or with the army during the war, and who are in possession of historical information of value for use in connection with the history of the war, are authorized and invited to communicate such information direct to the Chief of the Historical Branch, Army War College, Washington, D. C.

---

## Obituary

### William R. Williams

William R. Williams, architect, and one of the oldest residents of Oneida, N. Y., died at his home in that city last week. He was ninety years of age. At one time he was associated in business with the late W. I. Tillotson. He retired from active business twenty years ago, but kept up an interest in the welfare and advancement of Oneida until his death. Mr. Williams designed many prominent buildings in that section of the State.

---

### John W. Proctor

John W. Proctor, a widely known architect in the San Francisco bay cities, died last week in New Monterey, Cal. Mr. Proctor designed many buildings at Point Richmond and did all the Y. W. C. A. buildings at Asilomar, the association camp on the ocean side of Monterey peninsular, and a number of the finer homes at Pebble Beach. He was born in Nova Scotia, March 11, 1857. His widow survives him, and there are two brothers, one in Boston and one in Indiana. A sister lives in Belmont, Mass.



## City War Plans Memorial

A monument in the form of a club house is being planned in honor of the men in the service from Philadelphia's Twenty-fourth Ward. It will be fully equipped and will cost \$75,000. The proposed club house will contain a swimming pool, gymnasium, reading rooms and an auditorium, and will be used as a neighborhood civic as well as a recreation center. A prominent place will be given a tablet containing the names of the soldiers and sailors who died in the war.

## A Housing Exposition

A somewhat unusual exposition of housing will be held in Oak Park, Illinois, March 22 to 29, both inclusive.

It is planned to select a set of plans and specifications of a model house as the basis for the exposition. All material and equipment necessary to build and furnish this house adequately will be displayed in the forty booths of the exposition, arranged in sequence according to the order in which the building processes usually occur in actual building operations.

Undoubtedly an exposition of modern housing, arranged in this manner, will afford an unusual educational opportunity to the prospective home builder. Fuller particulars may be obtained by addressing Charles E. White, Jr., Director, Oak Park, Ill.

## Personals

F. J. McCabe has moved his architectural office from 303 Fifth Avenue, New York, to the City Savings Bank Building, Bridgeport, Conn.

Lauritz Lauritzen has joined William H. Gambert in the practice of architecture in New York City, the firm to be known as Gambert & Lauritzen.

Lewis Nixon of Staten Island, New York, has been named for the office of State Superintendent of Public Works by Governor Alfred E. Smith.

The removal of the architectural offices of D. C. Bennett from 1303 West Lake Street, Minneapolis, Minn., to 631-633 McKnight Building, is announced.

An architectural office has been opened by Charles S. Evans and C. C. Kirkland in the Unity Building, Tulsa, Okla. They request that manufacturers' samples and catalogs be sent them.

Henry K. Holsman, architect, has transferred his drafting room and library to 1544 East 57th Street, Chicago, but will retain his business conference office at 175 West Jackson Boulevard, Chicago.

William Pitkin, Jr., landscape architect, and Seward Hamilton Mott, associate, announce the removal of their offices from Rochester, N. Y. to the Guardian Building, Cleveland, Ohio.

The firm of Fahnestock and Raidebaugh, architects and engineers, Harrisburg, Pa., has been dissolved by mutual consent, and Mr. Fahnestock will shortly open a new office in that city to practice architecture.

Thomas Gannett Holyoke and Holyoke Davis have formed a partnership for the practice of architecture under the firm name of Holyoke & Davis, with offices at 649 Endicott Building, Saint Paul, Minn.

J. Howard Hess has opened an office for the practice of architecture in the Moorhead National Bank Building at Moorhead, N. D. For the past five years Mr. Hess has been associated in architectural and engineering work for Cass County and the State of North Dakota.

Robert C. Berlin, F. A. I. A., 19 S. La Salle Street, Chicago, has entered into a partnership with Messrs. Swern and Randall, under the firm name of Berlin, Swern & Randall, architects and engineers. Mr. Berlin has been practicing architecture in Chicago for the past thirty-five years. Perry W. Swern, formerly with Graham Burnham & Co., has been associated with Mr. Berlin for the past four years. Frank A. Randall, M. Am. Soc. C. E., has been practicing structural engineering in Chicago and New York for the past fifteen years.

## The Post-War Committee

This Committee asks advice and co-operation not only from every architect, but also from those men engaged in occupations allied to architecture and building.

Write your views to the Committee at the Octagon, Washington, D. C.

# Late News from Architectural Fields

*Special Correspondence to THE AMERICAN ARCHITECT*

## Construction Problems Discussed at Conference

Washington, D. C., March 15.—The conference of governors and mayors resulted in a clear exposition of the present industrial situation throughout the country. Although the aim of this meeting was merely to exchange views with the members of the cabinet, it doubtless had a far-reaching effect in bringing about crystallization of mere ideas and stimulating federal, state and municipal administrators to activity.

Problems of road construction, public and private building, freight revisions, unemployment, the soldier-and-the-land movement occupied the attention of the delegates to the conference. Their words did not fall upon barren soil, for the various members of the cabinet, and other federal officials sat in on the discussions and took note of protests and suggestions made by the representatives of the municipalities and states. A summary of the opinions expressed and agreed to by a majority of the delegates was embodied in resolutions adopted.

Portions of the resolutions, as adopted, follow: "There is a general feeling that freight rates on all road materials should be radically reduced. In fact, we are willing to express it as our judgment that it should be a sound public policy to make a further cut in freight rates on all building materials. Assuming that this contributes to a temporary deficit with the railroads, it would be more than offset by the compensating result of a re-established general prosperity.

"We are firmly of the belief that the National Government should create some organization to serve as a guide not only in its purchases but to those made by private enterprises, as well. Prices must change. There may be economic justification for some schedules, but not many; and if the Government, through the operation of a committee or commission, will invite industry to go forward in the work before us, revealing facts and figures upon which honest calculation can be made, it can then in any given line announce to the public what prices it finds fair and equitable.

"There seems to be a unanimity of sentiment with reference to making any readjustment in wage scales. If that is to come at all, it should be in consequence of a reduced cost of living.

"The bringing to an end of governmental contracts with private industry entailed tremendous labor, and while we are reassured by the able and illuminating statement of the Secretary of War, Mr. Baker, made to this conference, we urge the highest speed possible in formalizing these readjustments, in making prompt payment of every indebtedness certified to and in thus releasing capital for other uses. The lifting of governmental restrictions at the earliest possible moment in the conduct of these plants will be a further helpful contribution.

"It is the sense of this meeting that the Government take steps to announce its policy as soon as possible as to the disposal of the raw materials of industry now in its hands or under its control, so that the manufacturers may determine their policy under stable conditions.

"It is further suggested that communities be enabled to profit from Federal experience in the matter of working out the housing question, because as bases of industrial activities are changed in this transitional period, situations, quite as acute as they were during the war, are highly probable in the future.

"We regard with especial favor the practice which has been adopted in many parts of the country in establishing

living and suitable memorials to the heroic deeds of war. The modern conception of working out the composite result of perpetuity of sentiment and improved community utilities, educational and otherwise, has made such a strong appeal to the Conference that we recommend it as a helpful public policy."

## Reduce Freight Rates on Building Materials

Washington, D. C., March 17.—As a step toward increasing building activity throughout the country, the United States railroad administration will shortly cut down the freight rates on building materials of all descriptions from the present high level to the pre-war standards. The cut will apply not only to materials for general construction of buildings, but materials for roads as well, in the hope that private interests will seize the opportunity with the opening of spring to let contracts generally.

Such a cut would reduce the freight rates on lumber, bricks, cement and structural steel, and would consequently have a tendency to reduce the prices of these commodities, and would be an invitation to those who are contemplating building to go ahead with the work. It would also be a source of employment to a very large number of skilled mechanics.

Walter D. Hines, director general of railroads, in commenting on this situation before the conference of governors and mayors in Washington, declared: "The advances that were made in the rates effective last June to meet the conditions of increased cost growing out of the war, had borne too heavily on road building materials, and in order to encourage the program of resumption of building, there ought to be a substantial reduction in these rates. The matter is having the most careful and expeditious consideration of the Railroad Administration, and I hope very shortly—perhaps in the next week or ten days—to get final report on that matter upon the basis of which I can take definite action."

## Washington Memorial Topic of Discussion

Washington, D. C., March 15.—The type of a memorial to be erected to the soldiers and sailors of the recent war is the subject of much discussion, with Col. Robert N. Harper defending his plan of an arch of triumph, and Mrs. Henry F. Dimock favoring a George Washington memorial, to be dedicated to the men of '76 and '17.

Mrs. Dimock advocated the plan of making a building serve the purpose of both a memorial and an educational institution. In addition to a great auditorium, seating 7,000 persons, the plan of the building she advocates would include a museum, a large library and appropriate tablets and pictures of the war.

Preliminary work on the George Washington memorial has already begun, and about \$400,000 have been subscribed toward its erection, and the people of the country would gladly contribute enough to erect a \$2,500,000 structure, argued Mrs. Dimock. It is the plan to have the building a memorial to George Washington, and the two buttresses of the building dedicated to the men of '76 and '17.



## Resuming Building Activity

Washington, D. C., March 15.—Contracts awarded for building and engineering operations during the month of February amounted to approximately \$121,000,000, in the section of the country east of the Missouri and north of the Ohio rivers, as compared with \$50,731,000 in the same territory during January.

The bulk of this work was done by private individuals and corporations, a fact which the division of public works and construction development of the Department of Labor accepts as indicating that private interests rapidly are resuming building activities. During the war period a large percentage of work was carried on by the Federal government. At present, the amount of contracts awarded by the Government is negligible, and that done by states and municipalities not an unusual proportion.

By districts, the comparison of January and February contracts let is as follows:

District	Jan. 1919	Feb. 1919
New England .....	\$ 4,648,000	\$ 2,921,000
New York and North New Jersey	8,152,000	12,918,000
Philadelphia, Baltimore, Wash- ington and vicinity.....	15,805,000	8,923,500
Western Penn., W. Va. and Ohio..	7,916,000	10,893,355
Ill., Iowa, Ind., Wis., Mich., por- tions of Missouri and Kansas....	13,710,000	83,848,931
Minn., North and South Dakota...	1,330,000	500,000

## Prepare Building Stabilization Report

Newark, N. J., March 15.—A report on the stabilization of building is expected to be issued shortly by the New Jersey Society of Architects. The various elements of federal, state, and municipal control are being analyzed with the view of devising some plan to stimulate lagging construction.

"In theory this proposition is all right," said Secretary Hugh Roberts of the society, "but it is difficult to put such a plan in practice. While most people competent to judge believe that the cost of construction work will not vary much from present prices in the next three or four years, there is still a feeling on the part of the public that prices will be lower in the near future, and, therefore, there is a general tendency to delay building and other construction enterprises for the purpose of seeing how things will turn out. Some way undoubtedly will be devised to stabilize the prices of labor and material so that the public may be satisfied that their investments will be secured, and so that loaning institutions will be assured that the value of buildings erected at this time will not decrease in the near future."

The New Jersey Society was represented at the hearing in Trenton last week on the bill providing for the licensing of master builders, carpenters and masons. He added that architects were generally favorable toward the meas-

ure in the belief that it will protect the public and property owners against incompetent and dishonest construction work.

Announcement was made that the following sculptors, painters and landscape architects had been added to the society's advisory committee on war memorials: Mahonri Young of Leonia, F. G. R. Roth of Englewood, A. E. Foringer of Grantwood, William L. Mackay of Fort Lee, James L. Greenleaf and John R. Brinley of Morristown.

## New 3-Family Bill to Become Law

With every indication that the Burlingame Bill for the transformation of old-fashioned, three-story and basement dwellings into three-family houses will be passed in New York State within a short time, encouragement is held out to the many persons who have been unable to secure apartments in Brooklyn. The legislation will also be of great benefit to owners of these large residences.

Because of the present requirements of the Tenement House law, few of the hundreds of such dwellings in this borough have been altered since the passage of the Lawson bill in 1917, because of the great expense involved in meeting the requirements of the law.

Under the Burlingame amended bill, many concessions have been made by an agreement between the committee of the Brooklyn Board of Real Estate Brokers and the Tenement House Committee of the Brooklyn Board of Charities working in harmony in an effort to help the property owners and to protect the best interests of the tenants. The various defects in the earlier measure have been adjusted and all opposition being removed, the bill promises to become effective in time to relieve a situation in the real estate market which has become very serious in view of the scarcity of new apartments.

The amendments to the old bill make it possible to remodel the old residences at a cost which will permit a return on the investment.

## New York's Construction Program

Albany, N. Y., March 17.—Approximately \$20,000,000 of the \$90,000,000 it will cost New York State to administer its affairs during the next fiscal year—the largest amount in the history of the Commonwealth—will be for construction work to help take care of the unemployed.

A statement by the finance chairmen says that there will be other "large items which are more or less conjectural, but which will be appropriated this year." as follows: Hudson vehicular tunnel, \$1,000,000; necessary appropriation for difference in cost in completing abandoned highway contracts, \$2,500,000; additional amount necessary to finish canal terminals, \$900,000; allowance for other special appropriation bills, \$1,000,000. This brings the grand total to \$89,619,000, compared with a total appropriation last year of \$81,525,271.



# Department of Architectural Engineering

## Planning Sunlight Cities<sup>1</sup>

By HERBERT S. SWAN AND GEORGE W. TUTTLE, *New York*

SUNLIGHT cities must be planned from the start. The width and arrangement of streets, the length and breadth of the lot, the type, height and use of building, the least dimension and orientation of courts and yards, the latitude and the topography of the site—all of these have to be considered in laying out a sunlight town. If each of these factors is given its proper weight when the town is first planned, a maximum of sunlight will be assured every home and work-place in the community; ignored, then no amount of replanning can ever completely rectify the mistake.<sup>2</sup>

Two things are essential to a sunlight plan—a street plan and a building plan. Each of these has to be conceived and perfected in harmony with the other as one unit. They are reciprocal parts of the sunlight plan, and they therefore stand or fall together. It is impossible to give proper consideration to one without at the same time considering the demands of the other. Any other method of treatment is disastrous to the sunlight plan.

### SHADOWS CAST BY SKYSCRAPERS

The street plan and the building plan have been so poorly co-ordinated in the Borough of Manhattan, New York City, for instance, that it is safe to say that a preponderating majority of the rooms in the existing shops, factories, offices and apartments of the borough receive no direct sunshine on the shortest day in the year.

This is no less true of the residential sections than of the business sections. But the situation in the downtown financial district illustrates this condition most dramatically. There the shadows of different skyscrapers, at noon on Dec. 21, envelop large areas. The Adams Express Building, which is 424 ft. high, casts a shadow 875 ft. in length; the

Equitable Building, which is 493 ft. high, one 1018 ft. in length; the Singer Tower, which is 546 ft. high, one 1127 ft. in length, and the Woolworth Tower, which is 791 ft. high, one 1035 ft. in length.

The co-ordinates in Table I enable one to compute the ground area shaded by buildings of any height at different latitudes and times.

The effect of skyscrapers casting shadows from a sixth to a third of a mile in length on surrounding property is well illustrated in the case of the Equitable Building. The shadow, which at noon on the shortest day in the year is about one-fifth of a mile in length, completely envelops an area of 7.59 acres. The ground area of the Equitable Building is only 1.14 acres.

The shadow cuts off all sunshine from the Broadway façade of the United States Realty Building, which is twenty-one stories high. The New York Title & Mortgage Company Building, fourteen stories high, and the Washington Life Insurance Building, nineteen stories high, are both completely shaded. The south side of the Singer Tower is shaded to a height of twenty-seven stories. The nearest part of the City Investing Building, 400 ft. away, is in shadow for twenty-four of its twenty-six stories. Even part of the New York Telephone Building, north of Cortlandt Street, is shaded by the Equitable Building. For almost a fifth of a mile this giant skyscraper casts its shadow.

Cedar Street, the street immediately north of the Equitable Building, has an average width of 34 ft. between Broadway and Nassau Street. The height of the Equitable Building is 14½ times the width of this street. On a north-and-south street of this width in New York, uniformly improved on both sides with buildings having a height equal to that of the Equitable Building, and walls 14 in. thick, only 9.31 per cent of the windows would receive any direct sunshine on the shortest day in the year. On such streets only the windows nearest the top for a distance equal to 1.35 times the width

<sup>1</sup>Copyright, 1917 and 1919, by Herbert S. Swan. All rights reserved. This article was originally published in *The American City* in 1917. Since its first publication the article has been materially revised.

<sup>2</sup>See articles by Herbert S. Swan and George W. Tuttle on Sunlight Engineering in *City Planning and Housing*, *The Architectural Forum*, June, 1918; *Planning Buildings for Daylight*, *The Architectural Forum*, November, 1918; and *Report, Commission on Building Districts and Restrictions*, New York, 1916, pp. 176-188.

# THE AMERICAN ARCHITECT

of the street would admit direct sunshine on Dec. 21 at New York (taking 40° north as the latitude), assuming the windows to be set in walls 14 in. thick. The windows in the thirty-four stories nearest the ground would admit absolutely no direct sunlight. Direct sunshine would only enter those windows in the four stories nearest the top. Not a single window within 447 ft. of the street level would receive a ray of direct sunshine!

High buildings should be erected on wide streets

to impose any restrictions upon its use—there is enough for all. But in contrast with these there are other places, and these places contain the great bulk of the urban population throughout the world, which possess such a fluctuating supply of sunshine that its use must be subjected to the strictest safeguards or the supply will be squandered to no purpose.

The distance from the equator is of paramount importance in planning a sunlight city. In the first

TABLE 1.—CO-ORDINATES OF POINTS DEFINING SUNSHINE AND SHADOW ON THE GROUND LEVEL AT THE WINTER SOLSTICE

The co-ordinates in Table 1 define the ground area in shadow from obstructions at each hour and half hour throughout the day. The co-ordinates A are measured on the meridian running north and south through the obstructing point; the co-ordinates B at right angles to this meridian. Both co-ordinates are expressed in terms of the obstructing height. Before noon the co-ordinates B are laid out west of the meridian; after noon east of the meridian. The co-ordinates A as measured on the meridian are laid out north of the obstructing point.

		NORTH LATITUDE													
		25°		30°		35°		40°		45°		50°			
Time		Co-ORDINATES												Time	
		A		B		A		B		A		B			
7:00 A.M.	9.80	18.81	66.32	126.91	...	...	...	...	...	...	...	...	...	...	5:00 P.M.
7:30	3.41	5.67	4.97	8.12	8.89	14.29	37.96	60.73	...	...	...	...	...	...	4:30
8:00	2.24	3.22	2.91	4.02	3.99	5.37	6.26	8.29	13.88	18.21	...	...	...	...	4:00
8:30	1.76	2.15	2.20	2.54	2.83	3.19	3.86	4.23	5.82	6.43	12.65	13.46	...	...	3:30
9:00	1.51	1.55	1.84	1.79	2.31	2.15	2.98	2.68	4.18	3.66	6.76	5.81	...	...	3:00
9:30	1.36	1.14	1.64	1.29	2.02	1.52	2.56	1.84	3.41	2.39	4.98	3.41	...	...	2:30
10:00	1.26	.83	1.52	.94	1.85	1.09	2.31	1.29	3.01	1.63	4.19	2.22	...	...	2:00
10:30	1.20	.58	1.44	.66	1.74	.75	2.16	.89	2.78	1.11	3.79	1.46	...	...	1:30
11:00	1.16	.37	1.39	.42	1.68	.48	2.07	.56	2.63	.69	3.52	.89	...	...	1:00
11:30	1.14	.18	1.36	.20	1.64	.23	2.01	.26	2.50	.33	3.41	.43	...	...	12:30
12:00 M.	1.13	.00	1.35	.00	1.62	.00	2.00	.00	2.53	.00	3.35	.00	...	...	12:00 M.

The following formulae were used in computing the co-ordinates:

Let *A* = co-ordinate of shadow point on a horizontal surface measured directly north from point casting shadow.

Let *B* = co-ordinate of shadow point on a horizontal surface measured directly east or west (according as the position of the sun is west or east of the meridian) from point casting shadow.

Let *h* = height of point casting shadow above the given horizontal surface.

Let *a* = azimuth of sun.

Let *b* = altitude of sun

then:

$$A = h \cos a \cot b$$

$$B = h \sin a \cot b$$

The method of applying the co-ordinates in a specific case is illustrated in Diagram 1. The building in the illustration is situated at 40° North Latitude and is 100 feet high. The time for which the shadow is determined is 10 A.M. In the diagram the co-ordinates are measured with reference to the meridian projected through point C. Parallel lines of the same length as CF projected through D and E enable the ground area shaded by the building to be defined.

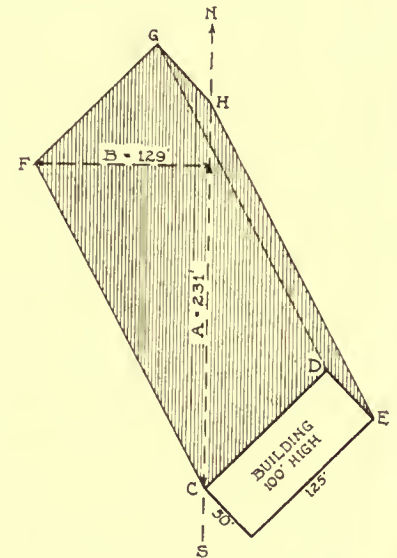

Diagram 1. Method of defining the ground area shaded by a building, 40° north latitude, time 10 a. m., building 100 ft. high.

$A = 2.31 \times 100 = 231$  ft.

$B = 1.29 \times 100 = 129$  ft.

Area shaded by building = CFGHEDC.

and large open spaces; narrow streets and small open spaces should be improved with low buildings. But although the height limit of a building should be proportionate to the width of the open space on each side from which it receives its sunlight, it does not at all follow that this proportion should be the same on all sides of the open space nor at all latitudes.

### EFFECT OF LATITUDE

The further north a city is situated the greater is its need for a sunlight plan. Sunlight is a natural resource to be conserved and economized like any other gift of nature. There are places on the earth's surface where the supply of sunshine is so constant that there is probably very little necessity

place, the length of the shortest day diminishes as the latitude increases. The sunlight period at Key West on Dec. 21 is only seven-eighths as long as that at the equator. At Winnipeg it is only two-thirds as long as that at the equator. In the second place, the sun's altitude diminishes with increased distance from the equator. At Winnipeg the altitude of the sun at noon at the winter solstice is only 16.6°. At the equator it is 66.6°.

The effect of this difference in altitude in the sun-lighting of streets and buildings at different latitudes is apparent. With each additional degree of latitude from the equator, to obtain the same amount of sunlight, assuming that it could be obtained, the height of building would have to be decreased or the width of street increased.

To illustrate: Suppose that the height of build-



# THE AMERICAN ARCHITECT

ings on the south side of east-and-west streets of a given width were limited on the principle that the sun's rays would shine for just one moment at the ground level on the opposite side of the street. On this basis buildings at Winnipeg could only be three-tenths the street width in height, while at the equator they could be 2.31 times the street width in height. In lieu of varying the height of the buildings, the above principle could be observed by varying the street width with the latitude. In that event the width of the street at the equator need be only 0.43 times the height of the building, while at Winnipeg it would have to be 3.33 times the height of the building. The street width required at Winnipeg would be 7.7 times that required at the equator.

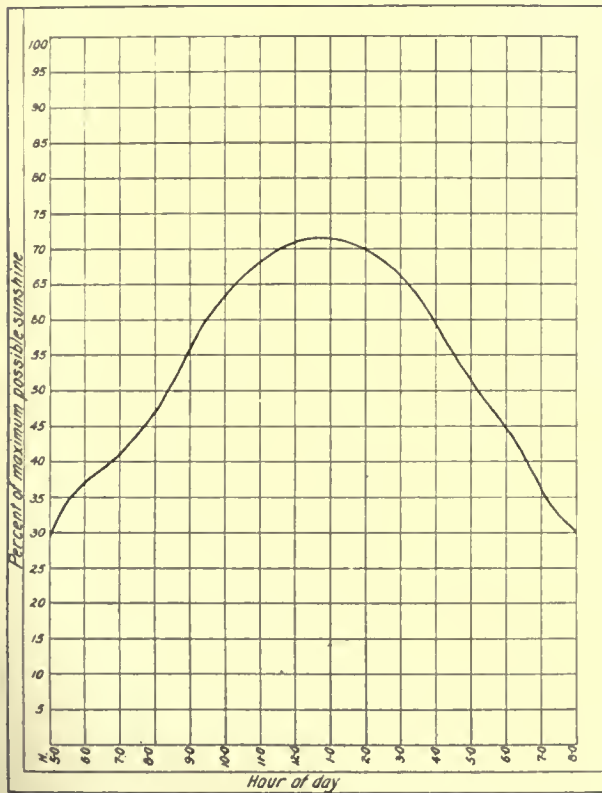

Diagram 2. Hourly percent of maximum possible sunshine in New York, average 1894-1910.

But even this does not tell the whole story. Meteorological observations show that the per cent of the actual to the maximum possible sunshine at any particular place increases generally with the altitude of the sun.<sup>1</sup> This is not only true of different months in the year, but of different hours of

<sup>1</sup>The sunshine observations at New York from 1894 to 1910 show that the per cent of actual to possible sunshine for any hour of the day is almost exactly proportional to the sine of the altitude of the sun. The corresponding per cent of actual to possible sunshine lags, however, about 43 minutes after the sun.

the day. Just as the per cent of the actual to the maximum possible sunshine increases after the winter solstice and decreases after the summer solstice, so it increases from sunrise until noon and decreases after noon until sunset (see Diagram 2).

The intensity of sunshine is no less intimately connected with the altitude of the sun than the per cent of sunshine.<sup>1</sup> It, too, varies throughout the

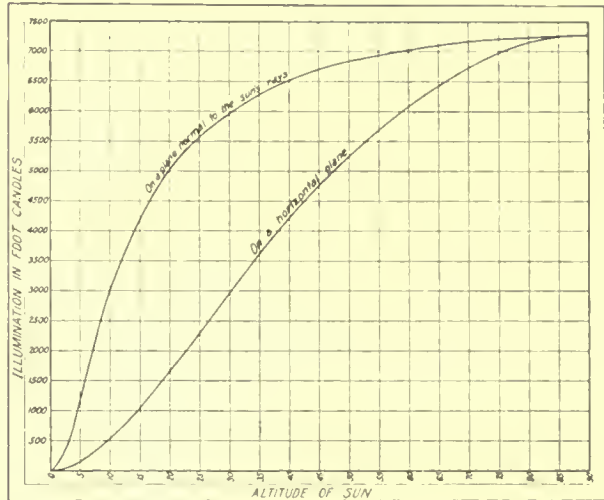

Diagram 3. Solar illumination on a clear day at sea level.

day and the year, increasing with the altitude of the sun and attaining a maximum when the sun is in the zenith (see Diagram 3). The intensity of

<sup>1</sup>The curves herewith shown were obtained by plotting observations of illumination of the sun on clear days which were made at Mount Weather, Va., in 1913 and 1914, by Herbert H. Kimball, Professor of Meteorology, U. S. Weather Bureau (Daylight Illumination and the Intensity and Duration of Twilight, Transactions, Illuminating Engineering Society, 1916). The solar rays are absorbed by the earth's atmosphere, and the illumination at any point depends on the mass of the atmosphere through which the rays have traveled. The air mass diminishes, and consequently the solar illumination increases with the height and with the altitude of the sun. The observations followed the theoretical law that the logarithm of the illumination should increase by equal amounts when the air mass through which the sun is seen is reduced by correspondingly equal amounts very closely. The air mass for points at the same height varies inversely as the sine of the altitude of the sun and we find that the following formula fits the observations:

$$\text{Log } I = 3.9478 - \frac{.0863}{\sin h}$$

Where  $I$  = the illumination from the sun in foot candles on a plane normal to its rays, and  $h$  = the altitude of the sun.

The illumination from the sun in foot candles on a horizontal plane which we will represent by  $I_h$  equals the illumination on the normal plane multiplied by the sine of the altitude of the sun, we have therefore

$$\text{Log } I_h = 3.9478 - \frac{.0863}{\sin h} + \log \sin h$$

The illumination of the sun in foot candles on a vertical plane at an azimuth of  $X_0$  from the azimuth of the sun which we will represent by  $I_v$  is given by the equation

$$\text{Log } I_v = 3.9478 - \frac{.0863}{\sin h} + \log \cos h + \log \sin X_0$$

The curves drawn differ slightly from the formula at very small altitudes as the air mass at the horizon departs from the sine law by a small amount. The intensity of sunlight is not necessarily the same in all parts of the world for the same height and altitude of the sun, since variations in atmospheric conditions may cause considerable variations in intensity of illumination. It is believed, however, that these curves will fairly represent the solar illumination anywhere under normal atmospheric conditions.



the sunshine received on any particular plane, however, depends upon the incidence of the sun's rays (see Diagrams 4 and 5). This occasionally results in surprising paradoxes. At this latitude we are so accustomed to obtaining the strongest illumination

Here, then, is a unique situation where the sunshine is most intense, not on a wall facing south, but on one facing east or west. This condition, however, applies only to the tropics. At all other latitudes the illumination obtained on a south wall is more intense than that received on any other wall.<sup>1</sup>

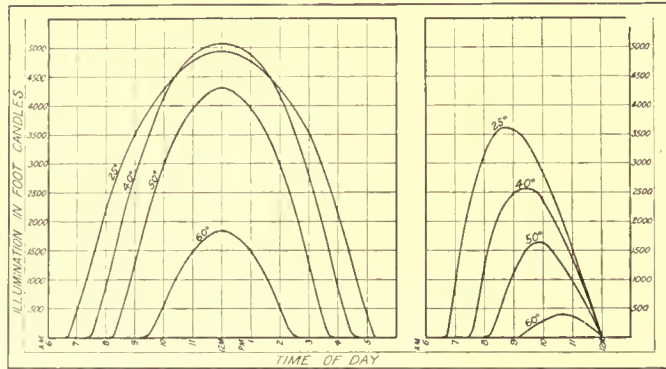

On vertical wall facing south. On vertical wall facing east.  
Diagram 4. Solar illumination at winter solstice for different latitudes and times of day.

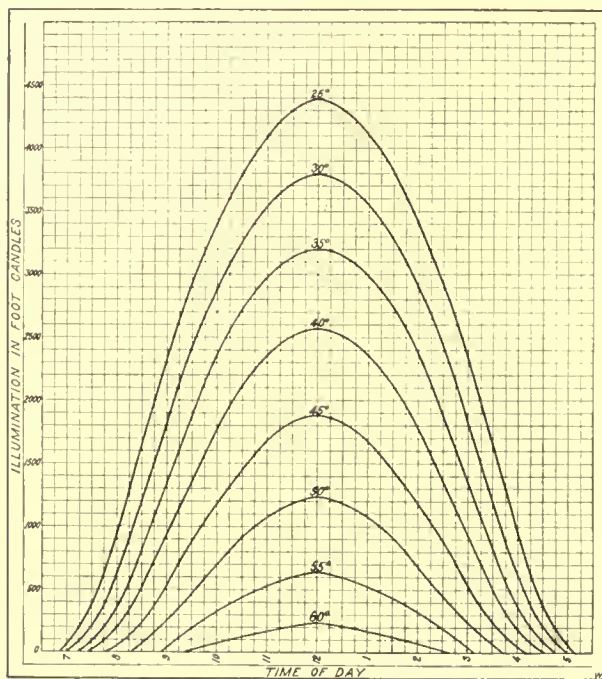

Diagram 5. Solar illumination on a horizontal surface at different latitudes, winter solstice.

on a wall facing south that we are apt to assume this to be universally true. But as we approach the equator the solar illumination received on a south wall diminishes below a certain latitude, due to the sharper angle of the rays, until, at the time of the equinox, it finally touches zero at the equator.

ORIENTATION OF STREETS

The orientation of streets counts for quite as much as the latitude of the locality and the height of buildings in planning a sunlight town. A little sunlight engineering in city planning can to a large extent overcome the two natural disadvantages of a northern latitude in winter—the shortness of the day and the low altitude of the sun. The fact that a sunlight plan can be designed for Winnipeg which will give the front of every house at the ground level more sunshine than a non-sunlight plan will at Key West, demonstrates this conclusively. Indeed, astonishing as it may seem, the very same buildings in solid rows, which, if arranged along the lines of a non-sunlight plan at Key West, would rob the pavement in front of every house of all sunlight, can be arranged at Winnipeg in such a

<sup>1</sup>Compare the intensity of sunlight with that of daylight, the former being defined as the illumination received solely from the sun, the latter as the illumination received from the whole visible sphere of the sky exclusive of that obtained directly from the sun (see Diagrams 6 and 7).

The illumination received from the sky is derived from the sun and appears to be due in the main to the reflection and dispersion of sunlight by fine particles in the atmosphere. It varies in intensity with the altitude of the sun. Enormous variations have been frequently noticed within short periods, and it is extremely difficult to obtain concordant results. It is found that in general the sky at various altitudes gives substantially the same illumination as in the zenith, although patches of white clouds may increase the illumination very much in a given spot. A clear blue sky as well as heavy dense clouds show the least, while a sky with white clouds will give the greatest illumination, the light from a white cloud being often many times the light for a similar area of clear sky.

Observations of skylight or daylight on clear days taken at Mount Weather, Va., in 1913 and 1914, by Herbert H. Kimball, Professor of Meteorology, U. S. Weather Bureau (Daylight Illumination and the Intensity and Duration of Twilight, Transactions, Illuminating Engineering Society, 1916), while not so concordant as the solar observations alluded to, are fairly represented by the following formula:

$$S_h = 2058 \sin h + 96$$

where

$S_h$  = daylight illumination from the entire sky on a horizontal surface in foot candles, the illumination on a vertical surface being half this quantity

and  $h$  = altitude of the sun.

These observations agreed very well with other observations with which they were compared up to about 35° and were somewhat less at higher altitudes.

It is hoped that future observations will enable much more accurate determination of the skylight illumination for any locality at any time under any specified condition. The daylight illumination has been computed, however, according to the above formula for different latitudes in the belief that it will represent approximately the daylight illumination in those latitudes.

Professor O. H. Basquin (Daylight Illumination, The Illuminating Engineer, N. Y., Vol. 1 and 2, 1906 and 1907) found at Chicago an average sky brightness throughout the year during business hours of 500 candles per unit of area of enclosing sphere of radius unity which give 1571 ft. candles on an unobstructed horizontal plane, and he considered a brightness of 250 candles the proper working quantity under different conditions as follows:

Clear blue .....	100 per cent
Stormy .....	66 per cent
More than half blue .....	133 per cent
More than half cloudy .....	166 per cent
Overcast .....	200 per cent

# THE AMERICAN ARCHITECT

manner as to give the street in front of every house more than an hour of sunshine. In each case the buildings would be once the width of the street in height, but in the southern city they would all front on east-and-west streets, while in the northern city they would all front on north-and-south streets.

The sunshine period enjoyed by buildings at the ground level of the street façade is shown in such a way in Table II that it may be readily compared for buildings of different heights, streets of different orientations, and places of different latitude as of the winter solstice.<sup>1</sup>

The number of days that the north façade of an east-and-west street is shaded at the street level depends upon the latitude and the height of the buildings. Buildings once the street width in height at Key West cut off all sunlight for 61 days in the year; at Winnipeg for 182 days. In very few cities of the United States does the sun penetrate down to the sidewalks on east-and-west streets in the skyscraper district for more than half the year. The alleys and yards back of such buildings are

The number of days in the year that the north façade on east-and-west streets improved with buildings of different heights receives absolutely no sunlight at the ground level is as follows for different latitudes:

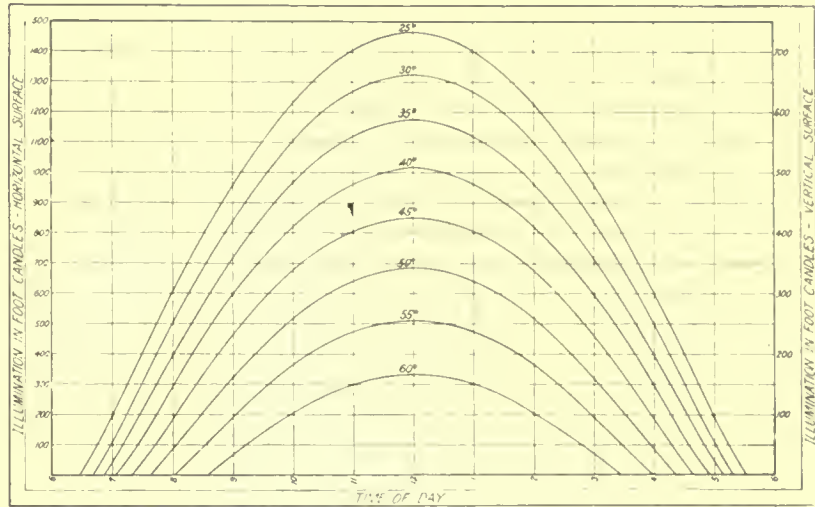

Diagram 7. Daylight illumination received at different latitudes, winter solstice.

Height of building in terms of street width	North Latitude						
	25°	30°	35°	40°	45°	50°	55° 60°
1/2	0	0	0	0	73	108	136 163
1	61	98	127	153	181	182	182 182
1 1/2	135	161	182	182	182	182	182 182
2	172	182	182	182	182	182	182 182
2 1/2 and over	182	182	182	182	182	182	182 182

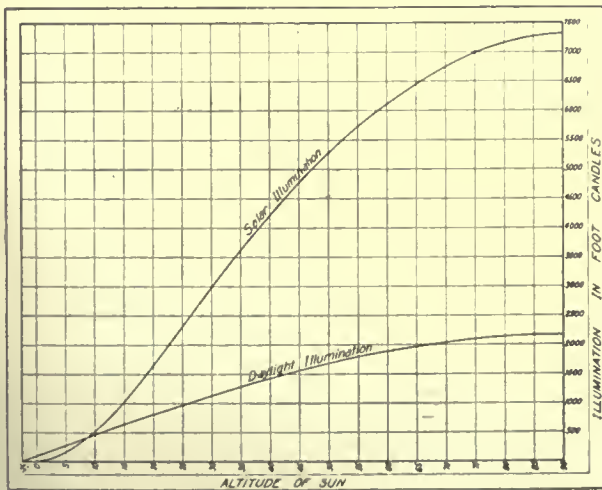

Diagram 6. Solar and daylight illumination for different altitudes of the sun.

often so narrow as to shut out all the noon-day sunlight throughout the year at the ground level.

<sup>1</sup>For method used in computing this table see note at end of article.

The street system of Manhattan (40° 45' north latitude) is an excellent illustration of what a sunlight plan should not be. The blocks, in brief, are 200 ft. wide and as much as 920 ft. long, the narrow dimension being oriented 28° 30' west of south and the long dimension 61° 30' east of south. This arrangement is most unsatisfactory. Where a block of the above dimension is uniformly improved with buildings once the street width in height, a height which allows the construction of a six-story tenement house, only the two ends near the avenues receive any sunlight at all at the ground level on the shortest day in the year. In other words, the tenement houses fronting on the streets embracing 82 per cent of the total block frontage receive no sunlight at the ground except near the ends of the block, due to the avenues. If the long side of the blocks paralleled the avenues instead of the streets in Manhattan, the situation would be very much improved. But 18 per cent of the frontage would then be in shadow at the ground level. Sunlight homes and sunlight streets would then be given to an additional 64 per cent of the population. The effect of this increase in sunlight on individual



# THE AMERICAN ARCHITECT

initiative and vigor, on public health, on sanitation, on the prevention of contagious disease, on snow removal and on traffic conditions can be imagined.

## MINIMUM STANDARDS OF SUNLIGHT

In a sunlight plan, minimum standards of sunlight will be established for the interior of rooms and for every street and yard as on the shortest day of the year. This standard of sunlight may be fifteen minutes, a half hour, an hour, or two hours, according to the requirements of the particular locality, but in each case the height of building, whatever it may be, will be regulated with reference to the width of the street and yard space in such a manner as to secure this minimum amount of sunlight.

Either the height of building, or the width of streets and yards, will at any given latitude be made to vary according to orientation in order to meet the requirements of this standard. At Philadelphia, for example, to obtain fifteen minutes of sunlight on either side of a north-and-south street at the ground level, the height of building may be 7.5 times the street width. But to obtain the same amount of sunlight on the north side of an east-and-west street the height of the buildings on the south side may not exceed one-half the street width.

The height to which buildings fronting on streets of different orientation may be erected at different latitudes in order to obtain minimum periods of sunshine at the ground level is indicated in Table III.<sup>1</sup>

### ARRANGEMENT OF BUILDINGS

In the winter season no sunlight can, of course, be obtained on the south side of an east-and-west street. No adjust-

<sup>1</sup>For method used in computing this table see note at end of article.

**TABLE II—SUNSHINE PERIOD AT GROUND LEVEL OF STREET FACADE**

(For different latitudes and for each side of streets oriented in different directions and improved with buildings of different heights. Winter solstice.)

Table II shows the sunshine period at the ground level of the street facade. It is given for different latitudes and for each side of streets oriented in different directions and improved with buildings of different heights. The figures in the body of the table give the sunshine period in hours and minutes on the side of the street indicated at the top or bottom of the columns as the case may be, and for the orientation there indicated, when the height of buildings on opposite side of street in terms of street width is given at the left. The table also shows the sunlight period at any distance below the top of the building given in the left-hand column. The table has been worked out for every five degrees from 25° north latitude to 60° north latitude, inclusive. These latitudes include all of the United States and Canada, Cities near or at the different latitudes are: 25°, Key West; 30°, New Orleans; 35°, Memphis; 40°, Philadelphia; 45°, Minneapolis; 50°, Winnipeg; 55°, Prince Rupert, British Columbia; and 60°, Mt. Elias, Alaska. The table includes north-and-south streets and those oriented every 15° west and east of south to and including east-and-west streets. The height used is in each instance a multiple of the street width, this multiple varying from one-half times the street width to six times the street width, the higher multiples being worked out primarily for alleys and rear yards. Both streets and alleys are assumed to be open at either end for an indefinite distance.

The sunshine period given in this table is that received by the street facade at a given distance below the top of the buildings on the opposite side of the street. The time that sunshine enters a window at any particular height is, of course, less than the time that it falls on the facade. The number of minutes of sunshine received by the facade cut off from entering a standard window by an 8-inch wall is indicated in the last line of the table for each latitude.\* For a wall thicker than 8 inches the amount of sunshine cut off from the window would be greater than that stated in the table.

Height of Building Times Street Width	ORIENTATION OF STREET													
	SOUTH		15° W.		30° W.		45° W.		60° W.		75° W.		WEST	
	SIDE OF STREET													
	E.	W.	E.	W.	E.	W.	S.	N.	S.	N.	S.	N.	S.	N.
TIME IN HOURS AND MINUTES														
	H M	H M	H M	H M	H M	H M	H M	H M	H M	H M	H M	H M	H M	H M
<b>25° NORTH LATITUDE</b>														
1/2	3 24	3 24	2 58	3 54	2 24	4 38	1 40	5 46	0 30	7 25	...	8 04	...	8 08
1	2 18	2 18	2 06	2 32	1 45	3 00	1 18	3 39	0 21	4 39	...	0 34	...	...
1 1/2	1 42	1 42	1 38	1 43	1 22	2 08	1 03	2 27	0 18	2 38	...	...	...	...
2	1 23	1 23	1 19	1 30	1 06	1 36	0 50	2 00	0 16	1 30	...	...	...	...
2 1/2	1 06	1 06	0 58	1 11	0 53	1 20	0 48	1 23	0 14	1 08	...	...	...	...
3	0 53	0 53	0 53	0 56	0 48	1 03	0 40	1 02	0 13	0 37	...	...	...	...
4	0 44	0 44	0 39	0 42	0 36	0 46	0 32	0 46	0 11	0 21	...	...	...	...
5	0 33	0 33	0 33	0 34	0 29	0 36	0 26	0 34	0 10	0 18	...	...	...	...
6	0 31	0 31	0 28	0 29	0 25	0 30	0 21	0 29	0 09	0 11	...	...	...	...
Deduct for windows	41	41	46	41	56	47	1 22	59	†	1 28	...	...	...	...
<b>30° NORTH LATITUDE</b>														
1/2	3 10	3 10	2 41	3 44	2 07	4 24	1 24	5 31	0 18	7 07	...	6 54	...	6 28
1	2 07	2 07	1 51	2 24	1 28	2 45	1 20	3 16	0 12	3 46	...	...	...	...
1 1/2	1 34	1 34	1 24	1 41	1 10	1 52	0 50	2 05	0 10	1 37	...	...	...	...
2	1 16	1 16	1 06	1 18	0 57	1 26	0 43	1 29	0 08	0 48	...	...	...	...
2 1/2	0 58	0 58	0 55	1 03	0 51	1 07	0 37	1 05	0 06	0 35	...	...	...	...
3	0 44	0 44	0 47	0 49	0 39	0 44	0 33	0 50	0 06	0 15	...	...	...	...
4	0 36	0 36	0 34	0 36	0 33	0 39	0 27	0 36	0 05	0 09	...	...	...	...
5	0 31	0 31	0 29	0 30	0 25	0 32	0 25	0 27	0 05	0 08	...	...	...	...
6	0 25	0 25	0 23	0 26	0 21	0 26	0 19	0 23	0 05	0 06	...	...	...	...
Deduct for windows	43	43	49	43	57	49	1 20	59	†	1 23	...	...	...	...
<b>35° NORTH LATITUDE</b>														
1/2	2 52	2 52	2 25	3 30	1 51	4 07	1 08	5 04	0 06	6 35	...	5 36	...	4 50
1	1 52	1 52	1 38	2 08	1 20	2 28	0 50	2 44	0 05	2 23	...	...	...	...
1 1/2	1 23	1 23	1 11	1 32	1 00	1 40	0 41	1 40	0 04	0 30	...	...	...	...
2	1 10	1 10	1 07	1 10	0 47	1 13	0 35	1 06	0 04	0 10	...	...	...	...
2 1/2	0 53	0 53	0 45	0 55	0 43	0 55	0 30	0 50	0 04	0 07	...	...	...	...
3	0 39	0 39	0 40	0 44	0 36	0 45	0 22	0 39	...	0 03	...	...	...	...
4	0 32	0 32	0 30	0 34	0 28	0 33	0 19	0 28	...	0 02	...	...	...	...
5	0 25	0 25	0 24	0 28	0 22	0 25	0 16	0 21	...	0 02	...	...	...	...
6	0 21	0 21	0 21	0 22	0 19	0 22	0 14	0 18	...	0 01	...	...	...	...
Deduct for windows	45	45	50	46	58	51	†	60	†	1 16	...	...	...	...
<b>40° NORTH LATITUDE</b>														
1/2	2 37	2 37	2 04	3 07	1 33	3 45	0 50	4 32	...	5 10	...	3 06	...	...
1	1 40	1 40	1 25	1 52	1 04	2 04	0 38	2 04	...	...	...	...	...	...
1 1/2	1 10	1 10	1 00	1 20	0 50	1 20	0 28	1 08	...	...	...	...	...	...
2	1 00	1 00	0 50	0 59	0 44	1 00	0 25	0 46	...	...	...	...	...	...
2 1/2	0 44	0 44	0 41	0 48	0 35	0 47	0 23	0 35	...	...	...	...	...	...
3	0 32	0 32	0 35	0 39	0 28	0 34	0 18	0 27	...	...	...	...	...	...
4	0 27	0 27	0 25	0 28	0 22	0 26	0 14	0 18	...	...	...	...	...	...
5	0 21	0 21	0 21	0 24	0 18	0 21	0 12	0 15	...	...	...	...	...	...
6	0 18	0 18	0 18	0 19	0 15	0 17	0 11	0 12	...	...	...	...	...	...
Deduct for windows	48	48	52	48	58	53	†	60	...	59	...	...	...	...



# THE AMERICAN ARCHITECT

45° NORTH LATITUDE

1/2	2 18	2 18	1 48	2 44	1 15	3 13	0 35	3 45	...	2 50	...	...	...	...
1	1 24	1 24	1 10	1 34	0 48	1 40	0 24	1 24	...	...	...	...	...	...
1 1/2	0 58	0 58	0 50	1 03	0 38	1 02	0 21	0 48	...	...	...	...	...	...
2	0 49	0 49	0 43	0 48	0 32	0 46	0 16	0 32	...	...	...	...	...	...
2 1/2	0 38	0 38	0 33	0 40	0 25	0 37	0 13	0 24	...	...	...	...	...	...
3	0 30	0 30	0 27	0 31	0 22	0 27	0 11	0 17	...	...	...	...	...	...
4	0 24	0 24	0 19	0 22	0 17	0 20	0 09	0 12	...	...	...	...	...	...
5	0 18	0 18	0 16	0 19	0 13	0 17	0 08	0 09	...	...	...	...	...	...
6	0 16	0 16	0 14	0 16	0 12	0 14	0 07	0 08	...	...	...	...	...	...
Deduct for windows	50	50	54	50	59	54	†	1 01	...	...	...	...	...	...

50° NORTH LATITUDE

1/2	1 52	1 52	1 27	2 14	0 55	2 36	0 22	2 39	...	...	...	...	...	...
1	1 06	1 06	0 52	1 13	0 36	1 10	0 15	0 36	...	...	...	...	...	...
1 1/2	0 47	0 47	0 38	0 47	0 28	0 50	0 10	0 21	...	...	...	...	...	...
2	0 41	0 41	0 30	0 38	0 23	0 40	0 08	0 15	...	...	...	...	...	...
2 1/2	0 30	0 30	0 24	0 26	0 20	0 30	0 07	0 13	...	...	...	...	...	...
3	0 23	0 23	0 21	0 23	0 15	0 19	0 06	0 08	...	...	...	...	...	...
4	0 19	0 19	0 15	0 16	0 12	0 14	0 05	0 06	...	...	...	...	...	...
5	0 15	0 15	0 13	0 14	0 10	0 12	0 04	0 05	...	...	...	...	...	...
6	0 13	0 13	0 11	0 12	0 08	0 09	0 03	0 04	...	...	...	...	...	...
Deduct for windows	51	51	55	53	†	55	†	1 01	...	...	...	...	...	...

55° NORTH LATITUDE

1/2	1 25	1 25	1 04	1 40	0 36	1 45	0 05	0 54	...	...	...	...	...	...
1	0 48	0 48	0 38	0 51	0 23	0 44	0 03	0 09	...	...	...	...	...	...
1 1/2	0 32	0 32	0 27	0 34	0 17	0 27	0 02	0 05	...	...	...	...	...	...
2	0 25	0 25	0 21	0 25	0 14	0 20	0 02	0 04	...	...	...	...	...	...
2 1/2	0 20	0 20	0 17	0 19	0 11	0 15	0 02	0 03	...	...	...	...	...	...
3	0 17	0 17	0 14	0 16	0 09	0 12	0 01	0 02	...	...	...	...	...	...
4	0 14	0 14	0 11	0 12	0 07	0 09	0 01	0 02	...	...	...	...	...	...
5	0 11	0 11	0 09	0 09	0 06	0 07	0 01	0 01	...	...	...	...	...	...
6	0 08	0 08	0 07	0 08	0 05	0 06	0 01	0 01	...	...	...	...	...	...
Deduct for windows	53	53	55	53	†	55	†	†	...	...	...	...	...	...

60° NORTH LATITUDE

1/2	0 53	0 53	0 37	0 59	0 15	0 43	...	...	...	...	...	...	...	...
1	0 28	0 28	0 21	0 28	0 09	0 16	...	...	...	...	...	...	...	...
1 1/2	0 20	0 20	0 15	0 19	0 06	0 10	...	...	...	...	...	...	...	...
2	0 15	0 15	0 11	0 14	0 05	0 07	...	...	...	...	...	...	...	...
2 1/2	0 12	0 12	0 09	0 11	0 04	0 06	...	...	...	...	...	...	...	...
3	0 10	0 10	0 07	0 09	0 03	0 05	...	...	...	...	...	...	...	...
4	0 08	0 08	0 06	0 07	0 02	0 04	...	...	...	...	...	...	...	...
5	0 06	0 06	0 05	0 06	0 02	0 03	...	...	...	...	...	...	...	...
6	0 05	0 05	0 04	0 05	0 01	0 02	...	...	...	...	...	...	...	...
Deduct for windows	†	†	†	54	†	†	...	...	...	...	...	...	...	...

Side of Street	W.	E.	W.	E.	W.	E.	S.	N.	S.	N.	S.	N.	S.	N.
	W.		E.		W.		E.		S.		N.		E.	
Orientation of Street	South		15° E.		30° E.		45° E.		60° E.		75° E.		East	

\*The standard window considered in this paper is one with a glass surface 32 inches wide and 61 1/2 inches high, the opening between the stop beads being 36 by 66 inches.

†Entire time.

ment in the height of buildings or in the street width can sunlight rooms having a northerly exposure. The remedy in such a case would be to require the rooms to have windows exposed toward one of the other three points of the compass. This can readily be done in detached houses, but it is very difficult in attached houses. This condition suggests the advisability of reserving east-and-west streets for detached houses. North-and-south streets, on the other hand, may be developed with either attached or detached houses.

In thickly built communities where it is impossible for all windows to have a southern exposure, buildings should generally be arranged in such a manner that the narrow dimension is oriented east and west and the long dimension north and south,

so that the greater length may receive sunlight on both faces.

Compliance with these principles would favor streets of a north-and-south orientation for attached houses. In the case of detached houses the orientation of the street is not so important, an east-and-west street in some respects being superior to a north-and-south street. For a detached-house district an east-and-west street has this decided advantage—the narrow dimension of the lot may front the street; on a north-and-south street the length of the lot would have to front the street. The requisite sunlight for detached houses of a villa type can, in other words, be purchased more cheaply on an east-and-west street than on a north-and-south street.

The undesirability of fronting attached buildings on east-and-west streets can scarcely be over-emphasized. The south side of such streets receives no sunlight whatever during the winter and very little during the summer. On the north side of the street no sunlight is obtained at the ground level except near the ends of the block, if the elevation of the building on the opposite side of the street exceeds the altitude of the sun at noon at that latitude. In other words, the pavement on the north side of an east-and-west street at the

winter solstice will be in shadow north of the latitudes given for different building heights as follows:

- 1/2 times width of street, latitude 39° 59' north;
- 1 times width of street, latitude 21° 33' north;
- 1 1/2 times width of street, latitude 10° 14' north;
- 2 times width of street, latitude 3° 07' north;
- 2 1/2 times width of street, latitude 1° 39' south;
- 3 times width of street, latitude 5° 00' south;
- 4 times width of street, latitude 9° 21' south;
- 5 times width of street, latitude 12° 09' south;
- 6 times width of street, latitude 13° 59' south.

Attached houses should, as a general rule, front on streets oriented north and south. This arrangement not only provides them with the maximum

# THE AMERICAN ARCHITECT

amount of sunlight, but it also secures the most intensive utilization of the land. Such buildings situated on streets oriented at an angle east or west of south, assuming a uniform height limit on both sides of the street, obtain a very uneven amount of sunlight, one side enjoying a superabundance at the expense of the other. No matter what the latitude, the height of building, or the street orientation, one side always receives less sunlight than would be the case on a north-and-south street. With buildings of an excessive height, and particularly at high latitudes, this would not only be true of one side, but of both sides.

To limit the height of buildings differently on the two sides of the street in proportion to the sunlight coefficient of each side would result in entirely different types of development on the two opposite sides of the street. To apply the sunlight coefficient, on the other hand, to the street width so that buildings of the same height could be erected on either side of the street and each side enjoy its minimum standard of sunlight would have the result in many instances of giving the street an absurd width. Either of these expedients is obviously not so satisfactory as a north-and-south orientation of streets with a uniform building height on both sides of the street.

There must be economy in the utilization of land as well as in sunlight. Where there is a conflict between the two there is little doubt as to the side the owner of land ripe for urban development will champion. Fortunately, in this case the interests of the owners harmonize with those of sunlight planning. A north-and-south orientation of streets for this type of building not only results in the fullest utilization of land, but it also secures the best distribution of

TABLE III—MAXIMUM HEIGHT LIMITS FOR DIFFERENT PERIODS OF SUNSHINE

The table shows the uniform height to which buildings fronting on streets of different orientations may be erected at different latitudes in order to obtain given periods of sunlight at the ground level or at the same distance from the top of the building on the opposite side of the street on the shortest day in the year. The figures in the body of the table give the approximate height limit of buildings in terms of the street width on the side of the street indicated at the top or bottom of the column as the case may be and for the orientation there indicated which will permit the period of sunshine given at the left, on the opposite side of the street. This height limit has been calculated by fifteen-minute periods from a quarter of an hour to two hours of sunlight. The maximum height to which buildings may be erected so as to allow a given minimum period of sunlight at the ground on the opposite side of the street is represented as a coefficient or multiple of the street width. To ascertain the height limit permitting the desired amount of sunlight, it is, therefore, only necessary to multiply the street width by the coefficient for the given condition in Table III. To ascertain the street width required to furnish a building of a given height a certain period of sunlight at the ground level, it is only necessary to divide the height of the building by the appropriate coefficient for the period of sunlight required, as given in Table III. The quotient will be the allowable width of street. The height of building in this table is in each case given only to the nearest tenth of the street width. This fact explains apparent discrepancies between Table II and Table III.

Minutes of Sunshine		ORIENTATION OF STREET															
		SOUTH		15° W.		30° W.		45° W.		60° W.		75° W.		WEST			
		SIDE OF STREET															
		W.	E.	W.	E.	W.	E.	N.	S.	N.	S.	N.	S.	N.	S.		
Height of Building in Terms of Street Width																	
25° NORTH LATITUDE																	
15	11.1	11.1	10.1	11.8	9.8	12.5	9.3	10.3	4.3	8.4	...	1.0	...	...	...	.9	
30	5.5	5.5	5.3	5.6	5.0	5.9	4.2	5.6	0.3	3.5	...	1.0	...	...	...	.9	
45	3.6	3.6	3.4	3.8	3.0	4.4	2.5	3.9	...	2.8	...	1.0	...	...	...	.9	
60	2.7	2.7	2.6	2.8	2.1	3.1	1.6	3.1	...	2.4	...	1.0	...	...	...	.9	
75	2.1	2.1	1.9	2.3	1.6	2.5	1.1	2.6	...	2.1	...	1.0	...	...	...	.9	
90	1.7	1.7	1.5	1.9	1.2	2.1	.7	2.2	...	1.9	...	1.0	...	...	...	.9	
105	1.4	1.4	1.3	1.6	1.0	1.8	.4	2.0	...	1.8	...	1.0	...	...	...	.9	
120	1.3	1.3	1.0	1.4	.7	1.6	.2	1.8	...	1.7	...	1.0	...	...	...	.9	
30° NORTH LATITUDE																	
15	9.9	9.9	9.7	10.3	9.1	10.9	7.5	8.6	...	4	3.1	...	.8	...	...	.7	
30	5.2	5.2	4.8	5.2	4.2	5.3	3.2	4.5	...	2.2	...	...	.8	...	...	.7	
45	3.2	3.2	3.1	3.5	2.6	3.6	1.8	3.3	...	1.9	...	...	.8	...	...	.7	
60	2.4	2.4	2.2	2.6	1.8	2.7	1.1	2.6	...	1.7	...	...	.8	...	...	.7	
75	1.9	1.9	1.8	2.1	1.4	2.2	.7	2.1	...	1.6	...	...	.8	...	...	.7	
90	1.5	1.5	1.4	1.7	1.0	1.8	.4	1.9	...	1.5	...	...	.8	...	...	.7	
105	1.3	1.3	1.1	1.4	.8	1.6	.1	1.6	...	1.4	...	...	.8	...	...	.7	
120	1.1	1.1	.9	1.2	.6	1.4	...	1.5	...	1.3	...	...	.8	...	...	.7	
35° NORTH LATITUDE																	
15	8.7	8.7	8.2	8.7	7.6	8.4	4.9	6.6	...	1.8	...	...	.7	...	...	.6	
30	4.3	4.3	4.1	4.4	3.7	3.8	2.0	3.6	...	1.4	...	...	.7	...	...	.6	
45	2.8	2.8	2.6	3.0	2.2	2.7	1.1	2.6	...	1.3	...	...	.7	...	...	.6	
60	2.1	2.1	1.9	2.2	1.5	2.2	.6	2.1	...	1.2	...	...	.7	...	...	.6	
75	1.6	1.6	1.4	1.8	1.1	1.9	.3	1.8	...	1.1	...	...	.7	...	...	.6	
90	1.3	1.3	1.1	1.5	.8	1.6	.1	1.6	...	1.1	...	...	.7	...	...	.6	
105	1.1	1.1	.9	1.3	.5	1.4	...	1.4	...	1.1	...	...	.7	...	...	.6	
120	.9	.9	.7	1.1	.4	1.2	...	1.2	...	1.0	...	...	.6	...	...	.6	
40° NORTH LATITUDE																	
15	7.5	7.5	7.2	7.6	5.7	7.1	3.2	5.0	...	.8	...	...	.5	...	...	.5	
30	3.7	3.7	3.6	3.7	2.7	3.7	1.3	2.7	...	.8	...	...	.5	...	...	.5	
45	2.4	2.4	2.3	2.5	1.6	2.5	.6	2.0	...	.8	...	...	.5	...	...	.5	
60	1.8	1.8	1.8	1.9	1.1	1.9	.3	1.6	...	.8	...	...	.5	...	...	.5	
75	1.4	1.4	1.2	1.5	.8	1.6	...	1.4	...	.8	...	...	.5	...	...	.5	
90	1.1	1.1	.9	1.3	.5	1.3	...	1.2	...	.8	...	...	.5	...	...	.5	
105	.9	.9	.7	1.1	.4	1.2	...	1.1	...	.8	...	...	.5	...	...	.5	
120	.8	.8	.6	.9	.2	1.0	...	1.0	...	.7	...	...	.5	...	...	.5	
45° NORTH LATITUDE																	
15	6.1	6.1	5.6	6.0	4.4	5.1	2.1	3.2	...	.6	...	...	.4	...	...	.4	
30	3.0	3.0	2.7	3.1	2.0	2.8	.7	1.6	...	.6	...	...	.4	...	...	.4	
45	2.0	2.0	1.7	2.1	1.2	2.0	...	1.5	...	.6	...	...	.4	...	...	.4	
60	1.3	1.3	1.2	1.6	.8	1.5	...	1.2	...	.6	...	...	.4	...	...	.4	
75	1.1	1.1	.9	1.2	.5	1.3	...	1.0	...	.5	...	...	.4	...	...	.4	
90	.9	.9	.7	1.0	.3	1.1	...	.9	...	.5	...	...	.4	...	...	.4	
105	.7	.7	.5	.8	.2	.9	...	.9	...	.5	...	...	.4	...	...	.4	
120	.6	.6	.4	.7	.1	.8	...	.8	...	.5	...	...	.4	...	...	.4	



# THE AMERICAN ARCHITECT

50° NORTH LATITUDE

15	4.7	4.7	4.0	4.3	4.0	3.9	.8	1.9	...	.4	...	.3	...	.3
30	2.3	2.3	2.0	2.3	1.7	2.0	.1	1.2	...	.4	...	.3	...	.3
45	1.5	1.5	1.3	1.6	.7	1.4	...	1.0	...	.4	...	.3	...	.3
60	1.1	1.1	.9	1.2	.4	1.3	...	.8	...	.4	...	.3	...	.3
75	.9	.9	.6	1.0	.2	1.0	...	.7	...	.4	...	.3	...	.3
90	.7	.7	.4	.8	.1	.8	...	.7	...	.4	...	.3	...	.3
105	.5	.5	.3	.7	...	.7	...	.6	...	.4	...	.3	...	.3
120	.4	.4	.2	.6	...	.6	...	.6	...	.4	...	.3	...	.3

55° NORTH LATITUDE

15	3.4	3.4	2.9	3.2	1.7	2.5	...	.8	...	.3	...	.2	...	.2
30	1.7	1.7	1.3	1.5	.7	1.3	...	.6	...	.3	...	.2	...	.2
45	1.1	1.1	.8	1.1	.3	1.0	...	.5	...	.3	...	.2	...	.2
60	.8	.8	.5	.9	.1	.8	...	.5	...	.3	...	.2	...	.2
75	.6	.6	.4	.7	...	.6	...	.5	...	.3	...	.2	...	.2
90	.5	.5	.3	.6	...	.6	...	.4	...	.3	...	.2	...	.2
105	.4	.4	.2	.5	...	.5	...	.4	...	.2	...	.2	...	.2
120	.3	.3	.1	.4	...	.5	...	.4	...	.2	...	.2	...	.2

60° NORTH LATITUDE

15	2.0	2.0	1.4	1.8	.5	1.1	...	.2	...	.1	...	.1	...	.1
30	1.0	1.0	.7	.9	.1	.6	...	.2	...	.1	...	.1	...	.1
45	.6	.6	.4	.6	...	.5	...	.2	...	.1	...	.1	...	.1
60	.4	.4	.2	.5	...	.4	...	.2	...	.1	...	.1	...	.1
75	.3	.3	.1	.4	...	.4	...	.2	...	.1	...	.1	...	.1
90	.2	.2	.1	.3	...	.3	...	.2	...	.1	...	.1	...	.1
105	.2	.2	...	.3	...	.3	...	.2	...	.1	...	.1	...	.1
120	.1	.1	...	.2	...	.3	...	.2	...	.1	...	.1	...	.1

Side of Street	E.	W.	E.	W.	E.	W.	N.	S.	N.	S.	N.	S.	N.	S.
Orientation of Street	SOUTH		15° E.		30° E.		45° E.		60° E.		75° E.		EAST	

sunlight. Blocks improved with houses in rows or with apartment houses should have their length parallel to north-and-south streets and their breadth parallel to east-and-west streets.

venience of traffic. Blocks the length of which parallels east-and-west streets should be re-subdivided into lots fronting on minor north-and-south streets laid out across the narrow dimension of the block before they are improved with attached houses.

The amount of sunlight obtained on east-and-west streets in detached-house districts may be effectively increased by staggering the buildings in such a manner that no house is directly back of one in front on the same block.

### ARRANGEMENT OF WINDOWS

All windows oriented in a certain manner obviously do not receive sunshine for the same time. Even though there be no buildings on the opposite side of the street, a considerable percentage of the sunshine received

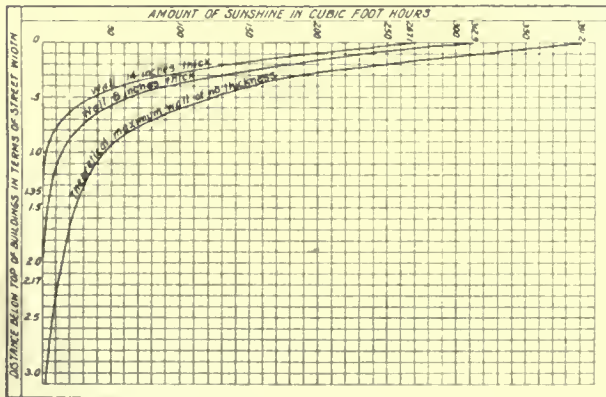

Diagram 8. Total amount of sunshine admitted by window facing east or west, 40° north latitude, winter solstice. Calculated for room 14 ft. square; window pane 32 in. wide and 61½ in. high, the opening between the stop beads being 36x66 in., and the inside dimensions of the masonry 40x70 in. Distance between center of window and south wall of room is 5 ft. and height of window sill above floor 2½ ft.

In such developments the distance separating east-and-west streets is of no particular consequence to the sunlight of apartments. The location of such streets in these sections of the city may therefore be left entirely to considerations affecting the con-

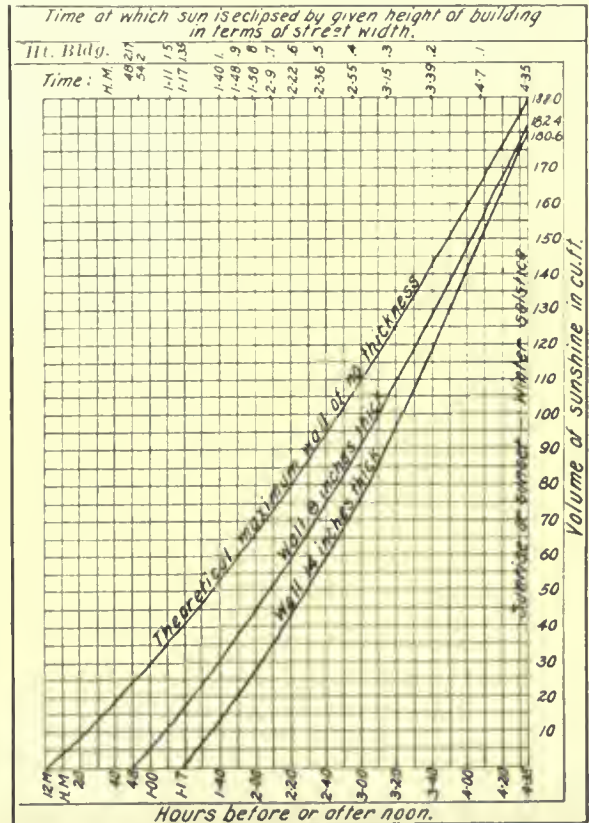

Diagram 9. Volume of sunshine admitted by window facing east or west, 40° north latitude, winter solstice. Calculated for same conditions as in Diagram 8.



by the facades will usually be cut off from entering buildings by the thickness of the wall in which the windows are set (see Diagram 8).

The walls enclosing a window on account of their thickness diminish the sunshine period in a room as

increases far more rapidly with increased height of buildings than does the sunshine period. Where opposite buildings obstructing the window are low, the ratio of the sunshine volume to the sunshine period is nearly as great for a thick wall as for a

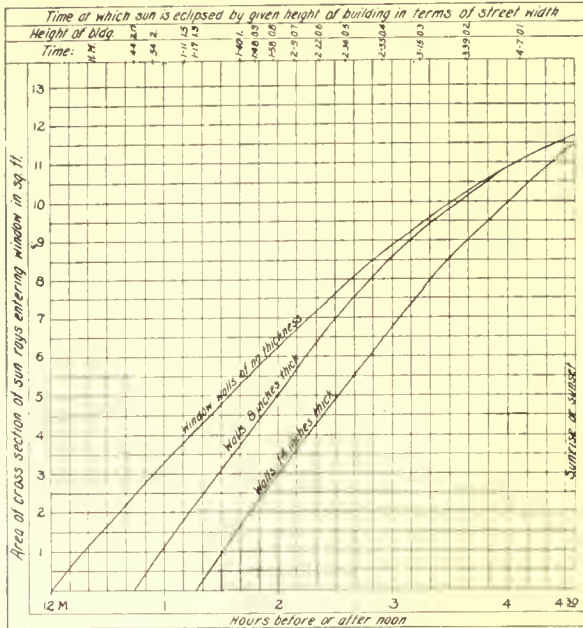

Diagram 10. Cross section of sun's rays entering window facing east or west, 40° north latitude, winter solstice. Calculated for same conditions as in Diagram 8.

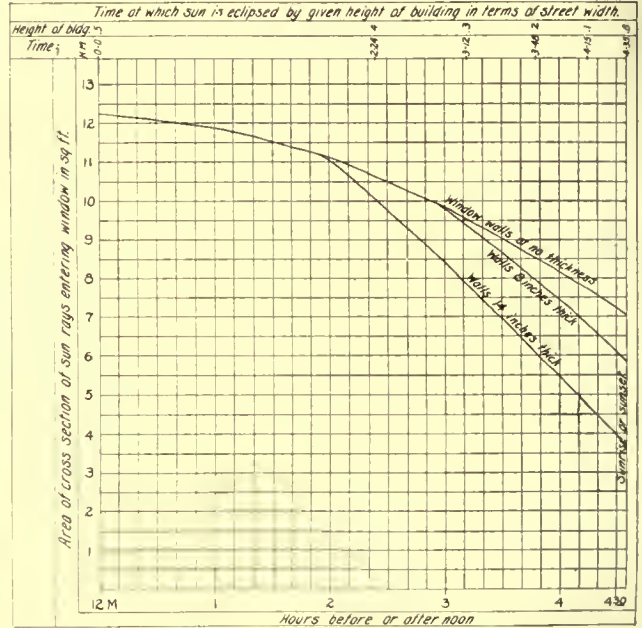

Diagram 11. Cross section of sun's rays entering window facing south, 40° north latitude, winter solstice. Window in center of south wall. Other conditions same as in Diagram 8.

well as the volume of sunlit air (see Diagram 9). These walls should therefore be made as thin as practicable. The effect of the thickness of the walls in cutting off sunlight diminishes as the size of the window increases. Consequently a single large window set in a wall of given thickness is much more efficient in admitting sunlight than several windows having the same collective area.

The sunshine period cut off by walls of a given thickness at a window opening, as shown by Table II, is very much greater in a northern than in a southern city.

The volume of sunlit air in rooms is of just as much importance as the sunshine period. A room, for instance, may enjoy direct sunshine for a considerable period and yet have a comparatively small portion of its cubic contents acted upon by direct rays from the sun.

The volume of sunlit air in a room de-

creases far more rapidly with increased height of buildings than does the sunshine period. Where opposite buildings obstructing the window are low, the ratio of the sunshine volume to the sunshine period is nearly as great for a thick wall as for a

thin wall. But this ratio is considerably reduced in the case of high opposite buildings. A window opening to the south obtains in this latitude not only a longer period of sunshine and a greater volume of a greater intensity than does a window facing any other direction (see Diagrams 10 and 11). As this disparity in the sunshine value increases with distance from the equator, it is plain that the farther north one proceeds the more desirable a southern exposure becomes for the windows.

Windows opening to the south admit at some latitudes the entire sunshine period enjoyed by the building facade, provided the walls are not too thick. But this is an exceptional condition. The general

rule is that the walls in which windows are set shut out sunshine for a less time on north-and-south streets than is the case on streets of any other orientation.

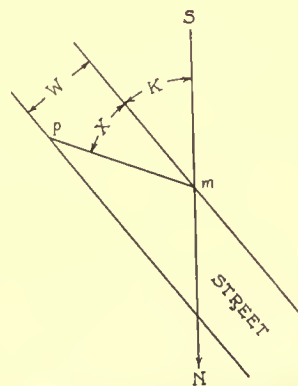

Diagram 12. Method of computing building obstruction.

## THE AMERICAN ARCHITECT

Various expedients may be tried to increase the volume of sunlighted air in rooms. By a beveling of the window opening, a window set in a thick wall can, within limits, be made to admit as much sunshine as one set in a thinner wall. The position of windows within rooms is also of importance. Thus a window the top of which is situated near the ceiling permits a deeper penetration of the sun rays into a room than one the top of which is placed some distance below the ceiling. The sunshine volume in rooms with windows opening to

the supply of sunlight, but they also economize space. Buildings "pocketed" at either end between deeper buildings receive much less sunlight than those conforming to a common building line, unless they are equipped with a side yard of sufficient width on the south to insure their own sunlight. The provision of such a side yard is usually so expensive that it can be afforded only in private home districts.

### INNER AND OUTER COURTS

Deep buildings in solid blocks are quite generally a misfit in a sunlight plan. They necessitate inner and outer courts and open spaces, the economic use of which does not ordinarily conform to the height standards of sunlight. Inner courts should not be used at all; outer courts, except those opening to the south, should be used very sparingly. The justifiable use of outer courts depends almost entirely upon the direction of their open end. Outer courts opening either to the east or to the west are subject to the same criticism as east-and-west streets—one side receives no sunlight at all on the shortest day in the year. Outer courts opening to the north are still worse; unless they are extremely long, only a triangular segment of either side wall near the top of the building receives any sunlight. These objections, however, do not apply to an outer court opening to the south, either side of which possesses the advantages enjoyed by buildings on north-and-south streets, while the end, if the court is not too long, has

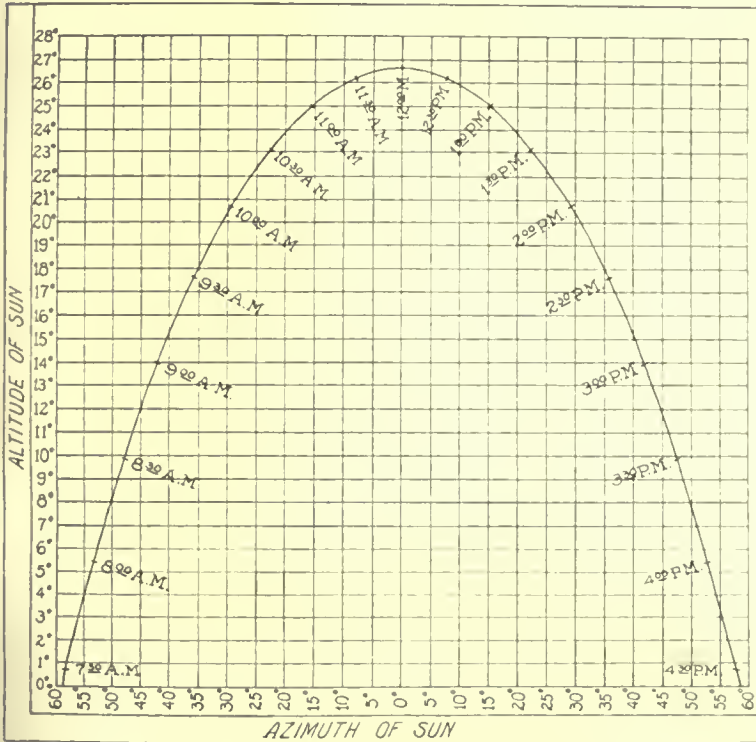

Diagram 13. The altitude and azimuth of the sun, 40° north latitude, winter solstice.

either the east or the west may be considerably increased by having the windows located as near as possible to the south wall of the room. Windows opening to the south should be placed as near the middle of the front wall of the room as practicable.

### FRONT AND REAR BUILDING LINES

Every attached house should preferably not only front on a north-and-south street, but should also back on a rear yard running parallel to such a street. This yard should be open at either end so that each building backing on it may derive full benefit of the sunlight purchased by its vacant space. Uniform building lines are highly desirable both in front and in rear. They not only conserve

many of the advantages of a building on the north side of an east-and-west street. An inner court possesses none of the advantages of an outer court open to the south, while it has all the disadvantages of courts open toward the east, west and north in an exaggerated way. Buildings on the south side of east-and-west streets should have their outer courts opening into the rear yard; those on the north side into the street.<sup>1</sup>

The type of building enjoying the maximum possible sunlight, and which most readily avoids the use of courts, is one facing on a north-and-south street not more than two rooms deep measured

<sup>1</sup>The writers have worked out two complete sets of tables, one showing the exact period of sunshine and the other the daylight illumination enjoyed by inner and outer courts under different conditions.



from east to west, every room deriving its sunlight directly either from the street or the rear yard in the case of attached houses or from the side yards in addition to the southerly exposure in the case of detached houses.

THE LOT UNIT

The size of the lot unit is, of course, always conditioned by the character of the building and the amount of space demanded for lawns, gardens and accessory buildings. For sunlight purposes it should also be conditioned by its latitude and its orientation. The minimum practicable depth of workmen's dwellings of low cost and built in rows is probably about 25 ft. How deep at different latitudes would the lot unit have to be for such buildings oriented on north-and-south streets with a yard in the rear, to obtain at least two hours' sunlight on either side at the street and yard level, assuming the height to be 25 ft. and ignoring any demand for extra space on account of gardens and accessory buildings?

The width of the yard on each lot provided in the rear of the houses at each of these latitudes respectively would be equal to half the street width in front. Utilizing the sunlight coefficients in Table III, we find the required street width at each latitude to be as follows:

Latitude	Street width	Minimum depth of lot
25°	19.2 ft.	34.6 ft.
30°	23.4 "	36.7 "
35°	27.2 "	38.6 "
40°	32.4 "	41.2 "
45°	41.0 "	45.5 "
50°	64.1 "	57.1 "
55°	83.3 "	66.6 "
60°	250.0 "	150.0 "

The depth of lot and width of streets required for any type of development with a minimum sunlight standard can easily be ascertained by using the proper sunlight coefficient. A sunlight plan does not concern itself with the width of lots except where side yards are utilized to obtain sunlight. The width of such yards and the height of the adjacent buildings must, of course, stand in the same relation as their sunlight coefficients.

SETBACKS AND CORNICES

Setbacks to maintain the minimum standard of sunlight at the ground level must be in the same ratio as their sunlight coefficients. If not, they are to be considered as an increased height of building,

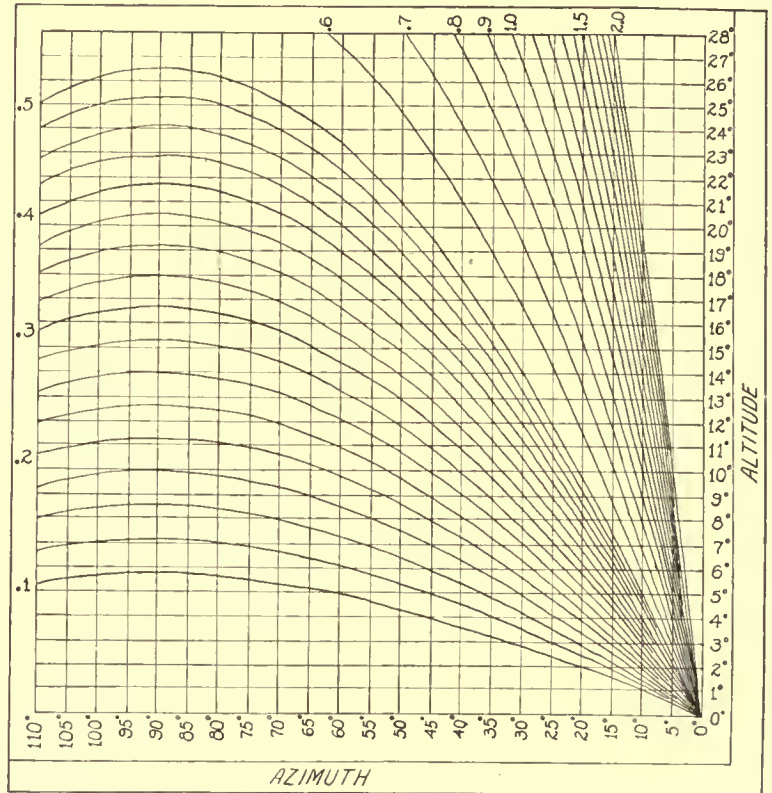

Diagram 14. Building obstruction at different altitudes and azimuths. Curves represent top edge of buildings at different heights in terms of street widths.

the amount of such increase depending upon the setback angle. Cornices usually diminish the effective street width by as much as, and often by considerably more than, the amount of their projection, when the height of building is measured to the cornice.

BUILDING REGULATIONS

Good housing means sunshine, daylight, air, ventilation. These are the avowed objects of all building codes. The height of buildings has been restricted, the percentage of lot that may be covered by buildings limited, and the size of courts and yards rigidly regulated—all with the hope that the aggregate amount of sunshine, daylight, air and ventilation in the community might be increased. This hope has, of course, in a measure been realized, for some control is better than no control, even though that control may be based upon a very imperfect appreciation of the means necessary for the achieve-



## THE AMERICAN ARCHITECT

ment of these ends. But what is needed for the promotion of good housing to-day quite as much as restrictive regulations is the definition of scientific standards which will directly relate height and area provisions to the minimum requirements of public health. Without the establishment of such standards we cannot be sure that our building codes encourage the right kind of development.

Note:

### METHOD OF CALCULATING THE SUNLIGHT TABLES

The tables have been worked out by graphic methods and in brief they consist in plotting the path of the sun, as seen from a given point, on a suitable projection, noting at the same time on its projected path points at 30-minute periods or oftener from noon (see Diagram 13). In the same manner the edge of the building casting the shadow is plotted as seen from the same point (see Diagram 14). Then it is plain that the arc of the sun's path as projected, which is above the projection of the edge of the building, will be the path of the sun while illuminating the point in question and the time may be determined from the 30-minute intervals noted on its path. This in general is the method and there are many ways by which it can be carried out, by using different planes of projection, different systems of projection, etc.

It is believed that the particular method devised by the authors for computing Tables II and III, which will be briefly described below, is new and has many advantages.

The location of the sun and also the point in cornice line or edge of building casting the shadow is defined by its altitude and azimuth from the point considered, azimuths being measured from the south, + toward east, - toward west.

- Let  $l$  = latitude of place
- $d$  = declination of sun, + when N, - when S
- $h$  = altitude of sun
- $A$  = azimuth of sun measured from south, + when east, - when west
- $t$  = hour angle from noon, + in a. m., - in p. m. (1 hour = 15 deg.).
- $W$  = width of street
- $H$  = height of building casting shadow
- $K$  = azimuth of street measured from south, + when east, - when west.

We then have for the azimuth of the sun

$$(1) \tan A = - \frac{\sin t}{\cos l \tan d (1 - \tan l \cos d \cos t)}$$

and for the altitude

$$(2) \sin h = \sin l \sin d + \cos l \cos d \cos t.$$

From these formulæ the altitude and azimuth of the sun may be determined at any time for any locality.

The U. S. Navy has published the azimuths of the sun so that they may be taken directly from tables, leaving only the altitudes to be computed.\* These quantities may also be obtained graphically.

The position of the sun is then plotted for every half hour, or preferably oftener, at all hours between sunrise and sunset from the altitudes and azimuths of the sun found as above, after adding the refraction to the altitudes by the use of a table of astronomical refractions. A rectangular projection is used (the plane of projection being vertical and perpendicular to the meridian, south being taken as zero azimuth). Azimuths are plotted as abscissa, altitudes as ordinates (degrees and minutes being laid off in the same manner as if they were linear measurements) and the corresponding times from noon noted on the resulting curve.

\*Hydrographic Office United States Navy Publication No. 71. Azimuths of the Sun.

The U. S. Coast and Geodetic Survey kindly furnished tables of altitude and azimuth for the particular latitudes and times used in this work.

We have now to locate the corresponding curve for the edge of the building casting the shadow (Diagram 14). If  $m$ , Diagram 12, is the point of observation at the ground level on the side of the street where its shadow is cast and  $p$  is a point on the cornice or edge of building casting shadow at height  $H$ , while  $X$  is the angle which the horizontal projection of  $p m$  makes with the side line of the street, assumed as level, and  $k$  is the altitude of  $p$  as observed at  $m$ , we have

$$(3) \tan k = \frac{H}{W} \sin X.$$

Values of  $k$  for each ratio of  $\frac{H}{W}$  required, as  $\frac{1}{2}$ , 1,  $1\frac{1}{2}$ ,

2, etc., are now to be found for different values of  $X$ , say for every 5 deg., or as may be required to plot a smooth curve. It is only necessary to compute that part of the curve, however, which will intersect the sun curves above described. We then plot these altitudes for different values of  $X$  referred to the side of the street on tracing paper in the same way and on the same scale as the altitudes and azimuths of the sun. Then when one of these diagrams is superimposed on the sun diagram with zero  $X$  corresponding to zero azimuth of sun, the sun diagram will represent on the projection the position of the sun at any azimuth as seen from the point of observation and the superposed diagram will represent the corresponding position of the skyline or cornice line of the buildings on one side of the street (assuming that they are of uniform height and continue indefinitely without breaks) when the street is in a north and south direction, as seen from the point of observation on the opposite side of the street at ground level.

The angles  $X$  and the corresponding altitudes  $k$  should be laid off on both sides of  $X=0$ , the curve being symmetrical about a vertical through that point. The resulting curve to the left of zero will represent the line of obstruction to sunlight (skyline or cornice line of building) due to buildings on the east side of the street, at the point of observation on the opposite side of the street at ground level, and conversely the skyline curve on the right of zero will represent the line of obstruction to sunlight due to buildings on the west side of the street at the point of observation at ground level on the east side of the street.

This combined diagram will show the time when the sun begins to shine on the west face of this north and south street, and when the sun leaves it entirely in shadow, for when the sun is below the skyline its rays are cut off by the buildings from the point of observation, and when the sun is above, that point receives the direct rays of the sun, consequently when the sun's position is at the point of intersection of the two curves the point of observation passes from shadow to sunlight, or conversely. In this particular case of a north and south street the intersection on the left locates the position of the sun when the sunlight first reaches the point of observation on the west side of the street and the altitude and azimuth of the sun, at that instant, as well as the time, is shown on the diagram. The vertical line through azimuth zero will represent the skyline or cornice line of the buildings on the west side of the street as seen from the point of observation on that side, and the intersection of this vertical line with the sun diagram will give the altitude, azimuth and time when the sunshine leaves this west face of the street and shines on the east face. Similarly, this same instant is the time when sunshine first strikes the east face of the buildings on the street, and the altitude, azimuth and time when it leaves this face is given by the point of intersection of the sun curve with the skyline curve to the right of zero azimuth. For any latitude or time of year it is necessary to use the proper sun curve for the given latitude and time.

A street in a north and south direction has thus been considered, but the same diagrams are applicable to a street in any direction. The only change necessary is the shifting along the axis of abscissa of the zero point of the skyline diagram on the sun diagram so that zero  $X$  on the skyline diagram shall coincide with the azimuth on the sun diagram which expresses the direction of the street. This lateral

## THE AMERICAN ARCHITECT

displacement is necessary to make the relative position of the sun and skyline of the street correct for the given direction of street; for example, if we have a street making an angle of 60 deg. west of south, zero  $X$  should be placed over 60 deg. west azimuth on the sun diagram, for only then will the azimuth and altitude of the skyline of the given side of the street be correctly represented on the sun diagram. Then  $X = 60$  deg. is azimuth 0;  $X = 45$  deg. is azimuth  $-15$  deg.;  $X = 30$  deg. is azimuth  $-30$  deg.;  $X = 15$  deg. is azimuth  $-45$  deg.; and  $X = 0$  is azimuth  $-60$  deg.; and the directions on the skyline diagram are now shown in their true azimuths measured from the south.

We have described the making of a skyline diagram for a level street with uniform building heights, but a diagram may be similarly plotted to determine the sunlight at any given point for any arrangement of obstructing buildings from the altitudes and azimuths at the given point, of points on the edges of obstructing objects casting shadows. Similarly a window diagram may be drawn on a skyline or building diagram which will show when sunlight is admitted by a window of any given dimensions. Only when the path of the sun appears above the skyline curve corresponding to the height of buildings above the window, and within the window diagram, will the sun shine through the window.

For all directions which a street may make it is sufficient to work out the required quantities for the street directions in a quadrant, say from south to west; for from symmetry the quantities found in the s. w. quadrant for a street having a given azimuth west of south, will apply to a street having the same azimuth east of south, counting times before noon in the latter case, in place of times after noon in the former, and vice versa.

The times given are such as a sun dial would give and are not mean local times. The maximum difference is about 15 minutes. Tables are available showing this difference, known as the "equation of time," for any time of the year, also the difference between sun dial time and standard meridian time, but as we are dealing with time differences during a day, the variation is inconsiderable for so short a period, and the reduction is only necessary when we require the clock time.

To get the entire time of sunlight on the face of a building the entire sun curve should be plotted from sunrise to sunset, bearing in mind that the curve is symmetrical about a vertical through azimuth zero; and the skyline should be plotted for the extent of azimuth reached by the sun both east and west (although only its intersections with the sun curve are made use of). Then any period when the sun shines on the side of a street can be readily seen by inspection; otherwise a period of sunshine may be overlooked.

We have projected the sun and the skyline on a vertical plane at right angles to the meridian, as best representing the phenomena; but the same method might be used by projecting both the sun's path and the skyline on a vertical plane parallel to the meridian or one having any given azimuth. Other projections may be and have been employed in solving this problem, as for example the orthographic or stereographic projections. The projection used herein has the advantage that the scale is equal for all altitudes and azimuths, so that one skyline diagram suffices for all street directions. With the other projections, however, owing to differences of scale, separate skyline diagrams are required for each direction of street.

The above diagrams give directly the time during a day that the entire front of a building is in sunshine, when the opposite side of a level street is occupied by a continuous row of buildings of indefinite length and are of any given height; that is, the front at the bottom will receive this amount of sunshine, while points above will receive greater amounts, which may be found by using, instead of  $\frac{H}{W}$ ,  $\frac{H_1}{W}$ , where  $H_1$  is the distance down from top of opposite building to level of point where period of sunlight is required. In the case of a street having a uniform grade for some length, the skyline diagram for that condition can be easily plotted.

The problem may arise, given the number of hours that sunlight entirely covers one side of a street, to find the limiting height of buildings on the opposite side of the street for a given street width. In this case, plot the sun curve for the latitude and time of year required and superpose thereon the sky curves for the given street direction

as before for several different ratios of  $\frac{H}{W}$ , noting the corresponding total number of hours that the sun will shine on the given side of such street until one ratio will give a time somewhat greater and another somewhat less than that required; then if these two ratios are taken near enough together so that the sun curve between them is substantially straight in all portions included, we may find the correct ratio for the given time by proportion, when the height of the building follows from the street width. Similarly, the width of street which will permit a given number of hours of sunlight when buildings in continuous rows are at any given height also follows from the  $\frac{H}{W}$  determination above.

At a given point on the side of a street the sunlight begins or ends in most cases when the sun comes from back of the face of the building or passes to the back of the building. In other words, the sun, at the instant of beginning or of ending of sunlight at a point on the front of a building, is in its plane. In this usual condition the height of buildings for a given width of street, or widths of street for a given height of buildings, which will permit a given period of sunshine on the opposite side of the street was found in the manner described below.

From the sun diagram for the latitude and time of the year required, find for the azimuth of the street the time on the sun diagram when the sun is in that azimuth, then subtract, if a certain number of hours of sunlight is required on the westerly side of the street, or add if these hours of sunlight are required on the easterly side of the street that number of hours, and we have the time when sunlight or shadow should appear. Take the corresponding altitude and azimuth of the sun at this time from the sun diagram, and this azimuth will be the azimuth of the sun when the edge of its shadow is at the base of the buildings on one side of the street, the given number of hours from the time that the sun is hidden by these buildings. From this azimuth  $A$ , and the azimuth of the street  $K$ , find the angle  $X$ , which the direction of the sun makes with the side of the street. This angle is the difference of these two angles when they are measured both east or both west of the meridian. When, however, one azimuth is measured east and the other west of the meridian, the angle  $X$  is the sum of  $K$  and  $A$ . Then, with angle  $X$ , and the width of the street, find the horizontal distance on azimuth  $A$  across the street, which is  $\frac{W}{\sin X}$ . Then this distance, multiplied by the tangent of the corresponding altitude of the sun  $h$ , will give the height of building required; or, collecting the expressions we have for height of building.

$$H = \frac{W}{\sin X} \tan h,$$

where  $X = A - K$ . The corresponding width of street for a given height of building is given by the formula

$$W = H \frac{\sin X}{\tan h}$$

The sun is assumed in the computations to have no appreciable size and the illumination concentrated at its center. The sun is about 32' in diameter and it takes about two minutes when in the equinox to travel across the meridian; sunlight will begin, therefore, a short time before the time found but will not reach its full intensity until after that time. In the same way the intensity will diminish a short time before the time found but will not be completely shut off until after the time given.

Sunrise and sunset are usually given for the time when the upper limb of the sun appears to be in the horizon. These times may be found by using the value  $-0^\circ 56'$



for  $h$  in the altitude formula previously given (2). At zero altitude the center of the sun would be in the horizon were it not for refraction, which makes it appear higher by about  $36'$ , so that the sun has to be  $36'$  lower before its center appears to be in the horizon. Adding the semi-diameter of the sun,  $16'$ , and a small correction for dip due to the height of the observer, we obtain  $-0^{\circ} 56'$  as above for the true altitude of the sun at sunrise or sunset.

Mathematical formulæ can be used to compute the quantities directly in all cases in which the period of sunlight is required as well as in all cases in which the sun crosses the plane of the face of the buildings on the street, and in other cases by trial and error. The process is tedious and complicated, however, but can be availed of whenever precise results are desired.

The formulæ are as follows:

We have in (3)

$$\frac{H}{W} = \frac{\tan k}{\sin X}$$

which serves to determine the altitude and azimuth of points on the edge of building. When, however, the sun casts a shadow from a point on the edge of the building to that of observation,  $k$  becomes  $h$  for that point and  $X$  becomes  $A - K$ ; substituting these values we have

$$(4) \frac{H}{W} = \frac{\tan h}{\sin (A - K)}$$

Substituting for  $A$  its value in terms of  $l$ ,  $h$  and  $d$ , according to trigonometrical formulæ, we have

$$(5) \frac{W}{H} = \frac{\sin K \sin d}{\sin h \cos l} - \frac{\sin K \sin l}{\cos l} + \frac{\cos K \sqrt{\cos^2 l - \sin^2 d - \sin^2 h + 2 \sin d \sin h \sin l}}{\sin h}$$

which expresses the relation between  $\frac{W}{H}$  and the altitude of the sun  $h$ , when the shadow of the sun from obstructing buildings falls at the ground level of the opposite face of the street.

This formula, with (1) and (2) previously given, will enable the desired computations to be made, to find the

times of sunshine with a given value of  $\frac{W}{H}$  we solve (5)

for  $h$ , and using the value of  $h$  so obtained we solve (2) for  $t$ . If the sun crosses the face of the street, we find the time of such crossing from (1) and the difference between this and that derived from (2) will give the time of sunshine desired. No correction has been made for refraction, however, but this may be taken into consideration as follows: In (4), knowing  $h$ , we can readily find  $\sin (A - K)$ , then adding the refraction to  $h$ , we have  $h_1$ , and

$$\frac{H_1}{W_1} = \frac{\tan h_1}{\sin (A - K)}$$

is the true ratio of height to width of street for which the interval of sunshine found as above applies.

When it is desired to find the ratio  $\frac{H}{W}$  which will permit a given period of sunshine on the street, we first find  $t$  from (1), after substituting for  $A$  the azimuth of the street. This gives the time when the sun passes the face of the building; adding the interval desired we have  $t_1$  the time when the sunlight should begin or end, with the required  $\frac{H}{L}$ . With  $t_1$  find the corresponding azimuth of the

sun  $A_1$  from (1), and from (2) with this time  $t_1$  find the corresponding altitude of the sun  $h$ , then by adding the refraction to  $h$  we obtain the apparent altitude  $h_1$ . Formula

(4) then gives  $\frac{H_1}{W_1}$  after substituting therein  $h_1$ ,  $A_1$  and  $K$ .

The total time of sunshine at a point, that is, the time from the first appearance of the sun at the point until it is

entirely eclipsed, and the corresponding values of  $\frac{H}{W}$  may

be determined similarly by adding the value of the semi-diameter of the sun, about  $16'$ , to the altitude of the sun corrected for refraction, and using this new altitude in the equations in the same manner as the altitude corrected for refraction was used above. When the sunshine is cut off by the face of buildings, however, the time that the semi-diameter of the sun takes in passing the face of building must be added to the period found above.

## Industrial Information

*In this Department there is published each week information as to the development of materials and methods derived from reliable sources.*

### A Contractor's Service

Among the valuable suggestions contained in the program of the Post-War Committee, considerable emphasis is given to the inter-relationship of the architect and the contractor.

As typical of the co-operation which contractors are prepared to offer, particularly with reference to industrial and commercial structures, the record of the Gaylord W. Feaga Co., Cleveland, is of interest. This is described in a booklet called "Buildings." Herein is discussed the importance of intensive effort on industrial construction work. In the production of industrial buildings, it is stated, the demand of the day is for a readiness to begin at

once the necessary operations, for accuracy and thoroughness of workmanship throughout the undertaking, and for the maximum dispatch consistent with efficiency.

Having analyzed the matter this far, they proceed to give evidence of how their facilities approach the ideals they have set down.

Space is given in this booklet to a discussion of the intelligent application of standardization. A feature is the graphic presentation of the extent to which this is limited by the special aspects of the needs of a particular manufacturer. So long as his needs remain wholly general, unmarked by any individuality, the advantage of standardization is highest. But when his needs are distinguished by



any specific departure from the needs of other owners, the disadvantage sets in, and from that point the graphic curve steadily falls.

This book closes with a comprehensive tabulation of the scope of service offered by the Feaga Company, which should tempt each firm of architects to formulate for itself a summary of its special facilities for carrying work forward in the most nearly ideal way.

---

### Wiring Chart for Country Home Lighting

A wiring chart for determining the proper wire size for use on circuits of 110-125 volt country home lighting systems has just been prepared by the Engineering Department, National Lamp Works of General Electric Company. The steady demand for the low voltage (28-32 volts) wiring chart for country homes, distributed in July of last year, shows that the information contained thereon is valuable and conveniently arranged. For this reason, the chart on 110-125 volt systems is designed along the same lines. To aid in distinguishing the two charts, the new one is salmon-colored and is contained in an envelope on which the printing is done in dark red.

In connection with the high and low voltage systems, it should be noted that there is a fundamental difference between the two designations, 28-32 volt lamps and 110-125 volt lamps. In the first instance, a single class of lamps, any one of which is designed to operate on any voltage within the range indicated, is referred to; but, in the latter case, there is a different lamp for each individual voltage between 110 and 125 volts. While the characteristics of all the lamps in this range are such as to allow of their being grouped together for many purposes, as in the wiring chart just prepared, it should be remembered that a 110-volt lamp is to be burned only on a 110-volt circuit; a 115-volt lamp on a 115-volt circuit, or, in general, each lamp only on a circuit of the voltage for which that lamp was designed.

As indicated above, the information on the chart for 110-125 volt systems may be used for all voltages within the range. Either chart may be obtained on request from the Engineering Department, National Lamp Works of General Electric Company, Nela Park, Cleveland, Ohio.

### Garden Ornaments

Considerable is the extent to which a formal garden depends for its success upon the careful selection and placing of garden ornaments.

A wide variety of garden ornaments has been designed by the Galloway Terra Cotta Co., established in 1810 and now located at Walnut and Thirty-second streets, Philadelphia. Terra cotta, or burnt clay, has the quality of long durability. Its use in art goes back through centuries, and much that we know of ancient peoples has come to us through pottery worked by them. The artistic possibilities of this medium are also recognized, for the unburnt plastic clay permits of unlimited artistic expression in the handling of detail.

Galloway pottery, having this unusual durability, coupled with the artistic possibilities of terra cotta, is particularly fitted, it would seem, for garden and decorative use. The simple lines of a sun dial or font stand out in striking contrast against a background of foliage or flowers, and in winter form a pleasing spot of interest. By the careful placing of jars, flower boxes and other decorative pieces a scheme of considerable beauty may be obtained that will be effective in all seasons. A garden pleasingly arranged can be made a delightful retreat for the best part of the year, and that feature should not be underestimated. If environment does all that is claimed for it, surely a garden may perform a distinct and important function by creating surroundings of refinement.

The Galloway Company has received important awards for its work in these fields, and a full guarantee accompanies each order. Its catalog is extensively illustrated and represents a wide range of well executed designs.

---

### Improved Cupboard Latch

The Moss-Ochs Company, 9801 Manor Avenue, Cleveland, manufacturers of machinists' tools, are preparing to place on the market a new form of cupboard latch. The feature of this latch is the plunger, which, instead of being rectangular in shape, is made with steps. The object of this is to enable the door to catch at all times, no matter how badly it may be warped. As most doors have warping propensities, this latch should be of value.

4422  
94-103  
420460

# The AMERICAN ARCHITECT



PULPIT, ALBANY CATHEDRAL

PUBLISHED WEDNESDAYS IN NEW YORK—FOUNDED 1876  
VOLUME CXV                      MARCH 26, 1919                      NUMBER 2257

Entered as second class matter January 6, 1909, at the Post Office at New York, N. Y., under the Act of March 3, 1879. Publication office, 243 West Thirty-ninth Street, New York, N. Y. Subscription price in the United States and Possessions, \$10.





Residence of Glenn P. Driscoll, Architect  
Des Moines, Iowa  
Bishopric Board used on entire house

# As a Key Turns the Lock and Holds the Door Secure

So Does Dovetailed Key  
BISHOPRIC BOARD HOLD  
STUCCO — Preserving  
the Original Beauty  
of Walls Indefinitely

**T**URN THE KEY and the lock on the heavy oak door prevents the movement of that door. It is held rigid and secure indefinitely. That's what a lock is for.

In the same way, Bishopric Board prevents the movement of Stucco walls. Its dovetailed key, formed by beveled wood strips, fastens the Stucco firmly—locks it irrevocably.

Bishopric Board differs from a door lock in but one respect—it can never be unlocked! The Stucco and Stucco Board remain sealed together forever, snug-tight to the building, the Stucco Board being fastened by a 6 D nail wherever it crosses a stud, and by four nails to each heavy wood strip where applied over Sheathing.

There isn't the remotest possibility of cracking, crumbling walls when Stucco is applied over Bishopric Board, especially if the Stucco mixture we recommend be used—a mixture universally conceded as the most perfect yet compounded.

Time does not lessen Bishopric Board's effectiveness. The wood strips are creosoted, like railroad ties and old-time wooden bridges. The Asphalt Mastic in which the wood strips are imbedded is itself a preservative and keeps out moisture. The waterproofed fibreboard is a non-conductor and prevents the circulation of moisture.

Specify Bishopric Board if you want attractive, unbroken surfaces in your Stucco construction. Specify it for its desirable insulating and sound deadening qualities. Specify it to provide other advantages for clients through the saving it effects.

When Bishopric Board is used on interior walls, ceiling and partitions, plaster, time and labor are saved. Splendid insulation and retarding of sound are secured.

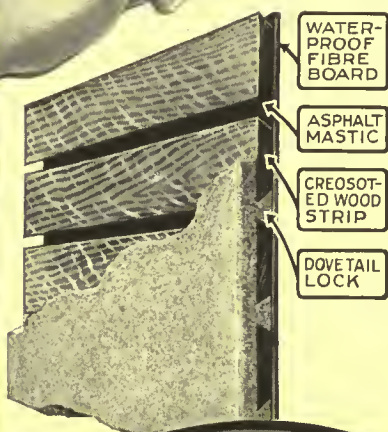

Have you used Bishopric Sheathing—the product which nearly one hundred concerns have specified for workmen's homes? It makes a solid, compact wall and saves 30 per cent over 3/8-inch wood sheathing.

#### OUR BOOKLET

contains the perfect Stucco mixture and numerous tests and endorsements of Bishopric Board by Engineers, Architects, Contractors and Home Owners. It will be sent on request.

THE BISHOPRIC MANUFACTURING COMPANY

904 Este Avenue

Cincinnati, Ohio

SEE

HOW

IT

LOCKS

THE

STUCCO

4424





PALAZZO DEL PODESTA, FLORENCE

THE AMERICAN ARCHITECT

# THE AMERICAN ARCHITECT

VOL. CXV

WEDNESDAY, MARCH 26, 1919

NUMBER 2257

## Architectural History of a Western Town

By THOMAS E. TALLMADGE, A. I. A.

WHEN one looks over a collection of photographs depicting in sequence the dwellings of any town from decade to decade, from generation to generation, he is inclined to lose faith in his belief in the grand sequence of the styles, that majestic evolution dictated by necessity and reflecting epic changes in national customs and ideals. Instead, one is unpleasantly reminded of Godey's Lady's Book, or of an old photograph album, showing the succeeding and senseless changes in costume and millinery from simplicity to extravagance, from good to bad and from bad to good. Mr. Cram places the end of the orderly procession of the styles between 1820 and 1830. That great march which started on the Acropolis at Athens and has left its monuments through

ancient, mediæval and modern times, disappears within the lifetimes of some now living nonagenarians. In other words, architecture made its last stand on the eastern shores of our continent and gave up the ghost in our own Colonial style.

All of the architecture which we are considering lies in the period of architectural anarchy and eclecticism which has prevailed since that ominous decade, as there was no Colonial architecture in the Middle West with the exception of the old French church at Cahokia, Illinois, built earlier than 1750, and a few scattered buildings along the lower Mississippi and New Orleans, built by French settlers. The town we have chosen is typical in many respects, and on account of its culture and wealth is able to present the best examples of those styles (shall we call them fashions?) which have prevailed since 1840. Lying within a few miles of a great metropolis on the shores of a great lake, the site of a university, it has been able to combine wealth, culture and beauty of location to as great an extent as



THE LOG HOUSE. BUILT ABOUT 1840 ON THE NILES ROAD

any other town in the Middle West might do so.

The first houses in this and in any community are the log cabins, built of squared logs with the chinks filled with mud or plaster and covered with a sloping roof. They are of no style and of no time. As the exterior skeleton of the mollusc was a pretty experiment, tried and discarded by nature for the vertebrate idea, so architecture has flirted with the log house from time immemorial, but has gone elsewhere for its grand passions with their majestic consummations. So the log house remains alpha and omega, the same yesterday, today and tomorrow.

Previous to the founding of the university in 1853 there was no town, and the only settlements were scattered farmhouses and inns lying along the old Ridge Road, which stretched north a mile or two west of the shores of the lake. The town was platted out in 1854, and the first railroad built in the same year. Although the population is now in excess of thirty thousand, as late as 1861 it had a



## THE AMERICAN ARCHITECT

population of only three hundred. Of the houses built along the old highway, a part are fortunately still standing. These were built before the town was a town and are very good but simple examples of the classic revival. They were evidently built by car-



CLASSIC REVIVAL. THE CRANE HOUSE  
BUILT IN 1845

penters who came from the East, and the mouldings all have unmistakable Greek profiles, and were, of course, planed out with hand planes. This was the day of the old-fashioned carpenter shop, when sashes, doors and blinds were run by hand, and pinned and tenoned together. Great pine forests in



THE BUCKEYE TAVERN ON THE OLD STAGE  
ROAD. CLASSIC REVIVAL, 1848

close proximity furnished the finest of clear white pine, and the excellent condition of these houses, many of which have been innocent of paint for a generation or more, is eloquent of the conscientious workmanship and good material employed. Exam-

ples of this period are the old Crane house, built in 1854, the Buckeye Tavern in 1849, and the original Methodist Church in 1856.\* There was little building during the war, and what little there was still maintained the traditions of the Classic Revival. Immediately after the war, with the revival of building, came new fashions of many varieties. There was the Cottage style, apparently inspired by a style-book issued by Robert Downing, with numerous plans and elevations of cozy cottages. Their principal characteristic is the sharp peaked roof, a vertical outside siding, with the joints covered with battens, narrow porches and narrow windows and narrow hallways. The details are ordinarily Gothic, and the style is, of course, related at least by marriage to the Gothic Revival. A very good



THE OLD ROUND HOUSE. BUILT IN 1856  
Wood Siding on Concrete Walls

example is Rest Cottage, the home of Frances Willard, built in 1866.

Exactly contemporary with this fashion was the Mansard Roof style. This fashion is apparently French in its origin, and was used for the houses of the rich. The captains of finance, who made their money in the nearby metropolis, lived in more or less old-time splendor in the adjoining suburb. These

\*A curious eddy in the architectural stream is indicated by the old Round House. In 1854 a book was published by Mr. O. S. Fowler called "A Home for All, or The Octagon Mode of Building." This book proved, at least to the satisfaction of the author, that a house of circular or octagonal plan not only had the smallest amount of outside wall space for the area of the enclosed rooms, but also resulted in a building more conveniently arranged and more elegant than the prevailing Cottage or "Doric" style of building, of which he was especially scornful. A number of these octagon houses had been built throughout the country, so Mr. Fowler, who was also an author of numerous works on phrenology, seems to have had a number of disciples. The house in question was built by some theological students in the University, whose chosen profession did not prevent them from filching a cargo of lumber which had been washed ashore from the wreck of a schooner on the Gross Point reefs. The building had various vicissitudes—it was moved once the length of the town, much to the discomfort of the moving contractor, who discovered that the supposedly lumber house was in reality concrete covered with siding. The stairs of these houses were also in a well in the center, which was lighted by a cupola, and the rooms presented an amazing variety of triangles, octagons, and trapeziums. The old building was torn down in 1889.



THE AMERICAN ARCHITECT



THE KIDDER HOUSE

An interesting attempt to elaborate on the simplicity of the classic revival: built in 1856



A MANSARD ROOF HOUSE WITH BOTH GOTHIC AND EASTLAKE DETAILS. BUILT ABOUT 1870



FRENCH INFLUENCE MANSARD ROOF AND CUPOLA BUILT IN 1867



A LARGE HOUSE IN THE COTTAGE STYLE. 1875. IRON CRESTING. VERY TYPICAL.



COLLEGE HALL. A FINE EXAMPLE OF VICTORIAN GOTHIC. BUILT IN 1873





THE GOTHIC COTTAGE STYLE

Rest Cottage, the Home of Frances Willard, Built in 1867

houses were usually built along the old Ridge Road, which had now become an avenue, as the beauties of the lake were either not appreciated or feared on account of the supposed deleterious effects of the lake air. These houses were generally of brick and the stories were extraordinarily high. The hallway was in the center, with a stairway which usually ran in one straight ramp almost to the second floor, where, on the short turn, was placed a niche, in which often stood a plaster statue of Canova's Hebe. Opening off the hall on one side through wide folding doors was the parlor. Behind this was the dining room. On the other side, usually of the same size and relationship, ranged the sitting-room and a large bedroom. Each of these rooms was provided with a marble fireplace carved in a debased rococo style, or else made of slabs incised with Eastlake decoration. Plaster cornices surmounted the wall, and in the center of the ceiling was a huge plaster rosette, from which hung iron chandeliers with their oil lamps. The arrangement of the rooms on the second floor was similar, except that a single bathroom, long, narrow and high, accommodated the household. A rear wing housed the kitchen, back stairs and an anomalous room behind the kitchen, which was part

laundry and part woodshed. The crowning glory of the house was the cupola. This room, never visited except by the children in fear and trembling, was plastered and finished off as the rooms below. Such a house was the Hamline House, which boasts twenty different kinds of wood in its interior finish; it was built in 1867. Of the same period is the Kedzie House, where the detail is Eastlake rather than French. It is possible that some of this work, usually ascribed to the influence of the English Eastlake patterns, was derived from the French neo-Grec, as exploited by Lebruste in the *Bibliothèque Sainte-Genevieve*.

The first important building of the university was University Hall, built in 1873. This is one of the most important and successful monuments of the Gothic Revival. When it was completed, Frances Willard called it

a "poem in stone," and writes that the best models on both sides of the water had been studied. G. P. Randall was the architect. Particularly interesting is the very original and impressive treatment of the tower, evidently influenced by the fashionable cupolas in vogue. Joliet limestone was the material par excellence for stone work, and it was invariably laid up in rock-faced ashler. Its



THE ROMANESQUE REVIVAL, ITS INTERPRETATION IN SHINGLES. BUILT IN 1889  
HANDY & CADY, ARCHITECTS





A QUEEN ANNE HOUSE BUILT 1885

extraordinary self-cleaning property has kept this and other buildings of the same material as new and bright as they were on the day of their completion.

The difficulties of Gothic architecture for domestic use, the desire for the picturesque, and the cheapness of labor and material soon called into being the Queen Anne style. The regularity and sobriety of the Mansard Roof houses gave place to Queen Anne waywardness and eccentricity. Dormer windows, bay windows, balustrades and turrets crowded each other and cried out for recognition on the distracted façade. These were halcyon days for the planing-mill and the jigsaw. Turned and sawed grills, balustrades and traceries formed the ornament. Plate glass windows had come into fashion, and at least one or two huge sheets proclaimed the opulence of the owner. These houses were invariably badly arranged; the stairways occupied a niche off the hall and reached the second floor after several turns; yellow oak became popular as trim, and hardwood floors replaced the pine painted boards of earlier days; corner fireplaces became fashionable, and these were made of several shelves and stories provided with little railings and niches and faced with variegated tiles. Cornices largely departed, and the fashion of dropping the picture moulding and leaving a frieze above prevailed. This frieze was highly decorated in fresco, or with a differ-

ent style of wall paper from the wall below. European travel had become popular, and alabaster replicas of the Leaning Tower of Pisa and bisque busts ornamented the mantelpieces and whatnots, and a colored photograph of the Taj Mahal, invariably referred to as the most beautiful building in the world, hung on the wall.

Finally, about 1885, the ripples of a great movement in the direction of good taste, initiated by H. H. Richardson, reached the Middle West. Burnham and Root in Chicago were building such splendid examples of the Romanesque as the old Art Institute and the Rookery Building, and their attempts to translate the style into wood and adapt it for domestic purposes were most interesting. The Fuller House, hooted

at by the proud owners of Queen Anne mansions at the time of its erection, was fairly revolutionizing in its effect. Of the same period and style is the Eliot House, a beautiful example of Romanesque, worked out in shingles with the picturesque features of the Queen Anne without any of its barbarisms.

In 1893 came the World's Fair. Although it was a noble exemplar of good taste and correct architecture, yet it undoubtedly killed a certain amount of romance and native Americanism which had existed in the good and bad houses of previous periods.

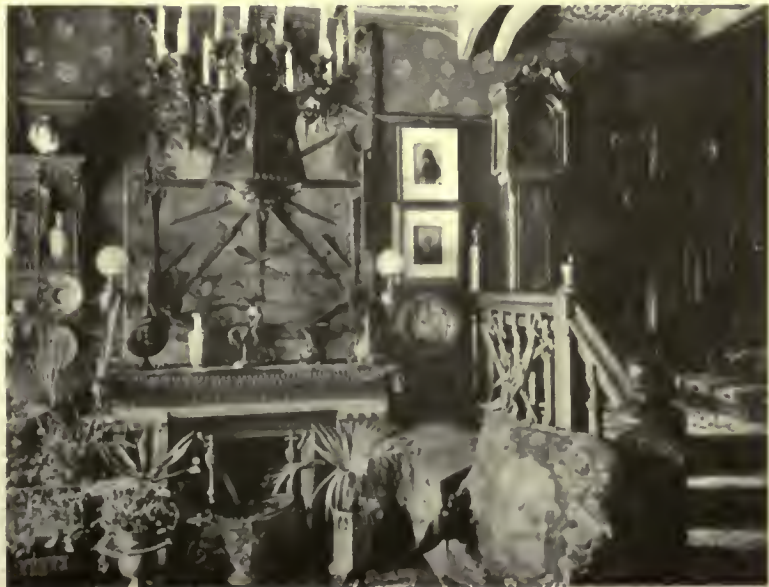

A QUEEN ANNE INTERIOR



## THE AMERICAN ARCHITECT



THE CHICAGO SCHOOL. AN EXAMPLE OF RATIONAL DESIGN

The nearest available style which employed the Orders was, of course, the Colonial, and a Colonial Revival ensued. Most of these Colonial houses, built in the late nineties, were Colonial, however, only in their employment of the Orders. A true appreciation of the spirit of Colonial architecture did not exist in any of them, and many of the shortcomings of the Queen Anne style, as far as interior finish and decoration are concerned, persisted.

By 1900 the accomplished eclecticism, initiated through the outpouring of the graduates of our architectural schools and through the dissemination of excellent periodicals on house building and good taste, had made itself felt with full force on our Middle West town. In addition to the styles practiced in the East, such as Elizabethan, Georgian and the 57 varieties of the Renaissance styles of France and Italy, we added our local school, owing its life to the Transportation Building by Louis Sullivan at the World's Fair. The house by Burley Griffin, Sullivanesque, translated through the example of Frank Lloyd Wright, the great Patten House by George Maher, and the Condict House belong to the local school, and are perhaps forerunners of a more truly national expression. A new revival in Colonial architecture also made its appearance. Now the Georgian and Colonial styles were treated with discernment and

understanding. Full-fledged and accomplished eclecticism now prevailed.

The introduction of expanded metal lath and the rising cost of dressed lumber made stucco, or a rough cast cement finish for exterior work, cheap and desirable, and this, together with the arrival of an English architect, made the English half timber Elizabethan style very popular. Very soon houses of all styles and of various vintages began to wrap about themselves white mantles of lath and cement—white, also, no longer, as the increasing use of soft coal has transformed their snowy vestments to a degree of drab and dinginess greater than their pristine condition.

Architects and owners soon turned the guns of their improving taste on the design and furnishings of the interior. No longer would baseboard and picture moulding with a plate-rail in the dining-room suffice for the downstairs rooms. The next step was the wainscot and beamed ceiling treatment. The panels of the wainscot were often of burlap, and the imitation wooden beams performed prodigies of strength in supporting nothing but themselves. The walls were covered with burlap or grass cloth, and the woodwork was usually stained, birch mahogany being a favorite. The popularity of the Colonial swung the style back to painted woodwork and to wall papers again. Everything



THE CHICAGO SCHOOL. BUILT IN 1913. SHOWS SLIGHT ITALIAN INFLUENCE

THE AMERICAN ARCHITECT



A HOUSE BY BURNHAM & ROOT. ROMAN-ESQUE REVIVAL. 1887



THE CHICAGO SCHOOLHOUSE SHOWING INFLUENCE OF FRANK LLOYD WRIGHT



THE WORLD'S FAIR PERIOD. PSEUDO-COLONIAL. BUILT ABOUT 1894



"EASTLAKE HOUSE"

Built in 1877 and known at the time as an example of pure Eastlake



AN ELIZABETHAN HOUSE BUILT ABOUT 1895  
ERNEST MAYO, ARCHITECT

The introduction of metal lath and stucco made this style very popular



THE CHICAGO SCHOOL. A GREAT HOUSE FOR A CAPTAIN OF INDUSTRY. BUILT IN 1900  
GEORGE W. MAHER, ARCHITECT



## THE AMERICAN ARCHITECT



THE FIRST OF THE CHURCHES

The Methodist church built in the classic revival in 1856

must be white or ivory, and the furniture mahogany; the walls were now crowned with carefully profiled cornices; gay cretonnes hung at the windows, and silk shades softened the electric candles on the wall.

Gradually the present mode is swinging away from the well-loved, if somewhat saccharine, beauties of the Colonial. Now walls are covered with muslin and are panelled; and walls and woodwork



MODERN GOTHIC. THE METHODIST CHURCH  
BUILT IN 1910



VICTORIAN GOTHIC

Its Successor Built in 1871



ADVANCED ECLECTICISM GEORGIAN

BUILT IN 1915

are painted together in soft colors; chandeliers are with us again, often in softly colored or rusted iron; breakfast porches essay daring combinations of purple, green and blue, in painted furniture and hangings; and now the smartest of our house furnishers are haunting the ruins of old dormer roofers in the hope of snatching from oblivion some forlorn marble mantelpiece with its rococo mouldings or its Eastlake ornament, to resurrect it in the glory of the fashion of today.

## THE AMERICAN ARCHITECT

About 1900, like the camel that poked its nose into the Arab's tent, the first flat building appeared. Slowly at first, and then with the rapidity of a contagion, these buildings sprang up, most of them designed by contractors and built by promoters from the nearby metropolis, perfectly willing to exploit and defile the peaceful and beautiful village, whose greatest treasures were its sunlit lawns, its arching

the home dwellers have been safeguarded and the camel, if not kicked out of the tent, at least denied further entrance by the enraged Bedouin.



AN APARTMENT BUILDING BY MYRON HUNT  
Built in thoughtful relationship to its surroundings and carefully studied in design

elms and its hospitable homes. Let it be known by other towns suffering under the same menace that the community finally awoke, and through the extensions of the police ordinances and building laws



AN APARTMENT BUILDING IN THE HEART OF  
THE RESIDENCE DISTRICT

Equally oblivious to the rights of neighbors and to the principles of good design

In other than domestic architecture our mid-Western town is in no degree notable, if we except its churches. Here we run the same gamut of the styles from the early Classic Revival frame building of the fifties, through the Carpenter Gothic or Queen Anne of the seventies, down to the Gothic Revival of the last decade, of which be it said that it is the most encouraging, the most consistent, and the noblest tendency in American architecture since the ill-starred Romanesque Revival of Richardson.





# Recent Legal Decisions

## CONNECTING OWNER WITH WORK CONTRACTED FOR WITH GENERAL CONTRACTOR

In an action to recover a balance alleged to be due for work done on the defendant's buildings at the defendant's request, the trial court dismissed the complaint on the ground that the plaintiff had failed to show any connection of the defendant with the work done, and that one of the plaintiff's witnesses had testified that the plaintiff had not performed the contract. This was reversed by the New York Appellate Division for the following reasons: The evidence showed that the plaintiff's work was begun pursuant to a contract made in the names of plaintiff and another with S. & B., contractors; that no other contractor was substituted for S. & B.; that the work was performed in the improvement of the defendant's property; that the defendant's supervising architect superintended the work and made reports thereon to the defendant; and that all payments, except the last one to recover which the action was brought, were made to the plaintiff by the defendant's checks. It was held that it was not essential to the plaintiff's cause of action that he should prove an express agreement with the defendant, substituting the defendant for S. & B. contractors, or undertake to pay the plaintiff for his services. No such contract was pleaded, and the evidence given was sufficient to put the defendant to its proofs. The plaintiff was not concluded by the testimony of his witness contradictory of his own; but a question of credibility for the trial judge was presented.—*Nerenberg v. Bronx Shore Park Dev. Co.* 172 N. Y. Supp. 507.

## CONTRACT OF SALE OF REINFORCED STEEL

In an action to foreclose a lien on account of reinforcing diagrams and steel furnished in changing a building from mill construction to a fire-proof building with reinforced concrete floors, the defense was false representations as to the amount of steel to be furnished for the contract price, as to the time of delivery, and failure to deliver as agreed. The contract was not to furnish a definite quantity of steel, but all that was required. Thirty-nine tons were necessary, while the contract estimated it would be fifty tons. It was held the buyers could not avoid payment by setting up misrepresentations as to amount. The written contract could not be varied by parol evidence of prior representations or agreements as to the time of delivery. The reinforcing steel was ordered from stock, not mill shipments, and the material was

furnished within a reasonable time. It was held that the buyers could not complain that mill shipments were made, although the jobbing company, not a manufacturer, from which the seller procured the steel itself, procured a small part from the mill.—*Wheeler v. Pitwood*, Washington Supreme Court, 175 Pac. 289.

## EXTENSION OF TIME FOR FILING LIENS

Where work or material is, in good faith, furnished at the request and with the knowledge of the owner, to remedy defects in the original work, and not done for the purpose of reviving a lien which had been lost, this is sufficient to establish a new period from which the time for filing notice or claim of a lien is to be computed. But where the subcontractor fails to file his lien for material and labor furnished to the contractor within the statutory time, though the owners declare a default as to the general contractor and complete the building themselves, the furnishing to them of material and labor by the subcontractor, not for repair work done in connection with the original contract of the contractor, will not extend the time for filing a lien for the material and labor furnished under the original contract.—*Decatur Bridge Co. v. Standart*, 208 Ill. App. 392.

## AGENT OR INDEPENDENT CONTRACTOR?

Action was brought against an owner and his contractors for the collapse of the plaintiffs' building, where the party wall owned by them and the defendant owner collapsed when its foundation was being replaced by the defendant contractors. Judgment against the defendant owner alone was affirmed on his appeal for the reason that the contractors were, under the circumstances, merely the defendant owner's agents and not independent contractors. The work done by them was performed under a written contract by which they undertook to "superintend" and "direct" the work of wrecking an old building and constructing a new one on the site; while they were given authority to employ all necessary labor and procure all necessary materials for the performance of this work, all such doings and expenditures were to be reported, with proper vouchers, to the owner every week, and he bound himself to pay promptly the expenses thus incurred, and repay any advances made by them on his behalf, together with an agreed compensation for their services. Being the owner's employees or agents, he was liable for their negligence.—*Wright v. Goldheim*, Iowa Supreme Court, 169 N. W. 343.

# Improvement of Farm Buildings and the Country-Side

By GEORGE W. MAHER, *F. A. I. A.*

THE movement so ably presented and championed by THE AMERICAN ARCHITECT for the improvement in plan and design of farm buildings and their immediate surroundings is bringing forth results of a most commendable and gratifying nature.

The encouraging responses received from Governors of many States, published in the December 4 issue of THE AMERICAN ARCHITECT, and the interesting letters published March 12 from many and widely separated State Agricultural Colleges and Institutes throughout the length and breadth of this country, testify most eloquently to the actual and immediate need of constructive methods to solve the farm building problem for the purpose of bringing order and beauty out of what now appears a depressing and chaotic situation.

There are many reasons of gravest import, why the light of intelligence and understanding should be brought to bear on this great issue. It is not a local problem affecting any one particular section of America; with rare exceptions the farm building situation is the same all over; the lack of order and of appropriate architectural design in farm buildings is general throughout the country.

The country-side as a whole is sadly deficient in taste and attractiveness so far as the work of man is concerned, and if it were not for the rare beauty of bountiful nature, the sweep of the open and the sky, the valleys and hills, the forest and the broad fields, there would be little to attract or inspire the beholder.

It is obvious that our civilization founded on the democratic ideal should progress in such an orderly manner that all phases of society, of life and habitation should co-relate and progress harmoniously so far as is practical and possible for the common good of all.

Although the city and the country will always portray in their respective developments certain inevitable differentiations inspired by conditions and environment, yet the art and architecture of the city and country should relate in respect to established standards of harmony and beauty and move apace so as to appeal to all people alike irrespective of place of residence or habitation. This phase of orderly development did occur to a limited extent in the early history of our country, notably in the Colonial Period. Country mansions and surround-

ings erected by the prosperous and educated farmers and planters vied in taste and attractiveness with city mansions of the same period, and thus in these country and rural districts the people were distinctive and cultured, in fact were a people as a class who exercised a tremendous influence in the proper and rational development of this country, such as our illustrious first president, George Washington, and many others well known in early American history. These old homesteads are still in evidence and are revered to this day as fine examples of American rural domestic architecture.

The lack of attractive farm houses and surroundings in our present day has been generally recognized and earnest efforts have been made with more or less success by those interested in improving the situation. It seems, however, that the results obtained have not been so satisfactory as the importance of the situation demands. General publicity has been given to the subject in many of our widely circulated magazines, and various designs of merit have been proposed at reasonable costs for the use of the farming and agricultural classes. Although the results so far apparent do not indicate that the right or consistent method has yet been evolved to reach the issue fundamentally for permanent nationwide progress, yet there is no doubt that the general publicity already given has been of great value in preparing the country for the next advance forward in order to achieve the desired end.

It would seem that our State Universities are the great mediums through which to carry on in a practical and constructive way the orderly improvement of farm buildings. A careful perusal of letters received from those in authority in these State Institutions clearly indicates this fact since they are in close touch with the situation and in accord with the desired results to be accomplished. It is they who recognize clearly the need of a state and national movement to assist the farming classes.

The State Universities supported directly by the people have the principle of organization at hand for carrying the work forward vigorously and consistently through the years.

What seems necessary at the present moment is to bring our representatives and legislators to an appreciation of the importance of this movement and through them provide ways and means properly to perform the work in our State Universities.



## THE AMERICAN ARCHITECT

For this reason it seems advisable that special State Commissions be created for this technical work, whose functions shall be to investigate all the problems affecting the farm building situation, and to prepare careful and exhaustive surveys of the exact situation.

This survey shall also discuss all that pertains to the beautifying of the country-side, such as the need for well designed bridges to be erected over the many brooks and streams in connection with the great road building propaganda now inaugurated and for which millions of dollars have been appropriated.

Such a commission could link with its survey all that pertains to the road details so necessary to aid their attractiveness, such as permanent and artistic sign posts, proposed monuments and fountains, school buildings and churches, and small country parks in connection with country hamlets. These features of beautification should all be brought into a proper correlation with the farm building proper as being a part of and affecting the great problem of the general betterment of the country-side.

Such a report or survey should be given the widest publicity to form a basis for State Legislation in order to provide the financial means of solving the present conditions, especially intolerable in the country, and commencing the new reconstruction era now upon us in America in a way that will be of lasting value to the entire people.

The farmer and farming class left entirely to themselves can make little progress in the direction indicated, the assistance must come through those same sources of inspiration and of knowledge which teach scientific methods of agriculture and which have achieved such distinct success in this country.

Building is a science as well as an art and must be taught systematically and with understanding. The agricultural colleges should be fully equipped for this purpose since they are close to and in sympathy with the farming classes and understand their needs. Men of vision and sound architectural training, who are in full accord with the farming classes and understand the problems affecting the farm, should be employed in the curriculum.

There can be little doubt that if the country-side can be provided with improvements of a type that

lend beauty and attractiveness in color, design and architecture, linked with all of the modern accessories that inevitably accompany orderliness of plan and procedure, the perplexing problem now presented to the nation of encouraging the farming classes and children to stay on the farm and homesteads is a long way toward being permanently solved. It resolves itself upon all of those in authority most interested in the welfare of the country and the beautifying of the environment of the farming classes to bring about this most desired result.

---

### Proposed Victory Building at Springfield, Mass.

ALBERT WINSLOW COBB, *Architect*, and ALBERT H. LAVELLE, *Consulting Architect*.

A Victory federal building is proposed by the Citizens' Improvement League of Springfield, Mass., for housing the post-office, custom house, Federal Land Bank and Federal District Court, with various supplementary offices. Albert Winslow Cobb with Albert H. Lavelle consulting, are the architects of the accompanying design of the memorial. It would be 230 feet long and 174 feet wide, and constructed of light stone.

The design of the building includes a war memorial symbolic of the heroic victory achieved by our gallant forces in the world war. This memorial feature is in the grand stairway and fore-hall of the Federal Court where naturalizations will be held, thus constituting an appeal to patriotism for new-made citizens. Internally and externally the dome, a concept recommended by the postmaster for dignity of effect, crowns all.

The principal façade also has panel titles of battles in which the 104th Massachusetts regiment engaged—Belleau Wood, Chateau-Thierry, St. Mihiel, Argonne and Alsace-Lorraine. It provides for medallions of the three chief war presidents of the nation. The committee believes a building of this design for federal purposes is befitting Springfield's dignity as represented by her municipal and commercial structures.

# Is the Cost of Construction High?

*The Government's Policy in Stimulating War Production and Curtailing Non-War Production, As Affecting the Difference Between the Cost of Labor and Materials in the Building Industry and Labor and Material Costs in General, Interestingly Traced in the Following Résumé of Conditions by the Division of Public Works and Construction Development, U. S. Department of Labor.*

**D**URING the war about one-third of the country's industrial capacity, including man power, was diverted to war production. To bring about this great diversion of industry two means were employed: stimulation and curtailment. Stimulation was practiced throughout the war and affected the prices of materials and the wages of labor because Government contracts were awarded on a basis which permitted contractors to compete successfully with non-war manufacturers for materials and labor.

Curtailment was not important until early in 1918 except for the orders of the Fuel Administration and the Railroad Administration for the purpose of conserving fuel and transportation, and certain priority orders.

But in a statement of February 5, 1918, Secretary McAdoo requested that homes should not be built except in case of urgent necessity. The statement contained by implication the premises on which the radical curtailment of the building industry was later carried out, i. e.: (1) that conservation of materials, labor and credit was necessary in order to win the war and (2) that the conservation must take place in those industries that were not essential, or only in part essential, to the winning of the war. Some time after the publication of Secretary McAdoo's statement, the policy of seriously curtailing non-war production was put into effect. Eventually the production of sixteen building materials was cut down 25 to 60 per cent. Non-war construction was greatly restricted until it was almost completely stopped from September 3, 1918, until the armistice was signed. It was estimated by the Chief of the Building Materials Section of the War Industries Board that the non-war construction in 1919 would be not more than 10 per cent of normal. This estimate indicates how great the diversion of labor and capital from the construction industry had been.

The stimulation of war industry and the curtailment of non-war industry was mainly carried out directly or indirectly by the Capital Issues Committee, the War Industries Board, and the War Labor Administration. Not only were prices of building materials affected by the stimulation of war industries, but in many cases also by direct price fixing. The same was true of the wages of labor. The power of the Government was exercised toward the lowering of prices of materials and the

wages of labor in non-war industries in order to prevent labor and material from being drawn away from the war industries.

This brief sketch of the Government's policy in stimulating war production and curtailing non-war production explains the difference between the cost of labor and of materials in the building industry and the cost of labor and of materials in general which was found to exist at the close of the war.

At the close of the war the index number of building materials, not including steel, had risen only 61 per cent over the pre-war prices of 1913, while the index number for commodities, exclusive of building materials, had risen 113 per cent. The average increase of wages in the construction industry in forty-one leading cities from 1914-1918 was only 28.5 per cent as against a rise of 94 per cent in commodities. When the armistice came, there was, of course, a great volume of deferred construction projects, partly in the form of public works, partly in the form of semi-public utilities, partly in the form of housing and of commercial and industrial buildings. This volume of deferred construction represented in large part the curtailment of non-war production which had resulted from the diversion of one-third of the Nation's industrial capacity to war production.

Fortunately the return of peace did not mean the complete, abrupt end of war production, yet it threatened serious unemployment. In order to minimize unemployment during the period of economic readjustment, the Government promptly removed the restrictions which it had imposed upon the construction industry. There probably never was a time when broadly speaking optimism as regards industry was better justified or meant more to the country than at present. It is distinctly encouraging to the construction industry to note that optimism—reasoned optimism—is most emphatic in the literature published by the leading banks of national reputation, compiled for them by trained investigators.

Evidence of a helpful attitude on the part of banks toward real estate is not wanting. In the great borough of Manhattan, in New York City, mortgages aggregating \$8,500,000 in value were extended (renewed) in January of this year, as against \$2,600,000 in January of last year. That is to say, the banks and insurance companies are not



## THE AMERICAN ARCHITECT

now, as they were a year ago, calling upon real estate borrowers to pay off loans in whole or in part.

Furthermore, 13,500 building permits were issued in 152 cities this January as against 9600 permits a year ago. The average value of the January permits this year was \$1,700, compared with \$2,800 in January, 1918. A year ago, it will be remembered, the Government was building extensively, and, besides many factories were being erected for war production. Fifty-four per cent of the cities showed gains in building this January over the preceding January. It is to be noted also that January, 1919, gained over December, 1918, although building permits are normally fewer in January than in December. The significance of these building figures is that there is a tendency to build extensions, to make structural repairs, and to erect inexpensive buildings, including particularly housing. The figures bear the characteristics one looks for at the beginning of a revival of the building industry.

It takes time for private building to get under way, and still longer for public works to get started in volume. However, the reports received from state, county and municipal officials justify the belief that an exceptional amount of public construction will be undertaken this year.

The turning of the tide in the construction industry that we have all been looking for since the armistice has unquestionably come. However, there are still obstacles in the way of its rise to normal. The most important of these is the high cost of construction as compared with the pre-war period. Not a few bankers and investors decline to consider a building project to-day merely because of the high cost of construction. Those who take this attitude do not generally stop to analyze the high cost of construction which alarms them so.

Although construction costs are higher now than in 1913, the union wage scales in the building industry have not advanced as rapidly as have the cost of living, while building material prices are not as high as are commodity prices. Wage increases in the construction industry, speaking generally, lagged behind because that industry was utilized to only a small degree in war production. The level at which the cost of construction stands to-day has been pushed up only slightly by temporary war conditions. It has been fixed mainly by conditions that can not be materially changed for years to come—by the tremendous expansion of money and credit.

During the war the volume of money and credit increased far more rapidly than the volume of industry and commerce; hence prices rose. But expansion of credit through Government loans is a world-wide condition which must hold up prices

everywhere until the Government debts are largely discharged.

The fact is that the cost of construction is not high today. It is low compared with food, clothing and commodities in general. It is high only in comparison with its own pre-war level. Commodity prices will undoubtedly recede because food and clothing and many other things were affected by special war conditions, for example, scarcity of transportation which prevented shipments from distant countries to the Allies. But they can not fall to the pre-war level.

But, although some readjustments in the wages of individual trades and in the prices of individual classes of building materials may take place, the cost of construction will not come down to such an extent as to endanger a judicious investment made today in the erection of a new building. Where the rents offered will show a fair net return on the cost today of a new building after deducting a reasonable sinking fund allowance, no one should hesitate to build or to lend money for building.

Rents are determined by supply and demand. In the case of housing, during the early part of the war, the demand was curtailed by the rapid advance in commodity prices, which impelled many tenants to crowd into or get along with less space than their normal standard of living required, and by the drafting of the young men of military age. With a year, however, these influences had spent their force. By the end of 1919, according to the replies obtained from a questionnaire sent to real estate boards in 91 cities, only four of these cities had a housing demand that was below normal, while in 52 cities rents had advanced 10 per cent or more, in some instances 40 per cent to 50 per cent. This rise in rents took place at a time when the population at home was as economical of house room as possible and while several millions of soldiers were absent in the service.

Another important fact was disclosed by the replies to the questionnaire, namely, that despite rising rents for housing in the majority of the 91 cities, the market values of house sites had declined in six cities, and had remained practically stationary in 72. The market value of land is, like rents, determined by the interplay of supply and demand. During the war the demand for city land was relatively small, because dealing in real estate was discouraged by the banks as a non-war activity requiring the use of credit. With a restoration of easier mortgage loan conditions, the demand for real estate will inevitably increase; nothing can seem more certain than that in our growing Ameri-

*(Concluded on page 459)*

# THE AMERICAN ARCHITECT

Founded 1876

PUBLISHED EVERY WEDNESDAY BY

THE ARCHITECTURAL AND BUILDING  
PRESS, INC.

No. 243 West Thirty-ninth Street, New York

E. J. ROSENCRANS, PRESIDENT AND TREASURER  
WILLARD C. HOWE, VICE-PRESIDENT

WILLIAM H. CROCKER, Editor  
ARTHUR T. NORTH, Engineering Editor

Subscriptions in the United States and Possessions,  
Mexico and Cuba, TEN DOLLARS. Other Countries,  
TWELVE DOLLARS.

SINGLE COPIES (Regular Issue) 25 CENTS

CHICAGO OFFICE, Mallery Building  
PAGE A. ROBINSON, Western Manager

ST. LOUIS OFFICE, Wright Building

CLEVELAND OFFICE, Guardian Building

SAN FRANCISCO OFFICE, 320 Market Street

Owned by United Publishers Corporation—H. M. Swetland, President;  
Charles G. Phillips, Vice-President; W. H. Taylor, Treasurer;  
A. C. Pearson, Secretary. Entered as second-class matter January  
6, 1909, at the Post Office at New York, New York, under the Act of  
March 3, 1879.

VOL. CXV MARCH 26, 1919 No. 2257

## The Conflict Between Pure Design and Fitness

A LETTER, recently published in THE AMERICAN ARCHITECT, calls attention to the art of planning in the following words:

"There is bound up in the daily practice of architectural design an art so subtle that few laymen realize its existence, and few architects themselves accord it a position which its importance should demand. Its practice is based upon information of such an exact nature that it might almost claim a place among the sciences as well as among the arts. We refer to the art of planning."

There is always the inevitable conflict between what is known as pure design and fitness of design. A building constructed on the basis of pure design may fulfill all of the sensuous demands of the most cultivated taste and still be a failure as a building for human use. The elements that constitute fitness are capable of being segregated into two distinct groups, the aesthetic or sentimental and the practical or utilitarian. Both are essential, but the degree of their influence is fixed by the use of the structure.

To combine both elements in the correct proportion is the true test of architectural efficiency and this is the case regardless of the character of the

building. The problem is involved as much in the designing of the industrial building as in the monumental building. As stated by our correspondent, the basis of all correct design is correct planning, to which the enclosing structure must be applied. This envelope must satisfy, as far as the circumstances permit, the aesthetic needs of the community. The true test of architectural ability is to combine these two elements in a perfect relation to each other without a servile copying of any existing structure. To do this is difficult and requires a great expenditure of real work and imaginative energy.

In this issue of THE AMERICAN ARCHITECT in the Department of Architectural Engineering is a happy illustration of a proper and satisfactory balance of good planning and designing which was accomplished by applying the idea of "fitness to function." Every demand of utility with correct architectural expression has been fulfilled.

## The Post-War Program

RELATION OF THE INSTITUTE TO OTHER  
PROFESSIONAL SOCIETIES

WHEN, during the course of a series of interesting impromptu remarks, printed in our issue of Feb. 12, D. Knickerbacker Boyd at the last convention of the Institute stated that architects owed a reciprocal obligation to other societies, he struck the nail squarely on the head.

Mr. Boyd directed attention to the fact that various departments of the Government and many organizations throughout the country are performing valuable services to architects by issuing publications of great interest to their profession. He very pertinently asks, what can architects do to reciprocate this obligation?

If it is claimed that architects are affiliated with many of these organizations and are therefore indirectly participating in this work, it may be bluntly stated that such a statement is not fact. But if it is assumed that architects are indirectly co-operating with other societies, is it not pertinent to inquire why they are not through their own organization rendering in part a service that they find so valuable when given by others?

If the Institute either through its Board of Directors or its State Chapters fails to give publicity to discussions and investigations of problems that are of vital interest to other professions, may it not be asked if they are not neglecting a most important service? To be sure, we have at each convention many carefully prepared reports, most of them of a valuable nature. What becomes of these aside from the printing in the *Journal*? Are they sent to allied societies, are they circulated



## THE AMERICAN ARCHITECT

among the architectural press and that of the arts and crafts allied to architecture? It is easy to recall many reports during the past few years that if widely distributed would have had far-reaching influence in acquainting the general public as to just what the practice of architecture represents.

**P**ARTICIPATION in the activities of other related organizations is not so general among architects as it should be. Does not every architect reap substantial benefit from the work of the American Society for Testing Materials? Mr. Boyd states he found but three architects to be members of that society. Again, the National Fire Protection Association has through its efficient organization and a campaign of education sent broadcast at considerable expense material help for every architect in the country. Mr. Boyd directs attention to the fact that a recent report of a committee on fireproof construction states that it had been prepared in collaboration with representatives from eleven important organizations, but he fails to find in the list the American Institute of Architects.

These instances are cited as indicating the seeming apathy of the profession of architecture toward questions, investigations and propaganda in which they should be active.

**I**F the profession of architecture as an organized body is to become as virile as other societies with which it necessarily comes in contact it must pursue the same methods as do those societies, none of which are in the least moribund. Architects must not be content in a self-satisfied observation of their own particular field. They have a reciprocal obligation. They must realize this, pay the debt they owe, and by this very straightforward course assume the station among the ranks of men to which they are by education and practice so eminently qualified.

These important matters will undoubtedly receive careful consideration by the Post-War Committee. To give it such attention and enable it to arrive at a correct conclusion it should be placed in possession of the views of men in practice.

The more the program of the Post-War Committee is studied the more one becomes impressed with the importance and the comprehensive manner of its framing. But the essence of success lies wholly in co-operation, and it will be unfortunate if there is a disposition toward apathy in this direction that will jeopardize the attainment of a high purpose.

**C**ONSIDERING the relationship of the American Institute of Architects to the profession as a whole (Subject C of the Program), and including with it an analysis of the purpose of a professional organization (paragraph d of Subject D) numerous illuminating things will be discovered, and on these there no doubt will be many and diverse opinions. As the desirability of a controlling organization in the profession is conceded, only the method of organization and its administration as representing the profession needs to be discussed.

Just what the relationship of the Institute to the whole profession should be can be stated in one word: representative. Not representative solely of Institute membership, but of architects in good standing everywhere in the United States irrespective of affiliation. Having assumed this representative function, the Institute will necessarily be expected to fulfill all of the obligations which such assumption imposes. It will have to be democratized, become aggressively practical, and it must by its every act show to the world at large that architecture is always an essential profession. It may subordinate, and in some instances entirely ignore many things upon which in the past it has placed emphasis. It might, for example, amend and considerably condense the Circular of Advice and Canons of Ethics, acting on the assumption that many of the present provisions in these documents on which so much time has been wasted, are unnecessary in a professional code of to-day.

Then there is the all important question of the State Societies and their relation to the Institute. Why not a special committee on State Societies with a view to their organization in all the states, their federation and the determination of their exact relation to the Institute?

Shall we concede any of our nationalism if we enter into a league with our professional brethren in Europe? Will it not make for a broader and a higher plane of professional practice if our relationship with the men abroad becomes more definitely practical than at present? Would it be advantageous to invite representatives from societies in Europe to attend our conventions and arrange on our own part for a representation of the Institute at the meetings in Europe?

We recall with considerable pride the very flattering reception accorded in England and France to representative American architects who have visited these countries and addressed their meetings. Could we not with advantage arrange for a continuation of this desirable custom?

## Cost of Construction

(Continued from page 456)

can cities the market value of land must advance briskly.

A judicious investment in the erection of a new building does not depend solely on the cost of con-

struction. It may well happen that the man who buys a lot today and builds on it a house the cost of which is not greatly out of proportion to the cost of the land will be better off a year from now than he would be if he had left his money in the savings banks in the meantime. City land at present is least inflated of all material wealth.

# Financial and Commercial Digest

As Affecting the Practice of Architecture

## Financing Building in Southern California

That prospects for the early construction of new buildings of all classes in southern California are excellent is the opinion of Harry Lee Martin, vice-president of the Mortgage Guarantee Company, of Los Angeles, Cal., who declares in a letter to THE AMERICAN ARCHITECT that the situation is "healthy and altogether satisfactory."

"While the problem in southern California takes a special form, and is affected by conditions that probably do not prevail elsewhere," writes Mr. Martin, "the financing of the building in this territory will be comparatively easy. It appears that building and loan associations, mortgage companies and private individuals are able and ready to make whatever loans are offered on a sound basis; that is to say, to make any and all loans that are not excessive.

"It is evident, however, that building operations will be curtailed to an appreciable extent by reason of the fact that costs of building material and building are still high. People generally expect a great reduction in prices, but there are some well qualified to judge who believe that the cost of material, both wood and metal, will not be appreciably reduced for quite a while. The situation is healthy and altogether satisfactory, with an evident readiness on every hand to start new buildings of all classes."

## Building Operations Show Gain

A substantial increase in building operations is shown in reports from various cities for the first time since January, 1917, a gain of 24.2 per cent in February over the same month a year ago being recorded by *Bradstreet's*. In New York alone

the gain over February last year was 90 per cent. One of the larger metropolitan construction companies, now doing the largest business in its history, has orders on its books totalling approximately \$75,000,000, compared with \$41,000,000 at this time last year.

## Reduced Wages and Building Resumption

That a reduced wage scale is not an indispensable preliminary to resumption of activity in the building trades is the opinion of Morton C. Tuttle, just retired as production manager for the United States Emergency Fleet Corporation. Mr. Tuttle bases his judgment on some very recent investigations of large construction enterprises located at various points from New England to Florida. These unmistakably indicate that increased efficiency of labor is bringing down costs even while wages remain at existing altitudes.

"In the course of viewing numerous undertakings more or less closely associated with interests of the Government," says Mr. Tuttle, "I have lately been impressed to find the statement commonly made that costs of operation are beginning to show a noticeable decline. And this, almost without exception, was attributed to increased efficiency of the labor force, due in part to the opportunity for weeding out the less dependable workers, in part to the growing desire of all members of the force to retain their jobs.

"Owing to inadequate or otherwise unsatisfactory cost systems maintained in connection with most of these undertakings, I found it impossible fully to check the statement by actual figures. Accordingly, I made out the cost of one process in an operation continued over a period of several weeks.



That which I selected was a piece of concrete work; the costs studied were those for the common labor employed on this work from January 7 to February 4 of the present year inclusive. During this period the wage scale remained unaltered; but the personnel of the labor force underwent frequent changes.

"A graph of the labor costs of the work during the period noted shows a sharp and almost undeviating decline from day to day. On February 4 these costs were exactly 50 per cent less per unit than were those of January 7. It is my belief that in almost any labor force there lies the opportunity of realizing economies ranging from 20 to 50 per cent without interfering with the wage scale.

"This implies, of course, that there is now increased opportunity for selecting men according to their suitability for a given task, and an increased eagerness on the part of the men to make good. But this is as it should be; and the whole country ought soon to feel the effect of it in general improvement at all points. It is a case of supplanting so-called liquidation of labor by proper adaptation of labor as a means of keeping the cost of doing things within the bounds of utility.

---

## Iron Ore Production in United States in 1918

Statistics and estimates of the production of iron ore in 1918, compiled under the direction of Ernest F. Burchard of the United States Geographical Survey, Department of the Interior, show a moderate decrease in output compared with the high records of 1916 and 1917.

The estimated quantity of iron ore mined in the United States in 1918 amounted to 69,712,000 gross tons, compared with 75,288,851 tons in 1917, a decrease of 7.4 per cent. The estimated shipments of ore from the mines in 1918 were 72,192,000 gross tons, valued at \$246,043,000, compared with 75,573,207 tons, valued at \$288,260,444 in 1917, a decrease in quantity of 4.5 per cent, but an increase in value of 3.3 per cent. The average selling value of the ore per gross ton at the mines for the whole United States in 1918 was \$3.41, compared with \$3.15 in 1917. The stocks of iron ore at the mines apparently decreased from 10,628,908 gross tons in 1918, or 23.4 per cent.

The decrease in output, which was general throughout the country, is probably to be attributed to a combination of circumstances. Industrial conditions were more or less disturbed, the supply of labor was uncertain, and transportation facilities

were inadequate, but notwithstanding these handicaps, the shipments from the Lake Superior district from April to October, inclusive, 1918, were over 2,500,000 tons more than those for the corresponding period of 1917. Owing to a scaling down of furnace requirements, however, in order to release vessels for carrying grain to Europe, the shipments in November and December, 1918, were nearly 4,000,000 tons less than those made in November and December, 1917. Government control of the entire steel supply, which became effective in June, 1918, undoubtedly regulated the demand for ore, and stocks at mines and lower lake ports were somewhat reduced, so that the consumption of ore remained about the same as in 1917.

About 86 per cent of the iron ore mined and shipped in 1918 came from the Lake Superior district, in which about 60,092,000 gross tons were mined and about 63,666,068 tons mined and 63,854,752 tons shipped in 1917, representing decreases of 5.6 per cent and 2.5 per cent, respectively in 1918.

---

## Call Money Rates at High Mark

The highest mark in more than two years was touched recently by call money rates on the New York Stock Exchange, when loans on good mixed collateral touched 7 per cent, and those negotiated on all industrial collateral loaned at 7½ per cent. These figures compare with the wartime maximum of 6 per cent and 6½ per cent, shortly after the flotation of the First Liberty Loan in May, 1917. The advance was taken as a warning that the stock market must go slowly. Bankers believe, however, that there will be no need for the reconvening of the money committee which was recently disbanded. While there are heavy demands being made on the money market now and although heavier demands will come in the near future, they are simply in response to the law of supply and demand.

---

## Steel Reports Conflicting

From various steel mills over the country conflicting reports of operations continue to come. It is decidedly evident that business is picking up, but reports of this character seem to be unevenly distributed, as some plants are working close to capacity, while others have taken up the high schedule maintained before the signing of the armistice. It is known that some mills are not merely restocking depleted supplies but are booking and filling substantial orders.

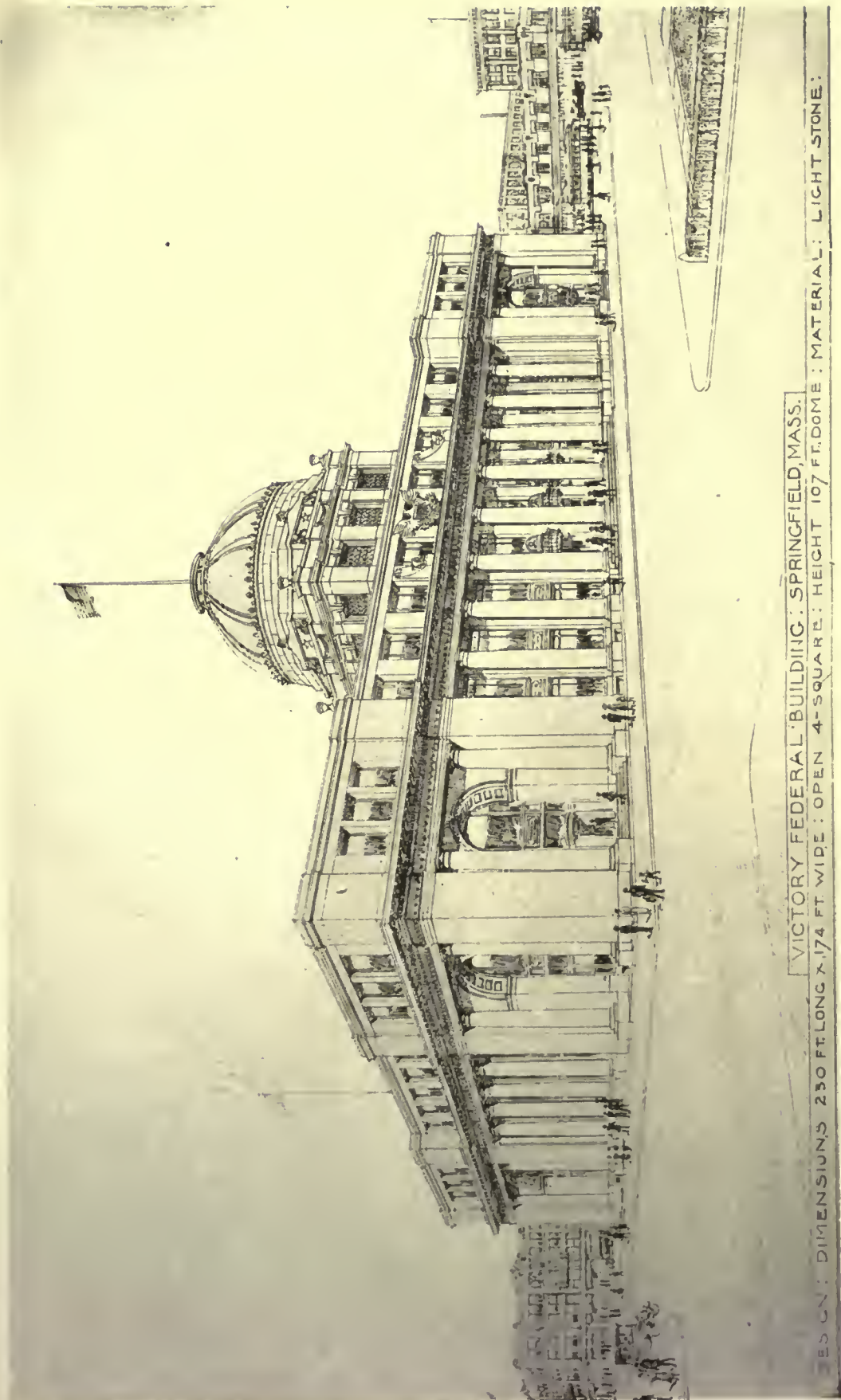

VICTORY FEDERAL BUILDING : SPRINGFIELD, MASS.

DIMENSIONS : 230 FT LONG X 174 FT WIDE : OPEN 4-SQUARE : HEIGHT 107 FT. DOME : MATERIAL : LIGHT STONE :

A. W. COBB, ARCHITECT V. H. LAVELLE, CONSULTING ARCHITECT











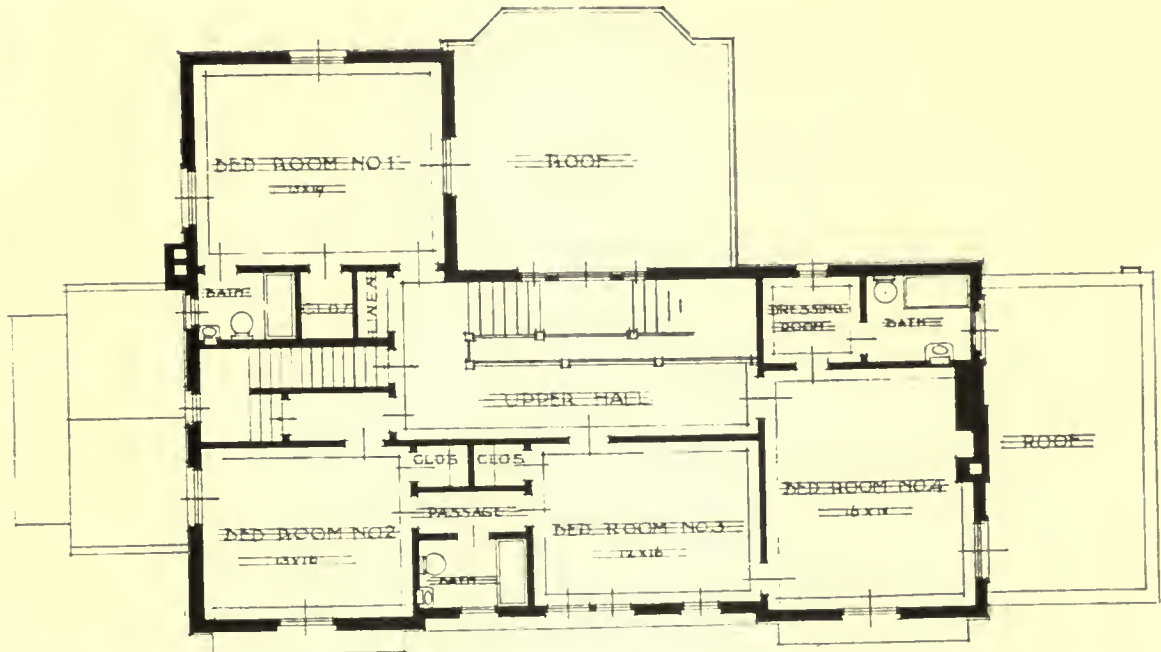

PLATE 96

HOUSE OF JOHN R. FLIPPIN, MEMPHIS, TENN.  
JONES & FERRINGER, ARCHITECTS







SECOND FLOOR PLAN

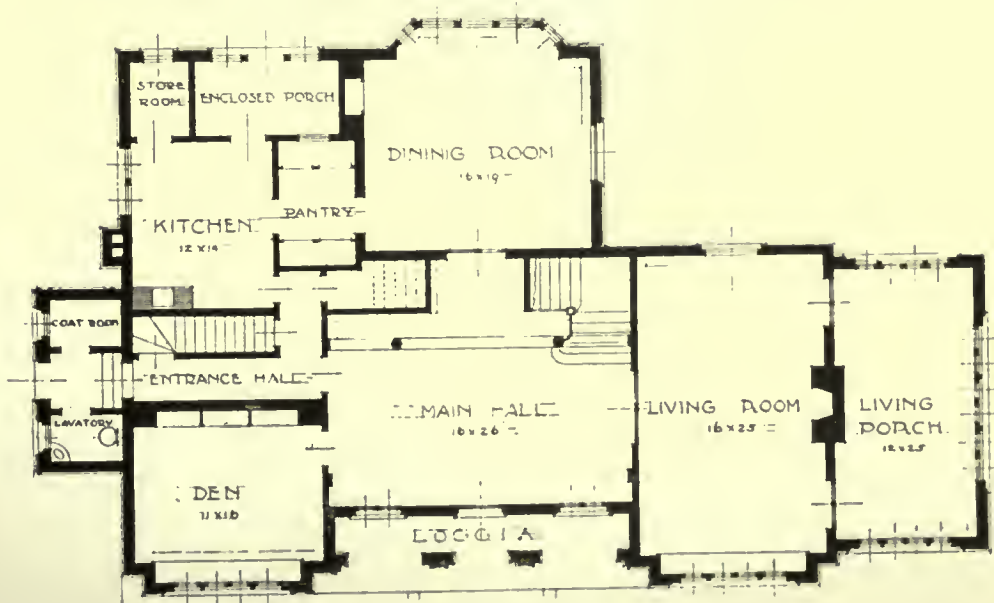

PLATE 97

HOUSE OF JOHN R. FLIPPIN, MEMPHIS, TENN.

JONES & FURBRINGER, ARCHITECTS







PLATE 98

MAIN HALL

HOUSE OF JOHN R. FLIPPIN, MEMPHIS, TENN.  
JONES & FURBRINGER, ARCHITECTS







LIVING ROOM



LIVING PORCH

PLATE 99

HOUSE OF JOHN R. FLIPPIN, MEMPHIS, TENN.

JONES & FURBRINGER, ARCHITECTS





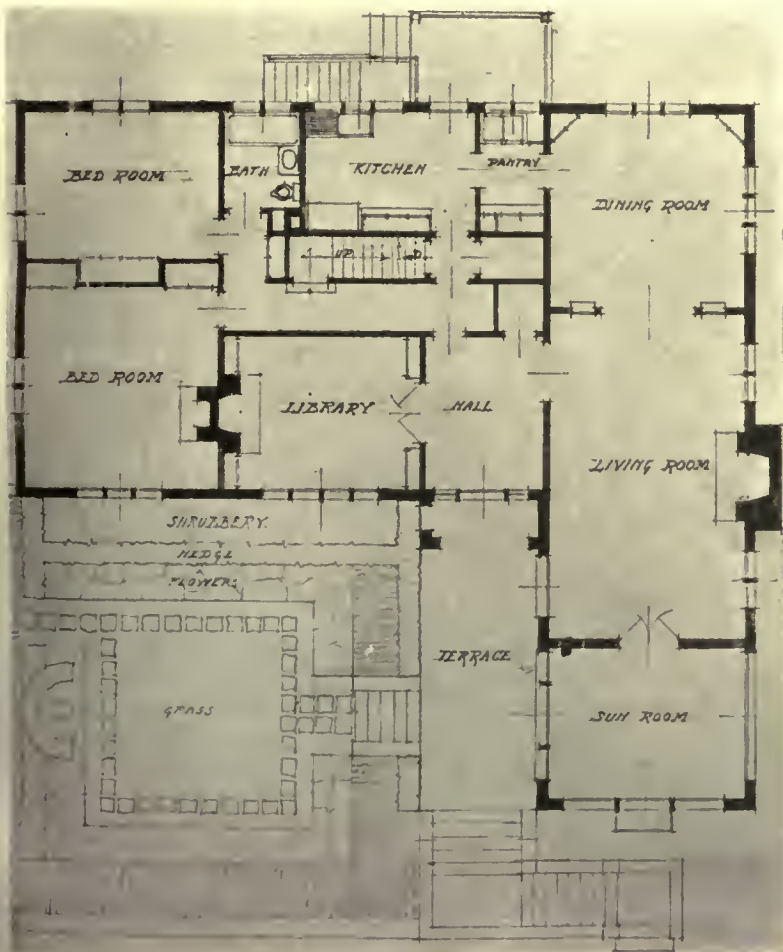

PLATE 100

HOUSE OF DR. E. S. BREESE, DAYTON, O.  
LOUIS LOTT, ARCHITECT







HOUSE OF  
DR. E. S. BREESE,  
DAYTON, O.

LOUIS LOTT,  
ARCHITECT







PLATE 102

HOUSE OF MR. BURTON P. GRAY, NEWTON CENTRE, MASS.  
COOLIDGE & CARLSON, ARCHITECTS







PLATE 103

HOUSE OF MISS WINSOR, NEWTON CENTRE, MASS.

COOLIDGE & CARLSON, ARCHITECTS





# Current News

## Aid in Selecting Appropriate War Memorials

A committee has been appointed by the American Federation of Arts whose services and advice are offered those throughout the United States who are considering the erection of war memorials. It is the purpose of the committee to afford assistance to officials, commissions and committees endeavoring to make memorials of the war express in permanently satisfactory manner feelings of honor, sacrifice and patriotism.

The Federation in a circular just sent out expresses the opinion that the American artist should be called on to design and to execute any structural memorials of the war and that in every community the memorial should be an individual, artistic creation. The committee is not interested in any particular form of memorial, or in any particular artist or group of artists, the only end in view being a memorial worthy of the community and the cause.

Convinced that thoughtful attention at the beginning of the project will bring good results, the committee may be consulted on the choice among the various forms of memorials, as to methods of selecting a designer and bringing the work to a satisfactory conclusion. The aim is not to dictate but to be helpful. Those desiring information touching any phase of the matter may communicate with Keila Mechlin, secretary of the general committee, the American Federation of Arts, 1741 New York Avenue, Washington, D. C.

## Pursue Interesting Pottery Study

The end of the war and a generous legacy bequeathed to the Pennsylvania Museum and School of Industrial Art enables that institution to continue developing the manufacture of what is known as Pennsylvania Dutch pottery.

The legacy was left as a memorial to Dr. Edwin A. Barber, a former curator of the museum. A committee has been appointed, with Mrs. Jasper Yates Britton as its chairman, and arrangements are now being made to erect a new kiln and install the necessary apparatus for studying this branch of the pottery industry, both for its artistic as well as for its commercial possibilities.

A hundred or more years ago, Dutch potteries were scattered over Bucks and Montgomery coun-

ties in great numbers. For various reasons, one pottery after another was discontinued, until there is now only one in the eastern section of the country, which is at Haddonfield, N. J.

Historians seem to have overlooked the fact that what might be termed ceramic literature was used as a method of transmitting ideas. By the union of expressive pictographs and inscribed words the workers in clay recorded the customs of the people who lived in the country districts, together with much of their folk lore and artistic progress.

## American Army Art School in France

The American Army University, the largest university in the English-speaking world, at Beaune, southeast of Paris, has opened a branch at Bellevue, near Versailles, for nearly 1000 students of art and architecture.

The American Army University is one of the four features of the educational system introduced for the benefit of the Expeditionary Force. The other features are post schools in all organizations for elementary work; division educational headquarters in all armies, corps, and divisions for vocational training and general education of high school grade and details of officers and soldiers as students at French and British universities for post-graduate college work.

Post schools have been established in units of 500 or more men. There are generally forty of such schools in each division, which will make more than 1000 in the American Expeditionary Force.

In the main school at Beaune 15,000 soldiers have enrolled for a three months' course. The faculty of 500 members, chiefly drawn from the American Expeditionary Force, is headed by Col. Ira I. Reeves, formerly president of Norwich University in Vermont. The study halls and dormitories were an American hospital during the war.

## U. S. Employment Service Activities

During the eight weeks ending February 22, the United States Employment Service received 1,090,124 applications from men and women for jobs. Of this number 930,029 were referred to opportunities and the remainder were reported placed in employment.



## More Houses the Remedy

The City Health Department, says the *Toronto Mail and Empire*, is denouncing "doubling up" of families in Toronto houses as being injurious to health. Dr. Hastings estimates that from 3000 to 5000 more houses would relieve the scarcity, and do away with the overcrowding.

But is not that view based on a misconception? What causes the overcrowding? Is it not a consequence of high taxes, high rents, and high property ratings? There is a shortage of houses, even for citizens able to pay high prices, but the doubling up that is injurious to health seems to occur mostly among the poorer families, and these are unquestionably victims of exorbitant values.

In the survey of 13,574 houses made by the Civic Housing Commission, it was found that in 4383 houses of four, five, six, seven or eight rooms there were two families. In 402 homes there were three families, and in 3954 homes there were lodgers or boarders. That is, in 64 per cent of the houses, either there was doubling up, or the taking in of outsiders to help pay costs. Surely this is significant of the actual conditions. It is not so much the scarcity of house accommodation that forces such doubling up as it is the imperative necessity of relieving unbearable costs of living. A four-thousand-dollar house, assessed at three thousand, will pay more than \$100 a year taxes, and heavy local improvements also, as a rule. Interest at six per cent is \$240. That is, the minimum cost of occupation of that house by a single family is at least \$30 a month, without regard to repairs. During the war rents have advanced about 50 per cent in many of the cheaper houses. In a family where there are several children to be fed and clothed, with prices as they have been, the paying of rents or taxes on a 31 or 32-mill basis is a hardship that brings up immediately the proposition of doubling up. Young couples getting married cannot, unless they have considerable savings, hope to buy their house and furnish it. They find it is better to go into two or three rooms. And with building costs what they are now, when the plain home of a wage-earner is from \$3,500 to \$5,000, what opportunity have they got to get into a home of their own? Paying rent, and living from hand to mouth, in the matter of housing, is the only alternative open.

The outlook for relief is dismal. As long as Toronto has a tax rate above 30 mills, on an assessment so high, the rents will not come down unless there is a depression that leaves many houses vacant. The building of large numbers of low-cost houses, as is proposed by the new housing commission to operate under the new housing act, ought to furnish some relief by making available homes within the proper economic reach of wage-earners. At present, to occupy a house good enough to satisfy reasonable requirements forces the average worker to go beyond his means. Overcrowding and doubling up will not diminish much until there is cheaper housing.

## Roosevelt Memorial Exhibition

A Roosevelt Memorial Exhibition will be held in the Avery Library Building, Columbia University, from May 1 until June 4, it has been announced by Prof. W. A. Braun, secretary of the memorial committee. The exhibition will consist of objects of every description connected with the life of Theodore Roosevelt, including manuscripts and mementoes lent by his friends.

Frederic R. Coudert will be treasurer of the me-

morial committee. The other members will be William Fellowes Morgan, Frederick Coykendall, Colonel Walter Sherwood, and Professors J. J. Goss and J. R. Crawford.

Among the personal friends of the late Colonel Roosevelt who will assist the committee are Otto H. Kahn, Stephen Baker, Benjamin B. Lawrence, Clarence Mackay, A. Barton Hepburn, and Felix Warburg.

## Favors School of Citizenship

Believing that Col. Roosevelt would have preferred a memorial appealing to the mind, Prof. Albert Bushnell Hart of Harvard has recommended the foundation of a training school of patriotism and citizenship to the Roosevelt Permanent Memorial National Committee.

In a letter to the committee, Prof. Hart suggests that the object of the school be to train teachers of government and politics from grade teachers up to college professors. He also suggests that a system of Roosevelt international fellowships be founded to give promising young men and women a chance to spend a year, or possibly two, in an educational journey around the world.

## France to Cut High Food Costs

With the expectation of lowering the cost of living in Paris forty per cent within a fortnight, the French Government has started an offensive against profiteering. Fifteen large sheds have been opened in various public squares for the sale of Government-controlled provisions. These supplies consist principally of food bought from interallied committees already in existence. The State will transport them from ports to selling places by special trains.

The Government hopes this scheme will result in reduction of other commodities through indirect pressure.

A model scientific ration for an average man, as worked out by the interallied commission, at present costs 65 cents a day in Paris, 42 cents in New York and 35 cents in London. Under the new Government sales system the cost will be only 39 cents a day here. If the Paris experiment is successful food will be sent to other towns, where it will be retailed either by the municipalities or approved merchants, subject to State control.

The Ministry of Food Supplies also is arranging a system of workmen's restaurants in Paris capable of serving 400,000 meals a day.

## French Ask Art Works for Those Ruined

As reparation for the works of art destroyed in France by the Germans, it is suggested by the French Academy of Fine Arts, according to the *Journal des Debats*, that works of French genius now in the collections of the former royal families in the public museums of Germany and Austria be put at the disposal of the French state, which will select some of these works as a legitimate indemnity. The petition sent by the academy to the government reads:

"The public monuments of twenty cities, cathedrals, museums, libraries and a large number of small churches known as the most precious among the churches of France have been mutilated and destroyed with the works of art they contained. In order to make up in a small measure for the loss of the home of the French works which composed our national art treasure destined to serve for the education of future generations, we do not demand that the museums of Germany and Austria be plundered, but only that the works due to French genius which are now in the collection of the former royal families and in the public museums in Germany and Austria be put at the disposal of the French state to let it select some works of art as a legitimate indemnity. The same can be said regarding the ravishing of the art patrimony of Belgium. Could pecuniary indemnities be considered sufficient to make up for the destruction of Louvain and Ypres? Belgium should be allowed to select a certain amount of Flemish works of art from the collections of the states which destroyed them on the same conditions as we demand for France.

"The destruction carried out in Italy which affected some precious works of Venetian art must also be compensated for, as justice demands, by the handing over of some Italian works of art now in possession of the enemy.

"In short, the signers of the petition demand that the following principle be written in the peace terms:

"That the diminution brought to the art treasures of the attacked nations be compensated for by the handing over of the works of art of the countries which have carried out the destructions."

## Utilize Wood Wastes to Conserve Lumber Supply

The United States Forest Service is experimenting in the utilization of wood wastes to conserve the timber supply of the country. Wood pieces and wood ends that were considered of no value are now used in the making of many valuable products. In the manufacture of aeroplanes and similar delicate structures there is much of the tree that cannot be used, but all ends and scraps are now being utilized in wood pulp and wood flour.

Wood flour is made by grinding spruce or hemlock on the end grain against a revolving grindstone, the wood being kept continually wet while grinding. It is then mixed with other materials for the manufacture of various articles. Because of the increased price of cotton, the use of wood pulp and

wood flour has been greatly extended. Tan bark has been successfully substituted for rags in the making of roofing felt, and a similar wood product is used in the manufacture of fiber for wood silk. Another method of treating wood is the paper making process in the production of furniture reed. Paper made from this chemical wood pulp is twisted into strands, and in furniture reed, shellac is applied for waterproofing.

## Improve Method of Plywood Manufacture

To find wood for air and sea planes that will be strong, light in weight, non-shrinkable and resistant to splitting has resulted in marked improvements in the manufacture of plywood. The strength of most woods when pulled parallel to the grain is several times that of mild steel, weight for weight, but wood is relatively weak across the grain and is susceptible to high shrinkage in this direction.

Plywood is made of several sheets of thin wood or veneer glued together so that the grain of any one sheet crosses that of both adjacent sheets. As many as twenty-seven or more sheets may be glued together to form a piece of plywood an inch thick. Such material has satisfactory strength in all directions, shrinks or expands little with changing moisture, has high resistance to splitting and is easily worked. It is therefore very satisfactory for airplane stock.

Thousands of tests have been made in the past few months at the Forest Products Laboratory to secure exact data as to the mechanical and physical properties of plywood, and as a result its use promises to be much extended.

The wing ribs used by the Bureau of Aircraft Production in one of the types of machines were developed by the Forest Service. These ribs were 30 per cent lighter than those formerly used and twice as strong. The laboratory has also shown the possibility of using many species of woods for plywood heretofore considered unsuitable for airplane manufacture.

As may be seen, the glue is a very important part in the making of plywood, but tests have resulted in the manufacture of a glue that is so water-resistant that plywood may be soaked in water for ten days or boiled for one day without showing any signs of separation into its individual layers and without materially lessening its strength. There are tremendous possibilities for the use of this wood in peace uses as well as in aircraft.



## Retraining Disabled Soldiers and Sailors

By the policy of placing disabled soldiers, sailors and marines for retraining in the existing institutions of the country it is figured that the Government has been saved over \$25,000,000, which is a reasonable cost had all the men in training, and to be trained, been assembled in one or two institutions provided and controlled by the Federal Government. By using the existing educational institutions, representing an investment of over \$300,000,000, there is available for the disabled man an infinitely greater opportunity than could possibly be given through any institution inaugurated especially for this work.

The training is now given in the best institutions of the United States, ranging from Harvard and Yale, Massachusetts Institute of Technology, Case School of Applied Science, Columbia University, and the various land grant colleges of the states to agricultural schools, scientific schools, and, in some instances, direct in the industries. There are, altogether, some 500 trades, professions, occupations, callings and the industries from which a choice may be made by the disabled man. He is by no means confined to manual trades and occupations, and the sole animating and dominating thought and object of the Government, as expressed and carried out by its agent, the Federal Board for Vocational Education, is to do that thing for the disabled man which will insure to him the greatest possibility for future usefulness, happiness and contentment according to his capabilities.

Placing the men in existing institutions instead of herding them in great camps of crippled and disabled men has a beneficial effect upon the men themselves, from a physiological standpoint, causing them to lose sight of their disabilities, to minimize them, and concentrate their attention upon the capabilities remaining to them and which are being capitalized by retraining.

---

## Reports Situation as Improved

Having traveled in the last six weeks all states in the Union except those of the southeast, Henry N. Teague, field agent for the U. S. Department of Labor, reports that industrial and labor conditions show a marked improvement during the last sixty days. This results, in Mr. Teague's opinion, from the fact that State and municipal authorities have come to appreciate the necessity for buffer employment for labor and the possibilities of stimulating business through extensive public improvements.

Mr. Teague has traveled, during the last six weeks, from Boston to San Francisco, and from Seattle to New Orleans, calling on all the governors and on the mayors of the principal cities and carrying a personal message to them from Secretary of Labor Wilson. When asked to state his outstanding impression from his trip, Mr. Teague said:

"There is to be a great deal of public building during the next six months. I am convinced the public improvements program for 1919 will equal that of any five years in the country's history and the road building activities from the Atlantic to the Pacific, once under way, are to be tremendous."

---

## To Spend \$1,059,000 on New Schools

In view of the fact that the shortage of school buildings over the country represents a larger total than any other form of construction, it is interesting to note that the City of San Francisco, Cal., has just authorized the expenditure of \$1,059,000 on new schools. Construction plans, announced by President George E. Gallagher of the Board of Education, include the erection of four new school buildings, including a high school, costing \$500,000, three modern six room additions and a reconstructed building with new equipment.

---

## Solon Borglum Honored by France

For his services as a member of the Foyer du Soldat, Solon Borglum, sculptor, who has made many small bronzes depicting western life, has been awarded the Croix de Guerre. In his citation it said that he "has not ceased for several months to organize foyers directly back of the first lines, and even in bombarded villages, showing in his work the soul of an apostle. He has rendered and continues to render the best services to the soldiers of the regiment with all his power of organization, his generosity and kindness of heart."

---

## Prisoners Manufacture Road Signs

Road signs and direction markers for use on state and country highways will be manufactured by convicts in the carpenter shop of the state prison at Trenton, N. J., in accordance with a plan prepared by Commissioner of Charities and Correction Lewis, in co-operation with the State Highway Commission. The new industry will get under way when samples are completed. Quotations have been submitted on 1000 concrete posts, 300 wooden signs and 1000 triangular metal signs.

# Late News from Architectural Fields

Special Correspondence to THE AMERICAN ARCHITECT

## Hasten Building is Advice Given

Detroit, Mich., March 22.—“Build now and as much as possible,” was the consensus of opinion at a conference of architects, bankers, building interests, real estate men and others interested in construction held by the Detroit, Mich., Board of Commerce this week. The purpose of the meeting was to learn what could be done to start a great building campaign in Detroit, which should take in all sorts of construction, both private and municipal.

Charles Kotting, president of the Michigan Chapter, American Institute of Architects, presided at the conference.

“We are prepared to make construction loans for any legitimate project,” said the bankers.

“There will be no reduction in the cost of building material,” said the manufacturers and the supply dealers.

“There will be no decrease in the wages of labor,” said the contractors.

“The available and desirable building lots are being grabbed up rapidly and we are building houses now which are sold before they are finished,” said the real estate men.

“Our government desires to see the building industry speeded up to high tension without delay,” said a representative of the United States Department of Labor.

The architects reported an appreciable increase in demand for plans of all kinds. The contractors announced they are being asked for figures on an increasing number of projects and that, in some cases, more work is in progress than usual at this season of the year.

The executive committee, which has called a conference, will meet again to prepare a report to be submitted to a general meeting to be called later. The committee, comprising Charles Kotting, Charles H. Bryan, J. F. Deacon, J. W. Boardman, Jr., Thomas Murray, F. M. Pauli and William W. Norton, is expected to outline plans to start the building program in large volume.

## North Carolina to Employ State Architect

Raleigh, N. C., March 22.—Senator McCain's bill creating the office of State architect has passed the House without opposition. This position will be under the direction of the State building commission and the McCain bill provides that the architect shall receive a salary of \$5,000 and \$7,500 additional for assistants. All plans for State buildings are to be drawn or approved by him and the estimated saving for the ensuing two years, according to Mr. McCain, will be \$125,000.

## Arthur T. O'Brien Dies

San Francisco, Cal., March 22.—Arthur T. O'Brien, architect, died at his home, 2218 Van Ness Avenue this city, last week. He had suffered from pneumonia, but was supposed to be on the road to recovery. He was feeling so well that two days before his death he was at his office. He was forty years old.

He was associated in business with his brothers, Walter J. and Albert O'Brien. He studied at the Mark Hopkins Institute of Art and other schools. He was a member of the Olympic Club, the Corinthian Yacht Club and the Indoor Yacht Club.

## Demands for Building

Washington, D. C., March 24.—Seventy-four cities have returned to the U. S. Department of Labor questionnaires on needs in getting building underway. Fifty-seven of these cities show a pressing demand for building and most of these emphasize the shortage of dwellings and apartment houses.

Typical of the representations in this particular are the following: Portland, Maine, reports a shortage in dwelling and tenement houses; Haverhill, Lawrence and Salem, Mass., report a demand for dwellings and tenements; Albany, N. Y., needs flats; New York City needs office, dwelling and storage buildings; Rochester needs dwellings and mercantile buildings; Atlantic City, East Orange and Elizabeth, New Jersey, are short in dwellings and apartments, and almost all the towns in Pennsylvania reporting, show a deficiency in residences.

Ohio, Indiana and Illinois show a shortage in dwellings with an occasional report on demands for schools and factories, and the major percentage of shortage in Colorado, Utah, Washington and California is in dwellings. In the South and Southwest there is a demand for business building, this being especially noticeable in Texas and Louisiana.

Tacoma, Washington, was the only city reporting no delay on account of wages, material prices, interest rates and available capital. Tacoma's obstacle was inclement weather and subsequent reports from the State of Washington indicate preparations for unusual building activity for the spring season.

The questionnaires, which were sent out by the Division of Public Works and Construction Developments of the U. S. Department of Labor, were calculated to verify the results of other investigations into the building shortage of the country and to develop what, if any, obstacles were being encountered by building interests. Specific information was asked on the influence of wages, material prices, interest rates and available investment capital. Several cities reported that it was none of these which was delaying building, but rather the uncertainty of the future labor and material market. A majority of the cities assert that high wages are a factor in holding back building; there is almost unanimous concurrence in the opinion that high prices of materials are determined obstacles. There is not much complaint about interest rates, but fourteen cities report builders are having difficulty in obtaining capital to finance projects.

This latter obstacle appears not to be a sectional matter, but rather one growing out of local conditions in widely separated territory. Cambridge, Mass., New Haven, Conn., Albany, N. Y., Philadelphia, Pa., Terre Haute, Ind., Wheeling, W. Va., Aurora, Ill., are among the cities reporting difficulty in borrowing capital for building work.

Wherever building industry organizations have gone into the subject the conclusion has prevailed that no decrease in labor wages may be expected for some time to come—not until the general price level on living necessities drops. The investigations of the economists in the Department of Labor, supported by no less an authority than Prof. Irving Fisher, of Yale University, assert no marked reduction may be expected in building material prices. Prof. Fisher asserts we are on a new and higher price level from which, in the main, we shall not recede. “We are on a permanently higher price level,” says Prof. Fisher, “and the sooner the business men of the country take this view and adjust themselves to it, the sooner will they save themselves and the nation from the misfortune which will come, if we persist in our present false hope.”



After setting out the circumstances and developments on which this conclusion is based, Prof. Fisher concludes his study of the situation with this: "Business men should face the facts. To talk reverently of 1913-14 prices is to speak a dead language today. The buyers of the country, since the armistice, have made an unexampled attack upon prices through their waiting attitude, and yet price recessions have been insignificant. The reason is that we are on a new high price level, which will be found a stubborn reality. Business men are going to find out that the clever man is not the man who waits, but the one who finds out the new price facts, and acts accordingly."

## "Own Your Own Home" Campaign Plans Announced

Washington, D. C., March 24.—Arrangements adaptable to any city in the United States, for an effective "Own Your Own Home" campaign, have been formulated by the U. S. Department of Labor and the literature is now ready for distribution through the Division of Public Works and Construction Development of the Department. Twenty cities already are getting under way with their drives for home building and home owning.

To supervise the formulation of these plans, Paul C. Murphy of Portland, Oregon, for two years working on "Own Your Own Home" work, was brought to Washington. In consultation with Department of Labor officials and several of the leading authorities on building in the United States, Mr. Murphy has drafted the campaign manual, now available for such cities and individuals as are interested in promoting home owning.

The "Own Your Own Home" bureau in the Division of Public Works and Construction Development will serve as an advisory board to the managements of these local campaigns, where requested, and will extend the fullest co-operation to every city in the country which undertakes a campaign.

Briefly, the campaign plan contemplates a general committee made up of civic and industrial leaders, with someone whose standing in the community justifies his selection, as the chief executive official.

Under this general committee are such sub-committees as have been found essential. The manual suggests the prudence of having vigorous committees on finance, publicity and campaign methods, mercantile institutions, public service corporations, education, religious activities, industrial workers and labor unions, hotels and restaurants, exhibits and management of headquarters, women's clubs, speakers and meetings, poster contests, civic bodies, theaters and amusements, transportation and automobiles, industrial plants, music, printing and supplies and donations.

The function of each committee is explained in detail, with suggestions on handling specific problems.

In the Department of Labor's plan of campaign the women, churches and labor organizations play an important part. The entire campaign is pitched on a civic betterment plane rather than on a purely commercial basis. It is a movement, having in mind only the incalculable permanent benefits to the community and the immediate helpfulness to the nation during the transition from war mobilization to peace production. The Department of Labor emphasizes the following benefits:

It will provide better living conditions, increase efficiency, encourage thrift, give greater comfort and happiness and create individual reserves for misfortune and old age. Every house owner with his family, whether rich, poor or well-to-do, becomes thereby a better citizen, with increased self-respect, independence and responsibility to the city and

nation and are more vitally interested in the welfare and prosperity of both.

That during the readjustment period, such a movement hastens the return of normal conditions; results in much needed construction for home and industrial purposes; provides work for returning soldiers and sailors and for labor changing from war to peace industries; stimulates all lines of business in each community; creates general prosperity.

## Price Movements Favor Builders

Advantage to prospective builders comes this week with the formal opening of the building season of 1919 in the announcement of material price changes. Quotations show a dollar drop in the price of wall plaster to \$23.30 a ton, delivered in New York. There is also a slight change in favor of the builder in small size window glass. A complete withdrawal of listed selling prices of sand, gravel, grit, and possibly crushed stone, is announced, thereby throwing the market open to the best price the buyer can get, depending upon the quantity and the location of the job.

## Lumber Bureau Protests Freight Charges

Washington, D. C., March 22.—The National Bureau of Wholesale Lumber Distributors, in a recent letter to Max Thelan, director of the Division of Public Service and Accounting, protested against the excessive demurrage charges now being assessed by the railroads, and urged that these charges be reduced to the normal pre-war period.

Many reports have come to the attention of the bureau advising that there is an abundance of idle equipment in all sections of the country, and it is the opinion of the bureau that 75 per cent of the delay of consignments and loss of freight is due to the inefficiency and negligence of the common carriers, through embargoes and congested terminals. This delay results in customers purchasing their wants in the open market or declining shipments when they finally arrive, in either case, causing great loss to the distributors.

It is urged that these excessive charges are unjust and illegal, and the Railroad Administration is asked to take immediate action in this matter, in answer to the protests being filed by various associations in all parts of the country.

## Kenyon Cox

Kenyon Cox, a mural painter of distinction, died at his home in New York on March 17. He was in his 62nd year.

For a quarter century Mr. Cox has been a prominent figure in the field of American Art. He combined with an unusual ability as an artist, many attributes as an advanced thinker and a profound student. He had also achieved reputation as a sculptor, but a rare sense for color and a highly developed appreciation for classical composition led him to devote his fine abilities more largely to mural painting. His work is to be found in many of our most important public buildings.

Mr. Cox was married in 1892 to Louise Howland King, former pupil and herself a painter of note. He was a member of the National Academy and the American Academy of Arts and Letters. Chief among his literary works were: "Old Masters and New," "Painters and Sculptors," and "The Classic Point of View."

# Department of Architectural Engineering



Perspective view of plant from the southwest, compare with the photograph of completed structures.

## Building a Home for an Industry

**F**ITNESS is the all important factor upon which good planning is based. This applies to all buildings of whatever kind. The type or kind of a structure is determined by its use, and the particular use establishes those essential elements which, when incorporated in the plan, make the structure fit. In industrial structures the dominating element that influences the design is utility. This is necessarily the case, as the motive that actuates the erection of such structures is to house

a profitable production process. Success is largely profitable production, and this is contingent, in a great measure, on the kind of building which houses the enterprise. The effect of the building on the business is often greatly under-estimated, and it is the purpose of this article to indicate and emphasize its relative importance.

THE AMERICAN ARCHITECT presents here, as an example of the best method of planning, an industrial plant designed by the firm of Charles H.



View of plant from the southwest, compare with perspective from the same viewpoint.



Higgins, Architects-Engineers, of New York City, for E. C. Klipstein & Sons Company, manufacturers of dyes, at South Charleston, West Virginia.

In discussing the development of this project, Mr. Higgins was emphatic in stating that the principal motive in the design of this plant was "fitness to accomplish the owner's purpose; in a word, fitness for function." This purpose he defined to be "to shape for the hand of the plant superintendent and his forces, according to the processes developed by the owner's technical staff, the best tool for production of full capacity, at low unit cost, of the materials the owner foresees that the country will demand. The arrangement and character of units, movement of materials and men, protection from weather and fire, compactness,



Site of the improvement on December 19, 1916.

orderliness, convenience and proper working conditions for the men, safety, light, heat, ventilation, sanitation—all make for the accomplishment of the purpose. A home for the industry."

The general location of a plant is determined by the source of the raw materials and their weight, the fuel supply and the weight of fuel compared to that of the raw material, the finished product and its weight compared with that of the raw material and fuel. The weight of finished product, raw material and fuel are translated into terms of transportation cost and time, for comparison. Labor is the other general element that affects the location of the plant. Skilled labor is always found adjacent to its employment. It may be that supplies of raw materials or fuel are developed in places where the necessary skilled labor is not found. The problem then naturally arises as to whether to transplant the labor to the raw material or fuel or to bring these to the labor supply. The supply of skilled labor is affected by the climate, character of the country, the housing and social conditions, and often by racial instincts and habits.

Having decided upon a certain section of the country as suitable for a general location, the particular location is decided by making surveys of

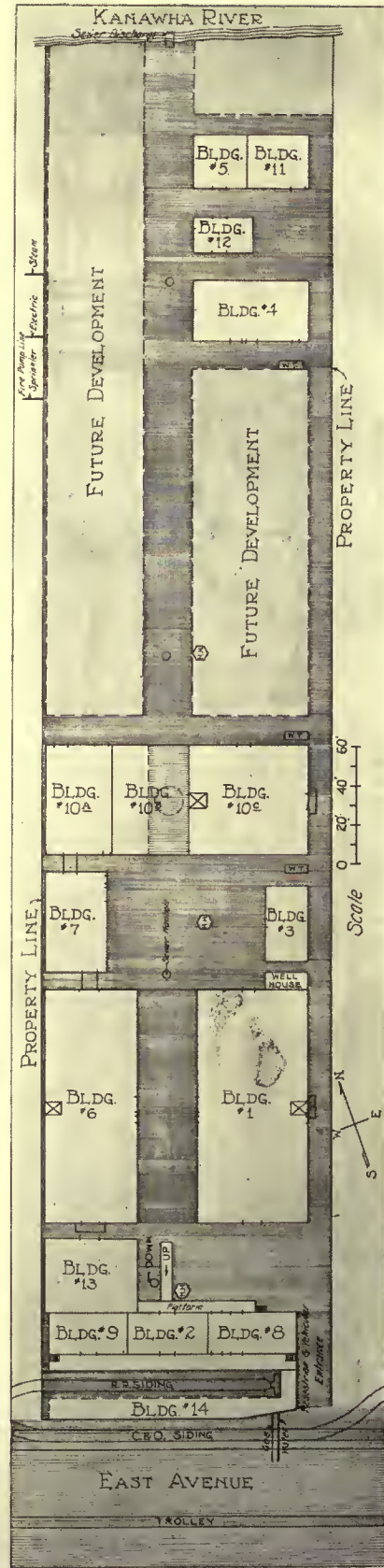

Location plan, showing the limits of the grounds; the highway, railroad, trolley and river connections; the buildings constructed and the areas set aside for future improvement.

## THE AMERICAN ARCHITECT

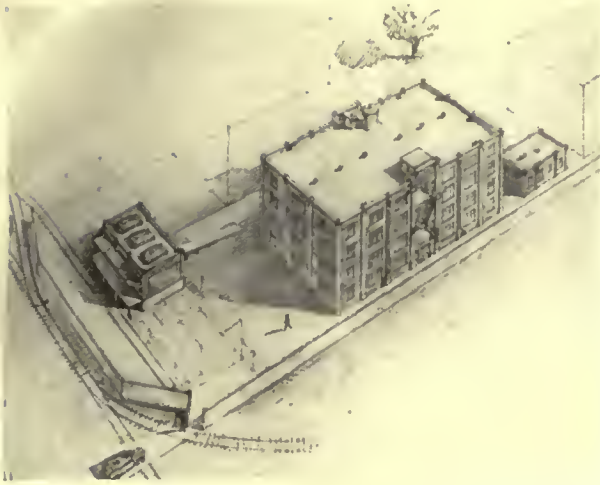

First project study from an elevated viewpoint, showing the first buildings whose construction was authorized. Buildings 1, 2 and 3, also the railroad connection, the vehicular and pedestrian entrance and the outlines of future buildings indicated.

the several available localities. Railroad transportation and switching facilities, highways and their condition, public utilities, cost of land and building materials, tax rates, local laws which may affect the construction and operation of the plant, local municipal fire and police protection, cost of insurance against loss by fire and accidents, employer's liability laws, labor supply and its characteristics, passenger transportation for labor, housing for labor and the general social and economic condition of labor—all are factors having a definite influence in the forming of the final decision.

All of these things are properly considered before the purchase of the ground, and when the land is purchased the shape and area of the tract is considered in its relation to the ultimate development of the project. The selection of the land depends upon the character of the business. Some kinds of manufacturing are better housed in buildings of several stories and within the closely built sections of a city. In these cases no particular limit is placed on the height of the buildings—this is true of the garment-making industry, as an example. Other kinds of manufacturing demand buildings of comparatively

low height, especially where the materials are extremely heavy and bulky, thus saving the expense of elevating the materials to great heights. All classes of manufacturing can be divided into two groups—one requiring large areas of ground and others requiring small areas. If the production process demands a maximum of horizontal travel it belongs in the first mentioned class, otherwise it naturally falls in the second mentioned class.

With the acquiring of the property the real task of planning is undertaken. The location of points of access for pedestrians, vehicles and railroad tracks is the first problem to solve. Entrance to the property by railroad is often fixed within close limits or it may be flexible, owing to conditions. The location of paved streets determines the entrance for vehicles and the location of street car lines govern the placing of the pedestrian entrance. It is very desirable that these three necessary entrances be as close together as possible in order that the supervision over this traffic can be delegated to as few persons as practicable. This traffic is made dangerous by the railroads, in a less degree by vehicles, and their relation to each other

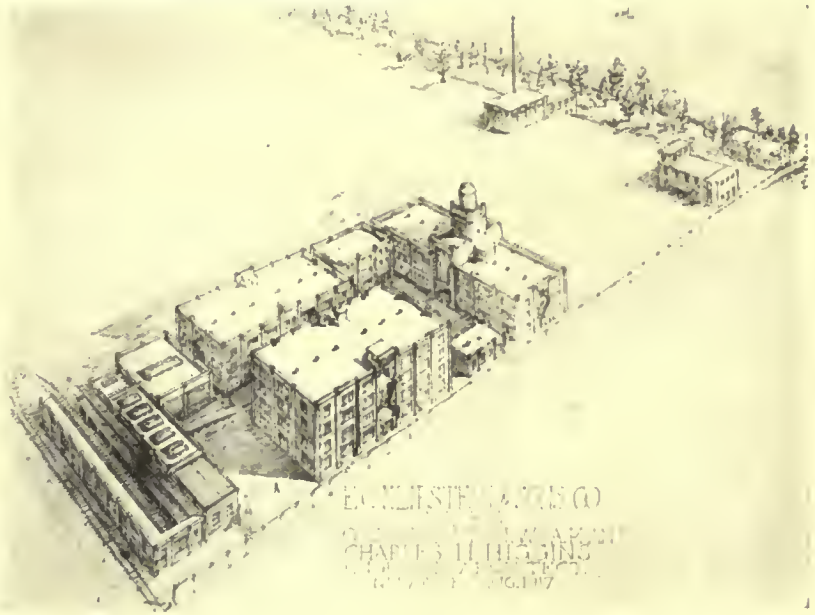

Developed project study showing the buildings whose construction was authorized after the first project study was made. The outlines of future buildings are indicated. These studies, from an elevated viewpoint, are the best method of showing the buildings as units and their relation to adjacent units and the surrounding conditions.

must be carefully considered before the final location is made.

The location of the administrative department should be adjacent to the points of access. This permits of the concentration of those forces that



## THE AMERICAN ARCHITECT



Perspective sketch of Building 10B from ground level. Building 1 at the right, Building 6 at the left. Compare with photograph of same view.

supervise the entrance and employment of workmen, the entrance of freight cars and vehicles as well as their exit, the receiving of materials and the shipment of manufactured products and the reception of business visitors. This latter point is of importance as it prevents entering of the plant by unauthorized persons, who might be without good purpose.

The storage of raw materials will naturally be adjacent to railroad tracks and vehicular traffic, depending on its nature and its origin. Such materials as lumber, structural steel, pig iron, clay and sand naturally demand storage yards and sheds of considerable area and outside the buildings wherein these materials are used in the process of manufacturing. Materials such as cloth, sheet iron, paper stock, leather and package goods, used in the manufacturing process, are stored in ware-

houses often one or more stories in height.

The shipment of the manufactured product is from warehouses convenient to the railroad tracks and also to vehicular traffic if shipments are made in less than carload lots. The value of the finished product is more than that of the raw material, and naturally its storage prior to shipment must afford protection from the elements, from fire damage and loss by theft.

In some cases raw materials are stored on the upper floors of high buildings, permitting the material to travel by the force of gravity downward through the various stories as required. The number of persons employed in storage spaces is comparatively small. In the disposition and concentration of operatives, it is important to consider the increased hazard in their travel in vertical lines of travel over that on horizontal planes. Travel distance in either case involves hazard, and it follows that it is better to reduce the number of occupants on the upper floors when possible.

Between the storage places of raw materials and for the finished product, the process of manufacturing is housed.

The routing of the material during this process has a very great effect on the cost of production. The primary law to be observed is to have the material travel from its place of origin as directly as possible to the point where the finished product is to be stored. This line of travel can be deflected to one side or vertically, but it should never be di-



View looking north from ramp leading to Building 2. Building 1 on right. Building 6 on left. The main roadway, the center of which is the main axis of the group plan, passes through Building 10B in the background. Compare this with the preliminary perspective drawing.

## THE AMERICAN ARCHITECT

verted toward its point of origin. The movement of material in any direction involves transportation costs. Upward movement is more costly than horizontal movement unless the downward movement is made by the force of gravity, and under these conditions the cost may be equalized. The weight and the bulk of the material has an important influence on the planning of its travel lines. To comply with the requirements of the economical routing of the product, the location of each process unit must be approximately fixed before the preliminary building plans are made.

Another feature that must be considered in the preliminary planning is the hazard from fire and safety of the operatives. Fire hazards are of two

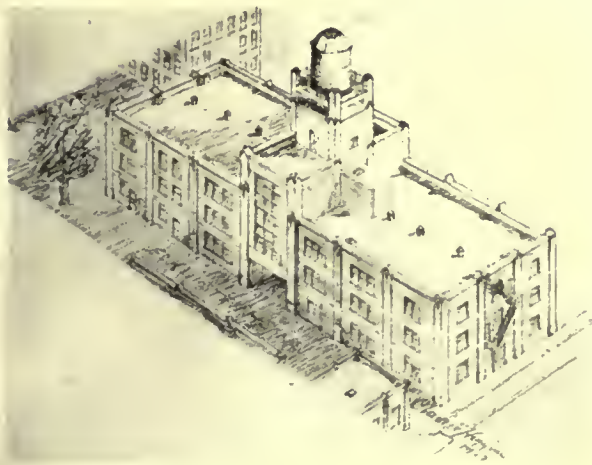

Study of a unit, Building 10A, 10B, 10C.

kinds, interior and exterior. The interior hazard governs the disposition of the various departments, the stairways and elevators. The exterior hazard governs the actual location of the building with reference to hazards originating in other buildings of the same plant or adjacent properties. Protection against interior hazard is provided for by means of fire walls, fire doors at all interior openings, properly protected interior stairways and elevator shafts, sprinkler apparatus and manually operated fire extinguishing apparatus. Exterior hazards are cared for by the installation of metal windows glazed with wired glass, and exterior walls of non-combustible material, fire doors in exterior walls. In plants where yard spaces occur, water mains, hydrants and hose houses are provided. The safety of the operatives is secured by the use of fire escapes leading from the various floors to the ground or by bridges connecting one building with another, these in addition to the enclosed stairways and elevators. These features of the plan have an important effect on the

rates charged for fire and liability insurance.

The distribution of mechanical service also has its influence on the plan. Water and gas are generally provided by public utility corporations, and these services taken from mains located in the adjacent streets. The electric service is purchased by others or produced within the plant, as may be most economical. In addition to these, both high and low pressure steam are supplied, the former for boiling water, cooking or sterilizing purposes and the latter for heating and often for extinguishing fires. The water distribution includes water for sprinkler system and fire service, for water closets, lavatories and shower baths, air washers, and humidifiers, hot water and drinking water. Refrigeration, compressed air and vacuum services are often a necessary part of the mechanical equipment. Aside from the ordinary cold water, gas and possibly electric service, the distributing of the other services mentioned must have some intimate contact with the boiler and engine plant. This must be located with reference to the fuel supply and its location with reference to the balance of the plant has an importance with reference to economy of



View of Building 10A, 10B, 10C, from the north, showing the main thoroughfare through the first story. Hydrant and hose house in the foreground.

operation. The distributing systems of high temperature fluids and gases, as steam and water, should be as compact as possible in order to avoid the losses due to radiation—this also applies to refrigeration.

Scales should be located at receiving and shipping points and at places where weights are required during the process of manufacture.

Aside from means afforded to protect the workmen from injury, their proper care includes the installation of toilet and locker room facilities, shower baths, lunch rooms and possibly a small first aid hospital. These facilities should be located convenient to the work in order to save time and to be under the supervision of the process foremen.



## THE AMERICAN ARCHITECT

When the operatives are of both sexes proper provision must be made for them according to their needs.

The foregoing items indicate, in a limited manner, those that Mr. Higgins considers and evaluates in order to establish their relative importance in the project plan. Special conditions and requirements necessarily develop in each project, and they are carefully analyzed and appraised. In this work he makes a close study of the requirements by conferring with the administrative and business departments, the mechanical department



Photograph of Building 7. Compare with perspective of same view. Note stairs and connection to adjoining buildings.

and the heads of the various production units. By correlating and adjusting all of the various factors and requirements he is enabled to produce a comprehensive and satisfactory plan.

In this industry the weight of the finished product is but a small proportion of the weight of the raw material, and the principal raw material is fuel. As the number of workmen is limited in number and the transportation of the finished product are relatively small items, a location near the source of fuel supply was indicated and the Kanawha Valley of West Virginia was selected. Local conditions at Charleston were favorable, and a site was secured at South Charleston. The tract of land is 150 ft. wide and about 800 ft. long. The 150 ft. frontage is on a highway improved with a brick pavement, in which are water and natural gas mains. A trolley line affords transportation for the operatives and an industrial siding of the C. & O. Railroad extended along this frontage. The property extends from this highway to the Kanawha River, a navigable stream, on which coal is transported in barges. The soil is a compact clay affording a good bearing for foundations, the surface of the ground, however, being but slightly above the high flood levels, preventing the use of basements.

In describing the development of this project

references will be made to the location plan. The general scheme is based upon locating the railroad spur along the south end of the tract with the vehicular and pedestrian entrance at the southeast corner of the property and not crossing this spur. This permits of an unobstructed and more safe passage way. The buildings are located with reference to a thoroughfare extending from the south end of the tract to the river and centered on a longitudinal axis which is 10 ft. west of the center line. The water and natural gas service is brought into the property from the street mains as indicated. The fire pump line for the sprinkler system, the steam and electric service is, for the present, taken from the adjoining plant on the west. The main sewer is under the main central thoroughfare and discharges into the Kanawha River.

The first structure to be authorized was Building 1 and was placed as indicated in the study for its location. Shortly after this location was decided



Perspective sketch of Building 7, showing exterior stairs and communication platforms connecting to Building 6 at the left. Building 10A, 10B at right, hose and hydrant house and motor truck in foreground.

upon, Buildings 2 and 3 were located. Building 3 is a laboratory building and was also intended to be a temporary administration building. Building 2 was the nucleus of the shipping or receiving building. It will be noted that Building 2 has its floor and platform at the level of the floors of the cars and that ingress into the building is by means of a ramp extending into the yard. An inspection of this study for Building 1 will show the outlines indicated for possible future buildings. In this way the effect of the future buildings as to fire hazard, obstructing sunlight and yard spaces, in relation to

## THE AMERICAN ARCHITECT

the building being designed, is measured and provided for. This drawing very distinctly shows the difference in methods for designing an isolated building and designing a plant composed of several adjacent buildings.

About the time that Building 1 had the fourth floor concrete in place the second progress study was made, including Buildings 5, 6, 7, 8 and 9, and as the plans for these were nearing completion, studies for Buildings 10A, 10B, 10C and 11 were added. The latter buildings were started about the time that Buildings 5 to 9 were nearing completion. Buildings 8 and 9 are extensions of Building 2, the ends of the latter serving as fire walls. A portion of Building 8 is used for administrative offices and Building 9 is for shipping and receiving. Buildings 5, 6 and 7 form the second manufacturing group. The processes requiring fire or gas flames were placed in Building 7, and for that reason it was separated from Buildings 6 and 10A. These hazards in a more pronounced form made the greater isolation of Building 5 desirable. Buildings 10A, 10B

and 10C having the appearance of a single structure, were at first intended to be three separate buildings, as each housed a different manufac-

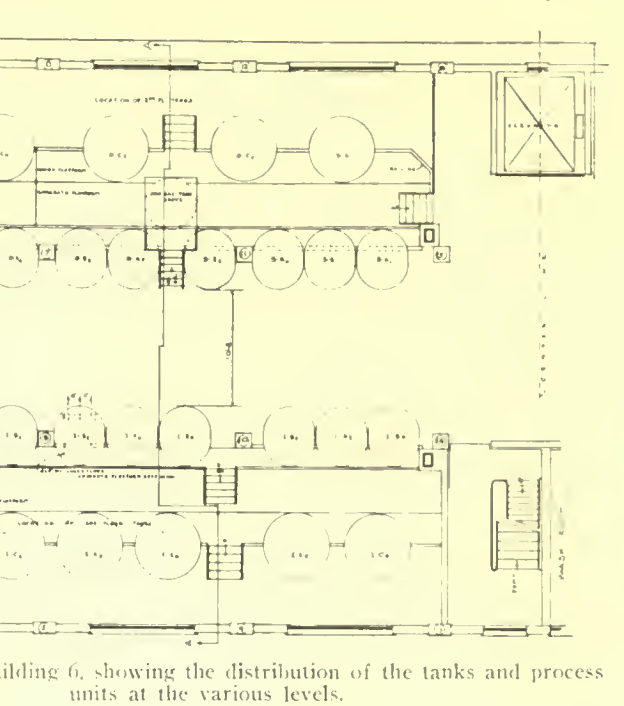

Partial plan of Building 6, showing the distribution of the tanks and process units at the various levels.

walls with openings protected by fire doors. One elevator serves the three sections. An individual study of this unit is shown. The process in Building 11 naturally associated with that in Building 5 and adjoins it with a fire wall between, but with no communicating doors.

In this plant there are four methods of dividing buildings with reference to fire hazard. Building 1 is divided horizontally in two parts; the first story with its mezzanine. The construction is of concrete and the communication between the two parts is protected by fire wall enclosures with automatic fire doors. In groups 2, 8, 9 and 5, 11 the divisions are made by pierced fire walls. Group 6, 7 have no horizontal divisions but have a vertical division by the building of two separate structures 8 ft. apart, a common stairway and platform serving both buildings, as shown in the illustrations. Group 10A, 10B and 10C is divided by 12 in. fire walls, with automatic fire doors, the

and 10C having the appearance of a single structure, were at first intended to be three separate buildings, as each housed a different manufac-

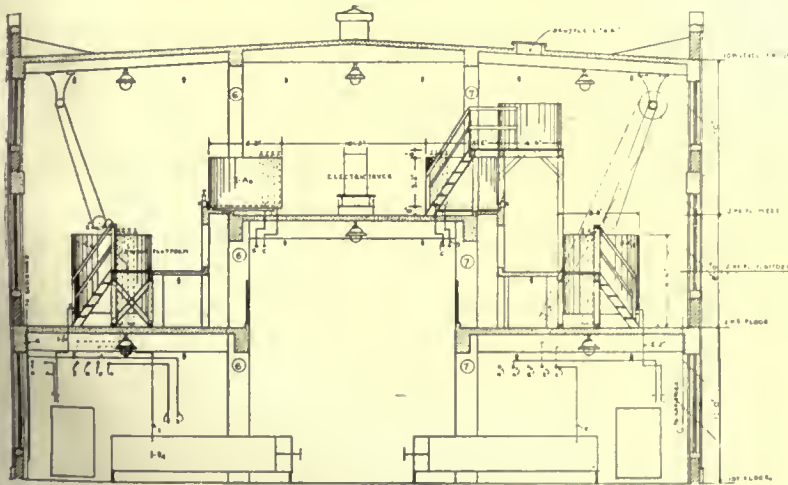

Transverse section of Building 6, showing the levels of the process units, the means of supporting them, the enclosing walls and roof. This illustrates the fundamental element of industrial planning, that of making the building conform to the requirements of the production process.

and 10C having the appearance of a single structure, were at first intended to be three separate buildings, as each housed a different manufac-



## THE AMERICAN ARCHITECT

floors are of reinforced concrete and all vertical communications protected by fire walls and automatic fire doors.

In strong contrast with the compact arrangement of this plant are those adjoining it on the east and the west. This is very apparent by inspecting the



Train of trailers loaded with acid carboys, hauled on paved yard with a 1-ton electric storage battery truck.

illustrations given. These adjoining plants also house the manufacturing of chemicals and are also subject to fire hazards.

A distinction can always be made between cheapness of low first cost and economy of low production cost, per unit of product. The first difference is in the movement of materials. Where movement by gravity is possible for materials in process, that feature determines the height of the building, each floor level being a stage in the process. Intra-plant travel distances are reduced to a minimum. The movement of materials is effected by means of elec-



Building 1 under construction.

tric storage battery trucks to which a train of trailers can be attached. These trucks, by means of elevators, can reach any point to which dry materials must be transported. Liquids are transported by air pressure, gravity or pumping. In the compact plant the installation of water, gas, steam

and other utility services is naturally much cheaper than in the spread-out plant. The maintenance and cost of service is also less, as the losses due to radiation, friction, leakage and "drop" are reduced to a minimum.

The compact plant makes possible the paving, at small cost, of the yards and open spaces with brick or concrete, which is a great aid to cheap intra-plant traffic. The cost of such yard paving in the old style plant would be a very large item and prohibitive.

The preliminary location studies were made from an elevated viewpoint in order to clearly show the relation of the parts. For the development of the architectural features studies from the ground level



Shooting the brine well, 40 seconds after firing 120 quarts of nitro-glycerine. Well 1050 ft. deep, 8 in. diameter.

were made. These are shown, as are also photographs of the completed buildings. The finished work parallels very closely the perspective drawings.

The absence of planting in the drawings and photographs is due to the fact that the nature of the industrial plants in this neighborhood does not encourage vegetable growth.

The electric storage battery trucks used in this plant are of 2000 lb. capacity and can operate with six or seven trailers. The trailers are also operated as hand trucks. These trucks provide the means of horizontal transportation and the elevators the means of vertical transportation. Access to the

## THE AMERICAN ARCHITECT

storehouse is by means of the ramp at Building 2. Traffic in this plant is very flexible and the distances are reduced to the minimum.

An automatic sprinkler system is installed throughout the plant. A fire main is provided which receives its pressure from the tank on Building 10B and is also connected with fire pumps in the power house and has a two-way steamer connection near the street entrance. In connection with this



View northwest of Building 1, showing adjoining plant. A typical plant with low buildings, partially combustible and spread out for protection. No special provision for paved roads and economical intra-plant traffic.

main there are hose houses and hydrants in the yards. Water operated fire alarms are provided throughout. In these buildings the water in the sprinkler system can be cut off and live steam supplied. Steam is necessary where the burning materials are of a character that float and would spread the fire if water was used. Windows are held open by chains with fusible links, so as to close automatically in case of fire.

A platform scale is provided at the receiving and shipping building and one is placed near the foot of each elevator. Power is now provided by an adjoining plant. Buildings 1 and 6 are connected by a pipe tunnel below the paved thoroughfare.

Compressed air, vacuum and refrigeration are developed in the north end of Building 1. From this point they are distributed to the places where needed. Refrigeration is distributed either in the form of cooled brine in mains or as manufactured ice. All service pipes and wires are located so as to be out of the way as far as possible and still be readily accessible for inspection and repairs. When these services are above the ground they are carried on one side of the property in a neat and orderly manner.

The process in each case determined the character of the building. This is clearly illustrated in the section and partial plan of Building 6. An in-

spection of this drawing will clearly demonstrate the fact that industrial planning is based on properly locating and supporting the process units, after which the enveloping walls and roof are provided.

The welfare of the operative is cared for by providing ample locker, toilet and wash rooms, sufficient light, heat and ventilation, safety from fire hazards. The owners felt very strongly that these facilities should be made ample and convenient.



View looking east from Building 1. This plant has the same characteristics as the one adjoining on the west.

The operation of this plant has practically demonstrated the many contemplated economies of operation which were discussed during the planning of the plant. The excellence of the facilities and arrangements for fire protection have been demonstrated.

In this plant, form followed function and the logical clean-cut and efficient methods of planning have proved their merit. The interest in the buildings is in their fitness for the purpose, effective protection and good conditions for the operatives.

In planning this plant, Mr. Higgins' organization produced complete and separate drawings for (a) building construction, (b) piping and mechanical systems, (c) refrigeration and ice making plant, (d) paving and drainage, (e) electric light and power, (f) motors (delivered), (g) well drilling and (h) erection and connection of apparatus for processes. On each of these divisions competitive bids were invited from a selected list of reputable contractors. Close and cheerful co-operation was maintained between the organization of the architects-engineers, the various contracting and owners' organizations, resulting in the execution of the owner's purpose efficiently, promptly and economically.

Since the planning and construction of this plant the organization headed by Mr. Higgins has become associated with that of Delano & Aldrich, as Delano & Aldrich and Charles H. Higgins, associated architects and engineers, New York City.



# Industrial Information

*In this Department there is published each week information as to the development of materials and methods, derived from reliable sources.*

## Damp-proofing vs. Waterproofing

The Society for Testing Materials at its last meeting adopted a distinction in the use of the words damp-proofing and waterproofing. For a long time these terms have been interchangeably employed. Confusion inevitably resulted, and materials ordered simply as damp-proof and wrongly believed waterproof, were a source of trouble, and often unnecessary expense, due to their wrong use or application.

It appears that the Hydrex Felt and Engineering Co., 120 Liberty Street, New York, manufacturers of materials for both damp-proofing and waterproofing, were influential in bringing about this clearer understanding. In a pamphlet entitled "Damp-proofing Walls Above and Below Grade," the distinction is drawn that damp-proofing a wall means that thereafter water may be shed down that wall's surface without penetrating to the interior. Waterproofing goes further. It stands for resistance against water *pressure*.

This pamphlet discusses the merits of the one method over the other for specific purposes and makes clear where each may with most advantage be used. The Hydrex Felt and Engineering Co. manufactures a number of materials for effecting both of these purposes, and these are fully described and illustrated in the pamphlet referred to. Architects will find this of considerable practical use, and it is suggested that they send for a copy. The Hydrex Felt and Engineering Co. describes itself as specialists in structural waterproofing, insulation and soundproofing, and manufactures extensively water-proofing felts, roofings, and paints. Co-operation with architects is offered.

---

## H<sub>2</sub>O Minus Germs

Why should a lot of thoughtful scientists evolve certain truths to benefit mankind, if these truths are to be accepted merely as academic facts and are not immediately and consistently applied? When one reflects that about 75 per cent of the human body is constituted of the elements of water, that about 95 per cent of healthy blood and 80 per cent of our food is also water, one cannot but marvel at our dependence upon it for actual existence, and incidentally want to pat ourselves on the back for be-

ing able to maintain any individuality at all under these aqueous conditions. A simple tomato, we have learned, is 98 per cent water. This cannot but increase our respect for a vegetable which preserves its personality on only 2 per cent of actual tomatohood.

To revert to the serious aspect of the topic, the urgency of having pure water would seem to be a self-evident truth. One of the accepted methods of purifying it is by adequate filtering. And yet in how few homes are found adequate filters. Though it is common knowledge that many of the most pernicious diseases are fostered by the use of impure water, the precaution of a filter installation is too seldom taken. Prudence dictates that people apply that knowledge as a measure of safety and refrain from taking chances with disease.

The Roberts Filter Manufacturing Co., Darby, Philadelphia, Pa., have received first honors for the variety of filters which they make. These cover all the needs for domestic use as well as for hotels, hospitals and other large public buildings. Testimonials signed by eminent physicians and recognized medical schools claim them germ-proof and in every way satisfactory. The Roberts Filters are constructed on correct mechanical principles; their workmanship and the material used are of high quality, and simplicity in usage and maintenance are characteristic. Further, they are inexpensive, durable, and easily fitted to any type or size of spigot. The Roberts Company undertakes municipal and industrial work as a specialty.

It is nothing short of a duty to the community to safeguard the residents by providing the purest possible water for everyone. Architects cannot give the subject too serious thought—and action.

---

## Post-War Committee on Architectural Practice

This committee has recently mailed a communication addressed to architects of the United States asking suggestions in co-operation with the work it is doing. The committee also desires to reach building trades and contractors' organizations, and if application is made for copies of this practical paper, it will be sent in such numbers as may be desired. Address the committee at 1741 New York Avenue, Washington, D. C.

416 a  
104-112 after p 490

# The AMERICAN ARCHITECT



CHURCH OF S. CROCE, FLORENCE, ITALY

PUBLISHED WEDNESDAYS IN NEW YORK—FOUNDED 1876  
VOLUME CXV                      APRIL 2, 1919                      NUMBER 2258

Entered as second class matter January 6, 1909, at the Post Office at New York, N. Y., under the Act of March 3, 1879. Publication office, 243 West Thirty-ninth Street, New York, N. Y. Subscription price in the United States and Possessions, \$10.



# RAYMOND

## CONCRETE PILES



## A Big Organization for Big Work

We are prepared to undertake, at very short notice, the biggest contracts for Concrete Pile installation, and to guarantee completion on or well within schedule. We are also in a position to give equal satisfaction on small contracts. And to contracts of *every* size we bring a Method of concrete pile installation which insures that each and every concrete pile will be PERFECT. For every Raymond Concrete Pile is cast-in-place in a spirally reinforced steel shell that remains in the ground.

### Raymond Concrete Pile Company

New York: 140 Cedar Street

Chicago: 111 West Monroe Street

Montreal, Canada: Raymond Concrete Pile Co., Ltd.

*Branches in Principal Cities*

A Form for Every Pile  
A Pile for Every Purpose







PATH ALONG THE FRONT OF THE SCARBORO, N. Y., SCHOOL  
WELLES BOSWORTH, ARCHITECT

# THE AMERICAN ARCHITECT

VOL. CXV

WEDNESDAY, APRIL 2, 1919

NUMBER 2258

## The Scarborough-on-Hudson School

WELLES BOSWORTH, *Architect*

SCARBORO-ON-HUDSON enjoys the unique distinction among all the stations in the suburbs of New York of being without shops, saloons or buildings of any kind to indicate a settlement, except those belonging to the station itself.

On alighting from the train one is confronted by a steep bank of goodly trees, and the road winding up a hill suggests nothing but country life remote from town. This road is bordered on the right by a beautiful old estate belonging to one of the most remarkable men of the day; a man whose power of imagination is strongly reinforced with self-reliance and aggressive energy to carry out his mental visions, a self-made man in the best sense of the word, and one whose abilities and energies have brought into first-hand acquaintance the best that the world has produced both in personality and in things.

Frank A. Vanderlip needed to consult no one when it came to the education of his children. He knew what they ought to be taught and how, in order to prepare them for useful and happy lives. Beginning from the bottom up, he formed a group of the right sort of neighbors, building houses for friends who had children on a near-by tract of land laid out in attractive house lots. This assured

to his children the right kind of playmates to grow up with.

He then remodelled an old studio building into a school. This was soon outgrown, but it had served to illustrate the success of the experiment to such an extent that Mr. Vanderlip then decided to build *de novo* an ideal school for children.

Situated near the Albany highway, on a sloping piece of ground such that the rear elevation has two stories while the front has only one, the building spreads out in plan like a letter T inverted, as it were, the vertical part being occupied by a fully equipped theater. Class rooms occupy the wing on the left, a gymnasium and laboratories the right wing, and a library and teachers' room the second story of the central portion.

The wings are designed with a clerestory treatment over the central corridor letting sunlight into the class rooms on the north side, as well as giving them better ventilation. At the outer end of the left wing there is a kitchen and dining room for those children who come too far to return home for luncheon, and a garage is worked in on the rear of the gymnasium, below the dressing rooms. A workshop equipped with all sorts of carpentry and manual labor appli-



STATUE OF MOGLI FOR FRONT OF SCARBORO SCHOOL

RUDOLF EVANS, SCULPTOR



## THE AMERICAN ARCHITECT

ances occupies the basement at the rear of the classroom wing.

The building, which is built of stucco on terra cotta blocks, faces northeast and is seen on the river side of Broadway, as the highway is called, half concealed by a high stucco wall with an interesting gateway.

Classic in style, it is highly academic and expressive of the school idea both in mass and detail. Its pediment rises above two stories of Greek columns—Doric and Ionic. Niches in which statues are to be placed flank the entrance portico. One of these, representing Kipling's boy hero Mogli and his panther, with great beauty of line and character, has just been completed by Mr. Rudulf Evans, Mr. Vanderlip's intimate friend and protégé. The Theater, directly opposite the entrance, is reached through the altogether charming vestibule with French-gray walls, black and white marble floor, and panels filled with plaster casts from the Parthenon friezes, with hanging light fixtures of alabaster supported by chains of antique green bronze. The spirit breathed by this foyer is cool, fresh, strikingly architectural, yet so simple that its design is comprehended at a glance—the very "type parfait" of vestibule treatment, as is well set forth in that admirable work on interior decoration by Edith Wharton and Ogden Codman. As one enters the theater he is surprised to find it so large and entirely "professional." There are seats for three hundred spectators. The stage



A GLIMPSE OF THE ENTRANCE PORTICO

is 25 feet deep and is provided with all the modern equipment of mechanical devices, lighting features, etc., so that regular companies of actors may be



CLASS ROOM END OF SCHOOL



SWIMMING POOL NEAR THE SCHOOL



ENTRANCE DOORWAY, LIBRARY OF FRANK A. VANDERLIP AT BEECHWOOD  
WELLES BOSWORTH, ARCHITECT



accommodated as well here as in their city theaters. Among others, the original cast of the "Yellow Jacket," that immortal little play, have come to this stage while no less a genius than Paderewski played at its dedication. Mr. Vanderlip conceived that the



BUST OF FRANK A. VANDERLIP  
RUDOLF EVANS, SCULPTOR

theater, being perhaps the greatest single educational influence in the world at large, could not be omitted from the experience of a child's schooling. Each pupil is obliged to do his turn on the stage—before all the other children as audience—at frequent intervals. How many of us have suffered from the lack of such an experience in our early years when for the first time we were called upon to face an audience in unfamiliar surroundings!

A moving picture booth is arranged over the en-



THE GOLDEN HOUR  
STATUE IN LIBRARY OF MR. VANDERLIP  
RUDOLF EVANS, SCULPTOR

trance in the rear of the auditorium and once a week the neighborhood is entertained with a regular "movie" program—while of course the gymnasium is adapted admirably for dances as well as basket ball or other indoor games. Out of doors, the land slopes down steeply in the rear, forming a beautiful amphitheatre bordered by a picturesque ravine and running brook. This gully is spanned by a rough stone bridge of single arch, reflected in the pool below and shaded by fine old trees of unusual magnitude and variety.

One can hardly imagine more perfect conditions for children to grow up in. There are tennis courts and a swimming pool, and every modern method is brought into play to train these boys and girls to a full and balanced development of both body and mind.

Mr. Vanderlip is planting seeds of good citizenship which will go far to bulwark as also to extend the boundaries of civilization.

GEORGE ELLING.

# Architecture After the War

## IV—What Is An Architect?

By C. H. BLACKALL, *F.A.I.A.*

WE know what he was before the war: an idealist, an individual whose mission was to make over the world in what he considered the most beautiful guise, a man entrusted with large opportunities coming in often faster than he could master them and striving his best to keep up with the tremendous increase in the requirements and the possibilities of modern construction, a dreamer and strictly a professional man. It was a splendid ideal and all honor to those who strove so nobly to uphold this exalted plane, but that the architect of after the war is a different man is evidenced on every hand. The point of view is changed not only because of the war but because it was in process of changing before. The profession as a whole set its face against change and looked frowningly upon those who from limited equipment or limited choice did not measure up to the individualistic, imaginative standard of 1876 and later, and now the question is a very pertinent one and should be scrutinized very closely by all who desire to be in the tide of progress, for progress is the only thing that keeps any profession or calling alive. It is the stirring of the water by the invisible hand which brings healing, growth and prosperity.

In the previous articles the statement has been made that an architect is first of all a business man; second, a constructor, and, third, a dreamer of dreams, or otherwise a designer. There have been those who assumed that because of this triple nature all that was necessary for an organization was for some clever business man with brains and power of organization to get around him some bright young men, divide up the work according to their several abilities, and presto we have an architectural organization. Nothing could be further from the truth than this. An architect must be a business man, but a business man by merely wishing cannot make himself an architect. An architect may and should develop into a business man if only by association, but if we can read at all aright the actual results, a business man unless he has the architectural instinct as a foundation can never develop himself into an architect even by association. Again, we have seen in the past repeated attempts to develop a building organization based only upon engineering experience. Strictly speaking, the engineer's structure may be mechanically perfect, but it is apt to be a

mere aggregation of units each possibly perfect of itself but not co-ordinated in a logical, symmetrical whole, thereby failing to be the record of progress and history which is an appanage of architecture. The engineer merely points the moral. The architect should both point the moral and adorn the tale. A structure such as the Brooklyn Bridge which starts out to be merely an engineering work may prove to be pure architecture for the simple reason that it becomes what all good architecture is, orderly creation and arrangement for a distinct purpose and need. And on the other hand architects have made some extremely successful factories which while governed by simple engineering requirements were yet creations. But it has been demonstrated again and again that the start must be from the architectural standpoint. Some years ago a prominent firm of contractors in New York set out, as they themselves expressed it, to eliminate the architect by doing themselves everything that an architect would do, hiring clever draughtsmen, attending personally to the construction and thinking thereby to leave out a certain amount of friction which seemed to them inevitable and which impeded the most economical results, but as a matter of fact I believe that same firm admits today that the attempt was a failure and that the architect could not be eliminated without at the same time eliminating the architecture. Again, an attempt was made by a very prominent brokerage firm to eliminate the architect by carrying out in the name of the builder all the portions necessary to a finished structure, hiring such architects as they saw fit to carry out their wishes but retaining the real direction, financial, artistic and otherwise, in their own hands. This organization has done some very creditable work but it has not been architecture in the sense in which we mean it as being in any way representative of the aspirations of the people and the clearly defined and simply worked out practical needs. It may be said as a general proposition that the architect is more apt to know when to use the engineer or the business man than either of them knows when he needs an architect. Furthermore, there have been some most lamentable examples of failure directly traceable to the fact that architecture was considered merely as an adornment and not something vital, or that the only vital factors were



## THE AMERICAN ARCHITECT

the engineering and the business ones. A Court of Honor in a large school group which is so arranged as to disrupt the interrelation of the parts is a hopeless failure. To enter a building expressed as a dome on the exterior with imposing portico before it and then to find oneself in a mechanical laboratory and discover that the dome is a mere useless appanage is surely not an ideal combination of architectural possibilities and engineering or practical demands.

How then do we find that an architect is temperamentally constituted in these days? Of course we have not changed wholly yet. The old régime still endures and there are always to be those who cling to the individualistic ideal of which Ruskin was so strong a champion and which really made possible the condition of the profession today, but if we try to take a dispassionate measure of the architects of today who seem to be doing the best work and are at the same time the most successful in every respect, we find a basis in every case of architectural appreciation, education and development. Whether the architect is one of a firm and devotes himself more exclusively to one department of the work, or whether he is the focus of the organization, the really successful ones are those who are artists by temperament and who have adopted the engineering and the business point of view as means to an end, as adjuncts to a desired consummation and as factors which are indispensable and which must be viewed from a strictly architectural standpoint. We find that the most successful architects today in this country have primarily had the creative faculty, and as far as can be determined by a pretty wide acquaintance in the ranks of the profession, there is not a single architect today who does not owe most of his success to the fact that he is businesslike and knows how to construct. On the other hand, it is equally true that there is not a successful architect in the United States who owes his success only to the fact that he is an artist. We find, too, that organization has counted in the past as a very important factor in the successes and that as a general proposition the architects who are awake to the possibilities of this day and are reaching out to larger fields, to broader horizons and to more perfect success are those who have been able most effectively to balance the three sides of the profession, not letting anyone assume any more than is due relative importance, but viewing them all from the architectural standpoint.

The case of one architectural firm comes to mind as typical of the new tendency in our profession. This firm occupies an entire building with its offices. On the ground floor is a bank which is so directly connected with the work of the architectural firm

that though in name they are distinct, in fact the resources of one are ever ready to back up the recommendations and the judgment of the other. In the second floor on one side is an art gallery where the architectural organization can exhibit its own ideas and where also it gathers pictures, furniture, tapestries or works of art which it can reasonably recommend to its clients for certain specific cases. On the other side are the reception rooms of the firm where the clients receive their attention and are encouraged to formulate and present their desires. There is a thoroughly equipped department of accounting, another equally well equipped of inspection and engineering, a large and carefully selected library, and finally the center of the whole organization, the designing department. This firm has done most excellent work and its work has been recognized by the profession and by the public as being of a very high order, and yet a comparatively short time ago its organization would have been looked at askance by the profession and its attitude towards financing and construction would have been condemned, yet this firm constitutes one of the most successful units in the country.

Again, there comes to mind another organization headed by a single architect who in his early days made a distinction for himself as a draughtsman and designer and an artist. His association represents as complete a business and professional equipment as one could wish, with every facility and every convenience and every accessory which would contribute in any degree to making the buildings he undertakes answer fully their best and highest purpose. It goes without saying that everyone would not solve the problem as he or his organization would, but the average of the work turned out by this office is so high and its buildings are so eminently successful that it would be denying the facts to assert that this does not represent the successful architectural effort of the day, even though five years ago his professional standing was not in favor with many of the conservative architects.

Examples might be multiplied indefinitely but they only serve to show that the architect represents a very different organism than what obtained a very few years ago, and summing up the results of observation, it seems no more than a recognition of existing conditions to say that the successful combination of today is not a union of an architect, an engineer and a prosaic business administrator, who associate themselves chiefly because the architect cannot get a job alone, the engineer cannot do it alone, and the business man can neither design nor construct, though all need the money; but it is the man, or group of men, who, starting with a solid foundation of architectural and creative ability on

## THE AMERICAN ARCHITECT

the part of all the members, has built up a business organization in a scientific manner and carried it out to success, financially, structurally and architecturally, depending not upon any one branch alone for its success but on the combined product of the individual factors. All architects cannot be great, but the essence of greatness is in all good architecture, and it is this element of imaginative conception wrought out into an efficient, well-rounded development that constitutes the best and most hopeful phase of the architecture of today.

The question may well be asked, is it any better than we had before? Some think it is and others while recognizing the efficiency of the modern viewpoint deny that its result can satisfy or ever produce work equal to the great periods of the past. But surely the present viewpoint is more attractive to the beginner in that it offers a distinct career leading to the highest results. The awards certainly are larger, for no architect can make more than a bare living if he depends upon his own effort; and measured by the highest standards of real service to the community, the modern architect is what the old régime never produced, a factor in civilization, an important element of modern life and a historian of the nation's progress. Architecture has been defined as a mood made permanent. There are many moods in the multitudinous currents of the busy life of today, so different in all its eddies and turns from the quiet, contemplative life of the past, and we make those moods permanent by clothing them in tangible, available envelopes and by fixing them in terms which mean permanence and efficiency. Surely this comes pretty near being good architecture. And, given a professional point of view such as has been intimated in this paper, there seems to be no end to the possibilities of the profession. Great achievements in large undertakings and great successes in the small, intimate work are

now equally within our reach. The moulding of public opinion through the mirror which we hold up to it is now our task and will be the rule rather than the exception. Architects are not a privileged class, only a small coterie of mutual admirers who can now be, if they wish, the leaders, the inspirers, the promoters, as well as the constructors and the idealists. Surely this is a program well worth following out and building upon, and whatever we may think of it, whether we agree it is right or wrong, whether we sigh for the old days, we cannot get away from the actual facts that architecture and the architect today carry out the program which has been outlined and that the successful architect is the man who has the widest grasp upon the many sided demands of his profession.

And with it all there still remains the ideals, but they are not lowered or cheapened by the associations with business and science. Rather they are made higher and more inspiring, and, as never before, the profession with its many sidedness can take to itself the words of John Ruskin, who wrote for an imaginative period when it was the rule to think and act in hyperboles and when common sense and hard, practical requirements were brushed aside as derogatory to a professional man, but words which are just as applicable today to the kind of work which, with all its opportunities and limitations, its hope and its necessities, can now be realized by the profession:

"When we build, let us think that we build forever. Let it not be for present delight nor for present use alone. Let it be such work as our descendants will thank us for, and let us think, as we lay stone on stone, that a time is to come when those stones will be held sacred because our hands have touched them, and that men will say as they look upon the labor and wrought substance of them, 'See! This our Fathers did for us.'"

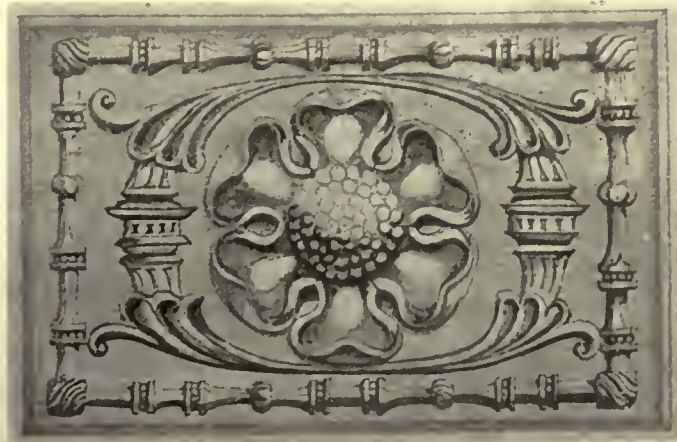



# Developing the American Craftsman

THE words "industrial art" imply the relation of art to industrial or mechanical production, which in daily parlance signifies the relation of appealing form and color to utility. They mean that usefulness, while remaining an essential objective, is shorn of its ability to contribute to cultural progress if it is not made sufficiently attractive to contribute pleasure to human environment. This relation between industry and art is embraced in the word "design," a type of thinking that Americans have been too ready to let others do for them these many years.

While counting upon mass production as a quick road to large figures on our national ledger, we have not been far-sighted enough to discover that mass alone becomes an obstacle in all articles which constitute our domestic surroundings, if a constant and consistently growing appeal does not form a part of its reason for being. The exact value to be placed upon the material and the design we have for many decades gauged incorrectly. The gloss of surface carving will not pass for design. The gimcrack assortment of motives which is the merest flimsy cloak for the structural conception identical in all styles unless related to every guiding line in the piece; the gathering of suggestion repeatedly from books—and usually from poor books or designs themselves copied from others of their own ilk without recourse to originals—brings about a stalemate in design. Execution improves, design lags.

Execution, methods of manufacture, cannot supplant design; they can only facilitate design. Without design they serve requirements of utility only, and might as well be diverted to merely mechanical objectives in which appeal to the mind through the eye or sense of touch is the least consideration. Objects of industrial art without an adequate inspiration in design serve their function as well as a piano played when out of tune.

American business men are known to be shrewd, yet their shrewdness is too momentary in its application. In the great field of the industrial arts commanding an outlay of \$500,000,000 each year these very business men have not taken thought for the future. They wail for the designers that Europe has recalled, they lament the fate of American craftsmanship, and turn around to make just what they have made before with a minimum improvement on the plea that design is too expensive, whereas correct reasoning would show that good

design is an investment costing less than any other single factor in industrial arts production when considered in terms of ultimate cash returns.

There is but one help for manufacturers in the industrial arts field—only one: education. They must educate designers, they must establish schools for training designers, they must realize that design is a cash asset, an all-for-business investment. They must come to the conviction that design means quality, and that only good design commands a good price. Refinement is the index of taste, and taste is the keynote of American industrial advance. Education points out the difference between the artistic progress of France and the industrial art statements of America.

In many branches of life men have seen the salvation of their business enterprises in the training of those to whom they pay salaries. In the industrial arts field the voice of not one manufacturer has been heard in favor of schools to teach designers. Rather a million dollars for mass output to achieve large selling figures now than five thousand dollars toward a school whose human product will make the one million into ten within a few years.

Schools we must have—in every branch of industrial art production we must have school training as a feeder for the factory of the future. Designers will surely always come up from the ranks, but if there are potential designers in the ranks of factory hands, they deserve the chance to make the journey toward a designer's salary by the line of least resistance.

The school is a part of the factory, and the fact that it is not under the same roof with the machinery of production does not alter this truth. To hesitate to train designers to turn out the best for the American market is to waste material, to waste effort, to waste money, to waste precious time as we have already lost it depending upon Europe so long.

And while the schools are being put under way, the educational values of museums must not be ignored. Practically all of our museums maintaining collections in any of the industrial art fields have made many efforts to reach designers, to appeal to manufacturers, to establish the business value of design. To develop design without the use of the museum is to study chemistry without the laboratory.

RICHARD F. BACH.

# Why Not Build Now?

By J. C. MURPHY, *Architect*

**M**AY we not soon have an end to the dreary song we so often hear that one cannot afford to build because the cost of building is too high? How men, whose judgment is considered sound in business affairs, can hope that the cost of building will go back to the abnormally low pre-war level when they do not expect other prices to return to that level, is hard to understand.

Shoes are high. Why? Because leather is high. Leather is high because cattle are high. Cattle are high because feed is high. Feed is high because the things the farmer must buy are high. All are high because labor is high. Labor in turn is high because shoes and food and clothing are high. We are told that none of these prices can be lowered. We try to trace this to the beginning only to find that we have an endless chain. The cost of building is but a link in the industrial chain and rises and falls with the other links. It takes no more days of labor, no more barrels of cement, no more bricks, no more pounds of steel, no more feet of lumber to build now than it took before the war. Lumber and steel and bricks and cement take no more—if as many—days of labor to produce now than they took then.

We hear men say that they will not build now but will wait until prices are lower. Is the cost of building so high? Carefully compiled statistics show that these costs, except the high pressure building done for certain war needs where speed only was considered, have been relatively lower than anything else.

Would one who desires to build now gain anything by waiting for prices to go down? I think not. Prices for building can no more go back to the old level than can prices of other commodities. Only in case all business goes to the bad will prices drop. Then there will be fewer jobs than men to fill them, more goods made than can be consumed. As men must have work, the old and unrepeatable law of supply and demand will assert itself. You can no more stop its operation by artificial restraints and combinations in the matter of labor than you can by combinations or otherwise maintaining high prices of food or clothing or buildings or any other thing. For the same reason down will go the prices of securities. Dividends on stocks will be cut or passed, and when the price of building reaches the low level your investor would have it reach he will find that his stocks or his goods have reached a corresponding level. It will take as many shares of

stock, as many pairs of shoes, as many wagons, as many bushels of wheat or barrels of flour to build the house then as it will take to-day. So where is the gain?

Prices are relative and in the last analysis are a matter of barter. To build, one must sell some of the goods he makes or trades in or some of the securities he owns, to get the money with which to build. If prices are high he sells for a higher price. If prices are low he gets less for his goods and pays proportionately less for his building. Relatively, he is no richer or poorer. To take a concrete example. If I desired to build a house that today would cost \$12,000 I would have to sell one hundred shares of L. & N. Railroad stock to pay for it. I might think the price of building too high and decide to wait. I may find in a few years that I can build the same house for \$9,500, and decide to build. When I try to sell my L. & N. stock I find that I can get only \$95 the share for it, so I still have to sell one hundred shares. What have I gained? This has actually happened and will happen again with high-class stocks like L. & N. Railroad. With stock of lower class the shrinkage in value is much greater.

No one of sound judgment hopes that the thing he has to sell will remain high while the things he wishes to buy will go down. By chance this might happen once in a while in isolated cases, but it is poor dependence. Speculating on margins sometimes brings large profits, but generally the result is failure, and if one makes a practice of this kind of speculation failure is certain. Your careful investor takes no gambler's chances, and in the end he wins.

It has been said that real estate is not a good investment because rents do not go up with other values and you cannot sell real estate for more money when building is high than when building is low. That this is not true has been shown in this city, Louisville, Ky., in a most forcible manner. Rents have risen, the values of homes and desirable real estate have advanced. Because some property does not increase is no sound argument to the contrary. If I own real estate in a town that is going backward or in a backward portion of a town that is going forward I am no worse off than if I own stock in a business or factory or utility that is on the down grade. I get some return from my real estate. I may get nothing from my stock. I may even lose the principal.



If my factory or business is prospering and I want more room I had better build now while business is good so that I can use the building for increasing my business.

I am told that by building now I increase my overhead expense by the additional interest resulting from the higher cost. If I am not to build now what am I to do with my surplus in the meanwhile? If I invest it in securities to hold until the cost of building declines I will have to sell the securities on the declining market at correspondingly lower prices. It were better to invest it in buildings now, profit by the increased output I would get while business is good and, by adding to and readjusting my plant, so equip it that I may reduce the cost of production and be in a better position to compete with others when the inevitable decline comes.

### How the Ancients Built Walls

The statement is frequently made, comments *Buildings and Building Management*, that the ancient Romans used concrete freely, and that their work has lasted perfectly down to the present day. The impression that is sought to be conveyed by all such statements is that the concrete was precisely similar to that we are using now, and consequently is an argument for the durability of some of our cheap construction. Every one who has looked into the subject with any thoroughness knows, of course, that the Romans faced their walls with stone, and merely used a core, or filling, of cement and spalls, says *Stone*. This is far different from our concrete poured into removable forms. C. R. Peers, chief inspector of ancient monuments and historic buildings in Great Britain, delivered an interesting address on "The Care of Ancient Monuments" recently. Among other things, Mr. Peers said:

"We are accustomed to hear comparisons drawn between the work of former ages and our own, not to our own advantage. This is by no means always fair. There has been good and bad building in all ages, and in the course of nature more of the bad buildings have perished than of the good, and in consequence the achievement of any period which has left an appreciable number of works is liable to be judged on too favorable a ground. Even in such Roman buildings as are left there is no uniform standard of merit.

"The Roman tradition of building with two faces and a core was continued in the Middle Ages, but often with none of the care and thoroughness which was necessary for its success. In the eleventh century, at any rate, the core in many instances was

little more than earth and building rubbish packed in between wrought stone faces, these latter in small stones with shallow beds. Such walls would stand no great weight and were also particularly sensitive to any foundation movement or lateral stress, having no natural strength.

"In a small building, where stresses are neither great nor complex, a weatherproof wall face protecting a weak core will often serve well enough for the time, but the ruin or reconstruction of many of our mediæval buildings has followed the adoption of such a principle. Walls were pointed in tolerable lime mortar, but built in nothing but clay, and as long as the pointing was able to keep the weather out, they were able to do the work for which they had been designed. But if, through any settlement or stress, a fracture developed, the masonry had no power of resistance, but fell away and became fit for nothing but pulling down, for lack of sound walling to which to bond a repair. It will easily be seen that it is almost impossible to strengthen such a wall so as to prolong its existence appreciably without destroying its character, considering that its character is the very source of its weakness."

### What an Architect's Military Experience Taught Him

What one necessary attribute were we taught in the army, more vital and beyond any other single item of experience? asks Charles E. White, architect, in an article in *The National Builder*. What peculiar quality of the new soldier finally came to the front and demonstrated his fitness to function in that army—what property did he possess after a few weeks of military training during which his mind and muscles were ever directed toward an ideal that was to make him eventually a winner?

Efficiency—that's the ideal sought for in military organization, and we can now pause and take our war-lessons to heart and apply them to civil life. What was good for the military is good for the business man who after all was the first one to demonstrate the power of systematic efficiency.

Efficiency is one of the greatest of words in a world where work is to be done. When applied to any sort of career efficiency is bound to spell the difference between success and failure. To be efficient is to be set, ready, alert, with all faculties aroused and all energies fixed on the goal. To be efficient is to have that complex machine, the human body, and that marvelous controlling element, the human mind, so thoroughly yoked that thought is but an instant ahead of action, and both thought and action are directed expertly, unmis-

## THE AMERICAN ARCHITECT

takably, with precision toward a result that is almost as assured as the movement of tides and the sequence of seasons.

Much had been heard of efficiency before the war and much had been learned of the power of organization when directed along efficacious lines, but the world's allied military establishment adopted efficiency as its key note and blew upon this note so constantly that its message beat down the careless, happy-go-lucky, drifting tendency of men and built of them a machine intricate of parts but so perfectly geared and with such effectual precision that the war was won.

This efficiency of individuals will live. Old-fashioned wasteful methods of doing business are gone forever, and it behooves every business man to note the tendency of the times and get into the band wagon if he wants to keep his place in the sun. Nowhere will efficiency be so potent and inefficiency so impotent as in the field of building. This applies to every operation of every worker, in every department; to the banker who loans the money, to the architect who draws the plans; to the owner for whom the building is built; to mechanics who labor, drivers who haul, dealers who sell, contractors who build, and every manjack who in any way has anything to do with the planning, building, occupying, or operating of any building, large or small, for no matter what purpose erected.

---

### Good Architecture as a Profitable Investment for the Owner

Discussing good architecture as a commercial asset, a contributor to *The Improvement Bulletin* states:

There still remain in this world persons who believe that architecture is a purely ornamental profession—that the man who retains the service of an architect to plan and superintend the construction of a building does so because he wants a few additional artistic effects, for which he is able and willing to pay.

The increased cost of building materials has been a pronounced factor in educating the public regarding the true field of usefulness which the architect occupies. A score of years ago a few thousand dollars sufficed to build a large box-like structure, with a great deal of room, but with no architectural merit. Architecture played very little part in the vast majority of buildings built a score of years ago. But when costs multiplied, owners naturally devoted more thought to the underlying requirements of good building construction. The

architect is on a very much higher plane than he was a score of years ago, and the public is beginning to have a growing conception of the important role the architect should play in the development of the country.

It does not require any considerable knowledge of architecture to appreciate the superior appearance presented by any community in which the services of an architect are utilized in the construction of new buildings.

There are still a good many small communities in the country in which the carpenter and the mason are consulted rather than the architect when a new building is to be constructed. The layman does not stop to consider when he encounters such a community whether the business and public buildings and the residences were planned by a competent architect. He merely knows whether the town is pleasing to the eye—whether it bears the mark of distinction that the prevalence of good architecture imparts to any community. The first impression that he gathers from his initial visit to a town is generally the lasting impression, and more than nine times out of ten it is correct.

For it is usually true (probably invariably true would be a safe statement) that a town in which the representative citizens appreciate good architecture is a better town in which to live than a community in which scant heed is paid to the call of art. The citizens of the town in which the architect is called in to design business buildings and residences—even though the buildings be of small dimensions—have, as a rule, a wider intellectual horizon than men who believe that architecture is merely useless ornamentation, and that the carpenter and bricklayer can create a building of harmonious and attractive design.

Then again, it is true that the citizen who wants an architect to design his building is generally a shrewd and long-headed individual as compared with the man who believes in paring down expenses by eliminating the architect's fee. The architect who is master of his profession must not only plan a building of harmonious design, and attractive appearance, but he must keep constantly in mind the matter of practical every-day utility. There must be no waste corners in the completed building, the interior must meet modern requirements of light and ventilation, the heating plant must be adequate, and yet there must be no waste of material used either in construction or fuel. The building must be planned with close attention to the purpose for which it is intended, in order that the interior arrangement may be completed to the end that the owner, instead of finding after the lapse of a few months or a few years that there are



## THE AMERICAN ARCHITECT

many features of the building with which he is not satisfied, will have an increasing satisfaction in the ownership of the building.

Good architecture increases the value of a building. That is a point that the astute owner always keeps in mind. Five thousand dollars or ten thousand dollars will buy just about so much material in any market. But five thousand dollars' worth of material built into a finished structure of architectural excellence has a higher market value than an equal or greater amount of material used in the construction of a building that is not pleasing to the discriminating eye, and is not arranged with a view to practical requirements.

### The English Post Office as Art Censor

Very properly Major Hayward asked the Postmaster-General, in the House of Commons, what he had to say about the destruction of a packet of etchings by Felicien Rops. It seems that Section 6 of the Foreign and Colonial Post Warrant, 1907, and Clause 63 of the Post Office Act, 1908, confer upon the Post Office officials the power to destroy any document or picture (if they consider it to be obscene) entrusted to them to deliver. It is nothing short of a grave scandal that apparently this power is exercised quite arbitrarily—possibly by officials who know nothing whatever about art, and whose ideas of obscenity may be those of Mrs. Grundy in her most prudish mood. Notoriously, the standard of judgment in such matters fluctuates with period, person, temperament, mood, climate. For Post Office officials to pass judgment on a work of art is utterly absurd, and for these unaccredited censors to order such a work to be destroyed is absolutely immoral. What is equally annoying is that such foolish presumption emphasizes

our insularity, excites the scornful laughter of our Continental and American Allies,\* who may well think us a nation of purblind hypocrites, continually straining at gnats and swallowing camels. These etchings by an eminent Dutch artist were consigned to a London picture dealer. It was the plain duty of the Post Office to deliver them, not to read indecency into them and thereupon to destroy them. Such tyranny is morally indefensible, and the act that legalizes it should be promptly amended. In the meantime, it cannot be made known too widely that any work of art sent through the Post Office may meet with willful destruction at the hands of some meddling and presumptuous official. Censorship of this kind and quality would deprive our museums and art galleries of their most cherished treasures.—*From The Architects and Builders' Journal (London).*

### British Reconstruction Plans Aid Agriculture

Reconstruction plans of the British Government are being based on an estimate that the United Kingdom, if its soil were properly cultivated, could produce enough food for about 30,000,000 people, according to Sir Auckland Geddes, Minister of Reconstruction.

Great Britain, however, said the Minister, must not be purely an agricultural nor purely an industrial nation, but a blend of both. Some manufacturers must go out of business, he contended, but enough will remain to employ those persons not engaged in agriculture and to maintain an export trade that will supply the United Kingdom with the remaining foodstuffs needed.

The policy of the Government, the Minister declared, is to stimulate agriculture to the utmost, while at the same time maintaining the nation's industrial importance.



THE AMERICAN ARCHITECT

Founded 1876

PUBLISHED EVERY WEDNESDAY BY

THE ARCHITECTURAL AND BUILDING PRESS, INC.

No. 243 West Thirty-ninth Street, New York

E. J. ROSENCRANS, PRESIDENT AND TREASURER  
WILLARD C. HOWE, VICE-PRESIDENT

WILLIAM H. CROCKER, Editor  
ARTHUR T. NORTH, Engineering Editor

Subscriptions in the United States and Possessions,  
Mexico and Cuba, TEN DOLLARS. Other Countries,  
TWELVE DOLLARS.

SINGLE COPIES (Regular Issue) 25 CENTS

CHICAGO OFFICE, Mallery Building  
PAGE A. ROBINSON, Western Manager  
ST. LOUIS OFFICE, Wright Building  
CLEVELAND OFFICE, Guardian Building  
SAN FRANCISCO OFFICE, 320 Market Street

Owned by United Publishers Corporation—H. M. Swetland, President;  
Charles G. Phillips, Vice-President; W. H. Taylor, Treasurer;  
A. C. Pearson, Secretary. Entered as second-class matter January  
6, 1909, at the Post Office at New York, New York, under the Act of  
March 3, 1879.

VOL. CXV APRIL 2, 1919 No. 2258

Wasted Opportunities

The Editors, THE AMERICAN ARCHITECT:

When this country declared war, I was one of the first to volunteer for service, and perhaps among the first fifty men who had practiced architecture, to go to France. The statement of qualifications as made by me to the recruiting officer at the time of my enlistment apparently was ignored in the matter of my assignment, as I was placed in an infantry regiment (I had hoped for an assignment to the Engineers) and in due course was sent to France.

I am now back after some fourteen months of service on the front line, having reached the rank of sergeant. I am in hopes of taking up my practice where I laid it down.

What advantage, professionally, has this experience given me? I believe I can truthfully answer, none at all. I never had an opportunity to visit any of the localities where by actual observation I might have been able to acquire a large experience of the highest educational value. I have tried, but without success, to get leave of absence, stating in my request just why this leave was asked for. I never secured a moment's respite from the monotonous round of my military duties, and the result of more than a year's service has been, as far as my training as an architect is concerned, of little value.

I am wondering if my experience has not been similar to that of many another of my professional brethren.

AN ARCHITECT DOUGHERTY.

THE foregoing communication is from a subscriber recently returned from more than a year's service in France. His experience is one that will greatly interest every man in the profession irrespective of military service, as it discloses a condition that should promptly receive the attention of the authorities in Washington.

Reference has been made in these columns to the failure of the Government to avail in a logical way of the services of men trained in technical pursuits. At the time of actual hostilities it was a delicate matter to advance the contention that architects should be detailed to assignments where their abilities could be of the greatest value, as it was open to the criticism that it was desired to shield them from the dangers of the battle-front.

At this time, however, it may be permissible to direct attention in a more forcible way to a condition such as is described by this correspondent, and inquire if it would not be wise to give the architects and engineers who may seek the privilege, sufficient leave to travel in such localities as will permit them the fullest opportunities for observation and study.

If something of this kind is not done, we shall have to depend for our architectural history of the war on the observation and deductions of that large class of newspaper correspondents, who, while cleverly trained for their work, yet lack the highly developed powers of observation of the man educated in architecture.

There is yet time to remedy this matter, as among the men comprising our Army of Occupation in France and Germany are many architects and engineers who would regard it as an unusual opportunity if they could be assigned to a service of observation for which they are so eminently qualified.

It would seem that this is a matter that might enlist the prompt action of the Institute, and that it could by well directed effort make it possible that a certain number of men could be detached from their present purely military duties, and given a special assignment in architectural observation.

Post-War Committee Report  
Relationship of Architect to Public

ARCHITECTS who fail to respond to the invitation of the Post-War Committee to communicate their suggestions as to the matters outlined in its program, will have only themselves to blame if the work of the committee fails through lack of proper encouragement. There is none too much time between now and the convention to be held during the last days of April for consideration of these matters, so it is earnestly urged that the committee should be assured of widespread co-operation.

In Section I of the program, treating generally of the relationship of the architect to the public, and with particular reference to the extension of the



## THE AMERICAN ARCHITECT

service that the architect may render, it is pointed out that one of the most important of the problems under consideration is to discover where lies the responsibility for carrying forward a large majority of building operations without the services of a competent architect. The question is asked, if it is not possible that architects have not in the past placed too much stress on the æsthetic and too little on the business value of their functions. They undoubtedly have and the fault for such an attitude may, we believe, be located more in faulty educational methods than in any other direction.

This statement does not necessarily refer solely to the architect's college days, a period only preparatory to the more strenuous one of architectural practice. A part of every man's education, and perhaps the most important part, will be found in his efforts to keep abreast with the times. It means the keeping in touch with every important new development. This development will not be confined to the æsthetic aspect of his work, in fact that phase will be largely submerged by those vastly more important industrial advancements which are constantly occurring and never with greater rapidity than during the past three years. A man can only successfully extend his field of service in directions to which he has by

education become fitted. So then, if architects either as individuals or as an organized body, are to keep abreast with the times, it becomes necessary to continue a process of self-education, to cultivate well trained powers of analysis. It would be regrettable if architects failed to appreciate the value of education for themselves when by their work they are constantly educating others.

Let us regard one field of architectural educational effort alone—the development of domestic architecture. Is it not a fact in the development of our houses, the refinement of domestic surroundings, that architects have largely contributed to the uplift of all the people from the lowest type of occupant, the industrial worker, to the owner of the most expensive type now being so numerous built by our wealthy citizens?

Again we feel justified in advancing the contention that each of the many questions that is put forward in the Post-War Committee's program has for its very foundation the subject of architectural education. And, whether it refers to that period at college or university, or the larger and more thoughtful one when men have gone into practice, there is not a minute when the subject of education ceases to be the most important of all.

### Planning a Department of Public Works

THE chairman of the National Service Committee of the Engineering Council, M. O. Leighton, McLachen Building, Washington, D. C., has called a conference of engineering societies, under the auspices of the Engineering Council, to formulate plans for the establishment of a Department of Public Works. This department is intended to control all of the construction activities of the national Government. There are now twenty bureaus of the national Government, controlled by six cabinet officials, which have to do with engineering and architectural construction work. The conference will be held at Chicago, April 23, 24, 25, 1919.

As a large proportion of public work consists of building construction, and its design and supervision are functions of architectural practice, THE AMERICAN ARCHITECT sent the following telegram to Mr. Leighton:

"Are national, state and local architects' organizations invited to send delegates to Chicago Convention April 23? Large proportion of public work is building construction, the design and supervision of which is the architects' function. If you have not invited them will you do so?"

Mr. Leighton telegraphed a reply as follows:

"Have invited American Institute of Architects and local club in Louisville and Los Angeles. Was unable to secure addresses of other state and local associations. Will be glad to invite other organizations if you will furnish me with names and addresses of officers."

THE AMERICAN ARCHITECT has furnished the data, as requested, and urges all architectural organizations at once to begin preparations for participation in this conference. In no other way can the interests of the architectural profession be conserved.



PLATE 104

MAIN ENTRANCE

SCHOOL ON ESTATE OF FRANK A. VANDERLIP,  
SCARBORO-ON-HUDSON, N. Y.

WELLES BOSWORTH, ARCHITECT







PLATE 105

NORTH END OF SCHOOL BUILDING, SHOWING ENTRANCE TO GYMNASIUM

SCHOOL ON ESTATE OF FRANK A. VANDERLIP, SCARBORO-ON-HUDSON, N. Y.

WELLES BOSWORTH, ARCHITECT, PLANTING BY OLMSTEAD BROS.







PLATE 106

REAR WALL OF THEATER

SCHOOL ON ESTATE OF FRANK A. VANDERLIP,  
SCARBORO-ON-HUDSON, N. Y.

WELLES BOSWORTH, ARCHITECT







PLATE 107

THEATER WALL, SHOWING DRESSING ROOM WINDOWS AND FIRE EXITS FROM AUDITORIUM

SCHOOL ON ESTATE OF FRANK A. VANDERLIP,  
SCARBORO-ON-HUDSON, N. Y.

WELLES BOSWORTH, ARCHITECT







PLATE 108

RUSTIC BRIDGE OVER RAVINE

SCHOOL ON ESTATE OF FRANK A. VANDERLIP, SCARBORO-ON-HUDSON, N. Y.

WELLES BOSWORTH, ARCHITECT







PLATE 109

GATEWAY

SCHOOL ON ESTATE OF FRANK A. VANDERLIP,  
SCARBORO-ON-HUDSON, N. Y.

WELLES BOSWORTH, ARCHITECT





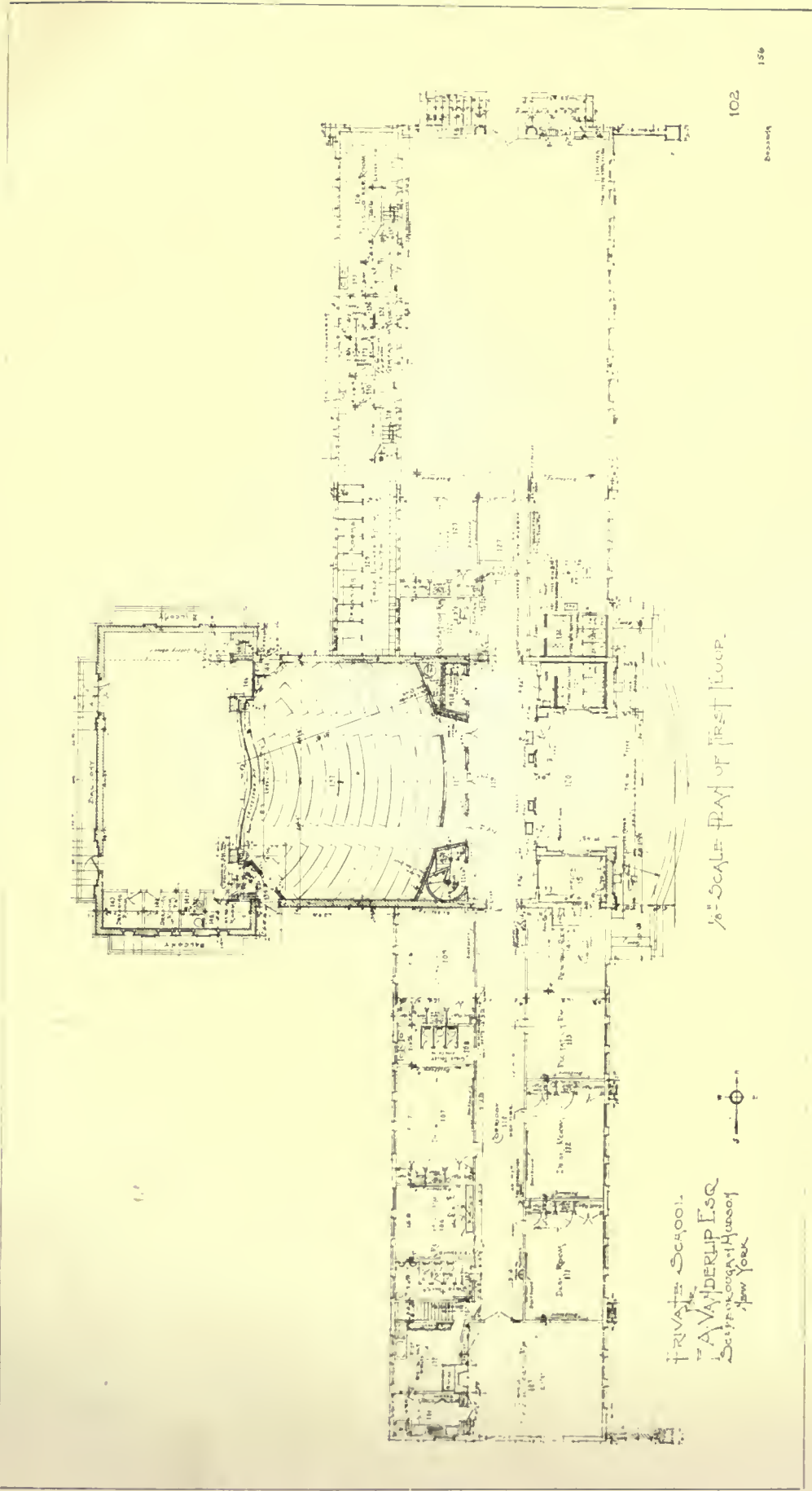

PLATE 110

MAIN FLOOR PLAN. THEATER REAR, GYMNASIUM ON THE RIGHT, CLASS ROOMS ON THE LEFT

SCHOOL ON ESTATE OF FRANK A. VANDERLIP, SCARBORO-ON-HUDSON, N. Y.

WELLES BOSWORTH, ARCHITECT







PLATE III

FIREPLACE AND MANTEL, WITH AN ORIGINAL PAINTING BY VAN DYCK

IN LIBRARY OF FRANK A. VANDERLIP,  
SCARBORO-ON-HUDSON, N. Y.

WELLES BOSWORTH, ARCHITECT







PLATE 112

SWIMMING POOL ON ESTATE OF FRANK A. VANDERLIP, SCARBORO-ON-HUDSON, N. Y.

WELLES BOSWORTH, ARCHITECT





# Criticism and Comment

*The Editors, THE AMERICAN ARCHITECT:*

Replying to Mr. Francis W. Grant's letter in the March 5th issue of your magazine:

The advocates of the quantity system do not claim that it will eliminate every element of risk for contractors. In discussing estimating, I have often called attention to its factors, which are quantities, labor cost, material cost, overhead and profit. Quantities are determinable and can be fixed; the other factors are variable. In speaking of taking the gamble out of contracting, I have in mind eliminating speculation as to how much and what kind of work will be required. How the work will be done, what it will cost in labor and material offers full scope for a contractor's skill and judgment which, if you wish so to term it, may be called a gamble.

One of the weak points in customary practice is that the proper interpretation of the drawings and specifications for too many items is left for determination during construction. Contractors cannot afford to take the time, and architects would not be generally inclined to give time to all the numerous bidders to explain all matters that seemed erroneous or ambiguous or discrepant. Contractor's quantities contain many items that are simply liberal allowances to cover almost any reasonable demand the architect may make. No one but the

architect can completely interpret the plans, and only when a conscientious and capable organization of quantity surveyors prepare quantities under his direction for the bidders can we be sure that the true requirements of a job will become the basis of estimates.

The quality of work required is controlled by the descriptive titles of the quantities edited by the architect. Quality in execution of the work can only be controlled by proper choice of contractor and supervision of work.

Yours truly,

New York.

WM. GRAVES SMITH.

*The Editors, THE AMERICAN ARCHITECT:*

The article appearing in your issue of Jan. 22, in which the waste due to building codes was discussed is interesting, and it appears to me that there is an opportunity for a great deal of action along the lines suggested. Overcoming some of the inertia, however, may be difficult. It seems that some recent tendencies have been in the other direction, toward more conservative regulations.

I hope the article will produce results and believe it should, if followed by others of a similar nature in a vigorous campaign.

Philadelphia.

PIERCE P. FURBER.

## Financial and Commercial Digest

As Affecting the Practice of Architecture

### Campaign for Mortgage Amortization

A national campaign for the purpose of urging the principle of amortization of mortgage loans has just been started by the Savings Bank section of the American Bankers' Association, through its committee on amortization of mortgage loans. The organization of the movement was brought about by the appointment of a committee of six in each state of the Union which will study the situation in its district. The results of the committee's endeavors will be announced semi-monthly.

The Committee on Amortization of Mortgage Loans is constituted as follows: John J. Pulleyn, Chairman, New York; M. W. Harrison, Secretary, New York; Peter J. Slach, Cleveland; B. F. Saul, Washington; H. P. Beckwith, Fargo, N. D., and William A. Nelson, Ansonia, Conn.

In commenting on the work of the committee Mr. Pulleyn said recently:

"The total amount of real estate mortgage loans in the United States in life insurance companies, trust companies and savings banks is over \$6,000,000,000. The greater portion of this is comprised of loans made for a period of years without any stipulation for gradual reduction or for amortization. There will be urgent need for funds within the next few years in order adequately to supply the demands of resumed building operations.

"The League of Building and Loan Associations, through its President, E. L. Keesler, has presented to an appropriate department of the Federal Government a request for legislation which would enable an increase of mortgage credit, that the treasuries of building and loan associations, depleted by patriotic response to the calls of war, may be replenished to meet the demands of peace readjustment. It may be a question whether such legislation is desirable.

"Nevertheless, the demands for mortgage loan money, other than for the building of homes in urban and rural districts, are insistent and increasing. The way in which adequate provision will be made to meet these demands is by the universal response on the part of lenders on mortgage security to some plan of amortization of mortgage loans."



## H. I. Cobb Outlines Building Situation

Henry Ives Cobb, architect, after an exhaustive investigation of building conditions in New York city and vicinity, has submitted a report to the Department of Labor, in which he declares the "cost-plus" method of making contracts is contrary to sound business principles.

Mr. Cobb feels that the uncertainty that has existed in certain quarters over the immediate future of the building industry was but the natural result of wondering as to what the Government would do. In his report he urges prompt and positive action by the Government, which, he says, is the first step toward a prosperity that awaits this country if not killed by neglect.

Speaking of the "cost-plus" system Mr. Cobb stated:

"For a number of years there has been much clever propaganda advocating the different methods of what used to be called 'day-work' under the new name 'cost-plus.' All such methods have but one object in view—the shifting of all financial risk on to the owner. It may be hidden in the most ingenious manner under promised benefits, but always fixes all costs on the owner whatever happens. Many of the good results promised might be realized if the human element could be eliminated, but unfortunately the results show poor work and excessive cost.

"A workman is human and irresistibly works differently if he knows the more his work costs the more his boss gets and runs no risk of loss if the work is badly done than he does if stimulated by the necessity of prompt, correct workmanship or his employer will lose money and reputation and he will lose his job.

"In order to produce quick results, the Government adopted very extensively a system of 'cost-plus' for war construction and the preparation of materials for the same. The extensive use of 'cost-plus' methods by the Government has produced a condition of complete demoralization in construction, labor, and materials which is constantly getting worse and will continue to do so until the Government takes definite action and fixes the method under which Government construction is to be handled.

"If the Government will come out clearly and positively that all departments are to return at once to pre-war methods, and all construction, including the completion of work under way, involving more than \$1,000 shall be executed under contract for a fixed price and time, let in competition, the first and most important step will be accomplished toward a normal and healthy condition.

"If the Government will come out in equally positive terms that all Government construction will be produced by any one of the numerous 'cost-plus' methods, then as well an important step will be taken toward clearing up the situation, as it will result in forcing all important construction on the Government.

"No private purse is long enough to compete with the United States Treasury. Private funds are not interested in construction unless it can be produced under legitimate business methods for a fixed sum, in a given time, at a cost that will yield fair returns on the investment.

"During the stress of war construction another situation was created that is causing some serious uneasiness in the minds of many, but which will be cured by return to normal conditions and methods. Many operations were controlled by men unskilled in the handling of large rapid construction and endeavored to produce speed by numbers of men regardless of cost, and made the common blunder of

thinking a mob of incompetents could replace organization and skill.

"As a result, many of the labor unions have quite a membership of men lacking the proper skill in the trade they were allowed to join. There are no workers more intelligent and careful about membership in their unions than the building trades and more particular in the selection of able leaders. A large part of the credit for all the benefits to human workers that has been brought about by labor unions is due to the skilled, educated mechanics of construction, and they can be depended upon to solve this problem in a satisfactory manner.

"Mechanics, labor unions, material men, sub-contractors, contractors, loan agents and capitalists all know that 'cost-plus' methods are contrary to sound business principles. The few investors who are indifferent to workmanship, time and cost who may employ such methods are of little consequence, but to have the Government adopt any but clean-cut, sound, practical methods is answered by the present conditions.

"The existing stagnation in construction is not due to high wages, but is the natural result of a feeling of uncertainty about what the Government is going to do. I cannot urge upon you too strongly the advisability of prompt and positive action by the Government, which is the first step toward a prosperity that awaits this country if not killed by neglect."

## Builders Ask for Boom Campaign

A project has been inaugurated in Pittsburgh which promises to result in a general resumption of home building in that section of Pennsylvania. A delegation, headed by S. P. Trimble, president of the Builders' Exchange, last week called on Mayor Babcock to get his immediate assistance in the project. They requested the mayor to appoint a joint committee of citizens whose duties would be to fix the prices of wages, materials, etc., so that building contractors and those contemplating the erection of buildings may be rid of the uncertainty that now exists in building circles.

## To Pay the War Debt

According to estimates of United States Treasury officials it will cost the American people about \$1,200,000,000 a year for the next twenty-five years to pay off the war debt. This calculation is made on the assumption that the net war debt, with deductions for loans to the Allies, will be in the neighborhood of \$18,000,000,000.

Interest on this amount, at the rate of 4 $\frac{1}{4}$  per cent, would be \$765,000,000 a year, to be raised by taxes, and then repaid to bond holders. In addition, about \$417,000,000 would have to be provided every year as a sinking fund to redeem all bonds in twenty-five years.

This would require a cumulative sinking fund provision of 2.32 per cent. Congress has not as yet authorized establishment of a sinking fund as recommended by Secretary Carter Glass.

# Current News

## Chicago Architectural Exhibition

The thirty-second annual Chicago Architectural Exhibition given jointly by the Chicago Architectural Club, the Illinois Society of Architects and the Illinois Chapter of the American Institute of Architects, with the co-operation of the Art Institute of Chicago, will be held in the galleries of the Art Institute of Chicago April 15 to May 8.

The Gold Medal of Honor established by the Illinois Chapter of the Institute will be awarded during the exhibition.

Entry blanks and full information may be obtained by addressing Frank A. Childs, chairman, 64 East Van Buren Street, Chicago.

## Buy Birthplace of Col. Roosevelt

The Women's Roosevelt Memorial Committee has purchased the house at 28 East Twentieth Street, New York City, where Theodore Roosevelt was born, and it will be remodeled and restored as it existed when he spent his early life there. In restoring the house, the descriptions to be furnished by members of the family will be followed closely, as well as the description written by Col. Roosevelt in his autobiography.

Before the house was sold several years ago for commercial uses it was a four-story brown stone, but alterations to make it useful for a restaurant and shops reduced it to only two stories, so that the interior will have to be restored entirely. When the Roosevelts occupied the house before the Civil War and for many years afterwards, the main entrance was slightly lower than the present street level and there were three floors above this main floor.

## Favors Reconstruction of Detroit's Blocks

Speaking of the housing problem in Detroit, Mich., F. Gordon Pickell, architect, states that 25,000 or more houses or apartments, which would cost at least \$50,000,000, are needed in that city. "Reconstruction of wasteful areas," he said, "can only be done by developing each block as a whole. The new zoning plan will be a great help to this, but its measures are only restrictive and our greatest need in this matter is something constructive.

"We need the reconstruction of our ideas, so that we will consider it useful and beneficial to take whole blocks, where the buildings are a detriment to the land they occupy, and rebuild them so that they will provide the maximum facilities for comfortable housing that they are capable of supplying, or their position will warrant."

## Jobs for New York's 77th

When the men of the 77th, New York's National Army division, come home in April they will find that most thorough preparations have been made for their re-entrance into the business world. While "New York's own" division is awaiting sailing orders in France, Major S. Fullerton Weaver has been sent to New York by Major General Alexander, commanding the 77th, to arrange for jobs for men of the division, and for a National Army Club house.

Major Weaver has opened a bureau in co-operation with the United States Employment Service. He has written a circular letter to 5000 business men, under whom the 77th division men worked when they entered the National Army, and who, the soldiers believed, might hire them when they returned from France. Major Weaver brought with him from France a card index system showing that 21,400 of the 27,000 men in the division are sure of jobs when they return. That left 5600 to be placed. This number has since been cut down to 5459, because 141 employers have sent word to the 77th Division employment bureau that each will take care of one soldier.

Outlining the labor situation in so far as discharged soldiers from other cities who are seeking employment in New York are concerned, Major Weaver asks that the slogan, "New York jobs for New York soldiers," be adopted by New York business men. He states:

"It is an unfortunate fact that many soldiers from various localities who, on being mustered out of service in the vicinity of New York, have preferred to remain in Greater New York, rather than return to their own homes, and in securing employment here have pre-empted positions which would have been available to New York soldiers returning home at a later date, while the jobs waiting in communities of these out-of-town soldiers are not available to the returning soldiers resident of Greater New York."



## Urges Builders to Watch Opportunities

"There is a real demand to-day for housing all over the country," said Hon. William M. Calder, United States Senator from New York, in addressing members of the Builders' Exchange at Baltimore, Md., recently. "And," he continued, "if I were to offer advice it would be to urge builders to watch their opportunities and be prepared to take advantage of them when they are presented.

"It is estimated that the financial resources of our insurance companies, savings banks and other institutions have accumulated during the last four years to the extent of \$4,500,000,000. It is also estimated that the plans of the country required this amount to put it in efficient working condition and to rearrange it for efficient peace production.

"The nation should immediately interest itself in the investment of its labor and surplus capital in the basic industry of construction, because every dollar and every hour of labor thus invested has earning power and will ultimately cheapen the cost of production of commodities.

"This problem will be met if public interest is centered upon it—if the people can settle it.

"The traditional American attitude toward industrial problems is one of optimism. It is justified by the natural resources of the country and by the character of the population, molded by the public school, educated and self-reliant. The transition period from a war to a peace basis is no doubt a different one, but we know it to be temporary and we believe that it will be followed by a period of exceptional prosperity.

"The one thing that troubles us most today is high prices. If it were not for the high prices there would be no serious transition problem."

---

## Cut Made in Employment Service

Owing to the failure of passage of the Urgent Deficiency Bill and the unavailability of funds from other sources, the United States Employment Service, the national machinery for placing soldiers, sailors and war workers in suitable employment, was reduced to 20 per cent of its present size on March 22.

The cut was made so as to preserve a skeleton organization that will enable the U. S. Employment Service to continue its efforts to place soldiers in employment and to centralize the activities of other Government agencies, welfare organizations and other bodies interested in employment.

While the regular branch offices of the U. S.

Employment Service formerly numbered 750, they have been reduced to 56, the 2000 emergency bureaus for returning soldiers and sailors and the representatives of the U. S. Employment Service in the demobilization camps being continued. The 56 remaining employment offices are located in strategic industrial centers where the employment problem is most complicated, while the special soldiers' bureaus already for the most part are financed by local funds. It is anticipated that many of the 700 regular employment offices, which can no longer be financed by the Employment Service, will be continued by the communities in which they are located.

---

## New York Society of Architects

The regular monthly meeting of the New York Society of Architects was held March 18 at the Society's headquarters, United Engineering Societies Building, New York. There was a large attendance of members and an interesting program of proceedings.

A motion was adopted raising the initiation fee for membership to ten dollars.

It was brought to the attention of the meeting that many architects do not think it worth while to record their certificate of professional practice. A motion was thereupon passed that it is the sense of the Society that it is the duty of every architect, regardless of personal feeling and as a member of a body of professional men, to record his certificate and assume the title conferred thereby.

---

## Lumber Shortage in Italy

There has been a great shortage of lumber during the entire period of Italy's participation in the war, according to Consul General David F. Wilbur at Genoa. Switzerland has furnished about 75 per cent of the imports of rough-hewn lumber and about 80 per cent of the squared or lengthwise sawn. Arrivals of squared timber, which were in 1914 no less than 960,703 tons, diminished in 1915-17 to an average under 250,000 tons.

The scarcity and high price of fuel led to a serious cutting down of the olive trees, thereby injuring one of Italy's greatest export industries, that of olive oil, especially in Liguria. Though the cutting has now stopped, it is feared that the damage will not be easily repaired.

There should be pitch-pine lumber needed for construction purposes following the partial suspension of building operations, but at present new enterprise halts, owing to the unsettled conditions.



## Forest Laboratory Tests

Co-operative work between the Emergency Fleet Corporation and the Forest Products Laboratory of the Forest Service has resulted in the improvement of grading rules for ship timbers, the development of methods of wood preservation, and the discovery of new woods for use as treenails.

Specifications for ship timbers that would yield a satisfactory grade of material and at the same time allow quantity production were prepared with the aid of data obtained by the laboratory on the mechanical properties of various native woods. These specifications were adopted by the Fleet Corporation and the American Bureau of Shipping.

Creosote specifications and methods to follow in the application of wood preservatives to wooden ships were developed and adopted. A large saving was thereby effected through making the Fleet Corporation independent of numerous proprietary wood preservatives which at that time were being promoted with the greatest vigor.

Driving tests on various grades of standard locust treenails were conducted at shipyards, and specifications based on these tests prepared. The adoption of these specifications by the Emergency Fleet Corporation resulted in the elimination of defective material prior to shipment and insured the delivery at shipyards of good, serviceable treenail stock. They also made possible the establishment of a scale of prices.

The use of live oak and osage orange for treenails in addition to locust was recommended after a thorough investigation of the suitability of various species for this purpose. The inclusion of these two woods relieved the seriousness of the situation caused by the failing supply of locust.

---

## Build Now!

"Despite the high prices of building materials, the unsettled labor market, the next Victory loan and other tendencies that make it look like there will be little building in the near future, there is an optimistic side as well as pessimistic viewpoint," writes F. C. Fowler of the New Jersey Materials Co.

"If the individual cannot afford to build some one must build for him, and that means a step near to quantity production. With the money market in its present condition the employers of labor should, from every angle of economics, protect their employees' interests by using their organization's financial strength to produce houses on a quantity basis that will give their workers the six thousand dollar house for four thousand or better.

"During the war the Housing Corporation instituted a movement of this kind under a stress that hampered them in getting the proper quantity production costs.

"The amount of the loan on each house in a project should be increased, as the loan value would not only be based on the real value of the dwellings, but would also be influenced by the rating of the sponsor. To a large degree the personal equation of the investor comes into the loaning of money; to such an extent as to limit the percentage of loan on the value of the house in accordance with the personal standing of the investor.

"There have been numerous ways offered to keep good times with us, including the usage of Liberty bonds as currency. There is enough currency now in circulation. All that is necessary is to speed up this circulation and business will take care of itself. With the industries starting a building boom, the individual will follow suit. If all industries would take a hand in the movement they would receive their money back through the regular channels of trade. Then labor will be better satisfied.

"To sum up it does not require a prescription to find out how to get money on mortgage during the period of transition between war and peace. It requires the business men to step out and make a building boom by building houses for their employees. If they do they will find that all the money that is required is there up to 100 per cent of the valuation of their project. In the meantime, the man who is living in one of their houses continuously over this period is helping the attainment of the perfect zero on labor turnover in the plant."

---

## Personal

Keffer and Jones, architects, have moved their offices from 610 Youngerman Building to 201 Hubbell Building, Des Moines, Iowa.

Clement S. Kirby, architect, has moved his offices from 757 East Sixth Street, to 9 Baker Building, Erie, Penn.

Charles B. Young, having returned from service with the Government, has re-opened his office in the Strand Theater Building, Lexington, Kentucky, for the practice of architecture.

Offices for the practice of architecture have been opened by the new firm of Beshgetoorian and Cobelli at Bangor, Texas. Harry J. Beshgetoorian has practiced his profession both in New York City and Miami, Fla., while Edwin G. Cobelli is from Chicago. The new firm desires to receive manufacturers' samples and catalogs.

# Late News from Architectural Fields

Special Correspondence to THE AMERICAN ARCHITECT

## Stabilizing Market Prices

Washington, D. C., March 29.—During the past week the Capital has been the scene of much argument over the industrial prospects of the country. With the opening session of the conference of the steel and iron men with the industrial board of the Department of Commerce, new hopes have come into the minds of economists, architects and business men here that the inevitable era of building and business prosperity soon will be launched in full blast. Although the effect of a revision in prices may not be felt for some months, it is expected that the official announcement of the agreement of the representatives of the various building industries with the industrial board will result favorably very soon in stabilizing the market and stimulating construction work and building.

On the chief basic iron and steel products the reductions agreed upon with the representatives of those industries range from 10 to 14 per cent below current figures and from 13 to 22 per cent below the prices allowed by the war industries board during the war. Hope that the cost of steel products might be still further lowered by a reduction in transportation rates was dispelled by the announcement of Director General Hines that such would not be the case.

The industrial board in announcing the new schedule of prices made the following comment:

"In giving its approval of the schedule of prices for the principal articles of iron and steel, the industrial board of the Department of Commerce, carrying out the purpose for which it was created, believes that a level has been reached below which the public should not expect to buy during the current year. The purpose of the board is to bring about such a lower level of prices as will affect stability and stimulate trade to the end that business and industry can proceed and build up with confidence and provide maximum employment. In giving its approval to these prices and others which it will consider immediately it will endeavor to strike a balance which while calling sooner or later for some sacrifice or adjustments on the part of all, yet will not subject any of these interests to undue hardships.

"It is fully understood and expected that the present wage rates or agreements will not be interfered with, the approved prices having this in view. The reduction in the price lists may involve the necessity of some high-cost plants either shutting down temporarily or running at a loss for a period, but it is expected with an increased volume of business soon to be developed a reasonable return to the average and better than average producers will be afforded. In view of the higher costs developed throughout the world during the war, a return to anything like pre-war prices is regarded as out of the question. It is expected that other industries, as well as the consuming public and labor, will recognize their obligations to the country in the circumstances and co-operate in the same generous spirit as has the steel industry."

The problem of lumber was on a slightly different basis from that of steel. The advance in the prices of lumber during the war period did not keep pace with that of other commodities, and due to the shortage of labor, building restrictions, increased production costs and the relative small proportion of the production capacity called into operation by the war program, many lumber manufacturers throughout the country very seriously have felt the effect of restrictions and regulations. The prices that were fixed for few woods during the war were not at all productive of increased output by many mills, and it was only the most

efficient and the largest mills that could operate under such circumstances at a reasonable margin of profit. Weather conditions and employment at the mills in the South during the last five months have permitted only about 50 per cent of normal production, and on the West coast, some woods have been manufactured at a sacrifice. Most hardwoods and certain of the less popular softwoods advanced very little during the period that other commodities and labor increased on a general average from 100 to 200 per cent.

The representatives of lumber manufacturers, entirely conversant with these facts, were very little inclined toward a reduction in lumber prices upon approaching the board yesterday. After six hours of discussion, during which time the members of the board were made to feel the justice of the contention of the lumbermen, it was suggested that a committee of representative lumbermen be detailed to provide accurate data to the board so that the question of price adjustment may be given more definite study next week. That committee will meet from time to time with the board next week during the conferences with the cement and brick men, and it is expected that an equitable agreement may be reached.

During the private conferences here among the lumbermen, there was little indication that they would favor any reduction in prices, although there was a definite willingness to contribute to the speedy resumption of building activity, even though it might entail a temporary loss to the lumber interests.

## Disposal of Surplus Hardwood Stock

Washington, D. C., March 29.—As a result of a conference held between representative members of the hardwood industry and representatives of the Office of Director of Sales in regard to the disposition of the surplus stocks of hardwood lumber in possession of the War Department, the hardwood industry chose a committee to act with the Government in this matter. The members of the committee are: C. A. Goodman, president of the National Hardwood Association; Horace F. Taylor and R. M. Carrier, and their function will be to act in an official capacity in disposing of surplus hardwood lumber owned by the War Department. It is the intention of the War Department to work in conjunction with this committee in offering its hardwood in such a way that the market for hardwood lumber will not be unduly disturbed.

## New Bill Aims for Cheaper Housing

Detroit, Mich., March 29.—The campaign for more houses and better housing facilities in this city has been given a big boost by the introduction of a bill by Representative Toepel, amending the State housing code. The new measure is the product of the deliberations of the Michigan Chapter of the American Institute of Architects, the Detroit Real Estate Board and is endorsed by the Board of Commerce and the new council.

The bill permits transforming a single dwelling into a two-family or multiple dwelling, provided the owner conforms with the spirit of the code. Many of Detroit's houses are built on one side of the lot within a foot of the lot line. In the two-mile circle are hundreds of such houses that would be doubles were it not for the fact that by alterations they cannot come under the code and then cannot proceed to remodel because the code calls for a three-foot space to the nearest lot line.



## THE AMERICAN ARCHITECT

Restrictions of the present code are so severe that in Detroit, Lansing, Flint, Jackson, and other towns that have been growing rapidly owners of vacant property are averse to constructing houses, and inability to remodel houses without coming under the code has prevented many property owners, especially in the two-mile circle in Detroit, from transforming big houses into duplexes or other multiple dwellings. It is said by Detroiters that the severity of the code actually has a bearing on rentals in the metropolis because it discourages property owners.

Apartments may be constructed under the new bill to the rear alley line, provided a court is constructed so that the legal amount of light is obtainable. Alleys 20 feet or more in width count in the rear yard space, but as there are few alleys wider than 20 feet, little is gained by the property owner.

### Architects Urge Park System Aid

Providence, R. I., March 31.—At the monthly meeting and dinner of the Rhode Island Chapter of the American Institute of Architects held at the University Club last week, much enthusiasm was manifested on the subject of Metropolitan parks. A resolution requesting the general assembly to provide sufficient funds, both for the proper maintenance of the park system and for the restoration necessary on account of damage done through recent lack of appropriations was heartily endorsed and ordered communicated to the General Assembly.

Col. H. Anthony Dyer was the special guest of the evening. After the regular routine business had been disposed of and the support of the Chapter pledged to the park project, much of the evening was devoted to a discussion of the especial form of victory memorial that should be adopted by the State.

Col. Dyer, as a member of the special committee appointed to consider the establishment of a permanent State memorial, warmly advocated the proposition to build it on the State House grounds.

An informal but unanimous vote showed it to be the sense of the meeting that such a memorial, if placed in the vicinity of the State House, should be at the axis of the building, on Francis Street, in substantially the location suggested by Col. Dyer and in accordance with the larger plans hitherto presented by the City Plan Commission and the joint commission of the city and State for the development of the whole "Public Garden" between the Union Station and the Capitol.

Detail drawings of the latter plan were exhibited and it was explained that these had been prepared after consultation and with the carefully considered approval of the expert advisers of the City Plan Commission, Messrs. Arnold Brunner and Frederick Law Olmsted, as well as the State House architects, McKim, Mead & White. Col. Dyer believed that the State memorial would be in entire harmony and a logical part of the development of this larger plan if they should be carried out later, and it was the unanimous opinion of the Chapter members that this ought to be the case.

### Washington Architects Optimistic

Washington, D. C., March 29.—A spirit of genuine optimism has already begun to characterize the thought of architects here, after a long period of more or less forced complacency over the building future.

Appleton P. Clark, Jr., president of the Washington Chapter of the American Institute of Architects, commented very favorably on the recent announcement of the reduction in steel prices, to the effect that such would bring about a much needed stimulation of business activity, and once more "set the wheels of industry in motion."

In commenting on the present situation, B. Stanley Simmons, architect, said: "The present situation is partly attributable to the reluctance of trust companies and in-

dividuals who usually seek real estate as a basis of security for their funds to withhold same pending the next Victory Loan issue, under the impression they will be called upon to absorb a large proportion of the whole issue. Since practically 98 per cent of the people who build are borrowers, it should be readily apparent that it is this hesitancy on the part of money lenders that is doing more than anything else to retard building. There are many substantial business men who are both ready and willing to build but for the lack of adequate loans with which to do so,—yet, in spite of these conditions, I am very optimistic."

A concerted effort is being made on the part of architects, builders and investors to come to some agreement with labor organizations whereby a regulation scale of wages will be decided upon. Much building is needed here, and it is the belief of E. H. Mealy, secretary of the Builders and Manufacturers' Exchange, that unselfish teamwork between all involved will reduce the cost of construction to a point where the owner and investor will consider it profitable to build now.

### Chapter Discusses Building

Pittsburgh, Pa., March 31.—Matters of vital interest to building affairs of the country were discussed at a special meeting of the Pittsburgh Chapter of the American Institute of Architects in the Fort Pitt Hotel last week. The discussions related for the most part to the post-war activities of the profession.

E. A. Russell, the Pittsburgh Chapter member of the Post-War Committee of the American Institute of Architects, presided. Among the speakers were Dr. Charles W. J. Chubb of Ohio State University, representing the Columbus Chapter; Harry E. Schenck, representing the Dayton, Ohio, Chapter and the Ohio State Association, and Clifford C. Brown, also of the Dayton Chapter.

The discussion brought out that architects must adopt a system of guarantee of their work to owners, as the owners' active interest is in the actual construction of buildings, not in architects' drawings.

### Bill Plans for Dividing Cities

Harrisburg, Pa., March 31.—A bill permitting cities of the second class, Scranton and Pittsburgh, to regulate and limit the height and bulk of buildings and areas of yards, courts and open spaces and to regulate and restrict the location of trades and industries and permitting the city planning commission to divide the city into districts for this purpose has been introduced in the House by Representative Stadlander of Pittsburgh.

In the Senate a bill was introduced appropriating \$199,500 to the trustees of the State Hospital for the Criminal Insane, of which amount \$100,000 would go toward the completion of a new ward and \$4,500 to putting the finishing touches to the home being built for Dr. William M. Lynch, superintendent. The bill permits the trustees to use inmate labor in the construction work.

### Post-War Committee Activities

Washington, D. C., March 29.—A meeting of the executive section of the Post-War Committee in Chicago next week promises to further the plans already outlined in previous reports of this important committee's activities.

The local Chapter is preparing to send four delegates to the annual convention of the American Institute of Architects in April, and it is understood that the major part of the discussion will be confined to the program of the Post-War Committee.



# Department of Architectural Engineering

## The Standardization of Building Products

By ROBERT D. KOHN, F. A. I. A.

WHILE the President of the United States and the Peace Commission are busily engaged in trying to secure for the world the just rewards of victory in the war, it is necessary that those who were engaged during the war in minor activities connected with its prosecution should devote themselves to making permanent some of the worth-while results of the war-time effort. That there are many such worth-while lessons to be learned no one connected with war production can doubt. Every trade and profession will unquestionably be materially changed as a result of the war, either for better or worse, depending on whether or not the war-time experience is examined with a view to securing as a permanent benefit the modifications which are suggested by the war-time experience.

Not the least of these war-time efforts was the work done by the building industries of this country in connection with the war-time housing. It is too early to judge of the effect of the work of the shipyard housing division and the housing corporation charged with the problem of caring for the workers in the munition plants. It is not too early to begin to study the indirect effects of this work.

The necessity for speed of production in all of this housing work required simplifications in the processes of production and simplifications in the details. It was necessary to standardize certain things and it may be said now that such standardization was not harmful to the appearance of the buildings produced and certainly shortened the time of production. Had the war continued for another year, the results in this direction would have been much more evident. But even before the armistice was signed, certain things had been pretty well standardized, thus, for instance, a type kitchen had been worked out with a bathroom located immediately above it, in which the arrangement of fixtures in the kitchen and those in the bathroom had been so simplified that it was possible to determine immediately the number of fixtures and the quantity

of piping of various kinds that would be required for any number of buildings. Doors and windows were used of certain stock patterns, and the design of cornices, interior trim, and other exterior details were frequently modified by the use of stock mouldings and parts without any apparently bad effect upon the appearance of the building.

Without going into the details of these items of standardization, the experience was such that we were justified in claiming that we could, with advantage to cost and to production, adopt similar methods in normal building practice. We find, for instance, that in current building work, almost every architect's office is in the habit of making full size details of window boxes with slight variations for every job. Why could not a standard window frame detail be determined for frame buildings, and one for brick buildings, a detail that would be worked out in agreement between a committee of architects and mill men? This could be so adjusted as to use the most convenient procurable size of materials, and there might even be a first grade and second grade of manufacture so that specifications would merely be drawn to the effect that window frames of a building would be of size as shown on plans and of standard detail, only the thickness of the sash varying with the size of the frame, for instance. Then, too, there is the matter of plumbing fixtures. Today we have several dozen manufacturers of plumbing fixtures and not only does every fixture vary from every other in its roughing measurements, but there is not even uniformity in any one kind of fixture produced by the same manufacturer. It would not seem difficult to secure uniform roughing measurements throughout the country for certain definite types of apparatus. Probably the same result could be attained with heating apparatus, radiators, registers, etc. There are innumerable kinds of building products to which this same principle might be applied. Today the variation between products lies not only in the size and method of construction, but in the quality of the products. If size and details of construction

## THE AMERICAN ARCHITECT

were standardized, qualities alone would be the basis of judgment. It is a common statement in the building world that a plumbing specification which gives the option as between the products of two different manufacturers is really absurd because there is no comparison between such products.

In the list of subjects proposed for consideration of the building world by the new Post-War Committee of the American Institute of Architects, this question of standardization is not the least important. It is one of the importance of which justifies the active co-operation of manufacturers, builders and architects throughout the country. It will undoubtedly require considerable earnest effort to accomplish results. Standards will necessarily vary in different parts of the country owing to the differences of available materials and variations in the requirements resultant on varying climatic conditions. Naturally the problem will have practically little interest for those who are mainly engaged in the production of buildings where the cost is not an element and where the æsthetic effect is the principal guiding consideration. In times like these, however, when building costs are high and the problems of construction more and more grave, standardization of products in common use will doubtless be exceedingly helpful in reducing costs and simplifying the processes of building.

\* \* \* \* \*

The foregoing article, in which Mr. Kohn so forcefully calls attention to an important war-time lesson, is well worth consideration and an earnest effort to bring about the suggested result. The recent experiences in house production to which he refers have taught the lesson that some things commonly thought to be essential are, in fact, non-essential to good design and construction. Intensive and speedy production necessitated the elimination of every factor that involved the expenditure of time—cost not being the controlling element. As stated, standard parts and fixtures were adopted and this method eliminated the dozen-and-one ways of accomplishing the same result in effect. The result satisfied the demands of the designer and of expeditious construction, that was the criterion.

Unfortunately many architects have a pronounced aversion to anything that is "standard" being incorporated in their design. This reluctance arises from a desire for the personal element in all parts of design, which is a laudable purpose in a certain measure. There are, however, very definite and reasonable limits to "originality." This limit should be determined by the relative importance to the whole effect of the appearance of the particular element

under consideration, as balanced by the excess cost of a special design.

Mr. Kohn's idea of standard window frames and sash is perfectly tenable. They perform a certain function and a minor variation in detail has no effect on the appearance of the structure but it does have an influence on its cost, involving a waste with no adequate return whatever. To the most careful observer the construction of the window box is buried in the wall, the detail of the sill, head and staff bead has no marked influence on the observer as long as it apparently conforms to customary proportions.

An architrave, picture mould, chair rail or base board should have a size in proportion to the height and size of the room and its openings. The base board, being utilitarian, serves its purpose regardless of the detail of its moulded member and if its proportions are correct the result is satisfying. Who makes a close-in inspection of the profile of a base board moulding? But many architects vary these mouldings with each structure without any added advantage to the structure. A qualified contractor of interior finish once illustrated how the change of a moulding profile, not exceeding one-sixteenth of an inch, would save 30 per cent of the material required to manufacture the moulding. The detail was made without regard to the stock sizes of the material from which the moulding was to be manufactured and the architect evidently had no comprehension of the manner in which mouldings were produced. Carefully prepared data on a year's production showed that this manufacturer had to add 20 per cent to all estimated quantities of materials in order to cover the waste due to designs not conforming to stock sized rough material.

In a recent address before the Municipal Engineers of the City of New York, Mr. C. E. Dobbin, Deputy Superintendent of School Buildings, Bureau of Design, states that about 80 per cent of their specifications are standard and that the variations amount to about 20 per cent. Industrial architects and engineers find in their work that the same proportion holds good. Consequently, if in schools and industrial buildings so large a percentage can be made standard, is it not reasonable to suppose that in other types of buildings, a large, if not as large, percentage of standard details could not be used? Standardization of these common factors can be accomplished with a benefit to plan production and the fabrication of material.

This well illustrates the necessity for standardization as suggested by Mr. Kohn. A committee of architects acting in conjunction with manufacturers could develop standard details, that are good looking, that conform to manufacturing requirements



## THE AMERICAN ARCHITECT

and thus effect savings in time and money without any sacrifice of an essential factor, either æsthetic or utilitarian. Architects should lend every assistance to the Post-War Committee of the American Institute of Architects in furthering this laudable purpose.—THE EDITORS.

### The Wisconsin Industrial Lighting Code

THE Industrial Lighting Code for factories, mills, offices and other work places, issued by the Industrial Commission of Wisconsin, has been received. This code was revised in 1918 and is the latest regulation of its kind.

The code consists of two parts. The introduction refers to the State laws requiring the Commission to fix standards for industrial lighting, and also describes the methods used in formulating them. The application of the rules and definitions of the terms employed and the rules themselves conclude the first part. The second part consists of explanations of the rules.

This publication is, in fact, a condensed and comprehensive manual on the subject. In advising the factory owner concerning compliance with the orders, it is assumed that he would not attempt to do this himself, but when he is contemplating the construction of a new building he is advised to call in an architect and instruct him to carry out the provisions of the code, with which the architect is supposed to be familiar. Provisions for natural lighting must be made when the building is planned—which is the architect's work. Artificial lighting should be provided for by a competent person, and the owner is advised, in case he leaves it to the architect, to assure himself that the architect employs a competent illuminating engineer or the owner employs an independent consulting engineer. A competent illuminating engineer will effect a saving in installation and maintenance. In any event compliance with the law is necessary.

The methods used for measuring the intensity of illumination and the apparatus made for this purpose are described. The means for providing natural illumination are described and are naturally a part of the building construction. The various types of artificial lighting units and the reflecting accessories are also described. A careful study of this code will enable Wisconsin architects to plan in conformity with the law, and this code is a guide to those architects who design in states where illumination is not regulated by law. Every architect, in order to properly serve his client, should be familiar with these standards. This code has

the same merit that is possessed by the other codes of the Industrial Commission of Wisconsin in that it is brief and limited to the minimum requirements, their State Building Code being a notable example.

This code was prepared under the direction of John A. Hoeveler, electrical engineer for the Commission, and evidences a large measure of research and care in its preparation.

### Industrial Zoning<sup>1</sup>

By HERBERT S. SWAN

*Executive Secretary, Zoning Committee, New York*

THERE seems to be a more or less general impression that zoning, insofar as it affects business and industry, is negative—that it is merely a means of keeping business and industry out of residential sections. So pronounced is this view that the very word zoning has commonly come to mean “protection” for dwelling houses, and “restriction” for stores and factories. This situation is most unfortunate, for zoning, when rightly understood, can be made something as positive and helpful for business buildings as for non-business buildings.

#### NEED FOR INDUSTRIAL ZONING

That the relative competitive strength of a city in the domestic and foreign markets of the world is frequently conditioned to quite as great an extent by the arrangements of the industries within the city as by the availability of raw materials and the proximity of a consuming public is just beginning to dawn upon us. Economical means of transferring and distributing freight within a city contribute proportionately no less to the development and expansion of its commercial and industrial hinterland than efficient outside connections by rail and water. Heavy terminal costs are as much a drag upon a city's prosperity as high freight charges. Every cent saved in needless trucking means just that much more money available for the extension of the city's commercial and industrial radius by rail or water.

When factories and warehouses are not located with reference to freight terminals, a situation frequently develops where the downtown streets are unnecessarily congested to the inconvenience and financial loss of the whole city. A similar condition results where mutually interdependent industries locate in widely separated parts of the city instead of near one another. It is maladjustments of this kind that zoning is designed to remedy.

If experts on transportation are correct in telling

<sup>1</sup>Paper read before the National Conference on City Planning held by the American City Planning Institute at St. Louis.



## THE AMERICAN ARCHITECT

us that the movement of freight increases as the fourth power of the population, that the freight traffic doubles every time the population increases 20 per cent, then the street congestion experienced by our large cities of to-day is as nothing compared with what our larger cities of to-morrow will be obliged to endure. They will be compelled to adopt every possible means in order to keep traffic moving or choke under their own growth.

The purpose of this paper is, however, not to analyze the various evils from which our cities are suffering. That is the function of the economic and industrial survey. The object of this paper is rather to consider the detailed method of formulating the zoning ordinance and of laying out the several business and factory districts than to dwell upon the necessity for zoning.

### SIMPLICITY OF CLASSIFICATION

The simplicity or complexity of its classification will affect as no other factor the continued success of a plan, for after all zoning is almost entirely a matter of classification. If the classification is vague, ambiguous or needlessly involved, it is apt to prejudice the operation of the whole plan.

These facts do not seem to be generally appreciated. Some cities appear to think that the prime requisite in a good zoning scheme is elasticity. A certain amount of elasticity is, of course, wanted, but not at the expense of simplicity.<sup>1</sup> The Minneapolis and Berkeley ordinances are both illustrations of instances where extreme consideration has been paid to elasticity. The Minneapolis ordinance subdivides trades and industries into sixteen different classes; the Berkeley ordinance into twenty different classes. Taken in all their possible combinations, the building classes of the Minneapolis ordinance would permit 241 separate and distinct kinds of industrial use districts. The Berkeley ordinance would permit of 381 separate and distinct kinds of use districts. Such elasticity is bound to develop into a situation where ultimately each district will be just a little different from every other district with the consequence that nobody will know what is allowed or disallowed in any district.

It may be urged that it is very unlikely that all of these combinations will ever be taken advantage of. This may be true, but their very possibility will lead to the development of unnecessary complications.<sup>2</sup> That such minute refinements in the

<sup>1</sup>It is a question whether it is not best to establish an administrative board to moderate and ameliorate the rigor of the law in exceptional cases, as is done in New York by the Board of Appeals, than to make the classification itself elastic. No matter what care is taken in framing the ordinance, instances will be found where the application of the strict letter of the law will work unnecessary hardship.

<sup>2</sup>The experience of Minneapolis illustrates this point. The establishment of the first twenty industrial districts there resulted in twelve different kinds of districts. Only three of these combinations were duplicated—two, three times; and one, five times.

classification are bound to prove irksome, if not unworkable in practice, is evidenced by the fact that Berkeley after less than two years' experience under its zoning ordinance is now contemplating its radical amendment by reducing the classes of industrial use districts to a maximum of five.

The classification is the substance of every district, the district merely bounds the classification. Once accepted, therefore, a classification almost must be continued, as any vital modification in its provisions would practically necessitate a general rearrangement of the districts.

### CLASSES OF USE DISTRICTS

Although a zoning ordinance should have a simple classification, it should not sacrifice needed protection for simplicity. This seems to be the main characteristic of the Alameda and Los Angeles ordinances. These ordinances provide only two classes of districts. In the residence districts the businesses not especially excluded are permitted; in the industrial districts all kinds of business and industry are unrestrained. Neither of these ordinances protects residence streets from stores, nor business streets from large factories or nuisance uses.

The New York resolution in establishing three classes of districts supplies both of these omissions.<sup>1</sup> The residential districts exclude all kinds of business and industry; the business districts all kinds of large manufacturing establishments and nuisances. But the New York classification is weak in one respect, it does not afford sufficient protection to manufacturing. If a factory requires more than 25 per cent of the floor area in a building, or a floor area in excess of the lot area, whichever is the greater, it is forced into the unrestricted district containing all kinds of nuisances.

To put manufacturing establishments and nuisance uses into the same classification thus is apt to produce many unhappy compromises, as every unrestricted district will be the result more or less of a balance struck, on the one hand, between the just claims of the district for factory development, and, on the other hand, the protection demanded by neighboring residence and business districts against nuisances. In some cases nuisances will be allowed where they will do great harm for no better reason than that the locality is naturally a manufacturing district; in other cases, factories will be prohibited on the ground not that their admission is undesirable, but because the nuisances that

<sup>1</sup>For an account of the experience under the New York resolution, see articles by present writer on "How Zoning Works in New York," *National Municipal Review*, May, 1918; "The Non-Conforming Building in Zoning," *THE AMERICAN ARCHITECT*, November 13, 1918; "Zoning and Reconstruction," *THE AMERICAN ARCHITECT*, December 25, 1918; "Zoning the Billboard," *THE AMERICAN ARCHITECT*, February 19, 1919.

## THE AMERICAN ARCHITECT

might slip into the district with them would prove a serious menace to adjoining districts. The proposed Philadelphia and St. Louis ordinances in creating four classes of districts—residence, business, manufacturing and nuisance—are in this respect a distinct improvement over the New York resolution.

### EXCLUSION OF RESIDENCES

A special feature of the Berkeley ordinance, and of the proposed Fresno ordinance, is the exclusion of residences from the heavy manufacturing districts and the nuisance districts. This plan has many distinct merits. The very reasons that make it desirable to exclude factories and nuisances from residence districts apply with equal, if not greater, force when it comes to prohibiting the erection of new dwellings in districts set aside for industrial development. If it is unhealthful for people to live near a factory isolated in the residence district, it is all the more unhealthful for them to live in a home isolated in the industrial district. To permit residence buildings in factory districts, moreover, tends to increase the size of these districts beyond their natural requirements, as the area included in this classification must also make provision for the erection of a considerable number of dwellings.

Mixed buildings furnish the real reason for zoning. The success of zoning is to be judged to a very great degree by the completeness with which it segregates different kinds of buildings. This segregation cannot, of course, be perfected unless exclusion is applied to one class of buildings as well as to another. But in considering the present advisability of excluding residences from industrial and nuisance districts, it may be well to recall that much which is even rudimentary in zoning has not as yet been sustained as constitutional by the courts. Until such vital parts of the zoning program as the exclusion of stores from residence streets have been favorably passed upon by the courts, the most deliberate caution should be exercised in extending the scope of the regulations.

How many classes of industrial districts is a question which cannot be settled by the application of theoretical principles. It must be decided after a careful examination of the facts in each case. The deciding factors will, however, most generally be: (1) the heterogeneity of the existing and prospective development; and (2) the degree to which different types of development have interpenetrated one another. A small homogeneous community may find it necessary to establish but one industrial district, an unrestricted district embracing all kinds of business and industry. More complex communities may, on the other hand, demand two, three,

four or more classes of industrial districts. The number should, however, in every case be kept down to the smallest working minimum essential to the performance of the primary objects of the plan.

### NUMBER OF DISTRICTS

With a simple classification, no worthy object will be served by keeping down the number of districts. A multiplicity of districts is not something in itself to be discouraged, provided the districts are well selected. Indeed, several small districts may prove preferable to one large one, as they can be made to conform more nearly to the existing or immediately prospective development as well as to promote a more uniform type of development. Industrial districts larger than the area demanded by the least restricted class of buildings in the district are apt to result in a very mixed development. The buildings belonging to the more restricted class would perhaps in most instances be better served if segregated by themselves. It is an open question, therefore, whether the general policy in drawing the district boundary lines should not be to limit the extent of the less restrictive classification, each in its turn, to the smallest practicable area.

### DISTRIBUTION OF DISTRICTS

The form which factory districts, as distinguished from business districts, should assume—whether they should be confined in the heart of the city, dispersed to the suburbs, segregated in concentric zones, laid out along lines radiating from the center, arranged in parallel districts bisecting the city, or discriminately scattered throughout—is one which has as yet not been satisfactorily answered. If one of these methods of distributing factories is more satisfactory than another, the fact has not been conclusively demonstrated. Such industrial surveys as are available do not enable one to say which type or types of districts produce the best results. It may well be that there is no *most satisfactory* method, that the most satisfactory method varies for different trades and industries and under different conditions, and that the most satisfactory method in one community is the least satisfactory method in another community.

### ZONING AND DECENTRALIZATION OF POPULATION

Industrial zoning as applied to factories has often been advocated with a view to effecting a decentralization of population, it being supposed that a judicious distribution of factories would at the same time prevent a piling up of the workers in congested tenements. If manufacturing were to be accommodated in the purlieus of the city—and this to a certain extent can be realized, for only those in-



## THE AMERICAN ARCHITECT

dustries which are engaged in manufacture for the local market need be near the business center—each establishment would no doubt in time become the center about which an increasing number of its operatives would seek to live, but this would not in itself solve the problem of land overcrowding.<sup>1</sup> Without drastic regulations effectively limiting the number of families that could be housed per acre, it might only serve to create new congested centers, worse than the old, in the outskirts of the city.<sup>2</sup> The way to limit congestion of population is to limit it, and this, it seems increasingly clear, can only be done by prohibiting more than a given number of families from inhabiting a certain unit of ground.

To scatter the factories for no better reason than that many factories assembled at one place will require a large number of employees is to ignore some of the fundamental facts in the case, as a decentralization of a city's industrial development does not necessarily mean a zoning of workers by place of work. In the first place the different members of a workman's family work in different places. If the head of the family lives where he can walk to his work, will not his daughter who clerks in a department store, or his son who keeps books in a downtown office, have to ride? In the second place, small industrial areas can be used intensively, especially when occupied by light manufacturing. In New York there are blocks improved with loft buildings accommodating more than 5,000 operatives.

Is not the answer to the dilemma that intensive industrial development is no excuse for a congestion of population, that a decentralization of population can go hand in hand with a concentration of industry? Factory centers, like business centers, must have convenient transportation. If there are many workmen employed in one place, it is not essential to house them on the same area which a smaller number would inhabit more sparsely. Through the construction of transit lines the housing area can be enlarged to such an extent that each family will still live in good surroundings.

### CHANGES IN DISTRICTS AND CLASSIFICATION

Action affecting changes in the districts or the classification should be taken only after a most deliberate examination of the facts. After a section has once been subject to certain restrictions a change in the regulations cannot be made without

due regard to the effect that the ordinance has had upon the development of the locality. In time it will, of course, become increasingly more and more difficult to make changes of this character without violating the interests which have come into being on account of the plan. Here is a district where certain buildings have been erected which, but for the protection afforded by the regulations, would never have been constructed; there is a district where certain buildings have been prevented from being erected which, but for the restrictions imposed by the ordinance, would have been built. A change in the restrictions will leave neither of these districts in the position which they would have occupied but for the adoption of the law.

### LOCAL CONDITIONS MUST BE CONSIDERED

The shape, size, location and distribution of industrial districts, as well as their classification, must be determined, not by theory, but by a careful consideration of the concrete facts in each case. The presence of rail and water terminals, the size of the block and lot unit, the width and grade of streets, the character of the existing development, in fact, practically everything connected with the physical plan of a city have to be taken into account and thoroughly studied and analyzed in framing a constructive program for industrial growth. That such a program for future development is essential in every city cannot be questioned. For years the pecuniary losses suffered on account of unregulated building in certain sections of New York have not only equaled but exceeded those suffered from fire. Investigation might show that this statement of facts was true of the metropolis as a whole. The city that does not protect its citizens against fire is generally considered derelict in its sense of public duty. The same is rapidly becoming true of the city that does not protect its citizens against unregulated building.

## Book Review

APPLIED MECHANICS, VOL. II, STRENGTH OF MATERIALS. By Charles E. Fuller and William A. Johnston, Professors of Theoretical and Applied Mechanics, Massachusetts Institute of Technology. Full cloth, 556 pages, size 6 x 9, illustrated. Price \$3.75 net. John Wiley & Sons, Inc., New York.

This work was prepared primarily for the use of engineering students, and is in no sense elementary in its scope. As a preparation the reader of this work should have a knowledge of differential and integral calculus, the principles of statics and dynamics and the methods of determining centers of

<sup>1</sup>Different surveys show that the proportion of employees living within walking distance of their work increases with the length of time that the industry has been established in one place. See Report on Detroit Street Railway Traffic and Proposed Subway, 1915, p. 7. Also Report of Chicago Traction and Subway Commission, 1916, p. 246.

<sup>2</sup>For a description of how far congestion can proceed, see report prepared by present writer on "Land Overcrowding in Brooklyn," 1916, Tenement House Committee, Brooklyn Bureau of Charities.



## THE AMERICAN ARCHITECT

gravity and moments of inertia of areas and solids. Considerable attention has been given to the logical development of the subject, and care has been taken to point out the limitations of the different theories, emphasis being laid on the divergence of the conditions met in practice from the ideal conditions, under which the theoretical formulas are deduced, and on modifications necessary or advisable when the formulas are used under ordinary working conditions.

The fifteen chapters treat of the physical properties of materials, analysis of stress and strain, uniform stress and uniformly varying stress, stresses in beams, deflection of beams, continuous beams, combined stresses, general theory of flexure, columns, shafting and springs, curved bars, arches and catenaries, cylinders and plates, and reinforced concrete beams and columns.

This book will be a valuable acquisition to the library of the technically trained architect and engineer as a reference work to be used in the solution of many of the problems that often demand their attention.

---

AUTOMATIC SPRINKLER PROTECTION, by Gorham Dana, Boston. Full cloth, 456 pages, size 5 x 8, illustrated. Price \$3.50. John Wiley & Sons, Inc., New York.

This book is based on a series of lectures delivered by Mr. Gorham Dana, Manager The Underwriters' Bureau of New England, before the Insurance Library Association of Boston. The fifteen chapters treat of the history of the development of the automatic sprinkler. The first three chapters devoted to perforated pipes, early automatic systems and sprinklers and the later developments in automatic sprinklers. The succeeding chapters are devoted to tests and characteristics of sprinklers, installation rules, layout of equipments, alarm valves, dry valves, sprinkler supervisory systems, maintenance and fire record, sprinkler leakage, automatic sprinklers as a protection to life, combined heat and sprinkler systems and the sypho chemical sprinkler system. The chapters on Combined Heat and Sprinkler Systems and Sypho Chemical Sprinkler Systems describe new developments and appear only in this, the second edition of the book. In the appendix a list of over 250 sprinkler heads are described and rated and a summary of 6277 tests

on 61 different kinds of heads, corrected to April, 1918, is included. The form of a standard report blank for inspection by the assured is given.

This book appears to be written for a diversified class of readers and not specially for any one class. Much space is given to records of performance and other data to justify the use of such apparatus. This gives the book a flavor of promotion propaganda which is as well taken care of by other agencies and which the reader, seeking data on which to base design and selection of equipment, has no need for in a book of this kind. The use of a sprinkler system is governed by a desire to have one or by the compelling force of insurance rates or municipal regulations. On this basis a book should be prepared to furnish the technical data needed to design such layouts, install and maintain them. Unfortunately the use of this type of apparatus is restricted in so many ways that there is no competitive choice of the working parts and a book limited to them would be much smaller than this one. The description of the discarded and badly designed heads will be of interest to an inventor, as it is an historical museum, but of no interest to the engineer or architect who is designing such an apparatus for a building.

The chapters on the combined heat and sprinkler systems and the sypho chemical sprinkler systems describe late adaptations and are of interest. The book is probably the best of its kind at present available.

---

HANDBOOK OF MATHEMATICS FOR ENGINEERS, by L. A. Waterbury, C.E., and G. A. Goodenough and H. H. Higbie. Third Edition, revised and enlarged, 278 pages, illustrations and tables. Morocco, \$1.50 net. John Wiley & Sons, Inc., New York.

This book, of vest-pocket size, is intended as a reference book for the use of those who have studied or are studying the branches of mathematics usually taught in engineering courses. It is not intended for a text book, and does not, therefore, attempt to prove many of the formulas which are given. It is a handy reference book for the engineer who wishes quick access to formulas that are not usually memorized. The book covers the field of mathematics, theoretical mechanics, mechanics of materials, hydraulics, heat engineering, electrical engineering and tables.

113 - 122 - 123 - 124 - 125 - 126 - 127 - 128 - 129 - 130 - 131 - 132 - 133 - 134 - 135 - 136 - 137 - 138 - 139 - 140 - 141 - 142 - 143 - 144 - 145 - 146 - 147 - 148 - 149 - 150 - 151 - 152 - 153 - 154 - 155 - 156 - 157 - 158 - 159 - 160 - 161 - 162 - 163 - 164 - 165 - 166 - 167 - 168 - 169 - 170 - 171 - 172 - 173 - 174 - 175 - 176 - 177 - 178 - 179 - 180 - 181 - 182 - 183 - 184 - 185 - 186 - 187 - 188 - 189 - 190 - 191 - 192 - 193 - 194 - 195 - 196 - 197 - 198 - 199 - 200

# The AMERICAN ARCHITECT



PALACE OF LUCRETIA BORGIA, VENICE

PUBLISHED WEDNESDAYS IN NEW YORK—FOUNDED 1876  
VOLUME CXV                      APRIL 9, 1919                      NUMBER 2259

Entered as second class matter January 6, 1909, at the Post Office at New York, N. Y., under the Act of March 3, 1879. Publication office, 243 West Thirty-ninth Street, New York, N. Y. Subscription price in the United States and Possessions, \$10.





Residence of Glenn P. Driscoll, Architect  
Des Moines, Iowa  
Bishopric Board used on entire house

# As a Key Turns the Lock and Holds the Door Secure

So Does Dovetailed Key  
BISHOPRIC BOARD HOLD  
STUCCO — Preserving  
the Original Beauty  
of Walls Indefinitely

**T**URN THE KEY and the lock on the heavy oak door prevents the movement of that door. It is held rigid and secure indefinitely. That's what a lock is for.

In the same way, Bishopric Board prevents the movement of Stucco walls. Its dovetailed key, formed by beveled wood strips, fastens the Stucco firmly—locks it irrevocably.

Bishopric Board differs from a door lock in but one respect—it can never be unlocked! The Stucco and Stucco Board remain sealed together forever, snug-tight to the building, the Stucco Board being fastened by a 6 D nail wherever it crosses a stud, and by four nails to each heavy wood strip where applied over Sheathing.

There isn't the remotest possibility of cracking, crumbling walls when Stucco is applied over Bishopric Board, especially if the Stucco mixture we recommend be used—a mixture universally conceded as the most perfect yet compounded.

Time does not lessen Bishopric Board's effectiveness. The wood strips are creosoted, like railroad ties and old-time wooden bridges. The Asphalt Mastic in which the wood strips are imbedded is itself a preservative and keeps out moisture. The waterproofed fibreboard is a non-conductor and prevents the circulation of moisture.

Specify Bishopric Board if you want attractive, unbroken surfaces in your Stucco construction. Specify it for its desirable insulating and sound deadening qualities. Specify it to provide other advantages for clients through the saving it effects.

When Bishopric Board is used on interior walls, ceiling and partitions, plaster, time and labor are saved. Splendid insulation and retarding of sound are secured.

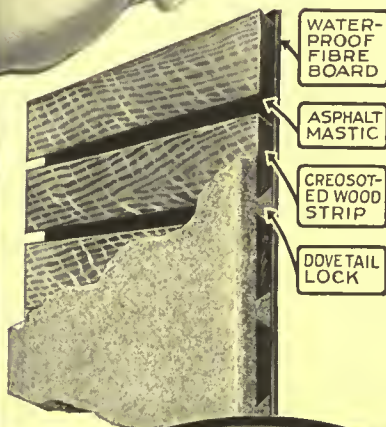

Have you used Bishopric Sheathing—the product which nearly one hundred concerns have specified for workmen's homes? It makes a solid, compact wall and saves 30 per cent over 1/4-inch wood sheathing.

#### OUR BOOKLET

contains the perfect Stucco mixture and numerous tests and endorsements of Bishopric Board by Engineers, Architects, Contractors and Home Owners. It will be sent on request.

THE BISHOPRIC MANUFACTURING COMPANY

904 Este Avenue

Cincinnati, Ohio

SEE HOW IT LOCKS THE STUCCO

# The Practice of Architecture

**M**ANY things give indications of changes in the making. Through conversation, correspondence or reading these signs are constantly recurring testimonies, and a tabulation is unconsciously made of them until the ideas become insistent in their presence. To verify the general impression, a systematic collation of all the evidence is in order.

In arriving at a conclusion by this mental process, it will be found that among the diverse problems demanding attention at this time, one of manifest importance is that of the attitude of the public toward the architect and of the architect in his relations to himself and others.

The practice of architecture is probably today, more than ever before, a matter of barter and trade. The monies invested in building structures demand a return service which represents full value. This value is measured in the adaptability of the structure to its use, its durability and its appearance. These three factors are the fundamentals of correct planning and to render adequate service it appears to be essential that the architect should fully qualify himself to meet these basic requirements.

An analysis has been made of a great amount of data pertaining to this subject and the majority opinion has been condensed into the following five paragraphs which embrace the most common of the points developed. This brief consensus of opinion is not intended to cover the multitude of conditions that exist in such relations, but it is thought that possibly it comprises the basic factors.

1. The business of architecture is inseparable from the profession of architecture. Together they comprehend the originating, promoting, designing, planning, directing and controlling the construction of buildings and their appurtenances.
2. To develop a general demand for architectural service—without which only limited opportunities for practice will be presented—the architect must, as an individual and collectively, employ proper and effective means to create a universal appreciation of its intrinsic value.
3. To fully perform his function, the architect must organize, equip and operate his business so as to render complete service in the production of plans and specifications for everything embraced in the construction, equipment and furnishing of buildings.
4. He must furnish complete and detailed supervision of construction and be closely identified with it. He must be responsible financially, as well as morally, for all of his acts, including the correctness of design, the completeness and accuracy of plans, specifications and details, and the construction of the building in accordance therewith; his responsibility to be contingent only on his being accorded freedom in deciding all matters of structural design, mechanical equipment and the selection of materials and workmen.
5. He must control and regulate the business affairs of the building operation so as to safeguard all interests. He must be just and impartial in deciding all controversies within his jurisdiction, but where his own interests are involved he must submit the controversy to arbitration.

*(Reprinted from issue of November 27, 1918)*



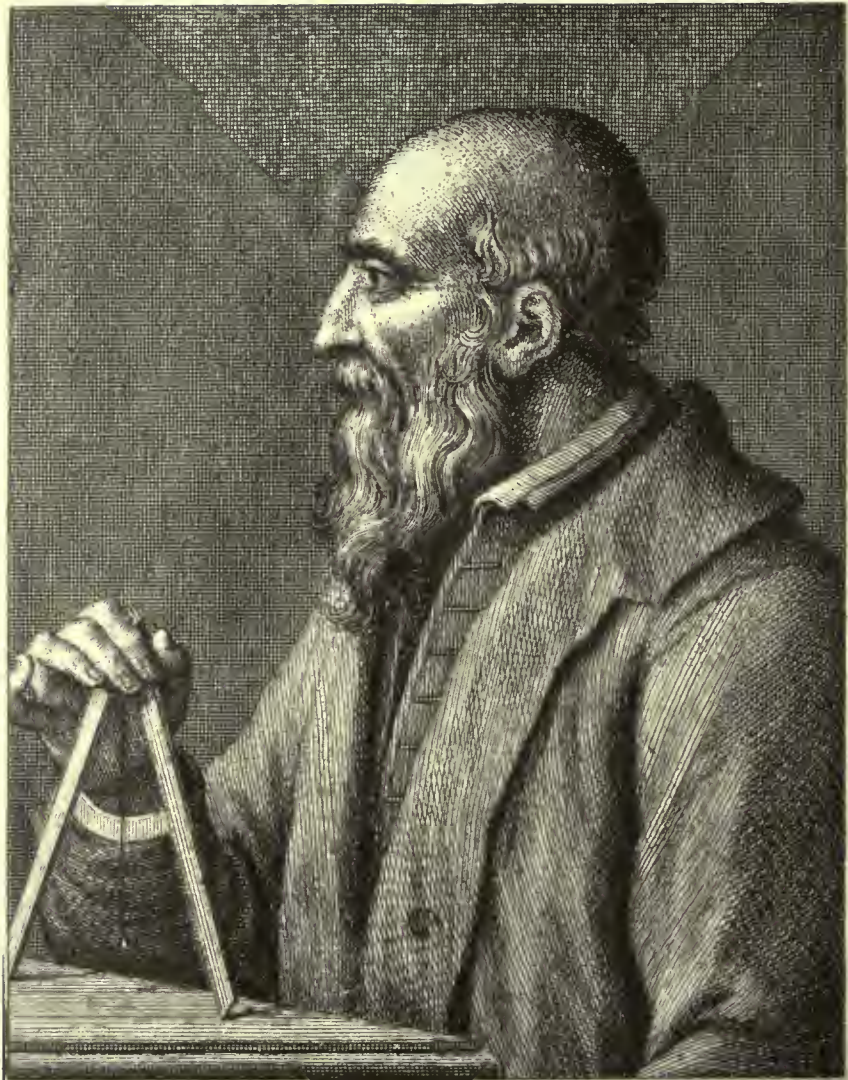

MICHELE DA S. MICHELE ARCHIT.

VENEZIANO

*G. Vafari T. II.*

*It. del:*

*G. Batt. Cecchi Sc.*

104

# THE AMERICAN ARCHITECT

VOL. CXV

WEDNESDAY, APRIL 9, 1919

NUMBER 2259

375-



THE SPARROW HOUSE IN THE STREET VIEW, IPSWICH, SUFFOLK, ENGLAND

## The Sparrow House and the Rabbit House

By JOY WHEELER DOW

**H**APPILY, there is going to be no shortage in our supply of architectural inspiration. even if the Germans do destroy some mediæval churches, and devastate parts of Flanders and France;—but every subject is not, at once, so remarkable, so “busy” and so beautiful as is the ancient Sparrow house in the Butter Market at Ipswich, England, erected in A.D. 1567. For a chance acquaintance with it, as far back as 1893, I am indebted to the interest taken in me by a friend who had made a collection of Wolseyana, i. e., literature and prints relating to Henry VIII's great cardinal—the erstwhile butcher-boy of Ipswich.

There were comparatively few architectural photographs published in 1893, and none of the universal post-cards. There were no half-tones of the Sparrow house with its marvelously pargeted façades, its tremendous eaves and frowning overhang, published in books, as there are today; and therefore it was little known except to people whose affairs or love of discovery carried them into out-of-the-way corners of England like Suffolk. From a steel engraving which I borrowed, representing the Sparrow house as it appeared in the time of William Sparrow, Esquire, and before it was turned into an emporium and sadly dismantled within, I made a



## THE AMERICAN ARCHITECT

sketch which I knew would be available some day. That day, however, did not arrive until 1904, some eleven years afterward, when one afternoon, I realized I was taking a train, at last, out of the smoky, Liverpool Street Station in London, bound for Ipswich. Rarely had I shown the sketch I had made, to anyone. I proposed to *keep* the Sparrow house until I built a home for myself. Here was a rare, historic prototype awaiting transposition into a modern theme to make an ideal home for someone, and I thought it might as well be—me.

There are a number of interesting old buildings in Ipswich. There is a charming walk to be taken

and the royal arms crowned by the initials "C. R." appear in the wall spaces between the fascinating oriels. From this mute testimony, I should infer that the royal acquaintance amounted to something lengthier than a one night stand. These are the incidents, however, even if sometimes apocryphal, that create architecture, and develop it. Without their influence acting upon me through the medium of this ancient dwelling, I could no more have sat down and planned the Rabbit house at Wyoming, New Jersey—out of whole cloth, invented it as it were—than I could have invented a chapter of the history of England.



GARDEN FRONT AND TERRACE, RABBIT HOUSE, WYOMING, N. J.

through Gainsborough Lane approached by a meandering, rural path through private estates. The respective boundaries are indicated by quaint stiles after the manner of Mother Goose architecture, the path being hedged in from the adjoining lawns and gardens—one of those inalienable rights of way enjoyed by the public in England from time immemorial—but the Sparrow house is the main attraction.

Of course, you will be told that Charles II took refuge here for a night during a problematical period of his fortunes (it may have been so) and you are tempted to presume Cromwell, also, once stabled his horse in what is now the garage. The Sparrow house was renovated about the time of the Restor-

Many people think that an architect simply takes pencil and paper and proceeds to sketch from his imagination about as freely as you would sketch the House that Jack Built to amuse some child. I have been complimented for having evolved a design so "startlingly original" as the Rabbit house, and for "having gotten away with it." I assure you I am not nearly so clever. When the wolf is at the door I can go into the garden and dig, I can go into the woods and fell trees, I can go out into the world to bargain and trade for a living, but I can do nothing about the design of a new house—a design equal in merit to that of the Rabbit house. Instead of the wolf's cry of want driving the demons off, as Bertuccio in the play of the "Fool's Re-

## THE AMERICAN ARCHITECT

venge" says the "blessed church bells" do, the fiendish noise merely draws more demons about me. I cannot collect my thoughts. I must wait for the planchette to move. I cannot see to make a mark, literally, on my paper until some charitable inspiration burns over the drawing-board and in that manner illumines it.

People affect to sneer at what they call the pose of an artistic temperament. There is no such thing as an artistic temperament, really, some eccentric equation. If you are a good man you are an artist

in the sixteenth century, and made them, in turn, its votaries, you can understand how the thing operates—why it is a peremptory long-distance call.

"Soldiers!" said Napoleon at the Battle of the Pyramids, "forty centuries are watching your achievement." But it was not the vast size of Cheops, nor the miracle of transporting the huge stones for its construction that appealed to this prodigious military captain (cribbed from Victor Hugo) so much as it was the *people* who did the stunt—those Egyptians, those pharaohs, those dy-



THE SPARROW HOUSE IN THE BUTTER MARKET, IPSWICH, SUFFOLK, ENGLAND

in your particular channel of usefulness. If you are a bad one, then, in the gentle words of the Earl of Beaconsfield to the noisy voter who interrupted his speech—"You oughtn't to be." The inspiration I am talking about is the element of godliness that is in every one of us, as it was in the Savior pre-eminently, the centrifugal incentive to exploit as much faith, hope and charity in the world through the chosen medium, in this case architecture, as lies within our power. Now, when you stop to consider that this inspiration of ours is not the first of its line but a reincarnation of predecessors which have repeatedly visited our antecedents since as long ago as the inception of the design for the Sparrow house

nasties—the personal element and dramatic story, the Pyramids epitomized so dynamically as to awaken spirituality even in a foreign invader bent on ruthless conquest. If the Pyramids, handicapped by their negative environment of arid sand, could have gotten Napoleon on the 'phone where one of our psycho-analysts would have failed before so positive an adversary, may we not readily understand how easy it is for the Sparrow house in a setting of quaint graciousness to captivate the art student in quest of just such inspiration? Like the Pyramids, it is not so much the architectural fabric as it is the intimate home history of England we read in every significant motive and detail; and that means



## THE AMERICAN ARCHITECT

our own home history, only an earlier chapter of it, still more romantic and absorbing.

The Sparrow house takes its name, legitimately, from the family with whose fortunes it was long-time connected, but all the rhyme and reason there was in calling its American adaptation "the Rabbit house" existed alone in the lively imagination of the architect who fancied his accomplice in the conspiracy resembled a rabbit. In the central oriel of the garden front there is a carved rabbit bearing a banner charged with the letter E and flanked by the initials of the builders surmounted by coronets. There are rabbits also in cartouches inserted in the leaded work of the windows, and other devices of a more or less personal nature besides *Mdles. Lapine* are distributed about other parts of the house. The commercial argument condemns this sort of thing. It is thought to militate against the ready sale of a piece of property in case it becomes desirable to sell. But that commercial argument is now a back number. People are only too glad to buy places, I have discovered, with these sentimental touches. The value of an historic dwelling at

owner of the Perry mansion in Providence, R. I., religiously preserves the busts of the founders of the estate in 1789, which preside over its charming, Colonial gateway, though no family relation whatever exists.

Unquestionably most curious of all the curious features of the Sparrow house is the archaic style of pargeting which ornaments its wall surface. It is not the classic pargeting that ornaments the famous Roman villas, but a distinctly genre, home-made-looking pargeting which, like the school of Flemish painting with its distorted not to say gro-

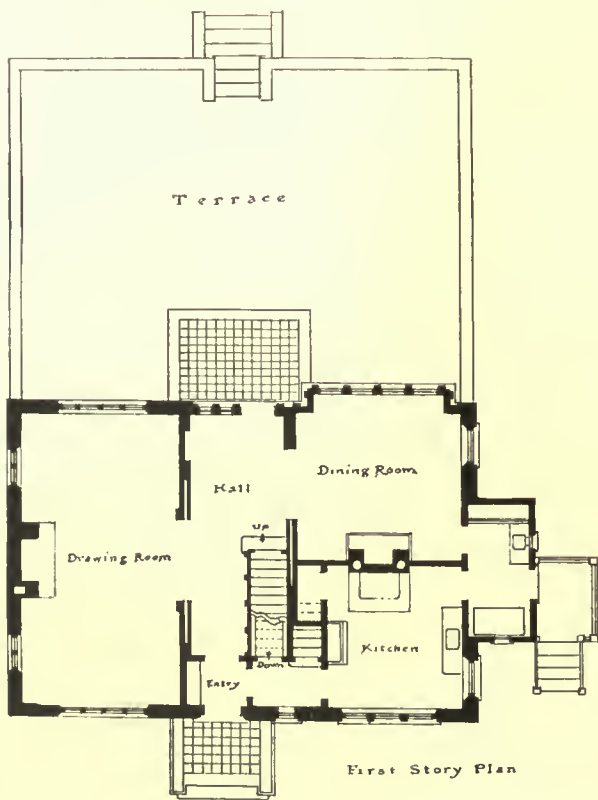

RABBIT HOUSE

Portsmouth, N. H., is enhanced materially because the autograph of our erratic admiral, John Paul Jones, happens to be scratched with a diamond on a pane of glass in one of the windows, and the present

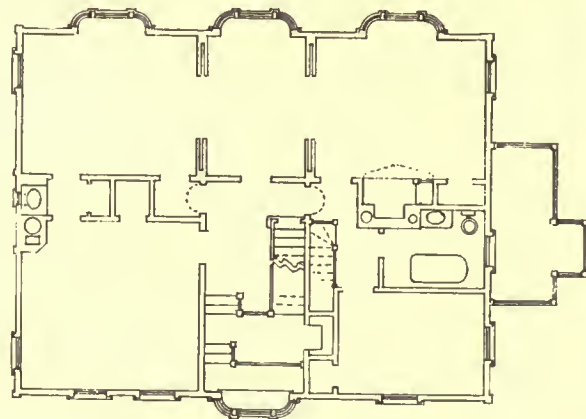

Second Story Plan

RABBIT HOUSE

tesque figures intended to be human, is a work of art just the same. It seemed to me to be useless to attempt anything of this kind for the Rabbit house, for I was convinced that one of our American winters would soon put any pargeting completely out of business. The next most remarkable feature is the oriels, unless it be the heroic cornice which forms a roof for the oriels.

Folks wonder how all these odd and curious windows of the English houses open. Well, they don't open, leastwise many of them do not. You see, at the time of the introduction of glazed windows into houses other than those belonging to the princes and noblemen in England, when the great building activity of the Tudor reigns began, it was like some wonderful modern improvement of our own day to be able to contemplate at leisure the inclemency of the weather without, through windows formerly draught pockets, and yet be snug and comfortable within. Only a "d. f." ever thought of opening the casements to defeat the very purposes for which they were designed. Even today, in the wayside inns (they call them "pubs"), you will find that the windows of the coffee room (dining-room of gentility) like as not are stationary. Once I had to change my lodgings simply because of this, and I am no



DETAIL OF WEST FRONT, RABBIT HOUSE

fresh-air fiend at that; but fancy a coffee room the next morning without ventilation! Many of these "pubs" are merely drinking places and refuse lodgers at the risk of losing their licenses, so I suppose they think it matters little about ventilating the coffee room while the bar reeks with odors of stale beer to remind an American of the typical cheap gin mill in his home town.

All the chambers of the mediæval dwellings were virtually sleeping-out porches, and the inmates had about all they wanted of that kind of "rough house." Instead of looking upon their unglazed windows as fun they regarded them as the source of unspeakable discomfort, and hailed with delight pieces of translucent horn, varnished paper or anything that would keep the pitiless gusts from the Archangel sector of Russia off the backs of their necks. If a casement is made to open there has to be a certain amount of play at the points of contact, and when the wind rises to a 70-mile per hour tornado and the temperature has a rendezvous with zero, as happens every winter in America, an isolated dwelling is bound to be well ventilated, even when all the windows and doors are closed as tightly as may be, but now comes along the fresh-air fiend, and what does he want us to do? He wants us to equip ourselves with Eskimo sleeping outfits, open all our bedroom windows and let the furious gale do its worst. Has he an object in returning to aboriginal life? He has, but it is not commendable. He desires to be able to eat to satiety all the indigestible things that appeal to a surfeited palate and let the outdoor

oxygen digest the curiosities he puts into his stomach.

The middle sections of the wondrous oriels of the Sparrow house apparently do open. I examined them once, but there was so much unusual detail to remember about the house that I cannot say now. I knew, however, that casements anywhere near that size would be wrenched from their stays and hinges by the first American storm that came along, so that I made the transom bars of the Rabbit house oriels continuous through the frame, hanging the transom sashes from the top. The sections thus divided reduced the size of the sashes opening

in pairs to 1 ft. 6 in. x 2 ft. 10 in., which offered to the wind only such resistance as I calculated the American hardware, always too light for the part it has to play, could withstand.

Having once lived in the Rabbit house, I can testify that its windows will admit the free air in quantities sufficient, and more than sufficient, for the respiratory requirements of any American family not too numerous for the size of the building. It is seldom necessary to open every window in a house anyway, especially small, oddly-shaped windows. Moreover, as the casements made to open admit air to the full capacity of the opening in the window frame, their ventilating capacity is double that of the usual double-hung window sashes. It is not generally realized that the sun never shines, the wind never blows and the rain never beats in England quite so fiercely as they often do in America.



NORTH ELEVATION AND GATE, RABBIT HOUSE



## THE AMERICAN ARCHITECT

Whatever merit there is in the terrace of the Rabbit house I cannot claim. It was built after the property passed beyond my control. I miscalculated on an hallucination which pursued me that I was a kind of architectural Meissonier, and that as nobody would dream of piecing out a canvas by Meissonier either with one's own work or that of a less skillful artist, I rested assured that no purchaser of the Rabbit house would think of changing anything

tionnaire of a local real estate dealer. I complied with all the hard-as-nails memoranda about modern improvements, such as a gas range, number and kind of laundry tubs, bathrooms, Welsbach lighting fixtures, size of lot, legal incumbrances, tax rate, etc., etc., to the best of my ability. The fact that the Rabbit house was a reincarnation of the great Sparrow house at Ipswich seemed unimportant to the real estate agent. In Greece they would



WEST FRONT, RABBIT HOUSE, WYOMING, N. J.

without consulting the architect. But the question of money that pervades everything in America pervaded this also, and fearful my plan would mean too great an outlay, my opinion was not sought.

I had planned for a very different kind of terrace than what is there. I began to think my critic was right in his casual statement: "This is a very expensive house; everything about it is expensive!" Consequently, one day when a cloud appeared on the horizon I obtained a copy of the familiar ques-

tionnaire *rather than discouraged*. Instead of *taxes* there would have been a *subsidy!*

The paper, however, I returned to the agent with a message adapted to the requirements of the average intelligence as I had found it. It was a message not unlike the sententious one that General Lee on the morning of April 2, 1865, dispatched by an orderly to Jefferson Davis, as the President of the Confederacy sat in his pew at service in St. Paul's Church—"I can no longer hold Richmond!"

# Observations on Types of Memorials

By A. L. BROCKWAY, *F. A. I. A.*

THE victory of the Allies in the great war and the returning of soldiers, marines and members of the navy have set the people thinking as to what should or could be done in each community appropriately to commemorate not only the part taken by the United States as a whole in this great conflict, but more especially to commemorate the participation of the men of each immediate community in the great result. The consequence has been a variety of suggestions from everybody interested as to the kinds of construction which should be utilized to express the appreciation of the nation for the heroes in its army and navy, both the dead and the living.

In order promptly to celebrate the return of our army it has been necessary to do a good deal of work of a temporary character, as was, of course, proper. In some cases this temporary work has been authorized as a suggestion or full sized model of what might later become a permanent construction. This is notably true of the arch in New York City; but in the majority of cases the local effort at a commemorative treatment has been without any idea of permanence. Of course, in many instances enthusiasm and haste have led to the erection of arches and other things which have been neither particularly beautiful nor appropriate, excepting as repeated for instance in the large electric sign: "Welcome Home" or some other phrase which comes undoubtedly from the heart of the people, but which is put in a form which pleases neither the eye, the sense of proportion nor the sense of color. It is regrettable that we have had some misguided efforts, as these could in many instances have been avoided. Of course, these temporary treatments will soon disappear; but it should be apparent that anything and everything done by the people of the United States to commemorate their participation in this World War should be most carefully and deliberately considered and should not under any circumstances be hurried into. We were deliberate enough in considering everything before this nation finally plunged into the world controversy; but when we did go in, it was with a consciousness that we were fighting for fundamental and great principles upon which the life, safety and very being of this nation depended.

No matter what the relative importance of our contribution may have been, the contribution itself in resources and in human lives was tremendous. The conviction of this nation that nothing tran-

scends the moral and spiritual qualities of human life should be expressed in the creation of permanent monuments, with a care and deliberation which will result in forms of beauty appropriate to what we believe are its fundamental characteristics. In other words, our contribution as a nation to the history of the world and our contribution to art in the form of monuments should, as heretofore, constitute a physical record to go down to posterity and should be, as those monuments have been, expressive of the lives, the thoughts, the ambitions and the daily duties of the people. The great monuments of the past are exactly such expressions of the nations which created them. We here would not be true to our duty today if we calmly appropriated the forms determined upon to commemorate victory by peoples of the past. Those monuments expressed the ideas of the time in which they were created; they expressed the ambitions and the principles of living and of the attitude of one nation toward another; they were truthful records of all these things and have been valuable in helping us to estimate what those peoples thought and believed and to draw lessons from their lives and actions which might in a measure guide us.

Were we always to take, for instance, the Triumphal Arch as expressive of victory, should we not take into consideration the following facts: That, practically originated by the Roman Empire, the Triumphal Arch invariably commemorated the return of victorious armies laden with spoil taken from conquered nations and brought back to Rome to increase its riches and embellish the city. Such wars were wars of aggression and conquest involving annexation of territory and subjugation of conquered peoples. The Triumphal Arch, then, was adorned with sculptures and bas-reliefs portraying the returning soldiers with their captives, laden with the public and private property which had been wrung from the conquered countries.

In spite of the beauty of Rome as the result of this world conquest, are we, the American people, ready to say that our contribution to commemorative architecture is to be the adaptation of forms created and employed to celebrate such events? The Roman victory arch affords a typical example of the way in which history is depicted in the art of the times, but if we examine the career of nations still more ancient, like Syria, Persia, Egypt, Greece, we will find in every case that the monuments erected express and typify the racial char-



## THE AMERICAN ARCHITECT

acteristics, make a record of the lives of the people of each nation and are of value for that very reason.

One hundred years hence, when our descendants look back upon the United States as it emerged with lofty spirit from this last struggle, shall we be judged as having lived up to our great possibilities if we devote our building efforts in the next period of years to the erection of monuments in any way associated with such events of the past? Certainly not. Rome, representing the climax of civilization, was practically destroyed as a great nation by the influx and overrunning of barbarians, and we look at a succession of centuries filled with the suppression of the individual, in which he was the victim of superstition and exalted mysticism, resulting in the restraint of the creative powers.

As we approach that period in the history of Europe when the death blow is given to feudalism and we enter that great epoch of cathedral building, we recognize that once more the individual was coming to the front in the communities; and the bishops in espousing the cause of kingly power and centralized authority, involving with it in some measure the cause of the common people, succeeded in arousing the great support of the mass of people as directed against the feudalistic and monopolistic nobility; so we have springing from the efforts of the people themselves the great cathedral churches of the 13th, 14th and 15th centuries, expressive once more of the lives and the thoughts, and the desires of the people of those countries.

It should be interesting to note that these wonders of architecture which every traveler in France and England admires and loves were not the gifts of rich individuals but of the great mass of people themselves, as they should be. There were no Carnegies or Rockefellers at that time, and the kings themselves were not rich enough to build these buildings all over France and England as they were built. On the other hand, if, for instance, one should follow the development of the residences of the individual from the earliest down to modern times, he would find expressed in these buildings the conditions of life, the political status of the individual and would see in them a reflection of the relative value of the people in the general contribution to the progress of the world.

It would seem apparent, therefore, that in considering types and kinds of monuments the American people in their various subdivisions should take careful account of the past and appraise themselves before trying to build something which should in itself be as accurate a record as possible of just what the American nation is. Now, this does not necessarily mean just one type of building, nor one kind of monument. Our minds probably have been so fixed upon the big things involved in

this war and in the peace negotiations now going on that possibly we have lost sight of many of the smaller details of life, which go to make up a community. For instance, our mind is so absorbed by the larger aspects of the League of Nations, that we are quite likely to lose sight of the question as to whether we, the United States, a League of States, and then again a League of Cities, a League of Civilized Communities, both in the city and in the country, are completely devoted to a League for Peace among ourselves in all the activities of life and that we do not anywhere desire to progress ourselves at the expense of any other one of our colleagues; whether in the life of each of our cities we realize the fact that in the interest of the community and the greatest good for all, each individual must of necessity curtail and perhaps give up some of the things which he is apt to consider as a prerogative of liberty and freedom. Such considerations must be firmly ingrained in our natures and we must fully realize them before we can successfully express them in architectural form, as we should, thus consecrating ourselves to the high position which we certainly hold, and must fill, and of which we are conscious as the result of this great world war.

"Slow to Anger!" It is a matter of history that we entered the war from altruistic motives, one of the few instances in the history of the world where a nation consecrated its resources and its citizens to the upholding of the fundamental principles which we are pleased to call the Principles of Democracy, upon which the life of a republic depends. We did not go in for aggression, for conquests of nations or territory. We did not go in to come back laden with loot as the victorious armies of ancient times, and subsequently, have usually done. We went in, as we all know, for principle. The principle is typified in all of the nobler and loftier moral and spiritual qualities of man representing the individual in any nation. Our armies are returning free from the degradation or desecration of stolen property taken from the conquered. They are returning almost in a spirit of exaltation because of the quality of the achievement which is in every way commensurate with the loftiness of the grounds upon which we entered into the conflict.

It would seem to me, therefore, that the character of the monuments or of the buildings which are to be erected in this country should be commensurate with all of these things, and I cannot see personally the appropriateness of the Triumphal Arch or of those monumental symbols of ancient times commemorating events of fundamentally and radically different character. I believe that the monuments which we erect should be expressive of our lives,

## THE AMERICAN ARCHITECT

devoted and appropriated to the requirements of the daily life of the people of our various communities; that they should not only afford opportunities for development along idealistic lines; but should in a measure consecrate to the nation of the future the ideals which have lifted this people to the mighty effort which has been exerted. I can see in the humblest and most ordinary of daily duties of routine an opportunity for the development of the character of the individual, and thus of the nation, in thrift, the avoidance of waste in daily living and the organizing of our facilities in the cities to accomplish this for the great mass of citizens.

Those humble elements are just as essential in the make-up of character as the spiritual and speculative things which occupy the dreamer in the community. Both are essential: both are necessary. And as Emerson has so beautifully put it in his poem of "Each and All": "Thou knowest not what argument thy life to thy neighbor's creed hath lent." We have given a wonderful exhibition of what this nation can do when roused to a man, as it was; how we can consecrate our energies, resources and efforts to save the life of a nation. When we recognize and realize that many things had to be done by Government, exercising centralized control, in order to accomplish the purposes in view, and when we remember that such centralization of authority had hitherto been jealously regarded, and that in the past we probably would have at no time been willing to admit that so much authority should be centralized in Government, are we not as a result of that centralization in a position to consider such things more rationally and with a broader view than we previously were? Has not this experience taught us that some things which we apprehended are not so dangerous, and has it not shown us in what ways to guide and control such centralized authority?

When we stop to remember that Government is really ourselves and is but a type of political machinery for enabling us all to participate in doing things for the benefit of all, is it not then perhaps a rational proposition to consider that Government may be the proper medium through which the construction of memorials such as we are contemplating should be undertaken? We do not hesitate in many civic matters, such as city halls, court houses, school buildings, fire stations, etc., to entrust these constructions to the city authorities. The same applies to institutions belonging to the state and also to the nation. Why not, therefore, utilize this same medium for erecting the memorials which are to come? Those things in our communities which are obviously for the benefit of all and which go to make up the comfort and well-being, both physically

and spiritually, of every community, of which I have already mentioned markets, schools, etc., and to which should be added places of public assembly for the discussion of matters affecting the welfare of all our institutions, as a rule our American Nation, while keenly appreciating, has nevertheless failed adequately to utilize and develop. The Greeks and Romans were keen for these places of public assembly, both in the shape of buildings and in open space; and it would seem to me that such treatments of our cities in the creation of open places of assembly surrounded by monumental buildings devoted to the Fine Arts, to politics as the science of Government, to great orchestral concerts, to great addresses by the great statesmen and orators of the world, might easily express both the ideals and the better elements in the life of the American people and be at the same time consecrated as a memorial to those who did their part in this war. The development of this idea is a thing which every community owes to itself to provide, and if followed out and developed to the utmost it should be easy to visualize the type of commemorative monuments which could be erected in memory of those who made the supreme sacrifice and which could at the same time be dedicated and consecrated to the finer qualities of this great nation.

In some such way as this, we as people would be contributing, as did those who contributed to the upbuilding of the great cathedrals of the middle ages, wherein they in their turn consecrated themselves to the better and loftier aspirations within them. It is unquestionably the duty of a community to educate its young, not only as we endeavor ordinarily in our public school systems; but it should go beyond that and extend to our universities. It is a humiliation to think that so many of our universities and institutions of learning are dependent upon the munificent generosity of some merchant prince who has accumulated a fortune out of all bounds. We ought not to be looking for such gifts. We ought to be collectively giving them ourselves.

Now, all of these considerations are not new. The philosophy of history makes clear that such thoughts as these are what animated most of the great people of the past and the difficulties which we have to contend with are but a repetition of the same difficulties they contended with. If the question of a memorial in any locality is hampered by questions of cost, there is nothing unusual about that—it was invariably, so far as we can determine, one of the conditions of the past in the creation of the great monuments, whether of architecture, sculpture or painting. Excepting only where the rights of the individual were so subordinate as to result in slavery, as was probable in the case of such



## THE AMERICAN ARCHITECT

monuments as we see in Egypt, could a king or monarch build regardless of cost and life. What I have in mind particularly are the difficulties with which Michael Angelo contended in the work which he did for the Holy See. When we look at the wonderful decorations in the Sistine Chapel, it is difficult for us now to realize that the jealousy of those who opposed him with the Pope, and the lack of funds, should have interfered with him and held up his work. When we consider that this was the case, therefore, our problems are nothing which should disconcert us. They simply call for thought, devotion and patience and a recognition that if we are true to our opportunities and to those who died in the struggle so that our principles might live and nations such as ours might continue, we cannot fail. I have one predominating thought in all this consideration, one that looms large and which somewhere, somehow by the ablest men that we have I hope to see commemorated. The French erected a column at Versailles which was dedicated to the "Assemblée Constituante." They considered this Assemblée of sufficient importance as a preliminary to the French Republic to erect this monument in its honor. I believe that one of the greatest monuments that this nation should erect should be one dedicated especially and solely to the Constitution of the United States and that it should be the affair of this nation as a whole. Aside from the Magna Charta, no other document in the world has had the influence upon the rights and liberty of the individual, and of enabling the individual collectively to establish a government founded upon right reason and truthfully reflecting the political possibili-

ties of the individual, equal to the Constitution of the United States as originally formulated and adopted by that great body of truly creative statesmen so early in our history. Around that document for one hundred and thirty years the growth and development of these United States have taken place. It has met every emergency. Its wonderful conception is still as strong today, if not stronger, than it was when formulated. It is one of the inspiring documents of history undoubtedly, and it would seem to me, in this struggle through which we have just been, it has been tried out and found to be not wanting and that it has offered the basis in principle and in thought for the creation for that League of Nations which we are about to see consummated. The influence of this document upon our nation and now upon the other nations of the earth is one which cannot be lightly touched upon. It is so profound and inspiring as to make one feel very small individually in considering it in all its ramifications and aspects. What I would do in commemorating in this country the successful achievement of the war would be to try to erect buildings and monuments of a type and kind which would keep everlastingly before our eyes these great principles and thoughts of the government upon which the United States was founded, and thereby consecrate the lives of this people of ours eternally in and through such monuments not only to the heroes who have returned, but to those who have made the supreme sacrifice in order that this nation might live, and to make possible in this country future generations of the character which this Constitution and this great nation deserve.



DECORATION BY HARRY W. RUBINS

THE AMERICAN ARCHITECT

Founded 1876

PUBLISHED EVERY WEDNESDAY BY

THE ARCHITECTURAL AND BUILDING PRESS, INC.

No. 243 West Thirty-ninth Street, New York

E. J. ROSENCRANS, PRESIDENT AND TREASURER  
WILLARD C. HOWE, VICE-PRESIDENT

WILLIAM H. CROCKER, Editor

ARTHUR T. NORTH, Engineering Editor

Subscriptions in the United States and Possessions,  
Mexico and Cuba, TEN DOLLARS. Other Countries,  
TWELVE DOLLARS.

SINGLE COPIES (Regular Issue) 25 CENTS

CHICAGO OFFICE, Mallery Building  
PAGE A. ROBINSON, Western Manager  
ST. LOUIS OFFICE, Wright Building  
CLEVELAND OFFICE, Guardian Building  
SAN FRANCISCO OFFICE, 320 Market Street

Owned by United Publishers Corporation—H. M. Swetland, President;  
Charles G. Phillips, Vice-President; W. H. Taylor, Treasurer;  
A. C. Pearson, Secretary. Entered as second-class matter January  
6, 1909, at the Post Office at New York, New York, under the Act of  
March 3, 1879.

VOL. CXV

APRIL 9, 1919

No. 2259

Democratizing the Institute

TWO years ago the architectural profession was in a sad state. Its pessimists believed that its very existence was in jeopardy, and its optimists could not ignore the difficulties then besetting the practice of architecture. But the war, with all its attendant horrors, had its beneficial side; it exerted a refining and strengthening influence that restored among architects themselves a previously waning appreciation of their true usefulness. It cast out doubt of the future, with the result that today there is a consensus in the profession, something that did not exist when the United States entered the war; and, moreover, that consensus is progressive. As far as sentiment, desire, willingness to serve, are concerned, the profession is prepared for progress. In some quarters, at least, there is a determination to go ahead that will not be denied. All indications point to a greater future for architecture and architects in America, and unquestionably the time has come to forget the troubles of recent years that attention may be concentrated on constructive planning for the future. Henceforth let "The Future" be the text.

It has been demonstrated that a large measure of American progress in professional and business life is based on efficient organization effort, and it is equally certain that the American professional and business structure is cumbered with many inefficient organizations that retard rather than promote progress. These are the chief causes of the vast differ-

ence between the accomplishments of similarly constituted professions and trades.

In the field of architecture there is but one national organization; there should be but one, and it should be as efficient as human ability can make it. Much of the future of American architecture is dependent on the wisdom or lack of wisdom displayed in the councils of the American Institute of Architects.

Without attempting any discussion of the past of the Institute, certain facts about its present status seem to merit contemplation:

Its membership represents the best class in the profession, but not *all* of the best class. Therefore, it is not completely representative of the men who, throughout this country, are morally entitled to call themselves architects.

Its constitution and by-laws were drawn under conditions far different from the present situation, and in some respects are deemed by some of its most active members inadequate or ill-formed for today's needs. Chief among the points of criticism heard by THE AMERICAN ARCHITECT is the allegation that the plan of executive organization and operation of the Institute is not in accord with methods that have been demonstrated sound by other organizations of comparable character.

It should be understood that in submitting the proposals that follow, and accompanying comments, THE AMERICAN ARCHITECT is making no effort to attempt interference with the executive and legislative processes within the American Institute of Architects. Such an effort would constitute the height of impertinence. It is the desire of THE AMERICAN ARCHITECT merely to bring to the attention of the entire membership of the Institute and all of those other architects who should be members of the Institute, certain questions of policy on which expressions have been had from some of the country's leading architects; in other words, to stimulate thought for the benefit of the entire profession, in the belief that every legitimate architect, regardless of membership in the Institute, has a legitimate interest in the future of the Institute as the only mouthpiece of the profession.

With this purpose, THE AMERICAN ARCHITECT submits the following proposals, with some of the reasons that have been urged in their behalf by architects, but without itself expressing an opinion for or against any of them:

Proposal One.—Amend Section 1, Article 10, of the by-laws to provide that officers of the Institute shall be elected by letter ballot of all members of the Institute in good standing, the official ballot to carry the names of duly nominated candidates, but every



## THE AMERICAN ARCHITECT

member being privileged to insert the name of and vote for any candidate not appearing on the ballot.

Comment: It is urged that this method of procedure has been proved in many other organizations, notably, for example, the American Society of Civil Engineers, and that it results in a desirable democratization of the organization, making the self-perpetuation of an objectionable administration impossible. Moreover, it gives every member who pays his dues and charges, a voice in the selection of the officers who control the destinies of the organization, regardless of his presence at the annual convention, and is in line with current tendencies and practice in government and in organizations, business and professional. It is suggested that such a change will result in a material increase in the membership by making membership privileges more attractive, and thus will increase the revenue of the Institute.

Proposal Two.—Provide by proper amendment of the by-laws for a system of referenda, whereby the board of directors of the Institute or any group of twenty or more of its members may, under proper safeguards, consult the entire membership and secure its views on questions of general consequence.

Comment: Such a referendum plan has been in effect in the Chamber of Commerce of the United States since that organization was formed, and has exercised a powerful influence over legislation and national policies. It gives the entire membership of an organization an opportunity to express its views in connection with issues and policies affecting the entire profession.

Proposal Three.—Amend the by-laws to provide for the consolidation of the office of Secretary with the position of Executive Secretary, in the position of Secretary-Manager. The occupant of this position to be a salaried executive, selected by the board of directors, on the basis of his qualifications as an executive, and to exercise the functions usually undertaken by the managing executive in similar organizations.

Comment: It is suggested that practically every successful national organization is operated on this plan, employing a "permanent" secretary, whose function is to manage the business of the organization. Under the guidance of a competent secretary the work goes on uninterruptedly, regardless of changes in administration. The sec-

retary-manager becomes thoroughly acquainted with every phase of the work, and acts as an efficient and practical aid to the president and other executive officers who come into office, usually, without intimate knowledge of the details of the organization's work and the routine methods which necessarily are employed in carrying it on.

Examples of organizations that pursue this policy are:

American Society of Civil Engineers. Charles Warren Hunt has served as secretary and as actual manager of the society since 1895. This organization has 8968 members.

American Society of Mechanical Engineers, 8720 members. Calvin W. Rice has occupied the secretarial position since 1906.

Chamber of Commerce of the United States. Elliott Goodwin has been executive-secretary and D. A. Skinner assistant secretary since the organization was formed.

Proposal Four.—Contingent on the adoption of proposals two and three, amend all articles of constitution and by-laws which now place the government of the Institute entirely in the hands of the local chapters and the board of directors, so as to provide that the chapters shall have power to make recommendations to the board of directors, to call for referenda, etc., but placing all power in the membership, working through the officers and directors, and making them directly answerable to the membership.

Comment: None necessary, as such action would obviously follow if Proposals One and Two were adopted.

Proposal Five.—Amend Section 2, Article 10, of the by-laws so as to give the president of the Institute the powers usually placed in the hands of the executive head of such an organization.

Comment: Under the present by-laws, the powers of the president are so restricted that he can be charged with little if any responsibility for the conduct of his administration.

\* \* \*

While THE AMERICAN ARCHITECT is not yet privileged to quote specifically the authors of the foregoing comment, it now places these five proposals before the membership of the Institute and invites their criticism and comment.

# Criticism and Comment

## Build Now?

The Editors, THE AMERICAN ARCHITECT:

The Department of Labor, real estate exchanges and architectural publications unhesitatingly advise the immediate resumption of building operations. THE AMERICAN ARCHITECT, in its issue of March 12, 1919, under the caption "Build Now!" gives some encouraging letters from bankers and others concerning the prospects for loans on property to permit us to "Build Now!" But I cannot avoid the feeling that the injunction to "Build Now!" should be followed by a "?" instead of an "!"

Of all the letters published, that of D. Everett Waid, President of the Board of Examination and Registration of Architects of New York, seems to discern the real or most important cause for retardation and inaction in building enterprise, namely, uncertainty and risk. "Owners will not willingly proceed as long as they fear a fluctuation in prices and a complete tie-up when a building is half constructed." This uncertainty and apprehension does not arise from fear that the contractors will raise their prices after having contracted to complete the building for a stated sum, or that the material dealers will increase the cost after agreeing to a price. Where, then, is the "Fluctuation in prices" which Mr. Waid says is the deterrent? Would it not be more accurate to say: Increase in wages? Whoever heard of wages "Fluctuating" downward, and have we not the assurance of the Department of Labor that they will not "fluctuate" downward?

If it be true that the brokers and bankers are willing to lend money for building operations while this uncertainty or apprehension exists as indicated in the letter of Mr. Samuel H. Beach, President of the Savings Banks Association of New York, who says that a strong feeling prevails in financial circles that small annual payments of principal should be required on all mortgage loans, and if *under such a plan of loaning money the lender would be safe* in making a fairly liberal loan, even based on prevailing high costs, then the gradual reduction of the principal *would counterbalance the possible eventual fall of values to a lower level*. Therefore, if the banks will lend money, even on less liberal terms than formerly, but on assured terms; if the contractor will complete the building for a fixed amount, and the material dealers will supply materials for the contract price, where is the uncer-

tainty, the risk, the "fluctuation in prices" and the fear that the building will be "tied-up when half constructed?" The owner who contemplates building can make a plain contract with the architect, his banker or building association and dealers in materials to render their respective services and materials at a fixed amount that will not fluctuate; but over 60 per cent of his outlay will be for labor, and how and with whom can he contract with any reasonable assurance that this part of the work will not fluctuate or increase to such an extent as to exceed the limits of the loan, and thereby tie-up the work? Under such circumstances, who is responsible for the feeling or uncertainty and apprehension as to the ultimate cost of the building? Is there any man or body of men, any association or any corporation that the building owner can turn to for bargain and agreement as to the limit of cost of the work and with the same assurance, that such limit of cost for labor will not be exceeded, as he has in the other expenses entering into the construction of the building? If it be true, as Mr. Waid has said, and as I believe, that it is the uncertainty and risk and fear of fluctuations on costs and future values that discourage immediate resumption of building operations, and such uncertainty and risk is due to our inability to deal with any parties competent to make a reliable contract, would it not be reasonable to ask the Department of Labor to assist in the movement to "Build Now," which they so ardently advocate, by fostering or creating either in or out of the present labor organizations some association or corporation which may bargain and agree on the limit of cost of labor for a building?

SNOWDEN ASHFORD.

Municipal Architect, Washington, D. C.

[EDITOR'S NOTE: It is obvious that the instability of labor can in no wise affect an owner as relating to the construction cost of his building, where he holds a contract for a fixed sum with a responsible builder. Any loss, by reason of increase in labor costs, would then fall on the builder or contractor.

If the contract was on a cost plus basis, then any change in wages would correspondingly affect the owner.

Of course, even in the first instance any interruption in the building operations due to strikes would affect the owner to the extent of delaying the date of completion of the building, involving a certain loss of income and increase in carrying charges.

In the second instance the loss to the owner would be both in an increased construction cost and possibly in delayed completion.]



## Beaux-Arts Institute of Design

*Director of the Institute*—LLOYD WARREN

Architecture—WILLIAM F. LAMB. Sculpture—JOHN GREGORY.

Interior Decoration and Industrial Art Design—ERNEST F. TYLER. Mural Painting—ARTHUR CRISP.

### Official Notification of Awards— Judgment of March 4, 1919

#### FIRST PRELIMINARY COMPETITION FOR THE TWELFTH PARIS PRIZE OF THE SOCIETY OF BEAUX-ARTS ARCHITECTS *PROGRAM*

The Annual Committee on the Paris Prize proposes as subject for this Competition:

#### “A BANK BUILDING”

*General*—A large city bank desires to have a small branch bank building in the fashionable residential district of the city. In addition to being fireproof, burglar-proof, well-lighted by daylight and conveniently arranged, it should be made so dignified and beautiful both inside and out that it will be the bank's best advertisement. To this end, the directors have decided to have nothing but the bank's quarters in the building, and to spare no expense to get the best possible design.

*Dimensions*—The level lot is at the corner of two important streets, with a frontage of 50 ft. on the main street and 100 ft. on the side street.

*Requirements*—The interior of the building shall consist of one large banking hall, extending the whole height of the building, subdivided below by means of grilles and partitions into two distinct parts:

1. Public Part, with a Ladies' Room and a President's Room opening directly off of it, and preceded by a Vestibule.
2. Private Part, equally large, for the bank clerks, officers, etc., including a large vault and stairs to the basement.

JURY OF AWARD: R. H. Dana, Jr., F. A. Godley, T. Hastings, J. O. Post, F. H. Bosworth, Jr., R. M. Hood, W. S. Wagner, M. J. Schiavoni and L. Ayers.

Number of drawings submitted—62.

#### AWARDS:

Placed First and 3rd Medal—L. Williams, Columbia Univ., N. Y. C.

Placed Second and 1st Mention—F. M. Hodgdon, Atelier Rebori, Chicago.

Placed Third and 3rd Medal—H. G. Anthenen, Univ. of Pennsylvania, Phila.

Placed Fourth and 3rd Medal—A. E. Middlehurst, Cornell Univ., Ithaca.

Placed Fifth and 3rd Medal—M. A. Bernhardt, Univ. of Pennsylvania, Phila.

Placed Sixth (1st Alternate) and 3rd Medal—R. H. Segal, Patrons—G. & E. Blum, N. Y. C.

Placed Seventh (2nd Alternate) and 3rd Medal—J. P. Roberts, Univ. of Pennsylvania, Phila.

MENTION:—E. A. Eames, Boston Archtl. Club, Boston; R. W. Craton, Columbia Univ., N. Y. C.; E. O. Shakespeare, Univ. of Pennsylvania, Phila.; D. W. Orr, Yale Univ., Sch. of Fine Arts, New Haven.

### Three New York Art Conventions this Spring

Three art conventions are to be held in New York City this Spring. The Eastern Arts Association will bring art teachers from all the Atlantic states and as far west as Ohio for its sessions April 17, 18 and 19. The middle of May will see the members of the College Art Association and the American Federation of Arts assembled for a week with two sessions a day at the Metropolitan Museum of Art.

There are more than one hundred art societies in New York and of these twenty-five are chapters of the American Federation of Arts.

Education along practical art lines, which is one of the special interests of the Art Alliance of America, will be shown in its galleries at 10 East 47th Street from April 5 to April 19. Every school in the city which includes design in its curriculum will be represented. In addition the trade schools that teach any of the artistic industries will make a showing. Thus the Vocational School for Boys, at 138th Street near Fifth Avenue, will send commercial design and sign painting; there will be jewelry made by the crippled boys at the Red Cross Institute for Crippled and Disabled Men; and lettering by boys from the Institute for the Deaf. In all, twenty-six will be represented.

The work will be exhibited not by schools but grouped as follows: Graphic arts; textiles; fashions; metal; wood; stone, clay and glass; leather, toys, novelties; interior decoration and stagecraft.

During the convention of the American Federation of Arts, the Art Alliance galleries will be devoted to a special exhibit of Graphic Arts organized in co-operation with the American Institute of Graphic Arts. The exhibition will include posters, magazine covers, advertisements, pamphlets, letterheads, lithography, color printing, containers, labels, wrappers and photographs.



PLATE 113

HOUSE OF WILLIAM H. REID, SPRINGDALE, CONN.

ARTHUR LOOMIS HARMON, ARCHITECT







PLATE 114

HOUSE OF WILLIAM H. REID, SPRINGDALE, CONN.

ARTHUR LOOMIS HARMON, ARCHITECT







PLATE 115

HOUSE OF WILLIAM H. REID, SPRINGDALE, CONN.

ARTHUR LOOMIS HARMON, ARCHITECT







PLATE 116

HOUSE OF WILLIAM H. REID, SPRINGDALE, CONN.

ARTHUR LOOMIS HARMON, ARCHITECT







PLATE 117

HOUSE OF WILLIAM H. REID, SPRINGDALE, CONN.

ARTHUR LOOMIS HARMON, ARCHITECT







PLATE 118

A GALLERY FOR ITALIAN PAINTINGS IN THE CLEVELAND MUSEUM OF ART

ARTHUR LOOMIS HARMON, ARCHITECT







PLATE 119

A GALLERY FOR ITALIAN PAINTINGS IN THE CLEVELAND MUSEUM OF ART

ARTHUR LOOMIS HARMON, ARCHITECT





THE AMERICAN ARCHITECT

APRIL 9, 1919

VOL. CXV, NO. 2259

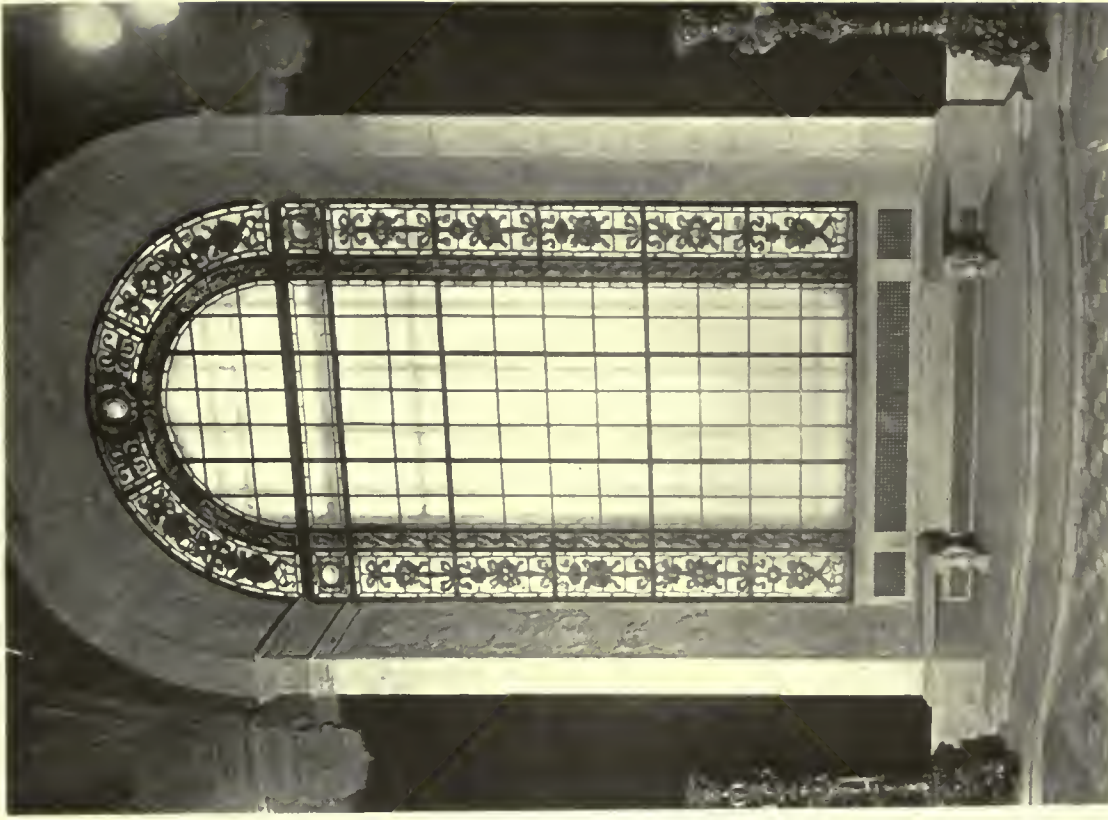

A GALLERY FOR ITALIAN PAINTINGS IN THE CLEVELAND MUSEUM OF ART

ARTHUR LOOMIS HARMON, ARCHITECT

PLATE 120





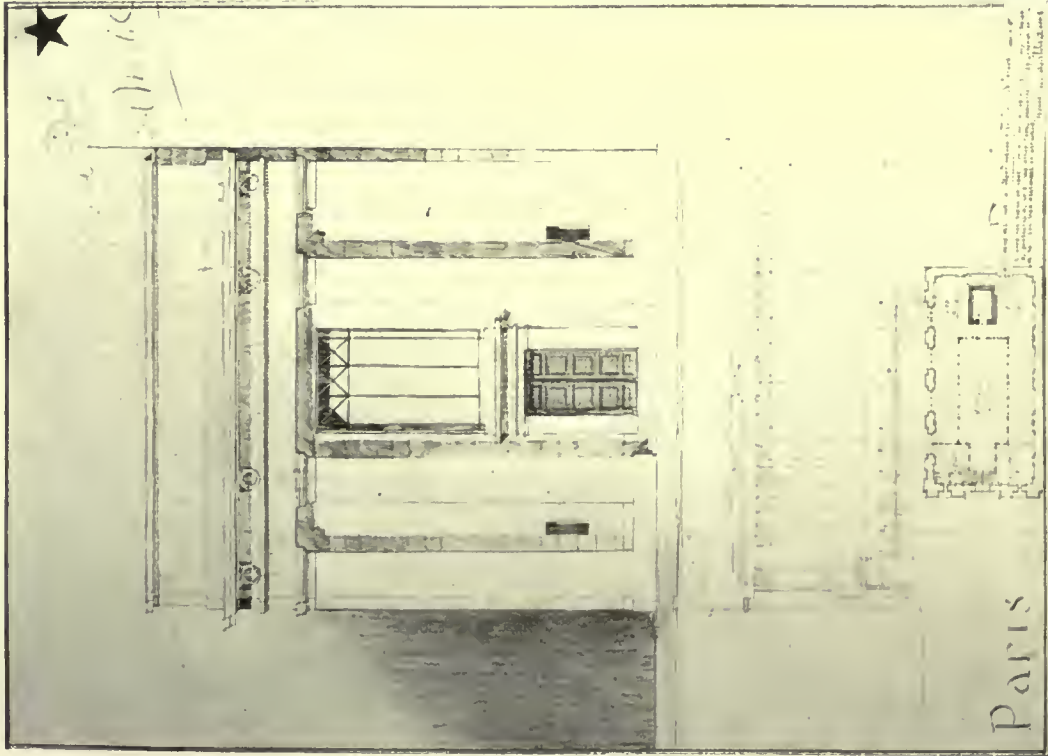

PLACED FIRST AND 3RD MEDAL—L. WILLIAMS, COLUMBIA UNIV., N. Y. C.

PLATE 121

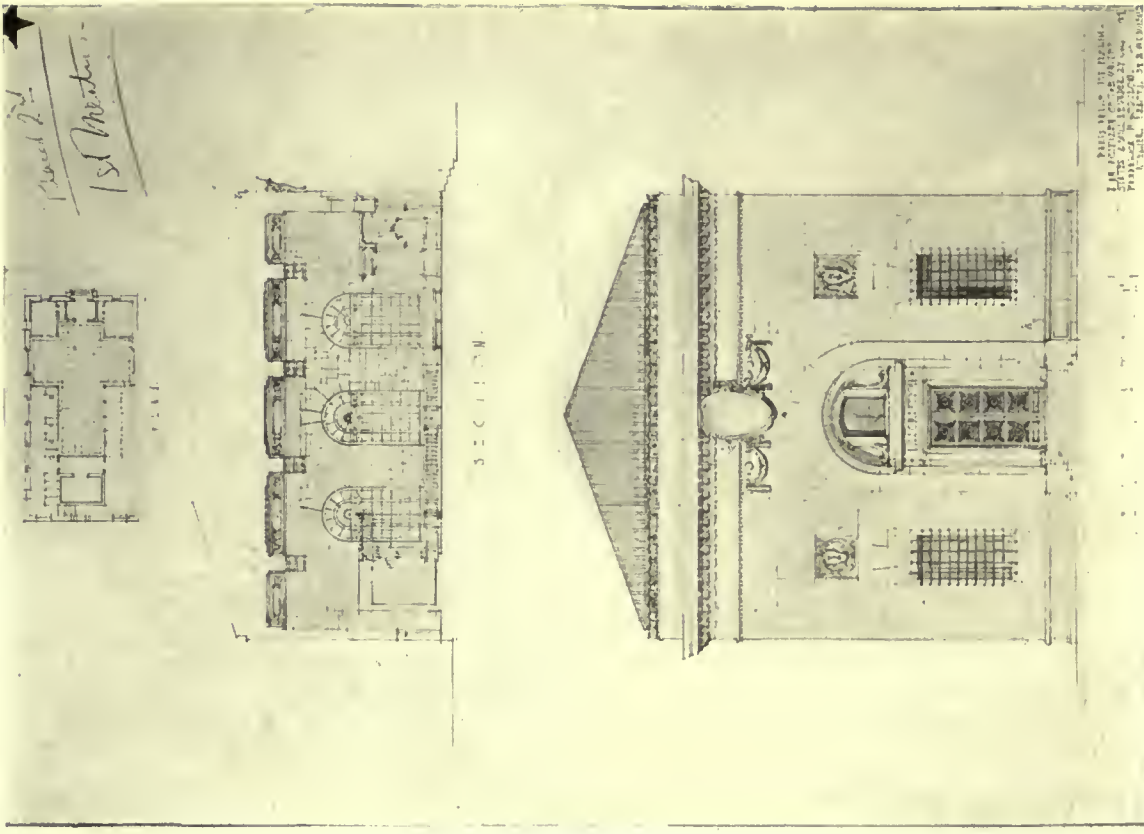

PLACED SECOND AND 1ST MENTION—E. M. HODGSON, ATELIER REBORI, CHICAGO

FIRST PRELIMINARY COMPETITION, TWELFTH PARIS PRIZE

STUDENT WORK—BEAUX-ARTS INSTITUTE OF DESIGN





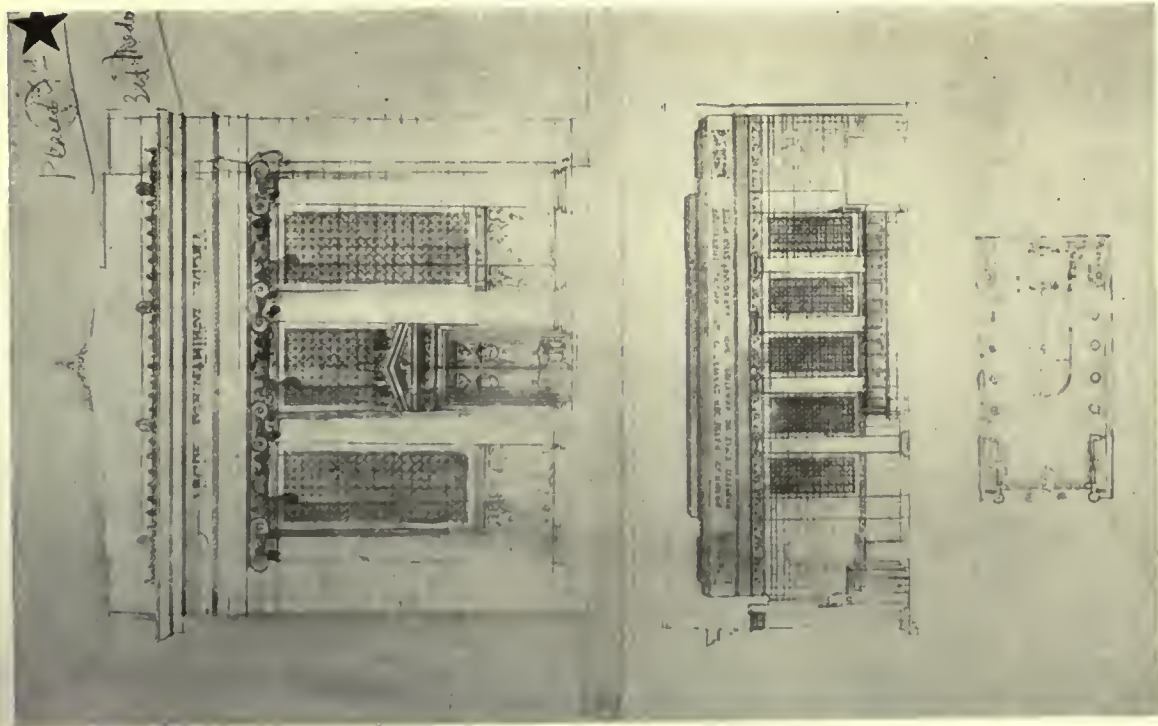

PLACED THIRD AND 3RD. MEDAL—J. G. ANTENEN, UNIV. OF PENNSYLVANIA, PHILA.

PLATE 122

FIRST PRELIMINARY COMPETITION, TWELFTH PARIS PRIZE

STUDENT WORK—BEAUX-ARTS INSTITUTE OF DESIGN

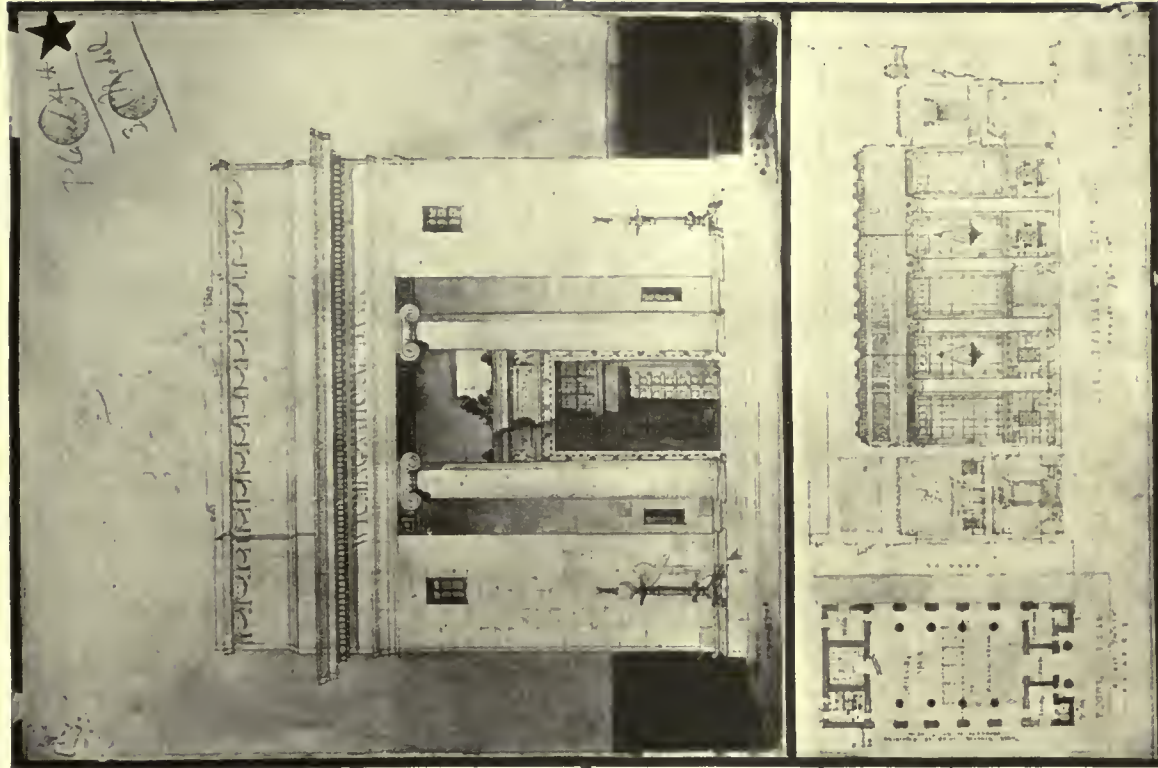

PLACED FOURTH AND 3RD. MEDAL—A. E. MIDDLEHURST, CORNELL UNIV., ITHACA





# Current News

## Owen Brainard

Owen Brainard, associated with the architectural firm of Carrere & Hastings, died suddenly of heart disease, on the evening of April 2. He was visiting at the house of friends when stricken.

Mr. Brainard was a man of rare personality. His untimely death—he was but fifty-four years old—will shock a large number of associates and friends who held him in the most affectionate regard.

As a consulting engineer he stood at the head of his profession. His rare abilities commanded respect, and his counsel and advice were widely sought as those of a man whose knowledge was founded on the most profound learning. His loss to the professions of architecture and engineering is very great, and will be more fully realized when his absence is noted from the many activities in the future, which, if he were yet alive, he would very largely dominate.

Born in 1865 in Haddam, Conn., Mr. Brainard came to New York as a young lad, where he attended the usual courses in public and private schools. He became employed by Carrere & Hastings in 1893 as consulting engineer, and had been associated with them ever since. Mr. Brainard's accomplishment in his profession is principally to be seen in the many monumental buildings where he has contributed as consulting engineer.

The measure of his wide activities in two professions is to be noted in the fact that he held membership in all of the important societies in the fields of architecture and engineering.

---

## Southern California Chapter Holds Monthly Meetings

The one hundred and twenty-third regular meeting of the Southern California Chapter, A. I. A., was held on February 11, President H. M. Patterson in the chair. Fifteen members attended. As guests of the Chapter were present Perry Sawyer, representing the Building Trades Development Committee, and George Gove, architect, of Tacoma, Wash.

Under Committee Reports, Mr. Krempel, for the Committee on "Contracts and Specifications," stated that he had been in consultation with Mr. Weeks of Seattle upon the subject of Quantity Surveying, and suggested that it might be of interest to members if Mr. Weeks were invited to

address a meeting of the Chapter in the near future.

For the Committee on "Competitions" the Secretary reported that the Committee had been in consultation with the Supervisors of the County of Santa Barbara relative to the proposed competition for a Courthouse; that information had been given out that the competition was to be held, and the Committee hoped to have the program made in compliance with the Institute rules.

Mr. Bergstrom, for the Committee on "Permanent Legislation," reported having attended meetings of the Joint Committee of the Technical Societies within the past few days, when the proposed State Licensing Law for Engineers was being discussed. The Committee recommendation to the Chapter was not to endorse the bill in its present form; thereupon it was resolved that the Chapter endorse the action of the Technical Societies in opposing the passage of the bill in its present form.

Mr. Allison, for the Committee on "Public Information," reported having met with the Joint Committee of the Technical Societies and taking up with them the method and means of obtaining employment for the returned soldiers.

The President introduced Mr. Perry Sawyer, who spoke on the subject of building conditions and future prospects of the country, and of California in particular. Mr. Gove gave a short talk on Chapter activities in the Washington State Chapter.

The one hundred and twenty-fourth regular meeting of the Southern California Chapter, A. I. A., was held on March 11, Mr. Lyman Farwell presiding and nine members present. Mr. Henry Rosenthal of Cincinnati, editor of the "Building and Loan Association News," attended as guest.

For the Committee on "City Planning," Mr. Withey reported that the mayor had appointed a Civic Center Committee for the purpose of studying the problem and making a recommendation to the mayor and council for the establishment of a Civic Center for Los Angeles. Although the mayor had agreed to place three architects on this commission, none were included in the final appointment; that the President of the Chapter had written a letter to the mayor, regretting he had not seen fit to include architects in this appointment, nevertheless offering the services of the Chapter in so far as the mayor might care to call upon it. Mr. Withey added in conclusion that the Chapter Committee was closely following the work of the Civic



Center Committee and would shortly offer some suggestions to bring to their attention the interest the Chapter has in this matter.

The Committee on "Competitions" approved the Competition Program for the Santa Barbara County Courthouse.

The Committee on "Permanent Legislation" met with the Joint Committee of the Technical Societies for further discussion of the proposed Licensing Law for Engineers. The Secretary read a letter from the Secretary of the Joint Committee of the Technical Societies, which briefly was to the effect that the proposed law is entirely unsatisfactory and urges that the measure be not passed at this session of the legislature.

Mr. Patterson reported a meeting of several members of the Chapter with Bert L. Fenner, an Institute Director, at which were discussed matters concerning the work of the Post-War Committee of the Institute. There were also present at this meeting Mr. Schnaittacher, President of the San Francisco Chapter, and Mr. Johnson of the Washington State Chapter.

Mr. Rosenthal was introduced and spoke on "National Housing."

### Washington Chapter A. I. A. Sponsors Bill to Regulate Use of Title

A new bill providing for the registration of architects has been submitted to the Washington state legislature with an appeal for its enactment, by the Washington State Chapter of the American Institute of Architects. The bill proposes to regulate the use of the title "Architect" states the *Improvement Bulletin*, by requiring all persons using it to have a certificate of registration, which may be obtained from an examining board upon proof of an established practice in the state, by presentation of certificates obtained in other states or diplomas from accredited universities or schools, or by passing an examination. The bill submitted was accompanied by the following preamble:

"In presenting this bill to the State Legislature we would clearly and firmly have impressed upon its members that the bill is not intended to, nor does it, prevent any person of any calling whatever from making drawings for buildings of any character, but regulates only the use of the title Architect. This, on the face of it, must show clearly a genuine lack of desire to monopolize or restrict the work of designing buildings, and also real desire to be of service to the public and indirectly to the profession. It is generally conceded that the public at large is almost universally ignorant of the functions of an architect and of the minimum qualifications for the practice of our profession. And this ignorance is but natural when we recall how seldom the individual undertaking to build, employs an architect. And still further, having once built, and by experience having gained some knowledge of the functions and the neces-

sary qualifications of the architect, how seldom he again builds without employing an architect, making of value the experience thus gained. It is to protect this individual in the first instance largely, that this bill operates. It affords him some assurance of at least minimum qualifications in the architect he employs, of which, in the present conditions, he is likely to have little. If the unqualified practitioner has not the ethical consciousness to restrain him from foisting himself on the public as a qualified one, then as in other professions, he should be restrained by law. If he be ignorant of the minimum requirements as herein presented, then, these present a standard for him to attain.

"The law as drawn, sets a standard of education for the time being and gives evidence that the architect so registered has had the proper training and experience brought about through academic training and subsequent practice or that he has acquired in practice for a long period a comprehensive knowledge of architecture, and has presented proof of this knowledge. This fostering the educational standard brings to the public a better service, procuring a minimum requirement by law as exists in the professions of law and medicine and other professional and technical occupations. It checks license to do that which is bad and provides punishment for so doing."

### The Post-War Committee

Is a committee representative of

The entire Profession of Architecture.

Its comprehensive program has been condensed to form a questionnaire, and mailed, as far as known, to every architect in the United States.

The Committee, desiring the fullest cooperation, asks that architects who have failed to receive a copy notify the Secretary, who will promptly mail one.

The Committee further desires to receive suggestions from organizations of the Building Trade and Contractors. A requested number of copies will on request be forwarded to these organizations for distribution.

This is the most important movement to place architectural practice on the highest plane that has been made in recent years.

CO-OPERATION WILL INSURE SUCCESS.

Write to Secretary, Post-War Committee,  
1741 New York Avenue, Washington, D. C.

### Architects Aid with Memorial Suggestions

The Wisconsin Chapter, American Institute of Architects, has offered its services gratuitously in the way of making suggestions and giving advice, both as to location and design of memorials and monuments erected in the state by various organizations in commemoration of Wisconsin soldiers and sailors. Gerrit J. DeGelleke, 725 Caswell Block, Milwaukee, is president of the Wisconsin Chapter.

## Portland's Extensive Building

The City of Portland, Ore., is actively working with the United States Department of Labor to establish a building campaign in its own section. As now proposed, that city contemplates the erection of at least two thousand houses this year. Portland now has a population of about 430,000, steadily increasing, while the number of buildings annually erected has for the past eight years been declining. As Oregon is the source of an immense lumber supply, and there is also an abundance of skilled labor, the outlook is reported to be most encouraging for building activities which may absorb at least a part of the surplus labor.

## The Progress of Craftsmanship in Brazil

The American consul at Rio Janeiro reports that before the European war furniture and other manufactures of wood were imported into Brazil to the value of more than a million dollars annually, but today Brazilian and Italian workmen in that country are able with Brazilian woods to imitate imported furniture so perfectly that the resulting article is often more beautiful than the model.

While the Amazon district and the extreme north are famous for their dyewoods and Parana is the home of Brazil's soft wood, Rio de Janeiro and Sao Paulo are the great woodworking centers. Furniture-making now in Brazil has reached the stage where its product can compete with the most particular of world markets. In some of the factories the lumber used is all kiln-dried before working. The workshops are equipped with modern machinery, including American machines for veneering purposes. The artisans work on the hardest and most beautiful of Brazilian woods; they do hand carving and inlaid work with a wonderful degree of excellence. Handsome inlaid trays and table tops may be had at a moderate price containing twenty or more varieties of wood. "Imbuya" is the finest wood for furniture making. It comes in a large variety of colors and grains, is hard but easily worked and after kiln-drying, is almost indestructible.

A number of proprietors and foremen in furniture factories have learned their trade in the Lyceo de Arts e Officios, at Sao Paulo, a school that teaches industrial arts and manufactures various articles. The students work in the shops for three or more years, then leave to become foremen in other factories or do special order work on their own account.

There are more than three hundred varieties of

woods in the Sao Paulo region alone. As a whole Brazilian forests not only abound in the finest of woods but are of enormous extent. Except for a few plateaus, the forests of Brazil stretch from the Atlantic to the heights of the Andes. Transportation facilities are developing slowly and the labor supply is a constant problem in every Brazilian industry, but with its enormous resources Brazil should become one of the world's principal sources of lumber.

## For a Pershing Highway

An organization has been formed in Lincoln, Neb., to exploit the construction of a "Pershing Highway," which is proposed to extend from San Francisco to New York.

Governor Samuel R. McKelire has sent invitations to governors of states through which the highway is proposed to pass, asking their co-operation.

The highway would be built along cities and towns in which the principal events in General Pershing's life took place, including Laclede, Mo., where he was born.

## The School House Problem

The Bureau of Education has estimated that not less than \$500,000,000 worth of new school buildings will be needed by the fall of 1920 before adequate service may be forthcoming, and large quantities of building materials accumulated by the Government in process of its war activities could be made available for this purpose.

A writer in the *Manufacturers' Record* points out that the facilities for proper instruction of children in the grade schools are woefully inadequate, overcrowding is so common that it has ceased to cause comment, buildings are poorly ventilated, badly lighted and altogether out of keeping with the educational ideals of this nation.

The war-time cessation of schoolhouse building has caused a deficiency to accumulate, which has resulted in hundreds of thousands of children having to attend classes in buildings entirely unsuited to the purpose. No one needs to be reminded that such a condition is bad for the future of these children and harmful to the ideals of the country itself. From the standpoint of Americanism alone, it is highly important that every city provide generously and wisely for its school system.

Furthermore, a comprehensive school building program would call for a large labor force, and present circumstances make this another point in its favor.



# Late News from Architectural Fields

Special Correspondence to THE AMERICAN ARCHITECT

## Organize for "Own-Your-Own-Home" Campaign

WASHINGTON, D. C., April 7.—Eighteen cities are organizing for an own-your-own-home campaign along the line suggested by the U. S. Department of Labor. Campaigns either are in progress or about to open in Billings, Mont.; Charleston, W. Va.; Chicago; Cleveland; Denver; Jacksonville, Fla.; Johnstown, Pa.; Lynchburg, Va.; Middletown, Conn.; Milwaukee, Wis.; Philadelphia, Pa.; Portland, Ore.; Salt Lake City, Utah; Seattle, Wash.; Spokane, Wash.; Staunton, Pa.; St. Paul, Minn.; and Toledo, Ohio.

In each of these cities there is a marked shortage in dwellings, and the campaign is being waged as a civic movement with the co-operation of every organized element interested in municipal and social problems.

In sixteen other cities tentative plans are under way, and it is expected from them will come many more vigorous campaigns for home owning and home building. In all these cities civic clubs, financial interests, municipal officials and labor organizations are being appealed to by the Department of Labor to lend assistance in starting such campaigns.

Since labor is so important an element in the home building projects, labor organizations are being invited and urged to take a conspicuous place in the campaign work in each community. Most of the homes built in this sort of a movement are for laborers and salary earners, and the building of these homes provides employment for the building trades and common labor. This double benefit in the home building movement has been recognized by many communities, and the response has been very promising.

## Institute to Widen Scope of Organization

WASHINGTON, D. C., April 7.—In order to give the program of the Post-War Committee the widest dissemination and the broadest contact, the executive council has decided to invite the architectural societies of Canada and all societies in states wherein there happens not to be a Chapter of the Institute, to the annual convention, next month, of the American Institute of Architects at Nashville, Tenn. The program will be the most important topic of the discussion, and all members and non-members alike will be asked to talk freely on the provisions as they have been outlined by the committee. Authorities in charge of the arrangements for the convention anticipate an unprecedented gathering of the members of the profession.

## Urge Co-operation of Builders and Labor

WASHINGTON, D. C., April 5.—The stabilization plan of the Builders and Manufacturers Exchange for building construction in the District of Columbia has been indorsed by local officials, according to a letter received this week by Edward H. Mealy, secretary of the exchange.

One of the principal plans of the stabilization campaign

is to bring about closer co-operation between the builders and labor. It is proposed that the labor organizations maintain their wage scale of 1918 throughout the year from April 1 next to April 1, 1920. The material dealers are also to be urged to agree to the lowest possible prices, while contractors are to consent to a minimum profit.

Several of the labor organizations have already announced their intention of co-operating in the movement, and it is expected others will take the same course.

## Building Reports Optimistic

WASHINGTON, D. C., April 5.—Franklin T. Miller, director of the Division of Public Works and Construction Development of the Department of Labor, summarizes data gathered from all parts of the country regarding building and construction work as follows:

"There is justification for the optimism in several significant developments of the last two weeks. The revival in business, for which some have been waiting and others working, seems to be on the way. This is indicated, in my opinion, by these circumstances:

"Bank clearings are comparatively large. The territory which in 1917 showed ten billion five hundred millions in bank clearings for January, and in 1918, in the same month, showed eleven billion eight hundred millions, in January, 1919, showed fourteen billion five hundred millions. Retail business is unusually active and is showing improvement from week to week, and there is a noticeable acceleration of advertising activities, which indicates confidence in future business possibilities.

"For the first time since 1907 real estate in the metropolitan district of New York City is active, some of it speculative buying indicating a conviction in the minds of the investors that real estate prices are to advance and present real estate prices are not abnormal but quite otherwise.

"Building statistics indicate very clearly there is a gradual improvement. Municipal building permits in November last were 6 per cent of normal, in December they were 10 per cent, in January 20 per cent, while in February they were from 35 to 40 per cent.

"The revival is more marked, however, outside the larger cities, and is especially noticeable in the Middle West. Allowing for the difference in money values, the contracts awarded for construction throughout the country in February, 1919, are 97 per cent of the five-year average for the same month. Of these February contracts 91 per cent were for private projects and 9 per cent for public. Of the private contracts 55 per cent were for residential property, 25 per cent mercantile and 20 per cent industrial.

"It is still difficult to get a realizing sense of the effect of present inflation upon prices of building materials and labor and to realize that neither have increased in proportion with other commodities or with the cost of living; and yet, it appears, the investing public generally is coming to an understanding of these facts. While other commodities and the cost of living have increased one hundred per cent and more since the beginning of the war, the advance in construction costs on such buildings as do not require steel is only about 48 per cent; on such buildings as require steel the advance approximates no more than 87 per cent. Construction costs, therefore, in their upward tendency, have not kept pace with other commodities and the cost of living."

# Financial and Commercial Digest

## As Affecting the Practice of Architecture

---

### The Stabilization of Commodity Prices

The stabilization of prices by the industrial board of the Department of Commerce on basic commodities has taken a temporary suspension due to the inability of the confrères to come to an agreement among themselves and with the board. In making the announcement of the conclusions of the steel men, the board anticipated that the other industries would adopt a similar course in meeting the suggestions of the board, but it has been admitted the action regarding steel was exceptional.

The lumber, brick and cement industries were confronted with peculiarly individual problems, and the representatives to the conferences were able to speak only for their particular companies. The lumbermen have had to delay further conference with the board until accurate data could be supplied showing production costs as compared with selling prices. It was necessary to postpone the meeting until the early part of next week, awaiting the preparation of adequate statistics. It is understood the cement men are waiting for the return from Chicago of Mr. George N. Peek, chairman of the industrial board, before any announcement is made as to the results of their conference.

Definite announcements as to price agreements affecting the commodities considered will not be made by the industrial board until all concerned have finished their labors, according to an official of the board. It is expected, however, real stabilization of prices will result from the negotiations now in progress.

---

### May Resume British Trade

A study of British import restrictions, effective March 1st, has led the American Manufacturers' Export Association to the conclusion that any temporary loss of British trade would enable American manufacturers to concentrate on other markets, and that the imposition of these restrictions was not to be taken as an indication of permanent British policy. It is asserted by George E. Smith, president of the association, that he has official and unofficial information that the policy was of temporary expediency and that the British had no intention of erecting a trade wall, which, if dupli-

cated by other countries, would destroy her own foreign commerce.

The keeping of a certain percentage of goods manufactured in other countries upon a restricted list, the statement said, represented merely the attempt of the British to put their own house in order, and there was no necessity for abandoning American branch houses in England, because normal conditions would be restored in six months or a year. Mr. Smith added that there was a disposition on the part of the American Government to take up with the British any particular statement of facts which showed that special hardship was being worked on a specific industry.

---

### Predicts Business Boom

That a boom in business throughout the United States is imminent and that the unemployment situation will be cleared up within two months, are the predictions of William C. Redfield, Secretary of Commerce. Wise men, states Mr. Redfield, are starting up their industries despite a rising market, and the Federal Industries Board has started the ball rolling by lowering the price of steel. The coming of Spring will start building operations, and the harvest within a few months, and this will mean a big impetus to business generally.

The Federal Industries Board, Secretary Redfield says, does not attempt to regulate business or "doctor" it, but will merely form a medium for discussion of the country's needs by experts in various branches of industry and will bring together the big buyer, the business man who sells or manufactures, and the workingman who produces, and will function much after the fashion of the Department of Labor's subsidiary boards.

---

### Bill to Establish Home Loan Banks

The next Congress will be asked to enact legislation necessary to the establishment of a system of Federal Home Loan Banks. A tentative bill has been prepared and has been mailed to all officers and committees of the U. S. League of Building Associations. This tentative bill provides that the building and loan associations be permit-



ted to organize regional banks, capitalized by the associations and operated by them under government supervision. The purpose of this is to provide a regional bank which will perform for building associations a service similar to that performed by the Federal Reserve Bank for the commercial banks, and by the Federal Land Bank for the National Farm Loan Association.

Owing to the congestion in important legislative matters in the last Congress, it was impossible to obtain consideration for the Federal Home Loan Bank project. The tentative bill, with such revisions as may be considered prudent, will be introduced, however, in the next Congress, and it will carry with it the influence of the national and State organizations of building and loan associations.

### Discuss Stimulation of Construction

Stimulation of construction activity, the promotion of home building and transportation conditions in lumber shipments were topics discussed at a recent conference of representatives of retail and manufacturing lumber interests held to discuss trade extension.

Specific action by the committee of retailers was taken, looking to the appointment of a committee to go to Washington to lay before Director-General Hines the desirability of the railroad administration placing further control upon the use of transit shipments of lumber.

Discussion was made of the desirability of securing standardization of nomenclature, sizes and grades for all competing species of ordinary structural lumber. This was put into a resolution which will be submitted for the consideration of the regional associations of lumber manufacturers.

It was likewise recommended to the lumber manufacturers that some provision be made for the more careful, more rigid and systematic inspection of lumber, possibly through the medium of joint inspection by both manufacturers and retailers.

### Studying Construction Activity in Europe

Industrial conditions in Europe, with special reference to the building business, are being investigated by R. R. Otis of Atlanta, Ga., a member of the Employers' Industrial Commission of the U. S. Department of Labor.

The commission was sent abroad under the auspices of the Information and Education Service of

the Department of Labor, and its aim is to collect data from European sources which will enable the United States to profit from what has been experienced and what is being accomplished abroad in the interest of better relations between employer and employee, and in the interest of business as a whole.

One of the subjects that will be investigated is the methods of the government and the attitude of the employers in handling problems of production that arose during the war. Special reference will be made to the adjustment of labor disputes both as to wages and to labor's voice in management.

### Ante-War Conditions Again

Now if we had the 4,000,000 immigrants that this country would have received if the war had not commenced, says *Engineering World*—if we had our 2,000,000 soldiers home again—if adjustments had been made and if we were all working steadily in the pursuits of peace—if we had the \$3,000,000,000 to \$5,000,000,000 worth of domestic structures of which we are short and the shortage of which is causing increase in rents (and rentals growing out of this shortage cumulatively increase the cost of every necessity of life)—if we had these things and were all working steadily, and if there were no exceptional draft on our products from abroad, prices might again be what they used to be.

### The New Steel Prices

Commenting on the announcement at Washington of the new steel prices, *The Iron Age* states that they are undoubtedly the result of a compromise, represented in concessions by the manufacturers. Probably the most helpful indication as to future stability in the prices of steel products is the clearly established attitude of the Industrial Board toward this important question. Stabilization is apparently the aim of the board, and the present established prices may for this reason be regarded as a minimum for some time at least.

An interesting comparison by *The Iron Age* of the new schedule of prices with preceding schedules, is as follows:

	Peak, July, 1917	First Govt. Price, 1917	Open Market, Jan. 1, 1919	New Agreed Prices
Pig iron, basic, gross ton.....	\$53.00	\$33.00	\$30.00	\$25.75
Billets, 4 in., gross ton.....	100.00	47.50	43.50	38.50
Steel bars, 100 lb.....	4.50	2.90	2.70	2.35
Structural shapes, 100 lb.....	4.50	3.00	2.80	2.45
Sheared tank plates, 100 lb.....	9.00	3.25	3.00	2.65
Black sheets, No. 28, 100 lb.....	10.00	5.00	4.70	4.35
Tin plate, 100-lb. box.....	12.00	7.75	7.35	7.00
Wire nails, keg.....	4.00	3.50	3.50	3.25
Rails, standard Bessemer, gross ton..	....	55.00*	55.00	45.00
Rails, standard open-hearth, gross ton	....	57.00*	57.00	47.00

\*Unregulated.

# Late Quotations in Building Material Markets

Somewhat heavier orders and a slightly more solid tone to the trading marked activity in the building material field the past week. Prices held firm in practically all branches, giving the indication that there will be no sudden drop in the near future. There has been no increase in business in the steel industry, as was expected with the lowering of prices by the Industrial Board. The new obstacle that has arisen with the impression that the Railroad Administration had refused to accept the newly established steel prices, supplies a serious block against the early renewal of purchases.

The attitude of purchasers of steel may be altered when fuller knowledge of what influenced Mr. Hines to refuse the price schedule. Until it was learned that the Railroad Administration and the Industrial Board were at loggerheads, commercial users of steel have appeared to be waiting only a signal from the Railroad Administration, which uses 25 per cent of the output in normal years, to place a large tonnage of contracts. There is an idea now prevalent that if the market is to be thrown open the trade will wait for lower prices.

There has been a small increase in the volume of lumber-yard business, due to increased small-house construction, but the situation is far from normal yet.

## New York

Price quotations now current on building materials and supplies as quoted by dealers and jobbers for delivery in New York City are as follows:

### BRICK—

Common (for Borough of Manhattan only), per thousand .....\$17.85

### CEMENT—

Per bbl. in 15 cent bags .....\$3.25

### COOPER SHEETS—

At the mill, hot rolled, 16 oz., base price, per lb...22½c.  
(From jobber's warehouse add 2 to 3 cents.)

### GALVANIZED SHEETS—

Nos. 18 and 20 gauge, per lb. ....\$25.90  
No. 26 ..... 6.20  
No. 27 ..... 6.35

### GLASS—

(Discounts from manufacturer's price lists)

Single strength, A quality, first three Brackets....80%  
Single strength, B quality, first three Brackets....79%  
Double strength, A quality .....80%  
Double strength, B quality.....82%  
Plate—up to 5 sq. ft. ....82%  
Plate—over 5 sq. ft. ....84%

### GRAVEL—

1½ in. (Borough of Manhattan only) per cu. yd....\$3.25  
¾ in. (Borough of Manhattan only) per cu. yd.... 3.25

### GYPSUM—

#### Plaster Board

(Delivered in Boroughs of Manhattan or Bronx)

27 x 28 x 1	35	cents
27 x 48 x ¾	32	"
32 x 36 x ¼	21	"
32 x 36 x ¾	21	"
32 x 36 x ½	23½	"

### Plaster Blocks

(Delivered in Borough of Manhattan or Bronx)

2 in. solid per sq. ft. ....	7½	cents
3 in. solid 12 x 30 per sq. ft. ....	10½	"
3 in. hollow .....	10½	"
4 in. hollow .....	12½	"
6 in. hollow .....	17½	"

### HOLLOW TILE—

Interior, 2 x 8 x 12 split furring per 1,000 sq. ft...\$ 70.00  
and 15 cents thousand pieces.

Interior, 3 x 12 x 12 split furring per 1,000 sq. ft.. 102.00

Interior, 4 x 12 x 12 split furring per 1,000 sq. ft.. 114.75

Interior, 6 x 12 x 12 split furring per 1,000 sq. ft.. 153.00

### LATH—

Eastern spruce, per thousand .....\$6.50

### LIME—

Common, 300 lb. bbls, per bbl. ....\$ 3.50

Finishing, 300 lb. bbls, per bbl. .... 3.70

Hydrated, in paper bags, per ton ..... 17.25

### LUMBER—

(All Prices F.O.B. New York)

Yellow pine, flooring, No. 1, common, per thousand,

flat grain .....\$ 42.00

N. C. pine, flooring, Norfolk, Va., 13/16 x 2½... 43.00

Hemlock, base price ..... 36.00

Spruce, random 2 in. cargoes ..... 38.00

Spruce, wide cargoes ..... 52.00

Cypress, by car, and factory selects 5/4..... 59.00

Cypress shingles, 6 x 18 (Heart) ..... 10.00

Oak, quartered, (Red) ..... 96.00

Oak, plain, flooring, (Red) ..... 72.00

Oak, white flooring ..... 72.00

Maple, No. 1, 13/16 x 2 in. .... 57.50

### PIPE—

Cast iron,

6 in. and heavier .....\$57.70

4 in. .... 47.70

3 in. .... 67.70

Wrought,

(Discounts to jobbers for carload lots on the Pittsburgh basing card; Freight rates from Pittsburgh to New York, in car loads, per 100 lbs., are 27c.)

Butt Weld

Steel,

Black, ¼ to 3 .....50½ to 57½%

Galv., ¼ to 3 .....24 to 44 %

Iron,

Black, ¼ to 1½ .....29 to 39 %

Galv., ¼ to 1½ ..... 2½ to 23½%

Lap Weld

Steel,

Black, 2½ to 6 .....53½%

Galv., 2½ to 6 .....41 %

Iron,

Black, 2½ to 6 .....34½%

Galv., 2½ to 6 .....21½%

### PLASTER—

Neat wall cement in 15 cent bags, per ton .....\$20.30

Finishing plaster ..... 24.00

### RADIATION—

#### STRUCTURAL STEEL—

Beams and channels up to 15 in, per lb. ....2.45c.

Beams and channels over 15 in, per lb. ....2.45c.

Angles, 3 to 6 in.....2.45c.

Zees and tees .....2.45c.

Steel bars, half extras, from mill .....2.35c.

### REINFORCING BARS,

Iron .....

Steel .....

### SAND—

Per cu. yd. (Borough of Manhattan only) .....\$2.25



# Department of Architectural Engineering

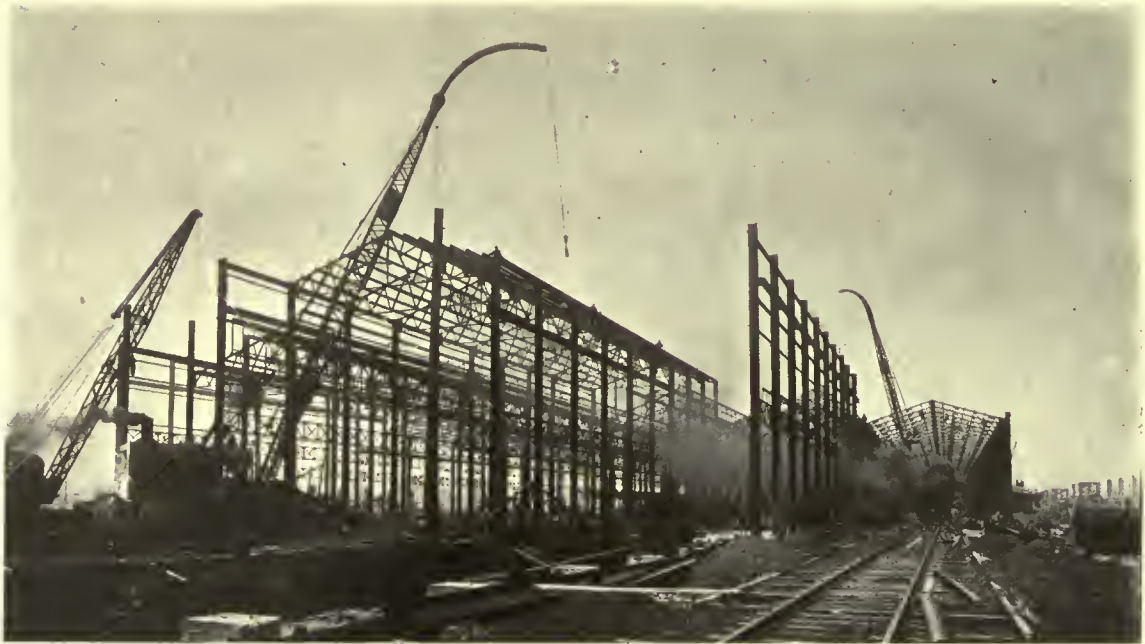

Erecting steel frame with locomotive cranes.

## Ford Shipbuilding Plant, River Rouge, Mich.

THE Ford Motor Company's Eagle Plant is located on the River Rouge, just outside of the city of Detroit, and three miles from the Detroit River. It adjoins on the north the Ford Motor Company Blast Furnaces, now under construction.

The plant was constructed for the sole purpose of manufacturing patrol boats for the United States Navy. It comprises a group of several buildings, a launching slip, a transfer table for shifting the boats from the construction tracks to the launching slip, a basin and fitting-out docks and sheds. The basin and fitting-out docks are part of the permanent construction of the blast furnaces. The buildings consist of a material storage and punching shop, transformer building, assembling shop and power house.

The material is received on cars at the storage building and punching shop, and after passing through the same is transferred on industrial cars of standard gage to the assembling shop. Contrary to

usual practice in ship construction, the patrol boats are assembled on a line of trucks moving on standard-gage railroad tracks. These trucks consist of special heavy platforms built on standard railroad-car trucks. As soon as the construction of a boat has reached a particular stage the line of trucks carrying the boats is moved along to the next station. There are seven of these stations on each construction track in the assembling shop.

After going through these various operations the hull of the boat is ready for launching, and, still carried by the trucks, is moved out of the building to the transfer table. This transfer table is of a similar type to that used for shifting cars in railroad and street-railway yards. By this means, the boat is shifted to the track leading to the launching slip. The launching slip consists of a small basin constructed with steel sheet piling and containing a steel bridge supported on hydraulic jacks. The boat, supported on the trucks, runs out on this bridge,

## THE AMERICAN ARCHITECT



Exterior view.

and is thus lowered into the water, from where it is shifted to the fitting docks.

With the exception of the assembling shop, all of the buildings are of a temporary character, and consist of either entire wood framing or brick exterior walls and roofs of wood construction. All of the buildings are one story in height.

There are 94,500 sq. ft. of floor space in the material storage and punching shop, 2,200 sq. ft. of floor

space in the transformer building, 518,000 sq. ft. of floor space in the assembling shop, 4,300 sq. ft. of floor space in the power house, making a total of 619,000 sq. ft. which it was constructed. This building is 305 ft. wide and 1,700 ft. long. It consists of five main bays, each 51 ft. wide, and two low side bays, each 25 ft. wide. There are three ship construction tracks in the building in the two outside and the center main bays, thus enabling operations to be conducted on twenty-one ships at the same time. The other two main bays are occupied by standard-gauge service tracks on which the material is deliv-



Assembling shop showing one of the five main bays and a low side bay. Note the fine daylighting.

space in the transformer building, 518,000 sq. ft. of floor space in the assembling shop, 4,300 sq. ft. of floor space in the power house, making a total of 619,000 sq. ft.

The assembling shop is, naturally, the feature of the plant in which centers the greatest interest, on account of its unusual size and the rapidity with

ered to the various points needed. The height of the building under the trusses for 1,300 ft. of its length is 36 ft. 5 in. For the remaining 400 ft. the three ship-construction bays are 50 ft. 9 in. under the trusses. This greater height was required on account of the greater height of the hull at the last two stages of operation. The two side bays



## THE AMERICAN ARCHITECT



Exterior view showing the large doors for passage of hulls and the transfer table to transport the hulls to the fitting basin.

are 14 ft. high. The side bays are used for shop offices, storerooms, toilet rooms, tool rooms and operations of various characters. In one side bay there is a compressor room 160 ft. long.

The entire building is enclosed in brick walls extending on the side walls to about 5 ft. above grade, above which is steel sash. In the end walls the brick extends to the top of the door openings. The roof of the side bays is of wood construction. These bays are of a temporary character, thus providing for the extension of the main bays. The main bays of the building consist of a structural steel

the building. The percentage of ventilation in the steel sash is 25 per cent in the monitors and 18 per cent in the side and end walls. There are 4200 tons of structural steel in the building.

In the three ship construction bays there are runways for 5-ton electric traveling cranes. These runways are not continuous from end to end of building, but are separate for the high and low parts of these bays above described. There are also a number of one-half ton capacity hand jib cranes attached to the columns in the ship construction bays. In the side walls of the building there are



Stern of boat ready to be placed on the transfer table.



Erecting frame with locomotive cranes.

frame, steel sash in the side and end walls and a cement tile roof. There are monitors over the three center main bays. Two of these extend the entire length of the building and the other extends for 1300 ft. There are 172,000 sq. ft. of steel sash in

double sliding doors in alternate bays. In both end walls there are steel rolling curtains. These curtains are 16 ft. wide by 20 ft. high in all cases except the three openings between the ship construction bays and the transfer table. In these open-



## THE AMERICAN ARCHITECT

ings the curtains are 32 ft. wide by 42 ft. high, and each is operated by a 5-hp. motor located just above the door head.

The character of the soil being good, the column footings are all independent rectangular reinforced-concrete footings. There is a plank floor in the building, laid on sleepers above 6 in. of cinder fill.



Hull on transfer table ready to be shifted to the fitting dock

February 18. The general contractor started at once on the construction of the punching shop, which was completed on March 30. He also started at once on the footings and foundation walls for the assembling shop.

Structural steel shop drawings for all the typical construction were completed and approved on

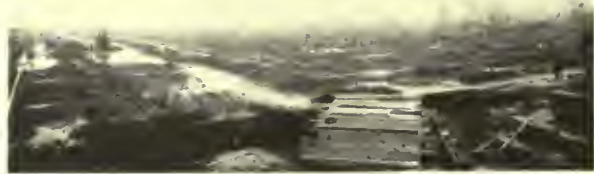

Site of plant on March 13, 1918

In order to give great stability to the ship construction tracks, the ties for the tracks were laid directly on a reinforced-concrete slab 14 ft. wide. The top of both the construction track rails and the service track rails is flush with the floor.

Preliminary sketches for the punching shop and assembling shop were started February 4, 1918. After consideration of various types of separate and combined buildings for the assembling shop, it was decided to adopt a building entirely under one roof as being the most flexible and best adapted for proposed operations. Final plans for this building were started on February 9, and were completed on February 11. The general contract was signed on February 12, and the structural steel contract on

March 1, and all drawings were completed and approved on March 7. The first structural steel deliveries were made on April 9. Erection started on April 13, and was completed on May 11. The erection was started at the head of the building, or that next to the punching shop. The steel sash and roof work followed the steel erection rapidly, so that work was started on the shop equipment and the first operations on the ship before the building was completed at the opposite end. The first ship was launched July 11, 1918.

The plans and specifications for every portion of this work were prepared and the construction supervised by the organization of Albert Kahn, architect.



Interior view showing the truck on which the hull is assembled

# Notes on Chimney Flues

## Causes of Poor Draft

By HENRY N. DIX, M.E.

IT is a common opinion that the success of an ordinary heating plant is determined only by trial. It is unfortunately true that many architects accept this opinion and look upon troubles with such plants as a thing to be expected. This is an unfortunate attitude to assume, as it is a tacit acknowledgment of inability to provide for a successful plant with absolute certainty. In the larger plants for industrial and commercial buildings, the plans and specifications for this portion of the mechanical equipment are included with the other such features which are designed by mechanical engineers. The interests in these cases are of such great importance, financially and otherwise, that successful operation is a certainty before construction begins. In the case of the ordinary dwelling or apartment building plant, an unsatisfactory apparatus is considered in terms of personal discomfort, often entirely overlooking the fact that such a plant may involve an extremely wasteful operation and maintenance.

It is estimated that fully twenty-five per cent of the fuel used for heating purposes in this class of installation is wasted. This was not seriously considered in the days of cheap fuel, but in these times of high-priced fuel it becomes a matter of economic importance.

Poor draft is the cause of more complaint about and dissatisfaction with a heating plant than any other one thing. The reasons for this condition are many and are to be found in every factor that enters into the construction of the plant. In discussing this subject, the travel of the air which is absolutely necessary for the combustion of the fuel will be described.

Air is necessary for the combustion of fuel, and it follows that it must be supplied in sufficient quantity. Boiler rooms are located below the first floor, and it often happens that these rooms are hermetically sealed as far as openings for the ingress of air are concerned. The only source of air supply in the majority of cases is that furnished by infiltration made possible by poor building construction. The primary condition is to provide deliberately for the admission of sufficient air to the boiler room. This can be accomplished by installing a grated or louvred panel in the exterior door or by replacing a light of glass in a window with a wire guard or grating. This admission of air must be provided for in order to make the

proper combustion of fuel possible, and it will also serve to keep the boiler room dry and free from musty odors.

The first position of the air is under the grates or in the ash pit. The air is supposed to and should enter this chamber only through the draft door provided for that purpose. There is generally no difficulty in securing the admission of air to the ash pit; on the contrary, it often arrives there too easily, or rather, not under control. If it can enter elsewhere than through the draft door,

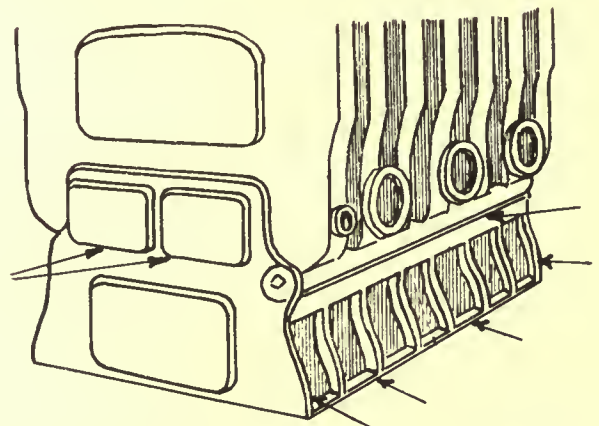

Air leakage below fire bed which prevents proper draft regulation

it is uncontrolled. Trouble is experienced in regulating the fire and it is not controlled by the damper regulator as it should be. A leaky ash pit renders it impossible to satisfactorily bank a fire at night so that it will last and still have sufficient coal available in the morning for quick steaming. These leaks are most frequently found where the base rests on the floor and can be effectively stopped by grouting with cement mortar. At the top of the base frame and in the joints between the sections themselves, and between them and the front and rear faces, are opportunities for air leakage. A careful application of boiler putty will seal these places. The openings of the ash and draft doors must be kept clear and free from ashes in order that they may be closed tightly.

The accumulation of ashes in the ash pit will obstruct the proper flow of air through the grates and may cause the destruction of the grates by warping or melting them. When the draft doors are at the side or rear of the ash pit the accumu-



lated ashes may obstruct the passage of the air through these openings. These troubles, however, are those of operation and maintenance rather than those of construction.

After passing through the grates, which must have sufficient opening or free area, the air must pass through the fire bed to make possible the combustion of the coal. The strength of the draft must be proportionate to the depth of the fire bed or the fineness of the fuel. This is governed by the

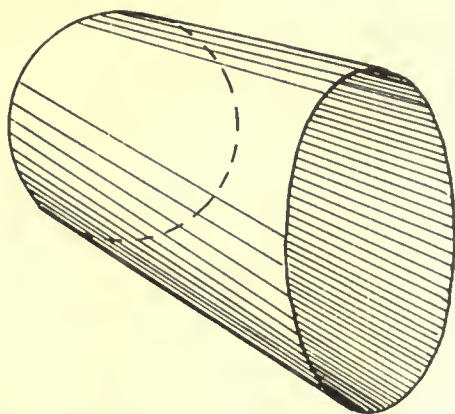

Distortion of breeching section may interfere with draft

chimney or flue. After passing through the fire bed the heated air and distilled gases pass through the boiler flues where a portion of the combustible gases are consumed. Naturally, these flues must be kept clean and free from soot and ashes in order that

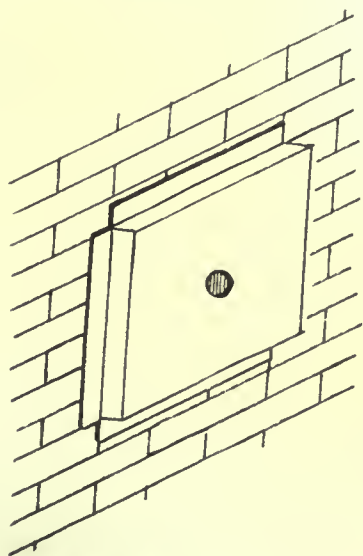

Metal test pan used to discover leakage through brick walls

their area be not reduced and the passage of the air and gases restricted. This is a matter of oper-

ation and maintenance rather than one of construction.

Infiltration of air into these smoke flues will greatly reduce the volume of air passing through the fire bed with a consequent impairment of the steaming ability of the boiler. This trouble is common in some types of cast iron boilers, the leaks being found around the clean out doors and frames and the joints in the smoke rings or iron bands that encircle the boiler. Leaks of this kind can usually be stopped by the use of boiler putty or asbestos cement.

In brick set boilers, leakage through the boiler setting is common. These leakages also reduce the volume of air which must pass through the fire bed and are due to the improper laying of the brick or the use of cracked, defective brick. These leakages can be detected by applying a shallow, rectangular metal pan to the wall, throughout its entire surface. The edges of the pan are bedded in putty, making an air tight contact with the brick work. A small hole is placed in the bottom of the pan and the behavior of the flame of a lighted candle placed at the hole will show if leakage occurs through the wall. If the flame is drawn into the hole, air is passing through the wall to the interior of the boiler setting. Pointing up the crack, applying a coat of plaster or asbestos cement will stop the

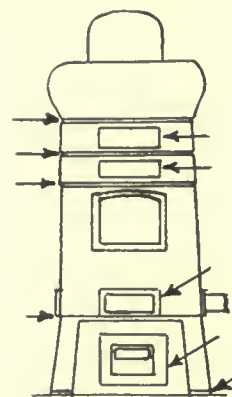

Air leakage above fire bed which reduces volume of air passing through it. Also leakage below fire bed which interferes with draft regulation

average wall from leaking, although at times it is found that the wall is so poorly constructed that rebuilding is the only remedy.

The gases, after passing through the boiler flues and smoke hood, enter a smoke pipe or breeching which connects the boiler and the vertical chimney or flue. The area of this breeching should never be less than that of the smoke collar on the boiler. The breeching should be as short and direct a connecting link as possible. To change the shape of the cross-section of the breeching may reduce its efficiency as much as fifty per cent. This is often done by changing from a circular to an elliptical section in order to make head room, when cramped for room back of the boiler or when entering the base of the chimney. The breeching should be so made and installed that it can be readily removed for cleaning. If more than ten feet long, it

is advisable to cover it with an insulating material. This covering will serve to prevent slowing down the draft by cooling the gases and with some fuels, prevents the condensation of creosote or other products of combustion at this point. The joints in the breeching and the connection to the boiler and the chimney must be air tight to avoid leakage into the breeching or chimney. A candle flame will detect such leakage if it exists.

If there is a damper in the breeching it must op-



Narrow rectangular flue. Shaded portion has no draft value and may permit back draft

erate positively, and its position be indicated correctly. A damper which is loose on its spindle or improperly indicates its position is often a source of trouble.

The flue or chimney should have a soot pocket below the entrance of the breeching. An air tight clean out door must be provided for this pocket. The breeching must not project into the flue, thus reducing its effective area. Flues should not have offsets as they may serve as places for the accumulation of soot and ashes. Where offsets are necessary they should have an inclination sufficiently steep to prevent the lodgment of solid matter. With such an offset the flue can be cleaned by passing an object throughout its entire length for the purpose of removing obstructions. Stone chimney caps must have openings as large as the flue in order not to restrict the flue area.

A chimney may be clean and of proper size and fail to draw owing to leakage through its walls. Chimney leaks can be detected by building a smoky fire at the base of the flue and when the flue is completely filled, covering the top so as to prevent further escape of the smoke. If there are leaks the smoke will appear within the building or from an adjoining flue. These leaks are often stopped by lowering a weighted, tight fitting bag into the chimney and pouring fairly thin cement mortar, in considerable volume, on top of the bag. By slowly raising the bag the mortar will flow into the cracks and close them.

Tile flue linings are always preferable as they are more easily made tight owing to the greatly reduced number of joints; they are smooth and offer less friction to the rising gases and are an admirable fire preventative. The space between the tile lining and the brickwork should be solidly filled

with cement mortar. Such an open space will permit the downward passage of cold air which will enter the flue through its joints and thus reduce the draft. An unlined flue should have its faces laid as smooth and true as possible to reduce friction and all bricks and other debris removed. Narrow rectangular flues should be avoided as they are of restricted *effective* area. If too long and narrow in section down drafts can occur at the ends.

Flues should be square or round in section. A round flue has the same *effective* area as a square flue whose side is equal to the diameter of the round flue although the square flue has a larger area of cross-section. The round flue will offer less frictional resistance to the passage of gases than the square or rectangular flue.

A chimney should be surrounded by warm air, as the cooling of the gases reduces the velocity and consequently the volume per unit of time. For this reason chimneys should not be placed in exterior walls or partially outside the building. If, for artistic effect, the chimney projects beyond the plane of the exterior wall, special care should be

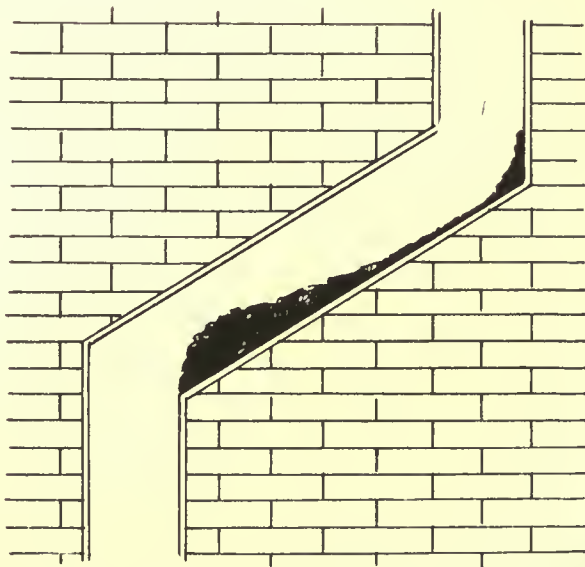

Offset flue on which soot and ashes may accumulate and restrict effective area

taken with its design and construction. Between the exterior facing of brick or stone and the flue lining, there should be introduced at least two thicknesses of 2-in. hollow tile with every joint solidly filled with cement mortar. The hollow tile should be laid horizontally and will serve as an excellent insulation. Unlined steel stacks, entirely exposed to the weather, are usually considered to have their effective diameter decreased 4 in., due to the chilling action of the cold metal wall.



## THE AMERICAN ARCHITECT

The size of the flue required is a most important matter, the governing factors being height and area. The flue must remove a certain volume of heated gas per hour based on the required fuel consumption in the boiler. If the area is increased the velocity can be decreased and *vice versa*; the volume being the product of velocity and area. A common idea of a good chimney draft is one that will carry a burning piece of paper up the flue when released at its base. This simply indicates velocity. A good draft depends on a volume sufficient to permit the necessary combustion of fuel in the fire box. A 3-in. flue will have the same draft velocity and gauge pressure at its base as a 12-in. flue of the same height, and we would not for a moment consider the 3-in. flue suitable for a chimney. Many persons will argue that a flue has sufficient draft if there is apparently a high velocity of gases. It should be remembered that an effective draft depends on a certain volume of gases being removed, regardless of its velocity.

The air velocity in a vertical flue is in direct proportion to the square root of its height. Based on this, the following formulas are used by the United States Treasury Department and many engineers:

For cast iron boilers, anthracite coal.

$$A = \frac{3}{4} \frac{G}{\sqrt{H}}$$

For lump size anthracite or bituminous coal

$$A = \frac{G}{\sqrt{H}}$$

For small sizes of anthracite and bituminous coal

$$A = \frac{5}{4} \frac{G}{\sqrt{H}}$$

in which

$A$  = area of flue in square feet

$G$  = area of grate in square feet

$H$  = height of stack in feet.

It would seem possible to increase the flue area to a degree that would permit a height of from 5 to 10 ft. This is not true, for several reasons, in practice. A chimney less than 30 ft. in height is very erratic in action, working splendidly at times and at times ceasing to function for no apparent reason. A certain draft tension is required to draw the air through the fire bed, the higher the flue the greater the draft tension produced. The draft tension is the difference in pressure at the ash pit and a point above the fire bed. This is measured in terms of inches of water, the inches being the difference in level of the water in a U-shaped glass tube which has one end open to the atmosphere and the other end connected at a point above the fire bed.

The approximate strength of the draft tension is given in the following table:

Height of flue in feet	Draft tension in inches of water
20	0.146
30	0.219
40	0.292
50	0.365
60	0.438
70	0.511
80	0.585
90	0.657
100	0.730

It is often desirable to know what size of boiler an existing flue will serve. The following table gives an approximate estimate of the amount of coal that can be consumed with a chimney of a given height. The values  $K$  are based on an effective flue area of one square foot and in terms of pounds of anthracite coal burned per hour, the coal being of nut or stove size. If smaller sizes, such as pea or buckwheat are to be burned, the values should be *decreased* 10 to 15 per cent.

Height of Flue in Feet	POUNDS OF COAL PER SQ. FT. OF FLUE AREA PER HOUR	
	Sectional Boiler	Round Boiler
20	40	30
25	45	34
30	51	38
35	56	42
40	62	46
45	66	50
50	70	53
55	74	56
60	77	58
65	81	61
70	84	63
75	87	66
80	90	68
85	93	70
90	96	72
95	99	74
100	102	76
105	104	78
110	107	80

The average heating boiler will evaporate between eight and nine pounds of water per pound of coal consumed, and this weight of water is termed the evaporative factor,  $E$ . It is seldom that the heating boiler is called upon to operate with an overload of more than one-third of its rated capacity. Therefore, three-quarters of the pounds of water capable of being evaporated will represent the steaming capacity of the largest boiler that should be installed at the chimney in question. As each one-quarter pound of water evaporated represents one square foot of steam radiation, four times the amount of water evaporated is the amount

# THE AMERICAN ARCHITECT

of radiation that can be served by the boiler. This determines the steam rating of the boiler that can be used. The steam rating should be increased 60 per cent to obtain the rating for a hot water heating boiler.

As a formula

$$\text{Steam rating} = \frac{3}{4} K A E 4 = 3 K A E$$

$$\text{Water rating} = 1.6 \text{ steam rating}$$

in which

$E$  = the evaporative factor of the boiler

$K$  = the pounds of coal per hour per square foot of flue area

$A$  = area of flue in square feet.

For example, assume a chimney 50 ft. high, 12 in. square and an evaporative factor of 8.5. What size of boiler will the chimney accommodate?

$$\begin{aligned} \text{Steam rating} &= 3 K A E \\ &= 3 \times 70 \times 1 \times 8.5 \\ &= 1785 \text{ sq. ft.} \end{aligned}$$

hence, a boiler with a rated capacity of 1785 sq. ft. of steam radiation can be attached to the chimney.

When making the preliminary plans for a building and before the required boiler capacity is known, the architect can approximately establish the flue size by the following table. The result will serve as a guide only and the exact size can be decided upon when the heating system is designed.

VOLUME OF BUILDING IN CUBIC FEET			DIA. OF ROUND OR SIDE OF SQUARE FLUE IN INCHES				
TYPE OF BUILDING			HEIGHT OF FLUE IN FEET				
A	B	C	30	40	50	60	70
20,000	16,000	12,500	7	7	6	6	6
40,000	32,000	25,000	9	9	8	8	8
60,000	48,000	37,500	11	10	10	9	9
80,000	64,000	50,000	12	11	11	11	10
120,000	96,000	75,000	14	13	13	12	12
160,000	128,000	100,000	16	15	15	14	13
240,000	192,000	150,000	19	18	17	17	16
320,000	256,000	200,000	22	21	20	19	18
400,000	320,000	250,000	25	23	22	21	19
480,000	384,000	300,000	27	25	24	23	22
560,000	448,000	350,000	29	27	26	24	23
640,000	512,000	400,000	31	29	27	26	25
720,000	576,000	450,000	32	30	28	27	26
800,000	640,000	500,000	34	32	30	29	28

In this table the type of building is described as follows:

A has 50 per cent of its surrounding wall exposed.

B has 75 per cent of its surrounding wall exposed.

C has all of its surrounding wall exposed.

C also applies to the average garage.

The sizes given in the table are based on furnace size anthracite coal; for pea or buckwheat size or bituminous coal increase 25 to 50 per cent.

For ready reference the commercial sizes of fire clay flue linings are given.

Nominal Size, Inches	Actual Outside, Inches	Actual Inside, Inches	Area, Sq. Ft.
4½x 8½	4¾x 8⅝	3¼x 7	.15
4½x13	4¾x13¼	3⅝x11¾	.25
4½x18	4½x17	3⅞x15½	.42
6 x12	6 x12	4½x10½	.33
7 x 7	7¼x 7¼	5¾x 5¾	.23
8½x 8½	8½x 8½	7¼x 7¼	.36
8½x13	8½x13	6⅞x11⅝	.56
8½x18	8½x18	6½x16	.72
13 x13	13 x13	11¼x11¼	.88
13 x18	13 x18	10¾x15¾	1.18
18 x18	18 x18	15½x15½	1.66

Round flue linings have their inside diameter the same as their nominal size, while in rectangular flues the nominal size is applied to the outside dimensions.

The top of a chimney should be so constructed and placed that no matter in which direction the wind may blow the air will pass the flue top in either a horizontal or upward direction. Should the air current be otherwise its action will be to build up an air pressure in the mouth of the flue sufficient, at times, to overcome or balance the upward pressure of the rising hot gases. If this happens the flue either ceases to function properly or in extreme cases its action may reverse, causing the coal gas to be forced into the house. To prevent or overcome these troubles it is necessary that the flue be carried above the highest point of the roof, especially in the case of a peaked roof. A little thought at this time in the designing will prevent the necessity of having an unsightly sheet metal extension on the chimney top. There are times when this is beyond the control of the builder, as when a perfectly good draft is ruined by the erection of a higher building nearby. In such a case the use of a rotating or swinging cowl is often resorted to, as such an apparatus is supposed to automatically turn so that there is no opportunity for downdrafts. However, they have the disadvantage, if not cared for, of rusting and thereby failing to rotate as they are supposed to. In many cases a conical piece of sheet metal, with the point up, placed over the flue opening is all that is necessary and should be used wherever possible. When using any of these top pieces care should be taken not to decrease the effective area of the flue.



5342  
pl. 123 - 132 after p 548

# The AMERICAN ARCHITECT



DETAIL OF DOORWAY OF A CHURCH AT FANO, ITALY

PUBLISHED WEDNESDAYS IN NEW YORK—FOUNDED 1876  
VOLUME CXV                      APRIL 16, 1919                      NUMBER 2260

Entered as second class matter January 6, 1909, at the Post Office at New York, N. Y., under the Act of March 3, 1879. Publication office, 243 West Thirty-ninth Street, New York, N. Y. Subscription price in the United States and Possessions, \$10.



Bell Telephone Building  
Kansas City, Mo.  
*Holt & Timlin, Associate Architects.*

# Armco Iron

for

## Permanence

Years of service cause but slight deterioration in Armco Iron and for this reason the architects of great buildings, intended for permanent service, specify Rust-Resisting Armco Iron for all Sheet Metal Portions, Metal Lath, Metal Roofing and Metal Window Frames; Pipes, Gutters, Cornices and Fire-proof Doors (all of which go a long way toward making a building fireproof).

When these are of the standard pure rust-resisting iron, they form worthy portions of buildings that are erected for the future.

In the beautiful new Bell Telephone Building of Kansas City, Mo., more than 100,000 pounds of Galvanized Armco Iron was used for window frames and other sheet metal work.

To keep down repair bills and maintenance costs; to insure long life and minimum replacements; to make the building increase the dividends by saving in operating expenses, use Armco Iron.

*Write us regarding your building problems.*

**The American Rolling Mill Company**  
MIDDLETOWN, OHIO



Licensed Manufacturers Under Patents Granted to the International Metal Products Company

*Armco Iron Sheets, Roofing, Pipe, Gutter and Metal Lath*

Branch Offices at

NEW YORK CHICAGO PITTSBURGH CINCINNATI ATLANTA  
WASHINGTON CLEVELAND DETROIT ST. LOUIS and SAN FRANCISCO





## The Practice of Architecture

**M**ANY things give indications of changes in the making. Through conversation, correspondence or reading these signs are constantly recurring testimonies, and a tabulation is unconsciously made of them until the ideas become insistent in their presence. To verify the general impression, a systematic collation of all the evidence is in order.

In arriving at a conclusion by this mental process, it will be found that among the diverse problems demanding attention at this time, one of manifest importance is that of the attitude of the public toward the architect and of the architect in his relations to himself and others.

The practice of architecture is probably today, more than ever before, a matter of barter and trade. The monies invested in building structures demand a return service which represents full value. This value is measured in the adaptability of the structure to its use, its durability and its appearance. These three factors are the fundamentals of correct planning and to render adequate service it appears to be essential that the architect should fully qualify himself to meet these basic requirements.

An analysis has been made of a great amount of data pertaining to this subject and the majority opinion has been condensed into the following five paragraphs which embrace the most common of the points developed. This brief consensus of opinion is not intended to cover the multitude of conditions that exist in such relations, but it is thought that possibly it comprises the basic factors.

1. The business of architecture is inseparable from the profession of architecture. Together they comprehend the originating, promoting, designing, planning, directing and controlling the construction of buildings and their appurtenances.

2. To develop a general demand for architectural service—without which only limited opportunities for practice will be presented—the architect must, as an individual and collectively, employ proper and effective means to create a universal appreciation of its intrinsic value.

3. To fully perform his function, the architect must organize, equip and operate his business so as to render complete service in the production of plans and specifications for everything embraced in the construction, equipment and furnishing of buildings.

4. He must furnish complete and detailed supervision of construction and be closely identified with it. He must be responsible financially, as well as morally, for all of his acts, including the correctness of design, the completeness and accuracy of plans, specifications and details, and the construction of the building in accordance therewith; his responsibility to be contingent only on his being accorded freedom in deciding all matters of structural design, mechanical equipment and the selection of materials and workmen.

5. He must control and regulate the business affairs of the building operation so as to safeguard all interests. He must be just and impartial in deciding all controversies within his jurisdiction, but where his own interests are involved he must submit the controversy to arbitration.



BALCONY—PALAZZO FRANCHINI, VERONA, ITALY



# THE AMERICAN ARCHITECT

VOL. CXV

WEDNESDAY, APRIL 16, 1919

NUMBER 2260

## Development of Ornamental Plasterwork

By MAXIMILIAN F. FRIEDERANG

WHEN Belshazzar, over 2500 years ago, saw the handwriting which foretold the doom of Babylon, it was upon the plaster of the wall. That the use of plaster has an even older history is revealed by its existence in the masonry of the pyramids, where it was constantly incorporated both to fill joints as a bedding and to level up hollows. The flaws and defects in the faces of stones were freely filled with plaster, which was then colored to match its setting. In some of the rock tombs in Egypt, plaster was also utilized in filling cracks, and examples of these exist today where the surrounding rock has decayed while the plaster has remained in perfect condition.

Evidence on the earliest dwellings of primitive man indicates that plastering is one of the oldest of handicrafts exercised in building construction. At that remote period he builded with sticks in simple fashion and plastered them with mud. In the course of time a more durable material superseded the mud, and excellence in producing plastering materials was approached early in the history of construction. This statement is supported by the fact that some of the earliest plastering which has remained undisturbed through the centuries equals in its chemical composition that which is made at the present time.

Just now, mortars and plasters are among the most familiar materials employed by the builder. These consist of three general classes which, however, merge into each other when mixed in different proportions: lime plasters, used for exterior and interior plastering; gypsum or plaster of Paris, so called from its extensive manufacture in Paris, used where perfection of detail is demanded, or where the walls are to be covered with tapestries or wall paper, or decorated with colors, for interior



ORNAMENTAL PLASTERWORK IN DRAWING-ROOM AT EASTON, NESTON, NORTHAMPSHIRE, ENGLAND

work; and cement plasters or stucco, for exteriors where strength and durability are required. Lime plaster is produced by heating very pure limestone to such a temperature as will drive off the carbonic acid gas and leave a residue called calcium oxide or "quick lime," lumps of which, after being removed from the kiln, are called lime shells. When water is added to lime shells they swell, crackle, and fall into a powdery mass. This process is called "slaking," and the resulting substance is "slaked

## THE AMERICAN ARCHITECT

lime." When more water is added, the slaked lime becomes a paste, and this paste is mixed with sand to form a mortar.

Mortar for plaster work is usually composed of slaked lime mixed with sand and hair. The sand should be hard, sharp, gritty and free from all organic matter. Hair is used as a binder to increase cohesion and tenacity. For this purpose it should be long, strong, and free from grease or

particulars the tools of plasterers in the early history of the craft were identical in design and aim with those now employed. The method of the Egyptians of plastering on reeds closely resembles our use of lath. The tools of today were used in Egypt 3000 years ago and in Pompeii in the day of Julius Cæsar. The technique of Greece and Brittany, of Rome and Gaul was the same. The material of the classic workers at Athens 800 years before Christ



PLASTER CEILING IN DIRECTORS' ROOM IN BUILDING OF TRAVELERS INSURANCE CO., HARTFORD, CONN.

DONN BARBER, ARCHITECT

other impurities. Ox hair is generally used, although sometimes adulterated with the short hair of horses. Substitutes for hair include manila fiber and sawdust.

Plaster of Paris is obtained from gypsum by gentle calcination. It is very soluble in water, and this fact renders it unfit for external use. It is, however, valuable for decorative details, for cornice, molds, and other enrichments, and is also used in several plastic mixtures. Plaster of Paris sets rapidly, acquiring full strength in a few hours.

Research has disclosed the fact that in essential

differs in no particular from that in use at the present.

Archeologists reveal that stucco of various kinds, natural and in color, was known in very ancient days for covering of walls. As long as five centuries before Christ its use had advanced to a high artistic standard when it covered temples both outside and in, even in cases where the building was of marble. There it formed a fine foundation for decorative painting which at this period of Greek history had reached a high degree of beauty. The extent of its use was very wide. In early times it was not un-



## THE AMERICAN ARCHITECT

usual to use inferior materials, mud bricks, or rough stone, and cover their surface with a coat of stucco which might be ornamented with frescoes or decorations of other kinds. The quality of early Greek stucco is wonderfully fine.

The rough stone used by the Greeks was like the Roman Travertin, very porous and not capable of taking a fine surface, so they stuccoed it over, polished it and sometimes decorated it with frescoes. Traces of this are still to be found. The Byzantine

plaster on which the painter drew what he liked. It is curious that sculptors should have continued to produce fine detail of work where it would immediately be disregarded. It would seem to indicate very little in the way of interdependence of the arts at that period of Egyptian history.

Among these people, stucco was also used for independent modelling, as in Italy. It was laid on a flat canvas base, stretched over wood, and the whole relief was in the stucco. The chariot of



PLASTER CEILING, CONNECTICUT STATE LIBRARY, HARTFORD

DONN BARBER, ARCHITECT

Greeks used stucco very generally in the cornices and enrichment of their churches, and their mosaics were embedded in a plaster-putty composition of similar nature.

In Egypt a strange use of stucco was as a thin coat over sculpture as a basis for whitewashing. At all occasions of its use in this way it concealed in some measure the full detail of the sculptor's work in reliefs. In the 12th dynasty the finest lines were hidden by it, and on coming down to less remote times the plasterer ignored all the sculpture below, filling the figures with a smooth layer of

Tahutmas III is an important example of such work. The relief is low and smooth and full of detail. There is none of the sketchy, rough tooling seen in Roman stucco reliefs. Minute details of dress and hair are all tooled in and supply some of the best studies of Syrian robes. The varying patterns in shields of the different branches of Syrians, the feathering of arrows, the shape of the flowers of the papyrus and lotus of north and south are all accurately rendered. Plaster was also used for casting in molds.

The Romans knew plaster and stucco intimately

## THE AMERICAN ARCHITECT

and used it lavishly for interior work. They molded delicate patterns in relief in the wet plaster or painted them with pictures or ornaments in fresco, tempera or encaustic pigments. It is unnecessary to quote the numerous examples of the use of stucco in Italy in ancient times. Its use has passed down to the Celts, the Gauls, the Teutons and the Slavs, and there is hardly a Celtic or Gallic-Roman build-

time have never been surpassed. It was an art demanding the quintessence of skill on the part of the worker. The work had to be done rapidly while the plaster was wet, so that upon hardening, the decoration became an integral part of the actual material. The colors were mixed to allow for a subtle change in their drying on the wet plaster, and once a mark was made it could not be done over.

Among the relief work done on plaster, sgraffito was conspicuous. This was also executed while the plaster was in process of hardening. It consisted, essentially, of laying a dark coat of plaster and upon it applying a coat of stucco. On this the worker executed his design, cutting and scraping it to reveal the dark subsurface. This also required expeditious handling before the stucco might have time to dry and harden.

In the 17th century the English began to use plaster extensively, too often as a substitute for solid masonry construction. The practice led to much trivial architecture and sham construction, and, it is regretted, became very general in the United



PLASTERWORK IN ST. JAMES CHURCH, NEW YORK CITY

LUDLOW & PEABODY, ARCHITECTS

ing in which the remains of stucco-coating polished and with decorative designs are not found either with or without color.

During the Middle Ages building methods suffered the same fate as the arts, and the rare fragments of monuments of the early centuries show us nothing but coarse coatings and stucco members made of very inferior materials, badly dressed and covered with rude paintings. They no longer presented the beautiful polish or the solidity that mark the stucco of Greek antiquity and the best periods of the Roman epoch.

The Renaissance revived the use of plaster and greatly extended its decorative application both by fresco painting and by relief ornaments and sculpture. The frescoes of Italian masters done at that



DINING ROOM CEILING, FORDE ABBEY, DORSETSHIRE, ENGLAND





ORNAMENTAL PLASTERWORK IN CONNECTICUT STATE LIBRARY  
DONN BARBER, ARCHITECT

## THE AMERICAN ARCHITECT

States with the adoption of wood as a building material. But considerable fine and delicate work was done both here and in England in the 18th century. In the days of Henry VIII the walls of large houses and mansions were plastered above



CEILING IN HALL, BARNSLEY PARK, GLOUCESTERSHIRE, ENGLAND

the wainscoting and colored, and some of the ornamental ceilings of that period are still admired by disciples of the art. Still earlier examples of the plasterer's skill are extant in the pargeted and ornamented fronts of half-timbered houses.

Plaster, we see, was once worthy of the best efforts of many of the world's most successful artists. The present day Renaissance of the great art of building, the use of more perfect material, and the new awakening of the crafts related to building, should stimulate further effort in art and decoration. Plaster may again become the medium of a decorative expression in the hands of men of art sentiment and education, men of refinement and ability to use it from its simplest to its most elaborate form. Plaster has been for the last century degraded as a medium of art, but the broader education of the architect today along these lines has given this decorative material value as a medium of natural expression and feeling, vitalized by the energy behind the tool.

The opening of the Centennial Exhibition held at

Philadelphia in 1876, the Chicago, Buffalo, St. Louis and Panama Expositions may be said to have marked an artistic quickening and awakening to a higher and broader plane of art than this country had ever before experienced. The progress in architecture, sculpture and other decoration since they took place has been rapid. The great courageous works of decorative ornamental sculpture and mural painting were great public educators and will be important guiding influences for our art of the future.

The impulse to plastic decorative art was slight, but none the less assertive, and was probably first felt in this country at the outbreak of the great war. It has reached an effective culmination in many serious monumental buildings and it has asserted itself in our artistic development in the most consistent manner.

The selection of illustrations is to show that the



THE DRAWING ROOM CEILING IN DORFORD HALL, CHESHIRE, ENGLAND

decoration should always be subservient to the purpose of the thing decorated. It should never be carried to such an excess as to hide or injure that purpose. In beautifying our dwellings and public buildings, let us, above all, be sincere. "That which





*Above:* PLASTERWORK IN THE "QUEEN ELIZABETH ROOM." PLAS MAWR, CARNARVONSHIRE, WALES.



*At right:* RAINHAM HALL, NORFOLK, ENGLAND

## THE AMERICAN ARCHITECT



LIBRARY CEILING, RUSHTON HALL, NORTH-AMPTONSHIRE, ENGLAND

is beautiful is true; that which is true must be beautiful."

Decoration must be simple. There must be no overelaboration, no obvious straining after effect. It is always preferable to err on the side of simplicity, for a plainly decorated room, for instance, if in good taste, will always please, while excessive decoration defeats its own object and produces a sense of weariness. An occasional plain surface is a relief to the eye and gives repose. Good decoration is as much characterized by what it leaves undone as by what it does.

Finally, decoration must be suitable. It must be adapted to the position of the object decorated, the use to which it is applied, and the material of which it is composed.

The use of stucco or Portland cement as a building material has had such prodigious extension in recent years as to make comment superfluous. A stone which may be produced artificially from natural sources practically inexhaustible, which becomes harder as the years go by, which does not deteriorate, is waterproof and fire-resisting, moderate in cost and easily worked has already everything to commend it. But its decorative value as set forth in these pages is but one further instance of the marvellous ways of nature and the ingenuity of man. For what was at first the mere groping of an untaught instinct, destitute of message or appeal, has gradually assumed character, a fundamental sincerity and remarkable gifts of utterance.



HENGRAVE HALL, ENGLAND



# The Architect and the Builder

By THOMAS T. HOPPER

THE crucible of war has produced a new relationship between the architect and the builder, due largely to the experience many architects have gained in Government service. This experience has created in their minds an appreciation of the necessity for an efficient system and organization in building construction. The result has been that the misunderstandings formerly existing are now past, and a closer and more intimate relationship exists today than ever before. Today the architect realizes that to execute modern high-class work properly, to get the exact effect that he desires, he must have the co-operation of the right builder, whose good will is essential in executing fittingly and interpreting broadly the architect's plans and specifications.

The builder realizes that he himself is only the hand which the architect shall guide. The architect realizes that the days of the hand-to-mouth contractor are over, and he wants to see his work carried out by firms who have at their head men of individuality, who give their attention and that of a well organized force in order to put into actuality the lines shown on their plans.

What, then, is a modern builder? Builders may be classified in many degrees, but three grades cover them all. Those who are not competent; those who subcontract everything; and those who, through their own organization are efficient and thorough. A good builder is one who has had both education and experience, who has an appreciation of texture, can point to well executed work, knows how to interpret plans and specifications, and is efficient in his calling. To be efficient, he must be responsible with a capable organization and established credit and capital. There are misfit builders as well as misfits in other professions, and there is a wide difference between the builder and the contractor. The builder constructs and creates. The contractor simply follows old and often obsolete forms of hiring himself out to follow as nearly as may be, certain instructions shown on a set of blue prints. A contractor is just what the word implies, but a builder, to be efficient and thorough, must be a master craftsman whose every thought and determination is to excel in his chosen vocation. In the builder's case, he is one who has a proper appreciation of the architect's point of view and who can give expression to ideas and feeling in the handling of materials.

To the architect of ability, the master craftsman

is his *alter ego*. The man who can take the cheapest of common brick and lay them in such a way as to give an interesting effect; the man who knows how to finish stucco and plastering so as to get the old-world effects in texture and color; the man who knows how to blend the colors in a slate roof, who knows how much irregularity to use in the laying of their courses to get the old time hand-hewn effect; the man who knows how to adze timber for exterior work—he is the master craftsman.

Just what service is required from such a craftsman? It is his duty to create from the architect's plans certain structures, to create them economically, thoroughly and quickly, to produce the result desired through system and efficiency in a manner satisfactory to the architect and according to his plans. In short, by his creation to produce a result which can be a measure of joy to all concerned. To do this, an organization is necessary.

Of what, then, should a builder's organization consist? Simply a group of a few men experienced in their different lines, who devote their time and experience to carrying out the ideas set forth above. It should be the duties of this organization to assist within reasonable limits in solving the problems constantly arising during building construction. To make, if called upon to do so, the necessary estimates; to find in the different localities the most suitable materials that can be used without long haulage; to see in all cases regardless of conditions or circumstances that the work is done substantially.

The builder should know the varying costs in the several localities where he operates. He should be sufficiently informed to know, for instance, that the costs at this writing are only 30 per cent more than in 1914, an abnormally low year. He should know that in 1918, an abnormally high year, the costs were 50 per cent over 1914, and that so far this year, there has been a decrease of 20 per cent with a further possible decrease of 10 per cent in prospect, with the result that today, April, 1919, building costs are not abnormally high, and with every indication that by summer they will be normal (say 20 per cent over 1914), at which they should remain for some time, depending of course on general conditions, but they will probably not get any lower in the future than the average of 1919.

For anything so intricate as a building project, system must be used to take care of expenditures, to time the completion, of

## THE AMERICAN ARCHITECT

the various parts, and to make what might be termed a time-table for the arrival and installation of a great number of different items that go to make up the whole structure. This is most important. The following system has been found to be of great assistance and when a contract is undertaken it may with advantage be at once blocked out somewhat as follows:

*Progress Schedule.* Made out when contract is signed showing twice monthly the expected condition of the work, delivery of materials and subcontractors work at building; also in adjoining column when drawings are required.

*Time Chart of all Branches of the Work.* Showing on left hand side when details are required; in adjoining column when subcontracts or orders must be given; in center is printed column of branches of work, in right hand columns, when each part of the work begins at the building and when it is to be finished. This is a great help to the architect as he has in his draughting room this constant reminder of what is required and when. His men work on what is wanted first and do not waste time on details that are not required for weeks or months.

*Statement of Progress Monthly from Superintendent on Building.* Showing actual conditions with materials needed and subcontractors required during the following weeks or months, with statement of details and information desired on the work from the architect.

*Bulletin Issued Monthly.* Giving conditions at building, stating delays, if any, of subcontracts behind, material deliveries behind or delays in obtaining same, etc., with a notice of what is expected of those interested in the following month. Details required, decisions needed, estimates for changes required, and other items of interest.

*Daily Job Time Report.* Subdividing payroll under items worked each day by foreman on the job.

*Financial Statement.* Showing monthly all expenditures which are charged to subdivided items, giving at a glance the cost of each item to date, and per cent done, in comparison with amount estimated. This is for cost plus jobs only. It is a copy of the builder's ledger and makes his organization part of the owner's force. This prevents inflation of cost. Step by step the financial condition is apparent at a glance.

*Order Blank.* Covering Changes. Kept on job and made out for every change, alteration and extra item. Sent to architect with duplicate on file in builder's office. Keeps actual cost up to date. Makes additional orders appear promptly and estimates for same given at once.

*Follow-Up System.* All material orders and sub-

contracts inspected in shop and reported on weekly or monthly as conditions require.

*Subcontractors.* Only the best subcontractors and material men are to be employed. Service and quality only count. Disputes and extras are to be settled in the builder's offices and not in the architect's. No more work should be undertaken than can be properly handled.

It is to be hoped that the better relationship now being established between architects and builders will eliminate every laxity of genuine interest and co-operation. That the architect will feel confidence in the builder, and that the builder upon assuming a contract will feel that the architect will make his detail drawings without elaboration on the scale drawings on which the builder estimated. That the architect will realize he is only helping himself when he helps the builder get results by giving quick decisions, by making his details promptly, by issuing his certificates as soon as possible, and in case of disputes which are likely to arise, he will not hesitate to protect the builder's interest as well as the owner's, in the most equitable way. When a builder feels that these conditions exist, it uplifts the morale on the job. He will go to any length to help and satisfy the architect who gives him the right assistance and co-operation.

The better relationship as indicated above is going to mark efficiency throughout the building trade. The day of wild competition is past. The time of taking twenty or twenty-five estimates for an operation and awarding it to one who makes the biggest mistake (the lowest bidder) is past. The architect realizes that a competent builder under present conditions cannot make an estimate of cost as accurately as he could several years ago. The unsettled conditions throughout the country prevent this. The result is that the architect can with confidence recommend a competent builder with a good organization, on the ground that he is honest, has had the right experience and will do the work with the right spirit at cost plus a fixed sum and further, will do it in such a way, through his system which he places in your hands and which becomes part of the owner's own organization, that he could not even if he wanted, charge you more than the work cost. And solely by this method, the only method fair to both parties, can modern work be done satisfactorily. The wide-awake architect realizes now as never before the necessity of having the right builder. He knows that the owner gets only what he pays for, and for the sake of his reputation, he should and does select the best master craftsman he can get.

Why treat this business differently from any other profession? Why put a premium on dishonesty by encouraging needless competition? Why not select



the best man? Let him give a guarantee of price to safeguard the owner and pay him an agreed sum for his services.

The architect is judged by the results he produces. The house may be artistic and well planned, but when the cellar is wet and the casement windows leak, because the details were not followed, the owner's wife will quietly tell all her friends that "our architect was artistic, but—" For his own pro-

tection the architect must select the best builder he can get to carry out his conception, for his reputation as a good architect rests on the builder more than some architects will admit.

The owner is a business man. He selects his architect because of his confidence in him, and in nine cases out of ten he will acquiesce in the architect's expert selection of the builder on precisely the same ground.

## Recent Legal Decisions

### PARTY TO CONTRACT MAY BE APPOINTED ARBITER

In an action on a building contract, one of the parties to which was a drainage district, the trial court refused to give effect to the following contract provision: "In the interpretation of these specifications and the contract and upon all questions concerning the execution of the work the decision of the commissioners shall be final." On appeal this was reversed for the following reasons:

This provision differs from the ordinary provision of like tenor found in nearly every building or construction contract only in the personnel of the arbitrators or umpires appointed to decide upon the contract, specifications, and work. If the word "architects" be substituted for the word "commissioners," it would be a provision usual and customary in construction contracts. It is well settled that where matters are thus left to the decision of an architect, his decision is final, unless impeached for fraud, accident, or mistake. It is therefore error to hold that such powers cannot be conferred upon one of the parties to the contract. Given the premise, the court says, that one may lawfully contract to perform certain work according to plans and specifications to the satisfaction of a third party, and that contracts to be executed to the satisfaction of one of the contracting parties will be enforced, it is difficult to appreciate the logic which condemns a contract to be performed according to plans and specifications to the satisfaction of the other contracting party. Certainly no consideration of public policy calls for the condemnation of one that does not always condemn the other. The powers and duties of the one appointed as arbiter are not materially different in the one case than in the other. In neither case can the arbiter act arbitrarily or capriciously. There must be the exercise of honest judgment, and the person performing the contract is not to be denied the fruits thereof by a fraudulent, arbitrary, or capricious action on the part of

the other.—*Keachie v. Starkweather Drainage Dist.*, Wisconsin Supreme Court, 170 N. W. 236.

### PERIOD FOR FILING LIEN STATEMENT

Under a statute providing that a lien statement shall be filed within four months after the date upon which the material was last furnished or the labor was performed under the contract, testimony to the effect that the building was completed on March 14, 1914, the record showing that the contractor filed his lien statement on 8th July, 1914, was held to show that the statement was filed well within the statutory period.—*Roper v. King (Okla.)*, 176 Pac. 926.

### MECHANICS' LIENS—RECORDING OF LOAN CONTRACTS

New York Mechanics' Lien Law, Sec. 22, relating to the filing of building loan contracts, is penal in character, and intended to furnish additional security to materialmen. Its effect is that if the owner is not in fact furnishing the money, if the constantly increasing equity in the property, as the improvement progresses, is not in fact to inure to the owner's benefit, but is to be subsequently absorbed by mortgages, in favor of one who actually furnishes the money, then the result so contemplated can only be effected in law by complying with the provisions of the section, *i. e.*, the contract creating the situation described must be in writing, acknowledged and filed as therein described. It is therefore held that under this section a contract for the lending of funds to enable a constructing company to build several buildings should be construed as a building loan; and so, where the contract was not recorded, the liens of laborers and materialmen were superior to that of the lender under the building loan contract.—*Y. T. McDermott v. Arden Const. Co.*, 173 N. Y. Supp. 597.





HOUSE OF CHARLES E. McINNES. RYDAL, PA.  
DUHRING, OKIE & ZIEGLER, ARCHITECTS



# THE AMERICAN ARCHITECT

Founded 1876

PUBLISHED EVERY WEDNESDAY BY

THE ARCHITECTURAL AND BUILDING  
PRESS, INC.

No. 243 West Thirty-ninth Street, New York

E. J. ROSENCRANS, PRESIDENT AND TREASURER

WILLARD C. HOWE, VICE-PRESIDENT

WILLIAM H. CROCKER, Editor

ARTHUR T. NORTH, Engineering Editor

Subscriptions in the United States and Possessions,  
Mexico and Cuba, TEN DOLLARS. Other Countries,  
TWELVE DOLLARS.

SINGLE COPIES (Regular Issue) 25 CENTS

CHICAGO OFFICE, Malters Building  
PAGE A. ROBINSON, Western Manager  
ST. LOUIS OFFICE, Wright Building  
CLEVELAND OFFICE, Guardian Building  
SAN FRANCISCO OFFICE, 320 Market Street

Owned by United Publishers Corporation—H. M. Swetland, President;  
Charles G. Phillips, Vice-President; W. H. Taylor, Treasurer.  
A. C. Pearson, Secretary. Entered as second-class matter January  
6, 1909, at the Post Office at New York, New York, under the Act of  
March 3, 1879.

VOL. CXV      APRIL 16, 1919      No. 2260

## Building Work Reviving

A FEELING of optimism, especially noticeable during the last two weeks, backed by convincing statistics, justifies the conclusion that general business conditions are improving. That building and construction works are reviving is certain. While they lag somewhat below pre-war levels, they are showing a gratifying increase from week to week.

It is well understood that on the signing of the armistice three determined obstacles confronted the building industry, which suffered approximately complete suspension during the war period. These obstacles were (1) finance, (2) prices of building materials, and (3) uncertainty as to the labor market.

The financial obstacle, especially in the East, today is the most embarrassing obstacle to a general revival of building and construction work and probably, it will be the last to arrive at a satisfactory status.

Economists, investigating financial conditions for the United States Employment Service, Department of Labor, recently gave their approval to the statement made by Walter Stabler, comptroller of the Metropolitan Life, in which he said the small investor must now, more than ever before, be an important factor in financing business and building. In a recent issue of the bulletin of the American

Bankers' Association emphasis was placed on the recognition of the fact that investment capital must be gathered from these lesser sources and that the capital so gathered must be made accessible to builders on long time loans with the amortization feature.

Another significant development in this field is the movement for the organization of a Federal Home Loan bank system, patterned after the Federal Farm Loan banks. This project is being urged by the building and loan associations, which are behind a bill to be introduced in the next Congress. By this machinery it will be possible, the building and loan interests assert, to make liquid their assets to the extent of almost two billion dollars, making this sum available for further loans on home buildings.

These and other developments indicate a realization on the part of our sources of building and construction capital that some changes in methods of financing are essential before there will be adequate finance for the unprecedented volume of building necessary to make up the deficiency incident to the war and, at the same time, take care of the current year's normal requirements. The aggregate of homes needed now because of curtailment during the war approximates 2,000,000.

Contractors and builders have been less disposed to complain of high prices of material than of the uncertainty in these prices. The question has been "Are prices going to fall and if so, how much of a reduction may we expect?"

This question has been answered in several quarters quite convincingly and those who speak most authoritatively appear to be agreed that pre-war prices have joined the buffalo and the ox-cart, never to return. It is agreed there may be slight reductions here and there but the main level of prices will not recede for several years, if ever.

Again accepting the Department of Labor's economists as authority we find that at the close of the war the index number of building materials, not including steel, had risen only 61 per cent over the pre-war prices of 1913, while the index number for commodities, exclusive of building materials, had risen 113 per cent. We find also that construction costs, in such buildings as do not require steel, have advanced only about 48 per cent, the figure for steel construction being approximately an 87 per cent increase.

While there are many that believe the present wage level will remain for all time as a minimum, there is unanimity of opinion that if it does yield, labor costs will be the last and will follow material and living cost, in their downward trend very reluctantly.

The wages of labor did not advance in proportion

## THE AMERICAN ARCHITECT

to the cost of living and those who have vision in the industrial world are slow to assert that it is imprudent to maintain the standards of living which have been reached during the past five years. And while the supply of labor and demand as shown by weekly "weather reports" of the United States Employment Service is steadily increasing it has not influenced wages. That an over-surplus of labor will not affect wages is scarcely to be denied, but whether this affluence will be sufficient to make any perceptible effect and the extent of same is, at the present time, a matter of conjecture. The report of the Employment Service shows, however, that labor is plentiful in most sections and this is favorable to the building industry. It assures adequate labor and enables builders and contractors to get efficient labor.

Whatever are the handicaps to building and construction work there is a gratifying acceleration of activities. Building permits in November were six per cent of normal, in December 10 per cent, in January 20 per cent and in February 35 to 40 per cent. Allowing for the difference in money value the contracts awarded in February are 97 per cent of the five year average for the same month. Of these February contracts 91 per cent were for private projects, 9 per cent public, and of the private contracts 55 per cent were residential property, 25 per cent mercantile and 20 per cent industrial. In view of these facts the conclusion that building and construction works are reviving and may presently approximate normal, is inescapable.

### Farm Improvements

THAT farm products have a greater purchasing power now than they have had in any earlier period of our history may in part account for the reason why rural districts of the country are actively undertaking building and construction work. Since building has such an important part to play in stimulating general business at this time, the farmer may serve both his own and the national interest by immediately making needed improvements on his property. Particularly is this true in the case of road construction, which assures him of early and permanent benefits and is the forerunner of further improvements to be expected in a locality easily accessible by good roads.

As in many other instances, farmers have largely been unable recently to get materials and labor for their needs. Barns, silos, houses and the pursuit of other improvements were necessarily neglected during the war. The farmer who at once utilizes

his share of the labor supply and gets his improvement under way, may ultimately, despite present prices, prove himself the prudent business man, for there is reason to believe that farmers who delay in the hope of materially reduced construction costs will have been deprived of the use of these improvements when they might have been of immediate value, and in the end be forced to pay approximately the building prices now prevailing. Campaigns for farm improvements are on in Nebraska, Kansas, Minnesota, South Dakota, Kentucky, Ohio and in localities in Texas and Iowa. In several states, among them Missouri, Oregon and Colorado, silo building campaigns are being carried on by the agricultural colleges. In Wisconsin there is a milk-house campaign being vigorously prosecuted in the dairy districts, while in Illinois farmers are being urged to build feeding floors. Much of this work is being conducted by building interests, but the Division of Public Works and Construction Development of the U. S. Department of Labor is also interested in seeing it successfully carried out because it is realized that such activities on the farms are bound to have a beneficial effect on general business conditions.

\*The Trans-Mississippi Readjustment Congress, held in Omaha, Neb., late in February, in summarizing the situation, said in part:

"We believe also that the promoters of private construction and business enlargement should take heart of courage and should believe in the immediate resumption of business prosperity in the United States. There is no place in the American scheme of things for the pessimist or the doubter. Our country to-day leads the world in prosperity. It can lose its leadership only by its own faint-heartedness. We especially deprecate any concerted holding back of construction and business resumption, for the purpose of forcing a reduction in wages or cost of material.

"Both as a means of stimulating the resumption of industry and removing the shadow of unemployment from the working people and also by serving the broader and more permanent purpose of supplementing the railroad lines and to develop the inland and farm commerce of the country, the work of constructing goods roads should be promptly carried on by co-operation of the Federal and State Governors and local communities."

In the recent Conference of Governors and Mayors in Washington, it was apparent that these executives were disposed to go in for extensive road and public improvement campaigns in their respective districts. These can be made a success only when they are supported by the citizens. For this reason, the farmer, as well as the city dweller, who understands how greatly building and construction work now affects general business conditions, will back up his local officials in every reasonable campaign for road building and public works of a necessary sort.



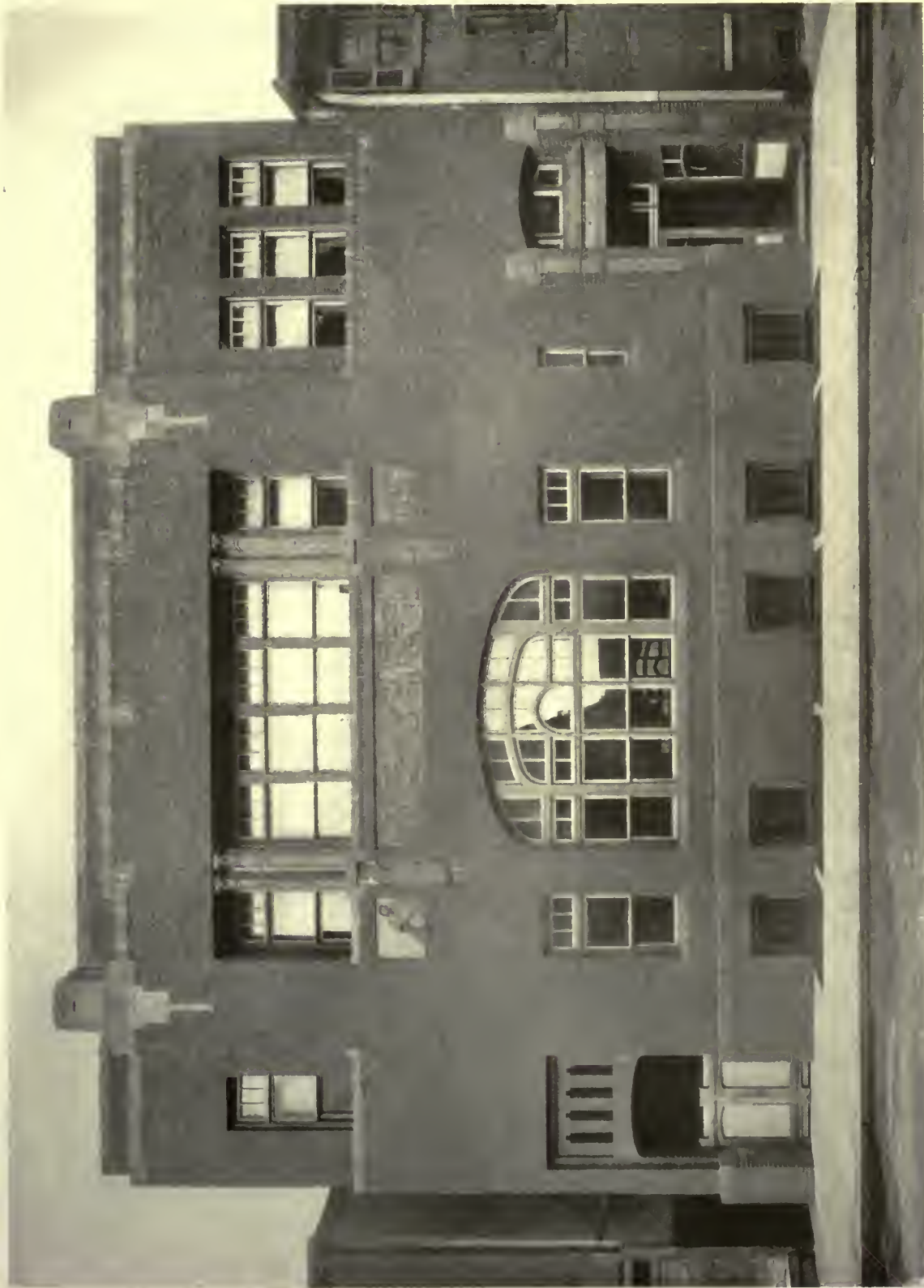

PLATE 123

MAIN ELEVATION

MUSICAL ARTS CLUB, WALNUT STREET, PHILADELPHIA, PA.

PRICE & McLANAMAN, ARCHITECTS







PLATE 124

MAIN ENTRANCE DETAIL

MUSICAL ARTS CLUB, WALNUT STREET, PHILADELPHIA, PA.

PRICE & McLANAHAN, ARCHITECTS







STAIR HALL



ENTRANCE LOBBY



PLATE 125

GAME ROOM FIREPLACE



GRILL ROOM FIREPLACE

MUSICAL ARTS CLUB, WALNUT STREET, PHILADELPHIA, PA.

PRICE & McLANAHAN, ARCHITECTS







LOUNGE



GAME ROOM

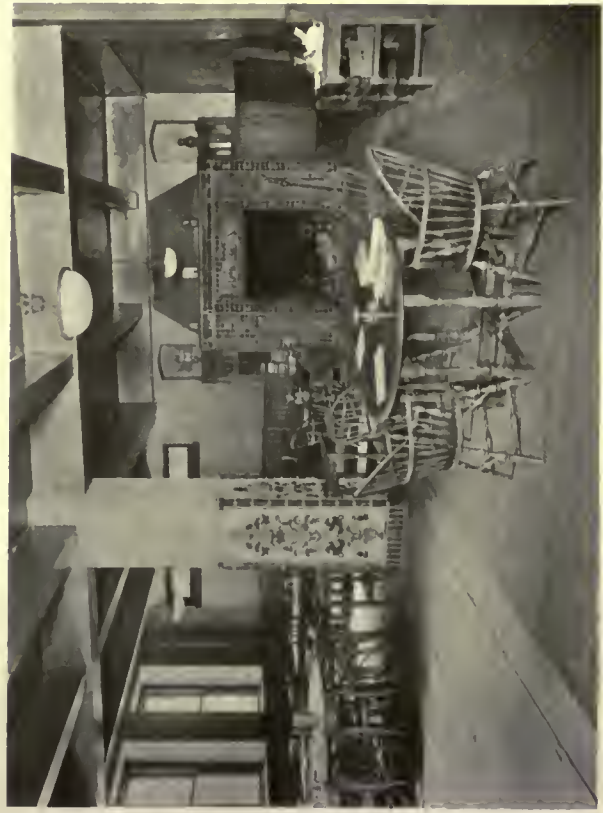

MUSIC ROOM

PLATE 126



LOUNGE

MUSICAL ARTS CLUB, WALNUT STREET, PHILADELPHIA, PA.  
 PRICE & McLANAHAN, ARCHITECTS







LOUNGE FIREPLACE

MUSICAL ARTS CLUB,  
WALNUT STREET,  
PHILADELPHIA, PA.

PRICE & McLANAHAN, ARCHITECTS



PLATE 127

LOUNGE OR MUSIC ROOM







PLATE 128

OFFICE BUILDING ON CADILLAC SQUARE, DETROIT, MICH.

LOUIS KAMPER, ARCHITECT





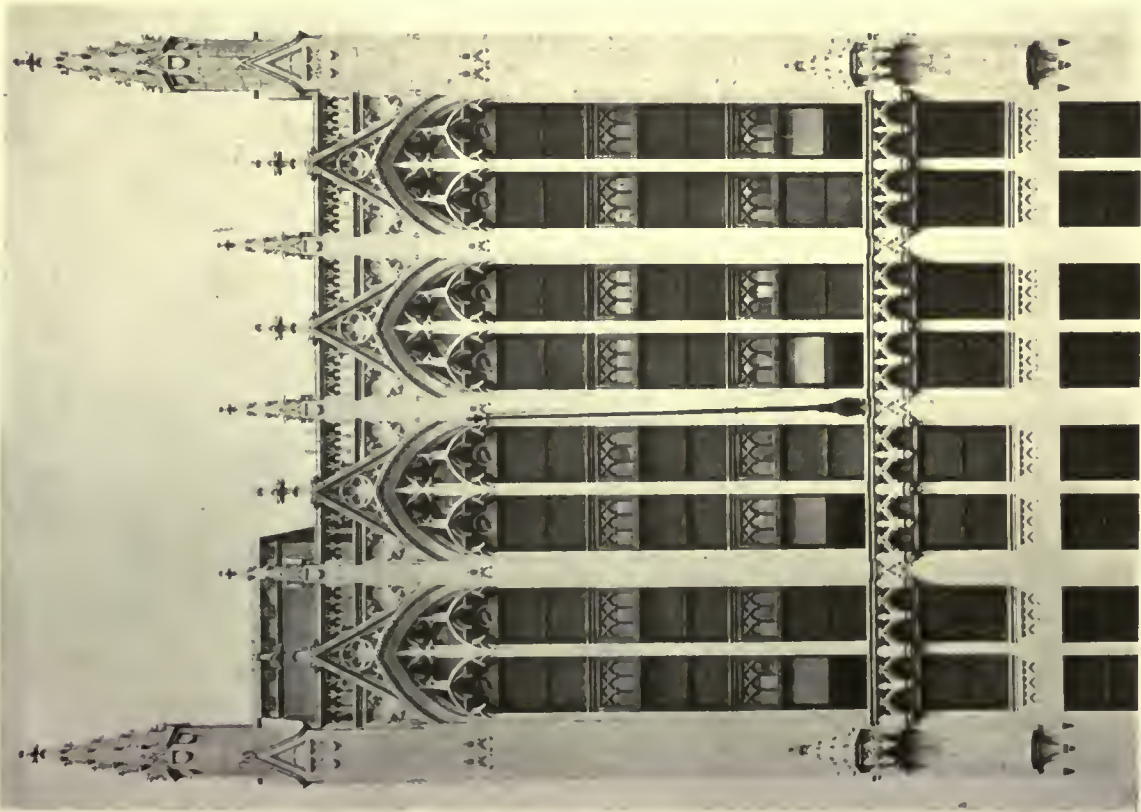

DETAIL OF UPPER STORIES

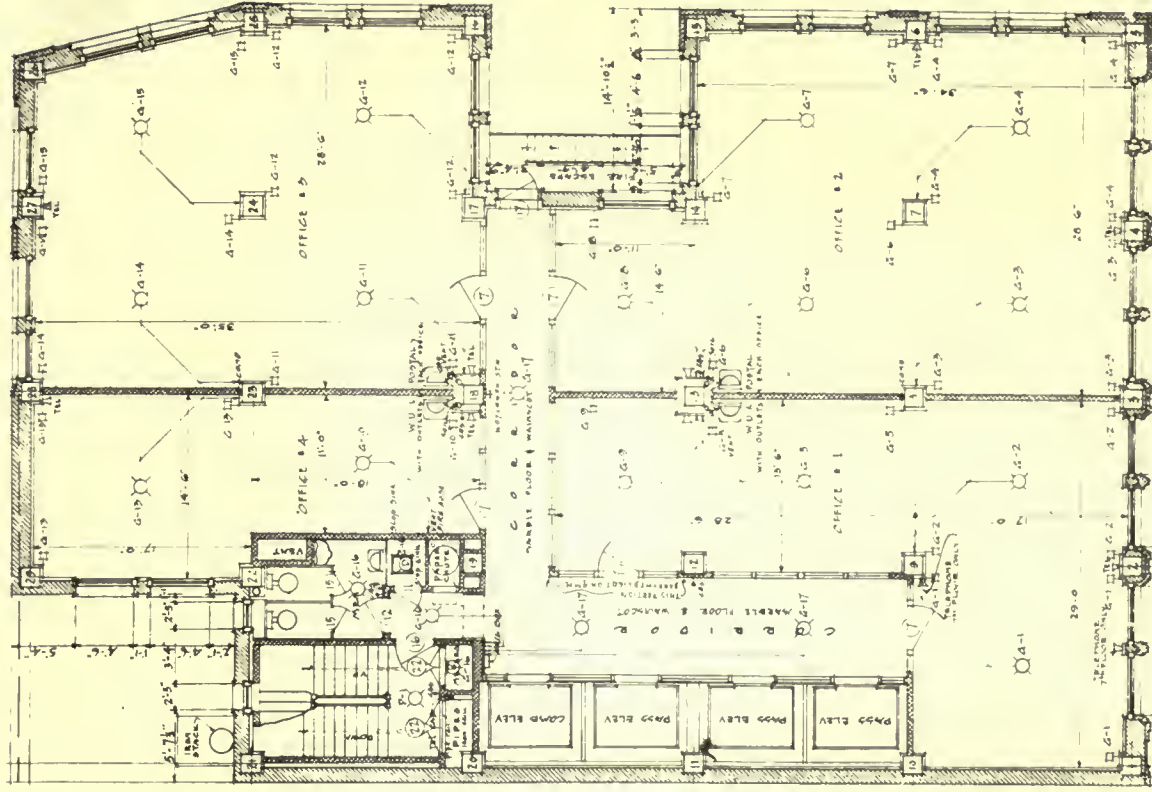

TYPICAL FLOOR WITH PARTITION LAY-OUT

OFFICE BUILDING ON CADILLAC SQUARE, DETROIT, MICH.

LOUIS KAMPER, ARCHITECT





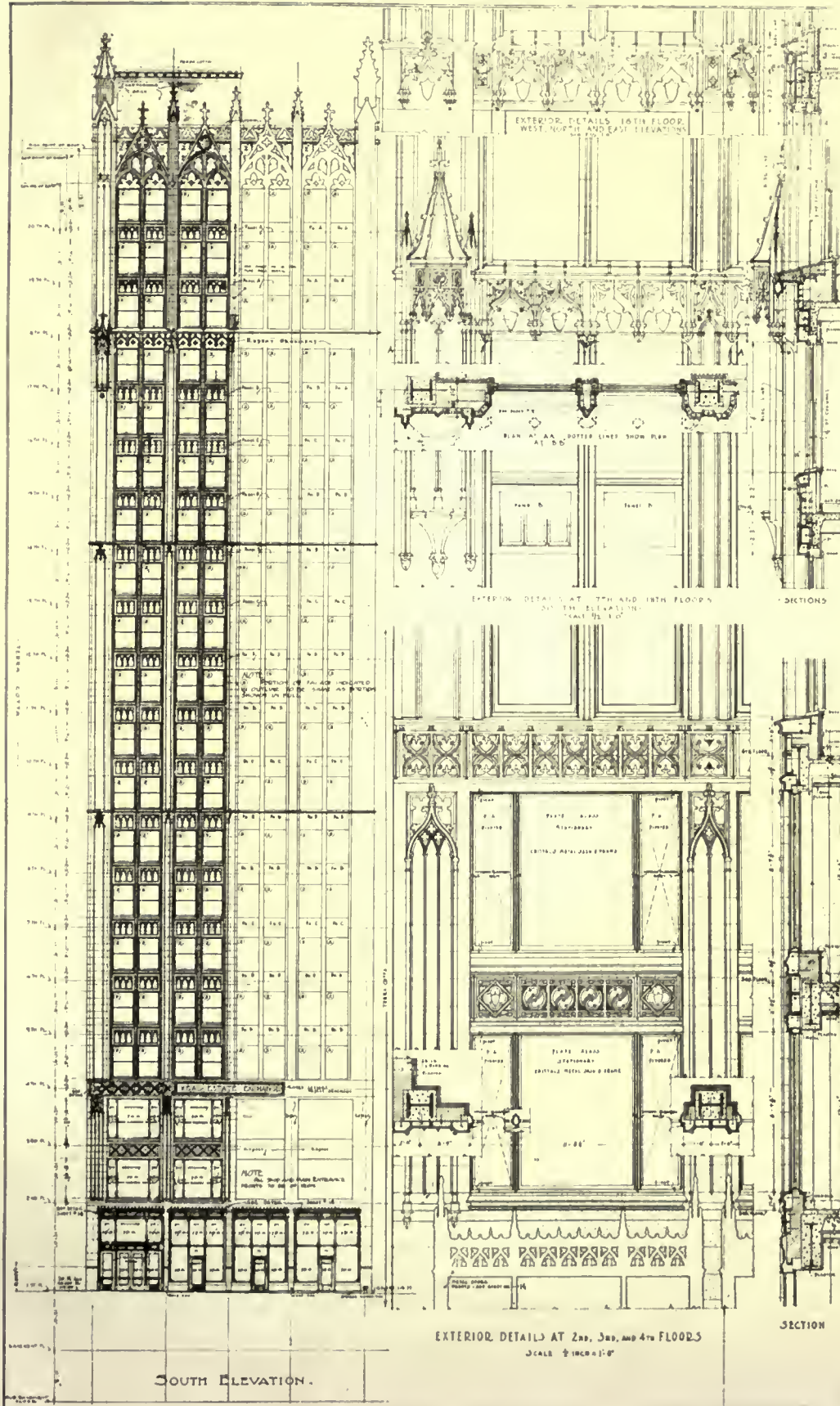

PLATE 130

OFFICE BUILDING ON CADILLAC SQUARE, DETROIT, MICH.

LOUIS KAMPER, ARCHITECT





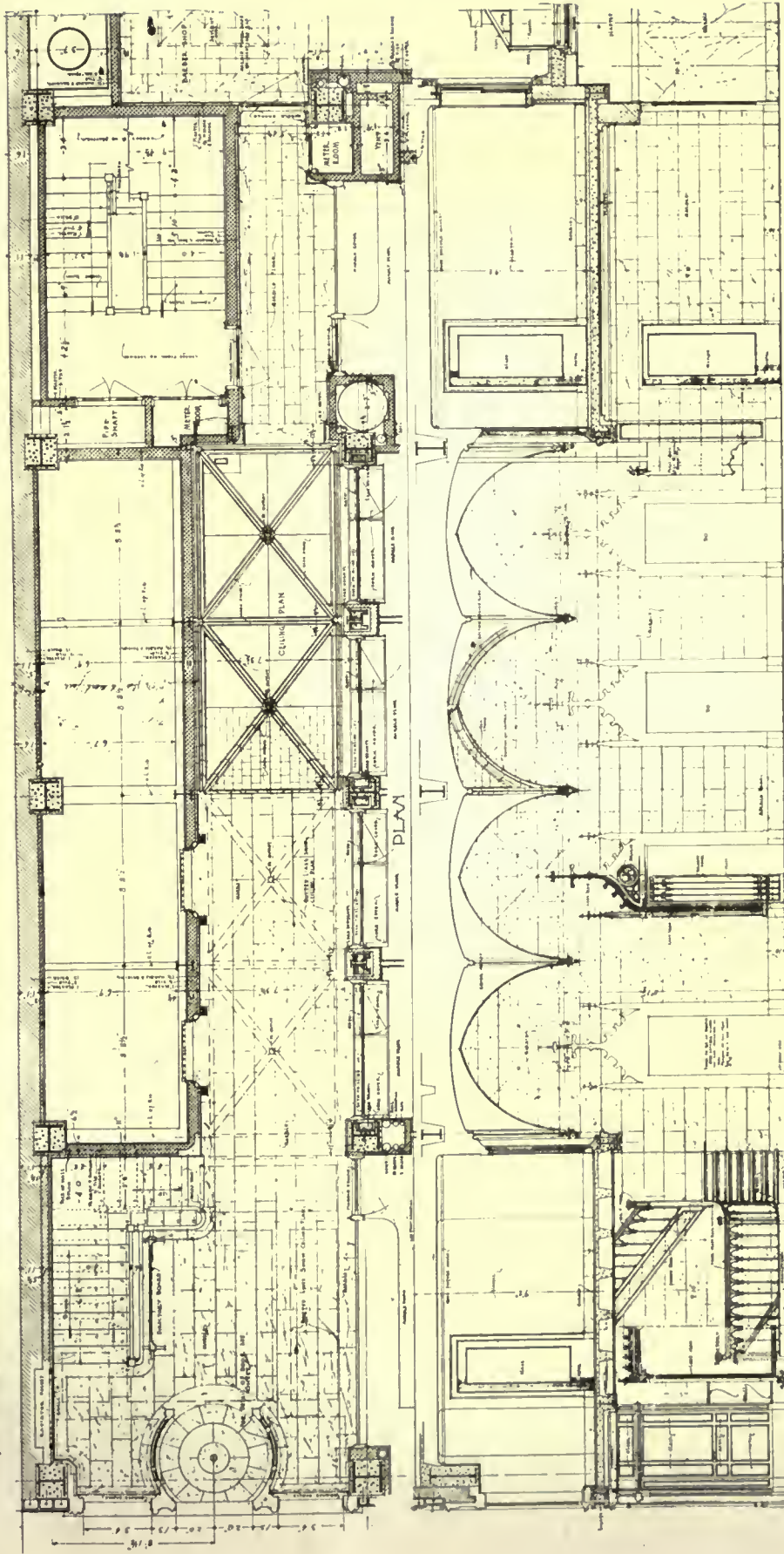

PLATE 131

DETAILS OF ENTRANCE AND ELEVATOR LOBBY

OFFICE BUILDING ON CADILLAC SQUARE, DETROIT, MICH.

LOUIS KAMPER, ARCHITECT





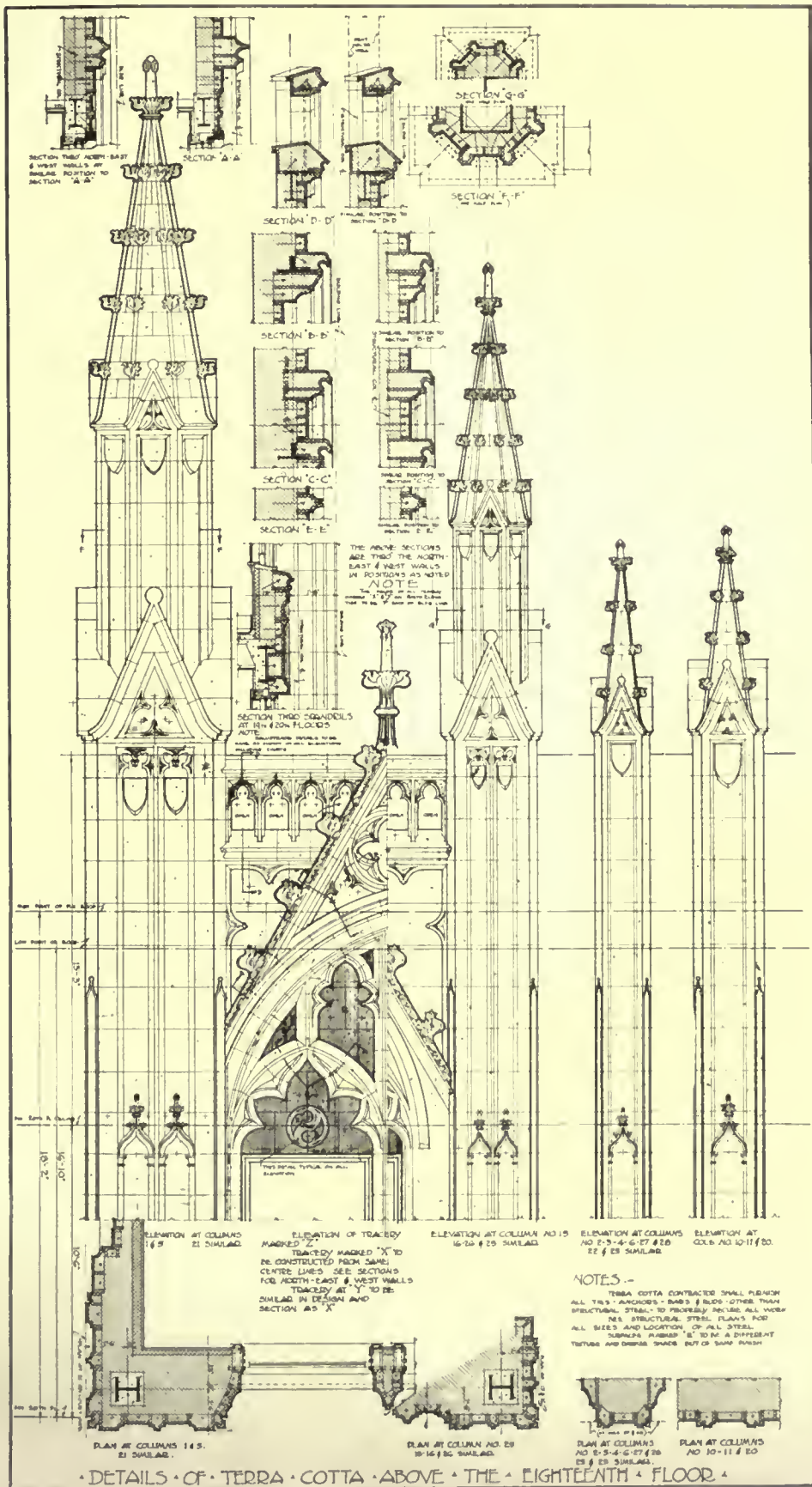

PLATE 132

OFFICE BUILDING ON CADILLAC SQUARE, DETROIT, MICH.  
 LOUIS KAMPER, ARCHITECT





# Current News

## Kansas City Chapter Meets

The Kansas City Chapter of the American Institute of Architects gave a dinner in honor of H. Van Buren Magonigle, architect, of New York, who went there to give suggestions to the Liberty Memorial Committee. Mr. Magonigle told of the plans of the Post-War Committee organized by the American Institute of Architects to begin its effort to get all the architects of the country together on common ground for the common good.

Following Mr. Magonigle's explanation of the committee's plans, there was a general discussion, and a resolution was adopted to co-operate and support the Post-War Committee in its efforts to improve its relations to the rest of the world so that those relations might grow better in every sense of the word.

## Prize for Best Landscape

Edward W. Redfield of Center Bridge, Pa., was the winner of the Altman prize of \$1,000 for the best landscape painted by an American-born artist, at the 94th annual exhibition of the National Academy of Design. "The Old Mill" is the title of the winning canvas. The Altman prize of \$500 for a landscape was awarded to Gardner Symons of New York for his "Shimmering Shadows."

## MacMonnies Statue at Princeton

The model for the statue of George Washington which was ordered by a committee of prominent citizens of Princeton, N. J., to be erected on the green in front of the Princeton Inn, has been completed by the sculptor, Frederick MacMonnies, and is now being done into stone at his New York studio.

He commenced his model in France just before the war and worked on it for two years. His statue was to represent Washington refusing defeat at the battle of Princeton. He put into it the same grim determination for victory which characterized the fighting of the French on the Marne. The face of Washington is represented as dignified and strong, his bearing infusing the courage into his weary men which led them from defeat to final victory.

The statue will stand twenty-six feet high and will be placed in relief against a fifty foot column which is being prepared by Thomas Hastings, architect. The figure of the woman represents young Liberty seizing the banner to lead on the despairing soldiers. Charles Dana Gibson was the model for the soldiers.

## Pershing Stadium Will Be Erected

An enormous monument to the memory of the American support of France, to be known as "Pershing Stadium," is now in prospect of erection on the old French military training ground at Joinville-le-Pont. This structure will be the scene of the great Inter-Allied Olympic games to be held about the first of June. The ground was broken for the stadium a week or two ago and the contract under which it is being erected says that it must be completed within ninety days.

After the Olympic games are concluded, the stadium will be presented to the French Government as a memorial to the first invasion of Europe by American troops. It will, when completed, be able to accommodate 40,000 persons and is intended to be one of the finest buildings of its character in the world.

The structure will be of reinforced concrete and will completely surround the vast field, which will have a 200-meter (218 yard) straightaway, and a 500-meter (545 yard) elliptical running track. Within the track there will be room for an English Rugby playing field, which is about 30 yards longer than an American gridiron.

## Famed Perseus is Uncovered

Florence, Italy, has just taken the sandbags away from the bronze statue Perseus, with the head of Medusa, executed by Benvenuto Cellini in 1445. It had been covered to protect it from German air raiders, along with other priceless statuary. Benvenuto's Perseus is a marvel of detail, but even more famous is his story, told in his biography of how it was cast. It made that very intimate recital a classic.

## 77th Division Plans Clubhouse

Warren & Wetmore have prepared preliminary plans for the proposed \$5,000,000 clubhouse of the 77th Division. The site of the old Astor Library at Lafayette and Eighth Streets, New York, has been tentatively selected as the location for the clubhouse. This piece of land and the building now occupying it have been leased for one year by the association to provide a temporary club for the men when they return to the United States this month. Carpenters and decorators have been put to work renovating the building. Keeping in mind the monumental character such an edifice should have, the architects have sought to design a building which will typify the spirit of Americanism that was developed in the division. The proposed clubhouse, as seen in the architects' drawings, resembles somewhat the Parthenon.

The building will contain a separate room for each regiment in the division, with a large drill hall capable of accommodating 6000 men. It is planned to install a gymnasium which will rank among the finest in the city.

## Our Soldiers Studying French Art

In line with the feeling of THE AMERICAN ARCHITECT that soldier-architects in France should be given opportunity to study the Beaux Arts while abroad, the Y. M. C. A. has opened at Bellevue, near Paris, the American Expeditionary Forces Art Training Center, with an enrollment of five hundred students recruited from the American Army. This school is dedicated to the purpose of training American soldiers in painting, mural painting, sculpture, interior decoration, industrial and commercial art design, architecture and engineering, and work associated with art generally.

The school is founded on the workshop system and will be the basis of organization as regards architecture and various fields of painting and sculpture. Arrangements are being made to facilitate the instruction of specially qualified soldiers so far as to permit their early attendance at the École des Beaux Arts and other well-known institutions.

The establishment of this school was made possible by the co-operation of Gaston Liebert, French Consul General in New York City; Lt. Col. Theodore Reinach, chief of the French mission of scholars to America; R. W. De Forest, president of the Metropolitan Museum of Art; Lloyd Warren, director of the Beaux Arts Institute of Design; McDougal Hawkes, president of the French Institute in the United States, and other people

prominent in cementing co-operation between France and America.

George S. Hellman of New York is supervising the work of the new art center, with the assistance of the army authorities.

The Y. M. C. A. workers will discuss with army chiefs the advisability of mustering out men abroad who may wish to continue study in France, for it is anticipated that this will result in the return to this country of trained groups of men who will bring to America an appreciation of French methods in art as a contribution to the cultural life in the United States.

## Housing Problems in America

Volume VII, of the proceedings of the Seventh Annual Conference on Housing, held in Boston in November, 1918, has been published by the National Housing Association. It is entitled "Housing Problems in America," and is a substantial cloth bound book of more than 450 pages.

The book contains edited copies of the various papers read at this conference, with stenographic reports of the various debates.

At no time have problems of housing been more vital in the United States than now. The enormous shortage of low-cost houses and the necessity for quick building to meet an insistent demand will, unless proper care is exercised, result in many unfortunate and costly errors.

The series of important and authoritative articles that comprises this volume covers every essential aspect of the housing problem. The book is therefore a timely one and may be read with profit by every architect, engineer and builder.

## Department of Labor Questions Building Trades

In order to apprise the building interests of the country with the present situation in related industries, the Division of Information and Education of the Department of Labor sent out nearly 20,000 questionnaires to builders, architects, manufacturers, banks and other institutions, and to Government officials throughout the country.

A preliminary report issued by this division states that 6,225 of these queries have been returned, reporting public and private projects approximating a total valuation of \$1,708,738,936.

Of these 6225 projects reported 3226 are public, such as street paving, road construction, water works, sewers, public buildings and water-



## THE AMERICAN ARCHITECT

front work, the approximate valuation being \$1,249,548,825.

There were 2999 private projects reported of a total valuation of \$459,190,111. These consist of apartment houses, residences, hotels, business buildings, factories, places of amusement, churches, social halls and railroad work.

While these reports are still coming in and are now in process of sorting, the results so far have Illinois leading with 220 public projects aggregating in value \$130,877,476, and 141 private projects aggregating \$94,574,476; a total of \$225,574,476. One item that swells the Illinois private project total is the new Union Railroad station in Chicago, which is to cost \$60,000,000.

New York comes second with 275 public projects to cost \$120,574,485, and 405 private projects to cost \$43,738,356; a total of \$164,312,841.

Ohio is third in the list with 226 public projects to cost \$103,323,691, and 424 private projects to cost \$37,685,515; a total of \$140,918,216.

Michigan comes fourth with 149 public improvements to cost \$93,110,694, and 77 private projects to cost \$37,994,700; a total of \$131,105,394.

### Furniture Market in South America

Largely because of the climate, the building laws of the West Coast countries of South America require that ceilings of all dwellings be much higher than is usual in homes in this country. For this reason, American consuls report, much furniture imported from the United States has not been acceptable, as it has appeared diminutive and out of proportion in houses with high ceilings. Certain European manufacturers have met this architectural difficulty by sending out representatives who, by their knowledge of interior decorations, were able to provide suitable wall decorations, coverings and arrangements of furniture so as to give pleasing effects.

Chile perhaps furnishes the best market of the west coast countries, its rich resources having attracted many wealthy foreigners who are able and desirous of buying imported furniture. There is generally a greater demand for the best grades of imported furniture because the cheaper grades are produced locally. The French manufacturers obtained a good share of Chile's trade in fine house furniture before the war, it being the custom of the wealthy Chilean families to travel in Europe and bring from France suites of furniture for their homes.

Much office equipment and some house furniture is imported from the United States but in

general manufacturers from this country have not been much interested in developing this market nor have they obtained able and energetic representatives to promote the sale of their goods. Accurate information concerning climate, customs and other peculiarities of this market are necessary to the growth of the American furniture trade on the South American west coast. In fact, technical knowledge and an ability to adapt products to South American needs is the secret of trade success on that continent—it is said to be of more real value than even a knowledge of the Spanish language.

### Adopts Zone Ordinance

What is considered one of the most completely worked out and comprehensive ordinances so far adopted in the United States, was passed by the Alameda City Council on the recommendation of the city manager and advisory city planning commission in February, 1919. Alameda is a city of approximately 35,000 population.

Neighborhood meetings and conferences were held and from each of the principal districts and centers of the city, an agreement was obtained as to what protections would be for the best interest of property owners in each neighborhood. These neighborhood recommendations were then combined together in a general zoning plan and the whole put up for public hearing as the preliminary form for the zoning regulations. There were practically no objections to the ordinance, either at this time or at the later hearings after it was introduced before the city council.

The ordinance is expected to stabilize property values, prevent the deterioration of residence districts, help business by requiring it to be concentrated at established centers, and make a definite place for industries to locate and invest where they will be safe from protest and interference.

### 450,000 Buildings Destroyed

Bad sanitation and housing, especially in devastated regions, have made France's problems still more acute than they would ordinarily have been.

A report bearing on this phase of the problem has been announced by Andre Tardieu, who says French official investigators have learned that a total of 450,000 buildings, exclusive of all public structures, were destroyed in France during the war.

## Exhibition of Industrial Art

The practical utility of what we call industrial art is one of its distinguishing features which should particularly appeal to the American mind. Everyone in every walk of life is in intimate contact with products of industrial activity. Extending the applications of industrial art therefore makes for a democratizing influence and eliminates for the plain man something of the feeling of aloofness which he assumes to be the attitude of those active in the "fine arts."

As a means to emphasizing its belief that art expression should be found in our homes, our clothes, our shops and intimate belongings as well as in our art galleries and museums, the Art Alliance of America has prepared an exhibition of the work of students in art and trade schools in New York City. Twenty-six institutions are included, and provide designs in graphic arts, comprising advertising, blockprinting, book covers, costume illustration, posters, wall paper, etc.; in hand-decorated textiles, jewelry, silverware and copper, pottery, architectural ornament, interior decoration, and stage craft, including both settings and costumes.

It may be noted that these works are executed by their designers, thus effecting the sort of co-ordination which *THE AMERICAN ARCHITECT* has already taken opportunity to commend.

The effect of interplay between these aspects of craftsmanship upon the practice and well-being of architecture will be apparent. The higher standards of art which the layman may attain to has a very direct bearing on the character of architecture which the profession may aspire to produce.

This exhibition, representative and far-reaching as it is, should receive the encouragement and support of every architect as a point of departure from which may result higher and better achievements in public taste than have been evolved in the past.

---

## Rotch Traveling Scholarship

RESUMPTION IN 1920 OF ANNUAL AWARD

For two years on account of the war conditions, there has been no award made of the Rotch Traveling Scholarship. In the opinion of the committee, the conditions do not as yet justify study abroad. It is now announced that the examinations will be resumed as usual in 1920 and that the age limit which was heretofore set at 30 years, will be extended during 1920 and 1921 to 32 years, so that those who did not have an opportunity to compete during the past two years will not be deprived of the opportunity now.

## A National Public Works Department

The Conference of Engineering Societies at Chicago, April 23-25, will be one of great importance to the architectural profession. As noted in *THE AMERICAN ARCHITECT* of April 2, the co-operation of the architectural organizations is desired by the Engineering Council, under whose auspices the conference is called.

The development of building construction has reached tremendous proportions, and the elemental problems are so diverse and complex that the co-operation of architecture and engineering is required. In fact the limits of either are impossible of definition. Recognition of this fact is freely accorded by the sponsors of this conference who consider that architectural organizations are, in a very large sense, engineering organizations. Invitations have been sent to all known architectural organizations, and if they have been overlooked inadvertently they should notify M. O. Leighton, Chairman National Service Committee, McLachen Building, Washington.

One year ago T. C. Young, in addressing the St. Louis Chapter, A. I. A., spoke of the necessity of co-ordinating the building construction activities of the Government under one head. In this way one standard of structural and mechanical requirements would be made common to such work rather than the four or five different requirements that now obtain to secure the identical result. The organized architects failed to act on Mr. Young's suggestion, and the engineer has proposed the same thing and will act. They ask the co-operation of architects and accord them every opportunity to become a potent factor in this undertaking.

Every organization of architects should take the necessary steps to take part in this conference having as its object the establishment of a National Department of Public Works.

---

## Personal

Architects Whitworth and Johnson have moved to 413 Engineers' Building, Cleveland, Ohio. They desire catalogs.

Ernest Greene announces that his offices have been moved to 52 Vanderbilt Avenue, New York, where he will continue the practice of architecture.

R. Bruce Atkinson and Jarrett C. White announce that they have entered into a partnership for the general practice of architecture, with offices at 818 Connecticut Avenue, Washington, D. C.



# Late News from Architectural Fields

Special Correspondence to THE AMERICAN ARCHITECT

## Cost Probe Started by Legislators

CHICAGO, ILL., April 12.—Probably millions of dollars' worth of public and private improvements in Chicago will hinge to a great extent upon the information to be obtained through the efforts of a state legislative committee now in session at the Hotel La Salle. The committee, made up of state senators and representatives, was appointed to determine whether profiteering exists among dealers in building materials.

More than 300 subpoenas have been issued by the committee for the appearance before the legislators of men interested in the construction materials. Statements of investors and real estate men recently are that many improvements in Chicago are planned, but are being held up on account of the cost of building materials and the uncertainty of rentals.

"We are after the whole truth and nothing but the truth," said Senator John Dailey, chairman of the committee. "And we are in a position, legally and otherwise, to get just that—the truth," he added.

"We accuse no one as we begin the work, but we are going to dig up the facts. If there has been profiteering or attempted profiteering we want to know it, and the people of Illinois are entitled to know. If present quoted prices are justified the alleged 'trust' should welcome the inquiry."

The investigation is expected to take six weeks or two months.

## Activity Credited to Builders' Show

DETROIT, MICH., April 11.—Nearly 65,000 people visited the Wayne Gardens during the nine days of this city's first Builders' Show. Those familiar with the building industry credit the exhibition with having engendered among those who are contemplating building a spirit of activity that will bring real results in helping to supply the 27,000 houses it is figured this city needs.

The exhibitors all report business transactions beyond their expectations and plans are being made by the Detroit Builders' Association to make the organization one whose influence will be felt in the city's building progress.

## Disposal of British Surplus War Property

WASHINGTON, D. C., April 12.—The Disposal Board of the British Government, which controls the disposal of lumber and building materials, is organized on lines similar to that in our own country. Here a great proportion of all building materials owned by the War Department is held by the construction division of the army, and the inventory surplus material has been compiled into several main groups. In England the central authority which has been set up by the British Ministry of Munitions to supervise the disposal of all government surplus property consists of a Board directly responsible to the Minister of Munitions, which is called the Surplus Government Property Disposal Board, and under this there are seventeen sections to deal with the different classes of property.

These sections include lands, buildings, factories and furniture; huts, building materials and timber; plant and ma-

chinery; mechanical transport; aircraft equipment; watercraft and dock plant, and several other divisions. At the head of each section is a controller who, in carrying out the duties entrusted to him, will have the assistance of an honorary advisory committee of men whose special knowledge and experience will insure that the various classes of property are disposed of to the best advantage.

## To Make Housing Plans Public

WASHINGTON, D. C., April 14.—Plans for dwellings, prepared by the U. S. Housing Corporation for various government projects during wartime, are to be made available for general public use by the "own-your-own-home" section of the Department of Labor.

Several types of houses have been selected as most artistic as well as most practicable, and the plans for these will be given to the committee in charge of these campaigns, which are now operating in forty different cities. It is explained that the purpose is not to interfere in any way with the work of the local architects, by thus providing government plans, but it is expected that when the estimates in widely separate states are compiled the information will be of value to prospective home builders, while it will afford comparisons of the varying costs of construction in many parts of the United States.

While the campaign was started primarily to furnish buffer employment to the men of the demobilizing army, the number of letters received by the Department of Labor from soldiers who ask advice about how to proceed in obtaining homes of their own proves that the campaign has for the boys in khaki more than a temporary interest, and contradicts the idea that military service breeds a distaste for settling down in a permanent abiding-place. The "own-your-own-home" campaign has seemed to show that war, instead of inspiring wanderlust, has made the Americans who served in it more anxious than ever before to live in houses that actually belong to them.

## Pine Men Refuse Prices

NEW ORLEANS, LA., April 12.—More than 250 manufacturers of southern pine, at a meeting here, have adopted resolutions declining to enter into joint price agreement proposed by the Industrial Board of the United States Department of Agriculture as a means of stabilizing market conditions.

The manufacturers unanimously declared that such action would be "contrary to the best interests of the public and the lumber industry, from both a legal and economic point of view, violative of state and federal anti-trust laws and likely to subject those involved to prosecution."

The resolutions, which were forwarded to the Industrial Board at Washington, set forth that there are more than forty thousand units of lumber production in the United States, 17,000 of which are producing Southern pine, and each unit makes its own prices. It was stated that it would be impossible for all to agree on a price schedule and that those who did not agree could recover damages under the anti-trust statutes. The Industrial Board was also advised that "any reduction in the price of Southern pine lumber would have to be met with a reduction in cost, principally through a decrease in wage scale."

# Gives Trend of Building Material Prices

HOMER HOYT, economist of the bureau of research and statistics of the War Trade Board, analyzes the building materials situation and the course of building in the last five years in the following excerpts of a bulletin which will be published soon by the price section of the War Trade Board as one of some 50 studies made by that department of as many groups of commodities, showing the causes and fluctuations of prices during the war.

"The course of building from 1913 to the end of 1918 was influenced by two sets of forces; the first being the business cycle, and the second the war. Building had reached a high level during 1913, but had declined somewhat during the slight business depression in 1914 and 1915. After the prices of building materials had reached a very low ebb by the fall of 1915, building was encouraged, at the same time a general era of prosperity began as the result of war business. The general business prosperity made necessary plant extensions, and the rising wages encouraged the building of homes. When this building activity was in full swing it continued regardless of the advancing prices of building materials. The war as well as rising prices brought the era of building activity to a close. Even in 1917 the higher cost of labor and materials, due to our entry into the war, caused a drastic curtailment of building. The order of the War Industries Board of March 21, 1918, discouraged building of homes, and other buildings not used for war purposes, and prevented any stimulation of the building activity by making it very difficult for builders to secure priorities as to cars, fuel, and labor, cutting off some demand for building that might

"The decline of building varied with respect to locality. It was greatest in the large cities of the East where the car shortage was particularly acute and where labor was difficult to secure on account of the competition of munitions plants. The decline was least in the South and on the Pacific coast, where lumber as a by-product of the military program was easily accessible and where, in the case of the South, the concentration of military camps caused the building of additional homes for the relatives of soldiers. Thus, while the decline in value of building between 1916 and 1918 was 72 per cent in the New England states, 58 per cent in the Middle Western states, 57 per cent in the Middle Atlantic states, it was only 46 per cent in the Southern cities, 25 per cent in the cities of the Pacific coast and 15 per cent in the leading cities of Texas and Oklahoma.

"The curtailment in building also varied according to the material used. The decline was greatest in the case of brick, steel, and stone, and hollow tile, and least in the case of lumber and cement. Lumber and cement were more adapted to quick construction than either brick or stone. Lumber had the additional value that the lumber mills used their own waste for fuel and hence required no coal. Cement, while requiring large amounts of fuel, was nevertheless necessary for a great many Government uses, such as armories, barracks, roads, bridges, fortifications, dry docks, reservoirs, munition factories and ships, and it was a durable and convenient material for these purposes. Brick and stone, on the other hand, were in small demand because they were adapted chiefly to perma-

PRODUCTION OF BUILDING MATERIALS IN U. S., 1913-1918, INCLUSIVE

Year	Lumber, M	Structural Steel, Long Tons	Portland Cement, Bbls., 380 Lbs.	Common Brick, M	Indiana Building Stone, Cubic Feet
1913	38,387,009	3,363,102	92,097,131	8,088,790	9,010,672
1914	37,346,023	2,274,859	88,230,170	7,146,571	7,929,006
1915	37,001,656	2,729,443	85,914,907	6,851,099	8,685,213
1916	39,807,251	3,393,560	91,521,198	7,394,202	8,545,534
1917	35,831,239	.....	92,814,202	5,864,909	6,570,645
1918	32,700,000	2,051,056 Estimated	71,632,000	2,500,000 Estimated	3,000,000 Estimated

have persisted in spite of the war. By 1918 the value of building permits in 143 leading cities was only slightly above 40 per cent of the value of building permits in 1916. The Government building of cantonments and Government factories and warehouses, which required no permits, is not included in these figures, and this would, of course, partially offset the decline in private building. In view of the fact, however, that much of the building in 1918 consisted of additions to munitions factories, homes for war workers and repairs to existing buildings, and also in view of the fact that with the higher prices of building materials, the same value in 1918, represented considerably less physical volume of building than it did in 1917. It is probable that not much more than one-eighth as many private dwellings for normal purposes were constructed in 1918 as compared with 1916. The statistics as to the cost of building during these years from 1913 to 1918 are shown by the Geological Survey to be as follows:

Year	No. of cities reporting	No. of permits	Cost
1913	147	285,850	\$ 859,657,250
1914	147	281,174	785,525,746
1915	144	283,792	799,735,860
1916	146	339,017	1,024,211,675
1917	145	259,668	687,415,605
1918	143	210,538	430,014,365

ment construction. Brick was also undesirable because of the large amount of fuel which it required. Steel, of course, was of such vital importance to the war program that its use in building was eliminated wherever possible. As a result of these influences the production of brick and stone for building declined to 25 per cent of normal during 1918, while that of cement and lumber declined only to 75 per cent of normal.

"The decline in the production of various leading building materials in the United States during the war is shown by the following table. This table also shows how the production of building materials rises and falls with the swing of the business cycle, the production having dropped to a low point in 1914 and 1915 and having risen to a high level in 1916.

"The prices of all building materials, except steel, responded in the main to the same causes of rising wages and materials cost. Building materials, except steel, lagged slightly behind the prices of other commodities because of the abundance of common building materials and the competition between the numerous producers of building materials. Nevertheless, some prices of building materials advanced more rapidly than those of others. Common brick prices, despite the competitive character of the brick industry, advanced more rapidly than cement. This was due to the fact that the chief cost of producing common brick is labor, and that when the demand is not sufficient



to cover rising wages cost, the brick manufacturers will close their plants and thereby curtail production and prevent the overstocking of the market. Cement producers, on the other hand, with their high overhead costs are tempted to run their plants at full capacity even though they must lower their prices to sell their entire output.

"Stone prices exhibited several tendencies. Indiana limestone, as a result of combination, maintained a high level of prices, but building granite lagged far behind other build-

ing materials because of the competition with granite of stone, cement, brick and hollow tile. Structural steel prices, of course, far outstripped prices of all building materials.

"Lumber prices, on the whole, did not rise quite as fast as those of other building materials, but if yellow pine and Douglas fir, the chief building woods, be considered, the rise in the price of lumber, hollow building tile, and sanitary ware all advanced in proportion to the average rise in the cost of labor and other building materials.

# Financial and Commercial Digest

## As Affecting the Practice of Architecture

### Are Costs Less Than Current Estimates?

**B**IDS just opened in the Bureau of Yards and Docks of the Navy Department, for the construction of the Seaman and Navigation Building in Annapolis, Md., indicate that building estimates now current may be too high. The Department's estimate for this granite building is \$800,000. Eighteen of the responsible general contractors of the country bid on the job and all but one submitted figures below the Department estimate.

It can not be stated at this time who was the successful bidder for the reason that alternates in the specifications may make enough changes in the bids to justify the awarding of the contract to someone other than the bidder whose lump sum figures now are the lowest. The lump sum figures, however, have challenged the attention of the Division of Public Works and Construction Development of the U. S. Department of Labor, because they appear to verify the opinion that prevalent estimates on construction and building works are too high, and when contractors have specifications and details of work before them, they can work out construction costs much lower than is popularly believed.

Where the Navy Department's estimate for this job was \$800,000, bids were had as low as \$658,927. Most of the bids were \$100,000 below the Department estimate.

For some time, it has been observed by the Division of Public Works and Construction Development that architects and prospective builders, asking for general estimates on work, without reducing the project to specifications, have been getting estimated costs which appeared to be out of proportion to actual market conditions. In the Navy Department project bids there is about 17 per cent difference between the estimate of the Department and the lowest bid—as the figures now stand and without considering the alternate features. This tends

to confirm the Division in the belief that where prospective builders call for actual bids on detailed specifications, so contractors may figure with certainty on the proposed projects, the actual bid may be from ten to fifteen per cent lower than the general estimates. It is certain that so many successful contractors, on a Government job where there is rigid inspection, would not put in bids lower than a sum necessary to do the work and provide a reasonable profit.

### Building Material Market Prices

**W**ITH the one object of putting the building cost factor within the reach of the investor, Federal pressure artificially lowering material prices to aid immediate construction, has resulted in a further drop in the price of Portland cement delivered in New York to \$3.25 per bbl., and at the same time forcing supplemental lines somewhat further downward.

More orders were placed for building material during the first ten days of April than during the entire months of January and February combined.

A noteworthy feature of the week's activity was the announcement of further reductions of from 10 to 15 per cent, by prominent manufacturers of radiators and boilers, making a total decline of from 33 to 36 per cent, since the first of the year. In view of the fact that during this period pig iron prices have declined but 20 per cent., that labor rates at the plants have not been reduced, and that production costs therefore do not warrant this readjustment of prices, manufacturers are deserving of great credit in the effort to do their part in assisting a general resumption of building activity.

In the steel market the opinion was expressed that active competition among producers might shortly begin regardless of the differences of views between the Director General of Railroads and the Industrial Board as to further reduction of prices. Less hope was expressed than at the end of last week that the matter would be compromised. The controversy between the Industrial Board and the Director General of Railroads only serves to complicate matters. This from the view of the man who believes that a period of stabilized prices is the only way in which building movement can be converted from a dull to active state. However, there are many close students of the markets who do not favor the muzzling of

# THE AMERICAN ARCHITECT

the law of supply and demand. They prefer to have the present controversy develop into a complete abandonment of effort to control commodity prices.

The entire Redfield plan has been weakened, at any rate, by the admission that price schedules may be revised, presumably downward, if necessary, for its primary purpose was to assure industry that prices would not go lower this year in order that business men might buy more freely with this understanding in mind.

The building industry is awaiting with great interest the report which the Attorney General will render as to

the legality of the price-fixing agreement, which, many contend, conflicts with the letter of the anti-trust laws. There is no question but that much will depend on the report. Some credence is given the belief that the entire plan will be abandoned.

The Navy Department neither admitted nor denied the principle of uniform prices, but bids received for its 20,000 tons of structural steel were at the new minimum prices. It will be decided shortly whether business will be artificially stimulated by this plan or left to work out its own salvation.

*(Price quotations now current on building materials and supplies as quoted by dealers and jobbers for delivery in New York City and vicinity, follow. The quotations set forth are placed before readers of THE AMERICAN ARCHITECT to afford an accurate review of market conditions, rather than for use as a basis for actual purchase. They will not only provide knowledge of the exact state of the market as to items quoted, but will also present a basis to judge conditions as affecting co-relating materials. Items marked (\*) indicate an advance over last week, while those marked (†) record a decline. Other prices did not fluctuate during the week.)*

<b>BRICK</b> —	Common (for Borough of Manhattan only), per thousand..\$17.85
<b>CEMENT</b> —	Per bbl. in 15 cent bags.....\$3.25
<b>COOPER SHEETS</b> —	At the mill, hot rolled, 16 oz. base-price, per lb.....22½c.
	(From jobber's warehouse add 2 to 3 cents.)
<b>GALVANIZED SHEETS</b> —	Nos. 18 and 20 gauge, per lb.....\$6.40*
	No. 26 ..... 6.70*
	No. 27 ..... 6.85*
<b>GLASS</b> —	(Discounts from manufacturer's price lists.)
	Single strength, A quality, first three Brackets.....80%
	Single strength, B quality .....79%
	Double strength, A quality.....80%
	Double strength, B quality.....82%
	Plate—up to 5 sq. ft.....82%
	Plate—over 5 sq. ft.....84%
<b>GRAVEL</b> —	1½ in. (Borough of Manhattan only) per cu. yd.....\$3.25
	¾ in. (Borough of Manhattan only) per cu. yd..... 3.25
<b>GYPSUM</b> —	Plaster Board:
	(Delivered in Boroughs of Manhattan or Bronx)
	27 x 28 x 1 .....35 cents
	27 x 48 x ¼ .....32 "
	32 x 36 x ¼ .....21 "
	32 x 36 x ⅜ .....21 "
	32 x 36 x ½ .....23½ "
	Plaster Blocks:
	(Delivered in Borough of Manhattan or Bronx)
	2 in. solid per sq. ft.....7½ cents
	3 in. solid 12 x 30 per sq. ft.....10½ "
	3 in. hollow .....10½ "
	4 in. hollow .....12½ "
	6 in. hollow .....17½ "
<b>HOLLOW TILE</b> —	(The New York Harbor strike makes a slight additional charge for cartage necessary.)
	Interior, 2 x 8 x 12 split furring per 1,000 sq. ft..... \$70.00
	and 15 cents thousand pieces.
	Interior, 3 x 12 x 12 split furring per 1,000 sq. ft..... 102.00
	Interior, 4 x 12 x 12 split furring per 1,000 sq. ft..... 114.75
	Interior, 6 x 12 x 12 split furring per 1,000 sq. ft..... 153.00
<b>LATH</b> —	Eastern spruce, per thousand.....\$6.50
<b>LIME</b> —	Common, 300 lb. bbls., per bbl..... \$3.50
	Finishing, 300 lb. bbls., per bbl..... 3.70
	Hydrated, in paper bags, per ton..... 17.25
<b>LUMBER</b> (All Prices, Wholesale, F.O.B. New York)—	
	Yellow pine, flooring, No. 1, common, per thousand, flat grain .....\$42.00
	Yellow pine, 3 x 4 to 14 x 14, 10 to 20 ft.....
	N. C. pine, flooring, Norfolk, Va., 13/16 x 2½..... 43.00
	Hemlock, base price..... 36.00
	Spruce, random 2 in. cargoes..... 38.00
	Spruce, wide cargoes ..... 52.00
	Cypress, by car, factory selects 5/4..... 59.00
	Cypress shingles, 6 x 18 (Heart)..... 10.00
	Oak, quartered (Red)..... 96.00
	Oak, plain, flooring (Red)..... 72.00
	Oak, plain, flooring (White)..... 72.00
	Maple, No. 1, 13/16 x 2 in..... 57.50
<b>PIPE</b> —	Cast iron:
	6 in. and heavier .....\$57.70
	4 in. .... 60.70
	3 in. .... 67.70
	(and \$1 additional for Class A and gas pipe.)
	Wrought:
	(Discounts to jobbers for carload lots on the Pittsburgh basing

card; freight rates from Pittsburgh to New York, in carloads, per 100 lbs., are 27c.)

<b>Butt Weld</b>	
<b>Steel:</b>	Black, ⅝ to 3 in.....50½ to 57½%
	Galv., ⅝ to 3 in.....24 to 44 %
<b>Iron:</b>	Black, ⅝ to 1½.....29½ to 39 %*
	Galv., ⅝ to 1½..... 2½ to 23½%

<b>Lap Weld</b>	
<b>Steel:</b>	Black, 2½ to 6.....53½%
	Galv., 2½ to 6.....41 %
<b>Iron:</b>	Black, 2½ to 6.....34½%
	Galv., 2½ to 6.....21½%

<b>PLASTER</b> —	Neat wall cement in 15 cent bags, per ton.....\$20.30
	Finishing plaster .....24.00

**RADIATION**—  
(A further reduction, effective April 4, of 15% on direct radiators, 12½% on wall radiators, and 10% on steam and hot water boilers is announced. This approximates a drop of 36% on radiators and 33% on boilers from prices in effect before the 1st of January, 1919.)

<b>REGISTERS</b> —	(Discounts from manufacturer's price list.)
	Cast iron semi-steel or steel, in black or white japan or electro plate and small faces and borders.....40%
	Wall frames .....40%
	Large faced, 14 x 14 in. and larger.....60%
	Base board registers .....40%
	Base board intakes .....40%
	White enameled goods .....15%
	Solid brass or bronze goods, except grilles.....net
	Grilles in black and white japan or electroplate in cast iron plain lattice design, smaller than 14 x 14 in.....40%
	Less than 14 x 14 in.....60%

**SLATE ROOFING**—  
F. O. B. cars, Quarry Station.  
Per Square According to Size.

<b>Pennsylvania:</b>	
	Best Bangor .....\$6.50 to \$9.00
	No. 1 Bangor Ribbon..... 6.75 to 7.25
	Pen Argyl ..... 7.25 to 8.00
	Peach Bottom ..... 10.00 to 12.00
	No. 1 Chapman ..... 7.25 to 8.25
<b>Vermont:</b>	
	No. 1 Sea Green ..... \$3.50 to \$6.75
	Unfading Green ..... 5.50 to 9.00
	Red ..... 13.00 to 16.00
<b>Maine:</b>	
	Brownville, Unfading Black, No. 1.....\$10.00 to \$12.50
	Slaters felt, 30 lb. roll.....\$1.75
	Slaters felt, 40 lb. roll..... 2.25

<b>ROOFING MATERIAL</b> —	
	1-Ply Tarred Paper, per ton, per roll, 108 sq. ft..\$63.00 to \$65.00
	2-Ply Tarred Paper .....95c.
	3-Ply Tarred Paper .....\$1.23 to \$1.30
	Rosin Sized Sheathing .....\$.60 per ton
	Corrugated Roofing, galvanized, 2½ in. corrugation, over flat sheets, 30c. per 100 lbs.

<b>STRUCTURAL STEEL</b> —	
	Beams and channels up to 15 in., per lb.....2.45c.
	Beams and channels, over 15 in., per lb.....2.45c.
	Angles, 3 to 6 in.....2.45c.
	Zees and tees .....2.45c.
	Steel bars, half extras, from mill.....2.35c.

<b>REINFORCING BARS</b> —	
	High carbon steel from mill.....\$48.50
	Medium steel from mill..... 48.50

<b>SAND</b> —	Per cu. yd. (Borough of Manhattan only).....\$2.25
---------------	--



# Department of Architectural Engineering

## The Double Stairway, Its Design and Construction

THE function of a stairway is to afford a means by the use of which persons may travel from one floor level to another. The efficiency of a stairway is measured by its ability to accommodate the passage of the greatest number of persons, with safety, in a given period of time. The width of the stairs is the factor which controls the volume of traffic. The safety of the persons is dependent on the proportions of the rise and run of the steps, absence of winders, kind and disposition of hand rails and the shape of the platforms and landings. These affect the safety of the person in transit, but another protection must be provided against the hazards of fire, smoke and life-destroying gases. This protection is afforded by the enclosing of the stair hall. It is apparent that two factors must be considered in the designing of a satisfactory stairway; the proportion and arrangement of the detailed parts; the enclosing walls, the entrance to and exit from the stair hall.

The volume of traffic is measured in terms of the effective width of the stairs. The width should be such as to accommodate a number of persons abreast. The width allotted per person varies from 18 to 22 in., the later practice favoring 21 or 22 in. It follows that the effective width should be a multiple of the unit width and that the width increments of 6 in., as required by some building codes, is wrong in principle, ineffective and possibly dangerous in practice. The age and size of the persons using the stairs has its effect on determining the unit width.

The ordinary stair, which reverses its direction of travel at an intermediate platform, accommo-

dates but one stream of persons. This movement of people is obstructed by a movement of persons in an opposite direction. This condition of traffic in opposite directions generally occurs at times when congestion is not probable. Stairways that accommodate large numbers of persons are generally in buildings of such a kind that the maximum traffic occurs at fixed times and in one direc-

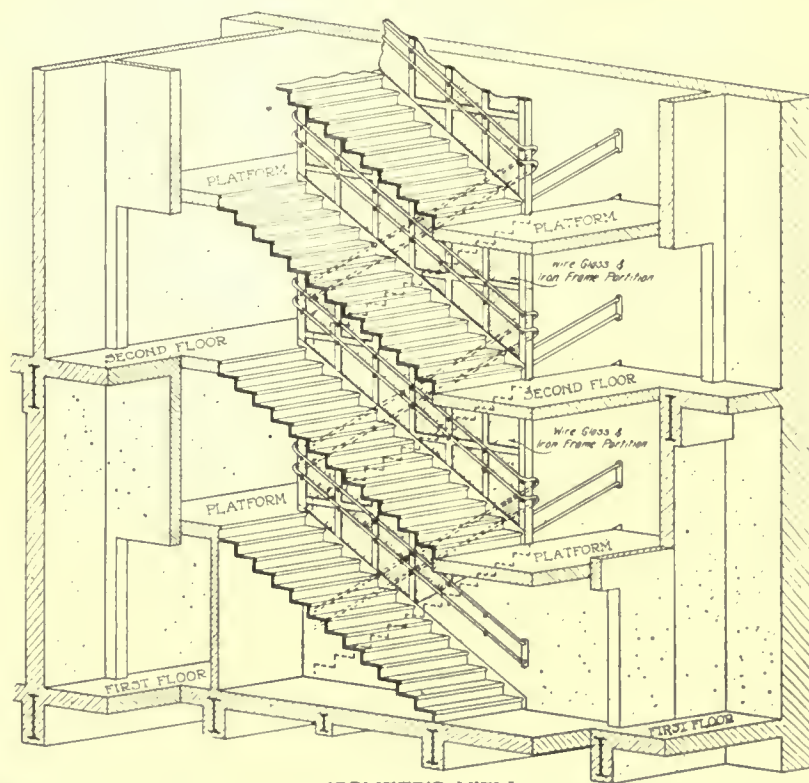

— ISOMETRIC VIEW —

Isometric view of the "double stairway" type of construction with two means of ascending or descending at each floor level, doubling the capacity of the ordinary "single stairway" without adding to the floor area required for the stair hall.

tion only. This is the case in school houses, factories and public institutions such as asylums and prisons.

The capacity of this type of stairway can be doubled by a construction known as the "double stairway" type. In this type of stairs a landing

platform is provided at each end of the stair hall, with intermediate platforms under each landing. From each landing the persons can either ascend or descend the stairs. This permits of two streams of persons to descend or ascend from each floor level without having any contact with each other. To effect this scheme of operation, it is necessary to have a sufficient height from top to top of floors to permit of head room under the platforms and landings. In the ordinary stairs this height is equal to the story height less the thickness of the floor or platform construction. In the "double stairway" this height is one-half the story height

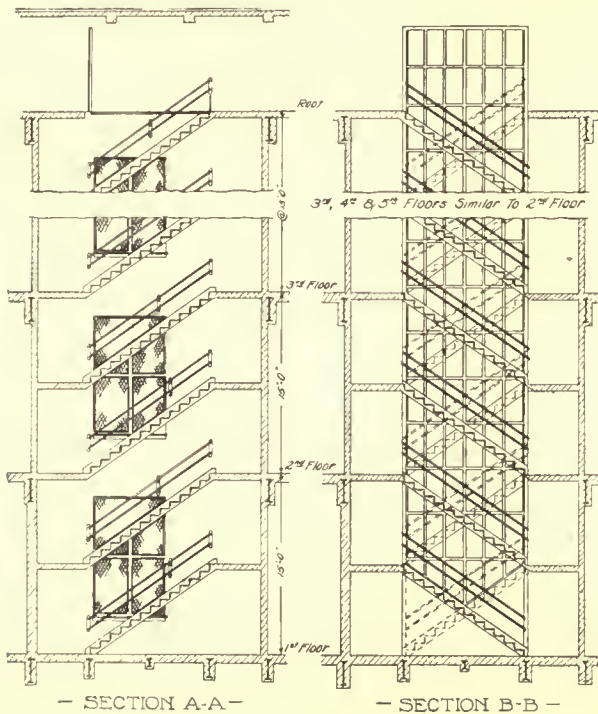

Longitudinal sections showing wall stringers and window guards, also face stringers with wire glass partitions and continuous newel struts or columns.

less the thickness of the platform and landing construction. The problem is to reduce the thickness of the landings and platforms in order to reduce the story height to a minimum.

It will be seen that this type of stairs will require greater story heights than are usual in many factories and residential buildings, and will not become in common use for that reason. Story heights that exceed the requirements of the occupancy are a source of expense in the excess heating and artificial lighting required.

In the design of schools and some types of institutional buildings this objection is not important, as the requirements of natural light, ventilation and

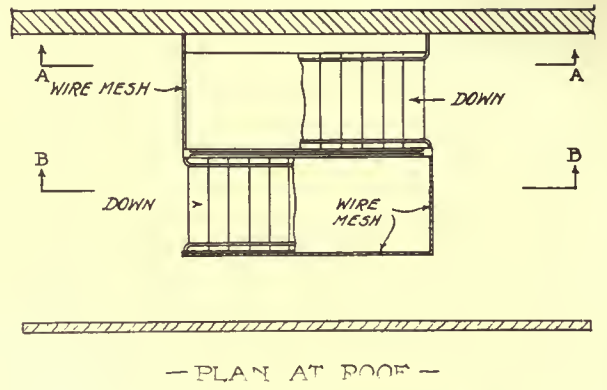

- PLAN AT ROOF -

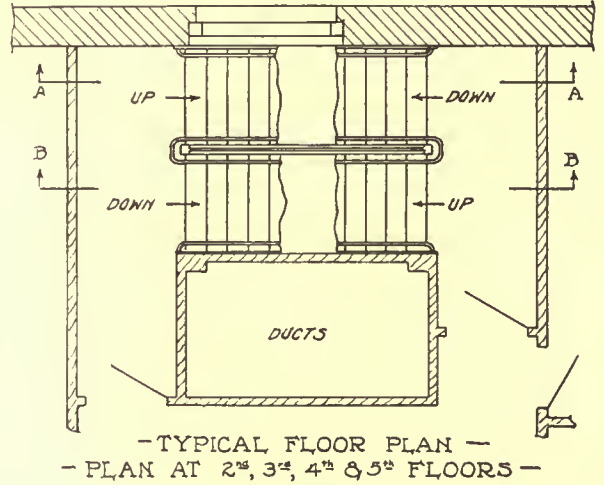

- TYPICAL FLOOR PLAN -  
- PLAN AT 2<sup>nd</sup>, 3<sup>rd</sup>, 4<sup>th</sup> & 5<sup>th</sup> FLOORS -

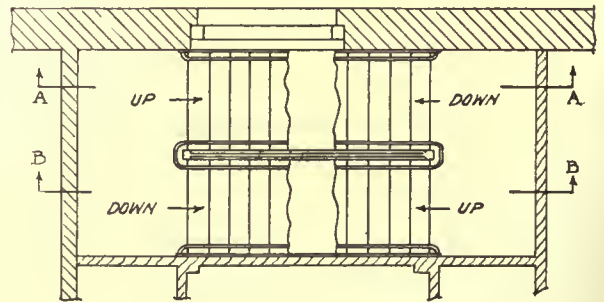

- TYPICAL PLAN AT HALF STORIES -

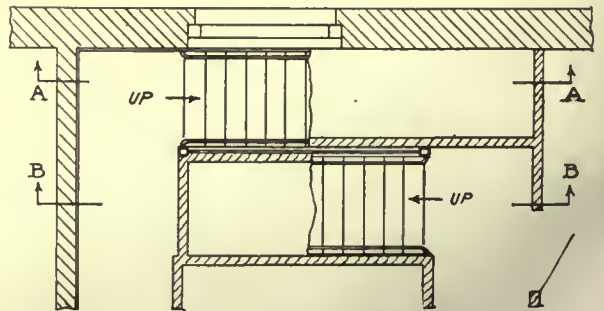

- PLAN AT FIRST FLOOR -



# THE AMERICAN ARCHITECT

safety to the occupants are the most important elements of influence.

The double stairway has been in use in the New

of stairs in stories of 15 ft. from top to top of floors. It will be readily seen that this effects a substantial reduction in the cubature of the building.

This reduction is obtained by a fundamental change in the scheme of stair construction. The ordinary stairway with intermediate platforms has wall supports of some kind for the face stringers which, of necessity, require a deep supporting member across the platform in some direction, with a consequent reduction of head room. The scheme devised for the New York City schools is one in which the newels become continuous columns or struts and support the ends of the face

stringers and their proportion of the platform and landing load.

As shown in the details, this newel strut or column is made by nesting two structural angle shapes into the form of a channel. The faces of the newel are 3½ in. wide. The face strings and hand rails are attached to the opposite sides, which

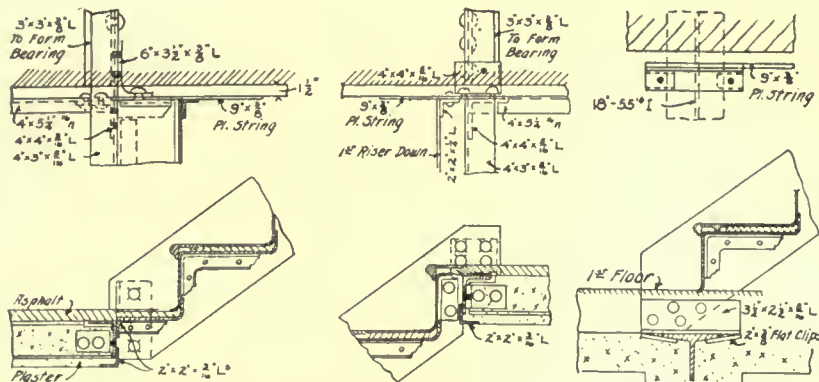

Detail of stair tread and riser, with face and wall stringer sections, safety tread and nosing, tread wearing surface and supporting brackets.

York City schools for several years, and the usual story height was 15 ft. 7 in. from top to top of floors. C. B. J. Snyder, Architect and Superin-

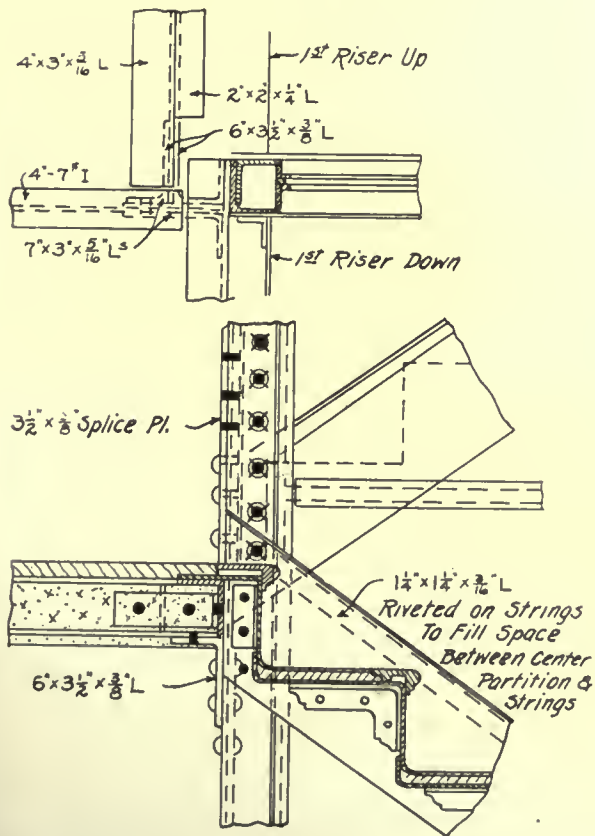

Details of face stringer and platform connections to the newel strut or column.

tendent of School Buildings, has developed such details as will permit the construction of this type

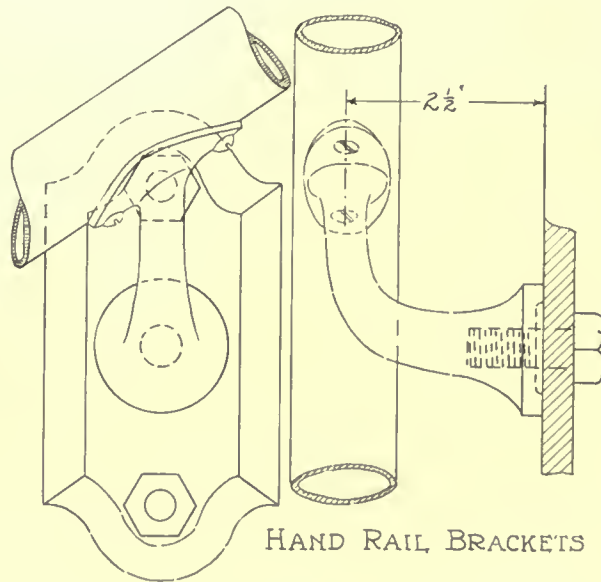

might be termed the flanges of the combined section. The wire glass partition or grille work which separates the adjacent flights of stairs is attached to a plate which closes the open face of the section. The platform supports are attached to the face, which may be termed the web of the combined section. The thickness of the angles composing

the struts are proportioned to the loads supported at the various levels.

A wire glass and iron frame partition is constructed between the inner faces of the newel struts, extending from the level of the tops of the face stringers leading from the first floor to the

from the brick wall. Deducting for the plastering and the projection of the hand rails the effective width is 3 ft. 6½ in.

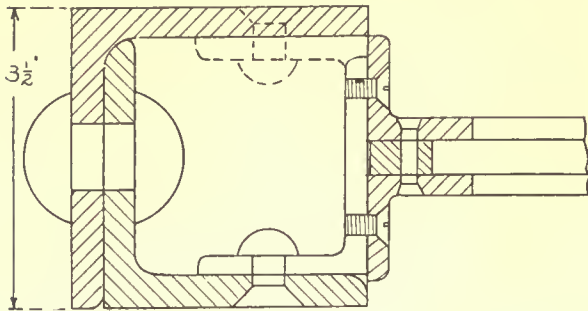

DETAIL OF STRUT & WIRE GLASS CENTER PARTITION FRAME

intermediate platforms up to the ceiling of the pent house on the roof. The purpose of this screen is to prevent any kind of contact between the persons passing on either side of the partition. The

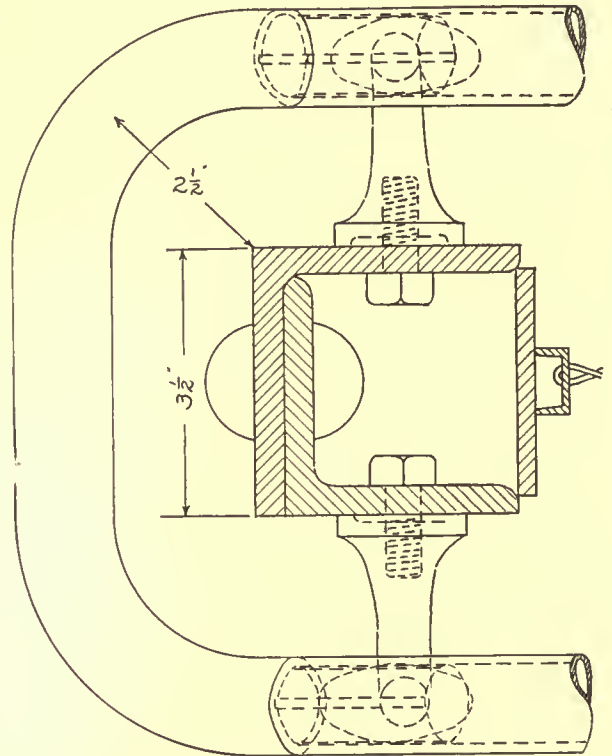

HAND RAIL BENDS AT CENTER PART.

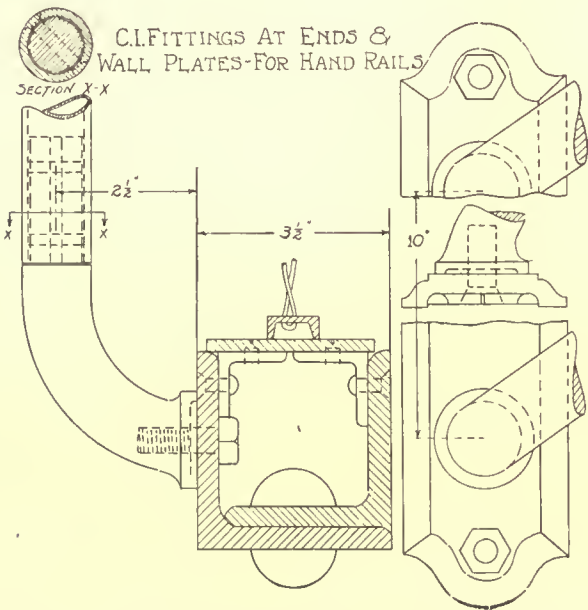

Detail of wall plate for hand rails, hand rail connection to newel strut at first floor and roof level and connection for wire screen partition.

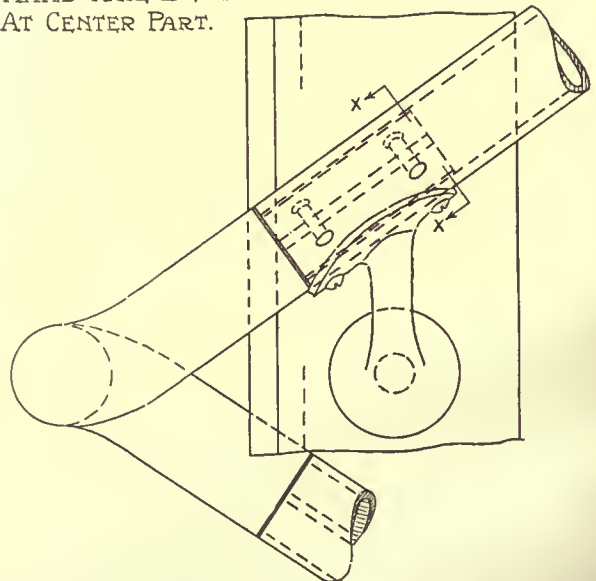

Detail of hand rails at the face stringers and about the newel strut.

wire glass does not obstruct the daylight from reaching all parts of the stairway. The partitions on single stairs are made of wire mesh.

In these stairs the distance from the face of the newel to the outer face of the wall stringer is 4 ft., this outer face of the wall stringer being 1½ in.

The stringers are 9 x ¾ in. steel plates. The face stringers have an 1¼ x 1¼ in. angle riveted along the top edge on the outer face, which closes



the space between the stringers and the wire glass and iron frame partition. An angle of the same size is riveted to the outer face of the wall stringer as a seat for the cement plaster cove base above the stringer. These covs, both above and below

cast brackets which are bolted to the stringers. The treads are finished with a  $\frac{5}{8}$ -in. wearing surface of asphalt. The platforms and landings are made of reinforced concrete finished with asphalt, as specified for the treads. The hand rails are made of 1 in. nominal diameter wrought iron pipe.

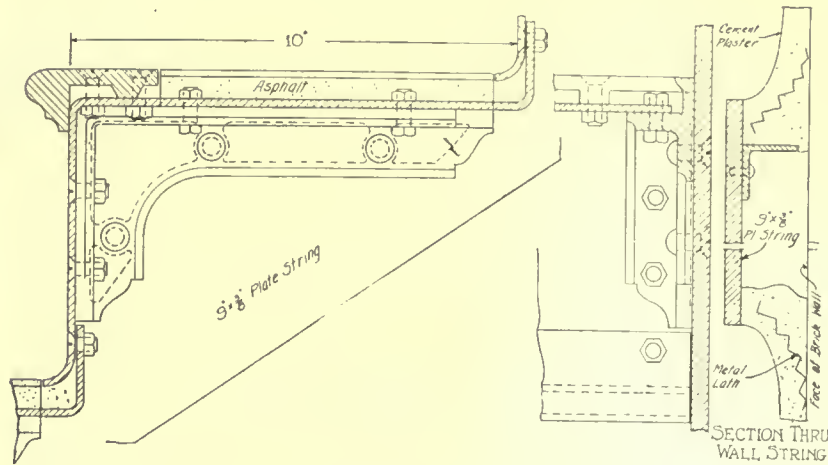

Details of wall stringer connections at floor landings, intermediate platforms and at first floor level.

the wall stringers, are reinforced with a strip of metal lath.

The windows opening into the stair hall are screened, as indicated on the section.

As shown in the details, the tread and riser is made of steel plate in one piece, the lower edge of the riser being bent to form a cove joining with the asphalt finish of the treads. A 3 in. wide approved cast safety tread with molded nosing is securely fastened to the steel tread. The top of the safety tread is  $\frac{5}{8}$  in. above the steel tread. The tread and riser is supported at each end by

two means of exit should be provided in any building, and the distance between these should be as great as possible. The use of the double stairway does effect a large economy in floor space and in construction cost and is eminently fitted to fulfill stairway requirements in many kinds of buildings.

Acknowledgment is made to C. B. J. Snyder, Architect and Superintendent of School Buildings, New York City, for the use of plans, specifications and details used in illustrating this article, and aid in its preparation.

## A Test of the Conductivity of Window Shades

By JOHN R. ALLEN, Minneapolis, Minn.

**T**HIS test was made for the purpose of determining the relative amounts of heat transmission through a single strength glass window, close fitting with stops on both sides, first without window shades and second with window shades pulled down in front of the window.

### APPARATUS

For the purposes of the test, a specially prepared cubical box, 5 ft. inside dimensions, open on one side, was used. The walls of the box, laminated and

insulated, were  $8\frac{1}{2}$  in. in thickness, and inside 1600 lb. of ice were placed in a galvanized iron pan from which a drip pipe led to the outside. In the open end of the box, two window sash were tightly fitted with stops on both sides. The adjacent sides of the box projected about 6 in. beyond the window, and in the recess thus formed, a window shade, fitting it, was hung. When pulled down, there was a clearance between the roller and the top of the recess of about  $\frac{7}{8}$  in. and a clearance on the sides of the curtain of from  $\frac{1}{8}$  to  $\frac{1}{4}$  in. The bottom of the curtain was held off the bottom of the recess by the drip pipe,

Presented at the Annual Meeting of The American Society of Heating and Ventilating Engineers, New York, January, 1919.

and between the curtain and the window stop there was a clearance of from  $\frac{1}{4}$  to  $\frac{3}{8}$  in. This testing box is similar to that described in my paper on Heat Transmission Through Building Materials (Transactions, Vol. XXII, 1916, see page 509).

Another curtain was hung on the top of the box at the edge immediately above the window and when pulled down hung closely on all sides of the opening or recess.

METHOD OF TEST

Temperatures were observed 8 ft. away from the box to determine the outside temperature, at two points immediately in front of the window and at seven points immediately inside the window.

The main criterion of the test was the rate at which the ice was melted under four different conditions which were as follows:

- (1) Both curtains rolled up;
- (2) Inner curtain only pulled down;
- (3) Both curtains pulled down;
- (4) Outer curtain only pulled down.

Measurements of the water running out were made in 100 c.c. and 1000 c.c. amounts to determine the time necessary for the melting to reach a uniform rate and also to check the longer time tests which ran from 3 hours to 20 hours in length.

Corrections were made for the difference in temperatures between the inside and outside temperatures which varied from 21.6 deg. to 29.3 deg. fahr.

RESULTS

The results from these tests show that the saving in heat transmitted by the use of the single inside curtain was 19.2 per cent, by the outside curtain, 28.7 per cent and by both curtains 42.7 per cent.

TABLE 1.—RESULTS OF WINDOW SHADE HEAT TRANSMISSION TESTS

Test No.	Time Elapsed during accumulation of 1000 c.c. of melted water, minutes	Difference of temperature between inside and outside air, deg. fahr.	Values of heat transmission factor "K" as calculated from first column	Corrected percentages of heat saving of heat over Test No. 1, with uncovered glass
1. Both shades up.....	35.55	21.6	1.01	....
2. Inner shade down..	36.58	26.0	0.817	19.2
3. Both shades down..	45.93	29.3	0.578	42.7
4. Outer shade down..	40.38	28.5	0.720	28.7

The marked difference in heat transmission between the tests of the inner curtain and the outer curtain, was without doubt due to the fact that the inner curtain did not fit its opening tightly. This allowed currents of warm air to enter at the top and being cooled between the curtain and the window, to

fall and go out through the clearances at the sides and bottom. The outer curtain fitted over the smooth sides of the box about  $1\frac{1}{2}$  in. and permitted very little movement of air between it and the window.

The author desires to here render acknowledgment to Prof. Frederick Bass for his assistance in conducting these tests.

Engineering Unity

AN engineers' symposium was held at the Engineering Societies Building in New York City on March 26. Fifteen national and three local engineering organizations participated. The meeting was in charge of Gano Dun, President J. G. White Engineering Corporation, and the five speakers were Philip N. Moore of St. Louis, Past President A. I. M. E.; Calvert Townley, Past V. P., A. I. E. E.; Nelson P. Lewis, Chief Engineer Board of Estimate and Apportionment, New York City; Spencer Miller, Chief Engineer Lidgerwood Manufacturing Company; Comfort A. Adams, Dean of the Engineering Department, Harvard University.

The civic responsibility of the engineer and his relation to legislation, to administration, to public opinion and to production and distribution were the topics of the addresses. A spirited discussion in which many took part followed the addresses.

The underlying feeling and object of the meeting was eventually to consolidate all engineering activities into one central organization which could speak as a unit for the engineer in a national way, regardless of individual special lines of activity. This is already the case in the instance of the American Bar Association, the American Medical Society and the Bankers' Association.

There are approximately four thousand organizations or units engaged in the practice of architecture in this country, in which about seven thousand qualified persons are engaged, either as members of organizations or as independent practitioners. In this estimate architectural draftsmen are not considered. The largest architectural organization has a membership of about one thousand persons. Possibly three thousand architects are members of architectural organizations, leaving a balance of four thousand architects who have no means of organized expression.

That the engineer, as a strongly organized unit of about one hundred thousand men, will soon be able to speak definitely on all subjects that interest him as a citizen and professional man is certain. That the general contractor will soon be able to



speak through a truly national organization is also certain. How can architects preserve their proper standing in civic and professional activities unless so organized that *all* of them can speak as one?

### An Unusual Concrete Construction

**F**ITNESS for use is the essential requisite quality for all buildings, and more especially for industrial plants. This is apparent for the reason that industrial plants are operated for profit, a condition that demands utility in the greatest degree. Operating for profit does not necessarily eliminate those features that make for the better conditions of the operative—such as light, ventilation, heat, sanitation and safety.

An addition to an existing industrial plant in Cleveland, designed by Christian, Schwarzenberg & Gaede, Engineers, has some interesting structural features in addition to the others above mentioned. This extension covers a ground area of 52 by 128 ft. Along the lot line the columns are centered 4 ft. 6 in. inside of that line. This permits the first floor to cover the entire area, with ample light and ventilation on both sides of the

area if future requirements demand. The supporting brackets for this extension are shown in the illustrations.

The building is divided into five panels longitudinally, the floor panels being 25 ft. by 23 ft. 6 in., center to center of columns. The floor construction is a flat-slab two-way system of reinforced concrete, designed for a live load of 125 lb.

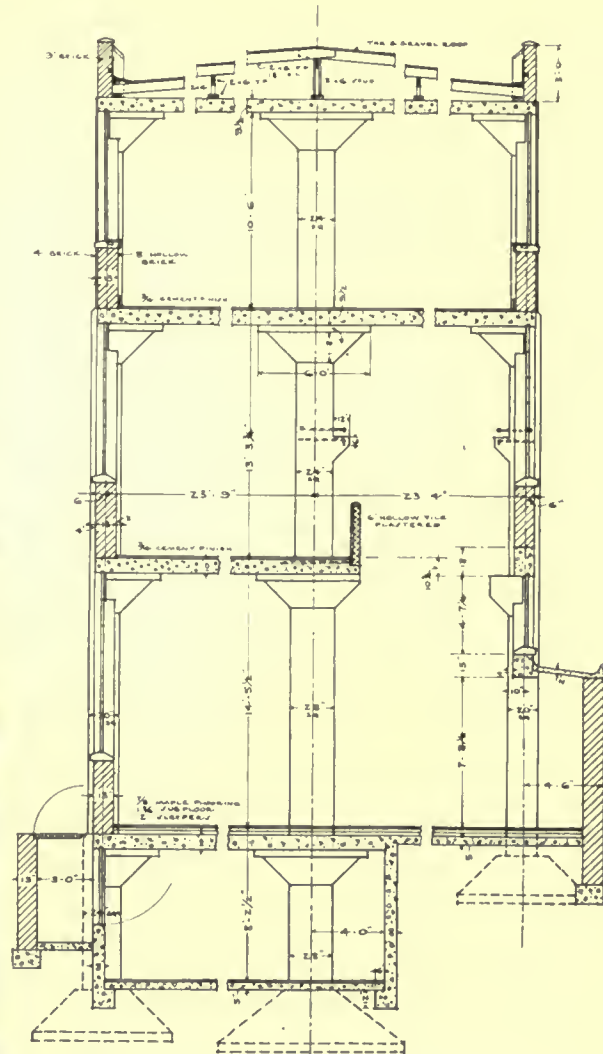

Transverse section



Interior view

building. This is shown in the transverse section of the building. A basement extends under a portion of the building.

The building is designed to have several added stories, the future fourth floor serving to support a temporary roof construction. The second floor is constructed one panel wide, allowing for a crane-way the entire length of the building. Provision is made for the extension of this floor over the entire

per sq. ft. The drop panels are 6 ft. square and 4 in. deep. The column heads are 5 ft. 4 in. square, splayed with an angle of 45 deg., the columns and heads are square. The end panel of the second floor was tested with an applied load consisting of sand 3 ft. deep over the entire panel. The maximum deflection at the panel center was 1/7 of an inch. This was an unusual test, as the panel was practically free on two sides, there being

no spandrel girders, one side wall bearing and the remaining side connected to the only adjoining floor construction. The correctness of the theory of the design and the quality of the construction were demonstrated.

The first floor is finished with 7/8-in. maple and 1 3/4-in. sub-floor on 2-in. sleepers. All other floors have 3/4 in. cement finish. The walls are faced with brick and backed with 8 in. of hollow brick or hollow tile, according to the uses of the rooms. It will be noted that the usual spandrel girders are omitted, permitting the metal windows to extend to the ceiling. This permits of the most advantageous daylighting. A steam-heating plant and automatic sprinkler system complete the equipment.

### The Standard Elementary School Medical Clinic

**I**N THE AMERICAN ARCHITECT of Nov. 6, 13 and 20, 1918, was published certain standards of school house planning. A standard plan for the medical clinic has been approved by the Board of Education of New York City, and acknowledgment is made to C. B. J. Snyder, Architect and Superintendent of School Buildings for the plan here presented.

Entrance to the clinic is made through the waiting room, which is in charge of an attendant, who is provided with a desk. The room contains a cabinet and settee for the waiting pupils. It will be noted that the door leading to the clinic rooms is so hung that the corridor and the persons therein are not visible to those in the waiting room. After the pupils have been treated in the clinics they pass out from the unit without going through the waiting room. This is desirable for very apparent reasons. Clinics are provided for dental, eye, nose and throat and general medical work. The arrangement of the rooms is very compact and affording all necessary requirements for the work in hand. A lavatory and wash room is provided for the doctors and one for the nurses.

The rapid increase in the incorporating of medical clinics in public schools is very noticeable, and

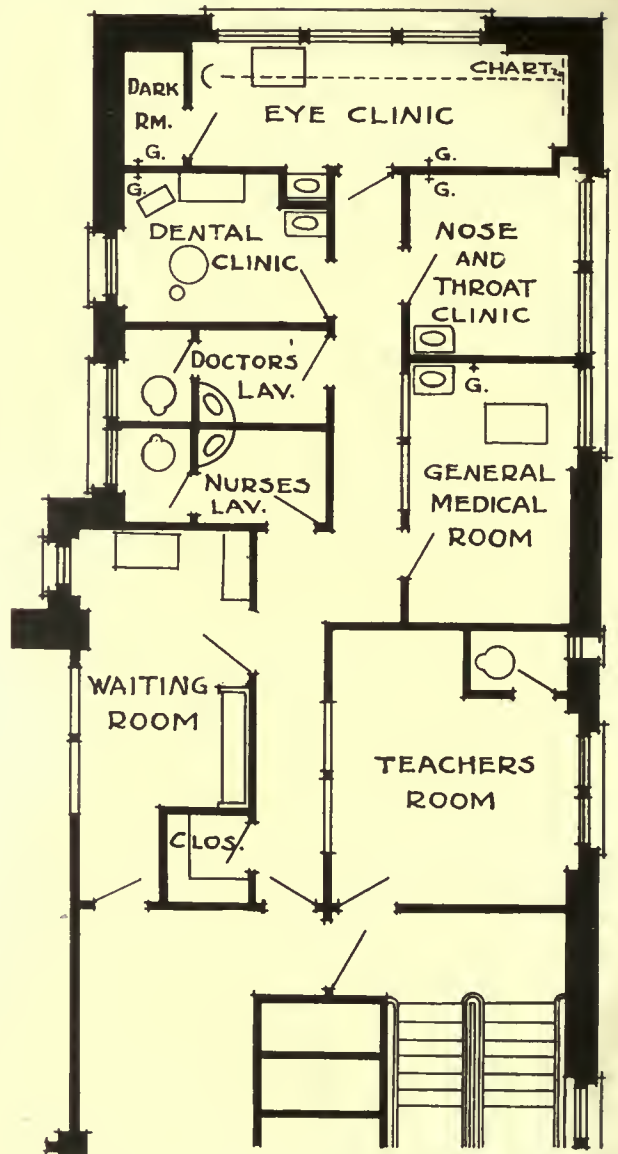

Plan of standard medical clinic approved by the Board of Education, New York City. "G" indicates gas outlets in baseboard.

it will probably be universally adopted in the larger cities and towns of this country. THE AMERICAN ARCHITECT appreciates the opportunity to present this excellent example of such a clinic to its readers.



124  
5-76

# The AMERICAN ARCHITECT



BASILICA DI S. EUSTORGIO, MILAN, ITALY

PUBLISHED WEDNESDAYS IN NEW YORK—FOUNDED 1876  
VOLUME CXV                      APRIL 23, 1919                      NUMBER 2261

Entered as second class matter January 6, 1909, at the Post Office at New York, N. Y., under the Act of March 3, 1879. Publication office, 243 West Thirty-ninth Street, New York, N. Y. Subscription price in the United States and Possessions, \$10.



Architect, Lewis H. Lovering  
Contractors, L. H. & P. W. Lovering

Built of Stucco on a Bishopric Board background, the walls of the Medford, Mass., Women's Club are almost as imperishable as stone. Crumbling and cracking are prevented by Bishopric Board because when this dovetailed, Stucco Background is nailed firmly to studding or sheathing, it holds the Stucco in a bulldog grip that never lets go.



The dovetailed heavy wood strips lock the Stucco. The creosote preserves the wood strips. The mastic asphalt and the water-proof fibre-board keep out cold, dampness, vermin, and deaden sound.

**C**OMPLETELY preserved and protected, naturally and scientifically, against all destructive influences, Bishopric Board lives indefinitely behind Stucco walls and supports them. It cannot deteriorate, hence cannot tear loose from its fastenings. There are never any repairs. Your Stucco building is up to stay, presenting an attractive, permanently unbroken surface.

A combination of principles ages-old in proven efficiency, Bishopric Board is the most economical and dependable Stucco background. It makes a damp-proof, fire-resisting building, thoroughly deadened against sound. Summer-coolness, winter-warmth, and low-heating bills are advantages of its use.

Used on interior walls instead of wood lath, it saves materials, time, and labor, and gives unmatched insulation.

Bishopric Sheathing saves 30 per cent as compared to  $\frac{7}{8}$ -inch wood sheathing, making a compact wall without joints or knot-holes.

All Architects and Builders should have our book, "Built on the Wisdom of the Ages". It describes and details the use of Bishopric Board; illustrates homes and institutions on which it has been used; tells how to get perfect Stucco work. It contains reports of scientific tests and letters from engineers, architects, builders, and home owners. Get it—and samples of Bishopric Board and Bishopric Sheathing.

**The Bishopric Manufacturing Co.**  
904 Este Avenue  
Cincinnati, Ohio

### A Few Other Bishopric Board Installations

University Park School for Boys,  
Arlington, Baltimore, Md.  
Architects, Smith & May,  
Baltimore; Contractors, Burn-  
ham & Co.

North Shore Golf Club,  
Chicago, Ills.

Exposition Building, Erie, Pa.  
Architect, Joseph Lee  
Contractor, William Siegrist

Grace Baptist Church, Bing-  
hamton, N.Y. Architect, E.H.  
Bartos; Contractor, William  
Ray.

Residence, Rear Admiral Chad-  
wick, Twin Oaks, Newport,  
R. I.

Rensselaer County Hospital,  
Troy, N.Y. Architects, Pem-  
ber & Camnaign.



# The Practice of Architecture

**M**ANY things give indications of changes in the making. Through conversation, correspondence or reading these signs are constantly recurring testimonies, and a tabulation is unconsciously made of them until the ideas become insistent in their presence. To verify the general impression, a systematic collation of all the evidence is in order.

In arriving at a conclusion by this mental process, it will be found that among the diverse problems demanding attention at this time, one of manifest importance is that of the attitude of the public toward the architect and of the architect in his relations to himself and others.

The practice of architecture is probably today, more than ever before, a matter of barter and trade. The monies invested in building structures demand a return service which represents full value. This value is measured in the adaptability of the structure to its use, its durability and its appearance. These three factors are the fundamentals of correct planning and to render adequate service it appears to be essential that the architect should fully qualify himself to meet these basic requirements.

An analysis has been made of a great amount of data pertaining to this subject and the majority opinion has been condensed into the following five paragraphs which embrace the most common of the points developed. This brief consensus of opinion is not intended to cover the multitude of conditions that exist in such relations, but it is thought that possibly it comprises the basic factors.

1. The business of architecture is inseparable from the profession of architecture. Together they comprehend the originating, promoting, designing, planning, directing and controlling the construction of buildings and their appurtenances.

2. To develop a general demand for architectural service—without which only limited opportunities for practice will be presented—the architect must, as an individual and collectively, employ proper and effective means to create a universal appreciation of its intrinsic value.

3. To fully perform his function, the architect must organize, equip and operate his business so as to render complete service in the production of plans and specifications for everything embraced in the construction, equipment and furnishing of buildings.

4. He must furnish complete and detailed supervision of construction and be closely identified with it. He must be responsible financially, as well as morally, for all of his acts, including the correctness of design, the completeness and accuracy of plans, specifications and details, and the construction of the building in accordance therewith; his responsibility to be contingent only on his being accorded freedom in deciding all matters of structural design, mechanical equipment and the selection of materials and workmen.

5. He must control and regulate the business affairs of the building operation so as to safeguard all interests. He must be just and impartial in deciding all controversies within his jurisdiction, but where his own interests are involved he must submit the controversy to arbitration.

*(Reprinted from issue of November 27, 1918)*



MAIN DOORWAY—CHURCH OF S. AMBROGIO, MILAN, ITALY



# THE AMERICAN ARCHITECT

VOL. CXV

WEDNESDAY, APRIL 23, 1919

NUMBER 2261



PROSPECTIVE ALONG STREET NO. 2

## A Housing Development That Solves the Lodger Problem

The Naval Ordnance Housing Development, South Charleston, W. Va.

GODLEY, HASKELL & SEDGWICK, *Architects*

RENEWED interest in the many developments of the United States Housing Corporation, work on which was so suddenly stopped at the cessation of hostilities, has been awakened by the recent announcement from Washington that twenty-two of the larger housing projects will be completed. The excellent work of the corporation in directing the development of such a large number of schemes, each with its individual problems, has attracted wide interest, and much has been said and written regarding the workman's home and its influence upon plant production and labor turnover. This is of a highly beneficial effect, for now that the war is ended it has brought forcefully to the attention of the heads of large industrial organizations the necessity for closer study of the Government's methods of handling the housing situa-

tion in the late emergency as they pertain to their own individual needs. Industrial housing, both from a federal and private standpoint, has come to be recognized as one of the big problems of reconstruction.

From the architect's point of view the problem of design is one where economic and social rather than purely aesthetic requirements are of prime importance, but it is only in meeting all three that he can reach a satisfactory solution. This has been emphasized by the Corporation, and is illustrated in their projects. Many complex though decidedly interesting situations have arisen where, restricted by conditions and limited by appropriation, the architect has had skillfully to meet demands for ample-size living rooms for general use and sleeping rooms of sufficient number and size to assure

## THE AMERICAN ARCHITECT



VIEW SHOWING SOUTH CHARLESTON, THE ORDNANCE PLANT AND

good standards of morals and health. The wishes of the housewife, and her national or local peculiarities must be carefully considered, for her contentment is of prime importance to the home. It is interesting to note how in various developments conditions which at the start were considered obstacles have by study often enhanced the artistic and practical solution. The success of the housing projects of the Corporation is directly traceable to the fact that they were built to suit the needs of the American workingman, and at the same time to educate him, by their modern refinements to appreciate bettered home conditions.



STREET NO. 2, LOOKING WEST

An illustration of these points and of the successful solution of the lodger problem is shown in the development built for the United States Naval Ordnance Plant at South Charleston, West Virginia. This project was in charge of a committee of design of which Godley, Haskell & Sedgwick, architects, acting as chairmen, were associated with James L. Greenleaf as town planner and designing engineer, and Burgess and Long in charge of engineering work in the field.

The development was originally intended to consist of a twenty-five-acre allotment by the Government, to include a community center, but when this was reduced to fifteen acres the recreation features were the first to be eliminated from the plans. Situated on the south bank of the Kanawha River, forty-three feet above the water level, about a quarter of a mile from the main entrance of the Naval Ordnance Plant, and four and one-half miles from the city of Charleston, the site is an admirable one for a well-developed housing scheme. The natural features of the topography blend harmoniously with the treatment given them. Gullies and woods and other details of the land have been utilized most advantageously. The woods, for instance, suggested the laying out of two curved streets which have added to the informal appearance of the village's thoroughfares.

The eighty-five houses are of five types, each of individual interest though harmonizing in design.



## THE AMERICAN ARCHITECT



THE LOCATION OF THE INDUSTRIAL HOUSING DEVELOPMENT

The buildings were to be as fire-resisting as possible, so stucco on hollow tile was used with composition slate roofing, substituted for slate as a matter of economy. To meet climatic conditions, each house has a summer kitchen as well as a large front porch. The houses of the four and five-room types are semi-detached, and to give each family the maximum of privacy, the porches are kept well apart instead of adjoining. The four-room house, the smallest unit, has a living room with a kitchen dining room on the ground floor and two bedrooms, each with two exposures, and a bath on the second, this on a ground area of 14 ft. 3 in. by 25 ft. 6 in. The five-room house has a dining alcove off the kitchen and an extra bedroom on the second floor. The eight-room houses have a separate side entrance which gives direct access to a lodger's suite of two bedrooms with a lavatory and toilet; the only connection of these rooms with the main portion of the house is through the lobby.

The housing corporation's requirements as to design have been closely followed. Living rooms for general use are all of an area not less than 10 ft. by 13 ft. 2 in., entirely separate from sleeping rooms. A cross ventilating system has been worked out in each home through windows of ample size. Each bedroom has at least 400 cu. ft. of air space per occupant, and every room has direct sunlight. Blinds were originally designed for the houses, and

although economy dictated that they should not be put up, demand by some of the tenants for them has now caused their installation.

This problem of economy has been given a thorough study by the committee. They have made it their prime consideration, and as a result they have given the workingmen every comfort and convenience in a modern development, thus supplying their wants at a fair rental. The practice of economy has included the use of stock lengths of timber throughout. The trim is of the simplest design. In considering this project, it is shown that the difference in first cost between good con-



STREET NO. 1, LOOKING NORTH

## THE AMERICAN ARCHITECT



FRONT ELEVATIONS, TYPE A



REAR ELEVATION, TYPE B

struction and poor construction is not great and is speedily amortized in reduction of repair bills.

Every phase of the development has been carefully handled by the architects. The street paving is concrete throughout. It was at first planned to build tar-bound slag roads, but as it was impossible to get enough tar for the work, concrete was substituted. The main thoroughfares of the community are 24 ft. wide, while the adjacent streets are laid out with a minimum of 20 ft. width. Three-foot-wide sidewalks are to be found, with a planting strip to an average width of six feet in which 220 plane trees have been set out.

The house lots average 100 ft. in depth and are from 25 to 40 ft. wide. Thirty-two hundred privet bushes were planted in hedge rows which mark each property line between the lots. The houses are so located on the lot that in every case there is room for a driveway should the tenants wish to put up garages at the rear of the property.

The houses are lighted by electricity, while natural gas is used for cooking and heating. Twenty-

five of the houses are heated by hot water; the others having stoves, and a gas radiator placed in each bathroom. No cellars have been provided due to the fact that the Kanawha River often overflows its banks and considerable flooding of basements might have resulted. Just south of Eighth Avenue the plans show a contemplated athletic field, bandstand and shelter, and, as the project is further developed, additional features for the recreation of the workers and their families.

A distinct feature of the development lies in its proximity to the munition plant. It is but seven minutes' walk to work, and so handy that many return home for the midday meal. The failure of many housing projects, especially those erected to take care of shipyard employees, has been traced to the fact that the center was not only too far away from their work, but also too distant from the city, where they might care to go for an evening's diversion. But that is not the case at the Naval Ordnance Development, where the thriving city of Charleston can be reached in a very short



FRONT AND SIDE ELEVATIONS, TYPE B



FRONT AND SIDE ELEVATIONS, TYPES E AND I



## THE AMERICAN ARCHITECT

time—it is only four and one-half miles distant—by trolley.

Due to the fact that the development is on Government property none of the houses can be sold. Consequently they have to be rented at an attractive figure. It is interesting to note that the detached dwellings of six and eight rooms are more popular than the semi-detached ones with fewer rooms.



FRONT ELEVATION, TYPES G AND K

This is explained by the fact that there are a great number of men who, because of their specialized ordnance qualifications, earn good wages at the plant, and these are the men who demand to live



STREET NO. 3, LOOKING NORTH

in the best possible style within their means. Some of them seem to feel that if they share a semi-detached house with a fellow-worker they will lose that sense of pride in what corresponds to individual ownership of their dwelling.

A distinct feature of the Charleston development is the adaptability of the houses to take care of the lodger situation. Some of the worst housing conditions in the country are to be found in old mansions stranded by the receding tide of fashion and now occupied by four or five families, all sharing the same toilet and water supply. In the Naval Ordnance Development the lodger is kept strictly to his own province. He has private toilet facilities and separate entrance to his rooms; in no way does he interfere with the privacy of his landlord.



PANORAMIC VIEW, LOOKING EAST

# Specification Clauses

By FRANCIS W. GRANT

## III.—Function of Specifications—Titles and Captions\*

### SPECIFICATIONS—THEIR FUNCTION

10. This specification is intended to supplement and explain the drawings in so far as said drawings fail to entirely express the full and true intent of the parties to the contract.

In case of discrepancy between the drawings and the specifications, except that due to omissions from the specifications, the requirements of the specifications shall be given precedence and be binding upon the parties to the contract to the exclusion of any conflicting requirement of the drawings.

**T**HE true function of the specifications is expressed in the first clause of the above paragraph, and if architects who acquiesce in this view could be induced to proceed accordingly there would result a vast improvement in the writing of specifications. This is not advanced as a new and novel theory, for most architects hold this view as to what constitutes the mission of the specifications.

Frequently, specifications are fruitful of controversy and litigation by reason of the inclusion of requirements intended to be in duplicate of those plainly and more properly shown on the drawings but which, through some slight error of punctuation, typography or judgment, are not really identical.

Anything capable of delineation on the drawings should occur there and in no other contract document. There is rarely an instance requiring the statement of a dimension in the specifications when drawings are properly prepared. Dimensions should be rigorously excluded from the specifications except when it is impossible or impracticable to show them on the drawings.

Another mischievous error in specification writing is that of attempting to give "bills of quantities." Under the prevailing custom of bidding and contracting for architectural undertakings the scheduling of quantities in the specifications is unbusinesslike and as much to be condemned as the attempt to make dimensions more accurate by repetition. No intelligent contractor would trust a quantity estimate made by an architect except at the architect's risk, and architects are not paid for assuming such risks. Furthermore, architects are not, as a rule, competent to schedule quantities correctly and in language and form consistent with trade practices.

As to the matter of conflict between the drawings and the specifications, many architects prefer so to write their specifications as to reserve to themselves the sole right to determine which of two conflicting requirements shall be valid, defending such course as being an act of interpretation, and as such especially within the province of the author of the drawings and the specifications. Some even go so far as to provide that the instrument, the requirement of which represents advantages to the owner, shall prevail in case of conflict.

It is more equitable, however, to give the specifications, which are always prepared (or should be) after the completion of the drawings, an invariable precedence, and such is the established practice of the courts.

For those architects, however, who feel that they must have some better provision for escaping the consequences of their own blunders and who wish more power over the contractor than their own competency and the above suggested specification clause affords, the following clause from Wait's "Engineering and Architectural Jurisprudence" is suggested as being as near one sided as possible:

"In case of repetitions, variations or discrepancies in the terms of the contract, specifications and drawings, the interpretation and determination of which are doubtful, it is distinctly understood that the engineer (architect) may adopt that interpretation or construction which shall secure in all cases the most substantial and complete performance of the work, and be most favorable to the city, company or owner, and secure to it the most ample protection."

Conflict of more or less importance between the drawings and the specifications is a probability rather than a possibility, as any architect of large experience can testify, and provision in the specifications tending to establish a reasonable procedure is highly appropriate. The A. I. A. Code of General Conditions ignores the subject. The nearest approach to it is a clause in Article 2 of the Code, stating as follows: "It is not intended that materials or work not covered by or properly inferable from any heading, branch, class or trade of the specifications shall be supplied unless distinctively so noted on the drawings." This, of course, is mere surplusage, being self-evident to the merest novice in legal procedure. It is not, however, entirely harmless, for by inference if not in fact it makes the headings or titles in the specifications a part thereof

\*For previous article see issue of July 3 (No. 2219), 1918.



## THE AMERICAN ARCHITECT

and obligations "inferable" from a heading may be imposed on the parties," though in no other manner, on drawings or in specifications, shown or mentioned.

### TITLES AND CAPTIONS

11. Titles to divisions and paragraphs in this specification and the index to same are introduced merely for convenience and are not to be taken as a part of the specification and are furthermore not to be taken as a correct or complete segregation of the several units of material and labor. No responsibility, either direct or implied, is assumed by the owner or architect for omissions or duplications by the contractor or his sub-contractors, due to real or alleged error in arrangement of matter in this specification.

Though the specification writer may fully intend to write in correct sequence and make appropriate segregation, it frequently occurs that items get into the wrong classification, whereby a sub-contractor is misled and makes omissions, or two sub-contractors are misled and identical items are included by both.

In either event trouble of more or less serious nature results.

A case recently taken to court was that of a sheet metal sub-contractor who refused to furnish certain metal covered window frames to the general contractor under a contract to "furnish all sheet metal according to specification," his grounds for refusal being that these frames were specified under carpentry with the wood window frames, and were not mentioned in that part of the specifications designated as "Sheet Metal Work," and hence were properly of the carpentry sub-contract. The court held that the specifications were misleading, and sustained the sheet metal sub-contractor.

The practice of so using captions of paragraphs that they *must* be read as part of the subject matter is sometimes harmless, but it is always slovenly and should, on that score if no other, never be permitted.



GARAGE FOR POLICE DEPARTMENT. BOSTON, MASS.

COOLIDGE & CARLSON, ARCHITECTS

# A Plea for a Classic Tradition

ARTHUR STRATTON, in the leading article in a recent issue of *The Architects' Journal* of London, reviews in a scholarly manner the conditions as affecting architecture in England at the present time, and sets up a plea for a classic tradition.

Mr. Stratton in reviewing the field of architectural design refers to a state of things almost identically analogous to those that exist in this country. He emphasizes the importance of the necessity for a complete recognition of pure form, and interestingly points out how the substitution of cheaper material and its intelligent adoption, may lead to the highest development of a new classic type.

We commend Mr. Stratton's article to careful consideration. It is as follows:—

With the cessation of hostilities comes a yearning for pent-up energies to be expended. Destructive intent is giving way before creative impulse, as naturally as day follows night. A long period of enforced inactivity in the realms of peaceful building will inevitably be followed by a still longer period during which activity will know no bounds, and during which enthusiasm will be rekindled even where it had almost seemed to be stifled beneath overwhelming stagnation. Events may prove that architecture, the first of the arts to suffer in any world-wide upheaval, will be the last to come into her full stride again, but already the air is full of projects; new vistas are opening up in all directions, and the universal longing is for a new and saner world to arise from the débris of a civilization that has been well-nigh pounded to bits. Never has such opportunity offered as now presents itself to survey the chaotic conditions under which architectural design was fostered in this country at the time when Armageddon overtook it. A break with them has been made possible. The building arts have been cast into the melting pot; it is for architects to say whether dross shall come out or pure metal. It is for the nation to see that victory over armed aggression shall be followed by a renaissance of the arts of peace.

England during these years of strife has been brought into close touch with her numerous Allies. Tens of thousands of her sons have trod the soil of lands which might never have been more than mere names to them, but which will now have other memories than horrors of the battlefield. It would not be the first time that advancing armies have been in the van of movements that have changed the in-

ternal aspect of a country for lasting good. Exchange of ideas with men from other lands and sights of cities in many climes have helped in the past, and cannot fail to help again, in breaking down the fetters of insularity which, when dominant, have always had such numbing effect on the outlook of the untravelled British-born. This wider knowledge, this closer intimacy with men and things overseas will inevitably have widespread influence on the nation as a whole, no less than on the individuals who constitute so large a part of it, and from this contact will ensue a closer union of thought and a sense of universal brotherhood beneficial to mankind from whatever standpoint it is viewed.

Unity of purpose in combined action has knit nations together for generations to come; to architecture this should have real portent, just as inspiring and far-reaching in its results as the contrary effects of the Napoleonic war were deadening and narrowing. Cut off, then, from intercourse with the other side of the Channel, jealous of their neighbors, and intolerant of their sentiment, Englishmen prided themselves during a long period on their insularity, and scorned whatever could be construed into bearing a "foreign" impress. The banalities of the Victorian era were the due reward; architecture sank to the lowest depths, to be saved in a measure only by revivals one after another, as confidence was restored and as the teaching of the Romanticists called for a wider field of exploit than was afforded by the heritage of mediæval England. But the calamity brought by one war may very well be effaced by the blessings arising out of another and a greater war. History does not necessarily repeat itself in every detail. The pendulum has swung back; England not only enjoys a truer friendship with France than ever before, but she has become more cosmopolitan in the best sense of the word. The conditions are ripe for picking up the wonderful traditions which bound the arts of Europe together before they were so disastrously severed by the events of 1870. The same thread ran through the conception of design in architecture in France, Russia and Germany, too, that weaved many a masterpiece in Great Britain and Ireland. There was a tacit universal understanding of the first principles of design, as apparent in the work of Labrouste and Schinkel as in that of Chambers and Cockerell. The war has revealed the eternal truth of first principles in directions where they have been lost sight of, and nowhere had they been more obscured than in the art of design as practiced by a long succession of archi-



## THE AMERICAN ARCHITECT

pects in this country. Confusion of thought had made the direct expression of a building the most rare achievement; the higher qualities of design had too long been sacrificed to ideals that are not of the best. Meaningless display of architectural features and worthless ornament, culled from a prolific past, have too often done service in hiding deficiencies that trained imaginations could never have tolerated.

General acceptance of a wider conception of design alone can bring architecture back to the main line of development along which progress was being made with the rest of Europe a century ago. To abandon side tracks is no indication of lack of real progress, for it has to be recognized that they lead by tortuous routes to no goal worth reaching, while the highway leads straight to the Capitol, no matter how steep the ascent may be. France has never lost sight of this, and America with steady purpose has resolutely pursued the same course. In England, the conservation of national prejudices and the jealous safeguarding of individual expression have helped to isolate architecture from the kindred arts, and more serious still, to curtail the comprehensive grasp of structural problems that alone could vest purely utilitarian works with æsthetic quality. Trained engineers were not slow to meet the requirements of industry; a breach once opened between architect and engineer rapidly widened as a result of the narrowing outlook of the one and the expanding vision of the other. The old order must change; the dimmest eyes can see a gleam of light that will penetrate far and wide unless apathy once more falls like a blinding curse to dim the vision of a future now made attainable through untold destruction of systems shown to be uninspiring and decadent. Rome was not built in a day; the classic tradition of the Italian school took centuries to reach its zenith. Architecture has ever been slow to reflect changes in the state of society, but that they have always been unmistakably recorded is such a truism that the Mistress Art is likened in common parlance to "history in stone."

Wherever the theory of academic design has already been accepted, it will be strengthened by the outstanding lessons taught in the prosecution of the war. Foremost among them are numbered concentration on matters of vital import; clearness of aim, and above all unity of purpose, all of which are as essential to design in architecture as to the successful prosecution of a campaign. But where the seed had not been sown, it is for the schools to sow it, and to watch its growth through the impressionable years of immaturity. Concentration on pure form should be a primary aim, and the direct expression of that form the keynote of all endeavor; while unity of thought with the traditions pursued

to such good purpose in the schools of our Allies should bring our teaching into line with theirs, building up year by year links in the chain which should bind them together in lasting harmony. No sacrifice of national expression need result from this acceptance of principles which are no more foreign to the soil of this country than to that of any other. No country can claim a monopoly of them, for east and west, north and south they have remained constant since the Greeks first grasped them and the Romans applied them, not only in their own land, but wherever their victorious armies gave them fresh fields for building enterprise.

The importance of pure form needs to be recognized above all else in the coming year, for it is likely that with the resumption of building activity will come the demand for extreme simplicity of mass and dignity of outline, resources no longer permitting of the stock-in-trade of meaningless features and ornament which in the past have engendered a false criterion of public taste. The use of materials costly in normal times may have to be avoided, and architects will in all probability be faced with the problem that the builders of Imperial Rome solved with incomparable skill by the aid of an inferior material. But to concrete as the Romans used it, new possibilities have been foreshadowed by the science of reinforcement in steel; limitations of material no longer offer insuperable difficulties to the spanning of wide areas and the carrying of loads on supports far smaller than they conceived to be possible. There never was more urgent need for so-called "science" to be welded to so-called "art," for the gulf between engineer and architect to be bridged. The exposition of classic principles must once more become part of the vernacular language of this country if the tide of commonplace architecture is to be stemmed and if architects are ever to regain their lost supremacy.

It must not be supposed from this reasoning that a stereotyped version of design would result. Architectural progression depends upon the activities of a nation as a whole, and buildings of outstanding merit will mark its progress from time to time, almost unannounced, due to exceptional endeavor on the part of individuals more gifted than their confrères. During the last half century evidence of what can be achieved by expressing modern conditions in classic language can be seen in the work of American practitioners, who at first seized upon Colonial traditions—inspired originally by this country—and later envisaged the masterpieces of the European continent. In this way a national style develops, as far removed from the original source of inspiration as the poles are apart, and yet instinct with everlasting truths.

# Recent Legal Decisions

## CONCLUSIVENESS OF ARCHITECT'S CERTIFICATE

Although by the terms of a building contract the construction of the plans and specifications is left to the decision of the architect and he is made the arbiter of the character of the work done by the contractors, and the contract purports to make his certificate to the owner conclusive, his construction of the plans and specifications and his certificate are not binding and conclusive if it be shown that his acts were in bad faith, and were arbitrary and oppressive or malicious. Assuming that the architect in good faith believed that a proper construction of the plans and specifications required the contractors to fill the lot on which the building was to be erected, which the contractors did not do, this afforded no ground for acting arbitrarily and oppressively or maliciously with respect to other matters involved. It was incumbent upon him to settle that issue upon its merits. If the owners terminate the contract upon the architect's certificate that the work is not being done according to the plans and specifications, the fact that the architect acted arbitrarily, oppressively and not in good faith was held to preclude the owners from recovering damages from the contractors for breach of contract, although there was no actual fraud on the part of the owners.—*Lund v. McClinton (Mo.)*, 205 S. W. 240.

## SURETY'S LIABILITY

A surety under its bond guaranteed that the contractor would pay all claims for labor and materials furnished. The contractor failed to pay claims for material. It is held that the owner could maintain an action on the bond without actually satisfying such claims, since liability on the bond accrued when the contractor failed to pay the claims.—*Ceremony v. Drummond (Cal.)*, 174 Pac. 696.

## SAFE SCAFFOLDING

A bricklayer in the employ of an independent contractor who had undertaken the construction of the wall of a building was killed as the result of a defective scaffold. In an action for his death it appeared that the owner and architect retained no right to control or direct the action of the contractor in the progress of the work, except in regard to the depth of the foundation, the material to be used, and generally to require a compliance with the contract. It was held that they were not

liable in the absence of a statute imposing liability upon them. The Illinois statute of 1913 provides that all scaffolds erected or constructed by any person for use in erecting, repairing, altering, removing or painting any structure shall be erected and constructed so as to give proper and adequate protection to the employee using it. It is held that under this statute the duty to comply with its terms is placed upon those actually constructing the scaffolding and other appliances, and consequently not upon the owner or architect where they do not erect the scaffolds or appliances.—*Bretin v. Levinson*, 207 Ill. App. 406.

## BOOKKEEPING ERRORS IN LIEN CLAIMS

Errors in bookkeeping in regard to a lien claim, resulting in a delivery of more material than was reasonably necessary to complete the buildings and a failure to note certain credits for materials returned, made through honest mistake and not willfully, will not render the lien void. Though some of the items were nonlienable the subcontractors would be entitled to a lien for the lienable items after deducting the credits for returned materials.—*Columbia River Door Co. v. Todd*, Oregon Supreme Court, 175 Pac. 443.

## REPAIRING DAMAGED BUILDINGS

A section of the Atlantic City building ordinance provides that when a building within the fire limits shall be damaged to an amount not greater than one-half of its value, exclusive of the value of its foundations, it may be repaired or rebuilt; but, if damaged more than one-half that value, it shall not be repaired or rebuilt, but shall be taken down. The owner of a building partially destroyed by fire desired to repair it, and claimed that the building had been damaged less than one-half its value; the municipality claimed that the damage exceeded one-half the value, and desired the building to be taken down. It was held, in a suit for injunction by the owner against the city, that the owner's remedy at law was adequate, and he could not have injunction to restrain interference with the repair of the building. But it appeared that some rooms on the first floor could be used if temporary roof were provided. It was held that the owner was entitled to have interference with temporary repair restrained, since irreparable damage might otherwise result, and the city would in no wise be prejudiced if the injunction were granted.—*Atlantic City Fire Ins. Co. v. Board (N. J.)*, 103 Atl. 1044.



THE AMERICAN ARCHITECT

Founded 1876

PUBLISHED EVERY WEDNESDAY BY

THE ARCHITECTURAL AND BUILDING PRESS, INC.

No. 243 West Thirty-ninth Street, New York

E. J. ROSECRANS, PRESIDENT AND TREASURER  
WILLARD C. HOWE, VICE-PRESIDENT

WILLIAM H. CROCKER, Editor  
ARTHUR T. NORTH, Engineering Editor

Subscriptions in the United States and Possessions,  
Mexico and Cuba, TEN DOLLARS. Other Countries,  
TWELVE DOLLARS.

SINGLE COPIES (Regular Issue) 25 CENTS

CHICAGO OFFICE, Mallery Building  
PAGE A. ROBINSON, Western Manager  
ST. LOUIS OFFICE, Wright Building  
CLEVELAND OFFICE, Guardian Building  
SAN FRANCISCO OFFICE, 320 Market Street

Owned by United Publishers Corporation—H. M. Swetland, President;  
Charles G. Phillips, Vice-President; W. H. Taylor, Treasurer;  
A. C. Pearson, Secretary. Entered as second-class matter January  
6, 1909, at the Post Office at New York, New York, under the Act of  
March 3, 1879.

VOL. CXV APRIL 23, 1919 No. 2261

“Democratizing the Institute”

MANY expressions of opinion have been received from fellows and members of the American Institute of Architects, based on the editorial “Democratizing the Institute,” which appeared in THE AMERICAN ARCHITECT of April 9.

A compilation of this material is being prepared and when completed will be transmitted to the Post-War Committee on Architectural Practice, in accordance with the committee’s request for constructive suggestions from the entire profession of architecture, and those interests affiliated with it, for “improvements which will affect the conditions and increase the efficiency of architectural practice throughout the United States.”

Speed Up Building At Once!

The situation resulting from the lack of increased construction activity is growing more acute each day. One of the most gigantic problems to be dealt with in half a century is now being faced by this country. It affects the fortunes of millions of persons in various cities in the quest of homes that cannot be supplied. The immediate erection of additions to dwellings in communities where they are so badly needed is the only solution of the housing

problem that is rapidly approaching a crisis. Present building activity is but a ripple on the surface.

In 1914 America built only 7 per cent of her quota. In 1915 and 1916 about 55 per cent—in 1917 and 1918 about 30 per cent. This country is over two years behind in its normal building program. We are facing a vast demand for buildings—and facing it without any reserve stocks. Conditions are proportionately similar all over the country.

New York City is today short 100,000 apartments. During the last four years the city has grown in population 500,000, excluding transients. In normal times this growth would have been kept pace with by the building industry, but as little or no building is being done to meet this increasing demand, the city is confronted with a serious situation. If the average yearly growth is at the rate of 4 to 5 per cent, this would require additional housing accommodations for at least 250,000 persons yearly—in view of the fact that people in New York City are on the average housed four to an apartment—this would approximate over sixty thousand new apartments yearly. New York is now paying tribute in the shape of increased rentals to the amount of \$5,000,000 monthly.

The situation in New York City was discussed in an informal way last week by Leonard Schultze of the firm of Warren & Wetmore at a meeting of the New York Building Managers’ Association. In the course of his remarks Mr. Schultze said:

“Now is the time to build, not next year. In the first place, labor will never be cheaper than it is today. There may be some reduction in the price of steel and building material, but not enough to be worth while waiting for, considering the present demand.

“As a matter of fact, there is not more than a 20 or 30 per cent increase in building costs, as compared with three or even four years ago.

“We will see the greatest building boom this country has ever known if we can only get the big loaning institutions to release the required capital to finance the construction. It’s coming and it’s coming fast and prices of material will advance as soon as construction starts. The New York Central Railroad Company has every parcel of its property along Park Avenue and in the vicinity applied for, but it will not be able to do anything until Walter Stabler of the Metropolitan Life, or some other big loaning company, sees fit to loan the necessary money.”

Only this week, at a meeting of the Philadelphia Operative Builders’ Association, discussion as to the building of new dwellings discloses that there is a shortage of more than 20,000 houses in that city. Take Philadelphia’s case as an example:

During the years 1910 to 1916 there was constructed in that city an average of 7500 dwelling houses each year, about 90 per cent of which were two-story brick dwellings in rows; and during the year 1917 this fell off to 2500 houses, and in 1918 to less than 1000 houses erected by private investors and approximately 1000 workmen’s dwellings

erected by the United States Government agencies. Taking as a basis only the normal conditions that prevailed previous to 1917, there is a shortage at the present time of more than 10,000 houses in Philadelphia, and when the influx of workmen from other sections of the country is considered, it is no exaggeration to state that fully 20,000 houses are required at the present time to relieve the congestion.

Atlanta, Ga., reports that there are today in Atlanta approximately one thousand families seeking the rental of houses and apartments, with less than a dozen rentable houses in that city to supply the demand. It is conservatively estimated that Atlanta requires five thousand new homes to domicile the people who are now practically homeless there.

What is true in New York, Philadelphia and Atlanta holds good proportionately in practically every other growing city in the country. These conditions are wide-spread and are natural, post-war conditions. Will the cities provide these necessary new homes and meet the emergency by building now?

### The Humanities in Educational Curricula

A WRITER in the current issue of *World's Work* refers to the curriculum at West Point. While directing attention to the great number of men who have since their graduation from the military academy gained high reputations, he is of the opinion that there is room for improvement in the courses of study as at present pursued. He states:

"Too much of the four-year course is wasted; too great effort is expended in an attempt to make the education general. Too little effort is made toward specialization. More efficient officers could be turned out if, after the first two years of general work, the cadet could select or be appointed to the branch of the service with which he is to work, and be taught specifically along those lines. But what is probably the greatest fault with the West Point curriculum is its failure to teach what might be called the humanities, the proper relation of man to man, the real democracy of service."

The experience gained since we entered into the war has taught many valuable lessons. Not the

least of these is that our educational methods need revision along more practical lines. It is interesting to note that there is a disposition to regard the curriculum of an educational institution hitherto always believed to be nearing perfection, as one which might properly receive consideration toward the development of specialization along lines of fitness.

The recommendations for West Point, as above set forth, might well be taken as a basis in the program for a revision of architectural educational methods. In a recent issue there was discussed in these columns a movement set afoot at Columbia University which would provide a means of determination as to the exact fitness of students for a college training, and once this fitness was established a further determination as to just what specific branch the student might with best results study would follow. Such a system makes for the highest and most valuable results.

During a four-years' course opportunity is afforded to observe the special fitness of each student, and when this has been determined the procedure might be exactly as is proposed for West Point. By such a method we would be spared the misfits so common in most professions, and in none, perhaps, more than in architecture.

Let us, by all means, include in our educational methods a better teaching of the humanities. Perhaps the tendency during the past has been too largely to ignore this important element in architectural education, leaving it for the student to absorb whatever he might gain in a knowledge of his fellow men by contact during his student-course.

Architects need a fuller realization of the humanities, or, more properly speaking, personal relationship in their practice, and when such a realization has been reached, and its attainment directed and encouraged by teaching methods, they will undoubtedly lose much of the aloofness that in the past has caused them to be regarded by the general public, and often mistakenly by themselves, as aristocrats.

Teaching such humanities would certainly lead to "a real democracy of service," and that is a consummation toward which the post-war committee might lend its efforts to a very good purpose.



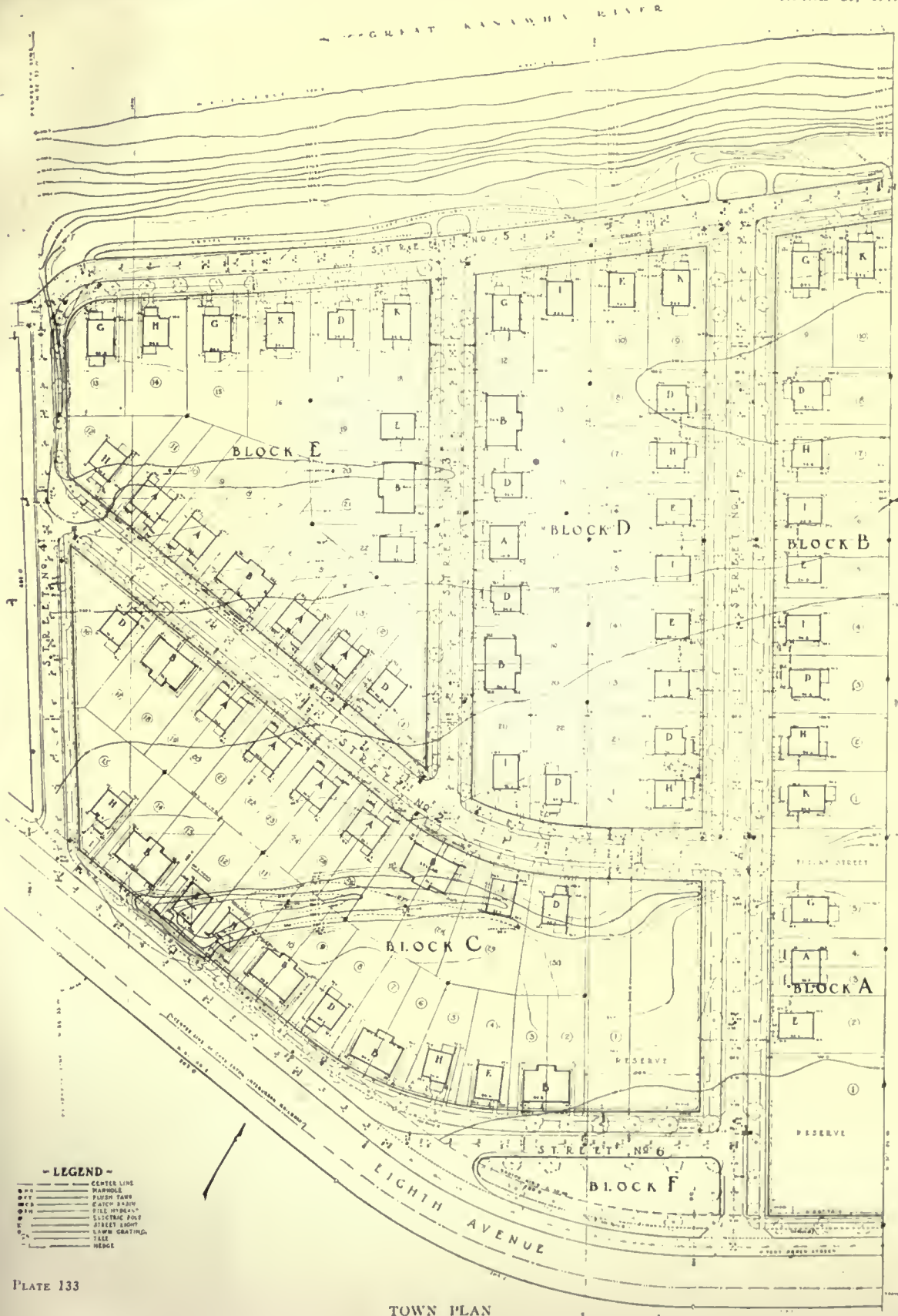

- LEGEND -**
- CENTER LINE
  - MANHOLE
  - CATCH BASIN
  - ELECTRIC POLE
  - STREET LIGHT
  - LAWN GRATING
  - HEDGE

PLATE 133

TOWN PLAN

NAVAL ORDNANCE HOUSING DEVELOPMENT, SOUTH CHARLESTON, W. VA.  
 GODLEY, HASKELL & SEDGWICK, ARCHITECTS







REAR OF HOUSES ON STREET NO. 5



PLATE 134

HOUSES OF TYPES A AND B FRONTING ON STREET NO. 2

NAVAL ORDNANCE HOUSING DEVELOPMENT, SOUTH CHARLESTON, W. VA.

GODLEY, HASKELL & SEDGWICK, ARCHITECTS





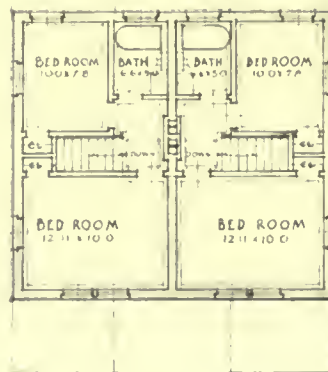
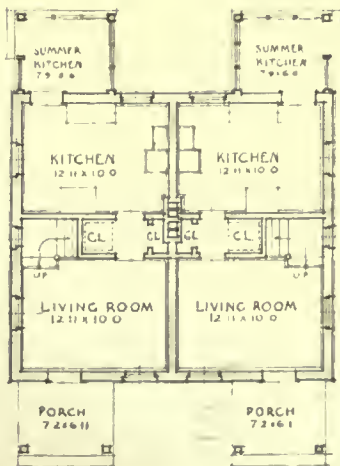
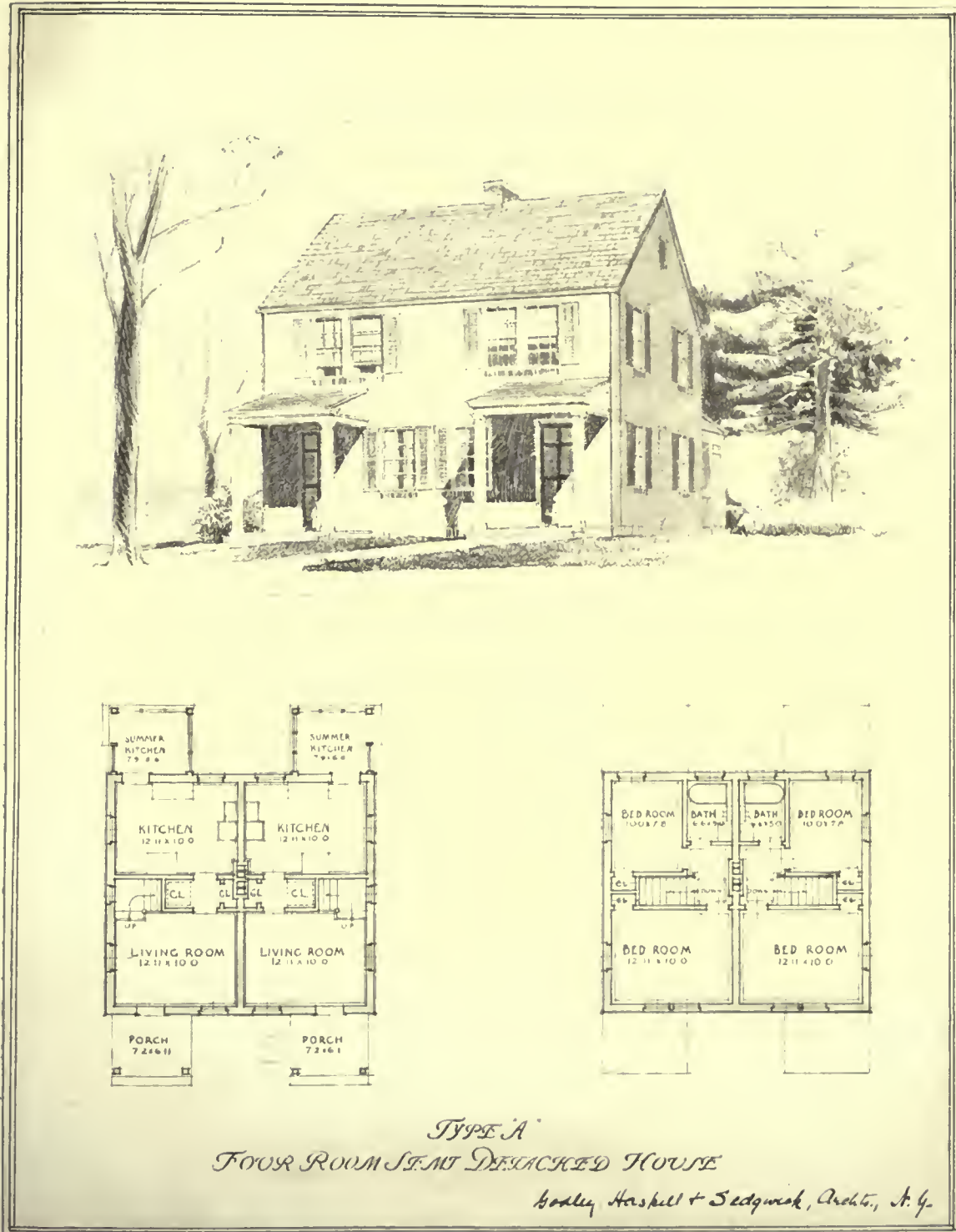

*TYPE "A"*  
*FOUR ROOM SEMI DETACHED HOUSE*

*Hodley, Haskell + Sedgwick, Architects, N. Y.*





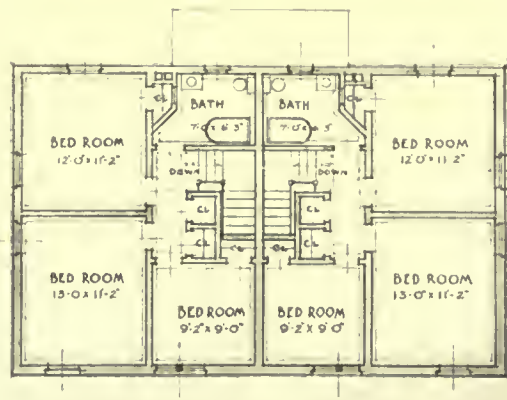
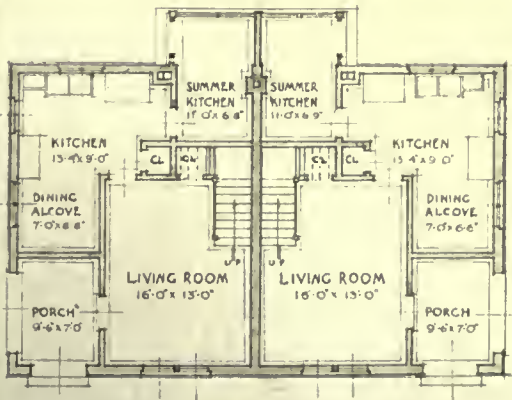

*TYPE 'B'*  
*FIVE ROOM SEMI DETACHED HOUSE*

*Bodley, Haskell & Sedgwick, Architects*

PLATE 136

NAVAL ORDNANCE HOUSING DEVELOPMENT, SOUTH CHARLESTON, W. VA.





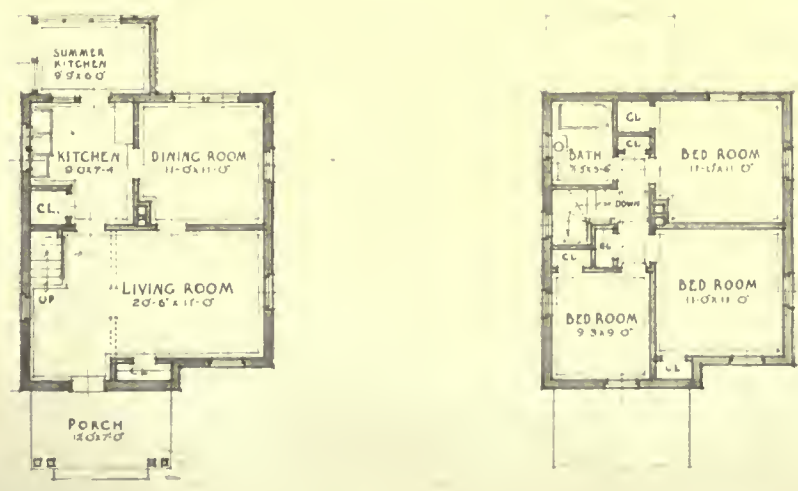

*Type 'D'*  
*Six Room House*

*Bodley Haskell + Sedgwick, Architects, N.Y.*





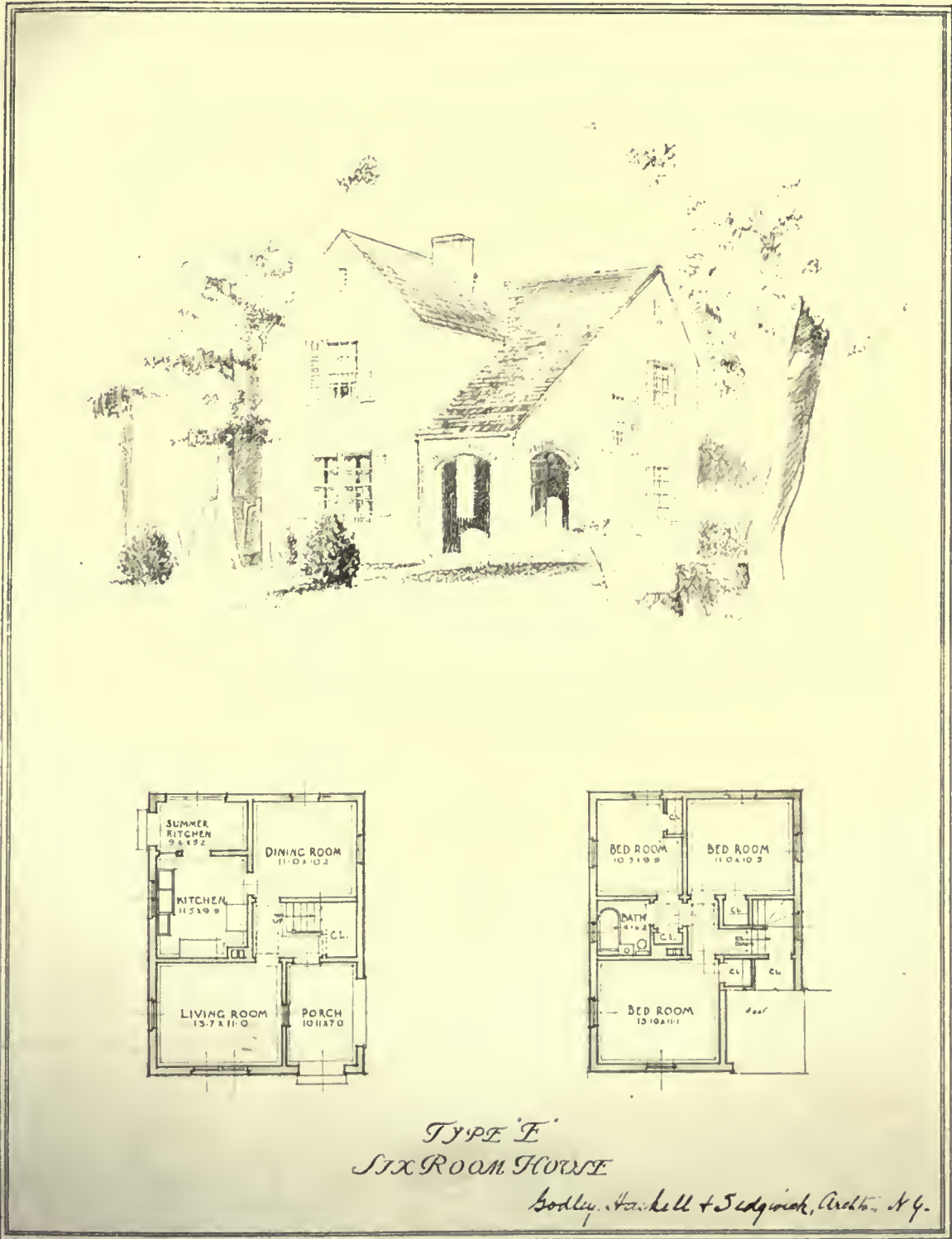

PLATE 138

NAVAL ORDNANCE HOUSING DEVELOPMENT, SOUTH CHARLESTON, W. VA.







PLATE 139

NAVAL ORDNANCE HOUSING DEVELOPMENT, SOUTH CHARLESTON, W. VA.





# Current News

---

## City Built of Zinc

Bareira, in Portuguese East Africa, is the only zinc city in existence. Zinc is the only practicable material so far known, which is capable, states an exchange, of withstanding the peculiar climate. It took some thousands of people who make up the population only six months to build the place. Hospital, church, arsenal, and every dwelling is of zinc; and even most of the railway cars are of zinc throughout.

---

## Building Work Increases

Records for the first three weeks of March, issued by the Department of Labor, show that contracts for building and construction aggregated \$96,619,791. It is estimated that the total amount for the month will reach close to \$150,000,000. These amounts exceed those for the same month in any former year. Contracts for about \$51,000,000 were made in January, compared with \$95,000,000 for February. The New York district reported 186 projects amounting to \$8,372,682.

---

## Forest Protection in Canada

The aeroplane as an aid in forest protection has not been tried out anywhere except for a short season in Wisconsin several years ago, but this Spring will probably see one or more aeroplanes patrolling timber areas in Canada, according to information just issued by the Canadian Forestry Association.

Great sums of money are spent each year in forest fire protection in Canada, the Province of Ontario alone now spending more than \$500,000 yearly for that purpose.

---

## South African Timber Markets

The high price of imported timber, due to the rise in freight and the difficulty in obtaining supplies has led to unusual attention being paid to South African woods, reports the American Vice Consul from the Transvaal. The match factories are running entirely on the locally grown material, and numerous box factories have sprung up in various places throughout the country. Reports indicate that the South African pine compares favorably with much that is imported.

The local demand has been the means of stimulating the interest of farmers and landowners in tree planting, and the government has shown some activity in meeting the needs for afforestation.

---

## Keep Pavement Intact Five Years

It has been nothing new to find that no sooner than a city street has been well paved and the people have begun to take a personal pride in its improvement, said pavement is cut up to allow for the placing of a pipe line or service connection.

Attention is called to the solution of this problem in Cleveland, Ohio, by the *Engineering World*. In this city, some time before paving is undertaken, signs are posted conspicuously along the street, giving notice of the proposed work, and requiring that all underground connections be placed before the paving is done. Thereafter the pavement must not be cut for this purpose for a period of five years. The warning reads: "This street will be paved. All underground structures, gas and water pipes, etc., must be put in at once. After completion, no permit to cut will be granted for five years." It is signed by the mayor.

A restraining influence of this kind is one more incentive for civic pride, and might with good purpose be emulated in other instances.

---

## Devises New Victory Emblem

Inspired by Col. McRae's poem, "In Flanders Fields," Miss Michael, a war worker with the Y. M. C. A., overseas conference headquarters, located at Columbia University, has designed an emblem entwining the Flanders poppy with the torch of Liberty, which she offers for adoption as a national victory memorial to be displayed throughout the country as America's continuous pledge that we shall keep in memory those who sleep in Flanders fields.

---

## Reforestation in Europe

According to reliable information in Government quarters, the forests of France, so carefully protected and cultivated for centuries, saved the cause for the Allies. More than 40,000 trees a day were cut during the four years of the war to meet the demands of military leaders. Not only because of these demands, but from neglect and the rav-

ages of war, the forests of France have been depleted, the war having destroyed more than two billion board feet of lumber and caused the neglect of about 750,000 acres of valuable woodland.

Reforestation is one of the French post-war problems, and Norway has planned to help out in this restoration by planting a belt of Norwegian forest trees in the front zone. The plan comprises the planting of 250 acres a year for five years and the sending of a forestry party of 50 fully equipped Norwegians, even bringing their food supplies, so as to save France any expense in connection with their work.

England and Wales had three million acres of woodland before the war. Now it has been reduced to two million acres, and the Government is faced with a reforestation problem. Its plans include the use of acres of stag-headed oaks, which are on private estates, and the planting of many new areas.

---

### Historic Property Sold

A residential development in connection with property in South Orange Township, N. J., is responsible for the transfer of ownership of the old Timothy Ball house in Ridgewood Road there. The Ball house was built in 1743 by Timothy Ball, a third cousin of General Washington, who frequently visited his relatives in this house during the Revolutionary War.

The house is located on the slope of the mountain between South Orange and Maplewood, in full view of several battlefields where British and American armies camped during the course of the conflict.

One interesting feature of the building is a small, square aperture in the front wall of the house which leads to an old-fashioned built-in bed, which for purposes of warmth, rather than economy of space, as now advocated, adjoins the huge chimney. The house is built of stone and occupies a four-acre site. Patriotic and historical societies are hoping it will be possible to preserve the old landmark intact.

---

### Sacramento Capitol Extension Delayed

Word comes from California that a postponement of about two years is likely in the completion of the Capitol extension. State Architect G. B. McDougall is pessimistic at the situation. It seems to be one further example of having committed to paper some worth while ideas and of not following them out.

The money was voted for this improvement in 1913 and it is said not a spadeful of earth has been turned. There are many excuses, but no one has undertaken any responsibility in the matter, and no solution is in prospect.

---

### Immediate Building

Representing the United States Department of Labor, Leslie W. Sprague spoke before the Rotary Club in Passaic, N. J., on the subject of building with relation to immigration.

Mr. Sprague declares that if building operations are not immediately undertaken it will be impossible to build at all within the next few months, due to what he believes an inevitable exodus of labor from this country.

Thousands of laborers, he said, are seeking passports to go back to their native countries where work will be plentiful during reconstruction. It is probable that the United States will lose more from this cause than it will gain by the coming of emigrants from Europe. "Within two years," said Mr. Sprague, "America will be face to face with a labor shortage of large proportions, as there will be no labor coming into this country. There is only one way to overcome the situation and that is to build now while we have the opportunity. Build while the labor is still here and available."

---

### Canadian Rail Construction

After-war construction on railroads in Western Canada, to begin at an early date in order to employ a large number of laborers, involving an expenditure of \$60,000,000, and reaching out into 3,000,000 acres of land, is contained in the development program of the Dominion railroad interests. Coal lands in the vicinity of Regina will be opened by virtue of the next extensions and thus employ additional labor in the operation of the mines.

---

### Expect Business Revival

Members of the New England Hardware Association, in annual convention in Boston, when queried as to the business outlook, remarked that it was "picking up considerably." They are the "outside men," so to speak, of the hardware industry, and they are looking forward to an early revival of big business. The whole matter of decided stimulus to the business, as sized up by the meeting, hinges upon what labor proposes to do.



## Demand Will Tax Mills' Capacity

Europe's reconstruction requirements are expected to make the United States the leading lumber exporting nation of the world, according to J. E. Rhodes, secretary-manager of the Southern Pine Association.

"With every country on the globe entering a great building period, reports from foreign investigators received by the Association indicate a serious shortage of lumber in practically all centers of consumption abroad," said Mr. Rhodes.

"Cut off largely from their normal sources of main supply because of economic and political demoralization in Russia and Austria-Hungary, and the natural limitations of Sweden's production Great Britain and the rest of the continent are looking to America to make up the deficiency caused by the virtual elimination of these three nations, which before the war contributed more than half of the world's total lumber exports. Foreign buyers are already arriving in the United States in considerable numbers, not only from Europe, but from South America, Australia and Africa, which have been practically without lumber supplies for four years, due to curtailed ocean transportation facilities.

"Russia before the war held first place as a lumber exporting country, and in 1913, the last normal year, sold to foreign buyers 5,513,618,000 feet or 26 per cent of all lumber exports, according to figures compiled from a report of Dr. Edward Ewing Pratt for the Bureau of Foreign and Domestic Commerce. Second in importance at that time was Austria-Hungary, whose exports in 1913 aggregated 3,635,473,000 feet, 17.1 per cent of the whole. Sweden contributed 15 per cent with 3,167,549,000 feet while Canada supplied 13.3 per cent, or 2,833,546,000 feet. In spite of her immense forest resources and unequalled manufacturing equipment, the United States in 1913 ranked fifth in the list of important lumber-exporting nations, with only 12.7 per cent of the total exports to her credit. This amounted to 2,700,575,000 feet, only a little more than Finland's exportations, which were 2,531,281,000 feet.

## Would Replant French Forests

A project for reforesting the battle areas of Europe has been advanced by Charles Lathrop Pack, ex-president of the World's Court League.

"About one and one-half million acres of forest land in France were destroyed by shellfire or cut down for war-time need," said Mr. Pack. "Practically all of Belgium's forests with any timber value have been felled by the Germans and sent to

Germany or used for fuel. Great Britain made a great sacrifice for war work, for fully 450,000 acres of forests were felled to meet war-time needs. In Italy also great sacrifices were made to supply the army with trench timber and firewood.

"Many claims are made as to who won the war, but I am safe in saying one of the greatest agencies was the forests of France, for those forests held back the enemy time and again. The offer of the American Forestry Association to aid in reforestation work has been accepted by the forest authorities of France, Belgium and Great Britain, and the association will shortly call upon the American people to aid in this great undertaking."

## Chicago School of Architecture

The Bulletin of the Chicago School of Architecture, illustrating students' work in architectural design, free-hand drawing and water color, has been received. The work illustrated is grouped by years. This method interestingly shows the progress of the student from the start to graduation, and permits opportunity to study the course of architectural education in design as conducted.

The work, naturally selected from the best available material, shows a wide range of subjects carefully and artistically treated, and discloses to a certain degree the system employed in instruction. It is an extremely creditable showing.

## New Organization to Expand Trade

A committee has been organized by the Department of State to co-ordinate the work of all Government departments in building up and extending American interests in foreign trade. This activity means that much of the extensive research work done in the last years by various Government departments may now be utilized to promote the expansion of American commerce. It also means that official recognition will be given to the need for obtaining long credits and removing other obstacles which have heretofore hindered the accomplishment of that purpose.

The Department of Commerce has been investigating the opportunities awaiting American industries in South America, and international conferences have been held. Financial problems have been discussed and ways considered to enable the United States to compete on an equal basis with any other country. A period of great development is in sight in South America, which opens fields of the utmost importance to any nation which has

## THE AMERICAN ARCHITECT

extensive interest in foreign trade. Similar efforts are being made in connection with European and Far Eastern fields.

The formal announcement of the Department of State says in part:

The committee includes representatives of all the governmental offices which deal in any way with foreign trade matters. Its duty is to formulate conclusions and to harmonize and co-ordinate all governmental activities in any way connected with foreign trade, thus safeguarding the economic future of the nation.

The committee will provide advisory and supervisory machinery of Government executives for unifying the work of further extending and developing the business interests of the United States in foreign channels.

Prominent among the problems which will receive immediate attention are tonnage allocation and marine freights, cable and radio facilities, reconstruction loans and Latin-American loans, consortiums for buying in Europe, labor and immigration and the development of what are known as "key industries," such as the dye industry and strategic raw materials.

The chief purpose, however, is to compile data and promote co-operation with the various Government agencies represented in the organization, for the most expeditious fulfillment of beneficial foreign relations.

---

### Meeting Industrial Unrest

The progress being made by employers in realizing the humanity of labor has again been exemplified by a performance of the International Harvester Co. This organization controls seventeen American and three Canadian plants, which comprise 30,000 employees.

The officers of the company have recently evolved an "industrial council" plan, which has for its purpose the representation of the employee in deciding matters pertaining to working conditions, health, safety, hours of labor, wages, recreation, education and other questions of mutual concern to employer and employed.

An election has been held in all twenty plants to determine how far creation of the "industrial council" had approval. All the Canadian and all but three of the American plants accepted it enthusiastically.

In each plant which approved the plan it is proposed to organize a "works council," details for which have been carefully worked out. In the three which did not, the company posted notices of the result of the vote, and stated that no further action would be taken in the matter except at the request of the employees. Two have already petitioned for another vote. The company made no effort to sway opinion. It attempted no campaign to induce the men to vote for the measure. They were simply asked to express their wishes with

regard to an arrangement which officials of the company believe will make for a better understanding between themselves and their employees, and which promises to safeguard their interests and make possible a speedier adjustment of grievances.

---

### Canadian Lumber Supply

The report that the government of Great Britain is to buy a billion feet of lumber in Canada this year has brought out the statement from prominent dealers here that if this order is received it will be the biggest boom to the industry that Canada has experienced in the past fifty years. It is claimed that there is not a billion feet of lumber in all Canada available for ready delivery, so that the order could not be met for the present at least. During the past two years labor has been very scarce, only old men and boys being available, and they demanding the highest wages.

In the province of New Brunswick there is little lumber cut awaiting shipment, this year's cut being about 60 per cent of normal—practically the same as last year. Influenza played havoc in the lumber camps the past winter, many having been compelled to close entirely because of it.

---

### Newark Window Designed by R. A. Cram

A memorial window, designed and executed by Ralph Adams Cram, architect, is being installed back of the chancel in Trinity Episcopal Cathedral Church, Newark, N. J. The window is regarded as a most excellent example of modern stained glass, and is the gift of Mrs. Frances Parkman of Boston in honor of her parents, Mr. and Mrs. Cortlandt Parker, Jr., and her brother, Cortlandt Parker, Jr.

---

### Cleveland Chapter, A. I. A.

The Cleveland Chapter of the American Institute of Architects held its monthly meeting on Thursday, April 3. There was no pre-arranged program, as arrangements in connection with the convention in Nashville had to be made.

At the March meeting of the Chapter an informal talk was given by Sergeant Carl S. Briggs, son of President Herbert Briggs. Sergeant Briggs had just returned from France, where he saw service in the camouflage section of Company B, Fortieth U. S. Engineers.



## Will Raze Historic Philadelphia House

The Guernsey mansion, built in 1705, and one of the oldest houses in Philadelphia, will be demolished shortly to make way for the new home of the Frankford Trust Company. The house has been in the Guernsey family for more than 200 years. The foundations were laid when Frankford Road was known as the King's Highway, and the house was occupied by ancestors of Martin Van Buren, eighth President of the United States.

There were few houses north of Frankford Creek at that time, the principal ones being the summer homes of the Guernseys and the Smedleys, who came over with William Penn. The original title to the Guernsey mansion describes it as "situate on the King's Highway below Jolly Post Inn." In the heyday of its Colonial fame it far outshone any of the houses of the period for social activity. Washington and Jefferson, when Philadelphia was the capital of the United States, visited there.

One of the greatest days in the history of the Guernsey mansion was in September, 1824, when Lafayette visited Philadelphia in his tour of the United States. A triumphal arch was raised over Frankford Avenue from the front of the old mansion, and beneath it the great Frenchman and friend of America passed, amid the plaudits of a mighty throng.

## The Marbles of Italy

Italy is one of the world's most famous sources of supply for both art and building marbles, and marble, granite, and building stones are the common materials used for buildings in that country. Venice is a fireproof city, built of stone of Istria and marble; and the foundations and first courses, at least, of all palaces, public and municipal buildings, government and business edifices are of these materials.

Venice is immediately adjacent to famous marble quarries with an inexhaustible supply of raw material, worked by cheap labor. The Istrian stone, which is quarried just across the Adriatic, reaches Venice by the cheapest forms of water transportation, being loaded on sailing barges at the quarries, and disembarked at the exact point where it is to be used.

The most important quarries in the Veneto are at and near Verona, the Veronese red and yellow marbles having been favorite building stones since the time when the Coliseum at Verona was constructed. For building they rank next to the stone of Istria in popularity, and are true marbles, while

the stone of Istria is not a true marble, although a very hard limestone, that is much used in Venice because it resists the action of salt water.

Besides their value for construction, the Veronese marbles are in great demand for decorative work. Among the names of the several varieties of Veronese marbles are white nembro, coral pink, white peach, partridge eye, yellow snail, yellow azure, and paradise.—*Scientific American Supplement*.

## Tells of Artists' War Achievements

Marcel Knecht, the chief of the Bureau of Public Information for the French Government in America, was recently entertained at dinner by the members of the Architectural League of New York. Mr. Knecht, who before the war was managing editor of the magazine *Art et Industrie*, published in Paris for the advancement of the arts allied to architecture, spoke to the members of the league on the subject of "Nature as Expressed in the Arts of Lorraine."

The conference was illustrated with lantern slides showing recent achievements by the great artists in the part of France nearest to the bloodiest battlefields of the great war.

Mr. Knecht was introduced by H. VanBuren Magonigle, president of the league. There were about sixty members of the society present at the dinner. The speaker showed the close connection between local industries and local art of Lorraine, Nancy and Luneville.

The natural resources of the country, such as the salt mines, sand, forests, etc., had encouraged and made easier, he said, masterpieces in glass, wood, and pottery. He spoke of the work of such modern French artists as Galle, Daum, Majorelle, Mouglin, and Baccarat, all of whose work, he said, should be better known in this country. On the effect of the war regarding French art Mr. Knecht said:

"France needs to be protected not only against German art but even against German ambition. Some people believe that the revolution pacified the German spirit of domination, but there is still existing danger in this quarter."

## A Timely and Valuable Pamphlet

Bulletin No. 17, for the first quarter of 1919, issued by the Municipal Art Society of New York, very thoroughly discusses the subject of war memorials and illustrates the best and most important examples that have been erected. This publication should be in the hands of every individual and

every committee that will be intimately connected with this subject.

The illustrations in this bulletin are of the most artistic expression in the form of memorials that has been made in this country. They show exactly what may be accomplished when these matters are carried forward in an artistic and painstaking manner. They offer, further, an object lesson by the illustration of a number of types of Post-Civil War memorials classified under the very proper heading of "What Not to Do." In addition to featuring St. Gaudens' beautiful Farragut memorial in New York, and the equally good Shaw memorial in Boston, there are presented fountains, bridges, exedras, doorways and stained glass, each one of which constitutes a part of our artistic heritage.

It is vitally necessary that the warnings and admonitions of a society of this important character should be carefully heeded and considered, and if this is done we need have no fear for the future of memorial art in this country.

Copies of this pamphlet, the price of which is twenty-five cents, may be had by addressing the Society of Municipal Art at 119 East 19th Street, New York. We cannot too strongly urge that this Bulletin be used as a reference and guide in important memorial undertakings.

---

### Wants Material Prices Specified for Seasons

Roy G. Owens, general sales manager, Lakewood Engineering Company, Cleveland, Ohio, believes that if material prices were published for specified periods they would then become established in the minds of the public, a confidence established between buyer and seller would be created, and there would result little halting in the construction business. Mr. Owens says:

"If every producer who is not already doing so will adopt this plan, making his prices known to the public, I believe that confidence will be restored and that the present enormous potential demand will be brought into action. Perhaps the best examples of this plan are the retail dry goods business of the country, whose prices are known to every individual through publication in advertisements and through tags on the goods in the stores, and the automobile industry, which once every season names its price to the public for that season, so that every individual, possible customer, or not, is made familiar with the value of the article.

"These two industries are perhaps the only two

large industries whose business has been and is now active since the armistice.

"If the manufacturers of cement, of steel, producers of lumber and other building materials, manufacturers of clothing, food products and machinery, had followed this method and the prices of these commodities were established in the minds of the public, there would not now be the marked halting in business.

"Help stabilize business promptly by adopting a plan of action with this slogan: 'Prices effective for specified periods or seasons will establish confidence between buyers and sellers.'"

---

### Where Work is Waiting

While there is a tendency for architects to be attracted to large cities as the center of their activities, which is in many respects justified, there are reasons why the smaller towns might prove "mettle more attractive." There is the idea, among these, that an architect is practically without a rival in some of the smaller towns in the Middle West. Mr. O. R. Hardwell, secretary of the Freeport (Ill.) Chamber of Commerce, taking that city as an example, says:

"Here we are, right in the heart of the richest farming country in America, tapped by nine railway lines, three hours' ride from Chicago, and not a single architect in our city of 22,000 population. Can you beat it?"

"This peculiar situation is common to many towns of our size in the Mississippi Valley. Moreover, it strikes home with a cold thud, when we begin guessing about our prospective work in this period of rebuilding and reconstruction—who is going to make our plans?"

---

### Competition for Rebuilding French Towns

A society called "*Renaissance de Cimes*," founded in 1915, has drawn up plans for the reconstruction of the war-torn districts in northern France. The city of Chauny has opened competition in which the Allies are invited to participate, for rebuilding the town and its suburbs in a manner to be modern and healthful in every respect. Before the war, Chauny was a prosperous city with a population over 10,000, but the last years have seen its almost complete destruction. In this competition the first prize is the sum of \$2,000, and a number of smaller ones will also be awarded. Prize-winning plans are to be exhibited in Paris.



## Lumber and the Box Industry

Based on production in 1912, 11.6 per cent of all lumber produced in the United States is converted into boxes. In fact, the manufacture of packing boxes and shooks, crates, fruit and vegetable packages and baskets is the second largest wood-consuming industry in the United States. More than four and a half billion feet of lumber annually, of which softwoods constitute about 69 per cent and hardwoods 31 per cent, are used by box makers in the United States.

## To License Building Contractors

The results of a licensing law for contractors would doubtlessly be so valuable that any movement to encourage such a procedure must be of interest to architects. A movement for this purpose in line with the general tenor of the program of the Post-War Committee is one proposed by the Wisconsin Master Builders' Association and to be discussed at its next convention. An effort can properly be made to encourage legitimate members of that industry and protect them from the increasing number of incompetents.

## Minnesota Proposes Registration of Architects

A bill providing for the examination and registration of architects has been reported upon favorably by both House and Senate legislative committees and is now before the legislature of Minnesota for final action.

The object of the bill is to stabilize the practice of designing and planning. While not prohibiting use of plans without state authorization, it places responsibility where it belongs and gives the people definite information as to the ability of the designer. It also gives the public an added security by the examination and certification of all applicants, permitting only those qualified to subscribe themselves "registered architect."

## J. Cleveland Cady

J. Cleveland Cady, senior member of the firm of Cady & Gregory, architects, of 40 West Thirty-second Street, New York, died on Thursday, April 17, of heart disease, after an illness of two months at his home, 214 Riverside Drive.

Since 1870 Dr. Cady—he had received the honorary degree of LL.D. from Trinity College in 1905

—had practiced his profession in New York, the associate member of the firm he established being William S. Gregory. Born at Providence, R. I., the son of Josiah and Lydia Cady, he received his early education at academies in New England, and was graduated from Trinity College with the class of 1860.

Dr. Cady was the designer of many of New York's most important buildings, notably the Metropolitan Opera House, the American Museum of Natural History, the later buildings of the Presbyterian Hospital, the Skin and Cancer Hospital, Bellevue Medical School and the Hudson Street Hospital. For Yale University he designed no less than fifteen buildings, including the Lanson, Fairweather, White, Berkeley and Pearson dormitories, Dwight Hall and the Chittenden Library. Examples of his work are also to be found at Williams, Trinity and Wesleyan.

Dr. Cady was president of the Skin and Cancer Hospital, a governor of the Presbyterian Hospital, a trustee of Berea College, vice-president of the New York City Mission, and president of the National Federation of Churches. His clubs included the Century, the Aldine, the Quill and the Delta Psi Fraternity.

Last autumn Dr. Cady presented to the library of Trinity College his collection of books and photographs relating to architecture. This collection comprised 375 volumes and more than 2000 photographs, and was considered one of the most complete of its kind in the country.

## Personal

Architect Allen Logg has opened offices at 319 Hippodrome building, Cleveland, Ohio, and is desirous of securing catalogs.

Architect Jos. G. Ludgen has removed his office from Room 910 to 1633 Monadnock Building, Chicago, Ill.

Architect Norman T. Vorse, 911 S. & L. Building, Des Moines, Iowa, has consolidated with Kraetsch & Kraetsch.

C. L. Momot, architect, who has been associated with Hawk & Parr, architects, has opened an office at 409 Empire Building, Oklahoma City, and is desirous of receiving catalogs and data.

W. H. Cameron, general manager of the National Safety Council, has resigned to become manager of industrial relations of the Eastman Kodak Company. His place will be taken by C. W. Price, formerly field secretary of the National Safety Council.

# Late News from Architectural Fields

Special Correspondence to THE AMERICAN ARCHITECT

## Government To Spend \$305,369,464 On Public Improvements

WASHINGTON, D. C., April 21.—Construction work is being launched by the Government at a rapid rate.

By the end of the fiscal year 1921 there will be available for Federal aid for State road building more than \$266,000,000. Congress passed the appropriation for \$9,050,000 for new hospitals and improvements to old ones needed by the Public Health Service and this building activity is being rushed and will be under way by the end of the year. Some of these projects will be under construction by midsummer. More than \$30,000,000 are involved in the maintenance and construction work set out in the rivers and harbors appropriation bill passed by the last Congress.

There is an appropriation of \$1,500,000 for the building of a sanatorium at Dawson Springs, Ky., the survey is being made; and for the site and hospital plant at Norfolk, Virginia, \$900,000 has been appropriated. An appropriation of \$550,000 was made to take care of the hospital project in the District of Columbia and \$190,000 were voted for improvements in the Marine Hospital at Stapleton, Staten Island, N. Y.

For most of these projects plans now are being prepared and it is safe to say work on all of them will begin within the year.

About 150 projects are being held up, for the most part post office buildings. Almost every State in the Union is represented in this list of deferred projects which involves the expenditure, on present construction prices, of more than \$23,000,000.

Many of these projects were contemplated before the war and money appropriated to cover the construction costs on the then prevailing prices. Estimates at that time showed these buildings would cost approximately sixteen and a half millions. The present estimates are about six millions more and before the work can be undertaken Congress must appropriate enough money to take care of this increase in building costs.

## Optimistic As To Building Prospects

Speaking of building conditions in the central west, Albert S. Owen, secretary of the Society of Architects, Kansas City, Mo., is of the opinion that residential construction should start later this year than usual, but that it will proceed normally when it becomes apparent that the general demand for homes will hold values up and insure against depreciation.

"The building of factories is already progressing generally in the central western states," he says, "larger interests being first at sensing the permanency of conditions.

"Material men, who see an assuredly and continuously active world market for their wares for the next ten years, believe that not only will it be impossible to duplicate later for less cost, homes that are constructed this year, but that the usual depreciation of a residence will be balanced in the next ten-year period by the general increase in real estate values."

"When the idea penetrates the public consciousness," one wholesale lumberman remarked, "and the fact that lumber never did take more than a quarter or a half as much of a rise as several other prime commodities in the war period, there will not be much hesitancy about building investments."

## Architects Hear Lectures

A number of lectures of more than usual interest to architects have recently been given at the University of Michigan. The first of these was given on March 13 by Albert Kahn on French Chateaux. The illustrative slides were from sketches made abroad by Mr. Kahn and from photographs.

On March 16 and 17 Professor Wm. H. Goodyear, Curator of Fine Arts of the Brooklyn Museum, gave the following illustrated lectures: "Optical Illusions and Architectural Refinements in Mediæval Cathedrals"; "The Widening Refinement in French Gothic Churches and Cathedrals"; "Architectural Refinements in Greek Temples." Prof. Goodyear is the greatest living authority in this field.

## Explain Chicago Building Hold Up

A letter from fourteen Chicago architects has been printed in the daily press of that city to the effect that building work, estimated at \$93,000,000, plans for which have been prepared by these architects, has been held up by high prices. The firms and the amount of building they are to supervise were printed as follows:

Graham, Anderson, Probst & White.....	\$20,000,000
Holabird & Roche .....	10,000,000
Marshall & Fox .....	13,000,000
Christian Eckstrom .....	8,000,000
Charles S. Frost .....	5,000,000
Richard E. Schmidt, Garden & Martin.....	5,000,000
F. E. Davidson .....	5,000,000
George C. Nimmons & Co.....	1,000,000
Samuel N. Crowen .....	5,000,000
Henry J. Schlacks .....	1,000,000
Walter W. Abschlager .....	5,000,000
C. W. & G. L. Rapp .....	7,000,000
Alfred L. Alschuler .....	5,000,000
Board of Education: F. Hussander.....	3,000,000
Total, \$93,000,000.	

## Build Now, Says Senator Underwood

United States Senator Oscar W. Underwood, speaking before the Birmingham, Ala., Real Estate Exchange, recently advised against the policy of postponing building activity and industrial development with the expectation of cheaper materials and labor later on. Said Mr. Underwood:

"Persons who will not build now because they have to pay more dollars for the material and the labor are taking the wrong view; they are measuring by the wrong standard, the wrong yard stick. We are not going to get back to 1914 for a long time."



# Financial and Commercial Digest

## As Affecting the Practice of Architecture

### Banks Study Amortization of Loans

Periods of reconstruction are intensely satisfactory from the point of view of those who advocate methods as opposed to the inertia of custom. There is not the opportunity to discuss new methods for temporary building loans and long term real estate mortgages in connection with the campaign to stimulate activity in building. The American Bankers' Association is making real progress for the advancement of plans of institutional investors in real estate loans as opposed to custom.

Amortization of loans is the principle upon which emphasis is placed as a method which will: (1) Make available a greater turnover of funds for re-investment in the renewed activities of the building industry. (2) Remove that element of speculation from the risk of investment that so often relies in vain upon an appreciation in the value of land to offset depreciation in the value of structures. (3) Replenish the reservoirs of financial capital, by encouraging thrift in the borrower, so that the supply of investment funds will flow uninterruptedly in response to requirements of the builders of national wealth.

Of marked significance is the fact that the American Bankers' Association Committee in charge of the campaign for amortization includes among its members a prominent representative of the United States League of Building and Loan Associations. This is as it should be, for the reason that the funds for investment in real estate loans provided by the building and loan associations of the United States, both in respect to the amount of capital contributed and in respect to its direct effect upon the prosperity of the building industry, is relatively as important as the amount contributed by the State banks and trust companies combined, or the insurance companies alone.

Rapid changes are developing in methods of banking technic that touch the public. Changes within the banking system itself, due to the tendency for banks of all types gradually to merge their activities into the style of the Federal Reserve System, give rise to the belief that funds destined for investment in mortgages no longer will follow

old channels in their customary volume. These changes are said to be the cause of reduced investments by new member institutions in real estate loans.

Suggestions already have been advanced from more than one quarter, that the country needs to develop a new medium, similar to the Federal Farm Loan Board, that should devote its special attention to temporary building loans and long-time real estate mortgages in our cities. This clearly is the function of a mortgage bank.

The United States League of Building and Loan Associations has been particularly active in impressing upon the Government the need for home loan banks that will standardize mortgage collateral and create a broad market for the securities based thereon. Interest prevails between the American Bankers' Association and the United States League of Building and Loan Associations in the matter of amortization. There is a possibility that these two interests may agree on establishing a federal mortgage bank. The American Banking Association bulletin develops the history of long-term mortgages abroad down to the establishment of the *Crédit Foncier de France*, recording that before the war this institution was offering to lend on mortgage for 75 years at 4.3 per cent, plus an amortization premium. The law under which the *Crédit Foncier* was formed contains provisions which have been more or less closely followed as models in other European countries.

The Division of Public Works and Construction Development, since embarking upon its campaign for renewed activity in the building industry, from the start has realized the important influence that new facilities for discounting mortgage loans and for the sale of collateral trust and debenture bonds would prove to be. Now that certain financial interests are united in the selection of models that have been successfully followed elsewhere in the establishment of mortgage banks, there is reason to hope that the same institutions soon will be ready to unite upon an acceptable plan for a new medium in the United States to extend the proper and adequate facilities sorely needed to finance the increasing activity of the building industry.



## Late Quotations in Building Material Markets

WITH the firm determination that nothing shall stand in the way of a free building market after the Victory Loan drive, building material manufacturers in eastern sections of the country are doing everything in their power to assure price stability for the rest of the year. By the establishment of maximum values for cement and barrel lime for the season the situation has taken on a decidedly brighter aspect, for the far sighted builder is not concerned as to how low the market will drop but as to how long it will remain at the low level.

Cement manufacturers took a most aggressive and logical step when they agreed to guarantee the market against any higher prices than \$3.25 per bbl., delivered in New York City, for the balance of the year. In addition to the agreement that Portland cement quotations will not go higher until January 1, 1920, the ten companies representing the industry, decided that if there should be a price reduction in favor of the builder that these firms would each follow the reduction. Besides this, the building lime manufacturers, representing the entire industry, have determined to meet shortly and fix a maximum price that will hold good until September 1. This date was chosen so as to permit manufacturers to attain a still lower level in event that the demand is great enough to allow the revision of costs to what is termed a quantity basis, in which event there will be a further drop.

It is probable that action on the efforts of the cement and lime manufacturers to stabilize prices will be followed by similar guarantees from other material producers and that this big movement will have its reflection in the building revival convention to be held May 7-8 in Cleveland, Ohio, by the National Federation of Construction Industries.

The action of the cement and lime manufacturers has to a great extent counterbalanced the unsettled state in the steel market, which followed the controversy between the Industrial Board and the United States Railroad Administration. Dispatches from Washington are to the effect that the Director General must take the entire responsibility for the results that must follow the frustration of the purpose of the Industrial Board to stabilize prices and stimulate building because the administration refused to accept the prices thus determined. That was the statement made by Chairman Peek in reply to the notice issued by Director General Hines to the effect that the board had set prices without authority.

Before the board, blocked by the refusal of the Railroad Administration to accept steel prices, abandons the vital industrial policy which it represents, the board will lay the entire matter before the President for final decision.

Mr. Peek declared:

"The use by the Railroad Administration of its enormous buying power to reduce any price would necessitate one of the following courses, increasing the price to the public, throwing all railroad business into a monopoly of powerful producers or reducing wages.

"While the Director General is within his rights in insisting upon his technical prerogative to determine prices, he is also under an obligation to see to it that the governmental policy is abandoned by the same authority that announced it, and to assume full responsibility for the results."

A reduction in brick prices and the establishment of a maximum level has been thwarted by strike of the Tide Water Boatmen's Association in New York Harbor, which has greatly increased the cost of handling this commodity between the Hudson River brick yards and the wholesale docks. Sand is scarce with two leading companies in live competition for the business. Gravel, grit and crushed stone prices are consequently irregular.

At a meeting held last week in Washington, represented by members of the American Institute of Architects, banks and trust companies which aid in financing building operations, builders, real estate men and labor unions, it was decided to call a conference in the near future to discuss stabilization of prices. Every city is beginning to realize that some action must be taken immediately to insure a resumption of building activity, knowing that while prices of materials and wages are above the 1914 levels they are no longer prohibitive if confidence can be had in their general stability.

Charles S. Keith of Kansas City, President of the Southern Pine Association, told the Legislative Commission investigating the prices of building materials this week that the present price of lumber was lower than it would be at any time in five years. He said that the increased cost of production, depletion of raw material in this country, and the increased demand from Europe to rebuild the areas devastated by war were certain to mean higher prices for lumber. Mr. Keith submitted statistics in support of his statement.

---

*(Special Building Report from our Chicago Correspondent)*

CHICAGO, ILL., April 21.—The beginning of actual building operations is resulting in fairly good demand for practically all materials in this market. While most of the work started is for small houses and repairs on old structures, dealers now believe it is but a matter of short time before big projects will be under way. Architects are busy with plans, and the lumber and material dealers say there is more figuring with contractors now than at any time since this country engaged in the war.

Figures given out by Building Commissioner Charles Bostrom indicate building permits issued in March for new structures showed a total of \$5,000,000 in value, an increase of 100 per cent over those issued during the same month of last year. Real estate men report a demand for small houses in the suburbs and outlying districts. Prices on most of the building items are holding exceptionally firm.

---

*(Price quotations now current on building materials and supplies as quoted by dealers and jobbers for delivery in New York and Chicago, follow. The quotations set forth are placed before readers of THE AMERICAN ARCHITECT to afford an accurate review of market conditions, rather than for use as a basis for actual purchase. They will not only provide knowledge of the exact state of the market as to items quoted, but will also present a basis to judge conditions as affecting co-relating materials. Items marked (\*) indicate an advance over last week, while those marked (†) record a decline. Other prices did not fluctuate during the week.)*

# THE AMERICAN ARCHITECT

	New York	Chicago
<b>BRICK—</b>		
Common (for Borough of Manhattan only), per thousand .....	\$15.00*	\$12.00
<b>CEMENT—</b>		
Per bbl. in 15 cent bags (Rebate 60c. per bbl. for bags .....	3.25	2.80
<b>COOPER SHEETS—</b>		
At the mill, hot rolled, 16 oz. base-price, per lb. ....	22½c.	22½c.
(From jobber's warehouse add 2 to 3 cents.)		
<b>EAVES TROUGH—</b>		
Galvanized Steel .....	60%	10%
Galvanized Charcoal Iron .....	50%	40%
Copper .....	40%	40%
<b>EAVES TROUGH MITERS—</b>		
Lap or Slip Point, list .....	10%	10%
<b>ELBOWS AND SHOES—</b>		
Galvanized Steel:		
Plain, round and corrugated—all sizes up to 6 in. ....	60%	60%
Square:		
Square .....	50%	50%
Copper:		
All sizes .....	20%	20%
<b>GALVANIZED SHEETS—</b>		
Nos. 1 and 20 gauge, per lb. ....	\$6.40	\$6.12
No. 26 .....	6.70	6.42
No. 27 .....	6.85	6.42
<b>GLASS—</b> (Discounts from manufacturer's price lists)		
Single strength, A quality, first three Brackets .....	80%	77%
Single strength, B quality .....	79%	77%
Double strength, A quality .....	80%	79%
Double strength, B quality .....	82%	81%
Plate—up to 5 sq. ft. ....	82%	84%
Plate—over 5 sq. ft. ....	84%	83%
Plate—up to 10 sq. ft. ....	83%	82%
Plate—over 10 sq. ft. ....	82%	82%
<b>GRAVEL—</b>		
½ in. (Borough of Manhattan only) per cu. yd. ....	\$2.75*	\$2.50
¾ in. (Borough of Manhattan only) per cu. yd. ....	2.75*	2.50
<b>GYPSUM—</b>		
Plaster Board:		
(Delivered in Boroughs of Manhattan or Bronx)		
27 x 28 x 1 .....	35c.	30c.
27 x 48 x ½ .....	30c.	25c.
32 x 36 x ¼ .....	21c.	25c.
32 x 36 x ⅜ .....	21c.	26c.
32 x 36 x ½ .....	23½c.	26c.
Plaster Blocks:		
(Delivered in Boroughs of Manhattan or Bronx)		
2 in. solid per sq. ft. ....	7½c.	10c.
3 in. solid 12 x 30 per sq. ft. ....	10½c.	11c.
3 in. hollow .....	10½c.	11c.
4 in. hollow .....	12½c.	11c.
6 in. hollow .....	17½c.	11c.
<b>HOLLOW TILE—</b>		
(The New York Harbor strike makes a slight additional charge for cartage necessary.)		
Interior, 2 x 8 x 12 split furring per 1,000 sq. ft. ....	\$70.00	\$67.90
and 15 cents thousand pieces.		
Interior, 3 x 12 x 12 split furring per 1,000 sq. ft. ....	102.00	99.60
Interior, 4 x 12 x 12 split furring per 1,000 sq. ft. ....	114.75	99.60
Interior, 6 x 12 x 12 split furring per 1,000 sq. ft. ....	153.00	135.80
Interior, 8 x 12 x 12 floor and partition per 1,000 sq. ft. ....	135.80	167.50
Interior, 10 x 12 x 12 floor and partition per 1,000 sq. ft. ....	167.50	194.60
Interior, 12 x 12 x 12 floor and partition per 1,000 sq. ft. ....	194.60	194.60
<b>LATH—</b>		
Eastern spruce, per thousand .....	\$6.50	6.00
No. 1 White pine, per thousand .....	\$6.50	6.00
No. 1 Hemlock, per thousand .....	6.00	5.25
No. 1 Yellow pine, per thousand .....	5.75	5.25
<b>LIME—</b>		
Common, 300 lb. bbls., per bbl. ....	\$3.50	\$2.00
Finishing, 300 lb. bbls., per bbl. ....	3.70	1.00
Hydrated, in paper bags, per ton. ....	17.25	1.10
Common (Chicago), 200 lb. bbls., per bbl. ....	1.00	1.10
Common (Wisconsin), 200 lb. bbls., per hhl. ....	1.10	1.10
<b>LUMBER (All Prices Wholesale F.O.B. New York)—</b>		
Yellow pine, 3 x 4 to 14 x 14, 10 to 20 ft. ....	\$42.00	\$44.00
Yellow pine, fencing and boards .....	44.00	45.00
Yellow pine, dimensions and timbers .....	45.00	50.00
Norway pine, scantling and joists (rough) .....	50.00	54.00
Norway pine, heavy joists and timbers (rough) .....	54.00	43.00
N. C. pine, flooring, Norfolk, Va., 13/16 x 2½ .....	43.00	36.00
Hemlock, base price .....	36.00	38.00
Spruce, random 2 in. cargoes .....	38.00	52.00
Spruce, wide cargoes .....	52.00	59.00
Cypress, by car, factory selects 5/4 .....	59.00	10.00
Cypress shingles, 6 x 18 (heart) .....	10.00	96.00
Oak, quartered (red) .....	96.00	72.00
Oak, plain, flooring (red) .....	72.00	72.00
Oak, plain, flooring (white) .....	72.00	57.50
Maple, No. 1, 13/16 x 2 in. ....	57.50	63.00
Douglas fir, timbers (rough) .....	63.00	51.00
Douglas fir, porch and stair lumber .....	51.00	51.00
<b>LEAD—</b>		
American Pig, per lb. ....	6	6½
Bar, per lb. ....	7½ to 8	8
<b>METAL LATH—</b>		
Under 100 sq. yd., per sq. yd. ....	40c.	40c.
<b>PAINTS, OILS, ETC.—</b>		
Leads:		
American White, in oil, kegs; lots over 100 lbs. ....	14c.	14c.
White, in oil, 25-lb. tin pails; add to keg price .....	¼c.	¼c.
Red, bbl., ½ bbl. and kegs; lots over 100 lbs. ....	14½c.	14½c.
Dry Colors:		
Red Venetian, American, per 100 lbs. ....	\$2.75 to \$5.00	24.00 to 32.00
Metallic Paints:		
Brown, per ton .....	24.00 to 32.00	24.00 to 30.00
Red, per ton .....	24.00 to 30.00	24.00 to 30.00
<b>PIPE—</b>		
Cast iron:		
6 in. and heavier .....	\$57.70	\$56.80
4 in. ....	60.70	59.80
3 in. ....	67.70	66.80
(and \$1 additional for Class A and gas pipe.)		
Wrought:		
(Discounts to jobbers for carload lots on the Pittsburgh basing card; freight rates from Pittsburgh to New York, and also from Pittsburgh to Chicago, in carloads, per 100 lbs., are 27c.)		
Butt Weld		
Steel:		
Black, ½ to 3 in. ....	50½ to 57½%	57½%
Galv., ½ to 3 in. ....	20 to 44	41
Iron:		
Black, ½ to 1½ .....	29½ to 39	39½%
Galv., ½ to 1½ .....	2½ to 23½%	23½%
Lap Weld		
Steel:		
Galv., 2½ to 6 .....	53½%	53½%
Galv., ½ to 3 in. ....	24 to 44	41
Iron:		
Black, 2½ to 6 .....	34½%	34½%
Galv., 2½ to 6 .....	21½%	21
<b>PLASTER—</b>		
Neat wall cement in 15 cent bags, per ton. ....	\$20.30	\$18.50
Finishing plaster .....	24.00	21.00
<b>RADIATION—</b>		
(A further reduction, effective April 4, of 15% on direct radiators, 12½% on wall radiators, and 10% on steam and hot water boilers is announced. This approximates a drop of 36% on radiators and 33% on boilers from prices in effect before the 1st of January, 1919.)		
Chicago reports a 57% reduction on all standard sizes.		
<b>REGISTERS—</b>		
Cast iron semi-steel or steel, in black or white japan or electroplate and small faces and borders .....	40%	40%
Wall frames .....	40%	40%
Large faced, 14 x 14 in. and larger .....	60%	60%
Base board registers .....	40%	40%
Base board intakes .....	40%	40%
White enameled goods .....	15%	15%
Solid brass or bronze goods, except grilles .....	net	net
Grilles in black and white japan or electroplate in cast iron, plain lattice design, smaller than 14 x 14 in. ....	40%	40%
Over 14 x 14 in. ....	60%	60%
<b>SLATE ROOFING—</b>		
F. O. B. cars, Quarry Station.		
Pennsylvania:		
Best Bangor .....	\$6.50 to \$9.00	7.25
No. 1 Bangor Ribbon .....	6.75 to 7.25	8.00
Pen Argyl .....	7.25 to 8.00	10.00 to 12.00
Peach Bottom .....	10.00 to 12.00	7.25 to 8.25
No. 1 Chapman .....	7.25 to 8.25	3.50 to 6.70
Vermont:		
No. 1 Sea Green .....	3.50 to 6.70	5.50 to 9.00
Unfading Green .....	5.50 to 9.00	13.00 to 16.00
Red .....	13.00 to 16.00	10.00 to 12.50
Maine:		
Brownsville, Unfading Black, No. 1 .....	10.00 to 12.50	1.75
Slaters felt, 30 lb. roll .....	1.75	2.25
Slaters felt, 40 lb. roll .....	2.25	2.25
<b>ROOFING MATERIAL—</b>		
1-Ply Tarred Paper, per ton, per roll, 108 sq. ft. ....	\$63.00 to \$65.00	95c.
2-Ply Tarred Paper .....	95c.	1.23 to 1.30
3-Ply Tarred Paper .....	1.23 to 1.30	per ton 60.00
Rosin Sized Sheathing .....	per ton 60.00	2½ in. corrugation, over flat sheets, 30c. per 100 lbs.
Corrugated Roofing, galvanized, 2½ in. corrugation, over flat sheets, 30c. per 100 lbs.		
<b>SHINGLES—</b>		
Red cedar, 5 to 2, clear .....	\$6.50	5.50
White cedar, extra star, A star .....	5.50	2.45c. 3.47c.
<b>STRUCTURAL STEEL—</b>		
Beams and channel, 3 to 15 in., per lb. ....	2.45c.	3.47c.
Beams and channel, over 15 in., per lb. ....	2.45c.	3.47c.
Angles, 3 to 6 in. ....	2.45c.	3.47c.
Zees and tees .....	2.45c.	3.47c.
Steel bars, half extras, from mill .....	2.35c.	3.37c.
<b>REINFORCING BARS—</b>		
High carbon steel from mill .....	\$48.50	\$49.50
Medium steel from mill .....	48.50	49.50
<b>SAND (Borough of Manhattan only)—</b>		
Mason, per cu. yd. ....	\$1.80	\$2.25
Torpedo, per cu. yd. ....	1.80	2.50



# Department of Architectural Engineering

## New Code for Automatic Sprinklers

THE automatic extinguishment of incipient fires has been the object of much effort. The development and present status of these efforts is well understood by architects. Several factors operate against the universal use of such apparatus, and they may be divided into commercial conditions and inherent mechanical defects.

The commercial objections are those pertaining to the cost of installing the elaborate equipment, the difficulty in securing Underwriters' approval of apparatus, the general opinion that unnecessary restrictions confine these operations to a very limited number of corporations with a consequent lack of real competition and the inability of the public to purchase approved apparatus. This latter condition restricts these installations to a very few construction organizations.

The result of these conditions has been the growth of an opinion that the use of automatic sprinkler systems involves an unnecessary tax or burden on the owner, although the desire for such protection is prevalent. The mechanical defects found in the present day standard installations are those of slowness to give alarm of fire, the danger of water leakage involving a special insurance tax against water damage occurring when there is no fire, and a lack of simplicity and directness in the many mechanical parts used.

The Board of Standards and Appeals and the Fire Department, of New York City, have made tests on an apparatus which has been developed and perfected. The results of these exhaustive tests have been of such a satisfactory nature that rules governing the use of such apparatus in that city have been adopted. The application of these rules will result in greatly decreasing the cost of such apparatus and overcoming some of the mechanical defects common to the standard apparatus as now made. This action of the Board of Standards and Appeals is in line with their policy of making rules governing building construction which will cheapen the cost of such operations by eliminating useless requirements and special privileges and at the same time conserving all of the requirements of structural strength, durability, fire protection and sanitation. It is a well-known fact that the majority of American building codes require useless expense to the owner by being many

years behind the rapid progress made in construction methods. Credit is due this Board for the manner in which they attack these problems, under the efficient direction of John P. Leo, chairman. They act on the proven merit of matters which

Table Showing the Comparative Amount of Pipe in Lineal Feet, Its Weight and the Number of Sprinkler Heads Required on the Three Plans Here Shown. Fittings Not Included.

Size of Pipe, Dia. in Inches	LENGTH OF PIPE IN FEET FOR		
	Standard ½-In. Heads	Conran 1-In. Heads	Conran 1¼-In. Heads
¾	165	.....	.....
1	192½	163½	.....
1¼	200	200	170
1½	400	200	200
2	950	200	200
2½	19	160	150
3½	19½	.....	.....
4	35	39	49
5	15	40	25
6	12	12	12
Weight of pipe in pounds	6700	4200	3700
	100%	62%	35%
Number of heads	205	53	34
	100%	26%	17%

come before them, regardless of precedents established by commercial interests, and the result is a relief from the many useless burdens that are imposed on the investor in buildings. This is a matter of interest to architects who are seeking to cheapen the cost of building construction without, in any way, impairing the elements of good construction.

The ruling, with an explanation of its application, is here given. This system may be installed in a manner similar to the ordinary standard automatic wet sprinkler system, the only difference between the two being in the design and size of the sprinkler heads and size and spacing of pipes. In the standard system the orifice of the head is one-half inch in diameter, and when operating has an average discharge of 20 gallons of water per minute. The maximum floor area covered by such a head is 100 sq. ft. The diffusion of the water over this area is obtained by a deflector at the top of the head which breaks up the half inch stream





of water into a fine spray and also deflects it downward. The Conran head, see the ruling hereafter given, is manufactured in two sizes, with orifices 1 in. and  $1\frac{1}{4}$  in. in diameter. The head is almost spherical in shape and has four holes equally spaced around the "upper hemisphere," four tangential openings equally spaced around the "equator" and four around the "lower hemisphere." The force of the water discharging through the tangential openings reacts on the sphere (which is mounted on a raceway with Tobin bronze ball bearings) in such a manner as to cause it to revolve rapidly, and this rotating motion causes a wide distribution of the water discharged. From tests made by the New York Fire Department, the smaller head was found to effectually cover a floor area of 400 sq. ft. and the larger a floor area of 625 sq. ft. From this it will be seen that the number of heads required by this system may be materially reduced from that required by the standard system; also, the lines of piping may be spaced much further apart, with a consequent saving of pipe. The size of pipe used in each line will be somewhat larger than required in a standard system. The average discharge of the 1 in. head is 80 gallons per minute and of the  $1\frac{1}{4}$  in. head 125 gallons per minute. The initial operation of the head is caused in the usual manner by the fusing of a solder, usually at 165 deg. Fahr., which normally holds the strut in place, the release of this strut permitting the unseating of the valve in the head by the water pressure in the piping system. The only logical objection which might be raised against such a system as this, which brings fire protection equal to that afforded by the standard system, is that the accidental discharge of a sprinkler head will cause from four to six times as much water damage as in the case of a standard  $\frac{1}{2}$  in. head. It is a well-known fact that such accidental discharges are not infrequent in standard systems. This is preferable to having the building destroyed had an actual fire occurred. This condition is overcome by using an automatic dry pipe system such as is hereafter described. Dry pipe sprinkler systems are in no sense an innovation, and the method here adopted is worthy of commendation.

The entire sprinkled area is covered by an automatic thermostatic fire alarm system, usually the "Aero" system (approved by the Underwriters' Laboratories), which consists of a finely drawn copper tube resembling a fine wire, hardly noticeable to a casual observer, strung in a loop around the ceiling. A quick rise in temperature causes the air in this fine tube to expand and automatically operate local fire alarm gongs, and it can be also

connected to send an alarm to Fire Department Headquarters at the same time. The system is connected to an electric trip, which in turn operates a hydraulically controlled valve in the sprinkler supply main where it enters the building. Up to this valve the supply line is wet, and beyond it both mains and sprinkler piping are dry and filled with air at atmospheric pressure. Thus it will be



Automatic Sprinkler Heads

From left to right,  $\frac{1}{2}$  in. standard head, 1 in. and  $1\frac{1}{4}$  in. Conran heads

seen that the accidental breaking of a sprinkler head will cause no water discharge, and a new head can be easily installed. Under conditions of an actual fire, it is well known that the fire must bank up considerable heat around a sprinkler head before the solder fuses and the head discharges water. The mere burning of a newspaper will not do this. With the ordinary system, by the time a sprinkler head opens there is a fairly good fire under way.

However, with this automatic dry system, as soon as a quick rise of temperature occurs from the burning of a little paper on the floor, the thermostatic fire alarm operates, doing three things simultaneously. It rings a local alarm; it notifies Fire Department Headquarters, and it operates the dry pipe valve, turning water into the entire sprinkler system. The fire may be quickly put out by a bucket of water by an employee who hears the alarm, in which case the sprinkler head does not operate and there is practically no "water damage." If, however, the fire increases and heat is banked at the ceiling, the head operates and dis-



## THE AMERICAN ARCHITECT

charges, not a fine spray, but a heavy blanket of water. This, in the majority of cases, will extinguish the fire.

In addition, the Fire Department apparatus has arrived and the firemen may either lend their efforts to the extinguishment of the fire by a hose stream or, if the fire is already out, they will shut off the water in the sprinkler system, thereby obviating any unnecessary water damage. Had buildings been equipped with dry, instead of wet sprinkler systems during the winter of 1917-1918 many thousands of dollars would have been saved by avoiding bursting of pipes, tanks, etc., and in addition the property would have been protected at all times from fire. The frozen "wet" system was worthless for many days at a time.

Standard wet systems have been preferred to standard dry systems, because the standard dry system gives inferior fire protection under normal conditions, it has increased initial cost and increased cost of maintenance. This is due to the fact that in the standard dry system the sprinkler pipes are filled with compressed air. When a head operates, instead of an immediate discharge of water a stream of compressed air comes out. This continues from three to six minutes or longer, depending on the distance the head is from the dry pipe valve, until all the compressed air has been discharged from the pipes. Naturally a tardy discharge of water means decreased protection, as the fire has had that much additional time to gain headway. A standard dry system necessitates the installation of a complicated and expensive dry pipe valve and an air compressor. This adds considerably to the already high cost of sprinkling. As the system is never absolutely air tight, the air pressure in the pipes constantly drops, requiring the compressor to operate to build up the pressure. Such machinery requires supervision, inspection and repairing, all of which costs money.

Under these conditions, except where a building is not heated, or in sections of a building which it is not possible to heat, it would appear to be poor policy to install a standard automatic dry pipe sprinkler system. The automatic dry pipe sprinkler system here described eliminates all the objectionable features of the standard dry pipe system and at the same time provides an automatic alarm, giving added protection, and all at a much reduced cost.

Comparative plans are shown, which indicate, with the accompanying table, the radical differences between the standard type of installation and that approved by the Board of Standards and Appeals. A casual inspection will disclose the elements that cause a reduction in the cost of installing the auto-

matic dry pipe system as compared with the standard system of either kind.

Rules for Fire Extinguishing Appliances (Sprinkler Systems) adopted May 24, 1917, by the Board of Standards and Appeals, as amended May 2, 1918, and January 21, 1919; effective February 17, 1919.

*Rule 1. Definition of Automatic Extinguisher Systems.* Automatic extinguisher systems shall consist of a system of piping connected to one or more acceptable sources of water supply, or other extinguishing medium, provided with distributing devices so arranged and located as to discharge and diffuse automatically under the action of heat an effective stream or spray over every part of the interior of the building area in which a fire may start or to which it may be communicated.

*Rule 2. Classification of Sprinkler Systems.* For the purpose of these rules, sprinkler systems shall be classified as:

(a) Automatic Wet Pipe Systems, in which all pipes and sprinkler heads are at all times filled with water;

(b) Automatic Dry Pipe Systems, in which the pipes and sprinkler heads are filled with air, either compressed or at atmospheric pressure, and the water supply is operated by a Dry Pipe Valve as defined in Rule 27 of these Rules.

(c) Non-Automatic Systems, in which all pipes and sprinkler heads are maintained dry with a fire department connection for water supply.

*Rule 3. Approved Devices.* Automatic Sprinklers and accessory appliances shall include all devices approved as such by the Bureau of Standards, Washington, D. C.; by the Underwriters' Laboratories, Inc., of Chicago; by the Associated Factory Mutual Laboratories of Boston; and all devices which meet the tests prescribed by the board of standards and appeals.

*Rule 4. Water Supply.* Approved sources of water supply shall be classified as Automatic and Auxiliary.

(a) Automatic Sources shall include the Gravity Tank, the Pressure Tank and the Public Water System.

(b) Auxiliary Sources shall include the Fire Pump and the Fire Department Connection.

*Rule 5. Gravity Tank.* Gravity tanks shall contain an available quantity of water sufficient to supply twenty-five per cent (25%) of the number of sprinkler heads in the average protected fire area for twenty (20) minutes, but not less than 5,000 gallons; and the bottom of the tank shall have an elevation of not less than twenty (20) feet above the highest line of sprinklers below the main roof.

Where a tank capacity in excess of 25,000 gallons is required by this rule, the amount of water to be provided in excess of 25,000 gallons shall be specified by the board of standards and appeals.

The tank shall be filled through a fixed pipe, independent of the sprinkler piping, not less than two (2) inches in size, discharging into the top of the tank, or through a by-pass not less than two (2) inches in size around the check valve in the discharge pipe, provided the supply is of sufficient pressure to fill the tank. The water supply and connections shall be capable of supplying the tank at a rate of not less than sixty-five (65) gallons per minute.

*Rule 6. Pressure Tank.* Pressure tanks shall contain sufficient water to supply twelve and one-half per cent (12½%) of the number of sprinklers in the average protected fire area for twenty (20) minutes, but not less than 5,000 gallons. No single tank shall have a capacity greater than 9,000 gallons. The tank shall be kept two-thirds (⅔) full of water under a pressure of seventy-five (75) pounds per square inch, and shall be so proportioned and located that a pressure of not less than fifteen (15) pounds per square inch will be available on the highest line of sprinklers below the main roof when all the water has been discharged from the tank.

The tank shall be placed either on the roof or in the highest sprinklered story.

Where a tank capacity in excess of 25,000 gallons is required by this rule, the amount of water to be provided in excess of 25,000 gallons shall be specified by the board of standards and appeals.

The water shall be supplied through a fixed pipe, independent of the sprinkler piping, not less than two inches in size with a one and one-quarter (1¼) inch connection to the tank, or through a by-pass not less than two (2) inches in size around the check valve in the discharge pipe provided the supply is of sufficient pressure to fill the tank. The water supply and connections shall be capable of supplying the tank at a rate of not less than sixty-five (65) gallons per minute without reducing the pressure in the tank. The tank shall have a fixed metallic horizontal line on the end opposite the glass gauge, or other acceptable device, to indicate the level of the water when the tank is two-thirds full.

The air compressor shall be of sufficient capacity to increase the air pressure at the average rate of one (1) pound in two minutes in each pressure tank.

*Rule 7. Public Water System.* Direct connection to the city water supply shall be capable of furnishing water at not less than fifteen (15) pounds per square inch static pressure at the highest line of sprinklers under the main roof.

Subject to the requirements of the department of water supply, gas and electricity, the size of each connection shall be as large as that of the main riser and not less than four (4) inches, and shall have a conveniently accessible control valve fixed to it, at or near, the curb, or when possible, still further away from the building. The control valve shall be fitted with a frost and waterproof box, not less than four (4) feet nor more than six (6) feet below the curb, with a fixed stem extending to a compartment at the level of the sidewalk. The cover shall be bolted to the casing and shall be so marked as to be quickly located and to indicate the purpose of the valve. The valve shall be of indicating pattern, operated by a special socket wrench approved by the department of water supply, gas and electricity.



# THE AMERICAN ARCHITECT

**Rule 8. Fire Pump.** Steam or electric standard fire pumps shall receive water supply from a suction tank, a direct connection to the city water main or other approved sources capable of supplying the pump at its rated capacity for sixty (60) minutes. The rated capacity of the pump shall be not less than five hundred (500) gallons per minute, and shall be sufficient to supply twenty-five per cent (25%) of the number of sprinklers in the average protected fire area.

The pump shall be located in a room of fireproof construction, properly ventilated, lighted and drained, enclosed in eight (8) inch brick or concrete walls with approved fire doors at openings and with fireproof floor and ceiling construction. If located in the lower story of the building, the pump shall be placed on a foundation not less than one (1) foot in height. The pump room shall be readily accessible with safe egress for the attendant.

A reliable source of energy for driving the pump shall be provided. For steam pumps, provision shall be made for sufficient steam power to operate the pump at full rated capacity, and a steam pressure of not less than fifty (50) pounds shall be maintained at the pump at all times. Where there is more than one boiler, the pipes and valves shall be so arranged to permit the cutting out of any one boiler without interrupting the steam supply to the pump from the other boilers. The boiler room shall be cut off from the remainder of the building by fireproof floor and wall construction with approved fire doors at all openings.

Electrical energy from a public service plant shall be acceptable as a source of energy for driving electric fire pumps. When local power plants supply the energy for operating electric pumps, two motor generator units shall be provided, or one generator unit supplemented by a public service break-down switch. Local electric power plants shall be located in rooms of fireproof construction with approved fire doors at openings.

**Rule 9. Sprinkler Discharge.** For the purpose of computing the capacity of water supplies, standard one-half (½) inch sprinkler heads shall be assumed to have an average discharge of twenty (20) gallons per minute, and the discharge of larger heads shall be computed proportionately in the ratio of the areas of their respective orifices.

**Rule 10. Fire Area.** A fire area is any floor space enclosed on all sides by exterior walls or fire walls or a combination of both. The number of sprinklers in the average protected fire area shall be determined by dividing the total number of sprinklers on a system in one fire section by the number of sprinklered stories in such section. In determining the required capacity of water supplies, the number of sprinklers in the average protected fire area need not include those located in low positions, such as under benches, low shelves, closets and platforms and between cars in car barns.

**Rule 11. Fire Department Connection.** All automatic sprinkler systems shall be provided with at least one two-way Siamese connection on each street front of the building for connection to the fire department hose. Buildings fronting on only one street shall be provided with at least two Siamese connections when the street frontage exceeds one hundred and fifty (150) feet in width.

All Siamese hose connections hereafter installed, except those on piers or warehouses intended for fire boat use, shall be three (3) inches in size. Fire boat connections shall be three and one-half (3½) inches in size. All hose connections shall be female, with standard fire department threads.

The inlets shall be placed at least eighteen (18) inches and not more than two (2) feet above the sidewalk, in a horizontal position accessible to the fire department, and shall be provided with a four (4) inch discharge connecting with a four (4) inch pipe to the sprinkler system for three (3) inch fire department connection and with a six (6) inch discharge outlet and six (6) inch pipe for three and one-half (3½) inch fire boat connection. Each inlet shall be provided with a clapper valve machined to a true face.

Each Siamese connection shall be designated by raised letters at least one (1) inch in size, cast in the fitting in a clear and prominent manner and reading for the service designated, viz.: "Base, Spkr.," etc., as the case may be. If the entire building is sprinklered, the fitting shall be marked "Auto. Spkr."

**Rule 12. Automatic Sprinkler Systems.** Automatic sprinkler systems shall be classified as:

(a) One Source Systems, supplied with water from any one of the automatic sources; and

(b) Two Source Systems, supplied with water from a combination of any two of the automatic sources; two pressure tanks with a total water capacity twice that required for a one source supply; direct connection to the city water supply on two different streets, so located that the closing of the controlling valve on one main will not eliminate the main on the other street; or a direct connection to the city water supply and one of the auxiliary sources provided the water supply main is at least six (6) inches in size, the main is fed both ways and a two (2) inch test pipe at the top of the sprinkler riser shows a flowing pressure of fifteen (15) pounds per square inch between the hours of 6 a. m. to 6 p. m.

**Rule 13. Sprinkler Spacing.** Sprinkler heads and lines shall be spaced as herein provided:

**Mill Construction.** Under mill ceiling (smooth solid plank and timber construction, 5 to 12 foot bays) one line of sprinklers shall be placed in the center of each bay and the distance between the heads on each line shall not exceed the following:

- (a) For Standard one-half (½) inch heads—  
8 feet in 12 foot bays;  
9 feet in 11 foot bays;  
10 feet in 10 foot bays;  
11 feet in 9 foot bays;  
12 feet in 5 to 8 foot bays.

- (b) For Conran\* one (1) inch heads—  
20 feet in 5 to 12 foot bays.

- (c) For Conran\* one and one-quarter (1¼) inch heads—  
25 feet in 5 to 12 foot bays.

Measurements shall be taken from center to center of timbers.

Ceilings of modified mill construction having bays less than three (3) feet wide shall be treated as open joist construction and sprinkler heads and lines spaced accordingly.

Bay timbers spaced three (3) feet or more on centers, but less than five (5) feet on centers, will require special ruling by the administrative official having jurisdiction.

**Joisted Construction.** Under open finish joisted construction, ceilings, floors, decks and roofs, the sprinkler lines shall be run at right angles to the joists and the heads "staggered spaced," so that heads on one line will be opposite a point half way between heads on adjacent lines.

(a) For Standard one-half (½) inch heads the distance between lines of sprinklers shall not exceed ten (10) feet, and the distance between heads on each line shall not exceed eight (8) feet, the end heads on alternate lines being spaced not more than two (2) feet from wall or partition. Permission may be given by the administrative official having jurisdiction to install but one line of sprinklers in each bay where girders project below the under side of joists and divide the ceiling into bays ten (10) to eleven and one-half (11½) feet wide from center to center of girders, and the heads shall then be spaced on each line so that the area covered by a single head does not exceed eighty (80) square feet. In all cases where such bays are over eleven and one-half (11½) feet wide, two or more lines of sprinklers shall be installed in each bay as required by the rules for spacing. Where girders and joists are flush at the bottom, heads shall be spaced according to the general rule.

(b) For Conran\* one (1) inch heads the distance between adjacent lines shall not exceed twenty (20) feet and the distance between the heads on each line shall not exceed sixteen (16) feet, the end heads on alternate lines being spaced not more than four (4) feet from wall or partition. Where girders project below the under side of joists and divide the ceiling into bays not exceeding twenty (20) feet in width, measured from center to center of girders, one line shall be placed in the center of each bay. In bays exceeding twenty (20) feet in width at least two (2) lines shall be installed in each bay and in no case shall the distance between adjacent lines exceed twenty (20) feet.

(c) For Conran\* one and one-quarter (1¼) inch heads the distance between adjacent lines shall not exceed twenty-five (25) feet and the distance between the heads on each line shall not exceed twenty (20) feet, the end heads on alternate lines being spaced not more than five (5) feet from wall or partition. Where girders project below the under side of joists and divide the ceiling into bays not exceeding twenty-five (25) feet in width, measured from center to center of girders, one line shall be placed in the center of each bay. In bays exceeding twenty-five (25) feet in width at least two (2) lines shall be installed in each bay, and in no case shall the distance between adjacent lines exceed twenty-five (25) feet.

**Smooth Finish, Sheathed or Plastered Ceilings.** Under smooth finish, sheathed or plastered ceilings, in bays six (6) feet wide and over (measurements to be taken from center to center of timber, girder or other projection or support forming the bay), sprinkler heads and lines shall be spaced as follows:

- (a) For standard one-half (½) inch heads—

One line of sprinklers shall be placed in the center of each bay for bays not exceeding twelve (12) feet in width, and the distance between the heads on each line shall not exceed the following:

- 8 feet in 12 foot bays;  
9 feet in 11 foot bays;  
10 feet in 6 to 10 foot bays.

Bays in excess of twelve (12) feet in width and less than twenty-three (23) feet in width shall contain at least two (2) lines of sprinklers; bays twenty-three (23) feet in width or over shall have the lines therein not over ten (10) feet apart. In bays in excess of twelve (12) feet in width, not more than one hundred (100) square feet of ceiling area shall be allotted to any single head.

- (b) For Conran\* one (1) inch heads—

One line of sprinklers shall be placed in the center of each bay for bays not exceeding twenty (20) feet in width, and the distance between the heads on each line shall not exceed twenty (20) feet. Bays in excess of twenty (20) feet in width shall contain at least two (2) lines and in no case shall the distance between adjacent lines exceed twenty (20) feet.

- (c) For Conran\* one and one-quarter (1¼) inch heads—

One line of sprinklers shall be placed in the center of each bay for bays not exceeding twenty-five (25) feet in width and the distance between the heads on each line shall not exceed twenty-five (25) feet. Bays in excess of twenty-five (25) feet in width shall contain at least two (2) lines and in no case shall the distance between adjacent lines exceed twenty-five (25) feet.

**Fireproof Construction.** The rules of slow-burning mill construction shall apply as far as practicable. The rule may be modified, however, the intent being to arrange the spacing of heads to protect the contents rather than the ceilings; but in no case shall the distance between a head on one line and a head on an adjacent line exceed the following:

- (a) For standard one-half (½) inch heads, 12 feet.

- (b) For Conran one (1) inch heads, 20 feet.

- (c) For Conran one and one-quarter (1¼) inch heads, 25 feet.

**Distance From Walls.** The distance from wall or partition to

\*Wherever the term "Conran head" is used in these Rules, it is to be taken as meaning either a Conran head of the type tested and approved by the Fire Department, or one that has passed similar tests by the Fire Department.

# THE AMERICAN ARCHITECT

the first head on a sprinkler line shall not exceed one-half the allowable distance between the heads on such line. Additional heads may be required in the narrow pockets formed by bay timbers or beams and wall. Where beams, girders, columns, walls, partitions or other obstructions prevent the effective discharge of water, additional heads shall be installed to effectively sprinkle the area.

**Vertical Shafts.** In vertical shafts having inflammable sides, heads shall be provided within the shaft in addition to the head or heads at the tops of shafts, as follows:

(a) One standard one-half ( $\frac{1}{2}$ ) inch head for each 200 square feet of inflammable surface.

(b) One Conran\* one (1) inch head for each 400 square feet of inflammable surface.

(c) One Conran\* one and one-quarter ( $1\frac{1}{4}$ ) inch head for each 500 square feet of inflammable surface.

Such head or heads shall be installed at each floor when practicable, and always when shaft is trapped. Where practicable, heads shall be "staggered" at the alternate floor levels, particularly when only one head is installed at each floor level.

**Pitched Roofs.** Under a pitched roof sloping more steeply than one (1) foot in three (3) feet, heads shall be located in peak of roof, and those on either side of the peak shall be spaced according to the foregoing requirements. The distance between heads shall be measured on a line parallel with the roof. Where the roof meets the side wall or the floor line, the heads shall be placed not more than the following distance from such intersection.

(a) For standard one-half ( $\frac{1}{2}$ ) inch heads,  $3\frac{1}{2}$  feet.

(b) For Conran\* one (1) inch heads, 7 feet.

(c) For Conran\* one and one-quarter ( $1\frac{1}{4}$ ) inch heads,  $8\frac{1}{2}$  feet.

Heads spaced not to exceed the following distance each way from the peak of roof, measured on a line parallel with the roof, may be used in lieu of heads located in peak of roof.

(a) For standard one-half ( $\frac{1}{2}$ ) inch heads,  $2\frac{1}{2}$  feet.

(b) For Conran\* one (1) inch heads, 5 feet.

(c) For Conran\* one and one-quarter ( $1\frac{1}{4}$ ) inch heads,  $6\frac{1}{4}$  feet.

In sawtooth roof construction, the end heads on the branch line shall be spaced not to exceed the following distance from the peak of the sawtooth:

(a) For standard one-half ( $\frac{1}{2}$ ) inch heads,  $2\frac{1}{2}$  feet.

(b) For Conran\* one (1) inch heads, 5 feet.

(c) For Conran\* one and one-quarter ( $1\frac{1}{4}$ ) inch heads,  $6\frac{1}{4}$  feet.

**Special Locations and Variations.** In special locations, such as over electric generating, power and transforming apparatus, over their controlling devices and switchboards, where water from the fire extinguishing equipment would be detrimental, the sprinkler lines and heads may be omitted at the discretion of the administrative official having jurisdiction, and when in his judgment a slight variation of this rule of spacing is desirable to effect a more efficient distribution of water for fire extinguishing purposes, the sprinkler lines and heads shall be spaced as he may direct.

**Rule 14. Sprinkler Position.** All sprinkler heads shall be located, wherever possible, in an upright position on top of the pipes, except that sprinkler heads on automatic wet pipe systems may be pendant on concealed piping and when construction or occupancy of a room or enclosure makes it preferable.

(a) Where standard one-half ( $\frac{1}{2}$ ) inch heads are installed sprinkler deflectors shall be parallel to ceilings, roofs or the incline of stairs, but when installed in the peak of a pitched roof they shall be horizontal. Distance of deflectors from ceilings of mill or other smooth construction, or bottom of joists of open joist construction, shall be not less than three (3) inches nor more than ten (10) inches.

In fireproof buildings, the distance between deflectors and panel ceilings shall not exceed fifteen (15) inches.

Not less than eighteen (18) inches effective clear space shall be left below the sprinkler heads, so that they may discharge an unbroken spray blanket from sprinkler to sprinkler and sides of room when in operation. Any stock piles, racks or other obstructions interfering with such action shall not be permitted.

(b) Where Conran\* heads are installed, the top of head shall be located the same distance below joists or ceiling as specified for deflectors in paragraph (a) of this rule; except that when heads are located under pitched roofs of piers or similar structures, they shall in general be installed in the upright position (not normal to slope of roof) and three (3) feet vertically below the underside of roof. When the administrative official having jurisdiction deems a variation of this rule advisable to obtain a more efficient distribution of water, the heads shall be located with respect to joists or ceiling, as he may direct.

**Rule 15. Pipe Sizes.** The number or heads on a given size pipe in one fire area in any story shall not exceed the following:

(a) For standard one-half ( $\frac{1}{2}$ ) inch heads—

Size of Pipe.	Maximum No. of Heads Allowed.
$\frac{3}{4}$ inch.....	1 head
1 ".....	2 heads
$1\frac{1}{4}$ ".....	3 "
$1\frac{1}{2}$ ".....	5 "
2 ".....	10 "
$2\frac{1}{2}$ ".....	20 "
3 ".....	36 "
$3\frac{1}{2}$ ".....	55 "
4 ".....	80 "
5 ".....	140 "
6 ".....	200 "
7 ".....	300 "
8 ".....	420 "

(b) For Conran\* one (1) inch heads—

Size of Pipe.	Maximum No. of Heads Allowed.
1 inch.....	1 head
$1\frac{1}{4}$ ".....	2 heads
$1\frac{1}{2}$ ".....	3 "
2 ".....	4 "
$2\frac{1}{2}$ ".....	6 "
3 ".....	9 "
4 ".....	18 "
5 ".....	34 "
6 ".....	51 "
7 ".....	75 "
8 ".....	105 "

(c) For Conran\* one and one-quarter ( $1\frac{1}{4}$ ) inch heads—

Size of Pipe.	Maximum No. of Heads Allowed.
$1\frac{1}{4}$ inch.....	1 head
$1\frac{1}{2}$ ".....	2 heads
2 ".....	3 "
$2\frac{1}{2}$ ".....	4 "
3 ".....	6 "
4 ".....	12 "
5 ".....	21 "
6 ".....	40 "
7 ".....	60 "
8 ".....	84 "

When it is desired to use pipe of larger size than eight (8) inches in diameter, special ruling will be required by the administrative official having jurisdiction as to the permissibility of its use and the number of heads that may be fed thereby.

Where practicable, it is desirable to arrange the piping so that the number of heads on a branch line will not exceed eight.

When the piping is arranged on the "gridiron" plan, the permissible number of heads may be doubled, provided the feed main is of the size indicated in the schedule for the total number of heads.

Where feed mains supply branch lines of only two heads each, the conditions approach those of long single lines. Such feed mains shall usually be centrally supplied where there are over eight (8) or ten (10) branch lines. Branch lines up to fourteen (14) in number may be fed from end, provided a two and one-half ( $2\frac{1}{2}$ ) inch pipe does not supply more than sixteen (16) standard one-half ( $\frac{1}{2}$ ) inch heads, in lieu of twenty (20).

Buildings having slatted floors, or large unprotected floor openings without approved stops, shall be treated as one room with reference to the pipe sizes, and the feed main shall be of sufficient size to accommodate the number of heads called for. Larger pipe sizes than are allowed in the schedule for a given number of heads may be required wherever the construction or conditions introduce unusually long runs of feed mains or many angles. Buildings with blind attics with small unprotected openings to floor below, may be piped from the system on the ceiling of floor below, provided pipe size schedule is not overloaded on sizes three (3) inches or under.

**Rule 16. Feed Mains.** The size of the feed mains shall not be less than the size of riser and shall be arranged to run as direct as possible from source of water supply to riser.

Feed mains for stair or other towers without approved stops between floors, when piped on independent riser, shall be of sufficient size to accommodate the total number of sprinklers in such tower.

**Rule 17. Risers.** There shall be one or more separate risers in each building and in each section of the building divided by fire walls. Risers shall be arranged to provide "Center Central" or "Side Central" supply to feed main. Each riser shall be of sufficient size to supply all the heads on said riser in one story, according to the schedule of pipe sizes in Rule 15.

If the conditions warrant, special permission will be granted allowing the heads in a fire section of small area to be fed from the risers in another section, provided the total number of heads in such area does not exceed the following number per floor:

(a) For standard one-half ( $\frac{1}{2}$ ) inch heads, 48.

(b) For Conran\* one (1) inch heads, 12.

(c) For Conran\* one and one-quarter ( $1\frac{1}{4}$ ) inch heads, 8.

Risers shall not be located close to windows, shall be properly protected from mechanical injury and freezing, and shall be properly supported on foundations and by floor plates, clamps, couplings or hangers.

**Rule 18. Pipes and Fittings.** All pipe shall be full-weight standard wrought iron or steel threaded pipe, well reamed and screwed up tight into fittings without reducing the waterway. Fittings shall be standard cast-iron fittings, and shall be long turn pattern on feed mains and risers.

Such fittings shall be designed and guaranteed for a working pressure of 150 pounds per square inch and must be capable of withstanding a hydrostatic test pressure of 750 pounds per square inch without failure.

All pipe shall be secured to the ceiling, walls and other parts of the building with standard steel, wrought or malleable iron hangers.

Extra heavy fittings shall be employed where the normal pressure in the pipe system exceeds one hundred and fifty (150) pounds per square inch, and shall be designed for a working pressure of 250 pounds per square inch and be capable of withstanding a hydrostatic test pressure of 1250 pounds per square inch without failure.

All underground pipe shall comply with the specifications for cast iron pipe of the American Water Works Association.

**Rule 19. Protection of Pipes and Sprinklers.** When exposed to moisture, sprinkler pipes and hangers shall be protected against corrosion whenever found necessary by thoroughly cleaning the pipe of all scale and grease and painting with a coat of red lead and linseed oil paint or other acceptable moisture resistive paint.



When exposed to chemical fumes, the pipe and fittings shall be coated with graphite or other approved chemical resistive paint. Care shall be taken not to paint the sprinkler heads.

Supply pipes of risers in low basements or low spaces under ground floors exposed to frost, shall be properly protected by a masonry or wood enclosure, properly heated, or filled with mineral wool, sawdust or tar mixed with granulated cork, extending below bottom of pipe and through the top flooring of ground floor, or the pipe shall be protected with three alternate layers of one-inch hair felt and building paper or by other approved method. When of wood, such enclosure shall be constructed double with a layer of tar paper between the two thicknesses of wood.

Where risers, drains, heating pipes, etc., pass through cinder concrete floors or partitions, they shall be protected with a metal sleeve or be grouted with cement mortar.

Wherever sprinklers are exposed to corrosion, the heads shall be protected with an approved hermetically sealed cover, or with an approved wax coating.

**Rule 20. Drainage.** All sprinkler pipe and fittings shall be so installed that they can be thoroughly drained, and where practicable, all piping shall be arranged to drain at the main drips.

Drains or drip pipes shall be so arranged as not to expose any part of the sprinkler system to frost, and shall be so connected, either by check valves or other means, that they will not over-throw domestic service or other connections to the same sewer or house drain.

Drains, pitched not less than one-quarter (1/4) inch in ten (10) feet, shall be installed:

- At the base of the main riser;
- At each alarm valve;
- At each dry-pipe valve;
- At each gravity tank;
- At each pressure tank;
- At each fire department connection;

On each floor, if independent floor control valves are used; and at each supply main, when the water in the same cannot be removed through any of the above drains. Such drains shall be installed with controlling valves so that flowing tests may be made to determine if the water supplies or connections from yard mains to the inside of the building are in order without causing water damage or overflowing service connections to the same house drain. Any such drain shall be not less than two (2) inches in size except that drains at independent floor valves may be one and one-quarter (1 1/4) inches in size. The drain at the main riser shall discharge into a cone or sight drain, or if carried through the wall and exposed to the weather, it shall be fitted with a hood or down-turned elbow.

On automatic wet pipe systems, the horizontal branch pipes shall be pitched not less than one-quarter (1/4) inch in ten (10) feet to drain towards the sources of supply with drip valves at the low points.

On automatic dry pipe systems, branch pipes shall be pitched at least one-half (1/2) inch in ten (10) feet.

**Rule 21. Test Pipe.** On all automatic systems a test pipe of not less than 3/4 inch in diameter shall be connected directly with each riser in upper story and arranged to discharge, through a 1/2-inch brass outlet, preferably to a point where it can readily be seen. With long runs or many angles, size of test pipe shall be increased to one (1) inch or larger.

**Rule 22. Pressure Gauges.** A four and one-half (4 1/2) inch double-spring Bourdon pressure gauge shall be provided in all automatic sprinkler systems as follows:

- Above dry-pipe valves;
- Below dry-pipe valves;
- At the pressure tank;
- At the air compressor;
- Above the alarm valve;
- Below the alarm valve; and
- In the connections from city water supply.

Provision may be made for taking the pressure both above and below the alarm valve and the dry-pipe valve with only one gauge at each valve.

Gauge connections shall be taken from the supply main or riser and not from the two-inch drain or test pipe.

Gauges shall be installed in a suitable place protected from freezing and be controlled by a valve with arrangements for draining. A plugged outlet, not less than one-quarter (1/4) inch in size, shall be located between each valve and gauge for purpose of installing the inspector's gauge.

**Rule 23. Valves.** All valves two (2) inches in diameter and under shall be of brass or bronze, or other approved non-corrodible material. Valves over two (2) inches in diameter shall be of brass, or bronze or iron body, brass-mounted, or of other approved non-corrodible material.

All sidewalk Siamese inlet valves, caps and chains shall be of galvanized cast iron or other approved non-corrodible material.

All gate valves shall be solid or double wedge disc, stuffing box pattern with hand wheel, outside screw and yoke, or other approved indicator pattern.

All check valves shall be approved, straight way regrinding pattern, so built that the clappers may be readily removed for repairs.

**Rule 24. Water Supply Gate Valves.** The piping connecting each source of water supply with the sprinkler system shall be provided with a gate valve of the outside screw and yoke type, sealed open and tagged to designate its purpose, so located as to control each source of water supply except that from fire department hose connections. All such gate valves shall be located within the building where easily visible and readily accessible and as close as possible to the supply inlet.

**Rule 25. Water Supply Check Valves.** The piping connecting each source of water supply with the sprinkler system, including fire department connections, shall be provided with a check valve.

On two-source systems, check valves shall have a gate valve on each side to permit repair of check without shutting off both

supplies, except that where the two sources of supply consist of tanks located above the highest line of sprinklers, a gate valve need only be provided on the down-stream side of each check valve.

**Rule 26. Control Valves.** All automatic sprinkler systems shall be provided with a main control or shut-off valve arranged to be readily accessible and sealed in the open position; except that when the sprinkler system is fed from water supplies on the roof of the building, independent and readily accessible floor control valves, sealed in the open position, may be installed.

When not more than ten (10) standard one-half (1/2) inch sprinkler heads or three (3) Conran\* heads in any automatic wet pipe system are exposed to cold and subject to freezing, shut-off valves may be provided to discontinue the water supply to such heads between November 1 and April 1. A greater number of heads than specified above, located in places which cannot be properly heated, shall be controlled by an automatic dry-pipe valve.

**Rule 27. Dry-Pipe Valves.** A dry-pipe valve shall be taken to mean a valve automatically controlling the water supply of the sprinkler system in such a manner that under normal conditions its piping system beyond the valve is maintained dry, but in the event of fire, the valve automatically releases the water into the sprinkler system, for fire extinguishing purposes.

Dry-pipe valves shall, for the purpose of these rules, be classified as follows:

**Type A,** in which the valve is actuated by the release of compressed air in the sprinkler piping system, due to the opening of a sprinkler head; and

**Type B,** in which the valve is actuated by an approved trip under electric control of an approved automatic thermostatic fire alarm system.

Dry-pipe valves shall be located as near as practicable to the sprinkler system in an enclosed and accessible place protected from mechanical injury and freezing.

Automatic wet-pipe sprinkler systems in which only twenty-five (25) per cent of the heads are required to be maintained dry for protection from freezing, shall have only such heads under dry-pipe valve control.

(a) When "Type A" valve is installed, the air pressure in sprinkler systems under such dry-pipe valve control shall not exceed forty (40) pounds per square inch, nor be permitted to fall below twenty-five (25) pounds per square inch, nor shall it be less than one-sixth (1/6) of the water pressure in any case.

The air compressor shall have a capacity of not less than eleven (11) cubic feet per minute and the air supply for the pump shall be taken, if possible, from a room containing dry air, or it shall be passed through a drying chamber containing calcium chloride, in order to avoid the introduction of moisture into the system.

The air pressure on such dry-pipe systems shall be maintained throughout the year.

Not more than the following number of heads shall be controlled by one "Type A" dry-pipe valve:

- (a) For Standard one-half (1/2) inch heads..... 400
- (b) For Conran\* one (1) inch heads..... 100
- (c) For Conran\* one and one-quarter (1 1/4) inch heads... 64

(b) When "Type B" valve is installed the actuating alarm system shall be designed to operate at a temperature lower than that required to open the sprinkler heads, and all connections between the alarm system and the dry-pipe valve shall be adequately protected against injury of any kind.

When required by the administrative official having jurisdiction, the dead end of every feed main in such dry-pipe system shall be provided with an air relief valve or vent, so constructed as to be normally open in order to permit the free escape of air from the system, but to close automatically against the escape of water.

Not more than the following number of heads shall be controlled by one "Type B" dry-pipe valve:

- (a) For Standard one-half (1/2) inch heads..... 500
- (b) For Conran\* one (1) inch heads..... 125
- (c) For Conran\* one and one-quarter (1 1/4) inch heads... 84

**Rule 28. Alarm Valve.** All automatic wet pipe sprinkler systems shall be equipped with an alarm valve so constructed that a flow of water through a one-half (1/2) inch orifice will operate an electric or mechanical gong.

Dry-pipe valves shall be equipped with a reliable device to give either an electrical or mechanical alarm.

**Rule 29. High and Low Water and Pressure Alarm.** All gravity tanks shall be equipped with a device to indicate when the water falls below or rises above the normal level in the tank, with an indicator or alarm located in the engineer's room near the pump.

All pressure tanks shall be equipped with a device to indicate when the pressure in the tank falls below seventy (70) or rises above eighty (80) pounds per square inch with an indicator or alarm located in the engineer's room near the compressor.

**Rule 30. Heating of Tanks.** The water in all sprinkler tanks subject to freezing shall be protected by internally heating the water or enclosing the tank in a frost-proof house properly heated and lighted.

**Rule 31. Concealed Pipe Systems.** All pipe in concealed pipe systems shall be of standard full-weight wrought iron or steel, painted with two coats of protective paint, one before and one after installation. Such pipe shall be installed in ducts or be encased in cement mortar and shall be inspected prior to concealment. When installed in the concealed space between floor arches and ceiling, such pipe shall be supported by hangers and all pipe, fittings and hangers be protected with two coats of paint.

**Rule 32. Preparation of Building.** Floor or wall openings and other structural defects which prevent the banking up of heated air and retard the automatic action of sprinkler heads shall be provided with the necessary curtain boards and draft stops to permit specific control of the fire by the local sprinklers.

Curtain boards shall project at least three (3) inches below the lowest sprinkler.

**Rule 33. Sprinkler System Tests.** All automatic sprinkler systems, excluding the water supply tanks, shall be subjected after installation to a hydrostatic pressure test of at least fifty (50) pounds per square inch in excess of that which will be normally carried and observed in the sprinkler system, such test pressure, however, never to be less than one hundred and fifty (150) pounds per square inch in any part of the system.

All pressure tanks shall be tested after erection to a test pressure of one and one-half (1½) times the working pressure. To prevent the possibility of serious water damage in case of a break, the pressure shall be maintained by a small pump, the main controlling gate being meanwhile kept shut. Brine or other corrosive chemicals shall not be used for testing systems.

In automatic dry-pipe systems with "Type A" valve control, an air pressure of forty (40) pounds per square inch shall be pumped up, be held for twenty-four (24) hours, and all leaks stopped which allow a loss of pressure of over two (2) pounds per square inch for the twenty-four (24) hours.

In the case of automatic dry-pipe systems with differential "Type A" valve, the valve shall be held off its seat during the test to prevent injuring the valve.

Non-automatic systems shall be tested after installation at not less than fifty (50) pounds per square inch in excess of the pressure necessary to reach the highest line of sprinklers.

All tests of installed systems shall be made by the contractor in the presence of the fire commissioner, or his authorized representative.

**Rule 34. Non-Fireproof Business Buildings.** Automatic sprink-

lers required in non-fireproof business buildings under the provisions of Chapter 5, Article 4, Section 72, code of ordinances, unless otherwise specifically provided in these rules, shall consist of at least a One Source System.

**Rule 35. Theatre Buildings.** Automatic sprinklers required in theatre buildings under the provisions of Chapter 5, Article 25, Section 324, code of ordinances, shall consist of at least a One Source System.

**Rule 36. Firework Storage.** Automatic Sprinklers required in buildings in which fireworks are stored or sold under the provisions of Chapter 10, Article 6, Section 92, code of ordinances, shall consist of a Two Source System.

**Rule 37. Nitro-Cellulose Products.** Automatic sprinklers required in buildings in which nitro-cellulose products are stored under the provisions of Chapter 10, Article 19, Section 232, code of ordinances, shall consist of a Two Source System.

**Rule 38. Inflammable Motion-Picture Films.** Automatic sprinklers required in buildings in which inflammable motion-picture films are stored under the provisions of Chapter 10, Article 20, Section 241, code of ordinances, shall consist of a Two Source System.

**Rule 39. Existing Installations and Approvals.** Automatic extinguisher systems and devices heretofore approved and accepted by the authorities having jurisdiction shall not be required to conform to the provisions of these rules; and all such systems heretofore installed shall not be required to be altered to conform to these rules so long as the fire hazard due to construction and occupancy of the building is not increased and the system after inspection is found to be in good working order.

JOHN P. LEO, Chairman.

## "The Building Contract of the Future"

WITH the above caption there appears an article in *The Journal of the American Institute of Architects*, March, 1919, by Sullivan W. Jones. A careful reading of this article causes some curiosity as to why many of the conclusions contained therein have been formed. An intimate contact with architectural practice and contracting work, covering a large portion of this country, is an experience such as to preclude the formation of many of Mr. Sullivan's conclusions. The article favors the adoption of the cost-plus-fee contract and presents many arguments in favor of such procedure, but does not carry it to the ultimate and logical conclusion. The practical result of his scheme would be disastrous to the architect as defined by modern conditions.

During the Middle Ages and the Renaissance period the architect did not exist, and construction was in charge of guilds and the work done on a cost basis, paid for from the public funds or voluntary contributions. The lump-sum construction contract "is a product of the mercenary spirit of modern industrialism." The main argument for the cost-plus-fee contract is for a return to the conditions of the Middle Ages and Renaissance period, the modern contractor to assume the function of the old-time guilds. The architect would then become a mere draftsman or layout man, yielding his present day prerogative of directing and controlling the project.

The "mercenary spirit of modern industrialism" is the result of the civilization of today, and it is questionable if a movement to return to the conditions of the Middle Ages and Renaissance period, merely to aid the contracting business, would meet with a general approval. The only existing build-

ings of those former ages are ecclesiastic monuments and the palaces of autocrats and aristocrats. Modern industrialism may have its drawbacks, but it can never be displaced, and as it is here to stay, it will continue to make its peculiar demands on architecture, such as did not exist in former times. Great progress has been made in satisfying these demands during the past half-century, and the immediate future will require every talent and effort of the architect to solve these problems.

"The contract system which was in almost universal use before the war had revolved about two wholly false assumptions: One, that a modern building can be described by drawings and specifications with sufficient completeness to provide for an accurate computation of costs, and, hence, for bids on its construction that are fairly competitive; and the other, that the contractors' business is that of selling finished work, that he is essentially a merchant, who should, but by no means always does, possess a specialized knowledge of the suitable and economical use of the things he buys and sells." It is not a false assumption that a modern building can be adequately described by plans and specifications. They have been, are, and will be so described by competent architects. Any contractor who has operated throughout this country can cite great numbers of architects whose work disproves the correctness of this assumption. A further refutation of this claim of the architects' incompetency is found in a recent address by C. E. Dobbin, Deputy Superintendent of School Buildings in charge of General Drafting Room, New York, before the Municipal Engineers of New York City, February, 1919. Under the general direction of C. B. J. Snyder, Architect and Superin-



## THE AMERICAN ARCHITECT

tendent of School Buildings, New York City, the extras *due to errors and omissions* during the past eight years amounted to \$24,000 on contracts for school buildings aggregating \$28,000,000, or less than one-tenth of one per cent. Many other architects can present a similar record.

Can it be imagined that the great bridges and steel constructions are fabricated and erected without adequate plans and details? The fact is that such plans and details are furnished by engineers as a *matter of course* with no yielding of control to others. This is a result of the engineer being trained to accurate workmanship and knowing that he is responsible for the results. That responsibility he never surrenders.

If the architect is going to acknowledge his inability to prepare adequate plans and specifications and place the responsibility on the contractor with a cost-plus-fee contract, he will very quickly be superseded by the competent engineer who never dreams of evading his responsibilities and obligations.

All contractors are not "merchants" in any sense of the word. It is true that some financial institutions have subsidiary corporations masquerading as contractors who assume cost-plus-fee contracts for projects that the parent organization finances. The amount of such operations is small compared with the total of building construction operations. Such firms are usually termed "brokers" and not considered to be real contractors by the craft. The real contractor is essentially a producer whose organization, by its own efforts, transmutes labor and materials into the finished structure. There are vast numbers of such contractors who would resent the appellation of "merchant or broker." Both of the assumptions appear to be based on conditions that do not exist.

Under modern conditions the owner "strives to drive shrewd bargains with the contractor." Bargains have always comprehended the element of shrewdness on the part of one or both of the contracting parties. If the contractor, through ignorance or incompetence, realizes he is unable to safely bargain for his service, it is readily to be seen why he prefers the cost-plus-fee contract, for in this way he can evade the responsibility and possible loss. With both the architect and contractor evading responsibility, the owner can pay the bill.

The purchaser of almost any known commodity buys with such guarantees that he can accurately measure the value of the thing purchased by the money expended. Then why make an exception of buildings? There is no reason for such procedure except to favor the architect or contractor who is unable to measure in terms of money the

value of his service. This exception will not, under normal conditions, be generally made. War conditions are no criterion for these matters.

Contracting methods during the period of the war were very wasteful and cannot be continued. A superintendent of a Government housing project writes that they "turned over" 5000 carpenters to get 1400 "halfway" workmen. He secured a very hard name as a "driver" and was even called to task, by Government inspectors, for driving the men too hard. It was a cost-plus-fee job, and such jobs always attract the incompetent and irresponsible, a fact known to all contractors.

If we wish to hold to the lump-sum contract and competitive bidding, it is "obvious, then, that we must find some way of giving the contractor in advance the information essential as a basis for fair competition on price. Can it be done?" There is nothing more simple. Real knowledge, intelligence and hard work incorporated into plans and specifications, with an accurate quantity survey of the materials involved, given to a competent contractor will solve the problem. This is being done every day, with success and satisfaction to both parties to the contract.

"Estimating, even under the most favorable conditions, will always involve risk to the contractor, and as long as there are risks, competition will be based on risks instead of the work to be done." Here again is afforded an example of the exact analogy between the selling of contractors' services and any other form of merchandising. With proper plans, specifications and a quantity survey, a large measure of the estimating and contracting risk is overcome. Risks will remain, such as labor and the weather. Every human activity involves a risk of some kind. If one is too cowardly or effeminate to assume a risk, living will lose its charm to all except architects and contractors under a universal cost-plus-fee system. But the owner is asked to assume all the risk, a thing which he will not do. The whole proposition leads to a state of inefficiency and supposed security which must finally eliminate the architect as such and build up a group of contractors who will control construction.

The Committee on Contracts and Specifications of the American Institute of Architects, and the members of that organization, will consider this important matter before committing themselves to a returning to the conditions of the Middle Ages and Renaissance period. THE AMERICAN ARCHITECT does not believe that architects will, in this way, yield their rightful privileges and prerogatives to the contractor, to whom in "confidence", the owner is expected to honor all monetary drafts.

146 after 6/12

# The AMERICAN ARCHITECT



CHURCH OF SS. STEPHAN AND NICOLAS, PESCIA, ITALY

PUBLISHED WEDNESDAYS IN NEW YORK—FOUNDED 1876  
VOLUME CXV                      APRIL 30, 1919                      NUMBER 2262

Entered as second class matter January 6, 1909, at the Post Office at New York, N. Y., under the Act of March 3, 1879. Publication office, 243 West Thirty-ninth Street, New York, N. Y. Subscription price in the United States and Possessions, \$10.



# RAYMOND

EVERY Architect knows that the basic principle of concrete construction is the use of FORMS which are left on the concrete until it attains its requisite hardness. Every Raymond Concrete Pile is placed in this manner, using a spirally reinforced steel form, which is left in the ground.

## RAYMOND Concrete Pile Co.

NEW YORK: 140 Cedar Street  
CHICAGO: 111 W. Monroe Street

*A Form for Every Pile—  
A Pile for Every Purpose*



# The Practice of Architecture

**M**ANY things give indications of changes in the making. Through conversation, correspondence or reading these signs are constantly recurring testimonies, and a tabulation is unconsciously made of them until the ideas become insistent in their presence. To verify the general impression, a systematic collation of all the evidence is in order.

In arriving at a conclusion by this mental process, it will be found that among the diverse problems demanding attention at this time, one of manifest importance is that of the attitude of the public toward the architect and of the architect in his relations to himself and others.

The practice of architecture is probably today, more than ever before, a matter of barter and trade. The monies invested in building structures demand a return service which represents full value. This value is measured in the adaptability of the structure to its use, its durability and its appearance. These three factors are the fundamentals of correct planning and to render adequate service it appears to be essential that the architect should fully qualify himself to meet these basic requirements.

An analysis has been made of a great amount of data pertaining to this subject and the majority opinion has been condensed into the following five paragraphs which embrace the most common of the points developed. This brief consensus of opinion is not intended to cover the multitude of conditions that exist in such relations, but it is thought that possibly it comprises the basic factors.

1. The business of architecture is inseparable from the profession of architecture. Together they comprehend the originating, promoting, designing, planning, directing and controlling the construction of buildings and their appurtenances.

2. To develop a general demand for architectural service—without which only limited opportunities for practice will be presented—the architect must, as an individual and collectively, employ proper and effective means to create a universal appreciation of its intrinsic value.

3. To fully perform his function, the architect must organize, equip and operate his business so as to render complete service in the production of plans and specifications for everything embraced in the construction, equipment and furnishing of buildings.

4. He must furnish complete and detailed supervision of construction and be closely identified with it. He must be responsible financially, as well as morally, for all of his acts, including the correctness of design, the completeness and accuracy of plans, specifications and details, and the construction of the building in accordance therewith; his responsibility to be contingent only on his being accorded freedom in deciding all matters of structural design, mechanical equipment and the selection of materials and workmen.

5. He must control and regulate the business affairs of the building operation so as to safeguard all interests. He must be just and impartial in deciding all controversies within his jurisdiction, but where his own interests are involved he must submit the controversy to arbitration.

*(Reprinted from issue of November 27, 1918)*





ABRAHAMUS BLOEMAERT,  
BATAV, PICTOR

*Pictor naturā est, usus vix ille magis tro:  
Arte hic egregius nec tamen inferior.  
Pmxit Aves, Naves, Homines, Herbaeque Ferāsque,  
Et lætos Flores FLORIDUS, innumeros.*

# THE AMERICAN ARCHITECT

VOL. CXV.

WEDNESDAY, APRIL 30, 1919

NUMBER 2262

## The Development of Craftsmanship

WHILE we are setting about the reformation of our methods of architectural education, it would be wise, when that arduous task is well under way, also to organize for the education of the craftsman.

One of the most admirable reports ever presented by a committee of the Institute, was that of the Committee on Education during the convention of 1912. In the course of that report it was stated:

"We may on paper create visions that rival those of Coleridge's *Kubla Khan*; we may on arising from a weary drawing board, our creative task accomplished, say with Justinian (and believe ourselves in the saying): 'Solomon, I have surpassed thee,' but when we see our drawings and our designs materialized in three dimensions we realize that, were we buried within their walls, the globetrotting New Zealander, a century hence, looking for our personal monument would hardly say with Sir Christopher's eulogist, 'Circumspice.' In the good old days, when architectural monument was a plexus of all the arts, the architect was pretty much at the mercy of the craftsman and he still is, with a difference, for then every bit of sculpture or carving or metal work and joinery, and glass and needle work, when these latter came into play, enhanced the architecture, glorified it, and sometimes redeemed it as well; now either our carving is butchered, our sculpture and painting conceived on lines that defy their architectural *ton*, our stained glass defiant of every law of God, man or architect, or it is all reduced to a dead level of technical plausibility, without an atom of feeling or artistry—and we are glad enough to take it this way for the sake of escaping worse."

After a lapse of now almost five years, the relationship of the architect to the craftsman has undergone little if any change. The fact that so little has been accomplished gives proof to the contention often made in these columns that the admirable reports of the Institute are too often purely academic, and chiefly, perhaps, through lack of proper execution, are nothing more than a waste of the best mental effort of their framers.

Despite the fact that we have not made progress in attaining a closer relationship between architecture and craftsmanship, there may, however, be pointed out men in the various crafts who by intelligent labor have by their own efforts elevated the dignity of their particular craft, but there the

matter rests. The schools of craftsmanship, like the schools of architecture, appear to be teaching but a small part of the essentially practical elements of their work. If it is asked just what cooperation architects might reasonably expect from the craftsmen, it might be said that they surely should not expect a slavish copying of a design originated in the architect's office. Why should not the design originate with the craftsman? Does not a mechanical copying of another man's artistic work dwarf originality and retard a free expression of ability? If the craftsman is trained, as he undoubtedly should be, in an exact knowledge of the material in which he works, is it not logical to assume that with an equal artistic training he should be better able to design and execute than some man whose ability lies in a clever faculty for design alone. It would seem therefore that the surest way for architects to promote a better craftsmanship would be to give the craftsman freer rein in these matters and let him produce the design, under the critical oversight of the architect. Perhaps it will be said that this cannot be done, that there are not enough men in this country sufficiently trained to undertake such work. If this is true, and perhaps it is, does it not at once point to the necessity for a finer development of the higher craftsmanship in this country? There does not appear to be a better opportunity for architects to lend assistance to work that will help them to attain the highest artistic ideals than in this direction.

Again quoting from the report already referred to:

"Every architect knows that the success or failure of his work depends largely on the craftsmen who carry it out and complete it with all its decorative features of form and color, and yet in a nation of 100,000,000 people, with a dozen schools of architecture, practically nothing is done toward educating these same craftsmen, and we either secure the services of foreign trained men, accept tenth rate native work, or go without. Take a case in point: It is decided to build a metropolitan cathedral with little regard to cost; plans are made; what then? If it is to be a great and comprehensive work of art, it needs—and exactly as much as it needs its archi-



## THE AMERICAN ARCHITECT

tect—sculptors, painters, carvers in wood and stone, glass makers, tapestry makers, embroiderers, leather workers. Are there enough schools in America to train all the craftsmen needed on this one monument—is there one school, and if so, where? One of the foolish arguments against Gothic, is that it is quite dependent on artist-craftsmen, and as we have none we must abandon the style; one of the foolish arguments in favor of classical design is that anybody can learn to carve an acanthus, therefore we had better stick to what we know we can do. Neither argument is sound. If we have no artist-craftsmen, then it would be better for us to close up half the schools that are training our architects and employ the funds so saved for the training of the only men who can give life to the architect's design."

Now this is the soundest of common sense. No good argument can be advanced in refutation.

It may seem presumptuous to insist that one of the lacking essentials in a profession that claims to be highly educated is the lack of education. This lack is, of course, not one of basic knowledge, but one in the exact direction that would accomplish the best and most lasting results. Undoubtedly we shall see a very decided change in the curriculum of architectural schools. Shall we have to wait until, by years of newer methods of education, we become sufficiently farsighted to sense the necessity for also educating the architect's *alter ego*, the craftsman? The advancement of one is in certain directions bound up in the progress of the other. We should, as architects, do all that we can to develop a class of men whose intelligent co-operation so largely contributes to the success of everything that we attempt in design.

As pointed out earlier in this article, there have developed in this country certain master craftsmen of the highest artistic ability. We have had here in New York an important demonstration as to just what can be and is done when architects and craftsmen co-operate in the broad spirit as brother artists.

The rapidity with which was executed the complicated detail of the architects who originated the Altar of Liberty, the Victory Arch and other decorative features along Fifth Avenue, most of which have appeared or will soon appear in THE AMERICAN ARCHITECT, offers an example and affords a basis of demonstration. In this particular instance, the master craftsman is Mr. Menconi, whose work as an expert modeler and ability as an artist is widely known among architects. Such educational work as is being done in this particular field of craftsmanship is being carried forward by Mr. Menconi. Under his highly skilled direction he has developed a group of master modelers whose work is to be seen in the Victory Arch in its highest development. Certainly this is worth while. Re-

sults so eminently satisfactory should be extended to other equally important fields.

When Mr. Egerton Swartwout had completed his very successful Eddy Memorial, he contributed an article to an architectural magazine in which he set forth the valuable co-operation he had received from this master craftsman. He interestingly described his relation as architect to the craftsman modelers. Throughout it was that of one artist in the most cordial co-operation with a brother artist in an allied field of art. When the plaster models had been finally approved and were to be cut in stone, Mr. Swartwout tells us that "each man was an artist in his way and that there developed the most intense rivalry in the execution in stone of the plaster models." Further, we learn that "in many cases the carving far exceeded the models in delicacy, and the most extraordinary results were obtained."

But the great object achieved was the manner in which the architect dignified to the craftsman the credit or honor of his work. We are told that "as an incentive, each man was allowed to put his name on the individual stone he carved, on the side bed to be sure, but still it was there, and at the conclusion of this work a full list of the individual carvers, arranged in order of merit, was sent to the Board of the Memorial and each man received a special letter of appreciation."

Can anything be finer than that? Can there be devised any more intimate and unselfish co-operation than existed under such admirable conditions? Can there be any surer way to develop craftsmanship and place it on the high plane where at one time it so securely rested?

The progress of the many decorative features that have been under Mr. Thomas Hastings' origination and direction since we went to war, have all been along exactly similar lines. The writer of this, by personal visit and actual investigation in Mr. Menconi's large studios, is able to bear witness to the absolute accord between the architect and the craftsman. The result stands forth, an artistic ensemble in which those who created it may take the fullest measure of pride. It is by these means we shall get set along satisfactorily on the road we shall travel in the elevation of the art of the craftsman.

It will be a slow work, but the end will crown it. There must be a long pull and a strong pull and a pull all together. But, if architects will take this matter as seriously as it deserves, we shall look forward to a renaissance of craftsmanship that will vie with all the glories of Italian art.

# Notes from London

By SELWYN BRINTON, *Special Correspondent to THE AMERICAN ARCHITECT.*

**A** SUBJECT which has profoundly absorbed public attention in England during the last few weeks, quite as much as the proceedings of the Paris Conference, has been the inquiry and report of the Coal Commission.

That inquiry revealed conditions of life in certain colliery areas which were to most of us an appalling revelation.

Mr. John Robertson, chairman of the Scottish Union of Mine Workers, in his evidence before the commission stated that in Hamilton, Lanarkshire, out of 88,000 inhabitants 27,000 were living in one- and two-roomed houses, and that in Wishaw 28.5 per cent were in houses of one room. Numerous houses, he added, had one apartment for husband and wife and several children, while the statistics of tuberculosis showed 78 per cent of cases in one- and two-apartment houses.

"Private enterprise," he continued, "has failed. . . . It must be done by the State. There is a legacy of bad housing, the result of many years of greed, selfishness and ignorance." This witness went on to quote an eloquent appeal from Dr. Russell, a former medical officer of the Local Government Board: "You mothers, with your cooks and housemaids and nurses, how would you, in your own persons, act all those parts in one room where, too, you must eat and sleep, and find your lying-in room, and make your sickbed? . . . Last of all, when you die, you still have one room to yourself where in decency you may be washed and dressed and laid out for burial. If that one room were your house, what a ghastly intrusion you would be. The bed on which you lie is wanted for the accommodation of the living."

The above states very feelingly the darkest side of the picture, for in many cases the miners have been earning very good money, and I have heard of as much, probably in a better position, as £7 a week being earned, with half the rent free and coal supplied. But even so, what has come to light has profoundly roused public feeling, and the *Daily Telegraph* interprets this in saying: "What the Government must realize is that housing has now become a matter of national conscience. Public opinion has been horrified at recent revelations, has been roused to an indignation which is justified, to an impatience which will only be allayed by vigorous action."

That action, promised at the opening of Parliament weeks ago, seems now being taken, and the

Housing Bill, published in recent papers, gives very wide powers both to the Local Government Board and to the local authorities to meet the widespread shortage of houses.

Briefly stated, this measure places local bodies under a stringent obligation to carry out housing schemes, failing which the County Council or Local Government Board may act over their heads. Local liability is to be covered by a penny rate, any excess to be borne by the State. There are special provisions for dealing with what are known as "slum areas," and for the purchase of housing sites; and it is satisfactory to hear that the "need for the provision of houses for the middle classes has not been lost sight of." Possibly this last assurance is due to the fact that the middle class, that long-suffering and much-taxed portion of the community, is at last beginning to "kick." A Middle Class Union has been recently initiated and received with enthusiasm, with a strong and active support within the House of Commons, for the express purpose of securing some adequate protection for the interests of a part of the community on whom the bulk of this heavy national expenditure, when the bill comes to be presented, will inevitably recoil.

The report of the Coal Commission, under Mr. Justice Sankey, which takes a middle course between the claims for hours and wages of the mine-owners and the miners themselves, was issued on March 21, but lies a little outside of my subject here.

I wish, however, to draw attention to a matter of the greatest importance in connection with this housing question, in a protest which has been sent to the Local Government Board, the Treasury and War Cabinet by the Industrial Council of the Building Industry. The terms of this communication could scarcely be stronger. "This Building Trades Industrial Council expresses profound dissatisfaction at the avoidable delay in pressing forward the resumption of building operations, so urgently needed to prevent unemployment, owing to the lack of adequate arrangements to enable the brickyards, stone and slate quarries through the country to restart, and believing that the delay is due to gross incompetence in handling the supply of materials, and further being of opinion that we could expedite the manufacture of such materials, we hereby demand that the experience of the



## THE AMERICAN ARCHITECT

members of our Council be immediately used toward restoring the building trade to its proper normal position."

The following facts appear to have influenced this resolution. The Government order, as announced, for 800,000,000 bricks had been confined to certain large makers, while no effort had been made to set going the enormous number of small brickyards scattered over the country, who made quite half the bricks in past days, and who could reduce transport by supplying locally.

Nor had the stone quarries, which are largely used for houses in Scotland and some parts of England, been started going, nor yet the very necessary quarries of slate, and thus, while waiting for the peace to be discussed and signed, the output of the next season's production was being seriously affected.

The fact is that in this, as in most other trades, production is not merely needed, but it is vitally necessary, yet no forward move can be really taken to re-establish the normal conditions while we are waiting for peace to be definitely arranged.

Mr. Frank Vanderlip's telegram is quoted in recent London papers as coming from an American observer in Paris: "Production has ceased, and unless it is speedily resumed the imagination cannot visualize the ensuing chaos. . . . Unless immediate peace permits the resumption of production, Bolshevism may overspread Europe, causing the breakdown of the machinery of civilization. No international guarantees can sustain exchanges while printing presses continue making paper money. America cannot withdraw in the belief that this chaos is remote and does not involve her. She must think internationally."

Government organization has, without doubt, during the war achieved magnificent results, more especially in connection with aircraft and munitions, and at a recent meeting of the R. I. B. A., Sir Frank Baines, to whose initiative at the Office of Works so much has been due, gave a very informing address, illustrated with lantern slides, on the subject of "War Factories and Their Adaptation to Future Needs."

"Mammoth factories," said the lecturer in describing these conditions of improvised building for war, "had to arise apparently at a wave of a magician's wand—sites had to be selected, buildings to be erected upon land presenting exceptional natural difficulties; the whole complicated, elaborate, highly technical problem of factory process and factory allocation, plant disposition and power distribution, railway siding, water supply, sewage disposal, electric lighting, heating, ven-

tilation—all had to be grasped, studied and carried into execution at fever heat.

"It should be borne in mind," he added, "that the work was generally of a highly confidential character, the processes involved frequently secret, experimental and excessively dangerous. The organization and responsibility normally delegated to the contractor had to be shouldered—labor had to be allocated, recruited, conciliated, fed, housed—and withal the public purse had to be safeguarded."

This interesting address, which was arranged by special request, to be continued at a subsequent meeting, gave the report of a most capable and highly qualified official on work whose merits we have just acknowledged.

On the other hand, there is another side, and a far less attractive one, to the picture; and this has only too fully brought to public notice of late in such revelations as the Slough Motor Depot and, even more, the National Shipyards at Chepstow.

"The whole record," said the *Times* correspondent of this latter undertaking, "would read like a screaming farce if so much public money had not been thrown away. . . . It was the constant change of plan and apparent absence of technical knowledge of shipbuilding, coupled with a decided refusal to learn, which led to so much loss of time and money." In expert opinion, "had the Admiralty employed an architect in the usual way, he would simply have required two or three draftsmen, a good clerk of works, and a responsible contractor. The many highly paid officials, with all their big staffs and circuitous methods of doing business could have been swept away." The whole method in which this work progressed backward was described at the time in a humorous poem, under the title of "The Boat Builders—a Tragedy in 18 Spasms." The Navy, said the writer, had acquired the property of the Standard Shipbuilding Company, and had called in the Army to provide labor. Then was seen the result—

"The first hundred thousand laid down a drain,  
The second draft took it all up again;

Then they held an inquiry, and tried to explain."  
And thus in process of time the conclusion was reached, which as the *Times* suggests, might have been adopted as the motto at Chepstow:

"Nobody minded. . . . The public paid."  
For it is the public which inevitably suffers and has to meet the bill; and the present state of things is one which, affecting every trade, hits most directly, as we have seen, the building trade and the architect.

"People are asking," says the *Daily Telegraph*,

## THE AMERICAN ARCHITECT

"why trade is so slow in recovering, why industry is not going full steam ahead. Dearer coal, dearer freights, higher wages, uncertainty as to costs and taxation . . . this is not the full catalog of their handicaps. One of the most serious of them all is the dead hand of Government control—a controller here, a licensing authority there, a department or a committee, an Order in Council or a schedule. The unseen presence is an official presence, and the dead hand is swathed in the red tape of Whitehall." Mr. Runciman lately put the case very truly and tersely: "The menace of a calamity is overhanging British commerce. Our instinct, as well as our reason, calls for fresh air and freedom."

A case of the greatest importance to both builders and architects has been recently decided in the House of Lords. Reported in detail in *The Building News*, it has been fully discussed in three successive numbers of *The Builder*, in connection with the admirable paper read by Mr. Valentine Ball before the Society of Architects, and the important discussion which followed.

"Nott v. Cardiff Corporation" dealt with a contract to build a reservoir, for over £200,000. During its progress the chief engineer required certain expensive work to be carried out, which, in his view came within the contract. The builder claimed this work as "extras," but did as he was instructed—the value of the work so done coming to £13,000. The engineer refused his written order, and the case came before the arbitrator, who ruled in the contractor's favor, and was supported in this view as to the work being "extras" by the High Court. The case went up for appeal.

"This case," said Mr. Valentine Ball, "merits the attention of all who are concerned with contracts for large works. It involved the consideration in a novel form of an old question, namely, in what circumstances can the employer be held liable for extras?"

"The broad, legal principle," he added, "which underlies every contract for erection of buildings is easy to understand and to enunciate. If a builder agrees to erect a certain house of certain materials

for £1,000, he can be compelled to carry it out to the letter. If he finds that he has to spend £1,500 to do the specified work, that is his misfortune. On the other hand, if there is a sudden fall in the prices which enables him to do it for £500, that is his gain and the employer's loss. . . . The forms of contract in common use have been so framed that the employer can only be liable to pay for extra work under special circumstances. Broadly speaking, he can only be charged (a) if the architect decides that the contractor is entitled to be paid for something which is an extra; and (b) if the architect has given a written order. In the case under notice the question arose as to the legal rights of the parties where the architect had refused a written order."

It will be seen at once what an important issue was here involved; for, as a matter of fact, a large number of the disputes which arise between builder and employer relate to "extras." In the Court of Appeals two out of three judges decided against the contractor on the technical ground that a written order was a "condition precedent," which arbitration could not override. Parker, L. J., dissented.

Carried to the Lords, by four judges to one this ruling was reversed, it being held that the arbitrator's award now took the place of the order in writing, which had been not given; so that the contractor had final judgment for his £13,000 and costs, and this case is now a leading authority.

The question of London Improvements is in the air, and is one of great interest. The reconstruction, now definitely sanctioned, in Piccadilly Circus and Lower Regent Street will be a great step forward, though it appears that the present unsightly buildings beside the Café Monico, whose removal is essential for a really effective treatment, are not yet to be disturbed.

But yet wider vistas are opened by the really magnificent scheme of a new bridge across the Thames at Charing Cross, and the redemption of the southern riverside, which has been called "the largest city area of wasted opportunity in Europe"; and this is a subject so suggestive that I prefer to reserve it for a fuller notice.



THE AMERICAN ARCHITECT

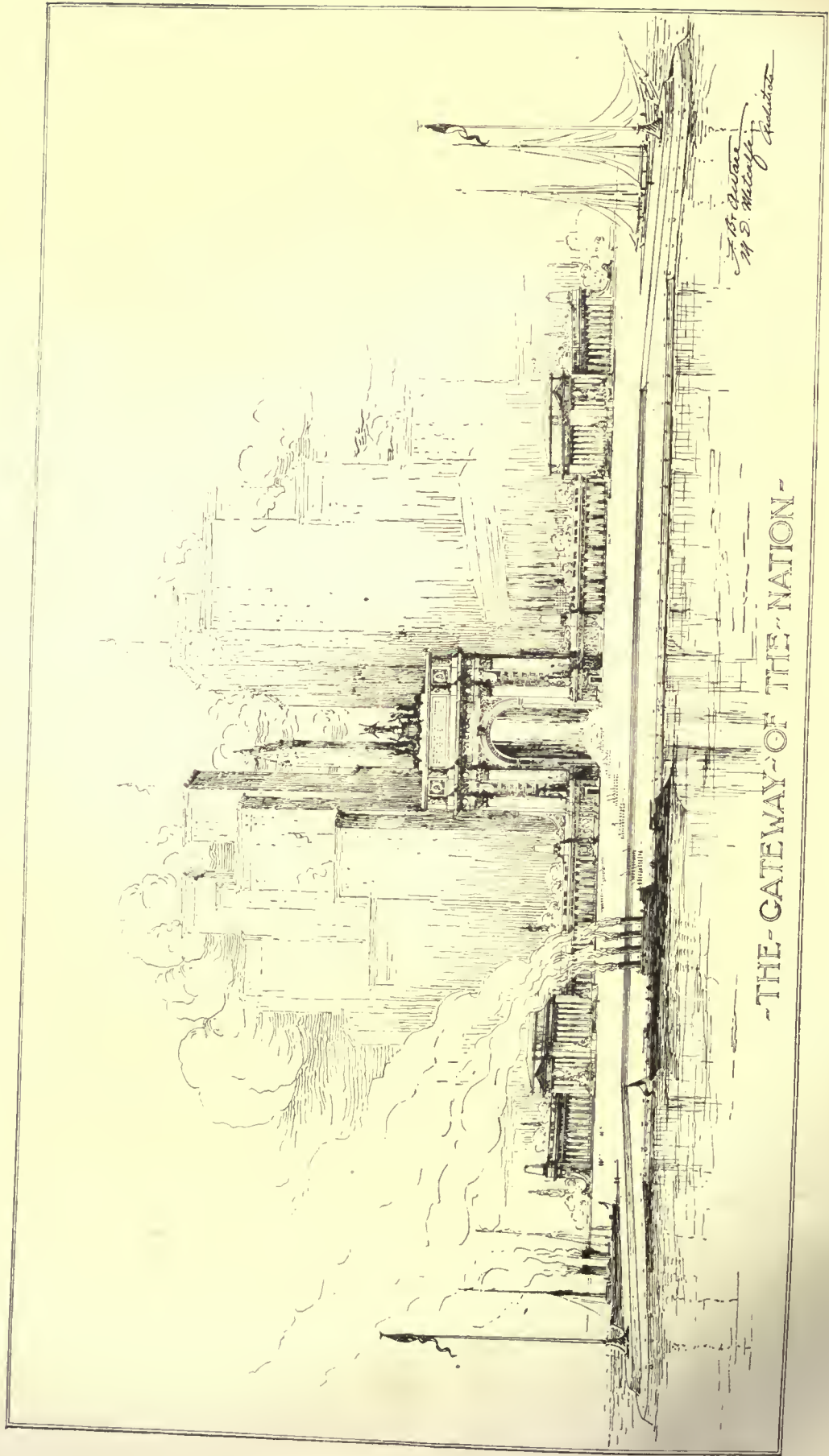

-THE-GATEWAY-OF-THE-NATION-

F. B. AND A. WARE AND M. D. METCALFE, ARCHITECTS

# The Gateway of the Nation

F. B. and A. WARE and M. D. METCALFE, *Architects*

THE subject of fitting memorials to commemorate the great victory of the Allies, is a matter of national discussion, and every city and town throughout the country will have its share of these creations, which will be erected during the months and years to come.

Recently the Mayor of New York formed a committee to take charge of all temporary decorations and other arrangements in connection with celebrations for our returning victorious soldiers, and this committee requested suggestions from the public as to the nature of these decorations, whether of a temporary or permanent character.

The Gateway of the Nation, which is illustrated in this issue of *THE AMERICAN ARCHITECT*, is a project which has been submitted to this Mayor's Committee and to a number of important downtown organizations for their consideration.

For a number of years the proposition for a monumental water gate and entrance to New York City has been discussed and studied, and several years ago an important competition was held for a water gate, the site chosen being in Riverside Park, between 114th and 116th Streets.

Since that competition was held, however, the great war in Europe has taken place, and as this country was fortunately associated with a number of Allies, the importance of a monumental water gate and entrance to New York City for the reception of distinguished guests, visitors, commissions, etc., from countries throughout the world becomes even more imperative.

We are of the opinion that the ideal and natural location for this monumental entrance to our city is Battery Park. Not only is this location a wonderfully beautiful one, commanding the most noble view of New York Harbor and the Statue of Liberty, but it is the natural entrance to Broadway, through Bowling Green, the most important artery of New York City, and, in fact, of the country.

This location also bears the proper relation to the City Hall. It is not expected that an anchorage for a fleet of warships is possible off Battery Park. An anchorage there is not practical. There is no reason, however, why the distinguished visitors cannot be brought to the Water Gate in tenders or destroyers and the larger ships continue on up the Hudson River to their permanent anchorage along Riverside Park.

The project submitted provides a large court of honor, approximately 600 ft. in width by 300 ft.

in depth. On this court there have been placed two buildings, one to be a reception and historical building for the Army, the other a similar building for the Navy. Surrounding the court, the design contemplates a monumental peristyle or Colonnade of Honor, forming an enclosure for the composition and at the same time a place to receive memorials and tablets.

This peristyle has been so treated that a vista through may be had of the court of honor from the park side. The central motive of the composition is a colossal arch of victory, placed on the axis of Broadway. The arch opening in the clear is approximately 80 feet wide, or the width of Broadway from building line to building line. This great width of arch opening allows a procession to pass through in platoon formation without any disorganization, and in the most dignified military manner.

The uncovered area of the Court of Honor is large enough to accommodate several regiments drawn up for review. The distinguished guests would be escorted through the great arch up Broadway, past what is probably New York's most important and interesting architecture (certainly to the foreigner), our great skyscraping office buildings. They would also pass several of our most important and best old examples of architecture, namely Trinity Church and St. Paul's. In a few minutes' time from the landing they would arrive with their escort at the City Hall, where they would be received by the Mayor and welcomed to the city in a dignified and natural manner. After the reception, the guests would proceed uptown through Lafayette Street or Broadway, to Washington Square, and then up Fifth Avenue, as the occasion may demand. We believe that this scheme provides a dignified entrance and reception to distinguished visitors.

The Statue of Liberty almost becomes a part of the composition, and the beautiful New York Harbor, with the two great rivers, the Hudson and the East, passing on either side, forms an ideal setting for the Gateway. As viewed from the bay, the composition should be most imposing. As viewed from the city, the Victory Arch would make a handsome vista and a noble termination to Broadway. It would also not interfere with traffic.

If this scheme should be adopted, as a permanent memorial to the Great War, we assume that the elevated railroad would be reorganized from



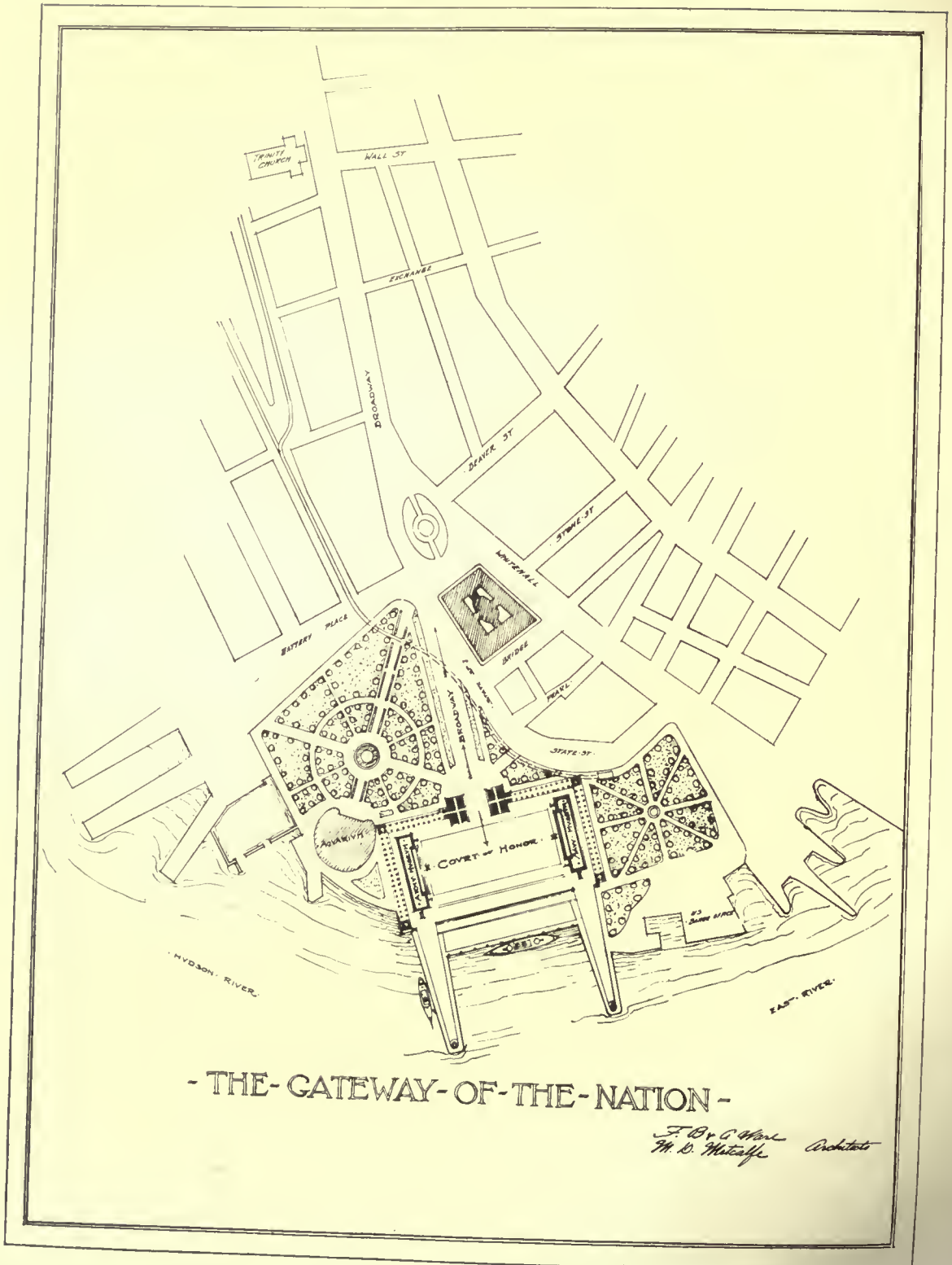

- THE GATEWAY OF THE NATION -

*F. B. & A. Ware Architects*  
*M. D. Metcalfe*

F. B. AND A. WARE AND M. D. METCALFE, ARCHITECTS

## THE AMERICAN ARCHITECT

Bowling Green to South Ferry, so that it would be underground when it passed the axis to Broadway.

This plan has been studied so as not to interfere with any of the present buildings on Battery Park. Even the ugly Aquarium is not disturbed. Battery Park at present is an unsightly place of landscaping, consisting of worn out grass beds, a few straggly trees, and almost no shrubs. The scheme suggested does not cover the entire park, but leaves a large uncovered area, which can be replanned and planted and made a truly beautiful park, enhancing the water gate from the city side. Battery Park is truly the gateway of the nation. It

was here that the great mass of immigrants to America landed and entered this country. The immigrants in great numbers passed up Broadway and eventually took trains to all sections of the United States.

During the past months thousands of the sons of these same immigrants have fought in the American ranks in France and many have paid the supreme sacrifice.

Where could there be placed a finer memorial to these men of the Army and Navy than at Battery Park, and what other site on Manhattan Island is better for a noble entrance to the city?





THE AMERICAN ARCHITECT

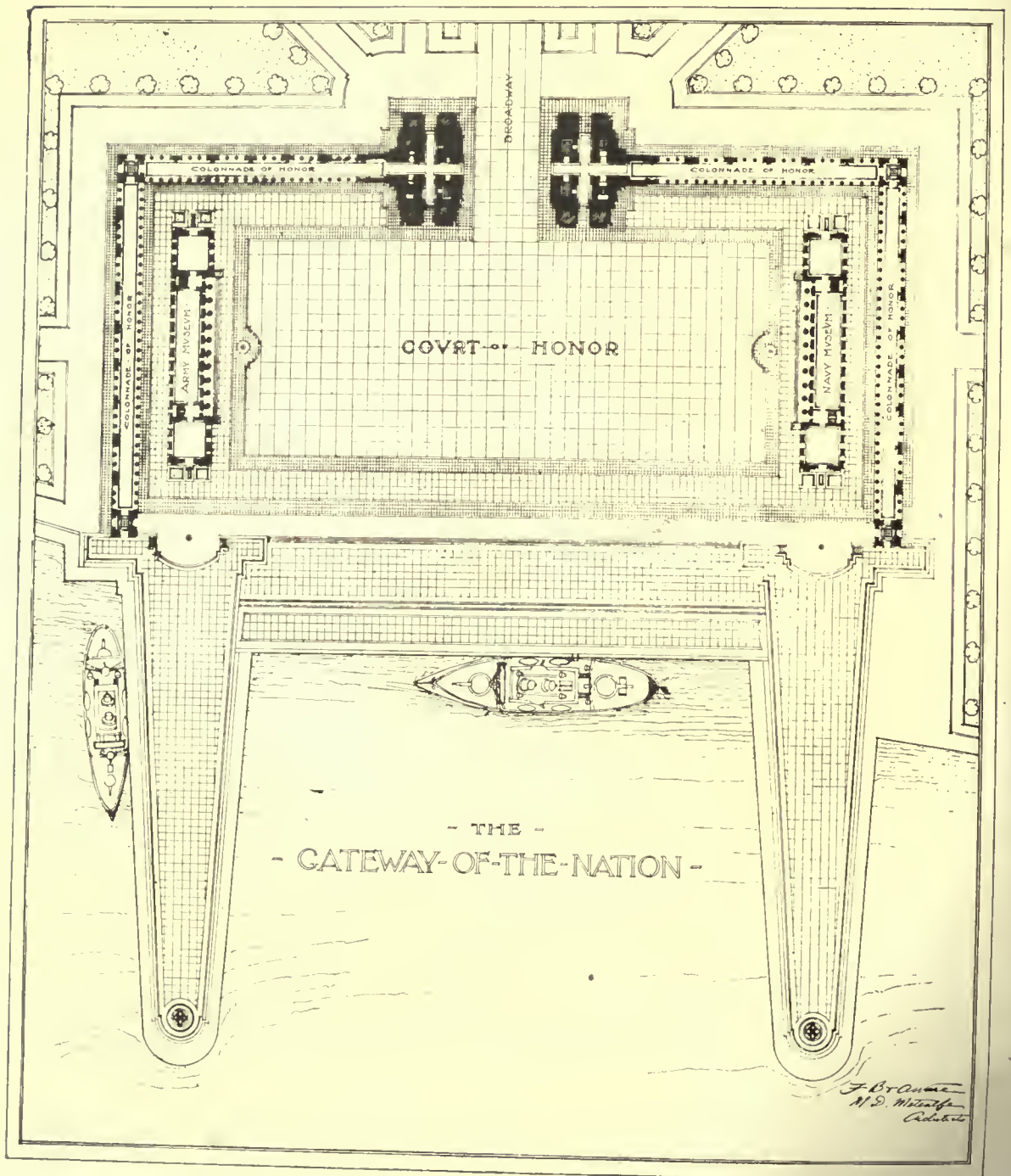

F. B. AND A. WARE AND M. D. METCALFE, ARCHITECTS

# Town Halls as War Memorials

*Illustrated by preliminary sketches for a Memorial City Hall at Attleboro, Mass., by  
KILHAM & HOPKINS, Architects*

THE city or town hall is running far ahead of its competitors as a popular choice for a "War Memorial." There may be many occult reasons for this fact, but the psychology of the citizen is usually simple enough. His town wants to do the handsomest thing possible for the lads returning from France. Public money is too scarce to squander in large amounts for questionable works

York City is a masterpiece easily interpreted to meet the needs of small cities and large towns to-day.

Of the same general character is the recently constructed Town Hall at Arlington, Mass., built of Indiana limestone, and with a type of auditorium worthy to stand as the memorial for any town's "Boys of 1917."

Similar in general style is the proposed City Hall



of art. An impressive sculpture of really distinguished merit is hard to guarantee beforehand, and, if a failure, is very extravagant. A painting is not visible to the passerby. The most tangible "big" thing is a building. Money can be raised for a handsome memorial of this kind if it also fills a practical need.

The most monumental type of public building, and at the same time the most *needed* building in hundreds of communities, is the town hall or city hall. It lends itself readily to a great variety of artistic treatments. If the community cherishes the Revolutionary tradition, the old City Hall of New

for Attleboro, Mass., drawings of which were presented to the city recently by a committee of the Chamber of Commerce.

There are many beautiful buildings scattered throughout the land serving as town and city halls, and there are myriads of buildings used for such purposes that are not beautiful. These latter are sometimes a source of shame or regret to the localities in which they stand. It is not easy, however, to destroy a useful building and at great cost to replace it by another in better style. Few towns could do this at the present time with any degree of justice to themselves. No town needs to do it.



## THE AMERICAN ARCHITECT

The art of architecture can be used to ameliorate the ugly lines of an old building as well as to create *de novo*. Many an eyesore has been converted into a thing of real beauty by a little skill and patient study. Never was there more need than at the

uninteresting and jaded structure of the early seventies a new memorial lobby, or to crown it with a memorial clock tower, meanwhile taking advantage of the opportunity for a general cleaning up, removal of jigsawed brackets and drab trimmings

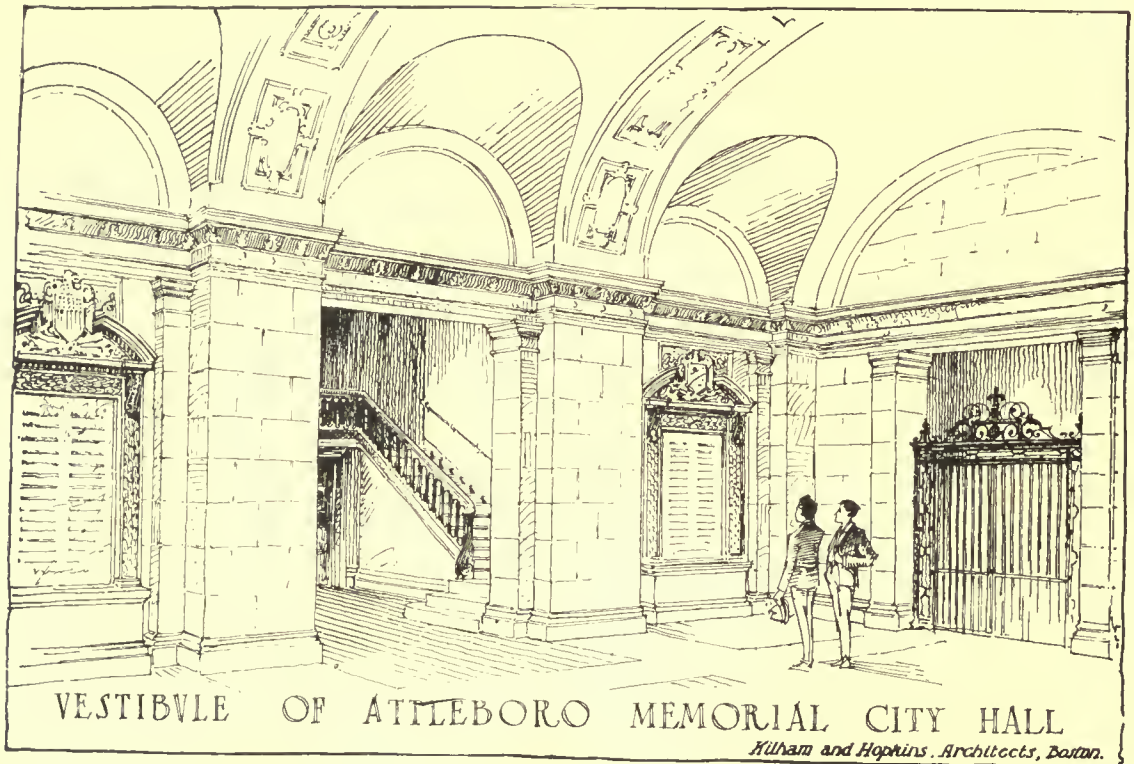

VESTIBULE OF ATTLEBORO MEMORIAL CITY HALL

*Hilham and Hopkins, Architects, Boston.*

present moment to conserve all existing values and avoid every form of waste or destruction. To beautify an old building is as honorable a task, therefore, as to design a new one. To introduce into an

to be replaced by white mouldings, that is a task full of interest and bearing fruit a hundredfold. It is the architect's way of causing the "wilderness to blossom as the rose."

### French Plan Monument

A national committee has been formed in Paris for the erection in Strasbourg of a monument to commemorate the history of the "Marseillaise," the French national anthem. It is expected to cost one million francs.

The head of the committee is Baron de Deitrich, a descendant of Mayor de Deitrich of Strasbourg, in whose home, in 1792, Rouget de Lisle sang the anthem for the first time. President Poincaré, Premier Clemenceau, President Deschanel of the Chamber of Deputies, and President Dubost of the Senate have given their support.

### Route of the Proposed Roosevelt Memorial Highway

The Theodore Roosevelt Memorial Highway, a transcontinental route from Portland, Me., to Portland, Ore., will enter the upper Michigan peninsula at St. Ignace, and will traverse the peninsula by way of Escanaba, Iron Mountain, to Hurley, Wis., thence to Superior, Wis., to Duluth, Minn. It will there follow in a westerly direction by way of Grand Rapids, Cass Lake, Bemidji, Crookston, into North Dakota at Grand Forks, and thence by way of Devil's Lake and Minot to Buford.

# THE AMERICAN ARCHITECT

Founded 1876

PUBLISHED EVERY WEDNESDAY BY

THE ARCHITECTURAL AND BUILDING  
PRESS, INC.

No. 243 West Thirty-ninth Street, New York

E. J. ROSENCRANS, PRESIDENT AND TREASURER

WILLARD C. HOWE, VICE-PRESIDENT

WILLIAM H. CROCKER, Editor

ARTHUR T. NORTH, Engineering Editor

Subscriptions in the United States and Possessions,  
Mexico and Cuba, TEN DOLLARS. Other Countries,  
TWELVE DOLLARS.

SINGLE COPIES (Regular Issue) 25 CENTS

CHICAGO OFFICE, Mallery Building  
PAGE A. ROBINSON, Western Manager  
ST. LOUIS OFFICE, Wright Building  
CLEVELAND OFFICE, Guardian Building  
SAN FRANCISCO OFFICE, 320 Market Street

Owned by United Publishers Corporation—H. M. Swetland, President;  
Charles G. Phillips, Vice-President; W. H. Taylor, Treasurer.  
A. C. Pearson, Secretary. Entered as second-class matter January  
6, 1909, at the Post Office at New York, New York, under the Act of  
March 3, 1879.

VOL. CXV APRIL 30, 1912 No. 2262

## The Convention at Nashville

IN the far famed "Blue Grass" region of the South, in the City of Nashville, the fifty-second annual convention of the American Institute of Architects, will, when this is read, be in session.

The place of meeting is in the beautifully designed State Capitol, the work of William Strickland, built from plans submitted in 1845. Amid such well recognized excellent architectural surroundings, and in the vicinage of the most correctly stated architecture to be found in our Southern States, there will be opportunities for calm, deliberate discussion of the many important things that will engage the attention of the delegates.

The four days to be spent in the South will not be all work and no play, for the Committee on Program has provided a most excellently arranged schedule that will afford the delegates opportunity to visit under favorable conditions the Hermitage, once the home of Andrew Jackson, Belle Meade, and other widely known points of interest. Such recreative moments, among interesting surroundings, should afford the proper relaxation from the meetings that will undoubtedly be filled with strenuous endeavor and much thoughtful work.

So much of importance hangs on this convention

that the attention of all those who are interested in the future development of the architectural profession in this country, irrespective of their membership in the Institute, is directly focussed. It may therefore be regarded as an epoch-marking gathering of architects. The outcome of their deliberation will be the crucial happening of a period that has been filled with much uncertainty.

## Before the Convention

JUST what the profession of architecture is today or what it has been in the past, does not now so much concern us as what we shall hope to make it in the future. Every man in this country who either by actual affiliation with the American Institute of Architects, with some of the many state or purely local organizations, or practicing alone, unattached, unaffiliated, has been invited to earnest participation in the work of the Post-War Committee.

Now more than ever before, will it be necessary for every man to do his bit, and as any effort to be productive of the best result should be properly organized, skilfully directed, it is most fortunate that there is available the leadership of the Post-War Committee.

The elements that go to make this program are those that the best opinion has determined basically to represent new ideals of practice. It is with these things that we are just now most deeply interested, and it is their discussion, and proper co-ordination for a well directed policy that the American Institute of Architects, now assembled at Nashville, may very properly seriously consider.

It is probably as certain as anything may be, that the policy outlined by the Convention will not embrace many of those distracting elements which in the past have been so strenuously put forward and have been proven so disastrous in results. It is further probable that the Institute has become so broadened that no comparatively small group of men may control its policy or dominate its attitude toward the profession.

Probably, and perhaps undoubtedly, the Institute will discard any attitude toward practice that ignores the vital lessons of the past two years, and if in carrying forward a policy based on a virile conception of the architect's functions it runs counter to a group that clings to ideals and principles which are not thoroughly democratic, in every phase, that group will undoubtedly have to stand to one side. It is certain that there will no longer be a disposition to temporize or to cater to any element that will fail to recognize that architecture while first of all an art, is none the less a business, and an extremely practical one.



## THE AMERICAN ARCHITECT

EVERY detail of the Post-War Program fore-shadows just such a policy for the future. As the criticism of this program and the replies to its many queries will not be restricted to Institute members nor to any group of that membership that would make the profession of architecture a resting place for poseurs and dilettanti, they are sure to contain the essence of mature judgment from a large number of thoughtful men who are interested in the advancement of the profession and who have none but the most unselfish reasons for sitting in its councils as invited by this Committee.

It must be borne in mind that no policy, no matter how well considered or carefully framed, can go forward by its own inertia. It will be vital to future success that none but highly important reforms be outlined and that they be placed in the hands of men with time and inclination to bring these matters to conclusion. Matters of minor importance, or what might be at this time called non-essentials, may well be put aside. But with the renewal of building, a renewal that in the future will call for the greatest activity, there is doubt that the men who could most efficiently labor to bring these things to pass will be able to give the time that will be necessary. Just here, then, it becomes important that there shall be added to the executive office of the Institute a highly qualified salaried official who will assume charge of the many details, and who can carry forward his work under the counsel of well-chosen committees of members.

This seems to be the all-important thing if the best results are to be achieved.

JUST what will be foremost in this policy of reconstruction that will be outlined by the Institute it is not possible to forecast, but it is safe to venture the opinion that first or last the subject of education will be a prominent one. With better educational methods, all supervised by the profession

and absolutely controlled by its members, all of the other problems that now are in need of attention would in the future become automatically solved. The architect's status, his relation to his associates, (ethics of professional practice) his relation to his clients and through them to the general public, his status before the government and his just distinction as an artist and a business man all would become satisfactorily regulated. For with such training as would be outlined by his elder brethren, the student would emerge from his college days with a mental foundation that would start him right and keep him right.

It is education that has bred certain types of men that have brought discredit on the profession, but it has been a wrong, a misdirected education. We stand a better chance for the development of a type of American architecture when we have developed a cleaner cut type of American architect. There is no quarrel with the classic precedent, no wish to brush aside the value of historic associations, but we shall need to eradicate what may be termed the effeminacy of too much misdirected academic learning and to replace it by a curriculum that shall be suggested and directed by the practical and successful men in the profession.

Every propaganda that is taken up by governments is founded on education of the people toward correct ways of living, and the cultivation of a viewpoint approved by well sustained practice.

The practice of architecture can be no exception in its attitude toward its future problems. When it has eradicated the poseur and blunted his ability to work mischief, when it has taught those who shall follow in the development of our architecture the right thing in the right way, it will have started toward a future so sure of success, so great in its possibilities, that even the man on the street will not need to be told that architecture is the greatest of all the arts; he will know and feel it in the evidence everywhere about him.



# Criticism and Comment

---

*The Editors, THE AMERICAN ARCHITECT:*

I have read with interest the article by Mr. George W. Maher dealing with the better architectural development of farm buildings. I wish to say that I am heartily in accord with the thought of Mr. Maher relative to the value of the State University as the medium through which to work to accomplish a new agricultural building reconstruction and also with the thought that this can best be accomplished by men thoroughly in sympathy with the average farmer and his problems.

No doubt the American Society of Agricultural Engineers would be able to help in a large measure in this field, as we number among our members men from nearly all the agricultural colleges and State Universities who are engaged in the work of furnishing improved plans for farm structures. We have one committee devoted to the task of standardizing barn design, another devoted to the standardization of barn equipment and still another dealing with ventilation. It occurs to me that we might arrange a joint committee to co-operate with a similar committee of the American Institute of Architects.

I see many obstacles to be surmounted; however they are not hopeless. The first is the feeling of the farmer, and I am speaking now of the actual land owner and man who gets his fingers in the dirt, that architectural service is for the wealthy only. This feeling has been brought about to some extent by the purchase of farm lands by men of wealth who are seeking diversion or cultivating a hobby.

This opportunity for picturesque development has been seized by certain architects who have little knowledge of or sympathy with such homely subjects as rural economics, soil improvement and the much used but effective term "overhead." This has resulted in a type of building altogether lovely to behold but discouraging to the man who actually must make his living from the soil of a small farm. He feels that architecture means great expenditure. Until he is convinced in terms of bushels of wheat or quarts of milk that attractiveness and utility may go hand in hand, the movement will never meet with success. Even with the free service now given in a modest way by our various Departments of Agricultural Engineering, the farmer hesitates, because to him the blue print symbolizes a lavish expenditure of money and we find that the well-to-do, who might well afford the services of a com-

petent rural architect, are the best patrons of this free service.

The next point to be considered is that of utility. There has been created among certain farmers the feeling, and rightly, that perhaps the old-time country carpenter with his matter-of-fact, rule-of-thumb methods, is good enough for them. He never fails to make a door large enough to admit a load of hay, although he may build "ventilators" that do not ventilate. In the mind of the bona fide farmer utility will always be the first measure of building design because he must get a return upon his investment. Convenience for himself and comfort for his animals, together with ample storage room for the products of the fields, will never be sacrificed for appearance sake.

The system of tenantry, however is the most discouraging of all. The absentee landlord is loath to make expenditures for adequate, let alone decent structures. There are instances in one of the most fertile counties of Ohio, not over forty minutes' ride from the capital, of tenant houses with earth floors upon which a few boards are placed in wet weather to keep the family out of the mire.

There is a brighter side however. Through the Extension Service of our agricultural colleges the farmer is learning of home conveniences and the demand for these things is so great that a number of large concerns are engaged in the manufacture of isolated lighting plants and water systems exclusively. Agricultural engineering specialists are overworked with the demands made upon their time by seekers of information on every conceivable means of making life on the farm easier and more attractive. Now, as never before is the opportunity open for the sympathetic and conscientious architect who has had personal contact with the soil.

It seems that whatever move is made for architectural betterment in farm structures might have to be carried out by sectional rather than as a national movement since the type of farming and climatic conditions vary so greatly. Would it not be well therefore to sub-divide the work of any committee or join committees into sections divided with respect to prominent agricultural characteristics? A non-competitive program of architectural projects might be arranged through the various chapters of the American Institute of Architects co-operating with the agricultural colleges in their respective zones. The American Society of Agricultural Engineers would, I am sure, welcome



## THE AMERICAN ARCHITECT

the opportunity of aiding in this movement. The only obstacle in the way of this co-operation is the lack of funds. This no doubt could be arranged. Personally I am vitally interested in this whole movement and will be glad to do what I may both individually and as secretary of the American Society of Agricultural Engineers.

F. W. IVES.

Columbus, Ohio.

*The Editors, THE AMERICAN ARCHITECT:*

There are a few underlying principles governing the much talked of subject of competitions which I believe may be set down for the advantage of your readers and the enlightenment of the architectural profession.

The programs of competitions superintended by the American Institute of Architects nearly always start with the assumption that competitions are held for the selection of an architect. Such assumption represents crude reasoning and results in unmanageable effects. It lets loose wholesale condemnation exalting one man to a position he would never wish could he foresee its results.

The finer things of life are not to be drawn out of pigeonholes in this fashion. I have overheard confessions from older men in the profession of architecture that they would like, as they expressed it, to put an axe through some of their structures. This sentiment is a telltale of the crude manner in which business in this country has been conducted.

Genuine worth never wishes to advertise itself, not from the desire of wishing to be unknown or unfamed in safe company, but from the inevitable misjudgment of the public directly concerned.

Genuine worth is not too interested in Mr. So-

and-So, no matter what his profession, but genuine worth is interested in ideas which make for genuine good.

So I am pleased to record and insist with my teachers that competitions should be held for the selection of ideas.

A competition worthy of the name should be judged, and won almost, before a T square or triangle has been evidenced. The large scale of the drawings required at the start in our American competitions precludes any but clumsy, crude ideas. Our competitions lose a very vital part in their makeup when we eliminate preliminary stages and judge them from "finished" drawings. Much more time should be spent in the judgment and boiling down, so to speak, of schemes. If a competitor wishes to put in his time at a larger scale and on details, that is his own affair, and represents his own manner of work and investigation; but the drawings presented to a jury should be at a small scale so that a plan may be judged as a plan or scheme of building and not as a diagram of however interesting a composition. Any draftsman who has been through a sufficient course of instruction, and who has been associated with older men, knows that a scheme once clearly worked out and solved may be represented by a few lines and at a convenient scale on a small sheet of paper.

Then why continue with technical encumbrances? If a city in France like Paris, with its muddy stream, can yet fill us with the true and noble, how much more should this recently discovered country with its clear waters awake in us visions of the real and the true and the beautiful!

HERBERT SCOTT OLIN.

Ogdensburg, N. Y.

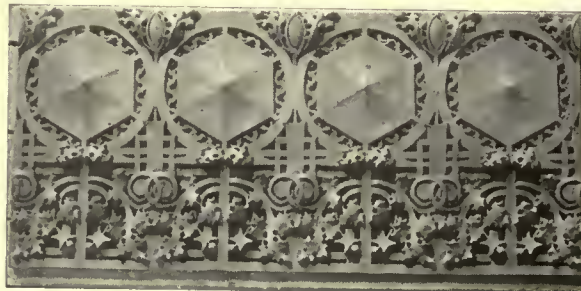



PLATE 140

VIEW LOOKING NORTH

THE ARCH OF VICTORY ON FIFTH AVENUE, OPPOSITE MADISON SQUARE  
NEW YORK

THOMAS HASTINGS, ARCHITECT







PLATE 141

DETAIL (LOOKING THROUGH CENTRAL ARCH)

THE ARCH OF VICTORY ON FIFTH AVENUE, OPPOSITE MADISON SQUARE, NEW YORK

THOMAS HASTINGS, ARCHITECT







PLATE 142

VIEW LOOKING SOUTH

THE ARCH OF VICTORY ON FIFTH AVENUE, OPPOSITE MADISON SQUARE, NEW YORK  
THOMAS HASTINGS, ARCHITECT







PLATE 143

THE TOWERS OF JEWELS

ELECTRICAL DECORATION ON FIFTH AVENUE AT THE PLAZA, NEW YORK





THE AMERICAN ARCHITECT

VOL. CXV, NO. 2262

APRIL 30, 1919



PLATE 144

DECORATION IN FRONT OF PUBLIC LIBRARY ON  
FIFTH AVENUE, NEW YORK, ON THE OCCASION  
OF THE PARADE TO WELCOME THE 27TH  
(NATIONAL GUARD) DIVISION ON ITS  
RETURN FROM SERVICE ABROAD







*At Left:*  
CENTRAL MOTIVE  
OF DECORATION IN  
FRONT OF PUBLIC  
LIBRARY, NEW  
YORK

*Below:*  
SUGGESTION FOR A  
PERMANENT SOLD-  
DIERS' MEMORIAL  
IN LINCOLN PARK,  
CHICAGO









PLATE 146

THE COURT OF NATIONS, SYRACUSE, NEW YORK

A. L. BROCKWAY, ARCHITECT

DAY AND NIGHT VIEWS FROM APPROXIMATELY SAME POINT OF VIEW





## Roosevelt Memorial to Teach Living Service

Following the announcement in the March 26th issue of THE AMERICAN ARCHITECT of the purchase of the birthplace of Theodore Roosevelt at 28 East Twentieth Street, New York City, the Woman's Roosevelt Memorial Association has issued a statement outlining the purpose for which the "Roosevelt House" will be used.

After the building is restored and the interior reproduced according to the description written by the late President in his autobiography, the house will be a "living thing, a place where the boys and girls of America, and the men and women as well, will come together in citizenship activities in order that their understanding of America may become deeper and keener and that the great ideal of practical service to our country, of indefatigable activity in its behalf, shall stir and move with vivid power all Americans that frequent or visit Roosevelt House.

"That Colonel Roosevelt's vigor of life, robustness of belief, and energy of will may be eternally recalled to the youth of America is the real spirit and background of this memorial," says the announcement issued by the association, of which Mrs. Leonard Wood is honorary president and Mrs. William Curtis Demorest is the president. Other officers are Mrs. Thomas Fox Preston, Jr., Mrs. Whitelaw Reid, Mrs. James Roosevelt, Mrs. Robert Bacon, Mrs. William Bayard Cutting, Mrs. Joseph H. Choate, Mrs. James T. Leavitt, Mrs. Elihu Root, Miss Louisa Lee Schuyler, Mrs. Robert Winthrop, Mrs. Henry A. Alexander, Mrs. John Henry Hammond, Mrs. Henry A. Wise Wood, Mrs. Charles A. Bryan, and Mrs. A. Barton Hepburn.

"We now urge every woman who believes that the spirit of Roosevelt is the spirit of a greater America and of a sounder American youth, to join us," said Mrs. Demorest, president of the association. "We want this to be raised not by a small group of women here and there, but by the women of America in a great body, following a nation-wide impulse thus to memorialize the great living spirit we want to see carried on by our own sons. We believe it is fitting that as the women, and the mothers, of America we should thus in this concrete, symbolic yet practical way, in the place and house of his birth, 'hand on the torch' of that vigorous flaming, never-dying spirit to the youth of America.

"A few years ago Colonel Roosevelt wrote to a friend protesting against 'meaningless mausoleums and monuments to the dead.' It seemed unthinkable to us to perpetuate his memory in that way. We

want a place set aside for the objects and ideas that characterized him, pervaded by the influences that developed him. In the letter we have just spoken of the Colonel wrote: 'As for the rest of us who with failures and shortcomings, but according to our lights, have striven to lead decent lives—if any friends of ours wish to commemorate us after death the way to do it is by some expression of good deeds to those who are still living.' "

The names of those who become members of the association will be inscribed in a book of donors to be placed in the memorial and the receipts for all donations will be a small bronze pin bearing the likeness of Mr. Roosevelt.

---

## Community Buildings as Soldier Memorials

Soldier memorials in the form of community buildings, dedicated to civil and social uses, and wherever possible built with bonds of the fifth Liberty Loan, are urged by the Bureau of Education, Department of the Interior, in a circular sent to every school community in the United States. A number of communities have already concluded that a building, in constant use as a reminder of the sacrifice made by the soldiers and sailors of the war, is more appropriate and enduring than the conventional graveyard monument.

"There is a growing conviction," says Dr. Henry E. Jackson, author of the bureau's circular, "that the conventional stone shaft, placed in a graveyard among the dead, is not a fitting memorial to those who died for freedom. The suggestion, made both in France and America, that these memorials take the form of community buildings dedicated to civic and social uses, is obviously wise and ought to meet universal approval. On the walls of such a building should hang a bronze tablet containing the names of each community's martyrs to liberty.

"Wherever possible, this community memorial building ought to be the public schoolhouse, in order to prevent needless waste through duplication. It is the logical community center. It is non-partisan, non-sectarian and non-exclusive. It is owned and operated by all the people and therefore furnishes a platform on which all can meet on terms of self-respect. The schoolhouse could be remodeled or enlarged or replaced by a new one. It is the natural capitol and clubhouse of every community. In rural districts small schools should of course be consolidated in order to eliminate a waste and secure a community large enough to support the kind of building here proposed."



## Roosevelt Memorial Bill

ALBANY MEASURE CREATES FORESTRY EXPERIMENT  
STATION IN HIS HONOR

A bill authorizing the State College of Forestry, at Syracuse University, has been introduced in Albany. The purpose is to establish an experimental station, to be known as The Roosevelt Wild Life Forest Experiment Station, in which there shall be maintained records to show the results of experiments and research work in relation to the habits, life histories, methods of propagation, and management of fish, birds, game, food and fur-bearing animals, and of forest wild life generally.

The measure is in accord with recommendations made by a special committee appointed by Chairman Will H. Hayes, of the Republican National Committee, to suggest some means of fittingly commemorating the life of Theodore Roosevelt.

---

## Memorial at Rheims for American Dead

Overshadowed by its battered cathedral and overlooking the 15,000 roofless houses of Rheims, will stand the first great memorial to the American dead in France. This seems assured by official advices that have reached the headquarters of the American fund for French wounded to the effect that the French Government will deed to the fund the ground in the environs of Rheims where a great American hospital will be erected.

The American hospital at Rheims will constitute not only a monument to the thousands of American soldiers lying buried throughout the battle areas of France, but is intended also to be an enduring reminder that America had brought relief to France even before the American armies arrived.

---

## Belleau Wood as Roosevelt Memorial

Widespread favor has met the suggestion made recently by the Roosevelt Permanent Memorial National Committee that Belleau Wood, France, since renamed by the French Government "The Wood of the Marines," be made a permanent Roosevelt memorial. Colonel William Boyce Thompson, chairman of the committee, states that approving comment had reached him from far and wide. The general tone of the letters was that it was by far the happiest suggestion made for a fitting and permanent memorial. Samuel Parsons, a well-known landscape architect, has designed a lofty watch tower, to stand at the entrance to the wood.

Mr. Parsons suggests that the tower be built of uncut stone. Surmounting it he has designed a huge eagle, representing America with wings outstretched over a French soldier.

The entire design he aims to have as American in character as possible.

---

## Big Monument to Chicago Heroes

A museum for world war relics, motion picture halls, art galleries, a restaurant, and a score of ultra-modern comfort features are included in plans for a Chicago heroes' memorial monument submitted for the city's approval by the Victory Memorial Association, Irving B. Brower, president.

The monument will be more than five hundred feet in height and nearly two hundred feet on the base, the highest point anywhere in the territory from the Alleghanies to the Rocky Mountains, says the *Chicago Tribune*. It will have a rotunda as large as the largest monument of the world. Six elevators to the top of the rotunda and four to the top of the monument will be installed.

The plans include moving picture halls, a museum for war relics, safe deposit vaults for records of all the heroes from Chicago, and a place for the public to view all of the flags and guidons of the regiments. It will have art galleries containing paintings by the best artists, illustrating the celebrated battles in which our heroes fought. Under the rotunda there will be a fine restaurant and club rooms and all arrangements for the comfort of the public.

On the top will stand a mammoth globe of steel and glass, representing the world, surmounted by a graceful conception of statuary illustrating liberty and victory of democracy over the world. The inside of this globe, thirty feet in diameter, will be used for a wireless station and weather bureau.

The monument is unique in that its entire construction is triangular, to represent the triangle city of Chicago.

---

## Plan Roosevelt Exhibit

Plans for the Roosevelt Memorial Exhibition to be held during May and June in Avery Hall, Columbia University, New York City, have been announced by Prof. W. A. Braun, who is directing the exhibition. The decorations for the exhibition rooms will be designed by William A. Boring, professor of architecture at Columbia.

# Current News

## Billions Tied Up In Foreign Loans Solving England's Housing Problem

With nearly nine billion American dollars scattered throughout Europe in the form of loans, treasury officials in Washington are giving careful study to the possible outgrowths of the complicated situations developing across the water. It has been hinted that this Government may have to wait its turn in receiving payments of money advanced to European countries. England, France and Italy are understood to be claiming priority. Meantime the situation in Russia and the Balkan states affects nearly \$250,000,000 in American loans there.

In event of England, France and Italy being paid off first on interallied loans, a large amount of the "pay on demand" paper held in the United States Treasury may have to be changed into long-term obligations. Foremost mentioned among these is the \$350,000,000 loaned to Belgium by the United States. Larger sums were extended Belgium—and most of them long before America contributed—by the other Allies.

### Over Their Heads

Just how to keep a roof over the heads of its people is a problem engrossing much British attention. It is now learned that the administration of what is called the State Housing Plan is to be entrusted to a Chief Commissioner in London and eight District Commissioners throughout England and Wales. The men chosen are to have wide experience in housing and will be given important discretionary powers. Technical staffs will be at their disposal.

The local government board, hoping to guide London building authorities, is issuing a manual containing plans of several types of houses of recent design. The general aim is to restrict the number of houses in city limits to twelve per acre and in rural areas to eight per acre. Practically all the essential features, it is learned, are being standardized, including doors, windows, kitchen ranges, baths, bolts and general fittings.

Where practicable, munition factories will be utilized to produce these articles at the same time providing employment for many munition workers.

In London, the local government board contemplates the erection in that city of a village of houses, each of which will be a complete model of architecture, style and interior arrangements, to serve as a guide for local builders in other sections.

Discussing the situation in London itself the *Pall Mall Gazette* suggests that if present facilities were ascertained, it would be found that many large derelict houses might properly be converted into the much needed dwellings with considerable economy. Overcrowding is so serious in London that it is a menace requiring immediate amelioration.

*Justice*, another London paper, believes that any local solution of the housing problem is sure to prove ultimately inadequate, and declares that it must be dealt with nationally. This, it states, would confer a benefit on future generations which could not be measured in money. In this day of new experiments, it is wondered, will this also be done?

One method devised for solving the housing problem in England is the organization of co-partnership housing societies, which attempt to combine the advantages of tenancy and home owning. There are sixty such societies in England, Scotland and Wales. In these co-partnership societies the tenant does not become the owner of the home he occupies. Instead of getting a deed to a house and lot he becomes the owner of stock in the company by investing a given amount of money.

The members of the society collectively own all the real property in the community. They form a corporation, buy suitable land and erect houses. These are let to members at the ordinary rental. Dividends are limited to five per cent. Any profits above current expenses, interest and amortization charges on mortgages and loans, and dividends on capital are divided among tenants in proportion to rents paid. Advantages claimed for co-operative home owning are as follows:

Lower rent for the same accommodations.

Freedom from loss if the tenant is compelled by loss of employment to leave.

Capital for investment is obtained cheaper than by any other plan.

Advantages of buying land in large tracts and erecting many houses at the same time are obtained by each individual.

If values go up the partners get the benefit either by dividends on rent or by rental at less than going price.

All surplus profits after paying fixed charges go to the partners.

Benefit of "unearned increment," if any, goes to tenants.

Outside investor gains, although his returns are limited to 5 per cent, by greater security, freedom from loss by poor tenants and no trouble to look after investment.

A portion of the capital needed for these projects is obtained from the national government in England, enabling the benefit of public credit in the form of lower rates of interest to be taken advantage of. Under the housing and town planning acts of 1909, up to two-thirds of the required capital could be advanced after the houses were built. Since the war this has been increased to 90 per cent.

If a tenant becomes objectionable to his neighbors the management can notify him to vacate, the amount of his investment is returned and his relation to the society ceases. Stock can be paid for on the installment plan. Communities built under this plan are carefully laid out, houses are designed by the best architects and the building is given careful supervision.

### Seaweed Aids British Building

In London a novel use has been found for seaweed. Combined with crushed slag and other heretofore neglected waste mineral products, it is used to make a kind of concrete out of which are being fashioned building bricks



and blocks. The seaweed acts as a binding and strengthening element.

Arrangements are being made to put up a large number of houses composed entirely of these blocks, and it is predicted that the material, owing to its cheapness, will aid in solving the housing problem.

Not only the foundations and walls, but the doors, window frames, and mantelpieces are to be constructed of the new concrete. The houses are to be made in sections and bolted together. The window frame is a new idea in itself. The glass, in one large pane, slips into a slot, and the edges of molding are then turned over, so as to grip it. To mend a broken window will be a simple matter, and will not require the services of a glazier.

It is said that dwellings made of the concrete will be warm and thoroughly damp proof.

### Tent City To Provide Housing?

Typical of the housing shortage throughout this country are those obtaining in Newark, N. J. Here, as a means of temporarily relieving housing congestion, investigations are being conducted with the idea of erecting tents to meet the present emergency. These are in charge of W. J. Morgan of the mayor's rent profiteering committee. About a month ago he made this suggestion to Mayor Gillen, and Capt. C. W. Beardsley, just out of service, and formerly a real estate man, was called into conference. No difficulty seems foreseen in camping out during the summer, provided proper sewerage and transportation facilities might be depended upon. The management might be on military lines, the sponsors believe.

That a tented city is not an innovation was a point made by Mr. Morgan in calling attention to such an institution which flourished in Flint, Mich., about fifteen years ago. In enlarging his plant, an automobile manufacturer found that the town was short in housing accommodations for about 3000 families. A plot of ground was procured, he said, and almost over night a city of tents sprang up, which endured until other and more permanent provisions could be made. It was the experience of this manufacturer, he added, that the health of the workmen and their families was never better than when they lived under canvas.

Until more dwellings and apartments can be provided by new construction, Mr. Morgan believes the tents would be a partial solution of the housing problem in Newark.

In other sections of Newark, tenants are moving into cottages before they are completed, giving further evidence of the urgent demand for housing accommodations. So strong is the need for immediate occupancy that it has been arranged to have the interiors finished first, in order that families might move in while the work on the exterior is being continued.

In connection with this demand, the following statement was given out from the offices of the Real Estate Board:

"The builder or contractor who still hesitates or is in doubt about the advisability of undertaking new building construction need only interview the various real estate offices of this city. The demand for small one and two-family houses is so great that the average real estate man will say that it is hardly possible to supply the wants of the many applicants.

"Builders will have to build whether they want to or not, price of labor and material notwithstanding. The people want the houses; they are willing to pay for the right thing. It only requires the enterprising and far-seeing builder to take advantage of the existing opportunities.

"There never existed a better opportunity to buy building sites and lots at prices that range nearly fifty per cent of their true value than now. The prevailing high tax rate

this year has been the incentive for the sale of many lots. "New York building contractors are already alert to these opportunities and are making overtures and bids for many of the large undeveloped tracts."

### The Use and Development of Malleable Iron

While the advancement made in industries dependent upon the malleability of iron has in the last few years been very great, the literature dealing with the topic has for some time proved inadequate to keep the public alive to its importance.

The American Malleable Castings Association, particularly qualified to discuss this subject, has prepared what would seem to be an authentic treatise on "Malleable Iron," a copy of which will be gratuitously sent to anyone mentioning this paper, if he will address the Association at Cleveland, Ohio.

This booklet is divided into three parts, the first discussing the subject broadly; the second, showing the relation of the Association to the present status of the subject, and the third, dealing with specific problems.

While this booklet is but the forerunner of a comprehensive volume to be issued later by the Association, it contains data of considerable interest to the architect.

### To Eliminate Bolshevism

While the General Assembly of New York was debating the other day on the best way to rid the Empire State of Bolsheviki, one of the members, it is learned, got right up and announced that he was one.

Pursuing the opportunity to continue, he said further: "If you want to stop the spread of what you have been pleased to call bolshevism, don't continue to waste your time as you have been doing here. Simply study the causes of social discontent and you will find them in the high cost of living, unemployment, inadequate housing conditions and in the intensity of the struggle for existence generally. While I have no desire to chide you, I ask, what have you done to meet these conditions?"

Referring to this tirade, the *Cleveland News* writes as follows:

"And is it not the truth that our municipal, state and national governments, while throwing rhetorical fits over the possibility of an American brand of bolshevism, are accomplishing little whatever toward removing its predisposing causes—that American law makers of all calibers can always find time to pass appropriations and increase taxes, but somehow never see their way clear to doing anything about lower prices and rents, more jobs, better houses, or any other material assistance in the struggle for existence, now become so hard for most of us?"

### Building Starts In Detroit

Anticipating a great revival in building the balance of the year and declaring that hesitancy on the part of many to build on account of material prices will be overcome, George H. Barbour, president of the Michigan Stove Company of Detroit, Mich., in a letter to *THE AMERICAN ARCHITECT*, writes in most optimistic vein regarding the early resumption of construction activity in that section of the country. Mr. Barbour's view of the situation follows:

"How will the expected boom in spring building be

financed? In this section it is not a matter of financing, but a matter of the excess cost in building that stands in the way of accomplishing what we would like to see take place in Detroit, because there is a large demand for houses from the large number of people who have come into Detroit in the past five years. You can realize the conditions when I tell you that our population today is very close to a million. This means that there are a large number of families that have been cared for by houses, apartment houses, bungalows and the general variety of houses that were built in large numbers up to the time that this country went into the war. Soon after we went into the war building seemed to cease and there was very little going on. I am pleased to say that there is a revival at the present time in the building line.

"Lately a large company has been formed to take this matter into consideration, and it is expected that a large number of houses will be built in a central location. It may be possible that they will distribute the building to different points in the city.

"I do not think that the financial part of it would in any way delay the matter of building, but there is a hesitancy upon the part of many that would like to build on account of the increased price, not only in building material, but in labor. I believe this is going to be more or less overcome. I have noticed already that cellars are being dug and houses are being built, and I anticipate that this particular interest will show a great revival the balance of this year over what it was the past year and the latter part of 1917. It has been estimated that Detroit could use at the present time 600 or more houses."

### Child Aged Two Exhibits Drawings

At the Royal Drawing Society's annual exhibition at Guild Hall a sensation was provided by a couple of sketches—a cat and a game cock—by a baby under 2. They are accompanied by a testimonial to the effect that they are really the precocious babe's own work.

### Discuss a National Building Bank

With the belief that a national building bank to be operated under the existing laws and as a part of the Federal Reserve system would establish a functionary in the building industry that would eliminate the principal factor of delay in construction, a conference has been held between United States Senator Calder, Justus Slater, building economist, Major Frederick Hyde of the American Bankers' Association, M. W. Harrison of the Savings Bank Association of the same association and officials of the Federal Reserve Bank. Present war emergency measures give ample powers for the establishment of such an institution without awaiting the enactment of special laws.

### British Lumber Control Ended

The British Board of Trade has canceled all orders relating to the purchase of imported timber and has also withdrawn the maximum prices for both imported and homegrown supplies other than pit wood. As regards importation, no licenses will now be required for the importation of hewn, sawn, planed, or dressed timber of all kinds, including hardwoods and sleepers. This does not include pit wood and manufactured and semi-manufactured

goods, such as box boards, for which licenses will still be required unless produced in parts of the British Empire. Stocks of imported timber belonging to the Government will be disposed of at the prevailing market prices through the Government Timber Buying, Salisbury House. These stocks, including goods yet to arrive, amount to about 550,000 standards.

### Planting Trees In Farm Gullies

Planting trees in farm gullies is a reclamationary measure advocated by the Forest Service of the United States Department of Agriculture. The results are of twofold advantage, as not only are the trees valuable in themselves but their presence stops the gully erosion. In the north Atlantic and mountain states and in the Mississippi Valley the locust is well adapted for this use as it has a large root system, grows rapidly and makes one of the most lasting woods for fence posts. The little trees may be dug up in locust thickets or obtained from commercial nurseries.

In other sections the native shortleaf pine is one of the best varieties for reclaiming gullies as it exerts, even when young, a marked influence in holding the soil. When set out in gullies, its growth is fairly rapid and in a few years it forms a complete protective cover.

### Columbia University Installs New Materials Testing Research Library

A research library in connection with the materials testing laboratory will be installed soon in the Engineering building at Columbia University, New York City. The library, which will be situated in a room adjacent to the laboratory, will be one of the most nearly complete in the country. It will contain all of the official publications having to do with tests, testing, and with specifications that can be collected. An additional feature of the library will be a collection of trade and industrial catalogs and pamphlets containing information relating to the properties of proprietary and patented industrial appliances. The purpose of collecting the catalogs is to provide information for those enrolled in the testing laboratory that will make them familiar with the numerous trade specialties and appliances upon the use of which all structural work depends.

### Red Tape In City Management

While New York is in many ways a law unto itself, there are some instances in which its shortcomings are shared in lesser degree throughout all municipal enterprises. A point at hand in connection with the New York-New Jersey Port Commission will doubtless be sympathetically understood through similar experiences in every town where officialdom is in the ascendancy.

Dock Commissioner Hulbert, appointed a member of this commission by Gov. Smith, reports that as a result of municipal delays, one big concern which made application for a lease of a large section of waterfront property in New York, had now entered into a contract for about fifty acres of New Jersey waterfront property upon which it will expend \$25,000,000 in the construction of new piers and warehouses.

"If we keep going along as we have," said he, "we will



## THE AMERICAN ARCHITECT

need another Abraham Lincoln to free us from the chains of an intolerable slavery."

The usual process of getting things done, or rather neglecting them, will be clear from the further statement of Commissioner Hulbert:

"When an application is made for a piece of waterfront in this city I refer it to my chief engineer. After he makes his report I go over it and make such suggestions as I think proper. Then it goes before the Sinking Fund Commission. It is referred by it to the Committee of the Whole. If it ever gets out of that body it goes to the Board of Estimate and then to the Board of Aldermen. It is often postponed in one or all of those bodies possibly for a year or more. By that time everybody is exasperated and the applicant goes elsewhere, where new enterprises are more hospitably received."

In one form or another, on a small scale or a large, such a procedure is common to every effort toward accomplishment. Decisions are made, agreements drawn, plans arranged, and the whole thing, often as not, stagmates for want of action.

The question might be asked if this is another "Circumlocution Office."

---

### New British Pottery

One of the most interesting features of the exhibition of pottery recently held at Stoke-on-Trent, England, is said by the London *Times* to have been a collection of samples of the new hard porcelain which grew out of research work conducted at that place.

The new china, which is intended to compete with German and other Continental hard or felspathic porcelains, is an all-British product, according to the supplement, and in several respects is superior to the Continental wares.

"Its appearance and texture approximate more nearly to the old Chinese than to the German porcelain," the supplement continues. "It is particularly adapted to the use of under-glaze colors, some of the blue printed ware being particularly charming, and it is capable of taking a wide range of enamel or on-glaze colors. This is in contradistinction to the Continental hard porcelain, from which enamel colors are apt to chip off.

"The new porcelain, though not rivaling in texture and delicacy the Staffordshire bone china, is more highly vitrified, wears better, and remains clean even if chipped. It can be made much more cheaply than bone china, and in some classes of goods can be made practically as cheaply as earthenware."

---

### A Foreign Market At Home

As an instance of an organization which is actively pursuing the ends to secure which it was inaugurated, the Inter-Racial Council, first discussed in our issue of March 5, may be cited.

The question is asked by this energetic group of men and women, that if it is profitable to spend hundreds of thousands of dollars to send skilled "trade missionaries" to the Old World in order to educate the natives in American methods and American products, why would it not be equally profitable to teach the foreigners already in this country to demand standard American goods and live in American style? These people, many of them, prefer the familiar wares from their own countries, and further than this they send their savings abroad, denying them-

selves present comforts here in the belief that they may live in finer style later on in the Old World.

Since foreigners are making good wages, but seem to have little inclination to spend them, the time would seem at hand for an educational campaign to encourage them to live in American style, teach them about American goods, and make them good customers for our products.

The Inter-Racial Council, believing that one very effective medium is the foreign language press, has recently acquired control of the largest advertising agency dealing with the racial papers, and henceforth the American Association of Foreign Language Newspapers proposes to conduct an extensive campaign of publicity and advertising to acquaint readers with the merits of our products, many of which the foreigners do not at present even know by name.

This should provoke an indefinite expansion of a most profitable market.

---

### City Plan for Janesville, Wis.

The Chamber of Commerce of Janesville, Wis., is having a comprehensive city plan made under the auspices of John Nolen of Cambridge.

A considerable increase in population is anticipated by Janesville through the expanding work of the General Motors Company, which will require from five to ten thousand additional employees for the manufacture of the Samson tractor.

The city plan will include recommendations for the location of thoroughfares, a study of railroad problems, zoning, location of proposed public buildings and a system of parks and playgrounds.

---

### Ascertaining Architectural Assets

Despite the fact that visitors to a city generally desire to see the sights, the whole sights and nothing but the sights, few cities, either through their Chambers of Commerce or other agencies, have tabulated their architectural assets in available form with that end in view.

The Oregon Chapter of the American Institute has recently attempted to determine impartially the examples in Portland in which civic pride might most properly be vested. Its method of procedure was to invite a jury composed of three outside architects, the Professor of Art at the University of Oregon, and the Curator of the Portland Art Museum, to go carefully over and discuss the buildings, landscape architecture and sculpture of the city, and name what they considered the most notable examples of each. In addition, the Chapter addressed a letter to each member, asking him to prepare a list of what he considered best. These lists were combined into one preliminary list of nominations so that the jury would not ignore any structure deemed worthy by the Chapter members. The jury met for four days during which they were taken by automobile to inspect, in a body, existing structures and gardens in all parts of Portland.

The report of the jury setting forth reasons for its conclusions has been published, together with photographs of the selections, in the March issue of *The Architect and Engineer of California*, and has considerable interest. The idea of tabulating this sort of information contains nothing of the dogmatic, and as a means of knowing what you have and making the most of it, may with profit be emulated by other municipalities.

## Would Build Memorial Theaters

In an address before the Society of Art and Sciences at a dinner at the Hotel Biltmore, New York, recently, Major-General John F. O'Ryan suggested that the proposed memorial in honor of America's soldiers in the great war should take the form of a municipal playhouse. The General, after telling of the part played by entertainment for our men in the war, said that the American fighters abroad had been particularly struck by the number of municipal playhouses in the small villages in France.

"I believe that the soldiers themselves," he said, "would prefer, as a memorial, something living, possessing a soul, rather than something stony and dead. They would prefer something that would play a part in the life of the city, and this the municipal playhouse would do."

## Paint Manufacturers' Association of the United States

There has been received from the Educational Bureau, Scientific Section, Paint Manufacturers' Association of the U. S., a series of circulars issued during March and April. These are No. 59, Paints for Cement Vessels; No. 60, Changes in Oils Upon Storage; No. 61, Metal Powders as Pigments, and No. 62, Rare Elements as Paint Pigments.

These valuable bulletins contain a large amount of accurate information on their various topics, and will be found of considerable interest to architects in keeping abreast with the latest research as to paints, their application and specific use.

They may be obtained by addressing the Institute of Industrial Research, Washington, D. C.

## Returning Soldiers Increase Home Shortage

Just what will be done to meet the demand for living accommodations in every corner of New York State, and especially in the larger cities, a demand accentuated every day by the return of soldiers from abroad and from cantonments in this country, is a question giving architects, real estate men, builders, and housing experts considerable to think about these days. In the large majority of cases when men were called from their homes, and there were 251,993 from New York State in the army under the selective service act, there ensued a general retrenchment of living costs by the families left at home.

This retrenching generally took the form of reduced living accommodations. Families which occupied dwellings of many rooms subleased, and took up smaller abodes. This placed considerable living space on the market.

Now, with the men returning, there is a general expansion in every direction and families that "doubled up" during the war now want their own places. It has developed that there is little room for the returned soldiers or for newcomers.

Builders see the only solution of the tangle in the stabilization of material prices by the Government, and then an intensive building program can be set on foot. So, while, the housing situation is becoming more acute with the arrival of every transport from France, construction is being held up for fear of a shrinkage in prices and lack of proper financial support.

## Launch Campaign to Stimulate Building Activity

As an effort to stabilize prices, lower the cost of living and stimulate business reconstruction, a "National Prosperity Campaign" under the direction of Philip H. Gadsden, of the National Public Utilities Committee, has been launched. The object will be to bring business men to the belief that it is within the power of industry to resuscitate itself. A statement issued from the headquarters of the campaign is partly as follows:

"Regardless of Government attitudes toward the present price situation, there is a realization of the necessity for the upkeep of production and the absorption of the unemployed, and the distribution of such propaganda as will stimulate confidence as well as activity in business projects. Several hundred firms throughout the country have wired their approval and co-operation.

"Granting that general retail buying by the ultimate consumer is still enjoying its usual boom even at present prices, the fact remains that industry has been waiting, and is waiting for basic prices to strike a permanent level that would justify going ahead and still be protected against loss by a drop in prices. Present prices are here to stay, so far as price levels are concerned; we cannot await the industrial adjustment of the entire world. Factory fires must be kept burning and wheels turning, and labor must be employed at a scale of wages commensurate with the prices of commodities."

## March Contracts Show Improvement

Contracts let in March for building and construction projects will be in excess of the normal average for March in money value. The total number of contracts let for the third week in March was 1,945, representing a money value of \$39,017,308. The New York district reported 189 projects involving \$8,372,682; Pittsburgh 163 projects involving \$5,063,614; Boston 443 projects involving \$2,602,000. The Chicago district reported 741 contracts let involving \$19,212,298. The record for the first three weeks of March was \$66,619,791.

From these figures has been omitted the Minneapolis district from which the total would be less than one million dollars. It appears likely that the entire month's figures will be between \$125,000,000 and \$150,000,000. The amount involved in contracts awarded in January of this year was about \$51,000,000 and in February about \$95,000,000; from which it appears the construction business certainly is picking up.

## High Rents Speed Building

Dwellers in the town of Corning, N. Y., have become convinced that it is cheaper to own a home than meet the excessive demands of landlords. The need for houses is so extensive and so inadequately supplied that there are frequently several prospective tenants bidding for the same quarters. Proprietors naturally rent the place to the highest bidder, and advances are from twenty-five per cent. to double the rental of a few years ago. This makes it cheaper to own a house than to rent one, and where none are available for outright purchase building will be speeded.



## Will Form New Society to Democratize Profession in New York State

A new organization, having for its purpose the democratization of the profession of architecture in New York State, is expected to be formed shortly to take the place of the old New York State Association of Architects. This comprised the New York City, Brooklyn, Central and Western Chapters, which, except for occasional social gatherings, has been inactive for the past few years.

Detailed plans for the formation of the proposed society will be decided upon at a meeting to be held in Utica, N. Y., on June 7. John B. Slee, for many years treasurer of the Brooklyn Chapter of the State Association, has been appointed secretary by that Chapter to take charge of the work, and will next week send a circular letter to the fourteen hundred registered architects in New York State informing them of the plan to form a new organization and urging their active support and attendance at the Utica meeting.

All qualified architects in New York State will be eligible for membership in the new society, the name of which has yet to be determined. One of its aims will be to take an active and decided stand on all pertinent questions of the day affecting the practice of architecture. The decision to form a new architectural society resulted from the recent application of the New York City Chapter for withdrawal from the State Association, which was refused by the board of directors. It was then decided that the New York State profession could accomplish better results by the formation of a new and more active organization.

---

## Portland Building Exhibit

Mayor Baker of Portland, Ore., is active in keeping alive the great interest in the "Own Your Home" campaign sponsored by Mr. Paul C. Murphy of that city, and now going on throughout the United States.

It is now proposed to arrange for a mammoth exhibit of building materials, furniture, fixtures, and house equipment of every variety, as well as a large number of building plans and sketches, at the Auditorium during the Rose Festival. The Mayor has arranged for a further meeting this week at his office, with representatives of leading material interests of the city to outline additional steps to be taken in connection with the present construction movement and its co-ordination with the national campaign.

A notable increase in building activities is now manifested throughout the city, hundreds of new projects being under way.

---

## Another Need Emphasized by Prohibition

Just how far the general public has depended upon the toilet facilities provided by liquor saloons and hotels cannot be easily determined, but the lack of comfort stations in our larger cities is one witness to the fact that semi-public places like saloons have filled this need quite considerably. With the passing of these places, the need for better toilet facilities where they may be properly accessible to the public in the streets becomes imperative.

In New York, for instance, there is hardly one comfort station to a mile, with the exception of what might

more properly be called the "discomfort rooms" off the subway platforms. If the public pays for anything, it expects service. But in a large city like New York, when all efforts are made in our schools and public buildings, to instill ideas of cleanliness and wholesomeness, there are some things for which the individual man should not be asked to pay; should, in fact have thrust upon him, and comfort stations might well be included in the list.

London has ample provision for public convenience. These places are mostly underground at the intersections of the principal streets, clean and well cared for, in marked contrast to many similar buildings in America where common decency seems scarcely to have been studied, and where sanitary conditions are often abominable.

In an analysis of this matter, Mr. Austen Bolam states, and very rightly, that this question is by no means an academic one, as anybody whose business calls him outdoors can testify. The provision of such comfort stations has long been neglected by our municipalities, but it must be faced. Soon the saloon will no longer be available. Architects should begin to think about this problem and bring it prominently forward.

These conveniences need not be an eyesore. They may be designed to conform to local architectural schemes and to include many other elements besides the obvious ones. In many European resorts, such places are planned to occupy the back part of a building, the front of which is devoted to shops. In these instances, the buildings are actually a profit to the municipality.

In one form or another this problem will have to be met, and soon. It reflects discredit upon American enterprise that a matter of this importance should have so long been allowed to exist in the present state of neglect, and that foreign cities should be so far ahead of us in this respect.

---

## Brooklyn Chapter Meetings

At the last meeting of the Brooklyn Chapter, A. I. A., held on March 31st, reconstruction matters were considered and discussed. It was decided that the industrial and architectural Brooklyn exhibition would be given April 20th to May 4th in conjunction with the Brooklyn Engineers Club.

---

## National Academy Officials

The annual meeting of the National Academy of Design, just held, resulted in the following elections for the coming year: President, Herbert Adams; vice-president, Howard Russell Butler; corresponding secretary, Harry W. Watrous; recording secretary, Charles C. Curran; treasurer, Francis C. Jones; members of council, Louis Betts, William S. Robinson and Arnold W. Brunner.

---

## Rhode Island Chapter Meeting

PROVIDENCE, R. I., April 28.—The Rhode Island Chapter, A. I. A., held a meeting with the Providence Chamber of Commerce late last week to discuss the "Own a Home" Campaign in that state. It has been arranged to study the needs of the different groups of businesses and professions to evolve a method which will assist in carrying the plans to successful fruition. Officials of the Chamber of Commerce were active in promoting the work in hand.

# Late News from Architectural Fields

Special Correspondence to THE AMERICAN ARCHITECT

## Building Increases in March

A gain in building of eighty per cent more than the actual average for the month of March for the preceding eight years is shown by a study of conditions made by the Department of Labor. It represents an increase of more than thirty per cent, estimating projects represented at the present cost of building.

During the first week of March, from the 22d to the 28th inclusive, building and engineering contracts were awarded in districts adjacent to five principal cities of the United States, as follows:

District	Number	Amount
Boston .....	376	\$2,880,000
New York .....	159	8,206,524
Philadelphia .....	381	5,641,008
Pittsburgh .....	274	7,177,630
Chicago .....	1,077	19,685,163
Total .....	2,267	\$43,590,325

The large cities have not yet resumed building in the same fashion as the smaller places. When they do, it is believed that the industry will enjoy a prosperity greater than at any previous time.

The following shows the classification of the contracts let, both as to number and amount, and the percentage of the whole comprised in each class, for the week ending March 28.

Class	Number	Per cent of Whole	Amount	Per cent of Whole
Bridges, culverts .....	153	6.8	\$522,104	1.2
Clubs, hotels, inst. ....	26	1.2	1,093,675	2.5
Federal, state, municipal..	33	1.5	2,917,153	6.7
Garages, stables .....	209	9.2	1,235,700	2.8
Industrial .....	180	7.9	10,193,600	23.4
Public work .....	130	5.7	7,622,662	17.5
Residential .....	1,287	56.8	8,066,101	18.5
Schools, churches, theaters	64	2.7	6,611,930	15.15
Stores, offices, banks.....	167	7.4	3,340,800	7.7
Street railroads .....	1	.04	29,800	.05
Terminals, railroad stations	...	...	...	...
Miscellaneous .....	17	.76	1,956,800	4.5
Total .....	2,267	100.00	\$43,590,325	100.00

## New York Society of Architects

The regular monthly meeting of the above-named society took place at its headquarters, the United Engineering Societies Building, New York, on Tuesday, April 15th.

Several applications for membership were announced, and among the communications read was one from the Engineers' Council convening at Chicago, inviting the Society to join a movement to create a Federal Department of Public Works. This led to an interesting discussion as to the relation existing between the architectural and engineering professions. It was maintained by some members that the present depressed condition of the former was largely due to lack of appreciation of the superior order of service rendered by the architect in his own special domain, embracing as this does, at one time or another, every form of engineering knowledge and skill, these being part and parcel of modern architectural practice. Reference was made to the scant and defective accommodation provided for the public in the metropolitan

subways, outside of the engineers' task of boring the tubes and laying the tracks.

The importance of co-operation between the architect and engineer was emphasized as essential to the success of large structural undertakings. Mr. Leo took occasion to refer in eulogistic terms to the late George B. Post, who, from being an able engineer, finally graduated into practice as an architect, thus combining in his own person the qualifications of both. Few men are capable of doing this in these days of highly specialized knowledge. Hence the necessity of co-operation if the best results are to be achieved. It was resolved to send a delegate of the Society to the Chicago Convention, with instructions to urge co-operation between the architect and engineer.

The Committee on Registration of Architects, reported that several cases of illegal practice of architecture had been presented to the Department of Education, but that the department, as well as the Board of Regents and the Board of Examiners, claim that the law cannot be enforced unless certain amendments are made.

Mr. C. Whitley Mullin read a letter addressed by him to the Post-War Committee on Architectural Practice, in which he analyzed a circular communication sent out by the Committee, answering questions and making suggestions.

The Committee on Nomination of Officers for the ensuing year reported as follows: For President, James Riely Gordon, re-elected; 1st Vice-president, Louis E. Jallade; 2nd Vice-president, Edward W. Loth; Treasurer, Henry Holder; Secretary, Frederick C. Zobel; Financial Secretary, Walter H. Volkening.

## Pennsylvania Architects Meet

The Pittsburgh Chapter of the American Institute of Architects held a meeting on April 11 to appoint delegates to the annual convention of the Pennsylvania Association of Architects which took place in Harrisburg on April 22. At this Harrisburg convention, the chief topics of discussion were the matter of licensing all architects, and the framing of a bill to that effect to be introduced into the State legislature. Delegates were also elected for the national convention of the Institute in Nashville.

## Conference on City Planning

The eleventh annual conference on City Planning is to be held on May 26-28 at Niagara Falls and Buffalo, under the auspices of the American and Canadian cities and towns of the Niagara frontier.

There is much of particular interest in regional planning on both sides of the Niagara River and the conference will have an international importance in view of the many interests in the Niagara section shared by both Canada and the United States.

The conference will meet for two days in Niagara Falls and emphasize there the city planning problems of the growing industrial city. The second day will be taken



up with the problem of regional planning, except for the morning session which will discuss a topic very vital to Niagara Falls and to other cities where the regulation of railroads has so affected the development of the city. On the third day, at Buffalo, residential zoning and civic centers will be discussed. Prominent architects, engineers and town planners have been invited to address the conference on this occasion.

### To Formulate Stabilization Plan

WASHINGTON, D. C., April 28.—A unique stabilization plan for building construction will be put into effect in the District of Columbia shortly as a result of the program adopted by representatives of various building interests. The Commissioners of the District have appointed a committee representing investors, material men, labor, Chamber of Commerce, local government and building tradesmen.

This committee has been instructed to draw up a wage scale to be submitted to the labor organizations for approval. This scale, if adopted, may continue for at least a year. It is proposed that the price of building material shall not be advanced during the period of construction; that labor shall not demand increased pay after entering upon a specific piece of work; and the banks shall supply building loans at the lowest possible interest rate. Under the tentative plan now being considered by the commission, the profits of the builder will be limited.

The famine in houses has become so acute that these extreme measures were advanced as the only adequate solution for the problem. Government estimates show that 90 per cent of the war-workers will remain in Washington. Federal officials have pointed out that the government will be forced to supply quarters unless the real estate men furnish dwellings. The building development in the District is revealed in the building permits. In January, permits for \$200,000 worth of improvements were issued; \$500,000 in February and \$800,000 in March.

### Late Quotations in Building Material Markets

WHILE the past week's activity in the steel industry reflected a disposition to abandon the entire plan of price stabilization, trading in other building materials, particularly in brick, cement, lime, sand, gravel and crushed stone, showed continued evidence of co-operation toward the guaranteeing of prices to the consumer at a fixed level, for the 1919 season at least.

At the annual meeting of the United States Steel Corporation held last week Judge Elbert H. Gary, chairman, said that he had gained the impression from reading newspaper accounts of the "so-called" controversy in Washington between the Railroad Administration and the Industrial Board that the whole price stabilization plan in the steel industry has been abandoned.

Judge Gary emphasized that the Steel Corporation had no controversy with any Government department, but his auditors understood that if the steel manufacturers had realized that the Railroad Administration would endeavor to obtain low prices for the particular products which it needed, without considering whether they were fair to the producer as well as the consumer, the steel men would have refused to enter into negotiations in the matter of stabilization.

After reviewing the history of the attempted stabilization of the steel industry, Judge Gary said:

"Evidently there existed a misunderstanding all of the time between the iron and steel industry, the Railroad Administration, and the Industrial Board. I am giving due credit to every one for entertaining frank and sincere opinions and having made candid statements. It is plain that if the Railroad Administration had accepted the judgment of the Industrial Board as to what prices were fair, the Railroad Administration would have reaped a large benefit, because business would have been stimulated and a large volume of business would have accrued to the carriers."

Judge Gary's statement that the stabilization plan of the Industrial Board had been abandoned came as a surprise to most of the steel manufacturers, who were of

the opinion that nothing definite had been decided. It is generally understood, however, that the larger steel companies will continue business on the basis of the prices agreed upon between the Industrial Board and manufacturers some time ago, no matter what may be the outcome of the controversy with the Railroad Administration with regards to minimum quotations. Some time ago there were rumors that price cutting and the establishment of an open market was a matter of only a few days.

Special dispatches from THE AMERICAN ARCHITECT'S Washington correspondent state that President Wilson's instructions to the Industrial Board and the Railroad Administration to resume negotiations in an effort to arrive at a fair price for the basic commodities may possibly bring relief to the material market, which has been erratic since the Director General of Railroads refused to pay prices for steel as fixed by agreement. The price controversy had a far-reaching effect on construction, for the Railroad Administration is recognized as the largest purchasing agency of the Government, regulating to a certain extent the price of basic commodities.

Mr. Hines based his objection to steel prices upon the contention that it was not justified by production costs. The action of the railroad chief threw the plans of the Industrial Board into temporary discard for the peace-time board for the adjustment of prices lacked the power to fix the price of materials. The plans for the unification of terminals, permanent improvements to the railroad systems and the construction of new buildings, as proposed by the Railroad Administration, were set aside when the dispute over steel prices became acute. In many instances building projects were suspended pending settlement of the price question.

It has been charged that the Director General has sought to underbuy prices accepted by industry in general as reasonable. Business men generally have expressed the opinion that it is an injustice to domestic buyers of all commodities to give the railroads exceptionally favored prices. Mr. Hines has answered these contentions by

## THE AMERICAN ARCHITECT

the assertion that he would be forcing inflated prices on the public by acceptance of the agreed price for steel and other products. He has expressed his dissatisfaction at being held up as an exponent of preferred buying.

The President's cablegram urging a quick solution of the price problem has brought the attention of the industrial world to the pending negotiations between the two Government bodies. It is expected that the lumber men will be prepared to submit their figures to the Industrial Board as requested several weeks ago. It has not been determined when the representatives of brick and cement will be called to the conferences. The general view is that the President's intervention will bring about a stabilization of prices at an early date and an immediate resumption of the great building program of the Government and private interests.

In the New York market in basic materials, outside of steel, definite progress was made toward price stabilization. The sand, gravel and grit companies that have been waging a bitter war for some time past have ceased hostilities without Government aid and new prices are quoted in the accompanying table for Manhattan delivery. In this connection Washington has announced that after May 1 a rebate of ten cents a ton will be allowed on sand, stone and gravel freight rates, where the rate is over forty cents a ton.

Brick prices still hold at \$15 per thousand, or \$1.50 below the Government fixed yard price basis, despite a demand that is as great as has been known in years. Common brick manufacturers up the Hudson are now figuring on a maximum return of 2 per cent and in some cases have put their product on the New York market at a loss in order to make it possible for the small operator to proceed with his building program. New plaster prices are expected shortly, gypsum interests being the latest to follow the lead of cement and lime in the movement for stabilization of prices.

In line with this effort to aid the solution of the rent problem one of the largest Portland cement companies this week issued a statement to the effect that if the cement manufacturers of the country could be assured of a profit of a dollar a ton on their commodity they would be elated, calling attention to the difference between the profits on this basic material and that of steel, which is nearer \$10 a ton. Cost of cement at his mills in 1913 averaged 62 cents a barrel and sold at 82 cents net. In 1918 the cost per barrel was \$1.44 and the net selling price was \$1.62, and with five barrels to a ton the net profit per ton was only 90 cents. The capitalization of his thirteen plants is \$24,488,000, putting the net earnings under 6 per cent and permitting dividends of only 4 per cent.

"Price stabilization is one thing, but ability to produce materials in quantity is another matter entirely, and we have been reading about the exodus of common labor from America, in the daily papers ever since the gateway to Europe has been unlatched. You cannot produce basic building material without 'wheelbarrow' labor in quantity. Skilled labor, that which assembles building materials into finished structures, is plentiful. Wheelbarrow labor, enriched by war-time wage scales, is going back to Europe. Who will take their places in the building material manufacturing plants?"

The general situation with reference to lumber stocks at American mills is reflected by conditions prevailing in the Southern pine producing territory, which normally supplies 40 per cent of all the lumber of all kinds consumed in the United States. Two hundred and thirty-five mills reported to the Southern Pine Association the first of March, total stocks on hand of 1,265,000,115 feet. This compared with 1,601,416,665 feet a year previous and 1,986,087,460 on March 1, 1917, when conditions were approximately normal. Present output of American mills, which in ordinary times aggregates about 48,000,000,000 feet a year, is slightly under 70 per cent of normal, due principally to labor shortage.

There is talk of another increase in freight rates, which, it is needless to say, is heard without pleasure by a great many shippers. An increase of railroad income would neutralize the over balancing expenses, but if freight rates go up the price of commodities in distributing lines will also increase, and it is a serious question whether business will not suffer immediately. An increase of freight rates will bring greater revenue to the railroads only in case the movement of freight continues without a decline. If rates are raised and buyers of building commodities as well as other goods refuse to pay the portion of the increase passed on to them, less building material will be purchased and the railroad income might actually decline.

### *(Special Market Report To The American Architect)*

CHICAGO, ILL., April 28.—The biggest business in this market the last week was the launching of the final Liberty loan campaign, with leaders in all industries working night and day to assure success.

Demand for practically all the raw metals is slow at this time, but the manufactured products are moving in better volume in consequence of increased activities in small building and repair work. This demand, however, is not being felt to any great extent by manufacturers and the jobbing trade. The shops all bought heavily for war contract requirements, and many still are using stocks on hand at the beginning of the cancellation period. Some employees have been laid off at the steel mills in this district, and the deadlock over the price of rails is causing continued hesitation in practically all buying. The large mills are now operating at about sixty per cent of capacity.

The clay products, and other building materials, including lumber, lime, brick, hollow tile and gypsum, are moving into trade channels in much better volume as the warm weather season advances. Building permits issued continue to increase and contractors are going ahead with the building of bungalows and small apartment buildings. All items in lumber are holding firm in price, with a firming up in yellow pine wholesale values. No changes have been made as yet in the dealers' lists.

It is now the general belief in this market that complete restoration of basic materials on their eventual normal level cannot be expected until the banks relieve themselves of the bulk of their war loan advances. The estimate of the Federal Reserve Board is that several months will be required to bring about this situation.

*(Price quotations now current on building materials and supplies as quoted by dealers and jobbers for delivery in New York and Chicago, follow. The quotations set forth are placed before readers of THE AMERICAN ARCHITECT to afford an accurate review of market conditions, rather than for use as a basis for actual purchase. They will not only provide knowledge of the exact state of the market as to items quoted, but will also present a basis to judge conditions as affecting correlating materials. Items marked (+) indicate an advance over last week, while those marked (—) record a decline. Other prices did not fluctuate during the week.)*



# THE AMERICAN ARCHITECT

	New York	Chicago	New York	Chicago
<b>BRICK</b> —				
Common (for Borough of Manhattan only), per thousand	\$15.00	\$12.00	96.00	63.00
<b>CEMENT</b> —				
Per bbl. in 15 cent bags (Rebate 60c. per bbl. for bags)	3.25	2.80	53.50	51.00
<b>COOPER SHEETS</b> —				
At the mill, hot rolled, 16 oz. base-price, per lb.	22½¢	22½¢		
(From jobber's warehouse add 2 to 3 cents.)				
<b>EAVES TROUGH</b> —				
Galvanized steel	.60	10%	70%	
Galvanized charcoal iron	.50	60%		
Copper	.40	40%		
<b>EAVES TROUGH MITERS</b> —				
Lap or Slip Point, list	.10	10%		
<b>ELBOWS AND SHOES</b> —				
Galvanized Steel:				
Plain, round and corrugated—all sizes up to 6 in.	.70	70%		
Square:				
Square	.60	60%		
Copper:				
All sizes	.20	25%		
<b>GALVANIZED SHEETS</b> —				
Nos. 18 and 20 gauge, per lb.	\$6.12	\$6.12		
No. 26	6.42	6.42		
No. 27	6.57	6.85		
<b>GLASS</b> — (Discounts from manufacturer's price lists)				
Single strength, A quality, first three Brackets	.80%	77%		
Single strength, B quality	.79%	77%		
Double strength, A quality	.80%	79%		
Double strength, B quality	.82%	81%		
Plate—up to 5 sq. ft.	.82%			
Plate—over 5 sq. ft.	.84%			
Plate—up to 10 sq. ft.	.83%			
Plate—over 10 sq. ft.	.82%			
<b>GRAVEL</b> —				
1½ in. (Borough of Manhattan only) per cu. yd.	\$2.75	\$2.50		
¾ in. (Borough of Manhattan only) per cu. yd.	2.75	2.50		
<b>GYPSUM</b> —				
Plaster Board:				
(Delivered in Boroughs of Manhattan or Bronx)				
27 x 28 x 1	.35c.			
27 x 48 x ½	.30c.			
32 x 36 x ¼	.21c.	25c.		
32 x 36 x ⅜	.21c.	26c.		
32 x 36 x ½	.23½c.			
Plaster Blocks:				
(Delivered in Boroughs of Manhattan or Bronx)				
2 in. solid per sq. ft.	7½c.			
3 in. solid 12 x 30 per sq. ft.	10½c.			
3 in. hollow	10½c.	10c.		
4 in. hollow	12½c.	11c.		
6 in. hollow	17½c.			
<b>HOLLOW TILE</b> —				
(The New York Harbor strike makes a slight additional charge for cartage necessary.)				
Interior, 2 x 8 x 12 split furring per 1,000 sq. ft. and 15 cents thousand pieces.	\$70.00			
Interior, 3 x 12 x 12 split furring per 1,000 sq. ft.	102.00	\$67.90		
Interior, 4 x 12 x 12 split furring per 1,000 sq. ft.	114.75	72.50		
Interior, 6 x 12 x 12 split furring per 1,000 sq. ft.	153.00	99.60		
Interior, 8 x 12 x 12 floor and partition per 1,000 sq. ft.		135.80		
Interior, 10 x 12 x 12 floor and partition per 1,000 sq. ft.		167.50		
Interior, 12 x 12 x 12 floor and partition per 1,000 sq. ft.		194.60		
<b>LATH</b> —				
Eastern spruce, per thousand	\$6.50			
No. 1 White pine, per thousand	\$6.50			
No. 1 Hemlock, per thousand	6.00			
No. 1 Yellow pine, per thousand	5.75	5.25		
<b>LIME</b> —				
Common, 300 lb. bbls., per bbl.	\$3.50	\$2.00		
Finishing, 300 lb. bbls., per bbl.	3.70			
Hydrated, in paper bags, per ton	17.25	17.50		
Common (Chicago), 200 lb. bbls., per bbl.	1.00			
Common (Wisconsin), 200 lb. bbls., per bbl.	1.10			
<b>LUMBER</b> (All prices wholesale f.o.b. New York)—				
Yellow pine, 3 x 4 to 14 x 14, 10 to 20 ft.	\$42.00	\$44.00		
Yellow pine, fencing and boards	43.00	44.00		
Yellow pine, dimensions and timbers	45.00	45.00		
Norway pine, scantling and joists (rough)	50.00			
Norway pine, heavy joists and timbers (rough)	54.00			
N. C. pine flooring, Norfolk, Va., 13/16 x 2½	43.00			
Hemlock, base price	36.00			
Spruce, random 2 in. cargoes	38.00			
Spruce, wide cargoes	52.00			
Cypress, by car, factory selects 5/4	59.00			
Cypress shingles, 6 x 18 (heart)	10.00			
Oak, quartered	110.00			
Oak, plain	80.00			
Oak, flooring, clear, quarter sawed	100.00	82-100		
Oak, flooring, clear plain sawed	72.00	66-80		
Maple, flooring, select	63.00	51-70		
Maple, flooring, clear, 13/16 x 2 in.	61.50	56-86		
Maple, flooring, No. 1, 13/16 x 2 in.	57.50	45-73		
Maple, flooring, factory, 13/16 x 2 in.	49.50	54-58		
Mahogany, selects, 1 in.	190.00			
Red gum	53.00			
Chestnut, F. A. S., 4/4	58.00			
Poplar, F. A. S., 4/4			96.00	63.00
Douglas fir, timbers (rough)			53.50	51.00
Douglas fir, porch and stair lumber				
<b>LEAD</b> —				
American pig, per lb.	5½ to 6	5½ to 6		
Bar, per lb.	7½ to 8	6 to 6½		
<b>METAL LATH</b> —				
Under 100 sq. yd., per sq. yd.	.40c.	40c.		
<b>PAINTS, OILS, ETC.</b> —				
Leads:				
American white, in oil, kegs; lots over 100 lbs.	.14c.	14c.		
White, in oil, 25-lb. tin pails; add to keg price	¼c.	¼c.		
Red, bbl., ½ bbl. and kegs; lots over 100 lbs.	.14½c.	14½c.		
Dry Colors:				
Red Venetian, American, per 100 lbs.	\$2.75 to \$5.00	\$2.00 to \$5.00		
Metallic Paints:				
Brown, per ton	24.00 to 32.00	24.00 to 32.00		
Red, per ton	24.00 to 30.00	24.00 to 32.00		
<b>PIPE</b> —				
Cast iron:				
6 in. and heavier	\$57.70	\$56.80		
4 in.	60.70	59.80		
3 in.	67.70	66.80		
(and \$1 additional for Class A and gas pipe.)				
Wrought:				
(Discounts to jobbers for carload lots on the Pittsburgh basing card; freight rates from Pittsburgh to New York, and also from Pittsburgh to Chicago, in carloads, per 100 lbs., are 27c.)				
<b>Steel:</b>				
Butt Weld				
Black, 1½ to 3 in.	.47 to .54	% 57½%		
Galv., 1½ to 3 in.	.20½ to .40½	% 41 %		
<b>Iron:</b>				
Black, 1½ to 1½	.26 to .36	% 39½%		
Galv., 1½ to 1½	.1 to .20	% 23½%		
<b>Steel:</b>				
Lap Weld				
Black, 2½ to 6	.37½%	53½%		
Galv., 1½ to 3	.50 %	41 %		
<b>Iron:</b>				
Black, 2½ to 6	.31 %	34½%		
Galv., 2½ to 6	.18 %	21 %		
<b>PLASTER</b> —				
Neat wall cement in 15 cent bags, per ton	\$20.30	\$18.50		
Finishing plaster	24.00	21.00		
<b>RADIATION</b> —				
(A further reduction, effective April 4, of 15% on direct radiators, 12½% on wall radiators, and 10% on steam and hot water boilers is announced. This approximates a drop of 36% on radiators and 33% on boilers from prices in effect before the 1st of January, 1919.) (Chicago reports a 57% reduction on all standard sizes.)				
<b>REGISTERS</b> —				
Cast iron semi-steel or steel, in black or white japan or electroplate and small faces and borders	40%	40%		
Wall frames	40%	40%		
Large faced, 14 x 14 in. and larger	60%	60%		
Base board registers	40%	40%		
Base board intakes	40%			
White enameled goods	15%	15%		
Solid brass or bronze goods, except grilles	net	net		
Grilles in black and white japan or electroplate in cast iron, plain lattice design, smaller than 14 x 14 in.	40%	40%		
Over 14 x 14 in.	60%	60%		
<b>SLATE ROOFING</b> —				
F. O. B. cars,				
Pennsylvania:				
Best Bangor	Quarry Station \$7.75 to \$9.00	F. O. B. Chicago \$10.20 to \$11.45		
No. 1 Bangor Ribbon	6.75 to 7.25	9.20 to 9.70		
Pen Argyl	7.25 to 8.00	9.70 to 10.45		
Peach Bottom	10.00 to 12.50	12.45 to 14.45		
No. 1 Chapman	7.25 to 8.25	8.70 to 9.95		
Vermont:				
No. 1 Sea Green	3.50 to 6.75	5.95 to 9.20		
Unfading Green	5.50 to 9.25	8.30 to 11.05		
Red	12.00 to 20.00	14.80 to 22.80		
Maine:				
Brownsville, U'fg Black, No. 1.	11.00 to 12.00	14.10 to 15.10		
Slaters felt, 30 lb. roll	1.75			
Slaters felt, 40 lb. roll	2.25			
<b>ROOFING MATERIAL</b> —				
1-Ply Tarred Paper, per ton, per roll,				
108 sq. ft.	\$63.00 to \$65.00	\$65.00		
2-Ply Tarred Paper	.95c.	95c.		
3-Ply Tarred Paper	1.23 to 1.30	1.30		
Rosin Sized Sheathing	per ton 60.00	60.00		
Corrugated Roofing, galvanized, 2½ in. corrugation, over flat sheets, 30c. per 100 lbs.				
<b>SHINGLES</b> —				
Red cedar, 5 to 2, clear		\$6.50		
White cedar, extra star, A star		5.50		
<b>STRUCTURAL STEEL</b> —				
Beams and channel, 3 to 15 in., per lb.	2.80c.	3.47c.		
Beams and channel, over 15 in., per lb.	2.80c.	3.57c.		
Angles, 3 to 6 in.	2.80c.	3.47c.		
Zees and tees	2.80c.	3.47c.		
Steel bars, half extras, from mill	2.70c.	3.47c.		
<b>REINFORCING BARS</b> —				
High carbon steel from mill	\$48.50	\$49.50		
Medium steel from mill	48.50	49.50		
<b>SAND</b> (Borough of Manhattan only)—				
Mason, per cu. yd.	\$1.80	\$2.25		
Torpedo, per cu. yd.	1.80	2.50		

# Department of Architectural Engineering

## Standard School House Equipment

THE pupils' wardrobe is placed either in a special room provided for the purpose or within the classroom. The latter location is used in the school buildings in New York City. This location has many advantages, among them being the fact that the wardrobe is under constant supervision, which reduces the liability of pilfering. The preparation and inspection of the pupils before dismissal

without interfering with those parts above mentioned. The ventilating system consists of main riser ducts, adjacent to the stair halls, from which branch ducts are carried on the corridor ceilings to each room.

As shown in the plan, the wardrobe is usually built in combination with a teacher's locker, book cabinet and library bookcase. The capacity of the

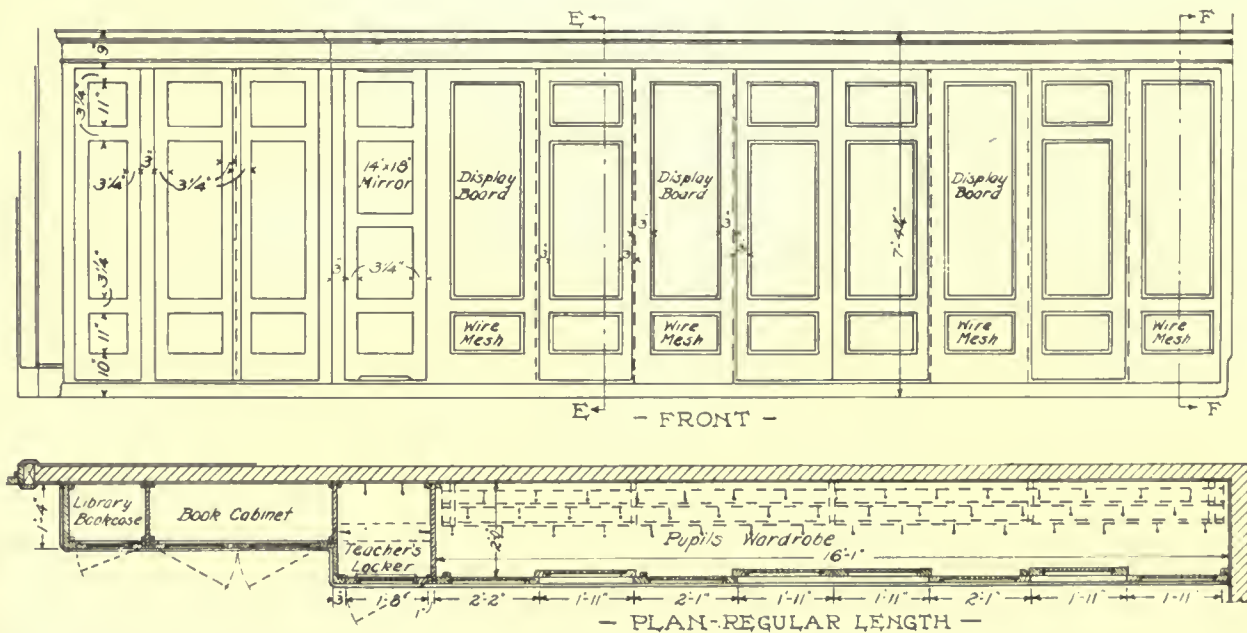

Plan and elevation of pupil's standard wardrobe in connection with the teacher's locker, book cabinet and library bookcase. See Sections EE and FF.

is better accomplished. As these wardrobes are movable they can be shifted from one place to another to suit any changes in the plan of the rooms. When a special room is provided for this purpose, it is generally immovable and renders the plan to that extent inelastic. As shown in THE AMERICAN ARCHITECT of Nov. 20, 1918, a standard plan has been devised which is essentially elastic, the only fixed partitions being those enclosing the toilets, auditorium, gymnasium, stair halls and the ventilating ducts. All other partitions can be moved

wardrobe can be made to conform to the pupil capacity of the room. Of this fixture the front is composed of a base and headpiece and a series of fixed sections and sliding doors; the base is joined to a cove at the floor; the head-piece is built up and molded as shown, with a nailing piece set on the back or inside for securing the roof, which is of strips  $\frac{7}{8}$  in. thick, not more than 4 in. wide, matched, glued and nailed; the sections are fitted between the base and head-piece and secured in place with slip-tongues at the bottom and iron



# THE AMERICAN ARCHITECT

plates screwed to the top; the doors close the openings between the sections and are hung with overhead hangers operating in a trolley track, one in

register in the lower panel and cork linoleum in the upper or center panels. The wire mesh registers in the lower panels are for the purpose of ad-

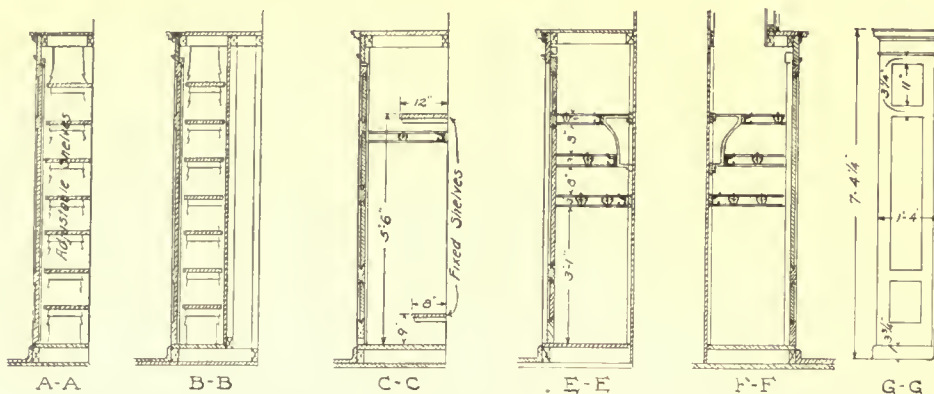

Sections EE and FF of pupils' standard wardrobes, the latter showing ventilation duct outlet. Sections AA and BB of standard book cabinet and library bookcase. Section CC of standard teacher's locker. Elevation GG of exposed ends of fixtures.

the center of each door. The hangers are carefully adjusted and rubber bumpers secured in place on each edge of the doors.

mitting the air from the room to pass through the wardrobe to the vent duct shown in Section FF and in THE AMERICAN ARCHITECT of Nov. 20,

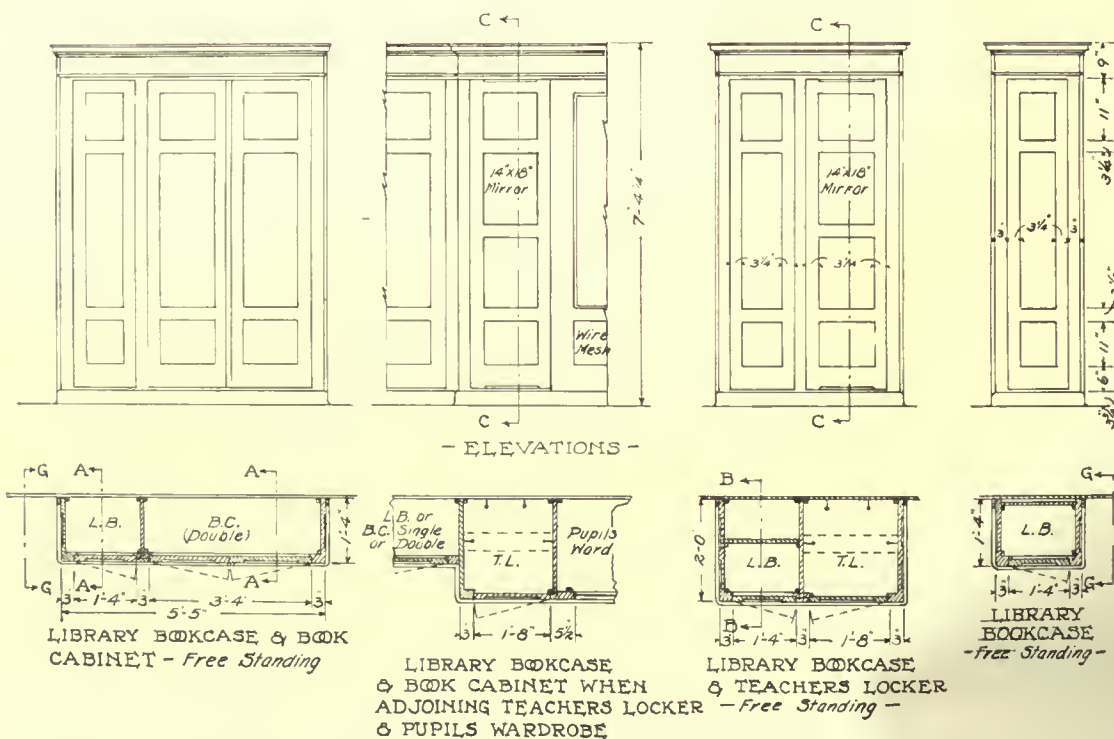

Plan and elevation of standard free standing library bookcase, library bookcase and teacher's locker, library bookcase and book cabinet, and engaged teacher's locker. See Sections AA, BB, CC and end elevation GG.

The doors and fixed sections are paneled and molded; stiles and rails are veneered; the ends are paneled. The fixed sections have a wire mesh

1918, Fig. 16, page 625. This vent connects with the large vent duct which is suspended from the ceiling of the corridor, which in turn leads to the

## THE AMERICAN ARCHITECT

main vertical duct located near the center of the building. It will be observed that this method of ventilation draws the warm air of the room through the wardrobe and thus dries the clothing placed therein.

At the top of the doors there is bolted a continuous connecting bar for each set; at the bottom of the doors there is a channel for each set, secured to the doors with angles and screws. The channel engages with steel guide bars secured to the floor.

The registers in panels are made of No. 12 wire,  $1\frac{1}{4}$  in. diagonal mesh in  $\frac{7}{8}$  in. channel frames, secured with  $1\frac{1}{4}$  in. flat head wood screws.

The flooring is made of clear maple,  $2\frac{1}{4}$  in. face, matched and blind nailed to 2 x 4 in. sleepers placed 16 in. on centers. The plastered walls form the backs of wardrobes.

The teachers' lockers, book cabinets and library bookcases, when grouped together with the pupils' wardrobe, are built as one continuous unit as shown in the wardrobe plan. When built free standing

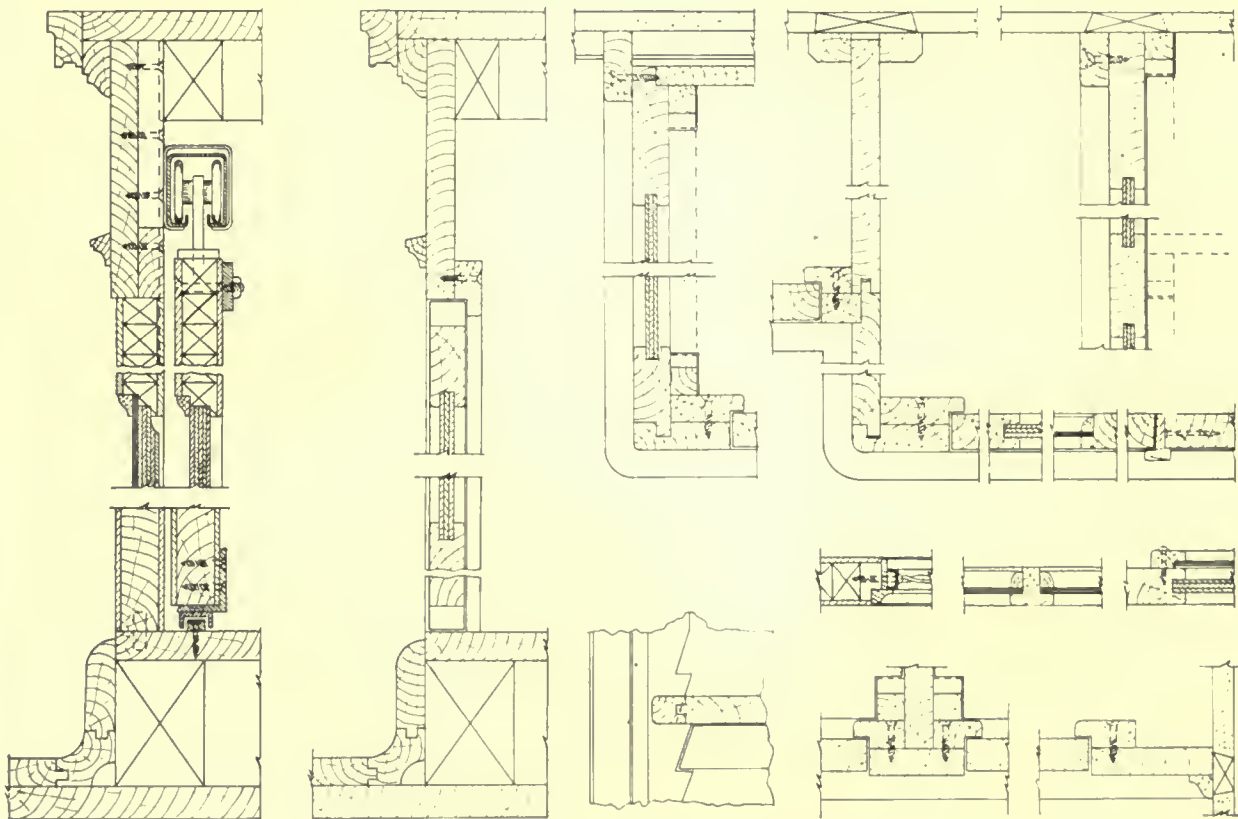

Details of pupil's standard wardrobe and connected fixtures.

Hook strips and shelves are supported by wrought iron brackets made as per the detail shown. Two  $3 \times \frac{7}{8}$  in. beveled hat hook strips are bolted to the brackets, and similar strips are secured to the wall where indicated to receive the iron brackets. The hat hooks are placed about 12 in. apart and staggered, as indicated on the plan. After the strips have been secured to the brackets, the ends of the bolts are upset with a chisel to lock them. The strips are made of wood to match the finish woodwork. The shelves are made of No. 8 wire,  $1\frac{1}{4}$  in. diagonal mesh in  $\frac{5}{16}$  round iron frames, secured with bolts and staples, made in sections to fit the conditions found in each wardrobe.

they are constructed as shown in the free standing plans. Where the distance between the end of the case and the wall is less than 16 in., the front is extended to the wall.

All doors have wood panels and are hinged. Where these units have dividing partitions or backing, these parts are made of matched whitewood or North Carolina pine. Each teacher's locker has two fixed shelves and four clothing hooks, as shown in the plan and section CC; also a mirror of the size shown, built in the door and resting on heavy felt strips secured to the door. The book cabinets and library bookcases are fitted with adjustable shelves.



## THE AMERICAN ARCHITECT

The janitor's wardrobe, visiting teachers' lockers and the bookcase and locker in the principal's office are similar in construction to the fixtures al-

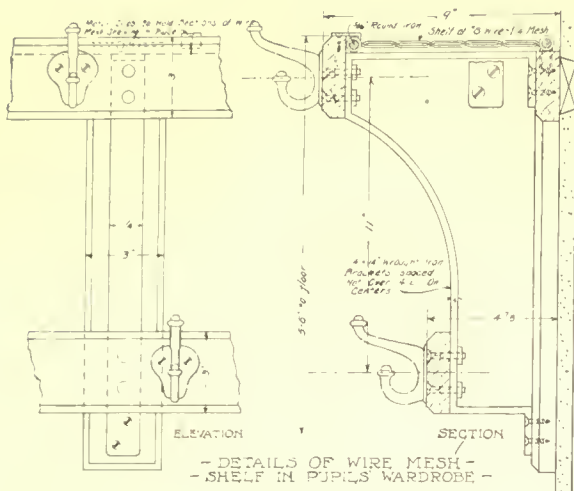

Detail of wrought iron brackets, wood strips for coat hooks, and wire mesh shelf in pupil's wardrobe.

ready described. The lockers have hinged wood-paneled doors with mirror on the inside as shown, similar to those in the teachers' lockers. The lockers are also provided with shelves, hook strips and hooks as shown. The bookcase has glazed paneled doors and adjustable shelves.

The book stacks are built in sections 3 ft. wide with shelves 8 in. deep. The material for all parts, except the shelving, matches the trim of the rooms in which the stacks are located. The shelving is made of white wood faced with a strip of the finishing material. The component parts of the stacks are paneled end uprights, plain intermediate uprights, round base, molded cornice and adjustable shelves for each section. The uprights are bored on  $1\frac{1}{2}$  in. centers to receive the supporting screw shelf pins, four to each shelf. The uprights are secured to the base and cornice by means of lag screws. The face strips of the shelves are channeled to receive labels. The construction of these stacks is indicated in the details here shown.

The Elementary Drawing Room is shown in plan, and its description given in *THE AMERICAN ARCHITECT* of Nov. 6, 1918, page 562. The details

of the cabinets placed at one end of the room are here given. A cabinet of drawers is placed at each side of the central raised platform. Each cabinet contains 44 small and 2 larger drawers. Above each of these cases of drawers is placed two display boards about 6 in. from the wall. The platform is 7 ft. wide and 3 ft. 6 in. deep and 18 in. above the floor. In the front face of the platform are six drawers 2 ft. 4 in. deep. Steps on each side lead to the platform. The back of the platform recess, between the side cases of drawers, is paneled with wood to a height of 2 ft. 8 in. Above this panel work is a fixed slate blackboard 6 ft. long and 3 ft. high. In front of this fixed blackboard are two movable blackboards which slide behind the display boards which are above the cases of drawers on each side of the platform. In this way three blackboards are available for use. These sliding blackboards are hung at the top in a track similar to those used on the pupils' wardrobe doors. A groove in the bottom of the blackboard frame engages with a  $\frac{3}{4} \times \frac{3}{4}$  in. angle guide.

The specification for wardrobes, cupboards, cases, etc., contains the following general items: All exposed wood panels, unless otherwise shown, shall be built with 5-ply veneer, grooved into stiles and rails. All exposed ends shall be paneled.

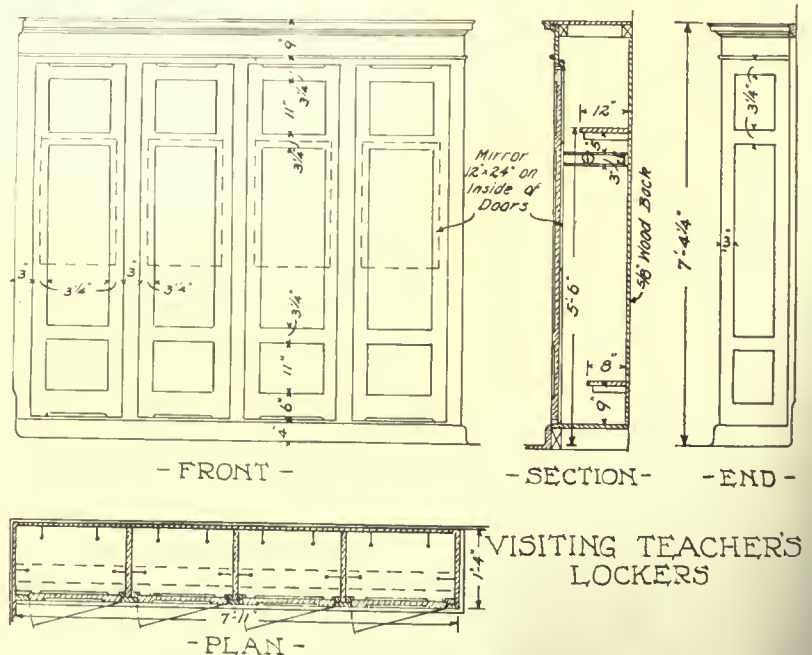

Plan, elevations and section of visiting teachers' lockers.

All exposed woodwork, except as otherwise specified, shall be of selected, thoroughly seasoned, straight-grained, kiln-dried material to match the trim of the respective rooms in which they stand.

# THE AMERICAN ARCHITECT

It shall be free from defects and planing machine marks, shall be put together in the best manner, and sand-papered smooth for varnishing. All parts shall be properly glued and nailed together, and nails set for puttying. Carefully fit and finish around all pipes.

All roofs, backs, and partitions, if not exposed to view, shall be of sound whitewood or southern pine. Drawer linings, etc., shall be of whitewood, poplar or birch. When fittings are shown to have backs they shall be constructed of beaded, matched sheathing, running vertically, and screwed to cleats running the full width of cases, unless exposed to view. Exposed backs shall be  $2\frac{1}{2}$  in. face by  $\frac{5}{8}$  in. thick, matched and V-cut. All shelving in cupboards, cabinets, cases, etc., shall be of white wood, faced with 1 in. strip of finishing material, tongued and grooved or doweled together and glued on. Where so shown the shelving shall be adjustable, resting on cleats supported as shown. The tops of cases and counters, when built up, shall be perfectly clear, selected finishing lumber. of narrow strips, grooved and splined, cleated on underside where so shown, secured in place with concealed screws and washers, hand scraped and left perfectly true and smooth.

All drawers shall have sides carefully dovetailed full thickness into fronts and bottoms and sides housed together. Runs and sides of drawers, where same are ploughed to receive runs, shall be of

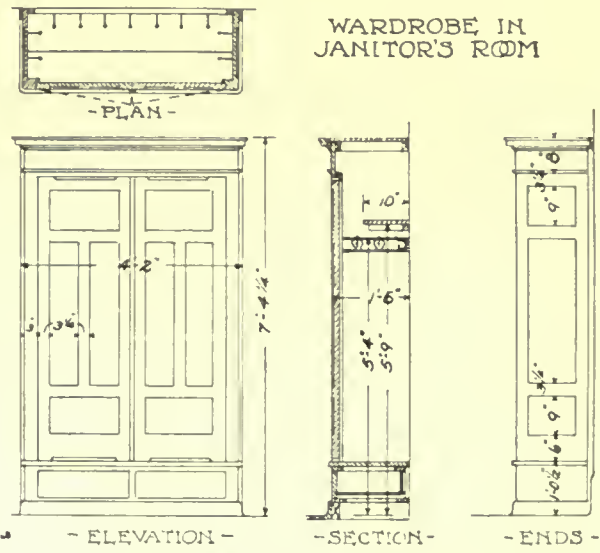

Plan, elevations and section of wardrobe in janitor's room.

maple. Stops shall be carefully adjusted and screwed as shown. Unless otherwise shown, the bottoms of drawers 12 in. wide or less shall be  $\frac{1}{4}$  in. thick, those of drawers over 12 in. wide and not more than 30 in. wide,  $\frac{3}{8}$  in. thick, and drawers over 30 in. wide  $\frac{5}{8}$  in. thick.

Where so shown the cove of room shall be carried around the cases, etc., and the base members shall be tongued into same except where floor is not of wood.

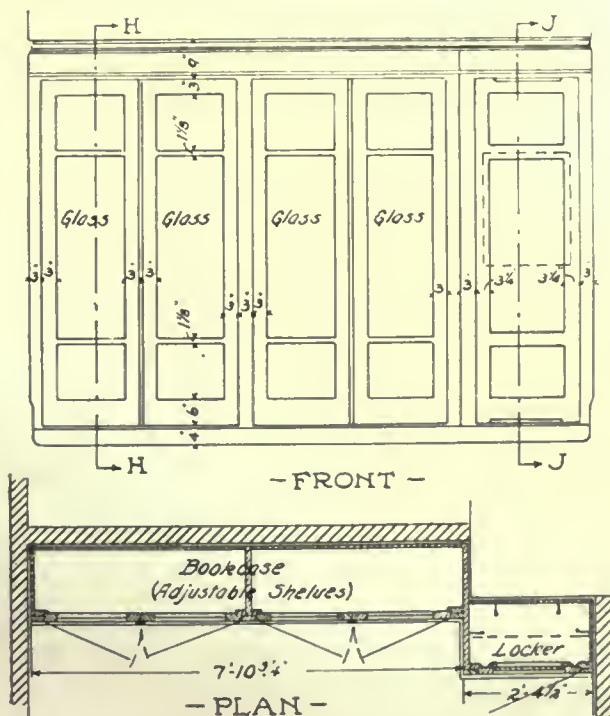

Plan, elevation and sections of standard bookcase and locker in principal's office.

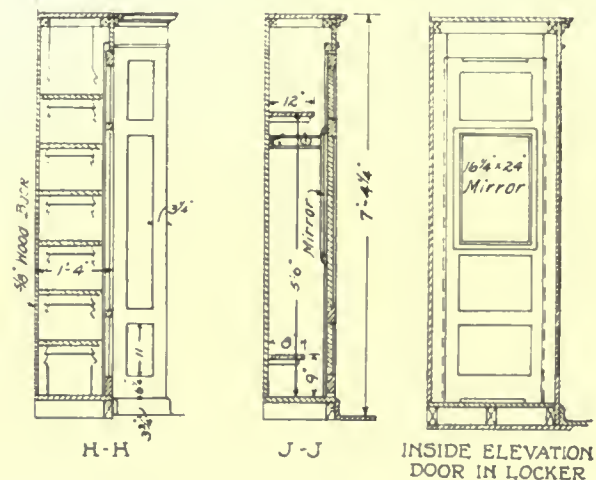

BOOKCASE & LOCKER  
IN PRINCIPAL'S OFFICE



# THE AMERICAN ARCHITECT

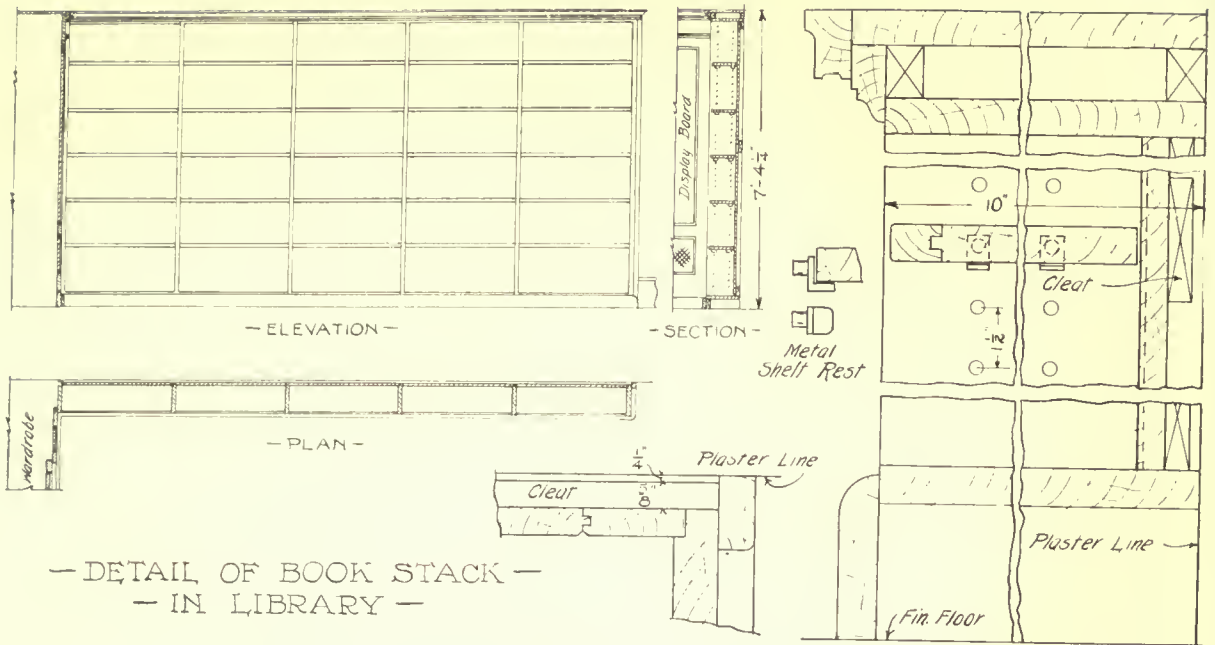

Plan, elevation and details of standard book stacks.

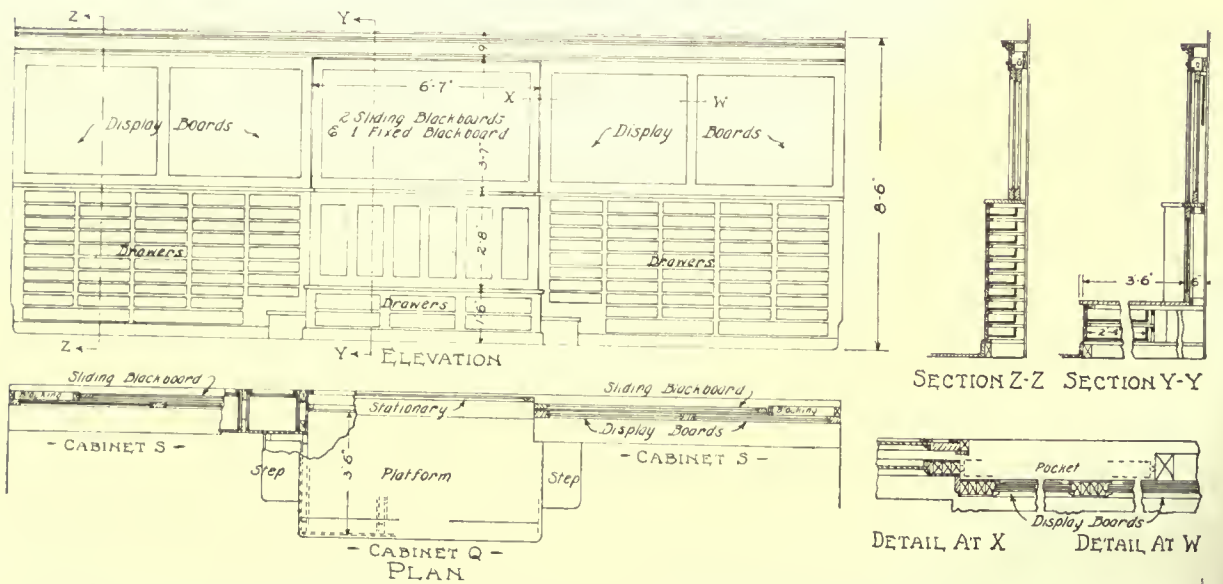

Plan, elevation, sections and details of drawer cases, display boards, blackboards and platform in standard drawing room.

## The Architect, Specialist and General Practitioner

**B**UILDINGS naturally divide themselves into classes according to the occupancy for which they are intended. Each class of buildings comprehends some special or intimate detail of plan which *completes* the structure and yet may not be clearly apparent on ordinary observation. The art of planning is not featured in the training offered by architectural schools in a manner commensurate with its importance. Books treating of the design of classes of buildings often fail to give adequate explanations of the plan. Architectural journals fail to explain the particular points of the plan that may have cost the architect many hours of earnest effort to solve.

A complete plan speaks for itself and every item is delineated, but every mind does not comprehend it in its entirety. To make the plan universally understood in all its details, the written word must be employed to supplement the drawing by explaining the reasons that dictated the final decisions. These reasons are based on experience, including its measure of failures, which yields definite and specific knowledge.

There are many thoroughly competent architects who do not have the special knowledge required to best plan every class of buildings and yet for many reasons they are entitled to be employed in planning them. They are safe and economical designers of the structural parts; produce a good plan and give a satisfactory architectural expression to the elevations, interiors and details. But they fail to give that intimate perfection to the plan in many of its details which makes the use of the building completely satisfying.

The planning of public buildings is often justly claimed by architects resident in the community and who are respectable citizens and tax payers. To award the work to these men, although it is conceded that they lack special knowledge, is often an embarrassing problem to those in authority. Their duty to the public is to secure the best results at the least cost and also to recognize the just claims of the local architect.

The solution of this problem is found in the employment of a consulting architect who has special knowledge concerning the particular class of building to be designed. The local architect should not resent an arrangement of this kind but should rather welcome it. It is no indication of his lack of professional qualifications and he will really strengthen his position if he asks for or proposes such an arrangement.

A general practitioner of medicine loses none of

his prestige by seeking the assistance of the specialist. The same condition applies to the lawyer. Why should it not apply to the architect?

A notable example of such an arrangement is that recently made by the public school authorities in Buffalo. It was decided to employ several local architects to design the buildings included in their eight-million-dollar building program. To insure a certain measure of uniformity or standardization in all of the plans, they have employed a consulting architect, well known as a specialist in school house design and construction, to co-operate with the local architects employed to do the work. This was the logical and sensible thing to do and met with the hearty approval of all those interested in the project.

It is only in some of the larger communities that the school boards employ an architect who devotes his entire time to this work. In most communities such work is infrequent and naturally special architectural knowledge is not developed among the local architects. Under such conditions the local architect should seek the work in co-operation with the specialist and the specialist should endeavor to render service in this way. By such arrangements there will be produced better planned and more economically built school houses.

Compared with other kinds of public buildings, school houses outnumber all others and, owing to the influence of the building on the young, their proper design and construction is of the utmost importance. This class of buildings is in great demand at this time and now is the time to see that they are properly planned and constructed in accordance with the most advanced standards. An improperly planned building is a burden to the community too valuable to destroy and often incapable of satisfactory reconstruction.

The planning of other classes of structures such as institutional and penal buildings, hospitals and other public buildings should be considered in the way here suggested. The owners of private structures such as hotels, office buildings and factories may well work along these lines when the circumstances justify such methods. It is to secure the best possible results in the architecture of to-day that this suggestion is made in order that our buildings may become permanent monuments to the best architecture that can be produced.

---

## Architectural Practice

By JULIAN MILLARD

In the recent discussions on the present conditions of the practice of architecture, my reading



## THE AMERICAN ARCHITECT

of architectural publications has failed to disclose any convincing analysis of our discontent. There is not even entire unanimity as to what is our trouble. I should say that our sore spot is this: that when the subject of building is under discussion, the presence of the architect is not considered essential. He seems to have every reason for being in the front of things pertaining to building, but nobody else sees it that way. Very disconcerting! All dressed up for the party and the invitation fails to arrive!

The architect has no leadership in the building world, and exercises far less influence on building policies than he should. He is not and cannot be, a member of the building fraternity. Under our present system of procedure, the elements of the building guild whose co-operation is necessary, are placed in such relation to one another that the real co-operation is the exception rather than the rule. Each building operation begins in an unethical and unbusinesslike gamble, and continues in a constant clash of interests and crossing of purposes. The time has come for the architect to kick over the table and start a new game.

Whatever modicum of truth there may be in the old phrase, "Competition is the life of trade," it has been entirely overshadowed by the new lesson learned during the last five years—Co-operation is the secret of production. This lesson has been burned into the consciousness of the world through bitter suffering, and it is to be hoped that it will reach the architectural profession of America. This principle will inevitably be applied to the building industry, and it is fitting that the architect should lead the way. If he fails to take the initiative, it will be taken by others. In that case, architecture will become a mere office function.

Here is a situation involving the very life of the profession! It requires vision and initiative to deal with it. Our leadership is in the American Institute of Architects, and while listening and waiting for a real message we have heard nothing but rumblings about non-essentials. Either the architect must content himself with the mere office work or he must consider himself responsible for the entire production of a building. If he fails to command in his own right the instrumentalities of production, he must go back and sit down.

Under the present system his vanity is satisfied

by large expressions of authority as set forth by wordy lawyers in contracts and echoed in specifications, but all this authority is merely judicial, post facto, exercised after the fact. This is the lawyer's view of authority, but the architect, in the rôle of production manager, must have a very different kind of authority. It is written in the skies that the architect must either command the production, or he must give up all hope of occupying the center of the stage. All the tendencies of recent years favor this view, and these tendencies will be accelerated in the period we are now entering. Is there vision and courage in the profession to deal with these things before it is too late?

There is frequent mention of the necessity that architects give a more complete service. With this sentiment, we agree heartily, but let us question what is the fundamental service called for. The client needs a building. His primary requirement is not plans, advice nor specifications—it is a building he needs. Obviously, the largest service the architect can render his client is to produce a building, and his profession requires him to produce a building that is suitably and skillfully planned, becomingly clothed, properly finished, economically and quickly built. Essentially this is a production problem, and what is commonly the architect's function is merely incidental, although indispensable.

The failure of the architect begins at the point where he loses direct control of the production. This occurs the moment he ties up the owner in a lump-sum contract on competitive bids. I know that many architects dispute this, but I am sure the majority would accept the thesis without further argument. Competitive bidding is extremely uneconomic, unethical and unbusinesslike. It costs the building public at least 5 per cent of its building bill—pure waste. The lump-sum contractor serves his own profit, while the architect serves the owner's profit, and the purposes of these two continually cross. There is no unity of service to the owner. If co-operation is the secret of production, the system is certainly poorly adapted for economic service to the owner.

As long as competitive bidding for contracts is the regular procedure, there is scant hope for the betterment of the conditions of the profession.

# The AMERICAN ARCHITECT



FOUNTAIN IN COURTYARD OF THE MUSEUM, BOLOGNA

PUBLISHED WEDNESDAYS IN NEW YORK—FOUNDED 1876  
VOLUME CXV                      MAY 7, 1919                      NUMBER 2263

Entered as second class matter January 6, 1909, at the Post Office at New York, N. Y., under the Act of March 3, 1879. Publication office, 243 West Thirty-ninth Street, New York, N. Y. Subscription price in the United States and Possessions, \$10.





Architect, Lewis H. Lovering  
Contractors, L. H. & P. W. Lovering

Built of Stucco on a Bishopric Board background, the walls of the Medford, Mass., Women's Club are almost as imperishable as stone. Crumbling and cracking are prevented by Bishopric Board because when this dovetailed, Stucco Background is nailed firmly to studding or sheathing, it holds the Stucco in a bulldog grip that never lets go.



The dovetailed heavy wood strips lock the Stucco. The creosote preserves the wood strips. The mastic asphalt and the water-proof fibre-board keep out cold, dampness, vermin, and deaden sound.

**C**OMPLETELY preserved and protected, naturally and scientifically, against all destructive influences, Bishopric Board lives indefinitely behind Stucco walls and supports them. It cannot deteriorate, hence cannot tear loose from its fastenings. There are never any repairs. Your Stucco building is up to stay, presenting an attractive, permanently unbroken surface.

A combination of principles ages-old in proven efficiency, Bishopric Board is the most economical and dependable Stucco background. It makes a damp-proof, fire-resisting building, thoroughly deadened against sound. Summer-coolness, winter-warmth, and low-heating bills are advantages of its use.

Used on interior walls instead of wood lath, it saves materials, time, and labor, and gives unmatched insulation.

Bishopric Sheathing saves 30 per cent as compared to  $\frac{7}{8}$ -inch wood sheathing, making a compact wall without joints or knot-holes.

All Architects and Builders should have our book, "Built on the Wisdom of the Ages". It describes and details the use of Bishopric Board; illustrates homes and institutions on which it has been used; tells how to get perfect Stucco work. It contains reports of scientific tests and letters from engineers, architects, builders, and home owners. Get it—and samples of Bishopric Board and Bishopric Sheathing.

**The Bishopric Manufacturing Co.**  
904 Este Avenue  
Cincinnati, Ohio

### A Few Other Bishopric Board Installations

University Park School for Boys,  
Arlington, Baltimore, Md.  
Architects, Smith & May,  
Baltimore; Contractors, Burn-  
ham & Co.

North Shore Golf Club,  
Chicago, Ills.

Exposition Building, Erie, Pa.  
Architect, Joseph Lee  
Contractor, William Siegrist

Grace Baptist Church, Bing-  
hamton, N.Y. Architect, E.H.  
Bartos; Contractor, William  
Ray.

Residence, Rear Admiral Chad-  
wick, Twin Oaks, Newport,  
R. I.

Rensselaer County Hospital,  
Troy, N.Y. Architects, Pem-  
ber & Camnain.

632

## The Practice of Architecture

**M**ANY things give indications of changes in the making. Through conversation, correspondence or reading these signs are constantly recurring testimonies, and a tabulation is unconsciously made of them until the ideas become insistent in their presence. To verify the general impression, a systematic collation of all the evidence is in order.

In arriving at a conclusion by this mental process, it will be found that among the diverse problems demanding attention at this time, one of manifest importance is that of the attitude of the public toward the architect and of the architect in his relations to himself and others.

The practice of architecture is probably today, more than ever before, a matter of barter and trade. The monies invested in building structures demand a return service which represents full value. This value is measured in the adaptability of the structure to its use, its durability and its appearance. These three factors are the fundamentals of correct planning and to render adequate service it appears to be essential that the architect should fully qualify himself to meet these basic requirements.

An analysis has been made of a great amount of data pertaining to this subject and the majority opinion has been condensed into the following five paragraphs which embrace the most common of the points developed. This brief consensus of opinion is not intended to cover the multitude of conditions that exist in such relations, but it is thought that possibly it comprises the basic factors.

1. The business of architecture is inseparable from the profession of architecture. Together they comprehend the originating, promoting, designing, planning, directing and controlling the construction of buildings and their appurtenances.

2. To develop a general demand for architectural service—without which only limited opportunities for practice will be presented—the architect must, as an individual and collectively, employ proper and effective means to create a universal appreciation of its intrinsic value.

3. To fully perform his function, the architect must organize, equip and operate his business so as to render complete service in the production of plans and specifications for everything embraced in the construction, equipment and furnishing of buildings.

4. He must furnish complete and detailed supervision of construction and be closely identified with it. He must be responsible financially, as well as morally, for all of his acts, including the correctness of design, the completeness and accuracy of plans, specifications and details, and the construction of the building in accordance therewith; his responsibility to be contingent only on his being accorded freedom in deciding all matters of structural design, mechanical equipment and the selection of materials and workmen.

5. He must control and regulate the business affairs of the building operation so as to safeguard all interests. He must be just and impartial in deciding all controversies within his jurisdiction, but where his own interests are involved he must submit the controversy to arbitration.

*(Reprinted from issue of November 27, 1918)*



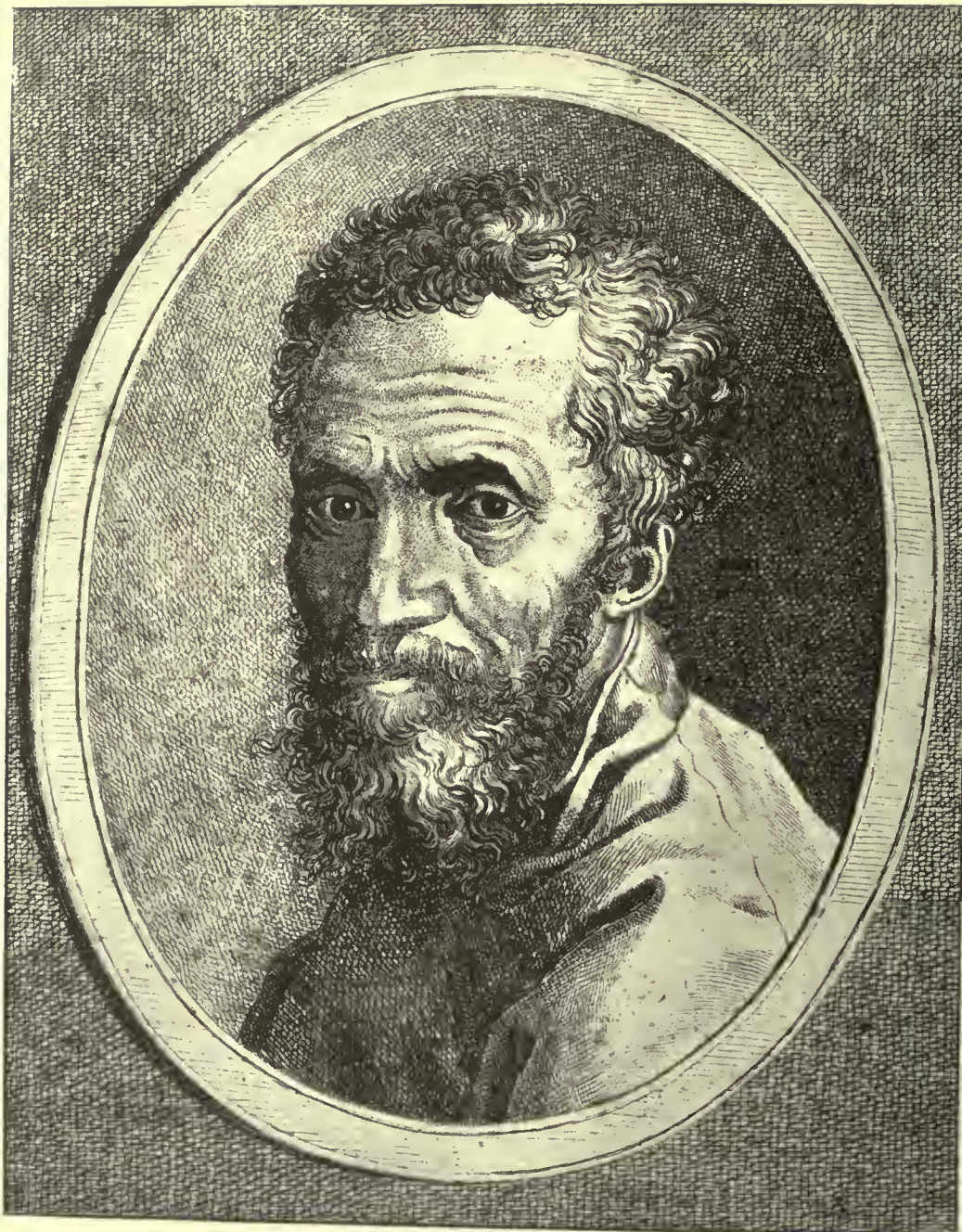

MICHEL ANGELO



# THE AMERICAN ARCHITECT

VOL. CXV

WEDNESDAY, MAY 7, 1919

NUMBER 2263

## The Nashville Convention

Noteworthy Results Attained at Fifty-Second Annual Meeting of the American Institute of Architects, Held April 30 to May 2

### THE FIRST DAY'S PROCEEDINGS

THAT the fifty-second annual convention of the American Institute of Architects, held at Nashville, Tenn., April 30, May 1 and 2, was to be primarily a discussion of principles as set forth in the program of the Post-War Committee, was at the outset foreshadowed in the brief address of President Kimball. Every other matter taken up for consideration was only of relative importance in its bearing on that important program.

When, on the morning of April 30, the convention was called to order by President Kimball, there were present more than 130 delegates. The sessions were held in the Assembly Chamber of the State Capitol building, designed by William Strickland. Not for many years past has the Institute held a convention amidst surroundings so well suited to its purpose.

The delegates were welcomed to Nashville by Mayor Gupton. He said Nashville was at all times ready to extend a welcome to any organization whose work was in the interest of progress. He welcomed the architects to "The Athens of the South" and to a city noted for its good architecture. He expressed in a most cordial way the desire of the City of Nashville to show the very essence of Southern hospitality.

In the opening address by President Kimball, an address that was received with much satisfaction, some very important matters were outlined. He spoke as follows:

#### PRESIDENT KIMBALL'S ADDRESS

In order that all the time possible may be devoted to the work of the Post-War Committee on Architectural Practice, the President's address will be extremely brief.

In view of certain signs of the times and in deference to some of my own pet prejudices, I shall not wholly yield to—though I sympathize with the Post-War Committee's well-earned right to every moment that can be spared from the imperative routine of the Convention.

On every side we meet the word "professional." It

crops up in most unexpected and unaccountable places, and strange associations. In the circular of our Post-War Committee we find it used in connection with and to define a recently assumed attitude of the contractor toward his work, wherein under the guise of a growing professional tendency he seeks to disguise a desire to shirk old and irksome responsibilities. Almost over night our friends the brokers in real estate have put on, together with a general clean-up, new paint, etc., the title "Realtor" and a claim to complete graduation into the class professional. I call this a sign of the times and a distinctly unpromising one—one I attribute to those among us who, for the sake of a theory more Utopian than purposeful, would have us believe that commerce itself is in line to take on the garb of unselfish service, in spite of the margin of profit for which it exists.

I would sound a warning against the tendency for which this post-war sign seems to stand. If professionalism is to be protected from such exploitation, indeed if it is to endure—I believe its disciples must awake to this and the other menaces of the all-absorbing commercial tidal wave that seems to be upon us, and which, if history really does repeat, should warn us of that never-failing visitation of force that is the only answer when the selfish control of necessities of life reaches higher water mark.

It is a pet fancy that it might pay to oppose to the commercial menace through organization—the one thing that has never yet been organized—the one thing that by reason of its essential character, is, and always must be, absolutely non-commercial—I mean simon pure professionalism.

Why not gather for this defense all those callings where skilled service unselfishly rendered to others is the qualifying requisite? Not so small an array when you realize that standing up to be shot at for one's country at thirty dollars per month qualifies and that khaki is the hallmark of preparation and skill.

Those versed in figures told us, some years ago, that by virtue of the sleeplessness of interest—the money (78 per cent of all there is) at that time in the hands of one per cent of the people—would draw to itself the remaining twenty-two per cent within fifteen years of which some six years have already passed. This money means bread and when all of it has come under the control of one per cent of those to whom bread means life, is it unreasonable to look for one of those sanguine outbreaks of force that have, I believe, always resulted under those conditions since history began to be written? It is the thought of this which makes it seem worth while to try to oppose organized selfishness by unionizing for that purpose the one thing that has, I believe, never yet submitted to the fetters of organization.

I offer this as a post convention thought, and really—I ask you—is it such an impossible idea that the combined



## THE AMERICAN ARCHITECT

intelligence which the professions represent might—acting together—parallel and in one and the same direction—result in a power worthy to be pitted against any human force—yes even this one that constitutes the menace from which the world trembles today?

In order that we may have a worthy part in such an effort, or for that matter, in any other post-war destiny that may include architects—I submit that we should no longer be satisfied with a membership that barely reaches ten per cent of those who practice the calling we profess.

With all my will I urge you to see to it that not less than a thousand be added to our membership in 1919. This, I think, is by no means a hard task. With the imminent return of building activity, of which the Committee on Institute Publications believes it has ample evidence, it should be but a short time before the dues can be materially reduced and that deterrent obstacle removed. To this end, enabling legislation in the shape of by-law changes is being suggested to this Convention.

Recent correspondence with some thirty professional organizations supports my belief in the possibility of a brotherhood or league of professions by the show of keen interest in the subject and a readiness to join in its further consideration.

A careful survey of the situation leads me to feel certain that a bigger and a better institute is immediately attainable.

Moreover, I am confident that architecture—the Art I mean—can never come into its own until some way has been found to make it easier for the young man in the profession to earn an honest living. Surely he can not hope to contribute much to art while 90 per cent of his time and energy is required to keep the wolf from the door.

A league of professions, an institute—really national in size and scope, and a vigorously and fully supported Post-War Committee on Architectural Practice—each offers possibilities. For the first I ask your post-convention interest; for the second, the greater institute, your help and for the Post-War Committee I bespeak your most generous and unqualified support.

Treasurer Waid's report was then presented. The cash receipts for the year were set down as \$36,000 and the expenditures at \$32,000. He announced that there was \$4,300 in the reserve fund. A summary of the budget for the ensuing year was contained in the Treasurer's report.

In the report of the Board of Directors, presented by Secretary Parker, it was urged that members engage in the fullest discussion of the matters that would be put before them.

In this report the Board of Directors submitted a resolution for permission to borrow from the reserve fund a sum not to exceed \$10,000 to meet expenses of the budget, the amount to be restored to the fund with 5 per cent interest added.

This report referred at length to the valuable individual services in war work rendered by members of the Institute.

The total membership of the Institute was now 1,499, a net gain of eight for the year.

Among the honorary members who died during the year was Theodore Roosevelt. The members stood during the reading of this part of the report as an expression of respect.

New Chapters were reported as organized in Nebraska and Tennessee.

The report contained a recommendation that the convention go on record with reference to a National Convention on Housing.

The report also urged that the Institute go on record as favoring a national Victory Memorial Park and Forest at or near Washington.

The question of State licensing laws was discussed in this report of the board and all of the Chapters in States where such laws are not now in force were urged to use every effort to secure the passage of adequate legislation.

It was announced that a committee of the Institute had been named to meet a committee of French architects which is soon to come to this country to discuss some problems of rebuilding the devastated areas in France. The Institute has pledged the most thorough co-operation in any matters which the French architects might desire to discuss.

The board recommended the election of Jean Paul Alaux of Bordeaux and Paris as an honorary corresponding member of the Institute, in recognition of his work in France and co-operation with American architects. M. Alaux was elected.

The Institute medal was awarded to Samuel Yellin of Philadelphia for his work in the Allied Crafts.

### AFTERNOON SESSION, FIRST DAY

The most important matter that was brought to a conclusion during this session was that of members' dues. After a somewhat protracted discussion it was resolved and carried that the annual dues of both Fellows and members be fixed at \$20.

The amendment to Article V, Section I, of the by-laws, referring to the initiation fee, was very fully debated.

The board of directors, in its report, suggested that there should be a low limit of ten dollars, in place of fifteen dollars, as now. The debate on this amendment brought out some interesting expression of views as to just what was and what was not a dignified attitude in the matter. Some delegates advanced the contention that a low initiation fee made for a poor class of membership and the possibility of the admission of men that were not sufficiently of good standing to be desirable. Others took a more democratic stand.

The motion was put and lost.

A proposed amendment to Article 12 of the by-laws, omitting the name of the Committee on Public Information, which would work a discontinuance of that committee, was seriously opposed by D. K. Boyd, former chairman of the Committee on Public Information.

It developed during the debate that it was the opinion of a majority of delegates that the contin-

## THE AMERICAN ARCHITECT

uance of a Committee on Public Information was favored, as its duties might properly be carried forward by the Committee on Publications.

This marks the end of a committee that was organized at a time, or, more exactly speaking, while the Tarsney Act repeal was being acted on by committees of Congress. The daily press throughout the country was full of the most misleading statements as to the practice of architecture. It was then the opinion of THE AMERICAN ARCHITECT, and it is yet of the same opinion, that there should be a committee of the Institute to set abroad a propaganda of education and by personal appeal to publications that were guilty of misstatements seek to correct them. This committee is now dead, and its history is that it never was made by those placed on it, what it was really intended to be, a committee on the formation and dissemination of correct information of the public. During the past two years this committee, if it had conceived a proper idea of what it really was brought to life for, would have been able to give a valuable service.

A series of documents and resolutions were presented to the convention and on motion referred to appropriate committees.

Among these was the matter of a resolution concerning the architectural improvement of farm buildings, in which the board of directors in its report expressed warm approval. George W. Maher, chairman of the delegates from the Illinois Chapter, and prominently identified with this movement, addressed the convention. Mr. Maher's contention was that the subject of farm buildings was a distinct one and should not be confused with matters of industrial housing or town planning. A motion providing for a separate committee on farm buildings was put and carried.

At half-past-four the convention adjourned to accept an invitation to view a collection of portraits and objet d'art assembled in the Parthenon in Centennial Park by the Nashville Art Association. About one hundred delegates, many accompanied by their wives, made the journey to the park, where they were received and entertained by a special committee.

The Parthenon is located in a picturesque park in the environs of Nashville. Here the Art Commission has gathered an interesting collection of portraits, mainly of historic interest, and many relics and heirlooms of the oldest families of the State of Tennessee.

In order that the discussion of the Post-War Committee's program might be carried forward apart from the routine convention business, it was arranged that the various sessions should be held in the evenings, commencing at eight o'clock.

The importance of these meetings is such that they will be reviewed in following issues of THE AMERICAN ARCHITECT.

### EVENING SESSION

The evening of the first day was given over to a meeting of the Post-War Committee. Mr. Milton B. Medary, Jr., presided.

That the work of this committee is considered of first importance by the delegates is shown in the fact that with few exceptions every one was in attendance. The debate on the various topics taken up was a serious and thoughtful consideration of elements of architectural practice that are now considered the vital things in the reorganization of the profession.

In his opening address Mr. Medary briefly outlined the reasons that were put forward by those who were responsible for the creation of this important committee. The movement has extended outside the membership of the Institute and every effort has been made to attract architects everywhere to the discussion of these important problems.

Preliminary to the discussion as planned, Mr. John Bell Keeble, a distinguished member of the Bar of the State of Tennessee, was introduced. Mr. Keeble spoke on the Relationship of the Professions.

President Kimball next addressed the meeting. He spoke on Professional Principles. He said:

In considering the professional aspect of the Post-War Committee's inquiry, we are by its circular invited to treat the subject as one of relationship. "Are we in right relation with those we serve—the public?" "Are we in right relation with those with whom we serve—all those who help us to build?" "Are we in right relation with those who parallel our service in our own and our brother professions?"

It is my province to point out the part professionalism does, and may, play in all this. That we may arrive at something tangible, we must, at least for argument's sake, come to common ground on the thing we are talking about. What is this principle we call professional, and which we are all so willing to have associated with architectural practice? To me it is what remains after you eliminate the art we have chosen to patronize, and the commerce which we are forced to practice in order to patronize that art. It is the third corner of the architectural triangle.

ART—our art—Architecture—gives its name to our calling and the objectives to our life's study, and to some the very God we worship.

COMMERCE—That life may be sustained, we serve with great fidelity that corner of our *cadre* which has to do with the *quid pro quo*, and in its service we are forced to cultivate a side of us that can but be destructive of the thing on which our art depends. Here I find the great paradox that we are living—living with such indifferent success; both elements as intensely selfish as they are involving, the one working to the limit to nullify the other. It is a good example of that "cancellation of effort" which accounts for much professional ineffectiveness.

There remains the third corner—the professional element—universally approved and respected, meagerly understood, however, and but weakly followed. As a principle it seems



## THE AMERICAN ARCHITECT

to me all that is unselfish in our vocational lives, all which has to do with the welfare of those in whose service our lives are spent—our clients and the public.

A glance at any of the recognized professions will show, I think, that each has its own titular objective that corresponds to our art of architecture, and each, by virtue of necessity, its destructive, though essential, commercial corner, which in each case is balanced by this unselfish counter-irritant—its professionalism.

In medicine, law, engineering, in fact in any profession, as in architecture the titular objective is always essentially selfish and full of the limitations of selfishness but in no other particular are these objectives at all alike nor do they offer any common interest; while in the commercial and professional elements all professions seem to be clearly alike—the one element an undesirable, and the other a most desirable, common factor to all, and so of surpassing importance, it seems to me, in this matter of inter-relationship which we are considering.

It is to the possibilities of the professional element as a democratizing influence within each profession, and as common ground between all professions, that I wish to direct your attention.

*Art*—through its exclusiveness tends to disorganize, to separate into *cliques* and then to sub-divide them, a process that results in impotence. This is why art affords no bond that binds, and why its associations are so often ineffective and short-lived.

*Commerce*—on the other hand has long since recognized the importance of effective organization, which makes it such a terrible thing with which to contend, and results in such a secondary rôle for Art, where they assume to practice as partners. On the other hand in his professionalism, the least among us or among any of our brother professions, may aspire to be the peer of the greatest in the purity of his profession, and in his joy in its practice. It is for this reason that the professional principle stands high as a possible bond of union among and between all those who aim to render skilled service for a fee shorn of contingent profit, and where the interests of client and public are cared for first.

I referred a moment ago to "professional ineffectiveness." What I had in mind was the condition resulting not only through the failure to help each other, but sub-consciously, perhaps, through the habit of interference with the successes of each other, that characterize the relationships of professional men,—a condition brought about, I think, quite naturally as a result of professional intelligence which clearly discounts the assumptions and presumptions in others that it condones in itself. A perfect familiarity with,—in fact the profession of,—some fifty odd sciences, each worthy a man's life study, is an architectural assumption or presumption that may well explain the discount with which Medicine and Law are apt to receive our professional advances; while between law and medicine the assumption is as aggravated and the discount as complete—witness the past ten years of futile effort at closer association between those two great representative professions. While many will fail to accredit the truth of this, my latest assumption, I doubt if any will deny the prevailing custom among professional men to indulge in tales of discomfiture to and of each other and before audiences prone to be more interested than discerning. To me the story that begins "once there was an honest lawyer,"—like those which exploit the disasters which result from our own traditional weakness in the matter of estimating costs,—have caused our respective professions to lose enough legitimate patronage to explain the full difference between success and failure in countless professional lives.

If through professionalism as a common factor we could reach an inter-professional understanding based on helping instead of hurting each other, the result to the young man in the profession would, I think, be beyond price. If only some one of our brother professions would catch from our Post-War activity a kindred self-questioning desire, and from his example others might follow,—is it too much to hope that from some broad-minded doctor or brilliant

exponent of law, may not come the suggestion of a brotherhood of professions based on this common factor—this professional principle of—skilled service to others? A brotherhood or league not of a chosen few, but of all those callings that can qualify as practicing professionally; and in such an event might we not find recompense sufficient to have fully justified the creation of our Post-War Committee?

This idea of a Brotherhood or League of Professions is a very pleasant one to me, with its measureless program of accomplishment and its limitless possibilities. First the suggestion—followed by the response of all those who really are professional—gathering together to decide what the professional principle really is, and who shall carry its banner—followed by organization, perhaps of a permanent Ethical Court with which to safeguard its future, and whereby each profession may, with the help of the brother professions, do what alone we have all so far failed to do—really clean house.

I am so obsessed with this idea that I do not stop at anything short of an intellectual power capable of doing the undoable thing,—namely, setting a limit to the advance of that organized selfishness we call commerce, something that, it seems to me, must be done if there is to be preserved to mankind this priceless thing—the professional principle.

At all events such a brotherhood could not fail to result in eliminating all that cancellation of inter-professional effort that now obtains, and that alone would give to the professional beginner including the young architect, his chance to acquire a competency honestly, and before the juices of life are so dried up as to preclude his making any worthy contribution to the art to which he has devoted his life. After all, it is the welfare of this young architect which interests me, and which I had in mind when I asked the Board to create the Post-War Committee on Architectural Practice.

Following Mr. Kimball, N. Max Dunning, chairman of the Post-War Committee, very lucidly outlined the work of his committee. He stated that the mass of information that had been placed at the disposal of the committee was so great that in view of the impossibility of digesting it so soon it would lead to no definite good and would be unprofitable of results to endeavor to formulate an opinion at this time.

Mr. Dunning further stated that in his judgment two important things have been emphasized by our war experience; the value and necessity of organization and the proper appreciation of the value and nobility of service. These remarks were received with much applause, indicating that the chairman of the Post-War Committee had exactly stated the views of those present.

In opening the discussion, Mr. Magonigle said:

It is rather difficult to know just where to begin with this tremendous program and I suppose I may as well plunge in about the middle.

I should say in answer to the queries, Has the architect laid too much stress on the aesthetics and too little on the other values of his service? Has the architect been led to believe that architecture is the art of designing monumental buildings and Has he kept in touch with industrial methods? I should say that that would depend largely on the architect himself and upon his individual training and upon the district in which he was born, the district in which he was trained and the district in which he ultimately practises. Our whole social life is so complex, we are spread out in a measure so thin, our profession at least is

## THE AMERICAN ARCHITECT

so thin, over so tremendous an area, that the problems of my city are not those of another's, and I think we shall have to look for the answer to all of these questions in just precisely the kind of discussion that we should carry forward throughout the discussions that we now propose to hold. In other words, these discussions will, I think, should, take more or less the form of experience meetings. It will be by interchange of personal experiences without biographical details, perhaps, that will help other men to see where they perhaps have not entirely succeeded in solving their own problems.

I think another thing too, to remember in the course of this whole discussion that we are here for the purpose of inquiry calm dispassionate inquiry into the various ills that are said to beset our profession. We are not here in the spirit of acrimonious debate. We are here to listen sympathetically to the story of the man on the other side of the country who has a totally different public, who has a totally different problem from ours. I have noted in reading through these documents, as I have a number of times, that queries have evidently come out of an atmosphere with which I am not at all familiar and with which, in some respects, I am not at all sympathetic. I hope to be before the discussion is over.

To me, the question as to whether I shall engage in building enterprises and financing enormous undertakings have not worried me a bit. Perhaps this is a worry I still have to face. I hope it is not. But by listening, speaking for myself, by listening to the problems of others, I shall probably learn a great deal that will help me in my own work and it is by the accumulation of all this great mass of detail and its reduction finally to its lowest terms that

we shall be able to make progress in the immediate future.

I note here this sentence: "Granting that it is essential to attempt to secure an aesthetically satisfactory solution of every building problem, should not the architect also accent the value of his services from the point of view of wise economy, adequate and practical planning, safety, and the most advanced building methods?"

I suppose he should accent that service, the value of that service, if he is fitted to perform that service. Otherwise I should say that he should not accent it. I think he ought to pass over that. I find here too a sentence which I think must have been written by me on the profession, a professional humorist. All of the professions have been criticized for doing work primarily in the interest of one class to the neglect of others, that he serves the moderately wealthy, and to a lesser degree, or not at all, the poor. If that applies to architecture, if not, to see how we would have been able to pay our fares to Nashville if we had not worked for the rich and moderately wealthy, for a little while at least.

I do not think that architects have been educated to believe that architecture is the art of designing monumental buildings. That depends entirely on where you come from. Nor do I think in some sections of the country does the architect lay too much stress on aesthetics. And, finally, does the public need to be educated? I would propose quite seriously that we do not debate that question at all until we have determined first whether our own education is as perfect as it might be. The work of the Post-War Committee will be one of the very best media for finding out whether we are as well educated as we might be. When we are then let us take up the public.

## Convention Notes

Commenting on the fact that William Strickland, the architect of the Tennessee State Capitol, lies buried in the northwest corner of the building, while the builder reposes in the northeast, a delegate was moved to remark that it presented a decidedly good example of both the architect and the builder keeping in touch with the job.

\* \* \*

The very active and often aggressive part taken by the delegates from the Illinois Chapter in the proceedings moved a perhaps jealous delegate from another Chapter to suggest that it should be called the *Illinois* delegation.

\* \* \*

The attention extended by the Nashville Society of Architects was in every respect so perfect an example of Southern hospitality as to call from every delegate the most hearty expression of appreciation. There could be nothing finer.

\* \* \*

The little fortune teller's tent on the Hermitage grounds was frequented by delegates who were enthusiastic over the auguries handed out. Some of the guests on this occasion were so thoroughly satisfied with the reading of the palm of one hand that they returned to have the other scanned.

A remarkable convention in the absence of acrimonious debate. From first to last every session was a harmonious discussion of the topic.

\* \* \*

The following advertisement by an architect was discovered by one of the delegates in the Senate Library in a copy of a Nashville paper dated Jan. 29, 1820. It reads:

### ARCHITECTURE

The subscriber has moved his family to this country and fixed his residence in Nashville, where he offers his services to design and execute public and private buildings. Gentlemen in the country can be furnished with ground plans and elevations by sending the size of the intended building.

Hugh Roland,

Opposite the Presbyterian Church.

N. B.—H. R. will execute in the country or furnish details on a large scale for the carpenter.

We are acquainted with H. Roland as architect of the Masonic Hall and are of opinion he is adequate to any business in his line.

W. Tannenhill,

M. Norvall,

Duncan Robertson.



## THE AMERICAN ARCHITECT

In presenting his motion that a committee on the Improvement of Farm Buildings be appointed, President Maher of the Illinois Chapter incorporated a recommendation that the plan as outlined in an editorial in THE AMERICAN ARCHITECT of March 12 be followed. The resolution was adopted.

\* \* \*

The promptness with which the \$10,000 was voted to defray the expenses of the Post-War Committee indicates the strong approval of the convention in the efforts of this efficiently working group.

\* \* \*

Many delegates who never before had visited this section of the South were enthusiastic in their

comments on the country and its people. There was to be noted everywhere an unadulterated Americanism in strong contrast with some of our Northern cities.

\* \* \*

The unanimous election of the officers of the Institute shows an absence of factionalism that indicates a successful future.

\* \* \*

The Post-War Committee is off to a good start. The amount of detail work that its members will have to undertake is so voluminous and so essential to best results that the committee should be authorized to bring to its assistance competent clerical aid.

# The Committee Reports

## Fifty-Second Annual Convention, American Institute of Architects

### COMMITTEE ON EDUCATION

It became evident, during the reading of the report of the Committee on Education, that the convention considered it of the very highest importance at this particular time.

As a discussion of just what is wrong with our present methods of architectural education, and a presentation of well-considered measures of correction, this report is worth careful reading. It is, therefore, with slight omissions, printed herewith as originally presented to the convention. The report was drawn by Messrs. Frederick L. Ackerman, Dwight H. Perkins and Milton B. Medary, Jr., acting as a committee. It states in part:

The first problem presented to the Committee was naturally that of establishing a basis of judgment. The question at once arises as to who is competent. If we consider seriously the character of our entire architectural environment, particularly in our urban centers, it appears that irrational purposes are clearly revealed as the dominant characteristic of modern life. Hence, public opinion, born of and nourished by irrational purpose, cannot be safely accepted as a criterion as to what should constitute the aims of the architectural profession. The purpose of architecture is to promote and support rational living; the great mass of architecture in our urban centers does not. For this condition the responsibility is general. In it the architect shares, for the profession as a whole has accepted the conditions and the program for buildings which are now developed by industrialism and capitalism.

It must be apparent, therefore, that we are presented with a dilemma. What should constitute the aims of education, both as to the creation and appreciation of architecture? The profession must either educate itself to conform to a standard and practice of building which is largely irrational—thus forfeiting its claim to real leadership—or the profession must educate itself actually to combat these

forces as the only possible means of developing a rational architectural environment. The profession has failed, thus far, to make this choice and in consequence the aims of the active profession and of vocational education in architecture have become both vague and uncertain.

Generally speaking, educational policies have come more and more under the direct control of business men who naturally have a personal and pecuniary interest in the product of education, both general and vocational. Among the results of this condition we witness a narrowing of the field of general education and the throwing of an ever-increasing emphasis upon the assumed value of narrow vocational specialization. Thus the larger social purposes, which should appear as the aims of the profession, have been lost sight of, while the possibility of really effective collaborative effort among closely associated vocational groups has been almost completely defeated.

Early architectural education in America emerged in what may be termed an aristocratic atmosphere, though, strangely enough, it was launched under engineering auspices in schools of "higher learning." The relatively recent exodus of American students to Paris and the journeying of the well-to-do to Europe gave an impetus to the production of better architecture and a new slant to educational policies and methods. These influences, it may be said, however, have not very materially affected, as yet, the character and the quality of that great mass of structures designed each year by those who are not recognized as belonging to the "educated" profession.

The character and quality of a relatively few buildings in our environment cannot furnish any clue to the average state of professional competence; nor can they be used as a basis of evaluating our system of vocational education. The degree of professional competence and the value of a system of vocational education must be judged in final analysis, by the quality of all buildings.

Over the total mass of our architectural environment and its orderly arrangement in the planning of towns and urban centers, it may be said that the profession has exercised almost no control. Hence it may be assumed that our education, both general and vocational, has failed to accomplish what should be its major purpose.

In particular is this true of general education, including

## THE AMERICAN ARCHITECT

in this our institutions of higher learning, for it is to general education that we must look, not only to furnish the basis of intelligence upon which to develop vocational competence in architecture, but also that criterion of judgment and taste on the part of the public which will demand that the character and quality of all buildings be such as at least to promote rational living in our urban centers.

In our architectural schools the introduction to the vocational work is not so arranged as to insure the stimulation of individual growth and development; the introduction is in the nature of an abrupt change in direction. Practically all of the former experiences of the student are cast aside and a study of architectural forms belonging to an aristocratic culture of the past is substituted. This automatically establishes a criterion of taste utterly unrelated to modern life. Thus it appears to the student that the practice of architecture is a cultural activity completely removed from the affairs which concern the mass of people.

This introduction to professional activity, and the scale of values thereby established, very largely explains why the majority of the "educated" profession take but slight interest in offering advice on community or political action which has nothing directly to do with commissions. It follows, as a matter of course, that the public and government officials do not ask advice.

The almost universal practice of teaching design without any contact whatsoever with the world of reality, and of imposing purely academic judgments upon the work accomplished by the student, develops a set of utterly false values with respect to architecture and the function of the profession in the community. The majority of problems do not even represent genuine situations, they are not related to actual experiences; and the student thus engaged is never afforded the opportunity of actually testing his ideas by application in order to determine for himself their validity. Responsibility of thinking is thus completely suppressed by these false and artificial methods of rating or appraisal.

It is this artificial practice, rather than the omission of lectures upon ethics, contracts, the architect's responsibility, and sundry other matters related to the technique of practice, which accounts for that atmosphere of irresponsibility which is generally admitted to surround the writing of specifications, the submission of estimates, and the making of contracts, particularly by those who are young in their practice.

In general, what is known as "subject matter" used in the problems represents situations which are remote from any immediate social interest of the student. Thus architecture is made to appeal to the student as an arrangement of forms rather than an expression, *in form*, of a dynamic society having social aims and purposes. Is it not reasonable to assume that this condition in education shows largely why, in practice, the architectural profession seems somewhat isolated?

In many of our schools, vocational education is carried on in closely related subjects, but there is little evidence to indicate that collaborative effort is considered of any importance whatsoever. Professional antagonisms are actually fostered through academic jealousies. Vocational education, as now organized, is in a large measure responsible for the great diversity of aims which we find among architects, landscape architects, decorators, and engineers. The academic institutions, particularly those teaching subjects related to art, very generally condemn the products of the world of industry; but no action whatever is taken toward aiding the student to gain an understanding of our industrial problems which so vitally affect the production of architecture. This condition, in a large measure, accounts for the fact that the profession as a whole has left to other groups and to individuals the work of developing that condition in industry in which the instinct of workmanship may find free expression, without which the production of art is utterly impossible.

Modern education revolves about a system of examinations, ratings, degrees, prizes, scholarships and medals. These fixed artificial and secondary aims have been pushed

into the foreground of educational activities and thus furnish the actual focus of the student's interest.

The result of this is that resourcefulness is suppressed rather than developed. And when we take into account the entire field of activities and interests which go to make up what we term the vocational education of the architect—the traditional classic introduction to the work, the subdivision of activities into "subjects," the theoretical study of construction, the paper programs, the "problems" developed exclusively through empirical criticisms, the elaborate renderings, the examinations and judgments imposed by others and the aims of study as represented by "mentions," medals, and prizes, and the all-important fact that not one of these educational experiences takes place in the world of reality, where the architect must gain an honest livelihood—when one takes all of this into account, is it not fair to conclude that about all that we have accomplished through this artificial educational mechanism is the development of clever draughtsmen who follow, not lead?

But we cannot allow this matter to rest with this destructive conclusion. How should we recognize education? It is futile to attempt to establish a general criterion of taste or an appreciation of art through vocational training in architecture, or for that matter, by the teaching of drawing in schools and by the inclusion in general education of courses in "fine arts." In nothing less than a complete revision of general education lies our only hope. As a profession and as individuals we might acquaint ourselves with what such a revision means in terms of action to such educational leaders as John Dewey, and we might push this work along. Such a study would have, also, a great advantage in that it would give us an insight into educational technique which we might apply to our own education.

What we need above all, in the vocational field, is a restatement of aims; we cannot educate a profession by simply telling students about their responsibility to the client, the public, and the nation, or by telling them about office methods, or by training them to be skillful draughtsmen. Were we to include within our schools such courses as would relate to the subjects above suggested our students would become merely clerks and office assistants, narrow with respect to aims, and irresponsible with respect to their functions.

What we must have—absolutely must have—is an education so staged that the student will learn by experience and contact with the work-a-day world as to what is actually meant by responsibility. He must be induced to find things out for himself and, as a result of his experiences, to come to his own conclusions. Is it possible to bring these actual experiences of the world into the schools of architecture? No one can possibly answer that question until it has been attempted.

And, above all, we cannot make the problems of the modern world vivid to the student by first drilling him in copying classic architecture. All such subject matter as relates to this phase of architecture must be made to appear as material of reference to be made use of whenever occasion demands. Were we to introduce the student to his vocational experience by making use of his immediate architectural environment, and by stimulating his inquisitiveness concerning its derivation, and the possibilities which are inherent in the problem of making that environment more accurately expressive of a social ideal which he is quite capable of creating if given the opportunity—if we were to bring him into actual contact with real problems and the difficulties encountered by the architects in developing our architectural environment, we would begin at least to develop an architect instead of a draughtsman. Confronted with real problems, he would attempt to find a real solution if we so organized the work that the judgments were real and not artificial.

We cannot dispense with specialization. The educational problem suggested, therefore, is: Who is to organize the specialized vocations concerned with building? Is it to be the business man or the architect? Surely, if it is our purpose to act as the organizer of that phase of building enterprises which have to do with design and construction,



## THE AMERICAN ARCHITECT

then one of the principal purposes in education would be to give the student an opportunity to gain his experience through actual collaboration with others, and so he would not work in isolation but in conjunction with those other professions which have to do with building. It is senseless to assume that we can effect collaboration by talking about it. It must be real, an integral part of education, for by no other means can the various professional aims be integrated and the spirit of common purpose developed.

And lastly, we must do away with the examinations and imposed judgments based generally upon presentation. The true aims of the profession should be clearly expressed by the tests which are set to win scholarships leading to further study. They should not all focus upon a single objective; opportunity should be afforded in a school of research for the architectural student, in collaboration with others, to study architecture and art, industry and government, and the complex forces with which we must contend in directing the growth of our environment.

### THE DEPARTMENT OF PUBLIC WORKS

The efforts of the Institute to secure a governmental Department of Public Works have been carried forward for the past two years. The report of the Committee on Public Works, as presented to the convention, states that in view of the fact that the subject matter is of such magnitude and the data available so meagre, the report is confined to the establishment of a few fundamental principles and to an outline of such recommendation as will establish a sound application of those principles. The report states:

When we glance over the many activities of the Central Government, and note the number of Departmental branches that have been created and have expanded from year to year with such constructive force that their recommendations became accepted dogma by the great mass of our people, we wonder why a department regulating the construction of public buildings and public works has been overlooked for such a long period.

The report then directs attention to numerous departments and bureaus of the Government, specifically directs attention to the great good these have accomplished, and adds:

If, then, it has been possible by proper selection of competent supervision to bring such activities to a high standard of efficiency, and almost beyond the pale of adverse criticism, we ask ourselves why a Department of Public Buildings and Public Works cannot be organized, which would gradually gain the public confidence and establish itself with the same excellence of service that we find in the other departments.

Such great impositions were being inflicted on the Government in the District of Columbia by apparent profiteering at the expense of the Government that even the Congress in 1916 was aroused to a sense of duty and it created a commission known as the Public Buildings Commission under an Act approved July 1, 1916, the purpose of which was substantially "with a view to ultimately providing permanent quarters for all the Governmental activities in the District of Columbia in buildings owned by the Government."

This report, with plates, appendix, and index, covers more than 600 pages of printed matter. It is a most illuminating document.

Each Department of the Government has been carefully analyzed, showing the space occupied in Government-owned buildings and the spaces rented to meet the growing needs.

The whole report is a comprehensive study of the

building situation in Washington as of January 1, 1917, and where there may be some divergence of opinion as to whether the recommendations made will give the best results, it is manifest that the situation as it existed at that time certainly required the attention of Congress.

The commission expresses earnest desire to alter an aggravated condition, and we believe was prepared to make drastic recommendations looking to a change in the public building policy.

Unfortunately, our active participation in the War diverted the attention of Congress at that time; we must therefore hope that a return to peace will bring about a thorough discussion of this report.

We have been unable to secure a report of the Supervising Architect's Office, but excerpts read from this report at different times indicate that, following the system now in vogue, this Department is unable to meet the demands of the country. It has gradually fallen behind its work. We understand that in 1917 it was nearly seven years in arrears of appropriations for public buildings entrusted to its care.

That the war has materially lessened its efficiency, no one can doubt, but if we are to interpret the attitude of Congress toward this Department by the recent so-called Omnibus Public Buildings Bill, known as H. R. 13987, it is manifest that at least the Committee on Public Buildings and Grounds, is really to ignore completely its existence and return to the employment of private architects under provisions similar in result to that obtained some years ago under the Tarsney Act.

Your committee feels that it could now be of material assistance to the Congress, and it is the opportune time to apply for a sound, sane and businesslike policy in dealing with public works.

### CONTRACTS AND SPECIFICATIONS

The Committee on Contracts and Specifications has had in hand the further development of a form of agreement between contractor and owner on the basis of a cost-plus fee and the development of the Handbook on Architectural Practice.

In its report the committee pays a very graceful tribute to the late Frank Miles Day, who for a number of years was the guiding spirit of this committee. Continuing, the committee sets forth:

The Form of Agreement on a Cost-Plus fee basis has been further developed during the past year and a fourth tentative draft, together with an amended Circular of Information in relation thereto, is appended hereto and submitted as a progress report.

The Committee feels that this method of executing work, so amply justified as a feasible way of executing emergency work by the Government during the past year, will secure in the future a larger occupation as a sound basis for executing any work in peace times. It is by no means standardized in its details, but much has been learned through the experiences of the past months with Government work. It involves a more professional relationship between the Contractor and Owner which vitally affects the work and the construction of contract documents for work so executed.

The draft as now submitted is but another step in the development of the subject and the Committee advises such circularization of it as shall be best calculated to secure further constructive suggestions. It refers this matter to the careful consideration of the next Committee.

The Handbook of Architectural Practice was issued by Mr. Day in its preliminary form and had been largely revised by him in the light of suggestions received. The Committee advises that it be published as intended by him, in its present form, as a supplement to the Institute Journal, at such time and under such arrangements as the Board may approve. The results of such publication,

## THE AMERICAN ARCHITECT

in the way of criticism and suggestion, should be referred to this Committee for the purpose of further revision, in the hope that the book may be ready for issuance by the Institute at an early date in a form that shall be considered satisfactory for a first edition. It is inevitably a book that will be subject to later revisions in the light of future developments in the practice of the profession.

### SCHOOL BUILDING MEASUREMENTS

The Committee on School Building Measurements, of which Wm. B. Ittner is chairman, has presented a valuable and comprehensive report.

For the purpose of obtaining and setting forth comparable data upon the educational utility and cost of school buildings, they have been classified, measured and defined as educational, construction and cost units. In the decision of the cost of school buildings four general items are set forth: Cost of land and grading, cost of building, cost of furniture and fixed equipment, and the cost of architects, engineers, brokers and supervision services.

The report sets forth in detail the various composition of the classifications.

### FIRE PREVENTION

The Fire Prevention Committee report is, naturally in view of the cessation of building operations during the war, but a brief statement of work accomplished.

Among the greatest of achievements of the Institute during recent years has been its valuable influence in the development of the Lincoln Highway.

The conditions presented during the war insistently showed the great economic importance of a well developed and efficiently maintained arterial highway. In fact, there are many and well authenticated instances where this National road has played a most important part in our war activities.

### LINCOLN HIGHWAY

The Institute Committee on the Lincoln Highway read a report showing in what respects it had effected co-operation with the Lincoln Highway Association.

It is a satisfaction to learn from the report of the Committee on Preservation of Historic Monuments that the Institute, and through it the various Chapters, has been active and alert to stay the hand of the despoiler, and by a generous expenditure of professional effort is doing all that can be done in the accurate restoration of our cherished buildings.

### COMMUNITY PLANNING

While for a number of years the many details that comprise the problems of community planning

have held large interest to architects the demand during the period of the war was so great and so insistent that the subject has to many men who practice architecture become the all-important one.

The Institute Committee on Community Planning presented a concise and interesting report to the convention. It stated in part:

The community plan deals with three main classes of structures or areas:

*First.*—Human habitations.

*Second.*—Structures and areas devoted primarily to spiritual and recreational uses.

*Third.*—Structures and areas devoted primarily to industrial uses.

In the planning of a community these three divisions must be kept constantly in mind in order that the scheme should lend itself readily to future changes. The plan, to be of lasting value, must contain within itself the possibilities of growth of each division with due regard to their several requirements. Otherwise it is still-born.

The subject must be approached with a full understanding of the order of importance of its three main divisions. The home is first; the things of the spirit are second, and buildings for commerce are so emphatically last that they may be considered as having no other reason for existence than to render possible the enjoyment of the home and the amenities of life. And lastly, there can be no successful scheme which fails to proportion accurately the part each one of the main classes of construction plays in the intricate pattern of a community life.

But alas! first things do not always come first. We have applied our major efforts to the development of our factories, wharves and railways. We have created a small group of experts, called architects and engineers, and have demanded of them that they apply their knowledge almost exclusively to the solution of problems relating to commerce. Our achievement lies open before us. There has been success and failure, but it is of tremendous significance that there has been no lasting triumph where the common good has been sacrificed to private profit.

Our transportation systems and the form of our cities are largely the result of individual initiative and daring, traits of character admirable in themselves. Private corporations and railways are accustomed to appropriate to themselves the entire water fronts of great ports, a policy which sooner or later strangles commerce and results in huge losses to the public as well as to themselves. Without a plan we are like men groping in the dark. In our cities the wealth created by the erection of buildings is not safeguarded against destruction caused by the bad placing of newer buildings. We move in a vicious circle. We erect gargantuan buildings, so badly shaped and located that to an undue extent they deprive the surrounding thoroughfares of light and air. The sin lies but incidentally in their bulk, primarily in their plan and silhouette. Prosperity smiles upon our efforts until the super-gargantuan building makes its appearance, initiating a fresh cycle, repeating on a larger and more devastating scale the former errors. It is individualism pushed to its logical conclusion, and the resulting over-crowding and gloom of the streets, transformed into canyons, react disastrously upon real-estate values. Indifference to public rights, imputable in various degrees to municipal authorities, owners, and designers, is responsible for this state of affairs. The sunlight, belonging to all, has been treated as private property. Failure is the natural result of each individual acting only from selfish impulses, and it is fitting that the causes of the failure can be so clearly traced to the violation of the principles of humanity and justice.

Housing is the most serious phase of all our building problems and no effective progress can be made in its

(Continued on Page 647)



## Engineering Conference at Chicago, April 23-25, Favors a National Department of Public Works

THE conference of engineering and architectural organizations held in the assembly hall of the Western Society of Engineers at Chicago, April 23-25, met in response to a call issued by Engineering Council, New York. This call was made to function by the National Service Committee of Engineering Council, M. O. Leighton, Secretary, 502 McLachlen Bldg., Washington, D. C. The engineering and architectural organizations that responded to the call were 76 in number, with a membership of over 98,000 persons, and were represented by 70 delegates. In addition the Engineering Council was represented by 7 members and the National Service Committee by 2 members. The architectural organizations that participated in the conference were the American Institute of Architects represented by Past-President Irving K. Pond of Chicago and W. D. Blair of New York; the Engineers and Architects Club of Louisville, represented by Warwick M. Anderson; the Illinois Society of Architects, represented by Charles H. Hammond of Chicago and the New York Society of Architects, represented by Arthur T. North, Western Editor of THE AMERICAN ARCHITECT.

As all sections of the country responded to the call by sending delegates from organizations interested in every phase of engineering and architectural activity, the conference was a truly representative body. There was a decided unanimity of purpose and ideas prevalent and the lively and extended debates developed none of those factional differences that possibly might have been expected where so many diversified and specialized organizations were gathered. This can be accounted for by the sincere desire of all the delegates to lend every possible aid to the purpose of establishing a National Department of Public Works. All submerged any desires of preferment for individual or special activities in the purpose best to serve the country first and engineering and architecture as a secondary proposition.

This attitude on the part of the delegates well exemplified the great lesson of the war—that service to the country must always have preferential consideration. Another striking feature of the conference, was the absence of any discord between architects and engineers. This has not always been the case in the past and it may be the result of the events of the past few years. The ability of all branches of engineering and architecture to do big

things in a large way has taught that lesson of dependence which is measured only by individual or group limitations. The old time antagonisms between engineering and architecture must have been the result of a lack of understanding and a correct measure of the true and proper function of each. Indeed, many architects claim that there is no definite line of demarcation between the two professions when considered in the broader aspects of the case. It appears certain that the rapid progress in all matters pertaining to building construction will make it increasingly difficult to attempt such a differentiation.

A careful reading of the declarations, resolutions, scope and plan of the proposed National Department of Public Works and the personnel of the committees named, will indicate the close relationship between engineering and architecture that has been established in setting up the machinery with which to accomplish the objects of the conference. Should these objects not be ultimately realized, the friendly and respectful intercourse between the two professions there established will well repay the expenditures of effort that were made in carrying out the conference program.

The conference was organized by the selection of M. O. Leighton as chairman and E. S. Nethercut as secretary. Seven sessions of the conference were held and a complimentary banquet was given by the General Committee of Technical Societies of Chicago to the delegates. An extended discussion of principles and scope of a National Department of Public Works resulted in the adoption of an expression favoring the establishment of such a governmental department. The result in form of resolution follows:

This conference of the delegates from engineering and related organizations respectfully recommends to the public and to the Congress that legislation be enacted covering the following principles:

1. That the services and bureaus of the National Government having to do chiefly with matters of engineering and architecture be grouped in one department, to be known as the Department of Public Works.
2. That the Department of Public Works comprise those works which are built and operated for the use of the public.
3. That the Department of Public Works be made available when desirable for the performance

## THE AMERICAN ARCHITECT

of special engineering and architectural work for the use of other Government bureaus.

4. That there be a systematic classification and organization of engineers, architects and other employees whose status shall be such that they may be recruited and maintained on merit.

Under leadership of the Committee on Government Engineering Activities an extended discussion was had in which the limits of the proposed department were considered. As the Department of the Interior employs at this time more engineers than any other department in the world, it was decided that that department was the one most adaptable to being transformed into a Department of Public Works. To this department it was proposed to transfer the various bureaus now operating in other departments and to detach many of the bureaus now included in the Department of the Interior.

The difficulty of securing an additional department and cabinet member was well understood and the proposed plan follows the line of least resistance. A vote was taken on the various factors entering into the proposed scheme for the guidance of the Committee which at a subsequent session presented the following report, which was adopted:

### REPORT OF COMMITTEE ON GOVERNMENT ENGINEERING ACTIVITIES:

To the Chairman and Members of the Conference:

Your committee charged with a consideration of the question which Government activities should be co-ordinated in a National Department of Public Works, recommends:

1. That the establishment of a National Department of Public Works should be accomplished by grouping those Government bureaus, services, commissions and other activities whose functions are predominantly of an engineering or architectural character, in what is now the Department of the Interior and thereafter designating that Department "The Department of Public Works."

2. That the transfer of any bureau, service or commission from any other department to a Department of Public Works should be accomplished without change in personnel, compensation and general plan of organization, leaving the co-ordination of the several activities; the simplification of organization and the establishment of additional bureaus, such for example as a Bureau of Chemical Engineering, to be effected as the need for the same may from time to time become apparent.

3. That in transferring river and harbor and other work non-military in character, but now in charge of the Engineer Corps of the United States

Army, to a department of Public Works, the relation of the Army engineers to such work be not changed that there should be no relinquishment of non-military duty by the Army engineers now on such duty until the transfer of these engineers to military duty can be made without detriment to the public interests.

Your committee finds that among the bureaus, services and activities which logically belong in a Department of Public Works are the following:

A Bureau of Public Roads.

The United States Reclamation Service.

The Alaskan Engineering Commission.

The Construction Division of the U. S. Army.

A Bureau of River, Harbor and Canal work, including such functions as are now exercised by the Mississippi River Commission, and the California Debris Commission.

A Bureau of Architecture.

A Bureau of Surveys, including the Coast and Geodetic Survey.

A Bureau of Mines.

The Geological Survey.

The Forest Service—at least until the same is divorced from the supervision of water powers and road building.

The Bureau of Standards.

Your committee believes that it would be unwise to determine at this time to what extent the proposed Department of Public Works should control the engineering activities of the General Land Office; of the National Park Service; of the Bureau of Lighthouses; of the Bureau of Indian Affairs, and of the Public Health Service and of various commissions, such as commissions on buildings and grounds, and therefore suggest that such matters may well be deferred for consideration to a later date, preferably until the department has been organized.

(Signed) C. E. Grunsky,  
J. Parke Channing,  
James H. Herron,  
Irving K. Pond,  
Baxter L. Brown,  
P. Junkersfeld,  
Frederick K. Copeland,  
W. O. Hotchkiss.

It was decided that this conference should not attempt to draft a bill, for presentation to the Congress, establishing a Department of Public Works. The care and labor involved in such an undertaking was fully appreciated and the efforts of the con-



## THE AMERICAN ARCHITECT

ference were restricted to indicating the plan and scope of such a department.

The following resolution was adopted:

"That this conference be known as Engineers', Architects', and Constructors' Conference on National Department of Public Works, that it continue in existence until dissolved by its own action, and that its officers and committees be empowered to further the development of a National Department of Public Works."

As indicated in the resolution, the organization of the conference was made permanent and its termination provided for. This enabled the conference to appoint an Executive Committee, Committee on Text of Bill and a Campaign Committee. The Executive Committee, with power to create a Finance Committee and add to its members consists of:

M. O. Leighton, Chairman, Washington, D. C.	P. Junkersfeld, Boston
Francis Blossom, New York	C. F. Loweth, Chicago
Frederick K. Copeland, Chi- cago	Phillip N. Moore, St. Louis
Daniel A. Garber, New York	F. H. Newell, Urbana, Illi- nois
Cass Gilbert, New York	M. C. Tuttle, Boston
C. E. Grunsky, San Fran- cisco	W. O. Winston, Minneapolis
	C. B. Burdick, Chicago
	W. H. Nichols, New York

### The Committee on Text of Bill:

M. O. Leighton, Chairman <i>ex-officio</i>	Irving K. Pond, Chicago
John W. Alvord, Chicago	Isham Randolph, Chicago
A. S. Baldwin, Chicago	Gardner S. Williams, Detroit
Lincoln Bush, New York	Horace S. Winchell, Minne- apolis
W. K. Hatt, La Fayette, Ind.	Charles T. Main, Boston
E. H. Lee, Chicago	

The Campaign Committee, which the Executive Committee is empowered to increase:

W. C. Armstrong, St. Paul	Louis Mullgardt, San Fran- cisco
Willard Behan, Cleveland	D. W. Brunton, Denver
C. H. Blackall, Boston	F. W. Bradley, San Fran- cisco
E. G. Bradbury, Columbus	J. C. Greenway, Bisbee, Ariz.
Baxter L. Brown, St. Louis	Hennon Jennings, Washing- ton, D. C.
J. Parke Channing, New York	R. A. F. Penrose, Philadel- phia
H. S. Crocker, Denver	R. H. Fernold, Philadelphia
F. L. Cranford, New York	Morris Knowles, Pittsburgh
Geo. W. Fuller, New York	Robt. Sibley, San Francisco
W. B. Gregory, New Orleans	H. W. Buck, New York
J. L. Harrington, Kansas City	E. F. Scott, Atlanta
W. O. Hotchkiss, Madison	L. C. Datz, Birmingham
W. H. Hoyt, Duluth	Wilmer Waldo, Houston
J. B. Lippincott, Los An- geles	Fred A. Jones, Dallas
E. J. Mehren, New York	Geo. A. Damon, Los Angeles
A. T. North, New York	W. D. Blair, New York
W. A. Rogers, Chicago	J. C. Ralston, Spokane
E. J. Russell, St. Louis	R. C. Gemmell, Salt Lake City
L. B. Smith, Kansas	J. J. Knoch, Fayetteville, Ark.
R. D. Kohn, New York	J. F. Coleman, Mobile
R. H. Thompson, Seattle	S. B. Earle, Clemson Col- lege, S. C.
T. U. Taylor, Austin, Texas	C. E. Ferris, Knoxville, Tenn.
Chas. F. Swigert, Portland, Ore.	Julius Stieglitz, Chicago
P. N. Norboe, Sacramento	
W. L. Huber, San Francisco	

During the conference the interests of contractors and producers of all kinds of construction materials and equipment was appreciated and their co-operation in the establishment of a Department of Public Works is expected. This same co-operation by real estate boards and all agricultural organizations is expected, as the construction of water power plants, public roads and other public works has a great influence on realty values and the transportation of commodities. The personnel of the committees indicates the broad aspect assumed by the conference towards the whole project.



# THE AMERICAN ARCHITECT

Founded 1876

PUBLISHED EVERY WEDNESDAY BY

THE ARCHITECTURAL AND BUILDING  
PRESS, INC.

No. 243 West Thirty-ninth Street, New York

E. J. ROSENCRANS, PRESIDENT AND TREASURER  
WILLARD C. HOWE, VICE-PRESIDENT

WILLIAM H. CROCKER, Editor  
EDWARD F. HAMMEL, Engineering Editor  
ARTHUR T. NORTH, Western Editor

Subscriptions in the United States and Possessions,  
Mexico and Cuba, TEN DOLLARS. Other Countries,  
TWELVE DOLLARS.

SINGLE COPIES (Regular Issue) 25 CENTS

CHICAGO OFFICE, Mallers Building  
PAGE A. ROBINSON, Western Manager  
ST. LOUIS OFFICE, Wright Building  
CLEVELAND OFFICE, Guardian Building  
SAN FRANCISCO OFFICE, 320 Market Street

Owned by United Publishers Corporation—H. M. Swetland, President;  
Charles G. Phillips, Vice-President; W. H. Taylor, Treasurer;  
A. C. Pearson, Secretary. Entered as second-class matter January  
6, 1909, at the Post Office at New York, New York, under the Act of  
March 3, 1879.

VOL. CXV

MAY 7, 1919

No. 2263

## The Nashville Convention

THE fifty-second convention of the American Institute of Architects was probably the most constructive and productive of actual results that has been held for many years past. The great changes that have been brought about during the past two years have seriously affected everything with which as a profession architects have to deal. Many problems that were never dreamed of as affecting the practice of architecture have developed, and in their development have brought radical changes in the point of view.

Architecture, at one time carefully guarded as an art and nothing else, has become broadened into the proper channels through which it should properly run its course. It has been difficult to instil this new thought in the minds of many members of the profession. These men have from a purely aesthetic point of view jealously guarded the profession from any contact with the more prosaic or practical elements which other men declared properly belonged to it. There is nothing more dangerous than the fanaticism of the purely intellectual, nothing that can so greatly retard the development of any movement toward its reconstruction on a basis of present well matured thought.

The program of the Post-War Committee was the first pronouncement on the part of the Institute that the "new thought" had invaded the councils of the profession. The fact that the sessions of the convention were along lines of elucidation and development of that program proves how thoroughly the delegates were in sympathy with this scheme for placing the profession just where it belongs. Naturally with so great a number of important matters for consideration and so limited time to give them, many things were postponed for another year or referred to proper committees with power to act on them.

The most significant statement as to just how the Institute proposes to set about the work of becoming thoroughly a representative organization is to be found in President Kimball's address on the opening of the convention. He said, "we should no longer be satisfied with a membership that barely reaches ten per cent of those who practice architecture," and made a strong appeal for an addition of at least a thousand to the membership during the coming year.

This, in view of the present attitude of the Institute toward the profession as a whole, should not be difficult of achievement.

From first to last this was a working convention. Not merely one that was filled with words and expression of noble aims that, while highly creditable, are often unattainable, but good, hard, earnest constructive work.

The regular sessions of the convention were supplemented by the meetings of the Post-War Committee. In fact, one intermeshed with the other to an extent that it will be correct to say that the meetings really developed into a most enthusiastic discussion of principles that are the basis of the Post-War program.

The machinery of the convention moved along in the most admirable manner. The interest was at all times maintained, and the large attendance of delegates at all the sessions showed that so earnest were they as to the matters in hand that even the many attractions of that delightful "blue grass" section held no allurements while the convention was in session. The lofty assembly hall in the State Capitol made an ideal place for the meetings and the wide corridors were thronged during intermissions with groups of delegates.

Taking it all in all, the American Institute of Architects may be said to have placed itself squarely in the van of the general movement of progress and to have proclaimed to all the world that the profession of architecture proposes to assume, and assuming, maintain, all of the best ideals of its honorable profession.



## Plan for National Department of Public Works

COMPREHENSIVE PROGRAM OUTLINED BY CHICAGO ENGINEERING CONFERENCE

The plan for a Federal Department of Public Works, which has taken tangible form as the result of the Engineering Conference recently held in Chicago and reported elsewhere in this issue of *THE AMERICAN ARCHITECT*, presents interesting possibilities and a number of novel phases which are likely to arouse more than passing interest.

Inasmuch as most of the argument thus far heard in connection with this proposal has been advanced by its proponents, it might seem that general assent may be taken for granted and that the suggestions which came out of the Engineering Conference are certain eventually to form the basis of a somewhat radical change in one of the government departments. Any attempt at the analysis of the program laid down, however, must take into account the fact that far-reaching changes in the character and scope of existing governmental departments can be forced only by an absolute preponderance of evidence supporting their desirability. The American people have had nearly their fill of tinkering with the government. Moreover, they are beginning to turn away from their leaning toward federal centralization of authority; the belief is becoming more and more prevalent that the legitimate business of the federal government is to govern, to confine its functionings within the scope, or nearly so, of the powers conferred by the Constitution. Increasing numbers of people are coming to believe that the growing control of the federal government over business in all of its phases means a gradual drifting toward a degree of paternalism that most Americans deem obnoxious.

These points are relevant in connection with the proposed creation of a Department of Public Works only in the event that such a department may be expected to assume powers not now existent in government agencies or to bring together in dangerous aggregate powers which, though now existent, are not dangerous as at present segregated.

It does not follow on the suggestions which came out of the Chicago conference that such dangers underlie the plan. A Department of Public Works, sanely and conservatively constructed, might prove a forward step in federal administration. It is a well known fact, however, that the tendency of governmental agencies is to seize power and to exercise it. It is equally obvious that where existing agencies of government whose present powers are sufficient and yet harmless are per-

mitted to pool their powers the result may be a menace to national welfare. Recent experience has demonstrated that the pooling of power over the railroads makes possible gross misuses that could not occur when the railroads were separately managed.

It seems, therefore, that the details of any plan for a Department of Public Works ought to be worked out with such care that we shall not see the possibility of the building industries eventually coming under the domination of a bureaucratic organization in Washington that, at any time, may develop inclinations and tendencies based solely on partisan ambition.

The functioning of such a department, moreover, should be definitely limited to control over purely public works. It should not be permitted to acquire any measure of influence or control over private enterprises or over state or municipal building projects, except that measure of influence which might be derived from the conduct of scientific research and the resulting establishment of standards based upon demonstrable scientific certainties, the use of such standards to be left to the discretion of those they affect.

A department so constituted and so circumscribed might and doubtless would prove of material benefit to the entire country. Properly planned and conducted, it should tend to increase efficiency and reduce waste in the conduct of the government's own business. Its development out of the present Interior Department would possess the very distinct advantage of avoiding any increase in the amount of political machinery in Washington—a point which most unbiased students of our form of government will commend.

Certainly the present situation with regard to the government's control over its own building business and other public works of national character is in vast need of improvement. The plan proposed by the Engineering Conference is by far the most constructive thus far advanced. It deserves the thoughtful consideration of every good citizen and particularly of architects, engineers and others whose professional interest is involved. It seems, however, that the taking apart of so intricate a machine as the government in Washington is a sufficiently precarious undertaking to warrant extreme caution and that the freest possible discussion is desirable before action shall be taken. For this reason, *THE AMERICAN ARCHITECT* will appreciate expressions of the views of architects generally and more especially of those architects who, either during or before the war, had experience in Washington or elsewhere in connection with some class of government work.



PLATE 147

FIRST PRESBYTERIAN CHURCH, SANTA BARBARA, CAL.

ROLAND F. SAUTER, ARCHITECT







THE PATIO FROM CLOISTER LOOKING TOWARD ENTRANCE TO SUNDAY SCHOOL.



PLATE 148

THE CLOISTER

FIRST PRESBYTERIAN CHURCH, SANTA BARBARA, CAL.

ROLAND F. SAUTER, ARCHITECT





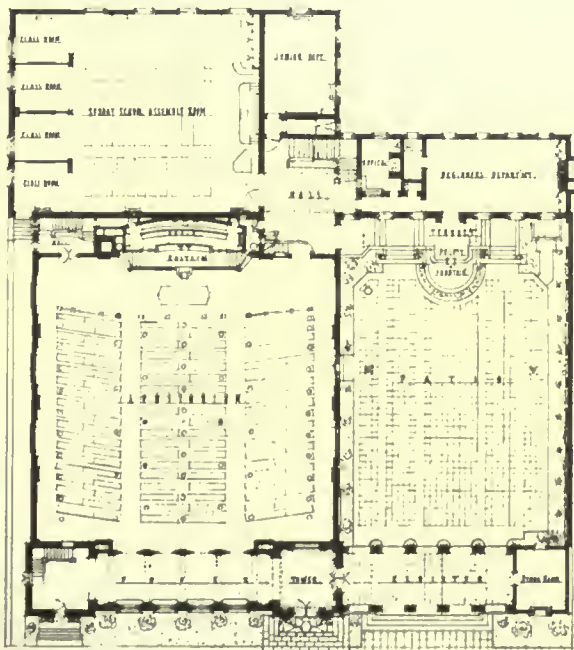
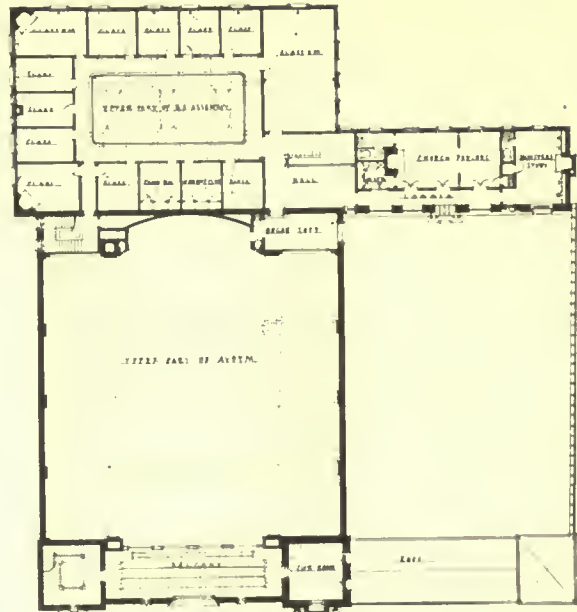
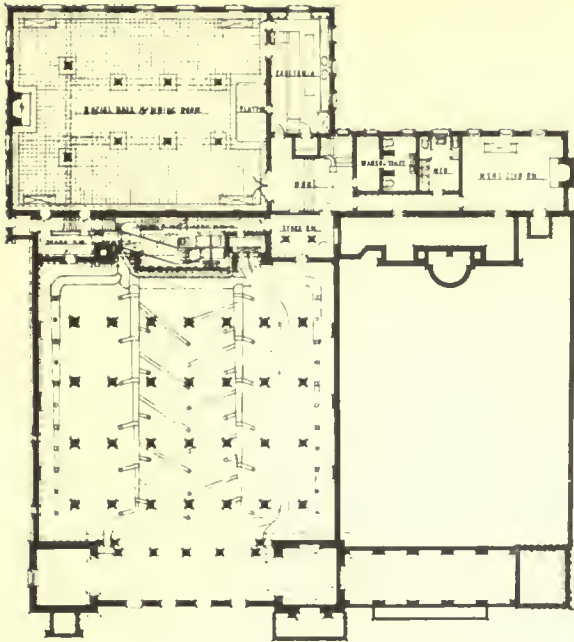

FIRST PRESBYTERIAN CHURCH  
SANTA BARBARA, CAL.

ROLAND F. SAUTER, ARCHITECT





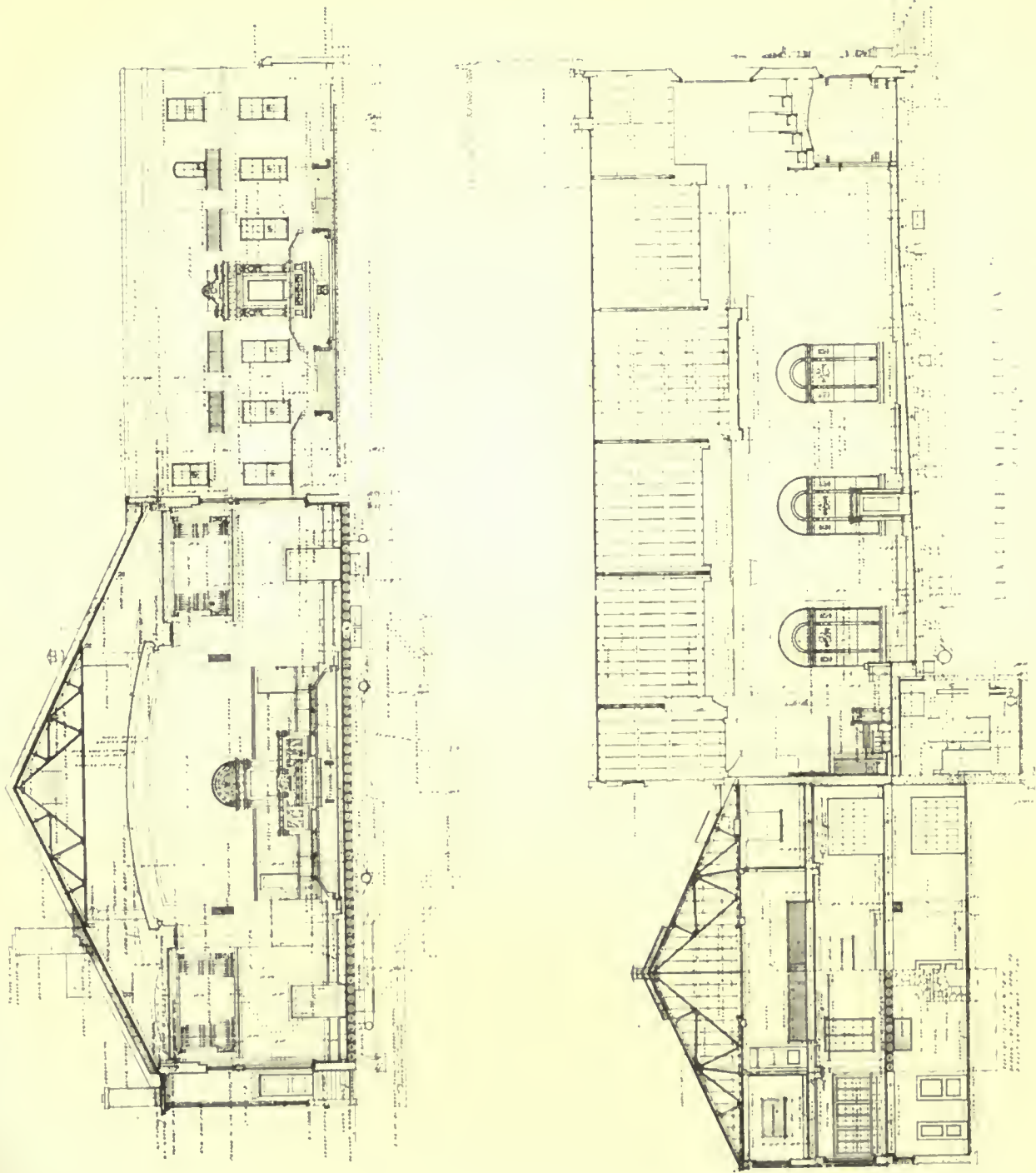

PLATE 150

FIRST PRESBYTERIAN CHURCH, SANTA BARBARA, CAL.

ROLAND E. SAUTER, ARCHITECT









# DETAILS OF ENTRANCE AND CLOISTER

SCALE  $\frac{3}{4}'' = 1'-0''$

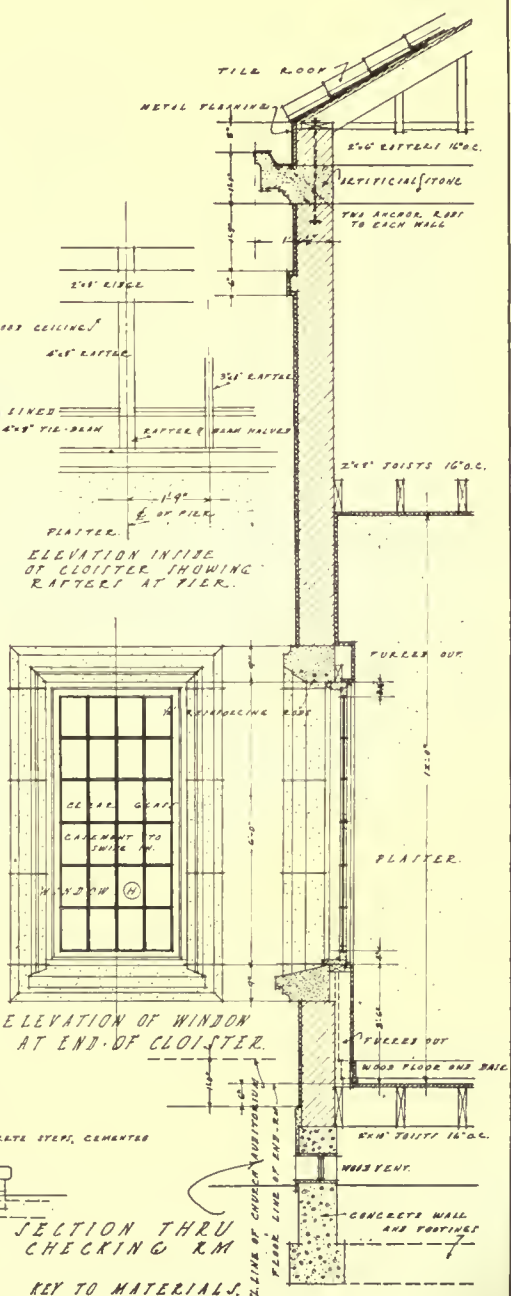
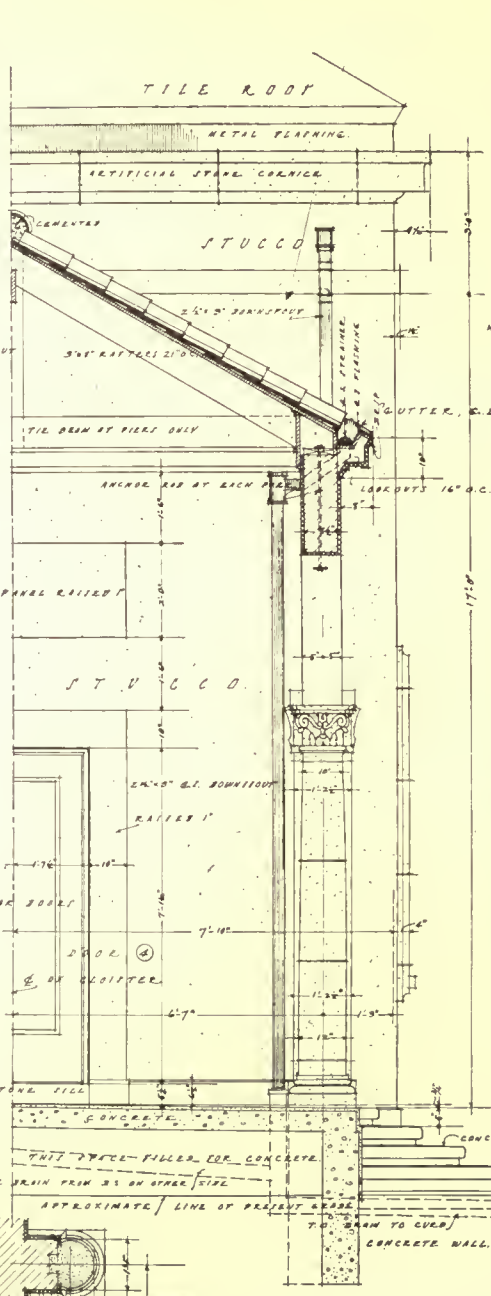
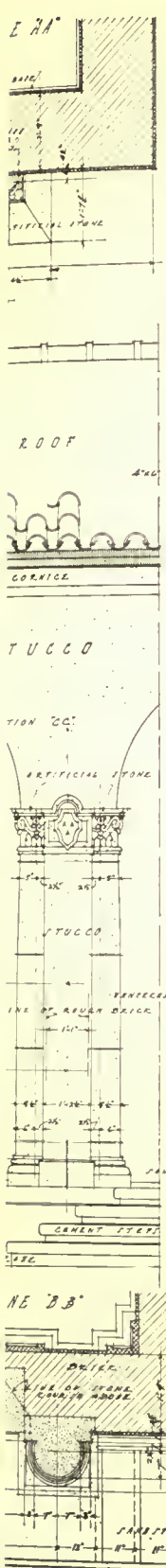

SECTION THRU CLOISTER ON LINE "CC"

SECTION THRU CHECKING R.M.

SCALE  $\frac{3}{4}'' = 1'-0''$

KEY TO MATERIALS.

	BRICK IN SECTION
	STUCCO OR PLASTER IN ELEVATION
	STUCCO OR PLASTER IN SECTION
	ARTIFICIAL STONE IN ELEVATION
	ARTIFICIAL STONE IN SECTION
	SANDSTONE IN SECTION
	CONCRETE IN SECTION
	WOOD IN SECTION
	METAL IN ELEVATION
	METAL IN SECTION
	TILE IN SECTION











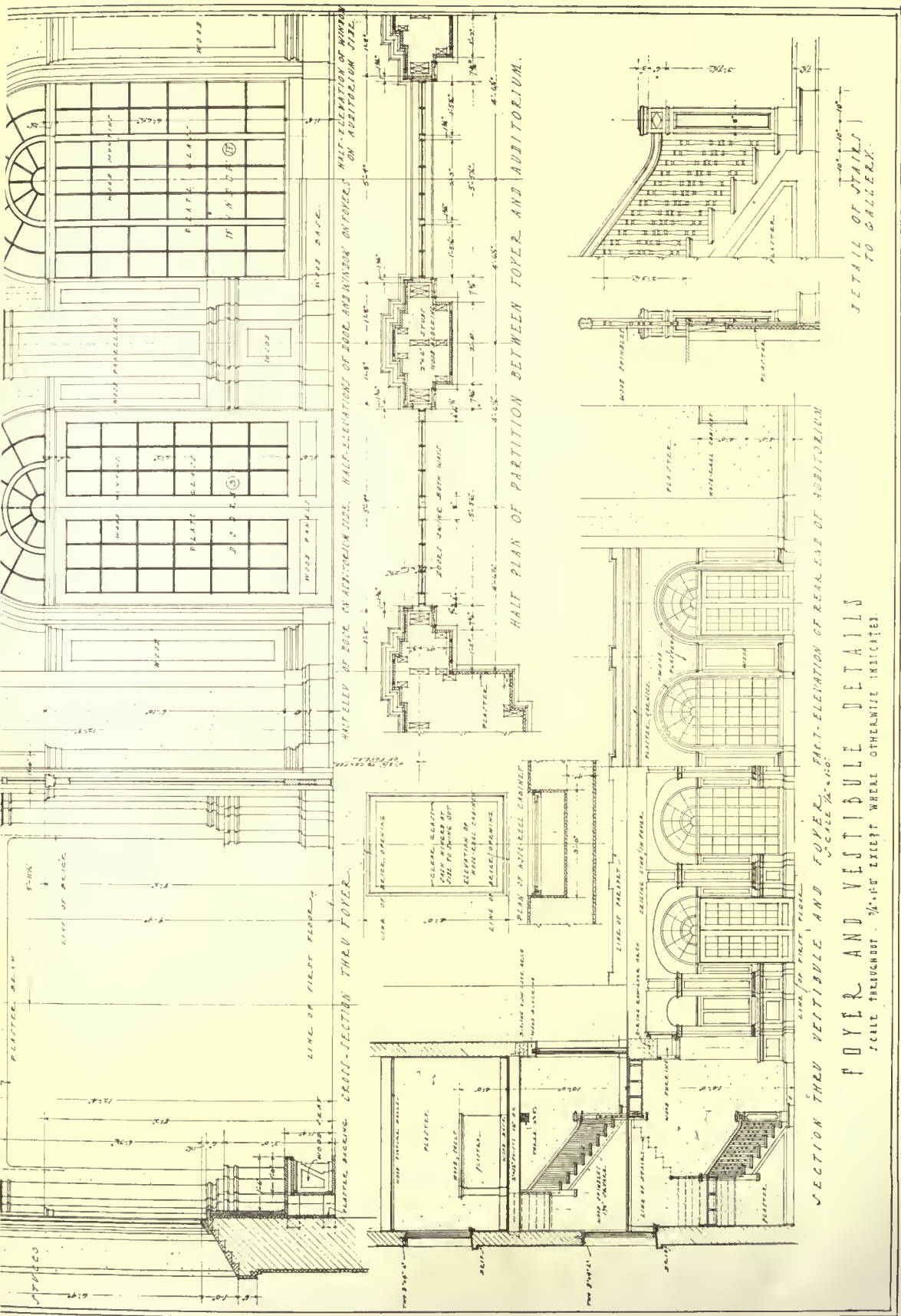

FIRST PRESBYTERIAN CHURCH, SANTA BARBARA, CAL.  
 ROLAND F. SAUTER, ARCHITECT



THE FOYER



PLATE 153

MAIN STAIR HALL, SUNDAY SCHOOL DEPARTMENT

FIRST PRESBYTERIAN CHURCH, SANTA BARBARA, CAL.

ROLAND F. SAUTER, ARCHITECT







SUNDAY SCHOOL ASSEMBLY ROOM



PLATE 154

A CORNER IN THE SOCIAL HALL IN THE BASEMENT

FIRST PRESBYTERIAN CHURCH, SANTA BARBARA, CAL.

ROLAND F. SAUTER, ARCHITECT







THE PULPIT, CHOIR AND ORGAN LOFT



PLATE 155

CHURCH AUDITORIUM LOOKING TOWARD FOYER FROM PULPIT  
FIRST PRESBYTERIAN CHURCH, SANTA BARBARA, CAL.  
ROLAND F. SAUTER, ARCHITECT





## Convention Reports

*(Continued from Page 641)*

solution until we cease to isolate it for purposes of study. It is by far the most important and the most neglected of all our tasks and it differs, not radically, but to an alarming degree, from the social and financial aspect of the factory and the harbor. For after all most of the loss chargeable to a badly planned instrument of commerce can be expressed in terms of money, but by what system of accounting can the moral, material and social loss caused by the slums of a great city be impressed upon our consciousness?

In our country the buying or renting of decent, wholesome dwellings is now and has been for many years beyond the financial power of millions of wage earners. What does this mean to our nation?

Do we realize the intolerable conditions resulting from

the economic system under which these workers with their wives and children are condemned to exist?

This is the Housing Problem. There is none other.

The cry "Own your own Home" is but hollow mockery to these people.

It is our duty as architects to point out not only the possibilities, but also the limitations of The Plan. Worthwhile results are not to be expected unless the community plan is an embodiment of human aspirations based upon a truly democratic conception of legality.

The subject is too momentous to be lightly discussed, as it evolves questions which affect every interest in our national life.

The committee believes that until these basic questions are solved in either one way or in several ways, Community Planning cannot function either rightfully or usefully. It begs to be continued until such time in the future as it can again report to the Board with recommendations as to a program for the Institute to adopt.



STONE BRIDGE AND POND IN A JAPANESE GARDEN



# Current News

---

## Big Office Building Started in New York

Further impetus was given the speeding up of construction activity on a big scale in New York City last week when work on what will be the first large office building to be erected since the signing of the armistice was started by the breaking of ground on West Forty-third Street, for the construction of a twenty-story structure of the arcade type. The building will run from Forty-third to Forty-fourth Street, with a frontage of 141 feet 10 inches on Forty-third Street and 50 feet on Forty-fourth Street, and will be known as the National Association Building. It will be one of the first office buildings to be built in accordance with the new zoning regulations. Starrett & Van Vleck are the architects for the owner, James T. Lee.

The building will cost approximately \$2,500,000, the financing of which was accomplished through a first mortgage serial 6 per cent bond issue for this amount, underwritten by S. W. Straus & Company. The mortgage is amortized, and the bonds will be offered in denominations of \$1,000, \$500 and \$100.

The building has been designed especially with the view for the occupancy of national trade associations and marks a new development in the uptown movement of tenants who have hitherto been located only in lower sections of the city. An arcade running through from street to street, will afford a mid-block passageway, somewhat similar in character to that in the Berkeley Building across the street, designed by the same architects.

It offers an interesting solution of the problems confronting the architects in connection with the zoning law, wherein the building, twenty stories in height will have setbacks at the thirteenth and eighteenth stories. The setbacks on both sides of the street frontages give access to roof terraces and also give advantages of light and outlook to the upper stories. Of the Italian Renaissance type of architecture, it will be faced with limestone and Harvard brick, and is expected to show decided improvements over the similar pre-war type of buildings.

---

## To Build New Home for Political League

A new home for the League for Political Education, the Economic Club, and the Civic Forum, to be built at 113-123 West Forty-third Street, New York, will take the form of a million-dollar town hall. Work will be commenced this month on plans prepared by McKim, Mead & White. The architects have designed a structure to cost about \$500,000, while the property was purchased for \$425,000 by a New York corporation headed by Frank A. Vanderlip, making the total investment about \$1,000,000. The property has a frontage of 125 feet, just east of Broadway, and a depth of 100 feet.

The principal feature of the building will be the auditorium, which will occupy the first four floors and have a seating capacity of about 1,800. On the fifth floor will be the offices of the League for Political Education, the Eco-

nomie Club and the Civic Forum, a library and reading room. The building of a new clubhouse was necessitated by the big increase in the club membership, the organization at present having over 4,000 members. It will be sort of an uptown Cooper Union and will be a meeting place for the discussion of subjects related to common welfare.

---

## Progressive Work for Art

The Art Alliance of Philadelphia has an ambitious program for the advancement of art interests in this country. It is proposed to raise the sum of \$1,000,000 for a new building already designed by Ralph Adams Cram.

The purpose is twofold: partly to provide an art center and market place for works of art that will meet the needs of the community, and partly to co-operate with other cities to help artists who in the recent crisis have turned to America as the art center of the world.

The building will be Elizabethan Gothic, occupying an area of 228 by 67 feet. In front will be a low two-story building, Old English in style, which will be the clubhouse and will contain offices, meeting rooms, library and restaurant. This low structure will extend back on both sides of a courtyard to the six-story brick building in which will be a theater, rehearsal halls, art galleries, a ballroom and studios.

Departments have already been organized in nine arts. In the fine arts department, two types of exhibits are held: those by artists already famed in their fields, and those by artists who do creditable work, but have their reputations still to make. The same idea is worked out in the music department. Any member, if passed by the department jury, is given the use of the hall, upon request, for a recital.

Several other novel features will be included in the conduct of the new building. A rathskeller will be provided, where students of all the arts may meet with the view of bringing into each art the stimulus from the others, and the benefits thus to be derived for the individuals and the larger groups.

Work of this character cannot be too strongly commended. It will provide exactly the outlet for energy and enthusiasm that is so pitifully lacking in large art centers at present.

---

## Portable Homes for Belgium

Portable homes for Belgium are being made of wood in Aarhus, Denmark, reports the Commercial Attaché in Copenhagen. It is stated that orders have been placed with concerns there aggregating thirteen million dollars.

A new course in carpentry and furniture-making is being introduced in Copenhagen Technological Institute. Students are being solicited to take such course in practical mechanics to render the country less dependent upon importations. American manufacturers of woodworking machinery would be making a good investment, says the Commercial Attaché, by sending to this institute some characteristic machines.

## Southern California Chapter Meets

The one hundred and twenty-fifth regular meeting of the Southern California Chapter, A. I. A., was held on April 8th.

The meeting was called to order by the president, Mr. H. M. Patterson, eleven members being present.

Under the reports of Standing Committees the following were given:

For City Planning, Mr. Withey stated that the Mayor's Civic Center Committee was holding weekly meetings, receiving from various citizens recommendations as to site and treatment of a Civic Center.

For the Committee on Public Legislation, Mr. Backus reported that they had taken up with Mr. Farwell suggestions for changes in the State laws as requested at the last meeting, and after thoroughly studying each measure, had taken the action that seemed advisable.

Under the head of "New Business," the Secretary read a telegram from the Secretary of the Washington State Chapter in which he protested against the action of the Institute in making an assessment against each Chapter this year for the delegates' expenses. It was shown that said action of the Institute was contrary to the best interests of the Western Societies, and resolved that the Secretary send a telegram to Mr. E. C. Kemper to that effect.

The subject of the evening was a discussion of architectural practice as it is being considered by the Post-War Committee of the Institute. Mr. Patterson spoke at length, recommending that the members in their practice assume greater responsibility in handling work, giving a more complete service to their clients and taking a wider interest in public affairs.

## Where Civic Pride is Born

With a view of encouraging the erection of homes by workingmen, architects of Pittsburgh are planning to give to prospective builders of modest means the benefit of their talent and training for a nominal fee, says the *Detroit News*. At a regional conference in the same Pennsylvania city by the Association of Ohio Architects similar action was taken, and there is a belief that it will become general, to the inestimable benefit of American cities.

Civic pride—sometimes a difficult thing to implant and to foster—takes root readily where conditions are propitious, and they are not where surroundings are squalid, or unattractive, unwholesome or otherwise depressing. The tendency heretofore has been for enterprising concerns either employing companies or private individuals, to open parcels of land and construct houses on a wholesale plan. Commendable as that is it has its defects, and in a measure they are serious, in the development of the very thing that is desired. Regularity of design imparts monotony, and even the hit and miss where alternate houses are alike is no relief. Individuality is not given any chance and members of the family have none of that close association with "home" that is created by having had a part in its construction.

With individual architects practically giving their services to prospective builders a new interest is created, and civic pride is born. The house that is to be erected is planned, in a measure, the way the husband and the wife would like to have it; their ideas govern in the size and location of the rooms and the exterior is the result of the good taste of the architect meeting the wishes

of his clients, with particular reference to the lay of the land, the character of the adjoining dwellings, and the amount of money that is to be expended. Into the house and grounds have gone something of the personality of the prospective occupants, and as soon as they move in the dwelling becomes a hotbed of civic pride.

## New York World's Steel Center ?

In one of the most important realty transactions of its kind on record, the United States Steel Corporation has closed contracts for the purchase of the twenty-one story Empire Building at Broadway and Rector Street, New York, for the sum of five million dollars. The structure faces Wall Street and Trinity Churchyard and has a frontage of 78 feet on Broadway, 220 feet on Rector Street and 50 feet on Church Street. When erected in 1897, the Empire Building was the tallest in the world.

According to Clarence H. Kelsey, representing the present owners, the O. B. Potter Trust Co., the purchase indicates that New York City is henceforth to be the steel center of the world. Just north of this property, adjoining Trinity Churchyard, is the twenty-one story Trinity Building in which large space is occupied by the Bethlehem Steel Corporation and its subsidiaries. A report is in circulation that the Bethlehem Corporation is negotiating for the purchase of this property, but the information is not official.

## Statuary Costing \$125 Worth \$25,000

A writer in the *Chicago Tribune* tells the following interesting story about one item on view at the annual architectural exhibition at the Art Institute in that city:

"Augustin Pajou was court sculptor in France when Comtesse DuBarry ruled Louis XV, and he made a new bust of her every time she discovered a new way of dressing her hair.

"But these sculptures were lost in the French revolution as Mme. DuBarry herself was lost. Only five of the marbles were known to have been recovered up to a few days ago. One of these is in the Louvre in Paris.

"A sixth sculpture of the vivacious French woman, identified as the work of Pajou, has just turned up in Chicago. Bought in a loop art store for \$125 by a young connoisseur and carted home in a ragman's push cart, it proves to be worth \$25,000.

"The fortunate purchaser is Burgess Stafford of a Chicago furniture company. He is exhibiting the sculpture at the Art Institute in the annual architecture exhibition.

"One large offer has already been made for it and a prominent New York dealer has appraised its value at \$25,000."

## Forest Laboratory Door Tests

Tests to improve door manufacture are being made by the Forest Products Laboratory at Madison, Wis. Various makes of doors are to be tested for strength and for the effect of humidity in warping the wood. If these tests are successful, and if the results are fully followed by manufacturers, it is claimed, there will be an end of doors that sag in the middle, doors that swell and refuse to be closed, doors that creak and shriek and groan whenever they are opened or shut.



# THE AMERICAN ARCHITECT

## Art Commissions

Appended to the annual report of the Art Commission of the City of Pittsburgh, for 1918, is a list of the similar bodies now organized in the United States.

The measure of co-operation which architects may receive from these bodies is of the utmost value. As an incentive to civic pride, and to the creation of a better character of art in our cities, this should not be overlooked. It is the part of wisdom for every one to profit as far as possible from the good work and researches that are already available and still going forward. In the matter of memorials as well as the innumerable other points of municipal pride, these groups of men are peculiarly fitted to assist, and will, it is assured, do everything possible to encourage and produce higher standards in these things. The list, complete to date, follows:

Art Jury .....	Philadelphia, Pa.
Art Commission .....	New York
Art Commission .....	Chicago
Art Commission .....	Pittsburgh, Pa.
Art Commission .....	Boston, Mass.
Art Commission .....	Denver, Colorado
Civic Art Commission .....	Berkeley, California
Art Commission .....	St. Louis, Mo.
Municipal Art Commission .....	Los Angeles, Cal.
Art Commission .....	Baltimore, Md.
Art Commission .....	Milwaukee, Wis.
Municipal Art Commission .....	Montclair, N. J.
Civic Art Commission .....	Oakland, Cal.
Art Commission .....	Salt Lake City, Utah
Fine Arts Commission .....	Washington, D. C.
Art Commission .....	Charleston, S. C.

## April Building Starts Well

Evidence of the increasing activity in the construction field is disclosed in the complete figures on contracts let as reported from the cities east of the Mississippi and north of the Ohio River, for the first week in April. The statistics as compiled by the Division of Public Works and Construction Development of the Department of Labor for the week ended April 4 cover 2713 contracts with a valuation of \$60,864,085. If this weekly record is equaled for the other three weeks of April, all building records will be shattered.

It is a noteworthy fact that the contracts let in the industrial group exceeded the residential class. In the division of contracts let during the week of April 4, the 328 industrial projects were valued at \$13,790,162 while the residential contracts for the same period reached \$9,203,111 involving 1644 awards. The Federal, State and Municipal contracts were limited to 34 but the valuation amounted to \$10,206,192. The other projects were: schools, churches, theaters, 71 contracts valued at \$6,518,693; public work, 143 contracts with \$8,020,275 valuation; stores, offices, banks, 227 contracts valued at \$7,483,477; clubs, hotels, institutions, 37 contracts having a valuation of \$1,969,430; one contract for a railroad station was valued at \$1,500,000, 32 contracts for bridges and culverts amounted to \$433,005 while the miscellaneous contracts awarded were valued at \$346,000.

Comparative figures for March showing the tremendous advance in building: week ending March 7, \$27,751,076; March 14, \$29,851,407; March 21, \$39,017,308 and March 28, \$43,590,325.

During March, building registered a gain of 80 per cent more than the actual average for the corresponding period for the preceding eight years. The increase is more than 30 per cent, estimating projects represented at the present cost of building. The amount for March, 1919, in contracts let was \$151,894,292 by adding to the actual total, one-twelfth of the total for 24 working days for which actual amounts are now available. This addition is made by the Department of Labor because two business days, Saturday, March 29, and Monday, March 31, were not counted. The average for the eight years is \$85,625,000. The average for the last six years is \$117,000,000.

## Ferryhouse Built to Stay

One of the oldest and, at the same time, one of the most substantial timber buildings in and around Greater New York is the Fulton Street Ferry in Brooklyn, which, though swept from roof to flooring by fire recently, still bids fair to defy time, fire and tide for generations to come in the service of the thousands who go each day between the two boroughs.

Brooklyn's Fulton Street ferryhouse was built in another day and age, says the New York *Evening Sun*, when builders put the best of themselves into their buildings for the pride of it, and constructed things, with less advantageous tools and materials, more durable and more painstakingly finished than is the case to-day. For example, the ferryhouse at Fulton Street is put together of heavy, hand hewn timbers, that, barring accidents, well may last for generations to come.

The fire in the ferryhouse the other day would have burned away to its last vestige some more showy but more fragile modern structure. Attacking this good old job of yesterday, the product of workingmen and contractors as intent upon the quality of their product as upon the margin of their profits, it spent its force in vain.

New York has nearly two score ferries now, and the pioneer line between the toe of Manhattan and Fulton Street, Brooklyn, is no longer the outstanding feature of the greater city's transportation system. The ferryhouse in Brooklyn, however, is one of the oldest and most solid landmarks of the city, a monument to the past which many thousands of old New Yorkers would be sorry to lose.

## Cincinnati Leads in Fire Prevention

"Cincinnati leads every other American city in the matter of fire prevention methods," is the statement made by Robert E. Andrews, of the National Board of Fire Underwriters, after a three weeks' survey of Cincinnati's fire prevention facilities, including water supply, buildings and the electrical lighting systems.

Mr. Andrews stated that there were 600 fires less in 1918 than in the preceding year and attributed this to the fact that Cincinnati has "become educated along fire prevention lines."

"Of course there is room for improvement even in this city," he said. "But we are well pleased with conditions here. The educational work in the schools goes a long way toward the prevention of fires. The lessons children receive concerning ways to prevent fires are lasting. A large majority of fires are caused through carelessness. The children are taught that rubbish heaps, loose paper and rags are the things that cause fires, and they take pride in pointing out these facts to others."

## Financing of Building Projects Assured Detroit

Investigation made by the Building and Traders Exchange shows that Detroit's banks are ready and willing to make construction loans and the volume of work which is coming out indicates that the building industry is getting into its natural stride. With plenty of material and labor available and financing arrangements possible, many prospective builders are taking advantage of favorable weather conditions to get work started. In this way they will gain time and reap the benefit, while delay now will mean delay in construction when the industry reaches high speed.

"We not only have assurance from the banks that they will take care of loans," said William W. Norton, secretary of the Builders and Traders Exchange, "but we have been offered a large amount of money from other sources which can be obtained for construction purposes.

"For industrial projects loans as high as \$200,000 may be obtained and smaller amounts are available for other work, such as apartments, etc. The Department of Labor of the United States is calling special attention to the fact that banks throughout the country are seeking construction loans and the number of mortgages recorded shows that prospective builders are taking advantage of this easing of the money market."

---

## Seattle to Experiment in Color

A MODEL BLOCK TO BE DONE FOR PUBLIC CRITICISM

A model block is planned in Seattle. Every house and every backyard is to be trimmed and painted to secure complete harmony in color and detail. The Painters' Association has agreed to furnish the paint at cost, to let a contract for painting every house in the block at actual cost and to handle the painting end of the program without profit as their contribution to the civic good.

The Civic Bureau of the Chamber of Commerce has agreed to select the location of the block and the color plan will be worked out by a joint committee.

Just an average city block with the usual number of styles of dwellings is to be chosen. Then a color plan will be decided upon the paint applied, and the city asked to "take a look."

The object lesson, as it is intended, should prove an incentive to stimulate neighborhood pride and co-operation in making home districts more attractive.

---

## Construction Industry to Convene

That a more thorough understanding of the new economic conditions with which the United States is now confronted may be had by the building industry as a whole a conference of manufacturers, architects, financial interests, distributors, consumers, and labor is expected to be held shortly under the direction of the National Federation of Construction Industries. It is the belief of this organization that what building needs today is not paternal supervision but a realization of the sense of co-operative endeavor.

The directors of the Federation feel that since the construction industry annually produces over three billion dollars of additional permanent wealth, is the largest

consumer of all materials, and affects the largest number of interests, the democratization of the industry should properly be the first undertaken because of the immediate and far-reaching beneficial effects.

E. T. Trigg, president of the Federation, believes that the present condition in the industry is one of psychology rather than one of materials. He says:

"Labor is available, money is at hand, material is abundant and the need for construction is pressing. All of the elements for active business are present, but construction does not resume at the rate it should. Many of the people of the United States still seem to feel that we shall revert to pre-war prices, and they are apparently postponing construction until the reductions in prices are realized. An examination of the history of prices shows clearly that after none of the wars of modern times, in any part of the world, have prices reverted to the pre-war status.

"The increase in prices in the United States during the recent war has been much less than in other countries, except Australia and New Zealand. Not only in Germany and Austria, but in neutral Europe and among our Allies have prices advanced, in many cases, far beyond those now prevailing in this country. The reason for our present increase in prices is apparent, if we will review our economic rôle. We have greatly increased our gold reserve. But we have not increased the service or the supply of goods to be exchanged therefor. As a result, more money is required in the purchase both of labor and commodities. On the other hand, prices have increased in Europe because of the great destruction of property and life which has been attendant upon the war. This world-wide after-effect upon prices is apparently the result of established economic law. The condition was true in Europe in the 16th Century and it has been true ever since. With a greatly increased gold reserve, having over seven hundred millions of dollars of free gold in this country in addition to that needed to meet the legal requirements of our present banking system, and with commodities not equal to normal demands, prices are not only higher than they were before the war, but they give promise of having reached a new permanent level."

---

## Railroad Administration Aids Homeseekers

The United States Railroad Administration recently has undertaken to furnish information to homeseekers. J. L. Edwards, manager of the agricultural section, homeseekers' bureau, at the railroad administration headquarters in Washington, is in charge of the service. Post cards addressed to Mr. Edwards, printed in blank form, may be obtained, and marked as to whether it is desired to buy or rent a farm, to obtain farm employment, as well as the kind of farming wanted, and the size and locality preferred.

---

## Electrical Workers' Latest Demands

According to the Rochester *Post-Express* the latest demands of electrical workers in that section of New York State include a six-hour day, double pay for overtime, extra time while working in cold or inclement weather, and one helper to every five electricians. If this schedule were adopted it would mean that a maximum day's pay for the electrician would reach \$20.



# Late News from Architectural Fields

Special Correspondence to THE AMERICAN ARCHITECT

## Material Prices Kept Up After 1865

WASHINGTON, D. C., May 5.—The U. S. Department of Labor, through the Information and Education Service, is issuing the results of a study of prices during the war and readjustment period made by the Division of Public Works and Construction Development. Discussing the Civil War period as a precedent for war prices, the report says:

"A comparison of the course of prices during the Civil War and the present war shows many points of similarity during the two war periods. The course of prices during the present period of readjustment and the corresponding period following the Civil War shows more points of difference than similarity.

"During both wars the wholesale prices of commodities in general rose steadily through the war period. The rise during the Civil War period, taking the year 1860 as the base, runs up to somewhat higher level than the rise during the present war. In both wars, building materials rose in price, but they did not at either time reach levels as high as the price levels of other commodities.

"At the beginning of the year 1865, the end of the Civil War being in sight, wholesale prices broke suddenly and violently. During the first six months of the year, prices in general fell off 27 per cent from the high level of January. However, the break in wholesale prices, though unprecedented in violence and accompanied by the unsettling influence of the end of the great war, produced no business crisis or depression. Though the latter half of 1865 prices recovered from the low point until in January, 1866, they stood just 16 per cent below the level of January, 1865. From the beginning of 1866 prices dropped slowly downward. They did not reach the pre-war level until the year 1878. As is well known, during that period of inflated currency, gold was at a premium. However, commodity prices remained above the prices of gold up to and including the year 1877.

"Building materials declined in price along with other commodities during the first half of the year 1865. However, the fall was less than in the case of other commodities. Whereas commodities in general dropped 27 per cent, building materials dropped only 14½ per cent. The recovery during the second half of the year was more marked, prices of building materials returning to the level of the last quarter of the year 1864, and remaining at that level for period of a year before the decline set in. The index figure for the building materials group remained higher than that for all commodities up to and including the year 1874.

"The currency was on a distinctly unsound basis in the Civil War reconstruction period. The sharp fluctuations in prices gave rise to much speculation and the opportunities for development of the resources of the country, such as unused land, rivers and harbors, building of railroads, led to over-expansion of business resulting in the Financial Panic of 1873. This panic was not accompanied by any sharp decline in prices.

"As was stated above, it was thirteen years after the Civil War before prices returned to the pre-war level. The principal cause of the return to the pre-war level was the fact that there was such abundant opportunity

for the development of new and more economic methods of production in the shape of new forms of machinery and new kinds of business organizations. These opportunities we do not have at the present day in any measure comparable with the previous period."

## Predicts Big Building Increase

WASHINGTON, D. C., May 5.—A country-wide survey of the business situation by the United States Chamber of Commerce presents a hopeful view for the building industry and anticipates renewed construction activity.

"Building and construction are the best barometers of the nature and extent of general business because in their operations they call upon the production of every line of industry for the completion of their activities," the report states. "It is peculiarly significant, therefore, at present that the general volume of business should be so large when building and construction are at so low an ebb. Such activity as exists is sporadic, scattered and altogether local. Speculative building practically does not exist and public buildings so far are few.

"There is some construction of homes and farm buildings in small towns and on farms but it is neither general nor exclusive. The reason for this quietude seems to be the high prices of labor and materials. Materials have declined somewhat but apparently not enough to incite general activity. Apparently we are up against a deadlock, but fortunately its solution does not depend so much upon logic as upon human nature. In the past it was axiomatic that building booms do not start from high levels of prices, also that they are the product and result of long period of prosperity, because they depend upon an accumulation of funds which seeks investment in real estate. Some of this is speculative but much, that of building homes, rather is indulgence of a sentiment than an investment."

The Chamber of Commerce predicts an increase during the next four months, of from fifteen to twenty per cent in volume of building as compared with the same period last year. An advance, rather than a decrease, in lumber prices is expected with the demand continually improving. No further reduction in the price of brick, cement, stone and other building commodities, the report points out, can be hoped for. There is no general expectation of a reduction in the price of paint.

## Will Start Improvements Immediately

WASHINGTON, D. C., May 5.—The National Commission of Fine Arts has given its approval to several projected improvements in the District of Columbia. Many plans for the artistic development of Washington, which were held up pending action by the commission, will be started immediately as a result of the decision just announced.

The commission approved the plans presented by the

## THE AMERICAN ARCHITECT

Secretary of Agriculture for the development of experimental farms. The buildings and grounds will cover many acres and will be located near Arlington Cemetery, overlooking the capital. The architectural adviser to the aviation section of the War Department conferred with the commission regarding the construction of buildings for a permanent aviation field at Anacostia along the Potomac. The Navy Department also plans the development of an aviation field in this section. The representatives of the two organizations told the commission that it was the endeavor of both departments to have the design of the buildings and the layout of the grounds harmonious with the general architectural scheme of the city.

Designs for two new bridges to span the Anacostia River were submitted by Col. Max C. Tyler, in charge of government engineering projects. The plans of the Pennsylvania Railroad Company for the new bridge across the

Anacostia were considered by the commission. The commission selected a site at the entrance to the National Zoological Gardens for the memorial to Francis Asbury, first Methodist bishop in the United States.

The commission announced that it had considered the copings and other details relating to the architecture of the proposed reflecting basin near the new Lincoln Memorial; the working model for the monument to the "Nuns of the Battlefield," the re-design of a road system at the approaches to the Lincoln Memorial; a revised planting plan for the Arlington Amphitheater, designs for a working detail relating to Meriden Hill Park; a report of a full-size clay model for an equestrian statue of Gen. Grant; the layout and design of roads to be constructed between the National Museum and the Freer Art Gallery and the Mall and a commercial water front along the Anacostia.

### Late Quotations in Building Material Markets

ALTHOUGH throughout the steel trade the belief is general that eventually there will be an "open" market, this week's activity has revealed no indication as to when this will come, and consequently little progress was made toward a readjustment that would bring about a demand. There is a general impression that nothing will be done until the Industrial Board makes formal announcement of its relinquishment of the price stabilization plan. The deadlock still exists and the industry is slowing down daily.

A decrease in steel mill operations continues, mills operating at about sixty per cent on the average. It is understood that the United States Steel Corporation is operating at an average of at least 70 per cent of capacity, while the large independents are in most cases operating at between 45 and 50 per cent. Past experience shows that if there should be a break in the market, orders would probably not go to the mills in a rapid rate and the market would require a period of two or three months for readjustment. E. H. Gary of the Steel Corporation feels that the effort of the Industrial Board to stimulate steel buying at an established price has gone for nothing. Steel men don't want to and cannot afford to lower prices and buyers hesitate because they don't want to pay what the producers ask them.

Whether there is any further attempt at Federal price stabilization on other building materials or not, there is increased confidence that quotations on most items have voluntarily found an acceptable level. However, it is generally conceded that the season is already too far advanced to give any decided relief to the housing situation by next Fall or even from a still more desperate renting crisis next Spring.

Builders in the metropolitan district of New York feel that a solution of the rent problem lies in the passage of amendments to the building code controlling the use of brick, yellow pine and extending the use of cinder concrete. It is suggested that the code be revised to allow the use of "light hard" brick for filling in walls where the strains are not applied; it would aid greatly in reducing construction costs.

The market for fir lumber has gained further strength in the last few weeks through the volume of new business taken by the mills. Stocks are low and production, on account of suspended operations at some important plants, was far below normal during the late Winter and early Spring. The amount of new business coming to the mills

now is substantially in excess of the volume of lumber cut. Thereby stocks are being still further reduced. The mills are greatly encouraged over the Government demand for ties and over the prospects of further Government business.

Despite the present strength of the market, the fir and spruce manufacturers still find themselves selling lumber for less money than it costs them to produce it. Comprehensive data recently compiled by the West Coast Lumbermen's Association show that the cost of production for the month of February averaged \$24.04 per 1000 feet, while the average selling price was \$21.96—a net loss to the mills of \$2.08 per 1000.

Appleton P. Clark, Jr., representing the Washington Chapter, American Institute of Architects, on the central stabilization committee of the District of Columbia, takes an encouraging view of the building situation. The rapidity with which the stabilization plans have been perfected. Mr. Clark believes, shows the willingness of the building industry to co-operate in the stimulation of construction.

Mr. Clark attended the meeting of the committee last week, when reports received from labor representatives indicated that the majority of building trades unions would agree to work at the wage scale which became effective November, 1918. The carpenters, who are not affiliated with the Building Trades' Union, are demanding an increase of from 75 cents to 78½ cents per hour. Elevator constructors were also reported to be asking an increase, though it is expected that the wage question can soon be adjusted in their case.

The master builders have reached an agreement whereby they will figure the same percentage of profit on work as prevailed before the war, disregarding increased overhead expenses after May 1. The builders urged labor unions to voluntarily recede to November, 1918, wage scale. The builders' supply representatives reported a general agreement to guarantee prices until the specific contract is completed. They will maintain the present schedule on contracts from August 1, 1919, until January 1, 1920, excepting revision due to freight rates.

A report of the Department of Labor tracing the trend of building material prices during the war and the readjustment period, being the digest of an address by T. S. Holden before the New York Chapter of the American Institute of Architects held recently in New York, follows:

There was this difference in the conditions that deter-



# THE AMERICAN ARCHITECT

mined prices on steel and on basic building materials. In the case of materials regarded as not essential, such as most of the building materials other than steel, whether the price was fixed by the Government or in the open market, this price was not sufficiently high to keep all producers in the market, simply because the maximum production was not required by the wartime needs of the country. In fact construction itself, as well as production of various building materials, was specifically curtailed by Governmental order.

Figures of the U. S. Geological Survey show that actual production of common lime in 1918 was 20 per cent less than in 1917. Portland cement produced in 1918 was 23 per cent under the 1917 figure. Lumber was reduced 19 per cent in output. Common brick in 1917 was 21 per cent under 1916. It has been estimated that in 1918 the production of common brick was less than half the 1917 figure.

As a consequence, the markets are understocked rather than overstocked in these commodities. If any one of these commodities had been considered as essential as steel, the Government would have been obliged to fix the prices on them at figures high enough to encourage every producer in the country to run his plant at maximum capacity with a guarantee of a reasonable profit on his output. In that case the prices on these commodities would have reached much higher levels than they actually did.

Lumber as a group during the last quarter of 1918 was 73 per cent higher in price than in the pre-war period, July 1, 1913, to June 30, 1914. The building materials group, including lumber but not including metal products, was 84 per cent above the pre-war figure. This seems large, but as compared with 113 per cent increase on commodities other than building materials, the increase seems justifiable. The farm products group showed an increase of 116 per cent at the same time.

It is interesting to compare the farm products group with the lumber group. The indices show that at the beginning of the year a farmer could exchange a certain amount of his produce for 25 per cent more lumber than the same amount of produce would have brought him in the year preceding the war.

Roughly speaking, by the end of 1918 the pre-war dollar, as expressed in terms of farm products, had shrunk to 46 cents; as expressed in terms of lumber, it had fallen to 58 cents; in terms of building materials (not including steel), it fell to 54 cents; and in terms of all commodities other than building materials, it fell to 47 cents.

A composite index for all building materials, including steel as well as lumber and the rest, would show an increase of 93 per cent over the pre-war period for the pre-war period for the last quarter of 1918. At the present time the index would be 189.

Building material prices increased somewhat more in the East than in the Middle West, and in the West. Since the opening of the year, lumber has increased somewhat in price. Common brick has also increased in the New York market. On the whole, the group of basic materials, not including lumber or steel, has remained practically stationary, declines in some items being offset by advances in others. From all indications the prices of building materials on the whole do not seem to be subject to any declines of consequence in the future.

(From our Special Correspondent)

CHICAGO, ILL., May 5.—Bungalow and factory building activities are giving impetus to the material markets in this city, the manufacturers, wholesalers and dealers all realizing a better demand with the advance of the season for outdoor construction work. In the suburbs and outlying sections of the city contractors are breaking ground for small homes, and while plans for building construction exceed any in the last five years, the present demand for housing far exceeds the visible supply. Indications now are for further increased activities which will include apartment and other speculative building projects held up in anticipation of lower prices.

In the minds of many who are students of economic conditions there is a feeling that present price levels will be maintained to a great degree, or that there will be no sensational decline under present high production costs. Lumber is firming up considerable in price. Oak, in particular, is scarce in the hands of the manufacturers, and there have been advances of from \$3 to \$5 per thousand feet in the upper grades in the last ten days. Maple and birch also are firm in price with slight advances in the wholesale prices of the former. Mahogany, however, has declined in price since the signing of the armistice. This is due to the fact that boats are now bringing logs from the Liverpool markets. Mahogany is now selling at 26 cents per foot. It was as high as 35 cents during the war.

Herman Waldeck, vice-president of the Continental and Commercial National Bank, in a recent statement concerning business conditions says he is of the opinion too much stress has been laid on the United States Railroad Administration's opposition to the steel price schedule. He believes the strong stock markets are based on an anticipation of unprecedented business prosperity. Statistics compiled by the Chicago Masons' and Builders' Association show that not only labor, but building material is cheaper in this city than in many other sections of the country.

Labor conditions are fairly satisfactory, with few employers showing any inclination to bring about a readjustment in this present period of high living costs.

(Price quotations now current on building materials and supplies as quoted by dealers and jobbers for delivery in New York and Chicago, follow. The quotations set forth are placed before readers of THE AMERICAN ARCHITECT to afford an accurate review of market conditions, rather than for use as a basis for actual purchase. They will not only provide knowledge of the exact state of the market as to items quoted, but will also present a basis to judge conditions as affecting co-relating materials. Items marked (\*) indicate an advance over last week, while those marked (†) record a decline. Other prices did not fluctuate during the week.)

BRICK			EAVES TROUGH		
	New York	Chicago		New York	Chicago
Common (for Borough of Manhattan only), per thousand .....	\$15.00	\$12.00	Galvanized steel .....	60%*	70%
<b>CEMENT</b>			Galvanized charcoal iron .....	50%	60%
Per bbl. in 15 cent bags (Rebate 60c. per bbl. for bags) .....	\$3.25	\$2.80	Copper .....	40%	40%
<b>COPPER SHEETS</b>			<b>EAVES TROUGH MITERS</b>		
At the mill, hot rolled, 16 oz. base-price, per lb...22½c.		22½c.	Lap or slip point, list.....	10%	10%
(From jobber's warehouse add 2 to 3 cents.			<b>ELBOWS AND SHOES</b>		
Cold rolled add 1c. per lb. to hot rolled.)			Galvanized Steel:		
			Plain, round and corrugated—all sizes up to 6 in..	70%	70%



# THE AMERICAN ARCHITECT

<b>Square:</b>	New York	Chicago
Square .....	60%	60%
Copper: (See note on page 654)		
All sizes .....	20%	25%

## GALVANIZED SHEETS

Nos. 18 and 20 gauge, per lb.....	\$6.12	\$6.12
No. 26 .....	6.42	6.42
No. 27 .....	6.57	6.85

## GLASS

(Discounts from manufacturer's price lists)

Single strength, A quality, first three brackets.....	80%	77%
Single strength, B quality.....	79%	77%
Double strength, A quality.....	80%	79%
Double strength, B quality.....	82%	81%
Plate—up to 5 sq. ft.....	82%	81%
Plate—over 5 sq. ft.....	84%	81%
Plate—up to 10 sq. ft.....	84%	83%
Plate—over 10 sq. ft.....	84%	82%

## GRAVEL

1½ in. (Borough of Manhattan only), per cu. yd.....	\$2.75	\$2.35†
¾ in. (Borough of Manhattan only), per cu. yd.....	2.75	2.35†

## GYPSUM

Plaster Board:  
(Delivered in Boroughs of Manhattan or Bronx)

27 x 28 x 1.....	35c.	.....
27 x 48 x ½.....	30c.	.....
32 x 36 x ¼.....	21c.	25c.
32 x 36 x ⅜.....	21c.	26c.
32 x 36 x ½.....	23½c.	.....

Plaster Blocks:  
(Delivered in Boroughs of Manhattan or Bronx)

2 in. solid, per sq. ft.....	7½c.	.....
3 in. solid, 12 x 30, per sq. ft.....	10½c.	.....
3 in. hollow .....	10½c.	10c.
4 in. hollow .....	12½c.	11c.
6 in. hollow .....	17½c.	.....

## HOLLOW TILE

Interior, 2 x 8 x 12 split furring, per 1,000 sq. ft. and 15 cents thousand pieces.....	\$70.00	.....
Interior, 3 x 12 x 12 split furring, per 1,000 sq. ft.....	102.00	\$67.90
Interior, 4 x 12 x 12 split furring, per 1,000 sq. ft.....	114.75	72.50
Interior, 6 x 12 x 12 split furring, per 1,000 sq. ft.....	153.00	99.60
Interior, 8 x 12 x 12 floor and partition, per 1,000 sq. ft.....	135.80	.....
Interior, 10 x 12 x 12 floor and partition, per 1,000 sq. ft.....	167.50	.....
Interior, 12 x 12 x 12 floor and partition, per 1,000 sq. ft.....	194.60	.....

## LATH

Eastern spruce, per thousand.....	\$6.50	.....
No. 1 white pine, per thousand.....	6.50	.....
No. 1 hemlock, per thousand.....	6.00	.....
No. 1 yellow pine, per thousand.....	5.75	5.25

## LIME

Common, 300 lb. bbls., per bbl.....	\$3.50	\$2.00
Finishing, 300 lb. bbls., per bbl.....	3.70	.....
Hydrated, in paper bags, per ton.....	17.25	17.50
Common (Chicago), 200 lb. bbls., per bbl.....	1.00	.....
Common (Wisconsin), 200 lb. bbls., per bbl.....	1.10	.....

## LUMBER

(Retail prices per M, F.O.B.)

Yellow pine, 2 x 4.....	\$49.00	\$47.00
Yellow pine, 2 x 6.....	46.50	45.00
Yellow pine, 4 x 4.....	56.00	52.00
Yellow pine, 8 x 8.....	65.00	52.00
Yellow pine, 12 x 12.....	52.50	57.00
Yellow pine, No. 1 boards, 1 x 6.....	55.75	53.00
Yellow pine, No. 1 boards, 1 x 12.....	58.00	56.00
Yellow pine, B and better flooring (plain).....	70.00	57.00
Yellow pine, B and better flooring (quartered).....	70.00	70.00
Douglas fir, 6 x 6 to 12 x 12.....	62.50*	63.00
Douglas fir, 12 x 14 to 14 x 14.....	64.00	64.00
Norway pine, 2 x 4.....	60.00	50.00
Norway pine, 2 x 12.....	65.00	57.00
Hemlock, 2 x 4.....	47.50	46.00
Hemlock, 2 x 12.....	51.00	48.00
Oak flooring, 13/16 quartered white.....	132.50*	120.00
Oak flooring, 13/16 quartered red.....	125.00	113.00
Oak flooring, 13/16 plain white.....	82.50*	80.00
Oak flooring, 13/16 plain red.....	82.50*	80.00
Maple flooring, 13/16 clear.....	75.00	69.00
Maple flooring, 13/16 select.....	70.00	59.00
Maple flooring, 13/16 No. 1 factory.....	62.50	54.00
Mahogany, 1" F. A. S.....	300.00*	260.00
Quartered oak, 1" F. A. S.....	180.00*	125.00
Plain oak, 1" F. A. S.....	120.00*	80.00
Red gum, 1" F. A. S.....	87.00*	62.00
Sap gum, 1" F. A. S.....	56.00*	50.00
Chestnut, 1" F. A. S.....	87.50*	75.00
Poplar, 1" F. A. S.....	130.00*	92.00
Birch, 1" F. A. S.....	70.00	60.00
Spruce, random 2".....	52.00*	.....
Spruce, wide.....	62.50*	.....

## LEAD

American pig, per lb.....	5½ to 6	5½ to 6
Bar, per lb.....	7½ to 8	6 to 6½

## METAL LATH

Under 100 sq. yd., per sq. yd.....	40c.	40c.
------------------------------------	------	------

## PAINTS, OILS, ETC.

<b>Leads:</b>	New York	Chicago
American white, in oil, kegs; lots over 100 lbs.....	14c.	14c.
White, in oil, 25-lb. tin pails; add to keg price.....	¼c.	¼c.
Red, bbl, ½ bbl. and kegs; lots over 100 lbs.....	14½c.	14½c.
<b>Dry Colors:</b>		
Red Venetian, American, per 100 lbs.....	\$2.75 to \$5.00	\$2.00 to \$5.00
<b>Metallic Paints:</b>		
Brown, per ton.....	24.00 to 32.00	24.00 to 32.00
Red, per ton.....	24.00 to 30.00	24.00 to 32.00

## PIPE

<b>Cast iron:</b>		
6 in. and heavier .....	\$57.70	\$56.80
4 in. ....	60.70	59.80
3 in. ....	67.70	66.80
(and \$1 additional for Class A and gas pipe.)		
(Discounts to jobbers for carload lots on the Pittsburgh basing card; freight rates from Pittsburgh to New York, and also from Pittsburgh to Chicago, in carloads, per 100 lbs., are 27c.)		
<b>Wrought:</b>		
<b>Butt Weld</b>		

<b>Steel:</b>		
Black, ½ to 3 in.....	50½%†	57½%
Galv., ½ to 3 in.....	24 %†	41 %
<b>Iron:</b>		
Black, ½ to 1½ in.....	29½%†	39½%
Galv., ½ to 1½ in.....	20½%†	23½%
<b>Lap Weld</b>		

<b>Steel:</b>		
Black, 2½ to 6 in.....	53½%*	53½%
Galv., ½ to 3 in.....	41 %†	41 %
<b>Iron:</b>		
Black, 2½ to 6 in.....	34½%*	34½%
Galv., 2½ to 6 in.....	21½%*	21 %

## PLASTER

Neat wall cement in 15 cent bags, per ton.....	\$20.30	\$18.50
Finishing plaster .....	24.00	21.00

## RADIATION

(A further reduction, effective April 4, of 15% on direct radiators, 12½% on wall radiators, and 10% on steam and hot water boilers is announced. This approximates a drop of 36% on radiators and 33% on boilers from prices in effect before the 1st of January, 1919.) Chicago reports a 57% reduction on all standard sizes.

## REGISTERS

Cast iron, semi-steel or steel, in black or white japan or electroplate and small faces and borders.....	40%	40%
Wall framed .....	40%	40%
Large faced, 14 x 14 in. and larger.....	60%	60%
Base board registers.....	40%	40%
Base board intakes.....	40%	.....
White enameled goods.....	15%	15%
Solid brass or bronze goods, except grilles.....	net	net
Grilles in black and white japan or electroplate in cast iron, plain lattice design, smaller than 14x14 in.....	40%	40%
Over 14x14 in.....	60%	60%

## SLATE ROOFING

F.O.B. cars,		
Pennsylvania:	Quarry Station	F.O.B. Chicago
Best Bangor .....	\$7.75 to \$9.00	\$10.20 to \$11.45
No. 1 Bangor Ribbon .....	6.75 to 7.25	9.20 to 9.70
Pen Argyll .....	7.25 to 8.00	9.70 to 10.45
Peach Bottom .....	10.00 to 12.50	12.45 to 14.45
No. 1 Chapman .....	7.25 to 8.25	8.70 to 9.95
Vermont:		
No. 1 Sea Green .....	3.50 to 6.75	5.95 to 9.20
Unfading Green .....	5.50 to 9.25	8.30 to 11.05
Red .....	12.00 to 20.00	14.80 to 22.80
Maine:		
Brownville, U'f'g Black, No. 1.....	11.00 to 12.00	14.10 to 15.10
Slaters felt, 30 lb. roll.....	1.75	.....
Slaters felt, 40 lb. roll.....	2.25	.....

## ROOFING MATERIAL

<b>Tarred Paper:</b>		
1-Ply, per ton, per roll, 108 sq. ft.....	\$63.00 to \$65.00	\$65.00
2-Ply .....	95c.	95c.
3-Ply .....	1.23 to 1.30	1.30
Rosin sized sheathing .....	per ton 60.00	60.00
Corrugated roofing, galvanized, 2½ in. corrugation, over flat sheets, 30c. per 100 lbs.		

## SHINGLES

Red cedar, 5 to 2, clear, per thousand.....	\$8.00*	\$6.50
White cedar, extra star, A star, per thousand.....	7.00*	5.50

## STRUCTURAL STEEL

Beams and channel, 3 to 15 in., per lb.....	2.45c.†	3.47c.
Beams and channel, 3 to 15 in., per lb.....	2.45c.†	3.57c.
Angles, 3 to 6 in.....	2.45c.†	3.47c.
Zees and tees .....	2.45c.†	3.47c.
Steel bars, half extras, from mill.....	2.35c.†	3.47c.

## REINFORCING BARS

High carbon steel from mill.....	\$48.50	\$49.50
Medium steel from mill.....	48.50	49.50

## SAND

(Borough of Manhattan only)		
Mason, per cu. yd.....	\$1.80†	\$2.25
Torpedo, per cu. yd.....	1.80†	2.35†

# Financial and Commercial Digest

## As Affecting the Practice of Architecture

### New York State Passes Rent Bill

The Legislature of New York State manifested a desire to look into the question of rent profiteering last week when the Senate unanimously passed the Abeles bill authorizing municipalities to appoint rent investigating commissions. The bill provides that if the commission finds a landlord who has unreasonably increased rentals it may publish his name or raise his assessment so that his return shall not be more than 10 per cent.

It is understood that the Senate leaders have agreed to pass Senator Abeles' resolution providing for a State-wide investigation of the rent situation. The resolution appropriated \$10,000 for the expenses of the committee, which is to consist of two Senators and three Assemblymen.

Simultaneously with the action of the New York State Legislature, the Housing Committee of the State Reconstruction Committee, after going over facts and figures bearing on the housing shortage, decided that immediate action should be taken with a view to stimulating the building program. The chairman of the commission, Abram I. Elkus, was authorized to call a conference of the principal commercial, industrial and financial agencies of the State to propose a prompt resumption of building as the solution of the rent problem.

A definite plan will be put forward by experts now studying the problem, and it will be shown that the lack of a building program, coupled with existing conditions, go to make up a situation that directly affects business interests and not alone the tenants immediately concerned. Over two hundred letters on rent profiteering have been received by the committee and many of them have told of families with young children facing eviction because of impossibility of either paying the rent increases demanded or of finding apartments in which to move.

Apparently the consensus of opinion at the recent meeting was that the remedy in the situation lay in the stimulation of building operations.

Robert D. Kohn, of the Post-War Committee on Architectural Practice, stated that the important thing was to meet the needs of those who pay from \$20 to \$35 for their apartments. The members of the committee feel confident that in a few weeks they will be able to present to the business interests a definite plan which will solve the problem.

Frank Mann, Tenement House Commissioner, at the meeting of the Housing Committees, quoted striking figures concerning the housing situation. He said that a survey of vacancies in 1916 showed that the percentage of vacancies in that year amounted to 5.60. In 1917 it had decreased to 3.66. Since 1917, he said, there has been no building, and with no immigration and a normal increase of 200,000

in the population there is a shortage of 100,000 apartments at least. Practically the only vacancies are those in old-law tenements, built prior to 1901, which, he said, are habitable "legally," but are humanly not fit places to live.

As an indication of the lack of building, Mr. Mann pointed to figures showing the building plans filed from Jan. 1 to April 8. The figures showed that eight new plans were filed, involving a total outlay of \$2,500,000. It appeared that the buildings were high-class apartment houses and not the kind of apartment buildings now in greatest demand.

Among those present at the meeting were Frederick Ackerman, in charge of housing design for the Shipping Board; Alexander Bing, a real estate man active in housing matters; Walter Stabler of the Metropolitan Life Insurance Company; John J. Murphy, former Tenement House Commissioner; Dr. E. P. Roberts of the Urban League; Frank Williams, Chairman of the City Plan Committee of the City Club; Alfred Marling of the New York State Chamber of Commerce; Lawson Purdy, Mrs. Henry Moskowitz, Secretary of the State Reconstruction Committee, and Clarence Stein, an architect interested in housing conditions.

In view of the nation-wide shortage of what is authoritatively estimated at 1,000,000 homes, Secretary of Labor Wilson this week urged that cities and large commercial and industrial interests give every assistance to plans for building new homes.

Among the shortages reported are the following cities, the figures representing the number of families that need accommodations, according to estimates of government and city officials and real estate boards. In New York State, New York City shows 75,000 families, Albany 800 and Syracuse 800; New Haven, Conn., 1,500; Detroit, Mich. 30,000; Columbus Ohio, 1,500; Kansas City, 200; Dallas, Tex., 400; Baltimore, 2,500; Huntington, W. Va., 500; Denver, 300; Seattle, 3,000; Portland, Ore., 5,000; San Francisco, 1,500, and Pasadena, 500.

Secretary Wilson is reported to be of the opinion that real assistance will be granted home builders if the next Congress passes the bill proposed by the Labor Department establishing home loan banks, through which loans can be made to prospective home builders. All dwelling plans of the United States housing corporations have been turned over for public use, and the secretary urges that big interests adopt the housing corporation's principles as means of solving the labor problem. Providing of modern homes for labor by large corporations is the best kind of an investment, he believes. These houses can be bought by the workingmen on the installment plan, as is being planned by an Elizabeth, N. J., company, which has purchased a large tract of land to erect houses that will be sold to employees at cost on the monthly payment basis.

# Department of Architectural Engineering

## Standard School House Equipment and Details

THE folding partition is an important factor in school house design. There are certain conditions that require the enlargement of a room temporarily and by the use of these partitions this is accomplished. They are either glazed or unglazed, as the use demands. In commercial department rooms they can be so glazed that the instructor can supervise the rooms with pupils on both sides of the partition. In this case the typewriting ma-

boards; the lower panels are of 5-ply veneer and molded. Partitions in playrooms and gymnasiums have panels of tongued and grooved V-cut sheathing finished flush with face of stiles and rails. Partitions in commercial rooms have the upper panels divided with muntins and glazed. All stiles and rails of sections have built-up white pine cores veneered with material to match the trim,  $\frac{3}{16}$  in. thick. The stiles and rails are  $1\frac{3}{4}$  in. thick. When

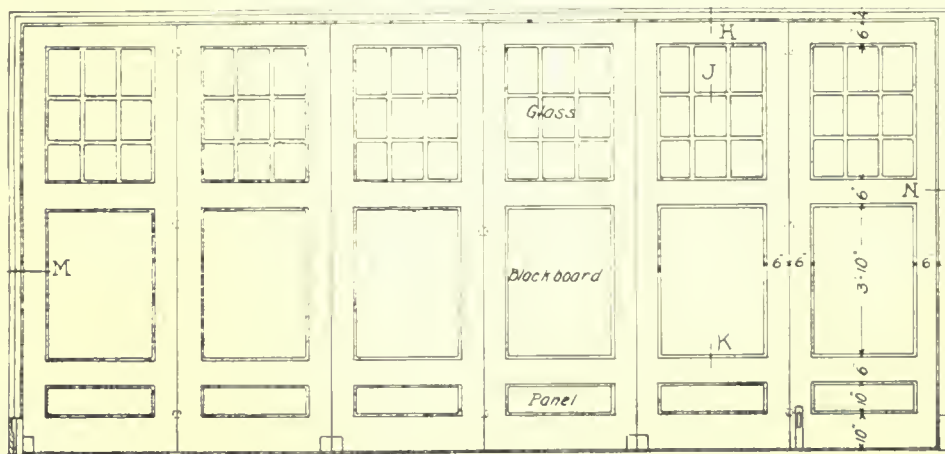

Elevation of folding partition between classrooms, with blackboard panels and glazed top panels.

chines are placed in one room in order that the noise made by typing does not disturb the other pupils in the department.

Folding partitions used in New York City schools are formed of sections hinged together and are specified to be furnished complete with hardware, including tracks, guides, trucks, etc., and made, fitted, erected and adjusted under the supervision of the manufacturers and to be guaranteed by them for two years.

Partitions occurring in rooms for instruction, such as class rooms, kindergartens and libraries, have the center panels omitted to receive black-

required the partitions have fly doors paneled to match the sections.

The fly door has hinges, dead lock, key plate, mortise latch and drop "D" handle. Each section, except the first, has a steel guide at the head; one guide for each pair of sections is swiveled and one is fixed. The first section is pivoted at top and bottom. The flush bolt for the first section has a cast brass face and back plates not less than  $1\frac{1}{2} \times 8 \times 32$  in. bolted through the door with 4 brass mill screws. The face plate has a flanged guide not less than  $\frac{3}{16}$  in. thick; steel bolt not less than  $\frac{5}{8} \times \frac{3}{16}$  in. with steel spring and brass thumb





54 in. deep; for high school boys and girls 32 in. wide and 54 in. deep. All of these fixtures have swinging doors. The stalls for grammar school

These fixtures are constructed with stiles and rails of wood and the panels of asbestos building lumber. These panels in doors are 1/4 in. thick and in the partitions 3/8 in. thick.

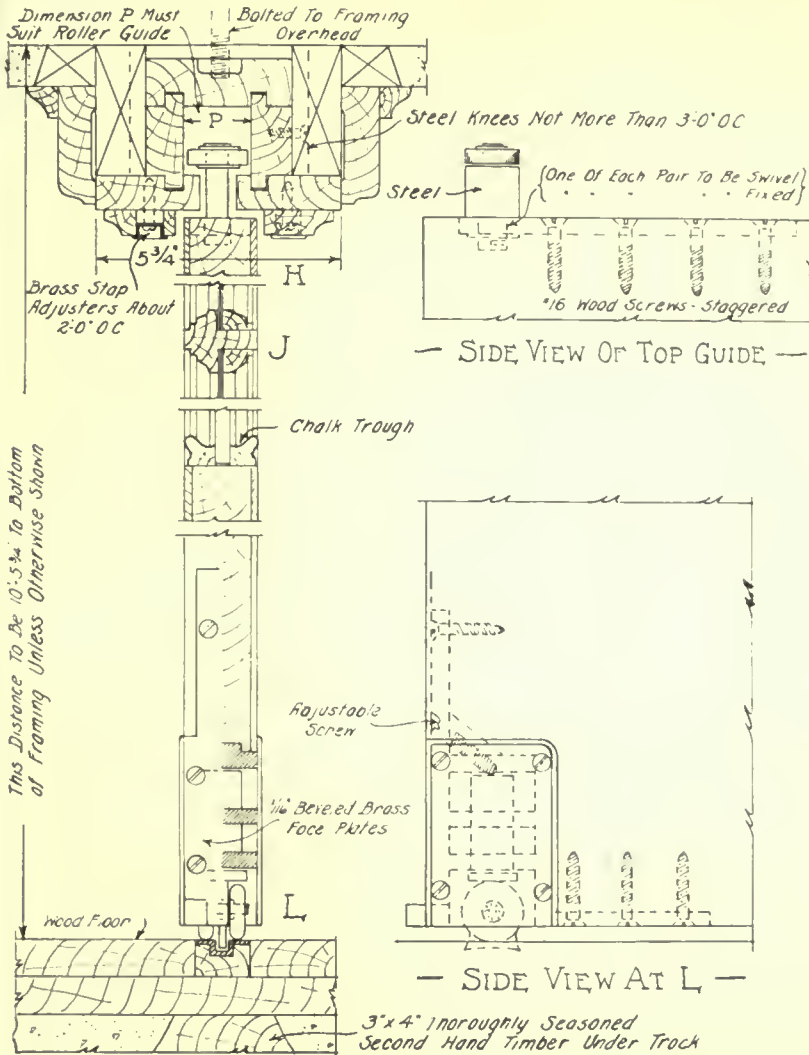

This Distance To Be 10'-5 3/4" To Bottom of Framing Unless Otherwise Shown

Where both sides of the panels are exposed they are double faced. The advantage of the asbestos building lumber panels consists of its lightness and great strength in comparison with its thickness. It will not shrink and will not crack. The uprights are built up and a wood top rail is provided over the doors and at the top of the partitions. The partitions are supported on cast-iron brackets, sockets and gas pipe legs as shown in the details. A novel feature of the door is the rounded member attached to the hinged edge. It was found that with the ordinary square edge door the pupils often got their fingers pinched by the closing door. By installing the rounded member on the door this difficulty was overcome very effectively. The radius of these rounded members varies for the type of hinge used. This is but one example of the careful and painstaking consideration given by C. B. J. Snyder, architect and superintendent of school buildings, New York, to those apparently trivial items which make for the safety and comfort of the pupils.

The kindergarten seat is formed with a wood seat and back and set on cleats resting on pipe supports having flanged fittings. The back of the seat is set out from the wall 7 in. to form a pocket for toys. The bottom of the pocket is made of No. 14 galvanized wire 1 1/4 in. square mesh. The seat is 10 in. above the floor and 10 in. wide and made of 1 1/8 in. lumber, the back is 12 in. high and made of 7/8 in. lumber. The detail clearly shows the construction.

The shower partitions are made of 1 1/4 in. marble slabs and are 7 ft. high. The door has 1 1/8 in. wood stiles and rails with 1/4 in.

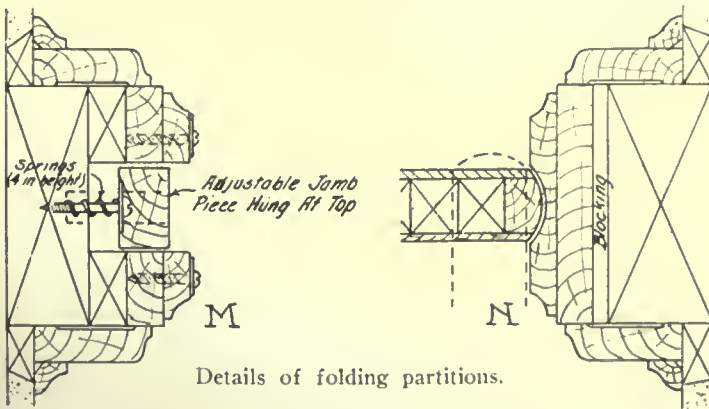

boys are 30 in. wide and 30 in. deep without doors. For primary and kindergarten pupils they are 27 in. wide and 30 in. deep, without doors.

asbestos building lumber panels. The hinged edge of the doors have a rounded member similar to that used on the water closet stall doors. The seat

# THE AMERICAN ARCHITECT

is placed in the corner, as shown, and is made of 1½ in. ash strips bolted to an angle iron frame. The strips are cut out on a portion of their length to permit the drainage of water and are doveled to-

5 ft. high. The concrete or tile floor is pitched to drain to the back of the stall.

The demonstration table in the science room, has a 2 in. soapstone top 6 ft. x 3 ft. in size, the top of

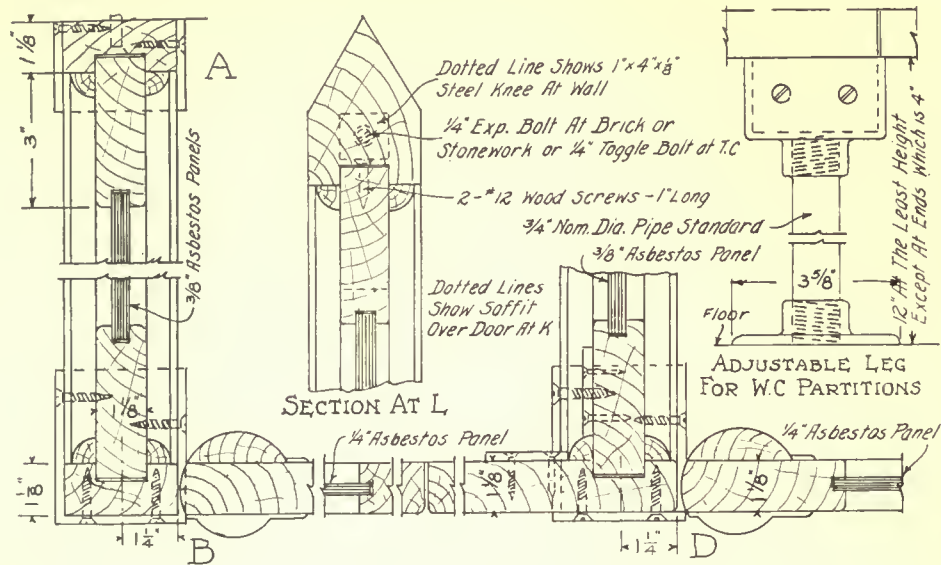

Details of toilet partitions. Note the rounded member at hinged edge of door.

gether and further tied together with a brass rod. The edge of the seat is rounded. The seat is 16 in. above the floor and has a radius, in plan, of 14 in. The stall is 3 ft. by 3 ft. and the door is

which is 2 ft. 6 in. above the floor. This table has an open space in the center on one side of which are ten drawers and on the other side five drawers and a cupboard. Into the top of the cupboard

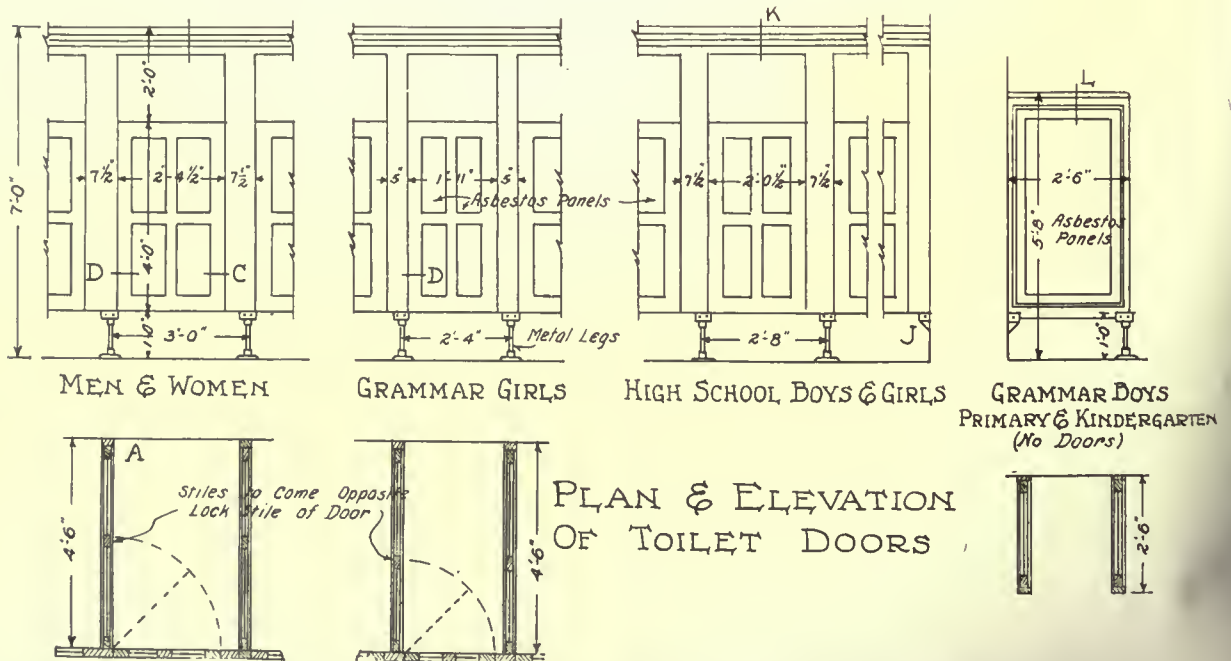

Plans and elevations of toilet room partitions for different grades of pupils and men and women.



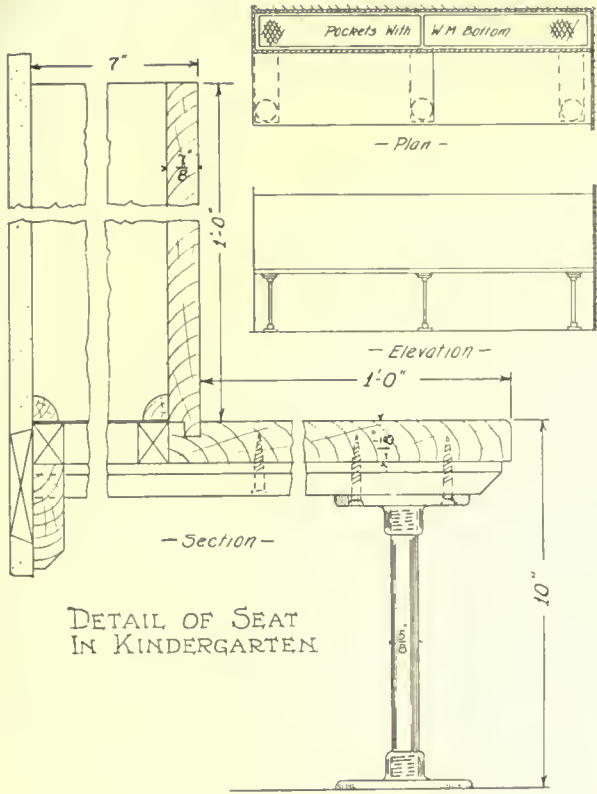

Plan, elevation and detail of kindergarten seat.

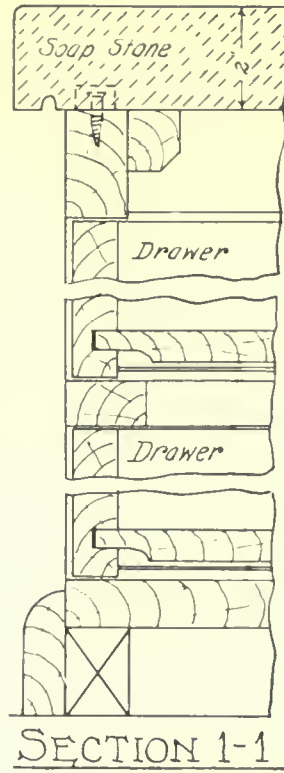

Detail of demonstration table in science room.

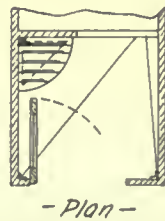
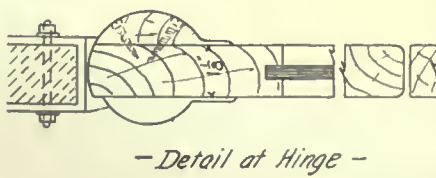
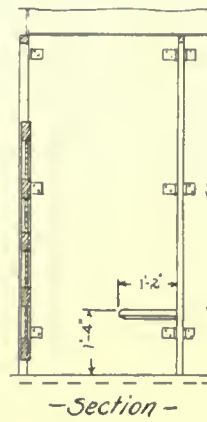
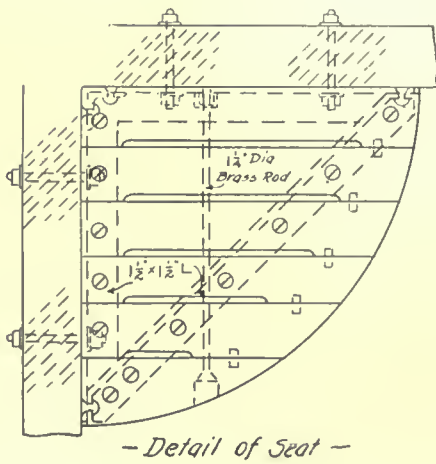

DETAILS OF SHOWER ENCLOSURE

Plan, elevation and details of the shower enclosure.

## THE AMERICAN ARCHITECT

there projects a 10 x 15 in. sink, 10 in. deep. Below the sink is a removable shelf. A gas outlet is provided in the top of the table and two brass sockets for  $\frac{3}{8}$  in. rods. All faces of this table are paneled.

The cooking bench in the domestic science room has a  $1\frac{3}{8}$  in. marble top 15 ft. x 3 ft. in size, the

the danger of the pupil's clothing catching fire is obviated. This apparatus is designed especially for school used by the Building Bureau of the Department of Education, New York.

From a study of the foregoing it will be seen to what extent the successful operation of a modern

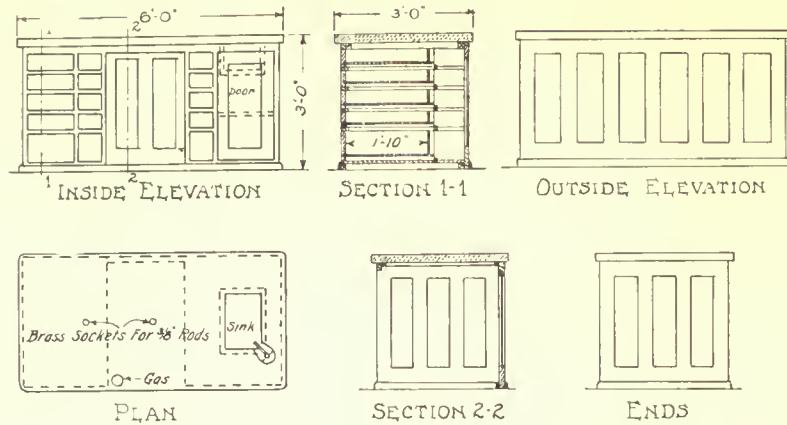

Plan, elevation and section of demonstration table in the science room.

top of which is 2 ft. 6 in. above the floor. There are wood kneading boards immediately under the marble top, which slide in under the same. Six drawers and six cupboards are provided on each side of the table. On top of the table are installed twelve single-burner gas hot-plates. These gas hotplates are supported on a cast iron pedestal

school building depends upon the knowledge, care and foresight of the architect. Too often the only phase to which serious study and painstaking care are given is the design of a pleasing exterior. The neglect of the other phases, equally important, may not be intentional, but nevertheless is lamentable. Important and desirable as is the ex-

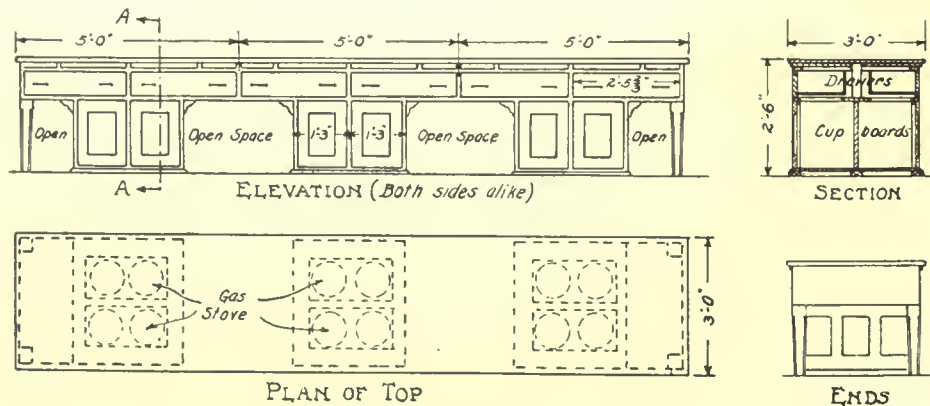

Plan, elevation and section of cooking bench in domestic science room.

which is bolted to the marble top from below, with an intervening rubber gasket. The pedestal arm which supports the gas pipe and hot-plate is elevated so as to leave a clearance of about 6 in. above the table top. This eliminates the legs usual to hot-plates and permits of easy cleaning beneath. The gas valve is in front of the burner and thus

terior treatment, and we would not for a moment depreciate its value, for beautiful school buildings should be the rule and not the exception, yet this alone is not sufficient, for the teacher, handicapped by makeshift apparatus and poorly designed and badly located furnishings and in other similar details, cannot render full value to the children of

## THE AMERICAN ARCHITECT

the community served. It is only by care in these details, combined with efficient study of the larger aspects of the problem, that a fully efficient school

building can be produced. This should be, and we believe is, the aim of all those associated with this important class of work.

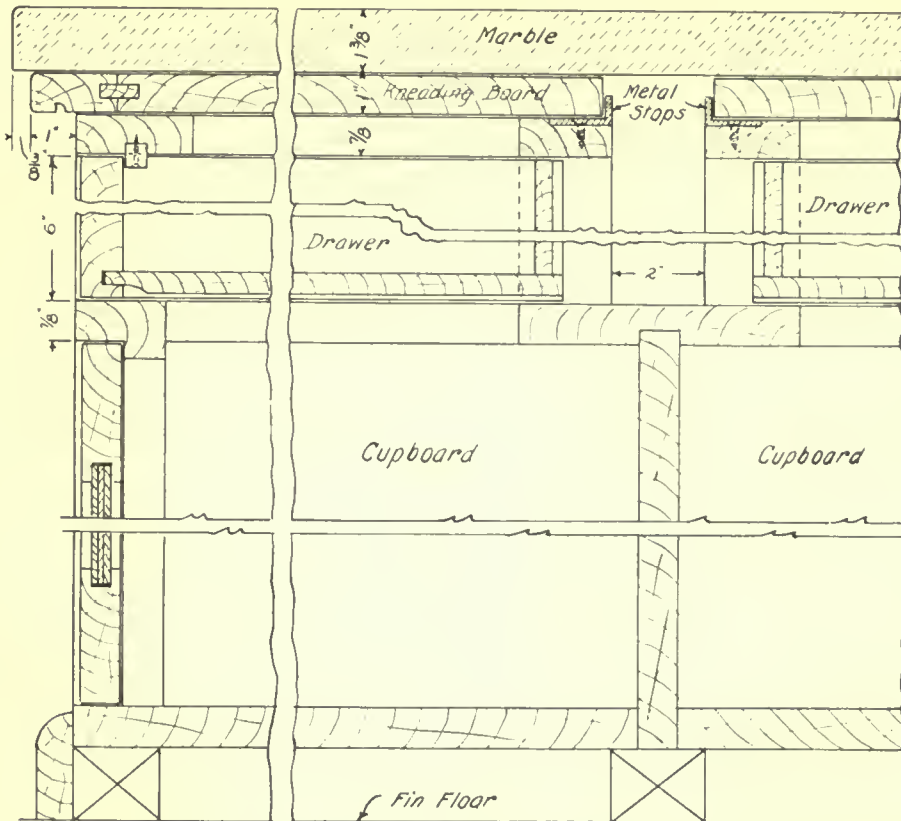

SECTION ON LINE A-A

Detail of cooking bench in domestic science room.

## The Forest Products Laboratory and the Architect

The Forest Products Laboratory is an organization of industrial research working on problems relating to the use of wood. It is a branch of the Forest Service, United States Department of Agriculture. Its present organization consists of a personnel of about 325 people, together with buildings, equipment, and other facilities necessary to maintain the work, and is financed by Federal appropriation.

Among the many lines of work undertaken by the Laboratory that on the development of methods of drying wood is probably of first interest to the architect.

The excessive demands of the war for air-dried wood products, particularly for use in manufactur-

ing escort wagons, artillery transport, etc., practically drained the country of air-dried material. The situation to-day is very serious as air-dried stock is practically unobtainable, and kiln-dried material must be resorted to for interior work. Satisfactory dry kilns and methods of kiln drying are practically unknown to the average planing mill. The consequence is that architects now must accept improperly or insufficiently dried material, which when it is used gives much trouble from shrinkage, open joints, etc., and is generally unsatisfactory. Information is at the present time available in the Forest Products Laboratory on methods of kiln drying lumber which, if they were thoroughly known in the trade, would go far toward



overcoming this difficulty. It is believed that architects should be in touch with the laboratory on this question.

During the war a great amount of work was done on waterproof glues, especially for use in gluing veneer panels. This work was done primarily for aircraft construction purposes, but the information obtained is now being applied industrially and makes possible the satisfactory use of veneer products, such as doors for exterior use and panels for situations liable to be subjected to water. The possibility of securing such material and specifications covering it are believed to be of interest to architects.

The laboratory has been active in studying such questions as the inflammability of wood, methods of fireproofing wood and fireproof construction generally involving the use of wood. It has also been very active in questions relating to the decay of wood and processes of treatment or methods of handling to prevent trouble from decay.

*Cumulative Index of Papers Issued\**

- A-1—Hints on storing lumber to prevent decay.
- B-1—Three-piece wing beams as strong as solid beams.
- B-2—Box handles of webbing instead of rope save shipping space.
- B-3—Metal strapping on wooden boxes.
- B-4—Two simple tests for inspection of airplane struts.
- C-1—Waste paper mill bark as a source of tannin.
- C-2—Recovery of waste paraffined paper.
- D-1—Steaming of vehicle stock during kiln drying.
- D-2—How to distinguish Douglas fir from Sitka spruce lumber.
- D-3—Built-up artificial limb blanks.
- D-4—Circulation and piling in the dry kiln.
- E-1—Good flotation oils from crude tar products.
- E-2—Potash from wood ashes.
- F-1—Foreign trade in furniture.
- F-2—The strength of commercial liquid glues.
- F-3—Aluminum leaf to moisture-proof wood.
- F-4—Water resistant glues.
- F-5—Scratched joints versus smooth joints in plywood.

\*Copies may be had on application to the Director, Forest Products Laboratory, United States Department of Agriculture, Madison, Wis.

- F-6—Bibliography on casein and casein glues.
- F-7—Some reference to literature on manufacture and testing of animal glues.
- F-8—Manufacturing furniture for export to tropical regions.

## Amending Building Codes

The work of keeping building codes abreast of the times is a problem confronting every municipality. Often the measure of a city's progressiveness can be had from the state of its building code. In this respect it is interesting to note that Harrisburg, Pa., has just swung into line, following the lead of other progressive cities, by appointing a committee to draw up a new code of building laws. Such a committee does not always have a light task before it, as is evidenced by the somewhat recent experience of New York City. Building in that city was largely handicapped by a code much out of date and failing to provide for present-day construction. The city realized the need for amendment, but despite the fact that numerous commissions were appointed, composed of experts, costing the city thousands of dollars, the several proposed codes submitted by them from time to time seemed to contain certain objectionable features, and each failed of adoption. This unfortunate situation covered a period of some ten years, the final solution being brought about by amending the code piecemeal, that is section by section, adopting each section after thorough preliminary discussion, revision and public hearing. The New York code as thus amended possesses many good features and may be supplemented from time to time by rules and regulations of the Board of Standards and Appeals. Judging from this board's action to date there seems little danger of its rules and regulations not being kept up to date. The same method was used in adopting the Cleveland code, and in connection with Detroit's proposed code, which contains a number of new features, a novel plan put forth having much to recommend it is to put the code in use for six months to permit the ironing out of any objectionable features which may become manifest during the trial period, then make the necessary changes and enact the code into law.

58-16, 10/12/19

# The AMERICAN ARCHITECT



PALAZZO DURAZZO, GENOA, ITALY

PUBLISHED WEDNESDAYS IN NEW YORK—FOUNDED 1876  
VOLUME CXV                      MAY 14, 1919                      NUMBER 2264

Entered as second class matter January 6, 1909, at the Post Office at New York, N. Y., under the Act of March 3, 1879. Publication office, 243 West Thirty-ninth Street, New York, N. Y. Subscription price in the United States and Possessions, \$10.

# Are You Building?

Sheet metal work on the roof—gutters,  
flashings, down spouts—should be of  
pure galvanized

## ARMCO IRON

Because of its Purity, Armco Iron pos-  
sesses remarkable rust-resisting  
properties.

---

*Write for prices and name of distributor in your city*

---

THE AMERICAN ROLLING MILL CO.

Middletown, Ohio

*Licensed Manufacturers Under Patents Granted to the  
International Metal Products Co.*



The trade mark ARMCO carries the assurance that iron bearing that mark is manufactured by The American Rolling Mill Company with the skill, intelligence and fidelity associated with its products, and hence can be depended upon to possess in the highest degree the merit claimed for it.

BRANCH OFFICES AT  
New York, Washington, Pittsburgh, Chicago, Cincinnati,  
Cleveland, Detroit, St. Louis, Atlanta,  
San Francisco and Buffalo



664<sup>a</sup>



PALAZZO MAFEI, VERONA, ITALY

# THE AMERICAN ARCHITECT

VOL. CXV

WEDNESDAY, MAY 14, 1919

NUMBER 2264

## The Nashville Convention of the American Institute of Architects

### The Second and Third Days' Proceedings

*An Historical Pilgrimage to the Hermitage, and an Old-Time Barbecue Mark the Close of an  
Epoch-Making Meeting*

AT the opening of the morning session, the report of the Committee on Credentials was presented. This report showed that the full quota of delegates certified to the convention was 213, of which 145 were registered, leaving delegates certified but not attending as 68.

In analyzing this non-attendance, it was found that the Baltimore, Brooklyn, Buffalo, Toledo and Wisconsin Chapters were entirely unrepresented. Boston, with fourteen delegates, had seven present with seven proxies, Cleveland presented a full delegation of five, and Illinois, entitled to thirteen delegates, presented a full attendance. The New York Chapter, with a total accredited delegation of twenty-two, was represented by eight delegates with fourteen proxies.

The Committee on Credentials recommended that the present system of registering delegates be discontinued, and that in future conventions a room be provided for the Credentials Committee and that delegates be instructed to file their credentials with the committee in advance of the opening session of the convention.

Following this report, Irving K. Pond read an appreciation of the late Frank Miles Day. When Mr. Pond's paper was concluded, the delegates stood in silence for a period as a tribute of respect to the memory of Mr. Day. Mr. Pond's address of appreciation was as follows:

#### AN APPRECIATION OF THE LATE FRANK MILES DAY

In honoring Frank Miles Day, the American Institute of Architects honors itself, for its honorable progress is linked insistently with the development of that many-sided man who lived to serve it with untiring devotion in its every need. There is scarcely a copy of the proceedings of the Institute for the last two decades which is not a chapter in the

graphic history of his profuse contributions to the cause he loved—here the scholarly report, there a tribute to a fellow architect done in beautiful English; here a timely warning against ill-considered action, there helpful interpolation wherefor to clarify the turbid waters of a convention debate.

And so, in setting forth the Institute's estimate of the man, Frank Miles Day, on the pages of the proceedings of the Fifty-second Annual Convention the record is complete, just as he would have wished it, and just as his family will want to find it, not in high-sounding phrases of formal resolution, but just the simple record written in loving appreciation and approval by a silent, heartfelt tribute to his memory.

In the prime of his professional career, Frank Miles Day, architect, teacher, practical man of affairs, and in all and through all an indefatigable worker, passed away. From his first day of service to the profession in its national organization, down to the day of his death, he worked unceasingly for the good of the profession with utter devotion and a complete disregard of self.

During the years of Mr. Day's active connection with the Institute, it grew from a small group of Eastern men who practiced architecture almost as amateurs, to a society embracing architects from every part of the country, and including the best men of the profession everywhere. He entered the profession when, as already suggested, it was almost an amateur occupation; he left it when it was one of the most complex and difficult professions; he kept pace with that progress, at many stages he led or directed its progress, and if his fellow architects owe him a debt of gratitude for his unselfish life of devotion to their profession, the public owes him a debt for his share in uplifting architecture.

Mr. Day shared in and took an active interest in the growth of the Institute, but also demanded the



## THE AMERICAN ARCHITECT

highest standards of those who were admitted to it. He believed in the growth of the Institute, but he believed still more strongly that its growth should be sound. Believing that the best way to maintain its standards was to better them and the best way to convince others, whether the public or the profession, of the value of the Institute was to improve the practice of architecture among those who composed the Institute, he devoted himself to that work. The code of ethics, the innumerable studies on the subject of competitions resulting in what is now established, and the vexed schedule of minimum charges, were among the subjects which he gave his unswerving attention. The Institute is his debtor for these, but much more is it indebted to him for the Standard Documents. No one who had never worked with him can appreciate the great amount of patient work which has gone to the perfecting of those documents. That was his great contribution. It is the more remarkable in that nearly all the work on these documents was done after he had served the Institute for years, risen from one office to another until he was honored by being made president, and after his term took up this laborious committee work, and was at the time of his death completing a general treatise on the profession. Such is the tribute the Institute owes to Frank Miles Day.

As an architect and practical man of affairs, Mr. Day was a leader. He began to practice in 1886. Architecture was then just beginning to wake from a period of terrible torpidity. From just before the Civil War until the eighties there had been hardly a good thing done in architecture, and of all the cities probably none was at a lower ebb than Philadelphia, notwithstanding the fact that then, as now, it was surrounded by innumerable examples of delightful country places and had not a few fine old buildings in the city. It was to this existing fine work that Mr. Day was attracted. Mr. Day, always associated in our minds with John Stewardson, Walter Cope and Wilson Eyre, struck out on new lines, new, yet old, for they were on the sound foundation of old work and led the way to much of that which is best today.

There was at that time in Philadelphia, as there is today, a group of very able painters, sculptors and illustrators, and many workers in the minor arts. With all of these Mr. Day was intimate and gained immensely, as one always does, from such companionship. Like all true lovers of the arts, he loved the country and was as skillful in handling that most fascinating of all materials, the growing thing, as he was with brick and mortar, so that his gardens, whether designed for himself or for his clients, were as charming as his houses. He was

one of the many architects who demonstrated in practice that the garden is as much a part of architecture as is the front hall, and also that no one who does not think in terms of architecture can design gardens.

With all this, he was an intensely practical man. He studied the economics of his office and his buildings. He delighted in devising ways and means of doing work better and more economically and, what is more, he knew what true economy is; for all this the profession and the public are his debtors. Those who knew him best will, however, remember him best not for his architecture, not for his service to the profession, but for himself, the true friend, the kindly, lovable companion.

### NOMINATION OF OFFICERS

The nomination of officers then followed. These were:

For President, Thomas R. Kimball of Omaha.

For First Vice-President, Charles A. Favrot of New Orleans.

For Second Vice-President, C. C. Zantzing of Philadelphia.

For Secretary, W. Stanley Parker of Boston.

For Treasurer, D. Everett Waid of New York.

For Directors (for term of three years), three receiving highest vote to be declared elected:

Edward N. Hewitt, Minneapolis.

William B. Ittner, St. Louis.

Henry H. Kendall, Boston.

Frederick W. Perkins, Chicago.

Wm. J. Sayward, Atlanta.

Charles Coker Wilson, Columbia, S. C.

In addition to the above, the following members were nominated for election to Fellowship:

Elliston D. Bissell, Philadelphia.

N. Max Dunning, Chicago.

William Emerson, New York.

Robert D. Farquhar, Los Angeles.

Walter H. Kilham, Boston.

Henry McGoodwin, Philadelphia.

W. S. Richardson, New York.

### UNFINISHED BUSINESS

Under the head of unfinished business, a discussion was held relative to enlarging the duties of the Secretary. The Board of Directors had recommended that the work of the Secretary be enlarged; that he devote his entire time to the Institute and that he be made editor-in-chief of the *Journal*. In addition, that the Secretary should assume the business management of the Institute, and should receive a salary of \$8,000 a year. There was a spirited debate on this measure, during which the delegates expressed in the highest terms their appreciation of

## THE AMERICAN ARCHITECT

the very painstaking and efficient efforts of Secretary Parker. The report of the Board recommended that the entire matter of a proposed executive secretaryship be referred to the Post-War Committee, and the convention voted accordingly.

An effort was made to take from the table a resolution offered at a former convention favoring universal military training. The motion was lost.

In the matter of war memorials, it was voted as the sense of the Institute that no undue haste be made in the matter of erecting war memorials, but that deliberation be given to such memorials to the end that architectural monstrosities be held down to the minimum. It was pointed out that France is now pursuing a similar course.

Burt L. Fenner of New York read a telegram received by him, stating that the Housing Corporation had decided to omit the author's name when a design should be published. The convention directed that a message should be sent to Lerry K. Sherman, president of the Housing Commission at Washington, protesting against such action. It was represented that the engineers, landscape designers and architects of the country had given faithful and patriotic service during the war, and that the Institute, respectfully but firmly, maintains that the slight recognition that would be accorded them by the publication of authors' names is their just due and is a matter of public interest.

### AFTERNOON SESSION

The afternoon session was a meeting of the Post-War Committee on Architectural Practice. N. Max Dunning was in the chair.

The following address was made by Irving K. Pond, past-president:

#### MR. POND ON THE STATUS OF THE ARCHITECT

I am asked by the chairman to speak for a few moments to the topic (C) "The Status of the Architect: Art, Profession or Business." If this is a question it was answered properly many decades ago for the Institute by *itself*. If it is a statement, the form is improper and should be: Art, profession *and* business; a "Trinity" and withal a "Unity"; a paradox which, in another field, the dogmas of orthodox Christianity have forced many to accept, and many others to contemplate with more or less strained acquiescence, or with no emotion whatsoever. But perhaps in the architectural field it is not a paradox, but upon analysis will prove to be a clean-cut statement of fact. Under whatever phase it may be discussed, however, I am going to regard it all in the light of the words of old Polonius, whose advice holds just as good

under post-war as it held under pre-war conditions, and it held with firm grip then: "Above all," he says, "Above all to thine own self be true; and it must follow, as the night the day, thou canst not then be false to any man." If the architect sincerely maintains that attitude the public will soon enough recognize him in and through it, and repose confidence in him as an artist, and as a professional man who, with the ordered instinct of business, co-ordinates his powers and faculties and accomplishments to the end of a deeper and richer personal and public service. "To thine own self be true"—and let post-war committees and a complaining public—if it exists—go hang.

And if the architect be true to himself what does he mean by Art? Is it what the narrow-minded structural engineer—not the engineer in general, but the narrow-minded structural engineer—for his own immediate, selfish, commercial advancement, says it is—though down deep in his own heart he knows better—a mere ornamenting of the inherent structure with pretty, or supposedly pretty, decorations? I shall not deny—but, rather, shall insist—that architects have too frequently given the public as well as the structural engineer some show of reason for entertaining at least such a suspicion. Art means, in architecture, not the *application* of anything, but the presence of a guiding and directing spirit through whose intervention the problem shall be so solved that function shall be perfect while through and permeating the material mass the spiritual essence of order, appropriateness and charm shall warmly irradiate. Charm is a rare word, and its essence is all too rarely distilled into architecture. Catch and hold its fleeting beauty! Art in architecture means that the desires of the soul as well as needs of the body are fully ministered to. In this age it were perhaps better to say the needs of the soul and the desires of the body. So much, and briefly, for the art. Now for the profession.

The architect who is true to himself will be true in his professional capacity, and so cannot be untrue to the profession. (My inadvertent introduction of "and so," just here, reminds me pleasantly of the rather anomalous position I occupy in discoursing in this august presence, even in response to an invitation, upon architectural art and professionalism. The *Journal* of the A. I. A. maintains and has promulgated the idea that my aesthetics, and the ethics involved therein and practiced by me throughout a long series of years, are a *blight* on architecture, "from which, however," it opines, "the profession will be secure." In spite of that bar sinister, as it were, across my professional shield, I am inclined to proceed.) What is the attitude,



## THE AMERICAN ARCHITECT

the state of mind, the state of being almost, which distinguishes professionalism from business? It lies in a dual function of the professional mind: the one phase touching the attitude of the professional toward his client and the other touching his attitude toward his calling, including self and brother practitioner. As toward his client the professional must always hold himself in position to give full and frank advice removed from the slightest possibility of being affected by self interest. This necessarily prevents the professional architect from engaging in the building trades, or in any building trade; or from letting a direct contract for a client in the architect's name; from operating similarly through a "cost-plus" contract, or even a fixed fee, as this is liable—extremely likely—to bring architects into competition with each other in point of fees. The architect's disinterested position, that is from the standpoint of self, has been wisely safeguarded in the past. I hope that the Institute as a professional body will never fall from that high estate. Post-war conditions have not made it necessary.

As to the architect's attitude toward his professional self: it should be one of dignity and self-respect, so that he should not feel called upon to slink out of his clothes in the dark when he retires, shunning any waking thought of himself, but so that he should be free and glad to behold his face in the mirror as he brushes his hair in the morning. A man who considers his creative power valueless, who is willing to let any wished for or hoped for client illegitimately mother, and, through ignorance, impotence or abortion, fail to bring forth well formed the children of his brain, has no self-respect, is not respected by others; has no sense of personal dignity and could not impart dignity or charm even to his legitimate offspring—which are justly looked upon with derision, at least with suspicion, by others. The man who offers his advice for nothing gets just exactly what it is worth—and finds the sum or the equation balanced in the minds of his clients and of the public. If architects, as a rule, were to place a value on their creations and on their advice, giving themselves not in anticipation of favors, but only for the public weal, the

vexed problem of competitions would mainly settle itself; a very minor code would be needed. Until that status exists, however, a real code will be required—not a code, by the way, such as has been suggested, which inadvertently opens the field to competitions without sign of supervision, placing restrictions only about a "formal competition" which under such circumstances never would be instituted. Self-respect will beget a respect for others and will be treated with respect by others.

As for business, that term must be made to cover all, and only, the necessary financial and executive or administrative side of the profession, and must not include the participation of the professional man in contractual relations except as with the client. The Institute, through its schedules and codes, should in these business matters be of much fuller assistance to its members—and so incidentally to the profession, which depends upon the Institute for leadership and guidance. If the Institute sets the example and is true to itself it will make a real study of the schedule nor hesitate through fear of confusing the public or creating in its mind the impression that the architectural mind is not a unity within itself—a fact which is fairly apparent to that small section of the public which knows or cares anything about the internal workings of the profession.

In the art, the profession, the business of architecture, it is the duty of the Institute to set the standard high, to draw all adherents of that high standard to itself—to educate the public and the profession at large to an appreciation of that standard, and to shut the door upon all who drag it down. There is no conflict between the art and the business of architecture; neither should be developed at the expense of the other; neither *can* be. An individual may be proficient in one branch or the other, in both, or in neither. His proficiency and his professional integrity will determine as to how each branch shall develop in the practice of that individual, while a reasonable proficiency in each branch and in all branches, and a reasonable amount of self-respect, will beget in the public mind confidence in and respect for the professional and the profession.



## Third Day's Proceedings

AN HISTORIC PILGRIMAGE AND AN OLD-TIME  
SOUTHERN BARBECUE

THE brief session held on the third day was devoted to unfinished business and the report of the tellers of the ballot.

The entire ticket for officers and Fellows was unanimously elected. The directors chosen were Edward H. Hewitt, Wm. B. Ittner and H. H. Kendall.

At eleven o'clock the convention adjourned to accept the invitation of the Nashville Society of Architects to a motor ride to points of architectural interest, with a barbecue at The Hermitage, the stately home of Andrew Jackson.

Much has been written of southern hospitality. If any members supposed that the cordiality in the South was a thing of antebellum days, but had now suffered in quality, they were soon to be shown their error. As the delegates moved in a body to the steps leading down from the Capitol building, they saw in the long vista of the street a great gathering of motor cars. As there was a full attendance of delegates, together with many guests of the Institute and the Nashville Society, there were probably two hundred to be taken on this enjoyable trip. The arrangements were so perfectly planned that soon a long *queue*, stretching along many blocks, was swiftly moving.

The route, first through Nashville, was then out into the beautiful blue grass region, circling about to reach the famous Belle Meade farm, the birth and training place of many famous race horses. On the sloping lawn of the mansion there lie buried many horses, and above them are stones setting forth their records. In some instances pretentious monuments have been placed.

From Belle Meade, over an undulating and beautiful country, The Hermitage was reached. Here the Nashville Society was assisted in entertaining the delegates by a group of women representing the organization that has secured and preserved this historic mansion and its contents. Proceeding up a long avenue flanked with pine trees, the house is reached. It is of the type so familiar as the residence of the well-to-do during the days of the Colonial period up to just before the Civil War. In these houses the owners of broad acres lived a life of dignified ease and luxury surrounded by large families, supplemented by numbers of guests. About the house were grouped the quarters of the slaves and the dependent buildings, while at one side the beautiful old-fashioned garden, full of carefully tended plants and shrubs made a delightful spot of color.

It is of this type that The Hermitage is. The wide central hall with its staircase is flanked on both sides with rooms, the first floor with those for ceremonial purposes—large drawing-rooms, their walls covered with paper of classical design, so much affected at that time, and all excellently well preserved. The beautiful mahogany furniture, that makes the collector envious, the many portraits of Jackson on the walls, all preserve the atmosphere of the day when Jackson sought this dignified retreat to rest from the many vicissitudes of a strenuous life.

The large dining room with its spacious mahogany table and old English chairs is set with the very china and cut glass used by Jackson, while the many pruned candlesticks are placed as if it needed only the entry of the serving men and women to lay a feast such as marked these southern homes at that time.

The various bedrooms in the upper story have each their "four-poster," and each a rare example of honest mahogany craftsmanship. The broad porches afford a pleasant shelter from the heat of the southern sun, and through the air is wafted the delicate odor of the surrounding pine trees. A most delightful and restful spot, a very haven of rest for the delegates who had for three days and nights been actively engaged in their deliberations.

In the garden, under a classic temple, repose the remains of Jackson and his wife, while near by are buried other members of the family.

In a grove of trees, opposite the entrance to the grounds of The Hermitage, the barbecue was held. This form of entertainment was new to many of the delegates, who surveyed the pits of glowing coals on which were roasting sheep and hogs, fish and chickens, and all the many things that long and honorable custom has declared are essential to the successful conduct of this feast.

A more enjoyable occasion it is difficult to imagine. In the shade of the trees on long tables heaped high with everything that is good to eat, and in Tennessee, proper to drink, the delegates gathered about. The contrast between this delightfully informal occasion, when many prominent architects were noted enjoying with evident relish the good things spread before them, and the formal full dress dinners of previous conventions was strongly to be noticed.

It is difficult without effusion to state just exactly how fine an occasion this was. It is difficult to express a proper sense of appreciation of the well-bred hospitality that was strongly in evidence at every hand. Certain it is that every man who was fortunate enough to have been present will "mark that fortunate day with a white stone."

## THE AMERICAN ARCHITECT

The weather was perfect, and the ride back to Nashville during the early evening carried the party through the grounds of the large Government powder plant. There at the entrance an officer politely but firmly demanded that every man give up his matches, and while the long line of cars was passing through the grounds mounted soldiers galloped their horses alongside to make sure that someone through force of habit did not fetch from a neglected spot a stray match and attempt to smoke.

And so back to town, tired but contented. First the traces of a day afield to be removed, then a hasty dinner and finally as a conclusion to a most

successful convention, a meeting of the Post-War Committee.

The late night trains on Friday carried to every point of the compass many tired but well contented men. Great questions had developed, and great and successful efforts had been made to solve them. The fifty-second convention of the American Institute of Architects was now history. Its results will undoubtedly be far-reaching. With the well-directed activities of the Post-War Committee, and all the efficiently working regular committees, we shall undoubtedly see a greater, a more influential Institute than ever before. A thousand new members in 1919? Why not?







SKETCH FOR MURAL PANEL, "GIFTS TO THE GODS"  
HARRY WATERS ARMSTRONG

## The Thirty-second Annual Chicago Architectural Exhibition

**I**MAGINE, if you please, an architectural exhibition, covering the walls of three large galleries in one of the most important art institutes of this country. Then, further visualize that on one side, this exhibition is reached through a large gallery filled with the work of the greatest American landscape painters, and on the other, through a gallery whose walls contain the best lot of Claude Monet's pictures that are to be found in the United States. Having all this in mind, receive the assurance that the exhibition of architecture suffers nothing adversely by comparison. There is no feeling of incongruity, no sense of a lack of fitness.

We have been referring to the thirty-second annual Chicago architectural exhibition which for more than three weeks has been hanging on the walls of the Art Institute of Chicago. This exhibition was given jointly by the Chicago Architectural Club, the Illinois Society of Architects and the Illinois Chapter of the American Institute of Architects.

If a man may be judged by the company he keeps, so may this exhibition be judged by its associates and by its neighbors. The writer hereof took a seat on one of the huge couches from which point he could command both entrances. The object was to learn, if he might, whether the large number of people who thronged the picture galleries would hastily pass by the architectural exhibit and continue their study of the painting and sculpture. They did not. On the contrary, there was a very



HOUSE OF MR. OTTO R. LIEBER, INDIANAPOLIS, IND.

HARRY H. BENTLEY, ARCHITECT



FACTORY BUILDING AT ST. PAUL, MINN.  
RICHARD E. SCHMIDT, GARDEN & MARTIN, ARCHITECTS

vital interest shown, a decided loitering in the three architectural galleries, and a keen appreciation of all that was hung on the walls. Further, this happening to occur on Saturday, there were throngs of young people. The drawings, renderings, photographs and models that made up this



# THE AMERICAN ARCHITECT

splendid showing of good architecture appeared to interest these young people to an unusual degree.

All these things have been set down here to support the contention, many times made in these columns, that when an architectural exhibition has been well selected and carefully hung, it holds its own in interest with exhibitions of the painter's and sculptor's art. Further, its opportunity for a



EDUCATIONAL BUILDING, UNIVERSITY OF ILLINOIS, URBANA, ILL.

JAMES M. WHITE, SUPERVISING ARCHITECT

wide appeal, an educational influence, is so greatly extended under conditions such as we are now referring to as to leave no room for doubt that it is in our art galleries that architectural exhibitions should be held.

It was well enough, perhaps, at one time to isolate them in clubhouses or their galleries where they would be only viewed where those directly interested might seek them. To such as those there was no novelty nor was there great need to stimulate interest. Hung as this Chicago exhibition is, its influence is so great and

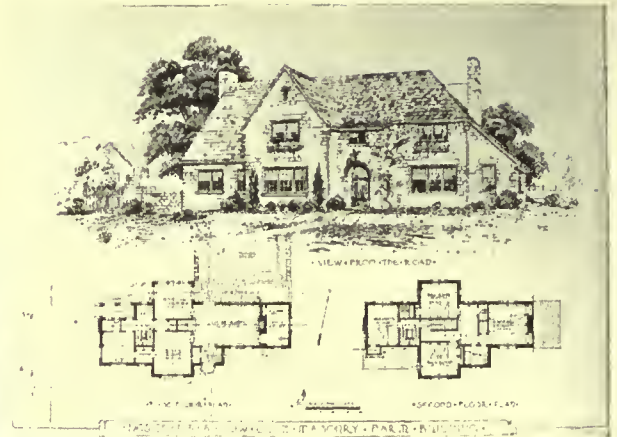

SKETCH FOR FARM HOUSE, PEN AND INK

FREDERICK M. HODGDON, ARCHITECT

its potentiality for the higher education so strong, that the allied societies who have brought this result to consummation are to be congratulated. And these congratulations may be specifically given to the committees of selection and the hanging committee. Their work has been admirably carried forward. There is of the ultra technical phase enough to stimulate the interest of the deeply technical observer, there is sufficient of the elemental aspect of the student work to make their visits worth while. There are renderings that are works

of good art, sketches in crayon and pencil that are deeply interesting and all very good. For the man who likes color, there it is in a most harmoniously beautiful arrangement. Every detail well balanced, all carefully grouped, the



UNITED STATES HOUSING CORPORATION, HAMMOND, IND.

J. C. LLEWELLYN, ARCHITECT



THE AMERICAN ARCHITECT



FACTORY, UNION SPECIAL MACHINE CO., CHICAGO  
GEO. C. SIMMONS & CO., ARCHITECTS



QUIGLEY PREPARATORY SEMINARY, CHICAGO, ILL.  
ZACHARY T. DAVIS, ARCHITECT

*Thirty-second Annual Chicago Exhibition*

## THE AMERICAN ARCHITECT

ensemble is just what it would naturally be when men well grounded in their art set about a thing of this kind.

So much for the artistic phase. As for the architecture, it is certain that the men in the Middle West have been progressive and in their progressiveness have they clung to their ideals. There is a certain well indicated originality in the work of these Chicago men that would seem to show that there is being developed a strong tendency toward what may be called a regional type. We are too broadcast a country, too widely diversified, to hope to evolve what may be known as a national type of architecture, so we shall perforce create regional types that will mark the section from which they spring.

The Middle West, like all the rest of the country, has during the past two years been almost stagnant in its building operations. But the architects in that section appear to have given strict attention to the admonition "plan now." This is apparent at the exhibition. There are many projects shown that only await some stabilizing influence when they will go rapidly forward. They range through every type of building, and they show the development of certain ideals in design and plan that will create a widespread interest and, it is believed, gain general approbation.



CLUB HOUSE



RESIDENCE STREET

INDUSTRIAL VILLAGE, MORGAN PARK, MINN.  
DEAN & DEAN, ARCHITECTS

Considering such an exhibition as this, and its great educational influence on all of the people, the question arises, why, in the future isolate exhibitions? Why not follow this present excellent example in all cities where important exhibitions are held? Philadelphia was first to set a precedent. The warmly commended exhibitions of the T-Square Club, held in the art galleries on South Broad Street some years ago, are known to have been highly successful and to have yielded the most fruitful results.

Here in New York, with our Metropolitan Museum of Art doing all it can to elevate the art of the



OFFICE BUILDING, THE WOMAN'S BENEFIT ASSOCIATION OF THE MACCABEES, PORT HURON, MICH.

RICHARD E. SCHMIDT, GARDEN & MARTIN, ARCHITECTS

craftsman, what more logical place to hold an exhibition of architecture than in some galleries near to the Willard exhibition of architectural casts? Can anyone doubt how measurably the good would be increased over a similar exhibition held in the Fine Arts building, whose very atmosphere breeds a sense of aristocratic aloofness that keeps away the thousands that would see an exhibition at the art museum? The genealogical tree of architecture has for its roots



THE AMERICAN ARCHITECT



WESLEY FOUNDATION, UNIVERSITY OF ILLINOIS, URBANA, ILL.  
HOLABIRD & ROCHE, ARCHITECTS

*Thirty-Second Annual Chicago Exhibition*

the finest of the arts. Its trunk and branches indicate its many ramifications through all the arts, many of the sciences and numerous of the crafts.



RESIDENCE OF MR. S. S. HUTCHINSON, SHERIDAN ROAD, CHICAGO.  
TALLMADGE & WATSON, ARCHITECTS

When the general public come to a closer knowledge as to what an architect really is, what he must know and do to practice his profession and how he must run the gamut from the most aesthetic to the

most prosaic and practical of things, they will have a better knowledge and a deeper respect for him and his work.

Interest in the thoughts that this Chicago exhibition has aroused has led to a drifting away from a specific review of it. That, however, is not necessary, perhaps, for enough has been set down to show how good it is and in its goodness how it points a method of conducting exhibitions that can be followed with the greatest success.

The book of the exhibition has been admirably prepared, and copies may be secured by application to the Secretary of the Exhibition Committee of the Chicago Architectural Club. A number of reproductions from the catalogue are presented herewith.

---

### Awards in Competition for a Memorial Tablet

Charles Ewing of Ewing & Allen, architects, chairman of the Jury of Award in the Polachek Memorial Tablet competition, has announced the following prize awards for original tablet designs:

John O. Vegezzi, care of J. E. R. Carpenter, 681 Fifth Avenue, New York City, first prize; Edgar Salomonsky, 491 West 119th Street, New York City, second prize; D. M. Allison, University of Illinois, third prize; Rudolph Holsstein, 701 Crotona Park North, New York City, fourth prize; August Reuling, McKim, Mead & White, New York City, fifth prize; and A. E. Fettis, Ascot Place, Queens, L. I., sixth prize. Designs by the following were also accepted by the Jury of Award: Allen W. Fraser, 2215 Tilden Avenue, Brooklyn; Ellason R. Smith, 26 Indianola Avenue, Dayton, Ohio; and A. E. Fettis, Ascot Place, Queens, L. I.



THE AMERICAN ARCHITECT

Founded 1876

PUBLISHED EVERY WEDNESDAY BY

THE ARCHITECTURAL AND BUILDING PRESS, INC.

No. 243 West Thirty-ninth Street, New York  
E. J. ROSENCRANS, PRESIDENT AND TREASURER  
WILLARD C. HOWE, VICE-PRESIDENT

WILLIAM H. CROCKER, Editor  
EDWARD F. HAMMEL, Engineering Editor  
ARTHUR T. NORTH, Western Editor

Subscriptions in the United States and Possessions,  
Mexico and Cuba, TEN DOLLARS. Other Countries,  
TWELVE DOLLARS.

SINGLE COPIES (Regular Issue) 25 CENTS

CHICAGO OFFICE, Mallery Building  
PAGE A. ROBINSON, Western Manager

ST. LOUIS OFFICE, Wright Building  
CLEVELAND OFFICE, Guardian Building

SAN FRANCISCO OFFICE, 320 Market Street

Owned by United Publishers Corporation—H. M. Swetland, President;  
Charles G. Phillips, Vice-President; W. H. Taylor, Treasurer;  
A. C. Pearson, Secretary. Entered as second-class matter January  
6, 1909, at the Post Office at New York, New York, under the Act of  
March 3, 1879.

VOL. CXV

MAY 14, 1919

No. 2264

A Thousand in 1919

WHY not a thousand new members for The American Institute of Architects in 1919? President Kimball in his admirable address on the occasion of the opening of the recent convention stated that it should not be a hard task to secure this increase. Nor should it. With the Institute now off to a start that bids fair to widen its scope and largely increase its usefulness to every architect in good standing, it becomes the duty of such men to offer substantial support.

As the convention has given its endorsement to the program of the Post-War Committee, and as that program is a most constructive presentation of just what the policy of the Institute will be, there need no longer be any doubt in the minds of men who have heretofore failed to affiliate, but who undoubtedly should, of their present duty in furthering the high aims that will in the future dominate architectural practice.

It was, perhaps, an error on the part of the convention to decide not to follow President Kimball's suggestion for a reduction of the initiation fee. If the present fee is a deterrent to joining the Institute, though it should not be, it becomes as much the duty of men in the profession to make certain economies in order to join the Institute as it would be to subscribe to our various liberty loans.

There are patriotic duties in times of peace as well as in war, and it is a duty to lend aid to a group of men whose efforts are not confined to the betterment of its immediate membership, but which include every man who engages in the practice of architecture.

It is only fair to surmise that now the Institute has declared a policy which should meet the approval of all reasonable men, this approval should be shown by a largely increased membership. With a thousand new members there would be removed to a great extent the onus of the statement that the Institute is not a representative organization. As its policy is now outlined it certainly will be, and if this policy is strictly adhered to, it is the worst form of ingratitude to withhold support. So then, let there be a thousand new members in 1919.

Iowa's Housing Law

THE State of Iowa has now a housing law which has for its chief purpose the elimination of slum districts in all cities of more than 15,000 inhabitants. Iowa is not the first to enact such a law, as other states have preceded her in similar efforts. But two things, it appears, may be expected to dignify the present undertaking: the fact that wide publicity was given to the subject, to formulate general opinion on the importance of the situation, and the further reason that the matter will not be permitted to rest after enactment of the law, but will be enforced by health officials throughout the State. Labor organizations, women's clubs, civic bodies, and many other societies all took active part in promoting the idea and the accomplishment. This law becomes effective July 1 next. Landlords are no longer to be permitted to erect shacks without windows, proper ventilation and sanitary facilities, and where such conditions already exist, they will have a year from that date to make the buildings conform to the law. After that time, the builder will have to submit his plans to the city board of health, where the details of construction are to be examined. If these are found satisfactory, the building may continue, but no one shall take possession of the dwelling until examination of the completed structure shows it has followed specifications. A written permit will then be signed by the health department after the inspection proves the building satisfactory.

The enforcement lies largely with the city health officer. Jurisdiction is also given the State board of health to enforce this law, and it may enlist the aid of any court or judge for an injunction, either mandatory or prohibitive, such action to be prose-



cuted by the county attorney or the attorney general.

While housing laws exist in other states, they have not the wide application that the present one possesses. Minnesota's law affects only Minneapolis; Wisconsin's, Milwaukee, and Detroit's is restricted by the Michigan law, it is said.

That each new housing law passed presents an opportunity to architects need not be proved. Where is there a greater appeal than in the eradication of ramshackle hovels and tenements in slum districts and the substitution of buildings to instill civic pride, encourage refinement of taste and guard personal and community health?

Where states have no housing law, it is the part of architects to urge them; where states have them, it is their chance to make them better.

### Safeguarding the Profession

THE encroachment upon professionalism, another one of the important matters dealt with in President Kimball's address, may very well be considered a menace to the practice of architecture. No one may with success encroach on the rights of another if those rights are alertly and carefully guarded. In fact this safeguarding against encroachment is the very essence of preparedness. The dangers pointed out in the address are not overdrawn. They have really existed. Now that the warning has been sounded, there should be a proper defence. It is believed that that defence has been set up in the present policy of the convention and the strong stand that the Institute has taken as to the future.

If there has been encroachment in the past, it has been simply because there has been more or less a transference of the architect's functions. It is because of a certain spirit of aloofness, a failure to be constantly on the alert against usurpation of prerogative. It is because there has occurred a delegation to other and less competent hands of duties that should be performed by the architects themselves, and an absence of personal service.

The lessons taught by these things, if we are to judge by the temperamental attitude of the recent convention, have been thoroughly learned. There is less chance for the would-be aggressor to encroach

on the professionalism of architecture than ever before, because he will find that architects are now so wide awake, so much better organized, that any attempt to rob them of their rights and privileges will not only be individually repelled, but also that the Institute, carrying forward its new policy, will lend its aid in such instances.

### A False Argument

IT is curious to observe how some men will borrow another's argument on a certain topic in no way related, to bolster their own contentions. For example, some delegates on the convention floor urged that the lowering of the initiation fee to ten dollars would result in attracting to the Institute a lot of undesirable men, that a low initiation fee meant a low standard of membership. This is reminiscent of a campaign slogan of some years ago that a cheap suit meant a cheap man.

It is the young and promising men in the profession whom the Institute needs to attract. If they find it difficult to set apart a considerable sum from a not too adequate income to maintain their Institute membership, they certainly will not seek that membership.

President Kimball in his address stated the case very clearly when he said: "I am confident that architecture—the Art I mean—can never come into its own until some way has been found to make it easier for the young man in the profession to earn an honest living. Surely he can not hope to contribute much to art while 90 per cent of his time and energy is required to keep the wolf from the door."

Paternalism is obviously one of the duties of the Institute. In its highest expression it may help the young man of demonstrated ability toward progress in his profession. If it builds a stockade about itself, it makes it impossible for the young man to become affiliated. It should, by promoting association with men of this class, encourage them in their work. If it does not do this it will have lost a great opportunity.

It is a pity this motion to reduce the initiation fee was not carried. It would have materially aided the campaign of recruitment.



# New Houses for Old

Alteration of House of O. L. Schwenke, at Bay Shore, Long Island, New York

DWIGHT JAMES BAUM, *Architect*

(For additional views see plate section)

THE structure was originally of that most unattractive middle period, partly erected about 1840, the greater part in the Queen Anne style, with jigsaw work, narrow front porch, and upright batten treatment on the service extension.

The house and land were purchased for a price which practically ignored the standing old buildings and the alterations, which were very extensive and included all the newer conveniences, cost one-half the price of a new house of similar size and requirements. The charm of the old place was there to be enhanced by well studied restoration.

The Schwenke house stood on brick piers, the first floor about three feet above the level ground surrounding the building. The building consisted,

as shown in its original state, of a long house with a large dormer, which, luckily, had the same height and width as the one on the end of the main building. This, together with the fact that the main cornice was not broken but carried straight through, gave the architect the idea by which the entire house was greatly simplified. The large front gable was removed bodily to the left end, the smaller dormer removed from the main roof, while the entire roof was reshingled with hand-hewn cypress shingles laid wide to the weather, with courses narrowing in width as they approached the ridge.

The three central windows on the second floor were raised to line up with the others, and flower boxes were added to two of these. The old jigsaw-





## THE AMERICAN ARCHITECT

decorated porch was completely obliterated and a simple pedimented portico with seats on each side was built. A new doorway with leaded glass side and fanlights was installed, completing the entrance treatment. A new grouping of windows was arranged on the first floor, while porches were added at each end, giving length to the house besides real comfort to the occupants.

The main transformation was secured by taking



HOUSE BEFORE ALTERATIONS

the fill obtained from the new excavation under the main house for a cellar and using this to form a terrace around the house. This had the effect of lowering the entire house. As rich loam was not obtainable along the south shore, this had to be hauled from the center of the island. After about

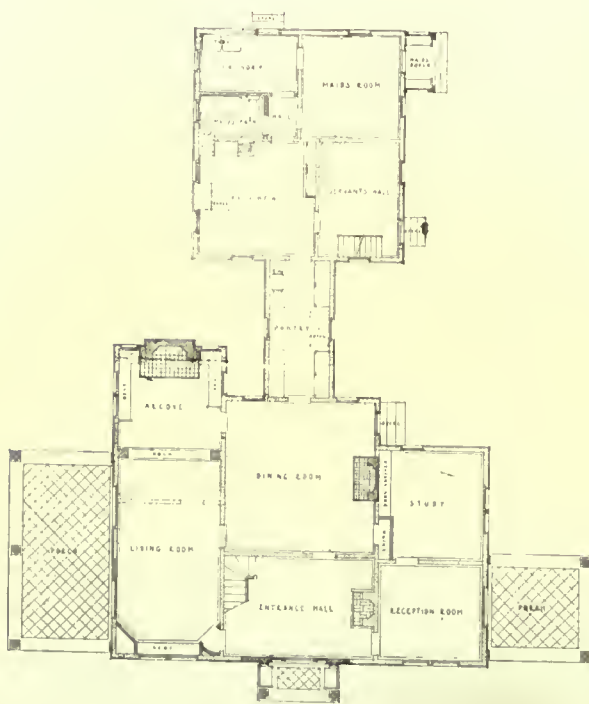

FIRST FLOOR PLAN

a year's constant search all over Long Island, the beautiful box bushes and hedges were assembled and planted, giving an aged appearance to the restoration, and taking away whatever newness there was in the finished effect.

The interior was given many changes; for instance, there was originally no cellar under the house, there being only a small excavation under the kitchen extension. This work was improved with modern hot water and electric lighting facilities throughout, modern plumbing with tile bathrooms, etc. The original and the usual two parlors were made into one large living room to do

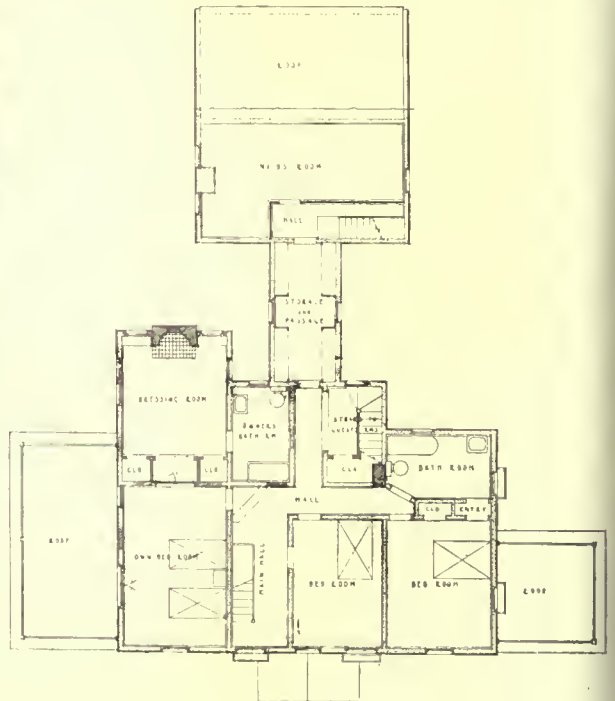

SECOND FLOOR PLAN

away with the long, narrow appearance, and an alcove with fireplace seats was built. A fireplace was also added in the former bedroom above, which was changed to a dressing room, opening by French doors to the owner's bedroom.

To the dining room was added a large fireplace with hanging crane, after the manner of the older kitchens. Wherever possible the old trim and doors were retained, repairing and adding to them to complete the old effect; lighting fixtures and hardware were specially designed to carry out this treatment.

It is intended at some future time to lay out a small formal garden on axis with the living room porch, and to build a new stable with chicken runs, etc., in keeping with the house at the rear of the building.



PLATE 156

ALTERATIONS TO HOUSE OF O. L. SCHWENKE, JR., BAY SHORE, LONG ISLAND, NEW YORK

DWIGHT JAMES BAUM, ARCHITECT







PLATE 137

ALTERATIONS TO HOUSE OF O. L. SCHWENKE, JR., BAY  
SHORE, LONG ISLAND, NEW YORK

DWIGHT JAMES BAUM, ARCHITECT







PLATE 158

ALTERATIONS TO HOUSE OF O. L. SCHWENKE, JR., BAY SHORE, LONG ISLAND, NEW YORK  
DWIGHT JAMES BAUM, ARCHITECT













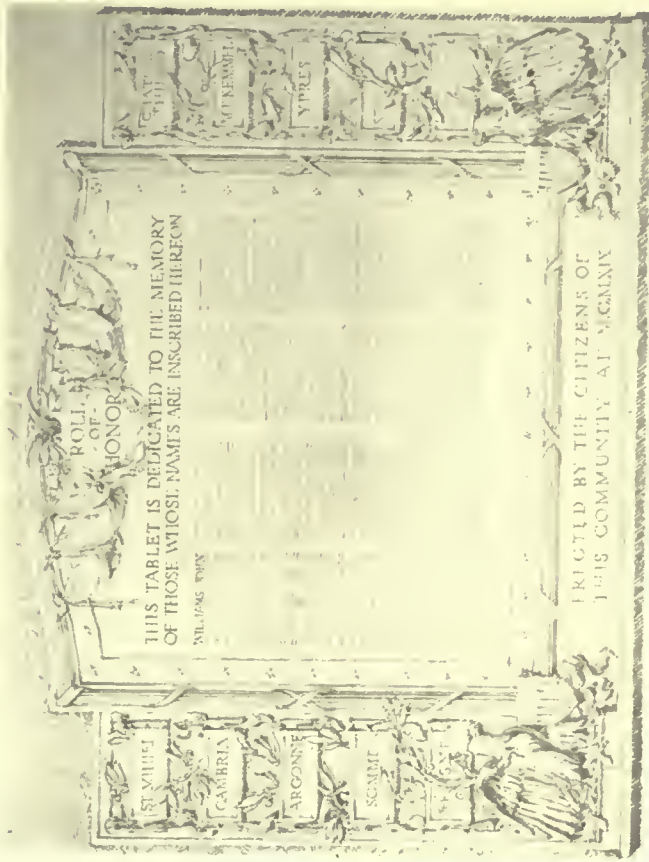





PLATE 161

THIRD AWARD TO D. M. ALLISON, URBANA, ILL.



FOURTH AWARD TO RUDOLPH HOLSTEIN, NEW YORK CITY

COMPETITION FOR A MEMORIAL TABLET HELD BY THE JOHN POLACHEK BRONZE & IRON COMPANY, NEW YORK





# Current News

---

## Registration of Michigan Architects

A bill has been passed by the Michigan legislature providing for the registration of architects, engineers and surveyors. Persons desiring to practice in any of these fields are hereafter to be registered by a board to be appointed by the Governor of the State and to be composed of three architects and five engineers.

Those who have for two years prior to the adoption of the act been engaged in active practice in these fields shall be registered without examination in the particular branch in which their qualifications lie.

Persons hereafter to begin practice in these professions shall pass an examination in the English language and in such other subjects as the board shall deem appropriate. Those of recognized standing, resident in other states, may be admitted without examination.

After the building season of 1919, no public work of an architectural or engineering character, the completed value of which totals \$2,000 or more, shall be undertaken by the state, or any division thereof, unless the plans therefor shall have been prepared by a registered architect or a registered engineer.

No restrictions are put upon carrying on architectural or engineering work for private parties by persons who do not call themselves architects or engineers. The act repeals the previous act for the registration of architects and provides that all registrants under that act shall be considered as registered under the new.

---

## Safeguarding Civic Beauty

With the resumption of building operations following the wartime slump, the Fifth Avenue Association of New York is planning a vigorous campaign to prevent any more large apartment houses being erected in the residential part of Fifth Avenue. A meeting of the Board of Directors held in the Bankers' Club saw the appointment of a special committee to inaugurate and carry on the fight. Elbert H. Gary was selected as one of the members, and Michael Dreicer, President of Dreicer & Co., as its chairman.

"If the building of these huge, unsightly structures continues, the most famous avenue in America will be ruined as a street of beautiful and exclusive residences," Mr. Dreicer said. "When the construction of one of these apartments commences, the value of adjacent land and properties immediately goes down, in many cases as much as 50 per cent.

"As members of the Fifth Avenue Association, we are anxious to see the beauty and fame of this avenue retained, but our interest is from a civic and not a mercenary point of view, for we are not the land owners concerned. The financial concern is theirs, and we should like to have them, and all others who are interested in the preservation of the avenue, communicate with us and join the fight. After all, it is a matter in which the people of the city at large should take great interest, for every New Yorker is directly concerned.

"What we hope to accomplish is to have the Board of Estimate rule that no building of more than 75 feet in height shall be constructed on Fifth Avenue between Fifty-ninth and Ninetieth Streets, with the same regulation for the side streets between Fifth and Madison Avenues in this

sector. The association, however, has attempted to accomplish this before; and it cannot be accomplished without public support and real public effort."

Mr. Dreicer said the fact that the law permits construction of high apartments on Fifth Avenue affords real estate men an opportunity virtually to blackmail owners of expensive private homes on the avenue, in that the former were able to purchase adjoining or nearby property and then threaten to erect apartments unless a high price were paid for the land concerned by those most interested in escaping the immediate presence of an apartment.

Lawson Purdy, formerly Vice Chairman of the Zoning Commission, attended the conference as an adviser and said that the commission would have recommended limiting the heights of buildings in this section several years ago had the property owners concerned taken an interest in the matter.

---

## France Chary in Rebuilding

Paris correspondents of New York newspapers, writing on the question of Americans being permitted to take part as business men in the rebuilding of northern France, express the opinion that sentiment is divided about permitting this country to aid. Some believe that the French Government will throw a protective wall around the devastated regions and admit only builders of their own nationality, on the theory that whatever profit is to be derived out of the reconstruction ought to go to those who have suffered most on account of the war.

One writer states that each side has its defenders and that each is eloquently sustained. He says there are signs that the "anti-wall" crowd will win and that France will welcome both American gold and American organizers and builders.

The thesis of the protective wall faction is that France is in such a run down condition as the result of war that her industries are scarcely in a position to fight successfully against their brothers from America. Americans, with their huge factories, cheap raw materials and superior organization, can build machinery such as is needed in the mills of northern France more quickly and cheaply than can be done in France, and that such being the case there is a danger of Americans—and the English, also a great industrial people—running away with the business of starting up northern France again, pocketing the profits and leaving the Frenchman in the position of Mother Hubbard's well-known dog.

The "antis" use the same argument, but with reverse English. They admit much of the reconstruction business would be captured by Americans and British because they are in a position to do the work without delay, but—and here is the whole point—it is greatly to the advantage of France as a nation that there should be as little delay as possible. They point out that Germany has not been damaged by shellfire; that her mills are in a going condition; that, in order to keep the economical life of Germany moving, German industries must be permitted to start up as soon as possible—otherwise the Germans will not be in a position to meet their own home expenses, let alone pay the huge debt they owe the Allies as the result of the war.

This being the case, with German industry grinding full



## THE AMERICAN ARCHITECT

blast, French industry must likewise hurry full speed ahead and at once, otherwise it will be hopelessly outdistanced.

A high French official of the Ministry of Reconstruction asserted that American co-operation would be welcome in France, thus forecasting the victory of the open door faction.

"The real opposition," he said, "comes from the interested parties, those who wish personally to profit through enterprises undertaken in the north. The opposition is not national. France realizes she absolutely must have this co-operation and France and America will find a way. And there is ten years of intensive work rebuilding the devastated regions, ten years of it for all of us working hard together, Americans with the rest."

---

### America Must Wake Up in Industrial Art

"America is an industrial nation without an industrial art," declared Dr. James P. Haney at a recent lecture in the Art Institute of Chicago. "We have the talent, but lack the training," he stated. Dr. Haney is director of art in the high schools of New York.

"This country," he said, "has never awakened to its need for trained designers. We have schools for the training of painters and architects, but no great group of public schools like those of continental countries, prepared to give fundamental instruction in the design and craftsmanship of the art trades. This lack on our part is going to cost us dear in the world-wide reconstruction of trade following the war."

Heretofore, we have depended entirely upon artisans from abroad. The war has curtailed the number of designers needed to supply our various industries. France, England and Germany are doing all they can to conserve every ounce of their own talent and prepare it for the commercial struggle ahead. Dr. Haney says:

"It is the adolescent, the young high school boy and girl, who is now looked upon through European countries as one of the most precious assets of the state. The adult adapts himself with difficulty, but the adolescent can be shaped and formed to meet new conditions. These new conditions are coming in different ways within the next decade, and that state is wise which uses its mobile youth to meet these changes. Now is the time to train our talented."

We need not experiment, says Dr. Haney. The large number and varied quality of industrial art schools abroad make it only necessary for us judiciously to select from the methods already employed, and adapt them to American uses. England is covered with a network of great industrial art schools, some forty in all. France is similarly provided with over thirty large city schools, and scores of local schools of design. Paris alone has a dozen craft schools, headed by the great institute of design named after Bernard Palissy.

A survey of our industries reveals over a hundred trades requiring trained designers, and many of them affect architecture directly, or are closely related to its nearest allies. Certain of these will be found in a great group under the heading of textile workers, rug and carpet weavers, and linoleum makers. Another group will be found under graphic arts: printing, lithography, commercial design, makers of posters and of book covers. The metal working division includes silver and goldsmiths, bronze workers, and designers of lighting fixtures. The wood working

group takes in carvers, cabinet makers, and designers of furniture and picture frames.

The interior decorators form a division in themselves with a dozen departments, all requiring trained talent. There are besides a score of miscellaneous trades: china decoration, lace making, enameling, wallpaper making, millinery, embroidery, stonecutting and mosaic work. Each one of the trades has a design technique of its own, and for each the designer must have some general preparation followed by specific training in the business itself.

Accordingly, Dr. Haney very properly states that our need for industrial art schools is pressing. Foreign schools offer examples which we may study, but exact duplication is undesirable. The indications, he believes, are that two types of schools are necessary: The "general" industrial art school and the "special" school.

The general industrial art school is one which admits its pupils at the age of sixteen or seventeen, and keeps them for three or four years in a course offering all forms of practice in drawing, design, and color. After this preparatory work, the student pursues two years of special training as a designer for a particular industry.

Aside from the fact that foreign states can no longer supply us with designers, America should learn to depend upon her own resources in industrial arts. Any other course would be inconsistent with her high ideals of national pride.

---

### Private Capital and New Construction

That the small investor is to be more than ever before in financial history an important factor in the financing of building in the United States is the opinion of Walter Stabler, comptroller of the Metropolitan Life. Mr. Stabler is quoted to the effect that large mortgage lenders will not be plentiful in the market, and borrowers must look to small investors whose participations may be pooled under the trusteeship plan.

Replies to a comprehensive questionnaire, recently distributed to a selected list of representative institutions throughout the country, indicate an absolute decrease during 1918 of funds available for investment in real estate mortgages, and indicate also a relative decrease since 1914 of funds so invested compared with the total resources of the institutions considered.

It is essential, in the opinion of the Department of Labor, to devise ways and means of availing of the small investors' capital, and for that reason the American Bankers' Association's plan, advocating the adoption of amortization schedules for real estate loans, together with the building and loan associations' agitation for a Federal system of "home loan banks," have challenged the sympathetic interest of the Labor Department.

Just how to gather the comparatively small amounts of capital held by the small investors, and marshal them in amounts necessary to finance extensive building projects is a problem which must be met by local initiative where the problem arises.

The Division of Public Works and Construction Development points out that the small investors were the balance of power necessary to the success of the Government's war finance program, and they may now be made the balance of power in the reconstruction work of the nation.

The home builder—he who builds for his immediate use rather than for rental purposes—appears to be getting under way with his building plans. This especially is noted

## THE AMERICAN ARCHITECT

in the Central West. The home building program will be facilitated and augmented if small investment money is made available for building loans.

In one or two communities this is being attempted by private organizations, brought together for this sole purpose. In other and more numerous cases the regular banks are giving thought to the problem.

The building and loan interests already have formulated a plan under which a system of Federal home loan banks would enable them to rediscount their first real estate mortgages, and make available for further loans more than a billion dollars of their assets.

---

### Workmen's Houses in Britain

E. Y. Bragger of Edgewood, Rhode Island, a specialist in concrete construction and representative of a large cement company, just returned from a visit to England in connection with the housing problem that now faces the British Government, reports that a serious condition exists in the home life of the working class.

Baths are almost unknown, he says. The open fireplaces and stone floors with earthen or small galvanized iron tubs have little attraction for those who desire to bathe. Consequently, many go without a bath for a long period.

The more prosperous families who possess a bathroom often rent it to a neighbor who is less fortunate. He finds that several of the larger cities conduct public bath-houses, where a bath may be obtained for a small fee. Many of the better class houses have a bathroom but no running water. Toilets are erected in the yard with no water connection.

Dampness is very pronounced in nearly every home and walls are damp continually.

The British Government fully realizes the serious conditions that exist and is considering various methods to improve the home life of its people. The architects and engineers connected with the local Government board, including the office of Sir Frank Bain, principal architect to His Majesty's official work, are very much interested in American construction work and desired to know more of the possibilities of American material.

---

### Home Improvement Week

A fine example of co-operation was to be seen in the recent "Home Improvement Week," held in Indianapolis. The object, as might be surmised, was to present an opportunity for gathering new ideas and suggestions for improvements in the home.

The plan was part of an extension course conducted by Purdue University and was a state-wide movement in connection with the home economics department.

Local merchants gave their co-operation and many had on display model rooms and various articles pertaining to the household.

To show how things should be done, a visual stimulus of this kind is very valuable. It causes discussion, and creates desire, which is the first step toward accomplishment. The fact that this had its inception in an institution like Purdue University is of particular interest. It serves as an instance of the practical aspects which education is more and more receiving and gives a feeling of confidence in the authoritative and competent carrying out of the undertaking.

### Giving the Builder a Chance

A recent editorial comment in the Brooklyn (N. Y.) *Eagle* discusses interestingly the present housing problem from the standpoint of the builder. A man, it states, will not want to build unless he can raise his rents enough to get back the extra costs due to high prices. In that case, he must compete not only with old apartments built at the cheaper figure, but he may have to compete also with the new ones to go up next year, should there be a sudden slump in the cost.

Continuing, the article goes on to say that some few builders take those chances, relying on special attractions which they may devise. More men would take them because the American business man is naturally adventurous and daring in his pursuit of fortune, but there is arising the fear of governmental interference in the shape of the arbitrary limitation of rentals. The danger comes from the agitation about profiteers and the wild rush for remedies which is being entered upon by politicians and philanthropists.

A good analysis then follows:

The speculative builder is accustomed to taking his chances with the natural laws of the market. He has studied them and can foresee their operation with reasonable accuracy. But governmental interference knows no law. It is invoked to meet a temporary need and it is empirical in the choice of remedies under emotional stimulation. It may take the form of wholesale city building, of a limit in the price of rents or in taxation of income from rents above a certain figure. In the face of such possibilities the builder discharges his men and lives on such money as he can raise until the storm blows over. Government aid to building may be necessary here, as it is in England, but it should take the form of making credit easier for builders and of encouraging them to resume their activities of six years ago by providing some sort of assurance of a living income from the houses they may put up.

---

### Building Optimism Grows

Dun's reports \$51,782,000 in building permits for March, which was 54 per cent above March, 1918, says *Business Digest*.

Housing is becoming everywhere increasingly scarce and expensive, so that with any sort of reasonable indication of price and wage stability in the building field, new construction will undoubtedly begin and will probably reach unprecedented proportions. The Government's proposed home and loan fund plan which, it is claimed, will do for the would-be house owner what the Federal farm loan banks are now doing for the farmer, has met with general approbation. Anything that will make home-owning easier is undoubtedly desirable, socially and economically; and nothing would do more at this time to stimulate what has been for four years (except for a Government construction) an almost dormant industry.

Building is a basic industry; normally it is a flourishing and profitable one. Just now all signs point to an approaching boom. The recent Seattle home building campaign shows how easily local booms can be started. The campaign, which was fostered by the Seattle Commercial Club and Chamber of Commerce, lasted only five days, but it created such a phenomenal stimulus to building that 3,700 new homes are now under construction in that city.

Securities based, directly or indirectly, on construction requirements, as a class, "look good" about now.



## The Dishonest Memorial

In the annual report of the Art Jury of Philadelphia, made by its president, Joseph R. Widener, to the mayor of that city, he warns the public that adept salesmen are abroad, seeking to take advantage of the patriotic impulse to invest in war memorials, and he foresees that Philadelphia, in common with every other city and town in the United States, will have offered to it many designs for monuments.

It is firmly stated in this report that no memorials whatever will be accepted and approved by the Art Jury unless they possess unquestionable artistic merit. As all monuments are intended to last as long as the city itself, quality is essential and nothing but the best can be approved by the official experts.

The public is further cautioned against stock model and ready-made monuments, also against any advertising on the monument of the individual or organization which caused it to be erected.

These warnings are timely and of more than local application. To perpetrate anything at all dubious in purpose or result would be to oppose the whole aim of the undertaking.

## Rush Building to Cut Down Rents

It is expected that there will be no time lost in beginning the erection of apartment houses in New York City through the use of private capital as a result of a definite plan for the stimulation of building on a scale comprehensive enough to remedy the apartment shortage by next winter. The plan, the result of efforts of the Executive Committee of the State Reconstruction Commission, includes apartments which will provide homes for families able to pay from \$30 to \$40 a month, and at the same time will include improvements in accommodations which have been worked out from the experience of the United States Government in housing war workers. It is also understood that enough money has been assured to finance the project, and that it will be carried to completion in time to provide for a large majority of the men and women of New York before the cold weather sets in next fall.

The detailed plan will be presented to the public within a few weeks. Tax Commissioner Hirsch expresses himself as being optimistic as to the effect which the work of the committee was having upon the landlords. Many have gone to Mr. Hirsch and declared that they would not attempt to enforce the demands they had made upon their tenants to take effect on May 1. When the situation was placed before them, they seemed willing and anxious to co-operate with us.

Another angle of the situation was pointed out by Mr. Hirsch. It appears that some owners are attempting to evade the responsibility of increasing rents, and the consequent possibility of being called before the committee, by leasing out their rents. In this way they are enabled to share with another immense profits and at the same time be safe from investigation.

In peace times building ran anywhere from two to three years ahead of the demands of the population; free rent and filled coal bins used sometimes to be offered to fill up apartment houses which speculative builders were anxious to sell. Now that there are fewer apartments than families, of course, tenants bid against each other for desirable quarters and landlords raise their rents not always on the basis of a fair income from the property,

but on the difficulty of their tenants in finding another place to move to.

The cure for that state of things is not more law, but more building, states the *Brooklyn Eagle*, New York, and two committees of the State Reconstruction Commission recently held a meeting during which they decided to call a conference of the business and financial interests of the city to stimulate a campaign of apartment building as a means of promoting general prosperity for the city as well as for meeting the needs of the people who cannot now find homes. Ordinarily there would be no need of such an official impetus. Builders have been only too ready to take risks in the past, but now the high prices of materials and labor hold them in check. Before they start building this year they want some sort of assurance that they could not have done the work for two-thirds of the money if they waited till next.

That situation is not confined to New York. It is so widespread that one of the Federal agencies in Washington is trying to deal with the problem in the same spirit as shown by the State Reconstruction Commission. One of the officials there calls it "a psychological hold up," based on the belief that prices of labor and material will be cheaper next year. He insists that this belief is mistaken and that prices will not be enough lower to give any advantage to builders who wait. It is clear that both the need of finding work for returned soldiers and of finding homes for the growing population of the cities would be met by an immediate campaign of building. We have not reached the point of a national housing commission as they have in England, nor of pledging the national credit for the erection of more homes, as they are doing to get rid of their slums in London. But we may come to that unless some simpler way is found to start building on a large scale. There has already been excited talk about putting tents in the parks for the evicted, and if such a step should become necessary the demand for either a Federal or a municipal building plan on a large scale would grow to formidable proportions.

## Issue Bonds to Promote Exports

The War Finance Corporation has announced the issuance of \$200,000,000 worth of 5 per cent bonds to enable the furtherance of American export trade.

The new bonds will be put out in denominations of \$1,000, will be payable in one year, and will bear interest at 5 per cent. They will be exempt from State and local taxation and will also be exempt from taxation by the United States, with the exception that they will be subject to estate or inheritance taxes and to surtaxes and excess profits taxes now or hereafter imposed by the United States upon the income or profits of individuals or corporations. Another important tax exemption relating to these bonds is that the interest on \$50,000 worth of them owned by any person will be entirely exempt from all income taxes, surtaxes, excess profits, or war profits taxes.

## George Tremaine Morse

George Tremaine Morse, born in Plainfield, N. J., in 1874, died on April 25 at Saranac Lake, N. Y. He devoted his life to the practice of architecture for which he studied in the Polytechnic Institute in Brooklyn, Columbia University, and the Ecole des Beaux Arts, Paris.



## Prices Doubled Since 1914

The average prices of articles bought by farmers in 1918 is estimated by the Bureau of Crop Estimate to be about 32 per cent higher than in 1917, about 97 per cent higher than in 1914, and about 108 per cent higher than prices of articles bought by farmers in 1909.

Prices of articles which farmers sell were only about 14 per cent higher in 1918 than in 1917, but about 97 per cent higher than in 1914. That is, since 1914 the prices of articles which farmers buy and prices of articles which farmers sell increased in about the same proportion. Farmers' products were the first to advance, but other products during the last year have overtaken the advance of farm products. Thus from 1914 to 1917 the advance of farm products was about 74 per cent as compared with an advance of about 49 per cent for articles farmers buy, but in the last year the increase of farm products was as stated only about 14 per cent compared with an advance of 32 per cent for the other articles.

Detailed comparisons of prices of many articles bought by farmers are obtained from about 5000 dealers throughout the United States by the Department of Agriculture. Schedules asked for average prices in 1918 and 1917. The inquiry a year ago asked for prices in 1917 and 1916. Therefore two sets of averages are obtained for each year. When the two averages differed an adjustment was made by adopting approximately the average of the two.

## Farm Land Values Rise

The value of farm lands is increasing steadily in the United States, the average for average grade plow lands being about \$74.31 per acre, as compared with \$68.38 a year ago, \$62.17 two years ago and \$58.39 three years ago.

Greatest percentage increase in values during the last year occurred in the South Atlantic States, in the Carolinas and Georgia, and extended to Alabama, Kentucky, and Arkansas. Small or no increases were made in the New England States, the Pacific Coast States, and Louisiana, Texas, Kansas, and Montana. Material increases were reported from Nebraska and South Dakota.

Iowa stands first in value of plowing lands, her average being \$169 per acre, followed by Illinois with \$144, California with \$121, and Indiana with \$100. Alabama reports the lowest average value of plow lands, at \$24 per acre, and Mississippi next, at \$25.50.

Average farm land in New York has increased from \$53 an acre to \$60 in three years, while in New Jersey it has risen from \$65 to \$76. In Connecticut the advance has been from \$49 to \$55, and in Massachusetts from \$62 to \$68. Iowa not only has the dearest land, but in three years it has advanced from \$135 to \$160. Pennsylvania farmers have gained exactly 20 per cent by natural increment, the rise being from \$50 an acre to \$60.

## Homes for Standard Oil Employees

Employees of the Standard Oil Co. in Elizabeth, N. J., are to have an opportunity to own their own homes. After a conference between a committee of the company and a committee of employees an option was obtained on a tract of land comprising 35 acres, easily accessible by trolley. Plans were then drawn for several types of houses, the cost of each being \$3,000 and upward, and the property was procured. These houses are to be

sold to employees on a monthly payment basis, the property to be managed jointly by a committee of the company and a committee of employees, which will finance the project on a 5 per cent return for the capital, no profit being sought. Work will be begun at an early date.

## First American Built Battle Plane Placed in National Museum

The first American built battle plane, the DeHl. 4, now is on exhibition in the National Museum in Washington. The machine, built at the Dayton-Wright company's plant in Dayton, was completed in September, 1917, and was the first plane flown with a Liberty 12 motor. It was adopted by the government for use by the American Expeditionary Force in France as a day bomber and observation plane. In all, more than 2500 experiments ranging from motor tests and different propellers to slight changes in control surfaces, have been made on this machine. It has been used in more than 4000 flights, has been in the air 1078 hours and has traveled more than 111,000 miles, but with the exception of a patch on the landing gear and a new section on the side cowling, there have been no repairs made to the craft. As exhibited the plane carries full equipment, including machine guns and wireless.

Despite its weight of 3800 pounds with a full load and armament, the DeHl. 4 has developed a much higher speed than 122 miles per hour, and when sent up with a light load for combat work was able, it is said, to attain at 1700 feet a greater speed than any other ship used in the war.

## A Larger—"Largest" Hotel Proposed

The present record for size in hotels now held by the Pennsylvania in New York is soon to be exceeded by the work of the same architects.

Plans have been prepared by McKim, Mead & White for an immense hotel of twenty-four hundred sleeping rooms and twenty-four hundred baths to be erected in Atlantic City, N. J., on three blocks of beach frontage at Albany Avenue, Chelsea. A theater and swimming pool are incorporated in the designs, as well as other novelties.

The proposed site is owned by the Philadelphia and Atlantic City Improvement Company.

## Personal

Albert C. Wirth, architect, has opened offices in the Banner Building, Greensboro, N. C. Manufacturers are requested to send literature and samples.

Charles Archibald, architect and civil engineer, St. Johns, N. B., Canada, late of Department of Militia and Defence, is opening offices in the Ritchie Building of that city, for private practice. He desires to receive manufacturers' samples and catalogs.

A partnership for the practice of architecture has been formed by Floyd F. Glass and Ernest W. Austin, under the name of Glass & Austin, architects and engineers, with offices at 55 East State Street, Columbus, Ohio. Samples and catalogs are desired.

# Late News from Architectural Fields

*Special Correspondence to THE AMERICAN ARCHITECT*

## Urge Code Changes to Aid Construction

PORTLAND, ORE., May 12.—As an aid to the stimulation of building in this city several amendments to the housing code have been agreed upon by members of the Portland Housing Association for presentation to the city council. The amendments will be in the form of modification which will avert much of the criticism directed at the code by Portland architects.

One amendment will allow development of an entire block for apartment houses without requiring a rear yard, as under the present code. Not more than 60 per cent of the ground area of the block may be used under these modifications, however, it being the purpose of the code to have restrictions which will force the builders of apartment houses, hotels and rooming houses to provide ample light and ventilation.

Under the present housing code rows or terraces of single or double family dwelling houses are barred entirely, through a provision which requires side yards. This provision has resulted in much dissatisfaction and H. E. Plummer, chief of the city bureau of buildings, after making extensive study of how similar situations have been handled elsewhere, prepared an amendment to modify the provision.

Under his amendment side yards will not be required when rows of dwelling houses are built, provided that not more than 40 per cent of the lot area is used. This can be done, even by building the rows of dwellings without side yards as the yard area needed can be provided in the rear and front of the houses.

## Models Prepared for Home Builders

MINNEAPOLIS, MINN., May 12.—Six model homes have been planned by architects of the Minnesota Chapter of the American Institute of Architects and will be erected on two and one-half blocks of lots on opposite sides of a city street, to give persons planning to build this spring and summer opportunity to view them before selecting their plans and making financial arrangements for actual building operations. Forty plans are available, and blueprints of any of these are furnished at a nominal cost. After the model homes are built, landscape experts of Minneapolis will furnish plans for beautifying the grounds.

The Minneapolis Real Estate Board and Builders' Exchange, who are in charge of the plan to stimulate building in this section, will also have a permanent building material exhibit at the Builders' Exchange. Prospective home builders will have every opportunity to become posted on any building information. The exhibit will include all kinds of doors and just how they are made. All kinds of woods and the effects of stains on woods will be shown. One exhibition will give proper methods of insulation. There will be an elaborate exhibit of hollow tile construction, and also a model kitchen and laundry and a library for moderate cost houses.

## Ask Federation's Aid in Planning Memorials

WASHINGTON, D. C., May 12.—The American Federation of Arts has received many requests for appropriate designs for memorials. State and civic bodies determined to honor the men who served in the Great War have sought the advice of the Federation in an effort to formulate plans for their tributes to the fighting men.

The Indiana State Chamber of Commerce in a communication to Miss Leila Mechlin, secretary of the Federation, with headquarters at 1741 New York Avenue, Washington, D. C., requests the assistance of the organization in designing memorials throughout the state. The Chamber of Commerce organized a special committee in Indiana, one member from each Congressional district, for the purpose of securing legislative action on memorials. The subcommittee drafted a bill which was later adopted by the state legislature. It provides that any taxing unit, city or county, upon proper petition can have spread on the tax rolls a tax levy to bond or retire sufficient money for memorials in the form of community houses, library, hospital, auditorium or some other public building. Hammond has already passed the bill and twelve other Indiana cities are preparing for similar action.

The Mississippi Memorial Association proposes a \$500,000 memorial fund. It has announced its intention to consult with the National Memorial Commission, represented by the Federation, as to the location and form of the Memorial Hall.

A communication from the El Paso, Tex., memorial committee, asks the Federation to suggest landscape architects to prepare plans for a memorial park. The committee points out that the architects competing for this project must have a wide knowledge of the climatic conditions of the arid West.

It has been definitely decided to reclaim some twenty-three acres in the residential section of El Paso. A memorial in the form of a grove has been approved by civic organizations. A tree will be planted for every man who answered the call for service. The heroic officers who died for their country will be remembered. The city plans to name the walks in the memorial grove after some prominent officers.

## American Lumber Stocks in France

WASHINGTON, D. C., May 12.—All sawmills which have been established in France by the Army Engineers of the United States have been shut down except the eleven mills operating in the fire-killed timber in the Landes. These mills will be in operation until about the middle of May.

The surplus stock of road plank, bridge timbers, and other thick lumber is being remanufactured at several plants into inch and two-inch dimensions for current army requirements. Contrary to expectations, the demands of the army for timber have kept up to a surprising degree and will use up all the stock on hand.

The material is needed for improvements at the large embarkation camps, for packing material and all sorts of



## THE AMERICAN ARCHITECT

structures at the divisional areas. Even the products from the fire-killed timber, the operations in which it was thought would be turned over to the French, will be used by the A. E. F. Some material will probably also be furnished the Belgium Relief Commission.

Many vexatious delays are being encountered in the settlement of the forest purchases. An adjustment of purchase contracts for timber which was but partly cut is under way to make the A. E. F. pay only for the timber actually cut.

---

### Abandon Housing Plan in New London

The United States Housing Corporation has abandoned its entire housing project at New London, Conn. As many as 116 houses, badly needed and all but 3 per cent completed, have been closed and no further effort made to finish them.

This was the culmination of weeks of futile negotiations with the New London engineer in charge of water and sewer connections. His attitude in insisting that the housing corporation abandon a modern plumbing installation for one more expensive and obsolete compelled the corporation to forego any return on a large investment which prevents more than 100 New London families from enjoying modern homes. L. K. Sherman, director of the Bureau of Industrial Housing, said in ordering the abandonment of the project:

"We are not going to proceed as violators of the law, but we have decided to abandon the entire New London development rather than submit to the injustice of an archaic, obsolete and unwarranted plumbing code that adds to the existing high costs to burden the home builders, owners and renters. We will not be consistent in our relations with the numerous other municipalities which permit the simplified plumbing if we relinquish the same class of plumbing in New London. We cannot justify ourselves in establishing a precedent there for expenditures which increase the cost of plumbing to the home owner and which are not warranted by sanitary requirements."

---

### Wide Interest in Arts Convention

Considerable significance is attached to the address of the Hon. Charles D. Wolcott, secretary of the Smithsonian Institution, before the American Federation of Arts at the tenth annual convention to be held at the Metropolitan Museum of Art, New York City, May 15, 16 and 17. He will discuss the need of a national gallery of art in Washington. It is expected that his talk will have the influence necessary to inaugurate a nation-wide movement among artists and art patrons for an appropriate building to house the country's art treasures.

The most distinguished patrons of art have been invited to the convention. Their influence in national affairs may have the desired effect of bringing Congressional action for the maintenance of a National Gallery. The plan is to bring public opinion to bear on the legislators to such an extent that Congressional appropriations will be made permitting the construction of a building worthy of the nation and the works of art it will store.

By charter, the Smithsonian Institution is recognized as the custodian of the National Gallery of Art. The National Museum has become overcrowded with the many acquisitions. The problem which confronts the Institution

now is to secure adequate accommodations for new collections.

One entire day, May 15, will be devoted to the subject of War Memorials, when the delegates assemble in the Metropolitan Museum lecture hall. A reception will be held on the preceding evening. Charles Moore, chairman of the general committee on War Memorials and chairman of the National Commission of Fine Arts, will open the discussion. He will be followed by Edwin H. Blashfield, N. A., mural painter, past president of the National Institution of Arts and Letters. Frederick Law Olmstead, A. I. A., landscape architect and member of the Washington Park Commission of 1900, will be the third speaker at the morning session.

The subject will be continued in the afternoon when the Hon. Elihu Root will address the assembly. Cass Gilbert, F. A. I. A., past president of the American Institute of Architects, Harold S. Bottenheim, secretary of the National Committee on Memorial Buildings, and Morris Gray, president of the Museum of Fine Arts, Boston, will outline their views on the subject.

The delegates will be accorded the privilege of visiting the private collections of former Senator William A. Clark, J. P. Morgan, Mrs. H. O. Havemeyer and Henry Frick.

The general subject for the second day will be "The peace program of the Federation—its opportunities, the extension of its activities." The third day will be devoted to a discussion of "Art and the Nation."

---

### Many Disabled Soldiers Studying Architecture

There seems to be a general impression that vocational education means a manual trade, and a good many disabled soldiers have at first rejected the idea of taking the training available to them through the Federal Board for Vocational Education on that account. Such is by no means the case, and the list of men already in training shows a considerable portion of the number to be pursuing strictly professional courses.

For instance, there are 24 studying architecture; 30 taking chemistry; 21 dentistry; 68 drafting; 178 engineering; 2 are taking a course in foreign trade; 9 are studying journalism; 7 are taking languages; 61 are taking mechanical drawing; 8 are studying music; 2 are qualifying as opticians; 49 are studying law; 8 are qualifying as teachers; 4 are studying theology; 3 as veterinary surgeons; and 8 as wireless operators.

---

### Bank Loans Increase in Washington

WASHINGTON, D. C., May 12.—Washington banks by their new plan of co-operation with building contractors, have provided a much needed stimulant for construction. A survey of the financial situation in the District of Columbia shows that banks are now lending at least 10 per cent more on building than heretofore. They have apparently accepted the general view that no reduction in building prices can be expected this year.

Architects having many deals held up through the failure of contractors to secure loans look forward to renewed activity as a result of the bankers' attitude. The banks have indicated their willingness to advance a loan of about 45 per cent.



# Steel Men Win Fight for an "Open" Price Market

An "open" market in steel, with the price completely responsive to the law of supply and demand and with the United States Railroad Administration asking for competitive bids at once on 200,000 tons of steel rails, resulted from the final conference last Thursday at the Hotel Plaza, New York, between representatives of the United States Railroad Administration and the manufacturers' committee of the American Iron and Steel Institute.

Some of the steel men who attended the seven-hour conference said that the decision to flout the Industrial Board and to refuse to abide by the prices fixed by that body in an effort to stabilize the industry means increased business in the steel trade.

The opinion was expressed freely that prices would work higher, as there was in abeyance a considerable volume of orders which awaited only the removal of uncertainty.

It was said in steel circles that the breaking up of the conferences means the end of stabilization, that the Industrial Board will probably go out of existence and that Secretary Redfield might resign on account of the defeat of his plan.

E. H. Gary, chairman of the United States Steel Corporation, who presided, issued the following statement:

"After a long discussion the representatives of the Railroad Administration and the iron and steel industry have failed to reach any agreement for reduction of the schedule of prices approved by the Industrial Board of the Department of Commerce, the former claiming the prices are not low enough to satisfy them and the latter insisting further reductions cannot be made without decreases in costs of production, which would necessitate a lowering of wage rates."

Judge Gary's statement was approved by steel officials present.

Points made by Director General Hines follow:

1. Reduction in cost of scrap material has been so great as to make prices proposed by steel interests and the Industrial Board as profitable to the steel interests as were the higher prices that prevailed during the war.
2. Prices proposed represent no concessions whatever from war-time profits.
3. Steel interests apparently included in war costs the increased profits in ore and on these war costs the proposed prices are based.
4. Representatives of the Railroad Administration remain entirely satisfied that the reduced prices could and ought to be adopted without affecting the wages paid labor in the steel industry.

Increased evidence that architects and builders are warming up for the big construction spurt which is expected shortly was to be found in the New York situation this week. Co-operation from large loaning interests, so vitally necessary if there is to be a big boom in the face of material and labor costs, is now assured, if intimations given by prominent mortgage and banking houses to the effect that building money will be much freer after June 1, come true. However, there is just one right way to meet this phase of the situation which has retarded the progress of construction on a big scale so far this spring, and that is Federal co-operation in the extension of credit to builders so that they may go ahead more rapidly and meet the pressing demand for dwellings.

This sane view was put before the State commission a short time ago, and follows the attitude of most foreign governments which are devoting funds and their power to improve housing conditions following the war. If Federal assistance can be secured the last hindrance to the free resumption of building would be removed.

In the New York market the price tendency is downward on neat cement, lime and hollow tile. All common brick remains firm at \$15 per thousand wholesale, with some grades at a slightly higher level.

Lumber prices, however, are not likely to drop for a long time to come. Mills in every section of the country are now operating at a loss or barely making expenses. In the North Carolina Pine region the average cost as shown by reports from 33 mills for the month of December was \$37.58 f.o.b. mill; the average selling price was about \$34.

From the west coast come statistics showing that for 24 operations in February cutting 64 million feet, the total return from the log f.o.b. mill, was \$21.22 and that the cost of producing this lumber was \$23.45. During January 28 operations cost \$28.10 with returns of \$22.61, making a loss of \$5.49.

The northern hemlock and Hardwood Manufacturers Association at Oshkosh, Wis., states that "the cost to transport logs, saw, pile and ship lumber is costing more in our territory than the product of the logs is bringing, and it has cost 25 per cent more to log in January and February than it did for the entire year of 1918. Until costs are reduced very materially, operating means an inevitable loss and the prospect of lowering cost is very poor."

Manufacturers in the great Southern Pine region are finding that their cost is very close if not greater than what the lumber brings. In December the average cost of producing lumber manufactured by 86 mills was \$28.76 while the average selling price reported was \$28. This basis allowed only about one-half of the mills to operate. In January the cost figures showed a reduction to \$25.85. As a general rule, labor conditions in the South have not been quite so bad as in the West, although the average of efficiency is lower.

The past week has shown architects that they should by all means advise clients that the material market is more favorable now than it has been since the war or will be for the next few years. They realize that there is an abnormal demand, that there is a below normal supply and that price levels are at a consequent low artificial level. Lumber has already started to advance while many of the other commodities are being held down at levels which are claimed cannot be lowered in view of the potential demand and present wage scales.

*(From our Special Correspondent)*

CHICAGO, ILL., May 12.—Statistics compiled by the Government show that this city leads the entire country in the value of engineering contracts and actual small building activities. In all branches of the building material industries conditions during the week have developed a marked improvement. All clay products, as well as manufactured goods in metals, are in better demand with wholesalers and dealers busy with orders for immediate delivery. Lumber is moving from the yards to the contractors in exceptionally good volume.

A feature of this market is in the announcement of building permits issued during the week. The permits show that contemplative builders are becoming more and more convinced of stabilization of prices and are going ahead with speculative projects. The Commissioner of Buildings announces that in April permits were issued for nearly seven and one-half million dollars' worth of new buildings, almost three-times the total for April of last year.

# Late Quotations in Building Material Markets

(Price quotations now current on building materials and supplies as quoted by dealers and jobbers for delivery in New York and Chicago follow. The quotations set forth are placed before readers of THE AMERICAN ARCHITECT to afford an accurate review of market conditions rather than for use as a basis for actual purchase. They will not only provide knowledge of the exact state of the market as to items quoted, but will also present a basis to judge conditions as affecting co-relating materials. Items marked (\*) indicate an advance over last week, while those marked (†) record a decline. Other prices did not fluctuate during the week.)

BRICK		New York	Chicago
Common (Delivered at job in Borough of Manhattan only), per thousand.....			
		\$17.85*	\$13.00
CEMENT			
Per bbl. in 15 cent bags (Rebate 60c. per bbl. for bags) .....			
		\$3.25	\$2.80
COPPER SHEETS			
At the mill, hot rolled, 16 oz. base-price, per lb., 22½c. 22½c.			
(From jobber's warehouse add 2 to 3 cents. Cold rolled add 1c. per lb. to hot rolled.)			
GALVANIZED SHEETS			
Nos. 18 and 20 gauge, per lb.....			
		\$6.12	\$6.12
No. 26 .....			
		6.42	6.42
No. 27 .....			
		6.57	6.85
GLASS			
(Discounts from manufacturer's price lists)			
Single strength, A quality, first three brackets.....			
		77%	77%
Single strength, B quality.....			
		79%	79%
Double strength, A quality.....			
		80%	80%
Double strength, B quality.....			
		82%	82%
Plate—up to 5 sq. ft.....			
		81%	81%
Plate—over 5 sq. ft.....			
		84%	84%
Plate—up to 10 sq. ft.....			
		83%	83%
Plate—over 10 sq. ft.....			
		82%	82%
GRAVEL			
1¼ in. (Borough of Manhattan only), per cu. yd.....			
		\$2.75	\$2.35†
¾ in. (Borough of Manhattan only), per cu. yd.....			
		2.75	2.35†
GYPSUM			
Plaster Board:			
Delivered at job, Boroughs of Manhattan and Bronx.			
27 x 28 x 1.....			
		35c.	35c.
27 x 48 x ½.....			
		30c.	30c.
32 x 36 x ¼.....			
		21c.	25c.
32 x 36 x ¾.....			
		21c.	26c.
32 x 36 x ½.....			
		23½c.	23½c.
Plaster Blocks:			
Delivered at job, Boroughs of Manhattan and Bronx.			
2 in. solid, per sq. ft.....			
		7½c.	7½c.
3 in. solid, 12 x 30, per sq. ft.....			
		10½c.	10½c.
3 in. hollow .....			
		10½c.	10c.
4 in. hollow .....			
		12½c.	11c.
6 in. hollow .....			
		17½c.	17½c.
HOLLOW TILE			
(Delivered at job, in New York below 72nd St.)			
2 x 8 x 12 partitions, per 1,000 sq. ft.....			
		\$70.15*	70.15*
3 x 12 x 12 partitions, per 1,000 sq. ft.....			
		102.00	\$67.90
4 x 12 x 12 partitions, per 1,000 sq. ft.....			
		114.75	72.50
6 x 12 x 12 partitions, per 1,000 sq. ft.....			
		153.00	99.60
8 x 12 x 12 partitions, per 1,000 sq. ft.....			
		135.80	135.80
10 x 12 x 12 partitions, per 1,000 sq. ft.....			
		167.50	167.50
12 x 12 x 12 partitions, per 1,000 sq. ft.....			
		194.60	194.60
2 x 12 x 12 split furring, per 1,000 sq. ft.....			
		63.75	63.75
LATH			
Eastern spruce, per thousand.....			
		\$6.50	6.50
No. 1 white pine, per thousand.....			
		6.50	6.50
No. 1 hemlock, per thousand.....			
		6.00	6.00
No. 1 yellow pine, per thousand.....			
		5.75	5.25
LIME			
Common, 300 lb. bbls., per bbl.....			
		\$3.50	\$1.40†
Finishing, 300 lb. bbls., per bbl.....			
		3.70	3.70
Hydrated, in paper bags, per ton.....			
		17.25	17.00†
LUMBER			
(Retail prices per M, F.O.B.)			
Yellow pine, 2 x 4.....			
		\$49.00	\$47.00
Yellow pine, 2 x 6.....			
		46.50	45.00
Yellow pine, 4 x 4.....			
		56.00	52.00
Yellow pine, 8 x 8.....			
		65.00	52.00
Yellow pine, 12 x 12.....			
		52.50	57.00
Yellow pine, No. 1 boards, 1 x 6.....			
		55.75	53.00
Yellow pine, No. 1 boards, 1 x 12.....			
		58.00	56.00
Yellow pine, B and better flooring (plain).....			
		58.00	57.00
Yellow pine, B and better flooring (quartered).....			
		70.00	70.00
Douglas fir, 6 x 6 to 12 x 12.....			
		62.50	63.00
Douglas fir, 12 x 14 to 14 x 14.....			
		64.00	64.00
Norway pine, 2 x 4.....			
		60.00	57.00
Norway pine, 2 x 12.....			
		65.00	57.00
Hemlock, 2 x 4.....			
		47.50	46.00
Hemlock, 2 x 12.....			
		51.00	48.00
Oak flooring, 13/16 quartered white.....			
		132.50	122.00*
Oak flooring, 13/16 quartered red.....			
		125.00	115.00*
Oak flooring, 13/16 plain white.....			
		82.50	82.00*
Oak flooring, 13/16 plain red.....			
		82.50	82.00*
Maple flooring, 13/16 clear.....			
		75.00	72.00*
Maple flooring, 13/16 select.....			
		70.00	69.00*
Maple flooring, 13/16 No. 1 fancy.....			
		62.50	58.00*

Mahogany, 1" F. A. S.....	300.00	300.00*
Quartered oak, 1" F. A. S.....	180.00	135.00*
Plain oak, 1" F. A. S.....	120.00	100.00*
Red gum, 1" F. A. S.....	87.00	70.00*
Sap gum, 1" F. A. S.....	56.00	60.00*
Chestnut, 1" F. A. S.....	87.50	75.00
Poplar, 1" F. A. S.....	130.00	100.00*
Birch, 1" F. A. S.....	70.00	65.00*
Spruce, random 2".....	52.00	50.00
Spruce, wide .....	62.50	60.00
LEAD		
American pig, per lb.....	5½ to 6	5½ to 6
Bar, per lb.....	7½ to 8	6 to 6½
METAL LATH		
Under 100 sq. yd., per sq. yd.....	40c.	40c.
PAINTS, OILS, ETC.		
New York Chicago		
Leads:		
American white, in oil kegs; lots over 100 lbs.....	14c.	14c.
White, in oil, 25-lb. tin pails; add to keg price.....	¼c.	¼c.
Red, bbl., ½ hbl. and kegs; lots over 100 lbs.....	14½c.	14½c.
Dry Colors:		
Red Venetian, American, per 100 lbs.....	\$2.75 to \$5.00	\$2.00 to \$5.00
Metallic Paints:		
Brown, per ton .....	24.00 to 32.00	24.00 to 32.00
Red, per ton .....	24.00 to 30.00	24.00 to 32.00
PIPE		
Cast iron:		
6 in. and heavier .....	\$57.70	\$56.80
4 in. .....	60.70	59.80
3 in. .....	67.70	66.80
(and \$1 additional for Class A and gas pipe.)		
(Discounts to jobbers for carload lots on the Pittsburgh basing card; freight rates from Pittsburgh to New York, and also from Pittsburgh to Chicago, in carloads, per 100 lbs., are 27c.)		
Wrought:		
Butt Weld		
Steel:		
Black, ¼ to 3 in.....	50½%	57½%
Galv., ¼ to 3 in.....	24%	41%
Iron:		
Black, ¼ to 1½ in.....	29½%	39½%
Galv., ¼ to 1½ in.....	21½%†	23½%
Lap Weld		
Steel:		
Black, 2½ to 6 in.....	53½%	53½%
Galv., ¼ to 3 in.....	41%	41%
Iron:		
Black, 2½ to 6 in.....	34½%	34½%
Galv., 2½ to 6 in.....	21½%	21%
PLASTER		
Neat wall cement in 15 cent bags, per ton.....	\$20.30	\$18.50
Finishing plaster .....	24.00	21.00
RADIATION		
(A further reduction, effective April 4, of 15% on direct radiators, 12½% on wall radiators, and 10% on steam and hot water boilers is announced. This approximates a drop of 36% on radiators and 33% on boilers from prices in effect before the 1st of January, 1919.)		
Chicago reports a 57% reduction on all standard sizes.		
SLATE ROOFING		
F.O.B. cars.		
Quarry Station F.O.B. Chicago		
Pennsylvania:		
Best Bangor .....	\$7.75 to \$9.00	\$10.20 to \$11.45
No. 1 Bangor Ribbon.....	6.75 to 7.25	9.20 to 9.70
Pen Argyl .....	7.25 to 8.00	9.70 to 10.45
Peach Bottom .....	10.00 to 12.50	12.45 to 14.45
No. 1 Chapman .....	7.25 to 8.25	8.70 to 9.95
Vermont:		
No. 1 Sea Green .....	3.50 to 6.75	5.95 to 9.20
Unfading Green .....	5.50 to 9.25	8.30 to 11.05
Red .....	12.00 to 20.00	14.80 to 22.80
Maine:		
Brownsville, U'f'g Black, No. 1.....	11.00 to 12.00	14.10 to 15.10
Slaters felt, 30 lb. roll.....	1.75	1.75
Slaters felt, 40 lb. roll.....	2.25	2.25
ROOFING MATERIAL		
Tarred Paper:		
1-Ply, per ton, per roll, 108 sq. ft.....	\$63.00 to \$65.00	\$65.00
2-Ply .....	95c.	95c.
3-Ply .....	1.23 to 1.30	1.30
Rosin sized sheathing .....	per ton 60.00	60.00
Corrugated roofing, galvanized, 2½ in. corrugation, over flat sheets, 30c. per 100 lbs.....		
SHINGLES		
Red cedar, 5 to 2, clear, per thousand.....	\$8.00*	\$6.50
White cedar, extra star, A star, per thousand.....	7.00*	5.50
STRUCTURAL STEEL		
Beams and channel, 3 to 15 in., per lb.....	2.45c.	3.47c.
Beams and channel, 3 to 15 in., per lb.....	2.45c.	3.57c.
Angles, 3 to 6 in.....	2.45c.	3.47c.
Zees and tees .....	2.45c.	3.47c.
Steel bars, half extras, from mill.....	2.35c.	3.47c.
REINFORCING BARS		
High carbon steel from mill.....	\$48.50	\$49.50
Medium steel from mill.....	48.50	49.50
SAND		
Mason, per cu. yd.....	\$1.80	\$2.25
Torpedo, per cu. yd.....	1.80	2.35†



# Financial and Commercial Digest

## As Affecting the Practice of Architecture

### Urges Building by Employers

Calling on the manufacturers' and the employers' associations of this city to take the initiative in forming an emergency building corporation with \$5,000,000 capital, Mayor Couzens of Detroit, Mich., has announced his willingness to join any such organization of public-spirited citizens in an effort to solve the shortage of homes. The mayor has abandoned his plan for a municipal bond issue. Although the legal difficulties in the way of such a move are not insurmountable, the delay would render ineffectual any attempt to relieve the situation immediately, his legal advisers told him.

"It is my judgment that a lot and a comfortable home can be secured for less than \$5,000, perhaps between \$3,500 and \$4,000 if a big organization takes hold of the problem without any idea of profit," said the Mayor. "Five million dollars could buy all the material for the houses and the lots, and contracts could be let for 100 houses at a time. There would be uniformity in quality, not in design, and thus a saving would be effected.

"I do not believe it should be a continuing company, to interfere with private initiative. It should be organized to meet the great necessity of the moment which private interests are not able to meet. There would be no danger of paternalism in this. It is simply meeting a problem which is a civic problem, like a flood. Surely building homes for flood victims is not paternalism."

Vancouver business men have already organized a corporation through which they are to underwrite the cost of building all the dwellings for which there is a demand up to one thousand. These houses will be sold at exact cost with a charge of but 6 per cent on deferred payments. The plan is that, as a preliminary, blanks are sent to all working men in the form of a questionnaire. These will form a record of those who want to buy such homes, how much they can pay down in cash and how much they can pay a month. There will be no building done until such contracts are made and, as can be seen, these will form a basis for credit.

This same organization controls a long list of lots. Those who wish can buy the sites for their houses from this list at an exact price and with no charge for commission above the cost of sale, which is office expense, or they can buy from local dealers. This plan, which calls for a comparatively small initial fund and which would finance itself through banking credit or bonds issued as the money was needed, should appeal to many other cities in this country where a housing crisis is imminent.

According to the plan, actual building would begin only after enough contracts were made to warrant wholesale buying of materials and the letting of building contracts on a large scale in blocks of fifty or more. It would assure the lowest possible costs in this way discounting the future and establishing a sound credit basis independent of the association's personal or separate credit.

The putting into operation of a plan similar to that of Vancouver in many of our cities would go a long way not only toward supplying the millions of badly needed homes, but also would provide employment to all grades of labor and expedite the return to normal conditions.

### Urges Liberal Credits to Our Foreign Purchasers

Attention is called to the vital necessity for granting more liberal credits to foreign purchasers of American products, in a statement issued by Charles H. Sabin, president of the Guaranty Trust Company of New York. Mr. Sabin advocates the meeting of international competition by the extension of longer credits than we have given heretofore. Mr. Sabin said:

"The war literally forced us into world markets on a scale never before even dreamed possible. And we are beginning to realize that our national prosperity is very materially dependent upon the continuation of our vastly increased production, which exceeds the requirements of our own market and must continue to find an adequate outlet elsewhere.

"But, owing to the war, other peoples cannot pay us on practically a cash basis for the goods which they want to purchase from us, and which they sorely need. Consequently, we must allow them more time in which to meet their obligations.

"We must revise our point of view about foreign credits. Our banks can no longer restrict such credits to sixty, ninety, or a hundred and twenty days, and render to manufacturers and exporters the service which the present readjustment period makes imperative.

"England and Germany built up their great foreign trade prior to 1914 largely by making six months' time the selling basis for their goods. If we are to hold our own in foreign trade, we must profit by the experience of other countries and adapt ourselves to the needs of the present situation. The war has taught us many lessons; peace will teach us more. We have learned, for instance, that our existing banking system, predicated upon elasticity, is to-day probably the strongest in the world. But we now need to develop greater elasticity in our banking methods, particularly in our point of view regarding credits for the fostering of our foreign trade. This is especially demanded in the selling of our manufactured articles overseas, although it holds true to some extent in the selling of raw materials also.

"The unpegging of sterling and franc exchange, recently, has surely made clear to us the condition which is bound to prevail if we continue to insist upon the short term credits which we have held to in the past. When the British and French governments withdrew their support to sterling and franc exchange, respectively, the tendency, naturally, was to put the American dollar at a premium in England and France, which means that it takes more francs and shillings to equal a dollar and, consequently, less imported goods can be purchased for an American dollar in those countries than was possible prior to the unpegging of the exchanges. This will tend to discourage the buying of American goods, and eventually will result in serious curtailment of our foreign trade—unless we counteract that tendency by extending credits for a sufficient period to enable purchasers of our products abroad to pay us at a more convenient time."



# Department of Architectural Engineering

## Modern Buildings for Printing Trades

MODERN civilization could not exist without the press. In it current events are described and illustrated, ideas exchanged, knowledge imparted and public opinion reflected. By the press we do not refer to the daily newspaper exclusively, but also to those many classes of publications, some treating of general subjects and others dealing with special features and topics, whose arrival we so eagerly await, whose contents we endeavor to absorb, and deprived of which, life would lose much of its charm. Knowledge is increasing and with it the publications setting forth human achievements and ideas. Publications require printing presses, and the modern printing press bears as much resemblance to that of Franklin's time as the oxcart does to the locomotive. Presses and the accessory uses customarily incidental thereto must be housed—hence the development of the "printing house" building.

Here the architect is called upon to design a building attractive in appearance, with interior arranged for the development of maximum utility, providing efficient light, air and ventilation in order

that employees may render maximum service, safe in its structural features, and also one which shall accommodate a large number of special machines, with movable parts constantly traveling back and forth in a horizontal plane and seldom arranged to neutralize each other's impetus, the structure to possess sufficient rigidity to prevent swaying or induction of excessive vibration. The difficulty in properly solving this problem is evidenced by the unfortunate fact that in almost every community there are

numerous examples of excessive vibration in such buildings, some built many years ago, and others of more recent construction. The vibrating building is a nuisance and sometimes a menace not



ADVERTISING BUILDING, ST. LOUIS, MO.  
ALBERT B. GROVES, ARCHITECT—A. A. AEGERTER, ENGINEER

## THE AMERICAN ARCHITECT

only to itself but often to its neighbors, so that the courts have had to decide many law suits and claims for damages as a result of such conditions. There is in St. Louis a building housing thirty-five presses, which causes vibration in the adjoining buildings and throughout the entire block. It is six stories in height, of slow-burning construction, with comparatively light masonry walls. Such construction is not sufficiently rigid to entirely resist the momentum of the presses, so the adjoining properties must absorb their excess energy. Another such building was erected nearly twenty years ago, constructed with an early type of reinforced cinder concrete floor, with concrete joists spaced in a manner similar to wood-joisted construction, reinforced with rods hooked over the top flanges of steel beams into which they are framed. The frame is of steel beams with cast-iron columns, and inclosed with masonry walls. Presses operating in this building rock it at the rate of some ninety vibrations per minute the year round, causing open doors to swing, window weights to knock, and producing a disagreeable sensation to persons working therein. In another instance a two-horse power printing press located in the seventh story of an eight-story reinforced concrete building caused so much vibration that a sample room on the eighth story, with hardware samples consisting of hanging chains, sleigh bells, saws, pans, etc., was unable to conduct business, due to the racket constantly made by these samples. The press was removed out of the building and into a two-story brick building 20 ft. wide. In this new location the press was used for the purpose of conducting experiments and was mounted on a steel truss, laid flat with ends firmly embedded in the side walls. The press was located so as to operate with the length of the building. This resulted in a total lack of vibration in the building proper, the energy of the press being taken up by deformation in the truss members. The truss diagonals consisted of steel rods with threaded and welded loop ends and were provided with turn-buckles. For the purpose of ascertaining the lateral thrust of the press the diagonals were loosened up, and while the press was running the horizontal deflections of both chords of the truss were measured, an analysis of which gave the horizontal press thrust.

This "press thrust" is made up of three factors, namely: The power of the operating motor; the collision impact of the horizontal moving type-frame or "belt travel", and the time consumed to stop collision. The press under study had a two-horse power motor (66,000 ft. lb. per minute) and a belt speed of 2000 ft. per minute, or 33 ft. per second. In other words, 66,000 ft. lb. of work was being carried to the press by the belt every

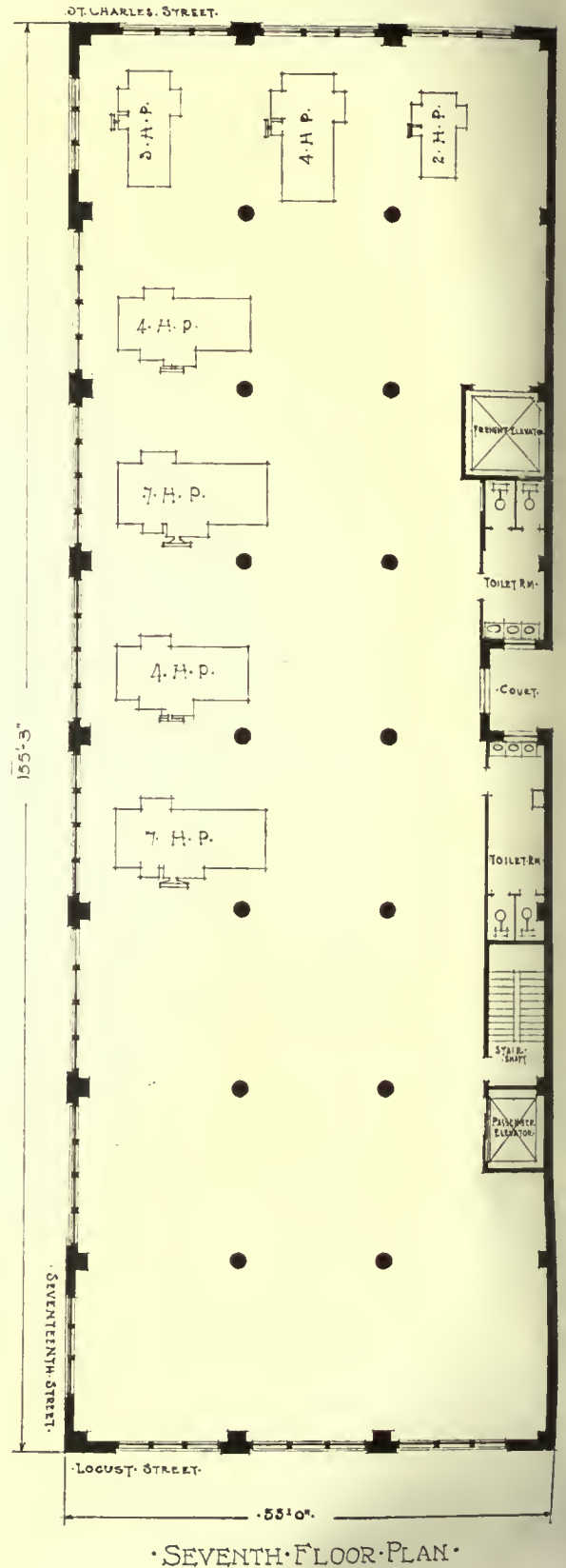

minute, which resolves itself into a 33-lb. load carried by the belt. Computations from the measured deflections of the truss chords showed that the press developed an energy or thrust of 33,000 lb., which indicated a "kick" due to collision impact of 1000 times more than the load carried by the belt from motor to press. Now, if the 33-lb. force had been stopped in one second, the horizontal kick of the press would have been 33 lb. Since the measurements gave this as 33,000 lb., the indications are that it took only 1/1000 part of a second to deliver or stop the blow. This stop or reversal is the important factor, acting in a manner similar to a falling body. No jar is felt until the falling body strikes the ground, so also in the press the thrust occurs at the instant the direction of the traveling type frame is reversed.

The results obtained from this experimental data have been used with satisfactory results in the design of many buildings, one such example being here set forth.

In February, 1917, just before this country entered the world war, a building operation was promoted, the promoters having made arrangements for leasing all floors with perhaps one exception (the ground floor). The proposed building was to be nine stories and basement high, of reinforced concrete construction, 55 ft. wide by 155 ft. deep. The height from curb to roof to be 130 ft., from which it will be seen that fairly liberal story heights had been allowed. This proposition was only possible provided the seventh, eighth and ninth stories could be leased to a printing establishment, so designed that presses could be located on the seventh floor, composition room on the eighth floor and photographic work conducted on the ninth floor. The contemplated operation involved an investment of \$250,000, with the promotor seeking a capable architect able to guarantee a safe and rigid building. From this it can be seen how important foreknowledge was, as leases so framed that they would not be binding should the completed structure develop excessive vibration would entail serious financial loss. However, as competent architects are in nowise like the proverbial needle in the haystack, the building was designed, erected and occupied.

The ground floor is a mercantile store room, the second to sixth are office floors and the seventh, eighth and ninth stories occupied as already described. With the exception of the seventh or press floor, all floors were designed for a live load of 150 lbs., the seventh being designed for a live load of 400 lbs., to provide for the heavy paper stock used in connection with the presses. At the time of designing the building the exact placing of presses and direction of operation could not be determined,

hence the thrust was taken care of in both cross and longitudinal directions.

Stress in a concrete frame travels about 15,000 feet per second, hence a line of presses as proposed, all headed the same way, hitting one after the other, could not pile up a stress in the frame, as the

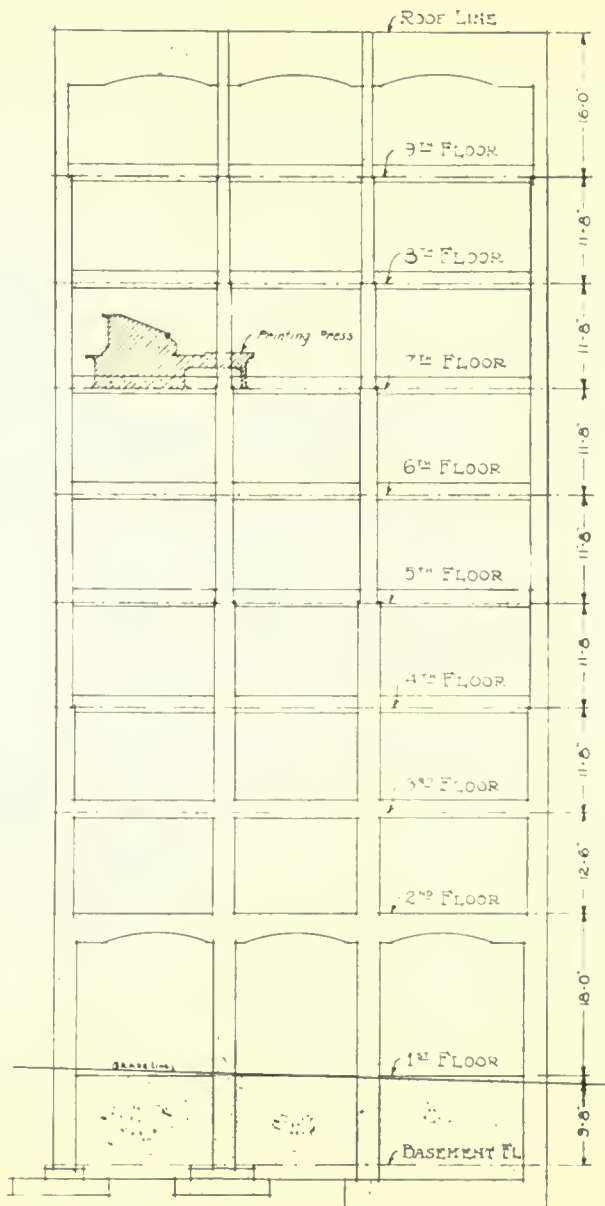

LOGGERS STREET ELEVATION  
SCALE: 1/4" = 1'-0"

velocity of stress is 15 times faster than the delivery of shock, and since 1/1000 part of a second is required to deliver the collision impact of a machine, the possibility of two out of seven hittings at the same instant is very remote, hence the collision of one press, the largest, was provided for only.



## THE AMERICAN ARCHITECT

A moving load in collision with another body causes a force entirely dependent upon the time it requires to stop the moving load, for a 3000-lb. blow can be struck with a 2½-lb. hammer head with a velocity of 40 ft. per second if the stop is made in 1/1000 part of a second.

There are several moving parts to a printing press any one of which could be analyzed to find the horizontal kick, and this horizontal kick also produces a vertical floor load as a rocking motion from front to back occurs. From the previous experiments it was found that a one-horse-power motor connected to a printing press develops a 16,000-lb. horizontal force.

In this nine-story building the largest press was taken as having a six-horse-power motor located at either end of the floor and operating in either a cross or longitudinal direction. The floor was assumed to act as a truss or plate girder, it being constructed of reinforced concrete nine inches thick.

As for the vertical live load, a press of this size weighs 26,000 lb. Such a press located in a 19 ft. x 20 ft. floor bay would produce a static load of 70 lb. per sq. ft. and an additional rocking load of 190 lb. per sq. ft., provided the horizontal moving shuttle was 36 in. above the floor line, resulting in a total live load equivalent to 250 lb. per sq. ft. This seventh floor was, however, designed for 400 lb. live load to accommodate paper piles as previously mentioned.

The frame of the building had a flat slab in each floor used to transfer any horizontal thrust to the end or side girders of the structure. At each floor,

from the seventh floor to grade line, the beams and wall columns were designed to take up this 96,000-lb. lateral thrust.

The beams were reinforced at both top and bottom; the columns were spliced at their mid-length and the footings were designed for the bending moment from lateral force in addition to the dead load.

The plans shown herewith give an idea of the layout and the diagram of skeleton frame shows the disposition of girders and columns. The photograph illustrates the architecture of the completed building.

This building has now been in use nine months and the measured vibration does not exceed 1/16 of an inch crosswise of building at the eighth floor sill line, with 80 vibrations occurring per minute. The largest press finally used had a 7-horse-power motor.

The ninth floor of this building is used for photography and five-minute exposures are taken with no ill results.

In conclusion it would appear entirely safe to work on the basis that a one-horse-power press kicks laterally with an equivalent static load of 16,000 lb. and rocks from front to back with an intensity depending upon the size of foundation frame or panel in floor and moment of moving shuttle.

The building described was designed by Albert B. Groves, architect, with A. A. Aegerter as engineer, built by Murch Bros. Construction Co., and occupied by the Garrison Wagner Printing Co., St. Louis, Mo.

---

## Present Status of Industrial Lighting Codes\*

By G. H. STICKNEY

### ABSTRACT OF PAPER

In order to protect workers from accident and eye-strain, industrial lighting codes have been adopted in four states and in Federal establishments. Similar action is under consideration in several other states and there is prospect of extension throughout the country.

Investigation and experience indicate the need of government regulation of factory lighting. When adopted by industrial commissions under authority granted by Legislatures, the codes become in effect state law. Variations in the codes as adopted are less than might appear, some features being experimental. The existing codes correspond in essentials to the Illuminating Engineering Society code, on which they are based.

Mandatory regulations are necessarily limited in function to the assuring of safety. Higher standards are essential for efficient production. Popular education in which

electrical and illuminating engineers can co-operate is an important feature of future development.

### INTRODUCTION

THE industrial lighting codes are an expression of the "Safety First" movement in terms of legal regulations directed to the lighting of factories. The prime function of these codes is the safeguarding of life, limb and vision of industrial workers. No argument should be necessary to enlist the support of all good citizens to such a humanitarian effort. In addition, the codes seem likely to teach practise which will enhance the earning power, not only of the workers themselves but also of the industrial plants. This incidental result seems likely to be of great economic importance in the coming period of international competition. Sufficient prog-

\*Presented at the 349th Meeting of the American Institute of Electrical Engineers, in Joint Session with the Illuminating Engineering Society, New York, April 11, 1919.

## THE AMERICAN ARCHITECT

ress has been made to indicate that such regulations will ultimately be in force throughout the country. Through their relation to lighting practise, these codes seem destined to have a broad influence on electrical engineering, and it is the purpose of this paper to inform electrical engineers regarding the scope and tendencies of these codes, as interpreted from a close association with the work and with those responsible for it.

Industrial lighting codes, based on the Illuminating Engineering Society's code, are now in force in the States of Pennsylvania, New Jersey, New York and Wisconsin. In several other States similar codes have been drawn up and are under consideration for adoption. In others, bills looking to the adoption of the code have been introduced before the legislatures. As a war measure, the Advisory Commission of the Council of National Defense, through its Committee on Labor, appointed a sub-committee known as the Divisional Lighting Committee, to encourage the movement. The sub-committee, working through State representatives, has approached the authorities in each of the States to encourage the adoption of such codes. As the result of this activity, progress has been made toward the introduction of an industrial lighting code or a safety code, by the Department of Labor, Industrial Accident Commission, or other agencies charged with the enactment and enforcement or regulations in regard to factory lighting.

Through co-operation of the Bureau of Standards and the Federal Inspectors of Safety, a lighting safety code was adopted during the war, in all Federal establishments, including arsenals, munition plants and navy yards.

### NECESSITY

The necessity for such regulation is well explained in the introduction to the new edition of the Wisconsin code, which reads as follows:

Insufficient and improperly applied illumination is a prolific cause of industrial accidents. In the past few years numerous investigators, studying the cause of accidents, have found that the accident rate in plants with poor lighting is higher than similar plants which are well illuminated. Factories which have installed approved lighting have experienced reductions in their accidents which are very gratifying.

Of even greater importance, poor lighting impairs vision. Because diminution of eyesight from this cause is gradual, it may take the individual years to become aware of it. This makes it all the more important to guard against the insidious effects of dim illumination, of glaring light sources shining in the eyes, of flickering light, of sharp shadows, of glare reflected from polished parts of the work. To conserve the eyesight of the working class is a distinct economic gain to the State, but regardless of that, humanitarian considerations demand it.

Finally, inadequate illumination decreases the production of the industries of the State, and to that extent, the wealth of its people. Factory managers, who have installed improved illumination, are unanimous in the conviction that better lighting increases production and decreases spoilage.

Illuminating engineers have recognized for a long time that inadequate lighting was responsible, in a greater or less degree, for industrial accidents, and that good lighting was a potent means of accident prevention. Extensive data, accumulated by John Calder<sup>1</sup>, R. E. Simpson<sup>2</sup>, and others provide convincing proof of this condition.

The loss of visual power, through improper lighting cannot be so readily recorded, and hence is not so directly substantiated by actual data. It is, however, recognized as a serious menace by oculists<sup>3</sup> and others. Because it incapacitates the skilled worker just when he should be most valuable, and further, because the danger is not readily recognized by those immediately responsible for industrial lighting, the necessity for Governmental supervision is even greater for this purpose than for the prevention of mechanical accidents.

In spite of the recent general improvement in industrial lighting practise, the increasing need of ample assurance in this matter is evident from the present tendencies of manufacturing, among which may be mentioned the following: the grouping of larger number of employees; the extension of all night processes; increasing use of dangerous machinery; intricacy of processes and specialization of workers requiring sustained visual application.

### HISTORICAL

Practically all the codes in force or under preparation are based on the "Code of Lighting Factories, Mills and other Work Places" of the Illuminating Engineering Society<sup>4</sup>, and conform closely to it in all essentials.

This code was prepared by the co-operative action of the Committee on Lighting Legislation, under the chairmanship of Mr. L. B. Marks, and the former Committee on Factory Lighting, under the chairmanship of Professor C. E. Clewell.

The Illuminating Engineering Society was called upon in 1913 to assist in formulating the lighting section of the labor law of New York State. It was found impracticable then to incorporate definite lighting specifications in the law, and so provision was made in the law for the later adoption of such regulations, by the Labor Commission. In preparation for the commission's requirement, work of drafting a code was undertaken. The problem proved a very difficult one and many modifications were found necessary, even after its first publication. Various societies, many engineers and State commissioners pointed out desirable changes, which were incorporated from time to time. Even at the present time, although the code is a very valuable working instrument, it is considered, by those who have had most to do with it, to be under develop-

1. For references, see Bibliography.



## THE AMERICAN ARCHITECT

ment and liable to slight changes and amplifications, with the development of the art and with increased experience in application of the various provisions.

In 1916 at a meeting in Philadelphia<sup>2</sup>, Dr. J. P. Jackson and Colonel L. T. Bryant, industrial commissioners of Pennsylvania and New Jersey, respectively, became interested, and after introducing some practical improvements, their respective commissions took action which resulted in the adoption of the code in the summer of 1916. The New York Commission adopted the code with some modifications and put it in force July 1, 1918, some of the features being tentative for a year.

The Wisconsin Commission began issuing lighting orders in 1913, but these orders did not contain any specification as to intensity of illumination on the work. After thorough investigation the orders were superseded by the present code, which was issued in May, 1918.

The author has just received word, as this paper goes to press, that the legislature of the State of Oregon has passed a bill establishing an industrial lighting code.

### SCOPE

In the States which have adopted codes, the action has been by industrial or labor commissions, under the authority granted them by legislature, to promulgate rules in the interest of safety of industrial workers. The codes are, therefore, backed by the State police power.

Since the function of the commissions is limited to insuring safety, the codes require only such lighting as is necessary for that end. Under these circumstances the codes cannot demand the higher standards of illumination desirable for economical production<sup>3</sup>. That the intensities specified are minimum limits, consistent with safety rather than good practise, is recognized, and in connection with all the codes, higher values representing more desirable practise are recommended.

It has seemed to be the experience of labor commissions that at least 90 per cent of the manufacturers cordially desire to comply with their regulations. The principal difficulty so far encountered in applying the codes has been to make clear to the layman just what is required and how it can be secured. It has, therefore, been found expedient to publish educational sections supplementary to the codes proper. Such sections explain the principles involved and make suggestions for securing and maintaining good installations. The recent revision of the Wisconsin code treats rather comprehensively of the selection and location of lighting equipment, illustrated by charts.

By joint action of the Pennsylvania and New Jersey Commissions a course of lectures<sup>4</sup> on the interpretation of the codes was given to their in-

spectors at the University of Pennsylvania in the spring of 1918. A similar lecture<sup>5</sup> was given to factory inspectors of the Board of Labor and Industries of Massachusetts in October, 1918. Doubtless this will be repeated and the method applied elsewhere. The New Jersey Commission has held meetings of contractors and manufacturers to assist in the educational work.

In all the codes the employment of expert engineering or architectural advice is recommended.

### SPECIFICATIONS

The principal lighting specifications common to all States which have adopted the code are intensity, glare limits and distribution. It is also usual to require provision of emergency lighting, watchman's circuits and certain switching provisions. In some cases these features are omitted from the codes, being provided for in the law or elsewhere.

A comparison of the codes adopted or under preparation shows a remarkable uniformity in the specification of these factors. There is some variation, especially as regards experimental features, but this is of a nature likely to help rather than retard the development of codes toward excellence and uniformity.

In drawing the specifications it has been constantly recognized that they must be kept simple and practicable so that conformance could be determined without recourse to lighting experts or bulky and expensive instruments. On the other hand, it is desirable to make the specification as definite as possible, minimizing the part left to individual judgment and thus avoiding controversy and prejudice.

### DAYLIGHT

While it has been considered desirable to require that new buildings and extensions be so constructed as to provide adequate daylight, it has been found very difficult, if not impracticable, to lay down a definite rule, and in most of the codes it has been assumed that the purpose was accomplished if suitable artificial light were required where and when daylight is unavailable.

Daylight is subject to a wide variation throughout the hours of the day, seasons of the year, with changes in weather and for different directions of window exposure, etc. In any building the natural lighting may be affected by surrounding construction on property not under the control of the owner. A workroom having ample daylight when erected may be darkened by later construction. In a dense manufacturing center, *e. g.*, downtown Manhattan, it would be impracticable to realize so good a condition, especially on lower floors, as might be reasonably required of a suburban factory. Some reasonable provision can undoubtedly be reached, which



## THE AMERICAN ARCHITECT

will at least require the minimization of glare and provide for wide distribution of light, by the use of suitable awnings, shades, refractive windows, etc.

The Wisconsin Commission has adopted the following rule in this connection:

Order 2111. Natural Light. Windows, skylights, saw-tooth or other roof lighting construction of buildings shall be arranged with reasonably uniform bays and the glass area so apportioned that at the darkest part of any working space, when normal exterior daylight conditions obtain, (sky brightness of 1.5 candle-power per sq. inch) there will be available a minimum intensity equal to twice that of Order 2112 for artificial light.

Awnings, window shades, diffusive or refractive window glass shall be used for the purpose of improving daylight conditions or for the avoidance of eye strain wherever the location of the work is such that the worker must face large window areas, through which excessively bright light may at times enter the building.

Note. The intensity requirements for adequate daylighting are much higher than those for adequate night lighting, because in general, under daylight conditions, the light coming to the eye from all the surroundings in the field of vision is much brighter than at night, and hence a correspondingly more intense light must fall on the object viewed.

It is the almost universal experience of illuminating engineers and others that it is possible to operate satisfactorily with a lower intensity of artificial than natural illumination. The reason for this has not been satisfactorily explained; but with daylight the relatively high illumination of walls and other surrounding objects, compared to the illumination on the work, is undoubtedly a contributory cause.

In the earliest draft of the Illuminating Engineering Society's code, a ratio of 3 to 1 between natural and artificial lighting requirements was specified. Later this was changed to 2 to 1, and still later, in the absence of definite data in confirmation of the necessity of higher daylight intensities, artificial lighting was required when daylight intensities fell below the values specified for artificial lighting. The Wisconsin code and one or more of those under preparation have adhered to the ratio of 2 to 1, which figure has also been used in the Illuminating Engineering Society's School Lighting Code. Further experience is apparently necessary before any final relation can be determined.

It is probable that in different conditions of daylight and of artificial light the relative value varies. It is not likely, at least in the near future, that actual foot candle measurements will become the criterion for turning on the lighting, so that an accurate determination of this ratio does not seem to be of immediate importance.

The Illuminating Engineering Society, Pennsylvania, New Jersey and New York codes are essentially artificial lighting codes and do not attempt to specify daylighting. On the other hand, serious conditions of glare are not infrequent in the natural lighting of workrooms, and the extension of the

code to mitigate such conditions seems to have considerable merit.

From a hygienic standpoint, sunlight has desirable features distinct from its relation to vision, so that it is desirable to have daylight available wherever possible.

There are some processes which inherently require the exclusion of daylight. Moreover, in the large cities workrooms, such as engine rooms, pipe shops, etc., have been established in basements, apparently without serious harm to the workers. On a larger scale workrooms have been established above ground, which require artificial lighting throughout the day.

Unquestionably, all visual requirements can be provided with proper artificial lighting. It is, therefore, doubtful if a mandatory requirement of daylight for all places is justifiable. One of the codes under preparation, but not yet adopted, meets these conditions by simply specifying the lighting features necessary without distinction as to whether the light is natural or artificial.

### INTENSITY SPECIFICATION

In all the codes which have come to the author's attention intensity is specified in foot candles. While at first some difficulty was anticipated in explaining these values and providing for their measurement, the development of an inexpensive and simple "foot-candle meter" has facilitated the application of these specifications.

For yards, passageways, aisles and stairways, the intensity on a horizontal plane, at or near the floor level, is assumed for measurement.

For various operations the intensity is required at the work and would naturally be measured in the plane of any surface requiring vision of the character indicated. In all cases the limits are given as minima, not averages.

It has been generally recognized in selecting the intensity levels that there are no definite critical points, where a variation of a small percentage, one way or another, would cross a definite line between safety and danger. In determining the various intensity levels, lighting experts have drawn on their experience, supplemented by special investigation. It inspires confidence to note that the American values correspond rather closely to those determined independently in England after a very exhaustive investigation under governmental auspices.

The intensity specifications naturally fall into two groups: those required over general spaces and those required for work operations. The former are primarily for the prevention of accident, while the latter have the added element of conservation of vision, especially in the higher intensity classes.

## THE AMERICAN ARCHITECT

A lower standard is allowed out of doors than indoors, on account of the difference in the usual character of surroundings and the nature of travel. The large out-of-door areas must, for economic reasons, have a low intensity requirement, and it would not be reasonable to demand much more than ordinary street lighting or moonlight intensities. The value of 0.02 foot candle, therefore, appears in all the codes. For interior lighting a minimum of 0.25 foot-candle has been required for all traversed spaces.

New York and Wisconsin have included a classification to cover elevators, washrooms, dressing rooms, etc., at 0.5 foot-candle. This has not appeared in the earlier codes, but seems to be a useful addition.

The lowest intensity for manufacturing under the Illuminating Engineering Society, Pennsylvania, New Jersey and Wisconsin codes is 1.25 foot-candles. New York has adopted 1 foot-candle for the corresponding class, *i. e.*, rough manufacturing. While this value is, in the opinion of some engineers, lower than desirable, there is doubt if there is evidence to warrant the standardization of the fractional value.

The New York Committee has also adopted a new level of 0.5 foot-candle for the handling of materials and other very rough operations, and this step is being included in some of the codes in preparation in other States.

The higher steps are the same in all codes being located at 2.3 and 5 foot-candles, according to the fineness of vision required by the operations.

While it is true that there are operations requiring more than 5 foot-candles, they are exceptional and usually performed by highly skilled specialists. As such individuals are likely to be able to protect themselves, it has not seemed necessary for Governmental authorities to take action.

Exceptions arising from the nature of a few processes are necessary to the illumination intensity requirements, as they appear in most of the codes. The omission has been due to the belief on the part of certain commissions that the exceptions were so infrequent and obvious that they can be taken care of readily and thus avoid misunderstanding on the part of others not entitled to exception.

One of the codes under preparation includes a class of zero intensity, while another lists the exceptions in a note following the intensity rule. This reads:

Note: Some exceptions to the Intensity Rule:

a. There are some operations that are performed in comparative darkness, as for example, photographic processes in the dark room.

b. There are some operations that are best observed by their own light, as in the parts of the process of working glass.

c. Some operations are best observed by the "silhouette"

method of lighting in which the work is seen against a lighted background in a comparatively dark room, as in some processes of working with dark threads and lamp filaments. In all such cases in which work is of necessity carried on in comparative darkness, special precautions should be taken to properly safeguard the workmen.

A limiting feature of the intensity specification is the rather indefinite descriptive classification of the operations assigned to the various levels. The need of more definite descriptions is well known to all who have undertaken the work of drawing up specifications. It is sometimes important that an inspector or a manufacturer be able to tell without question within what class any particular operation falls. This, however, is not so serious as a superficial consideration might indicate, being somewhat ameliorated by the fact that manufacturing economy should dictate a much higher intensity than required by the codes.

Many efforts have been made to render the specifications more definite, but the problem is much more difficult than appears at first. There are many degrees of fineness in the same type of process as carried on in different shops or even in the same shop. Lathe work in machine shops, for example varies in fineness all the way from very rough work down to watchmakers' fineness. An article is made by one manufacturer, say to 0.01 inch of accuracy, while another making nominally the same article works to 0.001 of an inch or finer.

Several proposals have been made, among which may be mentioned.

a. To make the intensity table simply an index of intensity levels, each indicated by an arbitrary designation (a, b, c, etc.) without any description of the process covered. Supplement this with a complete list of all manufacturing processes, using the symbol to designate the particular class to which each process is assigned.

b. To supplement the present classification with a detailed list of standardized processes.

The latter scheme (b) seems to have some advantages provided it is not extended too fast so as to lead to confusion through repeated changes. The New York Commission has adopted tentatively for a year a list of this sort, but has found it necessary so far to use in many cases the qualifying terms "rough work," "medium work," "fine work," which make the specification in such cases but little more definite than the general classification.

The first plan (a) has some ardent advocates, but has been objected to on the ground that such a list implies an accuracy of description that does not really exist.

In general, it seems desirable for the ultimate good of all that most States adhere to the broad descriptive specification, while a few experiment with the extensions and determine their practicability. They will then be more readily able to adopt any method which shall have been found especially meritorious.

(To be continued)



# The AMERICAN ARCHITECT



CAPITAL OF LOWER PORTICO, PALACE OF THE DOGES, VENICE

PUBLISHED WEDNESDAYS IN NEW YORK—FOUNDED 1876  
VOLUME CXV                      MAY 21, 1919                      NUMBER 2265

Entered as second class matter January 6, 1909, at the Post Office at New York, N. Y., under the Act of March 3, 1879. Publication office, 243 West Thirty-ninth Street, New York, N. Y. Subscription price in the United States and Possessions, \$10.



# BISHOPRIC SHEATHING



## First 40 Houses; Then 10 Houses; Then 50 More Houses

Gentlemen:

Irvington, N. J.

Have specified and used your stucco board on some 40 or more houses built in the Weequahic Park section of Newark and elsewhere and have always obtained the best of results.

We did not hesitate to again use same on 10 houses of the 60 for the Mesa Housing Proposition that are now nearing completion at Irvington, N. J.

When your representative first spoke to us about your Bishopric Sheathing we kept it in mind. As you know, we ordered two car-loads of it, enough for the other 50 houses for the above-mentioned Mesa Housing Proposition.

We are using it under shingles, wide and narrow clapboards, etc. Although somewhat skeptical at first about placing shingles over your sheathing, thinking it would be springy, we are no longer, this idea having long since disappeared. We find it everything ordinary sheathing could be and more. Being easy to handle, the carpenters liked putting it on.

Seeing its possibilities and the economy in using it, we will not hesitate to bring it to the attention of any of our clients who, in the future, expect to build.

Yours truly,

STROMBACH & MERTENS,  
Engineers and Architects,  
Victor H. Strombach.

An Engineering and Architectural firm which does big things in New Jersey has written us regarding its experience with Bishopric Sheathing on 50 houses it built in connection with the Mesa Housing Project at Irvington, N. J. Read the letter. It is more significant than anything else we could say about this modern Sheathing Board.

Note the list of institutions which have used Bishopric Sheathing either on Industrial Housing or Home Building projects:

Youngstown Sheet & Tube Company, Youngstown, Ohio; Virginia Shipbuilding Corporation, Alexandria, Va.; American Clay Machinery Company, Bucyrus, Ohio; F. C. Mesa Munitions, Irvington, N. J.; Hamilton, O.; Home Building Co.; Petroleum Iron Works, Petroleum, Ohio.

**The Bishopric Manufacturing Co.**

904 Este Avenue

Cincinnati, Ohio

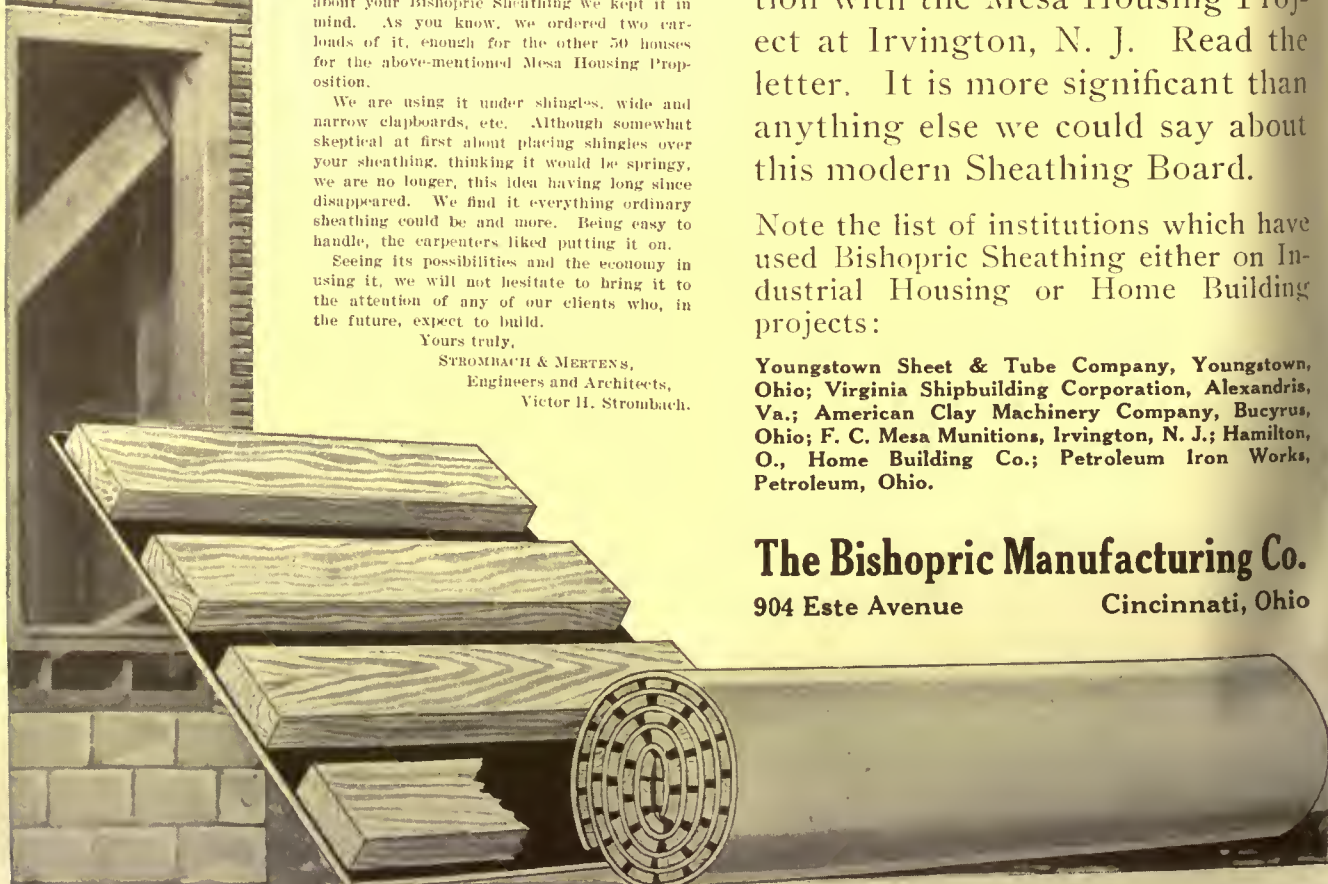







PARAPET DETAIL—CHURCH OF S. MARK, VENICE



# THE AMERICAN ARCHITECT

VOL. CXV

WEDNESDAY, MAY 21, 1919

NUMBER 2265



PHOTO 10. MAIN DRIVE AT JUNCTION WITH ENTRANCE TURN

Note provision for lawn to right of drive and at living end of house. See A, fig. 7 also photos 11 and 19.

## Garage and Entrance Turns—Part I.

By A. D. TAYLOR, *Landscape Architect and Town Planner\**

THE introduction of the automobile and its present universal use both for pleasure and industrial traffic has developed a new problem. This problem is the laying out of garage turns and entrance turns, and is presented to thousands of owners of both small and large homes throughout the country. Road space once ample for the use of horse vehicles has become within the past few years entirely inadequate for the use of the automobile. These new problems of width of road and degrees of curvature have been most acute at the entrance to residence and garage, although in some measure they appear along the course of the entrance drive itself. These problems have been

solved, not by definite rules deduced as a result of experience in designing these turns, but rather by "the rule of thumb" method.

This subject is worthy of detailed discussion, and it is the purpose of the present article to bring together for comparison and reference some of the results obtained in practice, as shown in the designs of various garage and entrance turns, each of which has been fitted to the actual curves of the wheel tracks under the conditions locally imposed by the size of the garage and the car, by the relation of garage location to property lines and residence, and by the direction of approach.

Unfortunately, there is very little available diagrammatic data pertaining to areas and outlines of garage and entrance turns in which an automobile

\*All illustrations are from work designed and photographed by the author.

# THE AMERICAN ARCHITECT



Photo 11. Entrance turn opposite entrance steps showing relationship of house to garage, as yet unscreened by planting. See fig. 8, fig. 7 and photos 10 and 19.

may be operated conveniently, and without either waste of space or lack of space. The automobile has now developed to a point where experience has taught us that certain general outlines for entrance and garage turns meet the requirements. This discussion, with accompanying figures and illustrations, is an attempt to put on record certain fundamental information regarding the size and outlines of these areas. The factor of circumstance is so variable that the designer will often find problems for the solution of which the information in this article will serve only as a suggestive or partial answer. Each solution here shown is the answer to a practical problem viewed from the standpoint of the professional designer as adviser, and of the automobile

Entrance and garage turns fall under one of four types, as follows:

- A. Turn-tables.
- B. Ovals.
- C. "Y" turns.
- D. Some combination of "Y" turns and Oval turns.

The first requisite of a well-designed turn is that it shall provide ample space of road-bed to allow



Photo 12. An interesting solution of the garage turn and entrance drive. See fig. No. 12.

ease of turning or reversing the direction of travel of any desired type of automobile. The second requisite is that while efficiency of operation is not to be unduly sacrificed, yet the total area of road-bed should be a minimum. The third is that wherever local conditions require it, space shall be pro-

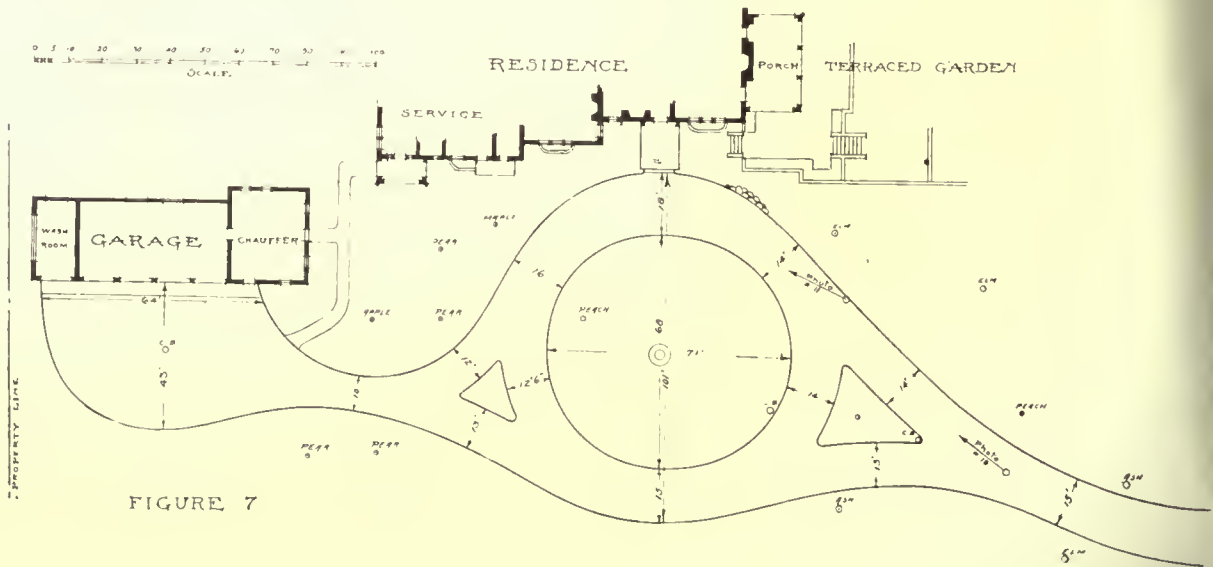

vided in which to park the first automobile either directly in front of and close to the entrance steps or in some part of the turn, while a second automobile enters and departs.

vided in which to park the first automobile either directly in front of and close to the entrance steps or in some part of the turn, while a second automobile enters and departs.

# THE AMERICAN ARCHITECT

receive the careful consideration of the expert designer.

## A—TURN TABLES

Turn tables are mechanical devices for reducing the turning space required by any automobile to a minimum; that is, to its own length. These are to be recommended only where the conditions of

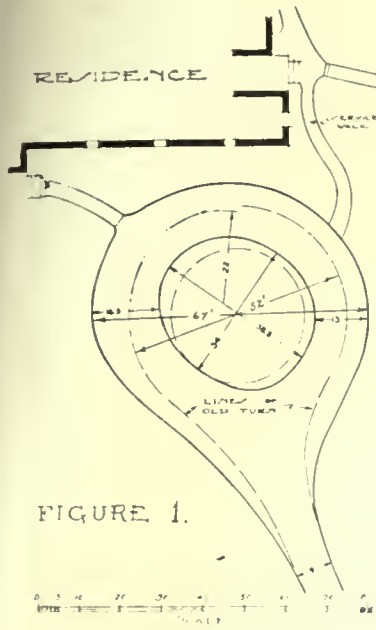

FIGURE 1.

In the actual execution of the work of developing an attractive and efficient turn, it is always essential to supplement the ground design of the turn with groups of plantings. These plantings will frame certain portions of the turn, thereby softening some of the uninteresting and particularly awkward lines as shown in photo-

graphs Nos. 13 and 15. On the other hand, these plantings often emphasize the interesting outlines of some of the curves, as shown in photograph No. 10. The relative value of plantings in these designs is seldom appreciated by the person who has not given considerable thought and study to

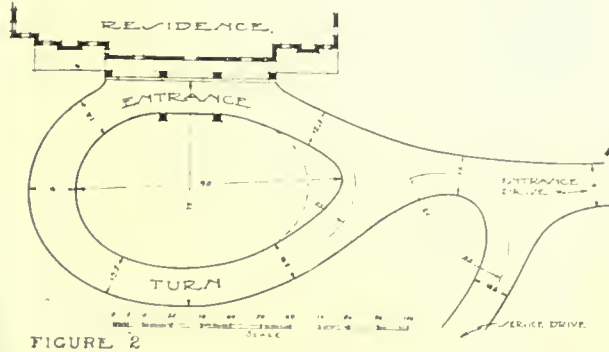

FIGURE 2

the effectiveness of these areas when properly framed with plantings.

In each of the illustrations the important measurements are indicated in figures. Other minor measurements may be scaled upon the diagram. Oftentimes if space is available these turns may be increased by from one to two feet in the major dimensions. The turns shown are the minimum space required for operating the automobile.

This article is compiled with reference to the space required by the latest models of large and small cars. This important question should be considered from all of its angles, with reference to both large and small machines, and there is no garage or entrance turn so small that it should not

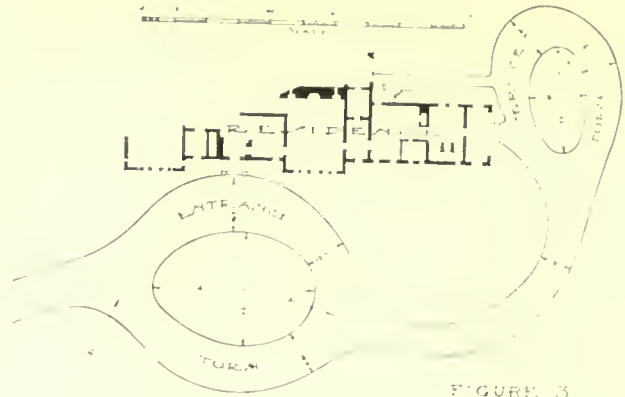

FIGURE 3

restricted area require their use, and in northern latitudes where snow and ice abound they should be located only under roof in the garage itself. The width of the space required for the turn table must equal the length of the car, and as the length of an average car is over twice its width, it results in giving up to occasional occupation by the ends of the revolving car a space adequate for the storage of a second car all the time. This is manifestly an uneconomic utilization of cramped quarters. It may be placed before the garage doors, but a turn table in any location is apt to prove too slow in operation, as most autoists are impatient of delay.

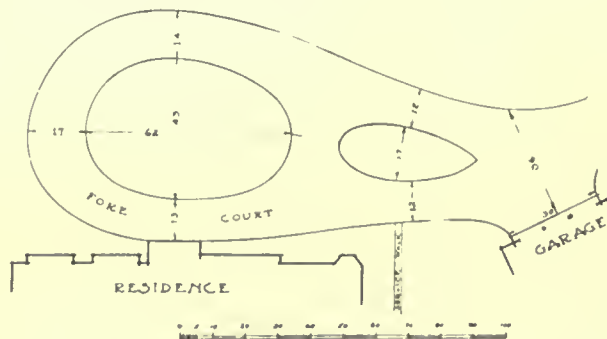

FIGURE 4

## B—OVALS

Here the turning is accomplished by curving continuously during the forward motion of car until the car is headed back in the direction from which it came.

There are four general considerations requisite





Photo 15. Looking into the entrance and garage turn from a point opposite the entrance steps. See A, fig. No. 14.



Photo 18. Entrance drive parallel with side of house and framed with newly transplanted trees and shrubs. See fig. 14, photo 15.

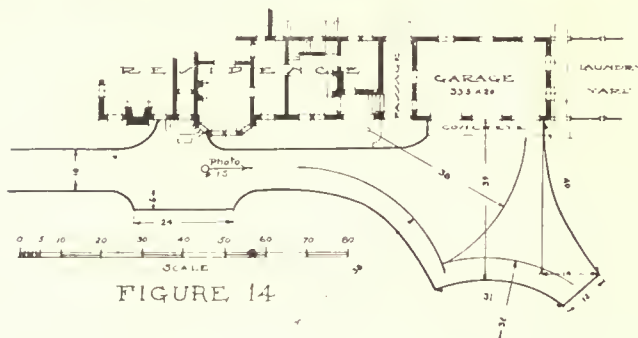

FIGURE 14

in a successful oval turn. The first is that a machine may traverse it comfortably at a speed of not over eight miles an hour without encroaching on the edges. This is more easily accomplished if the roadway of the oval is given a slope or "bank," high on the outer edge, rather than crowned, as in the ordinary road. The second is the provision of ample space for a standing and passing car before the steps by making the drive at this point not under fifteen feet, and preferably sixteen or seventeen feet in width. (Figs. 14, 12, 3, 7.) The third is the widening of the drive on the semi-circular curves to allow the rear wheels to take a shorter radius than the front wheels without going beyond the edge



Photo 13. The garage placed at an angle to provide space for planting seen in left of picture. See fig. No. 11.

of the road surface. (Fig. 2.) The fourth is the allowance of sufficiently easy curves adjacent to the steps, so that the rear door of the car may be readily brought parallel with, and close to, the house steps for convenience of receiving and discharging passengers.

In Figure 1, the oval turn is shown in its simplest form and dimensions, and is especially interesting in giving a comparison of size and shape required by the auto as compared with the old loop, as indicated in dash line, which was designed for horse-drawn vehicles. While a maximum diameter of 52 ft. answered for the horse turn, 67 ft. is allowed for the auto turn.

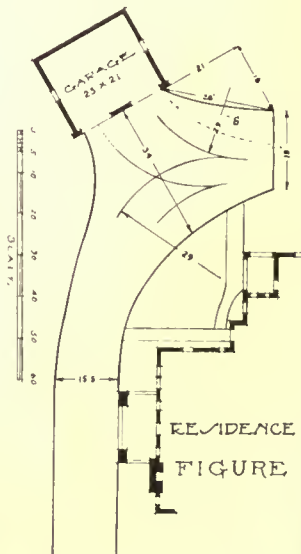

FIGURE 11

A loop is rarely best in the form of a circle, and the reasons have largely to do with limit of area. An oval with entrance steps on the long side occupies much less space than a circle which would give equal ease in bringing an automobile parallel with the steps. This is quite evident on reference to Figure 2. This is a typical and ideal front entrance turn on a large estate where no complications occur and the area need not be restricted. If the radius of approach to the steps were the radius of a circular loop, it would require a diameter of 160 ft. in place of the 77 ft. required by the oval. Figure 2 shows the type where the service road branches from the main drive before the loop

## THE AMERICAN ARCHITECT

begins; this is excellent but frequently not possible. The intersections and the radii in this case are the resulting compromise between ease of use and objections on the score of too large road surface



Photo 19. Flower garden and shrub lawn looking from entrance drive over an informal artificial pool. See photos 10 and 11.

areas. This is quite clear on consideration of the dash line at the small end of the "egg." The dash line curve would have made easy the return to the steps. This is a comparatively infrequent use and the net result would have been a vast expanse of glaring roadway and extra cost of construction and maintenance. Note also that the width of the drive varies with the tendency to narrow on the direct route while on the large sweep, which different drivers will take differently, it exceeds the maximum of the drive itself. It is the small refinements of this character, made on the ground by eye, that do much to make the final result fit unobtrusively into the total scheme. The width of drive in this example, at the entrance steps, is limited by the width of the *Porte-cochere*.

Figure 3 shows the oval loop with service drive leading from it. The arrangement shown has in view two purposes: First, the creation of ample space for screen planting to hide the whole service area, and service wing of the house from arriving guests, and second, the passage of service teams by the front of the residence at as great a distance as possible. Ample space is provided before the steps for a car in waiting and room for another to pass. The *Porte-cochere* in Figure 2 prevents this, but passing space is a very desirable feature.

In the next example, Figure 4, we have a combination of main loop and a minor service loop where the drive approaches the house from the service end, and the service teams can turn back without passing the front door. The secondary loop also serves as a "Y" turn to the garage entrance. Here the service intervenes between the entrance to the grounds and the house entrance,

being the opposite of the last example referred to.

This turn is perhaps open to the objection of large area of roadway with its original cost, its glare and its maintenance, but in this case the living side of the house is very definitely toward the ocean on the opposite side from the entrance, and this arrangement worked out very well. No space was allowed for the passing of autos opposite the entrance steps because of opportunities for easy turning, should occasion require, at the end of the service oval.

The double loop in Figure 5 is still more complicated. The original curves of the turn are shown in dash line. The service turn was retained contrary to the designer's desire, so the effort was made in relocation to make the approach to the entrance turn an easy sweep from both the garage drive and the main drive. The large loop is restricted by sloping ground and is in practice hardly adequate, the turns being difficult to negotiate. This turn should have a total diameter of not less than 60 feet. Also, there is an undesirable amount of roadway close to the house. A broad path from the garage drive to the service door and ice house, in place of the service loop, would do much to

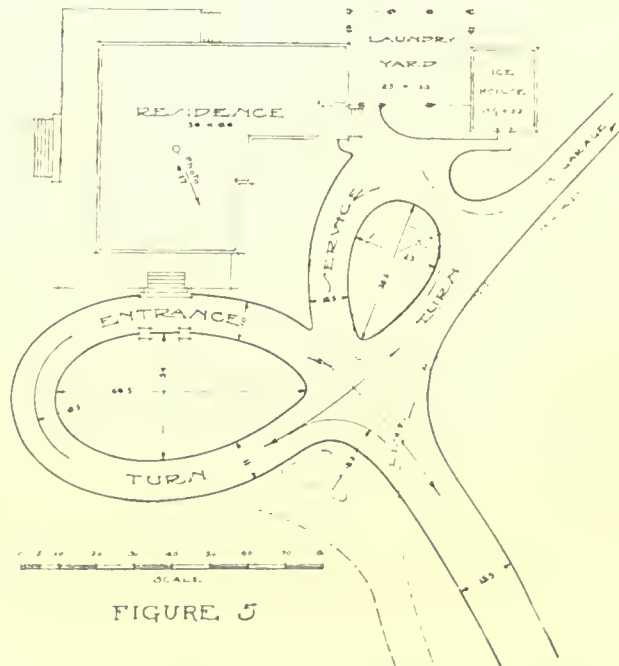

enhance the appearance as one approaches the house.

The next oval turn is in a highly developed formal forecourt with strong rectangular architectural framing and diagonal entrance and exit. (Fig. 6.) This is a rather unusual case, brought about by the narrowness of the lot upon which the large



# THE AMERICAN ARCHITECT

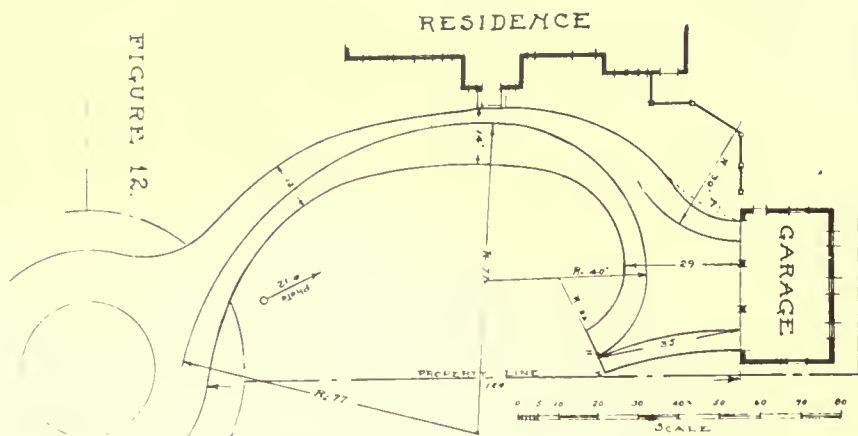

residence stands. Here we have the service court beyond the house entrance, and the service traffic passes over the side of the turn away from the front door of the house. The oval becomes as nearly symmetrical as possible on the axes of the court and the cut-away of the sides to secure easy entrance and exit and close approach to the steps was very minutely worked out with a limousine, much gasoline, and many small stakes. In use and appearance the effort has been justified.

The following is a summarized tabulation containing information with reference to the wheelbase and turning radius of representative makes of pleasure automobiles:

Make of Car	Type of Car	Overall Length of Car	Wheel-base	Turning Diameter
Cadillac.....	Roadster	15'5"	125"	Right 42', left 50'
	Limousine	15'10" top down	132"	Right 23', left 32' inside
Packard.....	Short chassis	15'9" top up	128"	45'
	Long chassis	16'5" top up	136"	47'
Rolls-Royce.....		18'6"	140"- 144"	48'
Stearns.....	Various bodies	15'	119"	43'
	Various bodies	16'	125"	43'
Overland.....	Light fours	13'6"	104"- 106"	32'
	85 fours	14'6"	112"	36 1/2"
Peerless.....	All types	15'7" top down 2 tires on	125"	39'
Pierce-Arrow..	Standard chassis	19'	142"	50'
	Largest chassis	19'6"	147 1/2"	59'
	Smallest chassis	18'6"	134"	43"
White.....	Smallest 7-passenger	14'	110"	.....
		16' top up	137 1/2"	42'
Hudson.....	All types	15'9"	125 1/2"	39'4" left turn
Ford.....	Runabout Touring, top down	10'10"	100"	28'
		12'1"	100"	28'
Winton.....	Big Six No. 33	16'1"	138"	45'
		15'	128"	41'
Dodge.....	Touring	13'9" top down	114"	Tires 32x3 1/2" 40' Tires 33x4" 45'
	Limousine	13'9"	114"	Tires 32x3 1/2" 40' Tires 32x4" 45'
	Roadster	12'9" top down	114"	Tires 32x3 1/2" 40' Tires 33x4" 45'
Buick.....	Roadster, Tour- ing, Sedan 7-Passenger Touring, with 2 tires	13'6"	118"	42
		16'	124"	44'
Electrics, Baker Rauch & Lang....	Brougham Coach	.....	92"	40'
		.....	102"	45'

No screen planting can hide the garage door from the front steps, but this could have been obviated by setting the garage further back and deepening the service court. This court is all road surfaced, and cars can drive all over it in reversing their direction.

The last example of the oval turn presents this type at its broadest development upon unrestricted area on a large estate. Every refinement of varying width is present, triangular islands make all curves easy sweeps and lessen the apparent area of roadway. While the service area is beyond the front door, all traffic to it is at a distance of 100 ft. away and several feet lower and is amply screened by shrubbery planting.

The broad swing of the driveway around the area devoted to terrace garden (See photo 19) gives a fine chance for developing this area next to the living end of the house, and presents to the visitor by this diagonal approach the best possible perspective view of the house façade. (See photo 10.) It is interesting to compare this with the more nearly parallel approach in Figure 2.

Photo No. 11 shows very clearly the minimum intrusion of the very large garage into the scheme, due to its being seen only "on end" as it were, and enframed behind softening foliage; yet the sweep from the garage to front door is short and easy. A circle in this situation would have appeared stiff and lacking in grace; and it is interesting to note that while there are at least four different radii in the major oval, most visitors on the ground would unhesitatingly pronounce it a circle. It is the knowledge of how far one may vary from geometrical forms without giving offense to the eye, wherein lies the secret of successful practical designing of this sort. In fact it is this license or liberty that when intelligently taken will give the best result in any artistic effort.

(To be continued)



DIRECTORS' ROOM

(For other illustrations, see plate section)

## The People's National Bank of Brooklyn

**T**HIS building, for which Koch & Wagner, architects, prepared the plans, is located at the southeast corner of Ralph Avenue and Quincy Street, Broadway, Brooklyn, New York.

The base course and columns are of polished Greens Landing Granite; the entrance and steps of tooled granite. Terra cotta with limestone finish form the entablature, columns and pier caps. The rest of the building is constructed of a grey, mottled brick. The panels in the frieze of the cornice are Golden Sunset marble. Entrance doors and frame are bronze, while window frames are steel.

The banking room within is 28 feet 6 inches high and has been so designed that a mezzanine may be installed when the future growth of the bank may justify. The floors are of Tennessee marble; the wainscot, counter screen, staircase, etc., honed finish Tavernelle marble. Above the wainscot, cream caenstone plaster is used for the walls. The upper part of the banking screen is gold bronze. The

wicket grilles are operated by a foot mechanism, leaving the teller's hands free and giving positive security. The officers, who are located on a platform in the rear of the public space, may command a view of all parts of the building and have quick access to the security vault and work space. While in most banks this work space is placed against the interior wall, an unusual feature in the present building is the fact that this space is located on the street side. Thus there is at all times an abundance of natural light. The tellers are located 6 inches above the public space, and have a sweeping view over the embossed glass screen.

Desks and furnishings are of steel, mahogany finish, and the cupboards and drawers in all essential departments have fireproof rolling curtains.

The Directors' room is in the English Tudor Period style, with parquet floor, English oak wainscot, limestone mantel with Numidian marble facia. The large window is in leaded glass with Norman variegated slabs in wide, flat bars to give an antique effect. The safe deposit department is in the basement at the foot of the marble staircase.



## A Fine Example of French Craftsmanship

**A** MAGNIFICENT example of French eighteenth century furniture in the Louis XVI style, a cylinder desk bearing the royal arms of France, has been presented to the Metropolitan Museum of Art by Jacques Seligman of Paris. In memory of Mr. J. P. Morgan, and as a souvenir of the help which the Americans have given to France during the war. In every way this splendid desk of mahogany and ebony, richly decorated with ormolu mounts, is a piece of capital importance. The Bourbon lilies surmounted by the royal crown, which appear in a cartouche upon the front and back of the desk, would seem to indicate that it was made for the king, Louis XVI, as the style of the desk is clearly that of his reign.

A small key opens the upper right-hand drawer. Here is kept a large key with a handle which unlocks the cylinder top. To insert the key, it is first necessary to press a hidden spring concealed in the ormolu mounts of the upper central panel. When this spring is pressed, the mask of a woman's head drops down revealing the keyhole. But there are further complications. When the big key is entered, it is necessary to make a half



FRONT—OPEN

turn to the left, push in the key entirely, and then make eight complete turns from right to left. The key is then pulled out half-way and pressed toward the right, while at the same time, the sliding cover of the desk is raised.

The desk chair, upholstered with leather, may now be pulled out from the front of the desk, of which, when closed, it forms an integral part. The leather-covered tablet is then drawn out. At the back are three compartments with sliding covers.

The central part may be opened up so as to form a sloping pulpit or desk. When this is raised, access is had to three sliding boxes and a large hiding place. The inner drawers, concealed when the desk is shut, open by pressure on springs. Two narrow drawers, faced with mirrors, on either side of the central compartment, may be pulled out without further ado. An interesting feature of the compartment, which is closed by two small doors, is that the back panel may be slid to one side so as



BACK—OPEN

to provide an opening through which the user of the desk might communicate with the secretary, for whom, as we shall see, facilities were provided on the back of the desk. At each end of the desk is a slide. The top of the desk is covered with a marble slab surrounded by a light gallery of gilt bronze.

Coming now to the back of the desk, we find that the upper part, composed of three panels, forms one leaf which opens downward when unlocked, revealing a series of small drawers and shelves. This lid is covered with leather and serves as a desk; a central part opens to form a pulpit. When the lid is let down, it is supported by a section of the desk, which is pulled out in the same way as the chair on the front of the desk. This, in turn, has several drawers, and the top may be raised so as to form a pulpit, if the section is drawn out while the lid is closed.

From the purely artistic side, the interest of the desk lies in the attractiveness of its severe but beautiful forms, and in the skilful use of ornament in gilt bronze to emphasize constructional lines and to relieve the simplicity of the form of the desk by the exquisite detailed work of the

## THE AMERICAN ARCHITECT

various garlands, rosettes and mouldings. The metal mounts, delightful works of art in themselves, contribute largely through their decorative value to the effectiveness of the desk. In the period of Louis XVI, furniture design and construction reached a height of perfection which has rarely, if ever, been surpassed.

The reproductions are made through the courtesy of the Metropolitan Museum of Art.

### Architectural Criticism

WRITING of architectural criticism, a contributor to the *Architects' Journal* of London, who signs his article H. J. B., states: "The individual patron who was often a person of great culture, is rapidly giving place to the State and the smaller governing and public bodies, as the architectural employer, and until these realize their responsibility, much that is rightly deplored will continue to exist."

The solution suggested is the creation of a school of scholarly criticism. Of just what essential elements would a school of scholarly criticism consist? Are we asked to educate in the higher branches of reasoned criticism the many different types of men who control the regulation of our architecture in the national, state and municipal governments? Just what is reasoned and scholarly criticism? Of course it consists of a sane and intelligent appreciation of good art as applied to architectural design, but with the many interpretations of what that measure of good art is as set forth by men whose judgment should be reliable and whose opinions are undoubtedly honest, we are confronted with adversity of opinion that leads to no definite end. "Who shall decide when doctors disagree?"

The fault of much of our architectural criticism today lies in the ignorance of the critic of the media of expression. This is equally true of a large number of critics in the field of the fine arts. This shortcoming of critics with other interesting phases of architectural criticism is very ably discussed in the article referred to. It is worth careful consideration, and believing this, we are reprinting it below, with due acknowledgment.

The article states:

The function of criticism has been variously described—one dare not say defined. Matthew Arnold regarded it in a general sense as "a disinterested endeavor to learn and propagate the best that is known and thought in the world." It has come, however, to possess a more specialized meaning, as the published account, either of the ideas or the sensation obtained from the contemplation of

a particular creation in literature or the fine arts, or an analysis of their qualities and characteristics, taking an independent literary form, which may in itself be—and, indeed, often is—a production of much beauty.

The objects with which aesthetic criticism deals—music, literature, and the various accomplished forms of human life—are but the objective manifestations of the natural forces and virtues within mankind, and the questions to which the critic must answer—put in their very simplest and most direct form—are, What aspect of life does this work reveal to me? Is it revealed truthfully and with beauty?

The history of art criticism is a study of much interest, and brings with it many great names, of which the earliest is Aristotle, who may be regarded as the founder of literary criticism. Thus note may be made at the outset of the fact that the functions of creator and critic are often combined in the same person, of which the student would have many opportunities of observing. At various periods in the development of criticism attempts have been made to stultify it and prove that it can claim for itself no place of permanency in the intelligent scheme of things, and to no less a person than Disraeli is attributed the harsh and unjust statement that "the critics are the men who have failed in literature and art," but the fact of its continued survival constitutes an eloquent testimony to the contrary. Useless adjuncts in a structure display a tendency toward atrophy. Some of the finest, noblest and most suggestive passages in English literature, Francis Thompson's *Essay on Shelley*, Walter Pater's *Renaissance*, the writings of John Ruskin, to name but a few random examples, are in the form of art criticism. But even the production of such beauty is perhaps insufficient justification, and it is, indeed, but a fragment of all that exists; for the critic by his utterances stimulates the interest of the public, on whose behalf as a layman he speaks, and this interest in its turn reacts on the artist, spurring him ever toward a higher goal. Thus is the circle completed.

All writers of the finer forms of literature have their counterpart in journalism, with their consequent broader and less specialized appeal, and the art critic today has a definite place in the social hierarchy, his function being, as it were, to epitomize, to guide, and to stimulate public opinion. His position is, therefore, at once one of great importance and responsibility and for the wise and conscientious fulfilment of it certain qualifications are necessary. In addition to a general breadth of vision and generosity of spirit—for an embittered critic is a source of much evil—is required, above all, a deep knowledge of the difficulties and limita-



## THE AMERICAN ARCHITECT

tions of the medium, be it words or music, marble or pigment, with which the work is created, and an historical knowledge of its traditions and past achievements. It is possible, however, that some of these limitations in their broader conceptions are arbitrary; the fact of their survival is no indication that they may not at some time be subject to readjustment. Thus, Lessing in his "Laocoon" maintains that the domain of literature is time while that of painting is space, a ruling which certain modern painters are tending to defy. A sound judgment is only to be acquired by a patient study of all that is best of what survives, and a knowledge of the problems with which the artist has been confronted; problems variously imposed by limitations of form, selection of matter, and possibly certain impositions particular to the undertaking. By such means a good critic should almost without effort accept that which is good and satisfying, while rejecting that which is meretricious and specious. By so doing he fulfills the purpose of assisting the less specialized public in their taste and in their selection, and, when new efforts appear, in overcoming their prejudices, since uninformed opinion is always hostile to what is unknown. Thus today the moment a new work of art appears the critic performs his task, and the power which he wields must not be underestimated. In one branch of art, however, the critic remains consistently silent. A new building never receives any genuine criticism from a qualified source. The reason for this anomaly is hard to find, but the result is bad and far-reaching. It is, indeed, strange and sad that architecture, which is the most democratic of the arts, should arouse so little public interest. Painting, music, sculpture and, indeed, literature are personal, but architecture is vitally bound up with the life of a people, surrounding it with beauty or ugliness. The character of a nation is read in its buildings.

It is the great love for their work which many architects bear that enables them to overcome public apathy and ignorance and to produce so much good work; but there can be no doubt that much that is bad and ignoble would never have found three dimensions had there existed a reasoned and re-

sponsible tradition of architectural criticism, which would have built up an intelligent critical and enlightened public. It is not now too late; the time is opportune. Reconstruction is the need of the moment.

What common quality lies in such diverse works as the Temple at Paestum, the Library at St. Mark's, Châtres Cathedral, St. Sophia, the Cavalry Club, Piccadilly, William Pain's Doorways, Inigo Jones's Banqueting Hall? (The writer by the exclusion of modern work does not wish to insinuate that in his opinion none is worthy of inclusion, but he does not set himself up to be an architectural critic. The works which he selects have stood the test of time.) Is it not just some delicacy of touch showing itself in restraint and selection of detail, in massing and balance—all manifestations of the master mind—some ineffable quality which makes the shell upon the shore or the wild flower by the wayside a thing of beauty? And is it not desirable that the public should acquire just this capacity of discrimination? By so doing, not only would it bring a new interest into its own life, but it would be in a position to assist in the building up of more beautiful towns: for however much the individual architect may strive and succeed to produce the best results, the larger aspect of our towns must ultimately reflect the outlook of the people, just because architecture is not a personal art, but depends in its realization upon the assent and collaboration of untrained minds who are always in a position to impose restrictions and limitations. When, however, a deep interest and understanding of good building has been acquired, it is probable that this power will cease to be a source of danger. The individual patron, who was often a person of great culture, is rapidly giving place to the State and the smaller governing and public bodies as the architectural employer, and until these realize their responsibility much that it rightly deplored will continue to exist. To bring about the improvement which is to be so devoutly desired, nothing can be of greater assistance than the creation of a school of reasoned and scholarly criticism.

THE AMERICAN ARCHITECT

Founded 1876

PUBLISHED EVERY WEDNESDAY BY

THE ARCHITECTURAL AND BUILDING PRESS, INC.

No. 243 West Thirty-ninth Street, New York

E. J. ROSENCRANS, PRESIDENT AND TREASURER  
WILLARD C. HOWE, VICE-PRESIDENT

WILLIAM H. CROCKER, Editor  
EDWARD F. HAMMEL, Engineering Editor  
ARTHUR T. NORTH, Western Editor

Subscriptions in the United States and Possessions,  
Mexico and Cuba, TEN DOLLARS. Other Countries,  
TWELVE DOLLARS.

SINGLE COPIES (Regular Issue) 25 CENTS

CHICAGO OFFICE, Mallery Building  
PAGE A. ROBINSON, Western Manager  
ST. LOUIS OFFICE, Wright Building  
CLEVELAND OFFICE, Guardian Building  
SAN FRANCISCO OFFICE, 320 Market Street

Owned by United Publishers Corporation—H. M. Swetland, President;  
Charles G. Phillips, Vice-President; W. H. Taylor, Treasurer;  
A. C. Pearson, Secretary. Entered as second-class matter January  
6, 1909, at the Post Office at New York, New York, under the Act of  
March 3, 1879.

VOL. CXV      MAY 21, 1919      No. 2265

What Could Be Done

WHILE the Post-War Committee on Architectural Practice may for the coming year be seriously engaged in the very important work of formulating what in a sense will be a creed that clearly states the real things which architects, to be successful, should believe, there are other and important matters that will properly engage the serious consideration of that committee.

What the profession has a right to expect as the result of the deliberations of the recent convention is, more than ever before, a measure of accomplishment. It will look forward to some practical fruition of at least a part of the many desirable aims that have been outlined. To accomplish this end it will be necessary to gather into Institute membership that large number of desirable men who up to the present time have held aloof from the organization. This can be more quickly done if every member of the Institute will labor to recruit those men. "A thousand in 1919" should be the slogan.

LOOKING backward to a convention held in Washington some eight years ago, and particularly to a certain reception held in the Hemicycle of the Corcoran Gallery, it is recalled that the meet-

ing was addressed by the late President Roosevelt, Elihu Root, then Secretary of State, and Ambassador Jussurand of France. M. Jussurand referred at some length to the great possibilities for artistic development that existed in that large tract of land lying between Annapolis and Washington. At that time the Institute was lending the weight of its influence to the development of the scheme for a Lincoln Highway and that influence was largely responsible in preventing a certain political faction from securing the abandonment of a scheme that is now rapidly assuming a most dignified and practical completion.

In the report of the Committee on Historic Monuments presented to the Nashville convention, the following interesting paragraph is to be found:

It is with interest that your Committee records a revival of measures to induce the United States Government to acquire a large area of land adjacent to the national capital for scientific reforestation and improvement as a national park and forests. The project when previously considered had the endorsement of leading associations and the press, and is one of the subjects especially recommended to your Committee for encouragement by the Board of Directors of the Institute. Not only does the territory in question between the District of Columbia and Annapolis offer unusual advantages as a natural arboretum already possessing a great variety of native trees and diversity of soil, but it is proposed to develop the land adjoining the national capital as a park, affording sites also for memorials and monumental structures along the proposed roadways leading toward Baltimore and Annapolis. Within the stretches of country elsewhere and exclusive of the forest areas it is proposed to introduce among other features a village or "insurance city" where the Government would provide homes for disabled soldiers.

In furthering a project so altogether praiseworthy, the Institute would be engaging in a patriotic work exactly within its particular province. It is strongly urged that this matter be seriously considered.

DURING the course of his remarks before a session of the Post-War Committee, H. Van Buren Magonigle, referring to the subject of architectural education, stated:

"Does the public need to be educated? I would propose quite seriously that we do not debate that question at all until we have determined first whether our own education is as perfect as it might be. . . . When it is, then let us take up the public."

This is very good advice, and suggests a further and careful reading of the admirable report submitted by the Committee on Education, from which may be learned just how this important movement may best be organized and conducted. As this report states, architectural education has a two-fold purpose: the creation and the appreciation of architecture. The student must be educated to conform to certain standards that he might now consider as



## THE AMERICAN ARCHITECT

incompatible with his educated view of his professional work. He must learn that it is his life work to support rational living in a higher sense than it has been heretofore supported. He must do this and at the same time create an impression of good architecture, a respect in the general public for his work.

The problem is one of great intricacy, and its solution has not been found in past educational methods. When it is at last discovered, and that will only result through the efforts of practical men in the profession, the student on graduation will be so well equipped mentally in his art—or profession—and the practical elements that dominate it to a greater extent than any other field of art, as to be thoroughly competent.

It is very apparent that there are things outside of the activities of the Post-War Committee that will afford opportunities for concurrent effort that will be of the most constructive nature. Some of these have been already referred to, and afford an opportunity for constructive work that would place the Institute squarely before the public as an efficient and energetic working body.

**T**HE abandonment of the Committee on Public Information would be an amusing instance of a misunderstood title, if it were not so unfortunate as to deprive the Institute of what could be made a very valuable part of its administration.

It was in these pages that the formation of this committee was urged, and it was at the time when

the fate of the Tarsney act was discussed in Congress. The papers teemed with misrepresentations as to the status of architects, and it was proposed to create a committee that would through the daily press, influence a correct point of view on the part of the general public. When this committee was formed there was apparently some misunderstanding as to just what section of the public was to become "informed." It set about informing the architects about matters on which it believed they should become posted. The general public is yet presented with glowing reports of some notable structure in which the owner's name is exploited, the town officials who participated at the opening are fulsomely quoted, while the architect is never even indirectly mentioned. It also reads in its daily paper of the many building activities by national, state and municipal authorities, but the architects' names are conspicuous by their absence. Further, there are constantly recurring examples of statements in the public press, framed in crass ignorance as to the practice of architecture.

It was through a well directed literary propaganda that it was originally proposed to have this Committee on Public Information work. It set sail on an entirely different course, and after floundering along, most of the time conflicting with other committees, it is at last wrecked and scrapped. If a properly constructed committee were formed, acting along the lines above indicated, we would see fewer false statements as to architectural practice, and fewer failures to accord architects their just recognition.





PLATE 162

BUILDING FOR PEOPLE'S NATIONAL BANK, BROOKLYN, N. Y.

KOCHI & WAGNER, ARCHITECTS













PLATE 164

DETAIL OF MAIN ENTRANCE

BUILDING FOR PEOPLE'S NATIONAL BANK, BROOKLYN, N. Y.

KOCH & WAGNER, ARCHITECTS







PLATE 165

INTERIOR DETAILS

BUILDING FOR PEOPLE'S NATIONAL BANK, BROOKLYN, N. Y.  
KOCH & WAGNER, ARCHITECTS







PLATE 166

APARTMENT HOUSE AT 78TH STREET AND WEST END AVENUE,  
NEW YORK

ARTHUR LOOMIS HARMON, ARCHITECT







PLATE 167

MAIN ENTRANCE DETAIL

APARTMENT HOUSE AT 78TH STREET AND WEST END AVENUE,  
NEW YORK

ARTHUR LOOMIS HARMON, ARCHITECT





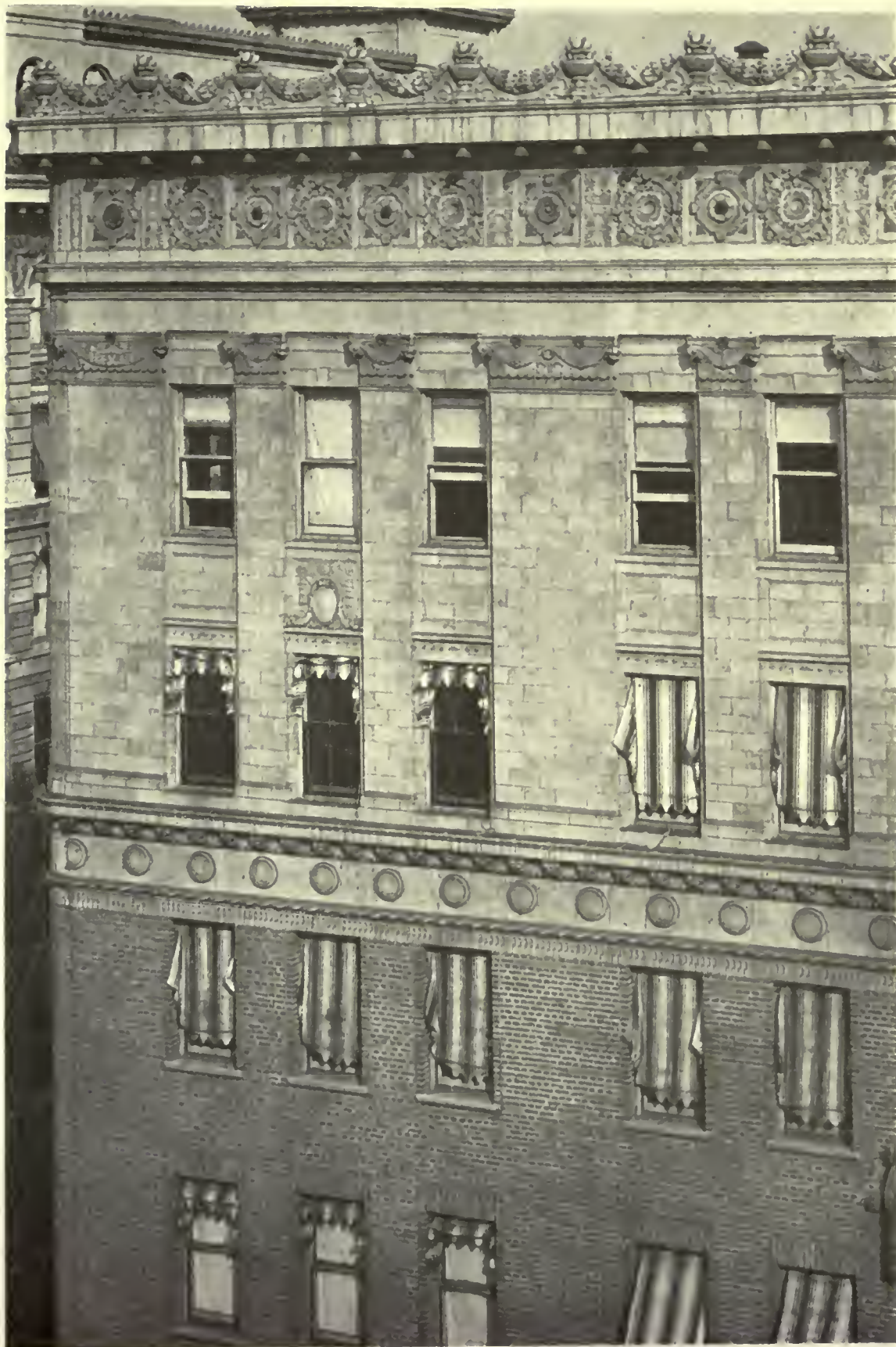

PLATE 168

APARTMENT HOUSE AT 78TH STREET AND WEST END AVENUE,  
NEW YORK

ARTHUR LOOMIS HARMON, ARCHITECT







PLATE 169

SCHOOL OF OUR LADY OF HOPE, SPRINGFIELD, MASS.

JOHN WILLIAM DONOHUE, ARCHITECT





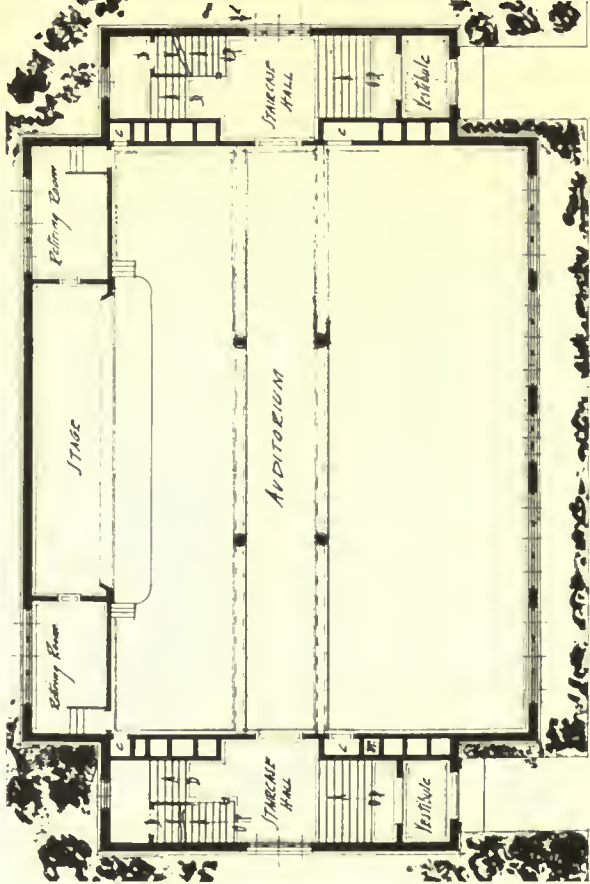
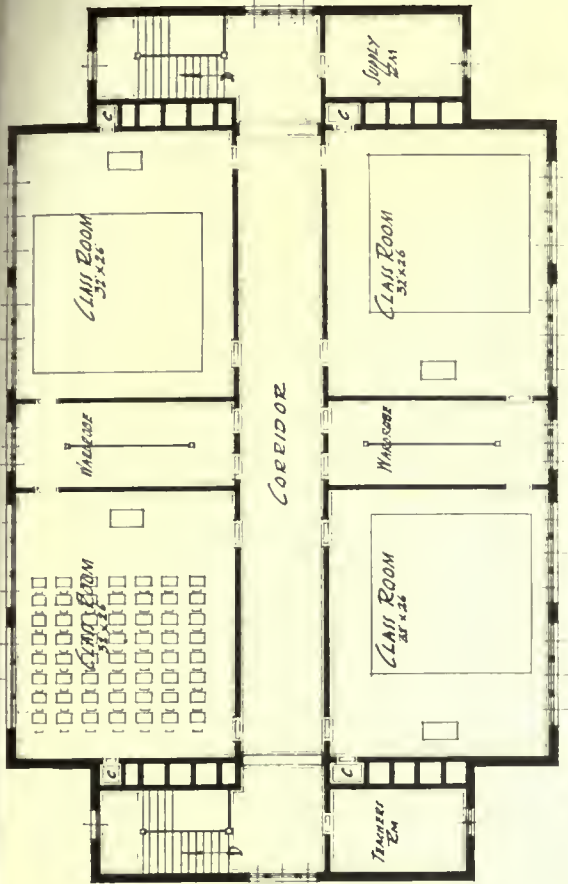
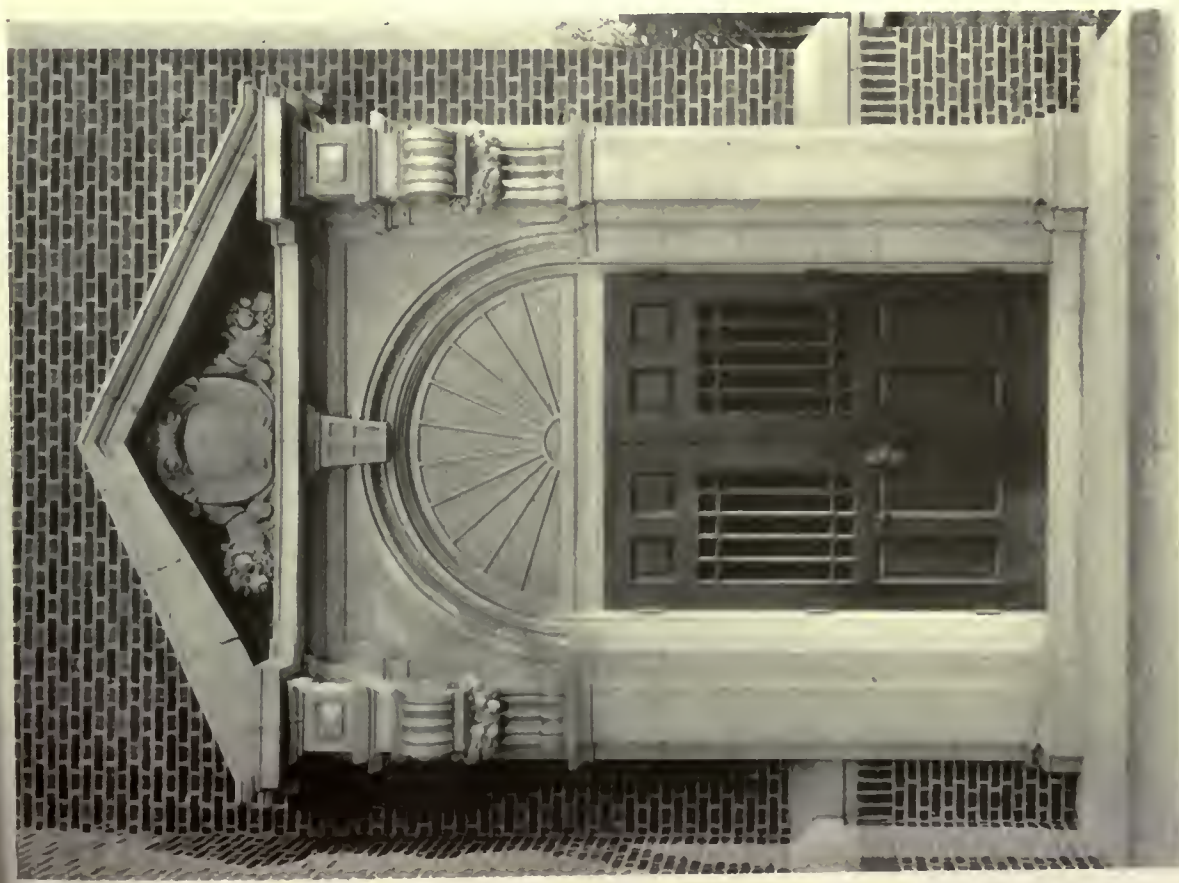

SCHOOL OF OUR LADY OF HOPE, SPRINGFIELD, MASS.

JOHN WILLIAM DONOHUE, ARCHITECT





# Current News

---

## The Academy and its Methods of Exhibiting

Considerable dissatisfaction is being manifested in the inner circles of the National Academy of Design with reference to the jury system for the selection of works of art for the annual exhibitions in New York. The insurgents, led by George Bellows, Robert Henri and Jonas Lie, claim that the Academy has ceased to be the representative exponent of the true spirit of American art and that the reputation of the Academy as an official expression of art in this country is at stake.

"The present jury system," says Mr. Bellows in the *Boston Transcript*, "is merely putting a premium upon mediocrity. It simply means that the pictures which nobody dislikes very much, in other words the more or less innocuous pictures, are going to get in. Great paintings, paintings of even noticeable merit, are apt to be paintings which some people prize very ardently and which other people just as ardently detest.

"The old-line artists who are in control of the Academy now are apt to detest the work of the newer men. They set themselves up to say what should be the spirit of American art, and they try to come as near that as they can, without any regard to what actually is the spirit of American art.

"Now, of course, we could meet them in an open fight on this question, but we prefer to let all varieties of opinion and expression have their outlet. That is the spirit of this era and this nation. And so what we propose is to let each man on the jury make an absolute selection, without regard to the opinion of the other jurors, of the pictures he wishes in the Academy show. Each of the jurors will choose in turn, and the selections of each will be hung. Care will be taken to have every shade of school and thought represented on the jury, so that full justice may be done to all styles of painting—academic, post-impressionist, ultra-modern. That is really all there is to it."

---

## British Army Huts for Homes

Reports from London have it that half a million British army huts are to be converted into homes for working men if plans made by the disposal board of the ministry of munitions are carried out. Each little hut will provide six rooms and bath all on one floor, and the cost of moving and fitting each for residence purposes would average \$1,000. Besides the huts in England, there are thousands in France that can be used in the same way.

---

## Air Fields Being Established

The government's plan for co-operating with municipalities in the establishment of airplane landing fields and creating a system of aerial highways capable of use for military, postal and commercial purposes has been announced by the Air Service of the United States Army. It is now further learned that the Air Service, in con-

junction with the Post Office Department, hopes in the near future to lay out airplane terminals in at least thirty-two cities and towns throughout the length and breadth of this country. Those selected are: Boston, New York City, Richmond, Va.; Raleigh, N. C.; Columbia, S. C.; Augusta, Ga.; Macon, Ga.; Atlanta, Ga.; Kissimmee, Fla.; Mobile, Ala.; New Orleans, Baton Rouge, La.; Beaumont, Texas; Flatonina, Texas; El Paso, Texas; Texarkana, Texas; Columbus, Ohio; Tucson, Ariz.; Phoenix, Ariz.; Yuma, Ariz.; Bakersfield, Cal.; Fresno, Cal.; Buffalo, Albany, Columbus, N. M.; Kansas City, Mo.; Oklahoma City, Okla.; Uniontown, Penn.; Daytona, Fla.; Cleveland and Chicago.

The minimum size of any field should be such as to allow a 600-yard runway in every direction, with no interfering obstacles. The shape should be square or rectangular. The announcement reads in part as follows:

The establishment of landing fields throughout the country through co-operation with the Government agencies and the cities concerned will certainly operate to the advantage of both the Government and the city, because in the rapid development of commercial aviation those cities which have provided the primary facilities for operation of aircraft in their vicinity will have paved the way for local benefits, resulting from the development of aerial intercity transportation, express service, mail service, emergency service and local photographic mapping of aerial protection.

The fields are to be established in accordance with articles of agreement to be entered into between the United States Government and the municipality. Neither the Air Service nor the Post Office Department will deal with any private societies or associations.

## Salvaging Old Homes

As a branch of the "Own Your Home" activities the salvaging of old homes is deemed important not only in its bearing on civic conditions but in its power to arouse interest in new enterprises. In every community are old homes that have been permitted to run down until they have become eyesores. An idea of a progressive Kansas town has been to salvage these houses by forming a fund with which to buy properties long neglected by owners and then to remodel the houses, making them modern and attractive in every respect. When fully restored the houses are sold.

---

## Tree Planting in New Bedford, Mass.

New Bedford, Mass., has planted 4000 shade trees in the last seven years, says the Massachusetts Forestry Association, and it is a conservative estimate that in twenty-five years these shade trees will be worth more than \$1,000,000 to the city. It has been said to be useless to plant shade trees in thickly settled districts, but New Bedford has disproved this theory. It has shade trees thriving on narrow back streets in the heart of the mill districts with scores of children playing about them.

## Says World Faces Lumber Famine

Roger E. Simmons, who was sent to Russia in 1917 as a member of a United States Government Commission, to study the lumber situation in the war devastated countries, told the Legislative Commission in Chicago recently investigating high prices of building material that the world was facing a lumber famine.

Prices of lumber, he said, were certain to rise in the next few years, because of the unprecedented demand which would come from the reconstruction of the war stricken regions of Europe. The major portion of this lumber, he said, would have to be supplied by the United States and Canada.

Canada already has received an order from the British Government for one billion feet of oak for England and from Italy for twelve shiploads of lumber.

Mr. Simmons said Russia, which before the war exported 52 per cent of the world's lumber supply, would not be in a position to cut lumber until five years after the government had been stabilized and order restored. Austria and other countries which exported lumber before the war are in a similar position, he said, so that the present burden in supplying this commodity would have to be borne by the United States and Canada.

England, Mr. Simmons said, had subsidized a corporation to erect saw mills in Siberia to supply the home needs of that country. Great Britain recently called on its citizens immediately to build 300,000 homes for returning soldiers and sailors, the Government agreeing to refund 75 per cent of any differential cost between to-day and five years from now.

## Western Lumber Stock Decreases 5.99 Per Cent

Stock on hand at 72 lumber mills in Western Oregon and Western Washington in March averaged 393,581,222 feet, as compared with 418,638,685 feet on January 1, a decrease of 25,057,462 feet, or 5.99 per cent., according to reports just compiled by the West Coast Lumbermen's Association.

The situation of these 72 mills is believed to be typical throughout the industry in the western part of the two states. Weekly reports show that the mills are shipping more lumber than they are cutting. Production is approximately 25 per cent. below normal.

On account of the prevailing high cost of manufacturing, a number of large plants in the fir producing territory have been closed since early in the year. This accounts for the comparatively small volume of production. Meanwhile orders from retail yards have continued in about normal measure with the result that the stocks at the mills have gradually decreased.

## Building Loan Report

An interesting sidelight on the stability of savings and loan associations during the war period is presented in the annual report of the Metropolitan League of Savings and Loan Associations, prepared by its secretary, Archibald W. McEwan. The report says, in part:

"During the year 1918 savings and loan associations in this section increased their assets as follows: In New

York County, \$418,862; Queens, \$37,473; Richmond, \$766,862. Richmond still holds its record of being the banner county in the greater city—population considered—assets having reached \$7,000,000, and our associations do more than any other agency in that county in providing homes for the people.

"The memory of the war is still vividly in mind, and 1917-18 will always be remembered as happy years by those mortgagors who are purchasing their homes through our associations. They saw friends and acquaintances who had mortgages become due—or, worse still, had open mortgages—worried immeasurably by notices of call, or to make substantial payments on principal, and often these unfortunates did not know which way to turn.

"In some instances persons got money from our savings and loan associations—fortunately for them—and, as usual, we gave preference to those who were saving members beforehand. The savings and loan mortgagor, however, went serenely on with his day's work, secure in the thought that his mortgage could not be called and that it was being paid off: that in a few years the 'kick' would be taken out of it and that he would own his home free and clear."

## Furniture High in Great Britain Due to Lack of Imports

Liverpool is not only becoming a great shipbuilding center, but is also the center of the British lumber trade, in which the shortage has been great during the war because of the enormous demands and curtailment of importations. The American consular service states that there is now a general tendency toward a relaxation in government restrictions with reference to timber. British officials have dispensed with permits for the purchase of home-grown timber, as also for imported hardwood and ply-wood.

Largely owing to the timber shortage, the prices of furniture have risen from 100 to 200 per cent during the war, and inquiries indicate that an excellent market exists for American furniture when it can be imported.

## Airplanes for Forest Fire Protection

Army airplanes and captive balloons will cover portions of the national forests of California, Arizona, New Mexico and other states this summer, to aid in detecting and suppressing forest fires, in accordance with orders from the War Department in co-operation with the U. S. Forest Service. Forestry officials believe that there is an important place for aircraft in fire protection of timberlands, but the first step must be the trying out of methods.

Army airdromes and bases will be utilized for the experiments. Some of the bases which are near the National Forests are the flying fields at San Diego, Riverside and Arcadia in Southern California, and one in New Hampshire is also advantageously placed. One of the tests to be made is the bombing of fires to put them out, and another is the transporting of fire fighters by dirigibles from which ladders can be lowered to the ground.

This summer the chief use of the airplanes will be in detecting fires, aircraft having a great advantage over the present patrol and watch system, and the wireless will be used in reporting fires. This use for fire protection will give fliers an opportunity to train and to develop further the possibilities of aircraft.



## German Forests for French Indemnity

The proposal has recently been made by M. Huffel, an official of *l'École Nationale des Eaux et Forêts*, that to prevent further cutting of the forests of France a substantial part of the German indemnity shall be paid in timber taken from the German forests, which have suffered much less than the French forests. This proposal, which is apparently meeting with favor in France, is made not so much as a matter of poetic justice as of sound economics. M. Huffel thinks that about five years would be required to carry out his program, and that it would take about 100,000,000 days' work,—that is, the labor of about 66,000 Germans for five years.

## Hostess Plan at Harvard

The Hostess House, opened in connection with Harvard University, furnishes new privileges to the students. One luxury is a candy kitchen, where the undergraduates can make fudge, taffy, or whatever strikes their fancy. Another added privilege gives the students free facilities for pressing clothes. Wives of the professors, who are in charge, also sew on buttons and mend tears without remuneration. If the project is successful the Student Council will take the Hostess House in hand next year, and establish it in the Harvard Union.

## Philadelphia Needs 20,000 New Houses

More than 20,000 new homes are required in this city to accommodate the great influx of workers who arrived in Philadelphia during the war and who plan to stay, according to officials of the Philadelphia Operative Builders' Association.

## Conservation of Beauty

A recent convention of the Iowa Conservation Association, held at Ames, Ia., was the scene of a discussion in which the conservation of places both of natural beauty and of historic interest, as well as the establishment of state parks and the improvement of Iowa's road system were the chief features. Resolutions were passed advising the leasing of tracts. The association also supported the proposed national park at McGregor. Prof. George L. Kay, state geologist, of Iowa City, was elected president, and G. F. McDonald, professor of forestry, Iowa State College, secretary of the association.

## Army Storage Buildings

Anticipating the disastrous results upon labor and industry which an abrupt cancellation of wartime contracts would precipitate, the Government has adopted the policy of accepting a certain percentage of such contracts. This has necessitated the erection of twelve temporary storage buildings, for which a contract has now been placed by the Ordnance Department of the United States Army. The buildings which are one-story

structures measuring 96 by 400 feet, are wooden frame with corrugated iron sides and roof, and will be built under the direction of the Construction Division of the United States Army. The cost is estimated at about \$450,000, and work will be pushed as rapidly as possible as practically all the existing storage space has already

## London's Housing Reforms

One of the housing schemes receiving much favor in London is that being developed in a congested district of Southwark just bought by the Duchess of Marlborough.

Here it is proposed to erect modern tenements, with bathrooms and hot water on every floor, and a playground on the roof. A central laundry with mechanical dryers is to be located in the lower part of the building.

At present there are no tenements in London with these conveniences. Doubt has been expressed as to their popularity because of the liking of London women for detached or semi-detached houses, even though they are not modern.

## Club Plans War Memorial

Secretary of War Baker, in a letter to the 17,000 members of his college fraternity, suggests an institutional memorial in honor of the members of the Phi Gamma Delta, who made the supreme sacrifice in the war. As a result of the suggestion, which has been received with enthusiasm by the members of the fraternity, there will be a national memorial building in New York City. At least \$200,000 will be raised for the purpose.

## Industrial Training and Foreign Trade

"It is up to American industries to learn as much from the war as have the industries of France and England"—that, in substance, is the message contained in a vest pocket bulletin entitled, "Industrial Training and Foreign Trade," recently issued by the U. S. Training Service of the Department of Labor at Washington. During the war, training conducted in the factory or shop to teach the workers the best ways of doing their tasks enabled the Allies as well as America to keep up production despite the drafting of millions of men, the bulletin explains.

In meeting the war emergency by training new workers, industry abroad and to some extent in this country, has learned an invaluable lesson for peace times, namely, that training of a similar character, but adapted to the needs of old employees as well as new, results in an immense benefit to the workers and industry. In these crucial days, when the lines of commerce and trade are being re-established, the bulletin contends, America cannot afford to be behind foreign nations in applying this lesson.

Charles T. Clayton, Director of the Training Service, emphasizes the need of training broadly, so that the workers become more versatile as well as more highly efficient. The chief task of the Training Service is to advise manufacturers who are interested in establishing training and to provide them with suitable courses in training methods—courses worked out by study and research covering the whole field of industry.

## Confer on Federal Home Loan Bank Legislation

The legislative committee of the United States League of Building and Loan Associations has decided that the proposed legislation for a system of Federal Home Loan Banks will not be submitted to the extra session of Congress. The decision is the result of a two-days' conference held in the Department of Labor Building, Washington, D. C.

K. V. Haymaker, expert on building and loan association matters, who has been working with the Department of Labor, announces that the legislative committee believes it prudent to submit the proposed bill for the creation of the Federal Home Loan Bank system to the annual convention of the Building and Loan Associations which is to be held in Detroit, Mich., in July.

E. L. Keesler, president of the United States League of Building and Loan Associations, who presided over the conference, said there was full agreement on the fundamental features of the tentative draft of the proposed bill, but members of the legislative committee hesitated to commit the league to certain details in the bill without submitting them to the national convention for discussion and approval. As this latter action can not be had in time to get action in an extra session of Congress, the building and loan interests have abandoned hope of such early action and will be prepared to make their campaign for this legislation in the next regular session of Congress.

The tentative draft of the bill provides for a Federal Home Loan Board, of five members, of which the Secretary of the Treasury is one, and the other four are to be appointed by the President of the United States with the consent of the Senate. Under the direction of this Board regional banks will be established and the membership in these will be restricted to building and loan associations. No bank may be established with less than a paid-in capital of \$100,000. Whenever ten or more building associations, located in a given district, with aggregate assets of not less than \$5,000,000 shall associate themselves together and comply with the requirements of the law, they may organize a district federal home loan bank.

The purpose of the Federal Home Loan Bank system is to enable building and loan associations to realize on their real estate mortgages and make more money available for loans to prospective home owners. This will be accomplished through Federal Home Loan Bank bonds, the underlying securities for which will be the real estate mortgages of the building and loan associations which are bank members. Within limitations the new system of banks would do for the home buyer of the city what the Federal Farm Loan Banks do for the farm buyers in the agricultural sections.

## Price Levels Following the War

The U. S. Department of Labor, through the Information and Education Service, is issuing the results of a study of prices during the war and readjustment period made by the Division of Public Works and Construction Development. Discussing the world-wide phenomenon of rising prices accompanied by an increase of money, the report says:

"A study of the index figures of commodity prices in the United States and certain foreign countries shows that

while prices have risen very considerably in this country through the war period, the rise in other countries has been greater. According to the figures of the Bureau of Labor Statistics, the wholesale prices of all commodities in September, 1918, were 107 per cent over the average for the year 1913. This was the highest figure reached in this country. The price level in Canada, according to the Canadian Labor Department, reached the high point in November, the price level then being 115 per cent over the 1913 figure. According to the figures of the *London Economist*, the price level in the United Kingdom was highest in the month of August, being at that time 133 per cent above the 1913 average. Figures on the increase of prices in France are not available for any time later than June, 1918; however, the index figure as published by the *Statistique Generale* for the month of May showed an increase of 235 per cent over the 1913 price level. Not only do the countries nearer the scene of actual warfare show greater rises in the price level, but it is also true that in these countries the prices began to rise at an earlier date than they did in the United States.

"The general rise in commodity prices was accompanied in all these countries by a considerable increase in the amount of money in circulation and in the amount of bank deposits. In this country, the average amount of money in circulation per capita in the year 1913 was \$34.65. This increased to \$56.23, the figure for December 1, 1918, an increase of 62 per cent. There has been a slight decrease since that time, the figure for March 1 being \$53.76, which is 55 per cent above the 1913 figure. During the same time, bank deposits in the United States have increased almost three-fold. In European countries, during the war period, bank deposits more than doubled.

"Professor Irving Fisher of Yale University recently issued a statement in which the facts concerning the increase of the amount of money and of credits were brought out, and the statement was put forward that this increase was responsible for the general rise in the price level. But Professor Fisher also pointed out that it is extremely unlikely that there will be a decrease of money and credits in either this country or European countries within the next few years, and that the price level will remain permanently high as compared with the pre-war level."

## Permanent Lincoln Highway Markers

The Lincoln Highway is permanently marked with enameled steel signs set on steel posts from San Francisco to Omaha, Nebraska, a distance of over 1900 miles. The Association is endeavoring to replace the old marking system of painting the Lincoln Highway insignia on the telegraph poles with these permanent steel markers as rapidly as possible, and hopes to complete the job from Omaha to Pittsburgh next year with the support of the local communities. Those sections of the route which are still marked with the painted markers will require repainting this Spring and many of the communities along the line between Omaha and New York are already taking steps to repaint the markers which have become faded from the weather.

Allen County, Indiana, has already thoroughly remarked the Lincoln Highway within its boundaries, and the other counties of that progressive state are expected to repaint their Lincoln Highway markers before the flood of early Spring touring begins.



# Personal Mention

H. S. Cheney, architect, 30 North Michigan Avenue, has moved to 208 La Salle Street, Chicago.

James Walker, architect, announces the removal of his office to 1326 Prudential Building, Buffalo, N. Y.

Frank J. Forster has resumed the practice of architecture in New York City, with offices at 1730-31 Aeolian Hall.

Charles B. Deer has opened an office at Room 506, Crozer Building, Chester, Pa., for the practice of architecture.

Francis A. Ankrom, consulting and supervising engineer, has moved his offices from Douglas, Ariz., to San Antonio, Tex.

Frank Austin Hersh, architect, announces the removal of his offices to the Chamber of Commerce Building, Altoona, Pa.

J. Henry Dewitz, architect and engineer, has opened an office at 232 St. Paul Street, Baltimore, Md., and desires catalogues.

Roy Seldon Price, architect, has opened offices in the University Club Building, St. Louis, Mo., and desires catalogues and samples.

White & Harvey, architects, have opened offices at 418-419 Kampmann Building, San Antonio, Tex., and desire catalogues and samples.

W. F. Gernandt has removed to Suite 634, Keeline Building, Omaha, Neb., and will continue the practice of architecture at this new location.

Davis, McGrath & Kiessling, architects, announce the removal of their offices to 220 Fifth Avenue, at Twenty-sixth Street, New York City, on May 1.

William Platt Sutherland, Jr., has opened offices for the practice of architecture at Rooms 44-45 Exchange Building, 45 Clinton Street, Newark, N. J.

William Francis Diehl has taken over the architectural practice of the late E. N. Alger, with offices in the Robson-Prichard Building, Huntington, W. Va.

A partnership has been formed by Arthur W. Archer and Galen V. R. Lloyd for the practice of architecture in the Reliance Building, Kansas City, Mo.

George H. Carsley has moved his offices from the Power Block to the Power Block Annex, Helena, Mont., where he will continue his architectural practice.

John Hanifen has opened an office for the practice of architecture in the Tribune Building at La Salle, Ill. Strawn Aldrich Gay, who will be in charge of the office, desires manufacturers' catalogues and samples.

Frederick A. Mühlenberg announces his return from the army and the reopening of his office for architectural practice at 901 Flanders Building, Fifteenth and Walnut Streets, Philadelphia. He desires samples and catalogues.

Philander P. Scroggs, architect, having been honorably discharged from the service, has reopened offices in the Lamar Building, Augusta, Ga., for the practice of the profession and desires manufacturers' samples and catalogues.

H. M. Sohn has been mustered out of the service and is now a partner in the firm of Terwilliger & Sohn architects, with offices at 1 West Thirty-fourth Street, New York.

Ernest S. Batterson, after several months with the Government on war work, has resumed the practice of architecture, with new offices at 405 Hanselman Building, Kalamazoo, Mich. Manufacturers' samples and catalogues are desired.

Oscar N. Newstrom, architect, announces that he has completed his work with the McDougall Duluth Co., ship-builders and engineers, and has located in temporary offices at 734 First National Soo Line Building, Minneapolis, Minn.

Morton Levy is leaving Fort McPherson, Ga., where he has been engaged as supervising engineer in the office of the constructing quartermaster, to resume civilian work in the office of Levy & Clarke, Savannah, Ga. Catalogues are desired.

William Newton Diehl, formerly of the architectural firm of Lee & Diehl, Norfolk, Va., has opened offices for the practice of his profession at 506 Law Building Newport News, Va. Manufacturers' samples and catalogues are desired.

E. R. James has received his discharge from the army as a First Lieutenant Field Artillery and has opened an office for the practice of architecture in the Dudley Building, Danville, Va. He desires manufacturers' samples and catalogues.

Theodore C. Visscher and James L. Burley announce the formation of a partnership for the practice of the profession of architecture, having moved their offices from 209 Madison Avenue to 363 Lexington Avenue, between Fortieth and Forty-first Streets, New York City.

Ernest Alan Van Vleck and Oran Winthrop Rice announce that Ernest Brooks has been admitted into partnership with them in the firm of Starrett and Van Vleck, architects, 8 West Fortieth Street, New York, and that the business will be continued by them under the present firm name.

C. E. Schermerhorn, A. I. A., having completed his work in the United States Army, announces that he has resumed the practice of architecture at 430 Walnut Street, Philadelphia. Mr. Schermerhorn's recent service has been with the Military Intelligence Section, Plant Protection Division, General Staff Corps, U. S. A.

Norman Hatton, Wm. J. Klein and S. E. Holmes announce the formation of a partnership under the name of Hatton, Klein & Holmes. Their practice will be devoted to general engineering, architecture, machinery layouts, heating and ventilating and industrial engineering. Address, Masonic Temple, Cedar Rapids, Iowa.

Rudolph E. Lee, A. I. A., of Clemson College, S. C., T. A. MacEwan of Pittsburgh, and Charlotte and A. R. Turnbull of Charlotte, N. C., have opened offices at 1214 Realty Building, Charlotte, N. C., under the firm name of Lee, MacEwan & Turnbull, for the practice of architecture and engineering. A. R. Turnbull is the business manager of the firm. They will be glad to receive manufacturers' samples and catalogues.



# Late News from Architectural Fields

Special Correspondence to THE AMERICAN ARCHITECT

## Revise Laws to Aid Building Boom

DETROIT, MICH., May 16.—Revision of the building code calculated to expedite the great home building campaign that this city is now entering upon, is now in process of enactment. The amendments will become effective as soon as they have Governor Sleeper's signature. They include nine modifications which, it is believed, will go far to relax rigid restrictions heretofore enforced chiefly as safeguards to public health. They will allow the commissioner of public safety much wider discretion than the law has given him in the past.

## Lumber Production in 1918

WASHINGTON, D. C., May 19.—Recent tables compiled by the U. S. Forest Service show that the State of Washington, with a record of more than three and a quarter billion feet of lumber cut in 1918, Oregon with two billion feet cut, and Louisiana with a cut of more than a billion and a half feet, are still the great lumber producing States of the country, with Mississippi, California and Nevada, Wisconsin, Arkansas, Texas and Idaho each cutting more than a half a billion feet.

A total lumber production of 32,760,000,000 feet is the estimated cut for the year 1918 on the basis of partial returns received by the Forest Service from 731 sawmills, each of which cut 5,000,000 or more feet in the years 1917 or 1918.

In 1917, the total production amounted to 36 billion feet. The decrease in 1918 is not confined to any one region but is general. It is largest in the Southern and Eastern States and least in the Western States. Maine shows the greatest per cent of decrease.

## Propose Memorial Armory for Washington

WASHINGTON, D. C., May 19.—An item of the public buildings bill now being drafted for the special session of Congress will be an appropriation for a million dollar memorial armory in Washington. A unique style of architecture, an entrance in the form of an arch of triumph, has been proposed by Representative John W. Langley of Kentucky, chairman of the House committee on public buildings and grounds.

Mr. Langley proposes to have architects submit their plans provided the project is approved by Congress, embodying his idea that the memorial should be of utilitarian value in addition to its artistic merit. The nation's capital has no arch of triumph. It is pointed out that European capitals have magnificent structures on the main highways.

The chairmanship of this important Congressional committee gives Mr. Langley great power in securing favorable designs for the proposed memorial armory. The fact that the new chairman has been a staunch advocate of improvements in public buildings and grounds for many years, gives more probability to the proposal. He has

suggested making the armory a club for all soldiers visiting the capital. The armory would be a monument to the valor of District of Columbia soldiers. Civic organizations have expressed approval of the plan and it is confidently expected that Chairman Langley's influence will push the measure through the extra session.

## Receive Appeal for Draughtsmen

WASHINGTON, D. C., May 19.—The Washington Chapter, American Institute of Architects, has received several appeals from architects in neighboring states for draughtsmen. Salary advances have not proved sufficient inducement to these men.

It is generally reported that increased building work this spring has exhausted the supply. Shortage of architectural draughtsmen in the Middle West has proved a serious factor in construction as many contracts were forfeited by architects who could not meet the demand owing to the lack of draughtsmen. Statistics given out by the Department of Labor recently show that the present salary of competent draughtsmen is from \$45 to \$75 a week.

## Housing Problem Gets More Serious

MEDIA, PA., May 19.—So serious is the housing problem becoming in Delaware County that steps must be taken at once local authorities say, either by some strong civic organization or by the Government to alleviate the conditions which make it utterly impossible for many persons in many sections of the county to get homes.

## Five-Day Week Is Plan of Builders

SEATTLE, WASH., May 17.—A five-day week now prevails in the building industry in this city, the action of the Building Trades Council, representing about 6,000 workers, having been put into effect. Similar action is expected soon in Tacoma.

According to Mr. Cotterill, the Council's secretary, the step is taken to insure employment for returned soldiers and sailors. By the five-day instead of the five-and-a-half-day week he said the Council expects to carry the building industry through normal conditions in 1919 and 1920 without any cases of unemployment.

"The change is not expected to disturb the building industry," said Mr. Cotterill. "To the contrary, we are certain that in many cases builders will find it more desirable to do away with the four hours' work on Saturday."

Trades affected by the order include building laborers, building and structural ironworkers and piledrivers, asbestos workers inside and outside electrical workers, plumbers and steamfitters, elevator constructors, lathers, plasterers, painters, bricklayers, hoisting engineers and roofers. Plasterers, lathers and painters already have the five-day week.

## Next Congress to Take Up World's Exposition Plan

WASHINGTON, D. C., May 19.—The plan for a permanent world's exposition in Washington, a subject much discussed by architects, will be submitted to the extra session of Congress for approval and aid. Original plans called for the development of the national capital through the erection and maintenance of forty-eight individual State buildings containing expositions of the natural, educational and industrial resources.

Widening the scope to include all nations blots out, in many respects, the nationalism of the plan as proposed. Supporters of the movement point to the remarkable success of the Pacific Exposition as an example of the manifold benefits and the feasibility of the proposed exposition. The main objective of the proponents is to make Washington, from an architectural standpoint, the most beautiful city in the world and a real world capital.

It is proposed to have every representative government erect and maintain buildings in Washington. The world's leading architects will be requested to submit plans to their respective governments for approval. These tentative designs will be passed upon by the Fine Arts Commission, which reviews all proposed plans for Washington buildings and by similar commissions from other countries or a joint commission. Each country will be asked to send commissions here to study the situation and report to various architectural and governmental organizations.

Such a prodigious undertaking as proposed would require several years to complete and the expenditure of millions of dollars. As an inducement to other nations, the States' exhibit committee has announced its intention to take up the plan for forty-eight separate buildings before extending the movement across seas. Col. Robert N. Harper, of Washington, D. C., chairman, has issued a call for a committee meeting next week. The plan has the official endorsement of several governors who have promised to secure legislative action in their respective states.

In each state, a campaign will be waged for an appropriation which will permit the construction and maintenance of a building here. It is proposed to have these buildings designed by architects in each state, constructed from material produced in the locality and built by representative labor. Each building will be pre-eminently an architectural triumph reflecting the spirit of the individual states.

The legislators and people will be told that such a building will afford extensive advertising for the state's products. It will be one of the chief arguments of the advocates in their appeals to the business interests of the country.

The initial costs of the nation-wide campaign are estimated at \$500,000, the greater share of which is to be donated by Washington business organizations and civic associations for the purpose of inaugurating the national plan. The custom following world fairs, that is, completely dismantling magnificent structures at a cost of millions, would be abolished through the proposed scheme of continual national or international expositions.

The Washington Chapter, American Institute of Architects has endorsed the proposal. The States' exhibit committee, hopes to secure the approval of all architectural associations and list the members in a co-operative effort for adequate legislation.

Real estate men here have evinced the liveliest interest in the proceedings. Careful analysis of the proposal shows

that the largest industries of the world would establish offices here; many new hotels would be required to house the constantly increasing throngs of visitors, convention hall would become a necessity and a general increase in all forms of construction could be expected.

Congressional action is necessary to obtain land in the District of Columbia. To this end, a campaign will be conducted in the Senate and House at the coming session.

## Start Building Plans to Last Ten Years

ST. PAUL, MINN., May 17.—Ground has been broken on the University of Minnesota campus for a new administration building, a store house and shops, which marked the opening of a great building program. For the next ten years it is expected that there will be only a few days which will not echo with the sound of hammering and riveting.

By 1930 the building plan of Cass Gilbert will be well in evidence on the new campus. Many of the buildings now on the campus will be torn down, or moved, as they mar the possibilities of the mall. The plan advocated by President Burton is for a series of quadrangular dormitories, each to take up an entire block, with an inner rectangular court. These would be located on a strip five blocks long.

## Roof Landing for Planes

Ground for Brooklyn's new building, with an airplane roof landing has been broken. It will cover a plot 175x175, and the platform landing will extend as a spur several feet beyond the edge of the roof.

## New Orleans Builders Foresee Skyscraper Age

NEW ORLEANS, LA., May 16.—Skyscrapers in abundance, many modern residences in one of the greatest building periods of the city, the construction of homes in the old segregated district, and a great sea wall along the lake front were predictions for New Orleans by speakers at a meeting of the Allied Building Council and the General Contractors' Association just held at the Grunewald Hotel.

## Brooklyn Industrial Exhibit

In accordance with the plans outlined in THE AMERICAN ARCHITECT on April 30, the Brooklyn Chapter of the American Institute of Architects joined with the Engineers' Club in an industrial exhibit extending over two weeks. The exhibit was well attended, and those passing up and down the long aisles, in addition to being shown the best methods of lighting, heating, painting and roofing a building, also saw artistic designs and models of buildings proposed or already constructed.

In this way, the progressive men in the Brooklyn Chapter are endeavoring to stimulate the demand for architectural service by such effective means as are at their disposal, and are laboring to create a greater appreciation of the value of well-planned buildings. Let us hope that this foreshadows a closer co-operation between art and commerce, to the end that the great structures which house industry shall become more aesthetic in appearance, and add to the artistic dignity of the communities in which they are located.



## Return of "Open" Market Aids Construction

DECLARING that inasmuch as the Industries Board has failed in its attempt to stabilize the price of steel and that in all probability there will be no further effort by the Government to fix the price on other building materials, architects and builders this week expressed the opinion that with a return to an "open" market and the revival of the law of supply and demand, construction is now ready to be speeded up with an impetus the like of which has not been seen in years. They feel that this indicates manufacturers must get what they may for their commodities. Whether purchasers will have to pay higher prices than they would if the Government's effort in fixing a temporary schedule of values had been successful, remains to be seen.

It is generally believed in architectural and building circles that in a large percentage of materials, prices cannot recede without a reduction in wages. It is not probable that leaders in industry will consent to a wage cut at the present time. In the steel market, where factories are working at approximately 60 per cent of capacity, the Railroad Administration's call for bids on 200,000 tons of rails to supply approximately 10 per cent of an estimated demand, is the first indication of large orders that are to follow. The building industry is closely watching developments in this phase of the situation, and what an "open" market, with the removal of Federal restraint, will accomplish. It is expected it will make a very active construction market.

A noteworthy feature of the week's activity in New York building material markets was the entry into trade of leading brick interests, purchasing heavily for future needs at \$15 per thousand wholesale on common brick, with higher prices for better grades. Sharp advances were noted by architects in Italian marbles, a quotation of \$8 a foot for seconds being obtained. No black and gold Italian marble could be had, but a liberal supply of domestic marble at nominal figures was to be had. Lack of labor in the quarry districts of Italy was given as the reason for the shortage of this imported commodity.

In making a nation-wide survey of building conditions, the U. S. Department of Labor recently sent out questionnaires to several thousand building and loan associations. These questionnaires covered inquiries concerning assets, the average amount of loans made each year, applications for 1919, the possibility of increasing demands for loans and opinions concerning the proposed system of Federal Home Loan Banks.

Returns disclosed that more than forty per cent of the building associations have not sufficient available funds to meet the desirable applications for loans that are coming in as a result of the shortage of houses and the general revival of construction activities. While the building associations of the country are reported on a sound financial basis their present difficulties are due to the facts that they have enormous investments and that the long time mortgages representing large amounts are not negotiable at commercial banks.

The movement to establish Federal Home Loan Banks is approved by a majority of the Associations that returned answers to the questionnaire. Out of 1200 thus far received less than 10 per cent of the Associations represented are opposed to the plan. An answer that is typical of the attitude of Associations that are financially independent came from the West. "Our organization does not need a Federal Home Loan Bank system at this time," writes the secretary, "but it will be helpful to those

who do and the time may come when we shall be glad to take advantage of it."

According to recent estimates made by the Division of Public Works and Construction Development, of the Department's Information and Education Service, there are now in the United States 7269 building and loan associations with paid-in capital stock amounting to \$1,503,770,848, the investment in building association stock having increased last year \$145,000,000. Available statistics show that the normal requirements of the building and loan associations before the war called for loanable funds amounting to approximately \$500,000,000 per annum, which could be supplied by the savings departments of these organizations. The solution of the problem of how to supplement the ordinary income of the building and loan associations in places where the demand for small mortgage loans might be greatly in excess of the supply of money is now sought in the Federal Home Loan Banks. In view of the shortage of houses estimated at something like 1,000,000, the demands on building and loan associations are likely to be heavier than ever before. Increase in building operations for April were so marked that the business of the associations in certain parts of the country was reported to be of unusual volume.

CHICAGO, ILL., May 19.—Building material dealers are cutting prices, each trying to undersell the other fellow to get the business. Architects are employing draughtsmen and other additional office help. Few, if any, bricklayers or carpenters are walking the streets in search of work. Commissioner of Public Works Charles R. Francis announces that 3000 additional men will be put to work on the new Pennsylvania terminal within thirty days. Joseph E. Otis, vice-president of the Central Trust Company, says there has been a complete reversal of the feeling over the business and financial outlook, and that optimism is now generally prevalent.

Those are but few evidences of increased activities in building and construction projects in this city. It is the actual starting of post-war building, first the remodeling of old structures and the construction of bungalows and cottage homes, and now the issuance of permits and the breaking of ground for apartments and factory plants, that is stimulating many lines of business and making readjustment from war to a peace basis possible.

Statistics compiled by the Chicago Masons' & Builders' Association show permits issued during April for buildings to cost \$7,447,800, as compared with costs totaling \$2,757,900 for the same month last year. The permits issued in April were for 140 frame and 565 brick structures. Included in these is an eight-story hotel to cost \$300,000; a three-story apartment to cost \$110,000; another to cost \$125,000; two churches at costs aggregating \$35,000; also a \$200,000 flat building, and several factory structures, one a three-story concrete manufacturing plant for the Hydrox Company at a cost of \$175,000. In all the outlying sections there is activity in small home building at costs averaging \$7,000 and less.

Steel and other metal products are moving into this construction at prices based on the break following the signing of the armistice. Common brick still holds at \$12 per M, while competition based largely on supply and demand is a factor in the selling prices for cement, lumber and some of the other basic materials. In the aggregate, however, there is but little change during the week in price levels.



# Late Quotations in Building Material Markets

(Price quotations now current on building materials and supplies as quoted by dealers and jobbers for delivery in New York and Chicago follow. The quotations set forth are placed before readers of THE AMERICAN ARCHITECT to afford an accurate review of market conditions rather than for use as a basis for actual purchase. They will not only provide knowledge of the exact state of the market as to items quoted, but will also present a basis to judge conditions as affecting co-relating materials. Items marked (\*) indicate an advance over last week, while those marked (†) record a decline. Other prices did not fluctuate during the week.)

BRICK		New York	Chicago
Common (Delivered at job in Borough of Manhattan only), per thousand		\$17.85	\$13.00

CEMENT		New York	Chicago
Per bbl. in 15 cent bags (Rebate 60c. per bbl. for bags)		\$3.25	\$2.80

COPPER SHEETS		New York	Chicago
At the mill, hot rolled, 16 oz. base-price, per lb.	22½c.		22½c.
(From jobber's warehouse add 2 to 3 cents. Cold rolled add 1c. per lb. to hot rolled.)			

GALVANIZED SHEETS		New York	Chicago
Nos. 18 and 20 gauge, per lb.	\$6.12	\$6.12	
No. 26	6.42	6.42	
No. 27	6.57	6.57	

GLASS		New York	Chicago
(Discounts from manufacturer's price lists)			
Single strength, A quality, first three brackets	77%†	77%†	
Single strength, B quality	77%†	77%†	
Double strength, A quality	79%†	79%†	
Double strength, B quality	81%†	81%†	
Plate—up to 5 sq. ft.	82%†		
Plate—over 5 sq. ft.	84%†		
Plate—up to 10 sq. ft.	83%†		
Plate—over 10 sq. ft.	82%†		

GRAVEL		New York	Chicago
¼ in. (Borough of Manhattan only), per cu. yd.	\$2.75	\$2.35†	
¾ in. (Borough of Manhattan only), per cu. yd.	2.75	2.35†	

GYPSUM		New York	Chicago
Plaster Board:			
Delivered at job, Boroughs of Manhattan and Bronx.			
27 x 28 x ½	35c.		
27 x 48 x ½	30c.		
32 x 36 x ¼	21c.	25c.	
32 x 36 x ⅜	21c.	26c.	
32 x 36 x ½	23½c.		
Plaster Blocks:			
Delivered at job, Boroughs of Manhattan and Bronx.			
2 in. solid, per sq. ft.	7½c.		
3 in. solid, 12 x 30, per sq. ft.	10½c.		
3 in. hollow	10½c.	10c.	
4 in. hollow	12½c.	11c.	
6 in. hollow	17½c.		

HOLLOW TILE		New York	Chicago
(Delivered at job, in New York below 72nd St.)			
2 x 8 x 12 partitions, per 1,000 sq. ft.	\$70.15		
3 x 12 x 12 partitions, per 1,000 sq. ft.	102.00	\$67.90	
4 x 12 x 12 partitions, per 1,000 sq. ft.	114.75	72.50	
6 x 12 x 12 partitions, per 1,000 sq. ft.	153.00	99.60	
8 x 12 x 12 partitions, per 1,000 sq. ft.		135.80	
10 x 12 x 12 partitions, per 1,000 sq. ft.		167.50	
12 x 12 x 12 partitions, per 1,000 sq. ft.		194.60	
2 x 12 x 12 split furring, per 1,000 sq. ft.	63.75		

LATH		New York	Chicago
Eastern spruce, per thousand	\$6.50		
No. 1 white pine, per thousand		\$6.50	
No. 1 hemlock, per thousand		6.00	
No. 1 yellow pine, per thousand	6.20*	5.25	

LIME		New York	Chicago
Common, 300 lb. bbls., per bbl.	\$2.50†	\$1.40	
Finishing, 300 lb. bbls., per bbl.		3.70	
Hydrated, in paper bags, per ton	17.25	17.00†	

LUMBER		New York	Chicago
(Retail prices per M, F.O.B.)			
Yellow pine, 2 x 4	\$51.50*	\$47.00	
Yellow pine, 2 x 6	48.00*	45.00	
Yellow pine, 4 x 4	58.50*	52.00	
Yellow pine, 8 x 8	67.50*	52.00	
Yellow pine, 12 x 12	55.00*	57.00	
Yellow pine, No. 1 boards, 1 x 6	58.25*	53.00	
Yellow pine, No. 1 boards, 1 x 12	60.50*	56.00	
Yellow pine, B and better flooring (plain)	60.50*	57.00	
Yellow pine, B and better flooring (quartered)	72.50*	70.00	
Douglas fir, 6 x 6 to 12 x 12	62.50	63.00	
Douglas fir, 12 x 14 to 14 x 14		64.00	
Norway pine, 2 x 4	60.00	50.00	
Norway pine, 2 x 12	65.00	57.00	
Hemlock, 2 x 4	47.50	46.00	
Hemlock, 2 x 12	51.00	48.00	
Oak flooring, 13/16 quartered white	139.50*	122.00	
Oak flooring, 13/16 quartered red	132.00*	115.00	
Oak flooring, 13/16 plain white	89.50*	82.00	
Oak flooring, 13/16 plain red	89.50*	82.00	
Maple flooring, 13/16 clear	82.00	72.00	
Maple flooring, 13/16 select	77.00*	69.00	
Maple flooring, 13/16 No. 1 fancy	69.50*	58.00	

Mahogany, 1" F. A. S.	300.00	300.00
Quartered oak, 1" F. A. S.	180.00	135.00
Plain oak, 1" F. A. S.	120.00	100.00
Red gum, 1" F. A. S.	87.00	70.00
Sap gum, 1" F. A. S.	56.00	60.00
Chestnut, 1" F. A. S.	87.50	75.00
Poplar, 1" F. A. S.	130.00	100.00
Birch, 1" F. A. S.	70.00	65.00
Spruce, random 2"	52.00	50.00
Spruce, wide	62.50	60.00

LEAD		New York	Chicago
American pig, per lb.	5¼ to 6	5½ to 6	
Bar, per lb.	7½ to 8	6 to 6½	

METAL LATH		New York	Chicago
Under 100 sq. yd., per sq. yd.	40c.	40c.	

PAINTS, OILS, ETC.		New York	Chicago
Leads:			
American white, in oil, kegs; lots over 100 lbs.	14c.	14c.	
White, in oil, 25-lb. tin pails; add to keg price.	¼c.	¼c.	
Red, bbl., ½ bbl. and kegs; lots over 100 lbs.	14½c.	14½c.	
Dry Colors:			
Red Venetian, American, per 100 lbs.	\$2.75 to \$5.00	\$2.00 to \$5.00	
Metallic Paints:			
Brown, per ton	24.00 to 32.00	24.00 to 32.00	
Red, per ton	24.00 to 30.00	24.00 to 32.00	

PIPE		New York	Chicago
Cast iron:			
6 in. and heavier	\$57.70	\$56.80	
4 in.	60.70	59.80	
3 in.	67.70	66.80	

(and \$1 additional for Class A and gas pipe.)  
(Discounts to jobbers for carload lots on the Pittsburgh basing card; freight rates from Pittsburgh to New York, and also from Pittsburgh to Chicago, in carloads, per 100 lbs., are 27c.)

Wrought:		New York	Chicago
Steel:			
Black, ½ to 3 in.	50½c.	57½c.	
Galv., ½ to 3 in.	24	41	
Iron:			
Black, ½ to 1½ in.	29½ to 39	39½c.	
Galv., ½ to 1½ in.	2½ to 23½c.	23½c.	

Butt Weld		New York	Chicago
Steel:			
Black, 2½ to 6 in.	53½c.	53½c.	
Galv., ½ to 3 in.	41	41	
Iron:			
Black, 2½ to 6 in.	34½c.	34½c.	
Galv., 2½ to 6 in.	21½c.	21	

Lap Weld		New York	Chicago
Steel:			
Black, 2½ to 6 in.	53½c.	53½c.	
Galv., ½ to 3 in.	41	41	
Iron:			
Black, 2½ to 6 in.	34½c.	34½c.	
Galv., 2½ to 6 in.	21½c.	21	

PLASTER		New York	Chicago
Neat wall cement in 15 cent bags, per ton	\$20.30	\$18.50	
Finishing plaster	24.00	21.00	

**RADIATION**  
(A further discount, effective April 4, of 15% on direct radiators, 12½% on wall radiators, and 10% on steam and hot water boilers is announced. This approximates a drop of 36% on radiators and 33% on boilers from prices in effect before the 1st of January, 1919.)  
(Chicago reports a 57% discount on standard heights.)

SLATE ROOFING		New York	Chicago
F.O.B. cars.			
Quarry Station			
Pennsylvania:			
Best Bangor	\$7.75 to \$9.00	\$10.20 to \$11.45	
No. 1 Bangor Ribbon	6.75 to 7.25	9.20 to 9.70	
Pen Argyl	7.25 to 8.00	9.70 to 10.45	
Peach Bottom	10.00 to 12.50	12.45 to 14.45	
No. 1 Chapman	7.25 to 8.25	8.70 to 9.95	
Vermont:			
No. 1 Sea Green	3.50 to 6.75	5.95 to 9.20	
Unfading Green	5.50 to 9.25	8.30 to 11.05	
Red	12.00 to 20.00	14.80 to 22.80	

MAINE:		New York	Chicago
Brownsville, U'f'g Black, No. 1.	11.00 to 12.00	14.10 to 15.10	
Slaters felt, 30 lb. roll.	1.75		
Slaters felt, 40 lb. roll.	2.25		

ROOFING MATERIAL		New York	Chicago
Tarred Paper:			
1-Ply, per ton, per roll, 108 sq. ft.	\$63.00 to \$65.00	\$65.00	
2-Ply		95c.	
3-Ply	1.23 to 1.30	1.30	
Rosin sized sheathing	per ton 60.00	60.00	
Corrugated roofing, galvanized, 2½ in. corrugation, over flat sheets, 30c. per 100 lbs.			

SHINGLES		New York	Chicago
Red cedar, 5 to 2, clear, per thousand	\$8.25*	\$6.50	
White cedar, extra star, A star, per thousand	7.20*	5.50	

STRUCTURAL STEEL		New York	Chicago
Beams and channel, 3 to 15 in., per lb.	2.45c.	3.47c.	
Beams and channel, over 15 in., per lb.	2.45c.	3.57c.	
Angles, 3 to 6 in.	2.45c.	3.47c.	
Zees and tees	2.45c.	3.47c.	
Steel bars, half extras, from mill	2.35c.	3.47c.	

REINFORCING BARS		New York	Chicago
High carbon steel from mill	\$48.50	\$49.50	
Medium steel from mill	48.50	49.50	

SAND		New York	Chicago
Mason, per cu. yd.	\$1.80	\$2.25	
Torpedo, per cu. yd.	1.80	2.35	

# Financial and Commercial Digest

## As Affecting the Practice of Architecture

### Prices, Yesterday, Today, and Tomorrow\*

The chief causes of the world advance in prices appear to be the inflation of world currency, coupled with the "scarcity demand" and the consequent advance in labor costs. The prospect of material reductions in the near future depends upon the removal or modification of the chief causes of the advance.

When prices began to advance in the opening of the war, we could readily see that the upward movement was due to the urgent demand for the food and raw material required by the enormous armies put into the field, and this cause has been designated the "scarcity demand," but when we found the advance extending to many articles in which there was no scarcity and which were not used by the armies or utilized in the manufacture of their requirements, we began to realize that a part of the advance must be due to some cause other than mere war or scarcity demands.

Much of the material used in preparing the supplies for the battlefield was "switched" from the usual lines of industry, for there was an immediate cessation of railway construction, building operation, and a thousand industries which formerly required manufacturing material and as a result of this cessation of activities the material formerly used by them became available for war purposes.

The chief causes of the advance seem to have been first the "scarcity demand" for war materials, food, clothing, manufactures, manufacturing materials and the labor required for their prompt production but this was quickly followed by an enormous world inflation, in which paper money with a face value of \$36,000,000,000 was emitted by the printing presses of the countries at war, and the legal tender circulating medium of the world was thus advanced from \$15,000,000,000 in 1913 to over \$45,000,000,000 in 1918, most of the gold formerly in circulation passing into the vaults of the governments and their great banks as a partial basis for this greatly enlarged paper currency.

Other principal causes of the advance in prices during the war besides "scarcity demand" were the advance in wages, presumably due to increased cost of living, and demand for labor and also the large increase in world circulating media, or to put it in a single word "inflation." Professor A. C. Miller, member of the Federal Reserve Board, an authority whose views are entitled to high consideration, in a recent address before the American Academy of Political and Social Science named as the two chief causes of the advance in prices, "scarcity demand" and "inflation," adding that "there is so much evi-

\*Excerpts from an address delivered by O. P. Austin, statistician of the National City Bank of New York before the Editorial Conference of the New York Business Publishers Association.

dence of an artificial abundance of money in comparison with the things that are purchasable by it that the abundance of money must be credited with at least an equal influence in explaining the high prices which have prevailed."

The "scarcity demand" still continues in everything except war supplies and even in that line is not entirely ended, since there are about 15,000,000 men still under arms. The demand for food is as insistent as ever, owing to the disordered state of the population of Central Europe and the impoverished condition of the neglected soils of all that continent, while the factories and empty shelves of all the world are clamoring for new supplies which ran low, during the war period.

The face value of the paper currency issued in the four years of the war was greater than the value of all the gold and all the silver mined in all the world since the discovery of America. We had been inclined to charge up the advance in prices occurring *prior* to the war to the fact that 8 billion dollars worth of gold was turned out by the mines of the world in the twenty years following our famous gold and silver campaign of 1896. But here are 36 billion dollars worth of paper promises to pay turned out as legal tender money by 15 responsible governments in a short four-year period.

If we are right in assuming that a considerable proportion of the world advance in prices is due to the enormous increase in world currency can we expect a marked reduction in prices until the cause, "inflation," is removed? Or, to put it in another form, that part of the advance caused by inflation can only be cured by deflation, by a reduction in the enormous stocks of currency which, as I have shown you, has trebled during the war, while that other form of slowly moving currency, governmental obligations, has quintupled.

As to a material reduction of the inflated currency, the prospects for the near future do not seem encouraging in view of the fact that the 1919-20 "budgets" of the principal countries of the world now being made up, call for fully four times as much money as those of the year preceding the war, suggesting that the governmental demands in the first peace year after the war, will be about \$50,000,000,000 as against about \$12,000,000,000 in 1913, and that the governments which must quadruple their demands upon their tax payers and prepare for a reduction of their debts will hesitate about reducing the amount of money in circulation.

If the governments which have been the chief participants in the world increase of currency should fail to materially reduce that excessive supply, and if the world's demand for food, manufacturing material and manufactures is to continue at the present rate, are we justified in expecting a general reduction in prices in the near future? The question answers itself. There will, of course, be instances in which there will be material reductions, but in general terms the outlook for marked or rapid decline, at least in the near future, does not seem encouraging.



# Department of Architectural Engineering

## Correct Proportioning of Concrete Mixes

THE importance of concrete as a building material may be judged from the fact that during the year 1900 a total of 10,000,000 barrels of Portland cement were used in this country; during 1910 a total of 75,000,000 barrels, and it is estimated that, in the first year following resumption of building activity a total of approximately 100,000,000 barrels will be used.

Reinforced concrete floor arches in skeleton steel structures are the rule rather than the exception to-day, and one does not travel far by rail before the growth of the reinforced concrete industrial building impresses itself upon the mind. While concrete is one of the most ancient of building materials, having been used by the Romans in early times, it is also one of the most modern. This may seem a paradox, but it is nevertheless true.

Concrete, as used in modern construction, is composed of three materials. First and generally considered of prime importance is the cement. Great care is taken in specifying its qualities, characteristics, etc., and this is as it should be. Next in order comes the aggregate, usually divided into fine and coarse, the fine taking the form of sand or stone screenings, and the coarse consisting of gravel, crushed stone or slag, and sometimes anthracite cinders. Finally and most neglected of all, so far as any definite specification of its quality or quantity is concerned, is the water.

Each of these component parts has a certain importance, and the final concrete will have characteristics reflecting the care with which all were chosen, proportioned, mixed and placed. It is the purpose of this article to focus attention on the importance of designing a proper mixture. Such design is, or should be, a subject of vital interest to all architects, engineers and constructors who have to do with concrete work, and all such are indebted to Professor Duff A. Abrams, in charge of the Structural Materials Research Laboratory, Lewis Institute, Chicago, for the contribution he has just made on this subject.\* This is not the first contribution by Professor Abrams, throwing

light on this subject, nor, we hope, will it be the last, but might be considered in the nature of a progress report, embodying data too important to withhold, and giving promise of further interesting information in the near future. The problem involved in the design of a concrete mix is catechised as follows:

1. What mix is necessary to produce concrete of proper strength for a given work?
2. With given materials what proportions will give the best concrete at minimum cost?
3. With different lots of materials of different characteristics which is best suited for the purpose?
4. What is the effect on strength of concrete from changes in mix, consistency or size and grading of aggregate?

This is a problem daily confronting the architect, and in justice to his client he should be able to solve it intelligently.

At the present time, the most generally advocated methods of proportioning a concrete mix are:

1. Arbitrary selection—such as a 1:2:4 mix, ignoring all other factors. Many building codes erroneously make this the basis in determining the permissible stresses in concrete.
2. Density of aggregates, the assumption being that in securing an aggregate of maximum density the resultant concrete has a greater strength.
3. Density of concrete, many believing that the strength of concrete increases with the density.
4. Sieve analysis, the aggregate being carefully graded to conform to some standard, considered as giving the best results.
5. Surface area of aggregates.

Professor Abrams goes on to say of these methods:

"It is a matter of common experience that the method of arbitrary selection in which fixed quan-

\*Published in Bulletin 1. Structural Materials Research Laboratory, Lewis Institute, Chicago, April, 1919. The data in this article is taken from this bulletin.



## THE AMERICAN ARCHITECT

ties of fine and coarse aggregates are mixed without regard to the size and grading of the individual materials, is far from satisfactory. Our experiments have shown that the other methods mentioned above are also subject to serious limitations. We have found that the maximum strength of concrete does not depend on either an aggregate of maximum density or a concrete of maximum density, and that the methods which have been suggested for proportioning concrete by sieve analysis of aggregates are based on an erroneous theory. All of the methods of proportioning concrete which have been proposed in the past have failed to give proper attention to the water content of the mix. Our experimental work has emphasized the importance of the water in concrete mixtures, and shown that the water is, in fact, *the most important ingredient*, since very small variations in water content produce more important variations in the strength and other properties of concrete than similar changes in the other ingredients.

### NEW STUDIES OF CONCRETE MIXTURES

During the past three years a large number of investigations have been under way at the Structural Materials Research Laboratory, Lewis Institute, Chicago, which throw considerable new light on the subject of proportioning concrete. These investigations are being carried out through the co-operation of the Institute and the Portland Cement Association. These studies have covered an investigation of the inter-relation of the following factors:

1. The consistency (quantity of mixing water).
2. The size and grading of aggregates.
3. The mix (proportion of cement).

Any comprehensive study of proportioning concrete must take into account all of these factors.

During this period about 50,000 tests have been carried out which have a bearing on this subject. These tests have been largely confined to compression tests of concrete and mortars. These investigations have given us a new insight into the factors which underlie the correct proportioning of concrete mixtures and show the limitations of older methods. Certain phases of these investigations are still under way.

### RELATION OF WATER CONTENT TO STRENGTH OF CONCRETE

Probably the most salient feature of these tests is the importance which the quantity of mixing water has on the ultimate strength of the concrete.

In the "Concrete Engineers' Handbook" by Hool and Johnson (recently reviewed in these columns) the following appears on page 72:

"Unfortunately, little is definitely known at the present time as to the proper proportions of water. It is known, however, that the quantity depends both upon the demands of the cement and also upon the character of aggregate employed, upon the surfaces to be covered, and the voids to be filled. Research has been recently directed to these lines with highly important results."

The following diagram (Fig. 1) shows with startling clearness what effect a variation of the water content has on the strength of concrete, and this smooth curve obtained from plating the results of many tests made with variations of mix, ranging from neat cement to one volume of cement to 15 volumes of aggregate, gives us an entirely new conception of the function of the constituent materials entering into a concrete mix. It will be noted that neither the size and grading of the aggregate nor the quantity of cement are of importance in increasing the strength of the concrete except as they produce in the mix qualities influencing the quantity of water required to produce a "workable" or plastic mix.

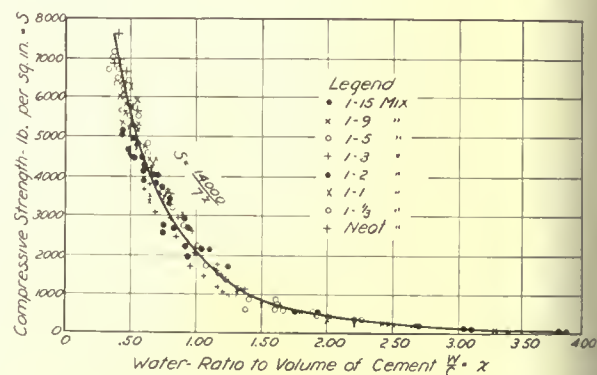

Fig. 1. Relation between strength of concrete and water content.

While the exceptionally high strengths obtained with low water ratios are enviable, they are not possible of duplication under present construction methods, as a mix having a volume of water less than from 75 per cent to 100 per cent the volume of cement (that is a water ratio less than from .75 to 1.00) would be too dry to be *workable*.

It is interesting to note the following statement: "Other tests made in this laboratory have shown that the character of the aggregate makes little difference so long as it is clean and not structurally deficient."

In connection with the water content, it must be constantly borne in mind that in the richer mixes a *workable mix* can always be produced with a lower water-ratio than in the leaner mixes. Take, for instance, a rich mix as 1:2:3, sometimes used

## THE AMERICAN ARCHITECT

in reinforced concrete construction, and assume a water-ratio of one (relative consistency approximately 1.30).

This is graphically illustrated by Fig. 2, page 724.

Now compare with this a lean mix as 1:4:8 and having the same water content (consistency approximately 0.70), graphically illustrated by Fig. 3.

A glance will show that 7½ gallons of water mixed with this latter quantity of material will not produce a *workable mix*; in other words, while the water-ratio is the same in both cases, namely, one volume of water to an equal volume of cement, the consistency of the resultant concrete differs widely. Table 1 is of interest with respect to the variations of water ratio, consistency and strength.

TABLE 1  
EXAMPLE OF INFLUENCE OF QUANTITY OF MIXING WATER ON THE STRENGTH OF CONCRETE

Values calculated from equation

$$S = \frac{A}{B^x} = \frac{14,000}{8.2^x}$$

Where  $S$  = Compressive strength of concrete (lb per sq. in.)

$x$  = Water-ratio (an exponent).

$A$  and  $B$  are constants whose values depend on quantity of cement and other conditions of the test. The values given for  $A$  and  $B$  are based on 28-day tests of 1:4 mix, pebble aggregate graded 0-1¼-in., fineness modulus 5.75.

The water-ratio is equivalent to the cubic feet of water to 1 sack (1 cu. ft.) of cement.

The strength values are *solely for comparative purposes* in showing the influence of changing the water content.

WATER IN A 1-BAG BATCH		Relative Consistency, per Cent.	COMPRESSIVE STRENGTH OF CONCRETE AT 28 DAYS	
Gallons	Water-Ratio ( $x$ )		Lb. per Sq. In. (S)	Relative Strength per Cent.
5.75	.77	100	2770	100
6.0	.80	104	2600	94
6.25	.84	109	2400	87
6.5	.87	113	2250	81
7.0	.94	122	1950	70
7.5	1.01	131	1670	60
8.0	1.07	139	1470	53
9.0	1.21	157	1100	40
10.0	1.34	174	830	30
12.0	1.60	208	480	17
15.0	2.00	260	200	7

In order to obtain definitely the quantity of water required in a given mix under specified conditions, Table 5 is given on page 730. This table is of interest when we consider that it has been found that a given water-ratio corresponds to constant concrete strength regardless of the combination of mix, consistency or grading of aggregate which may be used, so long as we have a workable concrete.

### RELATION OF GRADING OF AGGREGATES TO STRENGTH OF CONCRETE

The next question of importance discussed by

Professor Abrams relates to the grading of the aggregate. The terms "fine aggregate" and "coarse aggregate" are not used, the term aggregate covering both and the outer limits of gradation specified for each test sample. As the tests and investigations brought to light new matter it became necessary to extend the nomenclature used in connection with concrete construction, and the term "Fineness Modulus of Aggregates" has been coined, to supply a need in this respect. Before an intelligent understanding can be had of the results of these tests, it is necessary to comprehend clearly just what is meant by this new term.

Practically all aggregate for concrete used in building construction work is included within the limits of a 100 mesh screen (clear opening of mesh approximately 0.1000 of an inch square) and a 1½ inch screen (clear opening of mesh 1.5 inch square), although under certain conditions coarser material is sometimes used. For the purpose of grading aggregate, the Tyler standard sieves (embracing 9 sizes) were used, each sieve having a *clear opening* just double that of the preceding one. The *fineness modulus* of an aggregate is defined as "the sum of the percentages given by the sieve analysis, divided by 100." This may be a little difficult to grasp immediately, as it is an abstract number, and a graphical representation of the sieve analysis of two grades of aggregate is given by Figs. 4 and 4A, page 724, in order to illustrate this value. Let us suppose that a certain quantity of aggregate, represented as 100 per cent is placed on the finest sieve of the set. A certain percentage may pass through, and the balance is retained on the sieve. Now let the same quantity (the entire 100 per cent) be placed on the next larger size sieve. A greater quantity will pass through and a smaller quantity will be retained. Let this process be repeated over the entire set of 9 sieves and the percentages *retained* tabulated. Now if these percentages be added together and divided by 100 the quotient will be the "fineness modulus."

Table 2, page 725, gives the sieve analysis and *fineness modulus* of aggregate ranging from fine sand to coarse gravel, and also shows the method of determining the fineness modulus of a "mixed" aggregate, and Fig. 5 shows the method of plating.

A well-graded torpedo sand up to No. 4 sieve will give a fineness modulus of about 3.00; a coarse aggregate graded 4-1½ in. will give a fineness modulus of about 7.00; a mixture of the above materials in proper proportions for a 1:4 mix will have a fineness modulus of about 5.80. A fine sand such as drift-sand may have a fineness modulus as low as 1.50.

# THE AMERICAN ARCHITECT

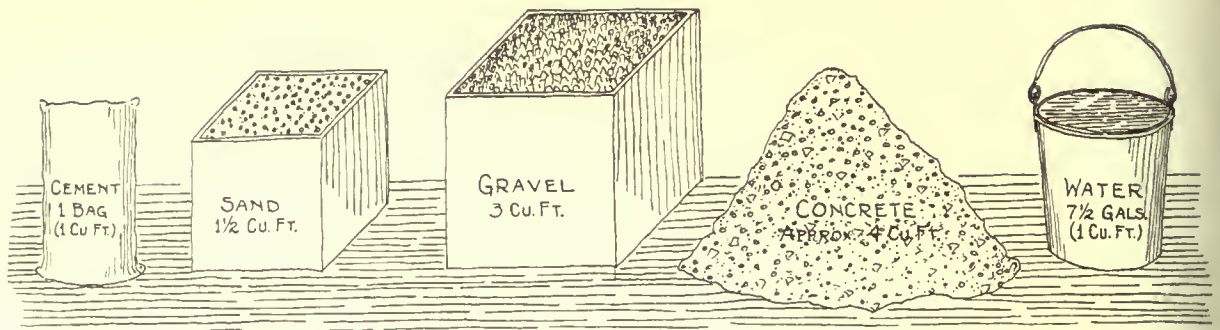

Fig. 2. Workable concrete mix—1 : 1½ : 3 with water-ratio of one, and 1.30 consistency.

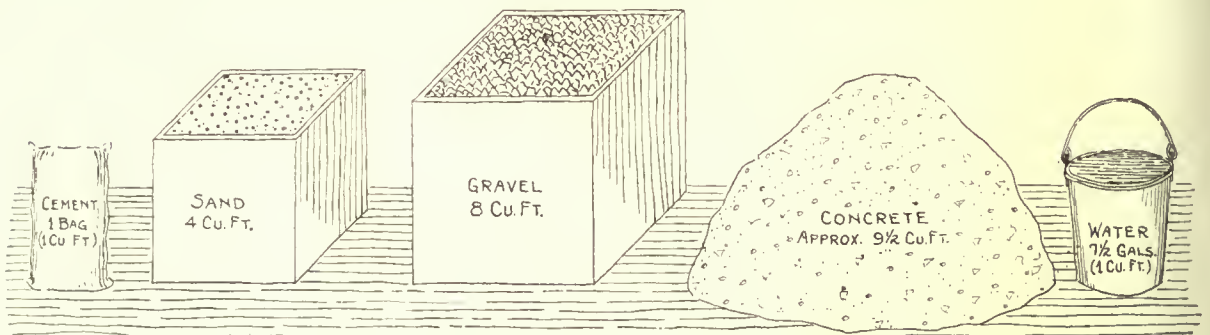

Fig. 3—Unworkable concrete mix—1 : 4 : 8 with water-ratio of one and 0.70 consistency.

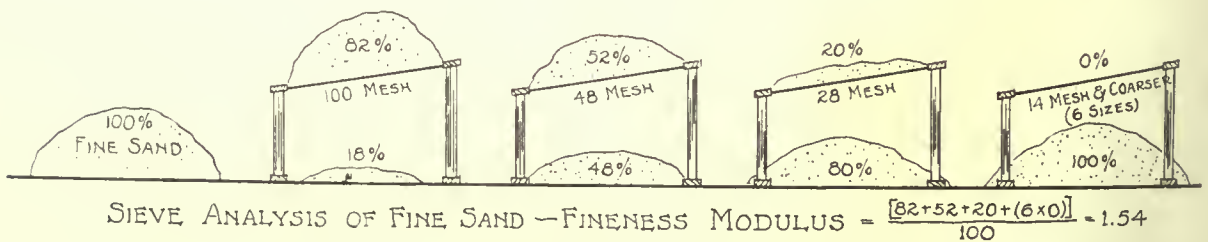

Fig. 4 (Sand "V")

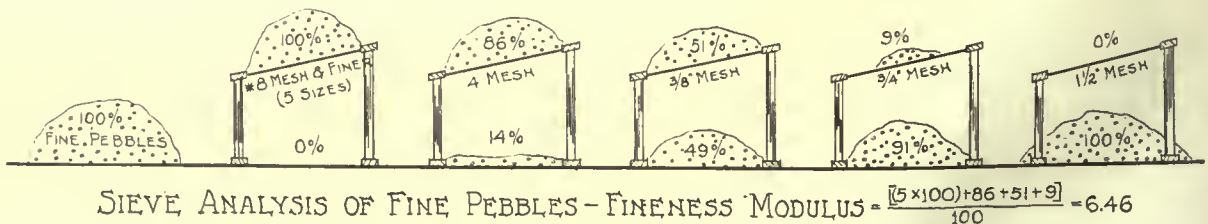

Fig. 4A (Pebbles "D")

\*It is to be noted that the amount of aggregate coarser than each sieve size must be tabulated to obtain the fineness modulus; thus when the entire aggregate is coarser than the first five sieve sizes, a value of 500 must be added (or 100 for each of these sieve sizes) to the summation of the percentages retained on the remaining sieves of the set, before dividing by 100.



# THE AMERICAN ARCHITECT

## SIEVE ANALYSIS OF AGGREGATE

There is an intimate relation between the sieve analysis curve for the aggregate and the fineness modulus; in fact, the fineness modulus enables us for the first time to properly interpret the sieve

abstract number; it is in fact a summation of volumes of material. There are several different methods of computing it, all of which will give the same result. The method given in Table 2 is probably the simplest and most direct.

TABLE 2

### METHOD OF CALCULATING FINENESS MODULUS OF AGGREGATES

The sieves used are commonly known as the Tyler standard sieves. Each sieve has a clear opening just double that of the preceding one.

The sieve analysis may be expressed in terms of volume or weight.

The fineness modulus of an aggregate is the sum of the percentages given by the sieve analysis, divided by 100.

Sieve Size	SIEVE ANALYSIS OF AGGREGATES PER CENT OF SAMPLE COARSER THAN A GIVEN SIEVE								
	SIZE OF SQUARE OPENING		SAND			PEBBLES			Concrete Aggregate (G)*
	In.	Mm.	Fine (A)	Medium (B)	Coarse (C)	Fine (D)	Medium (E)	Coarse (F)	
100-mesh	.0058	.147	82	91	97	100	100	100	98
48-mesh	.0116	.295	52	70	81	100	100	100	92
28-mesh	.0232	.59	20	46	63	100	100	100	86
14-mesh	.046	1.17	0	24	44	100	100	100	81
8-mesh	.093	2.36	0	10	25	100	100	100	78
4-mesh	.185	4.70	0	0	0	86	95	100	71
$\frac{3}{8}$ -in.	.37	9.4	0	0	0	51	66	86	49
$\frac{3}{4}$ -in.	.75	18.8	0	0	0	9	25	50	19
1 $\frac{1}{2}$ -in.	1.5	38.1	0	0	0	0	0	0	0
Fineness modulus			1.54	2.41	3.10	6.46	6.86	7.36	5.74

\*Concrete aggregate "G" is made up of 25% of sand "B" mixed with 75% of pebbles "E." Equivalent gradings would be secured by mixing 33% sand "B" with 67% coarse pebbles "F"; 28% "A" with 72% "F," etc. The proportion coarser than a given sieve is made up by the addition of these percentages of the corresponding size of the constituent materials.

analysis of an aggregate. If the sieve analysis of an aggregate is plotted in the manner indicated in Fig. 5; that is, using the per cent coarser than a given sieve as ordinate, and the sieve size (plotted to logarithmic scale) as abscissa, the fineness modulus of the aggregate is measured by the area below the sieve analysis curve. The dotted rectangles for aggregate "G" show how this result is secured. Each elemental rectangle is the fineness modulus of the material of that particular size. The fineness modulus of the graded aggregate is then the summation of these elemental areas. Any other sieve analysis curve which will give the same total area corresponds to the same fineness modulus and will require the same quantity of water to produce a mix of the same plasticity and gives concrete of the same strength, so long as it is not too coarse for the quantity of cement used.

The fineness modulus may be considered as an

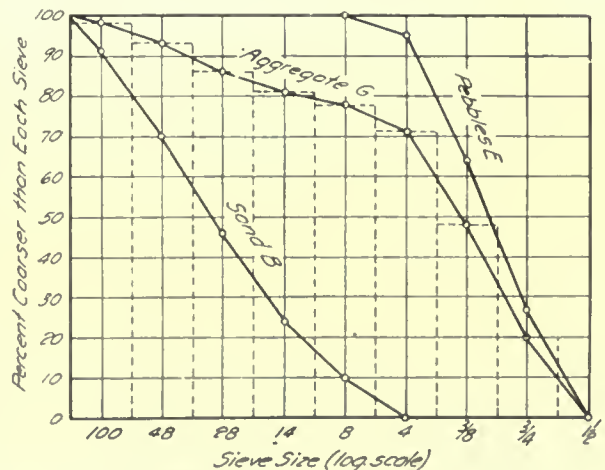

Fig. 5. Method of plotting sieve analysis.

Exactly what effect the fineness modulus has on the strength of concrete is demonstrated by the

results of many different series of tests. These show definitely that for a given plastic condition (consistency), and using the same proportions of cement and aggregate for the different samples, that the strength of the concrete varies with the fineness modulus. The results of these tests are shown graphically by the curves in Figs. 6 and 6A.

It will be noted that in each case there is a steady increase in the compressive strength of the concrete as the fineness modulus increases until a certain value is reached which corresponds to a maximum point. It will be noted also that this maximum point corresponds to greater and greater values of fineness modulus as the quantity of cement in the mix is increased. In other words, the maximum strength comes at a fineness modulus of about 5.80 for the 1:9 mix and about 6.40 for the 1:4 mix. In these tests the different values of the fineness modulus were secured by using a preponderance of the coarser sizes, but in all cases maintaining the same limiting size, that is, 1 1/4 in.

In Fig. 6A is found a similar relation between the strength and the fineness modulus, except that no

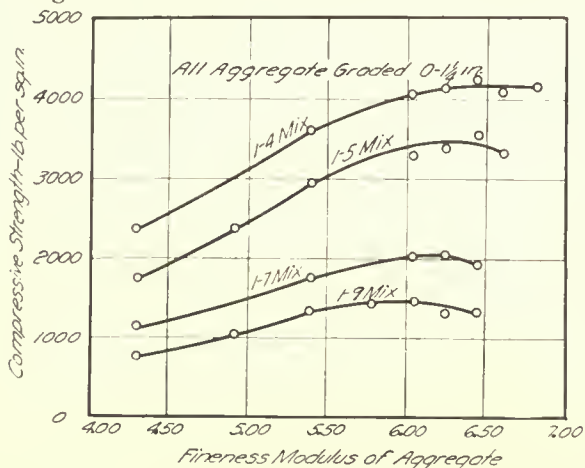

Fig. 6. Relation between finess modulus of aggregate and strength of concrete.

maximum point is found. This condition arises from the fact that the maximum size of the aggregate is increasing without changing the type of the sieve analysis curve, consequently the fineness modulus strength curve continues to rise indefinitely. The height to which the curve rises is limited only by the maximum size of aggregate which may be used. It is important to note that there is no conflict between the indications of Figs. 6 and 6A.

A given value for the fineness modulus of an aggregate can be secured with any combination of percentages in the sieve analysis which gives the same total, consequently, an infinite variety of gradings may be found which give aggregate of the

same concrete strength. Table 3, page 727, gives the results of groups of tests which bring out the wide variation which may be made in the grading of aggregate without producing any essential variation in the concrete strength. Twenty-seven different gradings of the same aggregate were made up. These gradings covered the widest possible range, but they had one property in common; that

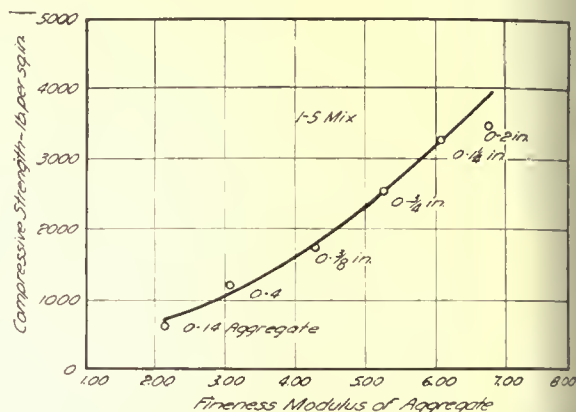

Fig. 6A. Relation between fineness modulus of aggregate and strength of concrete.

is, a fineness modulus of 6.04. All specimens were mixed with the same quantity of cement and water. Separate sets of specimens were made of two different consistencies. The mean variation from the average strength is about 3 per cent.

Since a maximum practicable value of fineness modulus is found for each size of aggregate and mix, it is necessary to place certain limits on the value which may be used for proportioning materials for concrete mixes. Table 4, page 728, gives limits which will be found practicable. Subsequent experience may dictate certain modifications in the details.

The purpose of Table 4 is to avoid the attempt to secure an aggregate grading which is too coarse for its maximum size and for the amount of cement used. It is also useful in prohibiting attempts to use sands which are too coarse for best results in concrete mixtures. For instance, it would be found from this table that the use of a sand of the nature of standard Ottawa sand is not permitted except in mixes 1:2 or richer.

The curves in Figure 7, page 729, are plotted directly from the values given for the standard sieves in Table 4.

From a careful consideration of the foregoing factors, it will be seen that the problem of designing the proper concrete mix under certain given conditions resolves itself into that of finding the combination which, with a given water-ratio will give a concrete of suitable workability, with a minimum quantity of cement.

# THE AMERICAN ARCHITECT

The following outline will make clear the steps to be followed in the design of concrete mixes on the bases of these studies of concrete:

### STEPS IN THE DESIGN OF CONCRETE MIXTURES

1. Having fixed the compressive strength re-

1.00 will hardly produce a *workable* concrete except for a fairly rich mix. Obviously the driest workable consistency possible should be used.

2. Make sieve analysis of fine and coarse aggregates to be used, using Tyler's standard sieves of the following sizes: 100, 48, 28, 14, 8, 4,  $\frac{3}{8}$ ,  $\frac{3}{4}$

TABLE 3

### EFFECT OF GRADING OF AGGREGATES ON THE STRENGTH OF CONCRETE

Compression tests of 6 by 12-in. concrete cylinders.

Mix 1:5 by volume; age at test, 28 days; stored in damp sand; tested damp.

Aggregates—sand and pebbles from Elgin, Ill. Aggregates were screened to different sizes and recombined to conform to predetermined sieve analyses.

The aggregates were made up in such a manner as to give the widest variations in the grading of the particles. All gradings had one common property, in that the *fineness modulus* was exactly the same— $m=6.04$ .

The same quantity of water was used in all specimens of a given consistency. The 110 per cent consistency contains 10 per cent more water than the 100 per cent.

Each specimen was made from a separate batch.

Each value in the strength tests is the average from 5 tests made on different days.

SIEVE ANALYSIS OF AGGREGATE											Fineness Modulus of Aggre- gate	SURFACE AREA OF AGGREGATE, SQ. IN.		COMPRESSIVE STRENGTH OF CONCRETE AT 28 DAYS (LB. PER SQ. IN.)	
PER CENT COARSER THAN EACH SIEVE												Per Lb. of Aggre- gate	Per. G. of Cement	100% Con- sistency	110% Con- sistency
100	48	28	14	8	4	$\frac{3}{8}$	$\frac{3}{4}$	$1\frac{1}{4}$	$1\frac{1}{2}$	2					
99	98	95	90	81	68	49	24	0	..	..	6.04	602	8.8	3300	2890
99	98	96	92	84	67	46	22	0	..	..	6.04	569	8.2	2950	2650
98	97	93	88	80	67	52	29	0	..	..	6.04	764	11.4	3120	2760
97	94	91	85	77	67	58	35	0	..	..	6.04	999	15.2	3140	2790
95	92	87	82	75	67	67	39	0	..	..	6.04	1292	20.1	3100	2800
95	90	84	78	73	67	62	55	0	..	..	6.04	1451	23.0	2830	2740
95	89	82	75	67	67	67	62	0	..	..	6.04	1565	25.2	2680	2580
100	97	91	79	72	67	58	40	0	..	..	6.04	761	11.9	3070	2690
100	97	93	88	83	67	50	27	7	0	..	6.04	616	9.0	3080	2790
99	97	94	86	77	67	47	27	16	..	0	6.04	709	10.5	3150	2710
98	95	90	83	83	83	50	22	0	..	..	6.04	834	12.6	3080	2500
98	94	90	86	83	80	55	18	0	..	..	6.04	898	13.3	3050	2550
96	90	80	80	80	80	60	39	0	..	..	6.04	1391	21.5	2970	2550
100	96	92	87	81	75	50	23	0	..	..	6.04	672	10.0	2930	2710
95	91	87	82	77	73	59	40	0	..	..	6.04	1315	20.2	3000	2580
99	95	88	80	76	73	61	32	0	..	..	6.04	911	13.9	2950	2740
90	85	81	78	75	73	66	56	0	..	..	6.04	1992	31.3	2680	2440
100	93	82	73	73	73	63	47	0	..	..	6.04	1076	16.7	2820	2620
100	100	100	92	81	60	45	26	0	..	..	6.04	390	5.6	3040	2780
100	98	95	90	80	60	50	31	0	..	..	6.04	557	8.3	2900	2770
100	99	96	92	84	55	50	28	0	..	..	6.04	483	7.0	2940	2750
100	99	96	91	80	50	50	38	0	..	..	6.04	514	7.6	3080	2750
98	84	84	84	84	57	57	57	0	..	..	6.04	1276	19.7	3000	2780
99	98	91	86	80	76	38	38	0	..	..	6.04	701	10.4	2940	2700
99	98	91	86	80	76	46	30	0	..	..	6.04	697	10.2	3020	2660
99	98	91	86	80	76	61	15	0	..	..	6.04	689	10.1	2930	2670
99	98	91	85	80	76	67	8	0	..	..	6.04	685	9.9	2970	2630
Average.....											6.04	904	13.8	2990	2690
Minimum value.....											..	390	5.6	2680	2440
Maximum value.....											..	1992	31.3	3300	2890
Mean variation from average—per cent.....											..	34.4	37.2	3.41	3.04

quired of the concrete, determine by the use of Fig. 1 the *maximum* water-ratio which may be used. Remember that a water-ratio lower than

and  $1\frac{1}{2}$  in. Express sieve analysis in terms of percentages of material by weight (or separate volumes) *coarser than* each of the standard sieves.



# THE AMERICAN ARCHITECT

3. Compute fineness modulus of each aggregate from the data obtained from (2).
4. Determine the maximum size of aggregate by applying the following rules:
  - (a) If more than 20 per cent of aggregate is coarser than any sieve, the MAXIMUM

SIZE shall be taken as the next *larger* "half-sieve."

- (c) If less than 10 per cent is coarser than certain sieves, the MAXIMUM SIZE shall be taken as the *smallest* of these sieve sizes.

TABLE 4  
MAXIMUM PERMISSIBLE VALUES OF FINENESS MODULUS OF AGGREGATES

For *mixes* other than those given in the table, use the values for the next leaner mix. For *maximum sizes* of aggregate other than those given in the table, use the values for the next smaller size.

*Fine aggregate* includes all material finer than No. 4 sieve; *coarse aggregate* includes all material coarser than the No. 4 sieve. *Mortar* is a mixture of cement, water and fine aggregate.

This table is based on the requirements for *sand-and-pebble* or *gravel* aggregate composed of approximately spherical particles, in ordinary uses of concrete in reinforced concrete structures. For other materials and in other classes of work the maximum permissible values of fineness modulus for an aggregate of a given size is subject to the following corrections:

- (1) If *crushed stone* or *slag* is used as coarse aggregate, *reduce* values in table by 0.25. For crushed material consisting of unusually flat or elongated particles, *reduce* values by 0.40.
- (2) For *pebbles* consisting of *flat particles*, *reduce* values by 0.25.
- (3) If *stone screenings* are used as fine aggregate, *reduce* values by 0.25.
- (4) For the top course in *concrete roads*, *reduce* the values by 0.25. If finishing is done by *mechanical means*, this reduction need not be made.

(5) In work of *massive proportions*, such that the smallest dimension is larger than 10 times the maximum size of the coarse aggregate, *additions may be made* to the values in the table as follows: for ¾-in. aggregate 0.10; for 1½-in. 0.20; for 3-in. 0.30; for 6-in. 0.40.

*Sand* with fineness modulus lower than 1.50 is undesirable as a fine aggregate in ordinary concrete mixes. Natural sands of such fineness are seldom found.

*Sand or screenings* used for fine aggregate in concrete must not have a higher fineness modulus than that permitted for mortars of the same mix. Mortar mixes are covered by the table and by (3) above.

*Crushed stone* mixed with both finer sand and coarser pebbles requires no reduction in fineness modulus provided the quantity of crushed stone is less than 30% of the total volume of the aggregate.

MAXIMUM PERMISSIBLE VALUE OF FINENESS MODULUS

MIX		SIZE OF AGGREGATE (LIMITS OF GRADATION)													
Cement	Aggregate	0-28	0-14	0-8	0-4	0-3*	0-3/8	0-1/2*	0-3/4	0-1 in.	0-1 1/2	0-2.1*	0-3 in.	0-4 1/2*	0-6 in.
1	12	1.20	1.80	2.40	2.95	3.35	3.80	4.20	4.60	5.00	5.35	5.75	6.20	6.60	7.00
1	9	1.30	1.85	2.45	3.05	3.45	3.85	4.25	4.65	5.00	5.40	5.80	6.25	6.65	7.05
1	7	1.40	1.95	2.55	3.20	3.55	3.95	4.35	4.75	5.15	5.55	5.95	6.40	6.80	7.20
1	6	1.50	2.05	2.65	3.30	3.65	4.05	4.45	4.85	5.25	5.65	6.05	6.50	6.90	7.30
1	5	1.60	2.15	2.75	3.45	3.80	4.20	4.60	5.00	5.40	5.80	6.20	6.60	7.00	7.45
1	4	1.70	2.30	2.90	3.60	4.00	4.40	4.80	5.20	5.60	6.00	6.40	6.85	7.25	7.65
1	3	1.85	2.50	3.10	3.90	4.30	4.70	5.10	5.50	5.90	6.30	6.70	7.15	7.55	8.00
1	2	2.00	2.70	3.40	4.20	4.60	5.05	5.45	5.90	6.30	6.70	7.10	7.55	7.95	8.40
1	1	2.25	3.00	3.80	4.75	5.25	5.60	6.05	6.50	6.90	7.35	7.75	8.20	8.65	9.10

\*Considered as "half-size" sieves; not used in computing fineness modulus.

- (b) If between 11 per cent and 20 per cent is coarser than any sieve, the MAXIMUM

SIZE shall be taken as the next *larger* sieve in the standard set

5 Determine by the use of Table 4 (or Fig. 7) the *maximum* value of fineness modulus which may be used for the mix, kind and size of aggregate, and the work under consideration.

6. Compute the percentages of fine and coarse aggregates required to produce the fineness modulus desired for the final aggregate mixture by the use of Fig. 8 or the following formula:

$$P = 100 \frac{A-B}{A-C} \text{ in which}$$

- $P$  = percentage of fine aggregate in total mixture.
- $A$  = fineness modulus of coarse aggregate.
- $B$  = fineness modulus of final aggregate mixture.
- $C$  = fineness modulus of fine aggregate.

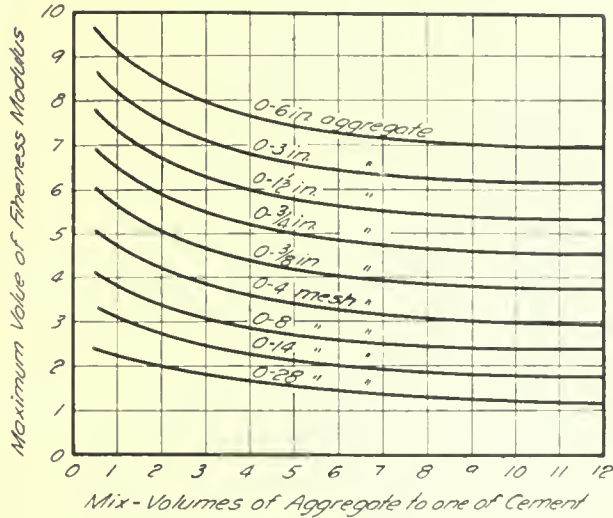

Fig. 7.—Maximum permissible values of fineness modulus of aggregate.

(NOTE.—Fig. 8 may also be used for making comparisons of the effect of certain changes in proportions of fine and coarse aggregates. The distinction between fine and coarse aggregate is solely for convenience in securing a uniform grading; the division may be made at any desired point.)

7. With the estimated mix, fineness modulus and consistency enter Fig. 9, page 731, and determine the strength of concrete produced by the combination. If the strength shown by the diagram is not that required, the necessary readjustment may be made by changing the mix, consistency or size and grading of the aggregate.

The quantity of water required can be determined approximately from Table 5 or more exactly from the formula given below.

FORMULA FOR DETERMINING WATER REQUIRED FOR CONCRETE

$$x = R \left\{ \frac{3}{2} p + \left( 0.22 - \frac{m}{42} + a - c \right) n \right\} \text{ in which}$$

$x$  = water required given as the ratio to the volume of cement in batch (water-ratio).

$R$  = Relative consistency of concrete, or "workability factor." Normal consistency (rel-

ative consistency — 1.00) requires the use of such a quantity of mixing water as will cause a slump of 1/2 to 1 in. in a freshly molded 6 by 12-in. cylinder of about 1:4 mix upon withdrawing the form by a steady, upward pull. A relative consistency of 1.10 requires the use of 10 per cent more water, and under the above conditions will give a slump of about 5 to 6 in.

- $p$  = Normal consistency of cement ratio by weight.
- $m$  = Fineness modulus of aggregate (an exponent).
- $n$  = Volumes of mixed aggregate to one of cement.
- $a$  = Absorption of aggregate, ratio of water absorbed to volume of aggregate. (Determined after immersion in water for 3 hours. Average values for crushed limestone and pebbles may be assumed as 0.02; porous sandstones may reach 0.08; very light and porous aggregate may reach 0.25.)
- $c$  = Moisture contained in aggregate, ratio of water contained to volume of aggregate. (Assume as zero for room-dry aggregate.)

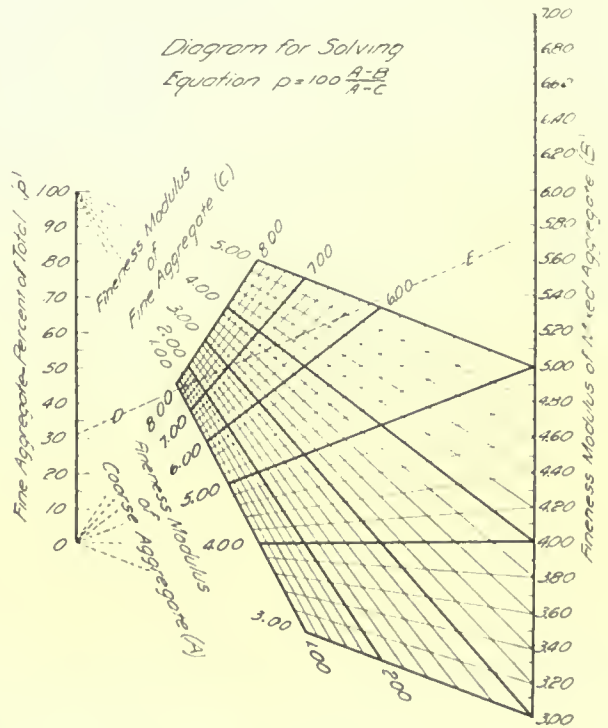

Fig. 8.

This formula takes account of all the factors which affect the quantity of water required in a concrete mixture. These factors may be classified as follows:

# THE AMERICAN ARCHITECT

TABLE 5

## QUANTITY OF MIXING WATER REQUIRED FOR CONCRETE

$$\text{*Calculated by formula: } x = R \left[ \frac{3}{2}p + \left( \frac{.30}{1.26m} + a - c \right) n \right]$$

Where x = Water required—ratio to volume of cement in batch (water-ratio).  
 R = Relative consistency, or "workability factor." Where R = 1.00 the concrete is said to be of "normal consistency."  
 p = Normal consistency of cement by weight (assume p = 0.23).  
 m = Fineness modulus of aggregate.  
 n = Volume of mixed aggregate to one volume of cement.  
 a = Absorption of aggregate, ratio of water absorbed to volume of aggregate.  
 c = Moisture in aggregate, ratio of water contained to volume of aggregate.  
 (a - c) = Net absorption of aggregate by volume.

In this table (a - c) is assumed as 0.02. In other words, the net quantity of water taken by the aggregate is 2% by volume. This value may be used for ordinary limestone and pebbles. For crushed trap and granite it is somewhat high.

A relative consistency of 1.00 (normal consistency) requires the use of such a quantity of mixing water as will cause a slump of 1/2 to 1 in. in a freshly molded 6 by 12 in. cylinder of about 1:4 mix upon withdrawing the form by a steady, upward pull. This consistency is somewhat dry for most concrete work, but can be used where light tamping is practicable.

A relative consistency of 1.10 (10% more water than required for normal consistency) represents about the driest concrete which can be satisfactorily used in concrete road construction. This consistency will give a slump of about 5 to 6 in.

A relative consistency of 1.25 represents about the wettest consistency which should be used in reinforced concrete building construction. Under the conditions mentioned above, this consistency will give a slump of about 8 to 9 in.

For mixes and fineness moduli, other than those given in the table, approximate values may be determined by interpolation. For specific cases use the formula.

Mix BY VOLUME		GALLONS OF WATER PER SACK OF CEMENT											
		FINENESS MODULI OF AGGREGATES†											
Ce- ment	Aggre- gate	1.50	2.00	2.50	3.00	3.50	4.00	4.50	5.00	5.50	6.00	6.50	7.00
RELATIVE CONSISTENCY — (R) = 1.00													
1	12	23.5	21.4	19.5	17.8	16.4	15.2	13.9	12.9	12.0	11.1	10.4	9.8
1	9	18.1	16.7	15.2	14.0	12.9	12.0	11.0	10.2	9.6	9.0	8.4	7.9
1	7	14.7	13.5	12.3	11.4	10.6	9.9	9.1	8.6	8.0	7.6	7.2	6.7
1	6	13.0	12.0	11.0	10.2	9.5	8.9	8.3	7.7	7.3	6.8	6.5	6.2
1	5	11.2	10.4	9.5	8.9	8.3	7.8	7.3	6.9	6.4	6.1	5.8	5.5
1	4	9.5	8.9	8.2	7.7	7.2	6.8	6.3	6.0	5.7	5.4	5.2	5.0
1	3	7.8	7.2	6.7	6.3	6.0	5.7	5.4	5.1	4.9	4.6	4.5	4.3
1	2	6.0	5.7	5.4	5.1	4.9	4.7	4.5	4.3	4.1	4.0	3.9	3.8
1	1	4.3	4.1	3.9	3.8	3.7	3.6	3.5	3.4	3.3	3.2	3.2	3.1
RELATIVE CONSISTENCY — (R) = 1.10													
1	12	25.8	23.6	21.4	19.6	18.1	16.7	15.3	14.2	13.2	12.2	11.4	10.8
1	9	19.9	18.4	16.7	15.4	14.2	13.2	12.1	11.2	10.6	9.9	9.2	8.7
1	7	16.2	14.9	13.5	12.5	11.7	10.9	10.0	9.5	8.8	8.4	7.9	7.4
1	6	14.3	13.2	12.1	11.2	10.5	9.8	9.1	8.5	8.0	7.5	7.2	6.8
1	5	12.3	11.4	10.5	9.8	9.1	8.6	8.0	7.6	7.0	6.7	6.4	6.1
1	4	10.5	9.8	9.0	8.5	7.9	7.5	6.9	6.6	6.3	5.9	5.7	5.5
1	3	8.6	7.9	7.4	6.9	6.6	6.3	5.9	5.6	5.4	5.1	5.0	4.7
1	2	6.6	6.3	5.9	5.6	5.4	5.2	5.0	4.7	4.5	4.4	4.3	4.2
1	1	4.7	4.5	4.3	4.2	4.1	4.0	3.9	3.7	3.6	3.5	3.5	3.4
RELATIVE CONSISTENCY — (R) = 1.25													
1	12	29.4	26.8	24.4	22.2	20.5	19.0	17.4	16.1	15.0	13.9	13.0	12.3
1	9	22.6	20.9	19.0	17.5	16.1	15.0	13.8	12.7	12.0	11.2	10.5	9.9
1	7	18.4	16.9	15.4	14.3	13.2	12.4	11.4	10.7	10.0	9.5	9.0	8.4
1	6	16.3	15.0	13.8	12.8	11.9	11.1	10.4	9.6	9.1	8.5	8.1	7.7
1	5	14.0	13.0	11.9	11.1	10.4	9.8	9.1	8.6	8.0	7.6	7.2	6.9
1	4	11.9	11.1	10.2	9.6	9.0	8.5	7.9	7.5	7.1	6.8	6.5	6.2
1	3	9.8	9.0	8.4	7.9	7.5	7.1	6.8	6.4	6.1	5.8	5.6	5.4
1	2	7.5	7.1	6.8	6.4	6.1	5.9	5.6	5.4	5.1	5.0	4.9	4.8
1	1	5.4	5.1	4.9	4.8	4.6	4.5	4.4	4.3	4.1	4.0	4.0	3.9

\*This formula given on page 729 in simpler form.



# THE AMERICAN ARCHITECT

1. "Workability" factor, or the relative consistency on the concrete. This is dictated by the kind of work being done; concrete must be more plastic (which generally means a wetter consistency) in reinforced concrete building construction than is necessary in mass work. The term ( $R$ ) in the equation takes care of this factor. ( $R$ ) may vary from, say, 0.90 for a dry concrete to 2.00 or higher for very wet mixes.
2. Cement factor, which is made of two parts; the quality of cement so far as normal consistency is concerned ( $p$ ); the quantity of cement in the mix ( $n$ ).
3. The aggregate factor. This includes the three terms within the parenthesis in the equation. The first term, involving ( $m$ ), takes account of the size and grading; the second ( $a$ ) the absorption, and the third ( $c$ ) the water contained in the aggregate.

sand mortars from the cement used in these tests are given.

Suppose we consider the case of concrete for road construction. This is generally specified as a 1:1½:3 or a 1:2:3 mix, with aggregate graded up to 1½ in. These mixes are about the same as what have been termed a 1:4 mix, the exact equivalent depending on the particular size and grading of the fine and coarse aggregate. Assume that gravel aggregate will be used, graded to 1½ in. Table 4 shows that we may use a fineness modulus as high as 6.00-.25 = 5.75. Knowing the sieve analysis and fineness modulus of both sizes of aggregate, apply the formula or Fig. 8 to determine the proportion of each aggregate which must be mixed to secure this value. Assume that the concrete will be mixed to a relative consistency of 1.10, which is of such plasticity as will give a slump of 5 to 6 in. in the test described

In case admixtures of any kind are used, another term must be inserted in the equation. This relation has been fully worked out, but is not included in this report.

### CHART FOR DESIGN OF CONCRETE MIXES

Fig. 9 is a nomographic chart for the design of concrete mixes. This chart takes account of the following four factors:

1. The mix (cement content).
2. The relative consistency.
3. The grading of aggregate (fineness modulus).
4. The compressive strength of concrete.

Given any three of these factors the chart enables us to solve for the fourth. This chart is, of course, based on the results of certain tests. For practical application these values must generally be reduced by certain factors, which will depend on the judgment of the designer. In order to furnish some basis for comparison, compression tests of 1:3 standard

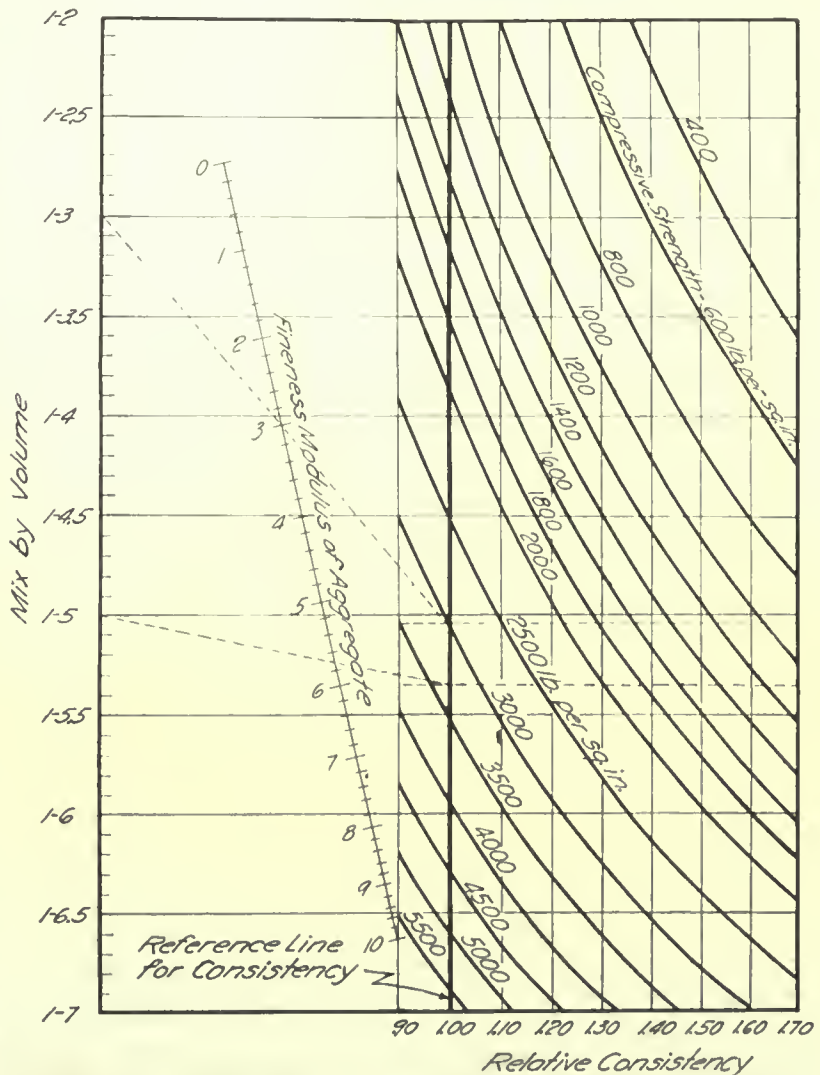

Fig. 9—Chart for the design of concrete mixtures.

## THE AMERICAN ARCHITECT

above. Place a straightedge in Fig. 9 on mix 1:4, and fineness modulus 5.75, and mark the point where it crosses the reference line for consistency; from this point project the line horizontally (as indicated in other examples) to relative consistency 1.10. It will be seen that this gives a compressive strength of 3,400 lb. per sq. in. at 28 days.

The effect of using other mixes, gradings or consistencies on the strength can be seen at once from the diagram. For instance, if the water were increased to a relative consistency of 1.25 (not nearly so wet as is frequently seen in road work) the strength will be reduced to 2,700 lb. per sq. in.—a reduction of over 20 per cent. If the mix were changed to 1:4½ and other factors the same as in the first example, the strength would be 3,200 lb. per sq. in. We should have to change the mix to as lean as 1:5¼ in order to secure the same reduction in strength as was found above for a change from 1.10 to 1.25 consistency.

By using the wetter of the two consistencies we secure concrete of the same strength as if we had used one-third less cement and the drier mix. In other words, *increasing the mixing water 13 per cent causes the same reduction in strength as if we should omit 33 per cent of the cement.* This example shows the reason for emphasizing the importance of proper control of mixing water in concrete.

This chart enables us to answer such questions as the following:

Which is the stronger, a 1:3 mortar or a 1:5 concrete mixture?

Assuming that concrete of the same plasticity is used, the relative strengths will depend, of course, on the grading of the aggregates and the mix. In one case we have assumed 1:3 mix with fineness modulus equal to 3.00. This will give a strength for normal consistency of 3,000 lb. per sq. in. The 1:5 mix (fineness modulus 5.70) gives a strength for normal consistency of about 3,300 lb. per sq. in. The strengths for other consistencies can be found by reading horizontally across the chart as indicated by the dotted lines.

Unfortunately, we now have no proper basis for absolute values for strength of concrete. This, of course, makes it necessary to refer to particular tests as in Fig. 9. This condition emphasizes the importance of working out a test of cement which will give us at once the concrete strength for given materials, mixes, etc. With the present method of testing cement it is impossible to do more than make a rough guess as to the strength of concrete from the results of briquet tests.

### FURTHER DISCUSSION OF CONCRETE MIXES

The importance of the water ratio on the strength

of concrete will be shown in the following considerations:

One pint more water than necessary to produce a plastic concrete reduces the strength to the same extent as if we should omit 2 to 3 lb. of cement from a 1-bag batch.

Our studies give us an entirely new conception of the function performed by the various constituent materials. The use of a coarse, well-graded aggregate results in no gain in strength unless we take advantage of the fact that the amount of water necessary to produce a plastic mix can thus be reduced. In a similar way we may say that the use of more cement in a batch does not produce any beneficial effect except from the fact that a plastic, workable mix can be produced with a lower water-ratio.

The reason a rich mixture gives a higher strength than a lean one is not that more cement is used, but because the concrete can be mixed (and usually is mixed) with a water-ratio which is relatively lower for the richer mixtures than for the lean ones. If advantage is not taken of the fact that in a rich mix relatively less water can be used, no benefit will be gained as compared with a leaner mix. In all this discussion the quantity of water is compared with the quantity of cement in the batch (cubic feet of water to 1 sack of cement) and not to the weight of dry materials or of the concrete as is generally done.

The mere use of richer mixes has encouraged a feeling of security, whereas in many instances nothing more has been accomplished than wasting a large quantity of cement, due to the use of an excess of mixing water. The universal acceptance of this false theory of concrete has exerted a most pernicious influence on the proper use of concrete materials and has proven to be an almost insurmountable barrier in the way of progress in the development of sound principles of concrete proportioning and construction.

Rich mixes and well-graded aggregates are just as essential as ever, but we now have a proper appreciation of the true function of the constituent materials in concrete and a more thorough understanding of the injurious effect of too much water. Rich mixes and well-graded aggregates are, after all, only a means to an end; that is, to produce a plastic workable concrete with a minimum quantity of water as compared with the cement used. *Workability* of concrete mixes is of fundamental significance. This factor is the only limitation which prevents the reduction of cement and water in the batch to much lower limits than are now practicable.

The above considerations show that the water



## THE AMERICAN ARCHITECT

content is the most important element of a concrete mix, in that small variations in the water cause a much wider change in the strength than similar variations in the cement content or the size or grading of the aggregate. This shows the absurdity of our present practice in specifying definite gradings for aggregates and carefully proportioning the cement, then guessing at the water. It would be more correct to carefully measure the water and guess at the cement in the batch.

The grading of the aggregate may vary over a wide range without producing any effect on concrete strength, so long as the cement and water remain unchanged. The consistency of the concrete will be changed, but this will not affect the concrete strength if all mixes are plastic. The possibility of improving the strength of concrete by better grading of aggregates is small as compared with the advantages which may be reaped from using as dry a mix as can be properly placed. Table 1 shows the effect of water on the strength of concrete.

It is impracticable to lay down a general rule for the quantity of water which should be used in a concrete mix, since it was seen in the water formulas given above that the total water is governed

by a large number of different factors. However, it is only the water which goes to the cement (that is, exclusive of absorbed water) which affects the concrete strength. The failure to recognize this fact has led to many erroneous conclusions from tests made to determine the relative merits of different aggregates.

Table 5 gives the quantity of water required for plastic mixes for certain assumed conditions of normal consistency of cement, absorption of aggregate, and relative consistency. Water is expressed in terms of gallons per sack of cement. In using this table the dependence of the value of fineness modulus which may be used on the size of aggregate and the mix, referred to in Table 3, should not be overlooked.

Without regard to the actual quantity of mixing water, the following rule is a safe one to follow:

Use the smallest quantity of mixing water that will produce a plastic or workable concrete.

The importance of any method of mixing, handling, placing and finishing concrete which will enable the builder to reduce the water content of the concrete to a minimum is at once apparent.

---

## Reinforced Concrete Tests

As the results of tests on reinforced concrete conducted by the University of Illinois are of vital importance to the architect as well as the engineer, the following should be of interest.

URBANA, ILL., April 15, 1919.

Rigidly connected frames are frequently used in reinforced concrete construction. Since about 1905 they have been extensively used in continental Europe, and there is a tendency in America to use them for buildings and bridges. The field of the application of rigid frames is almost unlimited, for most reinforced concrete structures are composed of elements of rigid frames. Every building construction of reinforced concrete may be considered as a rigidly connected frame, for columns, girders, beams and slabs are all rigidly connected with each other, although the effect of this condition is not fully considered in the design. Bridges, trestles and viaducts are also in the field of the rigid frame. Likewise parts of culverts, sewers, subway constructions, reservoirs and water tanks are examples of the rigidly connected frame.

The reinforced concrete frame is advantageous in that it is economical and permits effective designs. Notwithstanding the importance of the frame in construction, practical formulas to determine exactly the stresses as they occur in a rigidly connected reinforced concrete frame are not generally available.

A series of tests has been conducted by the engineering experiment station of the University of Illinois to obtain experimental information concerning the stresses in the reinforcement and in the concrete, the continuity of the composing members of a frame, the location of sections of critical stress, the reliability of a reinforced concrete frame and the applicability of the theoretical formulas in the design of frames. Formulas for moments and other indeterminate quantities for several types of indeterminate structures have been derived. To test practically the reliability of these formulas for reinforced concrete structures, eight test frames were designed according to the formulas found by the analyses, and the deformations produced in the various parts of the members by the test loads were



## THE AMERICAN ARCHITECT

measured. The specimens were made in November and December, 1913, and January, 1914, and were tested in January, February and March, 1914. The following cases have been analyzed for vertical load: (1) single story, single span; (2) single story, three spans; (3) trestle bent with tie, single span; (4) building frame with several stories and several spans; and (5) bridge trestle. For horizontal load the following cases have been analyzed: (1) single story, single span; (2) octagonal reservoir or tank; and (3) rectangular reservoir.

The formulas found from the analyses and graphs showing the main stresses that were observed at the principal loads are published in Bulletin 107 entitled "Analysis and Tests of Rigidly Connected Reinforced Concrete Frames" by Mikishi Abe under the direct charge of Professor Arthur N. Talbot, Department of Theoretical and Applied Mechanics, University of Illinois. Copies of this bulletin may be had without charge by addressing the Engineering Experiment Station, Urbana, Ill.

### Importance of Electricity in World's Largest Hotel

THE Hotel Pennsylvania, New York City, illustrated in our issue of February 26, was planned to be one of the most convenient and comfortable of hotels. Electricity therefore plays a large part in the service of the guests.

In fact, so important is this mysterious force to the life of the hotel that special precautions have been taken to prevent the failure of the supply. It would, for example, be extremely disagreeable if the lights should all go out and the elevators stop running. To prevent such a contingency arrangements have been made to supply current from three independent sources—from two stations outside of the building and from a generator inside. The cables come in through a tunnel deep under ground, and the power cannot be cut off even, it is believed, by an earthquake or an air raid (fire need not be seriously considered as the hotel is absolutely fireproof).

To provide further safety, the lights are operated from three separate circuits. Some of the lights in each corridor, and at other emergency points, are lit from each of these circuits, so that even if trouble developed on two circuits at the same time no important part of the hotel would be plunged into darkness.

The guest is constantly meeting novel applications of electricity. When he enters his attractive bathroom, the first thing he notices is a faucet labeled "ice water," which is supplied by an electric pump in the basement. Should he order breakfast served in his room he receives it in a surprisingly short time, and the secret of this rapid service is the electric breakfast kitchen located on every one of the guest floors. These kitchens are equipped with electric coffee percolators, stoves, toasters, egg-boilers and other cooking utensils. Each one also has a "cold box," or refrigerator, set in the wall and kept cold by refrigerated brine circulated by an electric pump.

He may, perhaps, notice that the air in the restaurants and other concourse rooms is fresh and pure in spite of the many people and the smoke from hundreds of cigarettes and cigars. This is due to the fact that air for these rooms is drawn in from the outside by electric ventilating fans, forced through cheesecloth filters, washed in running water, and heated in winter and cooled in summer, while the foul air is drawn out by exhaust fans. Each of the 2200 bathrooms is also ventilated by exhaust. Twenty-seven motors, specially selected because of their silent operation, operate these fans, and 800 tons of sheet metal were required for the ventilating ducts.

Everything is neat and clean, because two 20-horsepower motors drive vacuum cleaners that draw dust and dirt from 487 openings and carry it through a total of three miles of pipe to dust receptacles in the cellar.

The laundry, which is one of the largest private laundries in the country, is electrically operated throughout.

Perhaps the most unique electrical machine is the one that reproduces writing and is used to convey instructions throughout the hotel. These machines can be seen in operation at various points and to watch the pen of one of them busily spelling out a message in the handwriting of some one perhaps twenty floors below is fascinating and almost uncanny.

One of the inconspicuous but valuable features of the electrical equipment is the switch panels for controlling the lighting circuits on the various floors. These panels differ from the ordinary type in that it is impossible for anyone operating the switches to come in contact with live parts. Hence they are absolutely safe and cannot cause injury to the operator. The fuses and connections are locked in a separate compartment and are accessible only to authorized electricians.

1789  
722A  
73

# The AMERICAN ARCHITECT



INTERIOR OF SANTA MARIA DELLA SALUTE, VENICE

PUBLISHED WEDNESDAYS IN NEW YORK—FOUNDED 1876  
VOLUME CXV                      MAY 28, 1919                      NUMBER 2266

Entered as second class matter January 6, 1909, at the Post Office at New York, N. Y., under the Act of March 3, 1879. Publication office, 243 West Thirty-ninth Street, New York, N. Y. Subscription price in the United States and Possessions, \$10.



# RAYMOND



**This  
Concrete Pile Form  
will be left  
in the ground**

This is a section of the spirally reinforced steel shell in which every Raymond Concrete Pile is cast. Every Pile has its own shell. Every Pile is thus protected against distortion or weakening of the pile column by any unfavorable underground condition. You may inspect the shell interior after it has been driven.

**RAYMOND  
Concrete Pile Co.**

NEW YORK: 140 Cedar Street  
CHICAGO: 111 W. Monroe Street

*A Form for Every Pile—  
A Pile for Every Purpose*







BASILICA PALLADIANA, VICENZA, ITALY

The greatest work of Palladio and the finest secular building of the Renaissance period. The porticos surround an Italian Gothic town hall

# THE AMERICAN ARCHITECT

VOL. CXV

WEDNESDAY, MAY 28, 1919

NUMBER 2266

## A Review of The Post-War Committee's Activities at the Nashville Convention

By ROBERT D. KOHN, F. A. I. A.

IT would be quite impossible in a brief article to give any adequate impression of the discussions that took place on the items of the Post-War Committee's program at the recent convention of the Institute in Nashville. The transactions of the Institute, when published, will contain a fairly complete report, but it is worth while attempting to give the impressions of one member of the committee who is very deeply interested in the whole matter.

To begin with, the convention unquestionably went on record as approving the continuance of the work of the committee. This was shown by the vote recorded on the recommendation of the Board of Directors that the Institute be allowed to draw from its reserve fund if necessary in order to carry on this work, as well as certain other important work for the coming year. The vote required a two-thirds majority. While it secured that majority by a narrow margin, a vote of 82 to 40 was really most satisfactory because of the fact that many who voted against the appropriation did so because they thought that the expenses of the committee should be drawn from current funds and not because they disapproved the committee's work. A direct and clear vote on the issue as to whether or not the Post-War Committee was to continue its investigations would apparently have secured the almost unanimous vote of the convention.

The Post-War Committee held a meeting before the convention and one immediately afterwards. At these meetings consideration was given to many hundreds, indeed possibly close to a thousand, communications received from architects throughout the country in response to the questions contained in the program. A very large share of these replies came from men who were not connected with the Institute, thus indicating that the inquiry had aroused a very general interest on the part of the profession at large. The three sessions of the

convention particularly devoted to a discussion of the various items of the program were full of interest and in the opinion of many of those present brought out the most vital and lively discussions that have been heard for many years.

There was considerable delay in getting to the subjects assigned for the first evening session because a good part of the time allotted for the meeting was taken up by an admirable address delivered by Mr. John Bell Keeble, a distinguished attorney of Nashville. His professional message was inspiring and dealt principally with the distinction between the business attitude and the professional attitude toward life. His analysis of the social point of view in the practice of law and architecture was most welcome and highly appreciated.

Mr. Dunning's admirable introduction to the detailed discussion of the Post-War Committee program, followed by an address by Mr. Medary of Philadelphia, the chairman of the evening, set the pace at so high a standard that it was really difficult thereafter to get the modest delegates to express themselves freely. Before the evening was over, however, an enlightening debate had taken place on the possibilities of expansion of the architect's service, the self education that comes through his greater participation as a citizen in public work, and the methods by which he can make his importance in relation to the problems of building more quickly felt. There was no attempt on the part of the speakers to place the architect on a pedestal as a perfect being and to blame the public for all the ills of the profession. There was hardly a speaker who did not frankly say that the architect would have to make his own services more efficient and more complete if he wished to put himself right with the public.

Owing to the desire of the convention to give an earlier opportunity for the discussion of educational problems than had been provided by the program,



## THE AMERICAN ARCHITECT

the session originally arranged for the evening of the last day, and which was to be devoted to the subject of education and registration, was advanced to the afternoon of the second day. There were present not only the regular delegates to the convention but a large number of men connected with various universities and schools where departments of architecture are now already established. The report of the Committee on Education, signed by Mr. Ackerman, Mr. Medary and Mr. Dwight Perkins of Chicago, awakened great discussion, both for and against the principles maintained by the committee. The report attacked the problem in its fundamentals. It pointed out that the faults of our architectural schools are also the faults of our whole system of education. The common and secondary schools and our universities do little to develop independence of thought on the part of their pupils, and so the men who then study architecture have no adequate foundation to work on. Our schools of architecture, it was claimed, are bound by traditional methods of teaching and are out of touch with reality. They do little to give their students a sense of social responsibility and so their methods and their ideals are in need of radical change.

It was interesting to note the varying points of view expressed on the floor during the debate. There was no attempt to deny that the men going through our architectural institutions are inadequately trained. Some claimed, however, that it was impossible to teach men in any institution under any system so that they would be capable of practicing architecture efficiently when graduated. Some of the speakers claimed that the methods of teaching are right in principle, but need more thoroughness in application; that a longer period of instruction is essential; and that the men should be required to go through a number of years of practical training after graduation before being allowed to practice. In this connection the discussion on the value of the registration of architects was interesting. Mr. Waid clearly pointed out that when the standard of qualifications set for registration in the various States was placed sufficiently high, then registration would be an important element in the educational problem. Many who had rather grudgingly agreed to registration laws merely as a means to prevent the obviously inefficient from practicing now recognize that in some States registration has actually raised the educational standards of the profession.

Throughout the entire discussion of the problems of education there was displayed a very broad-minded willingness on the part of teachers to accept constructive suggestions for reform. They seemed

to realize the justice of many of the points made in the report on education, and so expressed themselves, saying that they welcomed this analysis of their problems. What they did urge, however, was that they might have the help of the members of the profession toward securing constructive reforms, not the least of which would be in the placing of architectural schools in a position where they would be independent of the schools of engineering, which in some cases still controlled their policy. Any tendency that the debate might have had to become acrimonious was prevented by an exceedingly amusing paper read by Mr. Magonigle, in which, among other things he listed the colossal number of subjects in which the architect is supposed to be proficient. On the whole the discussion was very well worth while, and indicated certain constructive lines of study which the Post-War Committee will now follow up.

The evening session of the second day was very well attended, and started off splendidly with the report of Mr. Russell of St. Louis on the recently organized National Board of Jurisdictional Awards of the Building Industry. This Board has been recently created to pass on all questions of trade jurisdiction in the building industries. It owes its existence in a great measure to the efforts of the American Institute of Architects, and indeed it is the first formal and definite act of participation on the part of the architectural profession in questions of adjustment between employers and employees in the building trades. The membership of the board includes representatives of the building trades department of the American Federation of Labor, the Associated General Contractors, the National Association of Builders, Executives of the Engineering Council, and the American Institute of Architects. The organization of the board seemed almost like a direct answer to that question in the Post-War Committee's program, which referred to the need for closer co-operation on the part of architects with the men who execute their work. Nothing was more stirring in Mr. Russell's report than the expression of his conviction borne of experience that the step taken by the architects in this matter was most welcome to the Federation of Labor, and secondly that there already were evidences that all the interests represented in the board would benefit by the co-operation thus established, particularly in the way of enlightenment and understanding.

Under the head of item K of the program, Standardization, Mr. Boyd presented an interesting paper in which he indicated the ways in which certain forms of construction might be standardized along the lines established by various Govern-

## THE AMERICAN ARCHITECT

ment departments during the war. An interesting letter on the same subject, written by Mr. C. B. J. Snyder of New York, in a great part confirmed the position taken by Mr. Boyd.

The major part of the evening was devoted to topics L and M of the program. The former raised the liveliest discussion as to the best and most desirable form of architectural societies. There seemed to be a very general agreement that the proposed action of the convention in encouraging the formation of State Associations had been justified. Illinois gave very interesting reports as to the effectiveness of the State organization—how it supplemented the work of the Chapter and supported it in every way and yet had developed an independent force of its own owing to the co-operation of great numbers of architects throughout the State, who for one reason or another were not directly associated with the Institute. There were interesting reports from Kansas and Pennsylvania, Ohio and New York. Delegates of the two latter States indicated that they are even now taking steps to reorganize their existing State Associations, making them independent of the Institute so as to take in on the basis of comparatively small membership dues all those architects who are qualified to practice, but who by reason of their distance from the principal cities or for financial reasons are not now connected with any architectural society. Ohio was apparently hesitating as to the advisability of this step, but delegates from New York reported that preliminary notices had already been sent out for a meeting to be held in Utica on the 7th day of June to form a new association.

Under the last topic, M, the subject of competitions was very thoroughly debated. Prof. Laird presented an interesting resumé of a statement on the subject which he had prepared for the Philadelphia Chapter. His opinion was on the whole favorable to competitions as being both the best means for selecting an architect and for getting the best architectural result. This stirred up a mighty discussion, some holding that results of competitions were rarely satisfactory either to those who participated or in the design of the structure resulting therefrom, some contending that they were a necessary evil, and others holding that they were an entirely unnecessary evil. There was no doubt that the members agreed that the principle of regulating competitions cannot be questioned; that is to say that competitions if held must conform to the code set by the Institute. One of the most interesting remarks made during the evening was that of Mr. Mauran of St. Louis, who told of a case in which his firm had been invited to compete for an important building and had declined on the ground

that the character of the building was such that a competition could hardly elicit satisfactory results because the problem needed intimate conferences between the owners and architect. In this particular case the owners had abandoned the idea of a competition and had awarded the work to Mr. Mauran's firm, whereupon they prepared quite a number of different schemes for the same building, developing, in other words, a series of sets of competition drawings themselves for their client's consideration. These different sets were then presented one after the other in the order of their development, and each in turn was declared by the client to be acceptable until the last in the order of development was acknowledged to be superior to any of the others. It was evident that in this particular case no competition could have produced a result so directly the effect of the conferences that had preceded the development of the plan.

Those who were most insistent on the value of competitions were perfectly ready to acknowledge that everything lay in the wisdom of the program and the wisdom of the jury, but the critics were quick to point out that if the program were properly written; that is to say that if the professional adviser had really studied the problem so as to include within its fundamental conditions the essentials to a satisfactory solution then the program itself would solve the program. On the whole, delegates from the eastern and central sections of the country were generally of the opinion that competitions are to be discouraged, but that in any case the standards must be maintained, insisting that the programs must be carefully drawn and the jurors carefully selected, while the delegates from the West and the South, with the exception of San Francisco, clung to the competition as their only hope against deplorable public architecture. These parts of the country hold that in the last few years the competition program of the Institute has greatly helped in clearing up the situation with regard to public work, and that for a great many years to come they will wish to continue the valuable educational influence which has come through its enforcement.

Quite aside from the three main sessions of the convention devoted to the Post-War program, the subjects covered by that program were constantly brought up in the course of other debates. While delegates from some of the big cities seemed to think there was nothing very important so far in evidence as the result of the committee's work, delegates from the rest of the country were unquestionably enthusiastic about the possibilities of this Post-War effort. The remark was common that the Institute had really thereby struck its gait and was



making itself of great value to the profession. Everyone wanted to know in what form the result of the investigation would be sent out, and offers of assistance and co-operation were received from innumerable sources.

On the whole the results of the discussions at Nashville were exceedingly helpful, and will un-

doubtedly help spur on the Post-War Committee to carry on its formidable task during the coming year with renewed energy. Its greatest hope must be that it may be able to help in the development of a public opinion within the profession as to the lines along which the practice of architecture ought to grow so as to become efficient in the public service.

## The Registration of Architects

Remarks by D. EVERETT WAID, *Treasurer, American Institute of Architects, before the Nashville Convention*

**T**HIS subject is a matter of present importance for the reason that perhaps a dozen States now have registration bills under consideration, and double that number are likely to pass such laws in the near future. For the good of the public and the credit of the profession, it is the duty of every Institute member to be prepared to oppose every bill drawn on a wrong basis and to be ready to fight for certain fundamentals which, if not provided, would mean the defeat of every State law proposed.

Our chief danger lies in the fact that selfish self-protection is the impelling motive most certain to initiate registration or license laws. Architects chafe when they see incompetent, conscienceless persons design buildings and impose on the public and the qualified practitioner by calling themselves architects and walking away with the commissions.

The first impulse is to say "bar such people by means of a license law." Such a method of meeting competition is a mistake and in the end brings trouble. As members of the American Institute of Architects, we should have the vision to work on a higher plane; we should have the foresight and energy to take the lead and act first, and not wait until we have to correct the missteps of others.

Our primary motive and object should be to make ourselves competent rather than to condemn the incompetence of others. A registration law should be an instrument for educating architects, not for placing a ban on a poor carpenter or an engineer who wishes to design a building. Druggists or practical nurses may advise a remedy for a cold; but they cannot call themselves doctors without first passing examinations which test their actual qualifications. A real estate man may give a sound opinion on a legal question or conduct his own legal operations, but he has no standing in court until he has acquired certain general and technical education and experience.

A professional man or an artist must excel in his particular line of work and be a real expert as compared with the laity or those in other professions, or he will bring discredit upon himself and the profession of which he pretends to be a qualified member.

Let us impress upon ourselves and every architect the fact that each State in the Union is going to have a registration law. That being the case, whether we feel any personal interest in registration laws or not (at any rate it should be an unselfish interest) let every member of the Institute stand for three things:

*First*—that every architect to win his title should have a general education equal to or a little better than that of the average well educated citizen, plus an adequate technical education.

*Second*—That present practitioners may continue to practice by legal right and that the Board of Examiners shall not be forced to give them certificates of competency unless they prove their qualifications.

*Third*—That all the States shall aim at some uniformity of standards and to that end all prospective legislation be submitted through *The Octagon* to the Institute Committee on Registration.

Since the last convention a new kind of legislation has been evolved. That is joint registration of architects and engineers. Three States have formulated bills of this kind: Ohio, Indiana and Michigan, and others are likely to follow, creating Boards of Examiners and Registration made up of members of both professions. In one State the bill provides for a board of examiners made up of one architect and two engineers. Think of the architectural standards of a State being placed in the hands of one architect, doubtless a political appointee, a mining engineer and an electrical engineer!

The American Institute of Architects has declared in favor of association with engineers on a basis



## THE AMERICAN ARCHITECT

which will insure friendly co-operation and not competition. But this bill may be regarded as a grave mistake which threatens to place the artistic quality of architects' work, in the eyes of the public, on a lower plane than ever.

The Board of Directors appeals to all Chapters to send a copy of every registration bill to *The Octagon*. Prompt action may prevent ill-considered legislation which would hamper the best efforts of our profession for years to come.

# Notes from London

By SELWYN BRINTON, *Special Correspondent to THE AMERICAN ARCHITECT*

The housing question, to which I have alluded in my previous notes, now seems to be taking a definite shape under the pressure of the Government Housing Bill, whose main provisions I have already detailed. On all sides there are signs of movement. At Roehampton, near London, the Dover House Estate is being acquired at a cost of £20,000; but as this is a very desirable location on the high ground adjoining Putney Park it is suggested that this should not be developed exclusively as a working class estate.

At Brighton it is proposed to erect 800 houses on the Moulscombe Estate, and it has been found that the expenditure as contemplated works out at £900 each, instead of the estimated £700, representing a rental of £1.12.6 per week. As the prospective tenants are not expected to be able to pay more than 12/6 weekly, there will be a balance of £1 to be paid "from some source other than the rental"; and the Brighton Housing Committee assumes that the Government will "contribute an annual sum representing the difference between the rent actually obtainable and the amount of the outgoings, less the proportion of the amount produced by a one penny rate."

Apart from this, as this estate will not be available until after inquiry and arbitration, the Brighton authorities are constructing fifty houses

for the discharged soldiers, who are working at the new diamond cutting industry which has been started in that town; and Professor Adshead, F. R. I. B. A., is now preparing an estate and development plan for this last proposal.

These are only instances of what is going on all over the country. The recent statement of the Local Government Board reported that by the end of March 658 housing schemes had been submitted by 358 local authorities in England and Wales for the Board's approval, most of these schemes being in the initial stage of a site having been submitted for approval.

Housing is certainly a national necessity at this moment; but it is evident that the total expenditure is going to be enormous, and the class which is going to benefit most ought to take its fair share in meeting this. Take the Brighton (Moulscombe Estate) instance above mentioned. It is within the knowledge of the writer that in that district quite good residential

houses could be obtained recently at a rental value of less than £40 a year. The weekly rental of £1.12.6 amounts to about double this, and obviously for the class of houses required is simply preposterous. It amounts to plunder of an already overtaxed community; and not only what are called the professional classes, but the skilled technical workers and managers are rising in protest. At the recent In-

(From *The Builder*)



PROPOSED HALL, BISHOPS STORTFORD COLLEGE

H. C. IBBERSON, ARCHITECT

## THE AMERICAN ARCHITECT

dustrial Conference a well-dressed man stepped on the platform to propose that "the National Industrial Council take into consideration the position of unions composed exclusively of the technical and administrative grades, and determine how such unions shall be represented." It is significant that in the recent annual meeting of the Association

should be abandoned at the earliest possible moment. "The underlying principle," it was remarked, "that seemed to obtain with the gentleman responsible for creating new ministries, departments and controls, was that of the spendthrift. They had been ready to adopt all sorts of wild and risky experiments; and the last consideration that entered



Fig. 5 A.



Fig. 8 A.



Fig. 6 A.



Fig. 10 A.

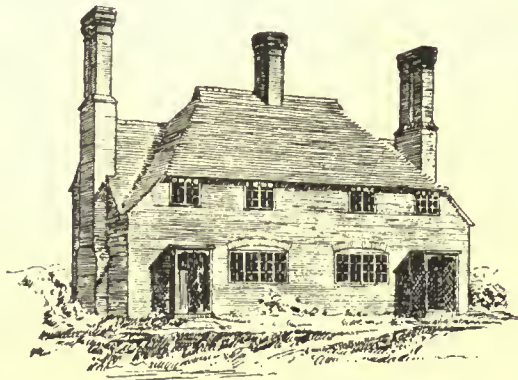

Fig. 7 A.



Fig. 11 A

The figure-numbers correspond to the numbers on the Plans on Page 741.

### THE ENGLISH FIVE-ROOM COTTAGE

of Chambers of Commerce at which one hundred Chambers were represented, the London and Luton Chambers joined in a unanimously adopted resolution that the House of Commons should resume control of public expenditure, and that the present unemployment donation, vicious in principle, and which is hindering the resumption of work,

into their heads was where the money was to come from. The unemployment donation scheme had been conceived in a hasty and reckless manner. It was demoralizing and degrading to pay men and women for doing nothing."

I have made it clear in my previous treatment of this subject that my criticism is directed against



(From The Architects and Builders Journal)

**THE FIVE-ROOMED COTTAGE**  
Its planning analysed.

*In the details of these typical plans, wherever possible, the Wash-house does not open into the Living Room.*  
*In order to avoid confusing the plans, cupboards of which there should be one in each bedroom, are not shown.*  
*Floor areas have been calculated inclusive of chimney-brass.*

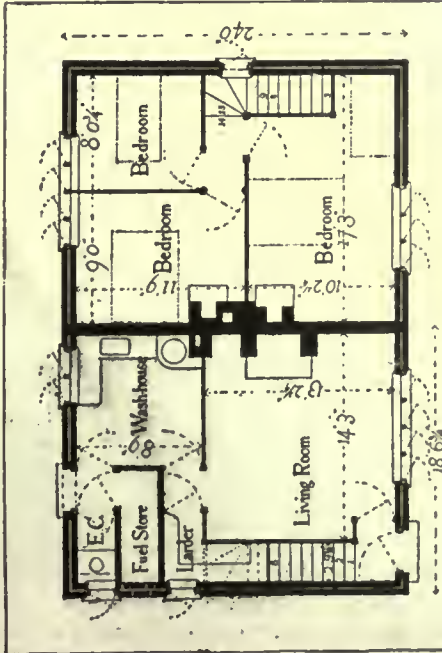

Fig. 1 Common Victorian Plan.

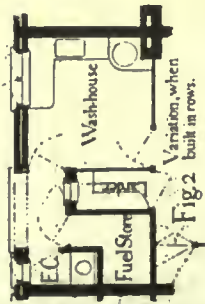

Fig. 2 Variation when built in rows.

Fig. 3 The same plan, with an entrance passage.



Fig. 4 The shallowest convenient proportion.

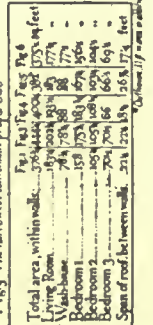

Fig. 4 The shallowest convenient proportion.

Total area within walls	276.44 sq feet
Living Room	117.77
Wash-house	18.18
Bedroom 1	153.17
Bedroom 2	105.08
Bedroom 3	70.66
Span of roof between walls	23.1

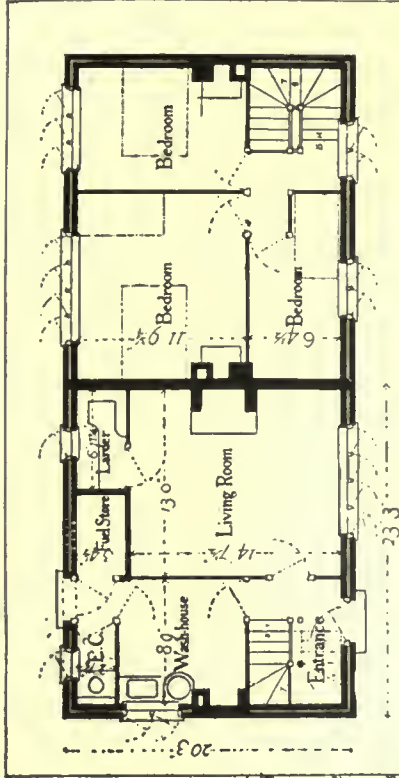

Fig. 7 Plan with staircase in front.

When built in rows, the wash-house reaches to the Fig. 8 Elongated Variant of the same plan.

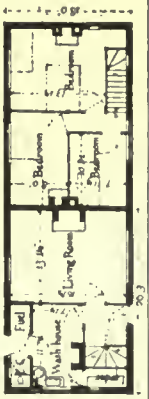

Fig. 8 Elongated Variant of the same plan.

Total area within walls	449.54 sq feet
Living Room	100.31
Wash-house	7.64
Bedrooms	153.09, 73.4, 106.10, 85.79, 110.51
Span of roof between walls	18.5

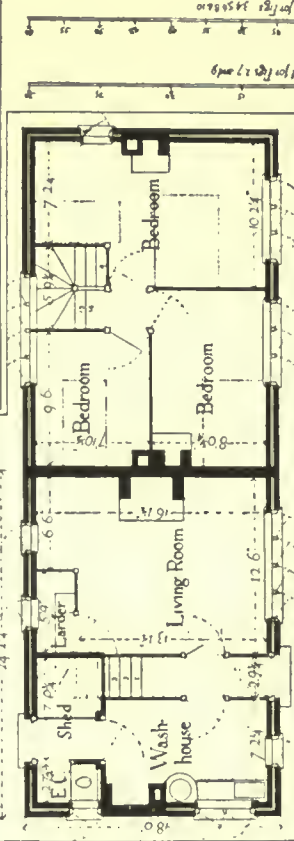

Fig. 9 Double-fronted Plan

This plan (Fig. 9) can be used for cottages built in rows, if the windows are re-arranged.

Total area within walls	390.32 sq feet
Living Room	183.18
Wash-house	6.04
Bedroom 1	45.4
Bedroom 2	100.10
Bedroom 3	75.4
Span of roof between walls	10.5

Fig. 10 Cottages joined together sideways. Dimensions as in Fig. 9.



the methods, not the principle, of the housing scheme; and it will be of interest now to study the practical question of how—given the site and the difficult problem of funds—the actual house is to be planned.

The discussion which has been raging for months upon this interesting question seems to have centered around two special points. The one is what has been conveniently christened the "parlor question"; the other turns on the no less harassing problem of the worker's—and his family's—personal ablutions.

I myself incline to favor the parlor for two reasons. One is that I have found, among my workmen friends, a strong feeling to have some place set apart to receive the honored guest and to be a shrine for their household gods. That these household gods may take the form of wax flowers, china dogs or other objects not equally admired in the most cultured art circles, does not matter; their value is in the eyes of the possessor—and they are often very dear to him.

Mr. Goodhart Rendel, in his interesting contribution to *The Architect's Journal* on "Planning the Five-Roomed Cottage," has indeed scant mercy for such sentimental considerations, though he admits their existence. "This is not the place," he remarks, "to argue the vexed 'parlor question,' if indeed it be a question at all. From various causes a great many cottages are built—and will be built—without parlors, and it is with the plan of such as these that this article is concerned. . . . Having then reluctantly denied to our tenant a shrine for his domestic gods, we must furnish his actual needs: a room to live in, some sleeping-rooms and a washing place for his crocks and linen. Besides these, he must have a store for food, and a sanitary convenience. The living-room, if it is really to be the place where he lives, should be the cooking-room in winter, but not in summer; the washhouse should contain the stove for summer cooking. Without this provision, in hot weather the family will sit in the washhouse."

As regards aspect, the writer wishes his cottage living-room to face as near southeast as possible, and suggests ventilators, instead of a window, in the larder, if it faces south or west. The aspect of the washhouse is unimportant; that of the larder, and its proximity to the closet, is material, and in his Fig. 1, which is of the type known as the "Common Victorian Plan," we see it separated by the fuel store. We have now arrived at the bath question, which—almost as much as the parlor—has been a source of conflict, the trouble being whether it shall be upstairs, or downstairs in proximity to the washhouse. The English cottager, as

a rule, is stated to have his "tub" before the kitchen fire, when the family have gone to bed, but this does not apply to such work as miners, who must have a bath when they come in dirty, and for whom the best arrangement would be clearly downstairs.

A very real problem—which Mr. Goodhart Rendel scarcely touches—is the question of fuel economy; but he does suggest in this direction that the bath and copper should share a small apartment screened or walled off from the scullery, so that

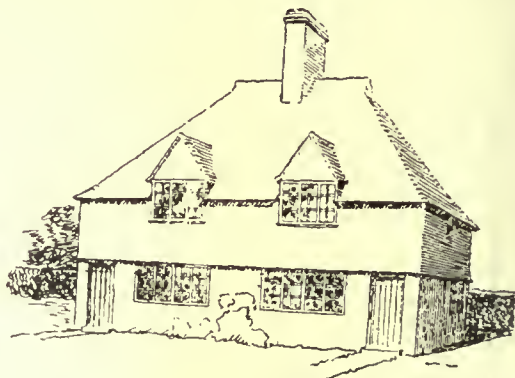

Fig. 1 A.



Fig. 3 A.



Fig. 4 A.

The figure-numbers correspond to the numbers on the Plans.

THE ENGLISH FIVE-ROOM COTTAGE



## THE AMERICAN ARCHITECT

the copper can heat the bath water at the same time. His plan will allow of three bedrooms and a fair-sized living-room, without the screened off room which has been elsewhere suggested; in the figures given he refers to the "Common Victorian Plan," shown in 1-5, that of Fig. 7, and still more the double-fronted plan of Fig. 9, which he considers the best, and which he notes can be rearranged for cottages built in a row.

It is interesting to compare this well-thought-out

small." Again, upon the "parlor question," his attitude is, if not hostile, at least unsympathetic. "There are many points both for and against. Beginning with the points against, the first is the great additional cost. Space, material and labor are expended on the parlor, which is often only used on state occasions. . . . This room is frequently shut up for weeks together, and has a characteristic odor about it that suggests intermittent life. It has a coldness as of death. But it

(From *The Architect's Journal*)

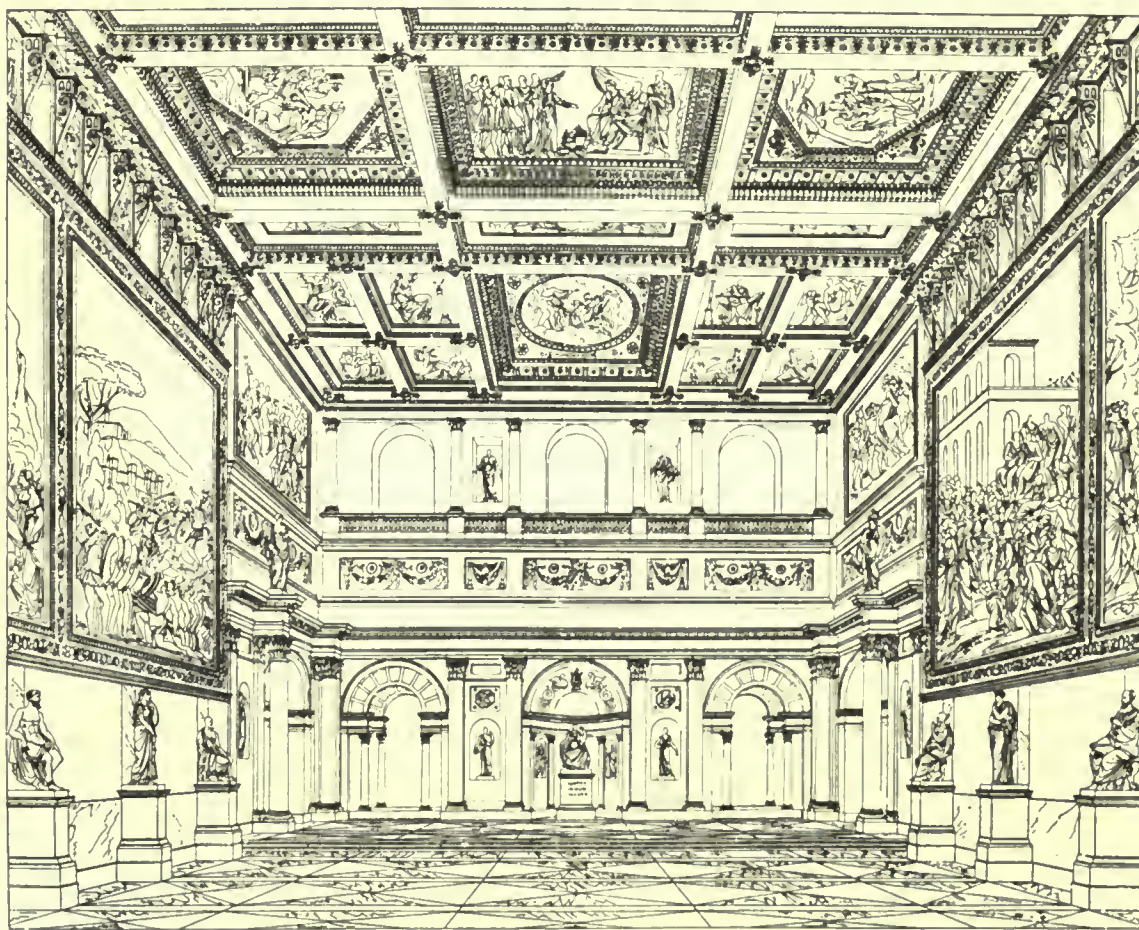

1.—PERSPECTIVE VIEW OF THE GRAND COUNCIL CHAMBER IN THE OLD PALACE, FLORENCE

(From an Engraving by Famin and Grandjean)

plan of the five-roomed cottage with Mr. C. F. A. Voysey's interesting article in *The Builder* of April 18 upon "The Artisan's Cottage." Upon two of the points which we have just noted his view is entirely different. "Every house," says Mr. Voysey, "should have its copper; but the idea of giving every artisan a fixed bath is extravagant, unnecessary, and often futile. He does not want to wash all over every day, so the labor of carrying up a can of hot water to a hip bath is comparatively

feeds the vanity of the tenant, and his head swells at the thought of his parlor gentility." But the writer admits that it often comes in very opportunely for the lodger, who is a most important factor in British lower-class life, and that even apart from its advantages as "a museum of photographs and wax flowers and a meeting-place for social affairs" it may be utilized for dressmaking or study, which must be all but hopeless in a living-room filled with clamorous children.





DETAIL OF ONE OF THE SIDE ALTARS OF THE CHURCH OF SAN JUAN DE DUERO, VALLADOLID, SPAIN



SANTA MARIA LA ANTIGUA, VALLADOLID, SPAIN

(From *The Architect*)



SECRETARIAT BUILDINGS, DELHI  
North and south side entrances, and detail of gateways to the side entrances.  
HERBERT BAKER, F.R.I.B.A., ARCHITECT



## THE AMERICAN ARCHITECT

I leave now the homelier theme of English cottage accommodation to turn to Imperial Delhi, that ancient capital of India, which is now being replaced in its high estate, which it possessed as early as 1193, when it became the capital of the Mahomedan Indian Empire, and was restored to that position under the Moghul Empire between 1638-58.

and Sir Edwin Lutyens, whom I met at Rome in 1911, is a designer of great imaginative grasp.

There has been a strong feeling in England, as well as India, that these designs should appropriately follow the characteristic lines of Indian architecture; and it will be seen that this feeling has not been overlooked in the proposed Government buildings.

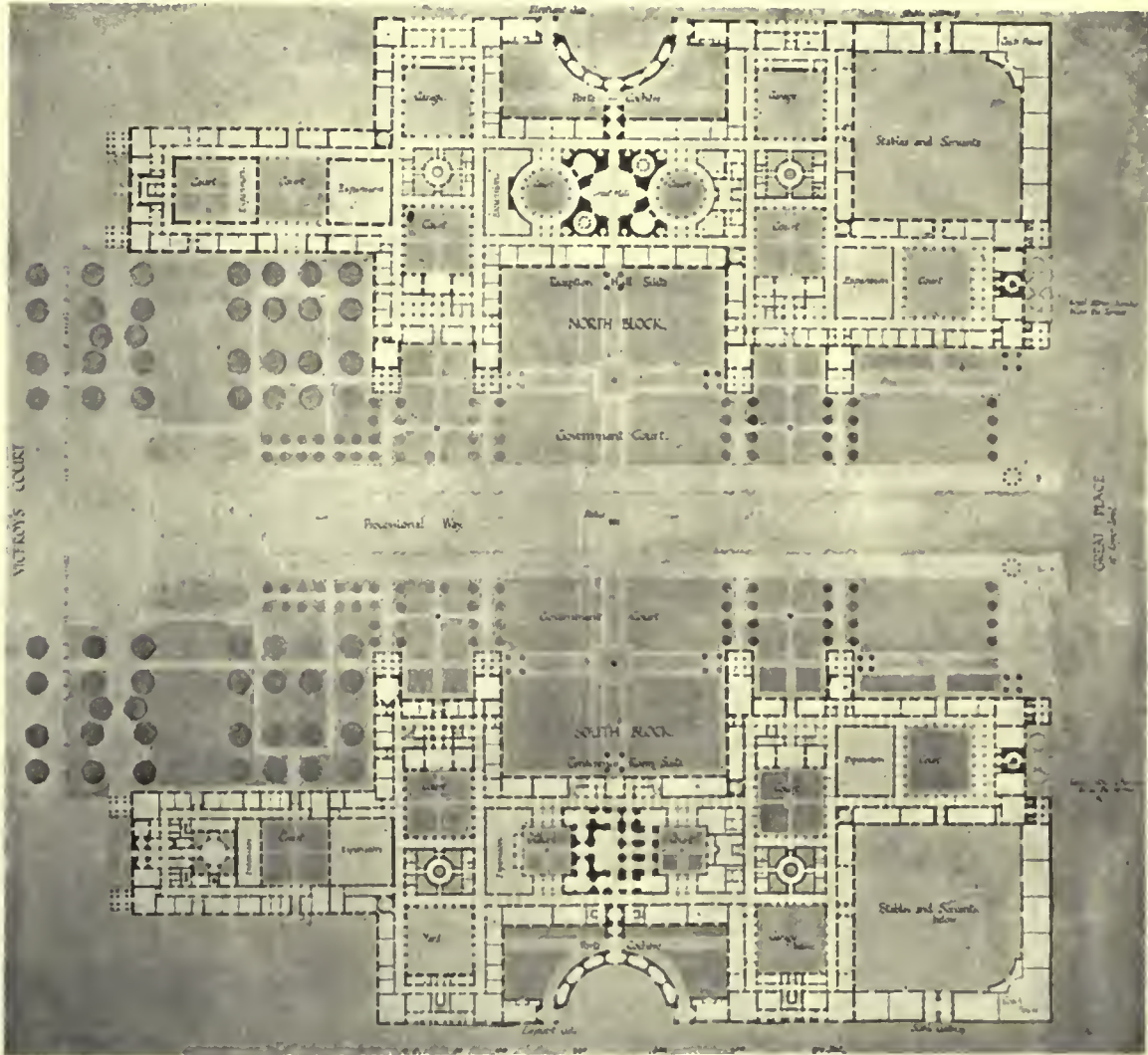

SECRETARIAT BUILDINGS, DELHI. HERBERT BAKER, F.R.I.B.A., ARCHITECT

In a recent number of *The Architect*, which commemorates—from March 27, 1869—fifty years of that journal's successful career, the plans proposed by Sir Edwin Lutyens, A. R. A., and Mr. Herbert Baker, F. R. I. B. A., as principal architects and architectural advisers to the Government of India, are shown in an admirable set of illustrations. Mr. Baker is well known for his Government buildings at Pretoria and his monument to Cecil Rhodes;

Government House itself consists of a central block—about 255 ft. by 300 ft.—connected to two western and two eastern wings, beneath which are triple carriage ways. The principal approach from the east is by a great columned portico, 120 ft. wide, with steps broken by landings leading up to the principal floor; and the central feature is the great circular Durbar Hall, some 70 ft. in diameter, whose dome forms a center to the whole

## THE AMERICAN ARCHITECT

group. The Secretariat buildings form two H-shaped blocks, with wings at right angles to the sides of the H, facing each other and divided by the Processional Way; and it is satisfactory to note that much of the detail will lend itself to the wonderful inherited craftsmanship of the Indian de-

design in much the same way that the administrators of India have bridged the gap between Eastern and Western ideals, in the effort to promote the happiness and prosperity of a vast area, which has been through centuries a battleground of conflicting races and creeds."

(From *The Architect*)

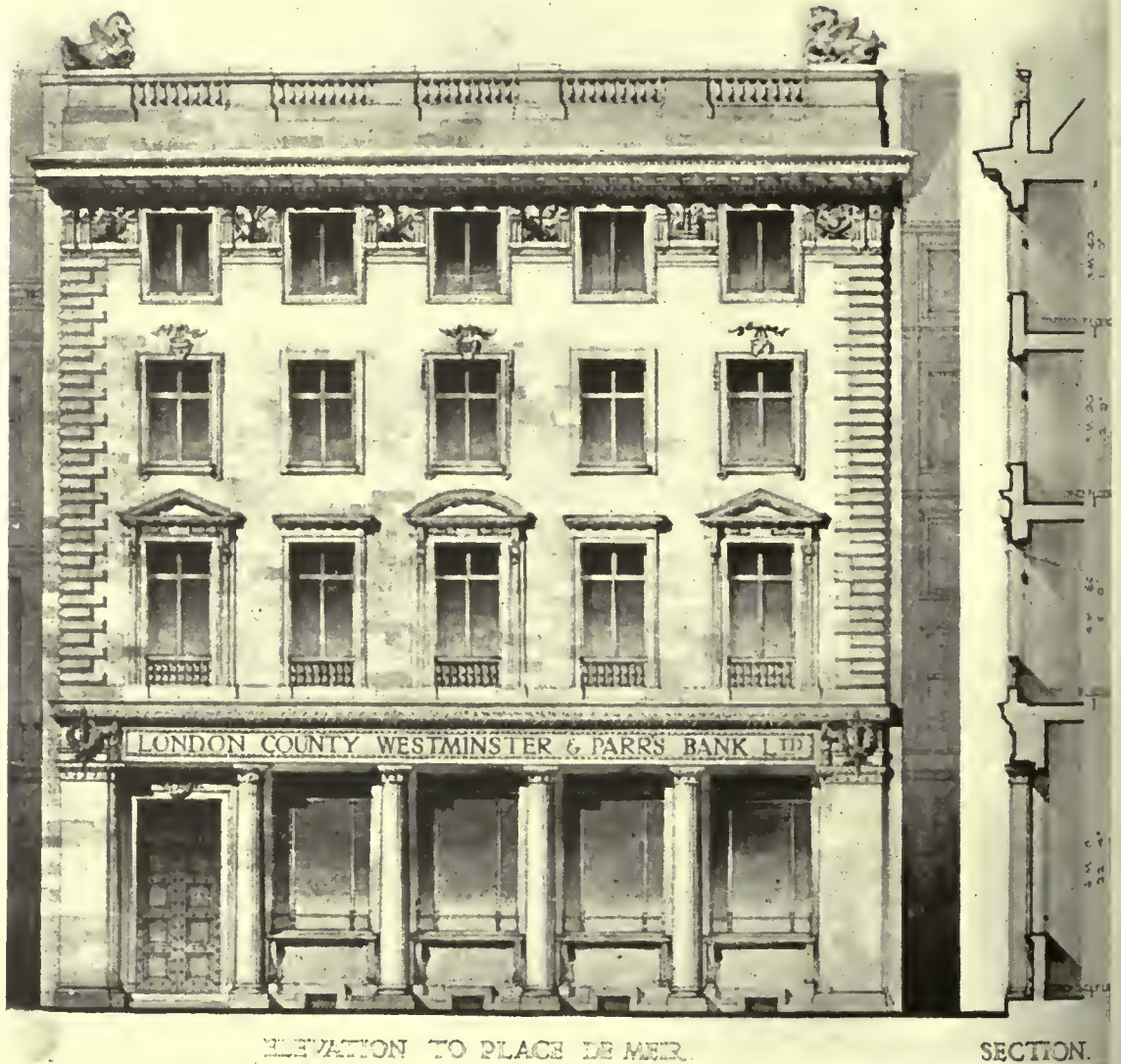

ANTWERP BRANCH, LONDON COUNTY, WESTMINSTER & PARIS BANK

MEWES & DAVIS, ARCHITECTS

signer. It has been remarked that a difficult problem—to design a building on general classical lines which would at the same time express the spirit of Indian design—has been successfully solved. "What Sir Edwin Lutyens has done is to bridge successfully the gap between Eastern and Western

A strong appeal has been made by Sir Sidney Colvin for public support to the acquisition by the Board of Education of the fine collection of casts and moulds, from Messrs. Brucciani, the well-known London "formatori," who are now in difficulties owing to war conditions. If this collection



## THE AMERICAN ARCHITECT

is acquired it will be used for purposes of art education by the Board, with the assistance of the Victoria and Albert Museum; and Sir Sidney says very truly that "It is well known that the provision of facsimile reproductions of sculpture and architectural detail is a prime necessity for practical teaching in art schools and historical and comparative study in museums of art," adding that "this necessity has never yet received from our Government the consideration which it urgently demands."

chosen. "La Antigua"—or to give its full title, "Santa Maria la Antigua"—at Valladolid, is one of the most ancient churches in Spain, and Mr. Street gives three pages to its beauties, describing in detail its finely groined interior. The "fine Western steeple," to which he also alludes, was, I regret to say the only part of the grand old building still upright when I recently visited Valladolid; and the work of "restoration" which was going forward alarmed me and was enough to make the author of

(From *The Architect's Journal*)

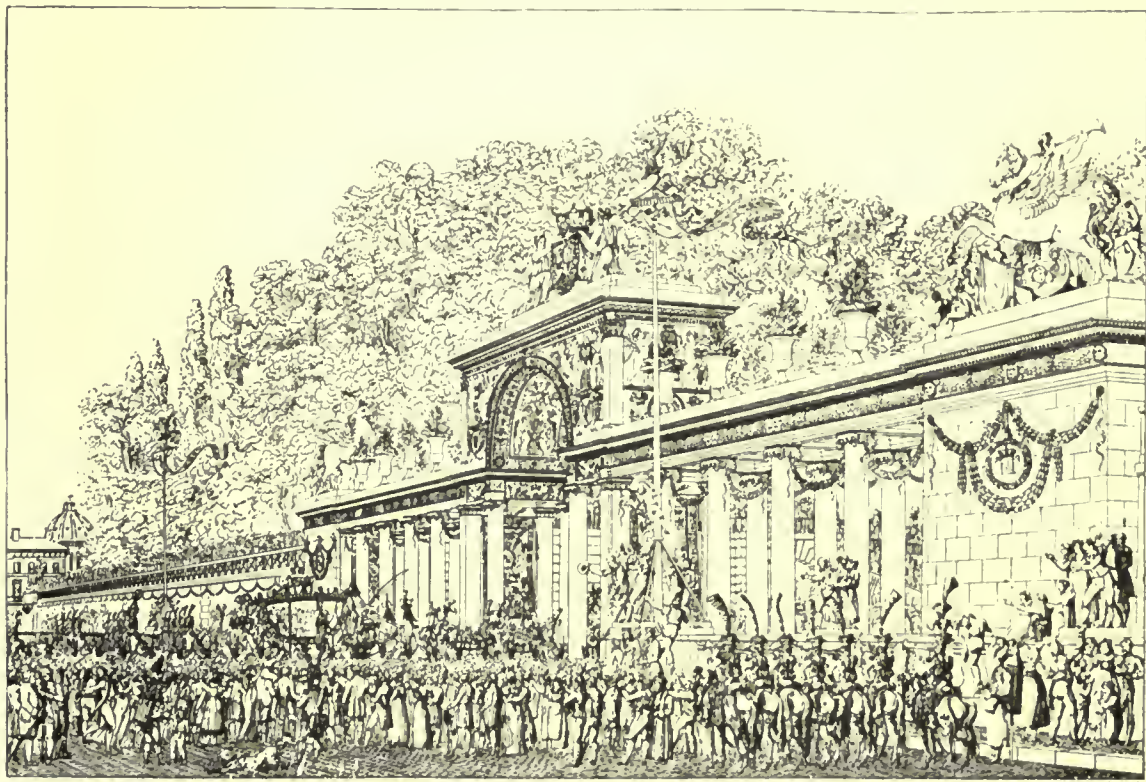

STREET DECORATIONS FOR PEACE: A FRENCH EXAMPLE OF THE EMPIRE PERIOD

I felt this very strongly when recently in Spain I came upon the admirable "Museo de Reproducciones Artísticas." Such a museum is, in fact, of priceless value both for the student of architecture and of sculpture. If it were to be undertaken in America it would surely be very efficiently carried through; and I hope to return to this again in a later letter.

Spain is indeed a country of surprises; she is often as astonishingly modern as she is overwhelmingly antiquated! No color magazine, for instance, in Europe in general quality can compare with *La Esfera*, and its architectural reproductions—from which I give two—are always extremely well

"Gothic Architecture" to turn in his grave. Soria I have not yet visited, though I had great accounts in Spain of its wonderful remains. The Church of San Juan de Duero, which was formerly a convent of the Templars, is without the city and picturesquely situated; the character of its architecture is Romanesque.

With peace in prospect the subject of war decorations is occupying the public mind; and it is interesting to note what has been recently achieved in this way by Messrs. Selfridge in Oxford Street and what was done in the old days of the Napoleonic Empire.

The Royal Academy is now taking the question



## THE AMERICAN ARCHITECT

of war memorials in hand, and is organizing two exhibitions, the first to be held at the Victoria and Albert Museum in June next, and to comprise selected examples of memorials executed in past and recent times by deceased and living artists. The second section will be held at the Royal Acad-

emy in October, and will consist of new designs for war memorials in any class of art or craft, with a view to the circumstances of the present war.

The 151st Exhibition of the Royal Academy promises, under present conditions, to be one of exceptional interest.

*(From The Architect's Journal)*



THE TYLORIAN BUILDING AT OXFORD. C. R. COCKERELL, ARCHITECT

*From the drawing by Hanslip Fletcher*

THE AMERICAN ARCHITECT

Founded 1876

PUBLISHED EVERY WEDNESDAY BY

THE ARCHITECTURAL AND BUILDING PRESS, INC.

No. 243 West Thirty-ninth Street, New York

E. J. ROSENCRANS, PRESIDENT AND TREASURER

WILLARD C. HOWE, VICE-PRESIDENT

WILLIAM H. CROCKER, Editor

EDWARD F. HAMMEL, Engineering Editor

ARTHUR T. NORTH, Western Editor

Subscriptions in the United States and Possessions,  
Mexico and Cuba, TEN DOLLARS. Other Countries,

TWELVE DOLLARS.

SINGLE COPIES (Regular Issue) 25 CENTS

CHICAGO OFFICE, Maffers Building

PAGE A. ROBINSON, Western Manager

ST. LOUIS OFFICE, Wright Building

CLEVELAND OFFICE, Guardian Building

SAN FRANCISCO OFFICE, 320 Market Street

Owned by United Publishers Corporation—H. M. Swetland, President; Charles G. Phillips, Vice-President; W. H. Taylor, Treasurer; A. C. Pearson, Secretary. Entered as second-class matter January 6, 1909, at the Post Office at New York, New York, under the Act of March 3, 1879.

VOL. CXV

MAY 28, 1919

No. 2266

Mr. Kohn's Review

THE lucid review of the sessions of the Post-War Committee on Architectural Practice during the recent convention of the Institute at Nashville, prepared by Robert D. Kohn, a member of the committee, and presented in this issue, will repay very thoughtful reading.

The responses, numbering into thousands, received by the committee indicate how widespread is the interest in its work and prove conclusively that this interest is not confined to Institute membership, but that a very large share of these replies were from men who are not affiliated. This indicates the representative character of the committee and should insure the widest measure of support by architects everywhere in this country as well as by the many men whose work brings them closely in touch with the architectural profession.

Probably no movement thus far set afoot in the profession of architecture offers possibilities for so large a measure of fruitful accomplishment. In it there are to be found the elements of all of the possibilities for expansion of the service that architects may properly render—"the self-education that comes through participation as a citizen in public work and the methods by which architects can make

their importance in relation to the problems of building more quickly felt."

THE time has now arrived when the profession of architecture must unite in an effort for the stabilization of all the elements that affect the profession. Prejudices, small jealousies, narrow-minded points of view should all be brushed aside and the upbuilding process swiftly advanced by a strong and unanimous effort.

Whatever shortcomings there may have been attributed to the Institute, it is quite clear that the organization is now pledged to a policy that should enlist the warmest co-operation. The very favorable attitude of the convention toward the matter of State architectural associations indicates the democratic and constructive spirit that now rules. These organizations while at present limited to comparatively few States, are to be encouraged as a means of securing the affiliation of those architects who are qualified to practice, but who by reason of their distance from large cities are not now a part of the organized profession.

It is a source of satisfaction to learn that the development of State societies is so favorably regarded, and it is to be urged that no time be lost in the matter. There are wide fields of endeavor for both the Institute and State Societies, and their harmonious working toward the common good would accomplish many desirable ends.

IN no topic discussed during the committee's sessions was there a more widespread representation or a more unanimous opinion than in that of architectural education. Much good will come of the efforts that are now being put forward to place on a more practical basis the curriculum of our architectural schools. This effort will be, if carried forward under the control of the profession, one for more far-reaching good than any of the many that are now under consideration.

The period of architectural construction in its most practical form has now begun. To let it lag for want of a strong and concerted effort would be an unfortunate thing. We shall need, in order to push to completion the essentials of this Post-War Program, all of the effort of the Institute, of every State Society, of all the architectural clubs, and also every man who has the good of his profession at heart, whether he belongs to one of these organizations or not. And, if he does not, he certainly should, for it is a most selfish attitude supinely to await the efforts of others in these great problems of reconstruction. They are not for the benefit of just those who most strenuously promote them but for architects everywhere.

## What An "Open" Market Means to Building

**N**OW that there are to be no further attempts to stabilize commodity prices—the result of the conference recently held in New York City between the Industries Board and the steel industry which forced an "open" market having created an unmistakably better feeling—it is to be hoped that the Government's tinkering with business is at an end and that the progress of construction will be allowed to resume its normal cadence.

Just how firmly the restriction has been while the Industries Board and Railroad Administration were at deadlock is shown in practically every large municipality where all but the more daring speculators and those soundly financially backed were hesitant about proceeding with building projects. The Government's apparent disregard of the fundamental principles of economics in strangling the always present law of supply and demand and the substitution of a price fixing policy, did more than any other one thing to retard the needed impetus that should long ago have been given post-war construction.

Not until the Railroad Administration refused to order steel rails at the price fixed by the Industries Board was an effort made to put an end to such ill-advised procedure. The Railroad Administration's attitude in the matter has not received proper recognition, due possibly to the fact that its reasons for taking the stand it did were not made public. Industry consequently has just had to surmise that it was done to prevent possible violation of the Sherman Act.

In explanation of the retirement of the Industries Board it was stated that the board had for its object the resumption of construction and production through the stabilization of prices. The legal phases of the question as raised by the Attorney General's comment on the legality of price fixing failed to disturb the opinions of the Secretary of Commerce who referred to the opinion of the Attorney General as negligible. It was contended the results sought could have been obtained without violation of the Sherman act, as the plan was to ascertain and make public fair prices reached by agreement.

Subsequently another effort was made to fix the price of steel, but when the leading corporations proved to the Industries Board that no further reduction could be made without a reduction of wages, they won their fight for an "open" market. But in the meantime it has been business that has been held up, as usual.

In the past it has been very clearly demonstrated that American business men can always find a way to solve problems that may confront them no matter how difficult they may appear. There is no reason to believe that they could not have worked out the solution of reconstruction period business difficulties had they been given a free hand and assurance that there would have been no crossfire interference by Governmental departments. Recently the Administration has been getting a dose of its own medicine, but, of course, at the expense of business.

No better illustration of the futility of the Administration's efforts to tinker with business can be had than the recent Navy Department experience. Over a month ago the Navy Department requested bids on 20,000 tons of steel, and on opening the orders found that each of the fourteen companies had submitted the price fixed by the Industrial Board. Naturally, the bids were rejected as being non-competitive. Last week, on opening bids on another lot of plates, the same situation was found to exist. The bidders either referred the Navy Department to their bids of early April, or put in new offers amounting to practically the same thing.

As far as the Navy Department is concerned, action has been taken under authority conferred by war emergency legislation by placing an order, or what amounts to a requisition, for 14,000 tons of steel with the Carnegie Steel Company. Decision to requisition the steel was the result of a conference on how to meet the situation when it was found that the bids submitted were the same as the bids previously submitted, and which were based on prices agreed upon between the steel manufacturers and the now abandoned Industrial Board, which were rejected on the ground that they showed no indication of competition.

The present order, according to an announcement made by Acting Secretary of the Navy Roosevelt, was placed "at a tentative price subject to later adjustment," and that only one company bid on the entire order. Whether the steel company will get a higher price than that fixed by the Industrial Board, or whether, on account of the fact that it is put through as a war emergency requisition the price paid will be lower, remains to be seen. The price tendency so far seems to be upward.

The freeing of the price situation from Governmental muddling by the dissolution of the Industrial Board and the resultant "open" market for building materials has already brought about an unmistakably better feeling in the construction industry.



# Training School and Home for Young Girls, Brooklyn, N. Y.

LUDLOW & PEABODY, Architects

(For interior views and floor plans, see plate section)

THE problem of what to do with young girls who have come into the courts for petty crimes and immoral conduct is a difficult one. In order to meet this to some extent the Brooklyn Training School and Home for Young Girls was established to take care of such cases, so that instead

The Brooklyn Training School, as the secondary title indicates, has for its keynote the feeling of "home." These young girls, from the age of 12 to 18, are taken care of and educated by women of fine character and ability, and the strict discipline to be administered is not that of the jail.

The problem of the housing of such girls, therefore, is to provide practically a prison that is, in aspect and administration, a home. Iron bars and show of locks are, therefore, tabooed. Freedom from institutional lines and the use of color are essential.

The group consists of three buildings, two of which have already been constructed, and are shown by the accompanying photographs. One of these is a school building, which provides two large class rooms and an instructional laundry, the latter being used by the girls to do the work of the institution. The other building now constructed houses the head matron, a number of girls in small private rooms, and a little suite of dining room, living room, bedroom and bathroom, which is a typical apartment such as the girls may be called upon to take care of in their home life. Two or three at a time live in this apartment for a short period and are instructed in its care.

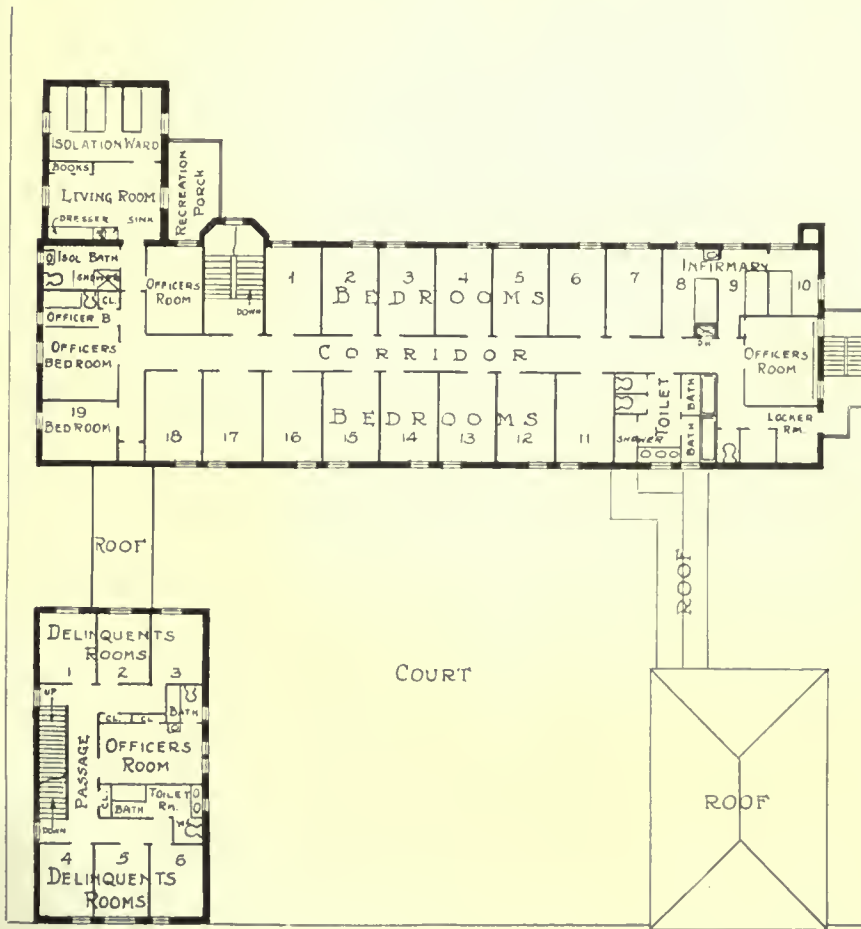

of the old-time method of sending these girls to the workhouse or jail they can be cared for in a manner that looks to constructive redemption rather than a period of incarceration which often confirms the culprit in her evil tendencies. Therefore, it is the practice now for certain of the judges of Brooklyn to send to the Brooklyn Training School such cases of this kind as come before their courts.

The large building which is to be erected later, to take the place of an old wooden structure which is now being used in its stead, will accommodate about fifty girls in private rooms, sleeping porch, detention ward, etc. It also houses the general dining room, recreation room, play room, solarium, and officers' room.

It is customary, on receiving new inmates, to

place them for two or three weeks in an entirely separate suite, called the "detention ward," where they are under surveillance during examination and a period of probation. In a little tower room in the fourth story, reached by a winding stairs, is a solitary room called the "thinking room," and is to this institution what the dungeon is to Sing Sing Prison; the difference is that this room is anything but a dungeon, the theory being that a flood of sunshine is better than darkness for the correction process.

These three buildings are connected by covered arcades so that access from one to the other is made convenient. They have red tile Spanish roofs and light buff pink stucco walls, with faded green windows and doors.

The court formed by the three buildings will be treated in simple garden fashion, so that the Italian effect of the whole group may be maintained.

To prevent the escape of the inmates, continual care is required, which is made easier by the ornamental grilles in the windows, which prevents a clear opening above or below either sash of more than 9 in. In addition to this, the annunciator in the officer's room on each floor connects with the door of each bedroom.

## Construction Field In South America

The requirements for construction materials in Chile, Peru and Equador are set forth in detail in a book of 200 pages just published by the Bureau of Foreign and Domestic Commerce, Department of Commerce. It appears that there is much construction and building work going on in Chile, where the Public Works Department has considerable work in hand. During 1917, thirty-five projects with a cost of over a million dollars were finished.

The author of the reports states that American manufactures are generally as good as those of Europe, and in some cases better. Some of the articles of American make that enjoy a preference in Chile are door locks, padlocks, hinges, iron and wire nails, tacks, lumber for construction and cabinet work, turpentine, varnishes, enamels and many other articles that are not imported in large quantities. The Chilean public is generally favorably impressed with American goods and considers them more up to date than the European articles.

During the past decade sanitation in Chile has made great progress. It is estimated that 15,000 fixtures, including enameled and porcelain bathtubs, water closets and lavatories are imported annually. There is also a steady demand for heating installations, hot water being the system most favored.

The time is ripe in Peru for the sale of construction materials, and there are possibilities of making some good contracts. The country has entered upon a period of prosperity. The government is progressive. The war has enriched the Peruvians who, a little uncertain how to invest their gains, are in many instances buying up lands and old houses and are preparing to rebuild with modern structures possessing all sanitary conveniences.

The financial condition of the Peruvian Government has been greatly improved, the income having increased more than 30 per cent, the result being that work has been commenced on several new public buildings, and will soon follow on others.

Impetus is being added to this activity by the fact that on July 28, 1921, the centennial of the independence of Peru will be celebrated, and it is proposed to have finished by that time the Judicial Palace, the Legislative Palace, the Archbishop's Palace, the model jail, the Prefecture, an orphan asylum and a hospital for women.

Some of the products that may be readily sold in Peru are yellow pine and Douglas fir, which will find a market in Peru so long as the native forests of the country remain undeveloped. The United States furnished the largest share of structural steel and Portland cement. In 1916 we furnished 89 per cent of the weight and 90 per cent of the value of window glass. England and Germany have led in supplying paints and paint materials. Paint materials coming from the United States have generally been higher in price than those from abroad.

## Demand For American Building Specialties

It is learned from a letter received by a prominent manufacturer in this country, from the American Commercial Attaché at Copenhagen, Denmark, that in the opinion of Professor Kampmann, a leading architect, there is a very large demand in Denmark for a number of modern American specialties.

Professor Kampmann is further of the opinion that it would be to the interest of American manufacturers to popularize their product in Denmark and has asked that samples, specifications and catalogs be forwarded to him. Professor Kampmann's address is Harsdorffsvej 3, Copenhagen, Denmark. For a wider distribution of commercial literature or advertising material it is suggested that the three most important architectural organizations in Copenhagen be addressed. These are: Akademisk Arkitektforening, Stormgade 12; Dansk Arkitektforening, Gyldenevesgade 3; Fri Arkitektforening, Strandgade 26; Copenhagen.

# Beaux-Arts Institute of Design

DIRECTOR OF THE INSTITUTE, LLOYD WARREN

ARCHITECTURE, WILLIAM F. LAMB

SCULPTURE, JOHN GREGORY

INTERIOR DECORATION AND INDUSTRIAL ART DESIGN, ERNEST F. TYLER

MURAL PAINTING, ARTHUR CRISP

## Official Notification of Awards— Judgment of March 4, 1919

### THE PUPIN PRIZE

The Gift of Prof. M. I. Pupin of Columbia  
University

Offered for the Ornamental Treatment of Some  
Scientific Appliance

FIRST PRIZE—\$50. SECOND PRIZE—\$25.

For conditions governing this Prize Competition,  
see Circular of Information, Article VIII—1 and 3.

### PROGRAM

The Committee on Architecture proposes as sub-  
ject of this Competition:

### "A CAR FOR A FUNICULAR RAILROAD"

A funicular railroad is supposed to make an  
ascent 3000 feet, at an average grade of 30 degrees  
from the horizontal, to the top of a mountain. On  
account of the length of time necessary for the  
trip, and the views along the route, the car shall



PLACED FIRST, D. M. ALLISON, UNIV. OF ILLINOIS.  
PUPIN PRIZE  
A CAR FOR A FUNICULAR RAILWAY

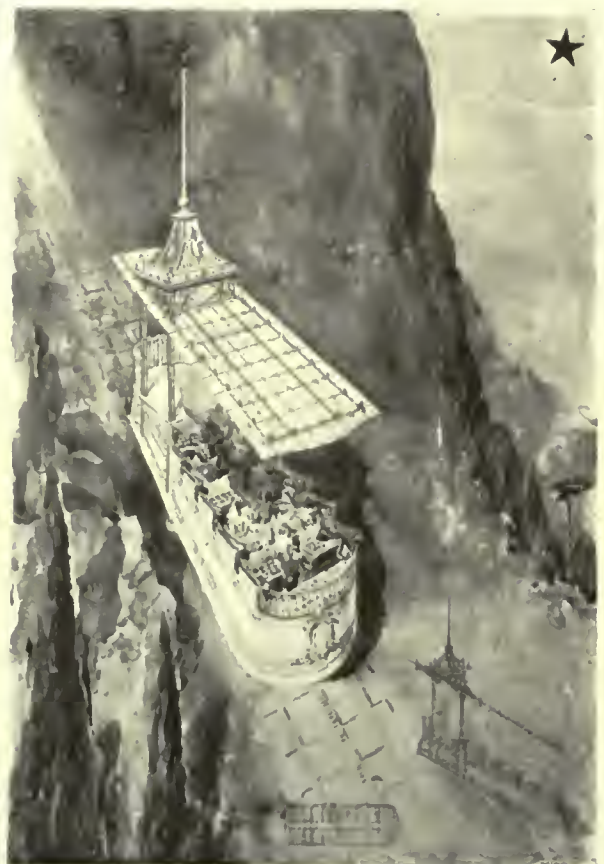

PLACED SECOND, A. C. RUNZLER, UNIV. OF PENNA.  
PUPIN PRIZE  
A CAR FOR A FUNICULAR RAILWAY



## THE AMERICAN ARCHITECT

be so designed as to be especially suitable for observation, but shall be comfortable, while providing place for as many people as possible. The arrangement shall be such that the platforms and seats will be level. The car shall be simple in design, but shall not lack a decorative appearance. In other respects the design is optional.

The car shall not exceed 20 feet in length by 6 feet in width, and shall be provided with a roof as a protection against the sun and rain.

**JURY OF AWARD:** F. A. Godley, T. Hastings, J. O. Post, F. H. Bosworth, Jr., R. H. Dana, Jr., R. M. Hood, W. S. Wagner, M. J. Schiavoni and L. Ayers.

Number of drawings submitted—33.

### AWARDS:

Placed First (Not qualified for Prize)—D. M. Allison, Univ. of Illinois, Urbana.

Placed Second—\$25—A. C. Runzler, Univ. of Pennsylvania, Phila.

Placed Third—E. Hayward, "T" Square Club, Phila.

Placed Fourth—S. M. Jokel, J. Huntington, Poly. Inst., Cleveland.

Placed Fifth—J. K. Smith, Univ. of Pennsylvania, Phila.

## Official Notification of Awards— Judgment of April 15, 1919

### Second Preliminary Competition for the Twelfth Paris Prize of the Society of Beaux-Arts Architects

*For illustrative prize winning designs, see plate form.*

### PROGRAM

The Committee on Architecture proposes as subject of this Competition:

#### "A TERMINAL RAILROAD STATION"

The station that is the subject of this problem, is supposed to be the terminal of one of our principal railroad lines in a large city. A level site, 600 feet square, bounded on one side by a broad avenue, on the two adjacent sides by important streets, and on the remaining side by the railroad

yard, is to be devoted to this purpose. The tracks, of which there are thirty, are approximately on the same level as the streets. The platforms for the arrival and departure of trains may be beyond the limits of the site described above, or included in it, at the student's option. There shall be ample provision on the site itself, however, either in the form of courts, or as may be otherwise arranged, for the arrival and departure of municipal street car lines, omnibus lines, and cabs.

The principal requirements of the station itself may be arranged in a single structure, or in several, as desired, and shall be as follows:

Concourses, ticket booths, baggage facilities (incoming and outgoing), parcel rooms, transfer companies, men's and women's waiting rooms with accessories, telegraph, telephones, a post office substation, information bureaus, lunch rooms and restaurants, newspaper and cigar stands, and the railroad executive offices.

All the above requirements should preferably be on one main level save the railroad executive offices, which may be on upper floors and need not be shown, although access to them must be indicated. If, however, any of the main requirements should be placed on different levels, their locations and dispositions shall be plainly indicated on the drawings called for.

**JURY OF AWARD:** R. H. Dana, Jr., W. Emerson, J. O. Post, R. M. Hood, L. F. Peck, H. Hornbostel, F. H. Bosworth, Jr., and L. Ayers.

Number of drawings submitted—15.

### AWARDS:

Placed First and 2nd Medal—L. Fentnor, Atelier Wynkoop, N. Y. C.

Placed Second and 2nd Medal—F. M. Hodgdon, Atelier Rebori, Chicago.

Placed Third and 2nd Medal—E. E. Weihe, Atelier A. Brown, Jr., S. F. A. C., San Francisco.

Placed Fourth and 2nd Medal—D. McLachlan, Jr., Harvard Univ., Cambridge.

Placed Fifth and 2nd Medal—A. C. Bieber, Univ. of Pennsylvania, Phila.

Placed Sixth (1st Alternate) and 3rd Medal—R. H. Segal, Patrons G. & E. Blum, N. Y. C.

Placed Seventh (2nd Alternate) and 3rd Medal—W. F. McCaughey, Univ. of Illinois, Urbana.

**MENTION:**—R. W. Cheesman, Cor. H. I. Schenck, Dayton; W. H. Livingston and G. A. Anderson, Univ. of Pennsylvania, Phila.



PLATE 171

TRAINING SCHOOL AND HOME FOR YOUNG GIRLS, BROOKLYN, N. Y.  
LUDLOW & PEABODY, ARCHITECTS





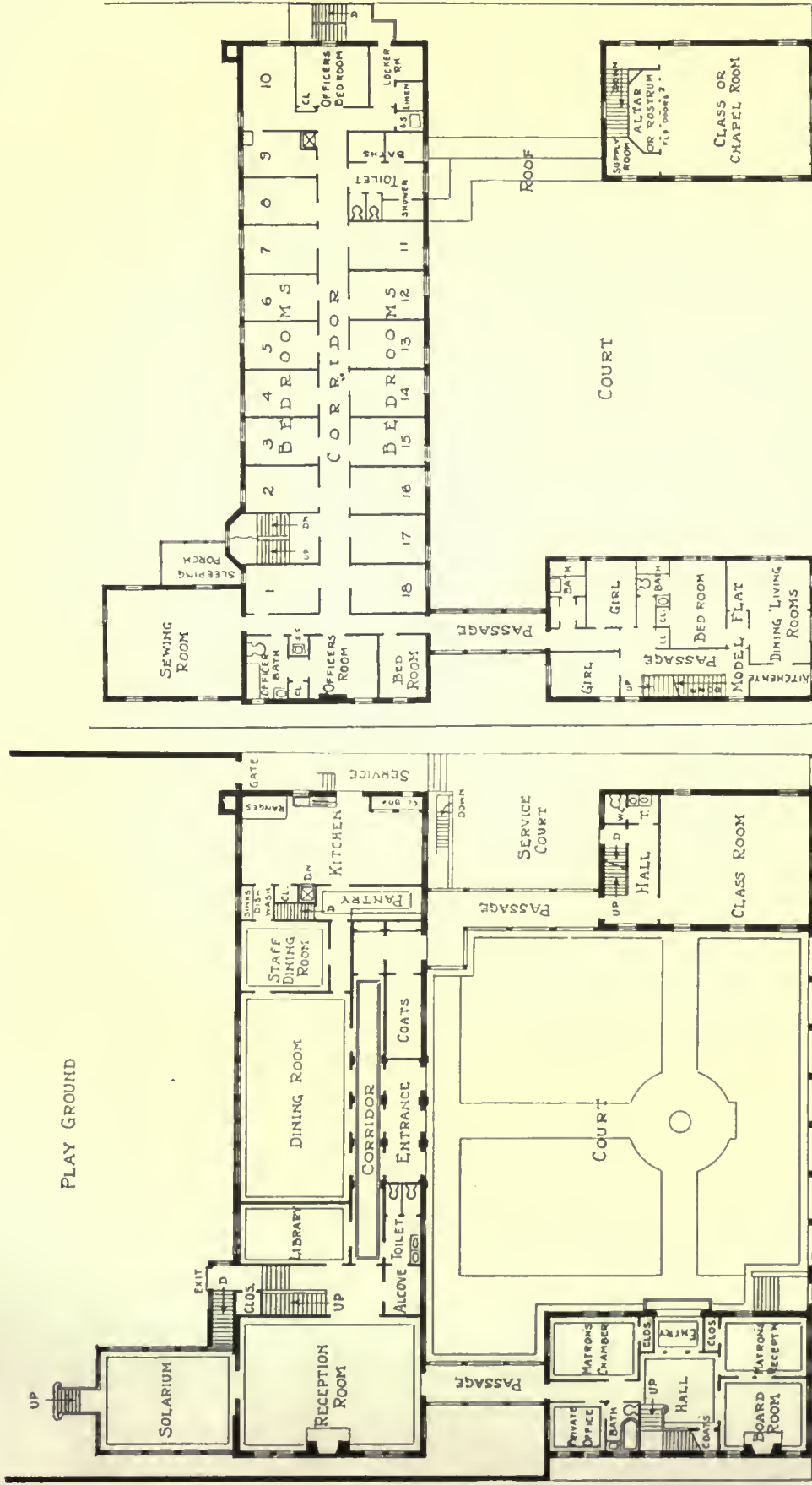

PLATE 172

TRAINING SCHOOL AND HOME FOR YOUNG GIRLS, BROOKLYN, N. Y.

LUDLOW & PEABODY, ARCHITECTS







PLATE 173

TRAINING SCHOOL AND HOME FOR YOUNG GIRLS, BROOKLYN, N. Y.

LUDELOW & PEABODY, ARCHITECTS







PLATE 174

GARAGE FOR EDWARD C. SCHAEFER, PREMIUM POINT, N. Y.

REILEY & STEINBACK, ARCHITECTS





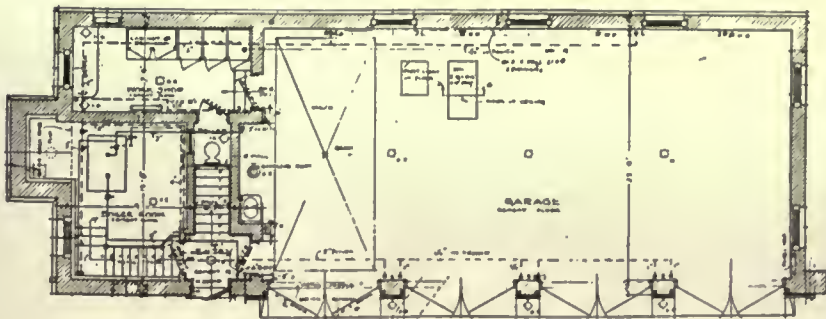
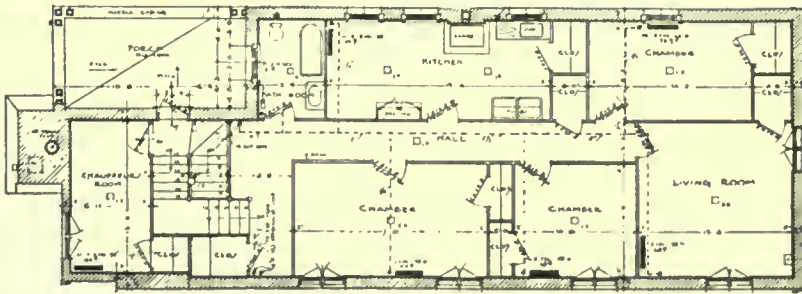

DETAILS AND PLANS

GARAGE FOR  
 EDWARD C. SCHAEFER  
 PREMIUM POINT, N. Y.

REILEY & STEINBACK,  
 ARCHITECTS





Placed 2nd  
1st Prize

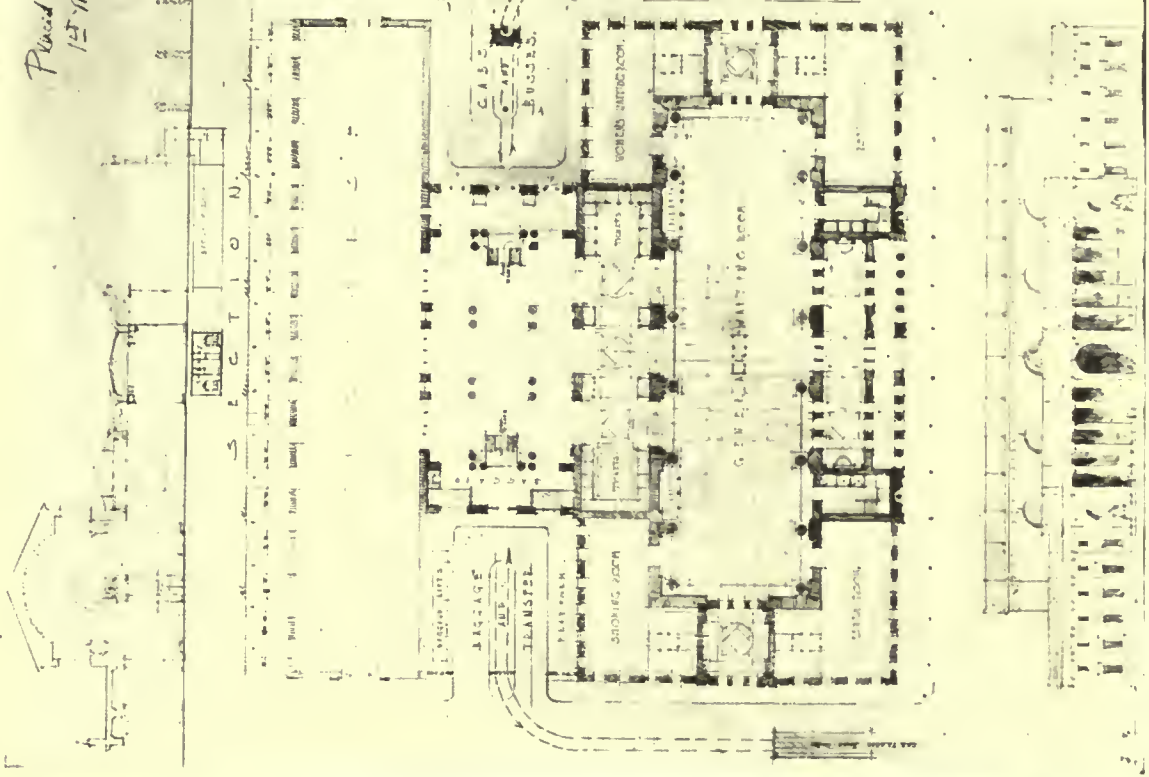

Placed 1st  
3rd Medal

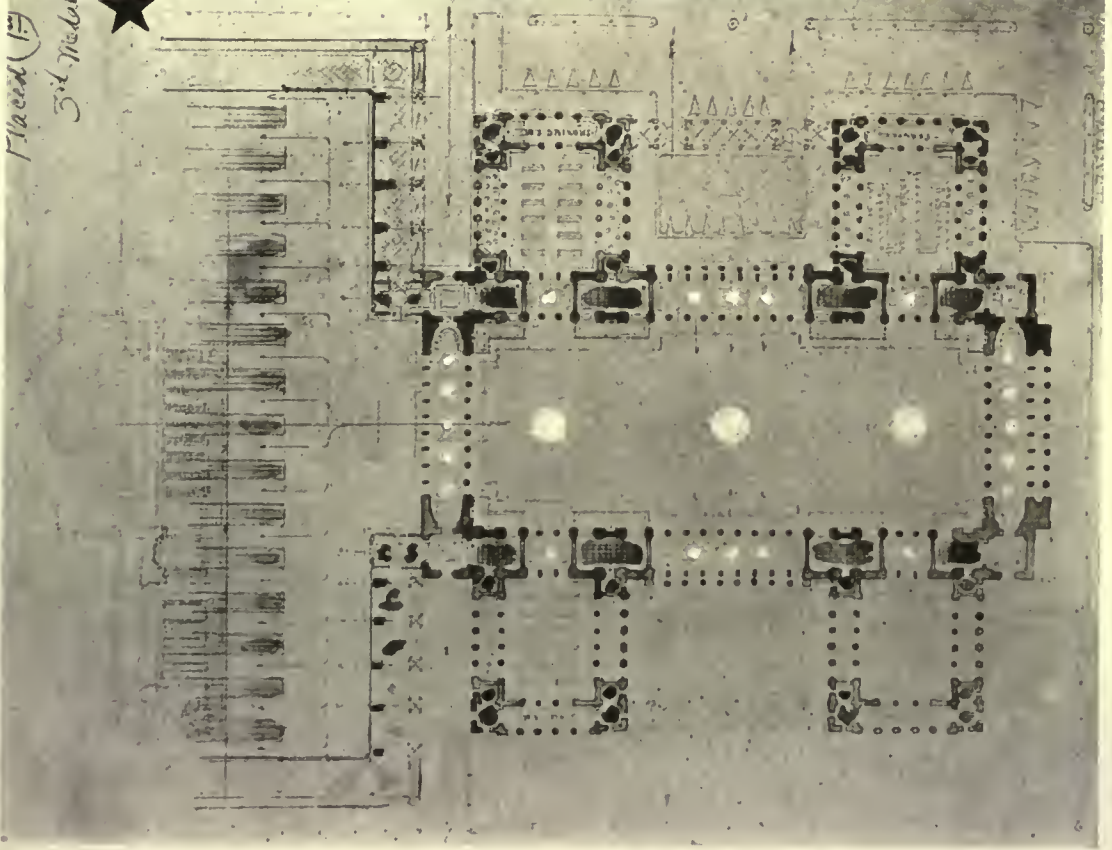

PLATE 176

PLACED FIRST, SECOND MEDAL—L. FENTON, ATELIER WYNKOOP

PLACED SECOND, SECOND MEDAL—E. M. HODGSON—ATELIER REBORI

A TERMINAL RAILROAD STATION

SECOND PRELIMINARY COMPETITION FOR THE TWELFTH PARIS PRIZE

STUDENT WORK—BEAUX ARTS INSTITUTE OF DESIGN





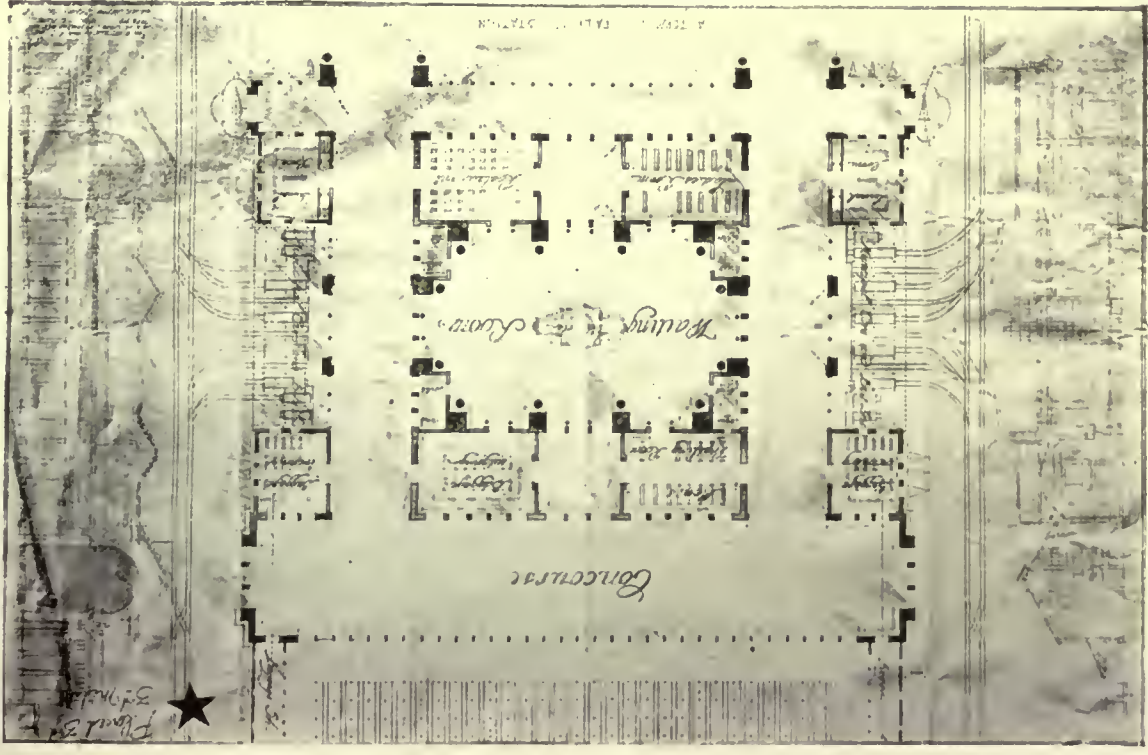
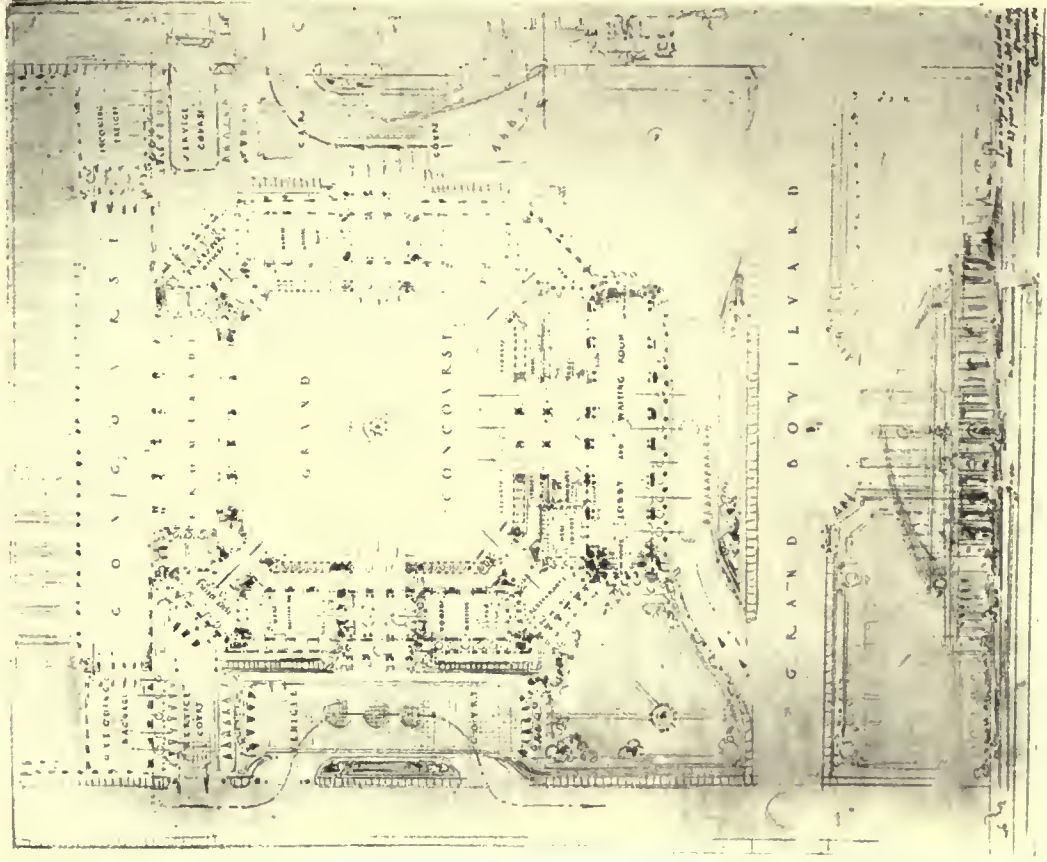

PLATE 177

PLACED THIRD, SECOND MEDAL  
E. E. WIEHE, ATELIER A. BROWN, JR., S.F.A.C.



PLACED FOURTH, SECOND MEDAL  
D. McLACHLAN, JR., HARVARD UNIVERSITY

A TERMINAL RAILROAD STATION

SECOND PRELIMINARY COMPETITION FOR THE TWELFTH PARIS PRIZE

STUDENT WORK—BEAUX-ARTS INSTITUTE OF DESIGN





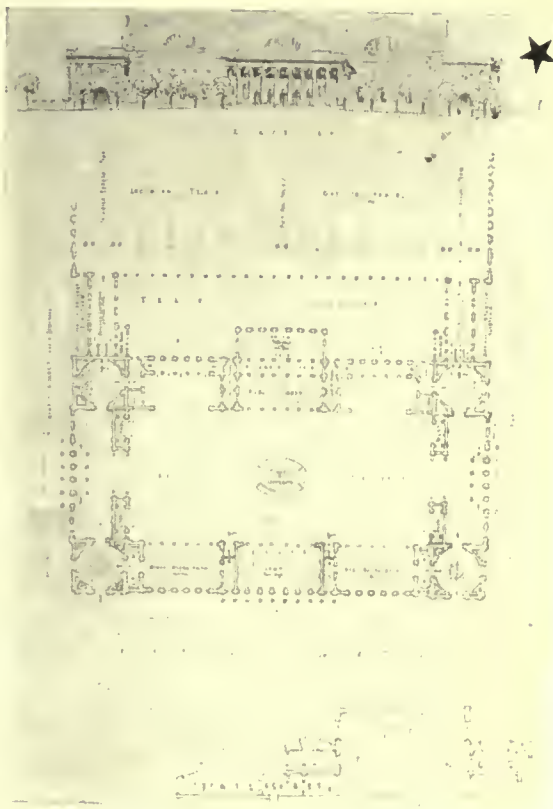

PLACED FIFTH  
A. C. BIBER, UNIV. OF PA.

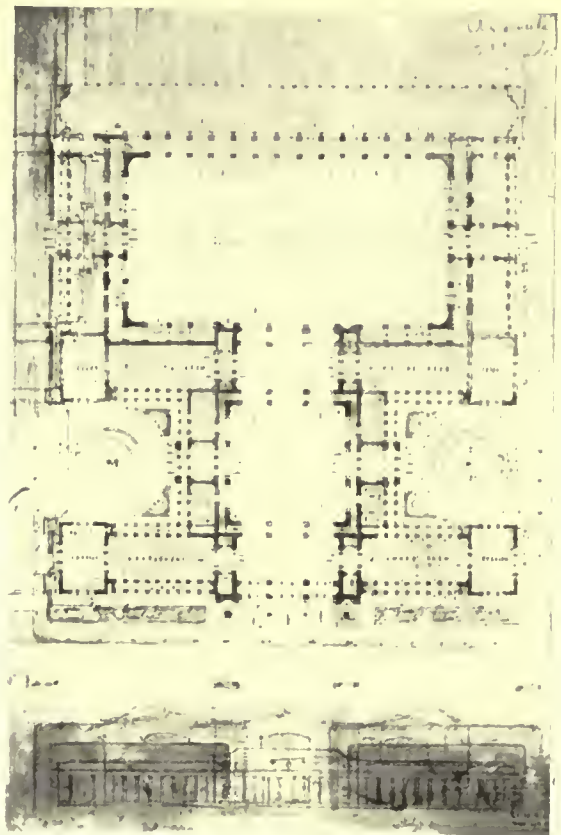

PLACED SIXTH  
R. H. SEGAL, PATRONS G. & E. BLUM



A TERMINAL RAILROAD STATION

PLACED SEVENTH  
W. F. McCAUGHEY, UNIV. OF ILLINOIS

A TERMINAL RAILWAY STATION

---

SECOND PRELIMINARY COMPETITION FOR  
THE TWELFTH PARIS PRIZE

---

STUDENT WORK  
BEAUX ARTS INSTITUTE OF DESIGN



# Recent Legal Decisions

---

## DIFFERENCE IN MECHANICS' LIENS UNDER DIFFERENT STATUTES

In New York and other jurisdictions which follow what is sometimes called the "New York System," no one except the principal contractor acquires an absolute lien on the real estate upon which the improvement is made, and the rights of the subcontractor, laborer, and material-man are acquired by a kind of equitable subrogation secured by written or record notice to the owner of their unpaid claims, and the lien thus acquired imposes upon the owner the duty of retaining such funds as are in his hands belonging to the contractor at the time of such notice. In such jurisdictions the subcontractor, laborer, and material-man are limited in their recovery to the amount due from the owner to the contractor.

Other jurisdictions, however, like Indiana, have adopted what is known as the "Pennsylvania System," where the statute gives to the subcontractor, laborer and material-man an absolute lien for the material or labor furnished, in accordance with the provisions of the act and asserted and created in the manner provided therein, and a lien so acquired is not affected by the mere failure of the principal contractor to perform his contract or by the cancellation or rescission thereof, or by the removal of the work or payment of the principal contractor. But where, in a mechanics' lien suit, it is alleged by the defendant that the subcontractor was a partner of the principal contractor and had guaranteed that the improvement constructed would do the work required, it is a defense that the material furnished by the plaintiff had been removed as not complying with the guaranty.—*Coonse & Caylor Ice Co. v. Howe Store Co. (Ind.)*, 121 N. E. 293.

## GENERAL CONTRACTOR'S RIGHT OF SUPERVISION

It is settled law that the general contractor has the right of general supervision in so far as it is necessary to insure full and proper performance by the subcontractors, and that it is only when he goes beyond the limits of that right and commits some affirmative act of negligence, as by taking some part in the performance of the work other than such general supervision as is necessary to insure its performance that he is chargeable. It may be difficult to say just what intrusion or participation in the work by a general contractor is enough to make him liable for its negligent performance, and it

would be unwise to attempt to lay down any precise rules upon the subject; but it is safe to say that the general contractor is not expected to be a mere interested onlooker, without the ability to complain and criticize, and thus indirectly to suggest; for if that were to be the measure of it, the so-called right of supervision would be a vain and empty thing. The New York Appellate Division holds that the fact that a general contractor took upon himself to have men bail water out of an excavation did not show such control of the construction of a building as to render him liable for negligence of the servants of a subcontractor working on stories above, resulting in injury to the roof of an adjoining building.—*Jacoby v. Broening*, 173 N. Y. Supp. 7.

## CONSTRUCTION OF CONTRACT FOR ARCHITECT'S SERVICES

In an action for a fee for designing and supervising the partial construction of a house on the defendant's land, two causes of action were set forth, one on written contract and the other on quantum meruit. Under the contract the architect agreed to render architectural services in connection with the building for a specified commission, and to arrange with the contractor to carry the work of construction forward to the point of completing the wooden frame and covering it with the rough boarding and outside trimmings before demanding any payment on account of his (the contractor's) contract. The architect further agreed to make no demand for payment on account of his own services until the owner had succeeded in negotiating a loan. The architect thereafter arranged with a contractor as agreed, furnished the necessary sketches, detail drawings, plans, etc., necessary for the construction of the house, and the owner then abandoned the work. The trial court found that the owner was liable for the architect's fee under a written contract; that the full fee would have been \$3,028, and that he had earned three-fifths of such sum, payable in case of abandonment, or \$1,816.80. This was affirmed on appeal, the California Supreme Court holding that the owner could not defeat recovery by abandoning the contract for failing to obtain a loan, for if the owner did not negotiate a loan the indebtedness became payable within a reasonable time.—*Rosenheim v. Howze (Cal.)*, 176 Pac. 456.





LOOKING NORTH ON PARK AVENUE

## The Park Avenue Improvement in New York

**A**FTER fifty years of patchwork improvement, including the opening, closing and relocation of various streets, the avenue which is known as Fourth Avenue below Thirty-fourth Street and Park Avenue above, in New York City, has been completed as an uninterrupted thoroughfare at a direct cost of \$1,220,000 to the city, \$1,131,150 to the New York Central Railroad Company, and \$150,000 to the New York Railways system.

The steel viaduct at Pershing Square, extending from Fortieth to Forty-second Street, is in some respects the most noteworthy portion of the improvement. It involved the setting up of six steel girders, each weighing from sixty to seventy-five tons, which act as the main supports of a high-level roadway beginning from the center of Park Avenue at Fortieth Street and terminating at the hitherto unused thoroughfare surrounding the Grand Central Terminal Building.

The width of this roadway, which is to be used entirely for passenger vehicles, is 36 feet. It connects at Fortieth Street with two vehicle levels 35 feet in width that are separated by a parked space in the center of the avenue immediately over the surface car tunnel. The width of the elevated stretch on the south side of the Grand Central Terminal Building is 45 feet.

This leads to a high-level street on the west side of the Terminal Building that is 35 feet in width and is really an upper story of Vanderbilt Avenue. On the east side of the Terminal there is also a high-level section varying from 40 to 60 feet in width, but for the present the public is excluded from this thoroughfare because it is legally a private right of way as a result of negotiations between the city and New York Central officials following a special act of legislature, passed in 1903, which provided for the closing of some streets in the terminal zone, and the relocation of others.



LOOKING NORTH ON PARK AVENUE FROM FORTIETH STREET

The other feature of the new thoroughfare is a ramp at Thirty-fourth Street, doing away with the stone wall and the long flight of stairs at this point. Before the construction of the ramp from Thirty-second Street to Thirty-fourth Street, pedestrians were forced to climb a long flight of stairs to get from the Thirty-fourth Street store district and the

cross town car lines. In place of the wall there is now a vehicular roadway 25 feet in width and a sidewalk for pedestrians 15 feet wide that connects lower Fourth Avenue, with the continuation of the street above, and with Thirty-fourth Street, and the connection is made at the grade.

The ramp has a grade of 3.6 per cent and inci-



LOOKING NORTH ON PARK AVENUE FROM THIRTY-THIRD STREET



dentally provides for opening Thirty-third Street at grade as a through thoroughfare by the elimination of the barrier that has existed for fifty years in the shape of a retaining wall that marked the beginning of the former tunnel at this point. To bring about the opening of Thirty-third Street across Fourth Avenue it was necessary to raise the grade of both the avenue and the street at that point about 6½ feet. This has resulted in increasing the grade of the tunnel cut for Fourth Avenue surface cars at the point between Thirty-third and

Thirty-fourth Streets to about 7 per cent. In the reconstruction work the west section of Fourth Avenue has been widened 3 feet, making the vehicle surface width for southbound 34 feet, so that where in the past there has been but 31 feet for vehicles moving in both directions, there is now a clear width of 24 feet for northbound vehicles and 34 feet for southbound traffic.

The new thoroughfare, it is estimated, will lessen traffic congestion 50 per cent on both Fifth Avenue and Madison Avenue.

---

## Current News

---

### Farms and Soldiers Again

In conference the other day with Secretary Lane of the Interior, both the republican and democratic leaders agreed to support a bill to provide land settlements for soldiers and sailors who served in the war. There is everything to commend this. So much is to be said in favor of helping the veterans to jobs, land and a home, that the question resolves itself into only how best this may be accomplished.

The whole country would reap the benefits from a plan which would make two blades of grass grow where but one grew before. The *New York Times* summarizes this by saying that there are millions of acres of arid land which can and should be irrigated for production, other millions of acres of swamp land that should be reclaimed for the same purpose, and still other millions of acres of cut-off land that should be cleared and plowed for sowing. Some of the land, if Secretary Lane is heeded, could be used for stock-raising. His plan is to put soldiers and sailors to work at current wages on a great reclamation scheme, and afterward sell them farms and implements to be paid for in installments.

In his last annual report, Secretary Lane, referring to this subject, pointed out that farms for returning veterans would solve many present difficulties.

During the period of reclamation the soldiers would have a job; the industrial labor market would be protected from oversupply; a large part of the best citizenship of the country would become attached to the soil; and great areas of land of no present value would be made productive for the benefit of all the people.

"Would it be unreasonable," said Secretary Lane, "to ask that we spend in the next two years on these veterans of the great war as much as it cost us to conduct that war for a single week? There is only one answer, and all will agree that there can be no surer insurance for the nation than to put its men upon the soil."

Community settlements on the order of farm villages are a feature of the Secretary's plan, for he realizes that without a social element to relieve the monotony of existence on the lands redeemed from wildernesses his plan would not be practicable. He has no intention of risking failure; therefore he would keep the soldier and sailor on the land in touch with society and its educational and recreational opportunities. "Canada," he says, "with less than 7,000,000 people is offering to each man 130

acres of land and \$2,500 with which to improve it. Surely the United States, which has escaped with so slight a comparative loss in life, would do no less."

At the meeting referred to, Representative Mondell, Republican floor leader, announced that he would soon introduce a bill appropriating \$500,000,000 to provide farms for soldiers and sailors, to be paid for by them in a period of years. Senator Smoot is to look after the bill in the Senate. As a beginning this will be promising, but it is of the first importance that the measure should become a law without the usual delays that attend social and economic legislation.

Returning soldiers and sailors cannot live long on prospects. Active interest must be shown in the plan proposed for their welfare, or it can get no further than the stage of discussion. If this happens, an opportunity valuable all around, will have been lost.

---

### Works of Art Lost to Russia

From Stockholm comes the news that seven hundred and fifty million dollars worth of Russian art treasures are in danger, and that if the Allies or Providence do not intervene, they will eventually be lost. The estimate of their value comes from Prince D. Golitzyne, an expert, who counts merely the contents of the Petrograd Hermitage and Museum of Alexander III; and of the Moscow Tretyakoff Gallery and the Historical and Rumantsieff Museums. Golitzyne takes no account of the uncounted millions worth of pictures, statues and books in the palaces of the Grand Dukes, and the great private families, the Yousouppoffs, Scheremetieffs and Stroganoffs.

An official "robbery museum," it is stated, has been created by the Bolsheviks in Petrograd, for loot.

The danger, he says, is not in Bolshevism itself. The responsible Bolsheviks though they rob art wholesale, destroy it only when it glorifies the Romanoffs or monarchism. The danger comes partly from the hungry mobs and the disorderly Red Guards; but most of all from the growing faction of anarchists, who have written on their banner that art is a luxury of capitalists; and that the best way to prevent capitalism reappearing is to destroy all the pictures, statues and imposing buildings, and to burn all libraries to the ground.



## Japanese Architecture

Writing in the *Asia Magazine*, a recent visitor to Tokyo asks the following questions:

Why have the Japanese abandoned their splendid heritage of eastern art? Why are they imitating the West? These are the first questions which spring to the lips of every sensitive European or American who comes to Tokyo. The call of the East has lured them a thousand leagues—to what? To the capital of the Tycoon? To the old Yedo of the color prints? To the diaphanous colors of Hearn's lovely pages? No!—to one of the ugliest cities of mixed architecture in the world. Old Japan lingers in by-streets, in temples, in tea rooms and gardens and in conservative art, but nowhere with evolving energy, as one is forced to admit, when chance throws old and new together for our comparison. To the traveler newcomer the contrast does not strike home, because there is enough of old tradition to satisfy his exotic needs. It is only when second-hand Europe in Asia begins to obtrude itself upon his attention that his indignation is aroused, and his resentment leads him to ask the answers to these questions.

Looking for oriental beauty, he finds all the ugly occidental trade-marks of materialism, and he turns and rends them because they are not up to date. The necessity for modern efficiency he reluctantly admits; but, being no psychologist, he cannot grasp the magnitude of this demand for the old exquisiteness of the extreme oriental people, whose whole energy has been spent during a short half-century in absorbing, at breakneck speed, western industrialism and material efficiency, in order to preserve independence. The west has taken at least four times as long in her own indigenous process and has effectively antagonized her art and action. It may well be that the traveler's protest is a cry of sympathetic pain and warning.

"But," exclaims the visitor, "what has art to do with industrialism?" Everything. In applied art directly and in pure fields indirectly. The Japanese are abandoning their old traditions of art because they are abandoning their old traditions of life. The two are inseparable; life feeds art, and art stimulates life. As well might one expect a cabbage to yield roses as to demand the old medieval flowers of Japanese art on the pavements of Tokyo.

## Rheims Cathedral, Past and Present

That Rheims Cathedral is more associated with the history, the patriotism and the art of France to a greater degree than perhaps any other similar structure may be gathered from the following account in the English architectural press.

Rheims Cathedral was built on the spot which tradition assigned to the baptism of Clovis—an event which gave to the Kings of France their titles of *Roi Tres Chrétien* and *Premier Fils de l'Eglise*. It early became the coronation church of the Capetian dynasty, and to it Charles VI was brought by Joan of Arc to receive his crown and to save his country. It was considered to be one of the most noble and most beautiful examples of medieval architecture in Europe.

Conflicting reports as to just what has happened to this noteworthy example of Gothic building, make an authoritative account of interest.

The western façade and portal are severely battered, the greater number of the pinnacles of the southern front

have been shot away, the roof has several gaping holes in it, the high altar is a formless mass of debris, and the choir as such has ceased to exist. The glass has entirely disappeared—some, indeed, has been preserved, but most has been totally destroyed. All that really remains is the core of the fabric—probably considerably shaken and weakened—and the remarkable series of statues within the west wall. Nothing in the way of restoration has yet been begun, and the public are shown the church by a guardian who tells them that it will take a generation to repair it.

## Pawtucket's Civic Theater

The disappearing saloon is creating problems which have been absorbing attention throughout this rapidly drying country. While the interesting work of the Pawtucket Civic Theater had its inception in an entirely different need, it might if adapted in other cities, also serve as an alternative for the saloon, particularly in cities where a large percentage of the residents are foreign born.

The Civic Theater movement in Pawtucket is an enterprise founded for the sole purpose of teaching Americanism to the foreigners in our midst. The common sense methods pursued, the sympathetic attitude of those who are conducting it toward those of foreign birth, commend it to the serious consideration of all who would have the melting pot melt a trifle more thoroughly than it has in the past.

## Survey Shows How Available Space Has Been Absorbed

The survey of housing conditions in thirty-four typical city blocks, which has been carried on by the New York State Reconstruction Commission with outside aid, reveals a percentage of vacancies which has continued to decrease since 1916. The vacancies now are at their lowest point and are found practically only in houses which are completely uninhabitable from the point of view of human things.

"At present there is a total of about 985,000 apartments in Greater New York," said the Tenement House Commissioner, Frank Mann. "There are altogether approximately 103,000 apartment houses including old law and new law tenements. These include all apartment houses. The relation between old law tenements and new law tenements is 75,000 old law and 28,000 new law, making a total of 103,000 houses.

"From January 1 until April 15, 1919, seventy-six plans were filed for tenement houses with an aggregate number of 120 buildings and 1,658 apartments. There is a shortage in the city today of about 100,000 apartments. The approximate normal increases in population, with immigration eliminated, as it is now, should be about 200,000.

"The vacancies in 1916 in tenement houses, both old law and new law together, was about 6.52 per cent; in 1919 it is 3.25 per cent, of which the vacancies in new law tenements are .6 per cent and in old law tenements 2.18 per cent.

"The vacancies which existed are on the lower east side—the old tenement houses some forty or fifty years old or more. They would house approximately 42,000 people. They are legally fit for human habitation, but that is all. The only remedy to this situation is the erection of new and better houses."

## Planning Model Cities

Cities looking for twentieth century results cannot expect to get them from nineteenth century methods. This is the substance of some comment in a daily paper of St. Paul. The writer of this comment calls attention to the situation in England. There, he says, new cities are planned for sites as yet unbroken, to provide localities for industries and homes for industrial workers. The great cities—London, Manchester, Sheffield—are no longer regarded desirable locations for industries. They are incapable of taking care of the pressing demands of housing, transportation and sanitation. They are too inelastic and unadaptable. Property is too expensive and the mistaken conservatism of proprietors is a bar to the improvements necessary for the development of a modern industrial community.

The same tendency may be noted in this country. Gary is the classical example, a city planned complete before a spadeful of earth was turned on the grounds where it was erected. But apart from paternalistic ventures of this sort, there are cities like Flint, Mich., and Janesville, Wis., both of which have had remarkable growth due to the automobile industries which have developed there, and both of which are laying plans for the maximum of municipal efficiency.

This is the course of procedure the benefits of which require no emphasis of statement.

---

## Paris Architect Estimates Rheims Construction to Cost a Billion Dollars

Architects of Paris, Rheims, and other French cities have been preparing plans for the reconstruction of Rheims, the total cost of which undertaking they have estimated at a billion dollars. Twenty complete plans have been submitted. The city of Rheims will select from each plan the features that seem most desirable, and will arrive at a final plan to be approved by the city council.

---

## Russian Housing Difficulties

In Russia, it is learned, housing accommodations fail to meet one-tenth the demand. Houses are so scarce that it is almost impossible to get a Trans-Siberian Railway passenger car, because they are used in all-important stations to house refugees and as Government offices.

---

## Simplicity of Beauty

Referring to the value of the civic association to every town or city, a writer in the Lansing (Mich.) daily press writes very tersely. A civic association, he says, may urge that industrial buildings can be just as useful if they are beautiful as if they are not, that their employees lose no efficiency because the shop has window boxes filled with green things or has its waste spaces kept in tended lawns.

It costs no more to erect a beautiful building than an ugly one, since beauty is a matter of line and color. Beauty can be produced with pine and carefully selected paint as easily as with marble. The limiting of workshops and railroad yards to certain districts may seem a hardship in

some cases, but the result in the appearance of the city, the sustained value of property and the class of persons attracted as residents will soon compensate.

---

## World Chamber of Commerce

The American Chamber of Commerce in London has put forward a plan for a consolidation of the various chambers of commerce throughout the world. Organizations in the United States are actively supporting the idea. The American Chamber of Commerce in London is in touch with Edward Filene of Boston, a director in the Chamber of Commerce of the United States. Mr. Filene is now in Paris, where he is working in the interest of such a procedure.

With such a combination of local and foreign chambers all working under uniform methods, it is believed that business men throughout the world will be provided with an international organization unsurpassed by anything at present available for the development of better business.

---

## Erect Building in 33 Hours

To have erected in 33 hours a building of 15,000 square feet floor space, including a theater, social rooms, two canteens, class rooms, kitchen, offices and five sleeping rooms, the whole being what in army parlance is known as a "hut", is an achievement of which the 101st Engineers of the 26th Division, American Expeditionary Force, may well be proud.

It is known as the "York Harbor Y. D." hut of the Yankee Division opened by the Young Men's Christian Association at Le Mans.

Foundations had to be leveled, French municipal authorities had to be dealt with for the site and for the location, of sewer, water and electrical connections; one car of material carrying the floor joints went astray and other timbers had to be cut at a local mill. Notwithstanding all these difficulties the hut, which is the largest one used by the American Expeditionary Force, was erected, New England stone fireplace and latticed doorways all complete, in a space of time that made the good people of Le Mans rub their eyes in amazement.

---

## Government Offers Business Data to Industry

The Council of National Defense announces its readiness to place at the disposal of business men the large fund of information now available in the quantity of data assembled and classified by its Reconstruction Research Division. This division, it is stated, may be called upon to procure such additional special information as will assist in the reorganization of industry and the resumption of trade, or in any way promote progress in reconstruction.

The division is well equipped for such service. It has access to every important report of foreign reconstruction, whether proposed or actually accomplished, that reaches this country. It also has available, what is thought the most reliable information to be obtained on foreign, commercial, industrial and financial conditions and prospects.

It is learned that this division has contact with all the war administration boards, and investigation commissions, as well with numerous sources of unpublished information,



dealing with price data, production estimates, wage data, labor supply reports, and the reported results of experiments in method of handling labor problems, on foreign production and other conditions abroad, including labor and immigration.

The division maintains its own clipping service, supplemented by commercial clipping bureaus, and has facilities for sifting practically everything in public print that has a bearing on any phase of reconstruction. This material is all classified, indexed, and ready for reference.

The material and staff now placed at the command of business are primarily intended for government use and will, of course, continue to function as the government clearing house of reconstruction information.

## San Francisco Struggles with Comfort Station Problem

Plans for the establishment of comfort stations throughout the city, in addition to those to be built by the city, are being discussed by the Board of Supervisors of San Francisco, Cal. A proposition has been advanced to make the permits granted automobile service stations contingent on the establishment and maintenance of such facilities.

The city engineer has recommended an appropriation of \$12,000 in the coming budget for the construction of convenience stations, but it is doubtful if work on any of these can be commenced before saloons go out of business, even if the application for funds is granted.

San Francisco is singularly lacking in public convenience stations, the city maintaining but one in the downtown district, outside of those in its City Hall and Hall of Justice. However, it has exceptional opportunities for the installation of stations, since it is the owner of all sidewalk area, an arrangement not true in many large cities.

Property owners have been making use of this free of charge for many years, and it has been suggested that they be called upon to pay a rental for this privilege, or to set aside basement room for comfort stations. Civic organizations are urging that some policy be decided upon at once and work commenced.

## Issue Call for Meeting to Form New State Association in New York

A call was issued this week to all qualified architects in New York State to attend a meeting to be held at Utica, N. Y., on June 7th, at which time a new organization, to be known as the New York State Association of Architects, will be formed. As was exclusively announced in the April 30th issue of THE AMERICAN ARCHITECT, all architects of New York State interested in the formation of this organization are requested to correspond with John B. Slee, acting secretary, at 154 Montague Street, Brooklyn. The purpose is to bring together those practising the profession of architecture in order that they may take a more active part in the working out of the important and timely issues that now have to be faced. Others on the committee of arrangements include Frederick L. Ackerman, William P. Bannister, James Riely Gordon, L. E. Jallade, Robert D. Kohn, Frank H. Quinby, Andrew J. Thomas, D. Everett Waid, all of New York City; A. L. Brockway, Syracuse; Edwin S. Gordon, Rochester; F. H. Gouge, Utica; Edward B. Green and H. Osgood Holland, Buffalo; Alexander Mackintosh, Brooklyn; Leon Stern, Rochester; Ornan H. Waltz, Ithaca, and Walter H. Whitlock, Binghamton.

## Personal

Architect Anton Dobman has moved his offices to 1003 Pabst Bldg., Milwaukee, Wis.

A. Raymond Ellis, architect, has opened offices at 30 Pearl Street, Hartford, Conn.

H. Childs Hodgens, architect, has opened an office at 1312 Walnut street, Philadelphia.

J. J. Kocher, architect, formerly of 7807 S. Loomis St., has moved to 806 W. 79th St., Chicago, Ill.

Fred A. Evans, architect, announces the removal of his office to 704 Book Building, Detroit, Mich.

R. E. Peden, architect, has opened offices at 945 New York Life Building, Kansas City, Missouri.

Chas. F. Bulrman, architect, R. F. D., Waynesboro, Pa., is about to open an office in Waynesboro for the practice of architecture.

F. W. L. Fochringer, architect, formerly 118 North La Salle street, has moved his office to his residence, 2677 Orchard street, Chicago.

Walter Frieling, architect, formerly in office of Hersch & Hersch, Altoona, Pa., has opened offices in room 20, Hutchinson Bldg., Altoona, Pa.

Albert C. Wirth, architect, has opened offices in the Banner Building at Greensboro, N. C. Mr. Wirth desires manufacturers' samples and catalogs.

Alfred Rapp, architect, has reopened offices at 215 West 26th street, Erie, Pa., to practice architecture and desires catalogues and manufacturers' samples.

Esselstyn, Murphy & Hanford, architects and engineers, have moved their offices from the New Telegraph Building, Detroit, Mich., to 810 Marquette Building.

John Hanifen, architect, of Ottawa, Ill., has opened an office in the Tribune Bldg., La Salle, Ill., with Strawn Aldrich Gay in charge, and desires samples and catalogues.

Ira G. Hedrick and W. W. Huff, consulting engineers, announce their association under the firm name of Hedrick & Huff, with offices at 506 Inter-State Building, Kansas City, Mo.

William Dewsnap, architect, formerly of 203 Broadway, New York, has removed his offices to 334 Fifth Ave., New York City. He would like to receive catalogs of building materials of size suitable for filing cases.

C. Howard Crane, architect, 2323 Dime Bank Building, Detroit, Mich., has opened an office at No. 6 Victoria Building, Windsor, Ont., and is preparing plans for a number of important theaters throughout Canada.

Alling S. De Forest, landscape architect, was the speaker at a recent luncheon of the Rochester, N. Y., Engineering Society. He spoke on the work done by the Government in town planning and in providing homes for workers.

Robert L. Fuller, of the firm of Fuller & Delano Co., architects, 44 Front Street, Worcester, Mass., has returned to the practice of architecture after spending several months as a representative of the United States Housing Corporation.

Mr. Phelps Wyman, landscape architect, 648 McKnight Building, Minneapolis, was elected to the board of trustees of the American Society of Landscape Architects at the recent annual election at New York. Mr. Wyman was, prior to last January, president of the Minneapolis chapter of the society. He has been employed in the town planning division of the United States Housing corporation.



# Late News from Architectural Fields

*Special Correspondence to THE AMERICAN ARCHITECT*

## Award of Prizes in Housing Competition

The American Housing Competition organized by the Journal of the American Institute of Architects, and conducted by it in conjunction with the Ladies Home Journal has now reached its conclusion in the award of two second prizes each of five hundred dollars, to Milo C. Hastings and Robert Anderson Pope, both of New York City. In making an award of two second prizes, the jury was governed by the fact that while both theses submitted offer a thorough analysis of the causes and cure for the housing problem that now exists in this country, the actual plans accompanying them did not fully provide for the application of the principles set forth in the theses.

The winning solutions will be offered broadcast as contributions which attack the problem fundamentally and relate it to our whole social and industrial organization.

## New York Society of Architects

The year book of the New York Society of Architects, revised and brought up to cover 1919, has been issued. This is a book of 200 pages, bound in flexible cloth and containing a vast amount of information that is of value and interest to architects not only in New York State, but generally throughout the country. It contains building codes, rules and regulations for plumbing and ventilating, a full report of the building zone resolution, and a complete list of the names of architects throughout New York State. The price of this work is five dollars and it may be secured by addressing the secretary of the Society in the United Engineering Societies Building, 29 West 39th Street, New York.

## Notify Institute of Wage Scale

WASHINGTON, D. C., May 23—The Builders' and Manufacturers' Exchange of Washington has notified the Washington Chapter, American Institute of Architecture, of the adoption of a price and wage scale for construction activities in the District of Columbia. The communication was read and approved at the regular meeting of the chapter Thursday night.

Appleton P. Clark, Jr., represented the Chapter on the central stabilization committee. The majority of the building trades union accepted the wage scale of November, 1918, as the basis for work. Builders have agreed to accept the pre-war percentage of profit until January, 1920.

## Architects Ask Government Aid

Fifty architects, formerly officers in the United States Army, have filed applications with the War Department for assistance in securing professional connections. The applications have been turned over to the U. S. Employment Service for placement.

## Annual Meeting, New York Society of Architects

The New York Society of Architects held its 13th Annual Convention on May 20th at the United Engineering Societies Building.

James Riely Gordon was again unanimously re-elected President, for the fourth consecutive term; Louis E. Jallade of New York was elected Vice-president; Edward W. Loth of Albany, Second Vice-president; Henry Holder of Brooklyn, Treasurer; Frederick C. Zobel of New York, Secretary; and Walter H. Volkenning of Brooklyn, Financial Secretary. Directors for three years, James Riely Gordon, Henry Holder, John Bergeson, Hugh Tallant, and Louis E. Jallade, and for one year, Nicholas Serracino and Frederick C. Zobel.

There were many interesting discussions. The consensus of opinion was that the present prices of labor and material will remain, and that this is the most advantageous time to build, in advance of the great amount of building which will undoubtedly be inaugurated before Fall. Many important steps are in contemplation this year, for the future welfare of the architectural profession. The society is heartily co-operating with other architectural societies and with real estate and building organizations allied with the profession. A number of applications for membership were received, and a number of new members were elected. In spite of the war this has been the Society's most prosperous year, it was stated.

## To Unify State Registration Laws

It has for some time been apparent that it would be desirable to bring about unification of the work being done by the various State Boards which are administering registration laws for architects. With this in view, an informal meeting was held at the time of the Institute Convention at Nashville by representatives of a number of registration boards. An informal association was organized which will seek to co-relate the experiences of the various States having such laws, enabling new boards to profit by that experience.

It is hoped that it will be possible to bring about a conduct of examinations as to make possible the exchange of credits between States, and thus facilitate the admission to practice in one State of architects who have already qualified in another. It is desirable that a special session be devoted to this subject at future Institute Conventions, for these State Boards, if properly constituted, will have the setting up of the standard of admission to the profession entirely in their hands.

The officers of the informal organization above referred to are Professor Emil Lorch, of the Michigan State Board, as Chairman, with Emery Stanford Hall, President of the Illinois State Board, acting as Secretary. All those interested in helping this work should address Mr. Hall at 332 South La Salle Street, Chicago, Illinois.

## Survey of Country's Economic Status Indicates Early Start of Construction Activity

**I**N a report just made showing the present status of economic conditions of vital importance to the country's welfare, John W. Platten, president of the United States Mortgage and Trust Company, states that the construction situation promises early improvement. Other indications are that the labor supply is at present adequate, and returning soldiers are being generally employed without unduly disturbing the labor market. Real estate conditions are found to be excellent and mortgage money is easy. Retail trade proves to be excellent. The Federal Reserve System is shown to be functioning in a highly satisfactory manner and the Federal Farm Loan System is gradually gaining in influence and popularity.

President Platten's report is in substance as follows:

Only in rare cases does there appear any shortage of labor. Indeed, it might easily be said that the contrary is true, due to returning troops and the closing down or curtailment of industries which were unusually active during the war. In view of these two important and far reaching factors it is evident that only the most intelligent effort and co-operation could have prevented an unsatisfactory situation. It is therefore most gratifying to find that employers, public officials and organizations generally have given the matter earnest and timely consideration with the result that up to the present time there is no serious disturbance.

It is true that there are sporadic outbreaks, a few strikes and some professional agitation, which, however, can no longer be classed as extraordinary or preventable even under the most favorable circumstances. Workers leaving the Government service are thus far being quite generally reinstated in their old positions, and this without in any large measure displacing the extra help taken on during the last two years.

From reports in hand, it appears that rents have increased almost universally, the percentage running from 10 per cent to 50 per cent, with occasional excessive advances in business space strategically located. The lack of new construction in the last two years, during which practically all available space came into demand, the flow of labor to industrial centers and the cost of labor and materials preventing needed new construction, have combined to force rents up to their present high levels, some of the non-industrial cities proving the only exceptions to this rule.

There are few large building operations in progress at the present time but there is considerable construction of dwellings, and a few business structures are under way. Building in a large sense, however, is not making any great headway, being unable thus far to adjust itself to the prevailing high prices of labor and material.

Organized labor is making vigorous efforts to maintain the present wage scales but the indications are that lower levels in some cases are bound to come. Reductions in a few lines indicate that material prices may possibly be on the point of a downward movement, but any immediate plans based on such development would doubtless be somewhat premature. However, these conditions considered in the light of the great need for new construction, give reasonable grounds for expecting a building campaign of good proportions at a reasonably early date.

One fact which stands out clearly in the Real Estate situation is the insistent demand for dwellings. This has literally forced a limited amount of home and apartment house building and vastly increased the rental demand for all available space of this nature.

In the wheat growing area the Government guaranteed price for the 1919 crop has resulted in a good demand

for wheat land. There is considerable activity in farm land generally, and more or less activity in small acreage plots. Oil and fruit lands are also in favor. Mortgage conditions are easy, with plenty of money available and rates declining.

Retail trade is in a healthy, flourishing condition, marked by only a few instances of depression and caution as to overstocking. The splendid possibilities for trade expansion opened up by the war are being met by a responsive appreciation of the part of business men, manufacturers, trade organizations and public officials. Particular attention is being given to exports, the improvement of waterfront facilities and the location of new industries. Significant, too, are the plans for bringing under cultivation largely increased areas through irrigation and other methods.

The Federal Reserve System is so well established and its beneficial operation so clearly demonstrated that it is now taken as a matter of course. By taking care of the war financing, the extension of credit, building of confidence and stabilizing conditions throughout the United States, it fills a place possibly higher than was anticipated by its most optimistic supporters.

The Federal Farm Loan System has proven of immense benefit in sections where opportunity has been given to show its worth. It continues to stimulate production by providing funds in large volume for long terms and at low interest rates. The one disappointing but perhaps natural feature is that it does not yet appear to be fully understood in some quarters, with the result that the benefits which it might confer are far from being fully realized. The indications, however, are that it is only a matter of a comparatively short time before it will be more generally known and utilized.

The following digest shows the trend of business and fluctuation of residential rents in the last two years, new building, labor and material prices and mortgage money in various sections of the country:

**In the South**—From reports received, rent increases are universal, ranging from 10 per cent to as high as 50 per cent. New building generally limited to dwellings and betterments, although a few large operations are under way. Good season in prospect. Labor and materials show little changes as yet, but generally appear to be weakening, although opposite tendency exists in one or two cities. Residential property is in big demand, with occasional instances of activity in business buildings and oil and farm land. Renting space very well filled. Mortgage money noticeably easy, with rates reacting accordingly.

**In the Central West**—Rents have generally increased but not to an excessive degree. The range is from 10 to 25 per cent, the larger increases usually applying to business space. A few large building operations are under way, but new construction is largely held up by present high prices of labor. There is some tendency toward reductions, but not to a degree warranting any early relief. The real estate market is strong in some lines, particularly renting, as the recent lack of new construction leaves practically no surplus space on hand. There is an insistent demand for dwellings and some call for farms and vacant property. Mortgage money is plentiful, as a rule, with rates easing off.

**In the Southwest**—Rents are generally higher, 10 to 25 per cent. There is some home building in response to urgent demands, but construction work generally is waiting more favorable prices. Labor is naturally anxious to maintain the present high wage scales, but with the general readjustment, some concessions are likely. Building materials show some reduction. The real estate market



## THE AMERICAN ARCHITECT

shows a brisk demand for dwellings with considerable activity in farm lands. The rental situation is good and some leases are being made on oil lands. There is an ample supply of mortgage money throughout the Southwest with the natural result of decreasing interest rates.

In the Inter-Mountain section—Rents are 10 to 50 per cent higher except in Spokane, which was deserted by its floating population when the neighboring industrial centers went on a war wage basis. There is considerable home building and planning, and a few larger operations but other projects are held up. These show a downward tendency. There is a good demand for homes, also some

sales of small suburban plots. Around Spokane, wheat and fruit land command good market. Mortgage funds are ample with rates tending downward.

On the Pacific Coast—Rents are uniformly higher, ranging from 10 to 50 per cent, with some choice retail space showing excessive advance. In response to a strong demand for homes there is a limited amount of construction. Materials show a tendency to lower levels. The real estate market shows a steady demand for moderate priced homes for occupancy by purchasers and wheat land is looked on with favor. Mortgage money is plentiful, with rates tending to ease off.

### “Open” Building Material Market Forces Prices Upward

WITH the return to an “open” building material market, forced by the recent abandonment of the Industries Board as a result of its conference with the steel industry, there has come a decided trend upward in commodity values. When it was learned that there was to be no further attempt by the Government to stabilize prices, architects and builders manifested keen interest as to just what the effect would be, and in what direction quotations would fluctuate.

There is no question but that construction activity is fast resuming its normal cadence, but weekly price tables also show that with the improved demand there has come an upward price movement and that the low level has been reached. The question now is how long can prices hold at present levels. Brick and lumber are now leading in the upward movement, due to the scarcity of labor and exceptionally high wage scale. The industry deems it most unfortunate that at this time building costs should be advanced.

It was clearly shown that while the Industries Board and the Railroad Administration were at deadlock over prices in practically every municipality only the more daring speculators and those soundly financially backed proceeded with building projects. The strangling of the fundamental laws of economics and substitution of price fixing, without any question, retarded the impetus that long ago should have been given post-war construction. Only when leading steel corporations proved that no further reduction in prices would be made without a reduction in wages was the fight for an “open” market won. But in the meantime business had been severely handicapped.

Before its retirement the Industries Board released hardwood manufacturers and other commodity interests from their promises of co-operation in price adjustments. In explanation of the withdrawal of the board, it was said that it had for its object the resumption of construction and production through the stabilization of prices. The legal phases of the question as raised by the Attorney General's comment on the illegality of price fixing failed to disturb the opinions of Secretary of Commerce Redfield or Mr. Peck, who referred to the opinion of the Department of Justice as negligible. The results sought could have been obtained, chairman Peck contended, without violation of the Sherman Act, as the plan was to ascertain and make public fair prices reached by agreement. When the Railroad Administration refused to buy rails at a fixed price, it was because Director General Hines believed that it would cause a later inflation of values. From the upturn in prices the past two weeks this theory has been borne out, not only in structural steel, but in common brick, sand, gravel, grit, broken stone, cement, plaster, lead, oils, and particularly lumber, as well.

An interesting sidelight on the many different problems affecting the progress of construction is to be found in the fact that contractors in estimating costs on suburban home construction are submitting bids that are decidedly close. On a recent project it has been disclosed that two bids on a country home were for the same amount and that the third was for but \$170 less. When the cubage cost based on these bids was found to be fifty cents and that similar work was being done elsewhere at from thirty to thirty-five cents, suspicions were aroused that there was collusion among the contractors in that section, and that they were attempting to profiteer in their work, especially, as in this instance, when the architect was from another locality. If these suspicions are confirmed it would seem that contractors in certain sections are by these irregular methods offering a severe handicap to construction.

Investigation into the cost of manufacturing various materials by the Illinois Senate as a result of suspicion that combines of dealers were holding up the prices of the various commodities failed to produce evidence to substantiate these reports. Manufacturers in the cement, stone, brick and lumber industries were called in, their books gone over, and every possible effort made to account for the present cost of their products. It was clearly shown that with the present high cost of labor there can be no reduction in manufacturing costs at present.

Reports from THE AMERICAN ARCHITECT's correspondents this week indicate that the building wave which has been working its way from the West is fast reaching the East. Two of the leading New York architectural firms have fifty-two distinct operations on their boards at this time, for many of which plans and specifications are about completed. Others are in the preliminary stages of closing the contracts. All of which indicates that the building boom is surely launched, having adjusted itself to the prevailing prices of labor and material.

The increased volume of material leaving the supply yard, the big demand for draughtsmen in the architect's offices, as well as the increasing commodity prices, are but few evidences of increased activities in construction projects. It is the actual start of post-war building, first the remodeling of old structures and building of low cost homes, and now the issuance of permits and the breaking of grounds for apartments and factories, that is stimulating many lines of business and making readjustment from war to a peace basis possible.

(Continued on Page 772-A)



# Department of Architectural Engineering

## Research Investigation of Warm Air Furnaces for House Heating

AMONG the many elements that constitute the building industry, there are several that are capable of being classed as unknown quantities. This is true because exact and definite data concerning them has never been secured. Among these are included the warm-air furnace for house heating. It seems remarkable that such an important factor in the heating of dwellings should have been so long neglected in this regard, and possibly the rapid advances made in the art of steam and hot water heating have so shaped competition that the manufacturers of warm-air furnaces were forced to recognize the necessity of making a scientific investigation of their own product.

The National Warm Air Heating and Ventilating Association, at their 1918 convention, appropriated the sum of \$8,000 to be used for a scientific investigation of the warm-air furnace. It was decided to have this investigation made at the University of Illinois Engineering Experiment Station under the direction of A. C. Willard, Professor of Heating and Ventilating. During the first year's work, now drawing to a close, this sum has been expended with a like amount of money contributed by the University of Illinois. Professor Willard's staff, conducting this investigation, consists of A. P. Kratz, Research Assistant Professor; W.

E. Pratt, Research Associate Special Investigator; V. S. Day, Research Assistant, and F. G. Wahlen, Graduate Research Assistant. The National Warm Air Heating and Ventilating Association deposited the funds with the University authorities to be expended by them. The Association has an advisory committee which has charge of securing funds and co-operating with the investigators if required. The appointment of the staff and the conduct of the tests has been entirely under the control of the Director of the Engineering Experiment Station, and the results,

as are all of those emanating therefrom, will be entirely free from the influence of any personal or commercial interest. A progress report will be made to the 1919 convention of the Association to be held at Columbus, Ohio, on June 11. Allen W. Williams, Columbia Building, Columbus, Ohio, is Secretary of the Association.

A description of the apparatus used for test purposes is here given, and some of the difficulties encountered are described. A steel channel and angle iron frame was constructed, on which three heavy plank floors were placed. These floors or platforms represent three floors of a dwelling and are 8 ft. apart from top to top of floors. Steel frame stairs are used, giving easy access to all

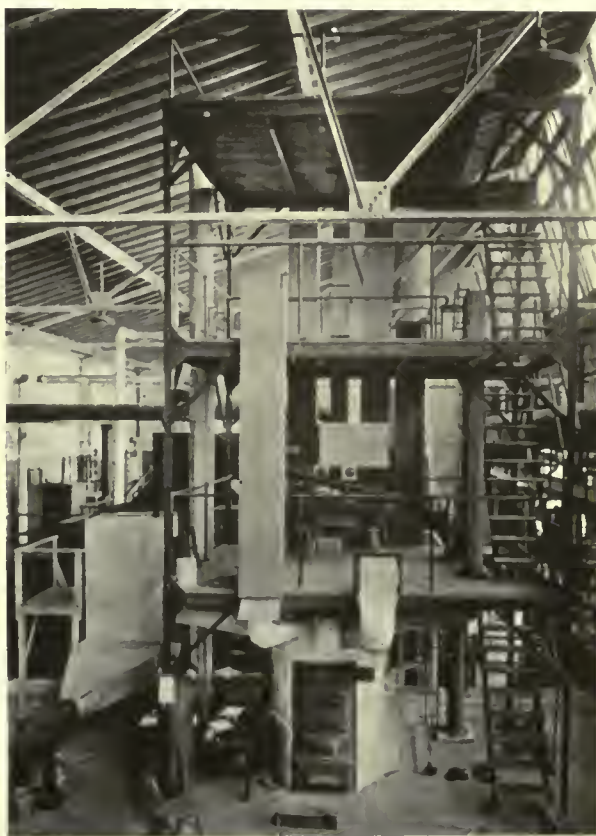

General view of the furnace testing plant. The switchboard for the electric thermo-couples is located on the first floor above the furnace. At the left is a portion of the auxiliary fresh air inlet. The construction of the frame work supporting the various floors and the various vertical ducts are shown. Tests have been made with the galvanized iron jacket insulated with a 1½ in. hair felt covering.

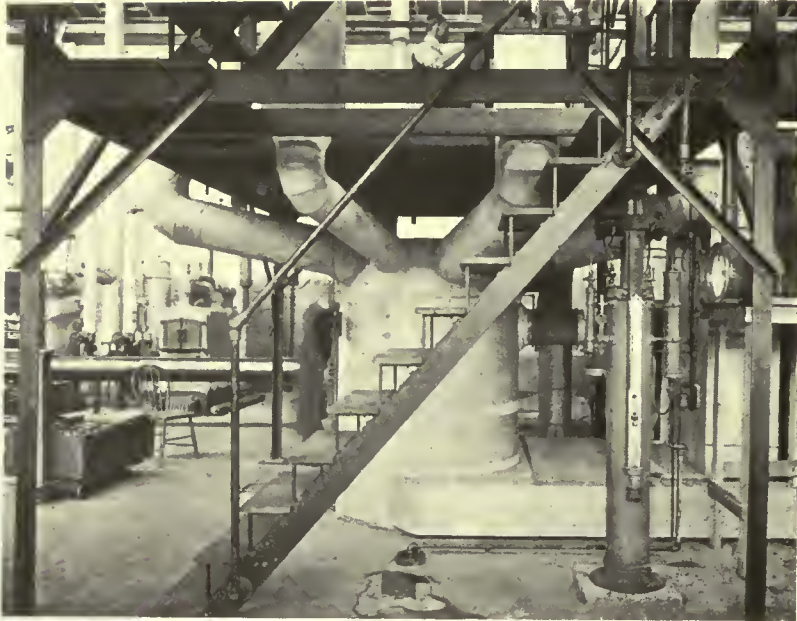

Side view of the furnace showing the fresh air inlet and the Uehling CO<sub>2</sub> Recorder at the right. In the rear is the 10 in. tube forming a portion of the auxiliary fresh air inlet.

floors. This structure is erected in the Mechanical Experimental Laboratory. The installation consists of a No. 270 hot air furnace, made by Moore Brothers, Joliet, Illinois. This is a standard fur-

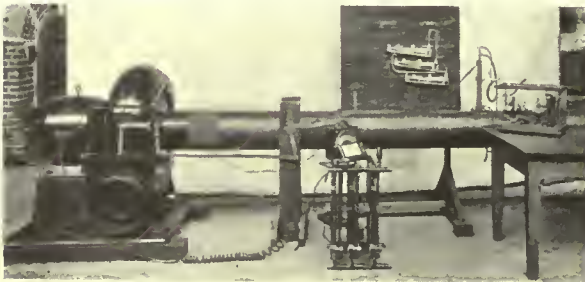

View of a portion of the auxiliary fresh air inlet apparatus. At the left is the exhaust fan attached to the 10 in. pipe connected to the auxiliary inlet shown at the left of the general view of the test plant. The apparatus for regulating the fan and damper is shown. At the table can be seen the Pitot tube for measuring the volume of air passing through the inlet. Readings are taken at various points in the diameter of the 10 in. tube. With velocity conditions at the auxiliary inlet identical with those at the furnace inlet the volume of air passing into the inlets is thus determined.

nace with an ordinary solid cast iron fire pot and galvanized iron jacket. There are four 12-in. round horizontal ducts for the first floor, two 9-in. and two 8-in. for the second floor and two 9-in. for the third floor. These horizontal ducts are covered with an asbestos paper. The first floor ducts are connected to a boot leading to the base board registers, as shown in the illustration. The other horizontal ducts connect with vertical flues after passing through the boots at the basement

ceiling level. The vertical flues are placed between two studs with plaster board nailed to the edges, thus enclosing the flues. The passage of air between the flue and the stud and plaster board closure is prevented. Single and double-wall vertical tin flues are installed to the second and third stories, and the variation in performance is noted. Electric thermo-couples are installed in each of the ten registers, six in the base of two vertical flues leading to each floor, one in the smoke pipe and one in the fresh air inlet. These eighteen thermo-couples are connected with a switchboard located on the first floor, where the temperature readings are taken.

A thermometer is placed in the horizontal duct at the left of the front of the furnace and is under constant observation in order to maintain a constant firebox temperature. The fluctuation of temperature is very small, and the average is well maintained. As yet only anthracite coal is used, and the firing, burning and weighing of the residual ash conforms to a standard procedure.

Temperatures are not taken in the jacket, owing to the radiant heat dispelled from the furnace, but it is expected that a method of measuring the air temperature at that point will shortly be developed.

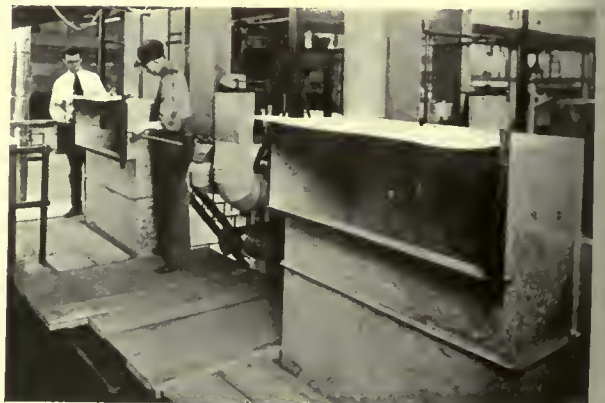

View of the furnace fresh air inlet at the left and the auxiliary fresh air inlet at the right. The anemometer readings are being taken at 24 points on the face of the inlet to the furnace. Identical velocity conditions are established in the auxiliary inlet by means of an induction fan shown in another illustration.

The velocity of the air passing through the registers is measured by a special type of anemometer. This anemometer is attached to a square steel bar of sufficient length to permit of its being



## THE AMERICAN ARCHITECT

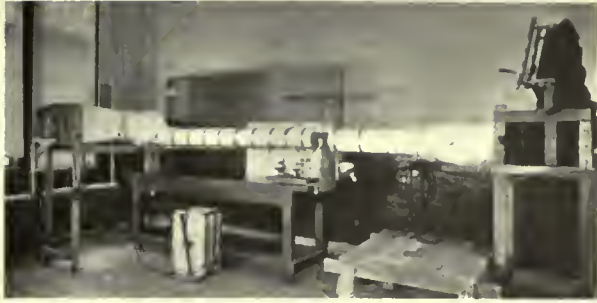

Auxiliary apparatus in small research laboratory. At the left is an electric heater placed in the end of the pipe which leads to an electric driven fan. The air is drawn through the heater and passed into a 5 in. tube which expands at the right end into a horizontal furnace duct which passes through a boot into and through a register. The same temperature and velocity conditions are established at the register as may be found at each register in the test plant. When these conditions are established readings are taken from the Pitot tube apparatus connected with the 5 in. pipe and the volume of air passing through the register is determined. By means of this apparatus the volume of air passing through all of the registers is measured. This is found to be slightly in excess of the air passing through the inlet and probably the result of infiltration through openings in the furnace jacket.

placed in three positions across the length of the register. Two steel bars are attached to the sides of the registers, in which are cut three notches in which the bar slides. By this means nine readings are taken on each register face and in identically the same position. The average of their readings gives the velocity of the air travel through the register. On the fresh air inlet, 17 x 47 in. in size, six horizontal readings are taken on each of four positions in the height of the inlet, giving twenty-four readings on the face of the inlet during a period of two minutes. This method of securing the average velocity is shown in the illustration of the fresh air inlet.

By these means the temperature of the air at the inlet, at the base of the vertical ducts and at the registers is found, as well as the velocity of the air at the inlet and the register faces.

To check the volume of the air passing through the furnace, a comparative inlet and register measurement is taken on an auxiliary apparatus. At the left of the furnace installation shown in the illustration is shown an auxiliary inlet connecting with a 10-in. tube. This tube in turn terminates in an exhaust fan, shown in the illustration. By means of this fan the same anemometer readings are established as occur in the furnace inlet. As shown, a Pitot tube is inserted and readings are taken at several points

in the diameter of the 10-in. tube, and thus the volume of air entering the furnace inlet is found. The apparatus for controlling the speed of the fan and the damper is also shown.

In a small research laboratory is installed a device for the purpose of checking the volume of air passing through the registers. At the inlet end of this, at the left in the illustration, is placed an electric heater attached to a duct leading to a fan. Leading from this fan, to the right, is a 5-in. tube which expands into a horizontal duct which enters a boot above which is installed a register. By manipulating the furnace and fan identical temperature and velocity conditions are established as were found at the registers in the furnace installation. A Pitot tube is inserted in the 5-in. tube, by which the volume of the air passing through the register is determined. It is found that the volume of air passing through the registers is slightly greater than that passing through the inlet. This is probably due to infiltration into the jacket.

An auxiliary plant is also used to work out problems on horizontal and vertical ducts. In this work the horizontal ducts will be of various lengths and inclinations. The vertical flues will be of different sections, round and rectangular, and the effect of any particular departure in design and installation from a typical standard is determined. The air is heated by a steam coil to any desired temperature and the water of condensation is measured. Temperature and velocity readings at the register are taken in the same manner as in the installation before described. The effect of various types of

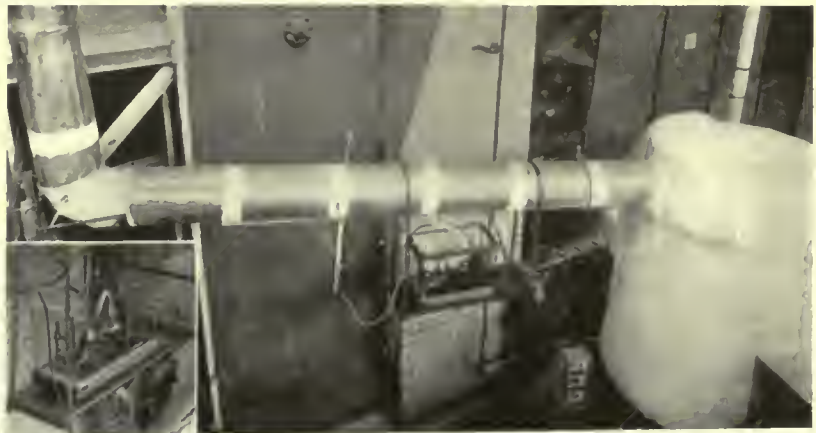

Auxiliary plant for problems on vertical and horizontal ducts, different sizes and shapes of ducts will be tested with different inclinations and lengths of the horizontal duct, insulated and not insulated. The air is heated by steam coils in the large air chamber at the right. The glass encased Wahlen Draft Gauge is shown suspended from the duct with which the draft is measured at various points in the diameter of the duct. An enlarged view of the gauge is shown in the lower left-hand corner. Temperature readings are taken at the base of the vertical duct, at the register and in the duct near the hot air chamber. Velocity measurements are taken at the register with an anemometer.



insulation will be measured. It was found that the draft in the duct was so slight that no known gauge would measure it. It was given to Mr. Wahlen to design and construct one, and he has succeeded in constructing the Wahlen gauge, which indicates 1/10000 in. head in alcohol, which is comparative to 1/12000 in. head in water. This instrument is shown in the glass enclosed cage in the illustration, and readings are taken at various points in the diameter of the pipe. This instrument is so delicate that the passing of the hand in front of the orifice causes it to register a variation in air conditions.

This description will indicate the vast amount of labor and time required to make the installation of the main testing plant, the installation of the auxiliary plants and the designing and making of the delicate instruments required for this particular work. At the same time certain conversion charts were prepared, from which the various instrument readings are quickly converted into final form.

The program aims to establish (1) a reasonable basis for rating furnace performance, (2) to compare the performance of several standard types of furnaces, and (3) to determine what are reason-

able velocities in pipes. The tests made at this time are to establish the capacity of a furnace to heat a given number of pounds of air from one given temperature to another temperature during a given period of time. The field of investigation is very great, and in order to complete it two more years of work may be required. New and important problems are continually arising which must be solved. Much data used in the design of warm air furnace heating plants has been found to be incorrect and conditions that have never been contemplated have been discovered. It will only be by means of such an investigation as this that the actual facts concerning warm air furnaces and their use can be known. It is of the utmost importance to that portion of the building industry devoted to the construction of dwellings mainly, and some other types of buildings, that this work be carried on to completion. When completed, and the various furnaces are standardized as to their performance and this data is available for installation design, the architect can proceed with some assurance of success in the use of warm air furnaces. This will certainly be a most welcome change from the conditions that now obtain.

## Reinforced Concrete Building Stands Extreme Overload

**R**EINFORCED concrete structures have often been loaded far in excess of their designed safe carrying capacity, both for the purpose of testing the efficiency of certain types of design and for other experimental purposes. The University of Illinois, in Bulletin No. 106, records the results of one such test conducted on a flat slab type of reinforced concrete building about to be demolished.

While overloading also occurs to a greater or lesser extent in structures under actual service conditions, it is seldom that a building is called upon to sustain an overload as great as that which was recently placed upon the second floor of a reinforced concrete building in Long Island City, N. Y.

The structure in question was erected about three years ago, and is one of a group of several similar buildings. It is four stories high without cellar, built over marshy ground upon a

concrete pile foundation, with floors designed to support a live load of 200 pounds per square foot. The section in which the overloading occurred is 80 ft. wide by 218 ft. long, divided transversely into three bays, the outer bays being each 26 ft. 4 in. wide, and the center bay 27 ft. 4 in. wide. In a longitudinal direction the columns, which are circular in section, are spaced 18 ft. on centers. The floor construction is of the girder, beam and slab type with troweled floor finish. The girders are 14 in. by 26 in., in section, and have a clear span of approximately 16 ft.; the beams are 8 in. by

22 in. in section, spaced 6 ft. on centers, the beams in the outer bays having a clear span of 25 ft. 2 in. and those in the center bay of 26 ft. 2 in. Beams and girders are reinforced with heavy twisted steel rods (about 1 in. square) some of which are bent up at the ends. The slab is 4 inches thick and reinforced



General view of building.



Interior view of second story showing heavy overload of tin. The work of removal has just been commenced.

by light round corrugated bars spaced about 4 inches on centers. Gravel concrete was used throughout, probably of a 1:2:4 mix.

It seems that the owners of the building had not occupied it for some time, but had leased it to a concern who in turn sub-leased the first and second stories to a warehouse man. This sub-lessee began using the two lower stories early in the year for the storage of sheet tin prior to its being shipped to Japan. This material is boxed in individual cases, each having outer dimensions of approximately 18½ in. by 14 in. by 4 in. deep, and of 122 lbs. gross weight, or 68 lbs. per sq. ft. when laid flat. From this it will be seen that the allowable safe load of 200 lbs. per sq. ft. would have been exceeded by 3 lbs. had the boxes been piled but one foot (or three cases) high. From the illustration showing the second story after partial

removal of the cases it will be seen that the tin was stacked nearly uniformly over the entire floor to a height of 15 cases (or 5 ft.), with a total resultant live load of 1020 lbs. per sq. ft., *over five times the design'ed safe load.* In some places the cases were stacked 20 high, thus loading the floor to 1360 lbs. per sq. ft. The equivalent average uniform load over the entire floor, allowing for the two longitudinal aisles near the columns, was between 900 and 1000 lbs. per sq. ft., as nearly as can be determined, but in many panels the loading was much higher than this figure. That these heavily loaded sections of the floor did not col-



Boxing beam forms around reinforcing rods left in place.

lapse is a remarkable testimonial to the efficiency of this type of construction.

The sub-lessee had several carloads of sheet tin on a siding, and apparently it was his intention to add this to the already overloaded floor. However, when the loading had reached the stage described, warning cracks in the beams and girders began to appear. The night watchman became alarmed by a series of rumblings or creakings, apparently due to the partial rupture of the concrete as the

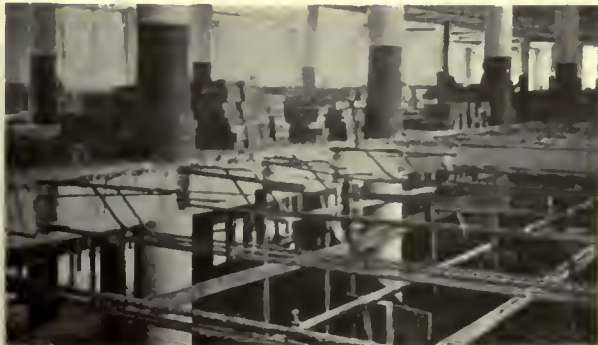

Condition of outer bay after concrete had been removed. Note beam reinforcing rods left in place; also that cases of sheet tin stacked in center penal are located over girders.



View looking down on first floor. False work for supporting forms already in place.



## THE AMERICAN ARCHITECT

deflection increased and the cracks opened. These seemed so ominous that this individual spent the rest of the evening in the fresh air outside the building and reported approaching trouble in the morning. The matter shortly thereafter came to the attention of the Bureau of Buildings, and Superintendent Moore took prompt steps to relieve the dangerous situation. An "unsafe" building survey was immediately held, and under the powers vested in him by law and acting under a court order, based on the findings of the board of survey, the Superintendent of Buildings caused the removal of the material and the shoring up of the weakened second floor construction. An examination of the floor after the load had been removed indicated a continuity of action in the structure from wall to wall transversely, cracks having appeared on the upper surface on each side of, and parallel to, the two lines of longitudinal girders at approximately the point of inflection, this action thus reducing the bending moment at the center of the beams to  $\frac{WL}{12}$  or possibly to  $\frac{WL}{20}$ . That real "T" beam action did occur between beams and slab is evident from the fact that in some cases the cracks extended through the slab and into the beam proper or stem of the "T." Polygonal cracks also

appeared in the upper part of the slab roughly concentric around the columns.

The elastic limit of the construction (if such a property exists for concrete) was evidently exceeded, and at the present time the work of reconstruction is in progress as shown in the illustrations. The concrete slab and beams in one of the outside bays have been removed leaving the heavy reinforcing rods of the beams exposed, but firmly embedded in the wall and interior longitudinal girders at the ends. The slab reinforcing rods were removed, straightened, and reused. Wood forms were constructed around the beam reinforcing rods that had been left in place, and the new concrete beams and slab poured. This process will be repeated in the center and other outside bay, thus replacing the entire second floor construction without any great difficulty.

This experience would seem to refute the statement so often made that a damaged reinforced concrete structure is practically unrepairable and must be demolished.

Reconstruction work of a somewhat similar nature, it will be recalled, was satisfactorily completed in the Edison factory buildings at Orange, N. J., a few years ago after those buildings had been seriously damaged by fire.



New slab being placed. Reinforcing rods showing are those taken out of demolished floor slab, straightened and re-used.



# Present Status of Industrial Lighting Codes\*

## Part II

By G. H. STICKNEY

### GLARE LIMIT SPECIFICATION

THE establishment of proper limits for glare is probably more important than even the matter of intensity. While the provision of sufficient light is fundamental, it is also better understood and has a more obvious relation to production. It seems to be generally agreed that more employees suffer from glare than from insufficient light. Certain lighting conditions are readily recognized as glaring, while others are equally recognized as free from objectionable glare. But when it comes to drawing a definite limit between danger and safety, our present inability to measure or accurately define objectionable glare makes it necessary to utilize a qualitative rather than a quantitative specification.

The I. E. S., Pennsylvania and New Jersey codes simply require that lamps be "suitably shaded to minimize glare," with an explanatory note that glare from lamps or unduly bright surfaces produces eye-strain and increases accident hazard. This is supplemented by the requirement (under "Distribution of Light on Work") that "sharp contrasts" of intensity on the work be avoided.

The New York code requires that "exposed bare lamps, located less than 20 ft. above the floor, shall be provided with shades, reflectors, diffusing glassware or other accessories, to eliminate or minimize glare." Sharp contrasts of intensity on the work must also be avoided.

The Wisconsin code goes a little farther and says,

Lamps suspended at elevations above eye level less than one-quarter their distance from any position at which work is performed, must be shaded in such manner that the intensity of the brightest square inch of visible light source shall not exceed seventy-five candle power.

Exception: Lamps suspended at greater elevations than twenty feet above the floor, are not subject to this requirement.

Note: (a) Glare from lamps or unduly bright surfaces produces eye-strain and increases the accident hazard.

The brightness limit specified in this order is an absolute maximum. Very much lower brightness limits are necessary in many interiors illuminated by overhead lamps, if the illumination is to be satisfactory. In some cases the maximum brightness should not exceed that of the sky (1.5 to 3.0 candlepower per square inch).

Note: (b) When the principal work is done on polished surfaces, such as polished metal, celluloid, varnished wood, etc., it is desirable (but not mandatory at present) to limit the brightness of the lamps in all downward directions to the amount specified in this order.

For local lighting the Wisconsin code establishes the limit of 3 candle power per square inch, whenever visible from any working position. This lower

limit is selected "because the eyes are more sensitive to strong light received from below."

There is a difference of opinion among illuminating engineers as to the proper values of candle power per square inch to be applied to this specification, while some think a better principle of specification can be determined. It has been suggested that glare be specified in terms of contrast of brightness, perhaps expressed in ratios. Some experimental work has been done along this line and at least two experimenters have made up experimental instruments for measuring ratios of brightness. It is recognized that there is a considerable range in the permissible contrast for different processes for different directions, especially of elevation, and for different intensities<sup>10</sup>.

It therefore seems likely that sometime in the future the codes will have some sort of glare classification corresponding to the intensity classification. But advance in such a direction cannot be made until further investigation and development has provided a reliable basis.

Considerable space has been devoted to the engineering limitations of the present glare specifications, with the view of interesting experimenters and engineers in the solution of the problem. On the other hand, the present specifications must not be regarded in any way as a failure. They are practical, working specifications which will do much to improve lighting conditions. They provide the means of eliminating practically all conditions which constitute a serious menace, and while the lack of a defined limit may in some cases be taken advantage of by either the manufacturers or the inspectors, such instances are likely to be quite exceptional. In reality the present specification is more definite than many existing legal requirements in force regarding matters other than engineering.

### DISTRIBUTION OF LIGHT

The New Jersey code reads: "Lamps shall be installed in regard to height, spacing, reflectors or other accessories, so as to secure a good distribution of light on the work, avoiding objectionable shadows and sharp contrasts of intensity."

The distribution of light is partly taken care of in the intensity and glare limit specifications. That is, the requirement that intensity shall not fall below a certain minimum, coupled with economic considerations, tends to avoid a wide variation in intensity, while the latter also requires the elimina-

\*Continued from issue of May 14, 1919.

## THE AMERICAN ARCHITECT

tion of dense shadows on the work. As worded in most codes these rules do not call for the elimination of bright striations of light, or, in brightly lighted rooms, of shadows which may interfere with vision, but still have an intensity above the minimum limit.

The distribution of light rule covers these omissions by calling attention to the relation of lamp equipment and location to light distribution. The lighting effects referred to, if objectionable, are so obvious that they are readily recognized when attention is called to them. Therefore, the rule seems likely to accomplish its purpose without much difficulty.

In the Wisconsin code a further requirement is made that the local lighting shall be supplemented by a moderate intensity of overhead lighting, except when reflection from light colored surfaces produces a general illumination. This renders more definite a feature than is implied by the general requirement of the rule.

### EMERGENCY LIGHTING

Panics, which have occurred in crowded rooms when the lighting has failed at the time of a fire, explosion or other emergency, have emphasized the necessity of avoiding any probability of darkness at such a time. There is, however, a wide variation in the actual needs of different workrooms. For example, where a large number of women workers occupy an upper floor surrounded by dangerous conditions, inflammable materials, etc., continuity of lighting is exceedingly important. But where a small number of employees are scattered over a large ground floor area, with convenient exits and without dangerous conditions, safety can be assured without an elaborate provision for continuity of lighting. Moreover, such provision as would be necessary in the first instance, might be prohibitively expensive for the second.

It has, therefore, seemed necessary to make only a general provision in the code, with the expectation that rulings would be made to cover specific cases, or that the detailed requirements would be supplied later by those having suitable experience. It is more a problem of safety engineering than of illuminating engineering.

The general requirement of the rule, common to most of the codes is: "Emergency lamps shall be provided in all work space aisles, stairways, passageways and exits. Such lamps shall be so arranged as to insure their reliable operation when through accident or other cause the regular lighting is extinguished." In some States the rule has been expanded to include instructions for insuring reliable operation—separate mains or sources of energy being required.

For example, the New Jersey code requires—

Emergency lighting systems, including all supply and branch lines, shall be entirely independent of the regular lighting system and shall be lighted concurrently with the regular lighting system and remain lighted throughout the period of the day during which artificial light is required and used.

Emergency lighting systems shall be supplied from a source independent of the regular lighting system wherever possible. This source of supply and controlling equipment shall be such as to insure the reliable operation of the emergency lighting system when through accident or other cause the regular lighting system is extinguished. Where a separate source of supply cannot be obtained for the emergency lighting the feed for emergency lights must be taken from a point on the street side of all service equipment. Where source of supply for the regular lighting system is an isolated plant within the premises an auxiliary service of sufficient capacity to supply all emergency lights must be installed from some outside source, or suitable storage battery; or separate generating unit may be considered the equivalent of such service.

It is apparent that the question of insuring the source of supply is one which is open to considerable discussion, involving, as it does, the reliability of the generating station and various classes of supply lines. Not only do the characteristics of service received from electric central stations and isolated plants have to be considered, but in some cases gas service and other illuminants.

It is evident that conditions of reliability vary considerably in different instances and that leeway must be allowed according to the merits of the particular cases. Where central station service is employed, it has usually been assumed that independent wiring to the street main provides a sufficient safeguard.

There is a tendency in some quarters to require the emergency lighting to be in operation whenever the regular lighting is in use. This comes from the apprehension of deterioration of unused equipment as well as the anticipation of failure to put the emergency lighting into operation instantaneously. In many cases simultaneous operation may involve an excessive expense. The provision of an automatic system, with reasonably frequent inspection and tests, should provide ample protection.

Where the system is not electric the automatic control may present more of a problem.

Most of the codes do not specify what intensity of lighting shall be provided. In New York State the emergency lighting is provided for in the law, while the code specifies one-quarter foot-candle as the intensity to be provided. This value, which might be implied from the intensity table, is being considered for inclusion in other State codes. It seems to be the reasonable value to require for exits, stairs, hallways and passageways, and also for the main aisles of large workrooms. It might, however, involve an unnecessarily high investment in lines and equipment, to provide such an intensity in all work space aisles.

*(To be concluded)*





Stained with Cabot's Stucco Stains  
Harland A. Perkins, Architect, Boston

### A Four-Year Record of Cabot's Stucco Stains

Gentlemen: Wakefield, Mass., November 11, 1911.  
Last spring I used over two hundred gallons of your Waterproof Cement Stains on Miss Boit's new house at Wakefield. This was a job I was very particular to have right, and I am glad to say your material has proved entirely satisfactory in every way.

JAMES F. SHERRITT.

Four Years Later:

In September, 1915, an examination of the Boit residence by an expert decorator showed that the Cabot's Cement Stains had worn so well and grown so soft and beautiful with age that he advised against re-coloring the stucco when the other parts of the house were painted. This is typical of the results obtained. These Stains tint stucco surfaces in soft, rich colorings that grow more charming under the action of the weather.

CATALOG SENT ON REQUEST

**SAMUEL CABOT, INC.,** Manfg. Chemists, Boston, Mass.  
1133 Broadway, NEW YORK 24 West Kinzie St., CHICAGO

Cabot's Quilt, Waterproof Cement and Brick Stains, Conserve Wood Preservative, Damp-proofing, Water-proofing

5-5

"A product without a peer"

## APOLLO-KEYSTONE COPPER STEEL Galvanized Sheets



Highest in quality and rust resistance. Unequaled for Culverts, Flumes, Tanks, Roofing, Siding, Spouting, and all exposed sheet metal work.

We manufacture Sheet and Tin Mill Products of every description—Black and Galvanized Sheets, Corrugated and Formed Products, Roofing Tin Plates, Etc.

AMERICAN SHEET AND TIN PLATE COMPANY, Pittsburgh, Pa.

## APPALACHIAN TENNESSEE MARBLE

has gone into the making of many of the country's finest banks and public buildings

A variety of colors and markings to suit each individual requirement

**APPALACHIAN MARBLE CO.**  
KNOXVILLE TENNESSEE

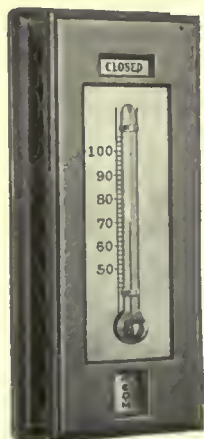

### Johnson "All-Metal" Thermostat Size 4 3/4 x 2 x 1



The Most Artistic and at the same time the most inconspicuous thermostat on the market.

It is a part of the Johnson system of heat regulation

**Johnson Service Co.**  
Milwaukee

## THE STANLEY WORKS

The oldest and largest manufacturers of wrought steel hardware in the world.

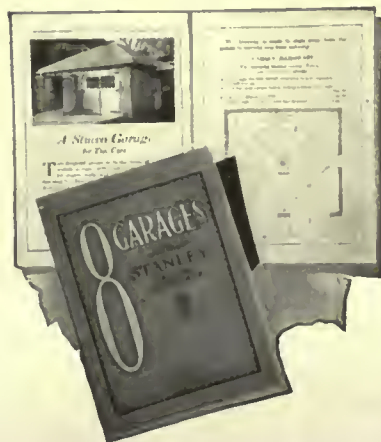

"8 GARAGES" is a booklet built around the illustrations, descriptions and plans of eight typical private garages. Your copy is waiting for you to ask for it. Gratis.

**THE STANLEY WORKS**  
New Britain, Conn., U. S. A.

New York Chicago  
100 Lafayette Street 73 East Lake Street  
"The Ball Bearing Halls for Permanence"



## Building Material Market Prices

(Continued from Page 764)

A digest of weekly reports showing the status of economic conditions vital to construction show that the labor supply is at present adequate and that returning soldiers are being generally employed without unduly disturbing the labor market. Real estate conditions are found to be excellent and mortgage money is easy. It appears that rents have almost universally increased from 10 to 50 per cent, with occasional excessive advances in business space strategically located, forced by the lack of construction in the past two years and the flow of labor to industrial centers.

Organized labor is making vigorous efforts to maintain the present wage scale but indications are that lower levels in some cases are bound to come. It is true that there are sporadic outbreaks, a few strikes and some professional agitation, which, however, can no longer be classed as extraordinary or preventable even under the most favorable circumstances. Workers leaving the Government service are thus far being quite generally reinstated in their old positions, and this without in any large measure displacing extra help taken on the last two years.

In the real estate situation the insistent demand for dwellings has literally forced a limited amount of home and apartment house building and vastly increased the rental demand for all available space. But whether labor or material costs hold at the present level or not the great need for new construction has forced the present building campaign, which before many weeks will develop into one of big proportions.

(From our Special Correspondent)

CHICAGO, ILL., May 26.—Commercial construction is about to start in this city. Inquiry among the architects shows that while many are busy designing low cost homes, more are at work on plans for stores, factories, warehouses,

and other commercial work. The permits issued daily also indicate that early June will see considerable speculative building under way, mostly apartment buildings.

The demand for all building materials continues to show steady gains as the season advances. Manufacturers say that while the dealers are not buying in exceptionally heavy volume individually, the demand is more widely spread and is coming from practically all consuming territories. It is evident from the size of orders that dealers are not any too anxious to replenish stocks heavily at present prices. They are buying to meet the present demand.

Lumber is advancing in price, with stocks exceptionally scarce at the mills, and dealers and wholesalers are experiencing difficulty in finding items suitable to fill their requirements. Oak and maple flooring is in better demand, with prices exceptionally strong. Further advances have been made on yellow pine and fir from the mill to the consumer. Brick, cement, lime, sand and gravel are all holding firm in price. The same is true of metal goods, including pipe, fittings and all plumbing and steam heating supplies.

Competition continues strong among the dealers in all lines of material. Contractors are taking advantage of this condition in the buying. But in consequence of curtailed production regulating the supply, any price cutting at this time is not of sufficient moment to have the effect of causing a break in any of the material markets.

"We believe it to be our duty as public officials to advise the public not to delay building projects in the hope that prices will come down materially. We do not believe they will," was a part of the report of the committee recently appointed by the Illinois legislature to investigate building material prices. Its members started out in the belief that prices of building materials in Illinois were too high, but after holding a hearing in Chicago, before which representatives of the various building industries testified, they were "driven to the inevitable logical conclusion that existing prices would not decline materially and that these prices express a new and substantially a permanent level upon which present and future business must be conducted. Reconstruction can only be accomplished in its real sense by every citizen subscribing to the doctrine 'Buy now, build now.'"

(Price quotations now current on building materials and supplies as quoted by dealers and jobbers for delivery in New York and Chicago follow. The quotations set forth are placed before readers of THE AMERICAN ARCHITECT to afford an accurate review of market conditions rather than for use as a basis for actual purchase. They will not only provide knowledge of the exact state of the market as to items quoted, but will also present a basis to judge conditions as affecting co-relating materials. Items marked (\*) indicate an advance over last week, while those marked (†) record a decline. Other prices did not fluctuate during the week.)

	New York	Chicago
<b>BRICK</b>		
Face brick (delivered on job):		
Common (Delivered at job in Borough of Manhattan only), per thousand.....	\$17.85	\$12.00
Rough red .....	37.00	.....
Smooth red .....	37.00	.....
Rough buff .....	42.50	.....
Smooth buff .....	42.50	.....
Rough gray .....	45.50	.....
Smooth gray .....	45.50	.....
Colonials .....	25.00	.....
<b>BROKEN STONE</b>		
(Delivered on job):		
1½ in. per cu. yd.....	\$3.25	\$2.35
¾ in. per cu. yd.....	3.25	2.35
<b>BURNED CLAY</b>		
(Delivered on job)		
Block partition:		
3 in., per sq. ft.....	.18	.10
4 in., per sq. ft.....	.20	.11
Chimney tops:		
12 x 12 for 8 x 8 flues.....	\$3.50	\$2.25
Flue lining:		
4 ft. x 8 ft., per ft.....	.18	.12
4 x 12, per ft.....	.22	.16
8 x 8, per ft.....	.22	.16
8 x 12, per ft.....	.27	.20

	New York	Chicago
12 x 12, per ft.....	.35	.28
8 x 18, per ft.....	.40	.32
12 x 18, per ft.....	.49	.42
18 x 18, per ft.....	.67	.55
Wall coping (double slant):		
9 ft., per ft.....	.24	.14
12 ft., per ft.....	.27	.18
18 ft., per ft.....	.36	.30
Wall coping (single slant):		
9 ft., per ft.....	.26	.17
12 ft., per ft.....	.30	.22
18 ft., per ft.....	.42	.35
(Corners and angles four times the price of one foot of coping the same size.)		
<b>Hollow Tile</b>		
(Delivered at job, in New York below 72nd St.)		
2 x 8 x 12 partitions, per 1,000 sq. ft.....	\$70.15	.....
3 x 12 x 12 partitions, per 1,000 sq. ft.....	102.00	\$67.90
4 x 12 x 12 partitions, per 1,000 sq. ft.....	114.75	72.50
6 x 12 x 12 partitions, per 1,000 sq. ft.....	153.00	99.60
8 x 12 x 12 partitions, per 1,000 sq. ft.....	.....	135.80
10 x 12 x 12 partitions, per 1,000 sq. ft.....	.....	167.50
12 x 12 x 12 partitions, per 1,000 sq. ft.....	.....	194.60
2 x 12 x 12 split furring, per 1,000 sq. ft.....	63.75	.....
<b>CEMENT</b>		
Per bbl. in 15 cent bags (Rebate 60c. per bbl. for bags) .....	\$3.25	\$2.80
<b>COPPER SHEETS</b>		
At the mill, hot rolled, 16 oz. base-price, per lb...22½c.		22½c.
(From jobber's warehouse add 2 to 3 cents. Cold rolled add 1c. per lb. to hot rolled.)		
Per foot .....	.05	.05
<b>CORNER BEAD</b>		
Per bushel .....	.30	.30

187  
after p 788

# The AMERICAN ARCHITECT



CIVIC MUSEUM, VENICE

PUBLISHED WEDNESDAYS IN NEW YORK—FOUNDED 1876  
VOLUME CXV                      JUNE 4, 1919                      NUMBER 2267

Entered as second class matter January 6, 1909, at the Post Office at New York, N. Y., under the Act of March 3, 1879. Publication office, 243 West Thirty-ninth Street, New York, N. Y. Subscription price in the United States and Possessions, \$10.



# BISHOPRIC SHEATHING



## First 40 Houses; Then 10 Houses; Then 50 More Houses

Irvington, N. J.

Gentlemen:

Have specified and used your stucco board on some 40 or more houses built in the Weequahic Park section of Newark and elsewhere and have always obtained the best of results.

We did not hesitate to again use same on 10 houses of the 60 for the Mesa Housing Proposition that are now nearing completion at Irvington, N. J.

When your representative first spoke to us about your Bishopric Sheathing we kept it in mind. As you know, we ordered two car-loads of it, enough for the other 50 houses for the above-mentioned Mesa Housing Proposition.

We are using it under shingles, wide and narrow clapboards, etc. Although somewhat skeptical at first about placing shingles over your sheathing, thinking it would be springy, we are no longer, this idea having long since disappeared. We find it everything ordinary sheathing could be and more. Being easy to handle, the carpenters liked putting it on.

Seeing its possibilities and the economy in using it, we will not hesitate to bring it to the attention of any of our clients who, in the future, expect to build.

Yours truly,

STROMBACH & MERTENS,  
Engineers and Architects,  
Victor H. Strombach.

An Engineering and Architectural firm which does big things in New Jersey has written us regarding its experience with Bishopric Sheathing on 50 houses it built in connection with the Mesa Housing Project at Irvington, N. J. Read the letter. It is more significant than anything else we could say about this modern Sheathing Board.

Note the list of institutions which have used Bishopric Sheathing either on Industrial Housing or Home Building projects:

Youngstown Sheet & Tube Company, Youngstown, Ohio; Virginia Shipbuilding Corporation, Alexandria, Va.; American Clay Machinery Company, Bucyrus, Ohio; F. C. Mesa Munitions, Irvington, N. J.; Hamilton, O., Home Building Co.; Petroleum Iron Works, Petroleum, Ohio.

**The Bishopric Manufacturing Co.**  
904 Este Avenue Cincinnati, Ohio





772 4



INTERIOR, CHURCH OF SS. GIOVANNI E PAULO, VENICE



# THE AMERICAN ARCHITECT

VOL. CXV

WEDNESDAY, JUNE 4, 1919

NUMBER 2267

## Allerton House

ARTHUR LOOMIS HARMON, *Architect*

ALLERTON HOUSE, illustrated in this issue, presents not only an attractive and well considered architectural solution of the often recurring problems of life in large cities, but it also affords opportunity to consider an interesting and satisfactory working out from a sociological standpoint of certain phases of the housing problem in New York City. There can be no doubt that man is very largely influenced by the character of his surroundings. In New York there are a large number of single men engaged in the professions and in the more important activities of commercial life, who have for a long time looked for just such living accommodations. Many of these men come from the smaller cities and larger towns, and some from the country, and among surroundings like these become merged into a social whole to form a community remarkable for its homogeneity and a certain *esprit de corps*.

It is interesting to note that the modern business men in large cities are becoming as keenly interested in the question of environment of their various employees out of office hours as are the manufacturers who seek to provide attractive working surroundings in addition to the best elements of modern housing.

This new venture has proved the business sagacity of its originators and promoters and from the start has been a successful commercial enterprise. There is no doubt that this fact will influence the erection of similar structures in our large cities and it is therefore believed that the working out by architects of problems that were presented and that have been so satisfactorily perfected, will afford an interesting and valuable basis for other men who may undertake a similar class of work.

This building has been erected on an interior lot approximately 71 x 100 feet and is seventeen stories high. Owing to the restrictions of the new



DETAIL OF ROOF GARDEN

zoning law in New York which took effect after the building was planned, the upper stories will be left exposed on all four sides. As will be noted, the architect has treated the building as far as possible as a tower, adopting a symmetrical plan and providing a nearly uniform wall surface treatment for all four sides. As economy of construction was a necessity in this project, there was selected a certain common red brick which was used on the front. The impossibility of providing a projecting cornice treatment except on the street front led to a treatment similar to that of mediæval Italian

## THE AMERICAN ARCHITECT

towers with a restricted use of red terra cotta trimmings. The main façade of the brick shaft on the street rises directly from a low granite base, which stone is used to trim the openings of the first floor. On the street façade the brick has been laid up with projecting headers to accent the slight vertical lines of the shaft and with wide and irregular joints.

It was difficult in superintending this job of bricklaying to get the masons to understand just what effect was desired or to get them to agree

able to produce more often an artistic result such as is shown in the brick work on the façade of this building.

In the designing of the interior and the arrangement of the plan, the architect has endeavored to get as far away as possible from the usual hotel aspect and to create an atmosphere more nearly akin to that of the private club. For this reason the lobbies have been kept small, the office has been put behind the elevators with circulation to it around that space, and the main feature of the in-



ENTRANCE LOBBY

to what they stoutly maintained was an unworkmanlike result. They were therefore told to "make a bad job of it." The foreman finally agreed to do this with the understanding that his name was not in any way to be connected with the laying of brick in such a way. This incident is set down here simply to illustrate how often it is difficult for architects to secure an artistic interpretation of material by a class of labor which stoutly maintains that it is "skilled" and which cannot visualize any result that departs from a hard and fast rule of their craft. When we shall have developed a higher state of craftsmanship, we shall, it is hoped, be

terior, the large lounge in the rear which extends for the full width of the building lot and through two stories in height, is located on this floor. On either hand, off the lounge there is a small writing room and library with clearstory windows over. The treatment is that of an English Hall of the early Renaissance, with panelling below and rough plaster above, and a beamed and panelled ceiling. As there is no outlook, the glass is not transparent and has therefore been treated in a purely decorative manner in two or three slightly varying shades, with interesting leading, and the occasional placing of well selected spots of color.



## THE AMERICAN ARCHITECT

This interesting window was designed by Clement Heaton.

The building has approximately 400 rooms, a typical floor containing thirty rooms. The larger and better located rooms have a shower and toilet between each two rooms, while for the remaining rooms the showers and toilets are located in convenient groups in the corridors. There is a lavatory in each room.

An interesting feature of this development is to be found in the planning of the roof. On reaching this point the elevator stops in a solarium treated in pebbled plaster with rough brick trim. Over the rear wing at a lower level is a larger gymnasium lighted from clearstory windows on three sides. Over the front wing facing the south and reached from the solarium by a short flight of steps is the roof garden. This is enclosed by the arcade columns forming the crown of the building. This screen gives the effect of an enclosed garden treatment breaking up the otherwise too wide outlook into interesting individual glimpses of the city. The floor of the roof garden



LIBRARY

is built up on the beams so as to leave pockets for earth for planting at the sides.

The present Allerton House is the third of a group of similar name that progressively have



RECEPTION ROOM

## THE AMERICAN ARCHITECT

marked the development of this housing scheme in New York. The first Allerton House was located in the Greenwich Village section and was a modest structure of fifty rooms. The name of Allerton was selected because the building was located on the spot where once stood the farmstead of one

ness activity on the East Side, near Peck Slip. When the second Allerton House was built, at Thirty-eighth Street and Lexington Avenue, the site was yet within the region that is most intimately connected with Manhattan Island's early history. It was within an easy stone's throw of the Old Bouwerie, or Bowery, the one-time important thoroughfare that led by a winding road and shaded lanes to the undeveloped country that composed Manhattan Island to the north.

The third and present Allerton House, on Thirty-ninth Street, has found a site but a few short blocks away from its predecessor and it is where old New Yorkers walk of pleasant Sunday afternoons and view with reminiscent eyes a neighborhood that at one time was the scene of ultra fashionable Murray



LOUNGE FROM LIBRARY

Isaac Allerton, who journeyed to this country in the *Mayflower* and located in Greenwich Village. The Allertons were a thrifty family and their farm became one of the best developed on Manhattan Island. Later, certain members of the family entered into commercial pursuits, and the warehouse of Allerton for many years was the center of busi-



ELEVATOR LOBBY

Hill. While this particular section may not have retained the artistic atmosphere that is claimed or affected by dwellers in Greenwich Village, or that more certain artistic environment that is so well sustained in the Gramercy Park section on the South, it has a preference for the sturdy and solid things of life, the substantial elements that built New York to its present prosperity.

If, as was claimed at the outset, environment has a strong effect on the character and the contentment of people, they who frequent Allerton House should find all of those desirable things amidst surroundings that have been carefully planned and excellently carried to conclusion.



# Garage and Entrance Turns—Part II

By A. D. TAYLOR, *Landscape Architect and Town Planner*

## C—"Y" TURNS

"Y" TURNS are so-called because in changing direction in the least available space, the wheels of the car leave the outline of a Y. Numerous forms are made more or less

Example 9 is probably the turn best adapted to cars of short wheel base. The dimensions of 16 ft. from the door along the line of the front, and 17 ft. at right angles to this line to the inner point of the reversing space are ample for the average small



Photo. 1.—The normal problem with a small garage and limited lot. See photo. 2 and Fig. 8.



Photo. 2.—Showing the general relationship of the house to the garage on a small lot. See photo. 1 and Fig. 8.

complicated because of the requirements imposed by the direction of approach and number of cars in the garage.

This type is made necessary primarily by the introduction of garages on small lots where every effort is made to secure maximum service on a minimum area. Such turns are often necessary because of limited space, and again because the landscape effect produced is more to be desired than that of an oval or a court. They occur primarily at the garage entrance, and may be broadly subdivided into turns where the approach is:

- (a) Directly from the front;
- (b) Diagonally from the front;
- (c) Parallel to the front.
- (d) From the rear parallel to one side of the garage;
- (e) From the rear diagonally.

### (a) DIRECTLY FROM THE FRONT

Under the first are Figures 8, 9 and 10, showing the simplest form for one and three car garages.

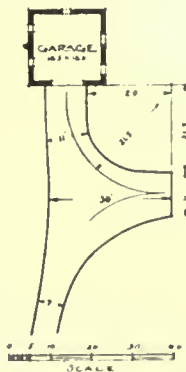

FIGURE 8

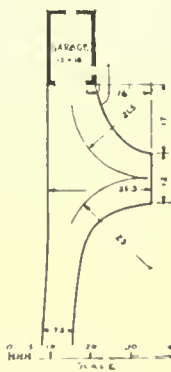

FIGURE 9

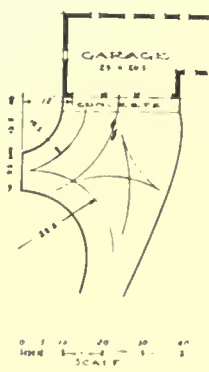

FIGURE 10

car where the wheel base does not exceed 120 in. It is to be noticed that they are less in the three-car example, as it has a wide court before the three doors.

It may be well to state here that the position of the large and small cars in the berths may enable one to reduce area in the turn. In Figure 10 the large car would best be in the right-hand berth, the small car in the middle berth and the electric runabout in the left-hand berth. If the large car is to be kept in the left berth, dimensions of the "Y" must equal those shown in Figure 8. Care on this point will

always give better results and often solves a problem of restricted area. This example unfortunately is a case of restriction by large trees and a property line.

### (b) DIAGONAL FRONT APPROACH

The nature of the location in Figure 11 and the proximity of property lines in Figure 12 resulted in diagonal approach well shown in the illustrations. In Figure 11, space "S" within the dotted





Photo. 4.—An interesting treatment in the location of a three machine garage. See photo. No. 5 and Fig. 18.



Photo. 5.—Preserving a maximum of space for the garden and allowing a minimum of space for the drive. See Fig. 18.

line is for parking of extra car. It is not necessary for the convenience of turning. In Figure 12, are evident all the refinement of curve and variation in width to allow standing and passing cars at the front door, easy access to and exit from garage, and liberal space for reversing direction of travel within the least practicable road area. The full curve just beyond the steps is necessary to bring the rear of the car close to steps. A banked drive in place of the ordinary crowned road is a distinct advantage here, as fitting the driveway curve, and



Photo. 8.—The ideal treatment of a garage for machines of small wheel base. See Fig. 9.

the natural slope for drainage away from the buildings.

(c) APPROACH PARALLEL TO THE FRONT

This example shows an easy solution when the drive is located well in front of the line of the garage, for an easy curve of approach and a reversing area of our normal measurements are all that are required. Small car berth is in stall "A."

The second example is more difficult of solution, as the driveway axis is but 12 ft. away from the line of the front of the garage. Here the wheel tracks in actual trial were the guiding element in the final design. Additional width was provided before the house entrance, while the straight short

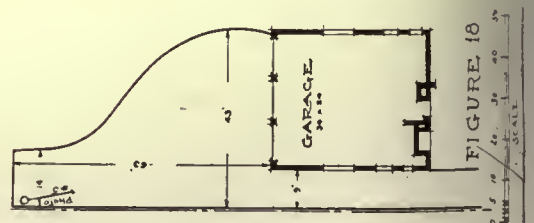
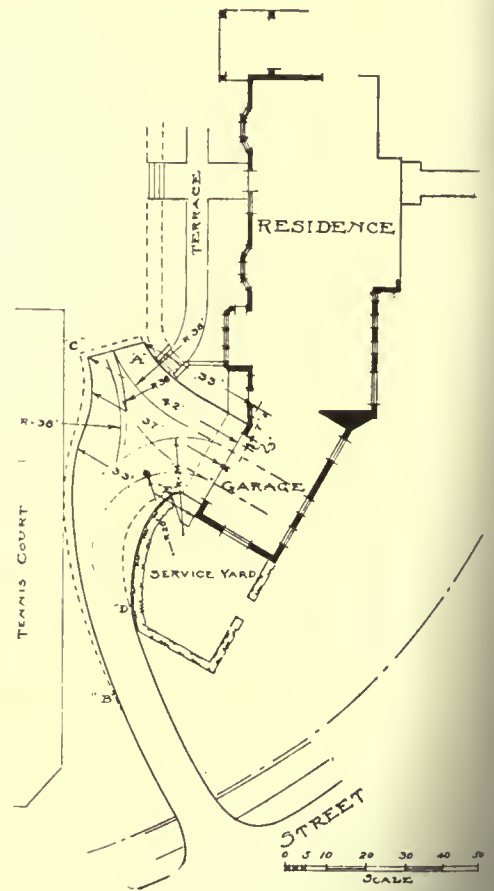

drive was kept to 10 feet in width. The large turning court allows any car to take any berth in the garage and provides considerable parking space for visiting machines and is not wasteful of valuable area. Planting has so screened it, as the illustration shows, that it appears small, the photograph being taken from a point just beyond the house door, yet does not show the right-hand side of the court. The designer may be asked why he did not formalize this turning area with a dignified rectangular court. A careful study of the illustration and photograph will show clearly that in order to

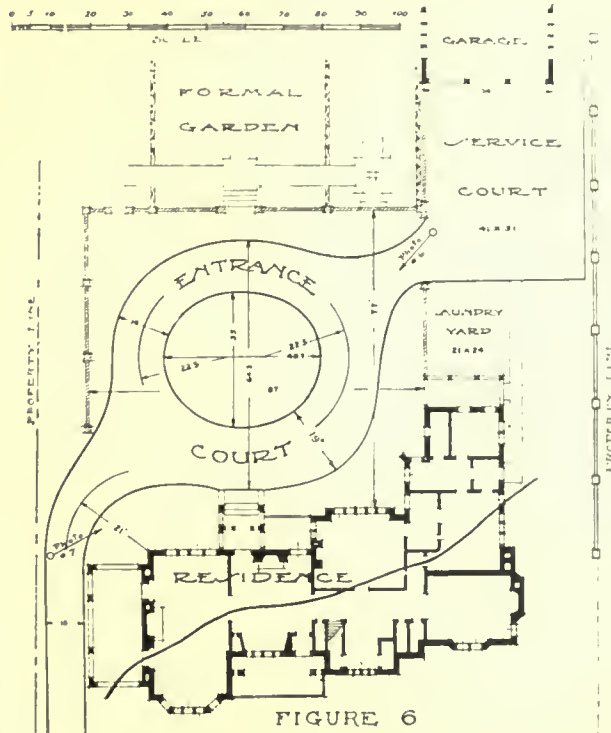

make this area into a court and still preserve ample space for parking, the area consumed by the design would have been much greater and the waste largely increased.



Photo. 7.—Placing the garage on the living side of the house in a restricted area and developing a proper relationship between the garage turn and entrance turn. See Fig. No. 6.

(d) APPROACH FROM THE REAR PARALLEL TO ONE SIDE OF THE GARAGE

This type is becoming the commonest problem of modern architects and landscape architects, and is due to the prevailing desire to attach the garage to the rear of the service portion of the house on ordinary suburban lots of restricted width. In "Y" turns designed to meet the requirements imposed by parking of an extra car, it will be noted that the parking space is in the apex of the turn. Types shown in Figures 15 and 18, with a spur preferably not less than 14 ft. in width, are more practicable for this purpose.

The simplest form, here shown, and one which will be frequently encountered, is that of a new garage attached to an old house in the only avail-



Photo. 6.—Meeting the requirements of a commodious and attractive entrance turn within a limited space. See Photo. 7 and Fig. No. 6.

able position wherein fine trees would not be sacrificed. While the turn is somewhat restricted by other trees, a satisfactory and minimum area is given for all necessary maneuvers, and the whole is splendidly away from the living area of the house and lot.

The next example is quite similar in type but



Photo. 9.—Different solution of a troublesome problem within a limited space to meet the requirements of a three machine garage.







not interfere with use of the turn, but enlargement to the dash line B-C would improve the turn were there ample room on the lot. The dash line D-E can be adopted as shown to reduce roadbed to a minimum and provide space for a better screen planting of shrubbery.

D—COMBINATION OF OVAL & "Y"

A five-car garage requires a large expanse of court, and in Figure 20 is shown an island which

should never be less than 35 or 40 ft. The radius of curvature for grades exceeding 6 per cent should never be less than 50 or 60 ft. On roads which exceed these extremes, the efficient operation of a pleasure car is seriously handicapped. In photographs Nos. 16 and 17 are shown interesting types of curves on entrance drives. A most pleasing effect on sharp degrees of curvature is that resulting from "banking" the drive. The curved lines of the drive are better emphasized,

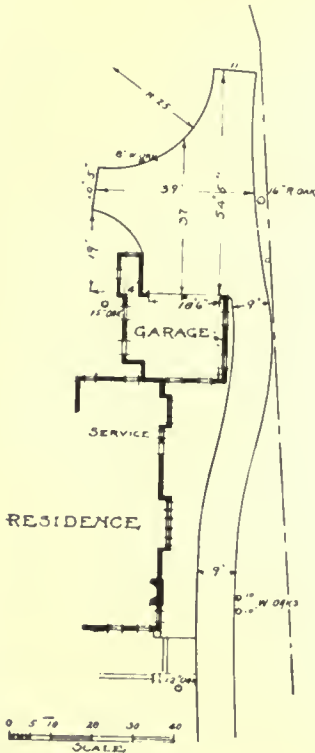

FIGURE 15

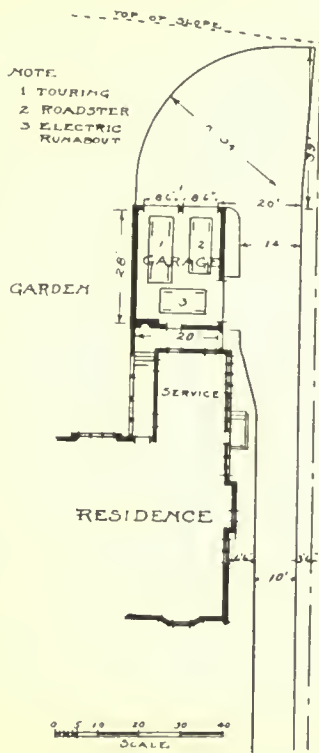

FIGURE 16

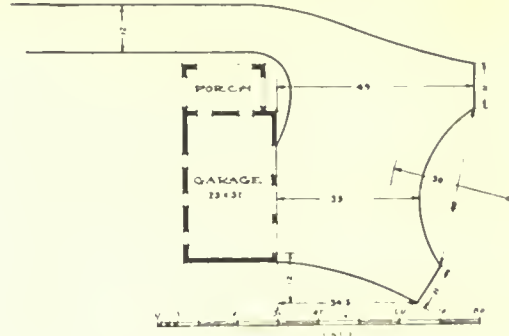

FIGURE 17.

and the wear on the roadbed from frequent or rapid traffic is much less, and the curve is easier for the driver than on the road with the ordinary crown. The ordinary crown on an entrance drive is  $\frac{1}{2}$  in. to the foot. A 16-ft. road would, therefore, have approximately a 4-in. crown. All roads on grades of less than 4 per cent should have at least an 8 to 10-in. bank on the curved portions. On steep grades as high as 8 per cent and with sharp curves, the bank of a 16-ft. road should be not less than 16 to 20 in. Good practice calls for an increase of width on sharp turns, particularly in the case of steep grades. This widening should commence 50 ft. before the sharper curve begins, increase up to 25 per cent of the road width in the depth of the curve, and taper out of 50 ft. beyond the end of the curve.

Considerable study has been given to the possi-

was heavily planted and served three purposes. It reduced the extent and cost of road metal, it gave a convenient loop for service vehicles, and provided opportunity for the high planting to partially screen the garage front from the house and entrance gate in the lines of sight shown by arrows A and B.

Two or three photographs have been introduced into this article in order to bring out one other interesting and closely allied point in the designing of entrance drives. There are numerous entrance drives on private estates, which, with careful consideration, could have been made very interesting and pleasing, but which possess extremely awkward curves, both from the standpoint of looks and from the standpoint of operating a car easily. The radius of curvature on entrance drives bears a direct relationship to the grade of the road. This radius on grades of less than  $4\frac{1}{2}$  to 5 per cent



Photo 16.—Sharp entrance drive curves should be safeguarded by ample width of road-bed.

bilities of drawing from accumulated data definite fundamental principles which may be applied to all garage turns. The subject, which seems simple, is in reality so complicated that it is much better to make a few general suggestions than to endeavor to cover fully the field of possibilities. The latter course would only serve to confuse the amateur and perhaps the professional designer as well.

1. It is not possible to establish precise diameters of turns for cars of different wheel bases under the present conditions of manufacture. Possibly the manufacturers will eventually arrive at a point where a car of short wheel base and a car of long wheel base will turn in proportionately varying diameters.

2. The width of the drive opposite main entrance steps should be no less than 15 ft. to allow one automobile to pass with comfort with another car waiting before the entrance.

3. The depth of the "Y" turn measured perpendicularly to the face of the garage, and directly opposite the doors, should not be less than 33 to 35 ft. for large machines. (See Fig. 17.) Outward swinging doors call for an increase in this dimension equal to the width of the door itself.

4. The minimum measurement across a "Y" turn, parallel with the front of the garage, from one side to the end of the "Y" for a car of long wheel base, should be approximately 30 ft., and for cars of shorter wheel base should be approximately 25 ft. (See Figs. 8 and 9.)

5. Much more consideration than is frequently the case should be given in locating a garage to

the possibilities in the development of the turning area. One factor to be considered is the type of door to be used, as it is evident that the use of sliding doors will minimize the amount of ground devoted to this purpose. Another factor is the relative arrangement of the long and short cars in the garage berths.

The providing of sufficient space for the turn, in addition to that required by the garage itself, is oftentimes such a dominant factor as fundamen-

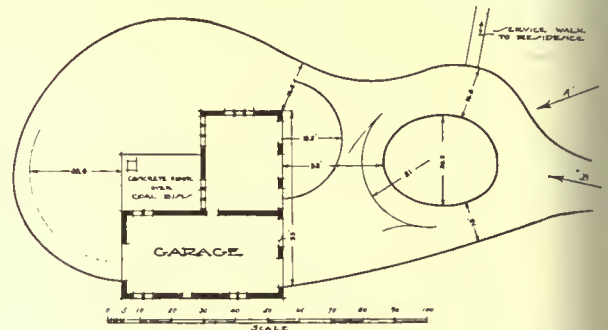

FIGURE 20.

tally to influence the planning of the position of the garage, even to the extent of modifying the location or orientation of the residence itself, and thereby the design of the entire composition. The whole matter should receive attention at the time of the determination of the arrangement of the major features of the estate, and not, as too often the case, as an incidental item in connection with the finish grading of the areas about the buildings.



Photo. 17.—A variety of interesting road curves is often the charm of many estates.



# England Revives Art in Industry

In the past century many British manufacturers recognized the importance of art in industry, writes Captain B. S. Townroe. The pottery made by Josiah Wedgwood, and the furniture created by Chippendale are still famous throughout the world. Recently, however, a soulless commercialism, aiming at dividends, has turned out thousands of articles on the same pattern, at the cheapest price, regardless of æsthetic quality or artistic design. Industry, careless of the traditions inherited from the craftsmen of former generations, has divorced craft. Those who are guiding British industry during the present period of reconsideration and reconstruction, are determined to bring them together again in the national interests.

A brief study of the steps which are being taken to encourage manufacturers to use the imagination and art of the craftsmen, will not be without interest to those Americans who have studied John Ruskin's efforts in the Mid-Victorian era to secure that the cheapest machine-made articles of trade be designed with art. He wrote in 1859:

"Let it be for the furnace and for the loom of England, as they have already richly earned, still more abundantly to bestow comfort on the indigent, civilization on the rude, and to dispense, through the peaceful homes of nations, the grace and the preciousness of simple adornment and useful possession."

Already in England and Wales there are some 200 schools of arts and crafts, which it is hoped will be the backbone of training in the application of art to industry. These schools are influencing furniture manufacturers to depart from the sham antique, textile weavers to turn out beautiful designs, and glass and dress and china to be made in good styles. In fact citizenship and workmanship are advancing together. At the Central School of Arts and Crafts in London, for example, a scheme has been introduced, both to raise the standard of English music-engraving, and to develop a trade which up to the war was largely in German hands. Under the new British education act there is ample opportunity for the establishment of day technical schools to provide for boys and girls between 13 and 16 years of age a pre-apprenticeship education in craft.

Unfortunately there is the same difficulty in Great Britain as occurred in the United States in 1910. In that year the report of the American

commission of labor stated that "the old system of apprentices has died out," and the "present system of specialization confines a beginner to one machine, or one operation." "The individual worker finds his life narrow and monotonous, his work a mere round of drudgery instead of a means of self-expression." In America this crisis was faced 10 years ago; the British are only beginning to face it today. Education is aiming at making the artist a better craftsman, and the craftsman a better artist, and, equally as necessary, at teaching the middlemen and the shopkeepers to understand what they sell, and to desire a higher standard. Yet ultimately a nation's trade reflects its character, and only the buying of an educated public can influence production. Purchasers have to be taught not to take nasty things home and live with them, but to create a demand for good work.

There are definite agencies at work to foster this better spirit, for in the future employers and employed are to be brought into co-operation on the Whitley councils, new democratic conferences, now being set up in all parts of Great Britain. Similar committees have existed in certain trades in the north of England for some time, and have improved the designs in book production, jewelry and kindred trades. In addition design and industries exhibitions are touring the country with specimens of fine workmanship, and a recent private exhibition this spring has already had a far-reaching influence. Further, the board of trade and the board of education are proposing to establish a British institute of industrial art, which will provide a permanent exhibition of work, showing a high standard of original design, and will also develop machinery to bring designer and art workers in closer touch with manufacturers. Special works of art are to be purchased by the state and special scholarships provided for research and experiments.

King George once said, "Wake up, England." His words did not seem to have much effect at the time, but the war has stirred even Rip Van Winkle. The British are at least awakening to a realization of the place of art in industry. Producers, craftsmen, distributors and consumers show signs of demanding quality as essential, both for industry and the nation. If this spirit is translated into action, we may see a new renaissance in the old country.

# An English Review Of American Architecture

**A**N exceedingly entertaining and well-informed contributor to *The Architects' Journal* of London, writing under the pseudonym of Aero, tells in the issue of March 26 the thoughts that were revived when he came across in a portfolio of an architect friend a bundle of snapshots the contemplation of which results in an exceedingly interesting retrospection of American architecture. He writes:

The other day, while searching among the portfolios of an architect friend, my fancy was caught by a brown-paper parcel. It was not a respectable package. The string was knotted, the paper was frayed at the edges; but somehow the packet had the look of having been neglected long enough to prove interesting. The legend on the cover, "World's Fair, Chicago: Snapshots Taken in 1893," whetted my curiosity still more. As I went through the photographs and sketches, the conclusion was forced upon me to rediscover America at leisure, so the package found its way to Tothill Street, and this week provides material for my causerie.

\* \* \* \*

For the past twenty years we have lived in the shadow of American architecture, and a very big shadow it is. No wonder we talk wildly about our insularity. Yet I sometimes wish that the wiseacres who imagine the buildings of this country to be all that could be desired would hire telescopes of abnormal power and take a nearer view of the American horizon. They would in all probability amend their paroehial ideas. It is not my purpose to generalize or sermonize, but to talk of the rise of architecture in America from the seventeenth to the twentieth century. For a hundred and sixty years building remained traditionally Colonial in expression, but pre-eminently British in pedigree. The men who settled on the east coast and founded the towns, as well as those who started the plantations in the South, did their best to transplant building idioms with which they were familiar. A great number of timber-framed houses were built in the early days, with the consequence that proportions were slightly changed. Merchants imported bricks by the shipload from England and Holland for their own and other people's use; as a result houses were often delayed in finishing, but each year witnessed a slight change in design, or some addition to the comfort of home life, which was reminiscent of the distant motherland. As the years progressed a high

degree of efficiency in construction was attained. Later on came the German settlers, who built Germantown, and the French colonists, who settled in Louisiana. The scale of the country stamped the architecture from the outset. The housing question was handled with dexterity, for it was a primary need. Then came the time of Independence, which, curiously enough, did not disturb either emigration or the flow of architectural ideas from England. At the end of the eighteenth century the building vernacular in the settled parts of the States had assumed definite lines—the development of civic buildings followed as a matter of course.

\* \* \* \*

In Washington's day a man of average intelligence, referring to Batty Langley's or some other work, was able to design a moderate building. A lawyer could direct the erection of Independence Hall at Philadelphia, or a doctor could build a church on the Gibbs model. The days of Jefferson, Latrobe, Hoban, Isaiah Rogers, and Strickland were to follow. I think my readers will concur with the statement that even as late as the year 1840, when Ithiel Town was an influence, architectural inspiration from England was accepted as a matter of course. After this, when Richardson stirred the country with his original thoughts, producing fanciful conceptions in the Romanesque manner, and inspiring a host of feeble imitators to track his steps, a further change took place. The Civil War was no sooner over than there ensued a veritable Reign of Terror, particularly in domestic work, which lasted into the late 'eighties. All this experimenting was destined to be changed, for new leaven was at work. About this time our American cousins turned their thoughts to France. Several New York architects had had the advantage of training at the *École des Beaux-Arts* in Paris; others not so fortunate subscribed to the *Croquis d'Architecture* published by the Intime Club; a good sprinkling of Frenchmen had emigrated to New York after the war of 1870, and these found immediate employment as designers, construction being left to the English. From this it will be gathered that the times were ripening for changes both fresh and drastic. The truth is, America was becoming a World Power. To what end must the chimneys of Pittsburgh smoke, New York rise, and Washington legislate if no means could be found to express these facts in literature of stone?

(Continued on page 787)



THE AMERICAN ARCHITECT

Founded 1876

PUBLISHED EVERY WEDNESDAY BY

THE ARCHITECTURAL AND BUILDING  
PRESS, INC.

No. 243 West Thirty-ninth Street, New York

E. J. ROSENCRANS, PRESIDENT AND TREASURER  
WILLARD C. HOWE, VICE-PRESIDENT

WILLIAM H. CROCKER, Editor  
EDWARD F. HAMMEL, Engineering Editor  
ARTHUR T. NORTH, Western Editor

Subscriptions in the United States and Possessions,  
Mexico and Cuba, TEN DOLLARS. Other Countries,  
TWELVE DOLLARS.

SINGLE COPIES (Regular Issue) 25 CENTS

CHICAGO OFFICE, Mallery Building  
PAGE A. ROBINSON, Western Manager  
ST. LOUIS OFFICE, Wright Building  
CLEVELAND OFFICE, Guardian Building  
SAN FRANCISCO OFFICE, 320 Market Street

Owned by United Publishers Corporation—H. M. Swetland, President;  
Charles G. Phillips, Vice-President; W. H. Taylor, Treasurer;  
A. C. Pearson, Secretary. Entered as second-class matter January  
6, 1909, at the Post Office at New York, New York, under the Act of  
March 3, 1879.

VOL. CXV

JUNE 4, 1919

No. 2267

Why Not Get Busy?

JOHN THOMAS SIMPSON in his recent book, *Hidden Treasure*, states that what led him to write that interesting story of farm life was the facts learned on a visit to the old farm where he had lived as a boy. Not a single boy of his former acquaintance was to be found on the neighboring farms, and even the names of the original owners had, in some cases, been forgotten.

Undoubtedly the case in that specific locality is duplicated in many another, and it is also undoubtedly true that this great hegira is due more to the general unattractiveness of farm life than to any other cause. If we are to preserve the continuity of occupation, to hand down from father to son the wide domain of our farm lands, we must certainly redeem life on the farm from the many dreary aspects that so often surround it. The most certain way to keep our young men and women on the farm is as far as possible to improve every feature of the farmer's domestic life, and to promote some social atmosphere, the absence of which is creating so wide a difference between country and urban life.

IT is unreasonable to expect that we may succeed in an effort so laudable if better houses and better farm buildings are not provided. No man or woman can form and carry forward worth-while ideals among conditions on the farm as at present they generally exist. It is unreasonable to expect the pride of home or any lure to younger people where the houses suffer in comparison with those of town dwellers in no better circumstances. Small wonder that farmers' sons and daughters regard with dissatisfaction a future that holds so few allurements. And, small wonder that the farmer's wife, tired of drudgery that comes from the lack of ordinary domestic conveniences and labor saving things, should lose interest in her surroundings and give ready consent that her children seek other fields rather than to carry burdens similar to those which are making her life one sordid round of daily toil.

THE improvement of our farm buildings is a matter of great importance. The whole future of our agricultural prosperity hangs on this very necessary thing. The matter has been discussed for a long while in these columns, it has been taken up by the Institute on the recommendation of George W. Maher, president of the Illinois Chapter. The Governors of the leading agricultural States have signified by letters to the editors of THE AMERICAN ARCHITECT their approval of this movement, and those in charge of our agricultural colleges throughout the United States have also signified a very active interest. Many of these communications have been printed in these columns. All well and good. But why should a matter so generally approved among those who might be expected to take the initiative, be further allowed to languish?

IN our issue of March 12, there was outlined a plan that it was suggested might be followed in setting this matter forward. Briefly it was by commissions appointed by the Governors of the various States. These commissions were to be non-political and composed of representatives of architectural and engineering professions, bankers and real estate operators. This plan received the endorsement of the Illinois Chapter of the Institute, and as stated, has also been concurred in by the Institute at its recent convention.

This is identically the time of the year when such a commission could proceed with some measure of good results. If every Chapter of the Institute will give energetic action, and if all the agricultural colleges will freely co-operate in an appeal to the various governments, we shall be able to set this very desirable matter afoot. Why not get busy at once?

## Labor Value Measured by Production

THE true value of labor is the wealth it produces, and the lower the production, the less there is to share in the community. This is the point of view of W. C. Teagle, president of the Standard Oil Co. of New Jersey, a corporation which employs more than 11,000 men.

To a greater extent than ever before does the problem of labor inject itself into every economic question. By what terms shall we describe a labor system that permits thousands of people to suffer for want of proper housing, while labor all over the country is seeking employment?

Restricting the law of supply and demand has in the past been so insistently practiced that it has become accepted by labor as the rule and guide of their organizations. Seeking to maintain high cost by restricting supply is now demonstrated as fallacious. The reacting influence is shown to be always detrimental to labor. Labor is beginning to learn this salutary lesson, and further to realize the error of many of their stoutly maintained contentions. It is productivity that really is the test.

Pomeroy Burton, of England, in an address on labor conditions in that country, has clearly pointed out that the chief errors of trade unionism have been the deliberate and persistent policy of restricting output and the opposing of the introduction of labor saving machinery. He directed attention to the relatively greater prosperity of the United States, and stated that it was because the average production per workman in the United States was three times that in England.

A FACTOR that in the not distant future, when we resume our normal activity, will have a large influence on labor conditions in the United States is that there will exist in all lines of work a shortage of men. Since 1914 there has been a tremendous narrowing of the labor supply. It is estimated that a million men left this country before we entered the war. These men returned to Europe in response to the call to arms of their native countries. It is predicted by the Department of Labor

that at least a million men will remain in the Army and Navy, and their branches at the close of the year. In addition, this country is short the millions of immigrants that normally would have reached here during the past three years.

With this certain shortage, it is not only possible but highly probable that the United States will not be able to put her factories on a peace-time basis for some time to come. This scarcity of labor naturally points to a higher scale of wages. It is therefore inconsistent to maintain that there will be any material cheapening of labor in the near future, and any hesitation as to the commencement of a proposed building operation based on a lower scale of wages will not be justified.

The United States Employment Service reports for the week ending May 24 that 90 representative cities show a decrease of 10 per cent in unemployed labor over the previous week. Of the 90 cities reporting, 39 of them or 40.3 per cent report a surplus of 227,425, while 17 cities or 18.9 per cent show a shortage aggregating 8,267, leaving 44 cities or 40.8 per cent of them reporting showing an equality.

Unemployment conditions by states from the 38 states reporting show 6 reporting a shortage of labor, 14 an equality and 18 a surplus. It will be readily seen that even with the present retardation of many operations, particularly construction, it will not be very long before there will exist an absolute shortage of labor.

It accordingly becomes necessary, if, in the future, labor maintains the present high scale, that production be increased to the highest possible point. By this means there would be a certain cheapening in materials without the usual cheapening of labor. As the present conditions advance, it will be less difficult to impress the fact that the only way in which organized labor can hope to maintain this present scale is to encourage the fullest measure of production. It is impossible to apply a line of argument to conditions in this country to-day, when in every type of building we are greatly underbuilt, similar to that advanced in 1914-1915 when conditions were exactly the reverse.





## An English Review

(Continued from page 784)

As yet the mass of opinion in the States had no other theory but that of business acumen. True, the size of the continent engendered a universal desire for enterprise, while the democratic constitution encouraged an atmosphere of mutual co-operation. The ingredients were ready for the crucible when the scheme for the World's Fair at Chicago was announced by a blare of trumpets that echoed from China to Peru, loud enough, indeed, to startle people in London, to whom the memories of Hyde Park in 1851 seemed recent. The projectors consulted with the architects. McKim and Burnham, Sullivan and Post, sharpened their pencils. Copies of the "Croquis d'Architecture" were sought and could not be purchased in sufficient quantities, for America was about to show the world what the power of selection, coupled with sound organization, could achieve.

\* \* \* \*

On the desk in front of me I have arranged the photographs my friend secured years ago: preparatory to applying the magnifying glass. All the sensations of Gulliver are mine as I look upon this collection of views. There are extraordinary experiments among them, lath and plaster for the most part, ranging from the domed "Administration Building" to a replica of the gateway to Donegal Castle. It is as though all the architects of the

world's history had foregathered at the bidding of Imre Kiralfy to produce a show a hundred times larger than the White City. The exhibition was intended to prove that America could act as a universal market immediately it advertised the commercial value of sound architectural design, and in this heterogeneous assemblage of gigantic compositions I can see the genesis of modern design as it is understood in the United States.

\* \* \* \*

I should like to have been at McKim's elbow when he discussed the plans with Burnham, or to have listened to the conversation in the drawing-offices when well-thumbed pages of Durand and the early Grand Prix designs were turned over. American architects without question had the perception to base the official style of the exhibition on classic lines, but it was the ghostly army of French students, many of whom had fought under Napoleon, who were responsible for its success. There was no precedent at this period in America for such masterly conceptions. Façades a quarter of a mile in length were unblushingly lifted from the pages of the Croquis, to form sides to the "Peristyle," the frontispiece of the "Horticultural Hall," the "Women's Building," and the "Machinery Hall." The "Art Palace," designed by McKim, was the exception, but even in this the portico bears some resemblance to Bernard's Grand Prix design.

## How Color of Surroundings Affects Health

The aim in selecting color schemes is twofold. That of securing good decorative effects has heretofore predominated, to the practical exclusion, in many cases, of the other. This other is the mental reaction which follows from the choice and arrangement of the colors. Some colors soothe, others irritate. The result is either repose or excessive stimulation of an unpleasant sort.

If the contention is made that good decorative effects presuppose wholesome mental reactions on the part of the inmates of the room decorated, this cannot be supported. Particularly in general living rooms where visitors are brought, conflicting temperaments and personalities will cause discordant impressions, and even the internal changes which mark the mental progress of the normal man may tend to make him discontented with his surroundings, and suggest that these should be as flexible as possible. Protective coloring, apart from its recently acquired usage in the sense of camouflage,

may also mean the function of color to protect him against his own melancholy or exhilaration, and as a matter of fact, physicians and psychologists have in recent years been experimenting elaborately with the effects of specific color-surroundings upon specific types of people. It is known that the average person is more alert to visual stimulation than to auditory sensation; for this reason the importance of the subject is considerable.

Mr. H. Kemp Prosser, a writer in the English medical press gives the results of such investigations with regard to neurasthenic and shell-shocked persons.

Color acts in three ways, he points out: as a stimulant, as a sedative, or as a recuperative.

Stimulating color, such as yellow, is necessary to a great extent in cases of neurasthenia and shell-shock, as it excites hope. In a great many cases strong, powerful, physical colors, representing physical power, must be used as well as mental

## THE AMERICAN ARCHITECT

ones to overcome the inactivity of the mind. In the case of neurasthenia minor tones should not be used, as strong measures are necessary. Shell-shock and neurasthenia, according to many doctors, create fear in the mind. Here, again, is the danger of the grey and minor tones.

Blue is a favorite color with most people. An interesting fact is that it has a health-giving power not only for human beings, but also for plants. Flowers grown under blue glass greatly increase in size and vitality. Red has its uses—so have morphia and chloroform! It has its place in the universe of color vibrations, but it must be used with knowledge. Scarlet rooms for lazy boys have been tried in this country. They have a tonic effect. Athletes also find help in fixing their eyes on a red handkerchief before running a race. This color causes restlessness in some people.

A most important matter in hospitals and houses is the medium formed by curtains through which the light comes. Purple is sometimes necessary, as it excludes the heat, while yellow increases it. In all rooms there should be a secondary curtain of yellow. It is an easy matter to arrange things so that only the one required is drawn. In mental cases color-tone curtains play an important part, according to the mental state of the patient. White has been used a great deal in the decoration of hospitals and houses for some time past, and the

present failing eyesight is largely owing to the glare of it. This opinion is confirmed by well-known oculists.

The proportion of color is very important. When a doctor gives a prescription, it is the proportion of each drug which he considers. This practice may very properly be observed in dealing with color. Color is often used by people who have not studied it, but what would be thought of the doctor who prescribed for his patient without any knowledge of medicine? Yet we take color medicine from people who are unable to give a logical reason for prescribing it.

It is not generally realized to what extent the Greeks delighted in colors, especially strong colors. Even their statues, many of them, were painted, and vivid purple and blue were among the colors used.

It will be found as this subject is studied, that as a nation declines, there also decreases the love of strong or barbaric color and gives way to a liking for minor tones. Therefore if the race is to be kept physically fit we must see that the people are surrounded by major colors. Nature is greater than art, and it is to Nature that we must go for our colors to maintain health, because they have a vitality which nothing else possesses. We must study Nature's vibrations, and, aided by science and theory, we shall then be able to attain good results.



SOUTH WRAXALL MANOR HOUSE





PLATE 179

ALLERTON HOUSE, EAST 39TH STREET, NEW YORK  
ARTHUR LOOMIS HARMON, ARCHITECT







PLATE 180

ALLERTON HOUSE, EAST 39TH STREET, NEW YORK  
ARTHUR LOOMIS HARMON, ARCHITECT





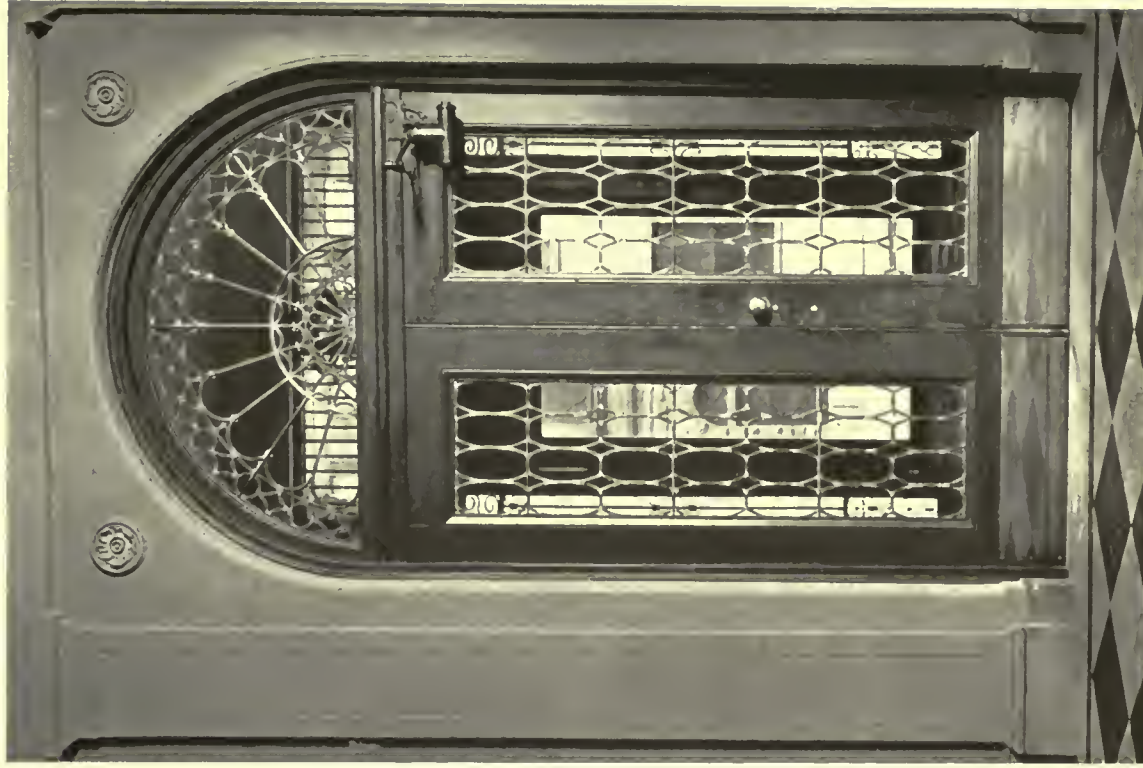

PLATE 181

EXTERIOR AND INTERIOR ENTRANCE DETAILS

ALLERTON HOUSE, EAST 39TH STREET, NEW YORK

ARTHUR LOOMIS HARMON, ARCHITECT





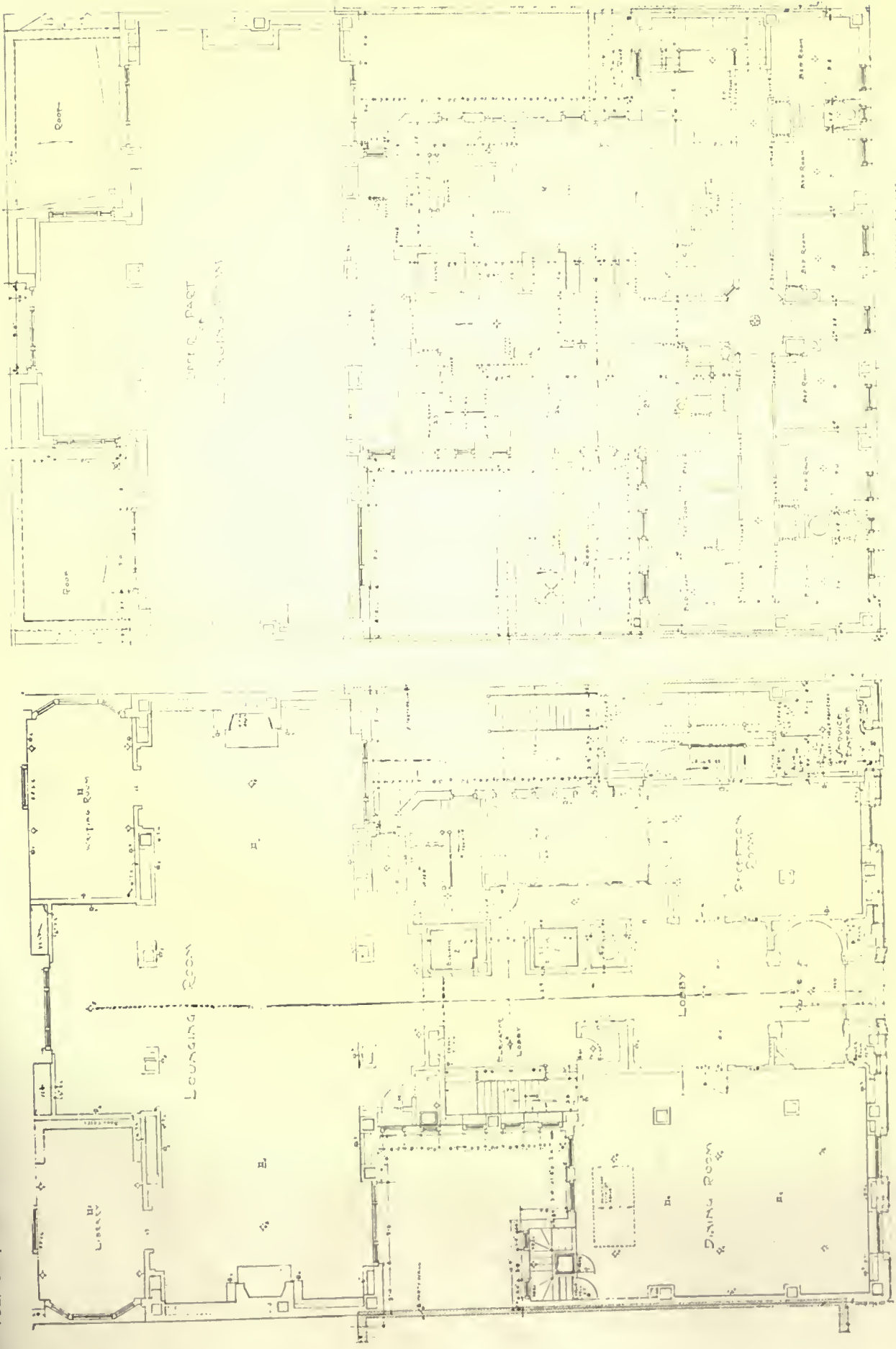

GROUND FLOOR PLAN

FIRST FLOOR MEZZANINE PLAN

ALLERTON HOUSE, EAST 39TH STREET, NEW YORK

ARTHUR LOOMIS HARMON, ARCHITECT





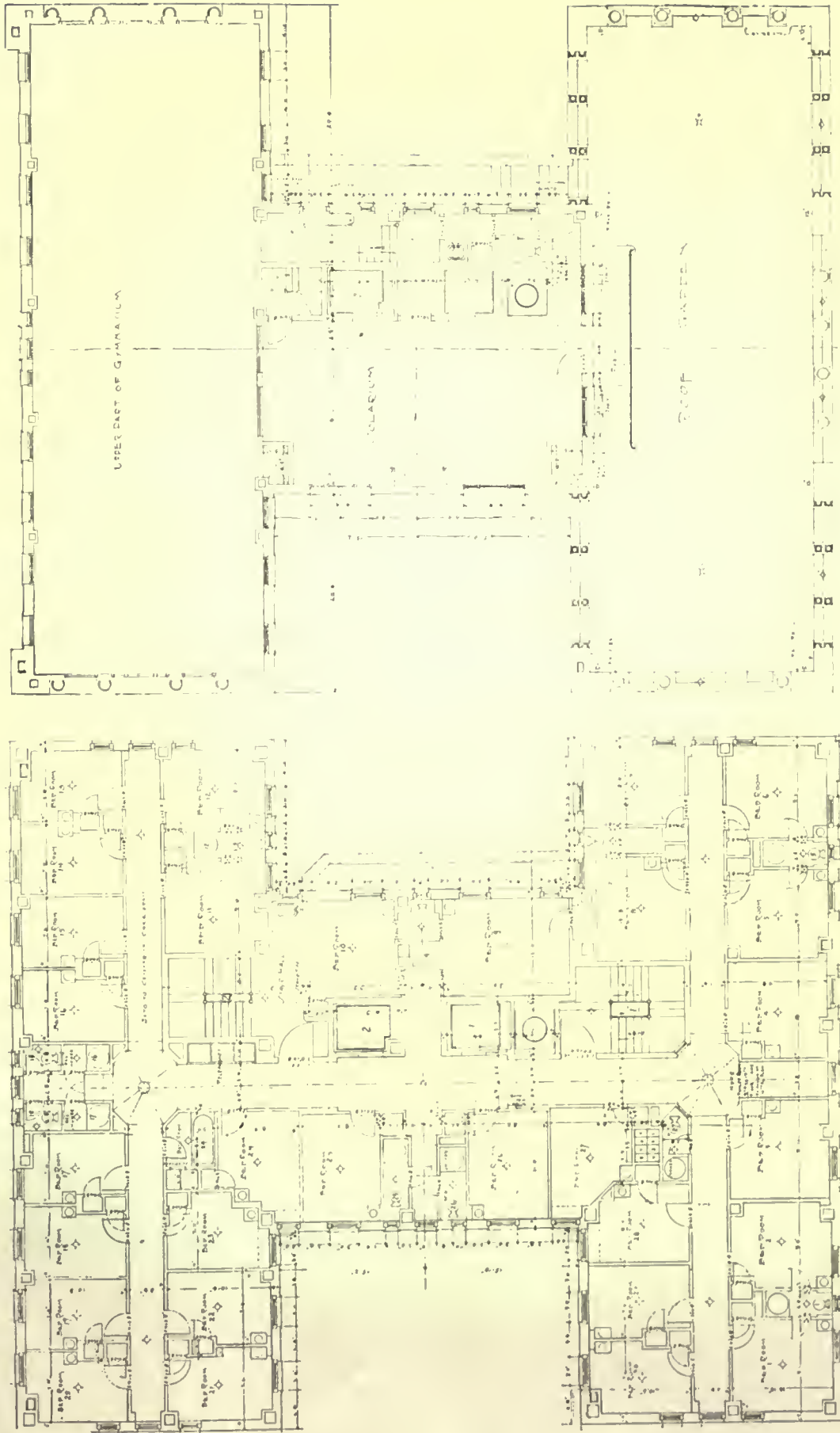

PLATE 183

TYPICAL FLOOR PLAN

ROOF PLAN

ALBERTON HOUSE, EAST 39TH STREET, NEW YORK  
ARTHUR LOOMIS HARMON, ARCHITECT







PLATE 184

DETAIL OF LOUNGE

ALLERTON HOUSE, EAST 39TH STREET, NEW YORK  
ARTHUR LOOMIS HARMON, ARCHITECT







PLATE 185

TWO VIEWS OF THE LOUNGE

ALLERTON HOUSE, EAST 39TH STREET, NEW YORK

ARTHUR LOOMIS HARMON, ARCHITECT







PLATE 186

SOLARIUM—SEVENTEENTH FLOOR

ALLERTON HOUSE, EAST 39TH STREET, NEW YORK

ARTIUR LOOMIS HARMON, ARCHITECT





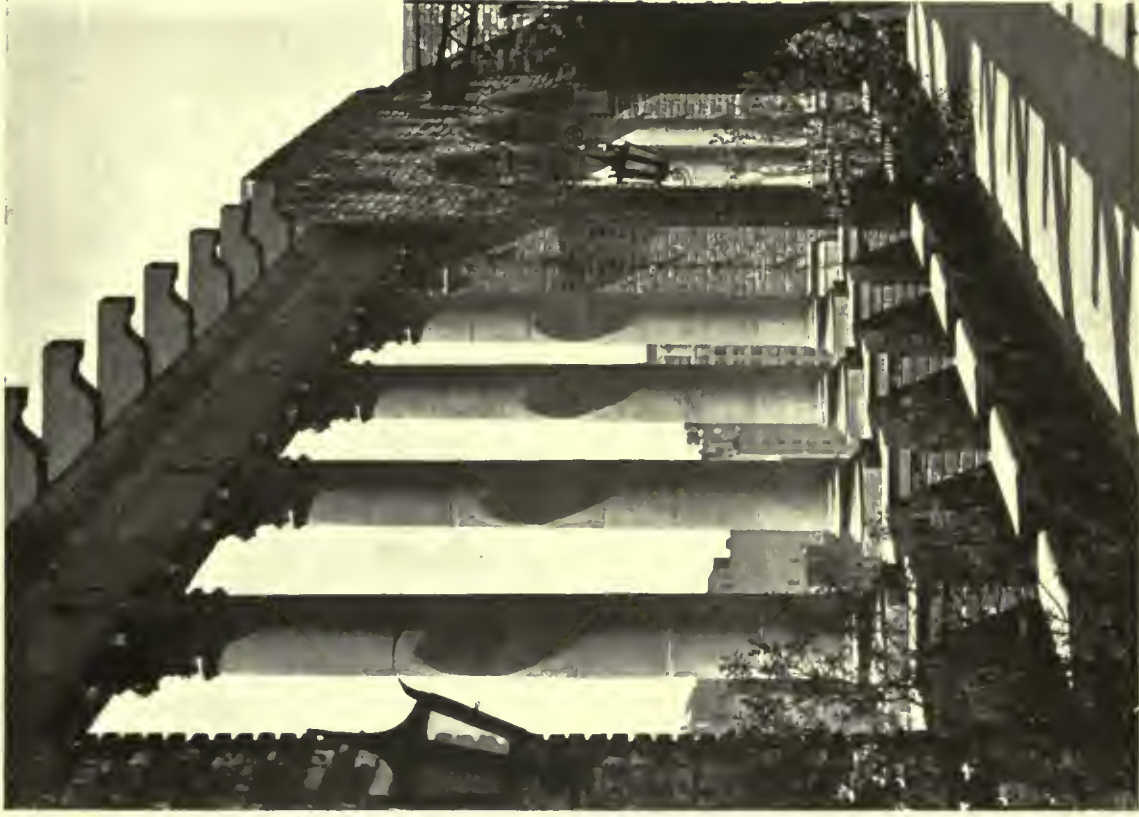

PLATE 187

VIEW FROM SOUTHWEST

ALLERTON HOUSE, EAST 39TH STREET, NEW YORK

ARTHUR LOOMIS HARMON, ARCHITECT



DETAIL OF ROOF GARDEN





# Current News

## Reconstruction of Art Study

Writing under this topic, the last issue of the *Vocational Summary*, published by the Federal Board for Vocational Education has the following well stated account of present and prospective conditions.

After much more or less vague discussion something now is being done toward the reconstruction of art study. The Architectural League has appointed a committee to look into the matter of an industrial school and craftsman shop, the National Academy of Design has appointed a committee on industrial art training, the Municipal Art Society has appointed a committee on industrial art, and the National Society of Craftsmen has appointed a committee on schools. The manufacturers of the country are joining the new federation of business, educational, and art associations that has been formed under the name of "The National Association of Decorative Arts and Industries." The older members of the conservative art organizations of the city are showing themselves thoroughly awakened to the need of schools of industrial art that shall in some degree, it is hoped, supply the training of the old atelier or apprentice system by which practice and theory went hand in hand and the pupil worked by the side of his master toward practical ends. Various schemes are in the air which will give the art students of this country what they so greatly need, effective teaching in industrial art.

Whatever form or direction of effort turns out to be the most effective, there is no doubt that this general interest in the proper teaching of industrial art will result in that co-operative and collective activity which is quite as essential today as it has been in the past to any important national achievement.

The war will stimulate such activity, again as in the past. Aside from the psychological reaction leading the minds of the public away from individual aims and ambitions and toward national interests, a conspicuous result of the discipline and associative habit of war, there has been clearly revealed the need of the country for practical craftsmen to be used in the industries upon which the commercial health of the nation depends. Such craftsmen are not numerous among us. They must be trained, and the few highly trained foreigners who have come to this country are priceless assets in the new business of building up industrial art. They should be paid enough to keep them here and give them ease of mind to do their work with care and conscience. If we are to ask an educated public to prefer modern objects of art to those made in the past we must face the necessity of making things that will bear comparison with what was made in the past. When we are able to place an American chair, or an American enamel, or an American piece of ironwork by the side of the ancient furnishings gathered by Mr. Altman and Mr. Morgan and Mr. Frick, with confidence in their equal honesty of craftsmanship and their equally intelligent design, there is little doubt that American industrial art will be "patronized," to use the hideous word consecrated to the arts and professions. Such a situation is, of course, to be seen only in far perspective. The task of "translating quantity into quality" will be slow, and it can be accomplished only by collective effort and the sacrifice

of temporary gain. Much time must be spent and much money, before we can establish a system of training that will make fine craftsmanship in the field of industrial art the matter of course that it should be.

The technical side of teaching industrial art must be left to those who have thrashed out the problems of the present situation in this country and who already are prepared to submit practical solutions. A most encouraging capacity for developing a simple and feasible plan has been discovered among the various committees, who presently will make public their program. In carrying out any program, however, the spirit in which the actual work is approached usually determines success or failure. Such craftsmanship as we are looking for in our industrial arts, and as we shall find essential to the creation of fine design, implies a degree of humility and patience not at present the recognized ideal of the American student. The mediaeval workmen who have raised the most glorious monument in all history to anonymous labor left the dignity and importance of their work rather than the dignity and importance of having their names signed to it.

## Co-operative Housing Plan in Washington Square, New York

Everyone in and around Washington Square, New York, is interested in a \$6,500,000 project for that section, conceived by Lewis Stockton, a Buffalo lawyer, and now in the hands of I. N. Phelps Stokes, architect of New York. It includes a solution of the housing problems in that neighborhood, and involves a reduction in the price of foodstuffs. The plan provides for dormitories for New York University, family apartments, clubrooms, assembly halls, restaurants and cafeterias, and studios for artists and musicians in that well-known district. The site proposed is the west side of Broadway between Tenth and Eleventh Streets, opposite Grace Church. It would be a twenty-three story structure if erection is undertaken. The financial arrangements are being considered by the president of the Chamber of Commerce in New York. If the building goes up, it will be in tribute to the women who have helped win the war.

## For National Budget Plan

The National Security League has announced that its Committee on Congress would soon undertake a campaign to urge Congress to adopt a national budget system. The league will disseminate information through the country on the "evils and wastes of the present lax system of handling the national purse strings" in order to consolidate public opinion back of the projected new order.

"The prime objectives of good business administration are efficiency and economy," said a statement on the plan, "and if Congress wishes to convince the people of the country that it is determined to encompass these two important conditions, it must do so by establishing itself on

a business basis. Its forces must be so organized and applied that there will be no superfluous machinery and no useless expenditures.

It is admitted that Uncle Sam is extravagant, and the people pay the bill in taxes—some direct and some indirect in the form of high prices. When the expenditures of the Government were \$1,000,000,000 or less annually the per capita tax for Governmental extravagance was necessarily not so great as it will be hereafter when several billions are going to be the annual tax budget.

"The greatest single factor in the direction of Government economy would be the establishment of a budget system. The United States is the only great country which does not follow it. Divested of the refinements of argument for and against, the fundamental propriety of this method of controlling and directing expenditures is a non-debatable subject. If the head of a household, who knows what his income is, or is likely to be, would permit every member of his family to spend what suited their fancy, or what in their individual judgment was desirable, he would soon meet with disaster. The United States Government averts disaster under similar circumstances merely because it can call upon the people at large to pay the bills, but the inherent fallacy of the methods followed by the Government remains apparent."

## More Architectural Draughtsmen Needed

Revival of building activities has proved that there is a serious shortage of draughtsmen, according to reports received by the U. S. Department of Labor. Architects in all parts of the country, it is stated, are experiencing difficulty in obtaining men and are offering a decided advance in salaries, but in many cases the much needed workers cannot be obtained.

The shortage was first reported from Ohio, where construction projects of various sorts were begun soon after the signing of the armistice. St. Louis, Mo., and Louisville, Ky., also have found difficulty in meeting the demands made by architects. Possibly draughtsmen are still in the army service and it might be that personal appeals from architects would hasten their release. It is probable, also, that many have drifted into other vocations and publicity might induce them to return to their former line of work.

## Origin of English Weights and Measures

According to a letter formulated by the World Trade Club advocating universal adoption of the metric system, the present coinage of the British Isles, as well as the weights and measures of both the British Isles and of America, is German. The British pound, both sterling and avoirdupois, originated with the old German Osterling Hanseatic League, which for hundreds of years controlled the trade of England. What is still more remarkable is that America and Britannia continue to use these old German tools after Germany herself has forgotten them. The latter country adopted in 1871 the simplest decimal system of quantity expression known—the application of

the decimal to weights and measures, the invention of that truly great Briton, James Watt, in 1783.

## Japanese Bathhouses

The public bathhouse in Japan has performed one of the functions of the American saloon, namely, that of serving as a sort of social club. Two doors open upon the street, one of which leads to the women's half of the building and the other to the men's. In the evening, from early until late, these bathhouses are busy.

Heretofore the price of a bath amounted to two cents, and the houses were open all day. A recent desire to increase the price to a half cent more has been discountenanced, and bathhouse keepers have retaliated by discontinuing daytime service altogether, claiming that the cost of fuel was not warranted by the small number of morning patrons.

There are many places in this country where conditions would justify a larger number of public baths, for tonic results, both physical and social.

## French Ask Wilson to Dedicate Site

President Wilson has been invited by the monument committee in Paris to dedicate the place where the monument to commemorate American intervention in the war will be erected, at the mouth of the Gironde. Deputy Maurice Damour, chairman of the committee, said the committee would be delighted if President Wilson, on returning to the United States, after having secured the triumph of right, would depart from Point de Grave, from which Lafayette sailed when he left France to aid the American colonies in their fight for independence. The Point de Grave is at the mouth of the Gironde, some distance from Bordeaux.

## Seven Million Workers Need Training

Upwards of 7,000,000 workers in this country have not had opportunity to become properly trained in their tasks, according to the United States Training Service, of the Department of Labor, the function of which is to promote industrial training in manufacturing plants in this country. The system of training which the Training Service advocates is one of upgrading workers by extending their knowledge of processes and increasing their skill. It devotes itself to raising the average output of poor and mediocre workers and fitting the more promising persons for promotion.

These and many other facts equally pertinent to reconstruction problems, are set forth in a vest pocket bulletin entitled "Seven Million Candidates for Training" issued by the Training Service. This pamphlet shows that part-time and continuation training, splendid as it is, does not reach the great majority of the 7,000,000 workers referred to. They are already at their jobs and because of economic necessity cannot sacrifice time or wages to attend continuation classes. To meet this situation training departments in the shops and factories, maintained at the employers' expense, are urged as the most practical remedy. The publication referred to



maintains that the training department idea has already demonstrated its great value for peace-time industry, and that the number of firms introducing training in their plants is growing week by week.

The task of the government's Training Service is to provide interested manufacturers with expert advice in planning their training departments and to supply them with carefully prepared training courses. The bulletin referred to above and others on this subject can be had free of charge by addressing the United States Training Service, care of the Department of Labor at Washington.

### Balzac's Home is Restored

The home of Honore de Balzac in the Rue Raynouard at Passy has been reopened as an artists' center. The house had been sadly neglected, but has been restored to present the appearance it had in Balzac's time, with its vestibule painted blue and the original oak carvings and dark red tapestries decorating the apartment where Balzac wrote his masterpieces.

On the table stands the big china coffee pot from which the author was wont to refresh himself, for Balzac was a mighty drinker of coffee. Old wood cuts and original printing proofs adorn the walls. In the garden the vine that Balzac tended still grows and his beloved lilacs have been replanted there.

In one room there is still the trapdoor through which Balzac used to disappear when importunate creditors called.

### "Inharmonious Distribution of Expenditure"

A great American architect was in the habit of using this expression to his clients and students—"The inharmonious distribution of expenditure!"

When asked for his meaning, he explained that he once stopped in a hotel with a white marble "grand" stairway, the posts and balusters of which were elaborately carved. To one side of this stairway was the cheapest type of passenger elevator; one that most of the time did not run because it was out of order.

The architect went on to explain that it would have been a more harmonious distribution of expenditure to have spent less on elaborate marble carving and more on the elevator.

There is going to be a lot of home building within the next few years, and this principle of the inharmonious distribution of expenditure will apply to the frame dwelling quite as much as to the commercial structure.

In our home building of the past we have sacrificed much in the way of comfort and convenience for mere bigness and useless elaboration.

But we are learning, for instance, that a chicken will cook just as well with the kitchen table or sink along side and next to the range rather than on the other side of a 16-foot room.

The modern kitchen is small, very much in the nature of a laboratory, and is being designed to save steps and motions as in the case of the modern factory.

We are learning that it is better to expend the cost of towers, dormers, elaborate gable fronts and beveled glass windows in more and better plumbing, heating and the general utilities of a dwelling; that this is the more harmonious distribution of expenditure.

### Greatness of U. S. Exemplified in Recent Industrial Statistics

The following interesting statistics appear in the current issue of *The Cincinnatiian*, official organ of the Cincinnati Chamber of Commerce:

Before the war the United States was a debtor nation, owing \$5,000,000,000; to-day the foreign nations owe us more than \$10,000,000,000. This nation has but 6 per cent of the population of the world, and only 7 per cent of the land, according to Finance and Industry.

It was the United States which was the deciding factor in winning the world war and establishing peace. It is the United States which is the financial center of the world, as well as the greatest producing nation on earth, now setting out to supply the commercial wants of all other peoples.

Some reasons why the United States has this record are that more than 22,000,000 of its citizens became financial backers of its war expenditures and that it produces:

- Sixty per cent of the world's supply of copper.
- Forty per cent of the world's supply of lead.
- Fifty per cent of the world's supply of zinc.
- Sixty per cent of the world's supply of aluminum.
- Sixty-six per cent of the world's supply of oil.
- Seventy-five per cent of the world's supply of corn.
- Sixty per cent of the world's supply of cotton.
- Forty per cent of the world's supply of silver.
- Twenty per cent of the world's supply of gold.
- Fifty-two per cent of the world's supply of coal.
- Forty per cent of the world's supply of iron and steel.
- Twenty-five per cent of the world's supply of wheat.
- Eighty-five per cent of the world's supply of automobiles.

To help in the distribution of these basic commodities the United States operates 40 per cent of the world's railroads, and is destined to control a big percentage of the ocean tonnage of the world.

### Public Work in France Held Up by Labor Shortage

There is work right now in France for every man who wants to work, according to M. Claveille, minister of public works, who recently told an Associated Press representative that the lack of labor alone is holding back some of the important public work for which material was assembled while the war was going on.

Besides the immense task of rebuilding Northern France, M. Claveille pointed out the following projects which will be executed as soon as the labor can be found:

The enlargement of the canal from the Rhine to the Rhone to give Alsace a better outlet for her products to central France and to the Mediterranean; extension of several other canals; enlargement and improvement of the ports of Algiers, Marseilles and Brest, with the extension of railroad lines leading to those ports; the building of water power plants of several hundred thousand horse power in the Alps, the Pyrenees and around the central plateau to furnish electric power to railroads and lighting current to cities, including Paris, the levelling of the wall of Paris; the extension of the Paris subways into the suburbs as soon as the fortifications have disappeared, and, eventually, the digging of the tunnel under the English Channel.



# Personal Mention

A. H. Knox, architect, Chicago, moved from 104 S. Michigan Ave. to 14 W. Washington St.

Mr. Fred A. Evans has removed his architectural offices to 704 Book Building, Detroit, Michigan.

Architect Jos. W. McCarthy, old address 4551 Sheridan Road, has moved to 1418, 139 N. Clark St.

B. Robert Swartburg has opened offices for practising architecture at 51 E. 42nd St., New York City.

M. F. Strauch, architect, has moved his office from 1356 Diversey Blvd. to 608 S. Dearborn St., Chicago.

Ray W. Leible, architect, has opened offices at 311 Valley National Bank Building, Des Moines, Iowa.

Architect L. M. Mitchell announces the removal of his offices from 19 S. La Salle St. to 607-35 N. Dearborn St.

Lowe & Bollenbocker, architects, 14 E. Jackson Blvd., have removed their offices to 108 S. La Salle St., Chicago, Ill.

F. Burr Modie, architect, Galion, Ohio, has opened offices, specializing on residence work. Catalogues and samples desired.

Albert S. Hecht, architect, announces the removal of his office from 154 W. Randolph St. to 64 W. Randolph St., Chicago.

Toltz, King & Day, Inc., has been organized to practice architecture and engineering at 1410 Pioneer Bldg., St. Paul, Minn.

Walter E. Perry, architect, formerly of Perry & Thomas, 140 S. Dearborn St., has moved to 607-64 E. Van Buren St., Chicago.

Architects C. W. and Geo. L. Rapp of 1005-69 W. Washington St., have moved their offices to Suite 1200, 190 N. State St., Chicago.

The architectural offices of Harold E. Paddon, will, on May 1st, be moved from 120 Broadway to 280 Madison Avenue, New York.

Governor Smith has appointed Edward S. Walsh of Brooklyn, State Superintendent of Public Works to succeed Lewis Nixon, resigned.

E. R. James has returned from Government service and has opened an office in the Dudley Building, Danville, Va., for the practice of architecture.

Mr. Edmund C. Stout, care of the Prudential Insurance Co., Newark, N. J., architect, desires catalogues and information from manufacturers.

Washburn & Nebelung, architects and engineers, have opened offices at Ranger, Texas. Mr. Geo. P. Washburn was formerly located at Ottawa, Canada.

Walter Scholer announces the opening of offices for architectural practice at 801 States Life Building, Indianapolis. Samples and catalogues desired.

Albert Speiden of Speiden & Speiden, architects, Washington, D. C., has been elected an associate of the Washington chapter, American Institute of Architects.

Two prominent Washington, D. C., architects, R. B. Atkinson and J. C. White, have formed a partnership. The firm's office is at 818 Connecticut avenue northwest.

Architects Vitzthun & Teich, 212 Van Buren St., now practice separately, the new firm being F. J. Teich, 305 S. La Salle St., and K. M. Vitzthun Co., 21 E. Van Buren St.

Herman F. Cason & Co., architects, have moved their offices to 311 Praetorian Building, Waco, Texas, where they desire manufacturers to send samples and catalogues.

Offices for the practice of architecture have been opened by Beshgetoorian and Cobelli, at Ranger, Texas, and not at Bangor, Texas, as previously stated. The firm desires to receive manufacturers' samples and catalogues.

Philip S. Avery, after an interval during which he has been engaged in Government housing work, has reopened an office at 95 Milk Street, Boston, Mass., for the practice of architecture, and would like to receive manufacturers' samples and catalogues.

Mills & Millspaugh, architects, 67 E. Long St., Columbus, Ohio, have recently opened a branch office at 1002 Marshall Building, Cleveland, Ohio. Mr. Glenn Snyder, formerly of Allen Osborn Co., will be in charge of the Cleveland office for Messrs. Mills & Millspaugh.

Having completed his services with the Military Intelligence Section, Plant Protection Division, General Staff Corps, United States Army, C. E. Schermerhorn, architect, announces the resumption of his practice at 430 Walnut Street, Philadelphia, Pa.

Urging a movement for better housing facilities in Buffalo, N. Y., and giving specific instances of what has been done along these lines in other places, Albert Hart Hopkins, architect, spoke recently on "Proper Housing for Laboring Men" before the Real Estate Association of that city.

Mr. William Leigh Carneal and James Ambler Johnson announce that O. Pendleton Wright has been admitted to partnership with them and that the business is to be continued by them under the present firm name of Carneal & Johnson, architects and engineers, Chamber of Commerce Building, Richmond, Va.

The firm of Meyer, Strong & Jones, Inc., has succeeded to the engineering practice of Henry C. Meyer, Jr., and Basset T. Jones, Associated, and of William E. S. Strong. The new firm will act as consulting engineers for steam and electrical work, power plants, etc., and will have offices at 101 Park Avenue, New York.

A new architectural firm with offices at 30 East 42nd Street has been formed in New York, with the following members as partners:

Edgar J. Williams, Registered Architect, B.Sc. and M.Sc. in Architecture, Massachusetts Institute of Technology, winner of the Rome Scholarship and Fellow of the American Academy in Rome, Italy; Walter R. Mahnken, Registered Architect, a graduate in Architecture of Pratt Institute and of the University of Pennsylvania; both having practiced in offices of prominent architects in New York, Pittsburgh and Boston and executed their own work; and Alfred J. Mahnken, B.Sc. and C.E., Rutgers College, with ten years' experience as an architectural, civil and structural engineer and in general engineering and building construction; all having recently been in active service as commissioned officers with the United States Army.

# Late News from Architectural Fields

Special Correspondence to THE AMERICAN ARCHITECT

## Housing Hampered by Michigan's Code

DETROIT, MICH., May 31.—Asserting that provisions of the state housing code are unreasonable in the extreme and should be taken into court and "knocked out," Commissioner of Buildings and Safety Engineering John C. McCabe has described to the council committee of the whole certain injustices worked upon those who desire to construct houses.

In one case mentioned the owner of a lot 140 by 30 feet desired to erect a building. His plans were drawn and taken to the inspectors of the health board for approval.

But under the state code it was impossible for the inspectors to approve any building on this lot for dwelling purposes unless it stood 10 feet on each side from the lot line. Consequently the house would have had the unique and peculiar dimensions of 10 feet wide by 140 feet long.

By direction of the common council the commissioner will have printed the new regulations drawn up to amend the city housing code. These will be as liberal as is possible without conflict with the state law.

## Carpenters Urge \$7 a Day Minimum Wage

DALLAS, TEX., May 30.—Adoption of a universal minimum wage of \$7 per eight-hour day for carpenters in Texas is indicated as the result of recommendations made at the annual convention of the Texas State Council of Carpenters.

A resolution favoring the adoption of this minimum rate throughout the district represented was approved by the delegation, which is composed of representatives from almost every carpenter's local organization in the State. Although the recommendations made by the State council are only approbation measures favoring the \$7 minimum wage, and have no compelling force, the delegates expressed the conviction that the action of the convention body will be accepted by the unions affiliated with the Texas State council.

## Des Moines Architect Made Housing Officer

DES MOINES, IA., May 31.—R. W. Leible, architect, has just been appointed housing commissioner by the Des Moines city council at a salary of \$2,500 a year.

## Million Ready for New Homes

DETROIT, MICH., June 2.—With a capitalization of \$2,000,000, of which \$1,000,000 will be subscribed within a week the Community Housing Corporation is nearing an active state.

The board of directors is nearly complete and comprises many of the city's ablest business men.

One of the organizers believes 20,000 homes will be built or under construction within the first year. The corporation will not build, but will finance the building of homes, duplexes and multiple dwellings.

## Philadelphia Housing Bill Approved

HARRISBURG, PA., May 31.—Governor Sprout has announced his approval of the Vore Senate bill prescribing the minimum live loads to be considered in designing dwellings to be hereafter erected or altered in Philadelphia. The bill established factors of safety, makes numerous definitions and classifications. The penalty is \$50 fine for the first offense and \$75 for subsequent offenses, city magistrates being empowered to hear cases and the chief of the Bureau of Building Inspection being charged with the duty of carrying out the act.

## Lumber Prices in Washington

WASHINGTON, D. C., May 26.—"The present level of prices of both material and labor represents a stable basis from which to figure construction work for the year 1919 and nothing can be gained by further postponing building operations," was the report of the Central Stabilization Committee this week to the District Commissioners. This committee was appointed in April to investigate the building situation here with a view to stabilizing construction and they further said: "Lumber prices today are firm with an upward tendency in the better grades. Indications are that the increase in prices will be felt the remainder of the year on better grades, while others will remain stationary."

## Architects Admit Women

British women have secured admission as members to the Institution of Naval Architects. The vote taken by the institute on the question was 491 to 220. In announcing the vote, Sir William Smith moved that women be admitted as members on equal terms with men. Sir Alfred Yarrow, in seconding the motion, gave instances of the excellent work done in this field by British women.

## C. W. Parks Named for Navy Projects

WASHINGTON, D. C., May 26.—C. W. Parks, chief of the bureau of yards and docks here, is the architect for the three projects for which the Navy Department has asked bids. Estimates are requested for a storage development plant at Galveston, Tex., costing \$758,000; a storage building for the medical department at Hampton Roads, Va., and officers' quarters at Hingham, Mass.



# Says High Money Costs, Not Material Prices, Retarded Post-War Building

## Construction Attracts New Capital

**T**HAT it is the high cost of money and not the high cost of building materials that has retarded post-war building activity, is the opinion concretely expressed this week by a leading New York builder. It is felt by this authority that builders have held off from starting new building on a large scale, not because they expect materials and labor costs to drop within the next few years, but for reason of the high rate asked for money. A stumbling block has been the plan of many bankers for amortization of mortgages. Builders discourage the tendency to force this scheme, which, while it is good banking, absolutely repels the ordinary speculative builder.

Freer loaning of building mortgage money, which has been scarce owing to the diversion of large sums into Liberty bonds, was a feature of the market this week, when many of the larger corporations showed evidence that now Government issues are over it is their duty to divert at least some of their funds from other investments into helping solve the building problem. For the first time in months, many prominent mortgage companies showed a desire to use their own money, together with all the capital they could attract, with which to make building and permanent loans on apartments and office structures.

Loan money, because of scarcity and like every other commodity, has advanced in value. It is logical that banks should desire to take advantage of opportunities to invest their money at more than the old rate of interest. There are many more attractive investments for them today than the  $4\frac{1}{2}$  per cent loan. From the banks' standpoint it can be clearly seen that with loans definitely restricted and limited and based on pre-war costs, there has come a prevailing insistence on amortization.

With the coming of an easier market for building loans, there is a more universal tendency to disregard the comparatively small average advance in the price of materials. With money at 5 per cent and the certainty that it will soon reach 6 per cent, there came hesitancy on the part of speculative operators. In some quarters the opinion is very freely expressed that with mortgage loans at six per cent bankers would be disposed to withdraw their insistence on amortization requirements and that building operations would at once gain impetus toward their normal condition.

There is not so much inconsistency as may at first be felt in arriving at a conclusion that an increased rate of interest would result in increased construction. With this condition revised, operators would be able to figure their equity and fix their price with a certainty that would inspire confidence. Another aid in overcoming the difficulties of the present building problem would be the establishment of a definite tax limit. Real estate for the past twenty years has borne an unfair proportion of the taxes of the cities. Thirty per cent of the rent from a house is at once paid for taxes. The difficulty has been that it has been hard to induce capital to build when a fair return cannot be assured and the landlord is held up as a rent profiteer.

In the meantime, the formation of housing corporations in many of the larger cities, following the notable example of Detroit, has interested private capital in the solution of the problem of building financing. This with strong efforts being made to secure Government and State aid through a system of loans at a low rate, similar to farm loans, is giving the prospective builder increased confidence in the future.

In New York added interest in the mortgage market has come about as a result of charges that have been made that title companies, savings banks and life insurance companies are withholding funds which should go to the builders; that three brokers with suitable connections are the only ones from whom appraisals will be accepted; that bonus must be paid for loans; and that men in need of building money have hard work getting it. Investigation has shown, however, that large institutions which make a business of financing building projects are endeavoring to do all in their power to provide relief for the situation which will make for a healthy development of construction.

A suggestion has been made by a prominent New York loaning interest that if all the savings banks would come together and agree to finance for a reasonable proportion of the value all new construction it would greatly increase the housing facilities of the earner of moderate wages. The banks should always have reserve funds for this purpose.

Lumber statistics of the manufacturers for last week show a large increase in orders received, and this is true especially in the great Southern lumber region and all along the west coast. For a month now the larger Pacific coast manufacturers have reported heavy orders and last week their orders ran far above normal. The Southern pine manufacturers show a big jump in orders and the Northern pine and North Carolina pine regions indicate slight advances in orders, the former cutting more than usual.

For many months the general lumber movement has been below normal and retailers have been allowing their stocks to become low. The present increases show that retailers are buying heavily and it goes without saying that they would not do this if they were not receiving many orders in realization of a big building boom.

Reports from THE AMERICAN ARCHITECT'S correspondents this week show construction conditions to be growing better daily, particularly in the mid-West section, where conditions have been such as to make it imperative that building proceed. The wave has slowly but surely been moving eastward. New York architects feel that it is only a matter of a month or so before there will be a great shortage of architects and draughtsmen to handle the tremendous amount of work that is developing. The large percentage of permits taken out this week were for residential work, which indicates that the building

*(Continued on Page 804-A)*



# Department of Architectural Engineering

---

## Back Venting versus Simplified Plumbing Has Simplicity, Economy and Safety in House Drainage Actually Been Attained?

WHILE plumbing installations date back many centuries, it is interesting to note that probably the first man legally appointed "Inspector of Plumbing" in the United States (Samuel A. Robinson, Washington, D. C.) assumed his duties as recently as 1873. In his report of July, 1877, rendered after a most thorough investigation of plumbing installations in the District of Columbia, he earnestly recommended that regulations be adopted providing for the proper installation of drains, traps and *vent pipes*. On March 27, 1879, typewritten recommendations were made and distributed to those interested, but not until July 1, 1880, were these, with slight modifications, given the full effect of a city ordinance. So far as can be ascertained, this constituted the first Plumbing Code in force in any city in America. The earliest code known to have been in effect in any country predated the Washington code by only a few years, having been incorporated in the "By-laws" of Up-pingham, England, about 1875. The New York Board of Health in 1877 issued to the people of that city a pamphlet with cuts showing the proper method of laying out the plumbing system, and in the year following recommended simple rules governing such work. Thereafter the matter of adopting plumbing codes was taken up by many of the leading cities in the United States as well as abroad, and the regulations later adopted followed somewhat after the pattern of those in force in the District of Columbia.

One of the basic requirements of these early plumbing ordinances was that each fixture be trapped, the trap to be placed as near the fixture as possible, and in addition some form of vent pipe was required to protect the seal from trap syphonage.

Inasmuch as many of the traps in use at that time contained interior mechanism such as a ball or other movable part to seal the trap, and as other

traps were of such a pattern as to become quickly fouled from the waste passing through them, later amendments to the various ordinances specified the construction of traps in more detail, and prohibited the use of such types as were deemed to be unsanitary for these reasons.

One of the greatest problems to overcome was the syphonage of the traps. Let us remember how crude such installations were when compared with modern plumbing systems. In many cases the soil or waste pipe terminated at the highest fixture, so that any discharge through it must leave a partial vacuum in its wake. The "S" or bend traps were found to syphon out more easily than the drum traps, and usually the greater the body of water retained in the trap, the less susceptible to syphonic action was the trap seal. Of the two types the "S" and half S or "P" traps were undoubtedly the most sanitary, retaining a smaller quantity of foul water and being more self-cleansing, due to decreased waterway. This type of trap has remained in favor to the present day and is probably the most largely used of any.

However, in order to continue the use of such a desirable form of trap and at the same time prevent it being syphoned out, air relief pipes, commonly called "vent" lines, were introduced and were thereafter generally required by law, as has already been mentioned. Although originally connected at the crown of the trap, they were later permitted within approximately two feet of it. These air relief pipes at first took the form of local vents, often being of small diameter and extending through the wall to the outer air. Experience proved this arrangement to be defective and often inadequate to prevent the loss of seal. Further investigation revealed the necessity of increasing the size of vent pipes and continuing them above the roof.

While experiments are still in progress to throw

further light on the matter of determining the proper size of stacks,\* and much is still to be learned about plumbing design, it is but natural that experience should have taught us many things of prime importance relating to drainage systems during the forty years following the adoption of the first regulations.

Certain features stand out as essential to the proper design of such a system. Of fundamental importance is the regulation requiring every fixture to have a trap placed as near its waste outlet as possible. The purpose of this trap is obvious: it must effectually lock the door against all gases contained in the piping system, so that they cannot gain access to the rooms through the fixtures. The prohibition against traps having interior mechanism is so well understood that it will not be discussed. This eliminates the use of all traps except those providing a water seal, which, to be effective must be maintained unbroken during the most exacting service conditions.

The drum trap has been mentioned as less susceptible to syphonic action than the S trap, thus being to a certain extent "anti-syphon." The fact that a trap could be developed, capable of maintaining its seal without the installation of relief or vent pipes, has led to the development of two distinct systems of drainage.

Keen students of sanitation saw with the introduction and extension of the vent pipe, the incorporation into the drainage system of certain dangerous features, as well as the increased cost of installation. These embraced the possibility of by-passes by improper location of traps; the danger of gas leakage, due to the vastly increased number of joints in the piping system; the danger of quick loss of seal due to evaporation;† the danger of trap syphonage should the connection of the back vent to the trap become stopped up by accumulations of rust scale, grease or extraneous matter flowing into the drain; the possibility of entire or partial closure of the vent pipe above the roof by frost during extremely low temperatures, thus for the time being rendering it noneffective; and also since many vent lines connect with the soil or waste stack below the roof, accumulations of rust scale at the offset may also cause such closure. The possibility of this latter danger has been emphasized by recent investigations on pipe corrosion.‡

\*Extensive tests being conducted by the University of Illinois, Urbana, Ill., under the direction of J. M. White, Supervising Architect. Results not yet published.

†It is estimated that a vented S trap will lose its seal in from one to two months if fixture is unused.

‡See the Relative Corrosion of Cast Iron, Wrought Iron and Steel Pipe in House Drainage Systems, by Wm. Paul Gerhard, copies of which may be obtained from the Am. Soc. Mech. Engr's., 29 W. 39th St., New York. Also the Life of House Drainage Piping by Thos. J. Claffy, published in the *Plumbers' Trade Journal*, Jan. 15, 1919.

Of all these the danger of stoppage of the vent (by any cause) is the most serious. This has led many sanitary engineers to advocate the entire elimination of the vent pipes, the adoption of a single pipe drainage system, and the installation of some type of trap not affected by syphonage, usually termed an "anti-syphon," but more properly named, a "resealing" trap. Such an installation is referred to as the "Simplified Plumbing System."

Each of these systems has its relative merits and objections. The two-pipe or vented system is probably all that is claimed for it by its most ardent advocates when designed by and installed under the supervision of competent persons. Unfortunately this is by no means always done, and when poorly designed and installed by incompetent contractors without proper supervision, it is probably as defective as its most severe critics would lead us to believe. There is no denying that its installation requires the use of approximately 30 per cent more pipe than would be the case for the simplified system, thus making it the more expensive of the two. The question before us is: "Are we justified in saddling this expenditure upon the owner?"



Fig. 1.—Objectionable type of re-sealing trap constructed with interior partition.

In endeavoring to answer this, we find that were it not for one great drawback the simplified system would be practically ideal. This drawback is the difficulty of finding an efficient anti-syphon trap. One essential feature of any trap (except a grease trap) is that it must be self-cleansing. This is as important as its ability to resist syphonage, for if it be not self-cleansing, the unscoured parts will soon become coated, and as accumulations of foul matter increase, it is only a question of time when the trap ceases to be anti-syphon. The drum trap is to a large extent "anti-syphon," but its self-cleansing qualities leave much to be desired. Apparently with but few exceptions every endeavor to produce an anti-syphon trap has followed along the lines of the drum trap, and it is difficult to believe that the traps of this type which have been produced to date are really self-cleansing. Other designs differing from the drum trap have incorporated baffles, interior partitions (see Fig. 1).



## THE AMERICAN ARCHITECT

diaphragms and other objectionable fouling surfaces. Many illustrations might be given showing to what extent inventors have gone to produce an "ideal" trap. Many of these proved impracticable and were little if ever used.

The opinions of leading authorities on the subject are of interest, and in this connection we quote from several.

R. M. Starbuck, a rather staunch advocate of back venting, as given in his book, "Standard Practical Plumbing," 1910 edition, states:

The trap constantly being sought for, and which may some day be brought out, should be simple in construction, self-cleansing, non-syphonable, have a good seal, and no internal partitions, depend upon no mechanical device, and have as few corners or places where filth may collect as possible. \* \* \* Although there are many excellent traps now on the market, it does not appear that perfection has yet been reached. \* \* \* When the non-syphonable trap becomes an accomplished fact from all practical points of view, there would seem to be no end to the changes that would result in the plumbing system. It will not be a matter of great surprise to see within the next few years, the plumbing system installed without the use of trap vents. When this result comes, the decrease in the complete form and in the cost of the plumbing system will be very great. *Such a system, however, will not be acceptable until the problems involved shall have been solved beyond a question of doubt.*

In a paper presented at the 11th annual meeting of the American Society of Sanitary Engineering in 1916, Louis A. Cornelius expressed his views as follows:

The perfect trap, which as you know, has not been evolved, is the one that contains a body of water sufficient to withstand evaporation for a considerable period, a seal deep enough to withstand syphonage even under unusual conditions, like stoppage of the vent pipe, etc.; and yet be a self-cleansing fixture, free at all times to promptly carry away the waste discharge. Insomuch as increasing the volume contained in the trap body and deepening the seal, proportionately decreases its self-cleansing properties, we are immediately confronted with the difficult problem of how much of the cleansing properties should be sacrificed to conform to some syphonage test. \* \* \*

In the first place, there is no such thing as an anti-syphon trap, using the term broadly. There has simply been a development of these fixtures which are anti-syphon to a certain degree, and this degree has been fixed by the minimum as called for in codes and by individual inspectors.

Wm. Beal Gray, a practical plumber, having served many years as such, later becoming a master plumber and now practicing as a sanitary engineer, has written a veritable compendium on plumbing, entitled "Plumbing Design and Installation," in which he has this to say on the subject:

The author does not wish it understood from anything said that he condemns non-syphon traps; they are safe and effective in competent hands; the door is open to them; they are generally specified for the locations they were designed for; the makers do not complain of any prejudice against the proper use of them and the desirable trade recognizes the merit of such goods. In fact the

U. S. Government specifies non-syphoning traps—not to save venting expenses, but because the conditions of its buildings lead the designer to believe such traps will give the best service.

Dr. Wm. Paul Gerhard, recognized throughout the country as an authority on all matters relating to plumbing, in his work entitled "The Water Supply, Sewerage and Plumbing of Modern City Buildings," says:

There are a number of water-sealed traps, called non-syphoning traps, \* \* \* which are shaped with a view of retaining a water seal when syphonic action takes place in the system, and their seal is, as a rule, made deeper than usual.

Where non-syphoning traps and water-closets with a deep water seal are used, the special back-air pipes may be dispensed with, *provided the fixtures are located close to a ventilated soil or waste line.* In my practice I consider a run of five feet as the largest allowable length for the use of such traps without a vent continuation of the waste pipe. Long branches should be vented, either by interconnection with vent stacks or by extension to the roof, but if so arranged, the branch trap vents may be omitted.

This improved system is far superior to the one commonly required by Building Department Rules or regulations. The present tendency involves unquestionably too much complication. A comparison between the two methods shows clearly the superiority of the simpler system, which is now advocated by some of the best authorities. Hence the municipal plumbing regulations of cities should be revised so as to make it *optional* with an architect or the owner which system to adopt.

Nelson S. Thompson, chief mechanical engineer, Supervising Architect's office, Washington, D. C., recently expressed his opinion, in a letter to the editor of the *Metal Worker, Plumber and Steam Fitter*, reading in part as follows:

During the time that the front and back outlet water-closets, with their shallow trap seals, were in common use, and prior to the invention of a reliable non-syphoning trap the individual back vent system had a valid reason for existence. \* \* \*

The use of syphon-jet water-closets and slop sinks with 3 inch deep water seals, the use of non-syphonage traps on lavatories and ordinary sinks, and the proper use of the dead-end or circuit vent to protect the shallow water seals of the "P" or running traps on urinals, shower baths, etc., solves the problem of protection of water seals from syphonage.

The only point left to consider is that of insuring a continuous circulation of air through practically the entire system of piping, which is accomplished by the circuit vent system. In the case of a branch to a fixture with a 3 inch deep water seal, or one provided with a non-syphoning trap, *no dead end or circuit vent is necessary* under ordinary conditions for protection against syphonage, nor is it necessary for air circulation until the developed length of the branch exceeds 15 feet. Tests by the Hygienic Laboratory and others have demonstrated that the law of diffusion of gases will insure practically pure air or at least a non-corrosive mixture in a branch of 1½ inch or larger pipe for the distance stated, if a continuous air circulation is maintained in the pipe to which it connects.

The system used by the Government for fixtures



# THE AMERICAN ARCHITECT

located more than 15 ft. from a stack is shown in Fig. 2. The adoption of the simplified plumbing system by the United States Government would indicate that it is more than the pet idea of a few misguided sanitary experts or inventors of anti-syphon traps. Its extensive use to conserve material during the war period is interesting. The United States Housing Corporation was organized shortly after the entrance of this country into the world war, its object being to provide good housing accommodations for war workers in as short a period of time as possible. It labored under re-

types having been installed. The question of availability and quick delivery was considered of prime importance. It is doubtful if this feature of the many dwellings erected by the Housing Corporation would have been given more than passing attention had it not been for the action of the authorities in several cities where dwellings had been erected. In the city of Bridgeport, Conn. for instance, where the Government had well along toward completion last November several groups of buildings of different types, serious difficulties developed. After permitting the construction of the

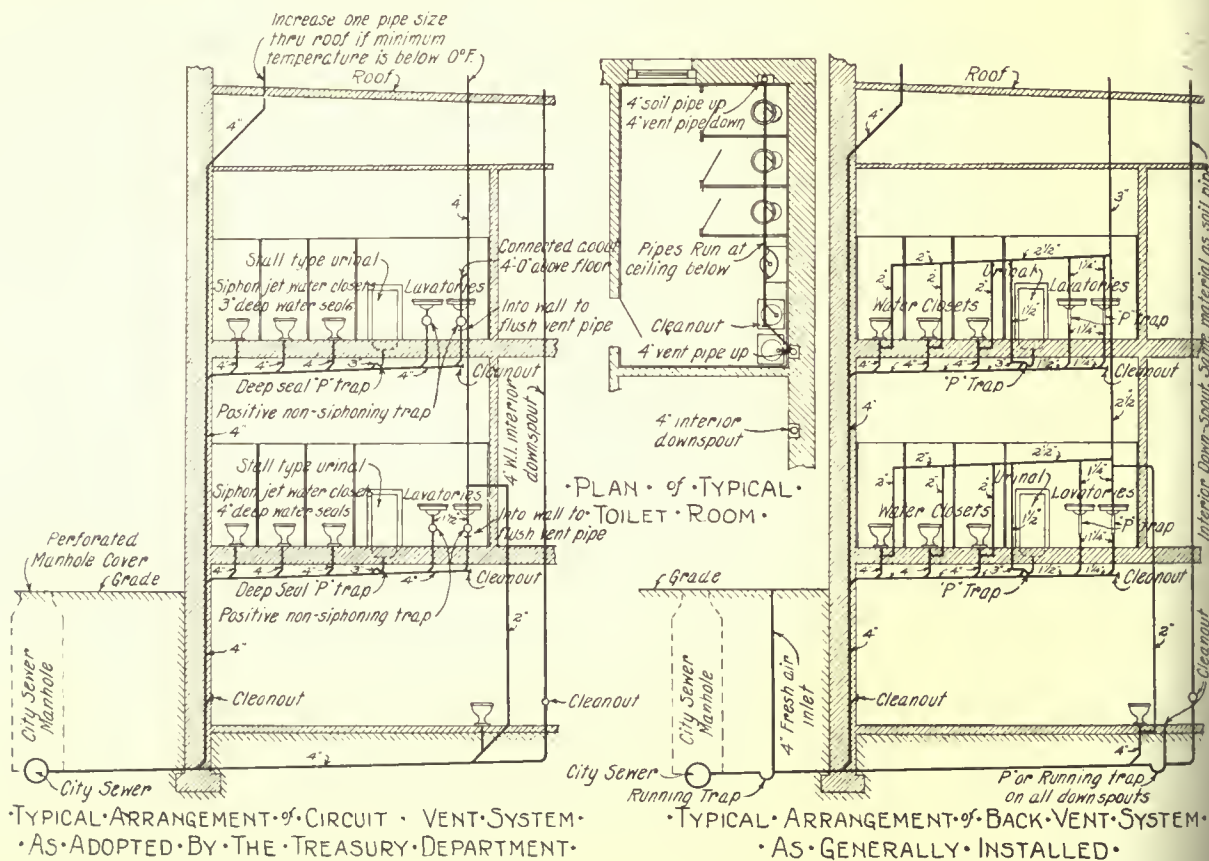

Fig. 2.—The system illustrated at the left has been in use in the United States Government's buildings for many years with entire satisfaction.

strictions governing the use of building materials imposed by the War Industries Board. The corporation endeavored to produce dwellings in all respects safe for human habitation despite such restrictions. One of the features of these numerous dwellings, adopted to conserve material, but only after the sanitary experts of the corporation had satisfied themselves as to its safety was the elimination of all vent pipes in the plumbing installations and the use of anti-syphon traps. So far as can be ascertained no definite standard was drawn as to the type of trap used, several different

buildings with unvented plumbing as a war measure, the local authorities, after the signing of the armistice, pronounced the plumbing as installed unsafe and a menace to health, and ordered that all such work be altered to conform to the Bridgeport plumbing code (which requires back venting) before occupancy of the buildings. The policy of the Government as to the final disposition of these buildings has not been decided upon as yet. It is possible that the buildings will be disposed of to prospective home owners or they may be rented for private use. In the event of their disposal, the

# THE AMERICAN ARCHITECT

approval of the plumbing by the local authorities would of course be necessary. The Government's experts declared the plumbing was safe but the local authorities were unconvinced. To determine fully the exact status of the plumbing systems under dispute the Government decided to make such tests as were necessary, and to this end retained as the test committee five authorities of unquestioned standing in the field of sanitation, to pass on the matter.

The members of this committee are: Albert L. Webster, consulting engineer, New York City, chairman; Dr. Wm. Paul Gerhard, consulting engineer, New York City, secretary; Chas. B. Ball, chief inspector, Division of Sanitation, Department of Health, Chicago; Nelson S. Thompson, chief mechanical engineer, Supervising Architect's office, Washington, D. C.; J. W. McCarthy, plumbing contractor, Washington, D. C.

The purpose of the tests\* was to determine whether the plumbing as installed in the buildings constructed by the United States Housing Corporation in Bridgeport is (in the opinion of the committee) safe.

Four types of buildings were tested, representing all the different designs of plumbing in the several groups of buildings constructed by the United States Housing Corporation at Bridgeport, as follows:

Black Rock Group, three-story, double apartment house, providing accommodations for two families on each floor; six families in all.

Mill Green Group, two-story, semi-detached house, providing accommodations for two families, each family occupying half of each story, separated by a party wall.

Mill Green Group, two types of two-story, double houses, providing accommodations for two families (superimposed apartments) one family on each floor.

Naturally the type of building in which the plumbing will be subjected to the most severe service is in the three-story apartments housing six families of the Black Rock Group. The Committee, therefore, applied extensive tests to this type of building, and had two similar buildings of the group equipped with different systems of plumbing. One represented the United States Housing Corporation's system, using anti-syphon traps, without back ventilation pipes, as illustrated in Fig. 3, and the other represented the Bridgeport system of vented traps, known as P or half S traps. Tests in these buildings gave the following results:

\*Data taken from preliminary report of committee printed in full in the *Bridgeport Times* of March 15, 1919, and reprinted with illustrations in *Domestic Engineering*, April 19, 1919.

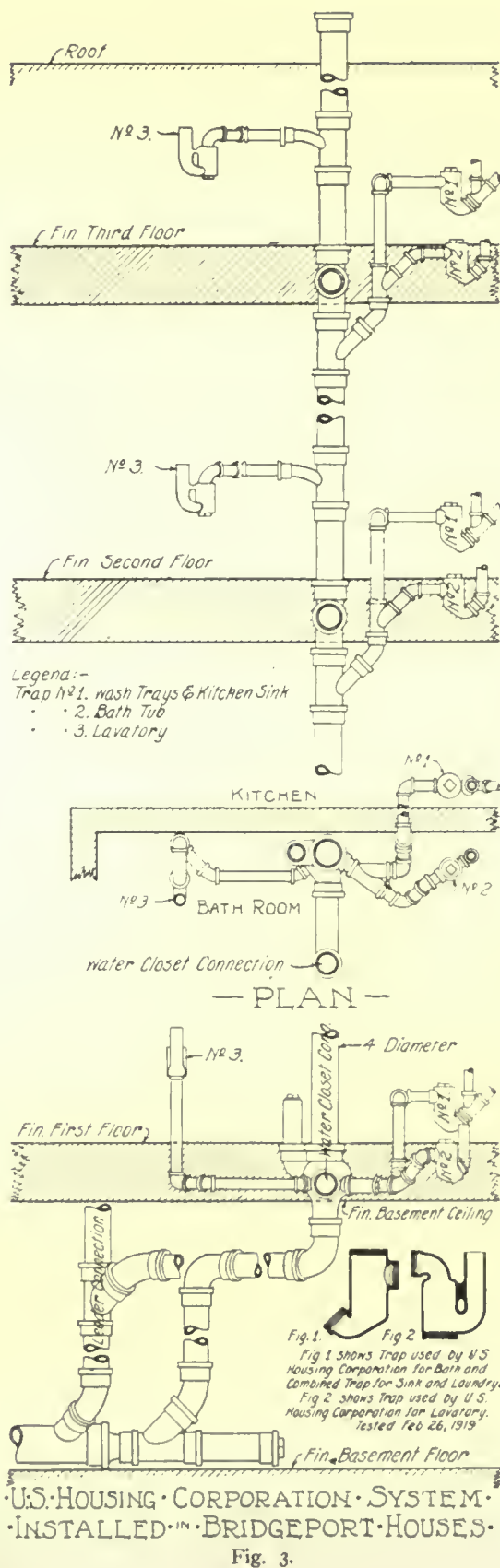



## THE AMERICAN ARCHITECT

The critical floor, under all kinds of tests, is the first floor.

The United States Housing Corporation's system *resists syphonage better than the Bridgeport system.*

The Bridgeport system resists back-pressure better than the United States Housing Corporation's system.

In the Committee's opinion, failure through syphonage is more serious than failure through back-pressure.

It might here be noted that no main house trap or fresh air inlet was provided in any of the Government's installations; also that the water-closet fixtures had a depth of seal of only 2½ inches. It would seem that had deep seal syphon-jet water-closet fixtures been used, the back-pressure would have been less pronounced.

In order to relieve the simplified system from back-pressure, a recommendation was made by the Committee that the United States Housing Corporation's system in the Black Rock Group be corrected by the addition of a 2-inch air relief pipe at each stack (there were two stacks in each building) properly connected to the water-closet and bath fixtures on the first floor, extended to the roof and increased to 4 inches in diameter, before passing through the roof.

The tests applied to both buildings were severe and searching, and, perhaps, subjected both systems to stronger strain than will occur often in actual service, but the Committee believed that any system of plumbing should have a sufficient factor of safety, and from this viewpoint the tests applied were not too severe to insure such safety.

Attention was called to the fact that both systems would show modified results after some length of service due to fouling, although in the Committee's opinion the extent of such fouling would not reduce to the danger point the trap seals of the two kinds of anti-syphon traps used in the United States Housing Corporation's system, nor does it believe that fouling of the Bridgeport traps and vent pipes will be sufficient to endanger that system.

The installations in the two-story groups stood the tests to which they were subjected satisfactorily and the only recommendation made by the Committee was to increase the 2-inch waste where extended above the roof to 4 inches in diameter to prevent possible closure by frost.

These tests are enlightening and would seem to verify the opinions of the Government's sanitary experts who laid out the plumbing work in these buildings.

Although the Bridgeport tests were so thorough that it would seem to settle the question of safety in this type of building beyond argument, it is sur-

prising to note the action of the authorities of New London, Conn. In this city the United States Housing Corporation has ordered abandoned its entire housing project, consisting of 116 houses, badly needed and all but 3 per cent completed, full details of which action appeared in the *AMERICAN ARCHITECT* for May 14, 1919, page 687.

We cannot agree with Mr. Sherman when he refers to the present type of vented system as archaic and obsolete, but all investigations would indicate that the simplified system as installed in these buildings is equal to the more complex system required by the New London regulations.

In addition to the Bridgeport tests, probably nothing has done more to bring the "Simplified Plumbing System" to the forefront than the action in New York City by the Board of Standards and Appeals who recently amended the plumbing regulations (printed in *THE AMERICAN ARCHITECT*, Jan. 22, 1919) so as to make it optional with the architect and owner as to which system shall be installed, and further provided for additional elimination of back vents by permitting the yoke or circuit type of venting, when fixtures are arranged in batteries and located more than the permissible distances from the stack for use of anti-syphon traps.

This important action was brought about in part by the application of George Cody (now dead), who in July, 1918, requested the Board of Standards and Appeals to grant him a hearing as to the merits of an anti-syphon trap he had invented, and suggested that tests be held to determine its efficiency. A committee was appointed to investigate the matter, specifications for a test were later formulated, and the test held August 13, 1918. The committee's report submitted to the Board contained the following conclusions: "The trap satisfactorily met the requirements of the test prescribed by the Board of Standards and Appeals as to its ability to resist syphonage action and maintain a complete water seal at all times, and also as to its self-cleansing properties." This report was adopted Nov. 13, 1918. The Board, however, had no authority to approve this or any other equally meritorious trap without back venting, since the plumbing regulations then in force required such vent pipes. Amendments to the regulations were therefore drafted and published, a public hearing held, and the amendments with a few changes adopted Dec. 27, 1918, becoming effective Jan. 27, 1919. These rules provided for the approval of such anti-syphon traps as met the tests prescribed by the Board of Standards and Appeals, and on Feb. 11, 1919, the Board promulgated the requirements for tests (printed on page 804), which are



## THE AMERICAN ARCHITECT

substantially the same as those to which the trap previously submitted had been subjected, but further required before granting approval, that a trap which had been in actual service for at least one year be submitted and split in half for inspection. One of the Cody traps which had been in use for some nine years under a lavatory in the Nassau Hotel, Long Beach, L. I., was thereafter removed and split in half, and no accumulations of foreign substances being evident (see illustration) a complete resumé of the facts in the case were submitted to the Board on April 1, 1919, and the trap approved for use within the City of New York. Unfortunately the inventor, some 62 years of age, who had worked on this device for many years to bring it to a state of perfection, died two weeks after his invention had been officially approved.

At about the same time that Mr. Cody brought this matter to the attention of the Board of Standards and Appeals the United States Housing Corporation filed plans for numerous dwellings to be erected in Staten Island, in which it was proposed to install the simplified plumbing system.

The Building Bureau felt it lacked authority to approve such plans, and the matter was taken up unofficially with the Board of Standards and Appeals. Had the Board not acted as it did in amending the plumbing regulations it is likely that the matter of permitting the simplified plumbing system would have been brought up officially by the United States Housing Corporation.

At the time the plumbing regulations came up for amendment, strong opposition to any changes was voiced by representatives of the Master Plumbers' Association,\* on the grounds that the present efficient system with vent pipes had been built up as the result of many years of careful study, and that the development to date in the design of anti-syphon traps had not reached such a stage of perfection as would warrant the changes

proposed. They conceded that the simplified system was sanitary, provided an ideal anti-syphon trap could be produced. Directly after the approval of an anti-syphon trap, for use in the City of New York, thus making the amended regulations operative, steps were taken by those opposed to the simplified system to prevent its installation. Request was made to the Mayor of New York City for the reception of a committee to present their views on the subject, and as this was a matter in which the public health was involved, the Mayor very properly granted the request. The Board of Standards and Appeals was represented by its chairman. After a lengthy hearing during which both sides had ample opportunity to present their evidence the Mayor said in substance: "If this trap does what is claimed for it (makes unnecessary the installation of vent pipes) I am in favor of it. If it does not, its use should be prohibited, and I am

satisfied the Board of Standards and Appeals would not want it used." Thus the controversy was brought to the bed rock of merit, and in order to decide the issue the Mayor suggested that the trap be installed in a fairly high building under actual service

conditions in order to demonstrate its efficiency. This suggestion was made, as it was claimed the test specified by the Board, to which the trap had already been subjected, was not analogous to conditions occurring in actual service, and not so severe.

Accordingly a ten-story fireproof building located on the Court House site (southeast corner Pearl and Park Streets), erected in 1902 and owned by the city, was selected. This building is at present occupied as a supply depot by the Quartermaster's Corps, United States Army. A 5-inch vertical soil line containing no offsets and exposed to view from roof to basement, into which the fixtures shown in Fig. 4, page 802, drained, was selected for use. As such a test is somewhat unusual and probably the most severe ever made on any anti-syphon trap, it will be described in some detail.

The preparatory work for the test consisted in

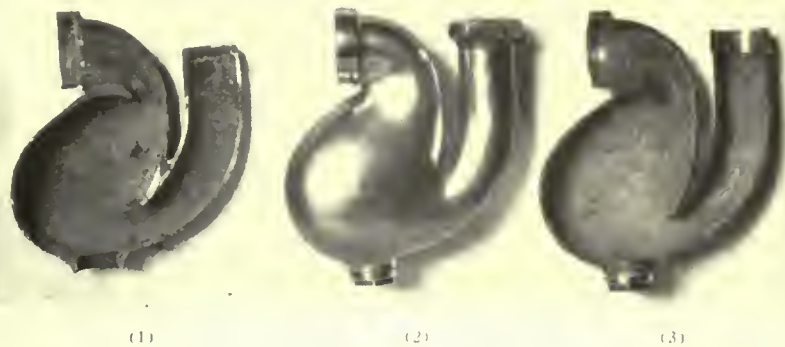

Re-sealing trap tested and approved for use in New York City. From left to right: (1) sectional view of trap taken from Nassau Hotel, Long Beach, L. I., after approximately 9 years' service; (2) general appearance of trap as now manufactured; (3) sectional view of new trap.

\*It cannot be assumed from this action that this is the opinion in general of the master plumbers of New York City since the Master Plumbers' Association (New York City) has a membership of less than 400, whereas there are some 4000 master plumbers registered in the Greater City.

cutting out the back vents in each story and plugging them up; disconnecting the existing 4-inch vent stack at the bottom where it connected to the house drain and capping both ends where cut; installing a Tee Y fitting in the 5-inch soil line, first story with a 1½-inch horizontal branch waste 22 inches long, to which the trap to be tested with a lavatory was connected. This trap contained glass windows so that the depth of water seal could be observed during the test. As there were no fixtures in several of the upper floors one 25-gallon tank was installed in each of the fourth, sixth and seventh stories, each tank being provided with an anti-syphon trap having glass windows for observation, and discharging into the 5-inch soil stack. A special signalling apparatus was provided so that the persons at the fixtures in each story could be notified when to discharge same.

The official demonstration was held May 1, 1919. During the morning session the anti-syphon trap was subjected to more severe conditions than would ever be likely to occur during actual service. Approximately 350 gallons of water was emptied into the soil line at each test by the simultaneous discharge of every fixture above the first story. At the same time a heavy rain was occurring, causing a large amount of water to be conducted by the leaders into the main house drain. During the recess between morning and afternoon sessions a half S trap, with back vent connection to the 4-inch vent line was installed in place of the anti-syphon trap and during the afternoon the same tests as had been made on the anti-syphon trap were repeated on the vented half S trap in order to make a fair comparison between the two systems under identical conditions. The results of these tests were as follows:

The anti-syphon trap lost no seal from syphonage, and the water within the trap was affected but little by syphonic action during the discharges.

The water seal of the vented half S trap fluctuated considerably at each discharge, due to syphonic action, but the seal remained unbroken.

The anti-syphon trap was affected by back-pressure during one discharge which occurred during a particularly heavy rainfall, some of the water within

the trap being forced into the wash basin, but the trap resealed completely, losing no water. During all the other discharges the back-pressure, while causing commotion within the trap, did not force any water into the wash basin, nor affect the seal.

The vented half S trap was affected by back-pressure during every discharge, and practically the entire amount of water contained within the trap was forced up into the wash basin, later receding and completely resealing the trap.

A fair comparison between the two systems, based on the foregoing tests shows that neither trap was affected to any serious extent by syphonage, and at no time was the back-pressure of sufficient intensity to prevent the complete resealing of the traps. Such strong back-pressure was not unexpected considering that the water from the uppermost fixtures fell ten stories, being augmented on its downward path by the discharges from fixtures on other stories, then entered a horizontal drain already partly filled by rain water from the leaders. These results would indicate that the proper use of this anti-syphon trap without back venting was entirely safe.

Fig. 5, page 803, shows a typical layout of kitchen and bath room fixtures, with simplified system conforming to the New York City regulations as they now stand. These regulations do not permit the placing of a fixture with unvented anti-syphon trap more than 7 feet from a stack, nor the placing of an unvented deep seal syphon jet water-closet more than 5 feet from a soil line. If all fixtures can be grouped so as not to exceed these limitations all vent lines may be omitted.

However, as batteries of fixtures are often arranged in such a manner that these limitations are exceeded, it is still possible to eliminate the back vents by using the yoke or circuit type of venting. This is illustrated in Fig. 6 for a battery of seven water-closets and a comparison with the back-vented system shown. A further illustration is also shown in the drawing submitted by Mr. Nelson S.

Thompson (Fig. 2, page 798), illustrating this method of venting as installed by the United States Treasury Department, in which several kinds of fixtures are arranged to drain into one horizontal branch.

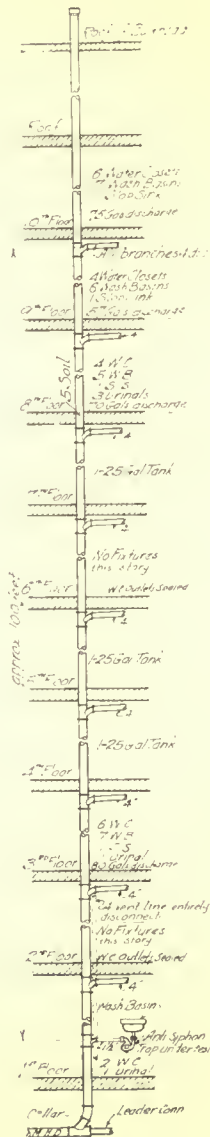
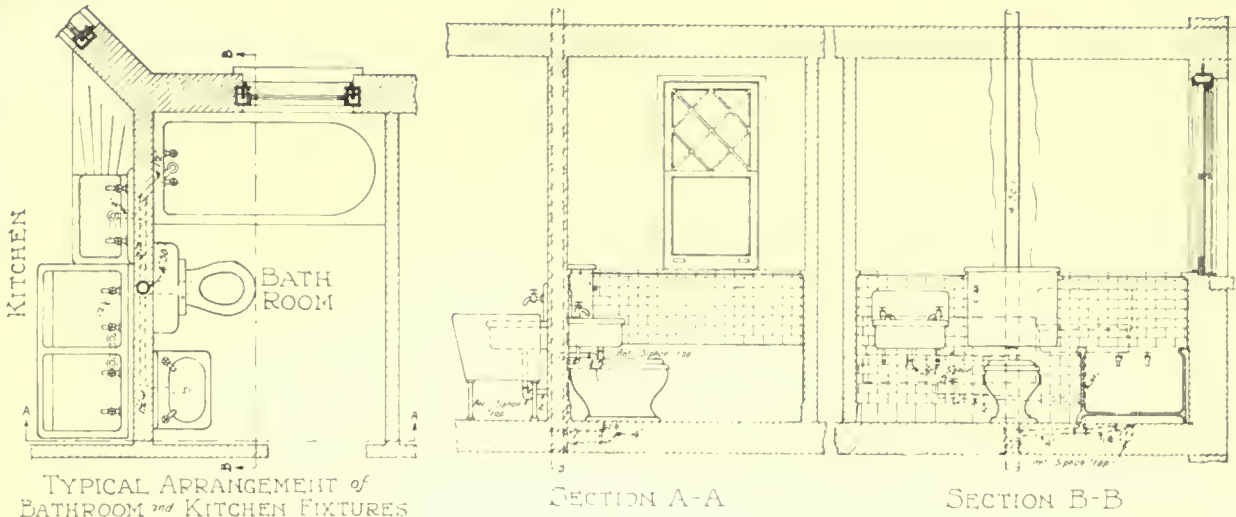

Fig. 4. — Diagram showing soil line of ten story building in which Cody resealing trap was tested



TYPICAL ARRANGEMENT of BATHROOM and KITCHEN FIXTURES

Fig. 5.—Plumbing system conforming to the New York rules, utilizing deep seal syphon-jet water closet and re-sealing traps, thus eliminating all vent pipes. Note the simplicity of connections.

Actual figures as to costs are usually of more acute interest than even drawings, and estimates for the arrangement shown in Fig. 5 for a four-story building are as follows:

Back-vented system .....	\$620.00
Simplified system .....	436.00
Saving if simplified system is installed, 29.7 per cent, or....	\$184.00

For the arrangement shown in Fig. 6 the figures are as follows for a four-story building:

For back-vented system.....	\$1,600.00
For yoke-type system.....	1,132.00
Saving if yoke type is installed, 29.2 per cent, or.....	\$468.00

These figures relate to the material and labor for piping system only from the basement ceiling to the roof, and do not include fixtures or horizontal house drains in the basement, leaders, etc., which of course would vary with each installation, depending on several factors. The cost of fixtures and these additional pipe lines would, however, be the same for both systems.

Attention is called to the fact that the simplified plumbing system is *not new*, but it is believed that recent developments in the design of anti-syphon or re-sealing traps and of deep seal syphon-jet water-closet fixtures have now reached that stage of efficiency which warrants the installation of this system, when properly designed.

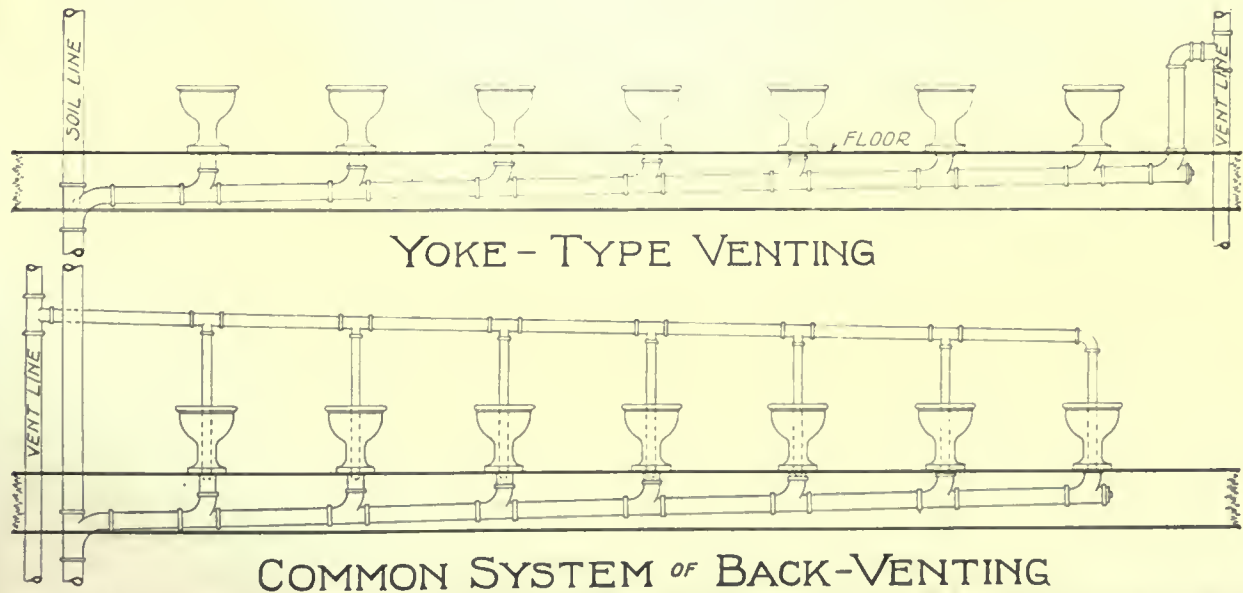

Fig. 6.—When fixtures are located as shown above the New York rules require the piping system to be specially ventilated. The Yoke type system will accomplish this with entire satisfaction, and at a saving of cost.



# THE AMERICAN ARCHITECT

The war despite its horrors has brought us many benefits, not the least of which is the lesson of conservation. Architects should be quick to retain and convert into permanent practice all those features, adopted by the Government as a war necessity to conserve labor and material, which can be shown to be safe, beneficial and at the same time economical. Where laws or ordinances prevent such proper progress the profession should lend their influence in an active way to the amendment of restrictive ordinances.

A partial list is here given of cities now permitting the simplified plumbing system.

City	State	Population
*New York	New York	5,800,000
Gloversville	New York	21,000
Johnstown	New York	11,000
Kingston	New York	26,000
Rochester	New York	220,000
Schenectady	New York	80,000
Atlantic City	New Jersey	52,000
Bayonne	New Jersey	65,000
Montclair	New Jersey	25,000
Orange	New Jersey	30,000
Trenton	New Jersey	104,000
Boston	Massachusetts	750,000
Cambridge	Massachusetts	110,000
Dedham	Massachusetts	11,000
Lowell	Massachusetts	108,000
Somerville	Massachusetts	87,000
Newport	Rhode Island	31,000
Providence	Rhode Island	250,000
Pawtucket	Rhode Island	56,000
Woonsocket	Rhode Island	41,000
Williamsport	Pennsylvania	32,000
Portland	Maine	60,000
Raleigh	North Carolina	20,000
Clarksburg	West Virginia	10,000
		8,000,000

Totals, 24 cities, located in 8 states, with an aggregate population of 8,000,000 persons.

\*Largest city in the world.

†Less deaths per thousand of any city in U. S. Sanitary code makes simplified plumbing system mandatory.

Rigid and searching tests should be applied to all anti-syphon traps and deep seal syphon jet fixtures before approval by any municipality, and if only those meeting the most severe requirements are installed no fear need be had as to the safety of the system.

Below are printed the New York City test requirements.

## METHOD FOR TESTS FOR ANTI-SYPHON TRAPS OR FIXTURES

*Resolved.* That the following be and it hereby is adopted by the board of standards and appeals as the method prescribed for tests for anti-syphon traps or fixtures, which must be successfully passed before such traps or fixtures shall be approved under Rule 99, Rules for Plumbing and Drainage:

### Instructions

1. The entire cost and responsibility for the installation of the necessary equipment for such test shall be borne by the person or firm submitting the appliance.

2. Such person or firm shall also furnish the board, together with the application for test, the following material and information:

(a) A stock trap of the size and design to be tested, which shall be of the P and S type and shall be of lead or brass, cast in one piece, and without interior partitions or mechanism.

(b) A similar trap cut in half.

(c) A similar trap, to be used in the test, provided with glass observation ports of sufficient size to permit clear observation of the action occurring within the trap during test, and such observation ports shall be so located that the amount of water seal remaining after each test can be readily observed.

(d) An affidavit that the three traps submitted are regular stock traps.

(e) A list of all cities, towns or municipalities where such trap has been officially approved for use without back venting.

The testing apparatus shall be located within the City of New York, and in a place, building or structure to meet the approval of the testing authorities. Such apparatus shall be so located that every part is easily accessible for inspection.

### Apparatus.

The apparatus shall consist of the following:

A tank of not less than fifty nor more than one hundred and fifty gallons capacity, with adequate water supply for refilling same during the test.

A vertical wrought iron or steel pipe line fifty feet long, connected to the underside of the tank, and of the same internal diameter as the trap to be tested.

A quick-opening valve, located ten feet below the underside of the tank.

A TY fitting located two feet below the quick-opening valve, with horizontal branch pipe connected thereto, of the same diameter as the vertical line, this branch line not to exceed two feet in length, with a pitch towards the vertical line of two inches to the foot, and the trap to be tested shall be connected to this horizontal branch pipe.

A wash basin, or fixture answering the same purpose, which can be conveniently connected or disconnected from the inlet side of the trap.

The test shall be conducted as follows:

### For Anti-Siphon Qualities.

For the purpose of determining the efficiency of the trap, the tank shall be completely filled, a water seal established in the trap; and—

The quick-opening valve shall be opened for five seconds, then closed for five seconds, and this alternating process repeated five times.

The quick-opening valve shall be opened and the entire contents of the tank discharged at one time.

The wash basin shall be connected to the trap, filled with water, and both wash basin and tank discharged simultaneously. The quick-opening valve shall be kept open until the entire contents of the tank has been discharged.

The trap shall be disconnected and a bridge of solid soap formed across the lower half of the discharge end of the trap, so as to effectually block one-half of the clear water way, and the foregoing tests repeated.

Each operation shall be repeated several times, if desired by the testing authorities.

### For Self-Cleansing Qualities.

For the purpose of determining its self-cleansing qualities, the trap shall be filled with sand and the wash basin filled with water and allowed to discharge. A similar operation shall be repeated with tea leaves, coffee grounds, sawdust and grated soap.

### For Service Qualities.

The service qualities of the trap may be tested as follows:

A trap which has been in actual constant use for a period of not less than one year shall be removed under the supervision of a representative of the testing authorities, split into two halves, and submitted for inspection, for the purpose of determining whether sediment or coating of grease or other foreign matter has accumulated in the trap during service conditions.

### Approval.

An approval shall not be issued for any anti-syphon trap which has been subjected to the foregoing tests unless the trap has:

1. Maintained its water seal throughout the test.
2. Been successfully scoured of any foreign substances placed in the trap, when water has been discharged through same.
3. Upon inspection, after service, shown no excessive accumulation of grease or other foreign substance.

*Deep Seal Syphon Fixtures, or Anti-Syphon Fixtures, Instructions:* Applicants for approval of deep seal syphon-jet or anti-syphon fixtures shall submit the following with their application:—

(a) A stock fixture of the size and design to be tested.

(b) A similar fixture, cut in half.

(c) A similar fixture, to be used in the test, provided with glass observation ports of sufficient size to permit clear observation of the action occurring within the fixture during test, and such observation ports shall be so located that the amount of water seal remaining after each test can be readily observed.

(d) An affidavit that the three fixtures submitted are regular stock fixtures.

### Apparatus.

The apparatus shall be similar to that required for anti-syphon traps, except that vertical and horizontal pipes shall have an internal diameter of three inches for testing sloop sinks and four inches for testing water-closets; tank shall have a capacity of not less than one hundred gallons and the fixture shall be provided with its usual water supply so that same may be flushed when required.

### Test.

For the purpose of determining the efficiency of the fixture to maintain a water seal, it shall be tested in a manner similar to that prescribed for anti-syphon traps, except that no soap bridge need be provided at the outlet.

Adopted February 11, 1919.

JOHN P. LEO, Chairman.

*Walls finished with Cabot's Old Virginia White; roofs stained with Cabot's Creosote Stains.*



*Tooker & Marsh, Architects, New York*

## Cabot's Old Virginia White

The Modern Architectural Outside White

The clean, brilliant "whitewash white" effect of Old Virginia White has real distinction. It is a softer and yet a brighter white than paint, and its texture and color-values are essentially different in character from the heavy, hard paint coating. This makes it especially appropriate for the modern "Colonial," because it gives the house at once the aspect of well-groomed old age—a result that it would take years to accomplish with paint. (You can get Cabot's Stains all over the country. Send for samples and name of nearest agent.)

1133 Broadway, NEW YORK Samuel Cabot, Inc., Manfg. Chemists, BOSTON, MASS. 24 W. Kinzie St., CHICAGO 5-1

## TUDOR-STONE

Suitable for any architecture and is not limited by cost, character or color. Architecturally satisfying and, in certain combinations, less expensive than regular graduated roofing slate.

### THE RISING & NELSON SLATE CO.

Since 1869 Miners and Makers of High-Grade Roofing Slates  
Quarries and Main Office, West Pawlett, Vermont  
Architects' Service Department, 101 Park Ave., New York  
Chicago Boston

*Among the users of Rising & Nelson Slate including Tudor-Stone are the following:*

*John Russell Pope  
Bertram G. Goodhue  
Howard Greenley  
Holabird & Roach  
Delano & Aldrich  
Dwight James Baum  
Chas. F. Platt  
McKim, Mead & White*



# Financing New Construction

**I**T is our function to cooperate with architects, engineers and builders who wish to get in touch with large amounts of capital available for the construction of new buildings.

We specialize in making construction loans in the form of first mortgage bond issues in amounts of \$250,000 upward, secured by income producing properties of the following classes, where the margin of security is ample for safety and the earnings sufficient to make principal and interest payments:

- office buildings;
- mercantile buildings;
- apartment buildings;
- hotel buildings;
- warehouses;
- plants of industrial concerns.

We make loans from architects' plans and specifications, paying contractors as the building progresses.

We also purchase outright first mortgage bond issues which are the obligations of well-established industrial concerns in need of capital for legitimate expansion and which have sufficient real estate assets and a record of successful operation.

Our plan provides the desired capital immediately and permits repayment over long periods out of current earnings.

We have a thoroughly developed organization and offer our facilities to those who contemplate construction or business development.

Write for our booklet explaining the Straus Plan of Financing. Ask for

Booklet No. F-20

**S.W. STRAUS & CO.**  
ESTABLISHED 1862 INCORPORATED

STRAUS BUILDING, CHICAGO  
150 BROADWAY, NEW YORK

**Thirty-Seven Years Without Loss to Any Investor**



## Construction Attracts New Capital

(Continued from page 794)

public has arrived at the conclusion that there will be no recession of prices and are now ready to build as soon as the predicted stabilization of the money market becomes a certainty.

The purchase of Southern pine lumber this week returned to the normal peace time volume for the first time since the end of the war. This fact has been brought out by the announcement that total orders received by 160 mills of the Southern Pine Association were two per cent above the line indicating normal business. Production was 81 per cent and shipments 75 per cent normal. Business has been climbing upward for the past two months. It is predicted that in face of business now in sight orders will be fifty per cent above normal within the next month.

"The lumber business has come back," said J. E. Rhodes, secretary-manager of the Southern Pine Association, in commenting on the statistics, which indicate that the demand for Southern pine is much in excess of its production.

"Since the signing of the armistice, when the government ceased taking lumber in large quantities, the production of Southern pine each week was considerably larger than the sale and shipments. This continued to the middle of April, with accumulating stocks at the mills.

"In April the number of unfilled orders reported by the members of this Association amounted to 18,433 cars. Last week the same mills had unfilled orders on hand amounting to 23,524 cars. There were received during the week by 166 mills, representing more than one-half the total production of Southern pine in the Gulf states, orders for 4,968 cars, equivalent to more than one hundred million feet. This is 25 per cent more than the output of the mills for the same week.

"The orders received by these mills during the week ending April 4 averaged 402,755 feet per mill; while the average orders last week was 631,355 feet, an increase of more than 50 per cent in business in six weeks.

"In addition to the large needs for lumber in foreign countries, especially Europe, a most conspicuous feature of the resumption of the lumber business is the great need for construction of every sort in the United States.

"The costs of manufacturing lumber remain high and manufacturers generally do not see any immediate prospect of reduction. There is still an acute shortage of labor at many Southern lumber producing points.

"With the gradual resumption of business generally, it is certain that the capacities of the Southern pine saw mills will be taxed to the utmost to furnish the building material required by the domestic market, in addition to supplying what foreign buyers will be able to ship from our shores."

The cost of erecting new buildings has increased 50 per cent beyond the cost during the pre-war period. The fifty-foot, sixteen-family house, which formerly cost \$35,000 to build will now cost \$50,000, if not \$55,000. This is the opinion of William E. Harmon, prominent builder, who is now undertaking large building operations.

Structural steel shops booked 40 per cent more business in April than in March, according to the records of the Bridge Builders' and Structural Society, which show that 24½ per cent of their capacity, or 44,100 gross tons, was contracted for in the past month, as compared with 17½ per cent in March, 12½ per cent in February, 12 per cent in January, and 64 per cent in April, 1918. The average business taken on in the four months of this year is less than 17 per cent of capacity, as against 55 per cent in the same period of 1918.

## Late Quotations in Building Material Markets

(Price quotations now current on building materials and supplies as quoted by dealers and jobbers for delivery in New York and Chicago follow. The quotations set forth are placed before readers of THE AMERICAN ARCHITECT to afford an accurate review of market conditions rather than for use as a basis for actual purchase. They will not only provide knowledge of the exact state of the market as to items quoted, but will also present a basis to judge conditions as affecting co-relating materials. Items marked (\*) indicate an advance over last week, while those marked (†) record a decline. Other prices did not fluctuate during the week.)

	New York	Chicago
<b>BRICK</b>		
Face brick (delivered on job):		
Common (Delivered at job in Borough of Manhattan only), per thousand.....	\$17.85	\$12.00
Rough red .....	29.00	40.00
Smooth red .....	26.00	40.00
Rough buff .....	32.00	40.00
Smooth buff .....	32.00	40.00
Rough gray .....	38.00	42.00
Smooth gray .....	40.00	42.00
Colonials .....	24.00	30.00
<b>BROKEN STONE</b>		
(Delivered on job):		
1½ in. per cu. yd.....	\$3.25	\$2.35
¾ in. per cu. yd.....	3.25	2.35
<b>BURNED CLAY</b>		
(Delivered on job)		
Block partition:		
3 in., per sq. ft.....	.18	.10
4 in., per sq. ft.....	.20	.11
Chimney tops:		
12 x 12 for 8 x 8 flues.....	\$3.50	\$2.25
Flue lining:		
4 ft. x 8 ft., per ft.....	.18	.12
4 x 12, per ft.....	.22	.16
8 x 8, per ft.....	.22	.16
8 x 12, per ft.....	.27	.20
12 x 12, per ft.....	.35	.28

	New York	Chicago
8 x 18, per ft.....	.40	.32
12 x 18, per ft.....	.49	.42
18 x 18, per ft.....	.67	.55
<b>Wall coping (double slant):</b>		
9 ft., per ft.....	.24	.14
12 ft., per ft.....	.27	.18
18 ft., per ft.....	.36	.30
<b>Wall coping (single slant):</b>		
9 ft., per ft.....	.26	.17
12 ft., per ft.....	.30	.22
18 ft., per ft.....	.42	.35
(Corners and angles four times the price of one foot of coping the same size.)		
<b>Hollow Tile</b>		
(Delivered at job, in New York below 72nd St.)		
2 x 8 x 12 partitions, per 1,000 sq. ft.....	\$70.15	.....
3 x 12 x 12 partitions, per 1,000 sq. ft.....	102.00	\$67.90
4 x 12 x 12 partitions, per 1,000 sq. ft.....	114.75	72.50
6 x 12 x 12 partitions, per 1,000 sq. ft.....	153.00	99.60
8 x 12 x 12 partitions, per 1,000 sq. ft.....	.....	135.80
10 x 12 x 12 partitions, per 1,000 sq. ft.....	.....	167.50
12 x 12 x 12 partitions, per 1,000 sq. ft.....	.....	194.60
2 x 12 x 12 split furring, per 1,000 sq. ft.....	63.75	.....
<b>CEMENT</b>		
Per bbl. in 15 cent bags (Rebate 60c. per bbl. for bags) .....	\$3.25	\$2.80
<b>COPPER SHEETS</b>		
At the mill, hot rolled, 16 oz. base-price, per lb... 22½c.		22½c.
(From jobber's warehouse add 2 to 3 cents. Cold rolled add 1c. per lb. to hot rolled.)		
<b>CORNER BEAD</b>		
Per foot .....	.05	.05
<b>FIBRE</b>		
Per bushel .....	.30	.30

(Continued on Page 804-B)



*m*  
*P. 188 - 1949/6/13 876*

# The AMERICAN ARCHITECT

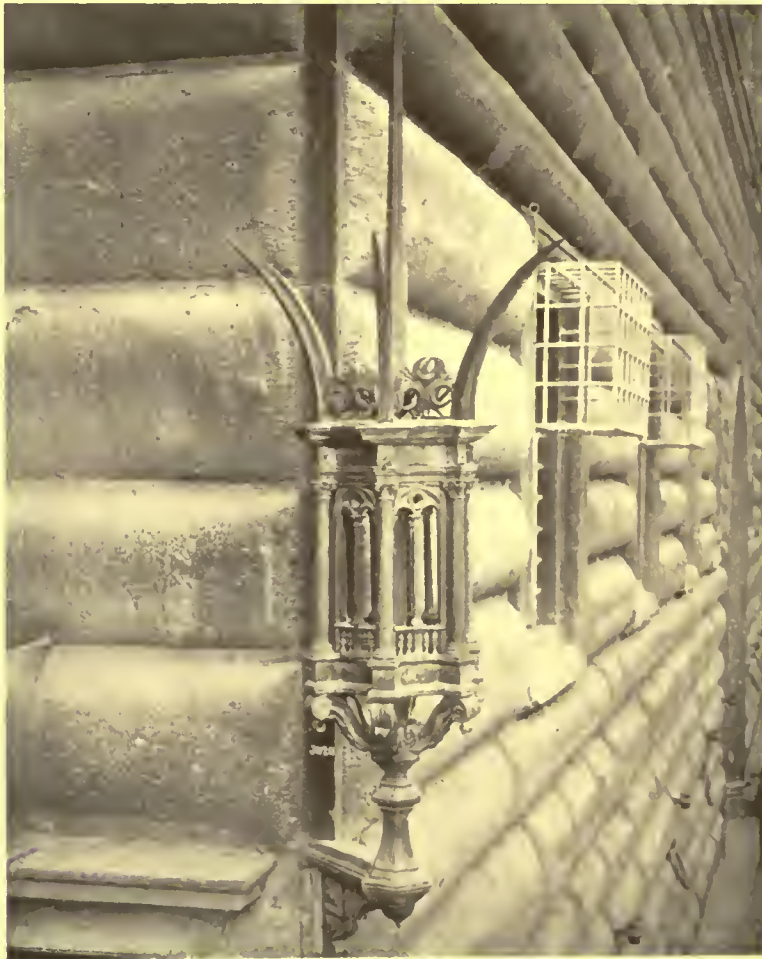

IRON LANTERN, PALAZZO STROZZI, ALENARI, ITALY

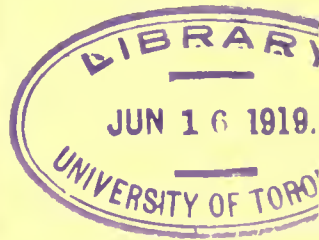

PUBLISHED WEDNESDAYS IN NEW YORK—FOUNDED 1876  
VOLUME CXV                      JUNE 11, 1919                      NUMBER 2268

---

Entered as second class matter January 6, 1909, at the Post Office at New York, N. Y., under the Act of March 3, 1879. Publication office, 243 West Thirty-ninth Street, New York, N. Y. Subscription price in the United States and Possessions, \$10.



Bell Telephone Building  
Kansas City, Mo.  
*Henry T. Hoyt, Architect*  
*I. R. Timlin, Associate Architect*

# Armco Iron

*for*

## Permanence

Years of service cause but slight deterioration in Armco Iron and for this reason the architects of great buildings, intended for permanent service, specify Rust-Resisting Armco Iron for all Sheet Metal Portions, Metal Lath, Metal Roofing and Metal Window Frames; Pipes, Gutters, Cornices and Fireproof Doors (all of which go a long way toward making a building fireproof).

When these are of the standard pure-rust resisting iron, they form worthy portions of buildings that are erected for the future.

In the beautiful new Bell Telephone Building of Kansas City, Mo., more than 100,000 pounds of Galvanized Armco Iron was used for window frames and other sheet metal work.

To keep down repair bills and maintenance costs; to insure long life and minimum replacements; to make the building increase the dividends by saving in operating expenses, use Armco Iron.

*Write us regarding your building problems.*

**The American Rolling Mill Company**  
MIDDLETOWN, OHIO



Licensed Manufacturers Under Patents Granted to the International Metal Products Company

*Armco Iron Sheets, Roofing, Pipe, Gutter and Metal Lath*

Branch Offices at  
NEW YORK CHICAGO PITTSBURGH CINCINNATI ATLANTA  
WASHINGTON CLEVELAND DETROIT ST. LOUIS and SAN FRANCISCO



24





DETAIL OF HOUSE OF PALLADIO, VICENZA, ITALY

*THE AMERICAN ARCHITECT*

# THE AMERICAN ARCHITECT

VOL. CXV

WEDNESDAY, JUNE 11, 1919

NUMBER 2268



VIEW FROM NORTHEAST

## An Italian House at Miami, Florida

GORDON E. MAYER, *Architect*

FOR many years, Northern men of wealth have sought and found locations in the South where they have built pretentious houses set in spacious grounds. Here, during the rigorous months of the Northern winters, they have found health and recreation amidst the most luxurious surroundings.

The house of Charles L. Briggs, of Haverhill, Mass., located at Miami, Florida, and illustrated in this issue, presents an excellent example of the type of house referred to. Its location is on a lot approximately 200 x 700 feet, and as indicating the highly restricted nature of its neighborhood it may

be mentioned that this lot and those of this tract are sold at as high a price as \$30,000 for a hundred feet frontage.

The architect states that on receiving the commission, a primitive dense jungle or "hammock" covered the entire site. In order to facilitate the determination of the contours of the property, and to avoid the destruction of natural features of the landscape effects it might be desired to retain, paths were cut through the jungle with machete and axe. Later, when the landscape effects were under consideration, the various paths and roads were all laid out so as to retain as far as possible the fine old tree



## THE AMERICAN ARCHITECT

growth that had for many hundred years been slowly forming.

The site is one of the most favorable in a section that has unlimited picturesque charms. From an entrance arched by sweet-bay trees, the land slopes gently to the blue waters of Biscayne Bay. The setting of the house has been accomplished with admirable skill. Every natural feature has been maintained. So dense is the natural foliage and planted shrubbery that the outlines of the buff stucco

branches out, and in the enclosure are climbing jasmine, night blooming jasmine and thevetia neerifolia. Right here the buff-tinted house emerges out of a park of Japanese grass, zoisiz pungens and bougainville. An English rock path leads away to the sunken garden. Completely filling up this space close to the house are clumps of dwarf poinsettias, cryptostegia and grandiflora. When the front of the dwelling is reached there is quite a drop to the lower grounds about the bay.



MAIN ENTRANCE AND GARAGE

house are scarcely visible from the entrance to the grounds. The effect is that much sought for one where the artist leads the eye by softness of outline and well enveloped color to an effect that stimulates the critical faculty of the beholder.

In a broad space near the house, the original hammock has been left intact, in which fern-lined paths wander aimlessly and cross each other. There is a striking contrast between this wildness and the soft green lawn that runs from the rocky wall down to the driveway. At this point the main walk

This is a broad expanse of lawn, except for the western side, which will ultimately become a flower garden. This will supply the house with a hundred varieties of cut flowers for table decoration. Perhaps the most appealing glimpse is had from the conservatory. The view spreads away over the lawn and clusters of cocoanut palms to the glittering bay. Far out are the dark splashes of the keys, while above this is the changeable sky, sometimes a pale, delicate blue, and on other occasions a flaming melting pot of clouds of all hues. The bay, too, is apt





MAIN ENTRANCE AND PORTE COCHERE  
HOUSE OF CHARLES L. BRIGGS, MIAMI, FLORIDA  
GORDON E. MAYER, ARCHITECT

## THE AMERICAN ARCHITECT

to "change its spots." Whether the water is indigo or a rich coppery green, the effect upon the sensibilities of the observer is always the same.

It was the idea from the beginning to preserve the grounds in the natural wildness of tangled hammock in so far as it does not interfere with the general plan. This has been accomplished to a satisfying degree. Where flowering shrubs have been introduced, they have been selected with absolute care so that they should not jar upon the original subjects. This recently transplanted nursery stock harmonizes perfectly with the landmarks. Fully to

in a fountain pool built in at the base of the eastern wall and supporting the patio balustrade. There are no inside doors on the first floor with the exception of that from the breakfast room to the pantry and kitchen, the rooms being divided by rich colonnades or wide openings.

The dining room is finished in red gum, worked to a finish that equals in richness of color that of Circassian walnut. This room has a spacious fireplace. At the east end large doors open on to a wide dining terrace from which there is an attractive view of the Italian formal garden and terraced



THE PATIO

appreciate a group of cocoanut palms, one must see their slender trunks curving upward against a tropic background of indigo water and lighter sky. The effect otherwise is greatly minimized.

This house in its design is thoroughly Italian, with an H-shaped plan. The screened loggia acts as the central feature to divide the recreative and guest rooms on the one hand from the domestic and owner's subdivisions on the other. About the central patio is a cloistered gallery upon which the rooms open through wide French doors. Sweeping stairways descend from the patio, winding around

lawns in front of the house and extending down to the bay.

A massive Italian staircase, that has for its origin in design a similar one in northern Italy, leads from the main hall to the second story where there are five large chambers, each with its well appointed bathroom. These rooms open to the central loggia and galleries.

The roof of the house as well as that of the garage has been particularly well handled and the color effect leaves nothing to be desired. The admirable blending with the hues of the landscape pro-



## THE AMERICAN ARCHITECT

duces just the effect of color that would properly emphasize the entire scheme. These roofs are covered with a hand sprayed roughened Mission tile of many complementary colors. The well appointed garage has in its second story rooms for servants with necessary baths and a sleeping porch.

From the porte-cochère there are steps, leading from the drive to a pergola and large domed fountain, which forms the central motive of the admirably planned landscape gardening effects.

Directly in front of the fountain is an Italian formal garden, from which the terraces and sloping lawns extend down to the sea wall on the bay. As

a central feature on the water front there is a Venetian boat landing. This is cantilevered over the water, supported by deep brackets.

The water system provides a hot and cold rain water service to the house, garage and laundry. There is a 50,000 gallon storage and filter tank, built under the house, using the bearing walls of the house for tank walls. These walls are reinforced and waterproofed. All of the water used percolates through a special stone filter partition constructed of Bahama (B. W. I.) limestone. From this tank the water is pumped by an automatically operated pump into a 500 gallon pressure tank.



PERGOLA AND SUMMER HOUSE



# Buildings As a Factor in Production Costs\*

**B**UILDINGS as a factor in production are often either not considered at all by managers and production men, or the influence of buildings and their parts on production costs, are not usually given their proper credit.

A building housing a manufacturing industry of whatever character, should be considered as a machine; and due to its first cost, expense of maintenance and cost of depreciation, should be thought of, and always considered the most important machine of the plant.

Unfortunately, some managers overlook the importance of the buildings which house their plants and quite frequently do not correctly charge in their production costs all of the items properly chargeable to building; as for example, interest on the cost of building and land occupied, maintenance, insurance, depreciation, etc. In so far as a manufacturer can reduce these fixed charges, other conditions being equal, he will be able to produce cheaper than his competitor; and while these items of fixed charges are costs that must be paid, irrespective of the type of building occupied, yet their relative amount is determined or controlled to a large degree by the adaptability of the buildings when considered as a huge machine fitted to the peculiar operations of the industry, and may be further controlled by the type of building irrespective of its adaptability.

Perhaps it would aid our discussion if for a moment I imagine myself the president or manager of a successful growing manufacturing corporation whose business has outgrown the plant and where conditions are such as to forbid any attempt at plant enlargement, thus necessitating the construction of a new plant, specially designed to meet the present and probable future needs of the business.

Let me therefore, in the light of my experience, in aiding in the successful solving of such problems, tell you how I would proceed.

I would at the outset frankly admit that I did not have a monopoly of human knowledge. That while I was proud to be known as the guiding spirit of a successful business, my success, or rather the success of the business which I own or control, of which I am only one unit, should not be considered as sufficient justification for me to assume that I could unaided, design and create a new modern manufacturing plant. I would pursue the same method of solving this problem that I daily use in operating my present plant and that is to frankly admit that this is the day of specialists and that in order to secure the best, I must employ the best

experience obtainable. Therefore, the first thing I would do would be to employ an architect. I would make him my confidant as to my plans, my financial resources, my prospects and my dreams for the future. In short, I would give him that same degree of confidence that I give to my family physician or to my attorney and more than I ever gave to my minister.

Having placed the problem in the hands of an architect, let us follow very briefly the work of the architect.

His first duty will be to make a careful study of the equipment, methods of production, etc., of the present plant it is proposed to abandon. He will interview shop superintendents, foremen, etc., and in this way become familiar with the present shop production. It is often even desirable to make a study of shop practices in other plants producing the same general class of goods. A few such study days will usually be sufficient to enable an architect to prepare a preliminary block plan of the new plant that would probably work out most satisfactorily. This block plan, however, will have been prepared without reference to any particular locality. It will deal with the problem broadly and without reference to building types, but will indicate the number of buildings, general grouping, number of stories, etc., that would be required properly to house the industry.

This block plan will then be submitted to Mr. President and discussed in detail, and it is very desirable that it be discussed and criticized not only by the president and manager, but by production managers, shop superintendents, etc. After the conference a new block plan would be prepared. This plan would then be re-submitted and at this conference the general type of buildings should be discussed. This method of approaching a problem by preparing tentative plans, revising same and re-revising same will be pursued until the best plan for the particular business in question has been developed.

At this stage another expert must be employed, the Realtor, an expert real estate operator. The realtor will be given a copy of the ideal plan and his advice requested as to the best possible location, and here is where many plant managers fail. They do not rely enough on the advice of their realtor as to location. The successful realtor is a man who knows not only real values; the tendencies in the development of a city or community, but he knows transportation, he knows where the various classes of skilled mechanics reside, etc., and his problem is

\*An address by F. E. Davidson, A.I.A., M.Am.Soc.C.E., before the Western Efficiency Society, Chicago, May 14, 1919.

## THE AMERICAN ARCHITECT

to find a piece of property as near like the ideal block plan as it is possible to secure. The price of the land must be carefully considered and must have a certain well known relation to the cost of the proposed improvement.

Then after the property is secured, either by lease or direct purchase, the architect must revise his block plan to fit the land secured. Then, after the general plan has been tentatively approved, the question of the type of the various buildings must be determined.

Briefly, insurance interests recognize three general types of building—ordinary, mill and fireproof. These may be either sprinklered or unsprinklered and in each general type there may be many modifications made that will affect insurance charges, but in determining the general types, as well as the degree of modifications to be made in the type selected, other questions than the one of insurance must be considered.

First, initial cost or the maximum funds that are available for buildings. Quite frequently an owner may be convinced that the type actually determined on is not the ideal one, yet the item of first cost may compel its adoption. Very briefly, all insurance interests consider the type of building known as standard mill sprinklered the ideal factory building; but please note that the standard mill building is one with all stairs and elevators enclosed by brick walls, all doors in same self-closing fully approved fire-doors, all windows in exposed walls fireproof with fire resisting glass, and in which there are no horizontal or vertical openings unprotected, and in which no floor is less than  $3\frac{1}{2}$  in. in net thickness. Such a building is given the same insurance rating by the large insurance underwriters as is given to a so-called fireproof structure, even if sprinklered, and with all horizontal and vertical openings protected as required for a standard mill structure; and a rating approximately  $1/10$  of that given to a so-called fireproof structure if unsprinklered.

Factories of ordinary construction if unsprinklered carry such a high rate of insurance that their occupancy by any manufacturing concern, unless as a temporary expedient, is bound to be unprofitable, as in many cases the insurance rate is even greater than the interest charge on the plant investment, and it must be remembered that insurance rates are based on the tables of actual losses from which there is no appeal. I have had many clients who questioned the justification of the underwriters in making the same rate on a fireproof building, even if sprinklered, as they do on a standard mill sprinklered structure, yet it must be conceded that experience has proved that a fireproof structure is, as a matter of absolute fact, a reverberatory furnace and that the actual percentage of loss by fire

in fireproof structures is greater in proportion to insurable values than in standard mill sprinklered buildings.

Another factor in determining the general type of building is its adaptability to change for other uses; the readiness with which alterations or changes may be made in the structure as the business to be housed develops, or as improvements in machinery are developed and shop processes change. Changes can readily and inexpensively be made in timber structures, but extensive changes in fireproof structures can be made only at great expense, and in the case of fireproof structures, known as flat slab, changes cannot be made at any time without endangering the stability of the entire structure.

There are in addition to the questions above noted some additional arguments in favor of the standard mill factory building. One of the principal ones which has recently been brought to the writer's attention is the fact that a skilled artisan will not work if compelled to stand on a concrete floor, if he can secure employment at equal wages in a standard mill building. Many owners of fireproof buildings have had trouble in keeping help, due to this reason only, and in some fireproof factories it has been necessary to cover the concrete floors with a layer of asphalt, or to place cork carpet or wood thereon, in order to render the factory "habitable."

There is yet another argument in favor of the standard mill building, which in any large city should be given serious consideration, and that is the salvage value of the building itself. We all know that a standard mill building can be wrecked, and if the work is carefully done all the structural material can be used in another structure, whereas in wrecking a concrete structure there is no salvage. In fact, I have been quoted by one of the largest contracting firms in Chicago a price for the wrecking of a monolithic concrete building which amounted to a trifle more than one-half of the original cost of the building, and our American cities are growing so rapidly that it would indeed be a courageous investor or at least one blessed with a prophetic vision, who could predict as to what particular use a certain piece of property would be best adapted for twenty-five or thirty years in the future.

Now, as to depreciation. A factory building of ordinary construction should be given a depreciation charge of at least 10 per cent annually, whereas a factory of standard mill construction should be depreciated not to exceed  $3\frac{1}{2}$  per cent per year, and a fireproof structure at a rate of at least 3 per cent per annum.

As to items of maintenance: It is, of course, evident that as much outside painting, and in fact as much interior painting and calcimining, or whitewashing, will be required for a fireproof building



as for a building of standard mill construction. Practically the only thing which wears and must be replaced in a mill building is the finished flooring. I do not know of any accurate records of maintenance cost of a standard mill building which will average more than three-fourths of one per cent per year. Yet, on the other hand, I do not know of any records of the maintenance charges on fireproof buildings which will average less than one-half of one per cent per year.

As to the first cost, which item will determine the annual interest charge, if we take the cost of the standard mill sprinklered building at 100 per cent, the cost under present conditions in the market of both labor and material for a standard fireproof sprinklered structure will be equivalent to approximately 120 per cent and for ordinary construction about 85 per cent; but here again local city regulations have a bearing on the problem. Large unobstructive floor areas are desirable in any manufacturing plant and while under any and all city and state regulations anywhere, buildings only one story in height may have any floor area, irrespective of the type of construction, yet the owner will find that there is an economical maximum even when first cost is considered if the building is sprinklered for the reason that the size of fire pumps, tanks, water supplies, etc., are determined by the maximum floor areas between fire walls to be protected, and even if sprinklered that the insurance underwriters will place a gradually increasing charge for floor areas in excess of a certain well established minimum.

I will now speak very briefly of some of the apertinances to factory buildings. The question of heating is one of the most important, but this question is related to that of power. Should power to operate the plant be secured from central station and a boiler plant installed to provide heat only, or should an independent power plant be installed and heat be secured as a by-product from the operation of the power plant? There are so many factors to the equation that each proposed industrial plant must be separately analyzed. Some of the factors to the equation are, is live steam required in connection with manufacturing operations, is the power load fairly constant or subject to excessive variations? What is the proportion of the total maximum power load to average heating load, etc.?

Having determined whether a power plant or heating plant should be installed, the next question is, if heating plant only, what system to install. Whether hot blast or direct steam, and if direct steam, whether single pipe gravity, two-pipe gravity or vacuum. This question will be easily solved by determining the amount of radiation required and the distance from the heating source.

The question of elevator service is also an important one, and the proper location of elevators in any building is one frequently ignored. As to type of elevator, the rapid development of the modern electric machine has been so successful that it may be unconditionally recommended for most installations. Care must, however, be taken to deal with manufacturers of known standing.

Under the sub-heading of traveling cranes might well be included conveying apparatus of all kinds. This is truly an age of machinery and the greatest problem any manufacturer will be compelled to solve in the future is how to conserve man-power. The problem of securing sufficient experienced labor to operate any plant today is most serious and will grow more acute in the years to come. Therefore, particular study should be given to any plant design to adopt all labor-saving devices that have proved successful, particularly in relation to the handling of raw materials and the finished product, and frequently the incompleting output. I might discuss this topic for hours, but let it be sufficient to say that if it is true that he who can cause two blades of grass to grow where only one grew before is a benefactor of mankind, it is equally true that any production man who can devise a means whereby one man with the aid of machinery of any kind can produce as much as two without this aid is also a benefactor of his race.

Referring to the sub-title plumbing, it will be sufficient to state that the general improvement in the invention and manufacture of plumbing specialties and their installation during the past twenty years has been greater and more advanced than any other specialty allied to building. The importance of scientifically installed plumbing is now so well recognized that its installation is regulated by both State and local authorities everywhere. Owners of large industrial plants have found that the installation of the very best plumbing specialties is in the end the cheapest when first cost and maintenance are considered.

In the solution of all of the problems, your architect will call to his assistance many experts. This is an age of specialists, and while every successful architect must needs have a working knowledge of all the arts and trades he must assemble to produce any building, yet the time permitted by the requirements of his client for speed, forbids that he should in person do more than coordinate the work of many experts into an orderly and harmonious whole.

Permit me to offer this thought to you plant managers and to you future captains of industry, that whenever you have a new plant to build always employ an architect. He has something to sell you



## THE AMERICAN ARCHITECT

not possessed by any other professional man on earth. He has a vision, a power of visualizing the possibility of your business that some of you do not yourself possess and remember that an architect is every kind of an engineer ever invented.

As a civil engineer, he must be familiar with all of the various types of building construction, and the peculiar adaptability of various methods and types of construction to meet varying conditions.

As a sanitary and hydraulic engineer, he has to do with water supply and sewage disposal.

As an insurance engineer, he must be familiar with the requirements of all insurance underwriters, and know how to secure for his client the minimum insurance charges.

He must be a production engineer, able to so lay out and group the various manufacturing departments so as to secure, as far as is mechanically possible, the lowest cost in production.

He must be an efficiency engineer, able to advise his client in the proper selection of the mechanical aids to production.

He must be a mechanical engineer, able to advise his client as to the power and engine-room equipment, and honest enough to advise against a power-plant equipment if power can be purchased cheaper than it can be produced.

He must also be an illuminating engineer, a structural engineer, as well as several other kinds of engineers whose exact status has not yet been legally defined, in addition to which he must be a skilled diplomat and a mind-reader. He must be familiar with the general principles of law and be as well a successful business man. He must be a diplomat in dealing with his client, as it is a peculiar fact, that, while a man is willing to trust his law business to the judgment of his attorney, his life and the lives of his family to his family physician, his religion and future life to his spiritual minister, yet, when it comes to the design of a manufacturing plant in ninety-nine cases out of every one hundred he knows more about economic design than any architect could ever hope to learn if he lived to be as old as Methuselah. Therefore, the architect must

be a diplomat in the broadest sense, as it would be absurd in many cases to give a client that for which he asks. So that he must, in reality, while apparently doing one thing, be able to accomplish by finesse what he knows his client should have.

As an architect, he should be able to give to the design of plant an individuality that will at once indicate for what purpose the plant was designed, and not follow blindly one of the three modern Chicago architectural schools, to which the writer will refer as, *first*, the Chicago River Renaissance, *second* the Stock Yard Byzantine, and *third*, the Calumet Saracenic. He must ever have in mind the self-evident fact that the handling of men more than the operating of machinery is the big problem in manufacturing; and in the design of any industrial plant, no matter how small, the comfort of the employees of that plant should ever be borne in mind. Labor is always more efficient and, therefore, more productive in a well-lighted, well-ventilated, sanitary shop, and the experience of many large manufacturers has proved that the fee of the landscape gardener and his assistants always pays larger dividends on the sums so invested, and remember that in the detailed design of your plant you should give your architect a free hand after you have determined on the essential things that you think you must have. If you will do this, he will make your plant not only all that you demand, but he will put into it some of himself that will make your plant a better place not only to manufacture goods, but a better place for your employees to spend a large share of their lives. Artistically designed buildings cost no more than others, but beauty and harmony in surroundings add something to the conditions under which your employees are compelled to labor, and these conditions will react to increase the output of your products with correspondingly greater profits to your company.

Landscape gardening, recreation rooms, gymnasiums, rest and reading rooms, all pay and pay probably greater dividends than any other investment made in connection with any new industrial plant.

## Important Matters Discussed at Annual Meeting of National Fire Protection Association

By RUDOLPH P. MILLER, *Consulting Engineer*

THE National Fire Protection Association held its twenty-third annual meeting May 6, 7 and 8, at Ottawa, Ontario, Canada. While the holding of this meeting in Ottawa was a departure from the usual practice of meeting in alternate years in Chicago and New York, there was for that reason no diminution in attendance nor lack of interest in the work of the convention.

The Committee on Fire Resistive Construction submitted a specification, which with a few minor alterations was adopted, of a Grade B office building. The distinguishing feature between this grade and the Grade A building is that the first floor and basement are permitted to be used for the sale and storage of certain kinds of merchandise. In the Grade A building that activity is not permitted in any part of the building.

The very difficult problem of adequate exit facilities for department stores was discussed in a report from the Committee on Safety to Life. The inability to state definitely the number of persons that would occupy a department store at any one time leads the Committee to recommend proportioning the stairs and other exits to the floor areas, allowing a certain number of square feet of floor surface to each person. The specifications are tentative only and the Committee requests criticisms and suggestions. The report also deals with the necessary exit facilities from schools.

After several years of controversy the Committee on Hazardous Chemicals and Explosives has now reported regulations governing the storage and handling of motion picture films. The extreme hazard of this material was well illustrated in a series of motion pictures shown by Mr. J. F. Ancona of the Eastman Kodak Company, of tests of automatic sprinklers in film storage vaults. Fires started in these vaults in which films had been stored caused flames of enormous size and heat intensity to shoot out a distance of seventy feet. How this great hazard was largely controlled by different numbers of automatic sprinkler heads was shown in the pictures. The conclusions drawn from these tests were part of the Committee's report. The Committee proposes to deal, in the near future, with other celluloid products.

The only formal paper presented at the meeting was one on Certificates of Occupancy. This paper described the certificate of occupancy as it has recently been prescribed in the building laws of

New York City. The reason for its inauguration was given by several instances illustrating the defeat of the use of restrictions of buildings, and its effect in overcoming this difficulty was shown by the legal test to which, since its establishment, the provision for the certificate has been subjected. How the certificate should be prepared and the general contents were discussed and its value to the owner was also pointed out.

A visit to the new parliament building, now in course of construction to replace the one destroyed by fire during the war, proved of great interest to the members.

The officers elected for the coming year were: Mr. F. J. T. Stewart, New York, as president; Mr. H. O. Lacount, Boston, as first vice-president; Mr. W. E. Mallalieu, New York, as second vice-president; Mr. Franklin H. Wentworth, Boston, secretary-treasurer; and Mr. Rudolph P. Miller, New York, as chairman of the executive committee. Mr. D. Knickerbacker Boyd of Philadelphia, represents the architects of the executive committee.

---

## A Recent Legal Decision

DECISION OF ARCHITECT OR ENGINEER—DAMAGES CAUSED BY SHIFTING OF SITE OF WORK

The rule in the federal courts is that where a construction contract provides that the work should be done under the supervision of an architect or engineer, who is empowered to determine the question of classification and to make estimates and allow them, his decision is binding upon both parties, and can be impeached only for fraud or such gross mistake as implies bad faith.

Where a city enters into a contract with a contractor to build a building, or to lay a sewer, or to do any other work of that kind, it warrants, just the same as a private owner would warrant, the delivery of the site upon which the work is to be constructed. If the city or owner, from whatever cause, whether blamelessly or wrongfully, is unable to deliver the site, either would be equally responsible in damages to the contractor for the interruption of his work. So, where a city did not have title to the site selected for an improvement, and the contractor was thereby delayed and injured, items such as added expense due to disorganization of his force and the shifting of his material to other positions, were items of damage and expense which it was the duty of the engineer and the authorities to estimate and allow.—*Casey v. City of Canton*, 253 Fed. 589.



**THE AMERICAN ARCHITECT**

*Founded 1876*

PUBLISHED EVERY WEDNESDAY BY

THE ARCHITECTURAL AND BUILDING PRESS, INC.

No. 243 West Thirty-ninth Street, New York

E. J. ROSENCRANS, PRESIDENT AND TREASURER  
WILLARD C. HOWE, VICE-PRESIDENT

WILLIAM H. CROCKER, Editor  
EDWARD F. HAMMEL, Engineering Editor  
ARTHUR T. NORTH, Western Editor

Subscriptions in the United States and Possessions,  
Mexico and Cuba, TEN DOLLARS. Other Countries,  
TWELVE DOLLARS.

SINGLE COPIES (Regular Issue) 25 CENTS

CHICAGO OFFICE, Mellers Building  
PAGE A. ROBINSON, Western Manager  
ST. LOUIS OFFICE, Wright Building  
CLEVELAND OFFICE, Guardian Building  
SAN FRANCISCO OFFICE, 320 Market Street

Owned by United Publishers Corporation—H. M. Swetland, President;  
Charles G. Phillips, Vice-President; W. H. Taylor, Treasurer;  
A. C. Pearson, Secretary. Entered as second-class matter January  
6, 1909, at the Post Office at New York, New York, under the Act of  
March 3, 1879.

VOL. CXV JUNE 11, 1919 No. 2268

**Make Money More Available for  
Mortgage Loans**

**N**OW that it is conceded in financial and building circles that it has been the high cost of money and labor and not the high cost of materials that has been responsible for increased construction costs, efforts that are being made in various municipalities to put plans into execution whereby money may become more available for mortgage loans, are meeting with real success. Most practical of the ideas so far advanced to make loan money more liquid are those which would exempt from income tax mortgage investments up to \$30,000 or \$40,000, and the Federal Loan Bank plan. In the present situation when so much depends upon speed in getting as many homes built by autumn as possible to aid in the solution of the housing problem, the exemption from income tax plan seems to be the most practical of those advanced. It would take considerable time for the Loan Bank plan to be put in operation and consequently it could not aid much in the present emergency. Exemptions from State income tax can be made quickly and then the Federal authorities can be asked to give some exemptions in favor of the mortgage holdings up to a reasonable amount.

It is unfair for the Government to put farm loan bonds at 5 per cent to the investor and exempt it

from all taxation. That is favoring one class against the rest of the people. The time should soon come when mortgage loans for building can be had the same as farm loans.

Opponents of these two plans, which have been strongly advocated by the New York State Reconstruction Commission, claim that in the case of the Federal Loan Home Bank there would be difficulty in the selling of bonds at this time, and that the exemption of mortgage loans from the income tax is poor principle, especially since United States Government bonds are still subject to tax. They charge bad methods, but is it not the best thing to be done under present conditions? It surely makes for the liquidity of loans and that is what counts above all else in the present situation.

**I**N attempting to solve New York City's problem, which may be truly said to be barometric of conditions elsewhere in the country, suggestions made by Samuel Untermeyer, widely known lawyer, include immediate disposal by insurance companies of the bank and other stocks which they were required by law to dispose of eight years ago; the compulsory investment in mortgages and bonds in unencumbered real property of one-half of the assets of life, fire, health and casualty companies and the savings banks of the state; and investigation by the Federal trade commission "to break up unlawful combinations that now exist in the building trades."

It would appear from these representations that what has been called the high cost of money is, in New York at least, due to the improper diversion of funds into channels which are more lucrative to the loaning companies, and to a discrimination which adversely affects the amount that would otherwise be available for mortgage loans.

It becomes each day more clearly apparent that the claims loudly set forth that it is the high cost of materials that is preventing the normal resumption of building is in a great measure propaganda to disguise the real cause. That the actual retardant is, in this immediate locality at least, as set forth by Mr. Untermeyer is conclusively proven.

**Efficiency and Service**

**R**EPORTS from many correspondents indicate that in spite of the pessimistic attitude in some quarters, the progress of building is going steadily and consistently forward, and that architects all over the country are again busy.

The past two years of comparative inaction have afforded opportunity for careful contemplation of the important problems which have had to be considered by architects. The deliberations at the recent convention are already becoming realized in



## THE AMERICAN ARCHITECT

action that will be of the most constructive and up-building character.

There is an active demand for the services of competent draughtsmen, and, with the gradual but certain loosening of the money market, as to mortgage loans—the real deterrent to a quick building resumption—it is reasonable to predict greater building progress than has been seen for several years.

**T**WO things the war has emphasized as essential to success in every activity. These are efficiency and service. We practically won our part in the war by the cultivation to the highest degree of these essential characteristics, and in the profession of architecture we shall regain any lost ground by the same means, giving the most efficient and personal service.

Architecture today is not, if it ever was, a monopolistic profession. Evidence has multiplied that other professions or enterprises in building have felt competent to usurp the functions of the architect. The lesson that has been learned by the general public has shown that it is futile to disregard the great technical advantage that comes when properly trained architects are placed in authority over work for which their professional training particularly fits them. It has also been very clearly shown that as organizers and administrators, architects are by education and practice absolutely essential in every building operation and that in every instance where this service has not been called for the result has been unsatisfactory.

**T**HOSE whose business took them among the many newly formed departments and bureaus in Washington during war times were able to learn the great and exceedingly valuable work that archi-

tecs were doing. The immense value of this service is not now generally appreciated, but it is certain that in every future building operation which will be carried forward by the Government its successful outcome will be largely influenced by the vast amount of valuable data that architects secured and made available while these departments and bureaus were in operation.

It was efficiency and service that produced this admirable result. There has been no loud proclaiming as to just what has been done, but those in a position to know are very certain that whatever we shall achieve in the always present big problems of housing, public buildings, and the large emergent work during unusual periods will have been simplified and made easy by the quiet and efficient work of architects during war time.

**I**T will be unfortunate if this great amount of valuable data is not permitted to become more widely known. The Council of National Defense has announced its readiness to place at the disposal of the public the large mass of information assembled and classified by this Reconstruction Research Division.

As a record of efficiency and service, it will be something in which every man in the profession will feel a personal pride. It will afford an opportunity to learn the identity of the group of efficient men who accomplished that great work. Their retiring and properly modest attitude toward the part they so representatively played during the period we were at war is entirely commendable, but they should receive the credit that is justly due them. Will not some architect turn historian and under the title of efficiency and service, write a review of these men's unselfish efforts?







PLATE 188

VIEW FROM THE SOUTHEAST

HOUSE OF CHARLES L. BRIGGS, MIAMI, FLORIDA

GORDON E. MAYER, ARCHITECT





THE AMERICAN ARCHITECT

VOL. CXV, NO. 2268

JUNE 11, 1919



PLATE 189

EASTERN ELEVATION AS SEEN FROM BAY

HOUSE OF CHARLES L. BRIGGS, MIAMI, FLORIDA

GORDON E. MAYER, ARCHITECT







VIEW FROM NORTHWEST

HOUSE OF CHARLES L. BRIGGS, MIAMI, FLORIDA

GORDON E. MAYER, ARCHITECT





THE AMERICAN ARCHITECT

JUNE 11, 1919

VOL. CXV, NO. 2268

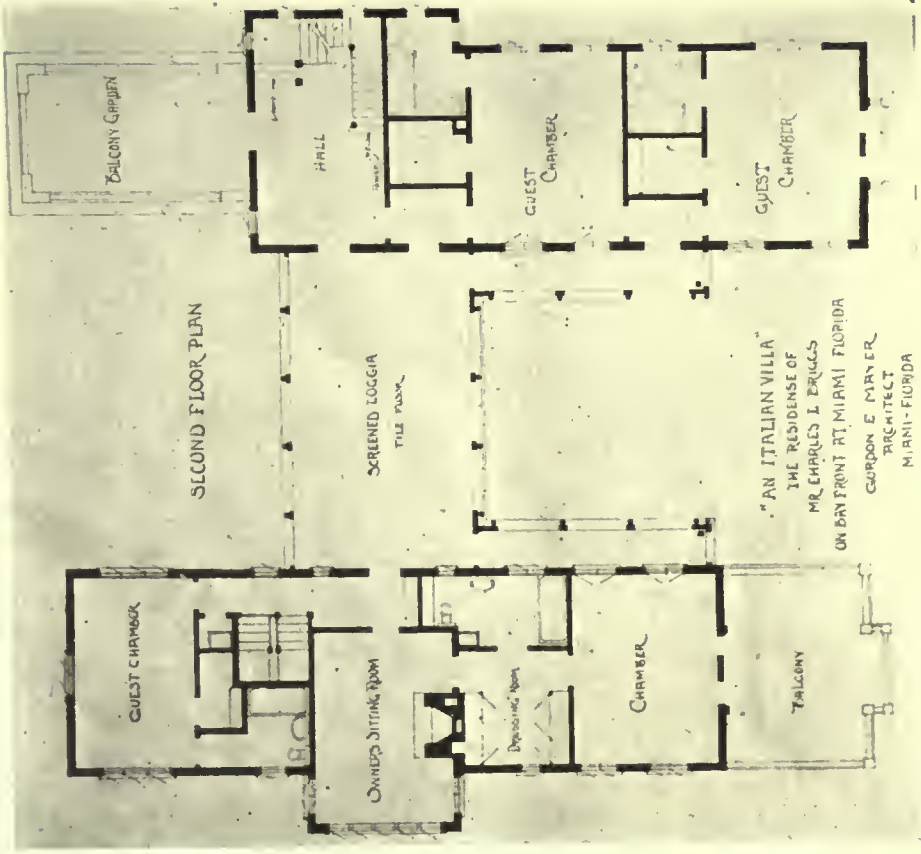
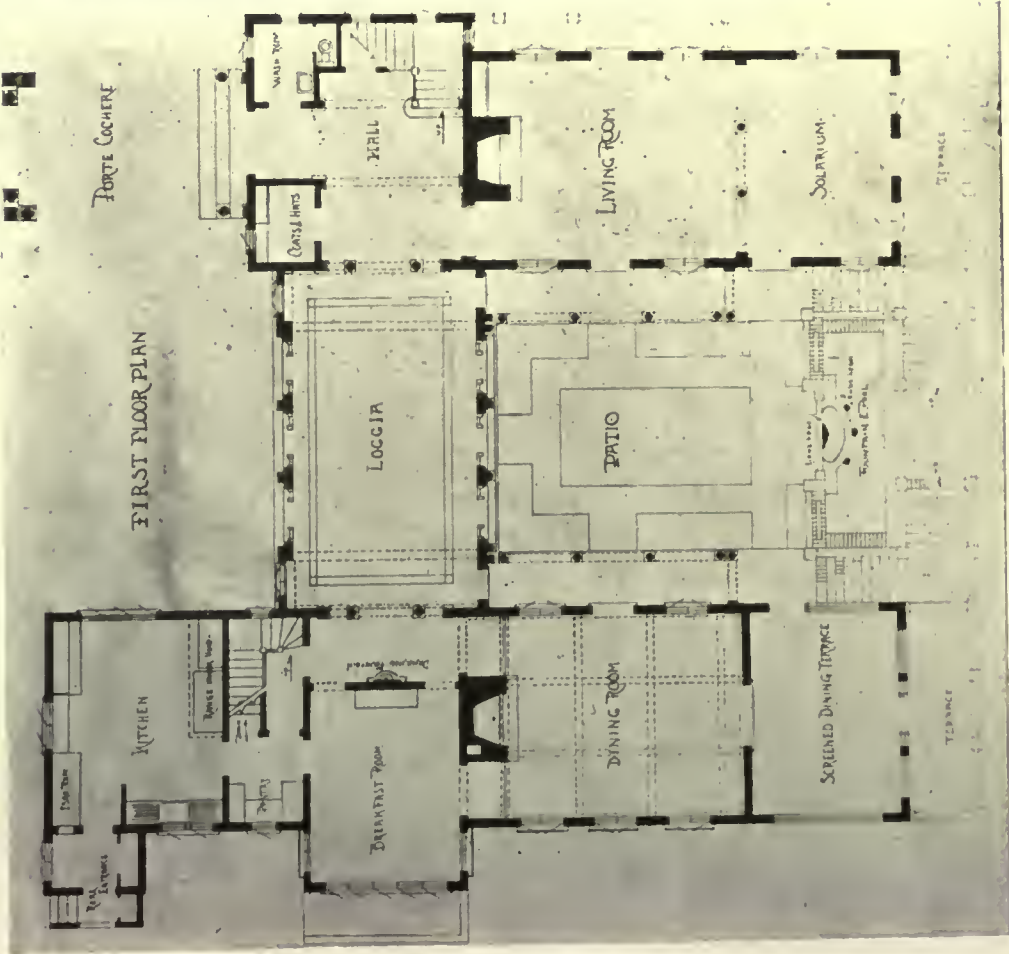

"AN ITALIAN VILLA"  
 THE RESIDENCE OF  
 MR. CHARLES L. BRIGGS  
 ON PAN FRONT AT MIAMI, FLORIDA  
 GORDON E. MAYER,  
 ARCHITECT  
 MIAMI-FLORIDA

PLATE 191

HOUSE OF CHARLES L. BRIGGS, MIAMI, FLORIDA

GORDON E. MAYER, ARCHITECT







FIRST FLOOR LOGGIA



LIVING ROOM

PLATE 192

HOUSE OF CHARLES L. BRIGGS, MIAMI, FLORIDA

GORDON E. MAYER, ARCHITECT







PLATE 193

GARAGE, SERVANTS' QUARTERS AND LAUNDRY

HOUSE OF CHARLES I. BRIGGS, MIAMI, FLORIDA

GORDON E. MAYER, ARCHITECT







PLATE 194

PERGOLA AND SUMMER HOUSE

HOUSE OF CHARLES L. BRIGGS, MIAMI, FLORIDA

GORDON E. MAYER, ARCHITECT





# Beaux-Arts Institute of Design

DIRECTOR OF THE INSTITUTE, LLOYD WARREN

ARCHITECTURE, WILLIAM F. LAMB

SCULPTURE, JOHN GREGORY

INTERIOR DECORATION AND INDUSTRIAL ART DESIGN, ERNEST F. TYLER

MURAL PAINTING, ARTHUR CRISP

## Official Notification of Awards

### PROGRAM

#### CLASS "B"—III ANALYTIQUE

The Committee on Architecture proposes as subject of this Competition:

#### "A FOUNTAIN"

A small town wishes to erect a fountain in the center of its public square, which shall be its dominating architectural feature. The fountain shall be designed with four Corinthian columns supporting arches arranged on a square or circular plan. The columns shall be elevated on a base. The structure shall be crowned by an entablature and roofed with a dome or other motive. In the space thus sheltered, there shall be a small basin or a statue, or both, while arranged about the base may be placed other basins or a series of basins at the will of the competitor. The total height from the ground should not exceed 35 ft.

JURY OF AWARD: H. R. Sedgwick, J. Wynkoop, M. J. Schiavoni, J. A. Gurd, M. B. Stout, F. C. Hirons, H. Sternfeld, G. A. Licht, Mr. Kreesly, A. L. Kocher and E. V. Meeks.

This jury also served as Jury of Award for the Class "B"—III Projet.

Number of drawings submitted—56.

#### AWARDS:

FIRST MENTION PLACED:—P. Goodwin, Atelier Licht, N. Y. C.; A. C. Smith, Yale Univ., New Haven.

FIRST MENTION:—W. F. Frederick, Beaux-Arts Atelier, Washington, D. C.; S. H. Jamison, Carnegie Inst. of Tech., Pittsburgh.

MENTION:—W. T. Spann, A. N. Schaeffer, Beaux-Arts Atelier, Washington, D. C.; C. H. Arras, Cor. J. J. W. Bradney, Buffalo; M. C. Drebin, B. H. Dierks, A. A. Lewis and E. A. Earley, Carnegie Inst. of Tech., Pittsburgh; M. S. McDowell, A. I. Berkow and Eleanor Roche, Columbia Univ., N. Y. C.; T. J. Lane, Catholic Univ., Washington, D. C.; E. Olsen, Atelier Hirons, N. Y. C.; F. F. Williams, Atelier Fowler, Baltimore; H. D. Whitworth, John Huntington Poly. Inst., Cleveland; F. Martinelli, Patron P. J. Rucker, N. Y. C.; H. O. Smith, A. A. Farnham, F. S.

Hobbes, P. B. Kapp and R. L. Albert, Pennsylvania State College, State College; M. Capobianco, "T" Square Club, Philadelphia; G. A. Dunwoody, D. K. Frohwerk, H. E. Machamer, Eva McCables, E. M. Moore, H. T. Flack, Ruth Herthel, H. F. Neville, J. L. Fleming and Myra McLaughlin, Univ. of Kansas, Lawrence; A. H. Corbett, E. R. Ayer, Univ. of Washington, Seattle; Mary H. Holden, Univ. of Texas, Austin; A. C. Weatherhead and H. M. Thompson, Univ. of Oregon, Eugene; E. Penfield, Atelier Wynkoop, N. Y. C.

H. C.:—W. H. Nash, E. R. French, P. F. Dowling and L. Laporte, Catholic Univ., Washington, D. C.; M. V. Falcone, "T" Square Club, Philadelphia.



P. GOODWIN—FIRST MENTION PLACED—ATELIER LIGHT  
CLASS "B"—III ANALYTIQUE—A FOUNTAIN

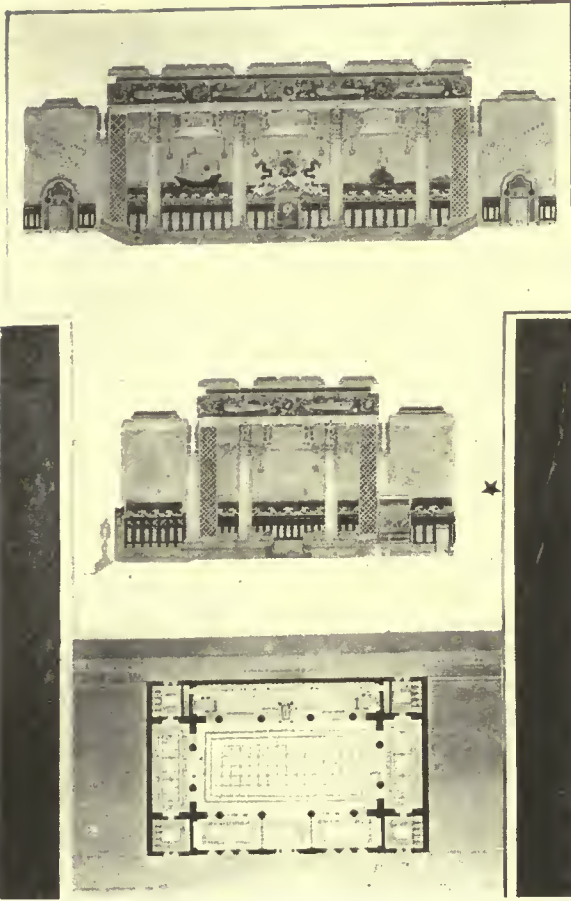

C. E. SILLING—FIRST MENTION PLACED—CARNEGIE  
INST. TECH.  
CLASS B—III PROJ—A STEAMSHIP OFFICE

PROGRAM

CLASS "B"—III PROJ

The Committee on Architecture proposes as subject of this Competition:

"A STEAMSHIP OFFICE."

With the new importance of the United States Mercantile Marine, the ocean passenger traffic should be largely handled by our vessels and the near future should see the erection of many offices for the sale of steamship tickets. Such an office requires a room of ample and open proportions, treated with a dignity of architectural design. Mural paintings of distant lands or maps of steamship routes may be included in the decorative composition, to stimulate the passengers' interest in travel.

The accommodation for the necessary clerks is provided back of a counter in full view of the public

while a space for the officials in charge of the office is located back of a railing as in a bank. The counter shall be 3 ft. 6 in. in height, and shall be so arranged as to allow a generous length about the public space and ample working area behind. The cashier's counter, which is the only portion caged off, should be prominently and centrally located.

As the steamship office is often used as a mail address by travelers, a lounging and writing space should be arranged both for first and second class passengers. These may be separated from the public space either by railings or grilles or they may be in rooms adjoining the main office room. Retiring rooms with toilet facilities should be placed in connection with them.

The subject of this competition is the design of the Main Office Room with its surrounding requirements. The floor area of the Office Room shall not exceed 8000 square feet and the extreme height shall not be more than 50 feet. The room may be lighted from the top or from two sides or from both.

Number of drawings submitted—56.

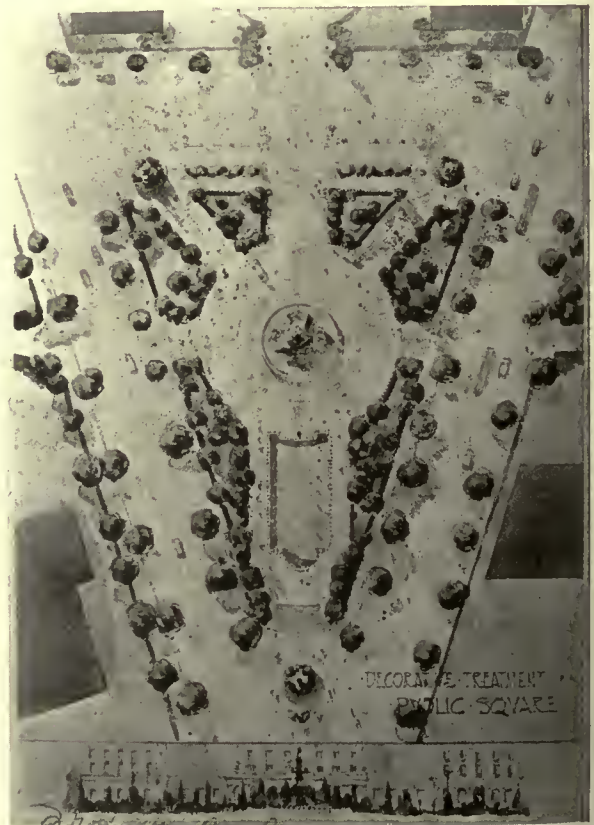

D. W. ORR—YALE UNIV.

CLASS "A"—IV ESQUISSE ESQUISSE—THE  
DECORATIVE TREATMENT OF A PUBLIC  
SQUARE



# THE AMERICAN ARCHITECT

## AWARDS:

FIRST MENTION PLACED:—H. T. Bell Beaux-Arts Atelier, Washington, D. C.; C. E. Silling and S. Lashmit, Carnegie Inst. of Tech., Pittsburgh; W. A. Rutherford, Jr., Georgia School of Tech., Atlanta.

FIRST MENTION:—W. R. Craton, Columbia Univ., N. Y. C.; J. Topnick, Carnegie Inst. of Tech., Pittsburgh; A. L. McGill, Cornell Univ., Ithaca; E. F. Stoeckel, Atelier Hiron, N. Y. C.; C. S. Thateimer, "T" Square Club, Philadelphia.

MENTION:—K. Carver, B. Hill, Cornell Univ., Ithaca; G. Goodwin, B. A. Pipinos, W. Perkins, R. Finkelhor, R. Bowers, Carnegie Inst. of Tech., Pittsburgh; W. R. Reece,

from funds bequeathed by him to the Society and given for the best solution of the fourth Class "B" Esquisse-Esquisse of the season.

PRIZE \$50.00



J. PENDLEBERG—3D MEDAL—NEW YORK CITY CLASS "A" AND "B". ARCHAEOLOGY. III. MEASURED DRAWING—THE CORTELYOU MANSION

G. Ramey and P. H. Giddens, Georgia School of Tech., Atlanta; J. Lucchesi, Atelier Hiron, N. Y. C.; E. L. Babitsky, John Huntington, Poly. Inst., Cleveland; H. A. Horn, 20 13th Street, College Point, L. I., N. Y.; E. W. Boyer, W. S. Hoffman, Pennsylvania State College, State College; K. Snow, H.-R. Diamond, H. H. Davis, Syracuse Univ., Syracuse; E. F. Biresak, L. F. Soxman, J. L. Benson, E. Pickering, Univ. of Kansas, Lawrence; W. S. Chinn, Univ. of Washington, Seattle; M. Rice, R. B. Thomas and G. H. de Grella, Yale Univ., New Haven; T. F. Price, Atelier Wynkoop, N. Y. C.

H. C.:—E. C. K. Schmidt, "T" Square Club, Philadelphia; G. Ramirez, Syracuse Univ., Syracuse; P. W. Strickland, W. M. Icenhower, Univ. of Kansas, Lawrence; F. V. Lockman, Univ. of Washington, Seattle.

## PROGRAM

### SPIERING PRIZE COMPETITION

A Prize founded in memory of Louis C. Spiering,



J. PENDLEBERG—3D MEDAL—NEW YORK CITY CLASS "A" AND "B". MEASURED DRAWING—THE CORTELYOU MANSION

### CLASS "B"—IV ESQUISSE-ESQUISSE

The Committee on Architecture proposes as subject of this Competition:

"A VICTORY LOAN BOOTH."

A Victory Loan Booth, for the sale of bonds, is to be built in a public place, facing a busy thoroughfare. It shall be constructed of temporary materials but its character shall be such that its purpose is plainly and adequately indicated. It shall have an open counter space at which the bonds are sold and a rostrum or platform for singers and public speakers. The space devoted to the booth, including the platform shall not exceed 30 ft. by 30 ft.

Number of drawings submitted—7.

## AWARDS:

Placed First—Not Qualified for Prize:—R. K. Galbraith, Beaux-Arts Atelier, Washington, D. C.

MENTION:—R. H. Douglas, Carnegie Inst. of Tech., Pittsburgh.





E. E. DAVIS—3D MEDAL—UNIV. OF TEXAS  
CLASS "A" AND "B." ARCHAEOLOGY. III PROJ-  
JET—THE APSE OF AN EARLY CHRIS-  
TIAN CHURCH

PROGRAM

CLASS "A"—IV ESQUISSE-ESQUISSE

The Committee on Architecture proposes as subject of this Competition:

"THE DECORATIVE TREATMENT OF A PUBLIC SQUARE."

The site which has been chosen for this Public Square, is in the form of an isosceles triangle. The base of this triangle is 400 ft. and the length on a line perpendicular to the base is 600 ft. The equal sides of the triangle are bounded by avenues, each 100 ft. wide, which form the point of intersection and continue as a single broad parkway on the bisecting line of the angle of intersection. The base of the triangle is bounded by a street 50 ft. wide. The plot is level.

The arrangement and choice of motives for the decoration of the square are left entirely free. A fountain or band stand with rostrum or both may be

used, with statues, vases, balustrades, ramps, etc.  
Number of drawings submitted—17.

AWARDS:

THIRD MEDAL:—R. K. Galbraith, Beaux-Arts Atelier, Washington, D. C.; G. A. Anderson, Univ. of Pennsylvania, Philadelphia; D. W. Orr, Yale Univ., New Haven.  
MENTION:—E. L. Howard, Cornell Univ., Ithaca; J. W. Hershey, John Huntington Poly. Inst., Cleveland. R. H. Segal, Patrons E. & E. Blum, N. Y. C.

PROGRAM

CLASS "A" AND "B" ARCHAEOLOGY—  
III PROJET

The Committee on Architecture proposes as subject of this Competition:

"THE APSE OF AN EARLY CHRISTIAN CHURCH."

The Roman Temples were usually planned with a semicircular niche where was placed the statue of the god to whom the temple was dedicated and in front of the niche, which formed the setting for the statue, was the sacrificial altar. This apsidal form first occurs in the temple of Mars Ultor and was later used in many of the basilica, palaces and baths of Imperial Rome. The early Christians, in building their first churches, took as models the pagan temples, placing in the apse the Episcopal throne and the seats for the clergy. A portion of the nave was screened off, forming the choir where the altar was placed. Examples of the arrangement of the bishop's throne are found at Torcello and at Parenzo. The apse is almost always semicircular, sometimes prolonged toward the nave by walls. It is richly ornamented with columns and niches, or more often with wall decorations in marble, fresco or mosaic, and is surmounted by a semi-dome richly decorated in color. Often three apses are found, one at the end of the nave and one terminating each aisle.

The subject of this problem is The Apse of an Early Christian Church. The clear opening between the piers at the end of the nave shall not exceed 130 ft.

Number of drawings submitted—9.

AWARDS:

THIRD MEDAL:—J. W. Brooks, Univ. of Minnesota, Minneapolis; J. K. Smith, J. C. Janney and W. H. Livingston, Univ. of Pennsylvania, Philadelphia; E. E. Davis, Univ. of Texas, Austin.  
MENTION:—E. C. K. Schmidt, "T" Square Club, Philadelphia; A. C. Bieber, Univ. of Pennsylvania, Philadelphia; H. I. Feldman, Yale Univ., New Haven.

CLASS "A" & "B"—ARCHAEOLOGY—III  
MEASURED DRAWINGS.

Number of drawings submitted—2.

AWARDS:

THIRD MEDAL:—J. Pendlebury, 2509 Avenue D, Brooklyn, N. Y.; E. C. K. Schmidt, "T" Square Club, Philadelphia.

# Build Now, Urges Willis Polk

**W**ILLIS POLK & COMPANY, Architects and Engineers of San Francisco, whose vast volume of reconstruction since the fire of 1906, places them in a position to speak with authority, give little credence to the popular fallacy, that present high wages and high cost of materials, result in high cost of building, and stoutly maintain that the generally accepted theory, that present building costs are forty per cent above normal and consequently reduce earning capacity, is all wrong. This conclusion is reached by the Polk Company after careful compilation of quantities and accurate estimating of every detail in several proposed buildings now under consideration. They point out that while wages were low and material cheap twenty-five to thirty years ago, buildings like the Mills Building, Merchants Exchange, Crocker Building, and others of that period cost approximately forty cents and more per cubic foot, that recent buildings like the Hobart Building, Insurance Exchange and others, with high wages and high price of materials, cost but from thirty-three to thirty-six cents per cubic foot.

The force of this argument lies in the fact that all the buildings heretofore constructed by Polk's Company were completed at from ten to fourteen per cent less than their original estimates. At the present time they have over ten million dollars of projected work under consideration in their offices. They point out that while small work, the moderate sized residence or flat, now costs from thirty to forty-five per cent more than pre-war-time prices, they have several very attractive investments, which under a twenty year, six per cent bond issue, amortized, would

give the investor a one million dollar building for an initial outlay of but two hundred thousand dollars.

The doubting property owner who continues to hold property in the hope that wages will be lower and material cheaper, may as well realize that he labors under a delusion. An improvement representing an investment of one million of dollars that would net fifty thousand dollars per annum, which if delayed for two years in the hope that a break in the market or a possible reduction in construction cost might result in a saving of one hundred thousand dollars, would out of its earnings, if constructed now, more than offset such anticipated savings.

But, says Polk, "There is absolutely no indication that a delay for two years will result in any such savings." Polk quizzically asks the prospective investor if he thinks wages are going down to \$1.25 a day for a ten hour day, which was the prevailing wage twenty-five to thirty years ago. Any such hope may as well be abandoned at once as absurd.

On the contrary, Polk opines that the reverse is more liable to be the case and the chances are, that within a few years, hours will be even shorter and wages higher than now.

"But it does not necessarily follow," he said, "that construction costs will be greater." He points out that improved labor saving devices, methods of fabrication and facilities of construction will keep pace with, and offset increased cost of labor and material. "Build now," says Polk.

---

## Current News

---

### American Academy of Arts and Sciences

The 1082nd meeting of the American Academy of Arts and Sciences, the annual meeting for the academic year, 1918-1919, was held at its house, 28 Newbury Street, Boston, President Charles P. Bowditch in the chair and thirty-five members present.

Reports of several important committees on research and publication were received; among these special mention may be made of that from the Rumford committee which, under the chairmanship of Prof. Charles R. Cross of the Massachusetts Institute of Technology, dispenses the income of the Rumford fund for researches in physics, the recipients of grants being distributed all over the United States. Professor Cross took occasion to refer to the serious loss sustained by the committee by the death of Prof. E. C. Pickering, director of the Harvard College astronomical observatory, who has served as a committee member almost continuously since 1869.

The election of new members, which now takes place only once a year, added twenty-five fellows and nine foreign honorary members to the Academy list.

Officers for the coming year were elected as follows:

President, Theodore W. Richards of Harvard Univer-

sity; vice-presidents, Elihu Thomson, Harvey Cushing and George F. Moore; treasurer, Henry H. Edes; corresponding secretary, Harry W. Tyler; recording secretary, James H. Ropes.

---

### Teach Art Through the Children

The City of Pittsburgh has recently gotten down to the heart of art education by opening, in the Carnegie galleries, a children's museum of art. The works of art are chosen for their educational value to children of about fourteen years old. A photographic reproduction of Edwin A. Abbey's mural decorations in the Boston Public Library, showing scenes of the Holy Grail legends, is used for a frieze around the gallery, and below are cases showing the processes of pictorial art, sculpture, metal work, ceramics, textiles, glass, enamel and wood blocks.

These cases are a part of the extension work of the Department of Fine Arts, and will be shown later in the high schools of the city. Their contents include the processes of Japanese wood-cutting and printing, Japanese coloring, Hispano Moresque glazed enamels, better known as luster ware, and Majolica carved ivories; Coptic textiles, tapestries and embroideries of the fourth century; specimens of historic glass work, including Saracenic perfume



sprinklers and Roman amphora; Champleve enamels of primitive type, dating from 1300 B. C., with drawing tools and chisels; stencil plates used by the Japanese to decorate textiles; Javanese resist dyeing; hemp fabrics woven by wild tribes of the Philippines; Flemish primitive landscape painting and cloisonné enamels.

Reproductions of work of noted American sculptors also have a place in the children's museum.

There are to be lectures given to children on these subjects, and prizes are awarded for the essay showing the best application of these lectures.

---

## Housing Campaign to Issue Message

To bring a constructive message productive of harmonious co-operation between the employe and employer, between the industrial manager and the industrial worker; to direct the 60,000 or 70,000 workers in the city of Portland to the important messages of the government relative to labor's place during the reconstruction period, are the purposes of a publication to be issued under the auspices of the "Own-your-home" campaign's committee on industrial plans.

The messages are of a constructive nature by the most prominent men interested in labor's cause, prominent government officials, including a special address by Secretary of Labor W. B. Wilson.

There will also be a special "Own-your-home" message to Portland's industrial population showing the advantages of home ownership in this city.

---

## State Board of Architects Named

Members of the state board of architect examiners, created by an enactment of the 1919 legislature, have been appointed by Governor Olcott of Oregon. They are: W. G. Chandler, Marshfield; M. H. Whitehouse, Portland; Lee Thomas, Bend; J. E. Wicks, Astoria, and W. C. Knighton, Portland.

May 29 is the effective date of the act. In the law it is stipulated that no one may become a member of the board who has not lived in the state and practiced the architect's profession for at least five years previous to the passage of the act. Members of the board serve without pay, but receive traveling expenses when on business of the board. The law allows the board to employ a secretary who need not be an architect, and he shall receive whatever salary is determined upon by the board.

---

## Over 550,000 Buildings to Be Rebuilt in France

There are 550,000 buildings to be rebuilt in the devastated districts of France, according to statistics given the Chamber of Deputies by M. Lebrun, the Minister of Liberated Territories. Three hundred thousand buildings were totally destroyed while 250,000 were destroyed in part.

## An Impression of the Convention at Nashville

If it is true that the national convention of the American Institute of Architects reflects the trend of the times in the practice of architecture in this country, then a new era is apparent and the profession is facing changes in procedure almost revolutionary in character.

The fifty-second Convention of the Institute will perhaps be remembered as the beginning of a country-wide tendency vigorously and constructively to meet all activities associated with the practice of architecture; the investigating of educational methods, with a view of broadening and modernizing the teaching of architecture, so as to prepare the student for the particular needs of this country in architecture and construction; ways and means to increase a wider membership in the Institute, thus making it truly representative.

This was the first convention held following the great world war, and the signing of the armistice. The principles for which we fought have been achieved and democracy is the ruling force to guide the destinies of mankind. It was, therefore, natural that the undercurrent of the entire proceedings of the convention should reflect this tendency and aim to correct any method of practice or any attitude of the profession that served a contrary purpose to that of the spirit of the day.

It is difficult indeed to change any system that has become entrenched through habit, convention or education. The architectural profession is not immune from this tendency and hence canons of ethics and rigid codes of practice, which have out-grown their usefulness should be amended or eradicated, as well as any policy that in any respect thwarts opportunity for service.

It is idle to expect the young man struggling for recognition to be limited in his practice by hindrances not recognized by the business world, to which he must become closely allied in his practice. It requires a great upheaval to bring this truth to the consciousness of professions organized and rooted in the past, and with traditions and conventions that have been established and upheld irrespective of changing conditions. Nevertheless the simplifying of mandatory rules and regulations is in accord with present day methods and is the American ideal.

The convention came together well aware of its great responsibility, and a careful perusal of the discussions and also what was accomplished by resolution and action verify this fact.

The Post-War Committee was given the inspiration and ample means to adequately perform its work, and the Institute as well as the architects of the country can look forward hopefully for suggestions effecting general reorganization plans for the improvement of the entire profession. It is hoped that the spirit which was so discernible in the convention will continue—the spirit of co-operation, of good fellowship and a desire to achieve.

The hospitality of the South and the beauty of spring and of pleasant associations were no doubt responsible in a large degree for this feeling.

The life and usefulness of the American Institute of Architects, as well as of any activity depends upon vision and progress, and this principle undoubtedly constituted the chief distinction of the fifty-second convention held at Nashville, Tenn.—George W. Maher, *F. A. I. A.* In the *May Bulletin of The Illinois Society of Architects.*

## Fire Investigation and Prevention

In a three years' record of fire losses in Canada, totalling more than \$35,000,000, two and one-third per cent of the loss was from fires in residence districts and 97 and two-thirds per cent from fires in congested business districts—public buildings, churches, manufacturing and storage plants, grain elevators and buildings other than dwellings. This emphasizes the fact that fires in residence districts are very infrequent and of small loss compared to the business sections, which are poorly fire-guarded, especially at night. Agitation is growing to hold legally responsible those who are to blame through carelessness for any fire which causes destruction of property and particularly loss of life.

Many fires go on record as "cause undetermined," whereas a careful investigation should be authoritatively made in every case to find out the cause, and publicity should be given to the result of such an investigation. This elimination of fire waste is being agitated more and more in this country as well as in Canada.

Not only would a thorough investigation show that the shingle roof in residence districts is responsible for only a very small percentage of fires, but fires would not so often be thoughtlessly and unjustly attributed to properly constructed wood buildings as is now the case.

Investigation as to causes, the holding to accountability and education for greater precaution would also result in fewer forest fires. The U. S. Forest Service is issuing these pithy statements which are especially pertinent as summer approaches:

"Forest destruction is quick—forest growth is slow."

"Burned timber pays no wages—keep the forest productive."

"A tree will make a million matches—a match may waste a million trees."

"Take no chances with lighted matches, burning cigarettes, or pipe ashes, brush fires or camp fires."

"Are you practicing fire prevention and forest protection?"

## Britain's Timber Shortage

Because of the serious shortage of timber supplies for use in the United Kingdom, the British Government has provided for afforesting 1,770,000 acres in a period of 80 years at a cost of about 73 million dollars, 250,000 acres to be afforested in the first ten years. This would be, however, almost a negligible factor in reducing imports.

Prof. Stebbing, head of the Forestry Department of the University of Edinburgh, says: "We found sufficient timber in the country—for the most part of a very inferior quality—to enable us to win the war, but to do that we have seriously depleted the three million acres of woods, all we had standing when the war began. . . . Just before the armistice was signed it had been estimated by the timber supply department that at the then rate of utilization there only remained in this country sufficient softwood timber to carry on to the end of the present year, pit wood for about six years and hardwoods for ten years. The supplies remaining in this country were insignificant when we consider the gigantic amounts required for reconstruction work on the Continent and our own enormous demands."

The shortage is claiming careful consideration from Chambers of Commerce and other responsible bodies in England and one government committee recommends that "immediate steps be taken by the Government for the im-

portation of at least 100,000 standards (nearly 200,000,000 board feet) a month of softwood for all purposes the first year after the war." This same committee reports that there is a shortage of 300,000 working-class houses in England and Wales and 100,000 in Scotland.

## Wooden Shingles Permitted

The anti-shingle ordinance prohibiting the use of shingles for wooden roofing and requiring roofs to be made of fire-resistive materials, has been repealed by the City of Dallas, Texas.

Mayor Wozencraft made the following statement in regard to repealing the ordinance:

"The ordinance was passed by the commission in order that the relief which is urgently needed in order that building may not be unwarrantably delayed might be given.

"The commission, and more especially Police and Fire Commissioner McGee, will look into the proposition of extending the fire limits into a secondary fire zone where fire-resistive roofs will be required, and all other regulations complied with.

"But it is not felt that this ordinance repealing the old ordinance should be held up until the details of the plan are completed.

"The commission satisfied itself that the use of fire-resistive materials adds materially to the construction of homes, and created considerable additional expense in the building of modest-priced homes.

## England's House-Building Needs

C. W. Barron, writing in the *Wall Street Journal*, says: "England is running a gamut of debt and taxation and labor payments from the National Treasury that means ultimate disaster unless she quickly and solidly rebuilds her entire industrial structure in man, machinery and transportation.

"She is beginning with the essential machine—man. She is considering how to shorten his hours of work, strengthen him physically and mentally and increase his output.

"She has forbidden the raising of house rents upon her laboring classes during the war, yet increases rates and taxes. The result is that the Government must build not only 300,000 homes as planned a few years ago, but must financially assist in the construction of 1,000,000 homes unless her people are to be encouraged to emigrate.

"A million houses at an estimated cost of £600 each means a national construction program that measures in money very nearly to England's pre-war national debt, which was just under \$3,500,000,000.

"I asked Lovat Fraser, the English economic and leader writer for the Northcliffe press, if my calculation was correct, and he said he could not dispute it. He added, however, that such a program could not be carried out except over a number of years. He said the first 300,000 homes, which were now being figured upon to cost nearly a billion dollars, would require 6,000,000,000 brick, and the annual brick-making capacity in Great Britain was now only 4,000,000,000.

"I learned from other sources, however, that England is encouraging tremendous imports of lumber and had signed up contracts, of which the public hears nothing, for



timber from around the world—Scandinavia, British Columbia, etc. She is reaching out for timber as she is reaching out for oil, and she will build and sail and defend as never before.

"Lloyd George with his wonderful leadership has given her the keynote, and it resounds in all her constructive and upbuilding plans: 'You cannot maintain an A-1 empire with a C-3 population.'

"The housing construction program begins with an increase in the local tax rate of one penny in the pound. Then the National Government advances money to the local government which, after construction, pays it back as best it can from the penny in the pound tax and the rents. But the return of the money is not so important as provision for sanitation and the safeguards against crowded tenement construction. The law permits only eight to twelve homes per acre, as compared with present construction of fifty.

### Building Research

Research is now admitted to be one of the essential parts of reconstruction or speedy progress; the advantage of research is now acknowledged in every industry—except building. Why not in building? Is it because we have achieved the perfect house? Clearly not. During the next few years we shall find new materials, processes and fittings. Just as in the last fifty years we have invented improved roofs, walls, floors, doors, locks, stoves, and lighting, ventilation and drainage, so we shall in the next fifty improve on today's methods. Then why use inferior methods when we could use better ones? If a thousand years ago a few brainy men had been picked to search deliberately to improve building (and other industries) we should have had better buildings five hundred years ago than we have today. During the next few years, says *Building World* of London, we are going to spend millions of dollars on building houses. Is it not mere common sense, is it not wisdom, to spend, say, one million in determining the right kind of house and the quickest way to make it? Isn't research really necessary more in building than any other industry? We must have houses; we must have them now; we know they can be improved. Research is not the builder's business; he can't afford it. Research is everybody's business and nobody's business. It is therefore the Government's business.

### Artificial Stone from Mica and Clay

Mr. Chr. Ingvaldsen, of Saaheim, Norway, claims to have devised a process of making a practicable building stone by mixing finely divided mica with a just sufficient amount of clay or other substance of similar properties, to form a coherent mass, which is then shaped into blocks, plates, and other objects of any desired shape and size. These, it is learned, are then fired at a temperature just high enough to fuse the mass, the resulting stone having in general the same properties as natural mica.

If it be desired to produce stone having greater resistance to high temperatures the process is modified as follows: Instead of mica alone, a mixture of equal parts of mica and of crushed quartz, with just enough clay to act as a binder. The stones formed from this mixture are fired at a temperature high enough to secure the fusing of the mica. The result is a homogeneous mass not only highly refractory to heat, but capable of acting as an electric insulator.

## Grand Central Palace, New York, to Become a World Trade Mart

One of the biggest enterprises to be embarked upon, having in mind the extension of American commerce in foreign countries, as well as the importation of foreign goods to America, has just been inaugurated in New York City. It is the new proposition of the Merchants' and Manufacturers' Exchange of New York to make Grand Central Palace a great clearing house for world commerce.

On September 30, the United States Government will turn Grand Central Palace back to the Merchants' and Manufacturers' Exchange. For months this great twelve-story building—the largest exposition building in the world—which occupies an entire city block, has been used as an army base hospital. Its evacuation, now taking place, will permit reconstruction of the entire interior so as to make it ideal as a permanent show place for all sorts of manufactured products. The industries will be grouped and permanent exhibits will be made on eight spacious floors, each floor having approximately 60,000 square feet of space. The remainder of the building (the four lower floors) will be utilized for the annual expositions which have made the building famous, such as the Automobile Show, Motor Boat Show, Flower Show, Electrical Exposition, Chemical Exposition, Hotel Men's Exposition, etc.

Permanent exhibits of products of the more important industries will be opened beginning October 15. The Merchants' and Manufacturers' Exchange has established foreign connections for export business in every important city of the world, and manufacturers, jobbers, retail dealers, and the thousands of foreign buyers undoubtedly soon will regard Grand Central Palace as the world's great trade center and will make it their headquarters when visiting New York. Looking forward to this the management will establish clubrooms, conference rooms, office facilities, etc., to increase the foreign buyers' comfort while in the Metropolis.

Never before has there been such a permanent exchange conducted along international lines which will give the American manufacturer an opportunity to come into direct contact with the domestic and foreign buyer. Some of the industries represented will occupy an entire floor. The plans of the Merchants' and Manufacturers' Exchange are decidedly elaborate, and in a number of ways they will afford a service to the manufacturer, jobber and dealer which has never been possible under the usual systems of merchandising.

Through its wide representation in other countries the Exchange will make its proposition known to every foreign buyer before he sails for America and acquaint him with the value of the service of the new enterprise, while in the United States and Canada the fact that the building is so well known leaves no doubt that it will be the mecca of thousands of domestic dealers and jobbers.

Only goods of proved quality and concerns of A-1 repute will be permitted to exhibit. Grand Central Palace, which is a beautiful building in itself and prior to the entry of the United States into the war, housed the largest expositions held in New York, is centrally located and most convenient to all railroads, steamship piers, hotels, theaters, and the shopping district. The march of the world's industrial progress during the reconstruction period, it is believed, will be largely via Grand Central Palace.



## Motor Car Methods in House Building

The Ford automobile plant in Dearborn, Mich., is combating its problems by the immediate construction of three thousand houses. Like the machines themselves, these will be built of uniform parts and materials, to save expense and time, and afford the quickest relief to the present housing shortage. A special mill to saw the raw material in uniform sizes is now under construction. Actual construction awaits completion of the mill, but land has been bought and hundreds of lots already laid out.

## Iowa Architects Publish Suggestions for the General Public

The Iowa Chapter of the American Institute of Architects, desiring to enlighten the public as to the place which the architect occupies in the general scheme of things, recently published and gave wide circulation to a brochure entitled, "Facts and Suggestions to Persons Interested in Building Operations."

The increased cost of building materials undoubtedly forms a cogent and unanswerable argument in favor of the employment of a competent architect. When clear white pine could be bought for \$12 or \$15 a thousand, all other materials at proportionally low prices, and skilled labor could be employed for \$2 a day—building materials could be used more lavishly than at present. It wasn't so necessary to count board feet, and comparatively little attention was paid to planning.

But with the rapid increase in costs of materials and labor, together with a growing realization of the solid benefits to be derived from the achievement of architectural merit, the architect's services began to receive more consideration.

A little additional care in construction—with trained intelligent consideration of the use of materials with a view to economy as well as attractiveness—may easily save for the owner several times the fee which the architect asks for his services. Then, also, must be taken into consideration the fact that buildings of architectural merit—no matter of what type, or what the use for which they are designed—bring a higher price in the realty market and sell more readily than buildings designed carelessly, without architectural merit or the benefit of careful planning.

One would think that in these days of high building costs every American with enough business acumen to get together sufficient money to pay for the construction of a building, would have learned that an architect is not a luxury—employed to add a few ornamental frills to an otherwise sufficient and pleasing building—but it is a regrettable fact that many otherwise astute persons wholly fail to take into consideration the real value of the architect's technical experience and knowledge. Now that the time has come when America has definitely entered an era of high building costs, owners must understand that building materials are too costly to be used except under the intelligent direction of an expert.

The Iowa Chapter points out that designing a building is an evolutionary process. In order to get the best result, the owner must give the architect his problem, and it is the architect's duty to find the best solution. This can only be accomplished by careful study, coupled to expert

knowledge. It is a comparatively simple matter to produce a set of blueprints. It is to be regretted that blueprints fail to convey to the layman any intimation of the deep study and thought that led by various stages to the completed plan.

## Origin of the Word "Miniature"

The origin of the "miniature", says an Attleboro, Mass., paper, is as follows: In the golden days of Roman literature, to be a successful author was to be as great as a king, for kings looked to their poets for immortality, as Augustus Caesar did to Horace. Hence it was to be expected that authors would feel their importance and display more or less vanity. One of their weaknesses was to see their portrait painted in artistic fashion in their parchment books. This work was intrusted to artists called "miniatores", that is, artists whose work was largely done in vermilion, a color extracted from cinnabar, and called by the Romans "minimum". The "miniatores" chose the oval form for their beautiful brilliant portraits on the parchment books, and hence the origin of the term "miniature", a small hand-painted oval or round portrait.

## Unightly Billboards

Billboard advertising has become a recognized feature of business activity in the United States. The boards offer practically the only method of advertising which compels every one to see and read, whether he wishes to do so or not.

In permitting the display of this advertising, the City of New York made it a condition that the operators of the billboards should keep the surroundings free from litter. Inspections made by The Merchants' Association through its Anti-Litter Bureau show that this condition is not always being fulfilled.

## Personals

John Kasurin has established an architectural office at 512 Empire Bldg., Detroit, Michigan.

Ray L. Weirick, Architect, Des Moines, Iowa, has moved his office from 309 C. N. B. Building to 1503 28th St.

Dwight G. Wallace and Alfred K. Kellogg have formed a partnership for architectural practice at 6 North Clark Street, Chicago. Catalogues are requested.

R. A. Bradley & Company, Architects and Engineers, have opened a new office in Scottsbluff, Nebraska, and would be pleased to receive catalogs from manufacturers and material men.

William G. Herbst and Edwin O. Kuenzli announce that they have formed a partnership for the practice of architecture. The firm, now known as Herbst & Kuenzli, maintains offices at 721 Caswell Block, Milwaukee, Wis.

The architectural practice conducted under the name of Arthur Woltersdorf, architect, will be known on and after June 1, 1919, under the firm name of Woltersdorf & Bernhard, architects and town planners.

Byron Sutton, who for twelve years has been engaged in the practice of architecture in the organization of Louis H. Osterhage, has now been admitted to partnership. The firm is located at 30 Second National Bank Building, Vincennes, Ind.

# Late News from Architectural Fields

Special Correspondence to THE AMERICAN ARCHITECT

## Urges United States to Send Artists to France

A letter urging that a party of American artists and painters be sent to France, to depict the part taken in the war by America, has been written to President Wilson by Albert Eugene Gallatin, who was Chairman of the Committee on Exhibition, Division of Pictorial Publicity, for the Committee on Public Information. Mr. Gallatin would have the pictorial history of the war on exhibition in the proposed \$10,000,000 National Soldiers' Memorial in Washington.

His letter is as follows:

Hon. Woodrow Wilson, President of the United States,  
Paris, France.

Sir: A group of Americans, who realize the importance of art as a national asset, and who are deeply stirred by the example of Great Britain, France, Canada, Italy, and Australia, in sending their best artists to the front to create permanent national records of the war, its heroism, sacrifice, and suffering, have deputed me to send you this letter.

We deplore the fact that thus far very little has been done to bring before present and future generations of Americans the great and inspiring part our country played in the war. We urge that a number of our leading artists be sent abroad immediately to paint from actual observation our historic battlefields, portraits of our army and navy leaders, of our soldiers, the life of our Army of Occupation on the Rhine, the scenes of war, the stupendous results of our efforts in engineering, railway building, hospital equipment, shipping, and all other branches of our war activity.

We also regret deeply that we have missed the opportunity of gaining the services of our greatest painter, Sargent, who has just painted for the British Government a monumental war canvas. It may be too late to paint incidents of warfare, but modern war consists not merely of fighting.

There are still immense fields to be covered if immediate action be taken. We appeal to you, therefore, for approval of such a project. The inspiring Canadian example proves that a national memorial of this kind can be created without the financial, though not without the moral and practical, support of the Government. The success of such a project would mean the presentation to our Government of the finest kind of a war memorial.

Respectfully yours,

ALBERT EUGENE GALLATIN.

Mr. Gallatin said the proposal was discussed recently at a dinner held by artists and critics. While no method of choosing the men for the task had been discussed, it was assumed they would be artists who have shown ability in war artistry. Some of the men whose names were mentioned when Mr. Gallatin first made the suggestion, while he was with the Committee on Public Information, were Childe Hassam, George B. Luks, Paul Dougherty, Henry Reuter Dahl, George Bellows, W. J. Glackens, Mahonri Young, and Joseph Pennell.

## Wants Investigation of Construction Financing

WASHINGTON, D. C., June 9.—Senator Kenyon of Iowa has introduced a bill to create a commission to investigate and report to Congress on the questions involved in the financing of house construction and home ownership.

The bill provides for an inquiry into existing conditions in the financing, construction and acquisition of homes within reach of people of modest means. The bill will give the commission power to inquire into the effect of present methods in stimulating or retarding the investment of capital in such homes and in controlling the quality, location and cost.

Senator Kenyon wants the commission to visit other countries and report to Congress by January 1, 1920. At that time, they will be expected to make recommendations for legislation. It is proposed to have two Senators and two Representatives on the commission consisting of agents of the Treasury and Labor Departments and two citizens designated by the President, one of whom shall be a woman. With the exception of the Presidential appointees all will serve without pay, the compensation of the salaried commissioners being fixed at six dollars per diem.

## To Construct Reflection Pool at Lincoln Memorial

WASHINGTON, D. C., June 7.—Congress has been asked to appropriate \$200,000 for the construction of the reflection pool at the Lincoln Memorial here. Landscape architects have devised plans for this project which call for two pools. The reflecting pool will be 2,000 feet long and 160 feet wide. The total cost of the pool is estimated at \$350,000.

It is proposed to use the first appropriation for excavation and drainage. The total cost may be increased to \$500,000 in event it is found that the soil will force the construction of a water-proof bottom.

## Building Supply Ban Lifted in Uniontown

UNIONTOWN, PA., June 9.—Restrictions placed by building supply concerns in Uniontown upon the sale of building material, pending the adjustment of a wage controversy with the carpenters, have been lifted to the extent that supplies may be purchased for repair work. The carpenters recently put into effect a wage scale, increasing from 75 cents to 87½ cents per hour the wages of all carpenters in the Uniontown union. Building contractors promptly refused to accept the scale, and suspended the sale of building supplies until an adjustment was reached.

A pronounced building boom in the city was halted, all new building being suspended by lack of supplies.



## Model Town for Negroes

TRUXTON, VA., June 7.—A model town, constructed by the Government exclusively for negroes is now formally open and Truxton, Va. has taken its place on the map as a suburb of Portsmouth.

Built primarily for war purposes to house the employed at the great Hampton Roads naval base, the 224 buildings in the little town will not be sold immediately by the Government, but will be rented at from \$16 to \$19 monthly. The town is one of the twenty-four housing projects the United States Housing Corporation is rapidly completing throughout the country for the Government. These projects represent a returnable value of more than \$25,000,000 and consist of a total of 6,000 houses and sixty-four apartments which by the end of June will be returning \$2,500,000

a year in rentals to the Government. Final disposition of the property rests with the Congress.

Truxton covers ninety acres and contains six store buildings which it is proposed to operate under a stock company formed by the tenants.

## To Consider Zone System

WASHINGTON, D. C., June 9.—Restriction of building in the District of Columbia is indicated in the bill introduced by Senate Calder last week. He proposed to have a commission appointed to consider the adoption of a zone system for construction of building in the District. This commission will make a report to the Commissioners of the District of Columbia together with their recommendations.

## Wage Scale of Trades Identified With New York Building Market

DURING the past six months the largest employer of labor, the Government, has withdrawn from the field. The signing of the armistice, which came overnight, caused the suspension and abandonment of many jobs which would have involved hundreds of millions of dollars and employed hundreds of thousands of artisans. With this work stopped, together with three million troops coming back from Europe, a situation has been created which requires considerable tact in order to be adjusted with the least friction.

The principal trouble has come from the unskilled laborers, those who have had no affiliations with central bodies, and are more or less irresponsible. These men have done much to hamper the building situation. On the other hand the skilled laborer has realized the trouble that has confronted his employer and met him half way. This, to be sure, was in a great measure, so far as the building trades were concerned, due to the fact that prohibitive wage scales made new work impossible. In the adjustment of just how much the wage earner can receive and still permit the builder to make a fair margin of profit, the cooperation has not been confined to the employer and employee by any means. A third factor comes into the field—that of the material dealer and manufacturer.

The manufacturer has been trying to place his goods on a stabilized basis, so that the contractor can figure his job and find out, after his building is under construction deliveries cannot be made at prices that maintained when the operation was started.

The New York Building Trades Association has prepared a table, of which the following is a digest, showing the wage scale in 1919, and the wage scale now in force. It shows the increase obtained by the various trades during this period, which accounts, in part, for the increased cost of building:

In Greater New York, carpenters (shop work) wage scale in 1916, \$4.50; 1919, \$6.00. All boroughs July 1, \$6.25, demanding \$7.00.

Bricklayers, in 1916, \$6.00; in 1919, \$7.00. Laborers, in 1916, \$3.14; in 1919, \$4.00.

Cement masons, in 1916, \$5.30; in 1919, \$5.60. Expires Dec. 31, 1919. Class A, in 1916, \$3.00; in 1919, \$4.00. Engineers (Hoisting Assn.) in 1916, \$5.75-\$6.00; in 1919,

\$6.50. Engineers (running pump) in 1916, \$4.75-\$5.00; in 1919, \$5.50.

Painters, in 1916, \$5.00; in 1919, \$6.00.

Decorators, in 1916, \$5.00; in 1919, \$5.00. (Varnishers the same.)

Plasterers, in 1916, \$6.00; in 1919, \$6.50-\$7.00. On strike for \$7.50. Laborers, \$3.50 in 1916; in 1919, \$4.50. Demanding \$5.50.

Metallic lathers, in 1916, \$5.50; in 1919, \$6.00.

Electrical workers, in 1916, \$5.00; in 1919, \$6.00. Expires December 31, 1919. Helpers, in 1916, \$2.50; in 1919, \$3.00.

Asbestos workers, in 1916, \$4.65; in 1919, \$6.40. Helpers, in 1916, \$2.90; 1919, \$3.00.

Plumbers, in 1916, \$4.50; in 1919, \$6.00.

Steamfitters, in 1916, \$5.00; in 1919, \$6.00. Expires Jan. 1, 1920. Helpers, in 1916, \$3.00; in 1919, \$4.00. Expires Jan. 1, 1920.

Elevator constructors in 1917, \$5.52; in 1919, \$6.80. Helpers, in 1917, \$3.52; in 1919, \$4.50.

Stone masons, in 1916, \$5.00; in 1919, \$5.00. Cutters, in 1917, \$5.00-\$5.50; in 1919, \$6.75. September 1, \$7.00. Setters, in 1914, \$6.00; in 1919, \$7.00. Laborers, in 1916, \$3.00; in 1919, \$3.60. Bluestone cutters, in 1903, \$4.40; 1919, \$5.00.

Mosaic workers, in 1916, \$4.75; in 1919, \$5.50.

Tile layers, in 1917, \$6.00; in 1919, \$6.00. Expires Jan. 1, 1920. Helpers, 1917, \$3.25; in 1919, \$3.65. Demanding \$4.00.

Marble cutters and setters, in 1917, \$5.50; in 1919, \$6.00. Expires July 1, 1920. Carvers, in 1914, \$6.00; in 1919, \$6.50.

Expires July 1, 1920. Polishers, in 1914, \$4.40; in 1919, \$4.70. Helpers, in 1914, \$3.25; in 1919, \$3.50. Bed rubbers, in 1914, \$4.95; in 1919, \$5.00. Sawyers, in 1917 and 1919, \$4.68. Machine workers, in 1914 and 1919, \$5.50.

Roofers (composition), in 1917, \$3.75; in 1919, \$4.75. Slate and tile, 1914, \$5.25 to \$5.50; in 1919, \$6.50. Roof and sheet metal, in 1914, \$5.00; in 1919, \$6.00.

Housesmiths (structural), in 1916, \$5.30; in 1919, \$7.00. Finishers, in 1916, \$5.30; in 1919, \$6.40. Helpers, in 1916, \$4.00; in 1919, \$5.00.

Houseshorers, in 1917, \$4.00; in 1919, \$5.00. Helpers, 1916, \$3.00; and in 1919, \$5.00.

Woodcarvers, in 1903, \$3.75 to \$5.00; in 1918, \$5.50. Workers (per week), in 1916, \$18.00.



# Freer Loans Stimulate Building

## Renewed Co-operation Between Mortgage Institutions and Builders Greatly Aids Construction Boom

FURTHER evidence of renewed co-operation between large mortgage interests and builders, lack of which for some time past has checked the progress of construction on a large scale, a result largely due to efforts made by unscrupulous speculators to place loans unwarranted by appraisals, was a feature of this week's activity in building circles. Although hotly assailed by this type of builder, who claims he will be driven out of business if the plan to force amortization continues, there is sound reason why lending institutions have hesitated in furnishing construction funds on first mortgages as freely as before the war.

The responsibility for an increased cost of lending capital can be directly traced to this condition of mistrust. The scarcity of available funds held by the title and life insurance companies and savings banks after they absorbed such a large part of all Government issues, has made for an expected rate of six per cent, and with it comes a closer scrutiny of all projects on which money is advanced.

It is only a short time ago that the speculative builder could get a bank to accept the appraisal of a broker whose connections might not be of the best, only for the bank to find later than an excessive amount had been loaned on the project. Evidence of this is to be found in many cities where lending companies have had to take over title to considerable property that had been over-appraised to such an extent that the speculator was willing to turn over the property to the company for the face value of the mortgage.

Since the war this state of affairs has undergone a decided change for the better. Additional safeguards have been taken by the mortgage institutions to guard against the reprehensible methods of unprincipled speculators. Appraisals have been put in the hands of competent men, the amortization clause placed in contracts, and other precautions taken to enable operators to judge their equity with more certainty, and allow building to proceed on a more normal basis.

The effect of the feeling of mistrust on the part of the banks in the larger cities was unfortunately reflected in the smaller municipalities with the consequence that the well-intentioned builder, or the man who desires to construct a new home, has had to bear the bonus, and pay the increased rate on loans. The moral hazard in transactions of this nature is as pronounced as in fire insurance, and becomes an important factor in the placing of a loan. It is not just that the small investor shall suffer for the suspicions that are rightfully directed against certain classes of speculative builders who use questionable methods to finance their project and shall have to pay a premium that ordinarily he would not be asked to give.

The banks and builders are now co-operating with the net result of getting construction started on a large scale. The need is for new houses and more new houses and this feeling of confidence makes their construction possible. The thing needed now is action in carrying through the plan. One large New York title company this week reported lending from two to two and one-half millions

of dollars in the metropolitan district in May. Other companies similarly active are helping the situation materially.

\* \* \*

A wide variety of construction was noted among projects which came to architects' offices during the week. Theaters had a leading position. Some complaints were heard regarding the difficulty of obtaining sufficient labor and it is expected that the situation will become more acute before the summer is far advanced. Material prices are holding firm, with a tendency upward in lumber and brick.

\* \* \*

A conference of New York members of Congress has been requested by Senator Charles C. Lockwood, chairman of the Joint Committee on Housing of the New York Legislature, who proposes to establish a Federal Reserve Home Bank along lines similar to the Federal Land Bank for farmers.

Senators Wadsworth and Calder have been asked to obtain consideration of this proposal as quickly as possible this session, that the "expected shortage of 30,000 homes in this city may be met at least partially."

Senator Lockwood said that under the legislative committee's plan the Federal Home Loan Bank aims to give to present and prospective home owners the same advantage as is given to farm owners by the Federal Land Bank, which exempts from taxation the 5 per cent bonds issued against farm mortgages.

"The exemption from Federal taxation of the mortgages on homes or holdings in mortgages up to say \$4,000, so that mortgage money can compete in the money market with Government and other securities which are now non-taxable, more liquid and give a larger net return.

"Exemption from Federal taxation of the bonds issued by the New York State Land Bank, which was incorporated several years ago by the Legislature, which issues bonds secured by mortgages deposited with the State Comptroller of New York, but which has been unable with its 4½ per cent taxable bonds to compete with the 4¾ per cent and other Government non-taxable securities, and the 5 per cent tax-exempt farm loan bonds, and such other and further measures by which they think Congress can aid the situation by stimulating construction of houses."

\* \* \*

WASHINGTON, D. C., June 2.—That prices will not soon drop is the prediction of authorities on all sides. The Federal Reserve Board in its May bulletin says: "The business community has given up the thought that it may profitably await a further considerable reduction in prices and is now contenting itself with the development of trade along lines dependent upon at least the temporary maintenance of existing levels." The review also says that though prices of a few basic commodities have fallen slightly, these declines have not yet been effected in retail prices. "What is now happening," it adds, "seems to indicate that business will, after a period

(Continued on Page 836-A)

# Department of Architectural Engineering

---

## Second Report on the Work of the Underwriters' Laboratories\*

By the Committee of the American Institute of Architects

**T**O THE MEMBERS OF THE AMERICAN INSTITUTE OF ARCHITECTS: For the information of those who may not be informed it should be stated that, at the last convention of the American Institute of Architects, the undersigned committee was appointed for the purpose of observing tests made on building materials and equipment at the Underwriters' Laboratories at Chicago, and reporting to the architects such data and results of these tests as might be of value.

The ultimate object of the Institute in doing this was to bring about a diminution in the annual fire loss of property and a decrease in the number of casualties and deaths by fire, by arousing the interest of the architects in those subjects and inducing them to make their buildings more fire resisting and more certain to afford safe exit for the occupants in time of fire.

The reason that the fire loss is so enormous and the number of casualties and deaths by fire so great in this country is because our buildings have been built with little or no consideration of the means to prevent these things.

No one who reads the annual records of the great losses sustained can fail to account for the greater number of them on any charitable basis, except that the people who are responsible for many of those buildings must have been ignorant of all fire prevention provisions or utterly devoid of any proper realization of their great necessity.

THE WHOLE SUBJECT of fire prevention, judged

\*This report is published in THE AMERICAN ARCHITECT in response to a request by the Committee of Architects and by the Underwriters' Laboratories. The original edition has been exhausted and copies of the report, as originally published, can no longer be supplied by the Architects or the Laboratories. "Calls for copies of the report," the Chairman of the Architects' Committee writes, "are coming not only from all over the United States, but also from Europe and even from as far away as Japan and India."

from the basis of the enormous annual losses, is a most fitting subject for National legislation and complete control, but in the absence of that, the only avenue left open for accomplishing any comprehensive reform seems to be by appeal to the people, and of course the most available way to reach them is through the architects who build their buildings.

There is no appeal that can possibly be made which should be received with as much earnest consideration as one made for the saving of human lives and the avoidance of the destruction of property, and that is exactly what this one is.

The effectiveness of an appeal such as this, is usually impaired by the belief on the part of most people that all of these great fire losses are the necessary and natural result of accidents that are bound to occur in spite of all reasonable efforts to prevent them.

Then in connection with this belief comes the final comforting thought, justifying the dismissal of the whole subject from the mind and conscience of these people, that we have fine fire departments with high stepping horses and smart motors, amply able to put these fires out, and back of all this, in case losses do occur, are the rich insurance companies who are fully capable of setting all things to rights and making full amends to all those concerned, so in this manner the average person disposes of the whole subject and the annual losses keep mounting upward and the property owner and not the insurance companies pay every dollar of these losses eventually in the increased rates of insurance.

To awaken these people out of their lethargy and to bring them to a realization of the fact that they



have one of the worst records for fire losses of any nation on earth becomes really a public duty of every one who has a knowledge of the subject and particularly the architects who design these buildings are largely responsible for whatever fire resisting qualities they may have.

In these days especially when the whole nation is struggling to economize and to stop every needless waste, these losses seem all the more regrettable when measured with the great needs of the war sufferers abroad.

Would it not startle the most irresponsible and indifferent person to realize that in 1916 we burned up enough property in this country to house and make comfortable most of the destitute people in France, who have been driven from their homes by the war? Two hundred and eight million dollars is the value of buildings so destroyed according to the approved statistics.

Would it not discourage and rightfully disgust those good people who have been trying to help feed the poor Bel-

gians, if they knew that from May to October of last year \$12,000,000 worth of food that we know of was destroyed by fire?

Could it reasonably be expected to awaken the

conscience of the speculative builder or the indifferent owner if he were to know that last year 1,332 people were burned to death and 5,280 injured by fire in this country?

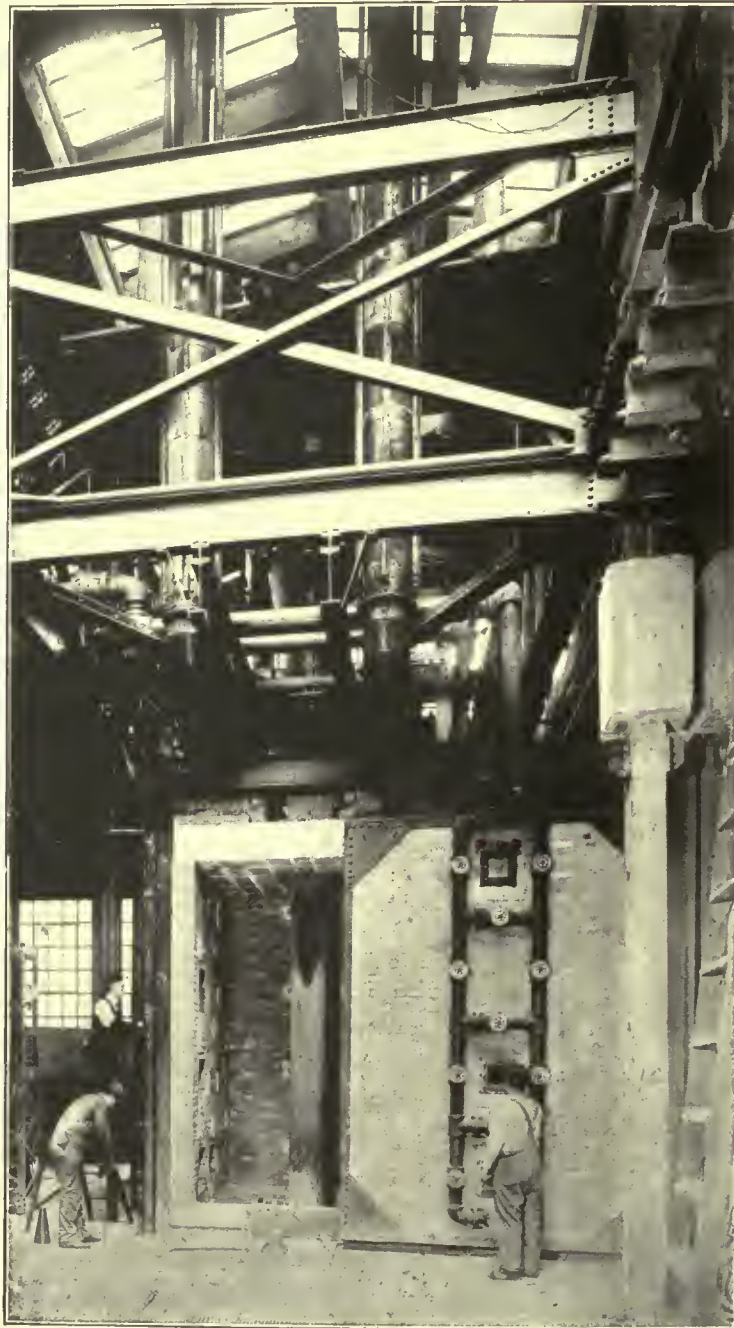

The great furnace erected for testing columns.

It would be a useless and undesirable thing to relate these things in this reproachful manner if it were true that nothing could have been done to prevent them or at least to diminish the number of them. It is of course impossible from the statistics to determine how many of them might have been prevented, but the most startling and convincing evidence of it all is, that this country has charged up against it every year more loss and destruction of property by fire, and more injuries and deaths by the same cause in proportion to our population than almost any other country in the world. Some nations have only half the fire losses proportionately, that we have, others only one-third and some even as low as only one-quarter as many. The statistics on these things are authentic and there

is no possible conclusion to draw other than that the people of this country are far below the average in preservation of its property from damage or destruction by fire and safeguarding of its people



from injury or death by the same cause.

It has grown to be a custom among architects to incorporate in their buildings only those safeguards against fire which the particular community in which they practice requires, or if these requirements happen not to be sufficient to secure a low insurance rate, it may be that minimum insurance requirements will govern. At any rate, strange as it may seem, it is seldom that any architect when planning his building adds anything to it not required by the law or the insurance companies that might save it or its occupants in time of fire.

In the face of these awful annual losses it seems clear that the architect should not have to be forced to save his buildings from fire, but he should realize that he is in a position if he will only take advantage of it to do more than anyone else, in making our future buildings safer and better to live in and occupy and much less destructible by fire than they are now. If the architect when he plans and designs his building would only give more thought to how a fire might be stopped or retarded when once started and how all the occupants might find safe and trustworthy means of exit, many a life might

be saved that would otherwise be lost and the fire and casualty lists of this country would gradually and surely diminish until they would compare favorably with any nation in the world.

EVERY ARCHITECT therefore is appealed to by the American Institute of Architects, to make a special study of each new problem for the purpose of providing safe exits and all possible resistance to fire, whether the law or the insurance authorities require it or not.

For the purpose of assisting the architects in this most worthy endeavor, there has been included in the Structural Service Department of the Journal of the American Institute of Architects a most complete and up-to-date list of all the literature and authorities on this subject. Any architect can secure with little or no expense full information of all those features and equipments of buildings that have been found by experience to be most effective against fire. In addition to this all the information and data which the Underwriters' Labora-

tories have been gathering for years from their tests and experiments are open and free to the architects if they will only use them.

COLUMN TESTS. Among the tests which the

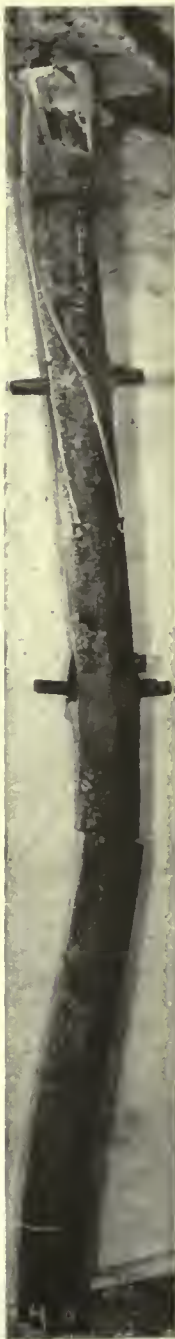

(A)



(B)



(C)



One of the round-headed windows which stood up excellently after a severe fire and high pressure water test.

Laboratories have been making recently are two which are of very great importance to the architects. They are the tests on building columns and new designs of fire retardant windows. Realizing that the fate of a building and often its occupants depends upon how well the columns supporting it will resist the effects of fire, the tests of columns have been made the most scientific and complete of any that have ever been undertaken. The United States Bureau of Standards, the Associated Factory Mutual Fire Insurance Companies, the National Board of Fire Underwriters and Underwriters' Laboratories decided to combine forces and try out and settle once and for all by real fire tests the relative merits of all kinds of building columns. The question of the relative merits of fireproofing for columns came up after the Baltimore fire and the San Francisco earthquake, and was discussed throughout the country by the press and leading magazines. It is now being settled by carefully prepared scientific methods. Over two years ago the preparations were begun and all the different kinds of columns and all the various ways of fireproofing were carefully considered with the view of selecting for a test a full representation of all the different types. Accordingly 100 specimens

were selected, and the work of testing started about a year ago, as soon as preparations for the work had been completed. Among those made during this year were the metal unprotected types of columns, which it is intended to describe in this report, in rather a brief manner and leave the more complicated fireproof columns for a more complete subsequent report. It is planned to provide the architects ultimately with a table of records and data so that they may at once select any kind of a column for any sort of a building with full and definite assurance of what it would do in case of a fire.

In order to prepare for the testing of these columns under the same conditions that would exist in a building, a great furnace was erected that would take a column 12 feet high and impose upon it during the test a load of 256 tons. The furnace was built for applying a maximum heat of 2300 degrees F. Provisions have been made for measuring temperature of furnace and test column and for measuring the deformation and deflection of the latter. Means have also been provided for applying streams of water under pressure to the heated column. Of the unprotected metal columns tested, 3 were of cast iron and 8 of various combinations



A new type of fire window without any muntins, approved for certain locations.



## THE AMERICAN ARCHITECT

of steel shapes. The cast iron columns stood up longer than the steel columns although the failure was more abrupt and complete. The temperature was raised gradually to about 1300 degrees F. at 10 minutes and 1500 degrees at 30 minutes. The cast iron column (A), shown in the illustration, (page 831), failed in 34 minutes and 13 seconds while one of the steel columns (B) failed in 11 minutes and 10 seconds and another (C) in 19 minutes and 13 seconds. The illustrations show

columns and the protected types became at once apparent in the tests, and when the tables and data are finally completed for all of the tests, the resistance to fire of the various kinds of fireproofing for columns will be fully determined.

**FIRE WINDOWS.** The tests of newly designed fire windows established certain facts not previously known which has enabled the Laboratories to put their approval and seal on certain windows which the architects will undoubtedly be very glad to



New type of fire window and transom having only a 2-in. mullion which tested out satisfactorily.

the condition of the cast iron column and the two steel columns after the test.

These tests on the unprotected metal columns show how quickly they will fail and cause the building to collapse even in an ordinary fire, thus proving conclusively that unless the architect takes the precaution to fireproof such supports his building may collapse even in a fire of very short duration. The great difference in the endurance between these

utilize instead of the ones formerly used for certain locations. This test has demonstrated that for certain exposures the architects need not provide for great wide fireproof mullions between units of these windows, but instead of that in certain locations may use mullions as narrow as two inches wide, thereby increasing light 75 per cent and doing away with wide mullions which were in some cases very objectionable features.

## THE AMERICAN ARCHITECT

They will also be glad to know that certain windows have been approved for certain locations, in which there may be no mullions used at all and where one entire single sheet of glass may be used in the sash. The illustrations show in a limited way several varieties of these new types of windows which came through the fire with unexpected satisfactory results. The limits of the size of these windows and the area of the glass and the various details of the construction may all be had in detail by application to the Laboratories. It is probable that later on all the information concerning all of the different types of fire windows may be tabulated and sent to the architects in convenient form for

their ready reference in determining the kind of windows to select for any situation.

In the next report of this committee it is the intention to present a complete report with all of the important data and conclusions reached by the Laboratories in regard to the relative merits of all the various columns which they are now testing.

Respectfully submitted,

THE COMMITTEE ON THE WORK OF UNDERWRITERS'  
LABORATORIES,  
ELMER C. JENSEN,  
H. WEBSTER TOMLINSON,  
GEORGE C. NIMMONS, *Chairman*.

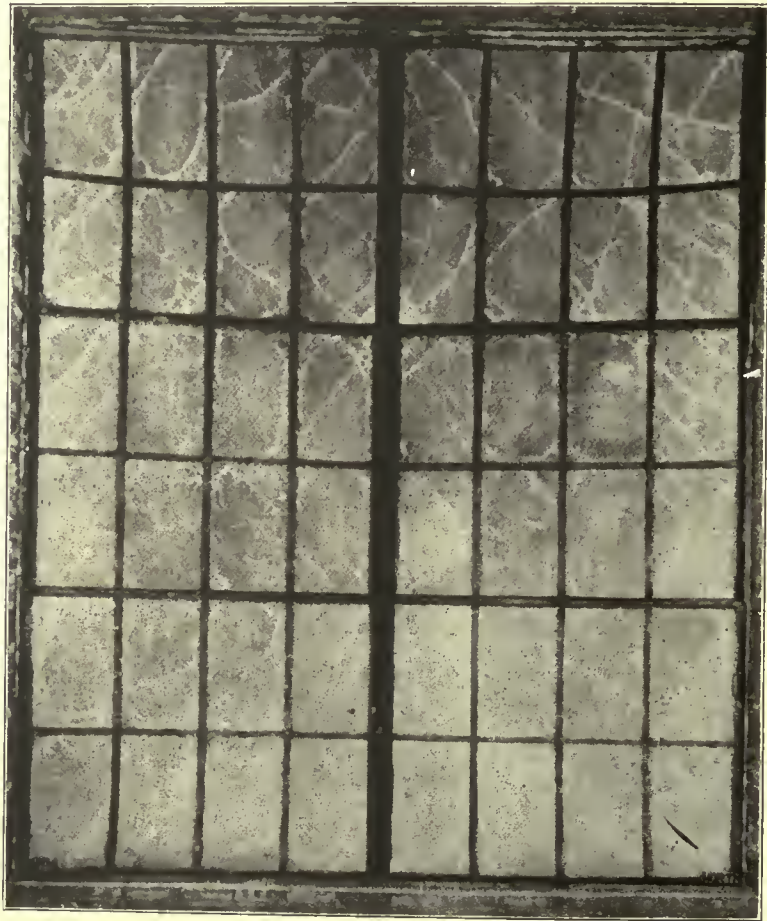

Large type of fire window with 2-in. mullion listed after a successful test.



# Present Status of Industrial Lighting Codes\*

## Part III

By G. H. STICKNEY

### SWITCHING AND CONTROLLING APPARATUS

THIS provides for the location of controlling switches so that at least pilot or night lights may be turned on at the main point of entrance.

Some commissions have considered it important that watchmen and others should be able to go about safely without lanterns, while others believe that the carrying of a lantern is sufficient. The former certainly has advantages, but may in some instances be unnecessarily expensive.

It would appear that the rule in this form is satisfactory on the assumption that an industrial commission would make exceptions where unnecessary hardship is shown.

### ENFORCEMENT

Attention has been called to the readiness and willingness of the industries to comply with commission regulations, if they are understood.

Other limitations of the code have already been discussed, but none of these has presented more of an obstacle than the fact that many of those by whom the regulations must be applied are not versed in the principles of light and illumination, and have but little idea of the qualities and quantities necessary for the definition of lighting conditions.

Every effort has been made to simplify the rules and make them understandable to others than engineers. Some of the commissions have included simple definitions of terms used. Some have attached explanatory treatises and articles on methods of designing lighting installations. But there is still a need for more popular education. The possibilities of rendering the codes more definite and accurate in the future depend in a considerable degree on such education.

Undoubtedly the commissions can take care of their inspectors, but the small manufacturers, foremen and others responsible for the construction and operation of industrial lighting installations need assistance.

The codes and their appendixes will undoubtedly provide effective mediums, but the help of those professionally related to the lighting practise is needed. It is earnestly hoped that the individual members of the American Institute of Electrical Engineers and the Illuminating Engineering Society will inform themselves regarding the principles of the code specification and not only offer constructive criti-

cism but also help in the educational effort of applying the regulation.

### CONCLUSION

The author is inclined to look with apprehension upon laws or regulations emanating from the professions whose business they affect most directly. There has sometimes seemed to be a tendency in such legislation to favor the profession. Such tendencies are presumably more due to the professional viewpoint or prejudice than to any intent to be unfair.

Having been connected from the first with the committees responsible for the illuminating engineering features, it is only fair to say that the danger of prejudice has been anticipated and carefully guarded against.

Especially care was exercised in the make-up of the committees and the solicitation of criticism, not only to represent the viewpoint of every phase of illuminating and other engineering, but also the light user and light purchaser. The engineer, the scientist and the practical constructor and operator were all included.

On the other hand, it is even more dangerous to legislate regarding such a technical subject without the guidance of the profession. In lighting we have numerous examples of such legislation as, for example, in the headlight laws for railways and automobiles. Many of these laws are not effective or reasonably enforceable, their meaning is not clear, while they not only impose unnecessary hardships, but have in some cases prescribed a dangerous rather than a safe condition.

The industrial lighting codes, besides avoiding both of these dangers, have been so formulated as to encourage uniform action throughout the various States of the Union. The continuation of the code development along the present lines is therefore of importance not only to those directly interested in the electrical and illuminating phases, but to the country as a whole.

In discussing the codes an attempt has been made to emphasize the principles involved rather than the details. Changes in details may be expected, but any considerable change in principles seems unlikely. No one is more conscious of the limitations of the code in its present form than the illuminating engineers who have been active in its development, but all who have had anything to do with the work

\*Continued from issue of May 28, 1919.

regard it as a valuable working instrument. The author feels safe in saying that they consider it highly important to any State that it be adopted and actively applied as soon as possible. The greatest possibility for future development is through the experience and popular education following its enforcement.

The author has tried to avoid the expression of personal opinion as far as practicable. He has sometimes found it desirable to express his understanding of the views held by committees and their members, but this has been informal and unauthorized and should be so understood.

He herewith acknowledges with thanks the helpful assistance in the way of comment and criticism of Mr. L. B. Marks and Professor C. E. Clewell, to whom perhaps more than to any other individuals we are indebted for the initiation of these constructive regulations.

The author also acknowledges the assistance of Mr. J. A. Hoeveler and others.

BIBLIOGRAPHY

1. "The Mechanical Engineer and the Prevention of Accidents," by John Calder, *Journal, American Society of Mechanical Engineers*, February, 1911.
2. "Illumination as a Safety Factor in Industrial Plants," by R. E. Simpson, *Transactions of Illuminating Engineering Society*, Vol. 9, No. 5, page 459. Also *Electrical World*, April 18, 1914, page 858.
3. "Illumination and One Year's Accidents," by R. E. Simpson, *Transactions of Illuminating Engineering Society*, December 30, 1915, page 868.
4. "Relation between Lighting Curtailment and Accidents," by R. E. Simpson, *Transactions of Illuminating Engineering Society*, Vol. 13, No. 8, page 429. Also *Electrical World*, November 16, 1918, page 935; *Central Station*, November, 1918, page 156, National Electric Light Association *Bulletin*, October, 1918, page 536.
5. "Relation of Industrial Lighting to Safety," by C. E. Clewell, *Electrical World*, June 16, 1917, page 1153.
6. "Illumination and Eyestrain," by E. M. Alger, *Transactions of Illuminating Engineering Society*, March, 1913, page 130.
7. "Conservation of Vision," by E. M. Alger, *Illuminating Engineer*, February, 1912, page 618.
8. "Hygiene of the Eye," by Wm. Campbell Posey, A.B., M.D., (published by J. B. Lippincott Co., Philadelphia and London).
9. "Code of Lighting Factories, Mills and Other Work Places," *Transactions Illuminating Engineering Society*, Vol. 13, No. 4, page 256.
10. "Lighting Legislation," by L. B. Marks, *Transactions Illuminating Engineering Society*, February, 1916, page 40.
11. "Productive Lighting Intensities," by W. A. Durgin, *Transactions Illuminating Engineering Society*, Vol. 13, No. 8, page 417. Also *Electrical Review*, November 2, 1918, page 686.
12. "Factory Inspectors Study Industrial Lighting," by C. E. Clewell, *Electrical World*, July 6, 1918, page 11.

8. "Instructional Session for Special Guidance of State Factory Inspectors, held in Boston, October 31st, 1918." *Electrical World*, November 9, 1918, page 904.

9. "First Report of the Departmental Committee on Lighting in Factories and Workshops, Home Office, British Empire, London, England," published by Eyre and Spottiswoode, Ltd., East Harding Street, E. C., London, England.

10. "Effects of Brightness and Contrast on Vision," by P. G. Nutting, *Transactions Illuminating Engineering Society*, Vol. 11, No. 9, page 939. *Electrical World*, February 17, 1917, page 326.

## Analysis of Statically Indeterminate Structures by the Slope Deflection Method

UNDER the above title the Engineering Experiment Station, University of Illinois, Urbana, Ill., have issued Bulletin No. 108, giving the derivation and application of formulas for solving problems involving statically indeterminate stresses. Among the cases analyzed are the following:

Girders having restrained ends, and continuous girders.

Two-legged rectangular bents, with legs of both equal and unequal length.

Two-legged Trapezoidal bents.

Skeleton construction framework with rigid connections.

Three-legged bents.

The use of statically indeterminate structures in recent years has grown rapidly and many new types of structures have been evolved. With the use of riveted connections in steel frames and the development of monolithic reinforced concrete structures of all sorts, it often happens that statically indeterminate stresses cannot be avoided. On the other hand, structures are frequently made of an indeterminate type for the purpose of securing economy of material. Rational methods of design will do much to inspire confidence in the reliability and economy of such structures, thus insuring their more widespread use.

It is felt that the treatment of statically indeterminate structures given in this bulletin will be helpful in giving information regarding such structures. The method has been explained in sufficient detail to enable the designing engineer to use it in the solution of his particular problems. It is believed that the fundamental principles can be quickly coordinated with the ordinary principles of mechanics so that the more complex problems and even the simpler ones may be studied from a new viewpoint.





Walls finished with Cabot's Old Virginia White Roof Stained with Cabot's Creosote Stains. J. W. O'Connor, Architect, N. Y.

## Cabot's Old Virginia White

*The Clean, Brilliant "Whitewash-white"*

Old Virginia White has real distinction. It is a softer but brighter white than paint, and its texture is essentially different. It is as handsome as new whitewash and as lasting as paint—though cheaper. It has the genuine old Colonial effect and when combined with

### Cabot's Creosote Stains

on the roof the result is so thoroughly harmonious and distinguished that the house is sure to represent the latest and best in exterior decoration.

*You can get Cabot's goods all over the country. Send for stained wood samples and name of nearest agent.*

**SAMUEL CABOT, Inc.,** MFG. CHEMISTS **BOSTON**  
 1133 Broadway, NEW YORK 24 West Kinzie St., CHICAGO  
 Cabot's Stucco and Brick Stains, "Quilt," Damp-proofing, Conservo Wood Preservative, etc., etc.

5-2

"A product without a peer"

# APOLLO-KEYSTONE

COPPER STEEL  
Galvanized

# Sheets



Highest in quality and rust resistance. Unequaled for Culverts, Flumes, Tanks, Roofing, Siding, Spouting, and all exposed sheet metal work.

We manufacture Sheet and Tin Mill Products of every description—Black and Galvanized Sheets, Corrugated and Formed Products, Roofing Tin Plates, Etc.

AMERICAN SHEET AND TIN PLATE COMPANY, Pittsburgh, Pa.

## APPALACHIAN TENNESSEE MARBLE

has gone into the making of many of the country's finest banks and public buildings

*A variety of colors and markings to suit each individual requirement*

**APPALACHIAN MARBLE CO.**  
 KNOXVILLE TENNESSEE



Frank Scott Clark Studio, Detroit Chittenden & Kotting, Architects

## CRITTALL STEEL CASEMENTS

for  
 Artistic Residences  
 and other substan-  
 tial buildings

Made in varied designs  
 to meet all conditions



**Crittall Casement Window Co.**  
 Detroit

Manufacturers of Steel Casements and Windows  
 Manor Works, Braintree, England

Building Material Market Reports

(Continued from Page 828)

of initial readjustment in prices, proceed upon a level not far removed from that established during the war."

At the solicitation of the Information and Education Service of the U. S. Department of Labor, J. J. Arnold, vice-president of the First National Bank of Chicago, has made a statement on "Inflation and Prices" in which he says it is futile for industry to wait for pre-war commodity prices and everything should be done to encourage resumption of peace business, the production of new wealth being absolutely essential for the reduction of costs.

Mr. Arnold suggests that the United States use the interest paid by foreign countries on their loans for a "rehabilitation fund" to be spent in Europe, which would mean that for the period of time required for the rebuilding of Europe we would be loaning funds without interest. He thinks it would pay to do this, both in terms of friendship and, in the long run, in dollars and cents.

\* \* \*

(From Our Special Correspondent)

CHICAGO, ILL., June 9.—Financial and industrial leaders in this city are predicting the biggest building boom in history to follow the signing of the peace treaty and the actual declaration of peace. They hold that pressure behind the resumption of all activities on a peace-time basis is such that many of the former causes for hesitation have disappeared, and are becoming more and more convinced that the one great move to restore confidence and start business and industry in volume is the finish of the greatest world's war.

Steel manufacturers from every district in the country

attending a meeting of the American Iron and Steel Institute, in Chicago, predicted that the mills would be operating 100 per cent of capacity before Fall.

Elbert H. Gary, chairman of the United States Steel Corporation, has made the flat prediction that steel production for this year will exceed all records. He held brief for all business in saying, "It is time that industry and enterprise in the United States shall be encouraged and protected instead of attacked, interrupted, and destroyed."

Mr. Gary said that whether the United States was to retain its financial, commercial, and industrial leadership depended "upon the attitude of our own people in official or private life." He added, speaking on behalf of the steel interests:

"We will do our part."

While the steel interests "have not always been exactly right in some, and perhaps in many particulars," he asserted, their intentions were good.

There are "things to be done" by legislative and administrative departments of the Government which are necessary to the protection of the nation's industries, Mr. Gary said, adding that other nations would do everything to see that private enterprise received protection, and American laws and rules should operate similarly.

"It is time that industry and enterprise in the United States shall be encouraged and protected instead of being attacked, interrupted, or destroyed," he declared. "Our nation, now the leader financially, commercially, and industrially, may be continued in this position or compelled to occupy a lower place, depending upon the attitude of our own people in official or private life, or both.

In the Calumet district the rolling mills just at this time are working two hours a day and some of the blast furnaces are down. Officials say the demand shows some improvement, but that what is now needed to bring about normal conditions is the signing of the peace treaty.

Late Quotations in Building Material Markets

(Price quotations now current on building materials and supplies as quoted by dealers and jobbers for delivery in New York and Chicago follow. The quotations set forth are placed before readers of THE AMERICAN ARCHITECT to afford an accurate review of market conditions rather than for use as a basis for actual purchase. They will not only provide knowledge of the exact state of the market as to items quoted, but will also present a basis to judge conditions as affecting correlating materials. Items marked (\*) indicate an advance over last week, while those marked (†) record a decline. Other prices did not fluctuate during the week.)

	New York	Chicago
<b>BRICK</b>		
Face brick (delivered on job):		
Common (Delivered at job in Borough of Manhattan only), per thousand.....	\$17.85	\$12.00
Rough red .....	29.00	40.00
Smooth red .....	26.00	40.00
Rough buff .....	32.00	40.00
Smooth buff .....	32.00	40.00
Rough gray .....	38.00	42.00
Smooth gray .....	40.00	42.00
Colonials .....	24.00	30.00
<b>BROKEN STONE</b>		
(Delivered on job):		
1½ in. per cu. yd.....	\$3.25	\$2.35
¾ in. per cu. yd.....	3.25	2.35
<b>BURNED CLAY</b>		
(Delivered on job)		
Block partition:		
3 in., per sq. ft.....	.13†	.10
4 in., per sq. ft.....	.15†	.11
Chimney tops:		
12 x 12 for 8 x 8 flues.....	\$3.50	\$2.25
Flue lining:		
4½ ft. x 13 ft., per lin. ft.....	.24*	.12
4½ x 8½, per lin. ft.....	.18†	.16
8½ x 8½, per ft.....	.24*	.16
8½ x 13, per ft.....	.54*	.20

	New York	Chicago
13 x 13, per ft.....	.46*	.28
8½ x 18, per ft.....	.54*	.32
13½ x 18, per ft.....	.70*	.42
18 x 18, per ft.....	.90*	.55
Wall coping (double slant):		
8 in., per lin. ft.....	.16†	.14
12 in., per ft.....	26†	.18
18 in., per ft.....	.54*	.30
Wall coping (single slant):		
8 in., per lin. ft.....	.16†	.14
12 in., per ft.....	.26½	.30
18 in., per ft.....	.54*	.30
(Corners and angles four times the price of one foot of coping the same size.)		
<b>Hollow Tile</b>		
(Delivered at job, in New York below 72nd St.)		
2 x 8 x 12 partitions, per 1,000 sq. ft.....	\$70.15	.....
3 x 12 x 12 partitions, per 1,000 sq. ft.....	102.00	\$67.90
4 x 12 x 12 partitions, per 1,000 sq. ft.....	114.75	72.50
6 x 12 x 12 partitions, per 1,000 sq. ft.....	153.00	99.60
8 x 12 x 12 partitions, per 1,000 sq. ft.....	.....	135.80
10 x 12 x 12 partitions, per 1,000 sq. ft.....	.....	167.50
12 x 12 x 12 partitions, per 1,000 sq. ft.....	.....	194.60
2 x 12 x 12 split furring, per 1,000 sq. ft.....	63.75	.....
<b>CEMENT</b>		
Per bbl. in 15 cent bags. (Rebate 60c. per bbl. for bags) .....	\$3.25	\$2.80
<b>COPPER SHEETS</b>		
At the mill, hot rolled, 16 oz. base-price, per lb.....	.22½c.	22½c.
(From jobber's warehouse add 2 to 3 cents. Cold rolled add 1c. per lb. to hot rolled.)		
<b>CORNER BEAD</b>		
Per foot .....	.05	.05
<b>FIBRE</b>		
Per bushel .....	.30	.30

(Continued on Page 836-B)



U. 1935-206 after 852

# The AMERICAN ARCHITECT



THE COURTYARD, PALAZZO VECCHIO, FLORENCE

LIBRARY  
JUN 24 1919  
UNIVERSITY OF TORONTO

PUBLISHED WEDNESDAYS IN NEW YORK—FOUNDED 1876  
VOLUME CXV                      JUNE 18, 1919                      NUMBER 2269

Entered as second class matter January 6, 1909, at the Post Office at New York, N. Y., under the Act of March 3, 1879. Publication office, 243 West Thirty-ninth Street, New York, N. Y. Subscription price in the United States and Possessions, \$10.



## Insuring-

*Bishopric Stucco Board used on this residence.*

*F. M. D. Watkins  
Binghamton, N. Y.  
Owner*

*Geo. H. Bakeslee  
Binghamton, N. Y.  
Architect and  
Contractor*

# Making sure the Stucco Walls will Hold and remain Crackless and Beautiful

This Binghamton, N. Y., home is shown, in the top picture, ready for Stuccoing. See those spaces between the wood strips of the Bishopric Stucco and Plaster Board? They are the dovetail keys which imprison the Stucco. Once Stucco is applied, it is locked rigid forever by these thousands of keys.

Note how the joints of the Board are broken every few feet. This strengthens the purchase of the keys by distributing the strain of the Stucco. The walls cannot sag or crack anywhere because they are completely unified.

## Insured!

**B**ISHOPRIC BOARD was nailed so securely to this building that the weight of the average Stucco wall—10 to 15 pounds per surface foot, could not possibly budge a single wood strip. Bishopric Board's resistance to deformation in the plane of the wall is extraordinary. No other Stucco base can be nailed so securely.

The beauty of this Binghamton home is insured for its life. The Stucco will always be smooth and fresh looking. Repairs will never be necessary.

Bishopric Board is the background that prevents cracking of Stucco. It insulates perfectly. It also completely sound-deadens the home. It is the most economical Stucco base and gives the Architect and Builder an opportunity to provide special conveniences with the savings made. One-third less plaster is required on account of the dovetail grooves. There is no waste—1,000 sq. ft. covers 1,000 sq. ft. of surface.

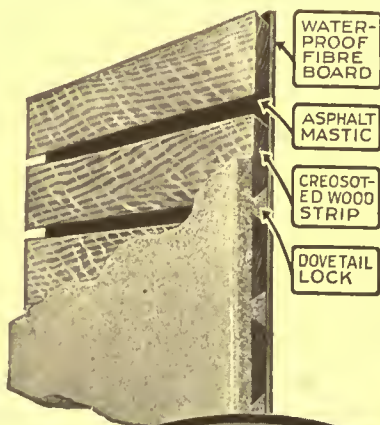

WATER-PROOF FIBRE BOARD

ASPHALT MASTIC

CREOSOTED WOOD STRIP

DOVETAIL LOCK

Bishopric Board is a combination of materials and principles that have been in constant and successful use for ages. It is protected in every way against the ravages of time and atmospheric change. It keeps the home always dry.

In interior use it saves plaster, time and labor, insulating against heat and cold and deadening sound to a remarkable degree. Bishopric Sheathing, our new product, saves 30 per cent as compared with  $\frac{7}{8}$  wood Sheathing and makes a solid, compact wall.



Architects and Builders: Send for Booklet which tells your clients all about Bishopric Board. It contains the perfect stucco mixture; reports of tests; and endorsements by Engineers, Architects and Builders.

THE BISHOPRIC MFG. COMPANY

904 Este Avenue



Cincinnati, Ohio



NO romance of the Oriental poets, no tale of the ancient genii (who by their wizardry constructed, between dusk and daylight, a city of palaces and mosques, guarded by crenelated battlements), is more thrilling than the evolution of the World of Architecture.

This *World*, unfolding between the dawn and noonday of human history, found Man living in apertures of the rocks, sharing his bedroom with the reptiles and the moles. Today (thanks to Architecture) he can live in a palace of exquisite workmanship, of beautiful design within and without, fitting itself to his every wish and convenience, his floors, ceilings and walls jointed and cemented with such skill that vermin of the earth, moisture of the clouds and draft of the elements cannot possibly enter.

The genii of Electricity and Steam are his servitors, close at hand, to light his house with artificial sunlight and warm it with artificial sunheat, to fan him through the long hours of the stifling summer night, to carry him in their arms up and down to the many levels of his home or work place.

Since Architecture first took up its tools, it has bridged the river with log and boulder and beam of steel. It has dug deep down in the living rock, and laid its everlasting foundations; it has climbed far toward the sky, until the clouds have slid along its topmost cornices.

It has taught Man the beauty of symmetry, and filled his life with untold comfort.

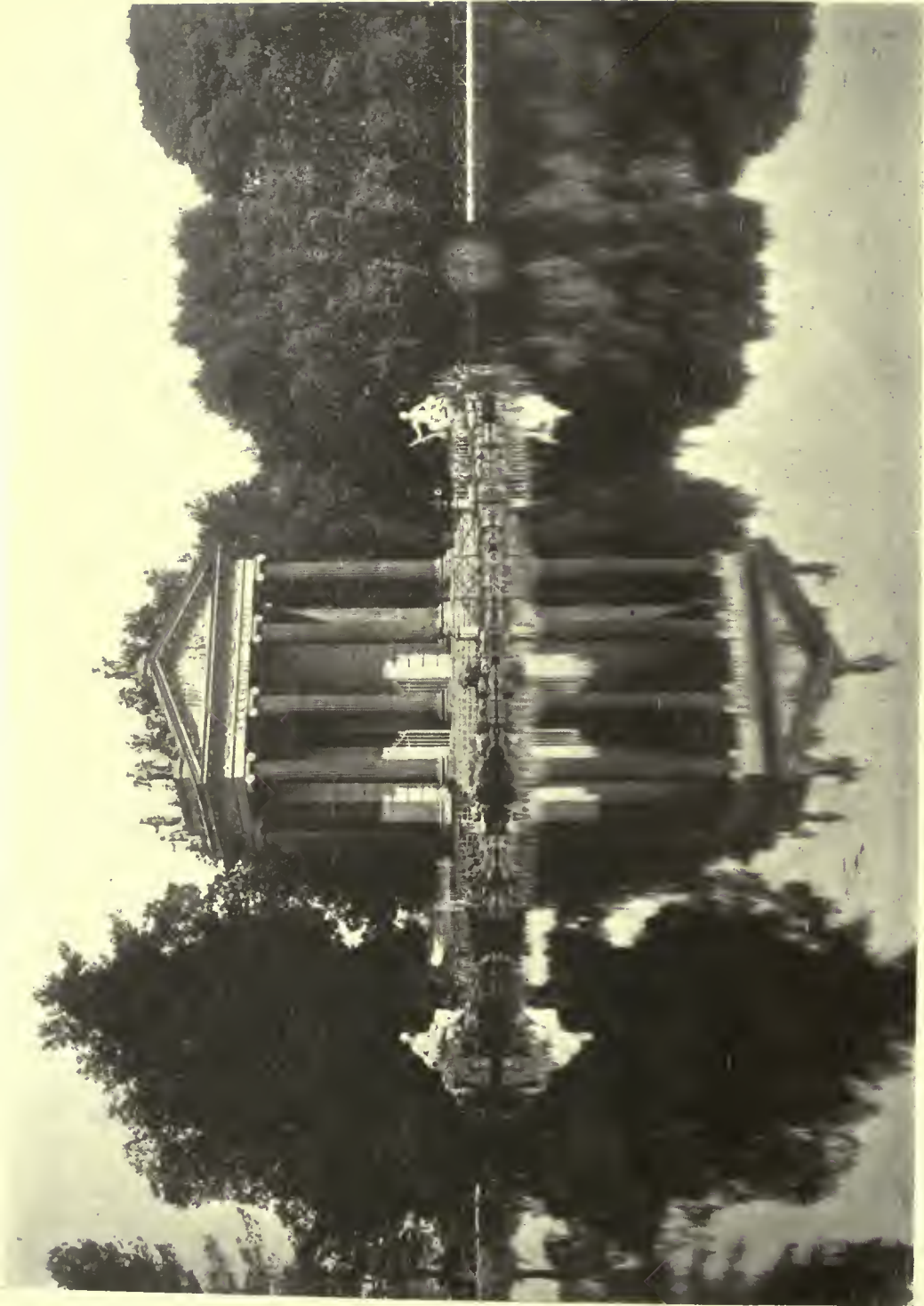

TEMPLE, ON LAKE OF VILLA BORGHESE, ROME

THE AMERICAN ARCHITECT



# THE AMERICAN ARCHITECT

837

VOL. CXV

WEDNESDAY, JUNE 18, 1919

NUMBER 2269



WEST FAÇADE OF CASINO. FROM DESIGNS OF VASANZIO

## The Villa Borghese

By JOY WHEELER DOW

Illustrated by Photographs by the Author.

“**A** GRACE of winter breathing like the Spring:  
Solitude, Silence, the thin whispering  
Of water in the fountains, all that day  
Talk with the leaves; the winds, gentle as they,  
Rustle the silken garments of their speech  
Rarely, for they keep silence, each by each,  
The dim green silence of the dreaming trees,  
Cyprus and pine and the cloaked ilexes,  
That winter never chills; and all these keep  
A sweet and grave and unawakening sleep,  
Reticent of its dreams, but hearing all  
The babble of the fountains as they fall,  
Chattering bright and irresponsible words  
As in a baby-speech of liquid birds.”

—Arthur Symons in *Harper's Magazine*.

Mr. Symons' poetry correctly visualizes the attitude of mind in which good society expects you to approach the awe-inspiring subject of the Roman

villas of the Renaissance, of which the Villa Borghese is a noted example. I pray you not to sigh, not to weep for my iconoclastic spirit when I say: "Now I will tell you about the Villa Borghese labeled as pieces of broken china on the bargain counters of department stores are labeled—'as is.'"

First, let us see if we know what a Roman villa of the Italian Renaissance was, what it represented, and for what it stood. It was not a palace. It was not a place of residence. It was not a dwelling—it was not a home. It was not a park for the people, nor a museum, nor an advertising medium of building materials, nor a public place of amusement for the encouragement of art, music or the drama. Indeed, we have nothing amid all our



INNER GATEWAY LEADING TO CASINO TERRACE

modern and varied requirements that would call for the offices of such an egregious proposition as one of these Roman villas in its pristine magnificence.

In the days of Imperial Rome and the Republic, although not exactly exemplifying the Anglo-Saxon idea of home, the villa was an essential part of the social fabric, and stood for the equivalent of a modern gentleman's country seat; whereas, for the anomalous villa of the Renaissance, perhaps as comprehensive a definition as any, would be to call it a private playground de luxe for adult members of the pontifical families as well as for the dead-game sports themselves.

If Germany had won the war, and the Junkers had desired to commemorate the triumph of Prussian organization, they could have found no more fitting monument to erect than a Roman villa: For as a monument to the splendid organization of the church of the Renaissance period, its business acumen and material achievement in corralling and harnessing people, to produce income, I can conceive of no means of expression to equal such an amazing conception of outlay without conscience, without use, without benefit—except to spend burdensome income and discourage avarice—than one of these villas belonging, ostensibly, to the nephew of some opulent pontiff or cardinal-prince.

When the altars of the churches would hold no more sacrificial jewels, when no more baroque enrichment could be superimposed upon the interior walls, and the glass cabinets containing the tawdry gold and silver trinket offerings of the poorer parishioners would no longer contain them—when the urban palaces of the clergy had room for no more sacrifices, there had to be some way to take care of the overflow.

The Borghese family already possessed numerous estates, palaces and suburban villas, more than they could possibly use; but Pius V was in the habit of tipping his relatives handsomely—his nephew, Cardinal Scipio Borghese, in particular. Between them, they conceived the idea of a far more extensive villa for the Pincio than any hitherto erected in this favorite section of Rome. Hence, in 1615, Vasanzio was employed to design the casino of the present Villa Borghese, and doubtless the interesting and extremely “busy” dependencies where the same introduction of plastic art in combination with sculptured detail is carried out—a fashion said to have

been set by the neighboring beautiful Villa Medici, which stands on the steep side of the hill overlooking the “eternal city,” with St. Peter's in the distance. The Villa Borghese has no view from the sites chosen for its architectural exhibits which are inclosed in a vast park. Although nominally belonging to the environs of Rome the villa is as much a part of the city proper as Prospect Park is a part of Brooklyn. It comprises an irregular reservation less in area but with boundaries that give to it a marked resemblance particularly so if we pretend the Via Porta Pinciana to be Flatbush Avenue, running along the north side of the park rather than the south, and what would happen if the park commissioners neglected the upkeep of the public's property for a number of years.

Take, then, Prospect Park, allow the turf to remain unclipped, let it become parched and dead, let the walks become dirt walks with undefined borders, widening and encroaching upon sections of the map where turf formerly grew, turn the leaves



EAST FACADE OF THE CASINO



## THE AMERICAN ARCHITECT

of the trees into rusty-brown leaves, such as we see on the trees of certain of our Western cities in the autumn. affected, they tell me, by the fumes and smoke from bituminous coal, litter the park

demude the aviaries of birds, the conservatories of plants, the dairy, restaurants and pavilions of tenants and guests, dismantle the casino of everything but cold statuary too heavy to be easily moved and



GATEWAY IN THE WALL, VIA PORTA PINCIANA, VILLA BORGHESE, ROME

with empty pasteboard boxes and the paper wrappings of picnic luncheons, discharge the attendants in uniform, substituting a few peripatetic laborers in overalls, remove the pleasure craft from the lake,

some venerable pictures on the second floor, restoring the exterior to a semblance of cleanliness by an application of white lead, let the annual and perennial flowers go to seed, let the parterres, the ter-

## THE AMERICAN ARCHITECT

paces, the ramps, porticos and exedras fall into a state of semi-decay, dust the whole place with a fine, brown powder, infuse into the atmosphere a palpable haze, not the saintly aureola I was talking about in my essay on the "Dramatic Note" (see THE AMERICAN ARCHITECT for October 9), but a haze of indescribable *tristesse*—a miasmatic haze rising from the Campagna over the escarpment of the Pincio, add the varied assortment of smells incident only to an Italian city, conceive all this—all these, if you can, and—that's the Villa Borghese, or as it was a few years ago, and I do not believe it has materially changed.

It may be only gossip that—

"——— unmerciful disaster  
Followed fast and followed faster"

—in recent times, with Prince Borghese, and that he saw his only way out by turning his villa over to the tender mercies of the municipality, which has changed its name to the Villa Umberto Primo; but this is what has occurred, and while the mercies of the municipality are sufficiently tender, its exchequer is low. Even at Versailles, available appropriations of the French Republic do not suffice to restore and keep the chateau, its prodigious landscape gardening and vast environs in Prospect Park order, while the waste of water necessary to play the grand fountains is considered, by the standard of economy introduced since the great

war began, to be sinful prodigality. One cannot read in the engaging "Letters of Mme. de Sevigné" that Louis XIV would not heed the number of lives he sacrificed to start a piece of work which all our modern wealth and resources shrink from attempting to complete, without wondering if these



THE AVIARY—CASINO FACADE

white elephants, for whatever charitable capacity they are destined ultimately can ever indemnify for the appalling attrition in flesh and blood they have cost. As far as educational purposes are concerned, the architecture of the Villa Borghese, which is as representative as any, does not supply



STEPPED RAIL, WITH SEATS



## THE AMERICAN ARCHITECT



VISTA OF THE PARTERRES

us with a great deal of inspiration. It is in the domain of the formal garden that the Italian villa comes into its own, has its enduring claim upon posterity, serving as it does for the universal model. The gardens of the Villas Lante and d'Este are finer and more elaborate gardens than those of the Villa Borghese, but at the expense again of

the architectural development, which is arrested and uninteresting.

The Italian school of architecture is incomplete. It has a defective grammar. One important part of speech is missing. There is no roof, i. e., no roof rising above the dignity of the lid to a cabinet, though the roof of a building has always been con-



THE AVIARY—LOOKING TOWARD CASINO



ARCHITECTURAL TREATMENT OF APERTURES  
IN BOUNDARY WALL

sidered the determining factor in architectural design. After concerning itself assiduously with the walls of a villa, the Italian school leaves the student to roof them any old way. It was funny and clever when John Drew told Kitty Cheatham to *exit* any old way, in Sheridan's "Rehearsing a Tragedy," for her to improve the opportunity, as a ballet dancer, and throw kisses to the audience; but in architectural practice that won't do. For educational purposes, our neglected American Renaissance in wood has a far greater value than have the villas of Rome. The Colonial houses did have roofs—academic roofs, splendid roofs, and in great variety.

Owing to the rigor of our winters, we may not avail ourselves of the possibilities of plastic art, of which the Villa Borghese is full of suggestion. The climate of Italy is kindness itself to all architectural detail, even to that executed in plaster. How all that wedding-cake frosting could have remained intact on the façade of the aviary facing the casino all these years is incomprehensible. Indeed, I should not dare to guarantee the travertine facing of the churches of Rome, so new looking and well preserved, if transplanted in America. I fear its destination would be so many heaps of spalls, the same that awaited the Egyptian obelisk in Central Park before it was processed with wax.

Among the architectural exhibits of the Villa Borghese—and there are many not illustrated—not the least interesting and admirable are the gates inserted in the city wall. They are the real stuff—beautifully carved stonework without a suspicion of ignoble stuff with wisps of cocoanut fiber visible under the abrasions. The formidable gates one meets everywhere in Italy are curiosities. What danger do they avert? There is nothing to steal within this park, nothing to eat, no flowers to gather, little danger of injury to anything; yet these gates are opened and closed at certain hours of the day, as though they guarded the crown jewels of Italy. Note, also, the cage-like window grilles that disfigure the casino. I don't know anybody who wants to break into the Villa Borghese, and I see no reason for aimlessly detaining those who want to get out. The only tenable hypothesis for the custom is that the gates are a relic of feudal times to which the Italians tenaciously cling. But in spite of grilles, gates and high walls, the Villa Borghese, like the king's chamber in the Great



VASE AND GARDEN GOD ON CASINO TERRACE



Pyramid, appears to have been thoroughly looted long before our visit. Nothing is left for us but memories.

This paper, I hope, will be read as analytically as it has been written, and that people will see the Villa Borghese through their own horn spectacles rather than mine. After some people have read something, the art, power or magnetism of the author, we may visibly note, has produced a mildly hypnotic spell. Let us say that it is all three together. Now, I am going to preclude any possibility of that here by one

wave of the disenchanter's wand, when I say I have no desire to Rasputin anyone. And this is saying nothing of certain dependent natures who can accomplish nothing, scarcely exist, in fact, without a Rasputin or two hanging about. Necessary as it may be to them, I am an honest guy, and have an innate horror of all that sort of thing. "Behold, there is a woman that hath a familiar spirit at Endor," and

they may consult her. For herein is the inception of the wrong kind of organization which, at its culmination point, permitted the political machine of Germany to make war upon the world. It is the kind of organization that leads to the vanishing point, the sovereign rights of the individual, of that "elder day" before the Renaissance, "when to be a Roman was greater than to be a king."



ENTRANCE, VILLA BORGHESE, ROME



# Our Army Educational Commission

## Its Admirable Work in Europe Described by an Architectural Student

Mr. James N. Holden, who writes the following article describing the work of the Army Educational Commission in Toulouse, is the 34th holder of the Rotch Travelling Scholarship. The prize was awarded to him in 1917, but on account of war conditions he was advised not to go abroad. He enlisted in war work with the 33rd Engineers, going to France in 1918. He is a young man of promise and displayed a high degree of ability on the work he did in connection with the work of the Scholarship. His judgment of the conditions at Toulouse, therefore, have more weight than if he had not won the position which he now holds. He is not even now officially on the Scholarship, but is simply profiting by his experience abroad, availing himself of this most extraordinary opportunity which has come to so many of the A. E. F. The educational value of an experience of this kind cannot be too strongly emphasized. It is exactly the sort of training that will make a young man appreciate the real significance of art and architecture, quite aside from the value of the training for general cultural purposes; and our soldier boys who are able to avail themselves of this training are certainly to be envied, while the opportunity to have an intimate acquaintance with French home life is something that few architectural students are ever able to accomplish. This is one of the compensations for the terrible war through which we have passed.—

*The Editors, The American Architect.*

THE period since the signing of the armistice has been somewhat tedious to most members of the American Expeditionary Force, particularly to those whose organizations had apparently but a remote chance of a return to the U. S. in the near future. Along in February when perhaps the "demobilization fever" was most acute among us, the Army Educational Commission announced that enlisted men and officers having the proper qualifications and desiring to attend foreign universities, would be granted this rare privilege. Thousands of Uncle Sam's soldiers quickly grasped this opportunity, with the result that the famous old university buildings of France, deserted for four long years, are once more echoing to the tread of student footsteps; students clothed in khaki and speaking a tongue quite different than these sacred halls formerly knew.

From the beginning the main objective of the Army Educational Commission was to offer the American college man of the A. E. F. the advantages of useful study of subjects particularly interesting to himself while he awaited the necessarily slow process of his return, also a more intimate association with the better class of French society and thereby cultivating the mutual under-

standing of two great peoples; a very worthy motive in this day of the young League of Nations.

This program adapted itself particularly to the soldier who had left the classroom for the army; for the graduate desiring further study and research in the many admirable courses offered by French institutions; and for the ambitious soldier-student possessing an equivalent of 2 years' academic work and the will to take advantage of all opportunities of self-improvement. The requirements of 2 years' college credits, or an equivalent, brought forth many applications from the A. E. F., which after all is nothing but the best of American manhood transported to another clime. Scarcely daring to hope that our individual appointments would materialize, we anxiously awaited the good word that would spell *fini* to army life, temporarily, at least, and a return to the pursuit of knowledge in more congenial surroundings.

Events transpired quickly, for the Army Educational Commission was in earnest, and one bright day shortly after, the fortunate ones received the glad tidings to "report with the least delay" at the designated universities. As if we could delay in the face of Dame Fortune! It was the sweetest military command we had ever heard.

The University of Paris claimed 5 men from my company, Edinburgh 2 and Glasgow 1. Three, including myself, journeyed to the fine old University of Toulouse, situated in southern France within a short train ride of the Spanish frontier. Arriving at the *gare* one sunny morning, loaded with the usual packs, barrack bags and equipment, we were directed to proceed to the outskirts of the city. Making our way along through the curious stares of the populace (many gazing for the first time on American soldiers), we finally arrived at the quarters reserved for us, formerly an industrial settlement and once occupied by the workers of the adjoining powder mills. The *poudrière* was easily adapted as dormitories, dining and recreation halls for the welfare of the new student colony and its many adjuncts.

The city of Toulouse itself is famed from time immemorial as a center of the best art, learning and culture of France. Situated on the River Garonne some 31 miles from the Pyrenees Mountains, it has ever been the mecca for the student, and is second only to Paris as a great intellectual power. With its charming architecture, mostly of the Roman-



## THE AMERICAN ARCHITECT

esque period, its interesting museums, grand opera, theaters and innumerable attractions, one could scarcely find more ideal conditions for profitable study. Because of its many brick structures and Spanish tile roofs, it is commonly known as the "Rose City," a particularly appropriate name, as all will agree who have ever been fortunate enough to enjoy the charms of this southern French town. War and bloodshed seemed part of another world in this peaceful, academic corner of "La Belle France." All were quite content with the Army Educational Commission's judgment in selecting Toulouse as our special field of endeavor for the coming four months.

Several days elapsed before the complete quota of 1500 men had arrived. In the meantime general lectures were outlined, all men organized into companies and platoons which corresponded to the lecture groups and French language classes, and the educational program at Toulouse made its beginning. A formal reception at the *église de Jacobins* was accorded the new student body by the Mayor and other prominent public officials and a large representation of the civilian population.

The general policy for the first month was to concentrate on the study of the French language as a preliminary to later specialized lecture courses delivered by eminent French professors. This was supplemented by intensive classroom exercises in the practical French conversation. Naturally ear training was the essential thing, as a majority of the students had had a previous academic training in the construction of the language. Building upon this foundation, rapid progress was soon made.

At the time of our arrival, city homes were crowded with many refugees from the devastated regions of northern France and by the billeting of large numbers of French soldiers. This had necessitated our temporary quartering at "La Poudrière," but eventually as rooms were vacated by departing refugees and soldiers, we moved by groups into the city. Thus by our residence with French households, one of the principal objects of the Army Educational Commission was accomplished. The advantages are quite obvious, for what better method could be devised for acquiring a knowledge of the language, customs and life of a people than by this intimate contact?

The authorities required each student to present a personal invitation from a French friend to reside *en famille*. This regulation was easily complied with, for the attitude of the Toulousians had been one of cordial welcome. Undoubtedly the great similarity in many ways of the American and French temperament made the process of creating friends an easy one, and this, coupled with the

Frenchman's warm desire to show hospitality and render aid to Uncle Sam's soldiers resulted in quick friendships on both sides. The better class of French were easily approachable under the peculiar conditions existing, and valuable friendships were formed of mutual benefit to both parties concerned. Obviously the type of American represented at the universities was the sort readily to adjust himself to the circumstances of the moment.

In a few brief weeks 1500 Americans had been absorbed in the local society and activities of one of France's foremost municipalities and the mutual knowledge acquired aided materially in promoting to a higher degree the ancient friendship of France and America. We proved that Americans were not "savages" at all and also learned in return that there is something more to French life and character besides the café. If one has never been privileged to be the recipient of French hospitality and friendship, he has surely missed one of life's charms. Our fellows have been made to feel as though they were an actual part of the family household, and home never seemed quite so close as now. The French "maman" can always find place in her family for another son, and many are the motherly things she can find the time to attend to.

Within a month after our arrival in Toulouse many organizations sprang into existence, representing army divisions, American universities, fraternities, etc. The Americans enrolled at the various faculties formed clubs and societies for the promotion of social relations between themselves and the French students. A debating, economic and law society was created, athletic programs planned and gotten under way. Even a Toulouse Ministerial Association was formed. Musical organizations made their appearance, orchestras, glee clubs, quartets, etc., and a genuine musical comedy of, by and for the student body was undergoing rehearsal. This play was written entirely by the men at the University and is original throughout, both as to words and music. Three weeks after the first students had arrived, the University paper, published weekly by the American students, made its initial appearance. This was record time and it holds the distinction of being the pioneer of its kind in France, just beating out several others by a few days. Up-to-date and strictly American from its front page headlines to its editorials, sporting page and cartoons, it serves as a medium of exchange in ideas between our French friends and ourselves.

Of particular interest to the architectural profession and artists is an account of the conditions existing at the *École des Beaux Arts* of Toulouse

## THE AMERICAN ARCHITECT

as we found them. In the first place the building had been serving as a war hospital and was still used as such with the exception of a small portion occupied by the few meagre classes of the young Frenchmen. During the war the school's alumni had suffered a loss of 1000 killed on the field of honor, besides the greater number of maimed and wounded. In happier years the students of all courses totalled about 700, but the terrible toll of the war had reduced this number to a mere handful. Of course many students are still retained with the Army of Occupation, but nevertheless the institution has suffered a severe blow.

So naturally the American students of Architecture and Art found a dead state of affairs when negotiations began for formulating the courses desired. Considerable official manoeuvring was undertaken with faculty and city officials and even the Mayor himself, for the École is a municipal institution and not connected with the University. After satisfactory agreements had been reached regarding tuition, etc., we pitched in with true American spirit and soon had the classrooms and drafting rooms assigned for our use, looking as they formerly did before the Hun became obnoxious. About a week after our first negotiations, the old building had taken on a rejuvenated appearance and classes held forth once more there. With admirable professors and a fine equipment what wonder that we thought ourselves thrice blessed for all this good fortune. The outstanding figure among the professors is Capt. Bonamy of the French Artillery, professor of architectural design. His ability is not limited to architecture, however, for his three crosses of honor testify to his soldierly qualities also. It will be of interest, I believe, to make note of those neighbors whom we have here in Toulouse in our particular case and which is more or less typical of the whole city.

Any American's heart would be touched to observe these poor unfortunates who bore the brunt of the Hun's hate in their home towns of northern France.

In our house there is a family from the town of Luneville and their stories of the Hun invasion with its deadly dangers cause an American to appreciate fully what these brave people have borne, and thank the Lord that America was spared this phase of warfare. In spite of their dark days of the recent past, these refugees are decidedly cheerful and live down their misfortunes in the characteristic French manner.

Certainly after our few months' sojourn in Toulouse and our intimate contact with France and her remarkably courageous people who have so nobly endured the greatest calamity ever to fall upon a nation, we shall carry back to America a valuable experience which should ever remain a source of inspiration and emulation to us in the life of our own country. This most unique experience through which we are passing has well served its purpose, and should prove a potent factor in the coming years for cementing the bonds of friendship between France and the United States of America.

The basis of all friendship is mutual understanding, and undoubtedly that is being established on a far higher plane by the many thousands of Uncle Sam's soldier-students scattered in universities throughout the length and breadth of France. May this interchange of knowledge, experience and friendship develop on a more permanent basis by the intermingling of students of both France and America in the great universities of both lands, so that the cause of international sympathy, co-operation and unity will become an accomplished fact.

JAMES N. HOLDEN,  
Co. "A," 3rd Platoon,  
University of Toulouse, France.





## National Victory Memorial Building, Washington, D. C.

TRACY & SWARTWOUT, *Architects*

**W**ITH initial subscriptions of approximately one million dollars already in hand, it is now proposed to inaugurate a nation-wide drive in an effort to raise by popular subscription an additional nine million to carry to completion the National Victory Memorial Building in Washington.

While this important structure will have a very large sentimental appeal to every American, it will combine with this sentimental aspect and its very excellent architectural design, a building of great practical worth. It will contain a convention hall seating more than 7000 people, a banquet hall with a capacity of 600, and various smaller halls for the

The fourth floor is entirely given over for office space for the various patriotic societies promoting the general welfare of the country.

The George Washington Memorial Association, of which Mrs. Henry F. Dimock is president, has pledged its support to this project, and Mrs. Dimock has announced that she has received assurances that the nine million dollars necessary to complete the funds will be promptly received. Explaining just exactly the purpose that this building is undoubtedly to serve, Mrs. Dimock has stated:

"We want the National Victory Memorial Building to be typical of the spirit that won the War of the Revolution and that won our World War. We want to have it written in the pages of American history that this building was put up by and for all the people of the United States. I should like to have school children subscribe pennies, young



use of patriotic organizations, and it will serve as the center for all nation-wide gatherings.

The site for this memorial building has already been selected. It will be erected on ground granted to the George Washington Memorial Association by Congress. This land comprises the north end of the reservation on the Mall between Sixth and Seventh Street, where temporary buildings of the war department are now located.

An interesting architectural feature of the building will be the acoustical dome which, it is said, will be three times the diameter of the dome of St. Peter's in Rome. The plan provides space for the establishment of museums and rooms for the safe-keeping of the archives and relics of the nation's wars. These are located on the ground floor. The national banquet hall and rooms for permanent national headquarters for military organizations are located on the second floor, while the rooms assigned to the various States are on the third floor.

people in colleges, dimes and quarters, and I should like to see the grown-ups give just what they can afford. And in the National Victory Memorial Building there will be a record containing the name and address of every subscriber to the National Victory Memorial Fund. Thus we will have a building unique in American history—a structure that typifies the 'one for all and all for one' spirit of our Republic.

"We realize that a great deal of work is ahead of us in raising the funds for this structure along the lines that we have laid down, in building it, and in maintaining it as a monument to our soldiers, sailors and marines.

"I desire to give a warning to the public that any person who solicits funds for the National Victory Memorial Building and is unable to present credentials from the George Washington Memorial Association is an impostor and should be dealt with accordingly."

# Entrance to the Tod Homestead Cemetery, Youngstown, Ohio

J. A. SCHWEINFURTH, *Architect*

(For additional illustrations see plate section)

THE Tod Homestead Cemetery, now in process of development, is situated in the suburbs of the City of Youngstown, Ohio.

It comprises, first, the lands of the old Tod homestead, given by the late George Tod, a descendant of the original owner, the war-governor of Ohio, and, second, the Memorial Chapel connected with the entrance, given by other descendants, among them John Tod of Youngstown. It is proposed in the future to have a monument erected to the war-governor and his family and descend-

campanile about ninety feet high and twenty feet square. Conveniently located in the rear is a receiving vault. There are also wide loggias which so few cemetery entrances have, and which are so convenient in case of sudden storms. The buildings, drives, shelters, vault and chapel are so planned as to afford the most convenience for their intended uses, and are designed in a severe rendering of an early Italian style which might be called "Italian Gothic" of the Campagna, reminiscent of the earlier architecture of many an old hill town

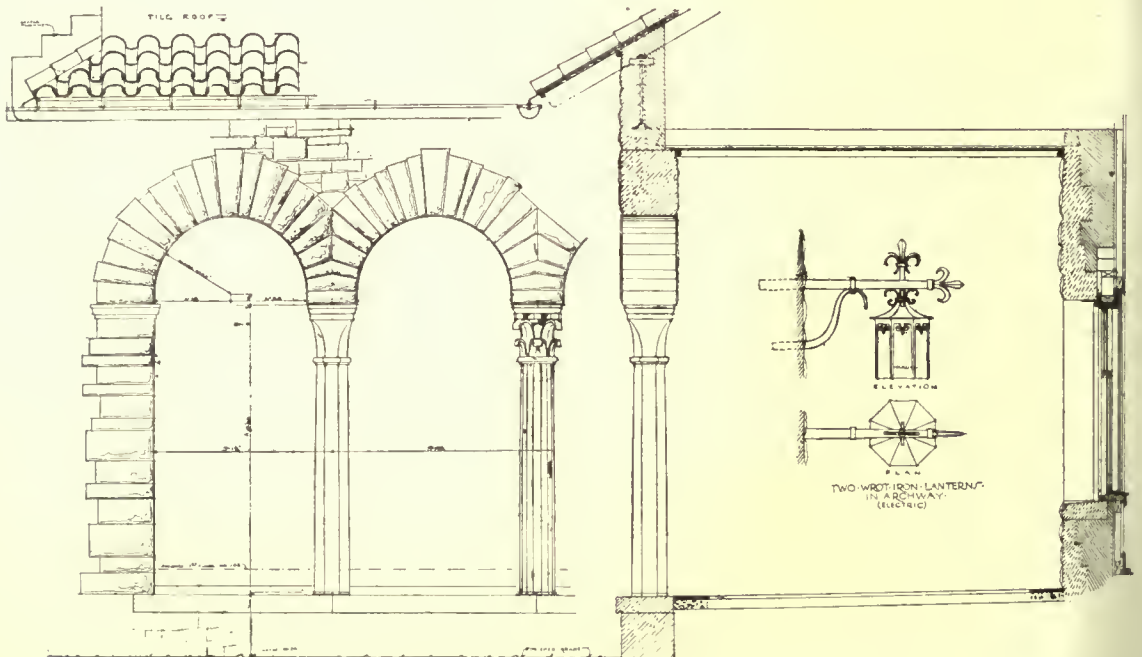

ELEVATION OF FRONT LOGGIA SECTION AND DETAILS

ants and this circumstance largely dictated the character of the design of the entrance. The principal feature of the design is a pointed arch of fifty feet span, and thirty-eight feet high, which is on the axis of the principal approach, at present a street nearly a quarter of a mile long, to be lengthened at some future time. Through this arch it is proposed to place the monument, to be seen thus framed in for a long distance. At the right of the arch, before one reaches the building, are the administrative offices of the cemetery, and, at the left, the memorial mortuary chapel with its

of Italy, and built of the local Ohio limestone with Indiana limestone trimmings. At one side of the arch is a sculptured figure representing "Death," and at the other a figure representing "Time," each ten feet high. From these two figures, running across the wall over the arch through which for a hundred years will pass the funeral cortege, is a scroll bearing these words from William Cullen Bryant's "Thanatopsis":

"The innumerable caravan, which moves  
To that mysterious realm \* \* \* \* \*



## THE AMERICAN ARCHITECT

A few scale drawings are presented, in order to show the character of the detail.

Built during the war, under the greatest difficulties, and consequently requiring nearly two years in its erection, where ordinarily eleven months

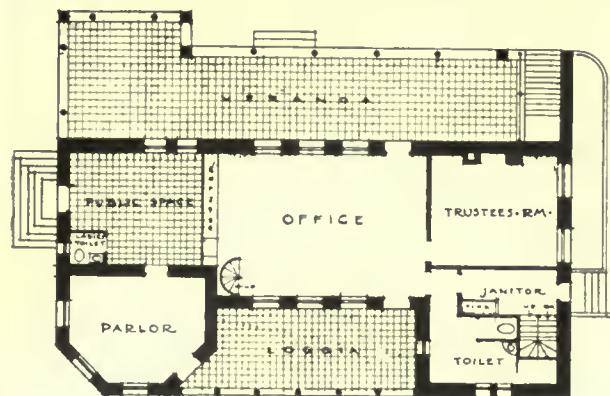

GROUND FLOOR PLAN

would be sufficient, the contractors, the W. B. McAllister Company of Cleveland, Ohio, are entitled to receive the "medal with palm" for most efficient and satisfactory service.

### Memorials of the War

The May issue of the *American Magazine of Art*, devoted entirely to the discussion of war memorials, is ably reviewed by the *Boston Transcript*, as being the official organ of the American Federation of Arts, which has just held its important annual meeting in New York. This issue, says the *Boston Transcript*, makes a most valuable contribution to the growing literature of this important subject, and provides a very timely and admirable mass of data relating to the best existing examples of memorial art.

Charles Moore, chairman of the American Federation of Arts, general committee on war memorials, and chairman of the National Commission of Fine Arts, thinks it may be doubted whether the time has come to express the ideas and ideals of the great war. It will require some years of consideration before we can make proper estimates—before the real artist can find his symbols. He feels certain that the great expression of national feeling will not be wrought for many a long year to come. What we may do today will be only temporary and tentative. He contends that the men and events worthy of commemoration will not suffer for waiting; they will not fail of recognition in due time. Mr. Moore quotes this excellent passage from a recent article by Cass Gilbert:

"The most impressive monument is one which appeals to the imagination alone, which rests not upon

its material use, but upon its idealism. From such a monument flows the impulse for great and heroic action, for devotion to duty and for love of country. The Arch of Triumph in Paris, the Washington Monument and the Lincoln Memorial are examples of such monuments. They are devoid of practical utility, but they minister to a much higher use; they compel contemplation of the great men and ideals which they commemorate; they elevate the thoughts of all beholders; they arouse and make effective the finest impulses of humanity. They are the visible symbols of the aspirations of the race. The spirit may be the same whether the monument is large or small; a little roadside shrine or cross, a village fountain, or a memorial tablet, speaks the same message as the majestic arch or shaft or temple, and both messages will be pure and fine and perhaps equally far-reaching if the form of that message is appealing and beautiful."

Summing up, Mr. Moore says that communities may express their ideals in any one of many ways, provided always that in whatever they do the memorial spirit prevails. The memorial spirit originates only in the mind of the artist. He is and must be the leader. No layman is fitted for leadership—if he were, he would not be a layman, but an artist. We shall have more indifferent memorials than great ones, because few artists rise into the realms of genius. But there is no reason to despair. If we can put an effectual ban on the stock soldier, the stock tablet, the stock anything, we shall take a long step forward. We can accomplish this result only by impressing on communities that each memorial shall be a separate, distinct creation of an artist. The simple, direct, conscienceful work of a trained mind and hand is always welcome, is always enduring. The great poets did not write all the poems that have found abiding places in the human heart."

In his article on "The Permanent Memorial," Arnold W. Brunner, chairman of the New York regional committee of the American Federation of Arts, takes the position that grandiose triumphal arches, over-pretentious architectural and sculptural compositions, typifying the victory of an army and navy, are not satisfactory memorials of a war fought on moral grounds. "To typify the splendid victory of force combined with the success of high ideals and a belief in universal and continuous peace, we naturally look for new forms and new methods of expression." Speaking of the kind of memorials which serve a practical purpose, Mr. Brunner says this is like giving one's wife a barrel of flour or a ton of coal for a Christmas present.

Frederick W. Macmonnies, the sculptor, points out some of the pitfalls to be avoided. Sentimen-

tality, for one, he thinks, "is apt to lead in the end to the angel in the cemetery." Monotony, another, produces literal figures of soldiers, "with not a button missing," the type that has become standardized and can be bought very reasonably from any firm of stone cutters.

### Plans for Greater Paris Are Forming

By authorizing the demolition of the wall of Paris and the cession of the site and the military zone outside the wall for city improvements, the French parliament has just removed the principal obstacle to a "Greater Paris." This is learned through the Associated Press. The city will thus obtain the room it needs, and one of the most remarkable parks in the world. With a width of 250 yards and a length of 25 miles, the park will completely surround the city, adding one more to the circular systems of improvements that have successively taken the place of disappearing walls since the time of Philippe Auguste, which show the growth of the city as rings mark that of the oak.

Americans revisiting the city ten years hence will come upon "Greater Paris" without knowing it if they look for the old landmarks. The rag-pickers' huts, truck gardens and piles of refuse that made the military zone look like "Shantytown" and gave arrivals the first warning of approach to the city will have disappeared to give place to the park. In place of the massive stone wall and deep moat in front of it that marked the city limits there will be another belt 140 yards wide and 21 miles long composed of buildings in the best French style built according to a general plan combining harmony with the most approved hygienic installations.

The demolition of the wall will release 1150 acres of ground, of which 300 acres will be taken up by new streets, boulevards, railroads and canals. The suppression of the military zone will make available 1,875 acres of space, of which 1,750 will be devoted to the new park, constituting a third of all the park area of the city. The rest of the space will be utilized for the erection of a permanent exposition building between the gates of Saint Cloud and Auteuil.

This improvement will involve the suppression of the sixty "gates" of Paris. New and wider thoroughfares will connect the city with the suburbs and, eventually, most of the immediately neighboring communes will be incorporated in the greater city.

### Architect Urges Advertising Need

Discussing the merits of the structural work of the large building company as contrasted with that of the architect, in an opinion submitted to the Post-War Committee on Architectural Practice of the American Institute of Architects, Elmer Grey, of Los Angeles, says:

"The product turned out by the building company method is not at all the same as that turned out by capable architects. Much of the public, however, does not know the difference—and here is where advertising should come in.

"The rates the building companies charge are no lower than those which high priced architects charge, only they are so camouflaged as to appear to be lower to those who do not investigate the matter thoroughly. The standard of work of the building companies is not high, however. Their business success depends upon the fact that at their heads in each instance, is a man who is a wizard at salesmanship. Theirs is a talking game.

"One of their heads, for example, recently spent an entire afternoon trying to get me to join his organization, and in order to do so he told me about his methods. It was illuminating! He was not an architect, not possessed of an architect's training or ability, yet he professed to be the intelligent creative genius and director of his designing department. The designers these companies usually employ are draftsmen of mediocre ability.

"If the building company plan were giving the public better service than the professional plan, it should survive and supplant it. I should then wish to join with a building company, and as I have said, I have had an opportunity. But it does not. The above experience is not the only one I have had with building companies. In another instance one of my clients who succumbed to the wiles of a building company salesman let him have their construction work on a percentage basis, and on a \$10,000 house her decision, against my advice cost her something over \$600. I had a bona fide bid for that much less amount from a reputable contractor.

"I believe from this and other experiences that the professional plan separated from the contractor is distinctly better for the owner than the building company plan—better not only from an æsthetic point of view, but also from a financial—and it is only advertising that will acquaint the public with the difference. I believe the war has taught us the value and the necessity of such propaganda."



## THE AMERICAN ARCHITECT

# THE AMERICAN ARCHITECT

Founded 1876

PUBLISHED EVERY WEDNESDAY BY

THE ARCHITECTURAL AND BUILDING  
PRESS, INC.

No. 243 West Thirty-ninth Street, New York

E. J. ROSENCRANS, PRESIDENT AND TREASURER  
WILLARD C. HOWE, VICE-PRESIDENT

WILLIAM H. CROCKER, Editor  
EDWARD F. HAMMEL, Engineering Editor  
ARTHUR T. NORTH, Western Editor

Subscriptions in the United States and Possessions,  
Mexico and Cuba, TEN DOLLARS. Other Countries,  
TWELVE DOLLARS.  
SINGLE COPIES (Regular Issue) 25 CENTS

CHICAGO OFFICE, Mallery Building  
PAGE A. ROBINSON, Western Manager  
ST. LOUIS OFFICE, Wright Building  
CLEVELAND OFFICE, Guardian Building  
SAN FRANCISCO OFFICE, 320 Market Street

Owned by United Publishers Corporation—H. M. Swetland, President;  
Charles G. Phillips, Vice-President; W. H. Taylor, Treasurer;  
A. C. Pearson, Secretary. Entered as second-class matter January  
6, 1909, at the Post Office at New York, New York, under the Act of  
March 3, 1879.

VOL. CXV

JUNE 18, 1919

No. 2269

### Plan Service by Institute Chapters

CAN there be any amicable relation between standardization and art? There is much diversity of opinion on this topic. Some will maintain, and with much reason, that while a single unit may be artistic to the highest degree, a combination of many similar units would be monotonous and therefore inartistic.

Buildings are first of all utilitarian. They are built for a certain use. While art should dominate design, it will not necessarily dominate all of the various elements that enter into the completed structure.

It is therefore possible to effect standardization and secure the economy that is the result, and at the same time insure the utmost in artistic refinement. This has been demonstrated many times in the industrial towns that have been erected by the Government at shipyards all over the country. These towns have been built up of houses of varying number of units, each different in design, but thoroughly standardized as to their dimensions and equipments.

FROM time to time there arise complaints among architects, because in some of the larger building industries and mail order stores, plans and specifications are offered at a merely

nominal price for small houses, and lately for dwellings up to ten thousand dollars in cost.

It is claimed that this is a direct invasion of the architects' proper field. Perhaps it is, but do architects show, until these conditions are pointed out, any great amount of interest to secure business of the isolated client who desires to build a low cost house? These plans and specifications are of the purely standardized type. They are sent broadcast all over the country. They are in some instances well designed and planned low cost houses.

If these building industries and the mail order stores should cease the publication and sale of these standardized plans, would the business then revert to architects? It is not believed that it would. The houses that would then be built by the class of people who buy and use these standardized plans would be handed over to local carpenters with the usual result. What that result would be we know. These United States are filled with this type of house, the greatest retardant to the architectural growth in design of the low cost house that has ever existed. Far better the standardized plan than such a house.

WHY is not this subject one that might seriously engage the attention of the American Institute of Architects?

If, for example, the lumber interests find that they can more easily sell a bill of lumber where they show its final use as assembled in a well planned standardized house of good design, why might not the Institute, through its Chapters, evolve types that would suit the various localities and place them at the disposal of the prospective interests and builders at a fair price?

The designing and planning of low cost houses would by this means be placed in the most competent hands and the artistic architectural development of our small towns secured beyond peradventure.

### A Wasted Opportunity Recovered

IN the issue of April 2, comment was made on a letter received from "An Architect Dough-boy," in which the writer deplored a wasted opportunity while in France. It was urged that it would be a wise thing on the part of the Government to afford members of the A. E. F., who had previous training as architects and engineers, a chance for travel and study before their return to this country and discharge from service.

It has been gratifying to know that since that time measures were taken by the army authorities to accomplish this very desirable purpose, and that

## THE AMERICAN ARCHITECT

a large number of men were assigned for certain periods to various colleges and universities in Europe for a course of technical training prior to their return to the United States.

Just how admirably this plan is working out is set forth in a communication received by the editors of *THE AMERICAN ARCHITECT* from an architectural student, one of the A. E. F., who has been assigned to a course of study at the University of Toulouse, France. This communication will be found in this issue.

**W**HO shall be able to compute the great influence that will be exerted upon the future of the professions of architecture and engineering by that group of more than fifteen thousand men, now detached from military service and distributed among the high seats of learning in Europe. A course of study, first a student period in this country, interrupted by the call to arms, then followed by intensive military training and later, by what might perhaps be designated as a post-graduate course in the universities of Europe, the very fountain head of knowledge in art, is filled with the greatest opportunities for progress.

Those who may reasonably expect to survive the next two decades will have occasion to watch the development of men who have had a course of education on such novel lines, while those who may not, can with the mystical lore that surrounds the sunset of life, predict the future greatness of men so thoroughly trained in their professions.

**I**T would have been a great pity, if from among the more than two million men who went overseas, there had been returned to this country the great number that had been before their enlistment trained in the arts and professions without first affording them an opportunity to apply by actual study and observations the principles of their early training.

France and Italy, the meccas of every architectural student, were at last reached by these men. But there was up to a certain time the tantalizing situation of close proximity to places that men had hoped for years to see and that then, owing to the rigor of military discipline they were unable to visit.

Many instances have been reported where whole regiments of men have been closely confined to the trains on which they were by slow stages being carried to the port of embarkation with no opportunity for sightseeing in Paris or other equally interesting European cities.

**O**UR Revolutionary and Civil Wars, having this country for their field of action, created large areas of historical interest, and left to the care of an appreciative posterity many buildings of historical association. These constant reminders of conflicts in which our forefathers took an active part, are incentives to patriotism and good citizenship. In the Spanish War and the World War just approaching its end, however, our battles were fought on a foreign soil. There will not be for future generations any hallowed localities in this country which will mark the spot of victorious action. All we shall have will be pictorial and written histories and the recitals of those who actively engaged in our Army and Navy. In fact, so closely has our participation in this great struggle been interwoven with that of our allies that in most important engagements the individuality of our encounter is merged by our men having been billeted with the troops of other nations.

**T**HE great opportunity, and the greatest measure of good to this country will be found in the chance for education that will have come to every man, exclusive of rank, who has served abroad. This great educational service will have a direct influence on every community, large or small, that has sent men overseas. Aside from the fine influence of military training, there is the broad education that comes from travel. Whether the man comes from the mountain fastnesses of our Southern or Western States, or out of the hearts of our larger cities, he will return broadened and with largely increased value as a citizen. It is in this that we shall probably reap the greatest advantage from our participation in this war, and it will serve as perhaps no extent of local tradition would, to implant in the minds of coming generations a respect for this country and the men who so ably represented it.





PLATE 195

FRONT VIEW

ENTRANCE TO TOD HOMESTEAD CEMETERY, YOUNGSTOWN, O.

J. A. SCHWEINFURTH, ARCHITECT





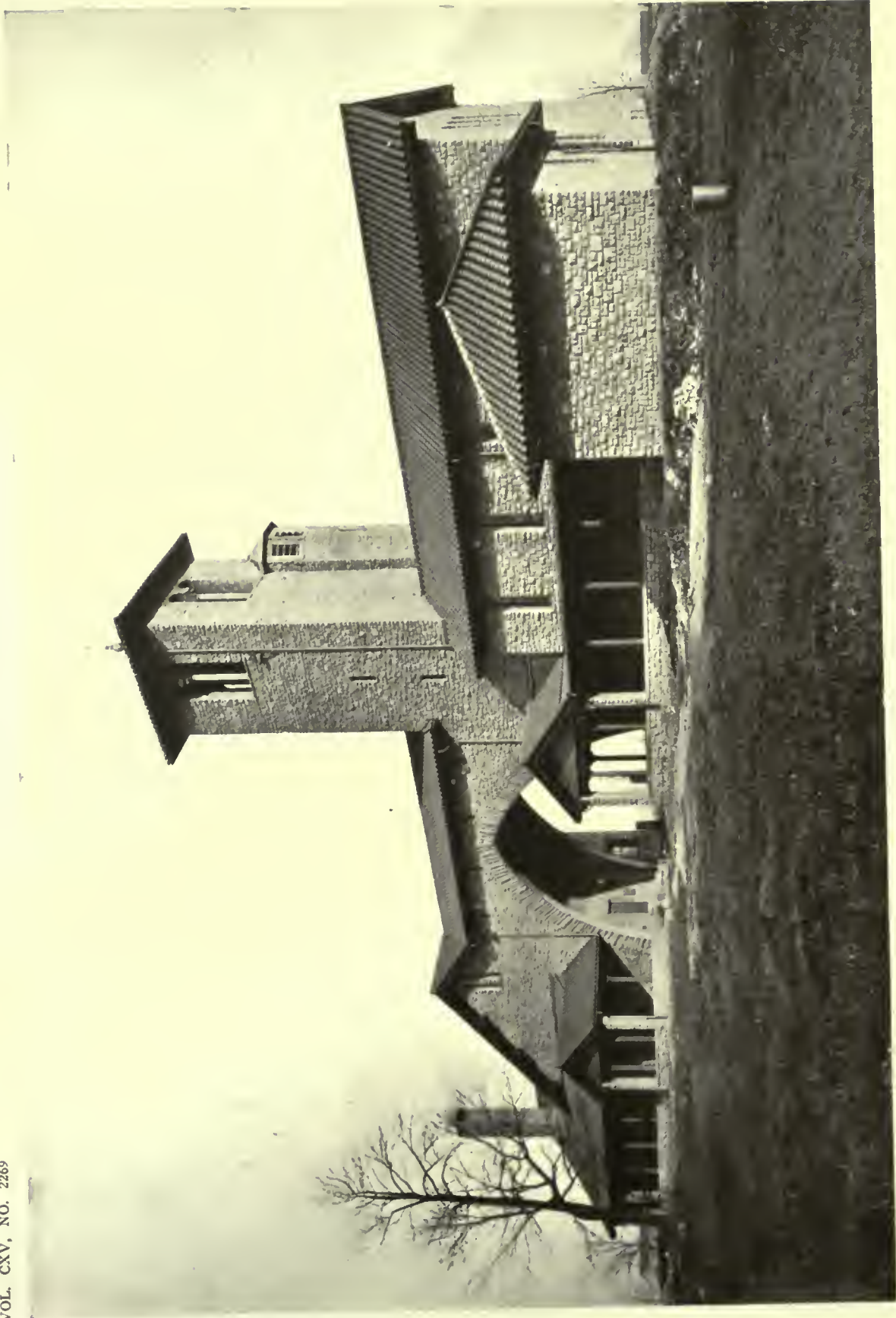

REAR VIEW

PLATE 196

ENTRANCE TO TOD HOMESTEAD CEMETERY, YOUNGSTOWN, O.

J. A. SCHWEINFURTH, ARCHITECT





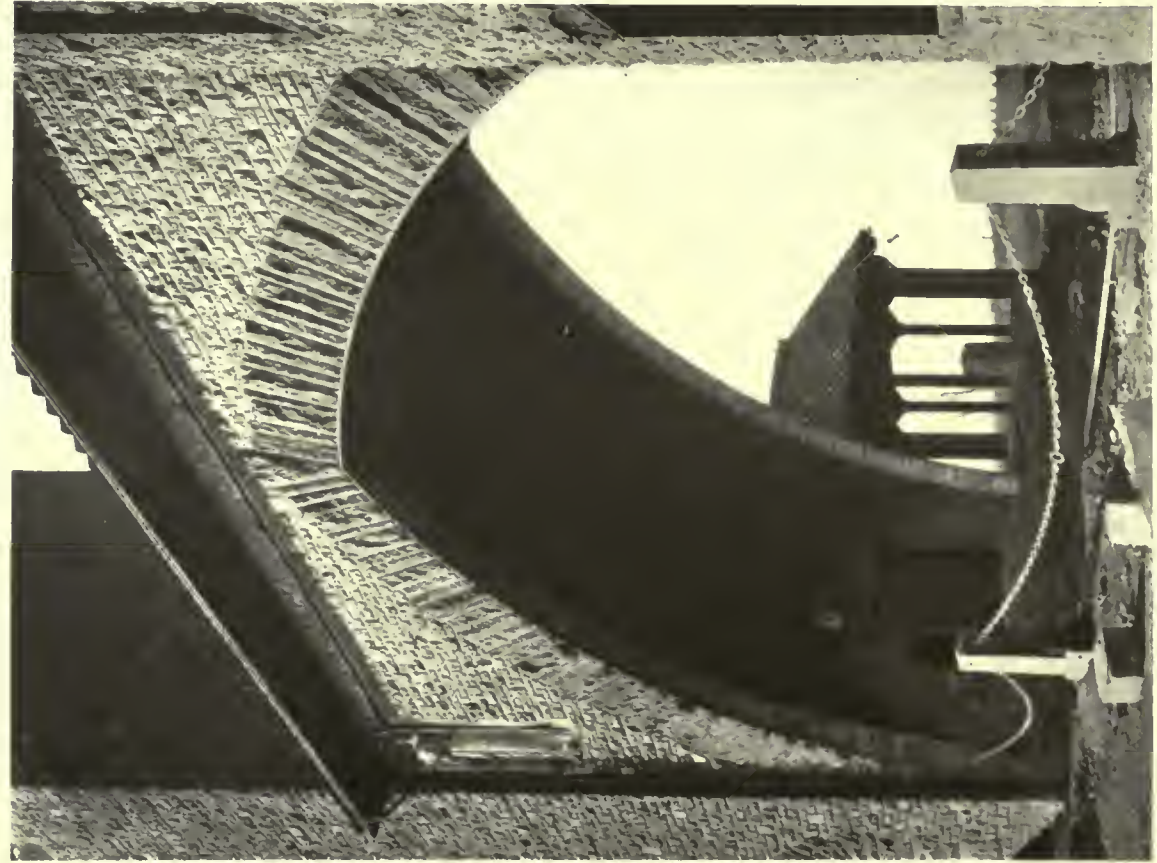

PLATE 197

ENTRANCE TO TOD HOMESTEAD CEMETERY, YOUNGSTOWN, O.

J. A. SCHWENFURTH, ARCHITECT







EXTERIOR DETAIL.

ENTRANCE TO TOD HOMESTEAD CEMETERY, YOUNGSTOWN, O.

J. A. SCHWEINFURTH, ARCHITECT



INTERIOR OF CHAPEL.





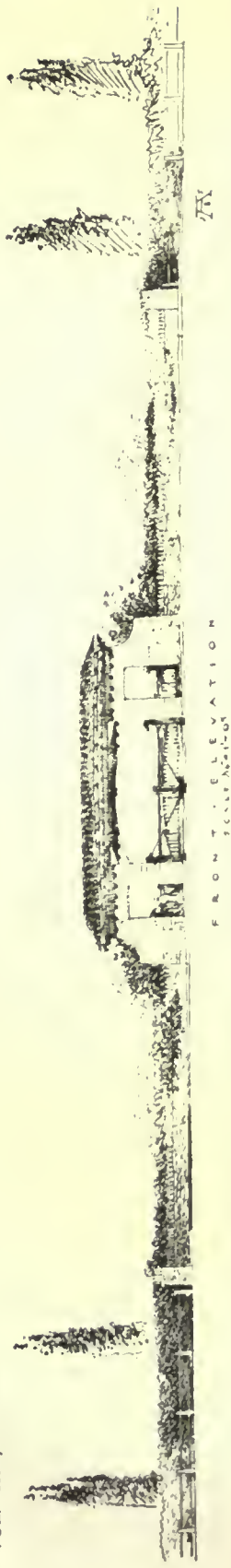

FRONT ELEVATION

77X

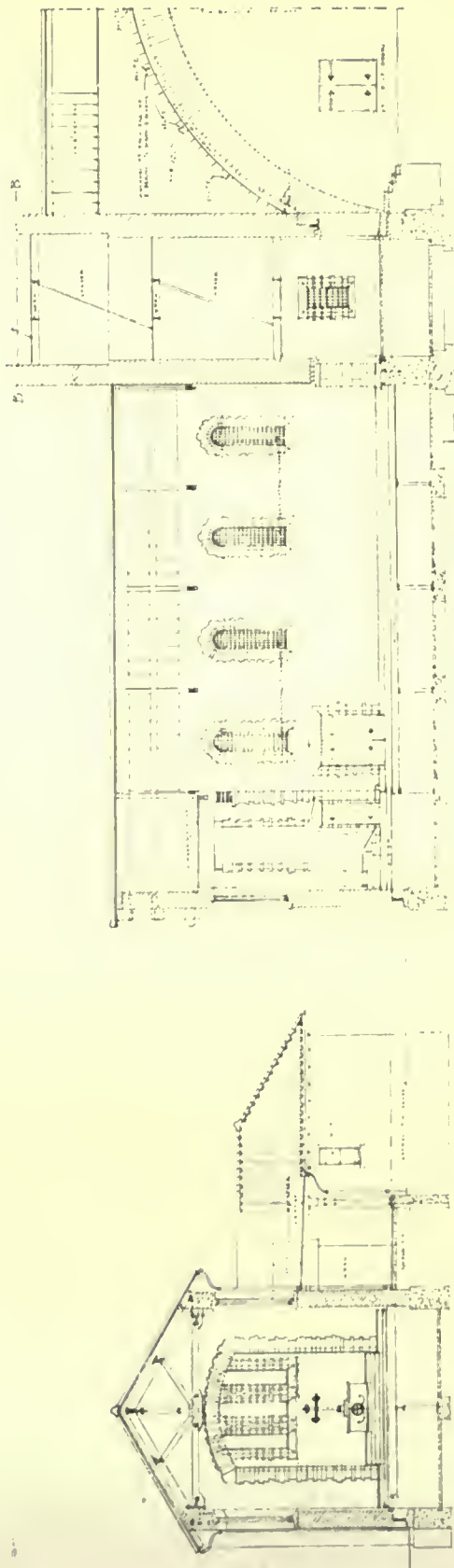

TRANSVERSE SECTION THRO CHAPEL

LONGITUDINAL SECTION THRO CHAPEL AND 7/8 ARCH





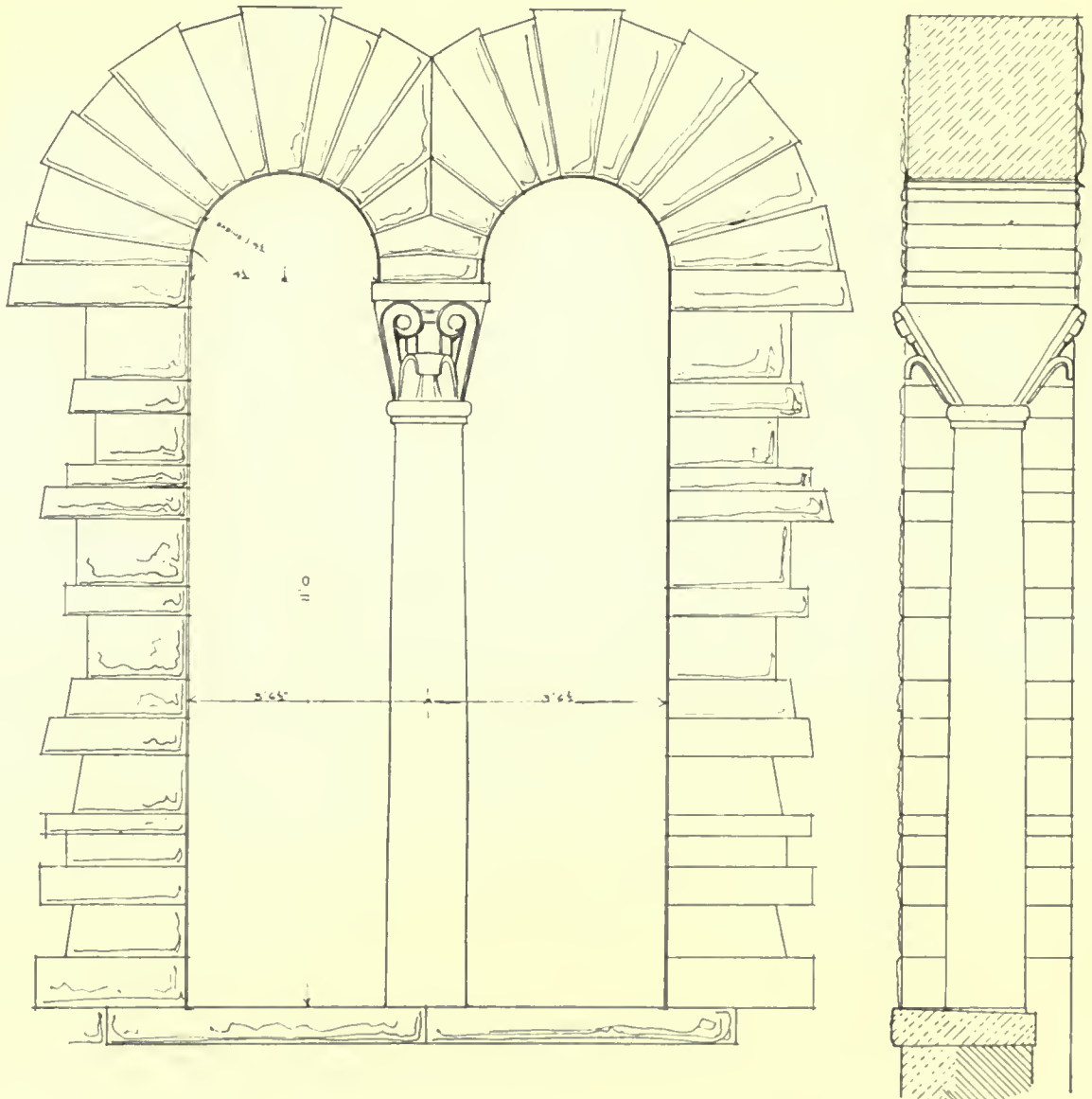

ELEVATION ·

SECTION

OPENING · AT · TOP · MAIN · TOWER ·

PLATE 200

ENTRANCE TO TOD HOMESTEAD CEMETERY, YOUNGSTOWN, O.

J. A. SCHWEINFURTH, ARCHITECT







PLATE 201

HOUSE AND GARAGE OF F. A. SCHICK, BETHLEHEM, PA.

C. E. SCHIERMERTORN, ARCHITECT





HOUSE AND GARAGE OF F. A. SCHICK,  
BETHLEHEM, PA.

C. E. SCHERMERHORN, ARCHITECT

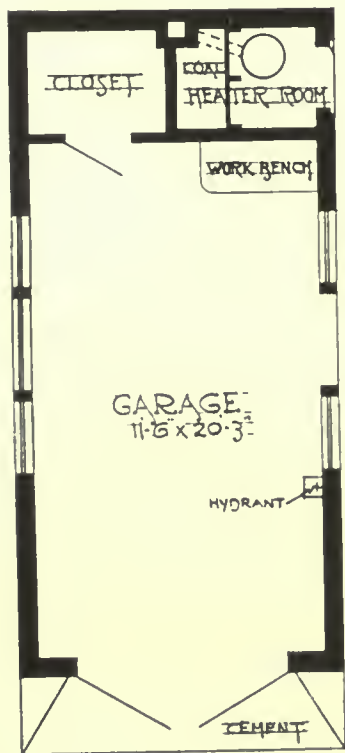

PLATE 202

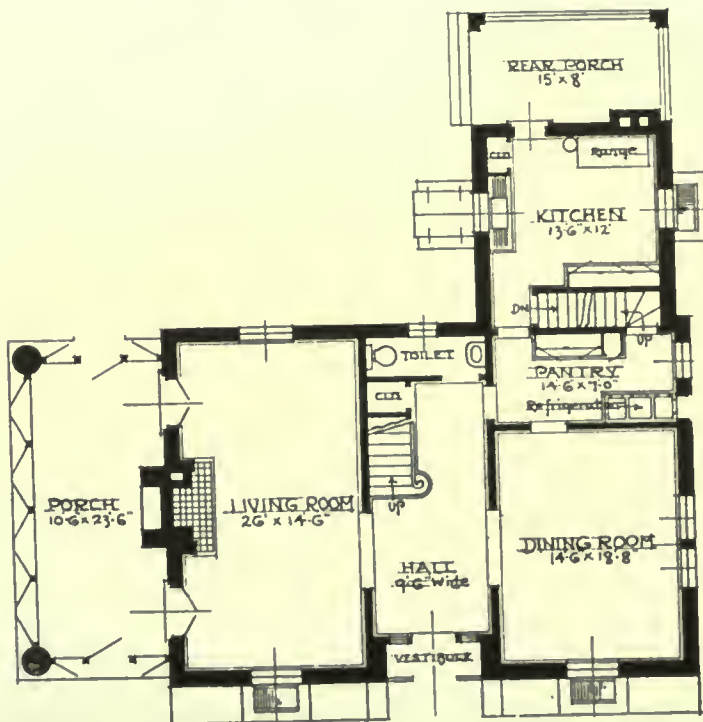
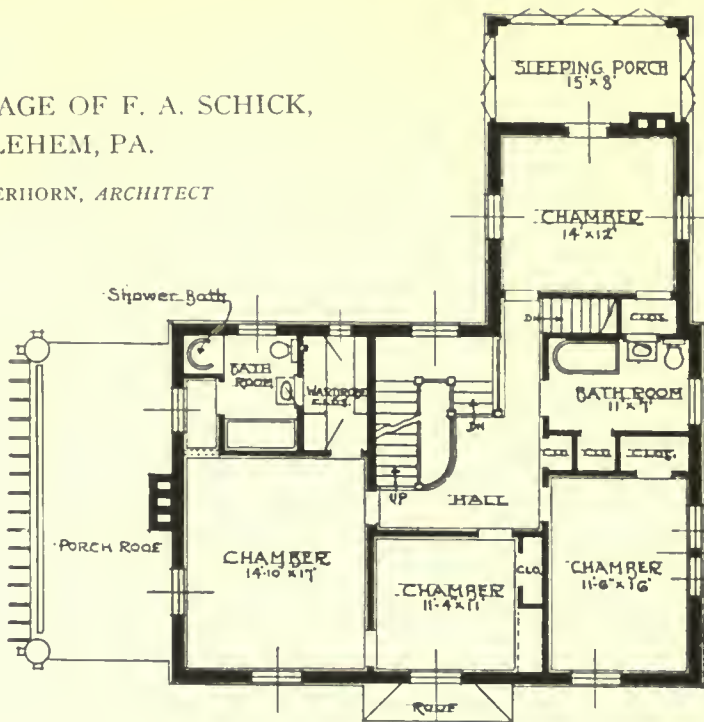





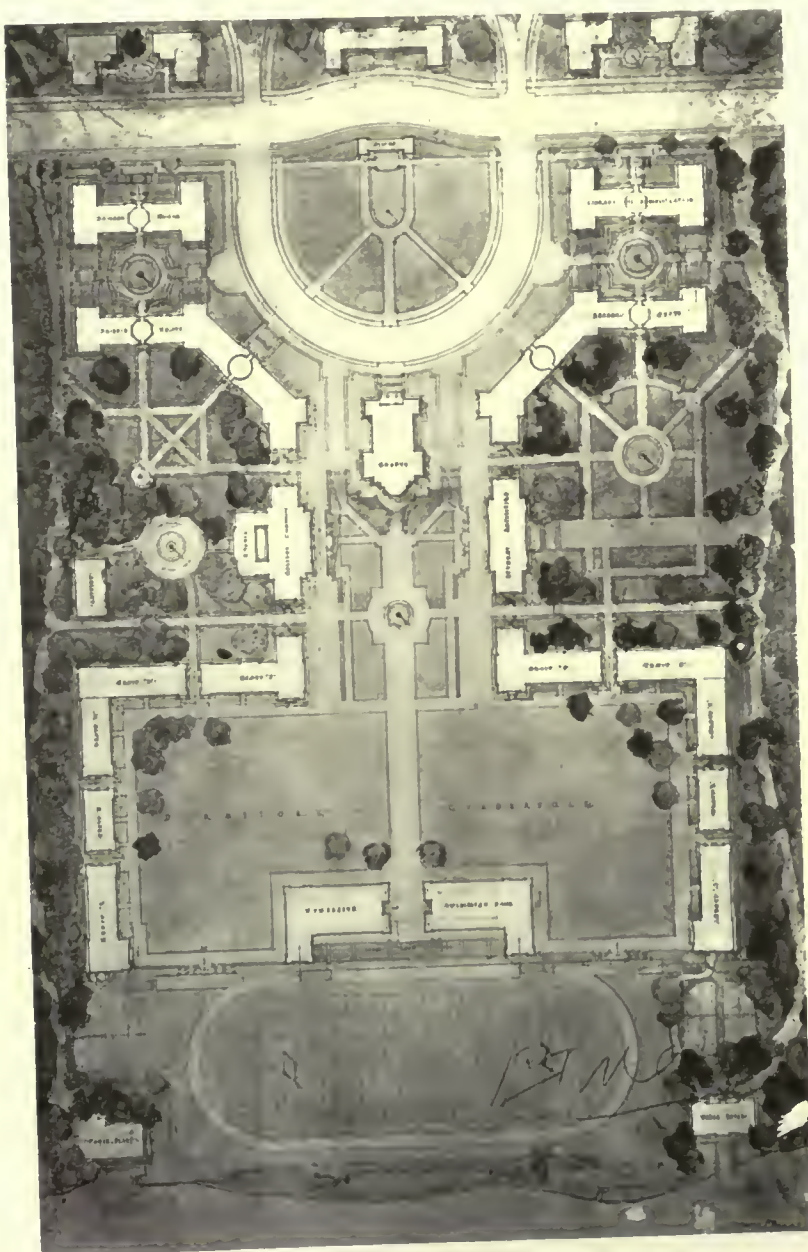

PLATE 203

GARAGE OF F. A. SCHICK, BETHLEHEM, PA.

C. E. SCHERMERHORN, ARCHITECT





CLASS "A" — III PROJET  
A COLLEGE GROUP

—  
A. C. BIEBER  
FIRST MEDAL  
UNIVERSITY  
OF PENNSYLVANIA

—  
STUDENT WORK  
BEAUX-ARTS INSTITUTE  
OF DESIGN

PLATE 204





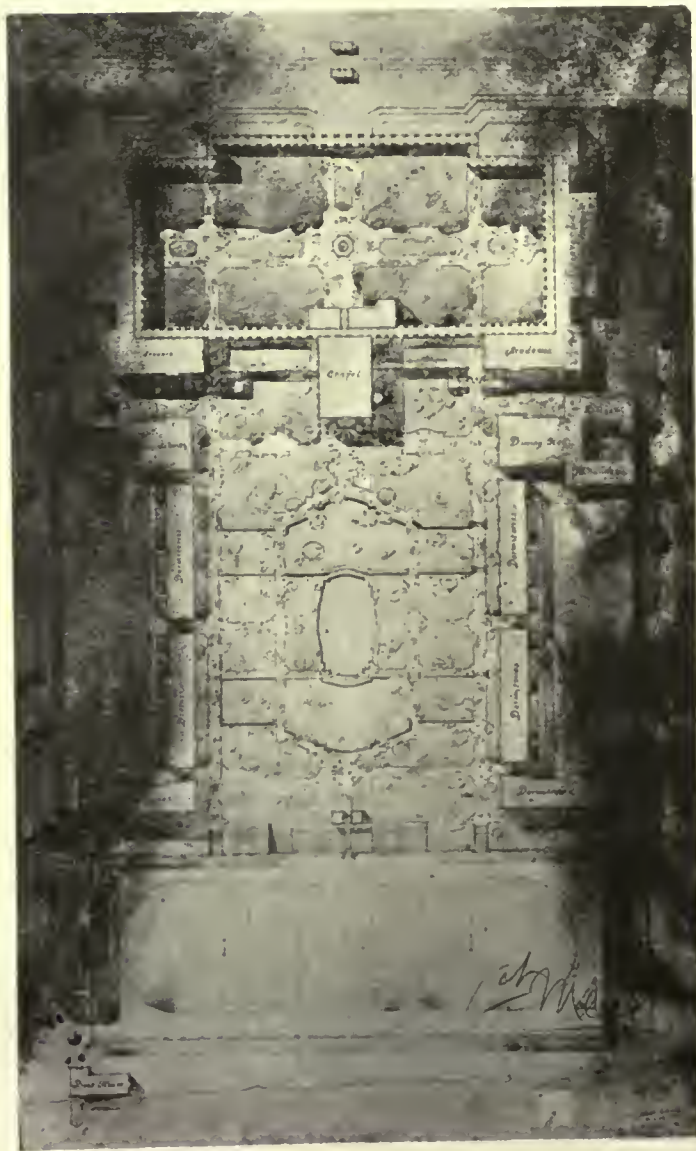

CLASS "A"—III PROJET  
A COLLEGE GROUP

—  
T. P. ROBERTS  
FIRST MEDAL  
UNIVERSITY  
OF PENNSYLVANIA

—  
STUDENT WORK  
BEAUX-ARTS INSTITUTE  
OF DESIGN

PLATE 205





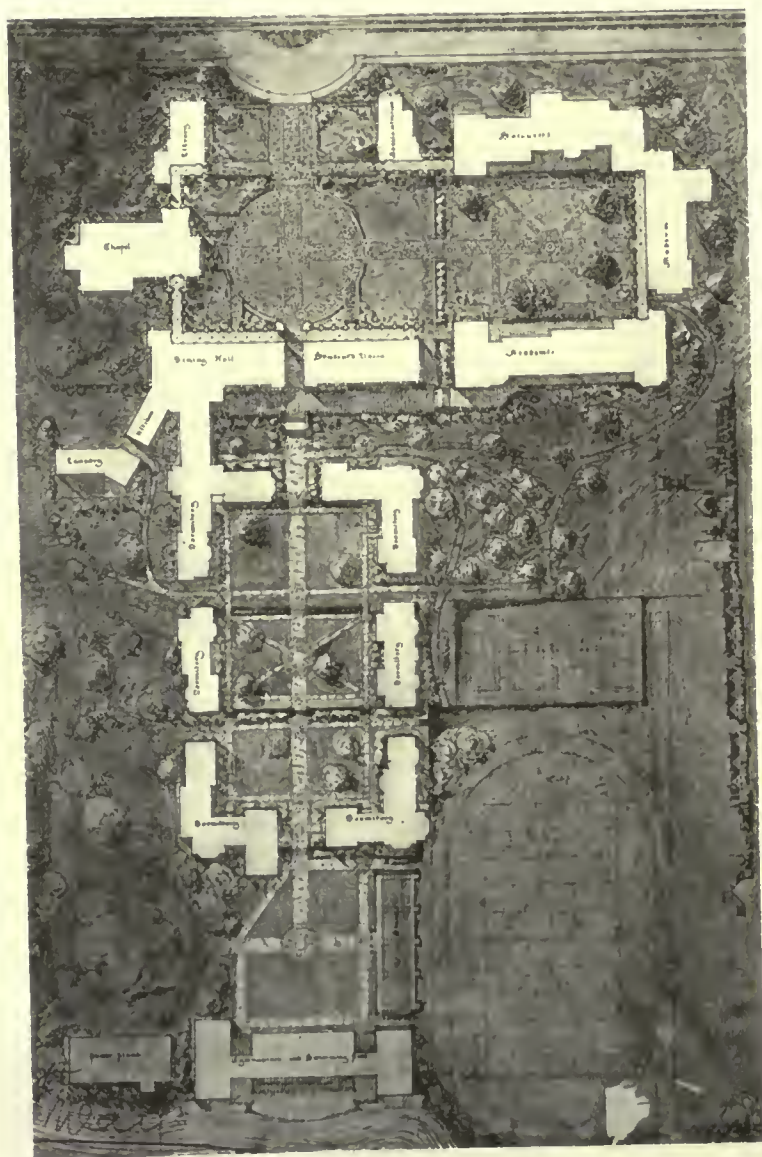

CLASS "A"—III PROJET  
A COLLEGE GROUP

J. R. SMITH  
FIRST MEDAL  
UNIVERSITY  
OF PENNSYLVANIA

STUDENT WORK  
BEAUX-ARTS INSTITUTE  
OF DESIGN



# Criticism and Comment

*The Editors, THE AMERICAN ARCHITECT:*

The building material dealers in the Northwest and other sections of the country have had in the past few years enormous demands upon them for plans and specifications of moderate cost dwellings and in sections where the services of a good architect are not possible, have developed plan service organizations which have more or less merit, but the designs furnished by them are by no means up to the standard of the recognized architectural profession and in consequence have received great criticism from many of the best known architects, and since the ethics of the American Institute limit the activities of their members in the business of selling plans, it has seemed impractical up to the present time for the legitimate architect to engage in a business of this nature.

Our Association receives continually requests for not only plans for moderate cost dwellings but all manner of requests for farm buildings of every character and if we were able to refer them to some central architectural plan service corporation, recognized and supported by the American Institute of Architects, or a group of architects represented by one of the Chapters of the American Institute, we would feel that we were performing a service, not only to the prospective owner but to the community in which he lives, as well as encouraging the practice of the architectural profession to take an interest in the field of designs represented by the small dwellings and encourage the man with small means, by furnishing him plans for small houses, properly planned and well designed.

It seems to me that the architect of today who criticizes the arrangement and design of small houses and groupings in both large and small cities, with reference to proper town planning, is not justified in his criticism because, generally speaking, he has not up to the present time rendered his service to better these conditions and it seems to me that through a service of this kind, as referred to above, results from the efforts which the architects might make toward this end, would in a very few years be very beneficial in educating the general public to a realization of the difference between good and bad designs.

My attention has recently been called to the Architectural Service Corporation, recently organized by a group of architects in Minneapolis and St. Paul, Minnesota, who have organized, so I am informed, for the purpose of developing just such

a scheme as I have outlined here and I feel assured that it will not only supply a great need for better designs, but encourage the erection of more and better buildings.

I sincerely hope that THE AMERICAN ARCHITECT may be convinced of the merits of this idea and through its columns urge the organization of a powerful Architectural Plan Service whose efforts may be recognized and whose influence may have a lasting effect upon American architecture.

R. S. WHITING,

*Architectural Engineer,*

*National Lumber Manufacturers' Assn.*

*The Editors, THE AMERICAN ARCHITECT:*

Having been absent from active participation in practice pretty largely since the fall of 1917, I was amazed to discover, on my return, that a great deal of house planning was being done by retail lumber dealers in the Northwest who are maintaining large and expensive draughting rooms for the production of these plans.

Judge further of my surprise to find that these firms were not only dealing in the small plant but were getting out plans for houses costing from \$10,000 and upwards. I was still further amazed to find that efforts were being made and were sometimes successful in hiring away from legitimate architects' offices, architectural draughtsmen who were lured by the promise of pay beyond what they were considered worth in an architect's office or that the architect can afford to pay under present rates of compensation for similar grades of draughtsmanship.

Please note that in making this assertion I am acting upon an impression conveyed to me by my own draughtsmen as well as by the almost universal upward tendencies of draughtsmen's salaries.

Another interesting fact is that there is a very great shortage of draughtsmen, far under the normal supply. This shortage of course, is not wholly attributable to the fact that the men are still mobilized, but may be ascribed to the increased use of our architectural draughtsmen in retail lumbermen's draughting rooms, railroad draughting rooms, etc., or by men who, during the war, have left the profession.

At a recent meeting of the Minnesota Chapter of the A. I. A., the faculty of the architectural department of the University of Minnesota stated



that the graduating class was already being solicited by these companies to come over into their field and the faculty did not relish the idea, after their four years' work in producing a graduating class, of having them go over into the service of those outside the legitimate profession.

Now in stating the above, which apparently are facts, I have been trying to ask myself what should encourage the lumber dealers to invade a field which certainly should belong to the architect and the only answer which I can find, which seems to me to partially satisfy, is first, that inasmuch as shelter is a fundamental need of human life, they are using the appeal of attractive plans to merchandise their raw product. There is no appeal in the raw product as such, unless it can be visualized in its final form in the minds of those interested; and the other fundamental reason probably is that the architect who is competent enough to build up a practice cannot afford and generally does not do the very small house or should I say rather, that the small average home builder does not go to the architect for his house plans because he cannot afford to pay a sum which would be profitable to the architectural firm in the production of his plans; hence the small average would-be home owner must procure his plans from some catalog house or popular publication, or from some other organization like the Lumber Dealers' Association; or buy his house ready built from the speculative car-

pen-ter-contractor or speculative real estate builder.

I took occasion, at the recent Convention, to plead for an appointment of a committee of the Institute that would actively study this problem and suggest methods whereby this fundamental economic difficulty might be solved, and I confidently expect that the profession will, in a practical way, find a solution.

I do not believe that the lumbermen, as a whole, particularly care about making the plans. Why should they? Their principal concern is to merchandise their product, and it seems to me that the architects, as a whole, are interested in their disposing of their product in a reasonable and safe form so that individual owners and communities may enjoy the employment of the material in as economic and useful a way as possible, not forgetting the aesthetic.

It seems to me that the time is ripe now for an open discussion of this matter while we are on the threshold of very active times in our profession and in the days to come we should seek every method of co-operation rather than friction in the new days that we are facing. If the architects have been remiss in their obligations, in a way, towards society, it is time for us to know it and to find a way to bring to this question the skill and brains which we assume we possess.

EDWIN H. HEWITT,  
Minneapolis, Minn.

## Current News

### New York State Association of Architects

At a meeting held in Utica, N. Y., on June 7, the New York State Association of Architects was organized. The purpose of this organization is set forth as seeking to unite the architects of the State of New York in fellowship that they may combine their efforts for the promotion of efficiency of the profession and to make the practice of architecture of necessary service to society. All architects registered in the State of New York, and all architects whose standing in practice is approved by the Board of Directors, are eligible to membership in this association. The dues of this group are placed at \$5.00 per year.

Provision is made for a Junior Membership, to include draftsmen employed in the offices of members or of architects qualified to be members. The dues in this class will be \$3.00 per year.

It is proposed to make this association so independent and democratic that it will attract to membership the entire eligible body of architects in the State. At the present time there is an enrollment of about 400 architects. The following officers have been elected:

President Ornan H. Waltz, Ithaca.  
First Vice-president, Robert D. Kohn, New York  
Second Vice-president, Edward B. Green, Buffalo.  
Third Vice-president, Frank H. Quinby, Brooklyn, N. Y.  
Secretary, Walter G. Frank, Utica.  
Treasurer, H. W. Greene, Watertown.  
First Director, J. Riley Gordon, New York.  
Second Director, Frederick L. Ackerman, New York.  
Third Director, Gordon Wright, Syracuse.  
Fourth Director, Maurice M. Feustman, Saranac Lake.  
Fifth Director, W. P. Bannister, Brooklyn, N. Y.

The following committees have been appointed:

#### Public Information

J. Riley Gordon, Chairman, New York.  
Frederick L. Ackerman, New York.  
A. F. Lansing, Watertown.

#### Membership

Frank H. Quinby, Chairman, New York.  
Edward W. Loth, Troy.  
John B. Slee, Brooklyn.  
Edward B. Green, Buffalo.  
Gordon A. Wright, Syracuse.

### War Pictured in Natural Colors

An exhibition of natural color pictures photographed on the battlefields of France by what is called an auto-chrome process has been held in New Orleans and will doubtless make the rounds of the larger cities.

The collection was taken by authorization of Foch, Petain, Joffre and Pershing, and includes scenes of the Marne, the English front, and places in France and Belgium which show the devastation caused by the war.

Starting with the first battle of the Marne, the photographers show the battlefields as they were at the beginning of the war, the guns used, the different methods employed, and the brilliantly colored uniforms of the French army in their natural colors. Pictures of the regions laid bare by the Germans are next shown, and the work of the American relief committee restoring recaptured sections.

Verdun, the greatest battlefield of the war, is another subject of the new photography, and the forts of Souville, Douamont and Tavanne are also brought in.

---

### William S. Wicks

William S. Wicks, for a period of thirty-eight years, of the firm of Green & Wicks, architects, of Buffalo, New York, died on May 30. He was in his sixty-fifth year.

Mr. Wicks' early education was in the public schools of Trenton, N. J., and Utica, N. Y. Later he entered Cornell University, from which he went to the Massachusetts Institute of Technology.

Mr. Wicks combined with his activities in the practice of his profession considerable ability as a writer on architectural subjects. He was a Fellow of the Institute and a past president of the Buffalo Chapter.

His identification with the architectural growth of Buffalo and the surrounding country resulted in the erection of a varied class of buildings of the highest artistic excellence.

---

### Venice Since the War

The following extract from a Canton, Ohio, paper, tells some of the history of an illustrious city and shows one way out of an almost hopeless situation. Under the caption "The Renaissance of Italian Art," the writer states:

"Venice, transfigured, silent and heroic, full of passion and of faith, is born anew into a grandeur worthy of her olden days. Her people who in the dark scenes of the tragedy of Europe suffered, hoped and toiled in courage and silence, greet her modern Renaissance.

"In the years before the war Venice had been a center of art and beauty. Life slipped by easily and quietly; the harbor was busy with its thousands of workers; the trades and industries were prosperous. She was the mecca for all the artists and lovers in the world. The war came. The lights were extinguished; the lovers fled. The city was suddenly deserted by all its own people, and stood, an outpost facing the enemy, in the dark.

"Life there grew harder and harder. For when every form of commercial activity had ceased, the harbor closed to traffic, all the factories and shops shut, Venice found herself utterly without means of livelihood. In August, 1914, the people of the city appealed to the Mayor for work, and then was formed the Association of Venetian

Industries. This opened shops, provided materials, took over the finished products and arranged for their sale in behalf and in the interests of the industries. It fostered especially the industrial arts and crafts, the small manufacturers of glass, mosaic, furniture, iron work and pearls—those heirs of the ancient traditions of Venice, her eternal glory and the riches of the world.

"The objects which they created in those hard days are of manifold beauty. The glass workers of Murano, aided only by their iron pipes, long as organ pipes, and their traditional instinct, blew their vases and their magic galleons; the women of Burano, alone with their grief, wove the hangings for their lost altars and snow-white linen starred with flowers. The woodworkers carved in walnut old chairs like those where their Doge sat on days of state, or saved old fragments, fashioning them in new forms, and restoring the old pieces which had been saved and brought away in safety. The marble workers carved in stone well tops and Byzantine fountains. The ironworkers fashioned lamp stands and gates of grill and hammered out cups, lighter and more delicate than those of their brothers, the glass-workers."

---

### Chicago Soon Will Construct Stadium to Cost \$1,000,000

Chicago in the near future can boast of having the largest stadium in the world, the cost of which will be \$1,000,000. The site chosen is in Grant park.

The South park board unanimously voted to raise \$1,000,000 for the project. Mayor Thompson has pledged that "money would be no object" in putting the plan through to its last and most elaborate detail.

---

### Jugo-Slavs to Build Monument to Union

Word comes from Belgrade that in Kossovo plain, where Jugo-Slav troops were crushed in 1389 by the Turks, a great monument is to be erected to commemorate the Jugo-Slav union. It will be known as the Temple of Kossovo. Ivan Mestrovic, Dalmatian sculptor, will execute the work.

---

### New York's Oldest Building Going

The building in which Alexander Hamilton lived at 122 William Street, said to be the oldest building on Manhattan Island, is about to be torn down to make way for another structure. It was built of bricks imported from Holland and was the headquarters of General Washington during the battle of Golden Hill.

---

### Theater Curtain a Mirror

The Little Theatre, one of London's smallest playhouses, is to have a mirror drop curtain. The theater will change its name to the Looking Glass Theatre.



## Would Let the French Rebuild in Own Way

America is going to do her full part in the rebuilding of France, but we are going to let France proceed in her own way, asserts Edward Hungerford, writing on "France Faces Forward," in the June issue of the *New Red Cross Magazine*, in which he tells why various schemes for the "adoption" of ruined French towns by American communities are not feasible.

"Back of the well-organized work of the French Government," says Mr. Hungerford, "back of such real assistance as we Americans may be privileged to give, must stand at all times the desires and the efforts of the French people themselves. There is no mistaking these last. The French are a peculiarly clannish and home-loving people. They cling tenaciously to their language and their traditions—and their homes.

"Long before the war was ended certain groups of well-meaning but impulsive Americans began formulating rather precise plans for the reconstruction of France at the end of the conflict. Their plans were good, their intentions even better. \* \* \* But France is the most highly civilized country in the world, and has very definite ideas of her own on architecture and city planning. \* \* \* If the Germans had swept across New England we probably should resent committees of Frenchmen or Spaniards or Italians trying to tell us how to reconstruct Providence or Worcester, but we would not resent their interest. \* \* \* And much real work has been accomplished by Americans, without either the 'adoption' of towns or the hurting of the rather delicate sensibilities of the French at this time."

## Hidden Beauties

Rare paneling of old Jacobean oak, worth \$10,000, was discovered under the plaster and wall paper of an old house which was torn down in Cambridge, England, a short time ago. There are probably no houses in America, even those dating back to the early history of our country, which could reveal hidden beauties of equal value; but there is many a beautiful old fire-place walled up. Many a trim of oak, walnut or mahogany has been covered with that hideous travesty upon fine woods, a coat of graining. More than one table, bed or chair made of wood which today is almost priceless but no more beautiful than when the article was first constructed, has been covered. It is natural to like a modern, up-to-date home, but too few of these possess the charm which breathes from those houses where year after year the plain, old-fashioned things have come to be a part of the very family life itself. Things are not necessarily beautiful because they are old, but things which are beautiful should not be sacrificed for anything so ephemeral as style in house furnishings. "Beauty is its own excuse for being."

## American Hospital for London

It is probable that London will soon possess an American hospital. A very large sum of money has been promised to found what will amount to a headquarters of the American Medical Association in that city. The headquarters are to consist of a hospital, a library, lecture theaters and demonstration rooms and reading rooms. The new hospital may, it is hoped in some quarters, become a kind of Rockefeller Institute in London.

## The Historic Site of Fort Washington on Manhattan Island Preserved

Included in that tract of land on Fort Washington Heights in New York City, belonging to the estate of the late James Gordon Bennett and recently sold at auction, is the site of Fort Washington, where the Continental troops made their last stand on Manhattan Island before they retired across the Hudson to Fort Lee and Hackensack.

The possibility that this historic site would become the property of speculative builders was greatly deplored by all patriotic people who regret the rapidly disappearing landmarks that should properly become the objects of preservation and guardianship.

At the eleventh hour, the American Scenic and Historic Preservation Society has purchased the site with the cooperation of the Sons of the American Revolution. It is the present intention to convert the property into a memorial park.

The property is now marked by a monument commemorating the historic traditions of the neighborhood.

## Personal

Berry & Commiskey, architects, have just opened an office at 1237 Real Estate Building, Philadelphia.

Delbert K. Perry, architect, formerly of Unkelbach & Perry, has opened offices at 408 City Hall, New Britain, Conn.

Guy Mahurin, architect and consulting engineer, 519 Lincoln Life Building, Fort Wayne, Indiana, desires catalogues.

MacKenzie & Wiley, architects, 806 Liberty Building, Philadelphia, desire catalogues on materials for building construction.

Berenson & Moses, architects, announce the removal of their offices from 26 State Street, to 1026 Main Street, Hartford, Conn.

Robert Frank Jordan, architect, 4 E. Redwood Street, Baltimore, Maryland, has recently opened offices and desires catalogues.

Architect James Rice, formerly with the Morgan Spring Co., of Worcester, Mass., has moved to 306 Main Street, Worcester, Mass.

Carl Hoermann, architect, formerly of Highland Park, Ill., has opened an office at Room 1414, 8 S. Dearborn Street, Chicago, Ill.

H. A. Brown, architect, First National Bank Building, Trenton, New Jersey, has moved his office to River Bank, Burlington, New Jersey.

Harry H. Hill, architect, P. O. Box 207, Stuttgart, Arkansas, desires catalogues of materials pertaining to construction of hotels and courthouses.

The partnership of Ottenheimer & Stern, architects, has been terminated. Mr. I. S. Stern will continue to practice at 220 S. State Street, Chicago, Ill.

Edward L. Gahl, formerly of Chicago, announces that he has opened an office in the Ione Hotel Building, Guthrie, Okla., for the practice of architecture and wishes samples and catalogues.

B. J. Schwertzer, architect, formerly located in the Record Building, Stroudsburg, Pa., has recently opened an office in the Security Trust Building, and desires catalogues of building materials.



# Late News from Architectural Fields

*Special Correspondence to THE AMERICAN ARCHITECT*

## Federation of Art Defines Attitude Toward War Memorials

WASHINGTON, D. C., June 16.—The American Federation of Art through the general committee on war memorials has defined its attitude on forms of memorials. All members and professional advisers have received a communication from Charles Moore, chairman of the general committee, in which the Federation expresses its opposition to the standardized building, monument or tablet.

The chairman states that the particular and fundamental idea which the Federation has in view in taking up the question of War Memorials is to bring the communities and committees in touch with artists, architects, sculptors and painters. The Federation favors the individual memorial made to suit the particular location, to satisfy particular needs and one that will express the patriotic emotions of the individual community.

Mr. Moore believes that if a building is needed, it should accommodate the special requirements of the community. He urges the study of these requirements by the committee in consultation with a person trained in the arts. Members of the Federation are advised to advocate the use of the best materials, getting the best design and carrying out the work in a thorough and adequate manner.

The committee of the American Federation of Art in discussing their views on community buildings reached the conclusion that a memorial building should cost at least \$75,000, exclusive of the site. Other views concerning architecture are set forth as follows:

The problem of the community building is difficult. If the building is to have a memorial character it should be architecturally good. This means that it should be located so as to have an adequate landscape setting, preferably with grass and trees. This is a feature to be insisted upon. The structure should partake of the nature of a temple—a place cut off and separated from the commercial activities of the town. It should be what its name implies, a center for the community and for every person in it, a shrine dedicated to the service of just so much humanity as it can possibly reach out to, always beginning at home. For such a building the grove has always been considered the most appropriate location.

Again, the materials of construction should be good. Every portion of the building inside and outside should manifest thorough and enduring workmanship. This means that by far the greater portion of the cost will not make a show to the untrained eye. The man on the street will have to be disregarded and opposed; he never can be convinced. He has no standards of judgment and acknowledges no laws of good taste.

Few people realize what are qualities in a building which impart to it the gift of eternal life. It is true that the Parthenon was ornamented richly; but shorn of its ornaments it still is, even in its ruins, the incarnation of beauty. The subtle harmony of its proportions make it supremely, immortally beautiful.

Then the community building must be adapted to the purposes for which it is to be used. Shall it be the meeting-place for the men and women who were engaged in the

Great War against a foreign foe and are now turning the forces for good against the foes of their own household? Shall it have an auditorium, a museum, a library, a bowling-alley, a kitchen? Is it to minister to both mind and body?

All these and perhaps many other elements enter into the problem of the community building; and every building must, by reason of the particular demands of the individual community, differ from every other building. In the same manner, the location imposes special conditions, so that a plan and design adapted to one site might not answer for any other. The goal sought is a perfect memorial. The problems are inherent in the undertaking and must be met. No smooth and easy road can be devised. One cannot buy a memorial as one buys a Christmas present. Time and thought and training are essential if the result is to be worthy of the cause commemorated. Unless the memorial committee approach their task in the spirit indicated; unless they are prepared to pay the cost of thorough work; unless they employ an architect who will support them and lead them into right ways, then they will not build a memorial that will endure.

The minimum cost of a memorial building may be set at \$75,000, exclusive of the land. Arrangements should be made to provide maintenance; otherwise the building will soon deteriorate and go to pieces. The only safe way is to provide an endowment fund. This is most easily accomplished at the beginning of the enterprise.

## Building Zone Restrictions to be Urged

WASHINGTON, D. C., June 16.—Establishment of a zone system for the construction of buildings in the District of Columbia, to prevent the mushroom growth of unsightly and objectionable buildings, principally in the residential sections of the National City, again will be sought by Senator Calder of New York during the coming session of Congress.

Drastic steps should be taken, in the opinion of Senator Calder, to curb the growing tendency among real estate dealers and builders to mar the beauty of certain sections of the city by the erection of unsightly buildings in strictly residential streets. It is Senator Calder's plan to provide that property owners in these streets shall have a majority right to decide upon the character of new buildings to be erected in their blocks. The consent of 75 per cent of the property owners and residents would have to be obtained before a builder could apply for a permit to build, the final decision to rest with a board to be appointed especially for that purpose.

Such streets as Sixteenth Street, in the smartest section of the Capital, are threatened seriously by the increased amount of building going on in the District, Senator Calder declared, unless measures are taken to prescribe the kind of buildings to be erected.

Restriction would enhance the value of real estate in the residential sections, he indicated, besides preserving the architectural symmetry of the city.

## Barge Men Halt Brick Shipments To Exhibit an American House at Norwegian Exposition

Brick barge captains in New York harbor have left their boats to enforce a demand for a new wage of \$175 a month instead of \$125. Unloaders have gone on strike for \$1 per 1,000 bricks, an advance of 20 cents. There are six barge loads of bricks in New York to be unloaded, and these bricks will last the present market only about ten days. Brick manufacturers are unwilling to go to prospective customers with the price advance of from \$2 to \$3 a thousand wholesale in case the new demands were granted and have decided to stop sending brick to this market.

The price of Hudson common brick in ordinary grade in this market to-day is \$15 a thousand, to which price the consumer must pay cartage, handling costs and 10 per cent. Before the war the price of this commodity was from \$5 to \$6 a thousand. If the new wage rate went into effect the base price to the manufacturer, with not more than 6 per cent profit to manufacturers, would be in excess of \$16.50 wholesale dock.

WASHINGTON, D. C., June 13.—U. S. Trade Commissioner Axel H. Oxholm, recently returned from a two years' study of lumber conditions in the Scandinavian countries, has advised the Department of Commerce of an American architect's intention to exhibit an American house at the Norwegian-American Exposition at Christiania, Norway, next fall. The Bureau of Foreign and Domestic Commerce holds the name of the architect confidential, though his name and business connections will be given out on an approved request.

The architect is scheduled to sail for Norway July 3. He is the representative of a company in Christiania and plans to erect a wooden house built of American material. In order to achieve this result, the architect is desirous of communicating with American firms interested in the exhibition of such material.

## Wants Stock Exchange to Trade in Mortgages Loans Should be Made More Attractive to Investors, Says New York City Tenement House Commissioner

DECLARING that if facilities are provided for the sale of building bonds and mortgages on the Stock Exchange in the same way as railroad and municipal bonds and mortgages are sold that construction will proceed with greater speed, Frank Mann, New York City Tenement House Commissioner, this week cited his chief reasons why it has been hard to obtain loans in sufficiently large amounts, from the point of view of percentage, compared with the cost of the building and the amount of the loan.

"In pre-war times," said Mr. Mann, "the amount of money loaned upon a building would be about 60 to 65 per cent. on first mortgage at 5 per cent. interest. The banks and the title companies and the mortgage and bond companies, which were the principal agencies through which money was obtained, made loans upon that basis.

"Under present conditions capital seems to be timid and lenders are apprehensive that if they made loans upon the old basis to-day within four or five years the value of the building—that is to say, the cost of construction, labor and material—would be lower to such an extent that a building erected now would then have to meet the competition of lower prices and would be lowered in value accordingly. The companies do not want to loan now more than 60 or 65 per cent of what would have been the cost of construction in pre-war times, or what it might be five years from now.

"My suggestion, or rather my views, on the subject are that if capital would be less timid and would realize—and the public would realize—that it is probable there will not be any change in the cost of construction—any lessening in the price of labor and material for the next ten years—and therefore it would be perfectly safe to invest in mortgage loans on the same percentage basis on the cost of construction as in pre-war times, there would be considerable stimulation in building enterprise."

When asked if he thought capital could be induced to lend itself to aiding building operations if some way could

be found to adopt a ten-year semi-amortized mortgage, Mr. Mann said:

"It would be still better to adopt a twenty-year amortized mortgage. Since the Federal Government has organized and created a law organizing the Federal Farmers Loan Bank to aid agriculturists, the same thing might be done to aid real estate interests and to aid housing in cities. In other words, a mortgage loan bank might be created."

Mr. Mann said he believed there would be a flood of money to lend if Federal and State Governments would exempt from income taxation the interest received by the holder of a mortgage of \$5,000 or less, which was a lien upon a home.

"There is another reason why mortgage money is not available," went on Mr. Mann, "and that is that a mortgage investment is not a liquid asset like an investment in mortgage railroad bonds or municipal bonds or industrial bonds, that pay practically the same rate, or even a larger one, to-day. In addition the man who has a mortgage investment cannot even borrow money on it and offer it as collateral in a bank, except in limited quantities. The banks in our States are prohibited from accepting real estate mortgages as collateral in excess of a limited percentage of their capital and surplus.

"I believe that facilities should be provided for the sale of bonds and mortgages on the Stock Exchange in the same way as railroad and municipal bonds and mortgages are sold. It could be done by a feasible plan whereby the State under the Torrens system, or some of the title companies, could guarantee the validity of the titles and the validity of the mortgage itself."

When asked if he thought the real estate borrower should be placed on the same level with the commercial borrower, who now has the advantage, Mr. Mann answered:

"It is my contention that it should be less difficult to obtain mortgage loans, or rather they should be made more attractive to induce capital to invest in them."



"Is it not a fact," it was suggested, "that the reason the financial status of the owner of a building, or the bondsmen, is not taken into account is the very general custom of having a bond made by a so-called dummy when the mortgage is given?"

"I do not know if that is always the case. It has become a custom among real estate borrowers to have the property in the name of a dummy, and then have the mortgage made and transferred back to the original owner, but that is not always so."

Although the assessed valuation of real estate should be taken as a fair guide by appraisers of property, Mr Mann said it could not always be regarded as final.

"The assessor takes into consideration the cost of construction, the character of the building and the use it is put to," explained Mr. Mann. "For instance, a man may erect a mansion that costs him a million dollars, and the city may assess it at a million dollars, yet the actual market value if the building were offered for sale might not be \$500,000 within a year after it was erected."

## Increased Production Logical Remedy for Expected Labor Shortage and Higher Building Material Costs

FURTHER complaints regarding the difficulty of obtaining labor sufficient for increased construction work now under way, which were accentuated this week by reports that thousands of foreigners are about to leave this country for their native lands with millions of American dollars, is expected to force a decidedly more acute labor situation before the summer is far advanced. This development confirms the recent statement of the United States Employment Service to the effect that if the decrease in unemployed labor continues at the same rate—approximately 10 per cent weekly—much longer there will be a serious shortage.

If there is to be a pronounced depletion of labor during the coming months, a period which will undoubtedly show the greatest amount of building operations ever known in this country, it will probably result in higher wages. This, in turn, may be reflected in increased costs of building materials, prices of which are now holding firm in all markets with the exception of an upward tendency in lumber and brick.

It therefore becomes necessary, if in the future, labor maintains its present wage scale or goes to new high levels, that production must be increased to the highest possible point. By this means there would result no further advance in commodity prices. As conditions develop it will be less difficult to impress on organized labor the fact that the only way in which it can hope to maintain the present high scale is to encourage the fullest measure of production.

It is inconsistent to maintain that there will be any decided cheapening of labor in the near future, and any hesitation as to the starting of building projects based on a lower scale of wages will not be justified. Since 1914 there has been a tremendous narrowing of the labor supply. It is estimated that a million men left this country before we entered the war. These men returned to Europe in response to the call to arms of their native countries. Now the men who made big money in various war enterprises here are returning to settle and spend it abroad. It is predicted that at least a million men will remain in the army and navy and their branches at the close of the year. In addition, this country is short the millions of immigrants that normally would have reached here during the past three years.

All these factors indicate that in the not distant future when normal building activities are resumed they will have a large influence on labor conditions in the United States and that there will exist a shortage of men in all

lines of work. This means that to a greater extent than ever before does the problem of labor inject itself into every economic question. By what terms shall we describe a labor system that permits thousands of people to suffer for want of proper housing while labor all over the country is seeking employment?

Restricting the law of supply and demand has in the past been so insistently practised that it has become accepted by labor as a rule and guide of their organizations. Seeking to maintain high costs by restricting supply is now demonstrated as fallacious. The reacting influence is shown to be always detrimental to labor. Labor is beginning to learn this salutary lesson, and further to realize the error of their stoutly maintained contentions. It is productivity that really is the test.

Pomeroy Burton of England in an address on labor conditions in that country has clearly pointed out that the chief errors of trade unionism have been the deliberate and persistent policy of restricting output and the opposing of the introduction of labor saving machinery. He directed attention to the relatively greater prosperity of the United States, and stated that it was because the average production per workman in this country is three times that in England.

The attitude of organized labor is becoming broader and shows a better inter-relation with capital. It is showing in the solution of its problems the same business principles and patriotic impulses that should properly dominate a group of men whose influence is so far-reaching and whose scope for bettering working conditions is so wide. This is very emphatically shown in the recent statement made by Hugh Frayne, general organizer of the American Federation of Labor, in which he said that union labor's interest in putting down Bolshevism in America is equal to or greater than that of any other class. This declaration that organized labor is not tainted by Bolshevik unruliness is most sane and it is to be hoped that the convention of the American Federation this month will heartily endorse Mr. Frayne's statement. He said, for all trade unions:

"They don't want to confiscate. They don't want to seize property. They don't want to live in idleness. They believe that capital deserves a decent profit on its brains and investments. They want to keep America as she has been for a century and a third. Those are our ideals and the convention is likely to express them."

(Continued on page 868-A)



# Beaux-Arts Institute of Design

Director of the Institute—LLOYD WARREN

Architecture—WILLIAM F. LAMB. Sculpture—JOHN GREGORY.

Interior Decoration and Industrial Art Design—ERNEST F. TYLER. Mural Painting—ARTHUR CRISP.

(See plate section for illustrations)

## Official Notification of Awards—

### PROGRAM

#### CLASS "A"—III PROJET

The Committee on Architecture proposes as subject of this Competition:

#### "A COLLEGE GROUP"

The subject of this projet is the group plan of a new college for men on a country site, four miles from a large city. It is enough in the open country so that a certain informality would be appropriate—but near enough the city so that formality if desired would not be out of place. Of the 800 students, 500 will live in residence in the college dormitories, the other 300 coming each day from the city and neighboring towns.

The property is a rectangle 800 ft. by 1200 ft., with the long axis running north and south. Across the north end is the main automobile and trolley road, which is the chief approach to the college. On the opposite side of this road is a residential park where the President and faculty have their houses, and where the infirmary is located. The property is bounded on the South by a large lake with extensive views to the South. The level of the main road is 60 ft. above the level of the lake—an even slope of 1 ft. in 20 running between the two. As no rock exists this slope may very readily be changed if so desired into several terraces at different levels.

An Athletic Field should be arranged for on the site, comprising a full ¼ mile oval cinder track, with 200 yards straightaway—with football and baseball fields alternately inside the oval. At least four tennis courts are desired as near this main field as possible.

Vehicle access is only desired for service approach to the buildings. No driveways within the site will be used by students or visitors, who will be entirely on foot inside the college grounds.

The Buildings may be grouped in quadrangles if desired, but should not be continuous. They should be separated at places for light and air, as suitable to a country site. For this reason also, none of the

buildings should be wider than 60 ft.—and some of them, such as the dormitories, might well be as narrow as 40 ft.

The following buildings should be arranged in the groups mentioned as far as possible. The ground area of each building may vary 10 per cent more or less from the areas given below:

#### COLLEGE GROUP:

	sq. ft.
Library and Administration.....	6,000
Academic Buildings (1 or 2) to total..	10,000
Science Museum .....	6,000
Science Buildings (1 or 2) to total....	10,000
Auditorium and Chapel (to seat 1000)..	8,000

#### RESIDENCE GROUP:

Dormitories for 500 men (at least 4 buildings) .....	40,000
Dining Hall .....	6,000
Students' Activities Building.....	5,000

#### SERVICE GROUP:

Kitchen and Service (connected to Dining Hall by Serving Pantry) .....	2,000
Laundry .....	2,000
Power Plant (at low level) .....	5,000

#### ATHLETIC GROUP:

Gymnasium .....	6,000
Indoor Swimming Pool .....	3,000
Boat House .....	2,000
Uncovered Grand Stand .....	6,000

JURY OF AWARD: F. A. Godley, H. W. Corbett, J. F. Harbeson, L. H. Burnham, D. J. Baum, Mr. Blum, F. H. Haskell, H. A. Davenport and Paul Cret.

This Jury also served as Jury of Award for the Class "A"-III Esquisse-Esquisse the Class "B"-III Esquisse, Archaeology-III Projet and Archaeology-III Measured Drawings.

Number of drawings submitted—38.

#### AWARDS:

FIRST MEDAL:—J. P. Roberts, J. K. Smith, A. C. Bieber and W. H. Livingston, Univ. of Pennsylvania, Philadelphia.

SECOND MEDAL:—A. E. Middlehurst, Cornell Univ., Ithaca; B. Laub, "T" Square Club, Philadelphia; H. G. Antenen and S. B. Baylinson, Univ. of Pennsylvania, Philadelphia.

MENTION:—D. F. Levy, N. M. Tinkham, Y. C. Lu, R. Bailey, A. F. Darrin, E. T. Seeley and R. E. DeWolfe, Cornell Univ., Ithaca; W. H. Wolcott, F. R. Schreyer and L. W. Devereux, Columbia Univ., N. Y. C.; R. H. Segel, Patrons G. & E. Blum, N. Y. C.; S. H. Brown and T. E. Ash, "T" Square Club, Philadelphia; E. W. Beacham, P. F. Taylor, L. D. Cook, H. L. Stone, A. Levy, H. M. Klaisz and S. H. Gordon, Univ. of Pennsylvania, Phila.; W. F. McCaughey, Jr., Univ. of Illinois, Urbana; H. I. Feldman and D. W. Orr, Yale Univ., New Haven.

H. C.:—E. P. Vianna, Univ. of Pennsylvania, Philadelphia.

# Department of Architectural Engineering

## A Typical Complete Water Supply System for Installation in Garage Basements

By J. ALBERT DEYO

**A** MOST satisfactory method of solving the important question of water supply in country residences is the installation of a private system in the garage or garage basement. The accompanying illustrations show the home of Everett L. Brown at Red Bank, New Jersey, and the garage where the system of water supply is installed, together with a drawing of the system itself.



Residence of Everett L. Brown, Red Bank, N. J.—Ernest A. Arend, New York, Architect.

The advantages of such a location are many, while objections are practically absent. By locating the well in the basement, it is possible to place the pump directly over it, obviating the necessity of a separate pump house, with the attendant disadvantages of cost of erection and heating. If a manhole or other opening is provided over the well, it is entirely practical to remove the lower cylinder for inspection or repair, without extra inconvenience, and at minimum cost.

As the chauffeur usually is given the charge of caring for the plant, the location, from this point of view, is ideal. While caring for the cars, it is a simple matter for him to give the water system all the attention it needs, without interfering with his other work. The pump is less apt to suffer from lack of attention, when so located, than if it were placed, as is commonly the practice, in a separate pump house or in the basement of the residence.

While the best pumps are practically noiseless,

there is always more or less sound, especially when the motor first starts or in the case of an engine driven plant, when the engine is running. As the garage is usually located at least a few feet from the main house this disadvantage is entirely overcome by the method here suggested.

In planning a home of this type, space in the basement is many times at a premium and as a system of this kind requires a room at least twenty feet by twelve feet, it is frequently much more convenient to arrange for this in the garage. The logical place for the storage of oil and gasoline is also in the garage, and by confining all of the machinery to this one building the odor and inconvenience may be kept there and away from the main house which is very desirable.

While it was not found advisable to do so in this case, it is many times practical to include the heating furnace or boiler in the garage, near the water supply system. This is especially practical if the method of heating is steam or hot water. All dust from coal or ashes is thus effectively banished from the home, without loss of efficiency.

By properly protecting the heating pipes between the garage and the house there is practically no loss of heat in transmission. A good insulating material



Garage of Everett L. Brown, in the basement of which is installed his private water supply system.



## THE AMERICAN ARCHITECT

around the pipes will absolutely protect them and, as they are laid below frost line, they will need no attention for an indefinite period of time. Municipal heating plants convey steam for many blocks and still the companies are able to give very satisfactory service. In practically all large buildings and institutions, where land is not so valuable as to make such a scheme prohibitive, heating plants are placed in separate buildings.

The size of the water supply system depends entirely on the service which it is expected to give. In some instances the main source of supply is secured from public service mains and the private system is only used for soft or cistern water. In other cases the well furnishes all of the water and in still other

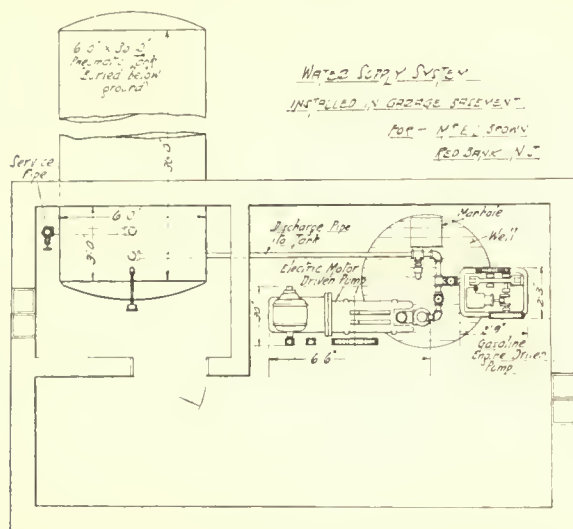

Drawing showing installation of private water supply system in basement of garage of Everett L. Brown.

installations both soft and hard water are furnished by private plants.

In the case of the house illustrated, the private system of water supply was depended upon to furnish all the water used on the place from the well. In order to make the installation entirely self-contained and, if necessary, independent of any other service, a motor driven pump was installed for general use to furnish the ordinary supply, but an engine driven pumping unit was installed with the tank, in case of emergency. As the entire buildings are dependent for fire protection upon this water system, it will be readily seen that this is a wise provision. Even should there be a fire which burned off the electric wires and thus put the motor out of commission, the water system would still be able to furnish water, by means of the auxiliary gasoline engine.

As this installation is somewhat unusual but still a highly practical and desirable one, a description will undoubtedly prove of interest. The pneu-

matic tank, in which the water is stored under pressure, is six feet in diameter by thirty-six feet long. It is buried under ground, at a depth protecting it from frost and at the same time insuring water of an even temperature the year round, regardless of weather conditions. One end of the tank extends through the basement wall, three feet into the garage space. On this end of the tank are mounted both the water and pressure gauge and a glance at them indicates the amount of water left in the tank and the pressure.

A tank of this size has a total capacity of 7,610 gallons but as it is one-third filled with air, to provide the necessary cushion, the actual water storage or working capacity is 5,140 gallons. Starting with the tank two-thirds full of water under a pressure of seventy pounds, four thousand gallons of water are available before the pressure falls below twenty-five pounds. As twenty-five pounds pressure is equivalent to a height of 57.72 feet, it will readily be seen that in addition to a plentiful supply of water for ordinary purposes an installation of this kind gives excellent fire protection.

The motor driven pump, which is used under all ordinary conditions is the larger of the two, and has a capacity of 20.7 gallons of water per minute. The pump is equipped with a differential cylinder and furnishes air with the water to the pneumatic tank, so that no auxiliary air compressor is necessary. It is operated by a four horsepower motor and will work against a maximum pressure of one hundred pounds per square inch. As the tank is tested under a pressure of one hundred and twenty-five pounds per square inch this gives a system from which exceptionally high pressure may be secured if necessary.

The pump is automatically controlled, so that it needs no attention other than an occasional oiling or cleaning. For an installation of this kind an automatic regulation of twenty pounds variation is sufficiently close. That is: when the pressure in the tank reaches a pre-determined point, say forty pounds, the automatic device stops the motor. When sufficient water has been used from the tank to lower the pressure twenty pounds (in this case to twenty pounds per square inch), the automatic device throws in and the pump is started running until the higher pressure is again reached.

With a pump of this capacity and a tank of this size, starting with an initial pressure of seventy pounds and the tank two-thirds full of water, there is instantly available 4,000 gallons of water and this is augmented by the pump capacity so that there may be used during the first hour 5,246 gallons of water at a maximum pressure of seventy pounds, and a minimum pressure of twenty-five pounds. The auxiliary engine driven pump could also be





Motor driven pumping unit installed for Everett L. Brown

started, increasing the capacity by 770 gallons.

This capacity is sufficient to keep approximately two five-eighths inch fire nozzles working simultaneously for one hour. Starting at seventy pounds pressure these nozzles would throw a stream nearly one hundred and ten feet high and even at the minimum pressure of twenty-five

pounds, the height of the stream would be forty feet. As this water is instantly available it gives a fire protection at least equal to that to be obtained in most cities, and this is taken into consideration by the fire underwriters in determining the insurance rates.

The auxiliary pump consists of a combined gasoline engine and deep well pump, direct connected by gears. Both this pump and the larger one are mounted directly over the well and are connected to the same discharge pipe. Gate valves are placed in this discharge line so that either pump may be cut off from the system. Under ordinary conditions the gate valve between the motor driven pump and the tank is left open so that the automatic device may control the operation of the pump, depending upon the tank pressure. In the event of an accident to the electric current or a break down of the larger pump it is only a matter of closing this valve and opening the one on the auxiliary pump discharge line, before the other pump is in commission and working without causing inconvenience.

The engine driven pump is also equipped with an automatic stopping device, so that it may be started and then left without attention. When the pressure in the tank reaches the pre-determined working pressure, the engine and pump will be automatically stopped. While both pumps are equipped with automatic devices, the best practice is to install a relief valve in the discharge line, between the pumps and the tank for added safety.

With such a relief valve installed, the machinery is protected against any undue strain which might be caused by failure of the automatic devices to work, causing excessive pressure in the tank. Such

pressure might also easily cause a break in the plumbing and considerable damage to furniture and decorations before it became known. The relief valve is therefore installed and set at a pressure usually five pounds over the maximum working pressure. Should the automatic devices fail, this valve opens as soon as the pressure increases five pounds over the maximum and, in this case, discharges the water from the discharge pipe back into the well. While this does not stop the pump it effectively protects the machinery and plumbing from excessive pressure, which is sufficient.

The following specifications are suitable for an installation of this kind and may be used for similar work, with minor changes to meet local conditions:

#### SPECIFICATIONS

The contractor to furnish and install complete, where shown on plans and in accordance with these specifications and following the details and instructions furnished by the manufacturer, one complete water system consisting of the following:

#### EQUIPMENT

One six foot by thirty-six foot plain pneumatic tank, having a total capacity of 7,610 gallons and a working capacity of 5,140 gallons. Tank to have manhole in head and to be tested under a pressure of 125 pounds per square inch and guaranteed by the manufacturer for a working pressure of 75 pounds per square inch. Tank to have longitudinal seams double riveted lap joint. Shell to be of five-sixteenth inch steel and heads of one-half inch steel.

One stringer containing two water gauges and one pressure gauge.

One deep well pumping unit, consisting of long stroke working-head fitted with differential plunger and having a capacity of 20.7 gallons per minute from a depth of 200 feet against a maximum pressure of 100 pounds per square inch, belt driven by a four horsepower, 110-220-volt, 60 cycle, single phase alternating current motor, mounted on cast iron sub-base.

One automatic starting and stopping device for

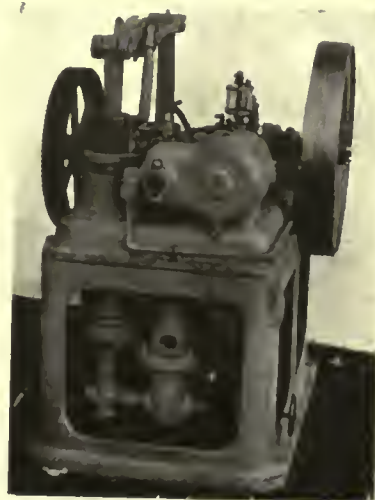

Auxiliary engine driven pumping unit installed for Everett L. Brown

## THE AMERICAN ARCHITECT

electric motor with not to exceed twenty pounds variation between maximum and minimum pressures.

One deep well pumping unit, consisting of deep well pump, fitted with differential plunger and having a capacity of 12.8 gallons per minute direct connected by means of gears to a two horsepower gasoline engine, mounted on the same cast iron sub-base.

One automatic stopping device for gasoline engine.

40 feet of  $3\frac{1}{2}$  inch galvanized drop pipe.

40 feet of  $2\frac{1}{4}$  inch wood rod.

One  $3\frac{1}{4}$  inch by 16 inch all brass artesian well cylinder.

Connections for three inch service pipe.

Connections for three inch discharge pipe.

One  $1\frac{1}{2}$  inch all brass water relief valve.

One  $2\frac{3}{4}$  inch by 10 inch all brass artesian well cylinder.

Forty feet of three inch drop pipe.

Forty feet of  $1\frac{5}{8}$  inch wood rod.

Connections for  $1\frac{1}{4}$  inch discharge pipe.

Both pumps to be equipped with devices for furnishing air and water at the same time, so that no auxiliary air compressor will be necessary. Pumps to have combined air chambers and check valves. Valves to be hard rubber disc on bronze seat. All bearings in pumps and engine to be fitted with removable bronze bushings. All pins, shafts and plungers to be ground to perfect circle and mirror finish. Both units to be furnished complete with sight feed oilers, hard oil cups and necessary tools for repair or adjustment, if special tools are required.

### SETTINGS

*Pressure tank:* Tank to be buried underground, at sufficient depth so that water will be below frost level when tank is full, with head extending three feet inside basement wall. Tank to be carefully set in place on wood bases or sand cushion, which shall be free from stone or other hard substances, and not to be allowed to be dropped or to fall. After tank has been set and all connections made, the outside surfaces shall be cleaned free of all dirt and rust spots, using a steel brush. The surface shall then be given two coats of asphaltum varnish, allowing the first coat to dry before the second coat is applied.

*Motor driven pumping unit:* The motor driven pumping unit shall be installed directly over the well, as shown and fastened in place by anchor bolts set in concrete floor. Sheet lead cushions shall be used in making the pumping unit set perfectly level; these lead cushions to be placed at corners of pump and motor frame, with anchor bolts extending up through the cushions.

*Engine driven pumping unit:* The engine driven pumping unit shall be installed directly over the well, as shown, and fastened in place by anchor bolts set in concrete floor. Sheet lead cushions shall be used in making the pumping unit set perfectly level; these lead cushions shall be placed at the four corners of frame, with anchor bolts extending up through the cushions.

### CONNECTIONS

Install the  $3\frac{1}{4}$  inch by 16 inch cylinder in the well for the motor driven pumping unit, using forty feet of  $3\frac{1}{2}$  inch pipe and  $2\frac{1}{4}$  inch wood rod. The drop pipe and rod to be cut to proper length, in accordance with instructions furnished by the manufacturers of the pumping unit.

Install the  $2\frac{3}{4}$  by 10 inch cylinder in the well for the engine driven pumping unit, using forty feet of 3 inch drop pipe and  $1\frac{5}{8}$  inch wood rod. The drop pipe and rod to be cut to proper length, in accordance with instructions furnished by the manufacturers of the pumping unit.

Well casings to be cut off above the pump room floor and threaded by this contractor, who is to furnish and install stuffing boxes, packing nuts and reducers to make water tight joints between the drop pipes and well casings.

Install a three inch discharge pipe from the motor driven pump to the tank. On this pipe install one three inch gate valve near the pump, as shown on drawing and a two inch water relief valve on this pipe between the pump and gate valve and run waste pipe from relief valve to discharge into well.

Install a one and one-quarter inch discharge pipe from the engine driven pump to the three inch discharge pipe, making the connection between the gate valve and water relief valve. On this pipe install a one and one-quarter inch gate valve and a one inch water relief valve between the pump and gate valve and run waste pipe from the relief valve to discharge into well.

Install and connect automatic starting and stopping device for electric motor in accordance with details furnished by manufacturers. Install and connect automatic stopping device for engine in accordance with details furnished by manufacturers.

Install a three inch service pipe from the pressure tank. On this service pipe install one three inch all brass angle valve.

### WORKMANSHIP

All work in connection with the installation of the water supply system to be done in a neat and careful manner by competent mechanics. All pipe and fittings to be of merchant stock and of full internal diameter through entire length. All pipe ends to be reamed after cutting.



**TEST:** A test of 75 pounds per square inch shall be applied to the discharge and service pipes and the service tank. The pressure tank shall be filled two-thirds full of water and the service and discharge pipes shall be filled full of cold water. This test to be applied for a period of three hours in the presence of the architect or his representative, without

loss of pressure. Should any leaks appear in the discharge or service pipes, these leaks shall be made perfectly tight in the usual manner. Any leaks appearing in the pressure tank shall be made perfectly tight in accordance with instructions furnished by the tank manufacturers. Such installations should give entire satisfaction.

## Short Cuts to Accurate Calculations The Reinforced Concrete T-Beam

By E. A. KUNZE, *Architect*

**I**N the following analysis we will attempt to criticize the reinforced concrete T-beam with a view to laying down some recommendations which it is hoped will lead to safer if not more economical design.

The majority of tests on T-beams have been confined to the single span, freely supported at the ends, and the results of such tests agree quite closely with calculated values. However very little practical information can be gained from these results since a simple beam of this type is rather the exception than the rule in ordinary building construction. Tests on the continuous and restrained beam generally show considerable difference between actual performance and calculated values, but whereas this difference is on the safe side, it nevertheless indicates a lack of economy in design.

Not so long ago it was the practice of some engineers to design their continuous beams for a moment of  $\frac{WL}{8}$  at the center, assuming thereby that

the added stiffness would reduce the bending moment at the support, only enough steel being introduced at the support "to tie the beams together." This can easily be proved to be not only a dangerous but a highly uneconomical design. In all continuous beams a definite moment exists at the supports and enough section must be provided to take up the stresses developed.

It is very commonly recommended that the unit compressive stress in the concrete at the support end of a continuous beam be increased to say 750 pounds per square inch when the normal value is 600, with the explanation that the moment changes very rapidly at this point and only a small section of the beam is affected. It is somewhat doubtful whether this assumption is warranted. Since the shearing value of the concrete at this point is somewhat disturbed due to the tension cracks which must necessarily occur to bring the steel into full action, and the proper inspection of the installation

of the concrete in this location is likely to be overlooked, it would seem that a lower rather than a higher than normal unit stress should be adopted. With a view, however, to the rapid growth of our knowledge in the mixing and placing of concrete and considering the fact that the usual maximum safe stress allowed in the steel is as much as one-half the elastic limit whereas the stress in the concrete is based on a factor of safety of 4 or 5, it would seem that the time is not far off when the allowable safe unit stress in the concrete will be placed at about 700 pounds per sq. inch.

On the basis of quantity of materials, economical design calls for haunched beams. In so designing, the flanges at the center of the beam can more fully be brought into action and with the increased depth of beam at the support a more economical section obtains throughout. This type of beam, however, requires more complicated form and rod work and on the whole a beam of constant section throughout the span may very well prove more advantageous. In this case the flange of the T-beam holds very little theoretical importance and in the continuous girder may be almost entirely neglected. Our theoretical section, therefore, is rectangular throughout. If we introduce 1 per cent of steel in the tension side and 0.5 per cent in the compression side the compressive stress in the concrete is about 650 pounds per square inch. This condition obtains where we bend up one-half the rods in each span and carry them over the support. One-half of the rods would remain in the bottom and form the 0.5 per cent of compressive reinforcement at the supports. At the center of the span we would thus have 1 per cent of steel. Considering the rectangular section throughout, the moment of resistance at the center of the span becomes approximately 100 per cent of the moment of resistance at the support. That we have approximately 760 pounds per square inch stress in the concrete at the center of the span is of no consequence since we have the



flange to reduce it. We have assumed our steel stress at 16,000 pounds per square inch. It will be seen that this stress is somewhat reduced due to the flange raising the neutral axis.

If we were to introduce more steel than here specified we would increase our concrete stresses at the support and if we were to reduce the steel we would have a less economical beam throughout. It will be seen that the girder so designed for interior spans would fulfill the moment requirements recommended by the Joint Committee on Concrete and Reinforced Concrete, that is,  $\frac{WL}{12}$  at both the support and center of the beam.

It is somewhat doubtful, by the way, whether these moment recommendations will stand in future practice.

It seems to the writer that for interior spans the

The two cases mentioned are extremes. Between them lie the cases where the continuous girder is partially restrained by the columns. In the majority of cases the maximum moment at the center of the span is substantially less than the maximum moment at the support. Add to this the fact that the shear considerations at the center of the beam are of no consequence in complicating the internal stresses at that point and reason would seem to dictate that a reduction of moment in the center as against the moment at the support would be amply warranted.

The design of the outside span should be governed by the special considerations usually existing at that point but the moment at the center of the span framing into columns should not be taken at less than  $\frac{WL}{12}$  nor less than  $\frac{WL}{10}$  where it frames into a girder. Considering all the points mentioned

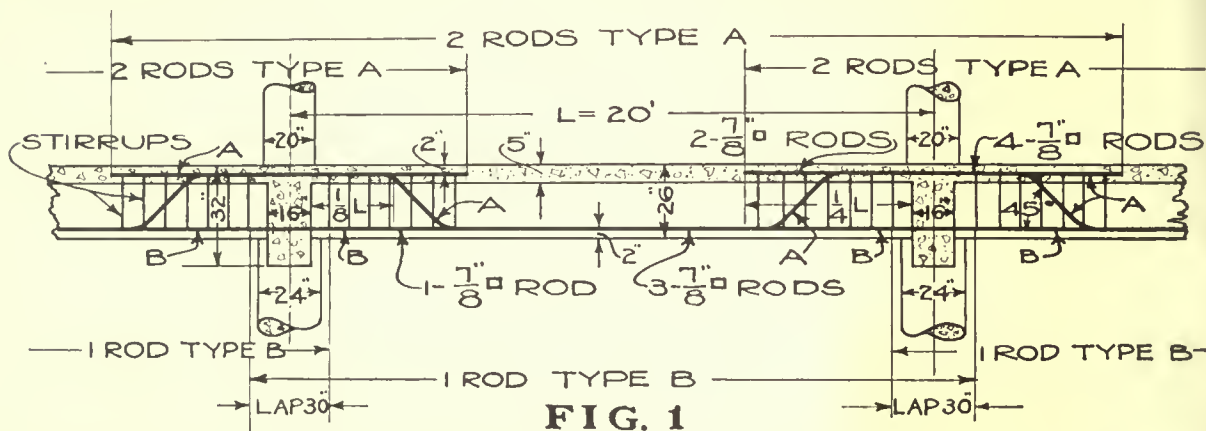

FIG. 1

moment at the center should be assumed at say 75 per cent. of or at least somewhat less than the moment at the support. On account of the actual span between columns being less than the theoretical span (center to center of columns), the moment at the ends of the beams and girders framing into interior columns may be taken at  $\frac{WL}{12}$ . For beams framing into girders, however, the moment at the support should be fixed at  $\frac{WL}{10}$ , it being assumed that the torsional deflection of the girder will make the actual and theoretical span practically identical.

Were the continuous girder resting on knife edge supports, the moment at the center of an interior span would be approximately  $\frac{WL}{12}$  and at the support  $\frac{WL}{10}$  for maximum conditions of loading. Were the span framed into inflexible columns it would become a beam with fixed ends, our moment at the center being  $\frac{WL}{24}$  and at the support,  $\frac{WL}{12}$ .

we may finally make the following recommendations for the beam of constant cross section (the beam without haunches). The bending moment at the support for interior beams framing into girders shall be  $\frac{WL}{10}$  and for interior beams and girders framing into columns  $\frac{WL}{12}$ .

The effective section of the continuous beam and girder shall be rectangular throughout. There shall be 0.75 per cent of steel at the center of the span, 1 per cent of steel in tension and 0.25 per cent in compression, at the support.

By so arranging the steel we will have very closely a compressive stress of 640 pounds in the concrete and a tensile stress of 16,000 pounds in the steel at the center of the beam, and 700 pounds in the concrete and 16,000 pounds in the steel at the support. On the same basis the moment of the resistance at the center of the beam is very closely 75 per cent of the moment of resistance at the support.

In designing it will only be necessary to calculate the section at the center of the span.

The center moment of interior beams framing into girders is to be calculated for a moment of

$$M=0.75 \times \frac{WL}{10} = \frac{WL}{13.33}$$

The center moment of beams framing into columns is to be calculated for a moment of

$$M=0.75 \times \frac{WL}{12} = \frac{WL}{16}$$

By introducing the unit moment of resistance into these equations we have for the effective depth of the beam in the first case  $d = \sqrt{\frac{WL}{1400b}}$  and for the second case  $d = \sqrt{\frac{WL}{1700b}}$ .

The total load applied to a girder may be considered as uniformly distributed.

In the following example (illustrated in Fig. 1, page 866) we will design an interior beam framing into girders.

The distance center to center of columns is taken as 20 ft. 0 in. in both directions.

The beams are spaced 6 ft. 8 in. center to center.

The live load is 200 lbs. per sq. ft.

The slab weighs 60 lbs. per sq. ft.

The stem of beam weighs 300 lbs. per lin. ft.

The total assumed dead and live load on the beam is thus

$$W=(260 \times 20 \times 6 \frac{2}{3}) + (300 \times 20) = 40,666 \text{ lbs.}$$

Assuming the width of the beam to be  $b=12$  in. the effective depth becomes

$$d = \sqrt{\frac{40,666 \times 20 \times 12}{12 \times 1400}} = 24 \text{ in.}$$

The rod area at the center of the beam is thus  $0.0075 \times 24 \times 12 = 2.16$  sq. ins., or three 7/8-in. square rods. Two of these rods are bent up and together with the two bent-up rods from the adjacent span make the required 1 per cent of reinforcement in tension at the support. The remaining rod at the bottom of the beam forms the 0.25 per cent of compressive reinforcement at the support. The rods in tension at both the center and the support are thus stressed to 16,000 pounds per sq. inch. The compressive stress in the concrete at the support is 700 pounds per sq. inch.

The distance from the face of the girder to the upper bend in the two rods is one-eighth of the span and the distance from the face of the girder to the end of the two rods from the adjacent span is one-quarter of the span. A few stirrups are introduced to take up the excess longitudinal shear.

## Physical Properties of Dense Concrete as Determined by the Relative Quantity of Cement

UNDER the above title the University of Texas has just issued a bulletin containing information to those having to do with concrete construction. There seems to be no doubt that our present method of specifying concrete mixtures is defective. A thorough study and analysis of the results of tests, such as those made by the University of Texas, the University of Illinois, the Lewis Institute and others, will help us to proportion concrete mixtures on a more scientific basis, so that maximum strength may be attained with the minimum use of cement.

This recent bulletin shows how the compressive, tensile and transverse strengths and other physical properties of dense concrete vary with the per cent of cement used in the preparation of the concrete. Thereby the designer and the builder of concrete structures is enabled to effect the greatest possible economy in the use of concrete by requiring the fine and coarse aggregate for the concrete to be mixed in such proportions as will secure a dense mixture, and adding only such a per cent of cement as is necessary to produce the strength or other physical

properties desired in the concrete. In these tests the usual method of specifying cement, fine and coarse aggregates is dispensed with, and the quantity of cement per cubic yard of concrete is substituted. The proportions of sand and gravel or broken stone used were designed to produce maximum density, the cement content being the variable, ranging from 1.66 to 12 sacks of cement per cubic yard of concrete. Concrete was aged from 12 days to 3 months at the time of testing. A study of the curves platted from the many tests indicate a rapid increase in compression strength as the cement content increases from 1.66 to 6 sacks per cu. yd. This latter would approximate a 1:2:4 mix. The curves then become flatter but show a further increase in strength up to 9 sacks per cu. yd. of concrete. This would represent about a 1:1½:3 mix. Mixes richer than this appear to add practically nothing to the strength of the concrete.

The modulus of elasticity increases up to a 6-sack per cu. yd. mix, after which it remains at practically the same value for the richer mixes. The ultimate tensile strength and modulus of rupture also increase but little beyond the same mix.

The bulletin is for free distribution on application to Publications Committee, University of Texas, Austin, Texas.



# How to Make Factory Roof Timbers Last Longer

ALTHOUGH there is scant information on the service and cost of treated roof timber in cotton mills, paper mills, and other buildings where high humidity causes rapid decay, a number of preservative treatments which it will undoubtedly pay to use may be suggested.

## *Preserving Timbers by Steeping Process*

The steeping process consists merely in soaking the timber in a water solution of a preservative such as zinc chloride, sodium fluoride, or mercuric chloride. The wood must be thoroughly seasoned. It is left in the solution one day for each inch in thickness and one additional day. After treatment, the timber should be air dried before using. Specific directions for the use of this process (and they are especially necessary for handling mercuric chloride) may be secured from the Forest Products Laboratory, Madison, Wisconsin. Zinc chloride attacks lead paints, but is very desirable otherwise. Mercuric chloride is very effective, but is poisonous and has a decided corrosive action on steel, so that steel tanks cannot be used with it. Sodium fluoride does not attack paint, is not corrosive, and in most other respects is very desirable.

## *Non-Pressure Creosote Treatments*

Timbers may be coated with coal tar creosote by a brush treatment, by dipping in hot oil for 5 to 15 minutes, or the hot and cold bath method. This last method consists in submerging the lumber in hot oil for several hours and then either allowing the oil to cool down slowly with the wood in it or plunging the wood into cool oil and leaving it for several hours.

Coal tar creosote is objected to by some insurance companies as a fire hazard, but whether or not it really does add greatly to the inflammability of wood is a debatable question. The odor of creosote may be objectionable in food storage rooms, but is not usually displeasing to workmen. Creosoted wood cannot be painted over successfully because the oil quickly comes through the paint and discolors it.

## *Pressure Treatment*

Although pressure treatments are the most expensive, they are the most effective because they result in the greatest absorption and penetration of preservative. Roof planking should receive 8 to 12 pounds of creosote per cubic foot, or  $\frac{1}{2}$  pound of the salt if zinc chloride is used. Such treatment should add at least 20 years to the life of roof plank.

## *Effectiveness of Treatment*

The effectiveness of treating timber depends upon maintaining a complete envelope of treated wood around the untreated interior of the piece. If this treated layer is broken through, decay can enter and destroy the untreated interior in spite of the treated outer layer. For this reason lumber should be cut to final dimensions before treatment. Whenever it becomes necessary to cut into treated timber the untreated wood exposed by cutting should be given two brush coats of creosote or some other preservative.

The addresses of wood treating companies adjacent to any given locality may be obtained from the Secretary of the American Wood Preservers' Association, Mt. Royal Station, Baltimore, Md., or from the Forest Products Laboratory.

## Notes of Interest

### ANNUAL MEETING OF THE AMERICAN SOCIETY FOR TESTING MATERIALS

The Annual Meeting of the American Society for Testing Materials will be held at Atlantic City, N. J., June 24-27, 1919. The Hotel Traymore will be the headquarters.

### APPOINTMENT IN CIVIL ENGINEERING

The Board of Governors of the University of Manitoba, Winnipeg, Man., Canada, announces that it will proceed shortly to appoint a Professor of Civil Engineering to take charge of the Department, at an initial salary of \$3,500 per annum. Applications for the position, accompanied by a full statement of training and experience and ten copies of testimonials, will be received by the Secretary of the Board of Governors, up to July 15, 1919.

### BUSINESS TRAINING FOR ENGINEERS

The Commissioner of Education has issued a call on behalf of the Conference Committee on Commercial Engineering recently appointed by him, for a public conference on business training for engineers and engineering training for students of business. This conference, national in scope and in character and fully representative of all interests, will be held at the New Willard Hotel in Washington, D. C., on Monday and Tuesday, June 23 and 24, 1919. All educational institutions, commercial organizations, manufacturing associations, and educational and engineering societies are cordially invited to co-operate and to designate one or more representatives to attend the conference. Prominent engineers, educators, and business men will be invited to discuss the following major topics: Business Training for the Engineer; Engineering Training for Commercial Enterprises; Significance of the War Experience for Engineering Education; Training of the Engineer for Overseas Engineering Projects.





Henry C. Smith, Architect, San Francisco.

## Picturesque San Francisco Apartments Deadened with **CABOT'S QUILT**

Every apartment-house should be sound-proofed. It makes them rent better and they stay rented. Quilt is the one deadener that has the power of breaking up and absorbing the sound-waves. It is ten times more efficient than even the best felts. Quilt is rot-, moth- and vermin-proof and fire-resistant.

*Full information sent on request*

**Samuel Cabot, Inc., Mfg. Chemists, Boston, Mass.**

1133 Broadway, NEW YORK      24 West Kinzie St., CHICAGO

Cabot's Shingle Stains. Old Virginia White and Tints.  
Stucco and Brick Stains. Conserve Wood Preservative,  
Waterproofings, etc.

5-3

## TUDOR-STONE

*Roofing slate at its best*

As eminently suitable for the Georgian Styles as the more intimate English Periods. Very flexible, can be used for any period work or non period styles.

### Rising & Nelson Slate Co.

Since 1869 Miners and Makers of High Grade Roofing Slates  
Quarries and Main Office: WEST PAWLET, VERMONT  
Architects' Service Department, 101 Park Avenue, New York  
Boston Chicago

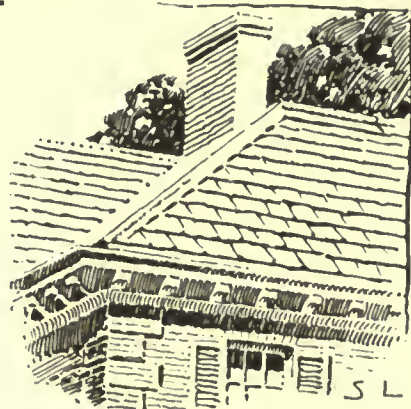

# Financing New Construction

**I**T is our function to cooperate with architects, engineers and builders who wish to get in touch with large amounts of capital available for the construction of new buildings.

We specialize in making construction loans in the form of first mortgage bond issues in amounts of \$250,000 upward, secured by income producing properties of the following classes, where the margin of security is ample for safety and the earnings sufficient to make principal and interest payments:

- office buildings;
- mercantile buildings;
- apartment buildings;
- hotel buildings;
- warehouses;
- plants of industrial concerns.

We make loans from architects' plans and specifications, paying contractors as the building progresses.

We also purchase outright first mortgage bond issues which are the obligations of well-established industrial concerns in need of capital for legitimate expansion and which have sufficient real estate assets and a record of successful operation.

Our plan provides the desired capital immediately and permits repayment over long periods out of current earnings.

We have a thoroughly developed organization and offer our facilities to those who contemplate construction or business development.

Write for our booklet explaining the Straus Plan of Financing. Ask for

Booklet No. F-20

## **S.W. STRAUS & CO.**

ESTABLISHED 1882

INCORPORATED

STRAUS BUILDING, CHICAGO

150 BROADWAY, NEW YORK

**Thirty-Seven Years Without Loss to Any Investor**

Late Building Market Reports

(Continued from page 859)

(From our Special Correspondent)

PHILADELPHIA, PA., June 16.—Unless more main sewers can be constructed, more water pipe laid, and more streets opened, paved and improved at an early date, house building must come to a stop in Philadelphia, and for these reasons, the Philadelphia Operative Builders' Association is urging that all citizens call upon the Councilmen from their wards, to pass the \$14,000,000 loan, which carries with it an appropriation of about \$3,000,000 for main and branch sewers and also money for the installation of water pipe, for paving, grading, etc.

It was pointed out by President Crawford and others, that unless the loan passes and the street improvement work provided for under it is put under contract and begun within a few months the supply of available building lots in the city will be exhausted, house building will stop, and a tremendous increase in the tax rate, probably to five per cent, may be anticipated.

It was asserted that a careful canvass of the situation about the first of the year, showed that only 3500 lots, in round figures, fronting upon streets in which all improvements, such as sewers, water pipe, etc., are in, remained for development in this city. Since the first of the year to date, permits have been taken out, it was said, for about 1400 to 1500 houses, leaving about 2000 yet capable of development.

Should the loan pass, the construction of main and branch sewers go on, it was said, sufficient land might be opened up to permit of the continuance of building for about two and one-half more years.

(From Our Special Correspondent)

CHICAGO, ILL., June 14.—Architects in this city are all very busy. There is a scarcity of draftsmen and those available are asking greatly increased remuneration.

Building is going ahead briskly in all sections of the city. There is not only a large amount of planning for low cost houses, but actual work has started on many factories, stores and other types of commercial construction. All this activity is reflected in a greater demand for building material. Lumber is moving from the yards to regular trade channels in exceptionally heavy volume, and with an acute scarcity of stocks, manufacturers and dealers are experiencing difficulty in replenishing supplies to meet the demand. All lumber is holding firm in price, with advances during the week in the wholesale values of yellow pine, hemlock, fir, cypress, and some of the hardwoods.

Brick, and all clay products are in good demand. The same is true of the metal building material items, especially radiation. Officials of the American Radiator Company report a marked improvement in business. They say that in consequence of bigger building projects there is a substantial gain in the demand for boilers, radiators, and all heating equipment. Prices of radiation are unchanged.

In practically all lines of business the former policy of waiting for lower prices has changed to one of buying at present quotations and there are few who now cling to the belief that reconstruction will go ahead on a lower price basis. Some are now realizing that they waited too long, and they are being forced into the buying market and paying the price.

Labor apparently is satisfied, and there is at the present time no talk of strikes or other serious differences in the ranks of the building trades.

In the mind of the ordinary business man and the ordinary working man the war is history. They are fast readjusting their businesses and their work on a peace-time basis. Financiers and the heads of big corporations now see nothing but activity ahead with a building movement following the signing of the peace treaty, likely to develop into a boom.

Late Quotations in Building Material Markets

(Price quotations now current on building materials and supplies as quoted by dealers and jobbers for delivery in New York and Chicago follow. The quotations set forth are placed before readers of THE AMERICAN ARCHITECT to afford an accurate review of market conditions rather than for use as a basis for actual purchase. They will not only provide knowledge of the exact state of the market as to items quoted, but will also present a basis to judge conditions as affecting correlating materials. Items marked (\*) indicate an advance over last week, while those marked (†) record a decline. Other prices did not fluctuate during the week.)

	New York	Chicago
<b>BRICK</b>		
(Delivered on job):		
Common (Delivered at job in Borough of Manhattan only), per thousand.....	\$17.85	\$12.00
Rough red .....	29.00	40.00
Smooth red .....	26.00	40.00
Rough buff .....	32.00	40.00
Smooth buff .....	32.00	40.00
Rough gray .....	38.00	42.00
Smooth gray .....	40.00	42.00
Colonials .....	24.00	30.00

	New York	Chicago
<b>BROKEN STONE</b>		
(Delivered on job):		
1 1/2 in. per cu. yd.....	\$3.25	\$2.35
3/4 in. per cu. yd.....	3.25	2.35

	New York	Chicago
<b>BURNED CLAY</b>		
(Delivered on job)		
Block partition:		
3 in., per sq. ft.....	.13	.10
4 in., per sq. ft.....	.15	.11
Chimney tops:		
12 x 12 for 8 x 8 flues.....	\$3.50	\$2.25
Flue lining:		
4 1/2 ft. x 13 ft., per lin. ft.....	.24	.12
4 1/2 x 8 1/2, per lin. ft.....	.18	.16
8 1/2 x 8 1/2, per lin. ft.....	.24	.16
8 1/2 x 13, per ft.....	.54	.20

	New York	Chicago
13 x 13, per ft.....	.46	.28
8 1/2 x 18, per ft.....	.54	.32
13 1/2 x 18, per ft.....	.70	.42
18 x 18, per ft.....	.90	.55
Wall coping (double slant):		
8 in., per lin. ft.....	.16	.14
12 in., per ft.....	.26	.18
18 in., per ft.....	.54	.30
Wall coping (single slant):		
8 in., per lin. ft.....	.16	.14
12 in., per ft.....	.26 1/2	.30
18 in., per ft.....	.54	.30
(Corners and angles four times the price of one foot of coping the same size.)		

	New York	Chicago
<b>Hollow Tile</b>		
(Delivered at job, in New York below 72nd St.)		
2 x 8 x 12 partitions, per 1,000 sq. ft.....	\$70.15	....
3 x 12 x 12 partitions, per 1,000 sq. ft.....	102.00	\$67.90
4 x 12 x 12 partitions, per 1,000 sq. ft.....	114.75	72.50
6 x 12 x 12 partitions, per 1,000 sq. ft.....	153.00	99.60
8 x 12 x 12 partitions, per 1,000 sq. ft.....	....	135.80
10 x 12 x 12 partitions, per 1,000 sq. ft.....	....	167.50
12 x 12 x 12 partitions, per 1,000 sq. ft.....	....	194.60
2 x 12 x 12 split furring, per 1,000 sq. ft.....	63.75	....

	New York	Chicago
<b>CEMENT</b>		
Per bbl. in 15 cent bags (Rebate 60c. per bbl. for bags) .....	\$3.25	\$2.80

	New York	Chicago
<b>COPPER SHEETS</b>		
At the mill, hot rolled, 16 oz. base-price, per lb....		
24c.*	24c.*	
(From jobber's warehouse add 2 to 3 cents. Cold-rolled add 1c. per lb. to hot rolled.)		

	New York	Chicago
<b>CORNER BEAD</b>		
Per foot .....	.05	.05

	New York	Chicago
<b>FIBRE</b>		
Per bushel .....	.30	.30

(Continued on page 868-B)



67  
P. 88  
9000-6

# The AMERICAN ARCHITECT

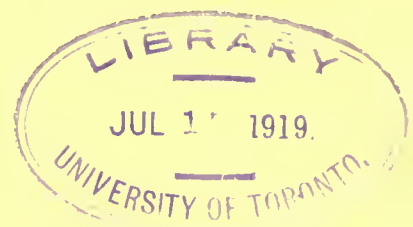

INTERIOR VIEW CHURCH OF THE SAVIOUR, VENICE

PUBLISHED WEDNESDAYS IN NEW YORK—FOUNDED 1876  
VOLUME CXV                      JUNE 25, 1919                      NUMBER 2270

Entered as second class matter January 6, 1909, at the Post Office at New York, N. Y., under the Act of March 3, 1879. Publication office, 243 West Thirty-ninth Street, New York, N. Y. Subscription price in the United States and Possessions, \$10.



# RAYMOND



## Why the Shell Must be Left in the Ground

To protect the soft, "green" concrete of the pile column against distortion by ground pressure, pressure of closely adjacent pile driving and the admixture of ground water or other foreign materials.

Every Raymond Concrete Pile is cast in place in a spirally reinforced steel shell. The interior of the driven shell may be inspected before concrete is poured into it. Thus you are CERTAIN that every Raymond Concrete Pile is perfect in the ground.

### Raymond Concrete Pile Co.

NEW YORK: 140 Cedar Street  
CHICAGO: 111 W. Monroe Street

*A Form for Every Pile—  
A Pile for Every Purpose*

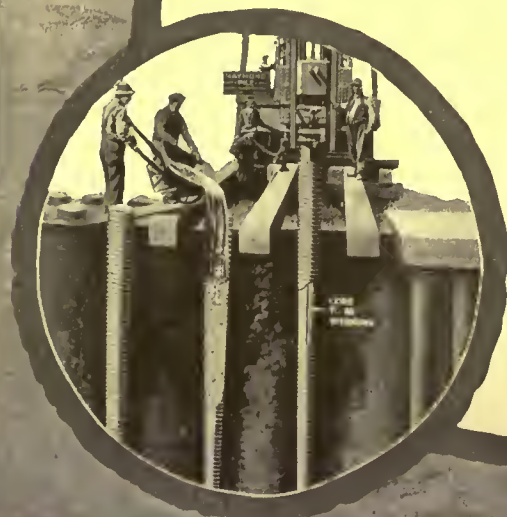





MAIN DOORWAY—CHURCH OF THE BADIA, FLORENCE, ITALY



# THE AMERICAN ARCHITECT

VOL. CXV

WEDNESDAY, JUNE 25, 1919

NUMBER 2270



A BRIDGE SPANNING A RAVINE

## Mill Creek Park, Youngstown, O.

By J. A. SCHWEINFURTH, *Architect*

"So far as natural beauty is concerned, there is no park in the country to compare with Mill Creek Park. It is as if a bit of choice scenery had been taken from the mountains of Switzerland and deposited in a level country." (The late Chas. Eliot, landscape architect of Boston, on viewing this park for the first time in 1891.)

"The existence of a tract comprising such a rare combination of attractive natural features in the immediate vicinity of a city is, so far as my experience goes, unparalleled elsewhere. The fact that for its whole extent it has been preserved from vandalism by those who have no conception of any other than a pecuniary standard of value, and finally the appreciation of its character and capacity for development, which has led to its being secured for all coming time as a resort for refreshment and enjoyment by all classes of citizens, are each and all subjects for congratulation \* \* \* and cannot fail eventually to confer a distinctive character upon your city as the possessor of a park so unique in the variety and beauty of its natural scenery that it cannot elsewhere be rivaled." (Written after visiting the park in 1893, by the late H. W. S. Cleveland, landscape architect of Minneapolis.)

**Y**OUNGSTOWN, Ohio, situated between Pittsburgh and Cleveland, is called the metropolis of the great iron and steel producing region of Eastern Ohio and Western Pennsylvania, better known as the Mahoning and the Shenango Valley. Where the iron tide

from the ore ranges of the North sweeps through this valley, with its coal, its limestone, oil and gas, Nature, it may almost be said, has located this great industrial city of Youngstown, the home of some of the most prosperous steel manufacturing companies in America. When it is related that dividends paid by companies operating in the Mahoning Valley in the fourth quarter of 1918 aggregated \$3,000,000—the largest disbursements on record—and Youngstown's payroll for 1918 reached over \$84,000,000, compared with over \$65,000,000 in 1917, one can gather some idea of the teeming life of this community, of its myriads of human workers, and their need of good living conditions and recreation. By day one sees a second Pittsburgh; at night the grandeur of the consuming gases from a hundred furnaces is a grand and moving spectacle never to be forgotten. Despite its dull and uninteresting aspect to the casual traveler, if he will visit the residential portion of the city upon both sides of the Mahoning River, he will find in its many attractive streets and homes a beautiful city, with marked evidences of a cultured and refined people. But its greatest attraction is not visible to

## THE AMERICAN ARCHITECT

the casual visitor as it lies hidden along the valley of an ancient stream.

It was a professional visit which took me to Youngstown in early September. Stepping out of a comfortable car in the early morning into a thick and clammy fog, I groped my way across the flat, looking in vain for a station. Not finding it, I inquired the way to the city, and mounting a long flight of plank steps soon emerged on a busy clanging highway, above the vast empty railroad yard below. At this early hour the streets swarmed with workmen, each with anxious tense face and his

the gray pall which is characteristic of cities of this class.

Business concluded, my client proceeded to show me the town. I had seen no signs of a park, and after a drive of about one and one-quarter miles from the Central Square of the city entered a simple roadway marked by no grand gateway—or sign post—and immediately found myself in the midst of wild nature, with the addition of the roads and bridges. Consisting of nearly 500 acres the section is now all included in the city limits, and by the skilful management of those in control, it has cost



VIEWS SHOWING DIVERSIFIED ASPECT IN PARK

faithful dinner pail, men or their descendants from all quarters of Europe, afoot and densely packed in huge trolley cars, hastening through the gloom to mill and shop, in that never ending pursuit.

Scanning the forbidding skies, it was concluded that a great storm was imminent, but this I later learned was no exception to the usual early morning atmosphere of the place. Indeed, before noon the conquering sun had devoured the clouds, the sky became clear, the sun shone with some constraint, the depression lifted from my soul, and I was enabled to attend more or less gaily to the affairs in hand. But over a part of the city still hung

up to date, including all its roads, bridges, etc., but \$850,000. Its dominating feature is its natural beautiful and picturesque scenery. One recalls many of the cities of the Continent of Europe which have waters flowing through them—and whose banks are lined to the water's edge with uninteresting rear walls or back yards; thus losing the opportunity which has been so well improved in Youngstown.

Mill Creek, from which the park takes its name, had flowed, ever since it came into existence after the Great Glacier, through a partly level country, on its way to join the Mahoning River, within the



## THE AMERICAN ARCHITECT

present city. During these years it has formed, in a picturesque valley, beautiful waterfalls, with meadows surrounded by cliffs and hills from sixty feet to one hundred feet in height. It is this ancient valley with its creek which has been preserved in its native wild state by Youngstown, as a place for the rest and recreation of its citizens, and it is these free, wild and untrammelled characteristics which make this park unique in America.

We reached at last a shady level with beautiful

utilitarian encroachment, and who first suggested the proper legal steps to preserve the beauties of Niagara intact; lover of trees, birds and flowers, and, as his whole life testifies, filled with a consuming desire to preserve the beauties of nature for the people.

About forty years ago, a young man who had but lately been admitted to the bar located in Youngstown. A lover of nature in all its forms, in the wanderings which all nature lovers find necessary,



LAKE GLACIER

green and gold vistas, blue hazy distances seen through mossy tree trunks, where picnic preparations were in progress for some of the workers we had met in the early dawn. It was a setting that a Sargent would have immortalized—or by which a Manet might have been inspired to paint "A Picnic." As we rested here, my friend told me the story of this park—and its creator, Volney Rogers, City Attorney of Youngstown for two terms, author of the Township, Park, and other Laws of Ohio; one of the earliest, most active and effective movers in the effort to preserve Niagara Falls from

he explored Mill Creek Valley, finding it wild, like a mountain gorge far from the haunts of men. There were a few meadows and level areas of grassland here and there, the hillsides and the banks of streams being covered with indigenous trees, shrubs, ferns and flowers. Thereafter, during the years of his law practice he came here to rest, to revel uninterrupted in the scenes he loved, and often to secure quiet for the study of his law cases. So much impressed with its charm was he, that he dreamed of the time when its influence should be brought into the lives of the thousands of busy



## THE AMERICAN ARCHITECT

workers of his city, for every lover of nature wishes all others to share his love. From this time on through all the years, he has devoted his life to making this dream come true. To convince the citizens of its value as a park for the people so that they would appropriate money for its acquirement and maintenance, and often going into his own pocket for the money to acquire a valuable addition when circumstances rendered it imperative; to arrange all the details of its financing, of law, to defend it at the bar, to serve on the Board of Park Commissioners, and make this park what it is today, has been his devoted life work. As Park Com-

ment in various forms through all these years, he has used his legal ability to defend its very existence, appealing to courts and to legislatures in its defense. The City of Youngstown tried some years ago to take the park for water supply purposes, having a bill presented to the Legislature authorizing such use. Rogers opposed this before the House and won. Next a referendum was demanded, and Rogers again opposed such use for the park, and the people voted against the water proposition and have until now kept their park intact. Mr. Rogers' work is not yet done, however, for it is now threatened by a proposal to use the



A NATURAL FALL ON MILL CREEK

missioner he would build a dam across this valley to form a lake; throw a superb stone arch of noble span across this ravine, sweep a magnificently curving road across that meadow, remove a few dying trees here to make a charming vista; build a shelter there for refuge from storms, a bathing beach here, and a boat house there. He worked like a great landscape architect, using valleys, hills, waters, trees, sky and air for his medium. To do this, and to be able to convince a people that it was good, so good that they would be willing to be taxed for it—such was the Cyclopean task he undertook—and accomplished.

When threatened with the dangers of encroach-

ment in various forms through all these years, he has used his legal ability to defend its very existence, appealing to courts and to legislatures in its defense. The City of Youngstown tried some years ago to take the park for water supply purposes, having a bill presented to the Legislature authorizing such use. Rogers opposed this before the House and won. Next a referendum was demanded, and Rogers again opposed such use for the park, and the people voted against the water proposition and have until now kept their park intact. Mr. Rogers' work is not yet done, however, for it is now threatened by a proposal to use the

the scenery he created, where he loved to linger, while he was laboriously making the dream of his early manhood come true.

Before leaving the city, my friend showed me pages 298 and 299 in "Chas. Eliot, Landscape Architect," written by his father, Chas. W. Eliot, from which I quote:

"The park at Youngstown, Ohio, was thus described by Charles in a note to his wife: \* \* \* 'A

fine river glen with numerous side ravines and some cliffs, a really good reservation, and the work of a single energetic young lawyer, an enthusiast, and he has done a fine thing.'"

On page 301 the father quotes from a letter from his son to the Park Commissioners of Youngstown:

"Your gorge is one of the finest park scenes of America, and deserves most careful handling; and all who work in or for it have my very best wishes."

## Mapping by Airplane

**J**UST how far the science of photography will be applicable to the production of topographic maps is a subject now engrossing considerable attention among aviators. When one considers the wide variety of purpose in map-making, the differences in aerial camera construction, and the many details involved in this work, it will be readily realized that many problems present themselves for solution.

J. B. Mertie, Jr., associate geologist of the United States Geological Survey, has gone thoroughly into the ramifications of this subject, and some of his conclusions are now printed.

To begin with, maps are of various kinds, are made in various scales and with different degrees of accuracy.

Thus there are recognized exploratory, reconnaissance, detail and ultradetail maps, ranging from scales of 1:1,000,000 or smaller up to an extremely large scale, and on, still farther, to natural-scene maps or even maps that are magnifications of the objects shown. Also, there are plan maps and relief maps, the former showing natural and cultural features and the latter indicating, by means of hachures, contour lines or other means, the regional relief. Likewise, there are timber maps, geologic maps, soil maps, and other special kinds. The most generally useful map is the modern topographic map as now produced by the Geological Survey, which shows all natural and cultural features, including also timber areas, and indicates also by means of contour lines the relief of the terrain. The production of such maps, at scales of from 1:250,000 up to 1:62,500 is the present aim of most workers from the air.

A photograph of a plane and horizontal surface taken from the air upon a photographic emulsion held parallel to the plane of the horizon is a true map. The lens has acted merely as a point of projection connecting one plane with another, and of

course the scale is dependent both on the distance of the lens from the ground and on the distance of the photographic plate or film from the lens.

Any relief upon the surface of the object photographed, however, or any inclination between the plane of the ground and the plane of the plate, or film, vitiates at once the results and necessitates the making of compensating corrections. As a matter of fact, the surface of the earth shows everywhere more or less relief, and also in actual practice it has not yet been possible to hold an airplane camera in a truly vertical position, though some schemes reduce the deviation very materially. But both causes of error are present, and both must be recognized and corrected. It has been the practice of some workers to take a series of pictures from the air, fit them together into a photographic mosaic, ignoring the two sources of error just mentioned, and to call the resulting product a map, or a mosaic map. In truth, it is neither, but only a series of pictures showing distortion, differences of scale within the individual picture as well as between them, and lack of geodetic control, which are fitted and fudged together to present a pleasing appearance. While this has many uses, certainly it is far from being a map and should not be considered as such.

The modern topographic map presupposes an accurate plan map upon which the contour lines may be drawn. It is possible to derive both the plan and the contour lines from aerial pictures, provided the necessary data are given, but, states Mr. Mertie, it is impossible to make either of them from uncontrolled pictures fitted together in mosaic form.

Opinions appear to differ on this point, however. Lieut. M. C. Lawson, in a recent address before the second Pan-American Aeronautic Convention, maintains that the map of the future is the air mosaic. "Whether it be the military map, the automobile road map, or a map of air routes, the only



## THE AMERICAN ARCHITECT

absolutely accurate information of the terrain, the roads, the elevation of towns, cities, and all topographic features, is the minute mosaic, the map produced by detail pictures snapped from the airplane, of any given territory. The Government already has begun using aviators in making a map that is to cover every inch of territory in the United States.

"This is a stupendous undertaking. It probably will require years of hard work and application, but its military and commercial value, once completed, will be unlimited."

"To realize the seriousness of the stability problem," says C. H. Calvin, a pioneer in the invention of safety devices for airplanes, "we have only to refer to a recent report of the United States Air Service. Out of 274 fatal accidents reported, in which the cause was known, 178, or 65 per cent, resulted from loss of control, due to the plane getting into unstable positions, side slips, skips, nose dives, stalls, and tail spins. I believe stabilizers, particularly of direction, will come into general use, and will be found highly advantageous on large commercial and mail-carrying planes.

"In flying a plane, fully 75 per cent of the pilot's energy is devoted to keeping the plane on its course."

The diversity in types of cameras also carries with it obstacles in consistent work. A large variety of aerial cameras has been designed and manufactured, both in this country and abroad, and it is safe to say that none is truly universal in scope. Nor should they be, says Mr. Mertie. They have been made to fulfill a variety of purposes, including scout photography along the battle line, more accurate and adequate photography from larger battle-planes, surveying cameras for peace times, cameras for pictorial aerial photography, and others. There have been automatic and nonautomatic types, equipped with various lenses and various types of shutters, and made to take plates or films or both. Multi-lens cameras have also been built.

Finally, with regard to photo-topographic surveying in general, certain facts should be more widely recognized, writes Mr. Mertie. In the first place, the making of topographic maps is a specialized science, and is a subject which is not mastered except by prolonged practice. Photo-topography is only a phase of the general science of cartography, and the cumulative results of long experience are just as valuable in photo-topographic mapping as in any other method. The laying out of projections, the subject of triangulation and control, with the consequent computations, the theory and practice of adjustments, and other matters familiar to

the topographic engineer, are equally applicable and necessary in photographic surveying. In other words, the making of maps by photography or by any other method should be the work of experienced engineers.

Correlative with this idea is the other that photographic practice is rather of subordinate importance. By this, the writer does not mean that the phototopographer should neglect the photographic side of his work, for good pictures are most desirable, though the quality of the map is not necessarily dependent on the securing of perfect negatives. The idea to be emphasized, however, is that the finest pictures may be entirely useless unless accompanied by the necessary engineering data; while, on the other hand, poor pictures if properly controlled may make a perfect map. The experienced phototopographer attempts to get the best pictures possible, but judges his work by the quality of the finished map and not by the pictorial quality of the pictures from which the map is made.

Summarizing, it may be said that photographic surveying from the air is both possible and practicable. No new principles are involved, but methods and apparatus other than those used in photographic surveying on the ground are needed and are gradually being studied out and developed. It has been shown that the production of an accurate plan map in an area of any considerable relief is intimately connected with the production of the much desired contour map, and that the latter will be produced with little more labor than the former. In areas of low relief, of course, the plan map can be produced as soon as perfect horizontalization becomes an accomplished fact.

The crux of the whole problem lies in horizontalization, and the most pressing need of the present moment is either a completely stabilized airplane camera or a successful attachment which will record the direction and amount that the camera deviates from the true vertical. Also, it should be clearly understood that map-making is an engineer's job, and that pretty pictures do not necessarily make the perfect map. Finally, although maps made by air surveys remain a development of the future, yet we may confidently look forward to an early solution of the various problems involved.

While in the beginning, the cost may be so great as to offset the advantage in time saving that is claimed for the proposed methods, yet this, too, will resolve itself into simpler and more practicable processes. Mapping by airplane, when extensively adopted, will serve to introduce a spirit of adventure and a lively interest into what is now a tedious and ungrateful operation.



# The Meaning of Architecture

ARCHITECTURE probably conveys as many meanings as there are individuals capable of receiving a message from it. These messages comprehend the entire gamut of those emotions which architecture can evoke and they may be segregated into groups. They range from the purely material messages which includes only the idea of shelter from the elements, to the message which exalts and gives the highest degree of pleasure to the observer through his ability to appreciate the meaning of the form, proportions, details and colors of the structure. Every person receives an impression from observing a structure, while probably but few have reduced these impressions into a concrete expression of the meaning of architecture. As truly as this applies to laymen, so truly does it apply to architects. To attempt to interpret and define the meaning of architecture is a task not to be undertaken without close study of the contemporaneous history of the peoples who developed architecture. In addition to this, mature deliberation and the attempt actually to evolve the architectural meaning of work already constructed, better fit one to attempt the interpretation. The bibliography relating to this subject is very limited, and the advent of such an expression by means of the written word and illustrations is an event of interest and importance. It is with an appreciation of this fact that one reads Mr. Pond's book.

The introductory chapter, treating of the animating spirit which is the basic motive of all human effort, is followed by eleven chapters in a logical development of the theme. The concluding chapter is devoted to the author's individual application of the theories advanced. The animating spirit he describes as the desire to attain the ideal. If this attempt to achieve beauty—to encompass the ideal—is art, then beauty is the individual's conception of perfection. This animating spirit leads to the development of architecture. Mr. Pond's definition of art and architecture reads: "Art is the expression, in terms of beauty, of a reconciliation to the struggle of life; just as a working definition of religion is that it is an expression, in terms of goodness, of an acceptance of the conditions which environ existence. The definition of art is frequently condensed into: Art is an expression of life. But art is all that and more; for to be art it must be the ordered and unified expression of an

ideal which life holds. Architecture, as a phase of art, is an expression in building of that idealism which is capable of translation into structural terms; that idealism which may be realized in an interpretation of the laws governing structure; an idealism which may find in terms of structural force a deep symbolism of its own true essence."

Under this definition, a building is not architecture just because structural laws have been obeyed, but because underlying and directing its structural expression is an ideal. A building is not architecture merely because it symbolizes some great vital factor of life, such as a religion or a philosophy, or any great intellectual or spiritual concept, but because it symbolizes or expresses it in objectifying the inhering structural forces.

This definition is in accord with the modern idea that architecture and engineering are inseparable and that the exact limits of each are incapable of being definitely established. The idea that architecture is merely a matter of pure design, to which the engineer applies his ingenuity to the utmost in order to achieve stability, is directly contrary to the meaning of architecture as here defined. This definition will disturb those whose procedure is guided by habit and whose idea of architecture is the application of the details of the architecture of past ages to modern structures regardless of the function of the building. "Habit is life in the brute creation," states Mr. Pond, "but habit in man has been aptly denominated 'The soul's tomb.' To what depths then have fallen those whose architectural existence is a habit and this habit the mere application of "perfectly good precedents?"

The architecture which is the result of the animating spirit, is analyzed and its meaning explained and compared with the decadent architecture of the past and present times. The ideas expressed in this book have been severely criticized by some, apparently for the sole reason that they do not conform to certain accepted habits. But the arguments of some of the critics are valueless for the simple reason that they have not, by their own activity, engaged in the development of architecture through actual work performed. The personal application of the meaning of architecture by the author to his work is, of course, an individual expression. If the reading of this book will induce others, in large numbers, to make the effort to express a worthy meaning in their work, rather than the offspring of habit, there will be developed

\*The Meaning of Architecture, by Irving K. Pond, C. E., A. M. (Hon.), Architect. Member of the National Institute of Arts and Letters, Fellow and Past President of the American Institute of Architects. Cloth, 5½ x 8, 226 pages, illustrated with drawings by the author. Price \$2.00 net. Marshall Jones Company, Boston.

## THE AMERICAN ARCHITECT

an architecture which will be truly modern and American. This will be the amalgamation of the individual efforts which will have merit and virility sufficient to justify their future development.

"If the underlying principle be sound, and the forms in which it is given æsthetic expression be valid, then others may and will use these forms in their individual efforts to solve the problem of communal expression. Such use is perfectly legitimate and is in the nature of creative, constructive effort rather than after the nature of imitation. Certain strong individualists of our day have charged their own "disciples" with being imitators because, forsooth, these same disciples were employing the "master's forms"! If the master's forms are specious forms, based on personal idiosyncrasies, their use by another would, indeed, be in the nature of unjustifiable imitation; but if the forms are the æsthetic clothing of a living idea they belong to the race, and one who did not debase them but who employed them rightly was in so doing assisting in a legitimate act of creation. A "master" will realize that the vital spark within him did not come from himself, but from the race.

and should therefore be freely given to the race."

To those Americans who have the ability to sense the communal spirit of the various regions of this country, this book will appeal as a *motif* in the overture which precedes the development of that American architecture which will be typical of this country. In this the influences of the Mississippi Valley region, that great valley of democracy, the heart of the nation, will dominate. It is so far removed from the close contact with other countries and is so lacking in precedents, that American logic, artistic instinct and common sense will prevail.

The book is written in a clear and pleasing style, approaching the epigrammatic at times. The influence of Mr. Pond's early engineering education and experience is in evidence in his clear and logical analysis of the subject, resulting in an impression of the reasonableness of his deductions. It has a place in the reading of the architect and those whose knowledge embraces an understanding and appreciation of the fine arts. Carefully studied by the broad gauge engineer it will bring to him an appreciation of certain responsibilities that he owes to himself and to the public.





# Building for the Colonial Trust Co., Philadelphia, Pa.

ALFRED E. BOSSOM, *Architect*

(For Exterior Views and Plans See Plate Section)

THE Colonial Trust Company, at the corner of Thirteenth and Market Streets, Philadelphia, Pa., occupies the corner in that city where more people pass in twenty-four hours than any other. The site, which is only approximately 45 by 118 ft. was valued, when this building was erected, at near to a million dollars, and the problem was as to how to develop this piece of real estate and get a revenue from it commensurate with its value.

The high cost of building made it essential that the utmost economy be exercised, for with the original value of the land so great, an exceedingly expensive building would have made it impossible to get a profit. Another problem was to provide enough rentable area so as to acquire sufficient square footage to produce a suitable return.

Figures were obtained on this building in steel construction, upon an entirely reinforced concrete construction, and also upon a compromise between the two, using steel in certain portions of the ground floor and reinforced concrete for the remaining twelve stories.



DETAIL OF BRONZE BANK RAILING

Here again reinforced concrete, although saving nearly fifty thousand dollars in the cost of this building, might have caused the piers to become altogether too large (had they been designed in



DETAIL OF WALL IN BANKING ROOM



accordance with the most economic ideas for concrete pier construction) that they would have made the offices totally impractical.

Consequently it was decided to permit the wall piers to be an uneconomical section for the concrete column, that is, long and narrow, but by so doing the very maximum amount of floor area was obtained in the building, thus producing a very handsome return upon the investment.

This building, thirteen stories above the sidewalk, is, it is understood, the tallest reinforced concrete office building that has been built here in



VAULT DOOR

the East, and it has proved the statement that an office building of this height could be built on very valuable real estate and made a financial success.

The general architectural style of the building is a modified Colonial, the building having a limestone base for the lower story and a hydraulic pressed brick above, broken up at intervals with decorative terra cotta string courses and crowned with a hipped roof resting upon a very suppressed Colonial cornice and balustrade at the twelfth floor ceiling level.

In the design of this building it was essential that it be made so that it could hold its own against the very monumental building opposite, which is the John Wanamaker granite department store.

This determined the selection of the color of the building. It was made light to contrast with the dark granite opposite. It was given a pointed roof to make it totally different from any building near it. A very large amount of window space was given so as to make the offices, which were rather big, as light with daylight as they possibly could be. In fact every attraction, both actual and artificial, which could be introduced into the building was incorporated, and the result has been that the former owners of the building, when the building was completed, were approached by a syndicate who purchased the complete undertaking from them at a very handsome profit, and who have in turn a most satisfactory investment.

## Architectural Causerie

THE FIRE PLACE IN ALL AGES

MY thoughts last evening centered upon the future of the fireplace, which, in all ages in this country, has been counted among the great joys of home life if not as the chief symbol of domesticity, as it is of hospitality, writes "Aero" in a recent issue of *The Architects' Journal*, of London. The round-arched fireplaces of Norman keeps, the hooded fireplace in the Guest Room at Netley Abbey, the flat-arched types at Tattershall and Eastbury, together with those of more recent date at Hampton Court, Portland Place, and Gower Street came to my recollection. I was perplexed with the variety. Knowing them all to be good, I could arrive at no satisfactory decision as to which was the best. Besides, I was tired and not a little perturbed by the remarks of an impudent fellow who earlier in the day had bluntly stated "that fireplaces were fast going out of fashion," and that he intended his new house to be free from such encumbrances.

\* \* \* \*

While ruminating on the subject it came to my mind that the future would, indeed, bring about some limitation in the number of fireplaces to each house, but nothing less than a complete transformation of an Englishman's soul could induce him to part with the most ancient feature of his home setting. For whatever convenience may accrue from the installation of central heating gas stoves and portable electric radiators, nothing could equal the charm of a wood or coal fire. This morning, far distant from the scene of my ruminations, I am at liberty to take my readers into my confidence, and state my feelings. Last evening, having reached my northerly retreat and supped, I closed the shutters in the living room, and piled fresh wood in the grate before settling down to read some designs by Blondel. The room was cheerful, the Empire can-

delabra ablaze with wax lights, the dark furniture catching and reflecting the darting flames, the pattern of the Aubusson carpet seemed formal and correct. Yet, notwithstanding the setting, such was my mood that I longed for surroundings the very antithesis of those arranged for my pleasure. The fact is, those who have the making of houses and the design of furniture in their charge can never hope to be satisfied, for the moment they indulge their fancy in pleasant imaginings, the joy of being at home in comfort vanishes, and they long to be elsewhere, perhaps on account of the added joy of returning to familiar luxury; for man is a perplexing creature, and over-prone to paradox.

\* \* \* \*

If there is one fireplace that delights me more than any other it is that in the kitchen of an inn or a farmhouse. The pages of my sketch books contain many representations of those chanced upon in distant parts of the country. With me the search for homely kitchens with firesides of goodly proportion has become a craze, and rarely is the privilege denied when I request to view the kitchen. Let it not be imagined for a moment that I am collecting data for the improvement of cooking, although conscience tells me that such research should be my office. A greater purpose is open to me, for during cross-country ramblings the discovery has been made that people removed from towns spend the greater part of their existence in the kitchen. The joy of the inn kitchen was well known to Fielding during his journeys between London and Somerset, which he induces Parson Adams to describe in the adventures of Joseph Andrews. Mr. Pickwick had a passion for conviviality and cheer in front of the kitchen fire, and although the kitchen of the Saracen's Head at Worcester now forms the bar I doubt not that its precincts are haunted by the shades of Pott and Slurk.

The kitchen in the country is the traditional common room. All meet there on an equal footing to witness the preparation of good cheer and the offerings smoking over the fire like incense fuming on the altars of Greece. In Cornish farmhouses a long table is arranged near the window, at which those employed on the land sit for meals. In Hertfordshire the kitchen is used as a species of hall, and I question not but what other special functions of country life, such as feasts, merrymakings, and reunions, common to every county, would be thought out of place if they were performed in any other room. The kitchen becomes again a hall. Formerly, let it be understood, the kitchen of the farmhouse reflected the squire's parlour, many such being fitted as living rooms. There were racks for guns over the fireplace, all sorts of cooking ap-

pliances forged by the local blacksmith, clockwork jacks for roasting, fire backs burnt and pocked with the heat of centuries of wood, high-backed settees to exclude the draught, and brick floors scrubbed and sanded. The fitted dresser, the table with columned supports, and the corner cupboard with its glazed door, complete the list. But the fireplace formed the chief attraction.

### A Housing Policy for Wales

**M**R. CHARLES T. RUTHEN, F.R.I.B.A., read a valuable paper before the Society of Architects on "Housing and Planning; a National Policy; with Special Reference to Wales."

While housing in its generally accepted sense, he said, should be good housing, in its little understood sense it meant the "scheme of lay-out"; the placing of the home in its proper and rightful place; the public housing of the community as well as the private housing of the individual citizen, the commercial and industrial housing of the worker.

It had been said that Nature had been unkind to Wales in her treatment of the surface, but her great valleys and mountain sides should rather be regarded as a splendid opportunity of terracing the dwellings of the people upon a scheme impossible where land is flat. In a well-considered plan the undulations of the surface permit most of the homes of the workers being built upon the southern slopes, each home having its own place in the sunlight with an outlook over the valley to the hill-sides or moors on the opposite slopes.

But the great mining populations had been crowded together in the narrow, once beautiful valleys, hemmed in on both sides by high mountains. The dwellings of the workers were huddled around the grimy surface works of the great collieries, in disordered masses, and the view obtained from the homes of the toilers was a jumble of dismal plant and barren spoil heaps, with their encircling railway lines.

In many of the important hilly districts of Wales future improvements and developments were rendered almost impossible by disconnected and disjointed planning. It was of the utmost importance that regional planning on a most extensive scale should be adopted for linking up upon national lines a chain of well-considered town planning schemes.

There would be required in Wales 75,000 houses in the towns and 25,000 in the country. If the blunders of the past were to be avoided, all these houses should be erected under town-planning schemes.

The control of the national regional planning



## THE AMERICAN ARCHITECT

would necessarily have to be undertaken by some central body, say a Welsh Town-planning and Development Commission, which should take over much of the authority exercised by the Local Government Board, and should be a small body of experts of great experience in town-planning houses and industrial problems. By a very little extension of the principles already agreed to by the Government, a Welsh Town-planning Development Commission with fairly considerable powers would bring housing and planning in a national sense under control.

### Masonry in Ancient Times

THE largest pyramid, writes M. T. Cantrell, in a west Canadian paper, was erected about 4,700 years B.C., and is said to have employed 100,000 slaves for 30 years in its construction. Its base was 764 feet square. It was originally 480 feet high and weighed about seven million tons. The immense amount of work its construction involved can be more readily realized when we consider that it contained sufficient material to build a city of about 20,000 houses the size of an ordinary apartment block, or to build a great wall from Cairo to Quebec, or if the stone was cut into one-foot cubes and placed together the line thus formed would extend about 17,000 miles, or about two-thirds round the earth's circumference at the equator. Many of the stones weigh between 40 and 60 tons. The granite blocks roofing over the central chamber are nearly 19 feet long by 3 to 4 feet deep and 2 feet wide. These were worked so true and were so close jointed that it is said to be at the present time almost impossible to insert the blade of a knife into a joint. The accuracy to which the stones were worked and bedded is further evidenced in the fact that there is an average error in length of only one in fifteen thousand, and even less in angle. The geometrical perfection is considered to be a marvel even in these times.

Another example of accuracy of this age of masonry is that of the granite sarcophagus of Senu-sert II, which was built with an average error in straightness and parallelism of less than seven

thousandths of an inch. Even at the present time it is a mystery how such perfect work could have been accomplished. It is known that saws and rock drills, which were set with hard stones, also drills of stone fed with sand or emery, were in use prior to the building of the pyramids, but no tools or appliances such as we now have were invented in those days. The ancient builders had no lifting machinery which is now indispensable, and yet blocks of stone much larger than we now use were truly worked and often raised and carefully bedded at great heights. Among the ruins of the temple of the Sun at Baalbec, in Syria, are the largest squared stones yet used in a building. In one wall about 20 feet above the ground there are three blocks each over 63 feet long and 13 feet high still bedded in the wall. The width is unknown. In a near quarry, from which these stones are supposed to have been taken there still lies a stone hewn, but not entirely separated, from the bed rock, 14 feet by 17 feet and 69 feet long, its weight over 1,300 tons. How such immense stones were handled is still and unsolved puzzle.

The ancient Babylonians invariably used brick for their buildings, the staple industry of the country being brick-making. The country possessed neither stone nor suitable building timber, but sufficient of the latter was generally obtained for columns and piers, which were of cedar imported from Amanus or Lebanon. When cedar was not obtainable, brick was used. The Assyrians, after the Babylonians, continued to use brick, but they imported alabaster and limestone from the mountains north of Nineveh. Important buildings were faced with this material similar to our modern work, the limestone being used for plain facing and the alabaster for carving. From that time on to the height of Greek civilization the working of stone developed into the fine art of which so many splendid examples still exist in ancient Grecian architecture and sculpture. The same can be said of the Romans, since which period the art has improved only in the speed with which the work is executed, this being due to modern improvements in tools and the invention of power-driven machinery for the working and transportation of the stone.



# THE AMERICAN ARCHITECT

Founded 1876

PUBLISHED EVERY WEDNESDAY BY

THE ARCHITECTURAL AND BUILDING PRESS, INC.

No. 243 West Thirty-ninth Street, New York

E. J. ROSENCRANS, PRESIDENT AND TREASURER

WILLARD C. HOWE, VICE-PRESIDENT

WILLIAM H. CROCKER, Editor

EDWARD F. HAMMEL, Engineering Editor

ARTHUR T. NORTH, Western Editor

Subscriptions in the United States and Possessions,  
Mexico and Cuba, TEN DOLLARS. Other Countries,  
TWELVE DOLLARS.

SINGLE COPIES (Regular Issue) 25 CENTS

CHICAGO OFFICE, Mallery Building  
PAGE A. ROBINSON, Western Manager  
ST. LOUIS OFFICE, Wright Building  
CLEVELAND OFFICE, Guardian Building  
SAN FRANCISCO OFFICE, 320 Market Street

Owned by United Publishers Corporation—H. M. Swetland, President;  
Charles G. Phillips, Vice-President; W. H. Taylor, Treasurer;  
A. C. Pearson, Secretary. Entered as second-class matter January  
6, 1909, at the Post Office at New York, New York, under the Act of  
March 3, 1879.

VOL. CXV

JUNE 25, 1919

No. 2270

## The New York State Association

THE new association of architects recently formed in New York State, the announcement of which was made in our issue of June 18, is founded on principles more democratic than any other at present in existence in this country. This organization is really an attempt to develop an architectural guild, since it is to include, if possible, everyone within the State engaged in the vocation of architecture. Employer and employee are to be members, side by side, a democratization of membership leaving nothing to be desired.

From the west coast we hear of draftsmen organizing in unions affiliated with the unions of skilled trades. It is reported in our news columns in this issue that draftsmen in the Federal Departments in Washington are seeking affiliation with the American Federation of Labor.

If the scheme proposed for the New York State Association of Architects is successful, there would seem to be no need for separate organizations of architects and draftsmen. They would all find themselves in one organization co-operating for the establishment of right relations within the vocation and for progress and better service in the relations of the vocation to the public need for its service.

The principle involved is one that has been successfully in force in the guilds of Europe for

centuries. It affords a common basis of interest for every man who shall seek to practice architecture and it eliminates all class or factional sentiments. The result will be watched with a great amount of interest.

For more than a year, THE AMERICAN ARCHITECT has stoutly maintained that in the formation of State Societies in all the States, and their ultimate federation, would be found the solution to the successful rehabilitation of the profession. These societies will in no way conflict with the well conducted activities of the Institute, and if formed after the admirable scheme of organization of the New York Society, will in the most successful and valuable way supplement the work of the Institute and its Chapters in a manner that will be truly representative of the profession of architecture all over the United States.

## Building Conditions Are Improving

AN analysis of a questionnaire sent by the National Federations of Construction Industries, to the leading construction industries and related interests in the United States, confirms the fact that during the past few weeks general business conditions have greatly improved.

A preponderance of opinion supports the view that the present price level is here to stay for an indefinite period of time. Many replies received strongly express the opinion that prices will go even higher.

As an incentive to a quicker return to normal building conditions it is urged in a number of instances that the government should promptly act in extending loans for housing construction, and further, by proceeding with all public works thus far authorized.

Another suggestion is that urging on the part of the government a campaign to demonstrate to the public that present prices are practically permanent.

The building interests of the country are, it is believed, thoroughly competent to bring all matters affecting construction to a safe and speedy solution. In order to accomplish this, those interests will best function which are freed from all governmental interference or control. A very large group of replies to the questionnaire referred to, reflect this opinion by stoutly urging the return to their owners of all private property, now and for some time past under government control, and the complete discontinuance of war-time administration of private business.

The Guaranty Trust Co., in its weekly bulletin on business conditions, states that there have been

## THE AMERICAN ARCHITECT

few periods since the signing of the armistice when the usual indicators of business conditions were more favorable than at present. The tremendous demand from Europe and other countries for American products, and the astonishing condition of wheat and other crops, is imparting an optimistic tone to our whole industrial life. With conditions presaging so great a period of prosperity, it is evident that we can only move forward to our great future when all the many restrictions, which were imposed during the war, and for which no good reasons now exist, are absolutely removed.

### The Post Office Building in City Hall Park

NO one qualified to judge a work of architecture would attempt to justify the retention of the old post office building, which for more than half a century has reared its disfiguring mass on the southern end of City Hall Park, New York.

Architecturally ugly, inconvenient and ill-arranged, it has stood for all its years a reproach to its neighborhood. Periodically there has been demand for the removal of this structure, and recently the Board of Estimate has unanimously adopted a resolution looking toward the accomplishment of this desirable end.

The site of this old building is the property of the Federal Government, but under the terms of its contract with the municipality, if the Government should abandon the building for its present purpose, the city would merely be compelled to return the \$500,000 it received for the site when the building was erected. If this great improvement can be effected at so small a cost, it will be a transaction to which undoubtedly every taxpayer will give quick approval.

With the Mullet Post Office removed and the site restored to the park, the beautiful Georgian City Hall would then have a fitting setting and there would be created a civic center that would become the most beautiful on Manhattan Island. There is no present need of the large post office facilities that

this building affords. The new general post office opposite the Pennsylvania Terminal and the important substation in the Terminal Building have greatly reduced the necessity for space in the old building. Aside from the fact that the Federal Government uses the greater part of the space for its federal courts, the Mullet building may be said to have outgrown its usefulness.

As it has nothing architecturally to recommend it, and as it disfigures what could by its removal be made a dignified locality, it is desirable for the artistic growth of the city that the municipal authorities and those of the Federal Government come to an agreement that will early rid New York of an architectural monstrosity, and return City Hall Park to its erstwhile impressive aspect.

### Solving Housing Problems in New York

THE New York State Legislature is to be commended for its recent enactment to conserve the rights of renters and curb the propensities of rent profiteers. Further, its action is commendable as very materially opening the way for a quicker resumption of building operations.

Under the new law four story and basement private houses may be altered into tenements for four families. The result of the removal of restrictions as to this form of remodelling is generally apparent, and in no location more than in the upper west side and Riverside Drive sections. Private houses that have long been vacant are now being turned into so-called studio apartments, and promptly rented, often before the completion of alterations.

Another feature of remodelling is the changing over of numbers of the earlier types of apartments with their many and large rooms, into smaller groups with smaller rooms.

The savings banks are now permitted to make more liberal loans, thus making possible the resumption of this class of remodelling and building. Such admirable legislation will certainly stimulate building and serve in a measure to relieve the present acute housing shortage on Manhattan Island.







PLATE 207

BUILDING FOR THE COLONIAL TRUST CO., PHILADELPHIA, PA.

ALFRED C. BOSSOM, ARCHITECT





THE AMERICAN ARCHITECT

JUNE 25, 1919

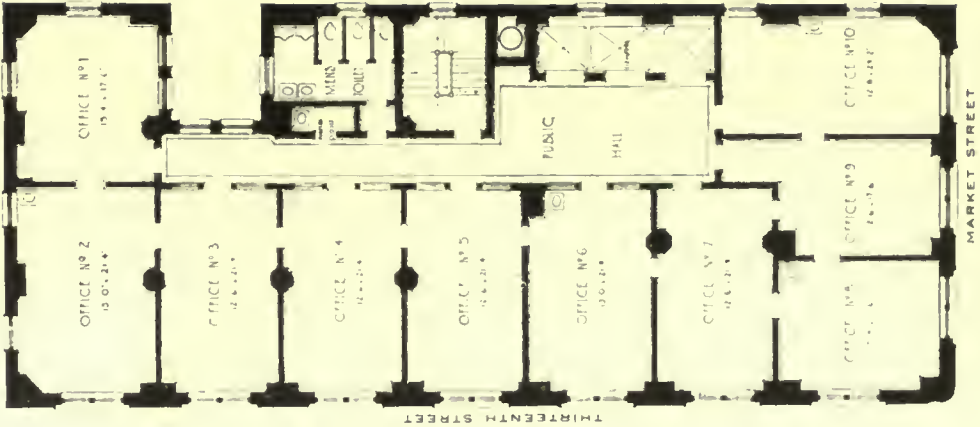
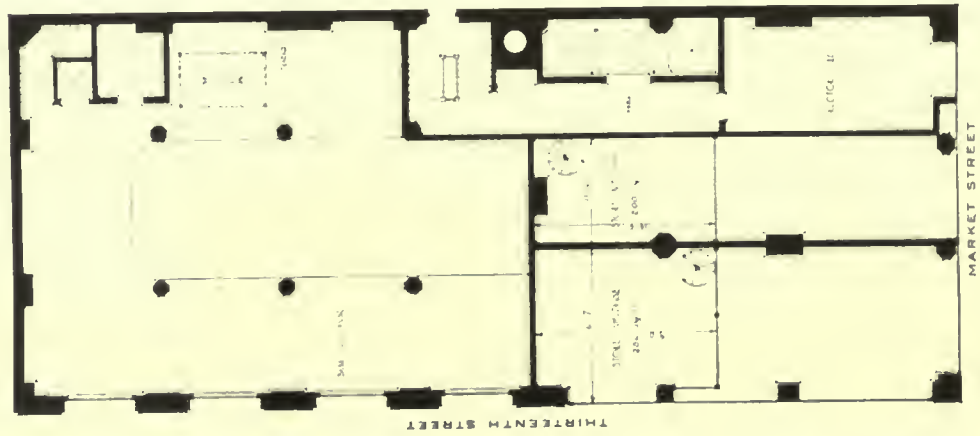
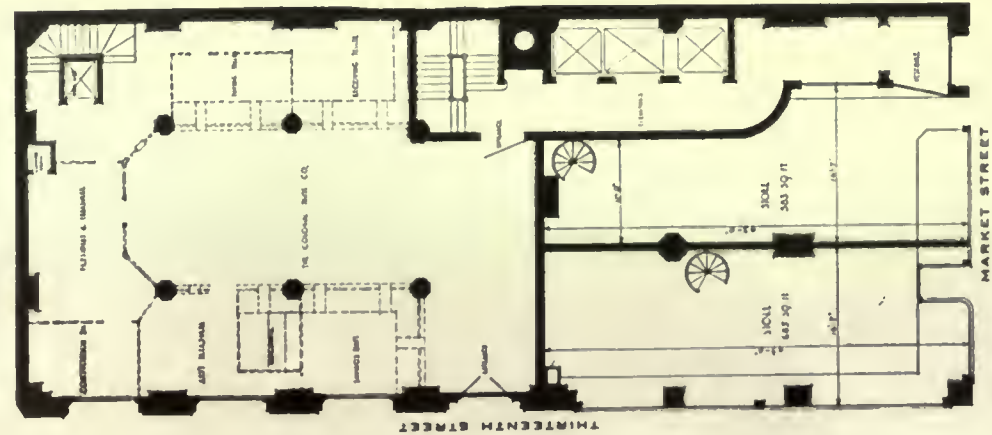

BUILDING FOR THE COLONIAL TRUST CO., PHILADELPHIA, PA.

ALFRED C. ROSSOM, ARCHITECT





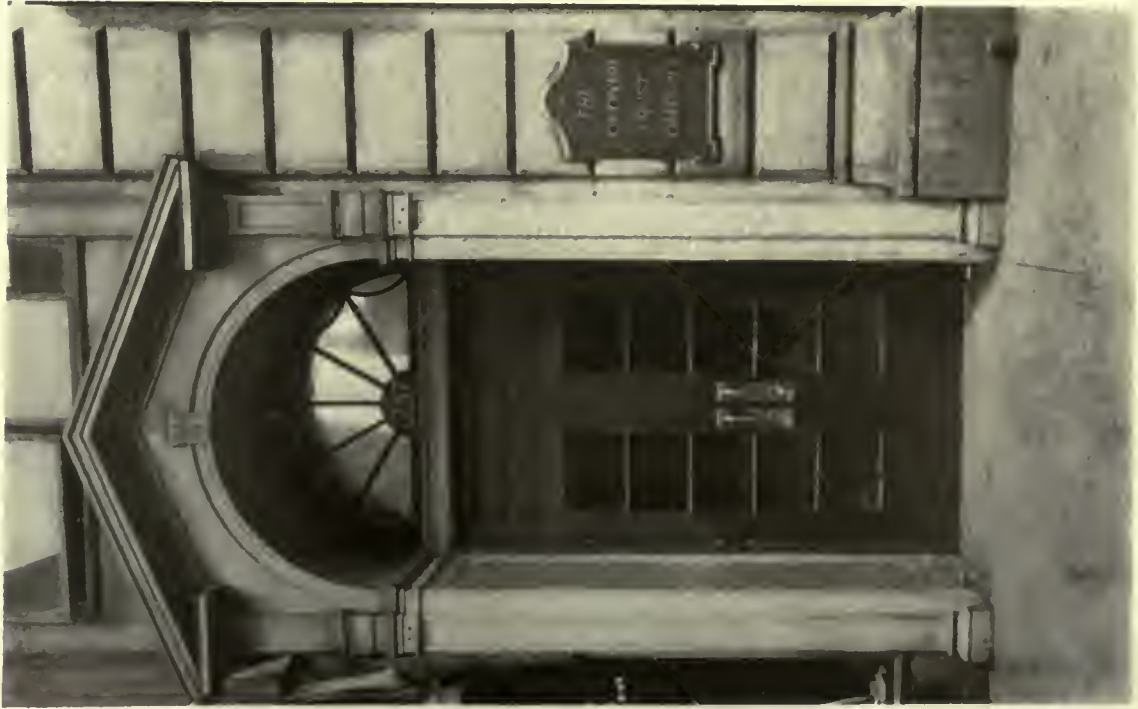
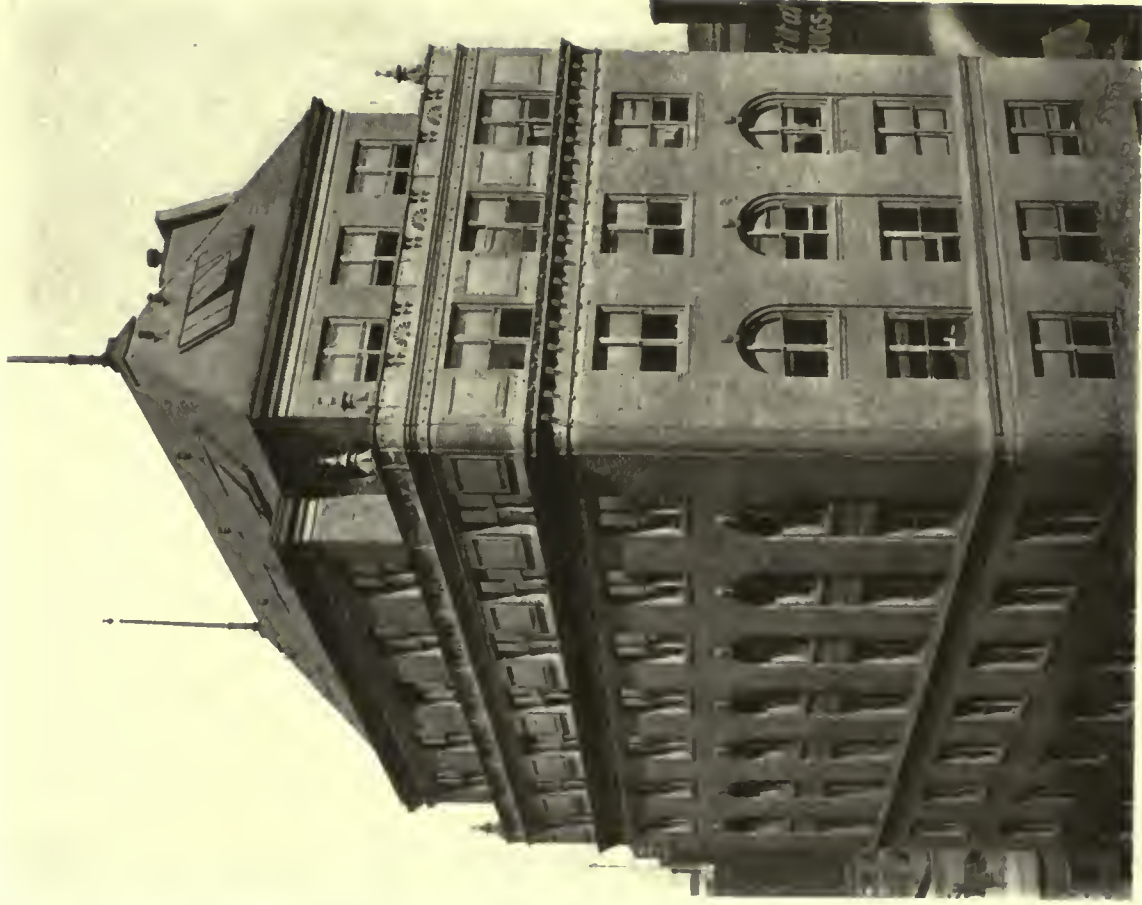

PLATE 209      DETAIL MAIN ENTRANCE



DETAIL UPPER STORIES

BUILDING FOR THE COLONIAL TRUST CO., PHILADELPHIA, PA.

ALFRED C. BOSSOM, ARCHITECT





PLATE 210

VIEW IN BANKING ROOM



VIEW ON BANKING ROOM FROM MEZZANINE FLOOR

BUILDING FOR THE COLONIAL TRUST CO.,  
PHILADELPHIA, PA.

ALFRED C. BOSSOM, ARCHITECT







PLATE 211

DETAIL, BANKING ROOM CEILING

BUILDING FOR THE COLONIAL TRUST CO., PHILADELPHIA, PA.

ALFRED C. BOSSOM, ARCHITECT







PLATE 212

OFFICE BUILDING FOR COSDEN & CO., TULSA, OKLA.

HENRY F. HOYT, ARCHITECT



THE AMERICAN ARCHITECT

JUNE 25, 1919

VOL. CXV, NO. 2270

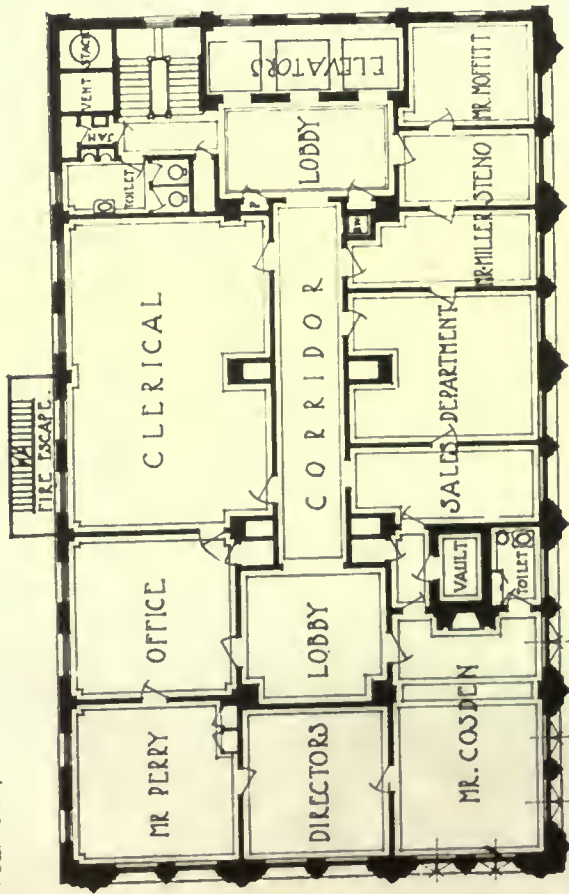

FOURTEENTH FLOOR PLAN

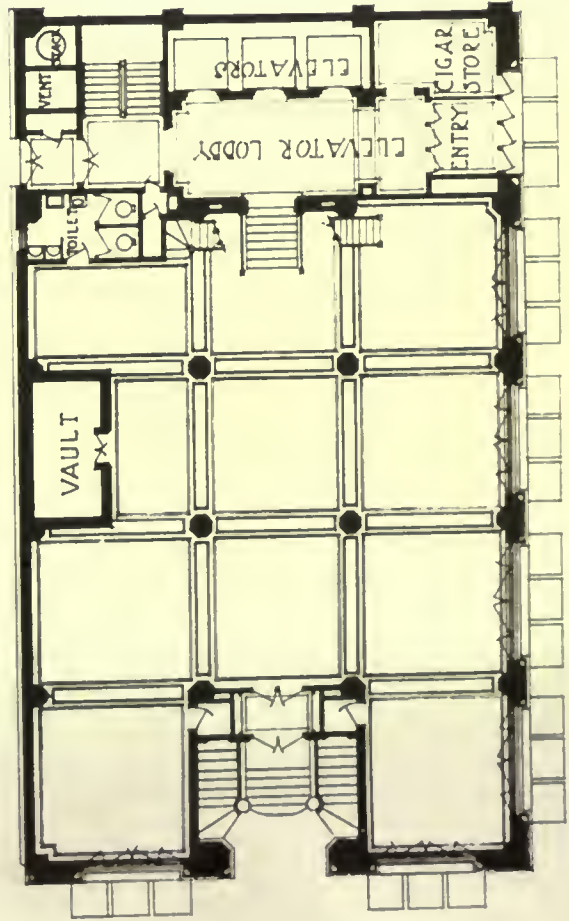

FIRST FLOOR PLAN

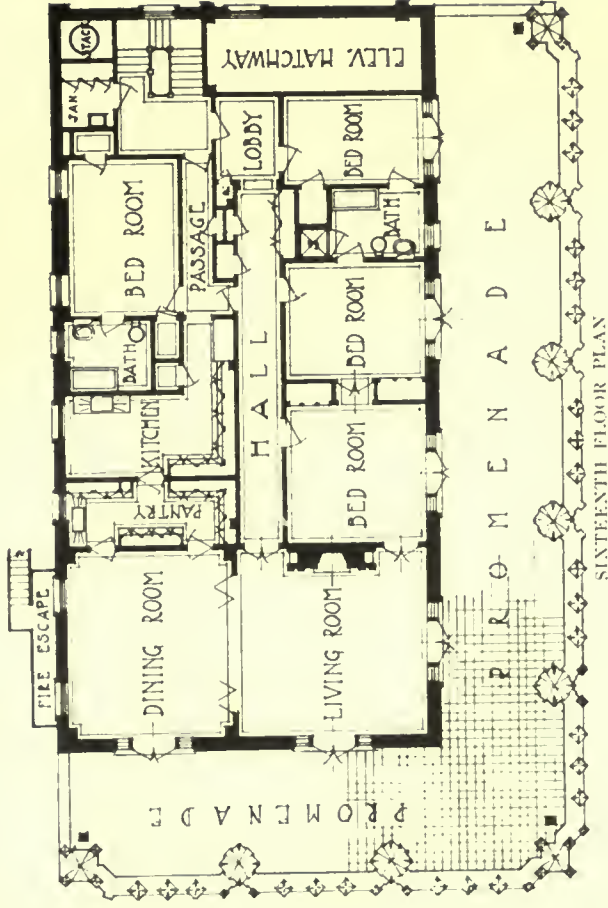

SIXTEENTH FLOOR PLAN

OFFICE BUILDING FOR COSDEN & CO.

TULSA, OKLA.

HENRY F. HOTT, ARCHITECT





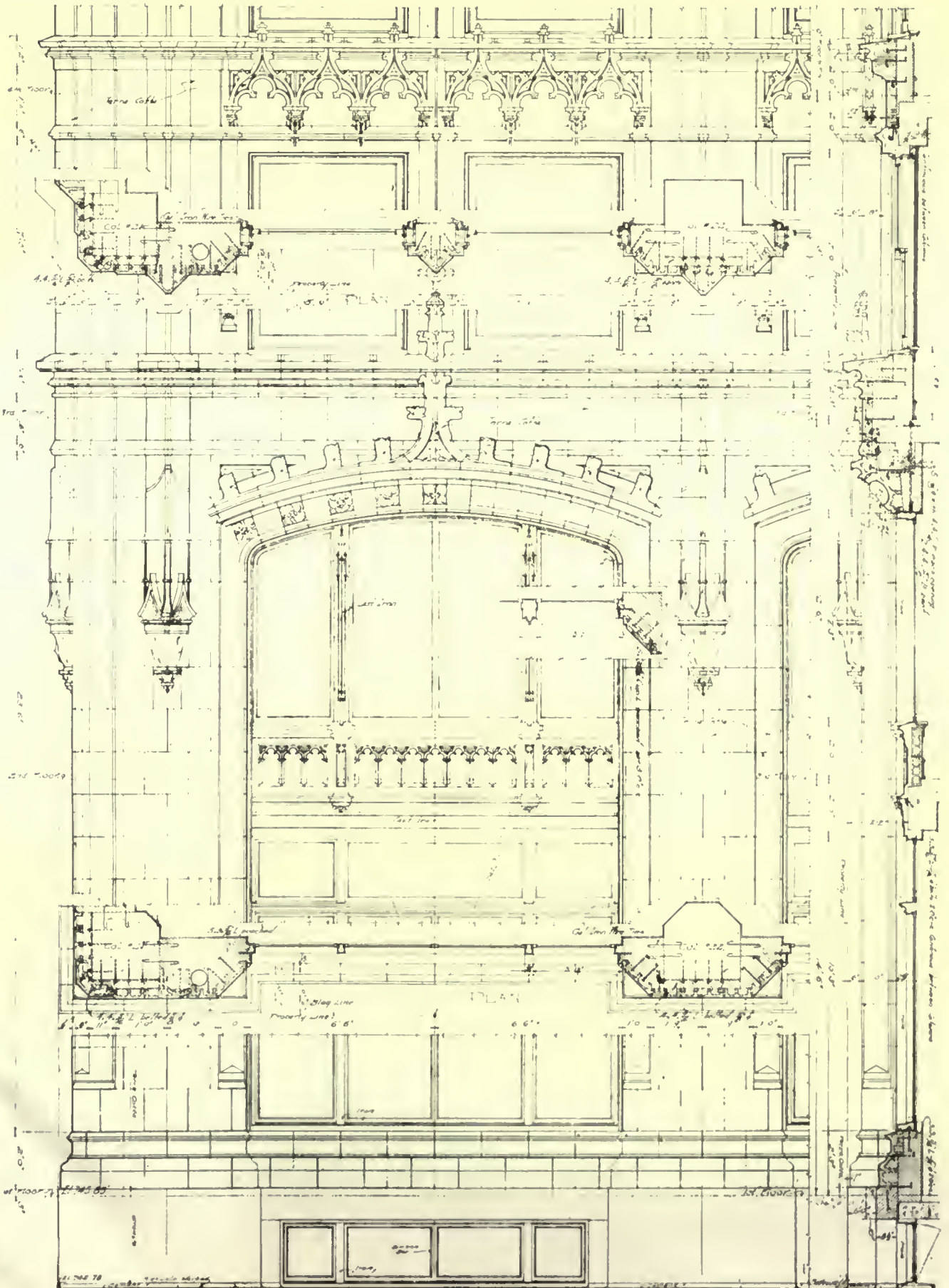

PLATE 214

TYPICAL DETAIL, LOWER STORIES  
OFFICE BUILDING FOR COSDEN & CO., TULSA, OKLA.

HENRY F. HOIT, ARCHITECT









# Recent Legal Decisions

## WHERE LIEN FOR MATERIAL NOT USED IN BUILDING MAY BE CLAIMED

In an action to foreclose a mechanic's lien for material furnished to the owner of a building, the defense was that the material did not actually go into the construction of the building for which it was furnished. The Indiana Mechanic's Lien Statute of 1914 rests on the principle that one who furnishes labor or material for the improvement of the property is entitled to look to that property for his compensation. And the Indiana Supreme Court has held that "a material man claiming a lien must *ordinarily* show that his materials were furnished for and were actually used in the erection, alteration or repair of the building against which the lien is asserted." *Potter Mfg. Co. v. A. B. Meyer*, 171 Ind. 513, 519; 86 N. E. 837. But it is not *always* necessary to show that the material furnished actually went into the building, since the circumstances in a particular instance, especially where the material was furnished to the owner of the building to be used therein, may be such as to estop the owner in a foreclosure suit from working the general rule. So, where the trial court has found specially that the material man furnished the material directly to the owner on his promise to use it in the construction of his dwelling-house, and on the security of that building and the real estate on which it was being erected, and that the owner diverted it to other use without the material man's knowledge or consent, these circumstances were held sufficient to estop the owner from relying on the general rule.—*Moore & Richter Lumber Co. v. Scheid (Ind.)*, 121 N. E. 91.

## GOVERNMENT CONTRACTORS' BONDS

Where the penalty of a government contractor's bond is sufficient to pay all the claims against the contractor, the Circuit Court of Appeals holds that a sub-contractor, or other claimant, may recover interest from the time his demand became due. Under the act of Congress of 1894, as amended 1905, permitting any person furnishing material to a government contractor to bring suit on his bond within

one year after performance and final settlement of the contract, and permitting any other similar creditor to intervene "within one year from the completion of the work under said contract and not later," the time limit is the same in the case of the original plaintiff and an intervener.—*Pederson v. United States*, 253 Fed. 622.

## EXPENSE INCURRED AFTER ABANDONMENT

Whether a provision in a building contract is a condition precedent or a condition subsequent depends upon the intention of the parties disclosed by all the provisions of the contract as applied to its subject-matter. If precedent, its performance is essential to the creation of the right, and must precede a suit for its enforcement; if subsequent, it is important only as affecting the maintenance of the right, and may be proved at the trial, although happening after suit brought. A provision in a contract, limiting the right of action to six months after the term fixed for completion, where the subject-matter was a building requiring six months to complete, was considered rather persuasive that the audit by the architect of the "expense incurred" in finishing after abandonment by the builder as provided in clause 5 of the uniform building contract was not intended as a condition precedent to suit within the term limited, for obviously it was more than likely that if so construed it would, in the ordinary course of events, defeat any recovery whatever under the bond. The point was not decided because, even if it was, it was held that, a completion contract having been entered into and the suit being for the expense so incurred and the answer not specifying any condition precedent, the performance of which was to be contested, the general allegation of the complaint, that all conditions precedent had been performed was conclusive, and the completion contract should have been admitted in evidence to establish the "expense incurred" in finishing.—*Board of Education v. Richmond Const. Co.*, *New Jersey Court of Errors & Appeals*, 105 Atl. 220.





# Current News

---

## Architectural Bureau Claims Big Savings

That the State Architectural Bureau is saving the taxpayers of California a considerable sum of money yearly, and otherwise is performing very valuable service, is the statement made by James S. Dean, Assistant Architect, in a booklet just issued from the State Printing Office.

Dean backs up his claims with figures showing that during the twelve years in which the Bureau has been operative the state architects have taken care of all new work in addition to the general overhauling of over twenty-eight major jobs.

Forty per cent of the construction and engineering work has been done by contract, 13 per cent by sub-contract and 47 per cent by day labor. The report also shows that a majority of the jobs come under \$5,000. It is estimated that a saving of more than 4 per cent has been effected through the Bureau during the last two years.

During this time the contracts totaled \$741,536; sub-contracts, \$218,932; day labor, \$837,151.

---

## Italians to Recover Stolen Art

Professor Paolo d'Ancona, of Milan, who is at the head of the Italian art mission, tells a correspondent of the *Associated Press* that the whole matter of recovering her lost art treasures has been laid before the peace conference for decision and that the Italians so far are only placing the works of art under sequestration, so that they may be protected in case of bolshevik attempts to destroy, steal or resell them as happened with the Hermitage gallery at Petrograd. The Italians feared this might be the fate of the Budapest gallery containing such priceless works as Raphael's Madonna.

Professor d'Ancona stated that the Italian claims fall under three heads: First, indemnities for art works, valued at \$10,000,000, destroyed by the Austrians in Italy during the war, including the air raids at Venice, Ancona, Padua, Ravenna and other points; second, works which have been stolen from Italy in the past; third, works which logically belong to territory now occupied by Italy or about to become her property, including Pola, Lissa Island and Fiume.

There are also provisional claims for Italy's share which belong to her historically in case the museums of Vienna and Budapest should be divided among the nations of the former empire, the Czechs having already submitted a similar claim.

Professor d'Ancona said that among the works of art, restitution of which is demanded by Italy, are eighteen paintings, of which only one is not Italian, the exception being the larger of two portraits of Rembrandt. These eighteen works have been valued at about \$5,000,000. Other notable works claimed are Raphael's "Madonna del Prato," "Jupiter and Io," by Correggio; five other Correggios of the twenty that are in the Austrian Imperial museum; Titian's "Madonna Delle Cillege," Moretti's "San Gustina," and two Tintoretts, one being "Susanna and the Elders."

Among second-class works alleged to have been stolen from Italy and included in the Hof museum collection, is

the famous Florentine diamond which Italians claim as part of the treasures of Tuscany carried off by Princess Anna Maria of Medici, contrary to agreement when nearly two centuries ago she renounced the Tuscan throne in order to become empress of Austria. There is also a collection of Venetian arms and manuscripts and Italian war trophies which the Italians claim have been stolen at various times, but which Austria has always refused to restore.

Regarding the 150 paintings which the Italians took in February, it is stated that the Austrians have admitted the justice of Italy's claims to them, as these works were alleged to have been stolen by Austria after the downfall of Napoleon.

---

## New Place for Art and Letters

A new appreciation of her artists and men of letters has come to Great Britain as the result of the war, says the English artist, Nevinson, who is now in this country.

At the beginning of the war Britain sent her artists and her writers to the trenches. It was not until they were invalidated home, and such of them as could began to write and paint, that she realized that here were forces which should be preserved as carefully for their own line of work as the specialists in industrial production.

As soon as England did awake to this she sent her artists to the front, to be sure, but this time to make the studies for the great war paintings which should serve as nothing else could to arouse patriotism in the present, and be an invaluable legacy for posterity as well. Equally her writers were encouraged to turn their clever pens to war service, and everybody who reads knows what the contributions of English authors have been as propaganda and as literature.

So, from those who lived to paint and write, and from those who died, but left sketch or immortal lines to rouse their countrymen, England came to a better understanding of art and letters as real factors in human life.

America too has learned something of the same lesson, and what has hitherto been regarded as only means for man's amusement has attained a new importance as a great and moving force.

---

## Mississippi Valley Highway

A proposal is afoot to organize a scenic highway along the Mississippi River. The first steps have been taken by the formation in St. Paul, of a group to have in charge the development of the northern division.

The highway begins at Lake Itasca, source of the Mississippi, in Itasca Park, and parallels the river to the Gulf of Mexico.

The northern division runs from Lake Itasca to Dubuque; the central from Dubuque to St. Paul, and the southern, to the gulf. Each section will co-operate with various highway officials for road improvement and maintenance.

## Stirling Calder, Sculptor, Discusses War Memorials

Stirling Calder has contributed a valuable letter to the *New York Times* on this much discussed topic, which is conspicuous for its clarity of thought and expression. In this letter he justifies the opinion that memorials should refer to the future and break away from past traditions.

At this time, he writes, when so much attention is centered on the subject of war memorials and our art journals are bristling with warnings and advice to prospective committees, it is natural to remember the most recent design for such purpose—the Arch of Victory at Madison Square. This, we understand, is a strictly temporary monument, but it nevertheless tacitly advocates a type in design. It would be well now to consider if this type is the best that is possible, for even a temporary purpose.

The ranks of artists engaged in matters of design, architects, sculptors, and painters, are broadly separated into two distinct camps defined by conviction and practice. There are those, a very large body, who are almost wholly swayed by the dictates of precedent, denying any place to expression and the present. And there is the other perhaps smaller camp of those who, while acquainted with precedent, only believe in using it to an extent, as one of many elements that are ours wherewith to design and express for ourselves the present, living ideals. Briefly, in other words, there are the creators and the plagiarists, those who have something to say and those who have nothing to say, but insist on graceful antics. They proceed upon a theory that everything worth while has already been done, that nothing remains for us but to copy, to adapt the superficial aspects of works of approved age, leaving their spiritual significance either quite out of consideration, or violating it by the adaptation. It is the practice of this theory that has studded our cities with Greek and Roman temples, Italian and French palaces, performing various and sundry domestic duties ad infinitum. And now we have a mutilated Roman arch of imperial triumph doing duty as our monument celebrating the victory of a free democracy over an imperial power.

The design of this temporary arch is based on the assumption that this age knows nothing, cannot learn, must remain stationary in stricken adoration of the phantoms of past achievement in art, instead of being stirred to new expression by them as we should be, and as some of us are. But how, may we ask, were these admirable works which now react with such deterrent influence in certain quarters achieved? They were certainly not achieved by brains paralyzed by precedent. Free artists have always exulted in calls on their invention, have grown mighty in striving for ideals. That is their food. It has knit them into giants at times. The stimulus to art growth today is as potent as it ever was, only those who could assimilate the strong diet cannot always come at it. Too often the husks of archaeology are preferred to the kernel of living thought.

Genuine work is not designed by visualizing as nearly as possible an old work designed for another purpose and then revamping it to serve a present need. This real war cannot be memorialized by imitation art. It was a deadly, serious thing. Good art is serious. Good artists are serious, devoting lives on bare subsistence for the privilege of exercising their function. "Art is the expression of the essential character of a subject." The subject in this case is the monumental celebration of the triumph of democracy over autocracy—in plain language the proof of the proposition that organized force is not to be endured—that

no man or number of men shall enforce their will on the rest of the world without challenge and combat, either in arms or art.

Thought, truth, justice, beauty must always ultimately defeat force, error, cruelty, perjury, because men will it so. It is the sense of the world that this is the better way.

This noble creed that America has upheld, and that we have all in some measure suffered for, is not in any way expressed, nor attempted, nor considered, in the temporary structure of three arches hung with disorganized ornaments, the totality of which amounts only to dreary decoration.

Art of the first class, and our permanent war memorial should be of this kind or not at all, is never primarily decorative. It is always primarily expressive. It stamps a fresh impression of character, meaning, beauty. It is an invention, only possible under conditions that demand it, distilled from the sweat of imagination and will, and as such has distinct spiritual value. It is a record, an achievement. A copy, on the other hand, no matter how good, is merely decoration, because its making is no longer guided by the mind demanding expression, but only by the mind seeking resemblance. A decoration is not an expression. It is a second-class work. Its use in the present case is a step backward in art.

The world today is looking to America for help to construct a generously practical theory of life. We can be most helpful by being genuine in our art. This is a really great opportunity. It should enlist in ordered fashion the art energy of the community. Whether we are intelligent, free, and honest enough to succeed remains to be proved. The school of precedent has had its chance with the design of the present Arch of Victory—an imitated gesture; it is not genuine.

Let it now be seen to that the present is expressed, that a national war memorial is created.

## Other Aspects of A. E. F. Study in Architecture

Not all the men making up the American Expeditionary Force in France were sent across as soldiers. There is much work of a civil nature to be done, such as construction work, educational work and other similar duties. To teach architecture to the soldiers of the American army might seem to be going somewhat astray from the main object of sending such a force to France, were it not for the fact that the continuance of education in the ranks has become a settled policy in most of the Allied armies.

Among the Americans who enlisted for construction work in France was Ernest Coxhead, a practicing architect of San Francisco. Before he reached France the armistice had been signed, so he was transferred to the educational commission and sent to Le Mans to conduct classes in architecture. Of the 200,000 young men in the Le Mans area quite a number were students of architecture whose studies had been suddenly broken off and their civil careers brought to a standstill. These young men found themselves in a land of wonderful buildings. Close at hand were cathedrals, chateaux, public halls, whose beauty and grandeur could be appreciated but not assimilated for lack of time and proper instructive guidance.

When Mr. Coxhead's plans were laid before the general commanding in the Le Mans area his enthusiastic consent was immediately obtained and a class was started. It contained 22 "boys" who had had some architectural training, who were detailed for a three-weeks' course of in-



tensive study. They reported to Mr. Coxhead for work at 8 A. M. and continued, with intervals for mess, until 9 at night.

The mornings were given over to out-of-door work, visits to the great Gothic cathedral of Le Mans, or to some neighboring church or chateau chosen by the instructor. In the afternoon they developed the notes they had taken in the morning into careful drawings under his supervision. In the evening they discussed the rules of form and construction as exemplified by what they had seen. In this way, what had seemed to be an interruption and a loss of time in their career became to them an architectural tour of great interest and value. The work was hard, but then the course was short, and they entered into it with enthusiasm, determining to profit to the full by the advantages thus unexpectedly placed in their way. During the third and last week of the course a five-day tour was arranged to Orleans, Tours and the great chateaux and churches of Chartres, Blois, Chambord and others.

The course ended with a highly successful exhibition of the work done, held in the hall of the Municipal School of Design at Le Mans. Here more than 200 drawings were displayed, varying from rough sketches to water colors and oils, attesting to the value of the work done. So delighted were the American officers with these results, and with the reception given by the public to the exhibition, that they gladly consented to a second and, later, a third course being formed. The second course was completed with a six-day study of the architecture of Paris, and a second exhibition of drawings—more than 300—in the Army Educational Commission Building.

Nor is this all. Mr. Coxhead has prepared a plan by which the work may be extended. He is seeking to establish a number of centers for architectural teaching, each under a competent instructor, which shall move in rotation from point to point, the entire course covering a period of three months. Of course, only architects, or men who have had some practical training under an architect would be eligible.

## Local Housing Problem Solutions

More and more is the housing problem coming up to vex and perplex in the big cities, where houses and apartments are difficult to obtain, and are commanding such high prices in the way of rents.

Mayor Hylan of New York city recently approved a plan which it is considered will help out the situation there, temporarily at least, and that is for the city to take over the Pelham Bay Park encampment built by the government to house 25,000 sailors, and to convert it into dwellings. Inspectors declare that with a few alterations the barracks could be made into perfect apartments which could be maintained on a co-operative house-keeping plan.

It seems that this big naval training base was built at an expense of \$10,000,000. The barracks consist of 537 buildings, occupying an area of about 135 acres, set in a park space of 1700 acres, where there are facilities for swimming, fishing and truck gardening for the prospective tenants, while baseball diamonds, tennis courts and other playgrounds can be built at small cost.

The project is considered feasible, and the committee in charge of the proposition feel that there will be no hitch in the negotiations now going on with the Navy Department for turning over the buildings for the purpose for which they have been requested.

## Architects Design Pittsburgh's Bridges

Mr. John W. Beatty, president of the art commission of Pittsburgh, informs us that two architects residing in Pittsburgh, A. B. Harlow and Benno Janssen, have been selected, together with a New York firm, to provide the plans for three of the new bridges to be built across the Allegheny River. The art commission of Pittsburgh has been deeply interested in this matter, and the county commissioners have loyally co-operated and supported the movement inaugurated about a year ago, when Ralph Adams Cram visited Pittsburgh and delivered an address on the subject. The first practical result of the movement was announced the other day. An extraordinary opportunity is now afforded the city of Pittsburgh, and the intelligent action of the county commissioners may be destined to affect architecture in this country to an important degree. "It is," says Mr. Beatty, "a distinct recognition of the importance of art in connection with works of public utility, and I doubt not that the other three bridges which are to be built will be designed upon the same high standard of artistic merit."

## An Ideal City

Beginning with Plato's "Republic," there have been from time to time, efforts to describe the ideal city. Everybody tries it, more or less persistently. The item printed below is the version of Mayo Fesler, of Trenton, N. J., and appears in the current issue of *Americanization*, a publication circulated by the Department of the Interior, Bureau of Education, Washington.

A city, sanitary, convenient, substantial;

Where the houses of the rich and poor are alike—comfortable and beautiful;

Where the streets are clean and the sky line is clear as country air;

Where the architectural excellence of its buildings adds beauty and dignity to its streets;

Where parks and play-grounds are within reach of every child;

Where living is pleasant, toil honorable, and recreation plentiful;

Where capital is respected, but not worshiped;

Where commerce in goods is great, but no greater than the interchange of ideas;

Where industry thrives and brings prosperity alike to employer and employed;

Where education and art have a place in every home;

Where worth and not wealth give standing to men;

Where the power of character lifts men to leadership;

Where interest in public affairs is a test of citizenship and devotion to the public weal is a badge of honor;

Where government is always honest and efficient and the principles of democracy find their fullest and truest expression;

Where the people of all the earth can come and be blended into one community life, and where each generation will vie with the past to transmit to the next a city greater, better, and more beautiful than the last.



## The Day of the Builder

The word on every tongue is the word of the builder. Writing in the daily press of Bluefield, W. Va., an editorial appears as follows:

The most important man in the new world we are living in is the builder. Be a builder—a builder of better conditions are well as of material things. Builders are needed in the distracted countries of the old world to build free governments on the ruins of despotism.

Builders of houses, roads, bridges and mills are needed in France and Belgium. Business builders are needed in America where industries and public utilities are in a bad way. We must build American nationalism in the place of the idealistic internationalism which impractical theorists have tried to set up in this country. We must restore opportunity for individual initiative which has been torn down. We must build a merchant marine and rebuild the transportation and communication organizations. We must re-establish American industry on a permanent peace basis, and build a foreign trade founded upon business principles, not upon paternalism. We must construct loyal American citizens out of several millions of men and women who are still aliens and not in full sympathy with our government and its institutions. We must build the character of our electorate so that it will not stand for crooked statesmen nor countenance any influence in politics except the public good. This is a reconstruction period in every sense of the word, and there is endless opportunity for builders.

## Reward for the Just Employer

The following statement is issued by Grosvenor B. Clarkson, director of the United States Council of National Defense:

The War and Navy Departments having issued a citation to employers who give assurance that they will gladly take back their old employees who have served in the armed forces of the United States, it seems fitting that some symbol representing this attitude on their part should be placed upon the service flag.

The United States Council of National Defense, therefore, endorses the placing of the United States shield upon the red border, but no names of individuals or business firms shall appear anywhere upon the flag. Any employer who sends the required assurance to the War and Navy Departments through Colonel Arthur Woods, Chairman of the Council's Emergency Employment Committee for Soldiers and Sailors, Washington, D. C., can receive the citation, and as soon as the citation is received such employer is entitled to put the shield upon his flag.

The shield should appear upon the service flag in the following manner: If the service flag hangs downward, as in a window, the shield should be at the top; if the flag flies from a mast, the shield should be placed on the border nearest the mast. In both cases, the shield shall be right side up.

## Needs 10,000,000,000 Bricks

Nearly 10,000,000,000 brick are needed for Government housing schemes and private building in Britain in the next two years.

The average annual output before the war was less than 3,000,000,000.

## Personals

Herbert A. Foster, architect, has moved from Arlington, Mass., to 72 Fox Street, Fitchburg, Mass.

E. N. Butler, architect, Flint, Mich., moved offices from Dryden Building, to 611½ South Saginaw Street.

William H. Thompson, architect, has opened offices at 235 S. 11th Street, Philadelphia, and desires catalogues.

Joseph A. Jollette, architect, has moved from 325 Grafton Street, to 419 Grafton Street, Worcester, Mass.

Frederick Muhlenberg, architect, has opened offices at 101 Flanders Building, Philadelphia, and desires catalogues.

Geo. M. Lindsay, architect, announces the removal of his office to 2201 Dime Bank Building, Detroit, Mich.

Waggaman & Ray have moved their office from 1211 Connecticut Avenue, to 1742 M Street, N. W., Washington, D. C.

Howard S. Chandler, architect, of 73 Newbury Street, Boston, Mass., has moved to 75 Boylston Street, Boston, Mass.

Urgel Jacques, architect, after two years absence has resumed his practice at 22 McKinley Road, Worcester, Mass.

Leonard H. Bailey, architect, Oklahoma City, has moved his office from 616 Colcord Building, to 1207 Colcord Building.

H. George Fink, architect, has opened offices in the Bliss Building, Miami, Fla., for the practice of his profession. He desires manufacturers' samples and catalogs.

Eric Kibbon, recently major of Engineers, U. S. A., announces his association with Welles Bosworth in the practice of architecture at 527 Fifth Avenue, New York.

Architect E. J. Hancock of Milwaukee has become associated in the practice of architecture with J. F. Everett, architect. The firm will maintain offices in Boston Block, Seattle.

Edward L. Gahl, for many years associated with Wheelock and Shank, architects, Chicago, announces that he will open an office at Guthrie, Oklahoma, for the practice of architecture and requests catalogs and samples.

Architect Alexander H. Spitz announces his return from military services and the resumption of his practice at 1303 Standard Trust Building, 105 West Monroe Street, Chicago. Samples, catalogues and literature on building materials are desired.

Richard Schermerhorn, Jr., Captain, Engineering Section, Sanitary Corps, U. S. A., has returned from service with the A. E. F. in France and has resumed his practice as landscape architect and civil engineer with offices at 363 Lexington Avenue, New York City.

Through an act of the North Carolina Legislature creating an office of State Architect, the State Building Commission being so authorized has appointed a State Architect, Mr. James A. Slater, and Engineer, Mr. L. R. Woodhull, and offices have been opened at 707-708 Commercial Bank Bldg. Raleigh, North Carolina.

The office will require and will be glad to receive catalogs, samples of information of all kinds of material and equipments for asylums, prisons, schools, etc.

## Foreign Handicraft Exhibition and Sale

An exhibition of handicrafts of many nations is now being held in the galleries of the Art Alliance of America, 10 East 47th Street, New York. This colorful and varied display, brought together by the Art Alliance in co-operation with the Settlement Houses, comprises the work of foreigners exclusively, although most of it was done in this country. Nineteen nationalities are represented.

Workers in native costumes are in the galleries, giving actual demonstrations of their crafts. A French artist-weaver is making on his loom a reproduction of a fine old Gothic tapestry. Nearby is a Ukrainian girl making bead bands and necklaces. Her needle darts at the tiny bead and spears it with the accuracy of a warbler catching midges on a leaf. There is an English lace maker with her bobbins, fashioning a butterfly, and the bobbins move like one. Two Italian boys are modeling bowls and vases in clay, while a jeweler, with his burins, is shaping silver and gold. Beyond, a Russian girl is painting wooden beads and queer-shaped vases and boxes.

Everywhere is color; cloth of gold is woven before your eyes by a Swedish woman; and there are gay-colored milk jugs hung on still gayer painted brackets done by Bohemians. There is rich gold and blue embroidery from China, a barbarically beautiful Korean costume, together with modern textiles, books of design and kakemono from Japan. Syrian wood carvings, two old chest fronts, lend a quieter note that harmonizes well with fine old Italian and Spanish draperies and vestments. But the dominant note is one of exuberance, nowhere better shown than in the rich display of Hungarian embroideries, where pillows, counterpanes and costumes vie with one another.

The great fact which this exhibition makes plain is that we do not need to send abroad, as we have done in the past, for beautiful things made by hand. They can all be made here—embroideries, laces, tapestries, jewelry—and by men and women of the highest skill in these crafts. There are hundreds of workers like those now at the Art Alliance who can be reached, and who only need the encouragement which must come from active interest and support of the public. The Art Alliance of America, with its organization, stands ready to facilitate this co-operation in every way.

The exhibition is further planned to draw attention to things of really good design, not necessarily made in this country, nor even of the present age, but which can be reproduced here by workers who had the necessary training before they came to this country. These well designed pieces will also serve as inspiration to raise our national standards of taste.

Some day—before long, we hope—America will have her great industrial art schools, as every other important nation has had for years; meanwhile it is of vast importance that we save and encourage the wonderful resources of ability that have already come to us from other lands.

## First Motion-Picture Forum Is Established

The first motion-picture forum in the United States was recently established at a school in Boston by the Information and Education Service of the Department of Labor. It proved so successful that a number of others will be established soon. The plan is to use films

imparting some definite social, economic or patriotic lesson, with discussion by the audience in the open-forum style to bring out the strong and show up the weak points in the teaching. The first picture shown was a dramatization of Edward Everett Hale's classic, "The Man Without a Country."

## Why Not An Architect, Too?

The Rural Welfare League of Texas will hold its second annual conference at the Agricultural and Mechanical College of Texas, in College Station, June 25-28. It is learned from the program that matters of vital importance are to be discussed and acted upon. While these are of particular interest to architects, it may be observed that no architects appear to contribute anything to the proceedings.

Better housing and sanitation, improved schools and churches, and more effective community organization are some of the social problems to be considered.

The subject of rural housing and sanitation is to be discussed, not by an architect, but by Dr. P. W. Corrington, of the State Board of Health, Austin, and by Rev. J. A. Hornbreak of Fort Worth, a Presbyterian minister who has given his life to the service of rural churches.

Prominent representatives of the schools, churches and other professions will read papers. There is also a Farmers' Clubs Section, through which an interest in better farm buildings might be created. Several men of national reputation in the field of rural sociology will address the general sessions of the conference. The question is, why should not architects be also represented. The conference promises to be well attended and all persons interested in the promotion of better rural living and social conditions, particularly in Texas, are invited to attend. Will architects in that section do their part?

## East Is West

Illustrative of the expanding interests in eastern countries along the lines of occidental developments is the fact that Frank Lloyd Wright of Chicago has been selected as architect for the Imperial Hotel at Tokio, Japan, and the contract for the construction has been awarded to the Mueller Construction Co., also of Chicago.

Mr. Wright is at present in Tokio, and states that the building contains many unique features peculiar to a hotel that will serve, also, in a measure, as a government building. The structure is designed to cost \$2,500,000. A representative of the contractor's company is now organizing his forces in Tokio for active work. He states that he will purchase about \$500,000 worth of mechanical equipment from American producers for the heating, ventilating, plumbing, electric, elevator and kitchen installations.

## New York State Association

The Chairman of the Committee on Membership of the New York State Association of Architects, Frank H. Quinby, 99 Nassau Street, New York City, will send, on request, blank applications for membership.

These applications have printed on the back the By-Laws of the Association.

Every registered man in the profession is urged to secure one of these blanks and become affiliated with this organization.



## Permanent Exposition Proposed

In connection with his study of the lumber needs of Europe, John D. Walker, Trade Commissioner at the American Embassy in Paris, suggests the desirability of a permanent lumber exposition. Architects, government officials and lumber dealers in England, France and Belgium seem, whenever questioned, to be in favor of the idea.

Plans for its development are now practically matured. They have been made for the purpose of illustrating the value of using standard grades and sizes of American woods abroad, and should greatly increase our lumber exports to Europe.

## Soldiers' Memorial Open to Competition

Competition for the selection of an architect for the proposed temporary memorial in honor of Marion County's (Indiana) war heroes will be open to all practicing architects of Indianapolis. The memorial is to be in the form of a triumphal arch. The appropriation for the memorial is \$3,500, and the competitor is urged to exercise every possible care in submitting a scheme which may be actually constructed for that amount of money.

## No Freight Reduction on Material

In answer to various inquiries as to whether the Railroad Administration contemplates a reduction in freight rates on materials used in construction of buildings, Walker D. Hines, Director General of Railroads, makes it clear that no such reductions are in contemplation.

Before the matter can or will be definitely determined it is intended to ascertain what, if any, reduction necessary to establish a stable price will be made in the price by those producing and supplying the materials.

## Shows Housing Need

While the United States Department of Labor has estimated that there exists in the country a shortage of 500,000 houses as a result of the stoppage of building by war conditions, it is probable that half a million does not cover the actual deficiency. In New York city living quarters are now at a high premium. Rents have gone up approximately one-third, modern priced apartments being subject to the largest increase. Thousands of war workers have been crowded into the city and the regular growth has been advanced in many other ways. Although it has not yet reached one-third of the normal volume of construction, a survey of 152 cities shows an encouraging increase of building.

## University of Virginia Receives Library and Works of Art

In addition to the gift of \$155,000 to the University of Virginia to endow a school of fine arts, embracing art, architecture and music, Paul Goodloe McIntire, a native of Charlottesville, has given to the city a park in which he will place an equestrian statue of Lee; a library fully

equipped—site, buildings, furnishings and books; a plot of ground near the courthouse upon which it is his purpose to erect an equestrian statue of Jackson; an exquisite group of statuary at Midway school, commemorating the Meriwether Lewis and William Clark expedition, and a monument to George Rogers Clark, who from the annals of our earlier times perhaps won more fame than his brother, William. Nestling in the foothills of the Blue Ridge, blessed with wonderful natural advantages, in sight of Monticello, the home of Jefferson, at the doors of the University of Virginia, enriched and adorned by the gifts of this man, Charlottesville is to become truly a beautiful city.

## Washington Draftsmen Organizing

Draftsmen in the employ of the government are rapidly organizing in an effort to secure a higher wage scale. A new schedule for draftsmen employed by architects of the Treasury Department became effective this week. Members of the craft in the Ordnance Department are now seeking an affiliation with the American Federation of Labor. Many of these men were employed by large building firms and engineering concerns before entering the government service during the war.

## To Complete Frieze in Capitol Rotunda

Senator Lodge of Massachusetts has introduced a joint resolution authorizing a joint committee on the library to select an appropriate design for the completion of the frieze in the rotunda of the United States Capitol. An appropriation of \$20,000 is asked to complete the unfinished work of two noted Italian artists, Constantino Brumidi and Filippo Costaggini.

Costaggini will be remembered by the older generation of architects and artists for his work in the large cathedrals of this country. He died before the frieze could be completed. Brumidi painted the scenes on the walls of the President's private room at the Capitol, the canopy of the dome, the picture of Cornwallis suing for cessation of war in the House side and other noted paintings in the legislative building. Pope Pius IX commissioned him to restore the Loggia of Raphael in the Vatican before the artists came to America. While working on the frieze in the early '60's, Brumidi fell from the scaffold and died from injuries.

## Build Now for Reconstruction

The War Department, through Colonel Arthur Woods, is urging State, City and County officials to push work on public buildings in order to provide jobs for returning soldiers and sailors. There has been a gratifying response to this advice, because it is universally felt that the immediate return of ex-service men to suitable employment is of the utmost importance. In commenting on the possibilities of this means of reconstruction, Colonel Woods says:

"Every contract which is let makes more work in the forests, at the mines, in the quarries and at the railroads, in addition to the labor requirements of the operation itself, and this means more jobs for returning soldiers and sailors."



# Late News from Architectural Fields

*Special Correspondence to* THE AMERICAN ARCHITECT

## Approve Plan for a National Memorial Forest

WASHINGTON, D. C., June 23.—The National Arts Commission of the city of Washington has approved the proposed National Memorial Forest. The project was discussed at a special meeting called Friday at the request of its proponents. While the Commission heartily endorsed the proposed memorial, it declined to take the initiative in securing the necessary legislation.

When the proposal was made in October, 1910, that the Government acquire a wooded area bordering on the District of Columbia, for scientific reforestation and rehabilitation as a National Forest and Park, it was endorsed by many organizations. The bodies expressing approval included the American Institute of Architects, Landscape Architects' Association, American Federation of Art and the American Forestry Association. It is now proposed that the forest be made a National War Memorial to commemorate the services rendered by soldiers, sailors and marines.

In addition to the forest, the suggestion was made at the meeting last week that the Government should secure the co-operation of the architects, landscape architects, foresters and engineers in planning an "Insurance City" to care for the thousands of War Risk cases which the Government has to provide for. The plan is to build a model city for the wounded heroes as a suburban extension to Washington. This would replace the soldier's homes of other wars. The Commission did not consider the proposal at this time.

## Bill Makes Homes for Workers Possible

HARRISBURG, June 21.—Modern homes for workmen could be built on considerable property Pittsburgh has seized for the non-payment of taxes, or the city could acquire other real estate and provide suitable homes and apartment houses for its workmen under the provisions of a bill offered in the Senate by W. W. Mearkle.

The bill is State-wide in its effect, affecting every municipality. It would be optional with each of them as to whether or not to launch upon such an enterprise. It was designed particularly for Pittsburgh to meet a situation there that probably exists nowhere else in the Commonwealth. Recently the Council sought authority to proceed along the lines indicated in the bill and was advised by the legal department that it lacked the authority the Mearkle bill contains.

Section one of the measure authorized any municipality "whenever the Council thereof shall, by ordinance, determine thereon" to "acquire private property and to apply, use, improve and develop property thus acquired and property now or hereafter owned by said municipality for the building, constructing and erecting of dwelling houses, apartments and homes."

The second section confers the right upon municipalities to enter into contract agreements for the purchase of property and the construction of buildings "with such

restrictions in the leases and deeds of sale as will duly insure the protection and preservation of the appearance, light, air, health and usefulness thereof."

Councils are authorized to make such rules and regulations for the acquisition of property, the letting of contracts and the renting and sale of the properties they may deem proper.

## Report of United States Employment Service

WASHINGTON, D. C., June 23.—Nearly 6,000,000 persons were directed to employment by the United States Employment Service from its organization January, 1918, to May 24 last. Of this total, over 4,500,000 themselves or through their employers reported back to the Service that they had been placed.

Figures made public today by the Department of Labor show that in this period, and with the returns for April and the first three weeks of May not yet complete, 6,578,086 persons applied at the offices of the Federal Employment Service for employment of all kinds from unskilled labor to positions calling for men and women of professional and technical training. Of this number, 5,979,233 were directed to positions and 4,574,287 reported placed.

With returns for six States missing, during the week ending May 24, the United States Employment Service placed 52,000 persons, of whom 42,826 were men and 9,174 were women. Of the male placements, 12,654 were soldiers and sailors. The States which have not yet reported are Alabama, Connecticut, Illinois, New Jersey, Texas and Wisconsin, whose placements will considerably swell the reported total.

## Canada Provides Money for Homes

MONTREAL, CAN., June 23.—The housing shortage of Montreal is to be overcome by government aid. A fund of between \$4,000,000 and \$5,000,000 will be available soon, and the administrative commission of the city of Montreal has been working on a plan by which it may be used most effectively. This plan contemplates the appointing of five public spirited citizens who shall have charge of all housing projects. A manager will be appointed, under whom plans and specifications will be prepared.

When a workman makes a request for money with which to build a home, he will have a choice of plans, provided he has not already chosen a required style of structure. After the required amount of money has been lent, the building will be inspected from time to time, so that assurance may be obtained that the specifications on which the loan was made are being carried out. The worker has the privilege of building the house himself, or he may contract for the construction.

The commission intends to give preference to labor in making the loans, but a certain amount will be at the disposal of contractors willing to undertake the building of houses for workers. Loans will be made for a period of 20 years at 5¼ per cent. The borrower, however, may provide for a sinking fund at a charge of 7 per cent.

In this connection it is of interest that the workers classified as eligible to preference in the loans are defined by the commission as "all low-salaried men, and not necessarily men who work with pick and shovel."

## Poor Housing Means Big Labor Turnover

NIAGARA FALLS, N. Y., June 21.—The labor turnover in Niagara Falls in 1917, in plants employing 5,249, was placed at approximately 13,600 employees or an average of 260 per cent. This percentage, applied to the total number of employees which, it is estimated, are engaged in industrial work in the city, would mean that the total labor turnover in the community in 1917 was about 38,000 persons.

It is the belief of a Housing Committee whose members have carefully studied conditions, that a labor turnover reduction of up to 25 per cent might be effected if the housing conditions were first class. This committee found that it had been difficult to attract the right kind of labor, that many men have refused to stay in the city because of inability to secure proper house or adequate boarding facilities and that a reasonable proportion of the high and costly labor turnover has been due to insufficient housing.

If 25 per cent of the present turnover, as was estimated, could be reduced by excellent housing conditions, it would mean a saving of about 10,000 employees. If the cost of turnover per employee averages the conservative figure of \$50, the saving to employers in Niagara Falls, resulting from good housing, would amount to something like \$500,000 a year.

As a result of these investigations, the Niagara Falls Chamber of Commerce has taken steps to establish a housing corporation which would help finance the erection of dwellings in the city. According to estimates, 10,000 will be needed within the next ten years.

## Wilmington House Shortage at End

WILMINGTON, DEL., June 23.—Real estate men, who have been predicting that 300 families will be homeless in Wilmington on June 25, the official moving day, have changed their opinions. More than 300 dwellings in the government housing project at Union Park Gardens will be ready for occupancy by that time, and it is not believed that any families will have to go homeless.

## Artists' Work Shows Canadians in the War

The Canadian War Memorials, an exhibition already shown in London and planned to continue in New York until July 31, is in progress at the Anderson Galleries, Fifty-ninth Street and Park Avenue. The great collection of Canadian war paintings present vividly that country's share in the war, and incidentally the part played by American volunteers in the forces of the neighboring Dominion.

The exhibition is under the joint management of Cap. Percy F. Godenrath, representing the Canadian War Records Office, and Paul G. Konody, Secretary and Art Director of the Canadian War Memorials.

## Memorial in Washington to Negro Soldiers and Sailors

WASHINGTON, D. C., June 21.—Congressman Sherwood has introduced a bill providing for the appointment of a commission to secure plans and designs for a monument or memorial to the memory of the negro soldiers and sailors who fought in the wars. The bill authorizes the erection of the memorial in the city of Washington, to cost not more than \$100,000.

Another provision directs the immediate use of a \$10,000 appropriation to commence the project. This commission will be empowered under the terms of the bill to employ the services of architects and sculptors.

## Late Building Material Market Reports and Quotations

The sum of \$15,000,000 has been made available for loans by New York City banks on bond and mortgages within the next two months to help along the program for the building of homes. Officials of eight large New York savings banks, testifying at the Legislative Committee's investigation of why construction has been retarded, declared that they were prepared to invest this amount, and although they are heavily loaded with Liberty Bonds, they are willing to lend every effort to relieve the situation. Many of them declared that they would be able to advance larger amounts at a later date.

In a letter to Senator Charles C. Lockwood, chairman of the committee on housing, Samuel Untermeyer characterized the committee's investigation of life insurance officials and building material men as "superficial, unintelligent and useless, to the point of being farcical."

"It is a pity to squander the money of the State in that way," he wrote. "You went on with your so-called 'inquiry' without another word to me," he said, "while circulating the statement that I had declined to assist, all of which has created a most unpleasant impression as to the earnestness and sincerity of your committee."

"You call the heads of the insurance companies and calmly permit them to 'get away' with the transparent camouflage that the investments of their companies in Government bonds are accountable for their having paralyzed the building industry for years past by suspending loans on real estate."

"You do not inquire (1) how much money they have received year by year for investment during that period; or (2) what part of it has gone into Wall Street securities; or (3) how much they invested in foreign securities before we entered the war; or (4) what real estate loans they have called, collected or reduced; or (5) why they have not sold securities that it has been for thirteen years last past the announced policy of the law to require them to sell, or any other of the hundreds of questions that might be asked that would tend to prove that there is no legitimate reason why they do not invest largely in real estate loans."

\* \* \*

The steel market has not increased materially in activity, but the improvement scored early in the month is well held. Some mills are showing slightly increased operating rates.

There is approximately as much price shading in finished steel products as formerly, few lines being entirely free from price irregularities, but the cutting does not spread, and March 21 prices are still regarded as representing the

(Continued on page 900-A)



# Building Material Costs Cannot Revert to Pre-War Levels, Say Business Leaders

THE U. S. Department of Labor has just prepared a circular containing a symposium of interviews with leading business and financial authorities on the topic of "How Much Will Prices Fall." Each statement clearly shows that there can be no appreciable recession from present price levels, confirming THE AMERICAN ARCHITECT'S analysis printed some time ago that it is the high cost of loan money and labor wages that have retarded post-war construction and not the cost of building materials. Some of the interviews follow:

J. Ogden Armour:—The greatest danger to our economic structure to-day arises from the failure of many to recognize a *new end higher level of prices, based on permanently increased cost of labor, and high taxation.*

Those who postpone building or buying in the hope of materially lower prices, are speculating in the future misfortune of the Nation. For falling prices, when reaching the point where profit is eliminated, mean panic, depression, unemployment, and other troubles.

In the final analysis 75 per cent or more of the cost of most commodities consists of labor, and reductions in the market price of commodities are, therefore, inevitably reflected in the compensation of labor.

Nothing in the labor situation warrants anyone in expecting materially lower cost of commodities in general, and building in particular. Wages will not be less for several fundamental reasons, viz:

1. The practical stoppage of immigration since 1914, depriving America of the several million workers who would normally have come to our shores.
2. The retention by the Nation's military and naval establishments of nearly 2,000,000 workers, which may continue for an indefinite period.
3. The creation of new industries, such as shipbuilding, and manufacture of chemicals and dyes, requiring hundreds of thousands of workers.
4. The urgent demand for building and construction of every class, due to their having been forcibly held back for several years.
5. The shortage of the world's food supply.
6. The proportionately higher levels of commodity prices existing practically all over Europe.

On the one hand, then, we are facing a serious shortage of labor as soon as we approach normal industrial activity, and on the other hand there is confronting us a tremendous, unsatisfied demand for many necessities which it was difficult or impossible to obtain during the war.

Normally, under such conditions, we could have expected a flood of low-priced goods from the Old World, while now we find that prices in Europe have risen proportionately much higher than in America, and the demand for commodities and labor, to make up for the wastage of war, is even more keenly felt there than here.

The manufacturer who now quotes the lowest possible price consistent with the high cost of labor, and guarantees this to be so, doing his buying freely on the same basis, ranks as our highest type of patriotic citizen. A new level of prices has been established, from which there can be no material recession until inventive genius succeeds in correspondingly increasing labor's productive capacity by mechanical means.

\* \* \*

Theodore N. Vail, of American Telegraph & Telephone Co.:—During the Civil War prices rose relatively more than during the recent war. The prices unquestionably were inflated, being based on the greenback currency.

Even so, however, the drop in the prices of 92 commodities in the decade from 1864 to 1874, *was at the rate of less than 6 per cent per year*; in building materials it averaged less than 4 per cent per year over the same period.

The principal cause of the gradual return to pre-war price levels has been ascribed to the rapid transformation of manufacturing, agriculture, mining, transportation, and business in general, from hand methods to machine methods, from small-scale to large-scale production. Opportunities do not exist at the present day in any measure comparable with those of the period following the Civil War. Price declines so far, since the cessation of hostilities, bear this out, having been trifling—only 5 or 6 per cent up to April 1, 1919, as compared with over 25 per cent for the corresponding period after the Civil War.

Abstract consideration of these facts does not support any expectation of sudden and radical declines in present prices. As applied to big building, it would appear that any structure should prove commendable which is calculated to show a sufficient profit to offset an expected decline averaging, say, from 2 to 4 per cent per year for the next one or two decades.

Another factor which should be considered as favorable to big construction is the present tremendous latent demand for buildings, commodities, labor, and raw material, which is expected to bring on a period of intense activity and national prosperity. It is also well to consider that, excepting steel, the rise in the cost of building materials has been relatively small as compared with other commodities. The price of lumber, in particular, may easily go higher, and in view of the decreasing lumber supply may never get back to the low levels of 1913-14.

\* \* \*

Darwin P. Kingsley, President New York Life Insurance Co., New York:—We have undoubtedly reached a new price level.

For some years food will be higher. Europe has been so stripped of every sort of food that it will take more than the harvests of 1919 to restore an equilibrium.

Food will remain high because wages will not go back to pre-war level. Wages will fall at some points—where production was overforced during the war; but unless our whole industrial and financial fabric falls into chaos—and nothing like that seems possible now—the post-bellum readjustments mean continued high wages and, of course, a higher cost for everything into which wages enter.

How far discoveries in science, inventions, improved methods, etc., may go toward overcoming this increased cost through increased efficiency and increased production is a question. These will be a factor, possibly a surprising factor, because the rewards will be large, and few things so quicken invention and efficiency as the incentive of large returns.

Carry the message to the Bolsheviks.

\* \* \*

John Hays Hammond:—The immediate problem that confronts us is the resumption of business, including, particularly building construction, manufacturing, and mining. Business is being retarded because we are hoping for—or fearing—lower prices. Whether these fears, or hopes are to be realized no one can, perhaps, adduce convincing argument, but above the maze of conflicting arguments that are being applied to the situation one fact stands out pre-eminently; we can return neither to pre-war conditions nor to pre-war prices.



# Department of Architectural Engineering

## Public School Buildings—Methods, Economies and Standardization in the Preparation of Plans\*

By CLARENCE E. DOBBIN†, M.A.I.A. AND M.E., N. Y.

THE work of the Bureau of Design, Construction and Maintenance does not possess the importance, from an engineering standpoint, of the Catskill aqueduct, subways, East River bridges, or other large public undertakings. Certain features of plan production as developed and practiced by our office may, however, be of interest to engineers as they pertain to one of the important branches of engineering—that of efficient management.

The term "plan production" may be objected to by some as resembling too closely the term "shop production" used almost exclusively by manufacturers; but the fact remains that there is a distinct problem of this kind in any architectural office with a volume of work such as we have in hand. It is a problem of sufficient importance to merit thoughtful, scientific treatment and if it is handled without sacrifice either in architectural design, planning or construction, there can be no valid objection to any appropriate term used to designate it.

The development of the type buildings, or rather perhaps the standardization of the public schools of this city, as illustrated by C. B. J. Snyder, our Architect in Chief, in his talk before this Society on September 25, 1918, made it quite clear that we have become specialists in this particular architectural line and therefore cannot hope to always obtain men sufficiently familiar with what we are doing to be of immediate use upon important work. The breaking in of new men, even when they are of high grade, involves trouble and expense. The situation is still further complicated by the limitations imposed by civil service rules.

In order to meet these difficulties, and also to obtain uniform practice for all jobs in course of

preparation at any one time, we have reduced to writing all instructions and decisions that go to make up our office practice. These, together with tabulations, small drawings showing typical arrangements of the various standard rooms, and other details that may be of assistance to draftsmen, are bound in loose-leaf form with subjects alphabetically arranged and make up what is termed our Office Manual. A copy of this is placed in the hands of each squad leader for ready reference.

Each new question that arises is investigated and considered with great care and when a satisfactory solution is reached the necessary instructions are placed in the manual. If later on a better solution is evolved, new instructions are issued to replace the earlier ones. The manual keeps everyone informed as to the latest decisions so that all effort may be directed toward the same objectives. The squad leaders are expected to see that their assistants follow these standards, or, if a variation seems advisable, to refer the matter to the Chief for decision.

In this way only can the practice of the office be kept standard. In the absence of such a manual the office practice must be transmitted from one draftsman to another by word of mouth. This is the usual method and it is responsible for great loss of efficiency, because the same questions are asked and answered repeatedly, and the same problems solved again and again, with attendant discussions, delays and variations in practice. New men have no definite, accurate way of acquiring the office practice and often proceed along incorrect lines.

The planning of our new school buildings is accomplished through the co-operation of the four divisions into which the office is divided—General Drafting and Plumbing, Heating and Ventilation, Electrical and Furniture. Each of these divisions has its own head and are all under the immediate

\*Paper read before the Municipal Engineers of the City of New York.

†Deputy Superintendent of School Buildings, in charge of General Drafting Room, Bureau of Design, Construction and Maintenance, Board of Education, New York City.

## THE AMERICAN ARCHITECT

direction of Mr. Snyder, who also has jurisdiction over the inspection force connected with the construction and equipment of the buildings. The general plan of this organization is indicated by the first of the two organization diagrams.

We do not claim that this form of organization or the work performed offers any new or startling features, but believe there may be something of interest in connection with our methods of systematizing and standardizing not only the types of buildings, but the working plans, details, specifications and office practice.

In our steel designing many of the factors are constant. The dead weight of our typical floor construction is always the same and the live loads for certain groups of rooms are alike. We have therefore developed tabulations of various kinds that enable the engineers to select the steel shapes much more quickly than by computation or by reference to a hand book. One such table gives the safe I-beams for different lengths and spans, assuming our typical dead load and a live load of 75 pounds. There are other tables for live loads of 100 pounds, 120 pounds, etc.

Having worked out a beam plan and fixed the lengths and spans of the beams, their sizes can be obtained from these tables with the least expenditure of time. Similar tables have been provided for many other structural members for which we have constant use: channel columns for our standard story height of 15 feet 0 inches, safe loads for struts made up of one, two and four angles in various positions, etc.

The volume of work is such that a number of jobs must be put forward at the same time. The work naturally segregates itself into subdivisions, such as general planning, designing, scale detailing, full-size detailing, structural-steel and other engineering, plumbing, specification writing and computing.

The first essential is a properly organized and

balanced drafting force. Reference to the second of the two organization diagrams shows that the employees of this division are divided into appropriate squads, each of which is continuously engaged in one kind of work. While the personnel of the squads may change from time to time the leaders at least are comparatively permanent and become thoroughly familiar with the established methods in their particular branches of the work. The qualifications, inclinations and aptitude of each man are studied so that he may be placed where he will count for the most. This is a matter of great importance and careful attention to it has led to the discovery of special ability in some men, which when developed has produced surprisingly good results.

The next step is to standardize the details for features which occur repeatedly in different buildings;

for example, a standard detail is made covering the entire construction of the ordinary double-hung window. This drawing is made on tracing cloth and once prepared can be used for any number of buildings without further drafting, by striking off the necessary number of blue prints. Similar standard details are made for

pivoted windows, hollow metal windows, steel windows, steel doors, wood doors, kalamein doors, skylight construction, vault-light construction, interior trim, cabinets, wardrobes, lockers—in fact for every possible feature of the building from column bases to the flagpole on the roof. These standard details do not entirely obviate the necessity for special details, but their number is thereby reduced to the minimum.

The advantages of these standards are threefold: First, the entire subject is very thoroughly studied when the standard is prepared and the detail is made to cover every phase of the construction, so as to furnish all the information required on that subject. Second, the draftsmen become familiar with the standards and are able to proceed with the plans much more expeditiously. Third, the con-

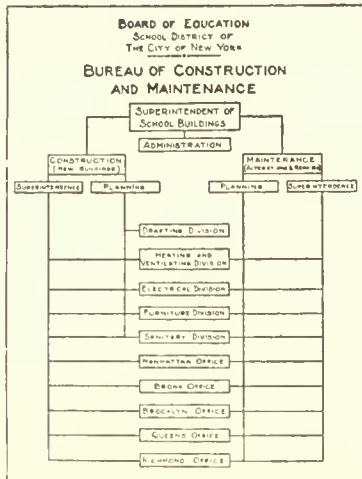

Organization Chart of the Bureau of Construction and Maintenance.

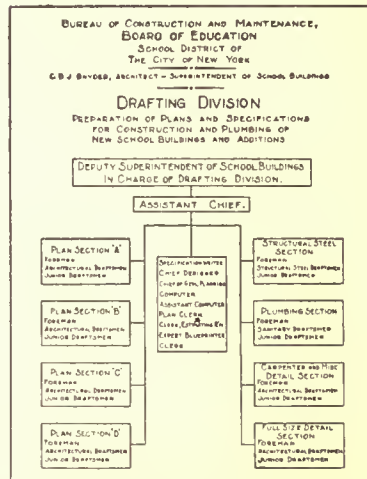

Organization Chart of the Drafting Division, which Prepares the Plans and Specifications for the Construction and Plumbing Work of New School Buildings and Additions.



# THE AMERICAN ARCHITECT

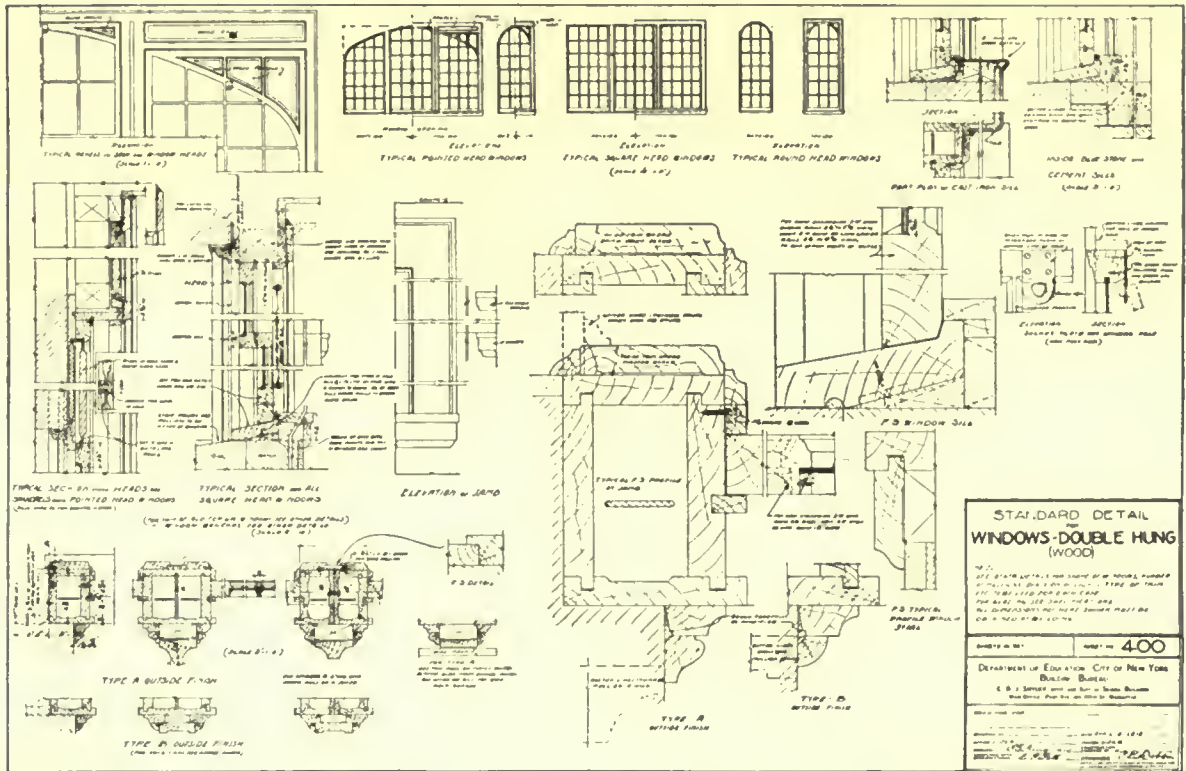

Standard Detail of Double-Hung Window and Frame, Covering all the Usual Conditions. There are Similar Standards for Pivoted, Hollow-Metal and Steel Windows.

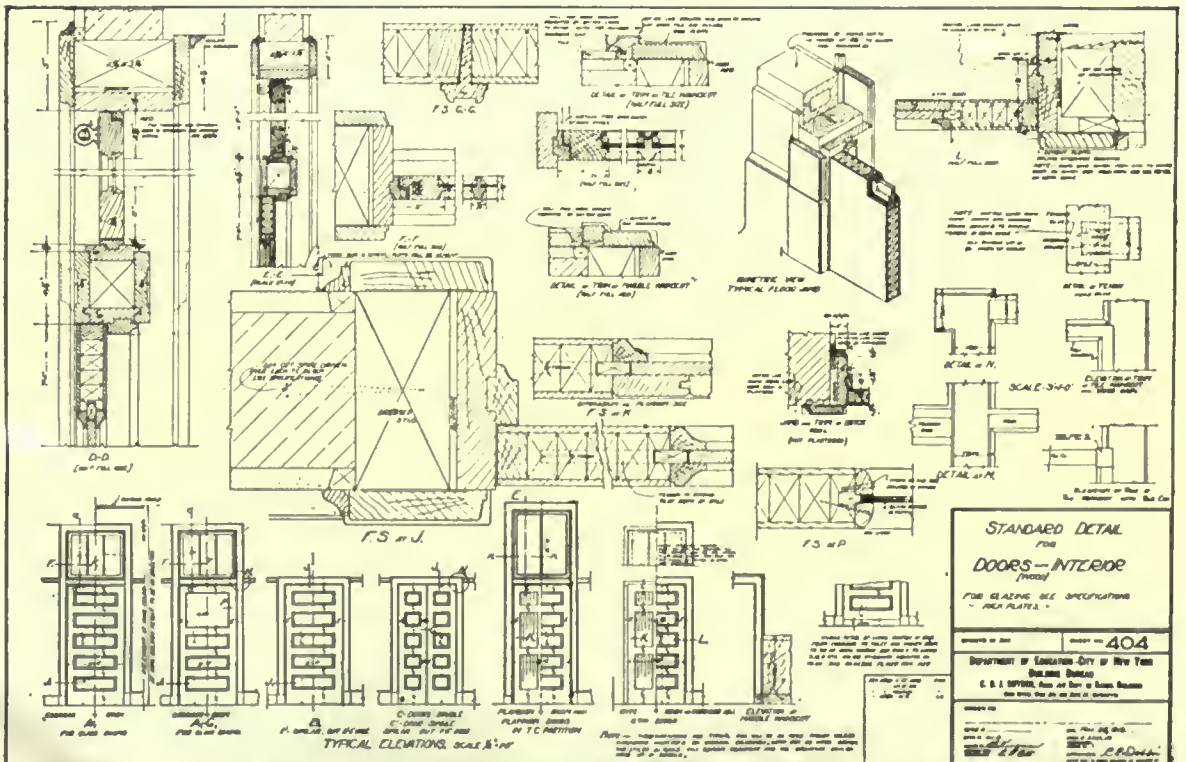

Standard Detail of Interior Wood Doors, Covering All Types Ordinarily Used, Together with Complete Details of Construction. Appropriate Letter to Designate the Type of Door to Be Used, Is Placed at Each Opening on the Floor Plans. The Standard Detail Does the Rest. There are Similar Standard Details for Kalamein, Steel, Aluminum and Metal-Clad Doors.



## THE AMERICAN ARCHITECT

tractors after becoming familiar with them, are able to systematize their methods of production and to reduce their estimates accordingly.

This Division has at the present time about one hundred standard details of this kind. A complete file of these is furnished to each squad leader and each is required to plan his work in conformity with them as far as practicable. This does not discourage suggestions on the part of assistants. These are always welcomed and the standards are revised whenever better methods are found. It does prevent waste of time in study of unauthorized variations of no practical value, undertaken often for no better reason than the desire to do the thing differently.

When conditions are such that a type building cannot be used, the general plans, framing plans and plumbing plans must all be specially made; but the standard details are applicable to these as well as to the type buildings, which minimizes the labor of detailing.

Where the drawings for one building are to be substantially like those for another building we take

advantage of methods of process reproduction in order to reduce the amount of tracing. It is necessary to have a full set of tracings for each building because additional prints may be needed at any time, either during the progress of building or after completion.

An earlier attempt to curtail drafting by making prints for all similar buildings from one set of tracings and then applying pasters covering the variations, had to be abandoned owing to the difficulty of keeping the great number of paster tracings, and of assembling sets of prints made up of the original sheets with innumerable pasters. There was also too great a liability to error.

Where the ornamental features of buildings of the same type are alike, the details for these are made in standard form, so that having once prepared tracings of these details for the first building they apply without change to any extent desired.

If all buildings could be made to conform to one

or another of the standard types, plans could be produced with great rapidity, but unfortunately this is impossible. The present building schedule comprises five new buildings of Type A, one of Type B, two of Type C, three of Type E, six of no standard type, and seven additions. This schedule of twenty-four items, made up prior to the adoption of the type buildings, offers only seven opportunities for duplication. In future building schedules it is expected that greater use will be made of the standard types.

Buildings requiring additions are usually old, badly planned and in many cases do not lend themselves to extension. The amount of time and study required for a comparatively small addition may easily equal or exceed that for a new building of much greater size. In the present building schedule, therefore, the advantage gained by the opportunity to duplicate seven buildings is largely counterbalanced by the seven additions.

It seems to be a matter of surprise to many that our plans are submitted for the approval of the city departments and that they are

scrutinized as closely as the output of other offices. The facts are that we must not only obtain the approval of all departments that have jurisdiction of the plans for private work, but must also submit our plans to the Municipal Art Commission and the Board of Estimate and Apportionment, as well as to our own board, its committees and Superintendent of Schools.

Before plans are given out for bidding they are made complete in every detail, so that there is no room for misunderstanding as to the extent or character of the work to be performed. The drawings for a Type A building comprise the following:

General plans .....	17 drawings
Steel plans .....	9 drawings
Plumbing plans .....	10 drawings
Special details .....	29 drawings
Standard details .....	78 drawings
Total .....	143 drawings

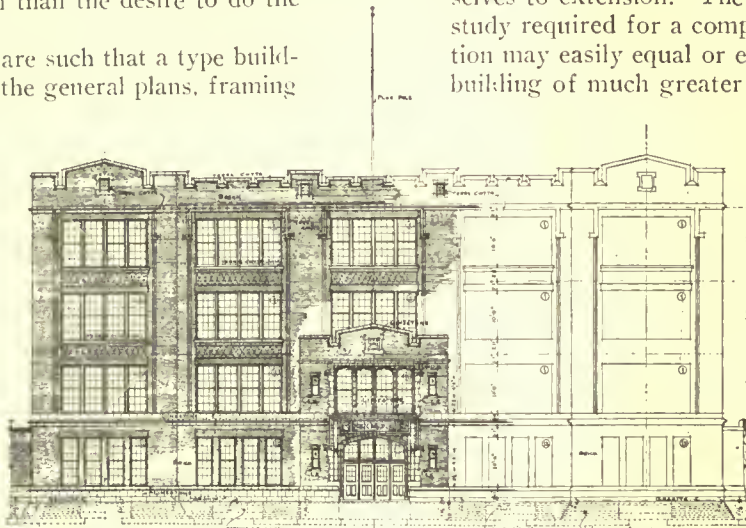

FACADE OF TYPE C BUILDING  
Note the simple straightforward character of the design. It is devoid of excessive ornament, but expressive of a school building.

# THE AMERICAN ARCHITECT

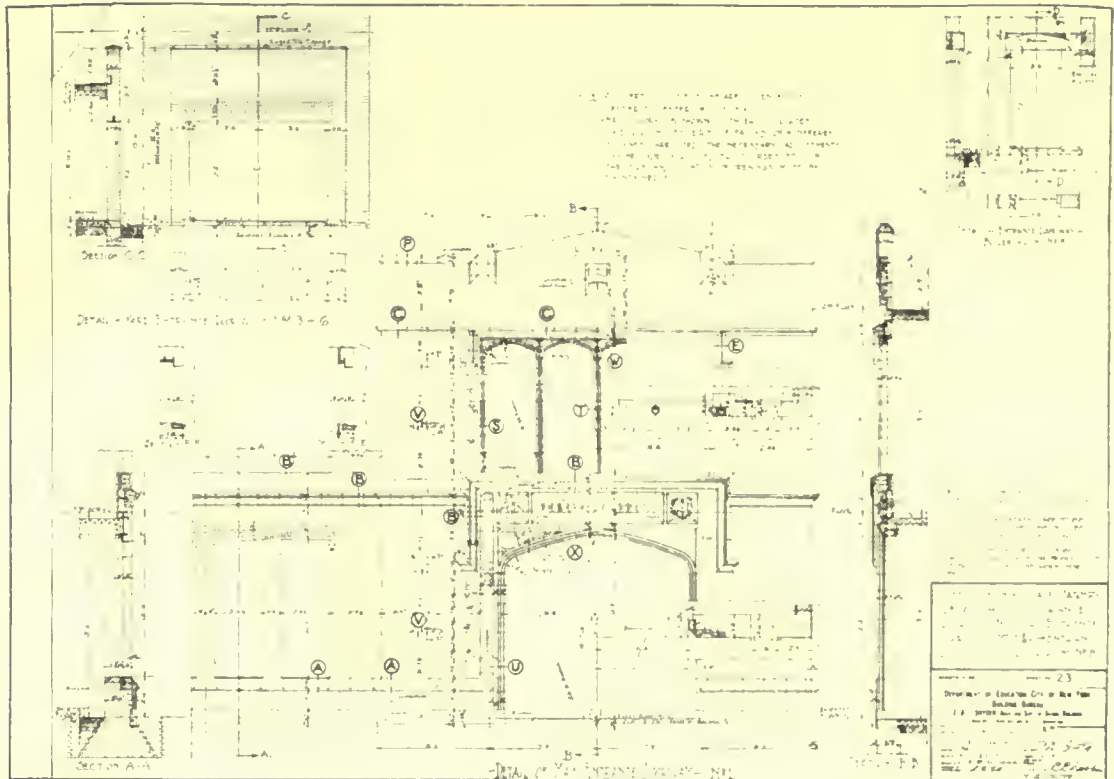

Detail of the Main Entrance Feature of the Type C Building. Scale  $\frac{1}{4}$  Inch to the Foot on the Original. The Large Letters, A, B, C, Etc., Refer to Full-Size Profiles of the Various Moulded Members as Shown in the Following Illustration.

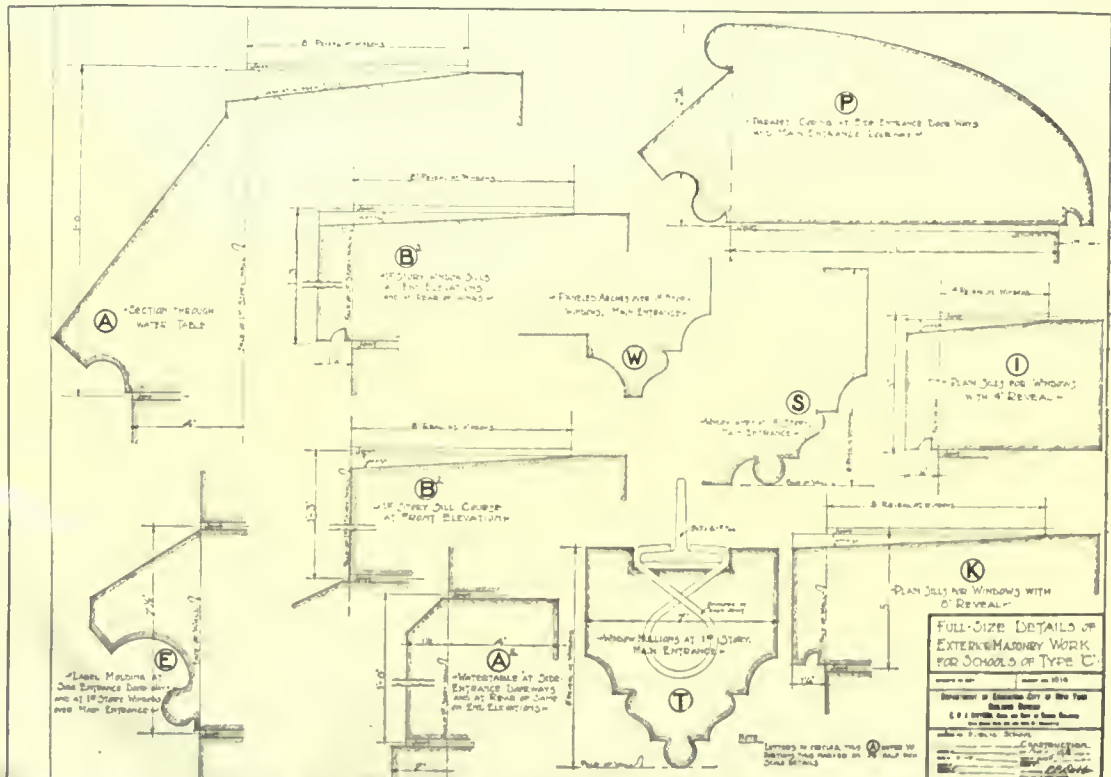

Details of Terra Cotta Work for the Type C Building Shown Full Size on the Original Drawing. The Large Letters, A, B, C, Etc., Refer to the Locations of the Various Details as Shown on the  $\frac{1}{4}$ -Inch Scale Details in the Preceding Illustration. Details of This Kind and Similar Ones for Interior Ornament Are Standard for All Buildings of the Type to Which They Apply.







# THE AMERICAN ARCHITECT

In order to fix the percentages for the various payments an accurate quantity estimate is made and this is segregated into the payments determined upon. Many other methods and short cuts have been adopted in the effort to conduct this branch of the people's business in the most careful and efficient manner. Those enumerated are sufficient to indicate that this Bureau is not hampered by old or traditional methods, but, on the contrary, follows the best practice of the profession and when that does not fully meet its requirements, develops new methods of its own. An excellent example of the latter has just occurred.

In a recent fire all our records and drawings, including the recently completed tracings for a building not yet under contract, were destroyed. Fortunately a set of blue prints from the tracings was

preserved. The cost of retracing these drawings would have been \$1,000 or more. There was no known process of reproducing tracings or negatives from blue prints, but by careful study of various methods of photographic reproduction and after some experimenting by our blue printer a way has been found to replace the lost tracings, at a cost of \$170. By this new application of existing processes we have solved a problem for which no less an authority than the *Scientific American* has been unable to find an answer.

Confronted as we are with a work of great magnitude and many complications it is our endeavor to apply factory methods to the less vital phases of our work, such as plan production and reproduction and to reserve our best thought and effort for the real problems that are always before us.

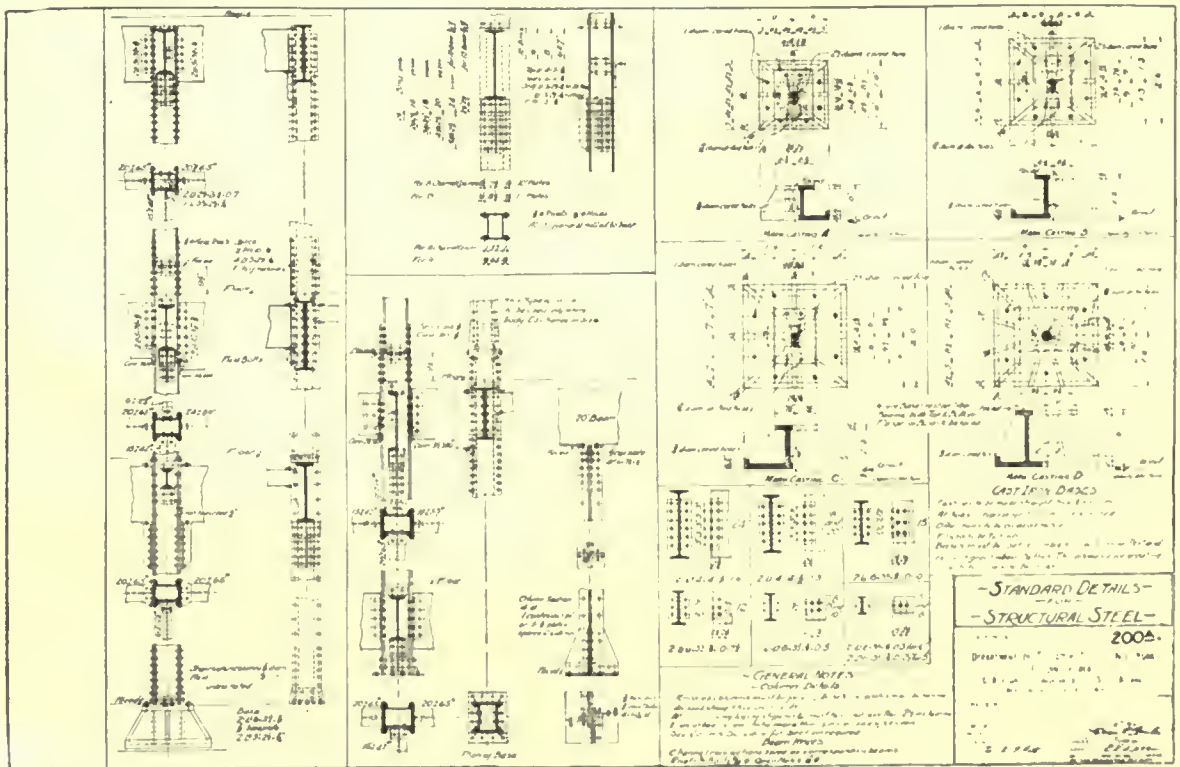

Standard Detail for Structural-Steel Work, Covering All Ordinary Conditions for Columns, Column Bases and Connections for Beams and Girders. Special Details Are Required Only for Plate Girders, Trusses, Etc.

## Reinforced Concrete in Office Building Construction

IN another section of this issue the Colonial Trust Company Building of Philadelphia is illustrated. While this building presents an interesting study from the aesthetic standpoint, it also has combined with a pleasing exterior and usable interior several structural features, not evident upon inspection, which can be studied with profit.

In the structural planning of a building three things must constantly be kept in mind: the cost of the type of construction selected, the contemplated use of the building and the adaptability to such use of each type, and the limitations of the several types of construction available.

In the building under consideration we note that the plot of ground is comparatively small, being but 4,200 sq. ft. in area, although located on what is probably the busiest corner in the entire city of Philadelphia. As a matter of fact this piece of property is valued at some \$800,000, or almost \$20,000 a front foot on Market St. In getting at the net rentable area per floor we must deduct from the gross lot area all walls, stairs, elevators, toilets, light courts, chimneys and columns. In so far as this space can be reduced to a minimum, the income of the building will be increased proportionately.

The Colonial Trust building is occupied by two stores and as a banking room by the owners in the first story, and for office purposes above with a rentable area of about 3,300 sq. ft. per floor. It is 13 stories high and roughly 42 ft. by 100 ft. in area, over-all dimensions. The type of construction which would be considered as most adaptable to these conditions would be skeleton steel construction with brick walls and stone trimmings, supported at each story, and concrete or hollow tile floor arches. This would of course permit columns of minimum size, and thin walls.

It is interesting to note that the design was first laid out in steel, but at that time the steel market was high, and estimates led the architect to believe that a considerable saving could be accomplished by the use of reinforced concrete. While this type of construction is common for industrial buildings, it has never been used to any great extent in the East for office buildings. However, the building was re-designed in concrete, and an estimated saving of \$70,000 was apparent, due to the change.

Unfortunately though the columns in the first story (according to this design) assumed such massive proportions as practically to ruin both show window, store and banking room space, if constructed as designed. The corner store was expected to (and does) bring an exceptionally high rental, and it was imperative that the columns occupy as little space as possible in the ground story.

After carefully studying all the factors involved a compromise design was adopted which has proved entirely satisfactory, and enabled a saving of over \$50,000 below the estimates for the original design in steel. This compromise design provided for steel columns below the second floor level, steel girders supporting the wall above the store front, and reinforced concrete construction above. At the rear, the building was divided transversely into three approximately equal bays, and the banking room rail arranged on a line with the columns, so that they in no way caused interference or obstruction in this area. At the front, it will be noticed that the columns are not on a line with those at the rear, for had they been so lined up it would have meant obstruction in the very valuable corner store space. The wall columns are rectangular in section, which while an uneconomical design from a structural standpoint, proves the best from a practical one, these columns taking up the least space possible with this type of construction. Several of the corner wall columns are almost triangular in section, and some of the interior columns are of irregular section so as to be largely hidden or lined up with the interior walls or partitions. The floor construction is of reinforced concrete with hollow tile fillers, the top slab being about  $2\frac{1}{2}$  in. total thickness with troweled floor finish (no wooden flooring was used), the tile fillers giving a good key for the flat plastered ceilings.

The walls are faced with hydraulic pressed brick and limestone trim. The roof is of slate. The total cost of the building was \$300,000, or about 50 cents per cu. ft. Had steel been used throughout the cost would have been nearly 60 cents per cu. ft.

From the foregoing the feasibility of the use of reinforced concrete in office building construction, when carefully designed to meet practical considerations is manifest, and the economy of such design is clearly proved.





Stained with Cabot's Creosote Stains  
Montague Flogg, 2nd, Architect, N. Y.

## Stained Shingles

The Warmest, Most Artistic and Most Economical of All House Finishes

Wood shingles are two or three times warmer than the gummed-paper substitutes, and they are cheaper, last longer and are incomparably more artistic and attractive. When stained with the soft moss-greens, bungalow-browns, tile-reds and silver grays of

### Cabot's Creosote Stains

they have a richness and beauty of tone that no other finish can equal, and the creosote thoroughly preserves the wood. Use them also on siding, boards, sheds and fences. Anyone can apply them, with best results, at least expense.

You can get Cabot's Stains all over the country.  
Send for samples and name of nearest agent.

**Samuel Cabot, Inc., Manfg. Chemists, Boston, Mass.**

1133 Broadway, NEW YORK 24 West Kinzie Street, CHICAGO

Cabot's Quilt. Waterproof Stucco and Brick Stains. Conservo Wood Preservative,  
Damp-proofing, Water-proofing 5-4

"A product without a peer"

# APOLLO-KEYSTONE

COPPER STEEL  
Galvanized

# Sheets



Highest in quality and rust resistance. Unequaled for Culverts, Flumes, Tanks, Roofing, Siding, Spouting, and all exposed sheet metal work.

We manufacture Sheet and Tin Mill Products of every description—Black and Galvanized Sheets, Corrugated and Formed Products, Roofing Tin Plates, Etc.  
**AMERICAN SHEET AND TIN PLATE COMPANY, Pittsburgh, Pa.**

## APPALACHIAN TENNESSEE MARBLE

has gone into the making of many of the country's finest banks and public buildings

A variety of colors and markings  
to suit each individual requirement

**APPALACHIAN MARBLE CO.**  
KNOXVILLE TENNESSEE

Schmidt, Garden & Martin, Architects  
The Shank Co., Contractors



The Speedway Hospital at Chicago Built for the War Department Required an Immense Equipment of MEYER Removable STEELFORMS

That this work was carried forward without a hitch demonstrates clearly the enormous Steelform Equipment we have instantly available.

That Meyer Removable Steelforms effect economy in structural design, labor and formwork costs is clearly evident, otherwise they would not have been used in a building of this character and importance.

## CONCRETE ENGINEERING CO.

Offices and Warehouses: Omaha, Chicago, Kansas City



Building Material Market Reports

(Continued from page 891)

regular market. In this respect the market is stronger than was to have been expected, for earlier in the year producers felt that the only way to prevent the bottom dropping out of the market was for every producer to adhere rigidly to the recognized price schedule. Now the steel market is showing decided signs of being able to stand on its own merits.

On this point the *Iron Age* says:

"It is interesting to watch the spread of the belief that substantially the present level of prices, with possible slight concessions here and there, also possible advances, is to be reckoned with for a longer time than seemed likely three months ago. Jobbers appear to be buying with less fear of having stocks decline in value before they can be sold."

\* \* \*

(From our Special Correspondent)

CHICAGO, ILL., June 23.—The demand for building material of every description is now greater than at any time during the past three years (according to an official of a company operating twenty-five yards in this city and neighboring suburbs). It is a general demand resulting from increased activity in building, and the call is for quick delivery in wagon-load lots. Prices are holding firm on all items, although competition is keen and dealers say there is but small margin of profit in consequence of high costs entering into the manufacture and a tendency to undersell in order to get what business is offered.

A total of ninety permits for new buildings was issued during the week for structures to cost \$1,218,685 in the aggregate. The same week one year ago the records show a total of forty-seven permits for buildings to cost \$712,000.

These figures give a fair idea of conditions in this city at the present time. There is a better tone generally in all markets; few idle men, and no labor difficulties of consequence.

New business of various steel companies in the Calumet district has been running in excess of production since the first of the month and orders continue to expand. A representative of one of the independent steel companies says the increased buying of steel products encountered by his company made greater strides in the past week than in any similar period in the history of the company. Steel manufacturers report a good demand for steel for export to South American countries.

Lumber is moving from the yards to the building contractors in exceptionally good volume. There also is better demand from the consuming industrials, especially the sash and door factories. Unusual conditions prevail in the wholesale markets. The demand is greater than the supply at the mills. It is now a question of placing orders for stocks to meet the demand and not a question of price. Values are changing almost over night, and during the past fortnight there have been some sharp changes upward in wholesale prices of cypress, hemlock, northern pine, and some of the more staple hardwoods. In consequence of the scarcity of oak, gum and poplar the building and furniture industries are substituting such northern woods as birch, basswood and maple to some extent. Low grades in both the hard and soft woods, for which the demand has been slow, are now moving into regular trade channels at high prices.

Fully ninety per cent of the war claims of this district against the Government have been adjusted. The aggregate of contracts involved in those not yet adjusted is between \$25,000,000 and \$30,000,000, as compared with an original amount of about \$400,000,000.

Late Quotations in Building Material Markets

(Price quotations now current on building materials and supplies as quoted by dealers and jobbers for delivery in New York and Chicago follow. The quotations set forth are placed before readers of THE AMERICAN ARCHITECT to afford an accurate review of market conditions rather than for use as a basis for actual purchase. They will not only provide knowledge of the exact state of the market as to items quoted, but will also present a basis to judge conditions as affecting correlating materials. Items marked (\*) indicate an advance over last week, while those marked (†) record a decline. Other prices did not fluctuate during the week.)

BRICK		
	New York	Chicago
Face brick (delivered on job):		
Common (Delivered at job in Borough of Manhattan only), per thousand.....	\$17.85	\$12.00
Rough red .....	29.00	40.00
Smooth red .....	26.00	40.00
Rough buff .....	32.00	40.00
Smooth buff .....	32.00	40.00
Rough gray .....	38.00	42.00
Smooth gray .....	40.00	42.00
Colonials .....	24.00	30.00

BROKEN STONE		
	New York	Chicago
(Delivered on job):		
1½ in. per cu. yd.....	\$2.75†	\$2.35
¾ in. per cu. yd.....	2.75†	2.35

BURNED CLAY		
	New York	Chicago
(Delivered on job)		
Block partition:		
3 in., per sq. ft.....	.13	.10
4 in., per sq. ft.....	.15	.11
Chimney tops:		
12 x 12 for 8 x 8 flues.....	\$3.50	\$2.25
Flue lining:		
4½ ft. x 13 ft., per lin. ft.....	.24	.12
4½ x 8½, per lin. ft.....	.18	.16
8½ x 8½, per ft.....	.24	.16
8½ x 13, per ft.....	.54	.20

	New York	Chicago
13 x 13, per ft.....	.46	.28
8½ x 18, per ft.....	.54	.32
13½ x 18, per ft.....	.70	.42
18 x 18, per ft.....	.90	.55
Wall coping (double slant):		
8 in., per lin. ft.....	.16	.14
12 in., per ft.....	.26	.18
18 in., per ft.....	.54	.30
Wall coping (single slant):		
8 in., per lin. ft.....	.16	.14
12 in., per ft.....	.26½	.30
18 in., per ft.....	.54	.30

Hollow Tile		
	New York	Chicago
(Delivered at job, in New York below 72nd St.)		
2 x 8 x 12 partitions, per 1,000 sq. ft.....	\$70.15	.....
3 x 12 x 12 partitions, per 1,000 sq. ft.....	102.00	\$67.90
4 x 12 x 12 partitions, per 1,000 sq. ft.....	114.75	72.50
6 x 12 x 12 partitions, per 1,000 sq. ft.....	153.00	99.60
8 x 12 x 12 partitions, per 1,000 sq. ft.....	.....	135.80
10 x 12 x 12 partitions, per 1,000 sq. ft.....	.....	167.50
12 x 12 x 12 partitions, per 1,000 sq. ft.....	.....	194.60
2 x 12 x 12 split furring, per 1,000 sq. ft.....	63.75	.....

CEMENT		
	New York	Chicago
Per bbl. in 15 cent bags (Rebate 60c. per bbl. for bags) .....	\$3.25	\$2.80

COPPER SHEETS		
	New York	Chicago
At the mill, hot rolled, 16 oz. base-price, per lb.....	25½c.*	25½c.*
(From jobber's warehouse add 2 to 3 cents. Cold rolled add 1c. per lb. to hot rolled.)		

CORNER BEAD		
	New York	Chicago
Per foot .....	.05	.05

FIBRE		
	New York	Chicago
Per bushel .....	.30	.30

(Continued on page 900-B)







NA  
l  
A322  
v.115

American architect and  
architecture

PLEASE DO NOT REMOVE  
CARDS OR SLIPS FROM THIS POCKET

---

UNIVERSITY OF TORONTO LIBRARY

---

