

BUILDING NEWS

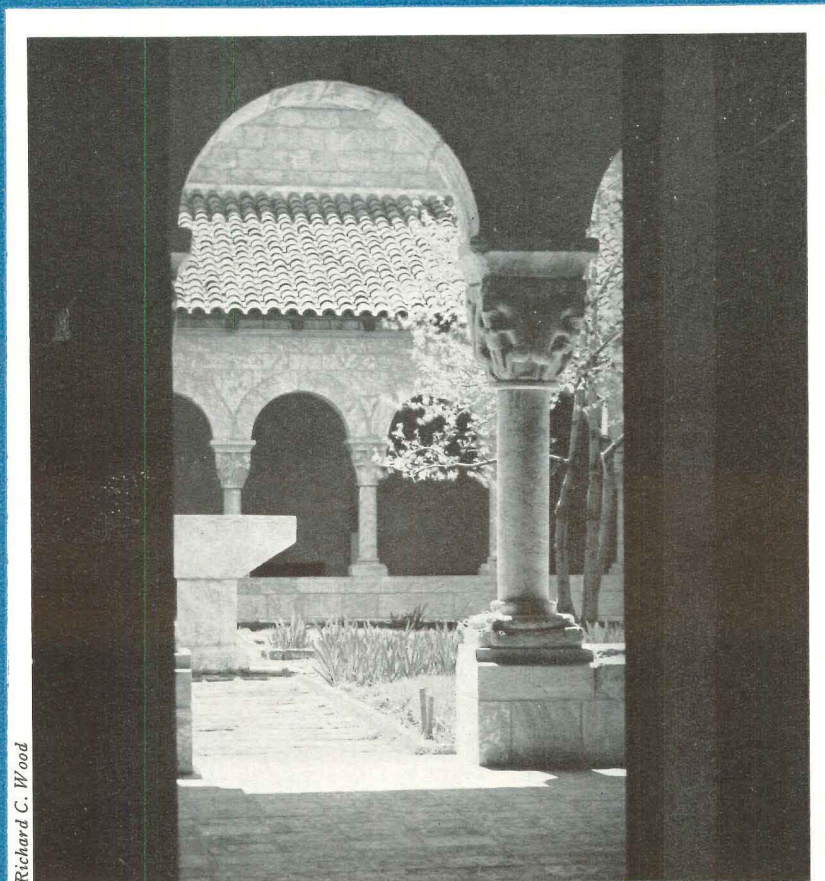

Richard C. Wood

Cuxa: built in the Twelfth, resurrected in the Twentieth...

ARCHITECTURAL
RECORD

COMBINED WITH
AMERICAN ARCHITECT AND ARCHITECTURE

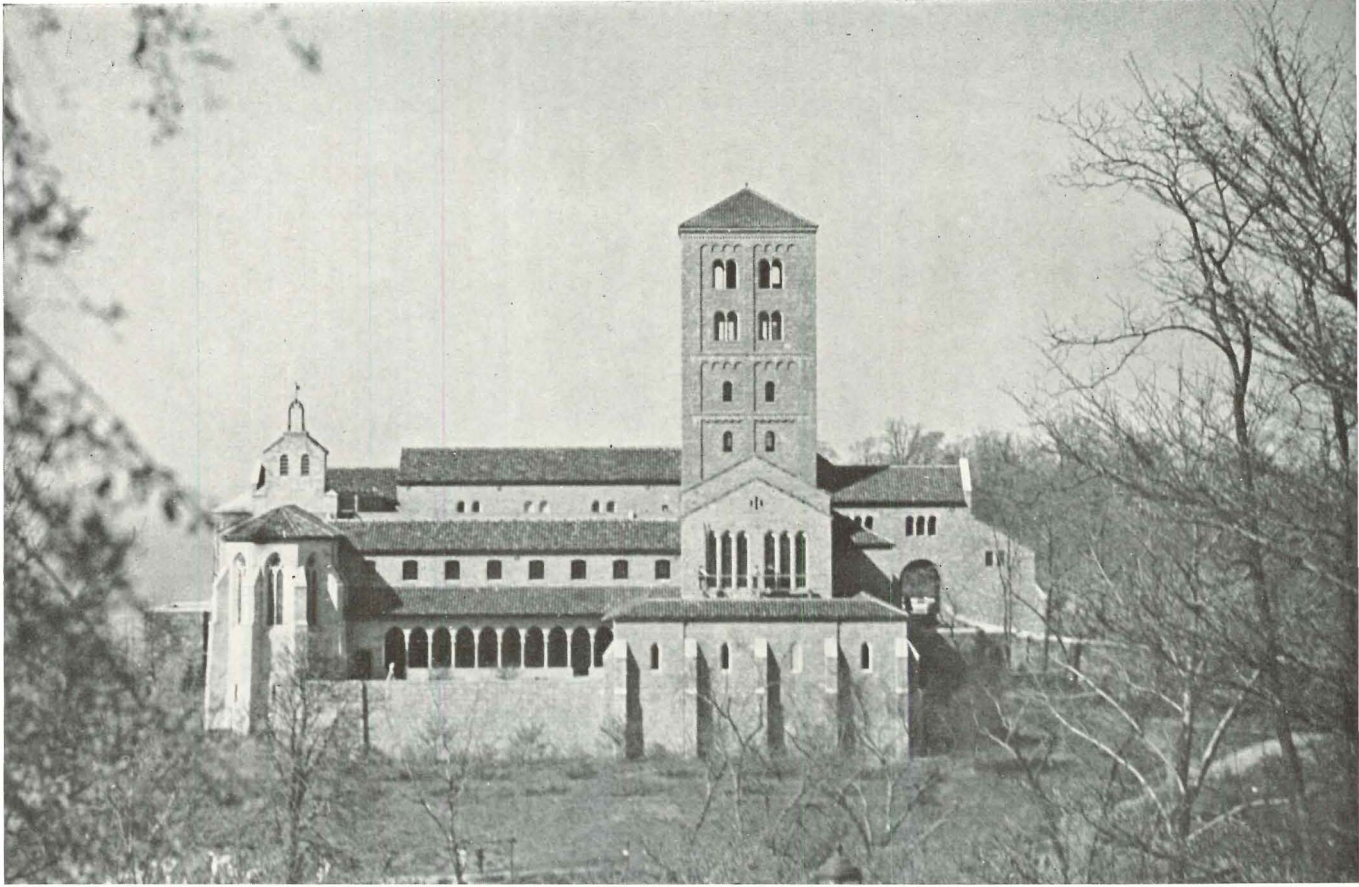

Photos by Richard Carver Wood

"THE CLOISTERS"—ANOTHER TECHNIQUE IN MUSEUM DESIGN

ALLEN, COLLENS & WILLIS

Architects

OLMSTED BROTHERS, Landscape Architects

THE RISING INTEREST in the preservation of historic architecture has led to the development of a number of specialized building designs, all of them variations of the museum—Ford's Dearborn Village, Rockefeller's Williamsburg, The Metropolitan Museum's American Wing, etc. Each of these projects has evolved its own technique of presentation, inevitably involving the highly controversial issue of *how* historic architecture shall be preserved and presented.

Still another technique is established at the Metropolitan's "Cloisters", opened last month in Fort Tryon Park, New York City. Here the problem was not the simple one of presenting complete interiors, nor yet of reconstructing complete buildings; it was rather the display of a large collection of architectural fragments whose common denominator was their place in time (the Middle Ages) and space (France and Spain).

Thirteen years ago, as a result of a fund established by John D. Rockefeller, Jr., the Metropolitan acquired the George Grey Barnard collection of medieval sculpture. In 1930, commission to design the new building was awarded to Charles Collens of the Boston firm of Allen, Collens & Willis; in association with James J. Rorimer, of the Museum's Department of Medieval Art, Mr. Collens set to work. The first principle established was that The Cloisters was to be *neither a copy nor a composite of old buildings*. Therefore, the general form of the building was to grow out of its function and protection for a collection with fixed limits. Next it was decided that exhibits were to be functionally incorporated into a plan which cataloged them according to their period, place, and style. Finally, all new construction, while providing an harmonious and unobtrusive background, was to have no "antiqued" finish; and reconditioning of exhibits themselves was to be avoided.

From such premises the present building was slowly evolved, each unit being carefully studied in the model stage. The four cloisters, the Pontaut chapter house, the Gothic chapel and early and late Gothic halls—were all designed as units in themselves before being organized into a general plan. The walls of the building are of a warm New England granite, reminiscent of that often used in Southern France, laid up in appropriate scale. The roof and floor tile are modern, modeled after contemporary examples.

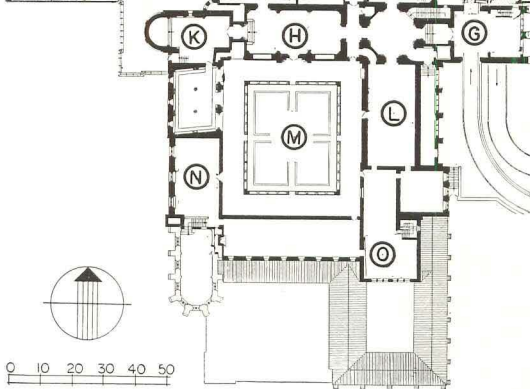
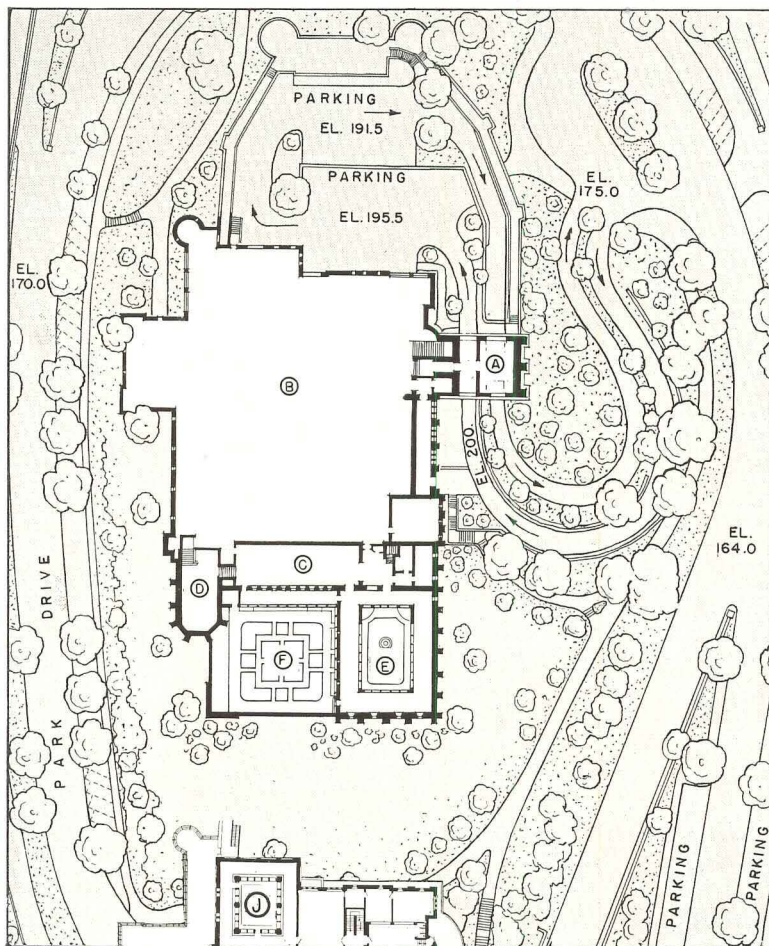

- A. Entrance from Lower Drive
- B. Offices and Storage
- C. 15th Century Room
- D. Gothic Chapel
- E. Trie Cloister
- F. Bonneville Cloister
- G. Entrance from Upper Drive
- H. Romanesque Hall
- J. Saint-Guilhem Cloister
- K. Romanesque Chapel
- L. Late Gothic Hall
- M. Cuxa Cloister
- N. Early Gothic Room
- O. Bappard Tapestry Room

Plans: ground floor, top, and main floor, center

Transverse section thru "M"

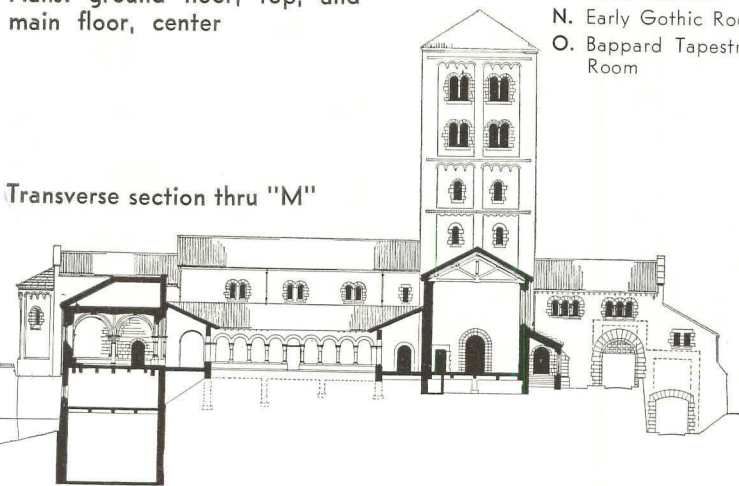

"THE CLOISTERS"

The functional incorporation of the various architectural elements—doorways, windows, stained glass, sculptural reliefs—which constitute a large portion of the museum's present collection, makes for an integration of exhibits into the building proper. This is apparent also in the layout of the building, which pays respect to the chronology and geographical source of exhibits: the visitor sees, first, examples of Romanesque architecture, sculpture, and frescoes, then proceeds to early and late Gothic exhibits.

Wherever possible, reconditioning of these elements has been avoided, as it is felt that the attempt to bring old and new work into complete harmony often irrevocably destroys an inheritance from the past. Since it was impossible because of the passage of centuries to obtain complete relics, the original stonework was used as far as possible and supplemented with modern work based on unornamented prototypes which in no way detract from the medieval effect. In the Romanesque chapel, 13th century glass, brilliantly colored and of the type and quality of the windows at Chartres and Bourges, has been used, since most 12th century glass has now disappeared. Thus, while "The Cloisters" affords unusual opportunities for study of medieval stonework and stained glass, it provides a setting for exhibits of a less architectural nature, which is at once unobtrusive and appropriate.

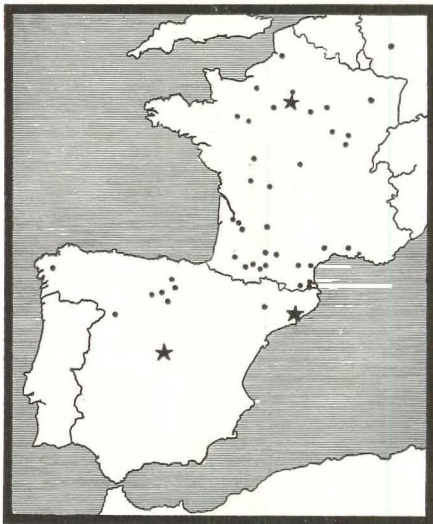

Map of France and Spain showing principal sources of "The Cloisters" exhibits: starred are Paris, Madrid, Barcelona.

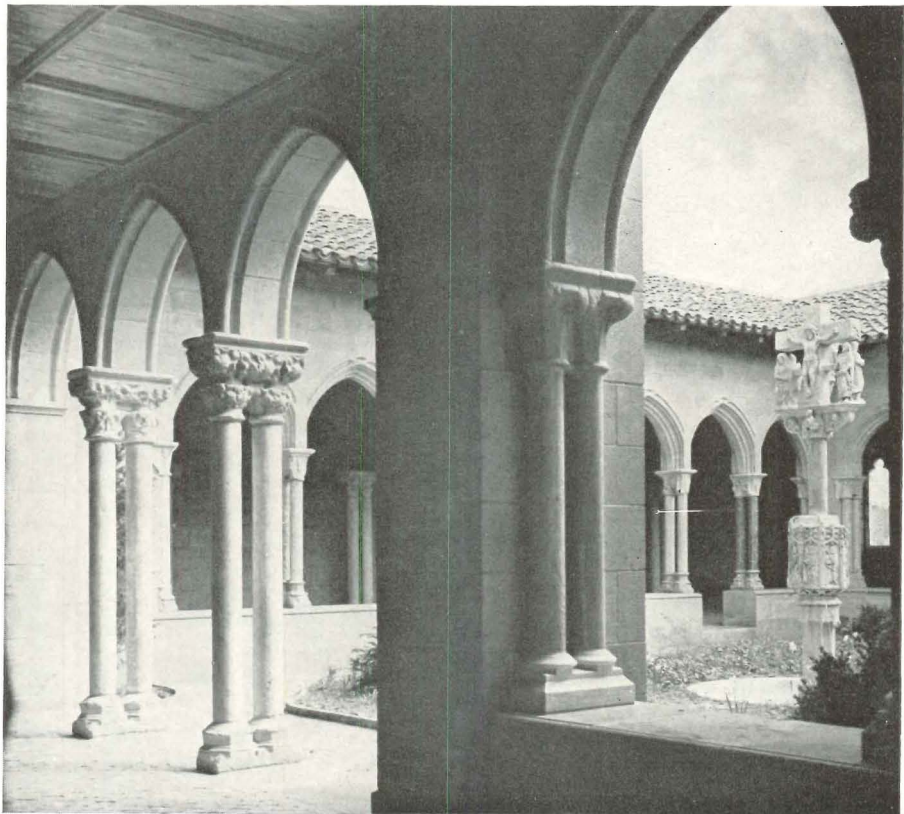
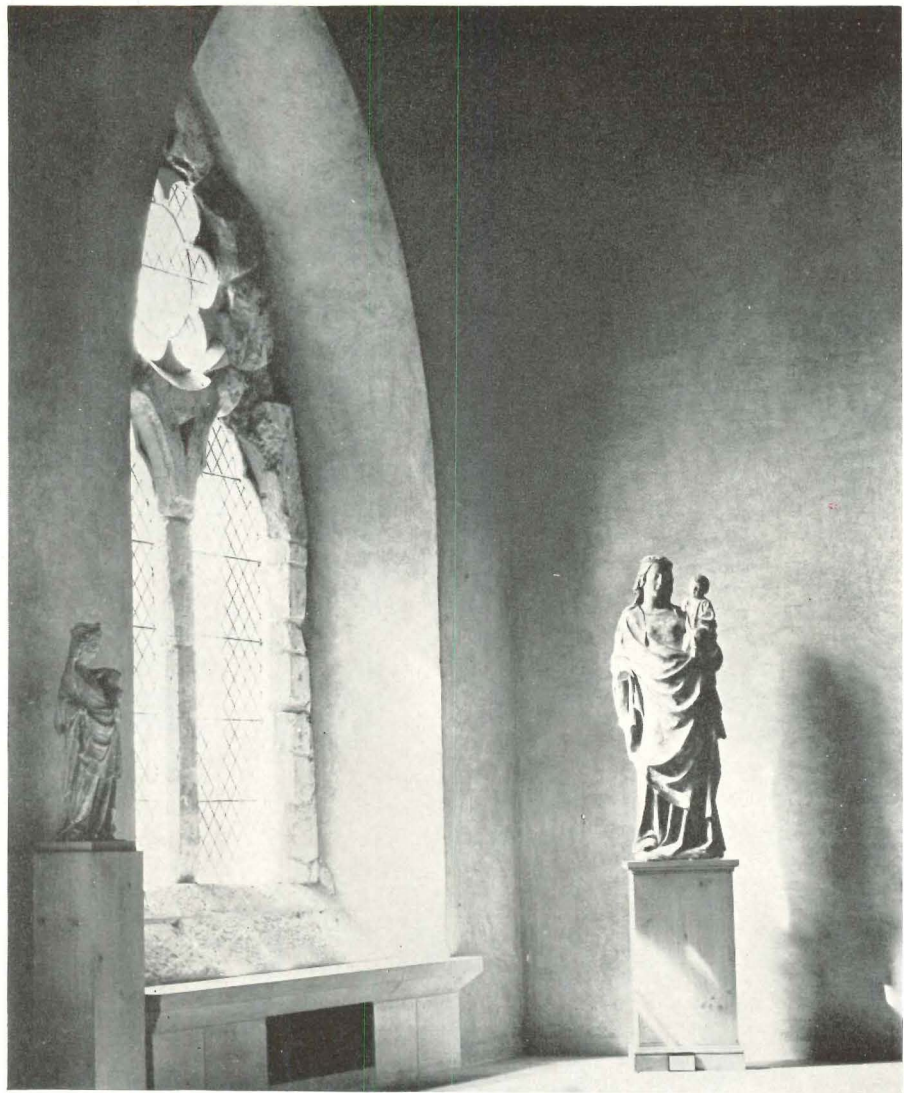



3

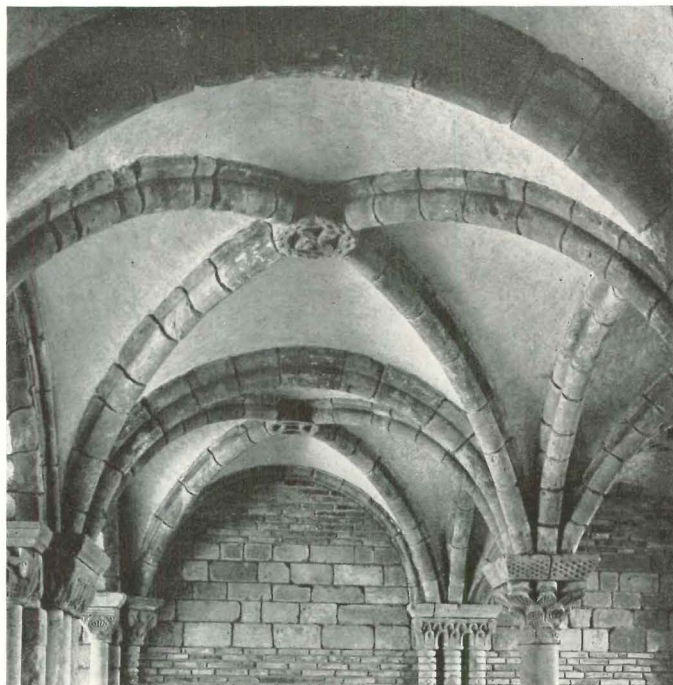

4

Construction Views courtesy Metropolitan Museum of Art

1. EARLY GOTHIC HALL: Madonna and Child, (French) Ile-de-France, 14th century. Window from Beaumont-le-Roger; beams suggested by similar ones in reconstructed Salle des Chevaliers in the Porte Narbonnaise, Carcassonne.

2. TRIE CLOISTER: Reconstruction of a cloister of the convent at Trie, which was destroyed by the Huguenots in 1571.

3, 4. CHAPTER HOUSE, NOTRE-DAME-DE-PONTAUT: Stone for stone the chapter house at Pontaut Abbey was removed and re-erected at the Cloisters. The 12th century round-arched ribs are original; only the infillings are modern. Walls are of soft yellow limestone, supplemented in some places by brick. No restoration of stones has been attempted nor have joints been filled completely.

5. CUXA CLOISTER: Taken from the 12th century abbey of Saint-Michel-de-Cuxa, this cloister as reconstructed is actually only a little more than half its original size; the width of walks has been decreased from 15 ft. to 12 ft. Original portions of the cloister have been kept together; where supplementary stone was necessary, it was taken from the same quarries from which the 12th century builders of Cuxa obtained their material.

5

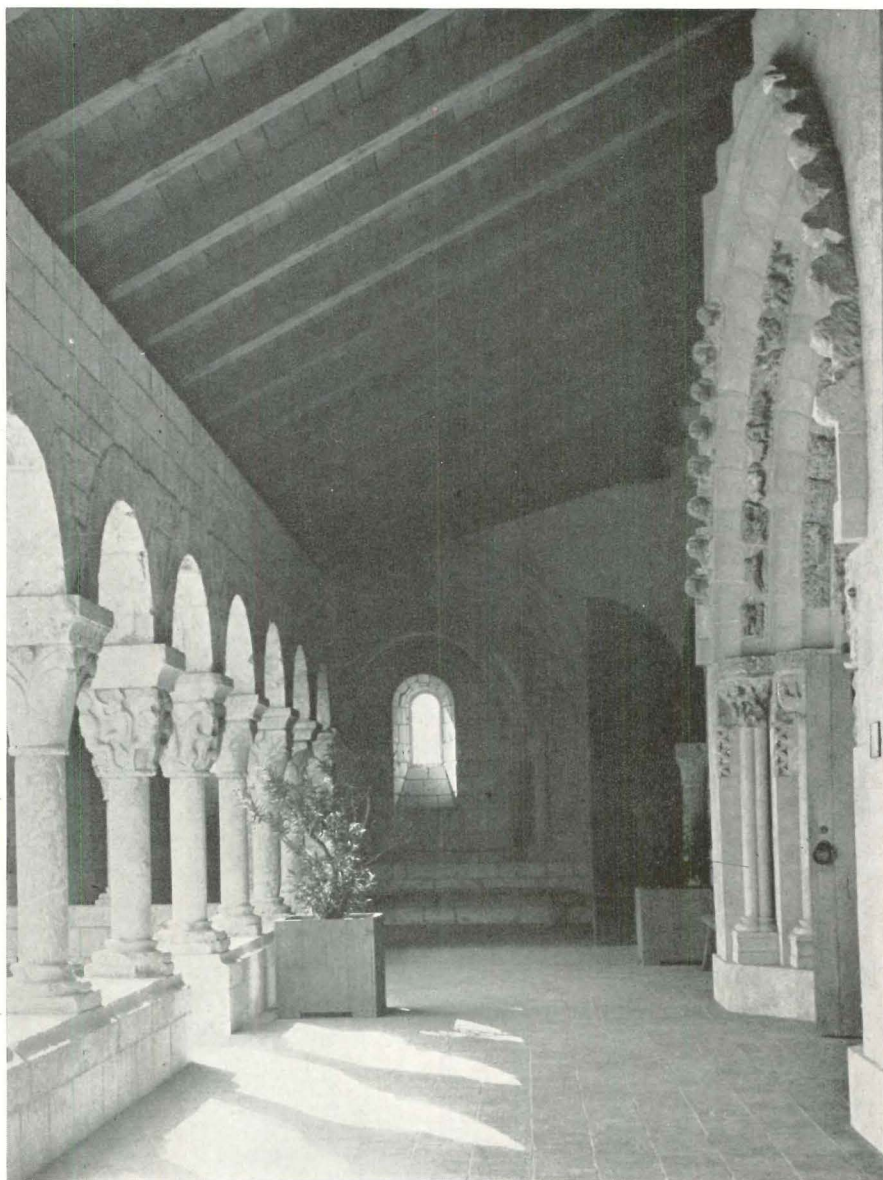

"THE CLOISTERS"



ROMANESQUE HALL (left): Entrance to the Romanesque chapel is through this 13th century Gothic doorway from the monastery of Moutiers-Saint-Jean. The chapel incorporates much of the original stonework of the church of Notre-Dame-du-Bourg at Langon near Bordeaux. **SAINT-GUILHEM CLOISTER** (below, left): Illustrative of the transitional period between Romanesque and Gothic is the doorway from Reugny, with its massive lobed and decorated tympanum. The Reugny doorway leads to the 11th or 12th century **SAINT-GUILHEM-LE-DESERT CLOISTER** (below, right) whose present architectural setting is based on the cloister of Saint-Trophime at Arles, and those at Montmajour and Saint-Remy. The high wall above the arcades, similar to that at Arles, makes possible the use of a skylight so that the delicate material here preserved is protected from the elements. The font in the center of the court was once a capital in the church of Saint-Sauveur at Figeac; since it originally supported heavy architectural members, its ornamentation is more boldly conceived and more rugged than that of the cloister capitals.



Photos by Richard Career Wood

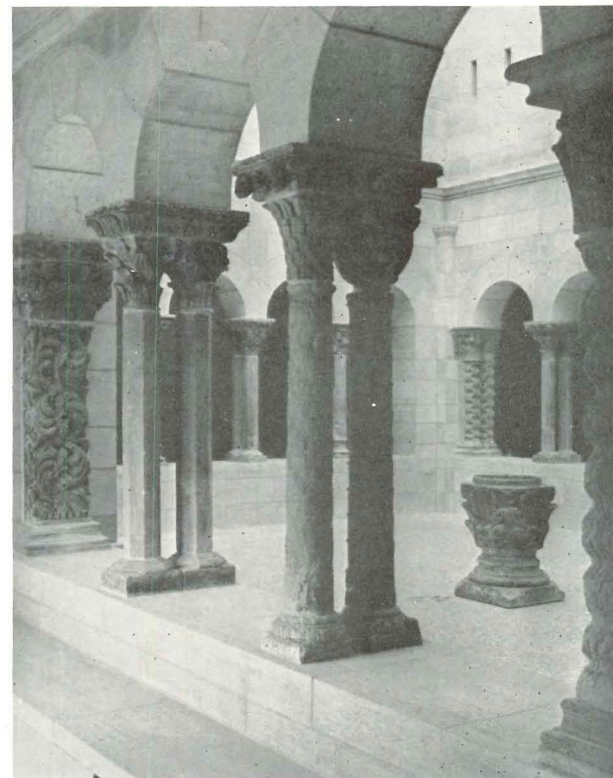



SWEDEN: SPECIALTY SHOP ORGANIZED ON VERTICAL BASIS

E. GUNNAR ASPLUND
Architect

IF THIS NEW store for Bredenberg's in Stockholm were turned over on its side, it would occupy approximately the same ground area as the typical small-town Swedish specialty shop. But the fact that the firm desired a central location, where a large ground area was out of the question, forced the architect, Gunnar Asplund, into a vertical design. Starting with a deep and narrow corner lot, Mr. Asplund has organized the sales areas in the three first floors, with a restaurant on the fourth. To make circulation between these floors as easy and attractive as possible, the stair shaft was developed into a major architectural feature (p. 56). On the top floors and penthouse unusually complete provision was made for personnel, offices, advertising, and storage. To increase the display area along the narrow frontage, the main entrance was recessed; and display windows run lengthwise the entire street floor.

Construction of the Bredenberg store is at once simple and highly refined. Discarding completely the load-bearing wall, the architect has employed a reinforced concrete skeleton frame with a curtain wall of extraordinary lightness (p. 55 for details). All elements of this structural system are refined: the concrete frame, exposed throughout, with its H-shaped column sections to accommodate the steam pipes; the cantilevered stairs; the glass and marble wall units. Aside from making for a light and airy interior, this system gives a building whose entire apparatus (rather than a few selected items) are on display in the long Scandinavian nights.



Photos by C. E. Rosenberg

Detail, main entrance

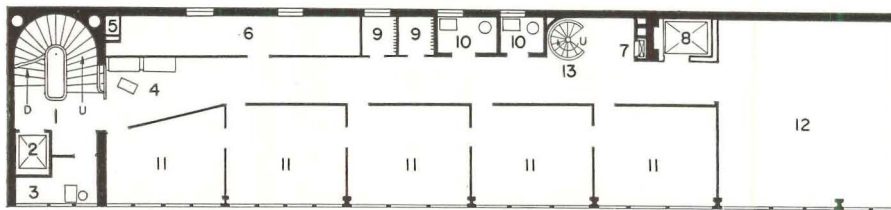

Sixth Floor

- | | |
|---------------|-------------------|
| 1 Stairs | 8 Lift |
| 2 Lift | 9 Coatrooms |
| 3 Phone board | 10 Toilets |
| 4 Lobby | 11 Offices |
| 5 Incinerator | 12 Advertising |
| 6 Samples | 13 Terrace stairs |
| 7 Dumb-waiter | |

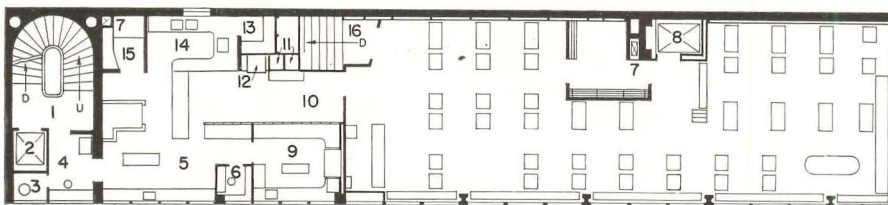

Fourth Floor

- | | |
|----------------------|----------------|
| 1, 2 Stairs and Lift | 10 Cafeteria |
| 3, 4 Women | 11 Closets |
| 5 Kitchen | 12 Cashier |
| 6 Manager | 13 Storage |
| 7 Dumb-waiter | 14 Dishwashing |
| 8 Lift | 15 Storage |
| 9 Pantry | 16 Stairs down |

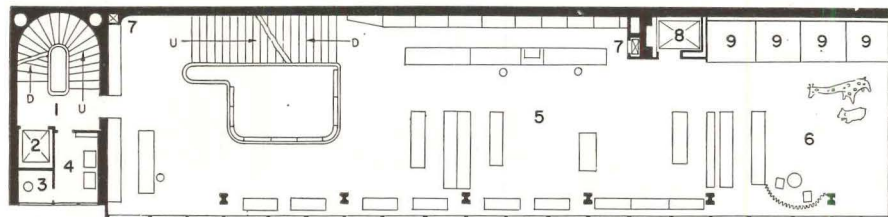

Second Floor

- | | |
|-----------------|-----------------|
| 1 Stairs | 6 Nursery |
| 2 Lift | 7 Dumb-waiter |
| 3, 4 Men's room | 8 Lift |
| 5 Sales area | 9 Fitting rooms |

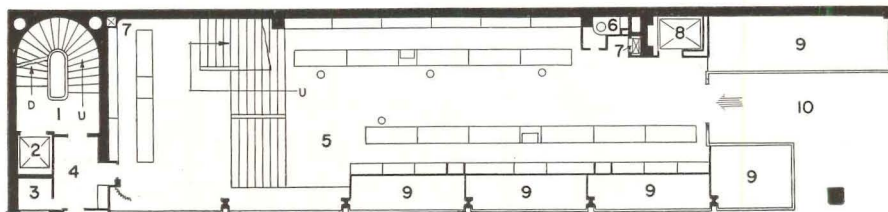

First Floor

- | | |
|--------------|-----------------|
| 1 Stairs | 6 Cashier |
| 2 Lift | 7 Dumb-waiter |
| 3 Display | 8 Lift |
| 4 Lobby | 9 Display |
| 5 Sales area | 10 Mainentrance |



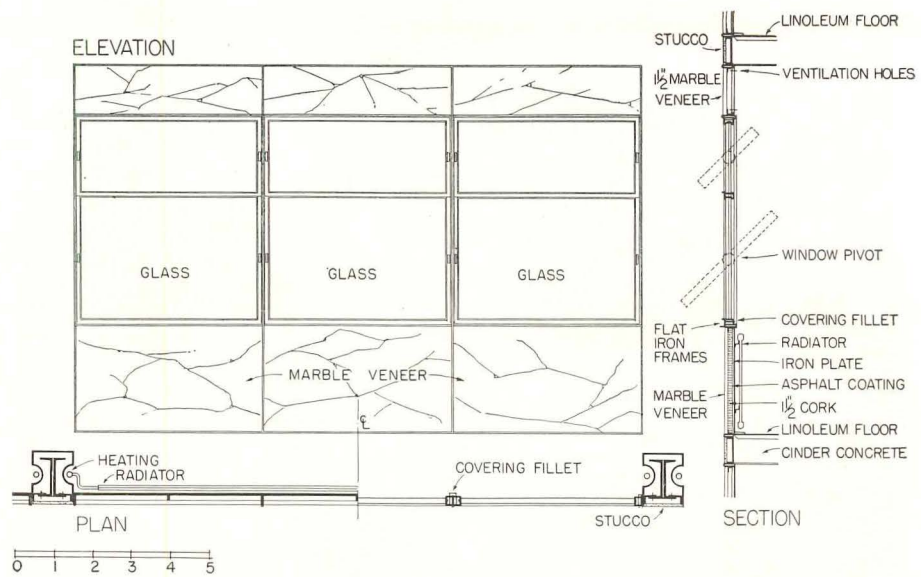

Economy of material, weight, and space is achieved by the architect's use of an exterior curtain wall whose total thickness, while only $3\frac{1}{3}$ in., is nevertheless adequate for the severe Stockholm winters. The wall units and windows are carried on a light steel frame; the $1\frac{1}{2}$ -in. marble sheathing is bolted in place and set in mastic; the belt course at each floor level is cement stucco, copper-flashed.

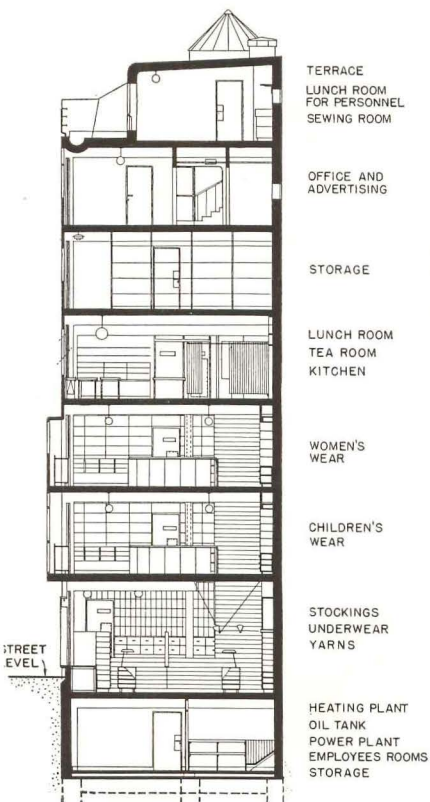
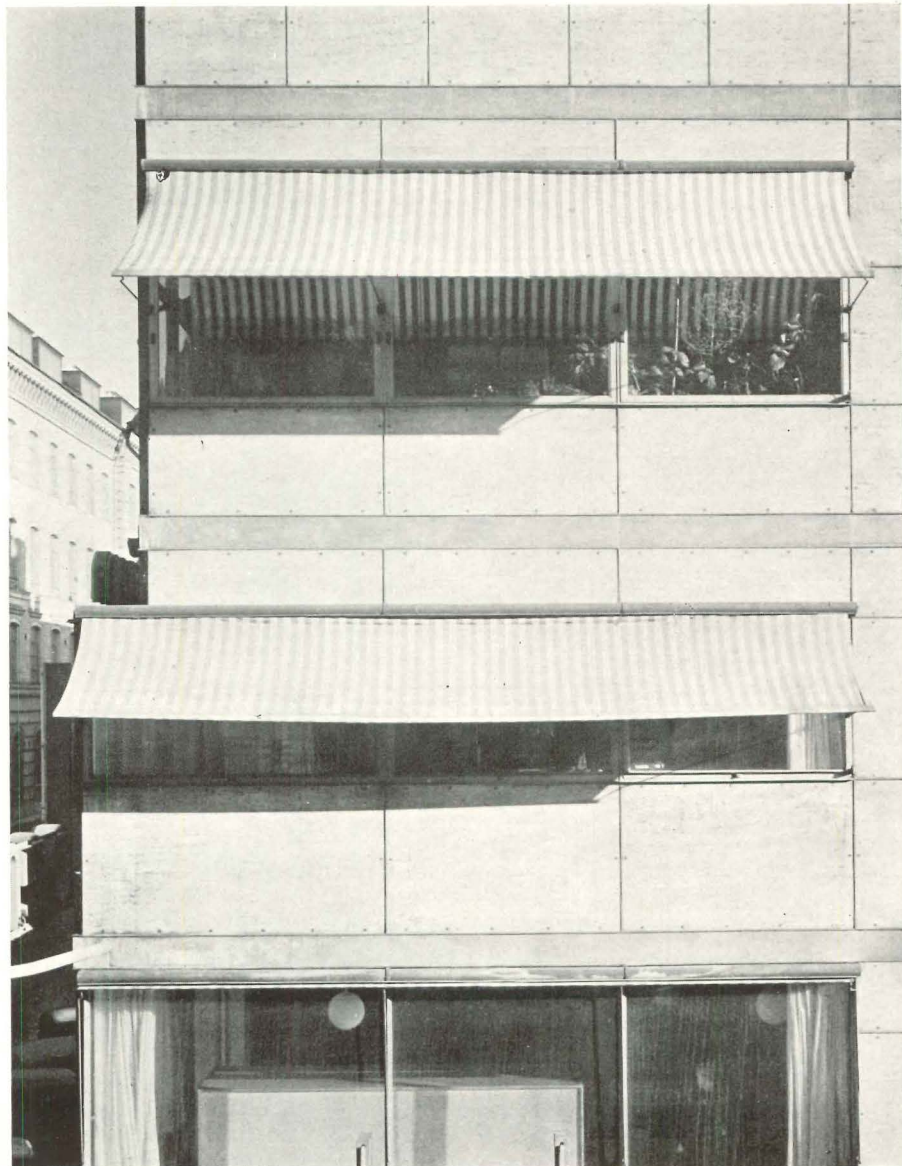

On a lot barely 25 ft. wide, the architect has contrived not only an excellent vertical organization of the plan elements (above and left), but also substantial economies in construction. The enforced concrete skeleton is so designed that each floor is carried by six standard 25-ft.-span beams.



Photos by C. E. Rosenburg

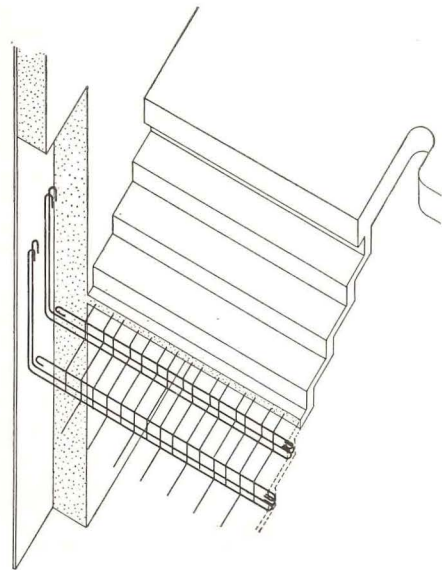

Mr. Asplund's skill in the use of reinforced concrete is demonstrated in the main stairway of the Bredenberg store which rises through the three main sale floors. By a careful study of his reinforcing (above), he has entirely eliminated the usual stringer, making a cantilever of the entire flight, with riser and treads serving as stiffener. Notice the section of columns and the lighted show cases instead of balustrades.

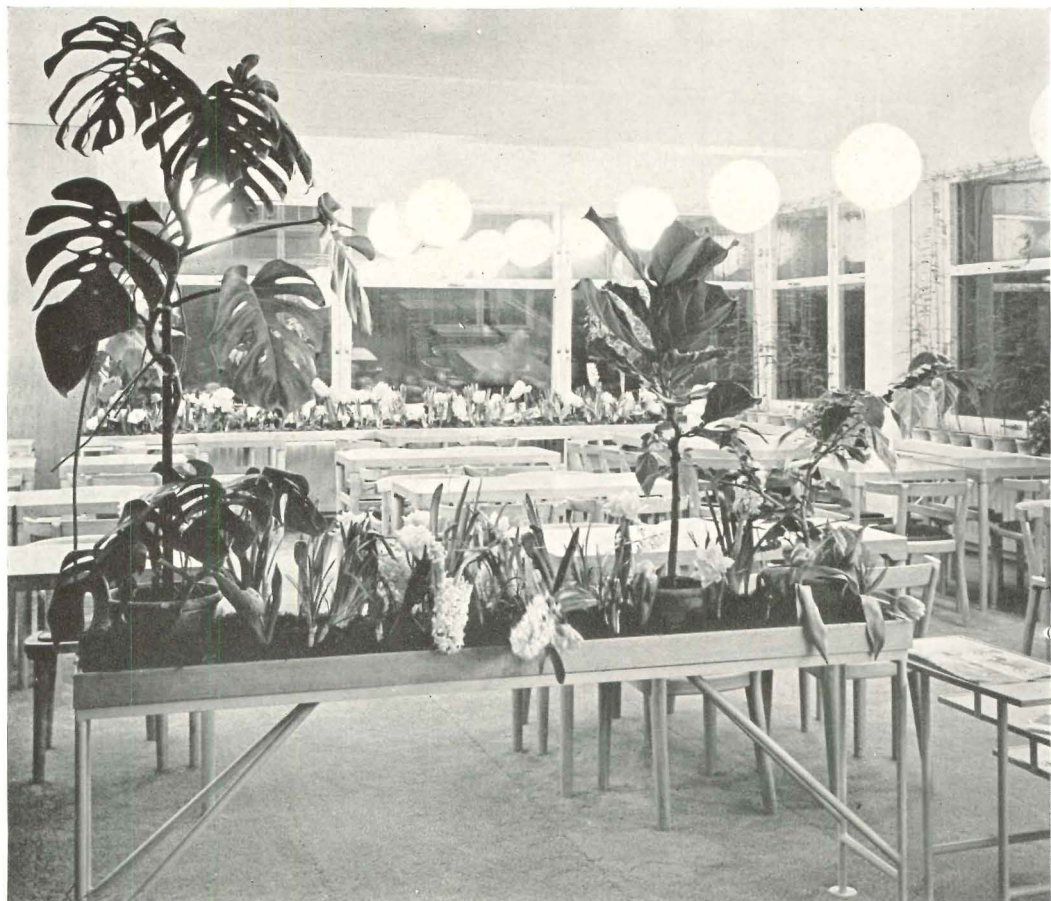
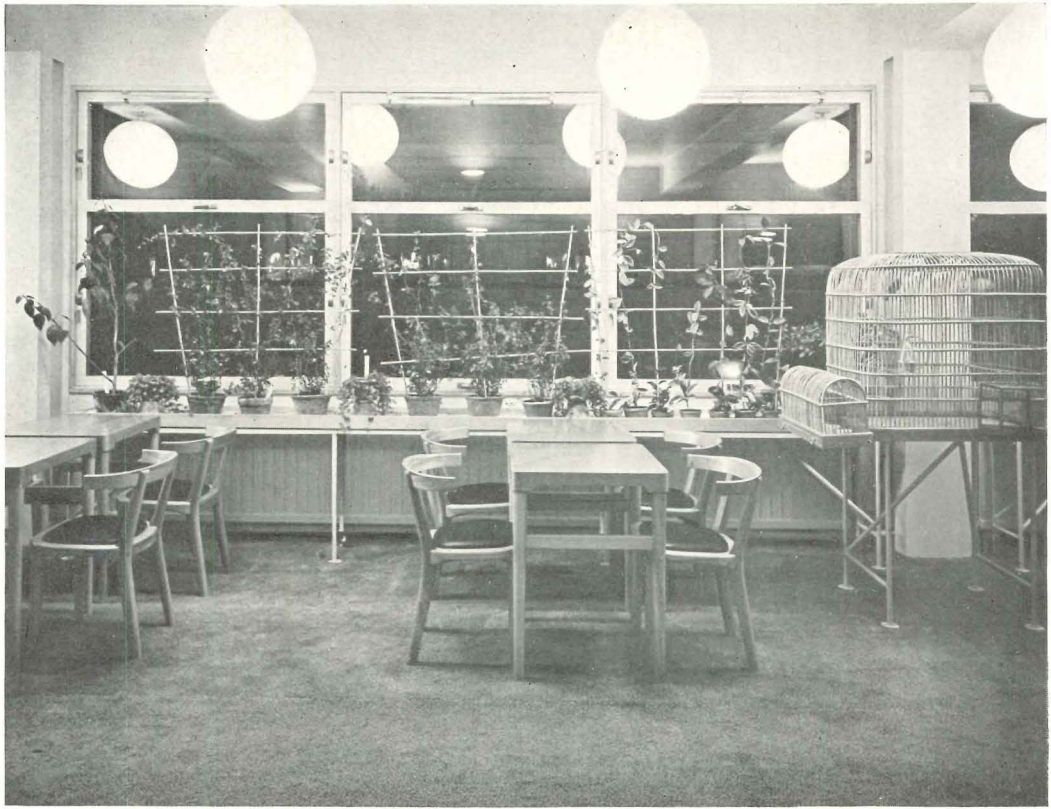

Specially designed by Mr. Asplund were all furniture, fixtures, and lighting equipment. These views of the fourth-floor lunch- and tearoom indicate the high level of design possible with simple and relatively inexpensive materials. The use of potted plants to divide the tables into groups, together with the large glass areas, give the room a festive and "alfresco" atmosphere.

Len Weissman

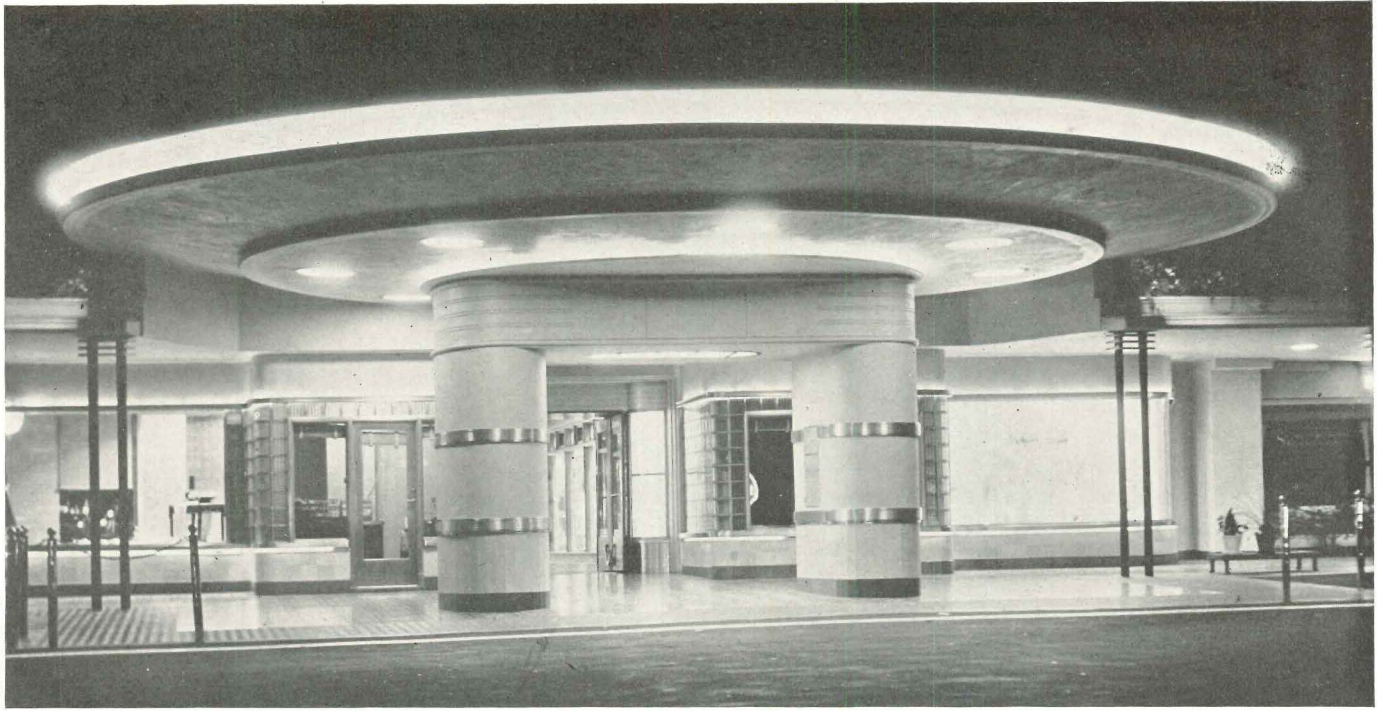

COCOANUT GROVE BUILDS MARQUISE TO ATTRACT NIGHT LIFE

WALKER & EISEN
Architects

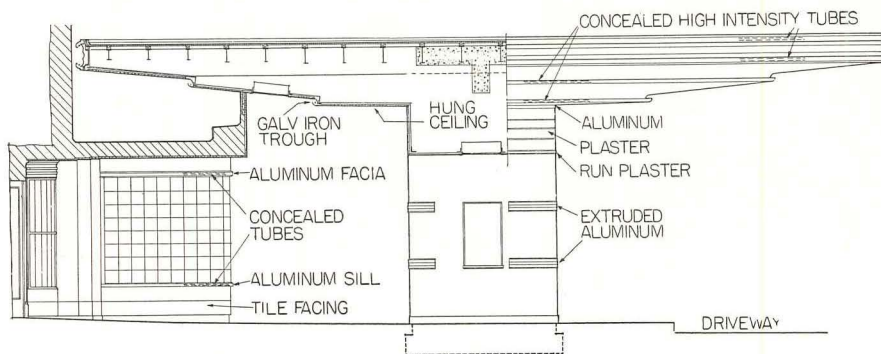
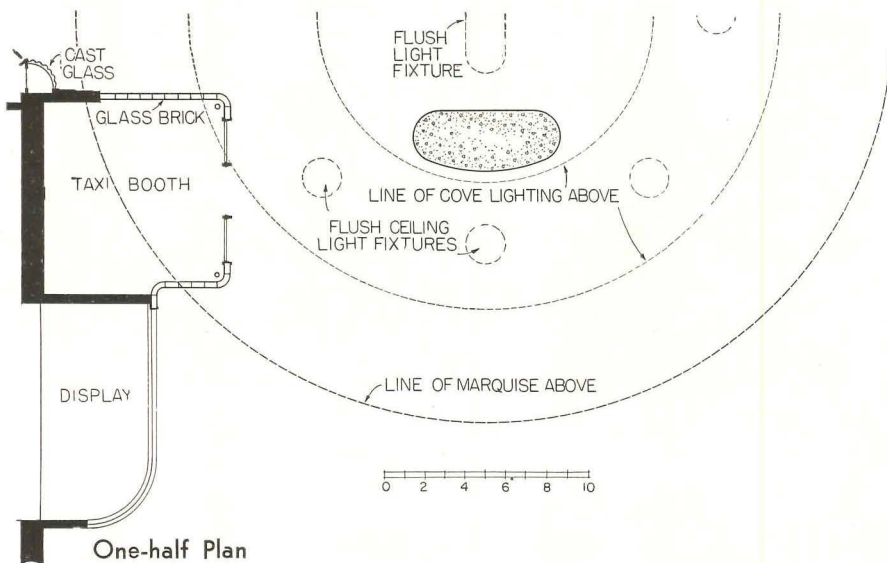

Section and Half Elevation

THE RECENTLY remodeled marquee at Los Angeles' Ambassador Hotel was designed specifically as a drawing card for the hotel's night attractions, among which is its famed Cocoanut Grove. The circular design was arrived at "in order to create interesting lighting effects": indirect neon lights are used around the rim and recessed troughs of the marquee, and concealed neon lights are placed back of the sill and head of the aluminum raceways over the display windows. Supporting pylons are of light steel frame construction with a plaster finish over concrete; all metal work is aluminum. Located on one of the pylons is a telephone connection and taxi call system.

In redesigning this main entrance the architects included inside the glass brick walls a waiting room on one side and a taxi office on the other; beyond these rooms are display windows for the various shops in the building.

AFRICA—MOBILE HOTELS TO SOLVE CONGO'S TOURIST PROBLEMS

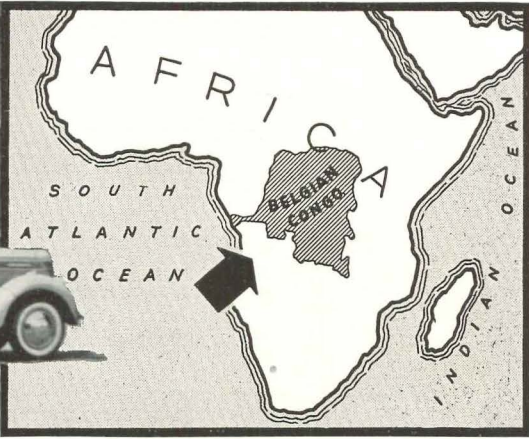
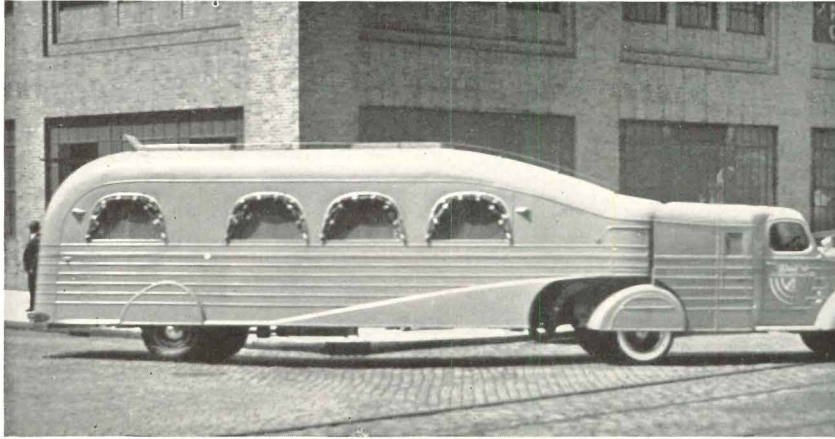

ALEXIS DE SAKHNOFFSKY
Designer

FLEETWHEELS-COATES, INC.
Fabricators

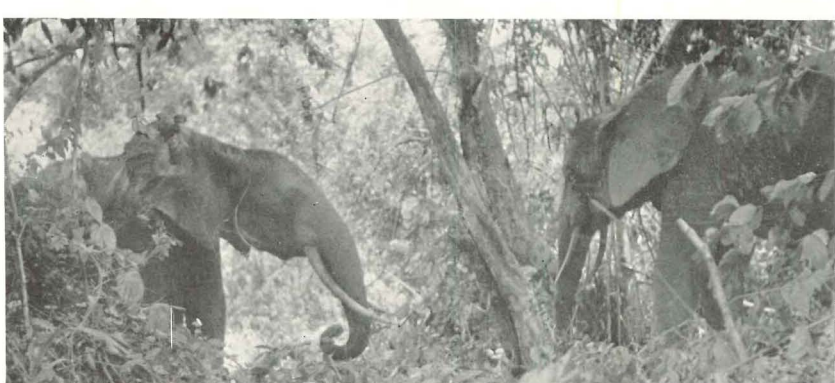
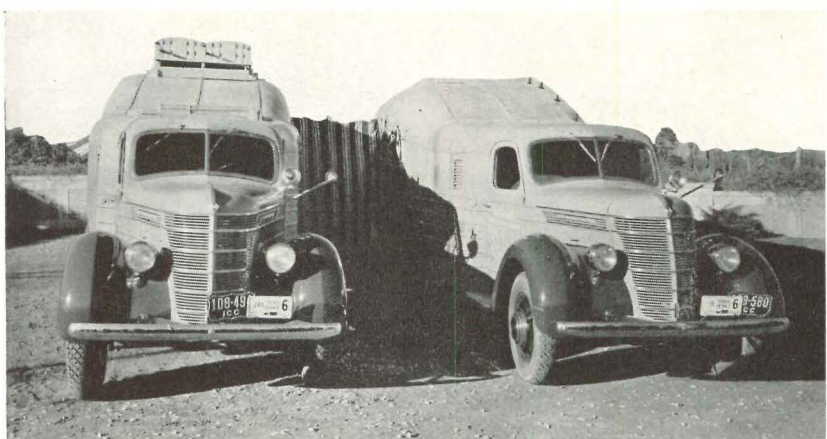

WITH AN EYE ON an as yet nonexistent tourist trade, the Belgian Congo has recently completed a modern highway system throughout the Colony. But touring the Congo—even today—is not the simple matter it is in more civilized areas: there are no gas stations, rest houses, telephones, etc., at easy intervals; more important, there is no chain of air-conditioned hotels. Furthermore, to build such a system of accommodation merely in *anticipation* of tourists was out of the question; yet without such accommodations, de luxe tourist traffic could not be expected. . . . This was the dilemma which the Congo government faced and for which Commander Attilio Gatti, long-time Congo explorer, had an answer. Why not a fleet of small, completely staffed and self-contained, mobile hotels, to be leased at fixed rates for any desired period? There was no problem of protection against fire, heat, cold, insect and wild life, thirst or hunger, against which such mobile units could not provide.

Constituting one of the most interesting design problems on record, the first unit of the proposed fleet of mobile hotels last month embarked for Africa. Joint result of Gatti's knowledge of African conditions, Sakhnoffsky's over-all design, and Fleetwheel's modifications, the units contain complete power, water, sewage, air conditioning, and communications (telephone, two-way local and long-distance radio) systems and provide maximum protection against the factors listed above. Controlling elements in the design were economy of cost, space and—though secondary, since African roads are not designed for high speeds—weight.

Powered by International, the Fleetwheel trailers are articulated (1 and 2); parked parallel (3), and connected by a collapsible "gangplank", they form a complete five-room dwelling unit. These elephants (4) are within a day's "safari" of the roads along which units will travel.



Photos by Drucher-Hilbert Co.

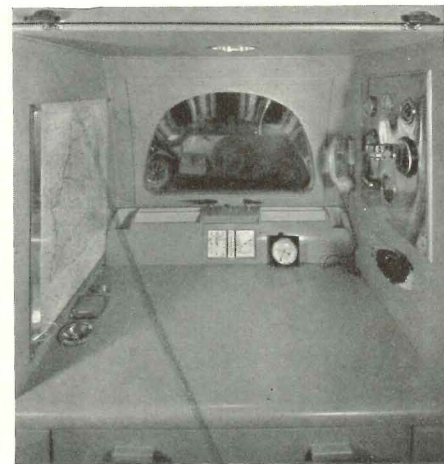

LIVING AND DINING AREA includes desk with instrument board, local and long-distance radio, files, gun cases, and bookshelves; built-in bar; folding table with chairs; china cupboards with special racking; and a complete kitchen (see next page). As is obvious from their design

and equipment, these units are primarily intended for comfortable living rather than for luxurious transportation—i.e., when they are parked and coupled rather than when in motion. Special seats atop each unit are provided for sightseeing, photography, etc.

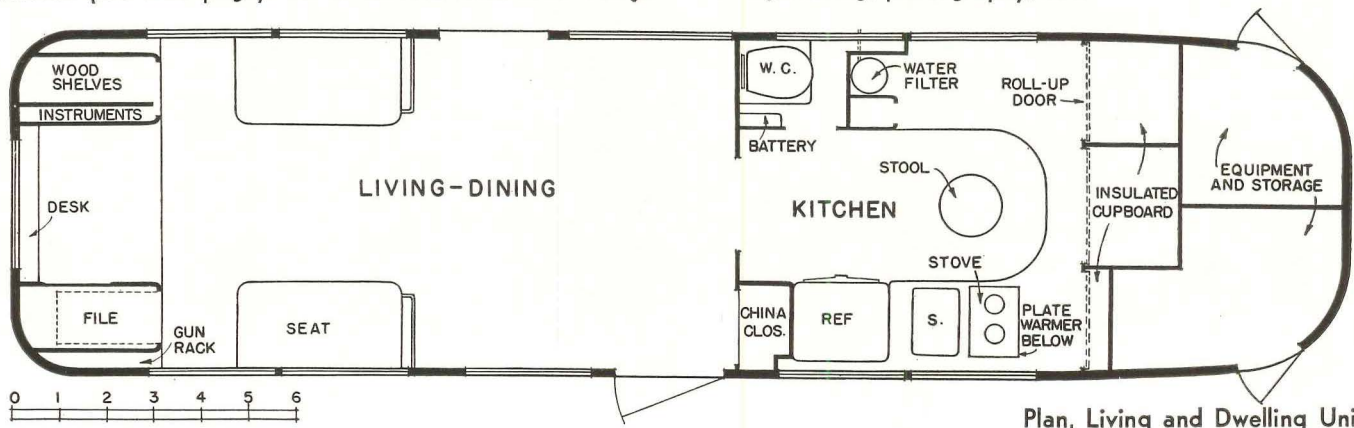

Plan, Living and Dwelling Unit

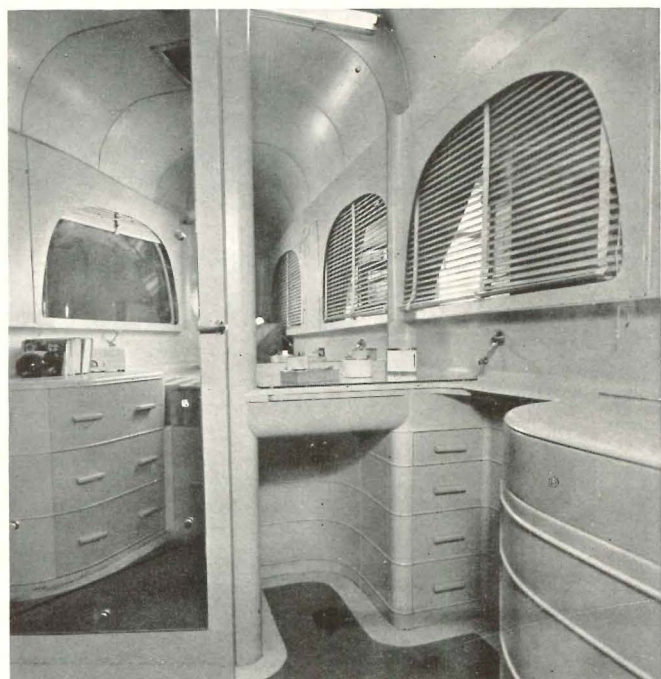
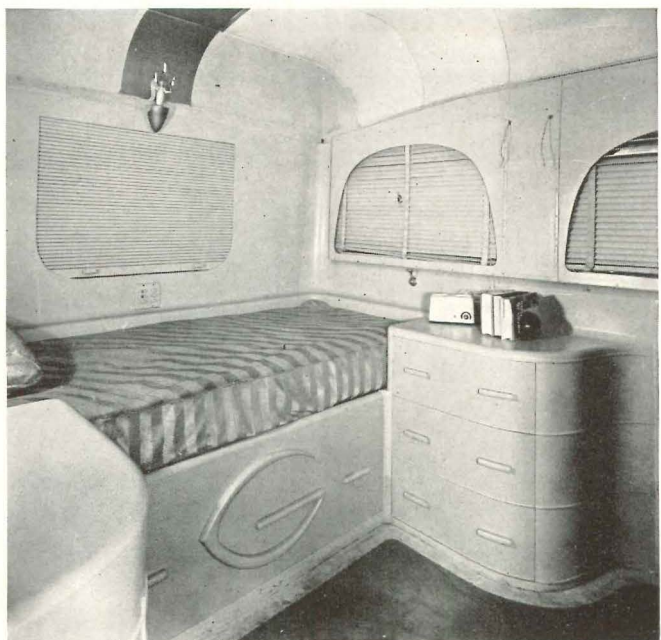

BEDROOM No. 2: By using a new electrical blanket with automatic thermostatic control, necessary bedding was greatly reduced. Storage space, equal to average bedroom, is compactly provided in all-metal, insect-proof cabinet work.

BEDROOM No. 1: Designed for feminine occupancy, this room provides more dresser and mirror space. Top of chest contains complete toilet set, racked to prevent breakage in motion. Like No. 2, this room has 'phone to chauffeur and two-way radio.

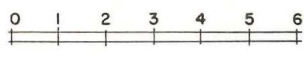
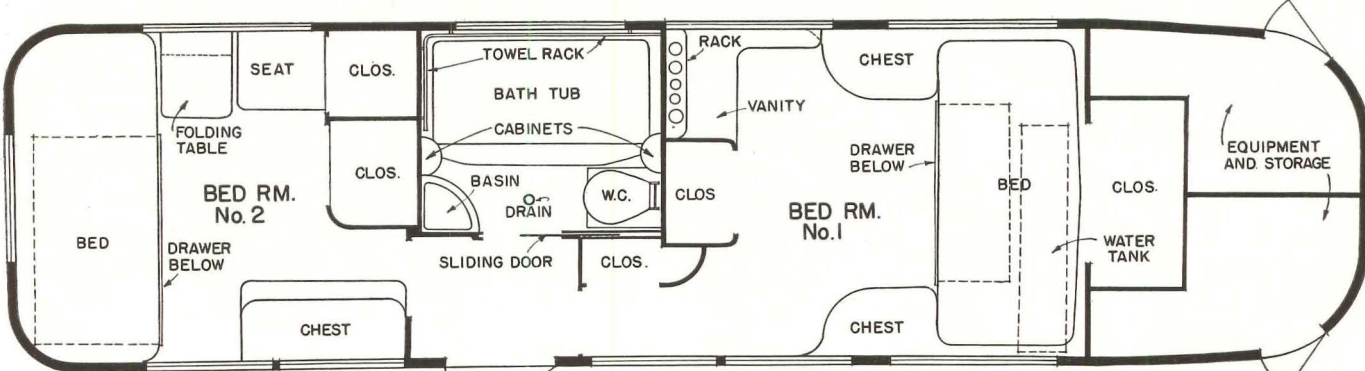

Plan, Sleeping Unit

MOBILE HOTELS

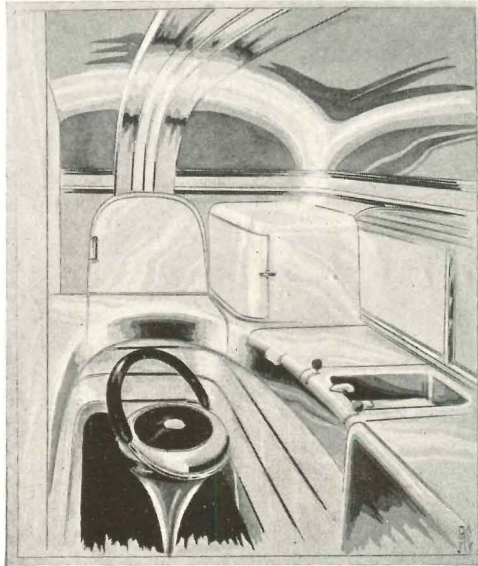

From de Sakhmoffsky's original sketch

KITCHEN: Besides regulation storage, counter and cupboard space, kitchen provides GE refrigerator, stove, electric roaster, plate warmer, waffle iron, percolator, toaster, fan to exhaust odors, etc. A complete water-supply and disposal system includes tank, compressor, filter, and sink with hot and cold water. Color scheme: floor, black and gray linoleum; walls and ceiling, gray with yellow stripe; all metal work, stainless steel.

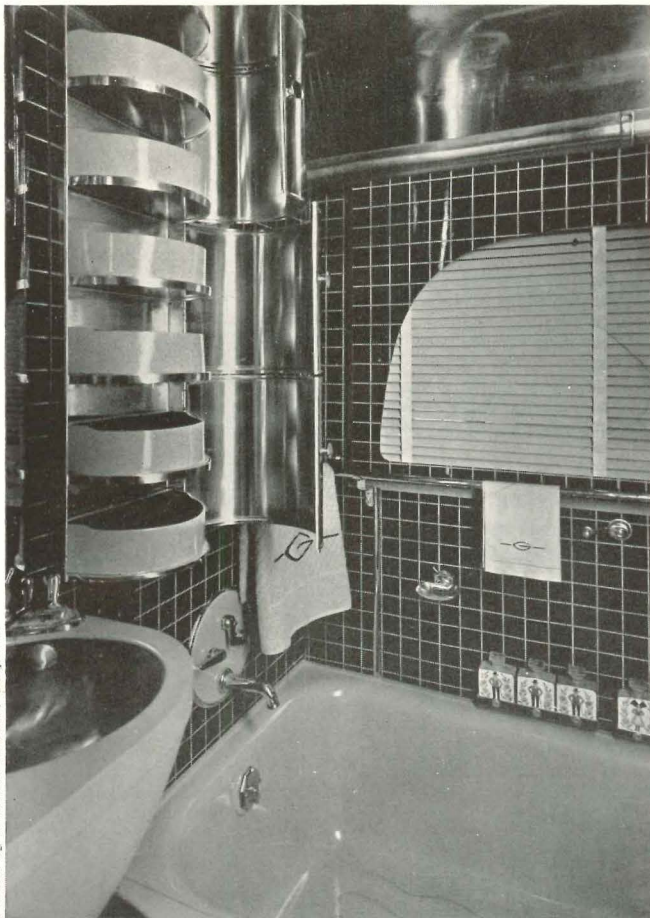

Photos by Drucker-Hilbert Co., Inc.

BATH includes Pullman-type lavatory and full-size tub with hot and cold water, chemical flush-type toilet, medicine and storage cabinets, Evalast mirrors, towel

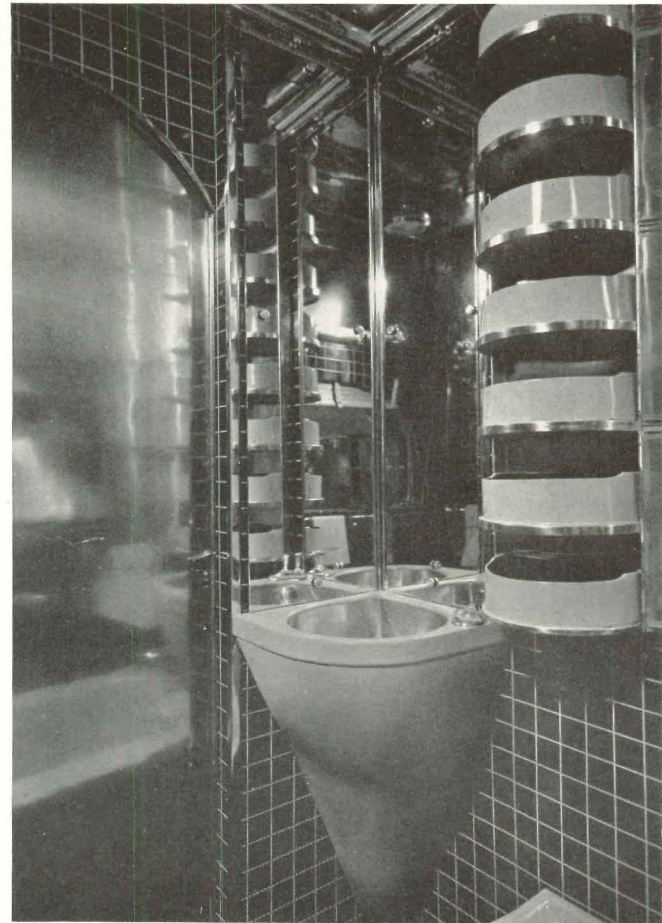

racks. Color scheme: floor, black linoleum; wall, black and pink Fibretile; ceiling, silver Fleximet; metal work, stainless steel; tub, pink.

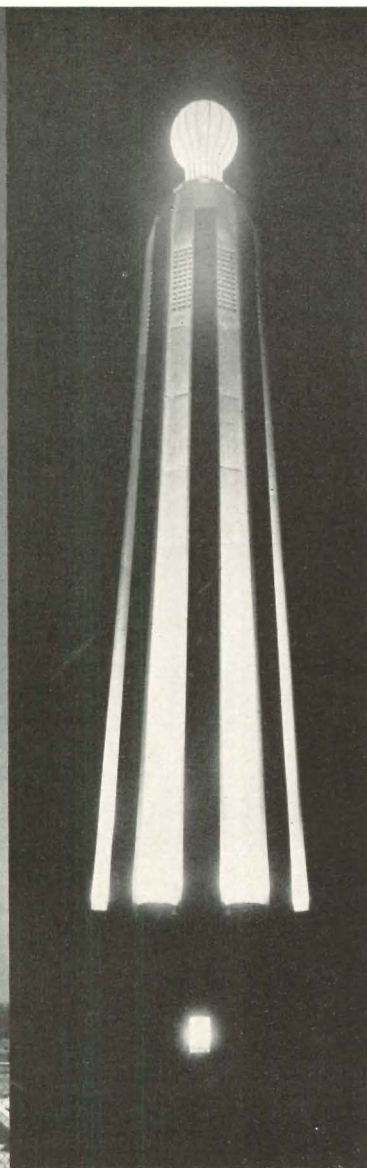
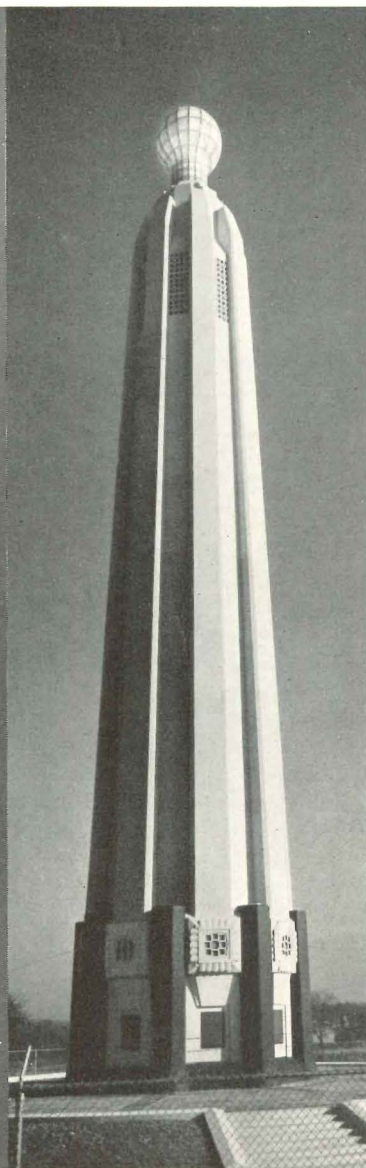
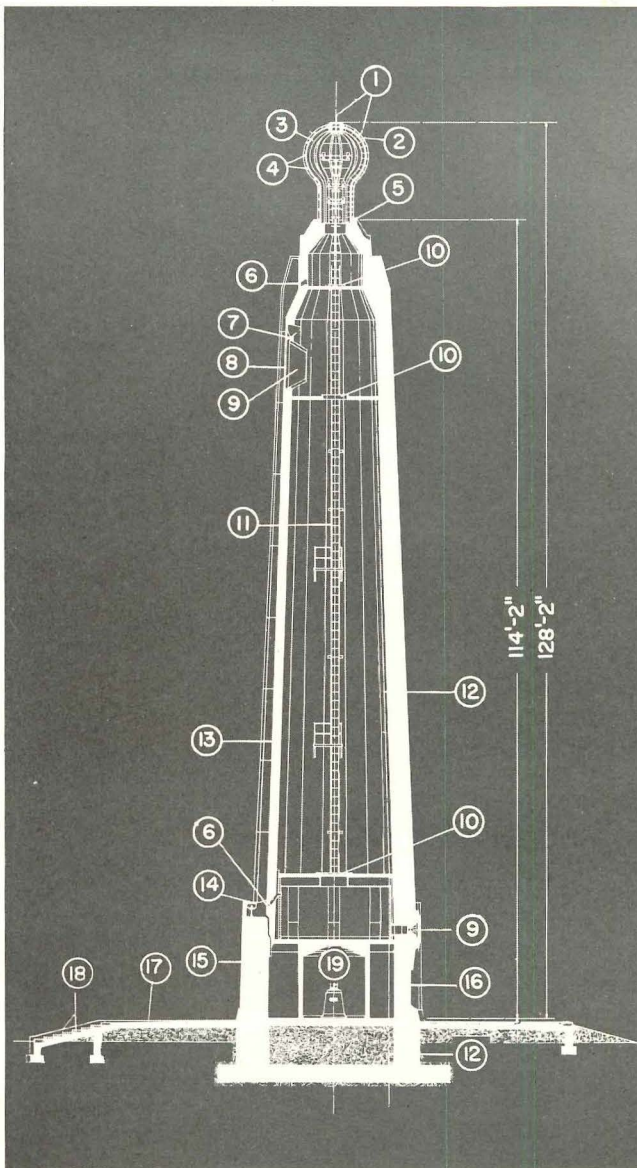

William M. Rittase

EDISON TOWER DESIGNED FOR DAY AND NIGHT EFFECTIVENESS

MASSENA & DU PONT
Architects

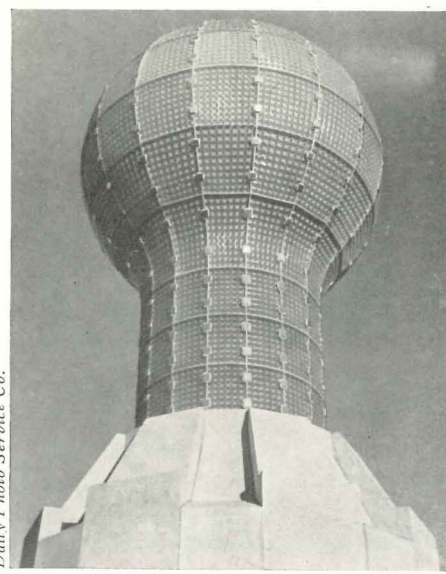

Large-scale replica of first incandescent bulb

THE TOWER at Menlo Park, N. J., commemorating Thomas A. Edison's work at that place from 1876 to 1886, and eulogizing his most famous development during that period, was designed "to express the value of light." By day the effect is gained by the sharp contrasts produced by the vertical buttresses and intervening recesses; by night floodlights from the base give even sharper contrasts. Dimensions of an existing steel tower, which was to be enclosed within the new structure limited the size of the present tower, and involved the use of a rather complicated construction system. Sudden destruction of the old tower by lightning simplified this somewhat, but original dimensions were adhered to. The sectional drawing above at the left shows the actual construction (further details on next page): 1. Lightning rods; 2. Pyrex glass bulb; 3. Steel ribs; 4. Calked joints; 5. Cork expansion joint; 6. Ventilating grilles; 7. Photoelectric cell; 8. Precast concrete grille; 9. Loudspeakers; 10. Trap doors; 11. Steel ladder; 12. Lightning conductor; 13. Precast mosaic concrete slabs; 14. Floodlight; 15. Reinforced concrete; 16. Bronze tablet; 17. Flagstone terrace; 18. Granite steps and coping; 19. Replica of first Edison bulb.

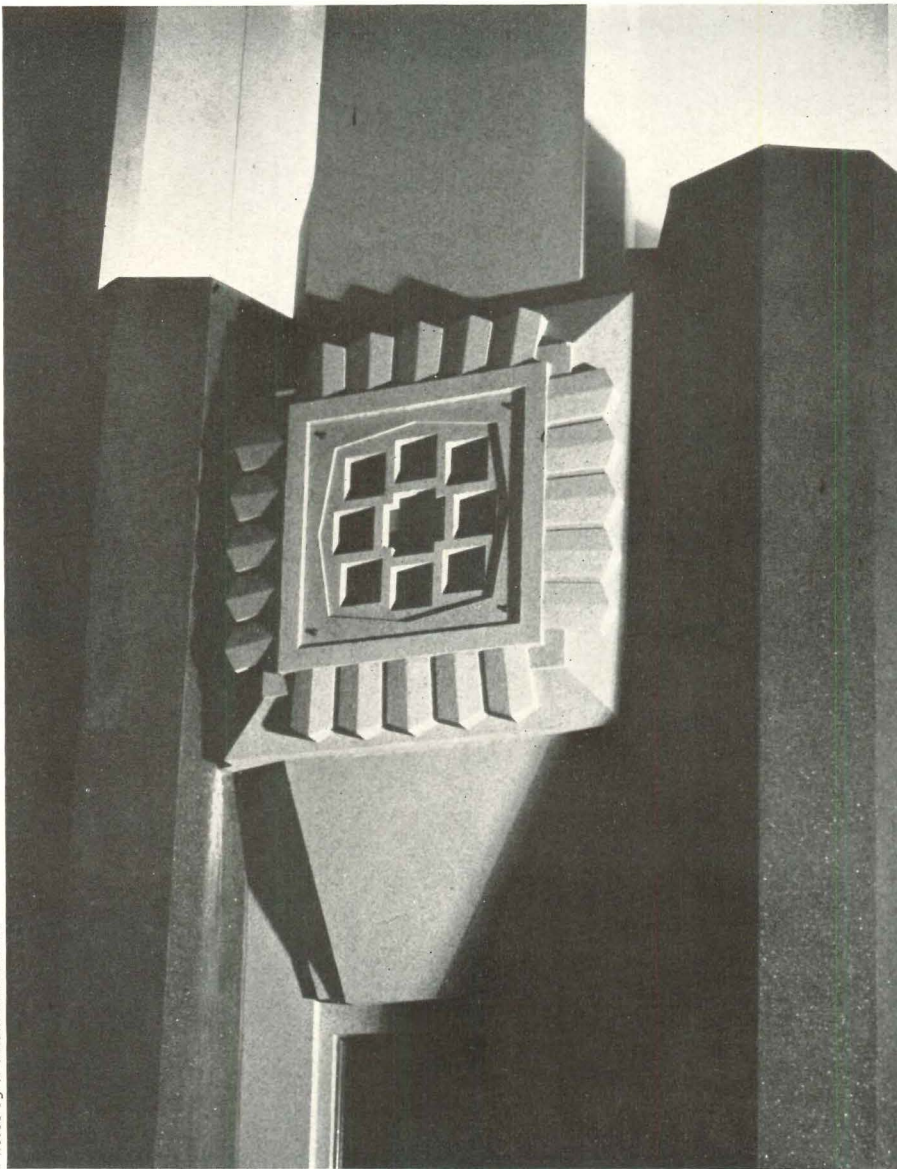

Photos by William M. Rittase

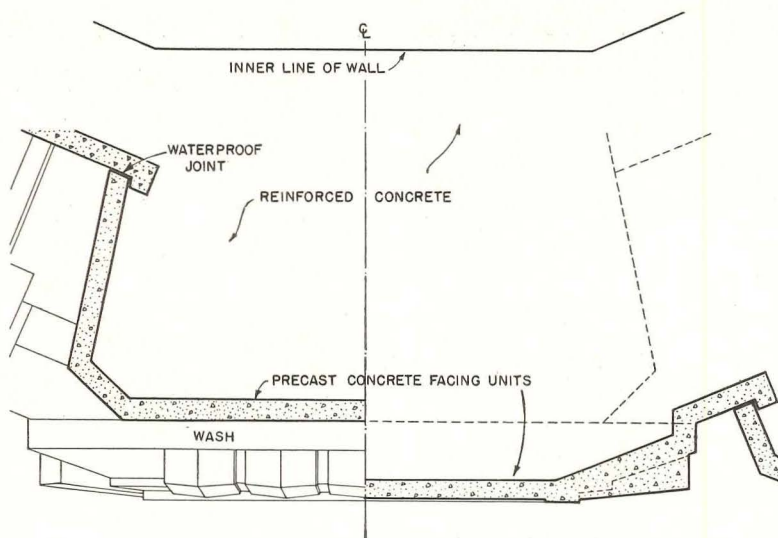

Construction of the tower is of considerable interest, as the precast mosaic-concrete blocks which act as exterior finish were also used as forms for pouring the monolithic structure. The facing units, 2 in. thick, were erected in successive stages and then fastened with steel anchors to the interior wooden framework; pouring the concrete between the facing units and interior forms produced perfect anchorage and complete monolithic construction of the entire tower.

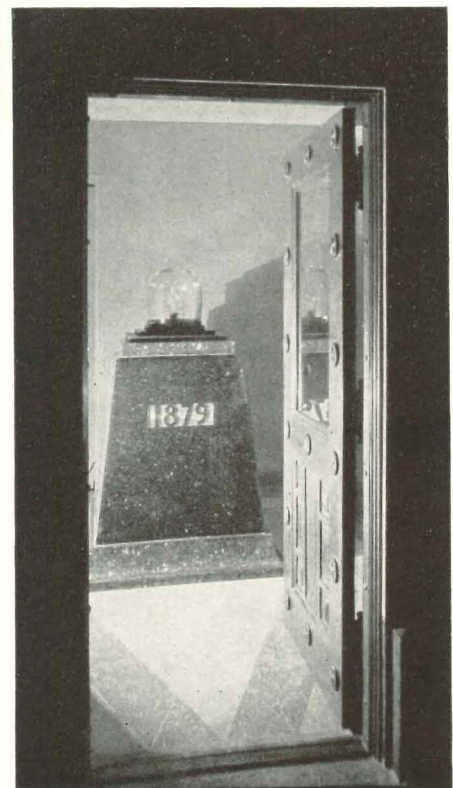

Replica of Edison's first incandescent lamp, which has been burning continually since 1929



FLORIDA STUDIOS PROVIDE STEEL AQUARIUMS FOR DEEP-SEA FISH

FREDERICK HENDRICH
Architect

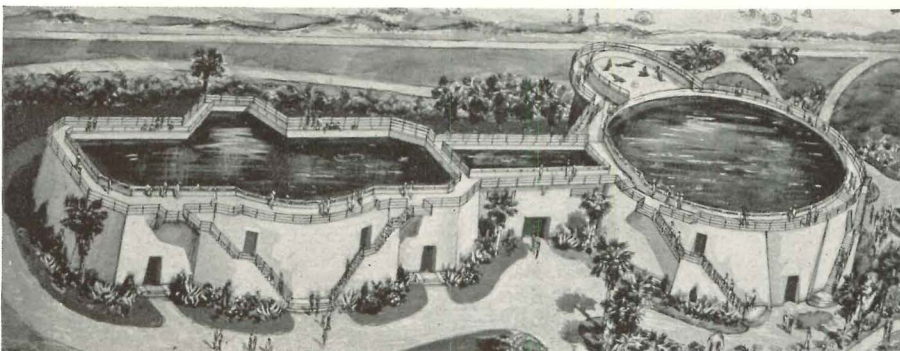

Perspective View of Tanks and Flume

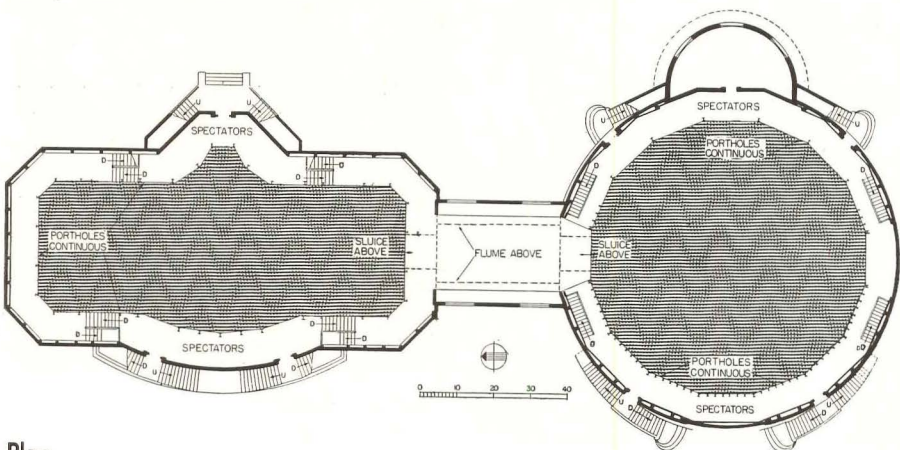

Plan

DESIGNED especially to house deep-sea fish that would explode from lack of proper pressure in the ordinary aquarium, the Marine studios at Marineland, Florida, 18 miles south of St. Augustine, represent an effort to reproduce ocean conditions and life on a comparatively small scale. The site at Marineland was chosen after tests had been made to determine the quality and visibility of ocean water at various points along the coast. Since the aquariums were built not only as a museum of deep-sea fish, but as a studio for filming submarine life as it actually is, the problem of visibility was an important one. It was this latter requirement which in the end dictated the present shape and dimensions of the tanks: the various camera angles necessary to afford producers the proper latitude and leeway in filming underwater scenes were studied in advance by a technical motion-picture expert. Specimens of marine plants, including a coral garden, and various sea grasses and weeds will provide a natural atmosphere for the fish. Exhibits are to be captured without injury by means of hypodermic injections of a drug which stuns in 60 seconds.

FLORIDA AQUARIUMS

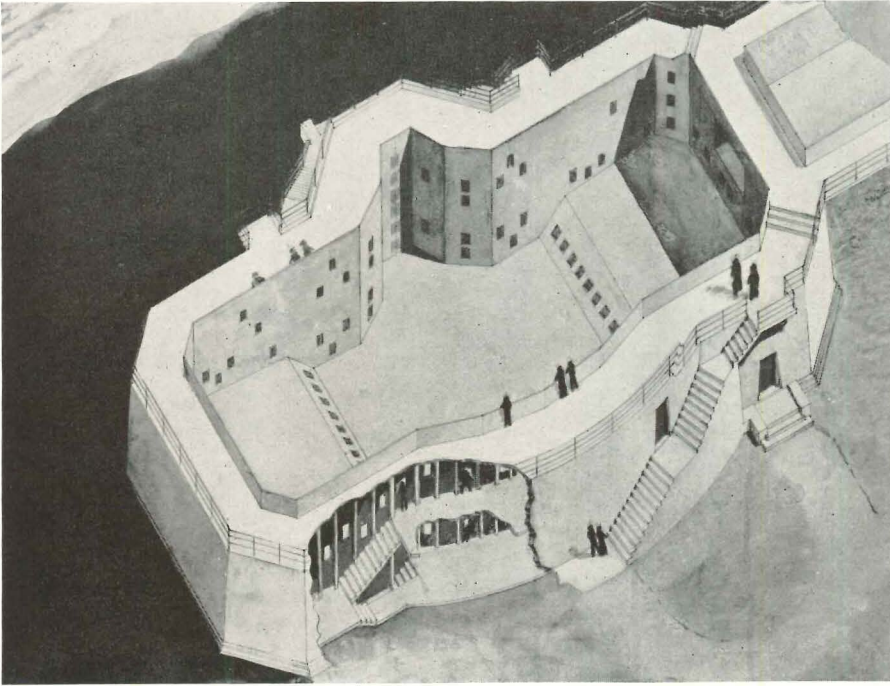

Of welded steel instead of the more usual monolithic concrete, the huge tanks are of skeleton construction, so designed as to withstand pressure from the water. The drawing (left) shows arrangement of stairways to the various levels and portholes for viewing fish and for underwater lighting of the tank.

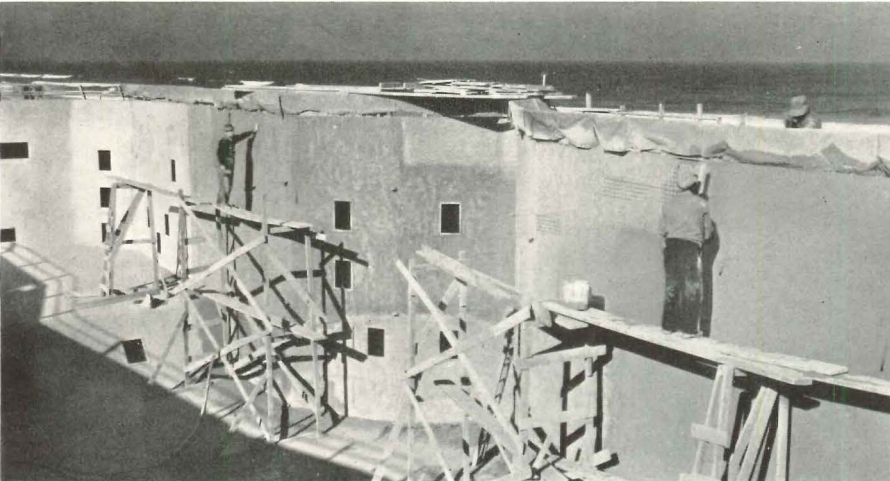

Exterior surfacing is of "gunite", applied by cement gun to a wire mesh spot-welded to the structure. This provides a waterproof finish which is easily renewed. At left is the rectangular tank, 100 ft. long, 40 ft. wide, and with maximum depth of 18 ft.

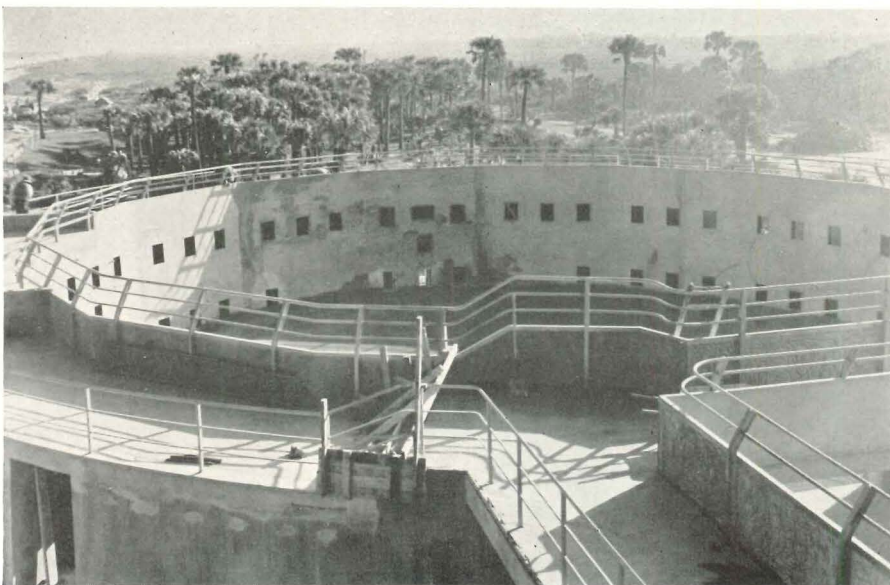

View of the circular tank, 75 ft. in diameter and 11 ft. deep, showing "gunite" surface completed. At the time this picture was made, the heavy glass portholes had not been put in place; tanks have been filled since, and are being filled with specimens. Portholes are so placed that marine life can be seen from four different levels: from the bottom of the tank, looking up; from the sides, just above bottom level, and just below water surface; and from open galleries around top of the tank.

PROPOSED BUILDINGS

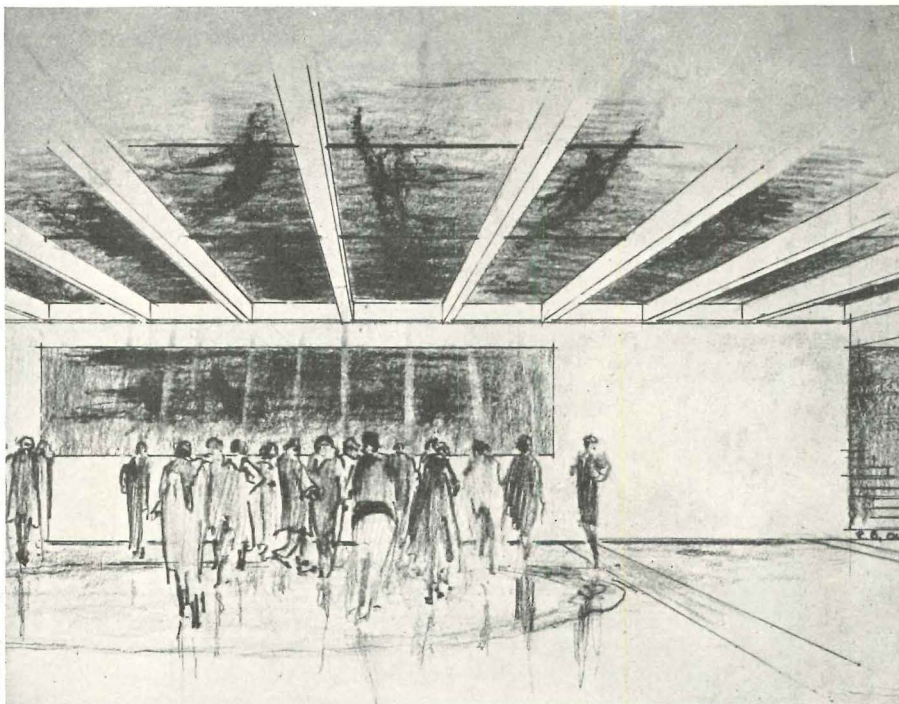

Glass-ceilinged foyer under shallow end of pool

MARK DANIELS
Architect

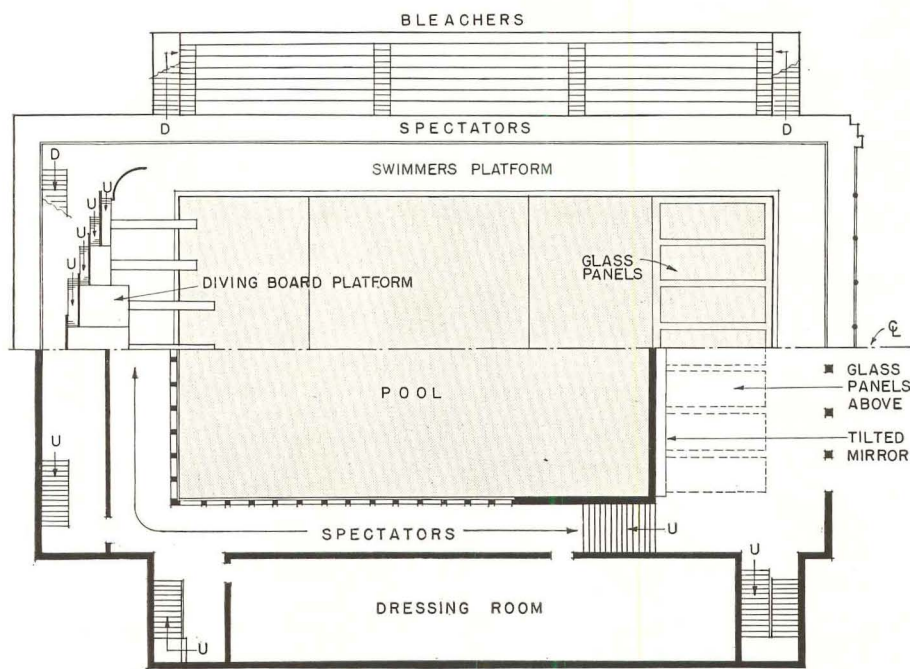

Plan

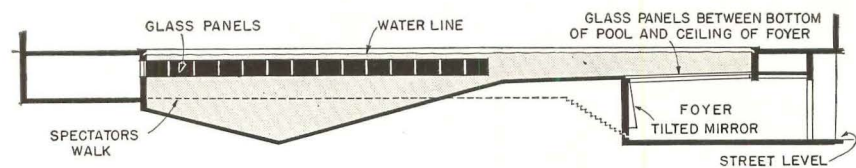

Section

Golden Gate Exposition Plans Glass and Steel Pool

CONSTRUCTED entirely of glass and stainless steel this swimming pool—proposed, but as yet minus a sponsor—obtains novelty from the fact that swimmers are visible from three sides at underwater level, and, at the shallow end of the pool, from below. (See AR, 10/37, pp. 26, 27 for Belgian precedent.) Proposed use of glass extends even to the diving boards, where it is proposed to substitute a new transparent plastic for the usual wood. A movable glass roof makes possible the use of the pool in inclement weather.

The pool, 55 x 110 ft., large enough for 12-lane competitive swimming, is the central feature of the plunge building. Entrance to this building is through a foyer situated under the shallow end of the pool. The ceiling of the foyer, made up of 6-ft. square panels of 1-in. glass, is the bottom of this portion of the pool. A tilted mirror on the foyer wall provides a view of the pool above. Observation galleries, with glass panels, 5 x 60 ft. at a mezzanine level, allow spectators to follow the progress of swimming events. At this same level is the swimmers' dressing room. The deep portion of the pool from the 14-ft. level is of stainless steel; the rest is of glass. The pool edge at surface has a trim of chromium steel. Twenty-foot runways of colored composition material surround the pool, and provide ample space for spectators. In addition covered bleachers are placed on two sides.

All light sources—except the spectacular colored light from neon tubing behind the panoramic back drop—will be from below, and will be of sufficient intensity to illuminate plunge room, pool, and spectators' gallery. Water for the pool will be supplied from the Exposition's 3,000,000-gal. reservoir. Estimated cost of the structure is \$200,000.

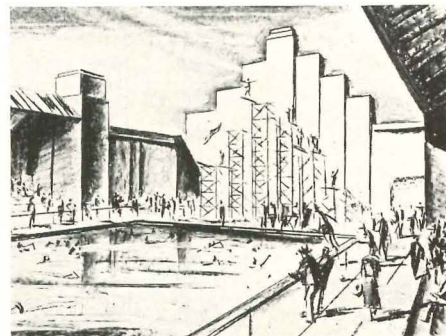

Spectators' gallery at surface of pool

NEW STRUCTURAL SYSTEMS

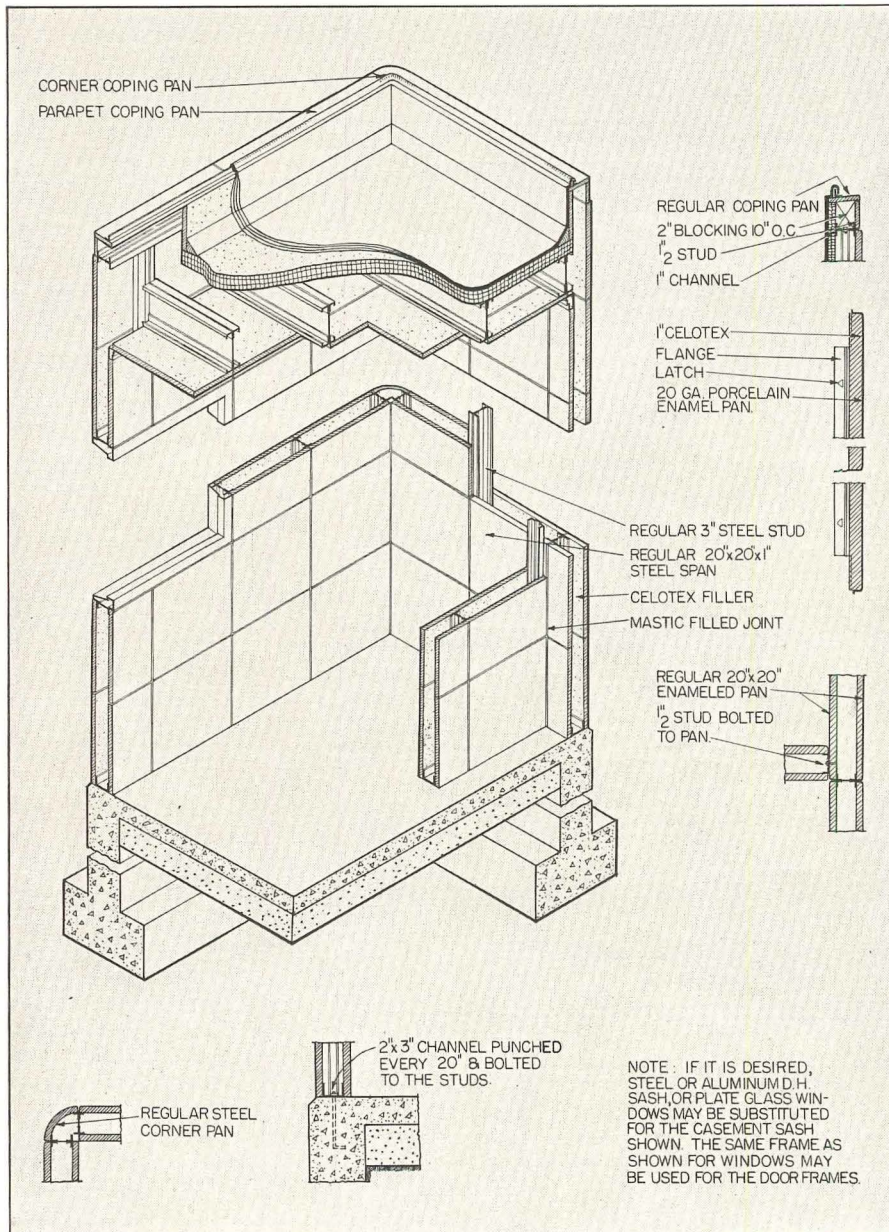

Washington architect perfects all-steel system

A SYSTEM of porcelain enameled iron construction which is not a veneer but a complete wall section has been devised by Philip M. Jullien, architect, of Washington, D. C. Structurally complete in itself, the section consists of steel or wood studs on which are fastened directly the enameled pans which serve as wall facings and lateral bracings. The system is equally adaptable for interior and exterior walls of vitreous enamel, and—although originally intended as an answer to the problem of low-cost, large-scale residential construction—is especially suitable for enameled store and theater fronts.

The porcelain enamel pans are 20x20x1 in.; the two horizontal edges of each pan are provided with lips which act as separators and mastic stops, while the vertical edges have 1-in. projecting flanges. Clips to hold pans in place are stamped into each flange at 5 in. and 15 in. from bottom of pan. These clips catch on an embossing stamped 5 in. from the end of each stud and every 10 in. thereafter. By thus interlocking flanges and studs, the flanges act as lateral bracing in transmitting stresses.

Framework for this system is simple: bolted on any desired type of foundation—brick, terrazzo, or concrete—are 2x3x2 in. channels to which are fastened steel studs made up of two 1x3x1 in. channels spot-welded back to back every 40 in. At the welding joints a small piece of 1/8-in. steel plate is inserted to make a space between channels; into this the vertical flanges of the pans are pushed and latched. When the pan is in place, it is filled with insulating board to a depth of 1 in. to give additional strength and to serve as a cushion between porcelain and steel stud. This also imparts sound-deadening and heat-insulating qualities.

Corners can be either round or square; if round, a 5-in. radius is used. Copings, designed to work with a 1-in. insulating back-up on studs, snap into a combination stud-and-plate. Frames or windows (double-hung, casement, or plate glass) and doors are fastened in the same way as the enameled pans. Joists, similar to studs but made up of 8-in., 10-in., or 12-in. channels depending on span, are bolted to studs with gusset plates, and are embossed on lower side for placing pans in the ceiling just as in walls. Interior partitions are similar to exterior walls; the last stud in each partition is a combination plate-and-channel with one-half the usual opening, bolted with toggle bolts to adjacent wall pans. Plate and sill panels are bolted at floor and ceiling



Courtesy "The Enamelist"

Unlike many porcelain enamel systems, Mr. Jullien's provides a structural as well as a surfacing unit, complete to parapets and corners. Flanges of the unit fit snugly into the embossed studs (left).

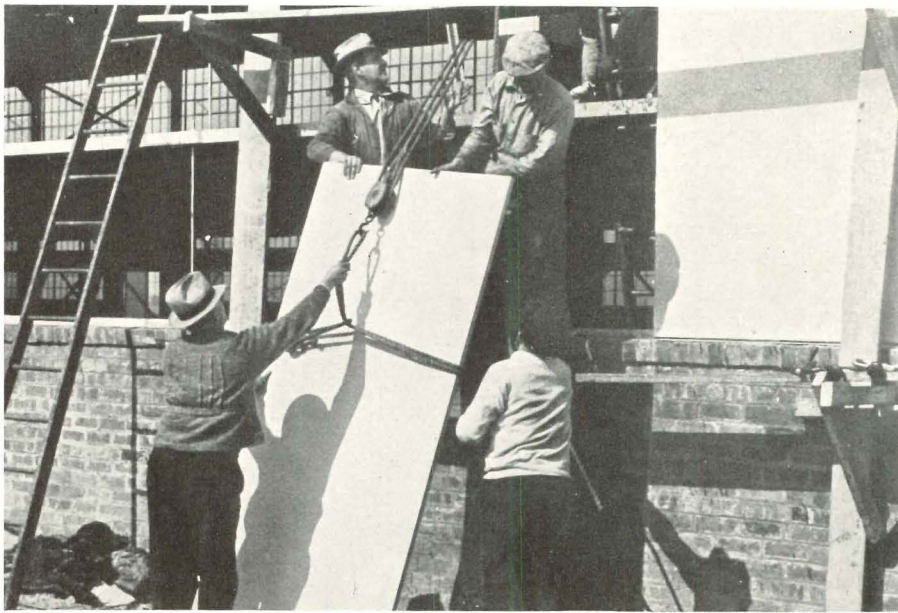

Large, lightweight rigid units make it possible for a small crew to erect many hundred square feet of curtain wall per day. The units come surfaced in either Flexboard (top) or corrugated Transite (below).

New wall units for industrial construction announced

USING ITS already known products, Flexboard and Transite, Johns-Manville Corporation has developed and patented a curtain wall for steel-frame industrial buildings. The prefabricated units consist of an application of encased insulating board (board is 1 in. thick and has $\frac{1}{8}$ -in. veneer of asbestos Flexboard or flat Transite) over which is applied a wall of corrugated Transite. Between windows the exterior facing is $\frac{3}{8}$ -in. flat Transite, cemented to the encased insulating board. Cadmium-plated bolts hold units to the steel framework; gray calking compound is applied to the

edge of each sheet. Since thermal expansion of Transite is approximately that of steel, no expansion joints are necessary.

This system, says the manufacturer, provides fireproof walls which withstand high temperatures without cracking, melting, or buckling. According to laboratory tests, the 1-in. encased insulating board has the same insulating value as a 14-in. wall of common brick. Its light weight implies easy application and consequently lower cost of erection. Reduction in weight of steel framing members is therefore possible.

Novel piling system used in furnace construction

CONCRETE-FILLED steel-pipe piling, carried to rock, supports the foundations for Republic Steel Corporation's new blast furnace now under construction at Youngstown, Ohio. This is the first time that such a system has been used, according to the Corporation. Confronted with complications caused by the fact that the site selected contained wood piling from the old furnace, and that borings revealed the presence of a layer of quicksand at a 35-ft. depth, engineers were forced to eliminate wood piles, precast concrete, and all three types of cast-in-place concrete piles. The depth to which the piling was carried, and the possibility of deflection from the hundreds of old piles, determined elimination of H-beam structural sections. Long sections were necessary for several reasons: the tremendous concentrated load of the new furnace might create enough hydraulic pressure on the quicksand to raise the adjacent buildings, or future excavations nearby tapping the quicksand might relieve the pressure and cause movement of the foundation.

Open-end steel tubes proved the best solution to the problem, and were chosen because the maximum radius of gyration of tubing makes this the most efficient form of steel possible for use as a column—and rock bearing piles have to be considered as columns. Random lengths of standard 16-in. pipe about 40 ft. and 25 ft. long were used; the former were driven first, and the latter fitted on with a New York City standard inside sleeve. After cleaning, the tubes were cut to grade with an acetylene torch and filled with 1:2:4 concrete. Altogether there are 180 piles, all 16-in. o.d., $\frac{3}{8}$ -in. electric-welded open-end tubes. These will support the 18,000-ton total weight of the superstructure.



Even before being filled, this piling tested as high as 92 tons per pile.

NEW EQUIPMENT



This new Polaroid unit . . .



destroys usual reflected glare . . .

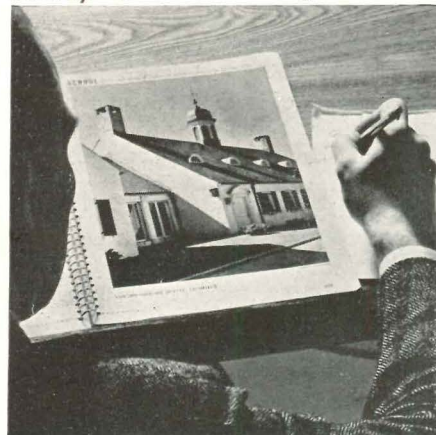

makes vision rapid, precise, easy.

Photos by Trinity Associates, Inc.

Polarized light now available for desks

FOR ILLUMINATION free from reflected glare, Polaroid Lighting, Inc., 72 Water St., West Haven, Conn., recently developed a desk lighting unit which produces no sense of brightness but maintains higher intensities than ordinary lamps. (For preliminary report on Polaroid, see AR, 3/36, p. 243; for recent application, see AR, 1/38, p. 38.) The selective action of this unit passes only those waves which vibrate in a vertical plane, since these penetrate paper and ink when they meet the reading surface and make visible color, mes-

sage, and detail. Horizontal waves, vibrating in the same beam, strike the surface horizontally and glance off, producing glare. Use of Polaroid lenses completely shuts off these latter. Elimination of glare points the way to solution of other problems, since the light source may be placed directly in front of the reader, permitting even distribution of light that is not optically tiring.

New tube transmutes X-rays into visible light

INVISIBLE ULTRAVIOLET rays, made visible by bombardment against fluorescent chemicals, are now used in a new cold light source to produce both white and colored light. (For earlier reports on use of fluorescence, see AR, 4/38, pp. 74, 75; 11/37, p. 39; 10/37, p. 42.) This product, Fluorescent Lumiline, is announced simultaneously by General Electric Company and Westinghouse Electric & Manufacturing Company. Basic patents are awarded by the Mazda Lamp Manufacturers. The lamp is tubular in shape and contains a trace of mercury and a small amount of argon at low pressure; the inside surface is coated with one of several types of fluorescent powders, each of which is capable of absorbing a particular quantity of ultraviolet, thus producing a different color. This fluorescent coating acts as an energy transformer, absorbing the short, invisible ultraviolet rays and reradiating them in the higher wave bands that comprise the color range of the spectrum.

The amount of light produced is governed by the intensity and quantity of the ultraviolet energy absorbed and the efficiency with which it is reradiated. In this respect the green lamp is the most efficient; it produces 60 lumens per watt in the 30-watt size. Other lamps of varying light output and efficiency are made in gold, pink, red, daylight, and white. Minimum color distortion is said to be obtained with this type of illuminant, since fluorescent materials usually produce broad bands or continuous spectra.

Because of their relatively high efficiencies and correspondingly low wattages, Fluorescent Lumiline lamps are intended to be of especial benefit where heat is a problem, as in show cases or air-conditioned interiors. Best operation is obtained indoors under normal conditions, say the manufacturers; outdoor operation should be attempted only in warm climates or during summer months. Although installation cost on these lamps is higher than on similar filament lamps, operating costs for equal lumens of visible light are lower.

Plastic reflectors shine mile away

REFLECTORS of molded Lucite, a synthetic resin product, crystal in color and nonshattering, were recently put to use as a means of lighting highways for safer night driving. Installed experimentally on a 70-mile stretch of road between Detroit and Lansing, Michigan, the reflectors diffuse light from approaching vehicles for at least one mile in advance of the point of origin. Reflectors for undivided pavement roads are bi-directional (facing both directions of travel); for dual roads with center parkway, they are mono-directional. The buttons, 1 $\frac{5}{8}$ in. in diameter with a slightly convex face and a prismatic back, are set 3 in a vertical row, and are said to be 10 times as powerful as any now in use. Height of the center button is in all cases 3 ft. above top pavement edge. The markers are spaced 100 ft. apart.

New awning falls at drop of rain

A RAIN-CONTROLLED awning which lowers itself automatically at the first few drops of rain, and rolls up as soon as rain stops, has been invented by Otto Vogel, Farmingdale, N. Y. The awning, which may also be used in the ordinary manner as a sunshade, provides protection for interiors when windows have been left open. Although details of the element which controls operation of the awning have not been released, the mechanism contains no springs and is simple to operate, says Mr. Vogel. In the same frame which carries and retains the awning are guides for a rolling screen; the latter is contained in the awning housing. Installed at the top of the window casing, the device appears as a small horizontal frame. The invention—as yet in the model stage—is expected to sell at a moderate cost, in comparison to present prices for separate awnings and screens which do not have the automatic protective feature.

Policeman perfects pickproof lock

RECENTLY invented by a New York policeman and declared "unpickable" by Underwriters' Laboratories, a new lock is now in production at the New York plant of Segal Lock & Hardware Company. Of cylinder construction, with a series of locking devices within the plug, the lock is said to prevent opening of the lock by any instrument other than its own key. The product is expected to retail at slightly more than prevailing prices for cylinder-type locks.

WITH THE PROFESSION

Competitions:

U. S. tries an open one

THE GROWING agitation among professional groups for open competitions for Federal buildings last month bore fruit when the U. S. Treasury Department announced two competitions for the design of post offices, open to all architects who are U. S. citizens, except employees of the Federal Government or the District of Columbia. In the first competition 10 designs for small post offices, costing approximately \$50,000 each, are being sought. The 10 winners will receive \$1,000 each for their designs; in addition, if any design is duplicated, the author will receive \$100 for each repetition occurring within one year of the award. This competition, which opened on May 25, with June 29 the last date for reception of entries, is for design only, since the services of winners will terminate upon selection and approval of winning designs. Working drawings and specifications for both competitions will be prepared in the office of the Supervising Architect.

The second competition, which opens June 21 and closes July 26, is for a post office and courthouse for Covington, Kentucky, to cost approximately \$450,000. The winner will receive \$3,000 for his design and \$3,000 additional for consultation services during preparation of working drawings and specifications and during construction. Second- and third-place winners will receive \$2,000 and \$1,000, respectively. This competition is open to architects registered in any state. In applying for the program, a photographic copy of the applicant's registration certificate or a statement of qualifications must be submitted. Competition programs may be obtained from Supervising Architect, Procurement Division, Washington, D. C.

Cuban competition open to all Americans

OPEN TO ALL architects and sculptors of the 22 American countries is a competition for the design of a monument to Jose Marti, Cuban patriot, recently announced by the Central Committee for the Marti Monument, Havana. The monument is to include, in addition to some physical or symbolic representation of Marti, a library of Martinian writings, and a museum for preservation and display of the patriot's souvenirs and works. Considerable emphasis is laid on the adaptation of modern acoustics and air conditioning to the Library and Museum, and of lighting effects to the monument as a whole. The total cost of the monument is to be not less than \$500,000 nor more than \$600,000. First prize is \$10,000;

second and third prizes are \$5,000 and \$3,000, respectively; in addition, there are 5 prizes of \$1,000 each and 10 honorable mentions. Final date for reception of entries is October 8, 1938. Copies of conditions and requirements for the competition may be obtained from the Cuban Embassy, Legation, or Consulate, or from the Comision Central Pro-Monumento a Marti, Empeadrado 5, Habana, Cuba.

Chicago Club's to Midwesterners only

FOR A YEAR'S TRAVEL and study in the Americas and (or) Europe, the Chicago Architectural Club offers a scholarship of \$1,000, open to male citizens who have resided for at least 2 years in Illinois, Indiana, Michigan, Wisconsin, or Iowa, or have been members of the Club for at least 6 months prior to the competition. In addition, applicants must be not more than 32 years of age on the date of rendu, August 1, 1938, and must not have been beneficiaries of any other traveling scholarship. All competitors must submit applications before June 18, the date of the esquisse. Both esquisse and rendu must be done en loge, at headquarters of the Chicago Architectural Club, 1801 S. Prairie Ave., Chicago. Application forms may be obtained from Thomas Mulig at the above address.

For women only

THE LOWTHORPE SCHOOL of Landscape architecture, Groton, Mass., announces a scholarship carrying a stipend of \$500, which is open to women, 21 years of age or over, who are holders of a bachelor's degree or whose experience has fitted them for professional training in landscape architecture. Award will be made after consideration of the applicant's personal record. Qualifications of applicants should be sent to John A. Parker, Director, The Lowthorpe School, Groton, Mass.

Columbia makes awards

COLUMBIA UNIVERSITY announces award of two fellowships and an exchange scholarship in the School of Architecture, effective for the year 1938. The \$2,000 McKim fellowship, given every three years to a graduate of the School, has been granted to Harry Beardslee Brainerd, New York City, architect and city planner, for investigation of the educational, legislative and physical correlation of civic design with city planning in the principal cities of Europe.

The \$1,500 University fellowship was awarded to Herbert D. Phillips, New York City, senior in Columbia School of Architecture, for graduate work

leading to the master of science degree.

Richard Compton Harrison, Jr., New York City, has been appointed exchange scholar to the University of Rome, Italy. The Italian Government will select an Italian student to study architecture at Columbia during the same period that Harrison is in Rome.

Academy award to Princetonian

WINNER of the American Academy in Rome prize in architecture for 1938-39 is Erling F. Iversen, New York, now studying at Princeton University as holder of the Princeton Prize. Mr. Iversen's design for a lakeside open-air theater with a barge for a stage was selected from eight entries in the final stage of the competition. The prize-winning design includes a circular stage that can be revolved by underwater cables, a band shell on the stage that can be raised or lowered, and lightweight metal drawbridges for access to stage from the shore. The Rome Prize, valued at approximately \$4,000, entitles the winner to \$1,500 a year for 2 years, and free residence and a studio at the Academy.

LeBrun to World's Fair employee

THE 1938 LeBrun Traveling Scholarship of the New York Chapter of the American Institute of Architects has been awarded to Harvey P. Clarkson, New York City, draftsman for the Board of Design of the New York World's Fair and assistant instructor in history at New York University. The competition program called for the design of a "suburban shopping center, developed out of an existing business center in a small town that had become blighted by a main highway passing through it." Mr. Clarkson will travel and study in Europe for six months.

Decorators to discuss air-conditioning problems

BECAUSE OF the increased use of air conditioning in buildings where interior designers are retained, a conference of interior designers will be held at New York's Waldorf-Astoria Hotel June 7 and 8 to discuss types of equipment and applications, and relationship of air conditioning to interior design. The conference is being sponsored by the professional publication, Interior Design and Decoration. Charles S. Leopold of Philadelphia, engineer, consultant, and designer of air-conditioning equipment installations, will serve as chairman of the sessions at which papers by industrial and interior designers, health authorities, and architects will be presented.



Photo by Karsten, from F. P. G.

40,000 paid a dime to see the sculptors "sculp"

At New York's first public outdoor sculpture show, a vacant midtown lot was turned into an outdoor studio. Not only were examples of contemporary sculpture on exhibit, but actual demonstrations of various phases of the making of sculpture were a daily feature. The show was sponsored and arranged by The Sculptors Guild, whose members turned carpenters and gardeners in order to prepare the lot for the exhibit. Above is shown "Standing Nude", by Harold Cash, member of the Guild.

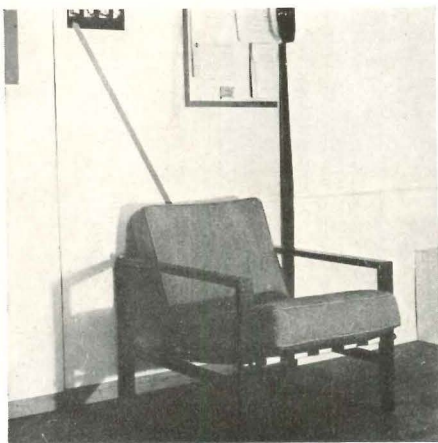

Design lab faculty stages its own show

On exhibit last month at the Design Laboratory in New York City were examples of recent work by members of the school's faculty, all of whom are active in their various professions. The exhibit, requested by the students, but entirely arranged by the faculty, included such fields as industrial, architectural, and machine design, sculpture, and advertising. Hilde Reiss and William Friedman exhibited (left) a knock-down armchair for mass production designed to retail for \$10-\$12.

World's Fair to have Arts Building after all

REVERSING its decision of several months ago, the New York World's Fair has decided to have an exhibition of contemporary art. Preliminary plans had been to present a community arts demonstration in which artists at work would appear in suitable ateliers and workshops. With the abandonment of this plan, controversy sprang up on all sides, and, capitulating to demands of various groups, the Fair Corporation made its present decision. In the building designated for the exhibit there is space for showing 800 works of contemporary art in the fields of sculpture, painting, and graphic art. Grover Whalen, president of the Fair Corporation, has appointed a governing committee for the exhibit, of which A. Conger Goodyear is chairman, and an artists' committee; the two groups will work together.

Proposed Fine Arts Bureau brings stormy discussion

CONTROVERSY over the proposed establishment of a Bureau of Fine Arts as a function of the Federal Government, already a source of widespread dissension among this country's art groups, reached new heights when, last month, the Pepper bill was favorably reported out of Committee in Congress. (Central in the present battle royal are four similar bills now before Congress: the Sirovich Bill, the Pepper Bill, and the two Coffee Bills.) Wholehearted endorsement of both idea and bills has been advanced by some 80 societies throughout the nation—women's clubs, labor unions, and theatrical groups including American Artists Congress, League of American Writers, The Sculptors Guild, Arts Unions Conference, Mural Painters Guild, The Juilliard Graduate School, Taos Artists Association, Theater Arts Committee, American Newspaper Guild, etc.

Opposition to the proposed form of the Bureau rather than the basic idea, has been expressed by such groups as The National Society of Mural Painters; and the Fine Arts Federation of New York feels that "enactment of any one of the four bills would be a disservice to the cause of Art in America." Although the opposition of the Federation of Fine Arts represents majority opinion, the individual constituents of the Federation are not committed to majority policy. Prominent in the Federation's minority are the National Society of Mural Painters and the American Society of Painters, Sculptors and Gravers, which endorsed the proposal embodied in the bills.

DESIGN TRENDS

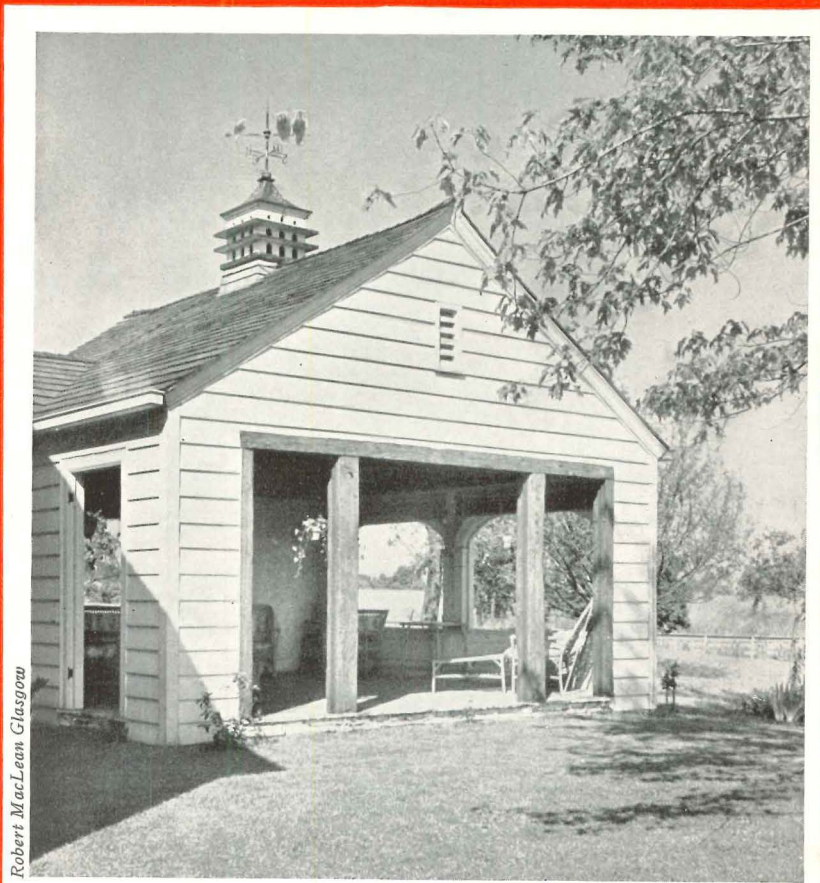

Robert MacLean Glasgow

PORTFOLIO OF PORCH DESIGNS . . . PAGE 87

ARCHITECTURAL
RECORD

COMBINED WITH
AMERICAN ARCHITECT AND ARCHITECTURE

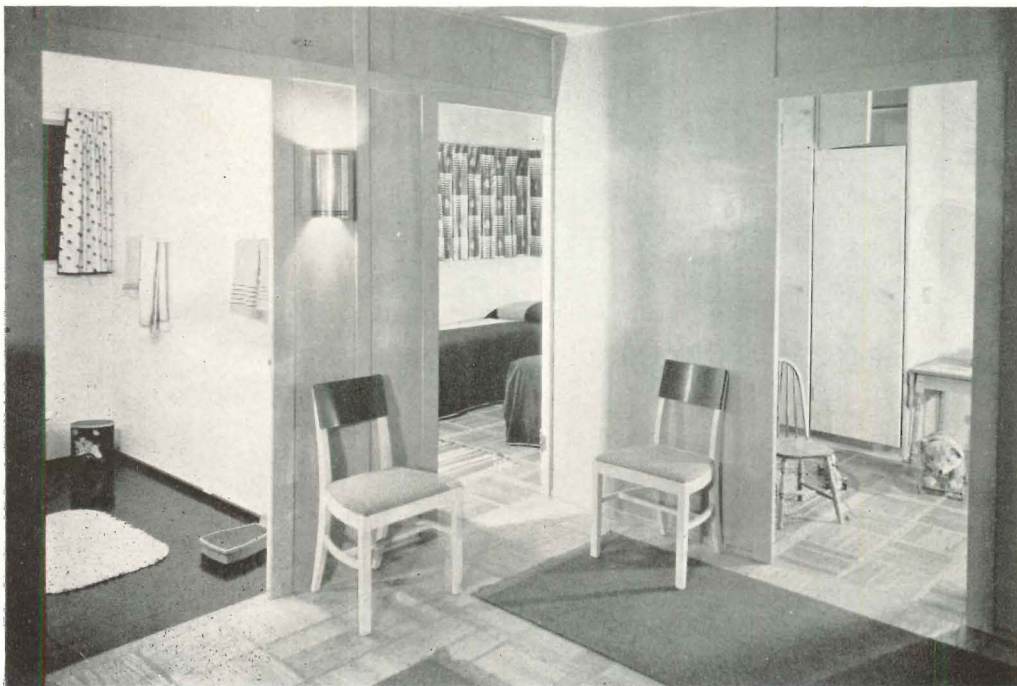
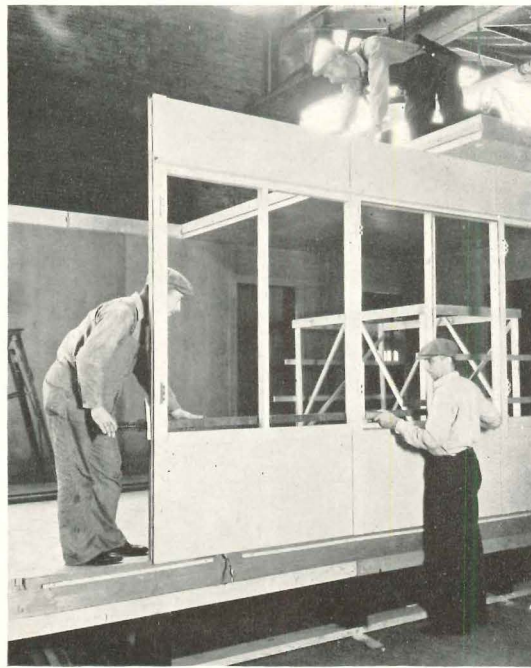
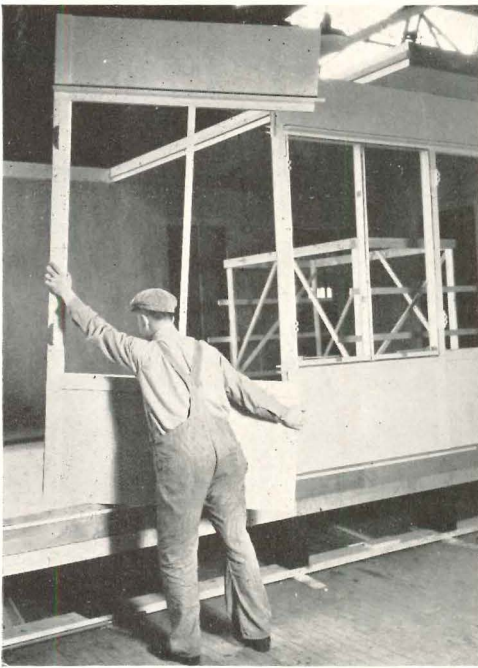

EXPERIMENT WITH SHOP-FABRICATION

The first of the U. S. Forest Products Laboratory's demonstration houses at Madison, Wis., was completed in March, 1935. Developed by Laboratory engineers as an experiment in all-wood, prefabricated construction, it demonstrated the feasibility of economical shop-production of structural units utilizing plywood panels built upon the "stressed-skin" principle that had proved successful in airplane construction.

In addition, it suggested new methods of design, manufacture, and assembly, most of which have been adopted in principle by commercial efforts at shop-fabricated construction with plywood since developed. Thus, resin-bonded panels in stock plywood sizes are now largely used for walls, floors, and roofs. They show evidence that use of panels does not necessarily imply standardization in design; that the joint problem can be handled in a number of practical ways; and that accuracy of shop-fabricated parts can produce economies in field erection.

Pictures on this page show the first Forest Products house as it was erected in the Laboratory building. It was completed 21 hours after the time construction was started.

Residential Construction With Plywood

PART 2: SHOP-FABRICATED SYSTEMS

BY OSCAR FISHER

This is the second of two articles concerning those types of residential construction which involve the extensive use of plywood. The first, dealing with job-fabricated systems of construction, appeared in the May, 1938, RECORD.

IN RESIDENTIAL construction there is a decided trend toward shop-fabrication of more and more elements of the finished structure. Any shop-fabricating system which utilizes wood as its basic material has a myriad of factories at its disposal equipped and ready for production. In that respect, structural systems recently developed with plywood appear to have a distinct advantage over other methods. Every locality in the United States has its wood-working mill, with tools and experience necessary for shop-fabrication of structural units if they are made of wood, plywood, or other similarly workable material.

Only a relatively short time ago all sash, doors, and molding were laboriously manufactured at the site. They are now delivered to the job all ready for simple erection. Shop-fabrication has succeeded in improving the quality of these elements and at the same time reducing prices. The designer has found their preciseness and accuracy of dimension useful.

There is no reason why this trend should not extend to shop-fabrication of walls and floors. One of the factors which has militated against shop-fabricated wall and floor units has been the difficulty of variation in design caused by rigidly limited dimensions. In addition, the exterior appearance of most wall units has proved unpopular. Many prefabricators have attempted to evade the problem by applying popular finish materials to their wall units. By this expedient they have sacrificed any possibility of competing in price with traditional methods of construction, because the wall units are more costly than ordinary structural frames. Perhaps after bending over backward to

satisfy a mode, they will find that the mode has passed and that they have developed a wall unit expressly for a finish which is no longer desired.

It is far more important to retain flexibility in design, proportion, and disposition of rooms and openings than to sacrifice these for unlimited variety in finish materials. Compared with many of the unit construction systems thus far developed which have these basic weaknesses, the advantages of plywood structural systems are evident. Plywood may be fabricated into structural units in existing scattered factories and may thus be employed according to various individual requirements. The material itself is amenable to satisfactory finish treatment, and therefore requires no covering.

Shop-fabrication has a number of advantages which are lacking in job-fabrication. Shop-fabrication should result in precision-fitting, accurate dimensioning, easier preservation of finish, reduced waste of material, and greater saving of labor.

On the whole, such units present no more difficulties than job-fabricated units in their relation to other elements in the structure. Integration with foundations, mechanical equipment, and finish require identical analysis in both systems. Most systems of prefabrication have not completely solved the problem of connecting wall units with the foundation. Only small tolerances of error may be permitted in the construction of foundations when prefabricated wall units are used.

Because plywood is such a workable material, a great variety of framing and jointing methods have been developed. In the various systems, plywood is glued, nailed, screwed, and

riveted to wood or steel structural frames. A number of prefabricated houses now use plywood for at least one face of the wall unit. When the plywood is used in combination with other materials than wood, the respective coefficients of expansion from heat and shrinkage should be carefully checked. For example, if plywood is joined to a steel frame, the difference between coefficients of expansion may be sufficient to cause movement at joints which will crack the finish.

Vertical units are used by most systems of prefabrication. This has not always produced the exterior appearance the designer desired. As a result, recent experiments have been directed toward the more generally pleasing horizontal wall unit. The horizontal joint is easier to waterproof and, in the opinion of many, has greater architectural merit. On the other hand, the vertical face grain is better for weathering and the plywood itself has greater strength along the face grain.

Shop-fabricated units with plywood glued to the frame may be so accurately fitted as to be almost completely impervious to air infiltration through joints. This, however, makes the problem of condensation within insulated wall units more serious than in ordinary construction, since in more usual construction, moisture collected within the wall may be evaporated out through openings in the exterior face of the wall. It has been demonstrated, however, that a vapor barrier applied to the exterior side of the inner panel will prevent the warm humid air from entering the wall. The accurate fitting possible in shop-fabricated units should enable the manufacturer to

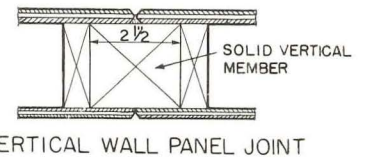
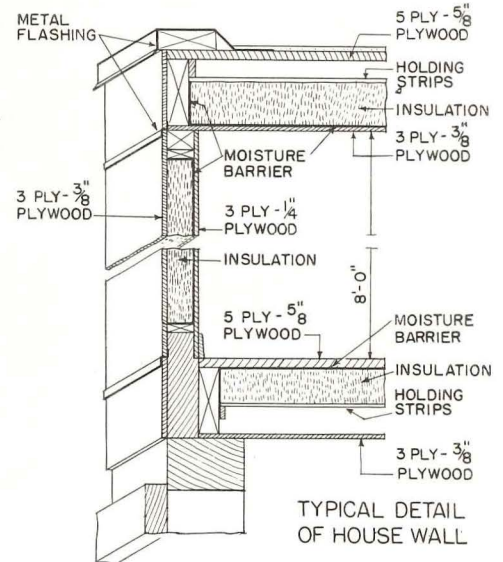
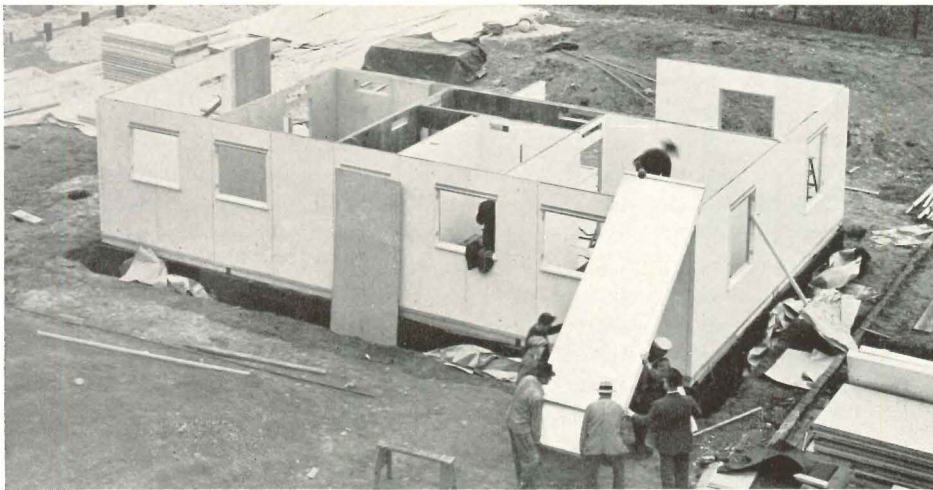
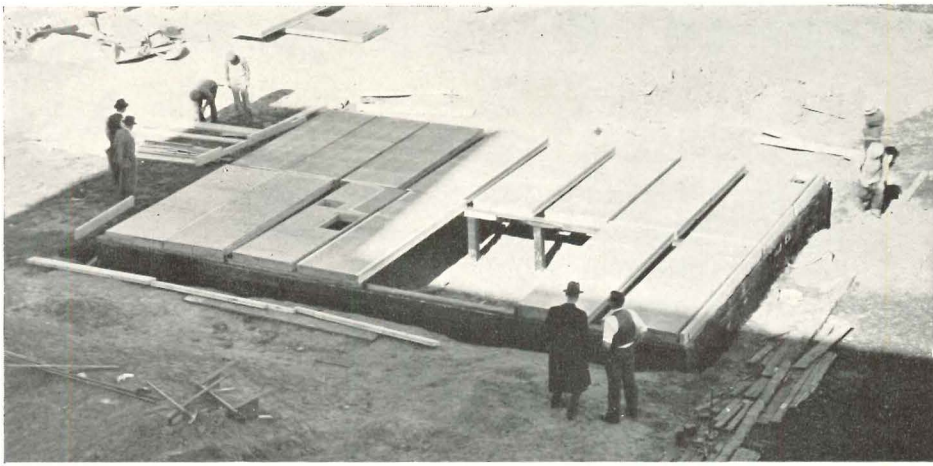

SECOND FOREST PRODUCTS LABORATORY HOUSE

This shop-fabricated house at the Forest Products Laboratory was built with resin-bonded plywood panels containing mineral insulation and moisture barriers to prevent wall damage through condensation. As a test of the permanency of this construction, the house was built in the open as shown. Structural principles and the general type of panels used do not differ materially from the Laboratory's first experimental structure. Now under construction at the Laboratory is a two-story house built with similar plywood units.

produce a tightly sealed vapor barrier which should eliminate this hazard.

Insulated wall units reduce the plywood's tendency toward conductivity of sound. Hence, insulation may accomplish a triple purpose since, if mineral wool is used, wall units have comparatively greater fire-resistive qualities.

Plywood will take as many different finishes as any other wood. In built-up prefabricated units it is generally given its final finish after erection. It is easier to transport shop-fabricated and finished units of plywood than other materials, because the lightness of the units makes damage in transit less likely. For exterior finish the plywood is usually primed with two coats of aluminum paint in the shop, the final paint being applied after erection. Stains, paint, varnish, wax, wallpaper, canvas, and other special finishes may be successfully used on plywood. As in other materials, it is important to select the finish from the standpoint of low maintenance as well as for beauty and protection. For that reason, it is often more economical to use the higher-cost hardwood plywoods because their finish may be less costly.

In general, the experiments with plywood, an old material made new, have begun to bear fruit; and we can look forward to wide application of the excellent principles of construction and the splendid results so far accomplished. Whether fabricated on the job or in the shop, we will undoubtedly see a great many plywood-panel houses built in the near future. Should they prove popular, a new indigenous architecture may take root and grow, based upon a rational structural system and not artificially foisted on unsuitable materials or construction methods.

References

The Timberman. Annual Plywood Supplement Handbook of Douglas Fir Plywood. Harbor Plywood Corp.

Plywood. United States Plywood Corp.

Architectural Record, August, 1935, pp. 102-106; April, 1936, p. 334; July, 1936, pp. 72, 73; February, 1937, pp. 41-47.

John B. Pierce Foundation. New York.

Home Information. Better Homes in America, Purdue University.

Forest Products Laboratory. U. S. Dept. of Agriculture.

American Builder, July, 1937.

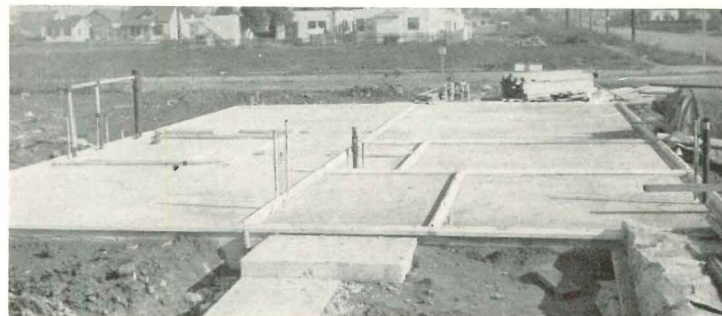
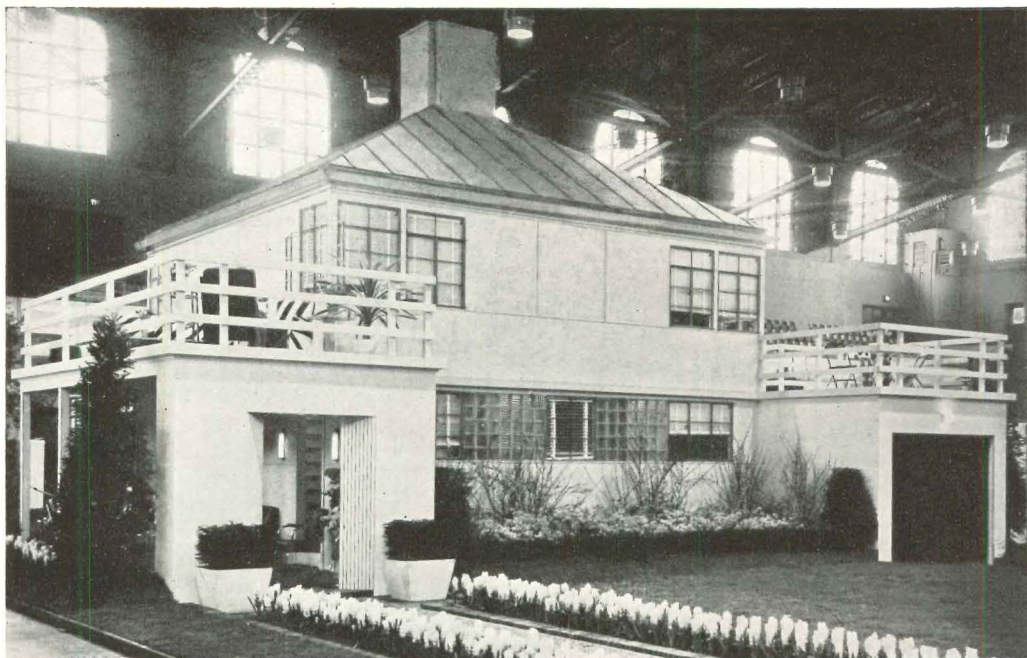

Top: A prefabricated plywood-panel house designed by the Baltimore Chapter of AIA and erected in 1937 as an exhibit at the Baltimore, Md., home show by the Harbor Sales Company, Inc. Pictures at the left illustrate a house in Los Angeles, Calif., built of factory-fabricated plywood panels with the "Lyco System" developed by John B. Lyman and Russell E. Collins, associated architects, and for which a patent application has been made. It utilizes panels constructed upon the stressed-skin principle, with special sills, plates, posts, and locking members to facilitate field erection.

Jacobs

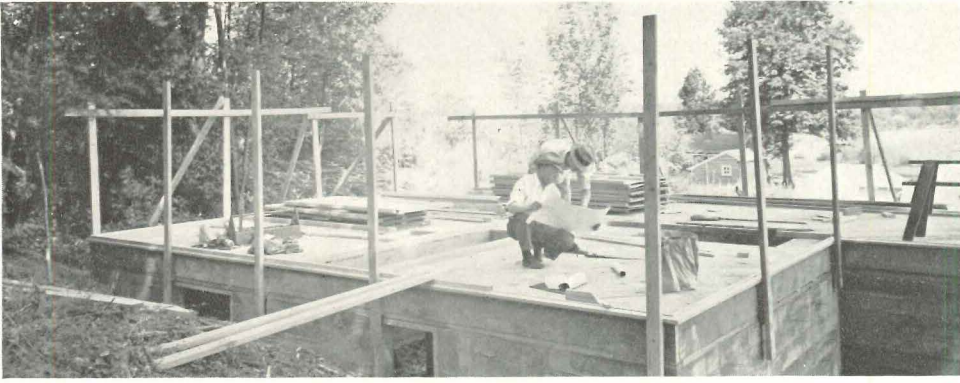

Jacobs

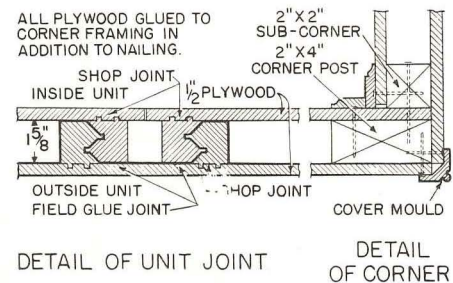
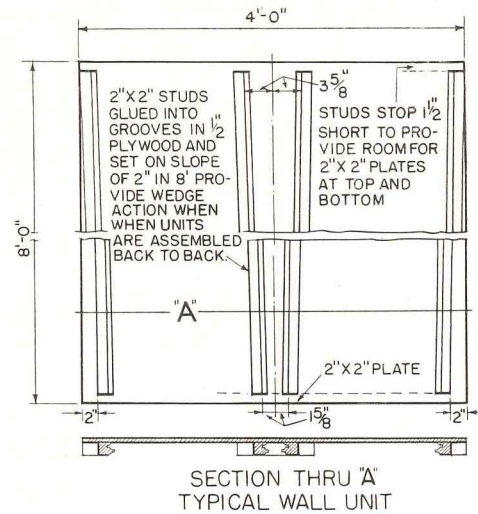
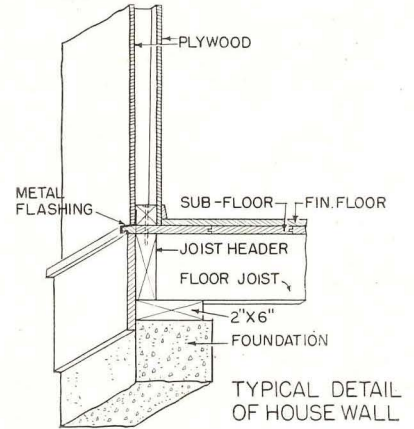
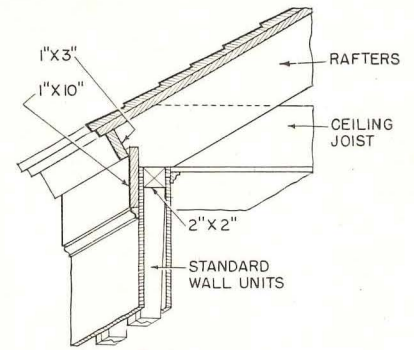
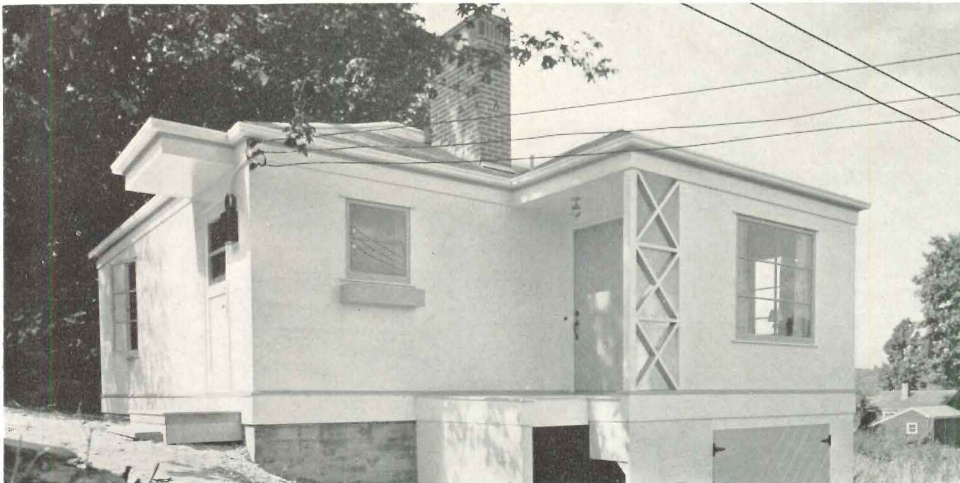
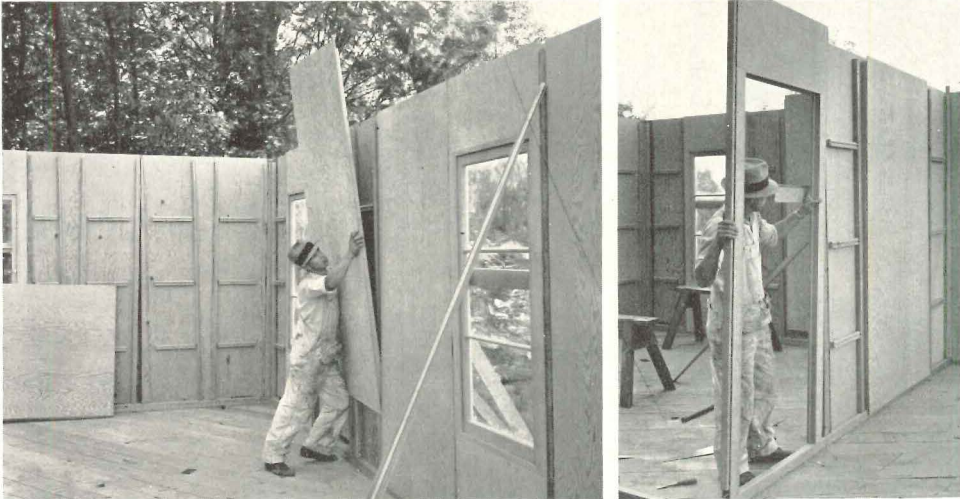

INTERLOCKING "SPEEDWALL" CONSTRUCTION

Developed by E. A. Horn of Seattle, Washington, is a system of factory-fabricated wall construction that utilizes two resin-bonded plywood panels glued to 2 x 2 in. studs that interlock to form a rigid, double-membrane wall. Panels can be cut on the job or pre-cut at the factory; thus the designer is not limited to use of stock-size units. Assembly does not involve use of ordinary studs, but is accomplished by gluing units together during erection. Joints are made by routing panel edges and field-gluing splines, which are then dressed down flush with plywood surfaces. When painted, joints are not visible. . . . Half tones illustrate the method of erecting the wall units. Five drawings show typical construction details. Note that the 2 x 2 in. studs are splined and glued at an angle to provide a wedging action when panels are assembled.



Gus Peterson



Gus Peterson

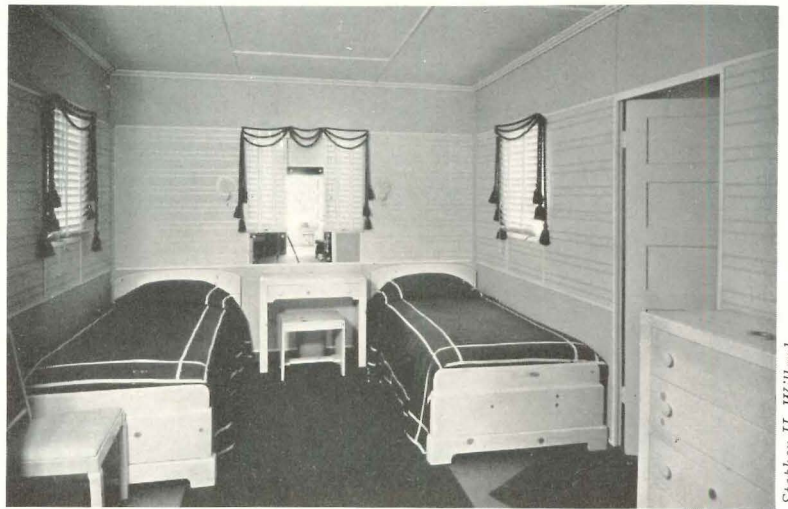

Stephen H. Willard

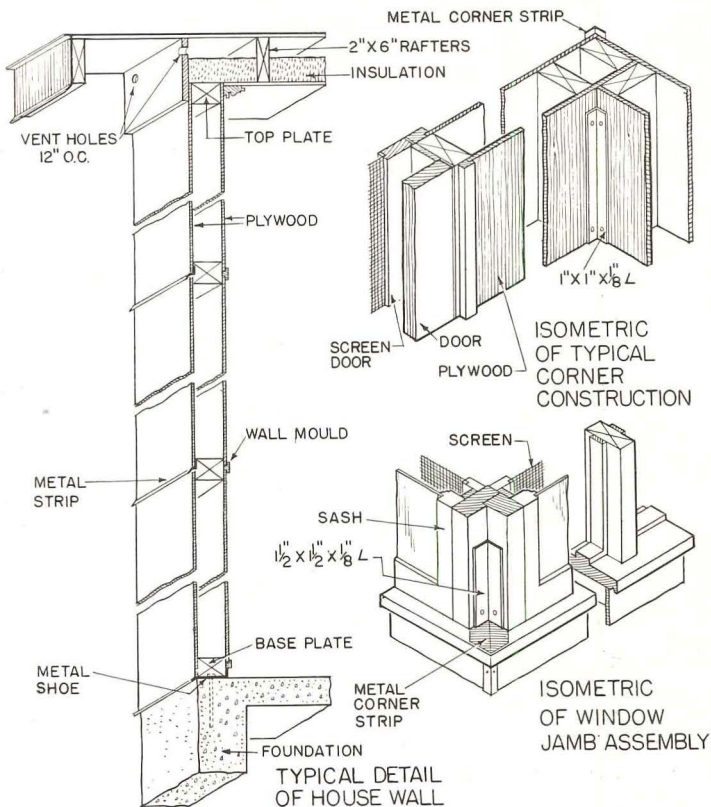

COMPLETE FACTORY-FABRICATION OF LARGE-SCALE UNITS

Buildings in the Desert Retreat at Palm Springs, California, were shop-fabricated of resin-bonded plywood in large units up to 30 ft. in length and of full-story height. Units were shipped from Los Angeles—120 miles distant—and walls were complete with windows and door frames, electric wiring and hardware, requiring only a finish coat of paint after field erection. The designers, W. F. Ruck, architect, and Zara Witkin, civil engineer, state that this type of prefabrication cost 35% less than construction by customary methods based upon contract proposals. As indicated in the line drawings, joints were confined to corners where steel channels and angles were anchored into reinforced concrete floors. The stressed-skin panels have stood up well for three years of sun, with extreme dryness, heavy rain, and winds of gale velocity, without apparent damage. According to the designers, large-unit fabrication of this type can be standardized to produce far-reaching economies without sacrificing variety in design.



Federal Home Building Service Plan



Not to be confused with a stock plan service, the Federal Home Building Service Plan aims to bring architectural service to homes priced under \$7,500. The plan was devised to eliminate jerry-building and safeguard investments. The "Home Selector", shown above, is a sample portfolio containing house designs from which the prospective home builder makes a selection.

ALTHOUGH COMPARATIVELY new, more than two years were spent in developing and testing the Federal Home Building Service Plan sponsored by the Federal Home Loan Bank Board. Applications for its use have been filed by 100 lending institutions and the first steps have been taken toward application of the plan. The plan grew out of the experience of the Home Owners Loan Corporation, which was forced to recondition 500,000 out of the million homes it refinanced. This experience revealed the extent and tremendous waste of shoddy construction in the small home field.

In the era before 1929, architects were crying their warnings in the wilderness against the jerry-built house and its danger to long-term investment. It must be gratifying to those who were active at that time to

hear their echo come back so clearly. Essentially, the plan proposes to equip members of the Federal Home Loan Bank System to offer new-home buyers a complete home-building service. The service comprises advice on financing and technical advisory and supervisory facilities supplied by co-operating architects and technicians. The plan furnishes these member lending institutions with a means of controlling the character of homes which they finance, to the end that substandard construction may be eliminated.

With the co-operation of the architectural profession, the service expects to extend the advantages of technical guidance into the vast field of small homes built for less than \$7,500. This field is recognized as the one most in

(Continued on page 82)

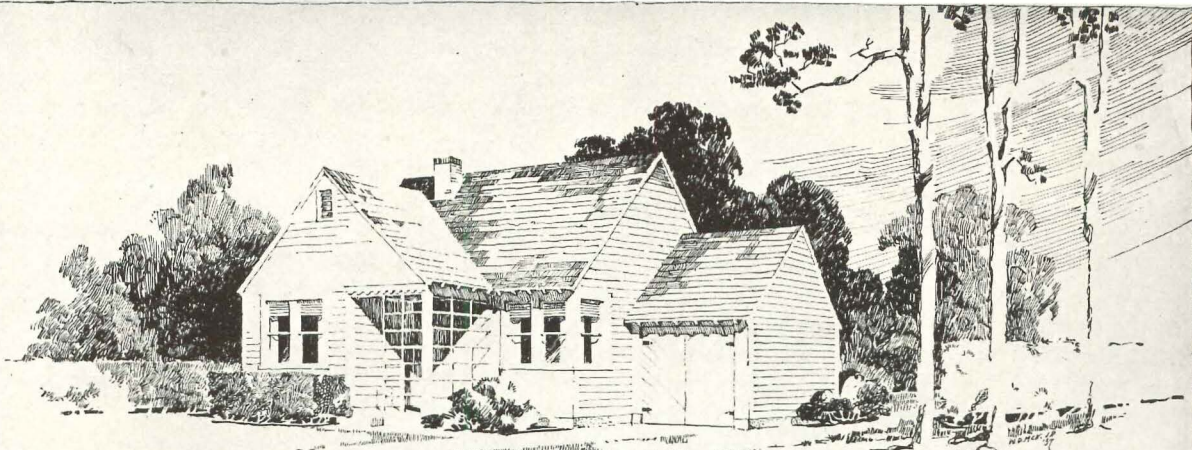

DESIGN "A"

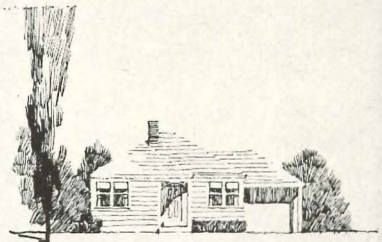
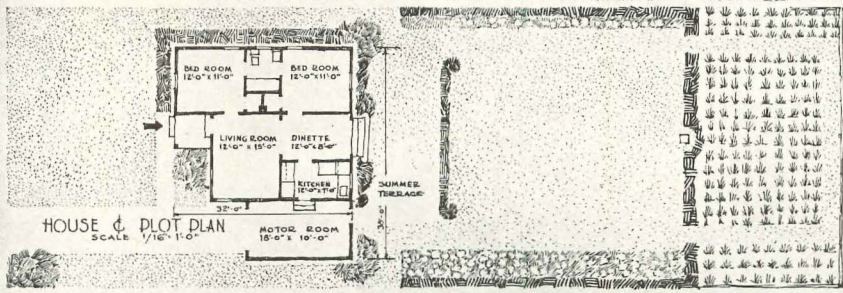

"B"
ALTERNATE ELEVATION DESIGN SCALE 1/16" = 1'-0"

AREA IN SQUARE FT. 815 SQ. FT. GARAGE 200 SQ. FT.	CUBIC CONTENT 11,410 CU. FT. 2,200 CU. FT.	MEMPHIS SMALL HOUSE CONSTRUCTION BUREAU INC. J. FRAZER SMITH, INC., ARCHITECT	W. D. MCKINNIE, JR., ASSOCIATE	5 M.S.-03A 5 M.S.-03B
---	--	--	--------------------------------	--------------------------

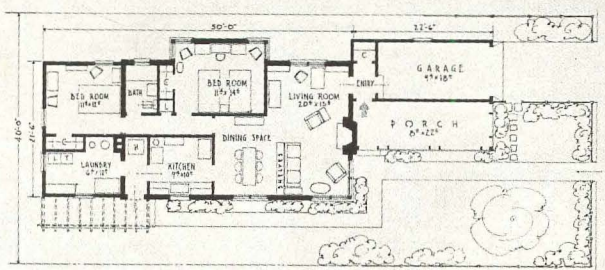
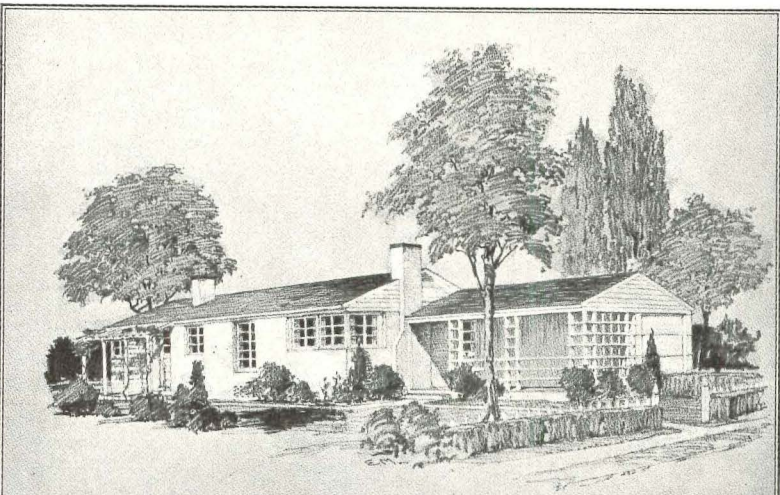

THE PROBLEM OF THE NARROW LOT HAS BEEN ECONOMICALLY SOLVED IN THIS ATTRACTIVE HOUSE. LOW IN FIRST COST AND IN UP KEEP THIS HOUSE HAS ARCHITECTURAL FEATURES WHICH DISTINGUISH IT FROM THE RUN-OF-THE-MILL SMALL HOUSE DESIGN. THE REAR BED ROOM AND LAUNDRY PORCH AND GARAGE, MAY BE BUILT AS FUTURE ADDITIONS. PARTICULARLY NOTEWORTHY ARE THE POSSIBILITIES FOR GARDEN DEVELOPMENT, NOT PRESENT TO THE SAME DEGREE IN MOST DESIGNS SUITABLE TO A NARROW LOT.

CONSTRUCTION BRICK & FRAME
EXTERIOR FINISH BRICK & SIDING
CEILING HEIGHT 8'-0"

FOUR ROOM BRICK AND FRAME HOUSE

DESIGNED ESPECIALLY FOR A NARROW LOT

Approved for use under the Federal Home Building Service Plan
Designed by Harlow T. Halcomb—Architect—Washington, D. C.

CUBIC FEET 9,366 & 14,604	DESIGN 3-DC-37 4-DC-37
------------------------------	------------------------------

Above: A \$3,000 house out of a portfolio of designs prepared by the Memphis Small House Construction Service, one of the first groups organized. Left: One of the designs out of the "Home Selector." Over 250 designs have already been prepared. This is one in the sample portfolio prepared for the Federal Home Loan Bank System. A prospective home builder thumbs through the designs at the bank, selects one that fits his needs and purse, and then the architect is called in to render modified architectural service at a moderate fee. The home builder has a fairly accurate idea of costs and materials at the start and the complete job is simplified. If the plan works, it is estimated that \$20,000,000 a year will be added to architects' incomes, and builders of low-cost homes will receive, at a price they can afford, the benefits resulting from technical guidance.

(Continued from page 80)

need of such guidance. The miniature mansions, built of papier-mâché without benefit of competent design or supervision, have proved to be a yoke around the necks of both the low-income owner and the lending institution holding the mortgage. The high maintenance costs which jerry-building entailed have contributed to the great blighted areas which result from bankrupt home-owners' inability to keep their houses in repair. A successful method of providing good standards of design to the lower-priced home would be an important step forward in eliminating blight and improving the country's standard of living.

The plan of the Federal Home Loan Bank Board is aimed primarily at eliminating poor design and pays particular attention to the 8 out of 10 houses built for less than \$7,500. It has been estimated by the Committee on Housing of The American Institute of Architects that this program would involve the architect in a volume of residential construction of \$600,000,000 yearly in which he does not now participate. At an average modified service fee of \$100 per \$3,000 unit this amounts to \$20,000,000 yearly for the architectural profession. It is the opinion of the Institute's Housing Committee Chairman, Walter R. McCornack, that the Home Building Service offers architects the opportunity to co-operate with two capably operated government agencies which the architect cannot afford to disregard. Mr. McCornack maintains: "The objective of this program is to make a definite start toward the solution of the small house problem, and to find a common ground upon which the architect, lender, and builder can unite with government agencies in a wise forward movement." The Institute's Committee on Housing advocates the formation of local groups to put the plan into operation. Some groups are already beyond the organization stage, notably Memphis, Tenn., Southern California, St. Louis, Mo., Boston, Mass., and others.

How the plan works

The plan is intended to operate through the 3,800 local home-financing institutions of the Federal Home Loan Bank System. These lending institutions finance about 50% of

the country's residential construction. The particular form of organization and details of the service are to be determined by the group in each locality. To encourage reasonable uniformity in the conduct of local services, the Federal Home Loan Bank Board asks that certain agreed upon standards and procedures be observed. The type of architectural service proposed is entirely different from the usual plan service. Moreover, since it is directed to furnishing technical guidance to home builders whose limited incomes have precluded the purchase of regular architectural service, it is not in competition with regular professional activities.

The average group is composed of representative architects specializing in residential construction. Competent technicians may likewise become affiliated to participate in the technical service under the plan. Wherever practicable, approved architectural groups will be utilized. Otherwise, approved technicians may be qualified by the Bank System to perform the services for a member institution.

Standard designs utilized

Under the plan each house must be built according to plans and specifications of an approved technician. Standard designs prepared by the co-operating group will be utilized in most instances. These must be approved by the Architectural Division of the Federal Home Loan Bank Board at Washington. Where designs are re-used, the designer is to be paid a royalty. A collection of approved home designs and minimum specifications is furnished the lending institution by the co-operating architectural group. If the institution so desires, it can obtain from FHLBB a binder—the "Home Selector"—for holding sketches, plans, and documents of interest to prospective home buyers.

The modified architectural service

The lending institution helps the prospective home owner to select from the portfolio a design suited to his needs and income. A meeting is then arranged with the architect of the design chosen who may make minor alterations without charge and other alterations at an established fee.* The architect will then inspect

*Problems of territorial jurisdiction are still to be solved.

the site for suitability of the chosen design to the lot and the neighborhood. At each stage, the architect will report to the lender on the soundness of his investment. Details of the frequency of inspection, etc., will be formulated by each local group. Specifically, the architectural group advises and assists the home builder: in securing an efficient design, suitable to the neighborhood and the site; in the selection of qualified contractors through competitive bidding; in the provision of the customary contract documents; in the regular inspection of materials and workmanship.

The architect provides the home builder with a plot plan, working drawings, specifications, and a job cost estimate; these must be approved by the lender. The home builder is charged in accordance with a schedule of fees set in advance by each architectural group, and ranging ordinarily from \$150 to \$300. Each house built under the plan is granted a certificate of registration upon completion, which should act as a guarantee of stable value.

Projects of large-scale builders or operators may qualify in a similar manner. The assurance that the foregoing procedure gives to the prospective home owner respecting quality of design should prove an aid in selling the homes.

If the small-house problem is solved to the advantage of the small home owner by this plan, the architectural profession may find itself in a key position in the home-building field. An important step forward is taken when the lending institutions carry the message of the need for architectural guidance to the public.

Additional information

Additional information may be secured from:

The Federal Home Loan Bank Board, Washington, D. C.

Committee on Housing, American Institute of Architects, Washington, D. C.

The Memphis Small House Construction Bureau, Memphis, Tenn.

The Producers' Council, 122 East 42 Street, New York City

Home Owners Loan Corporation, Washington, D. C.

Federal Housing Administration, Washington, D. C.



Mattie Edwards Hewitt

Co-operative Exhibitions Attract Prospective Clients

IF THE PUBLIC'S interest in models sets any standard of judgment, architects have at hand an economical means of attracting wide attention to their professional activities. The means are scale models of the structures they have designed.

The manner in which these are displayed necessarily has a bearing upon the extent of interest which they may arouse. Because, in all fields, models have become elements of recognized value in advertising, architectural groups are finding it increasingly profitable to join local organizations in presenting co-operative exhibitions. In these, architectural models form the background of special advertising to promote products related to building design.

To the extent that such exhibitions are designed particularly to interest buyers, the architect is participating in advertising. But it is advertising with an educational basis; and the fact that a model exhibition can bring best results if presented co-operatively

serves to bring participating designers into closer economic relationship with the various business interests of his community.

If there exists today a trend toward wider use of such professional promotion, department and house furnishing store executives have had a large hand in providing it with impetus. From R. H. Macy's, W. & J. Sloane's, and B. Altman's in New York, Marshall Field's and the Merchandise Mart in Chicago to Bullock's-Wilshire in Los Angeles—throughout the country, stores like these have run model shows. Most have been profitable to store and exhibitors alike.

Among most recent of all store exhibitions was that sponsored by W. & J. Sloane in collaboration with ARCHITECTURAL RECORD.

Fifty New York architects participated. And from the store's viewpoint the exhibit was so successful that the possibility of repeating it is now being considered.

W & J SLOANE
IN COLLABORATION WITH
THE ARCHITECTURAL RECORD

announces an

EXHIBITION OF
MODELS OF HOUSES

by contemporary American architects

ALSO
PHOTOGRAPHS · RENDERINGS

Second Floor

W & J SLOANE
FIFTH AVENUE AT 47TH ST.

Advertising attracts people interested in house building, prospective clients of designers who have put their professional abilities on display.

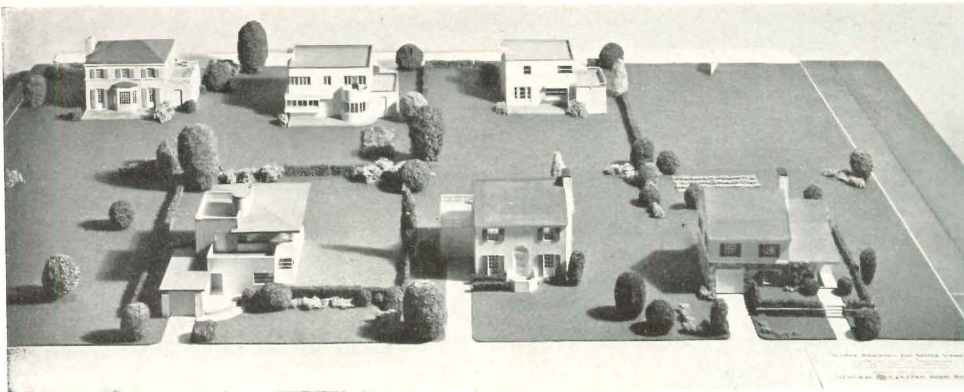

1

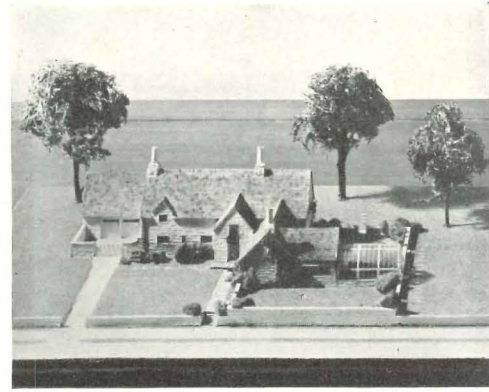

4

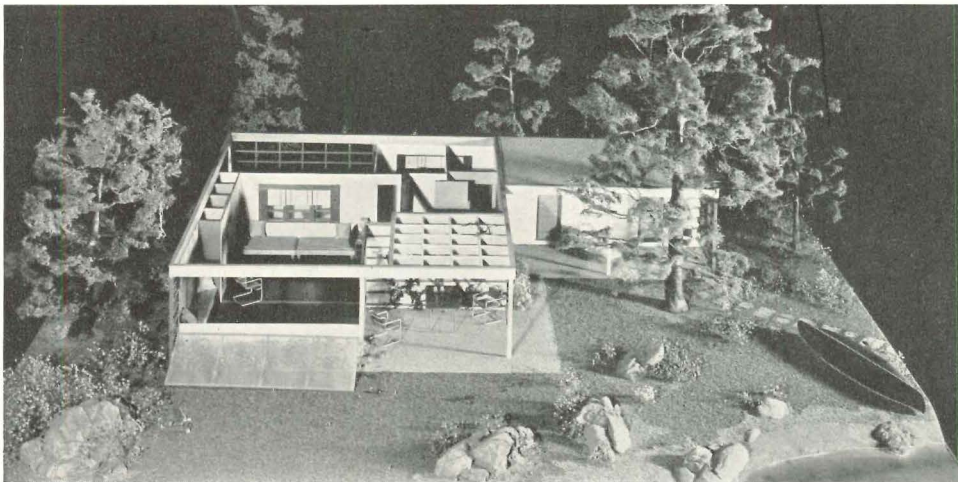

2

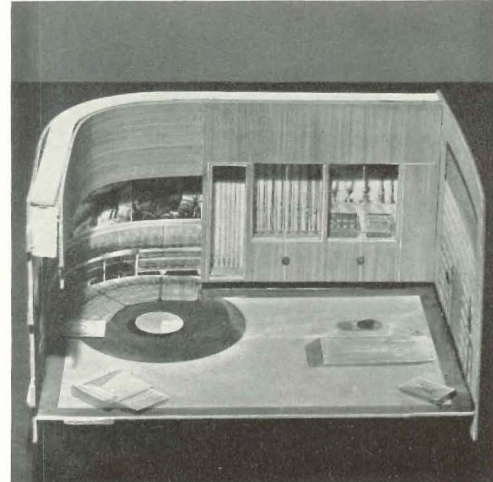

5

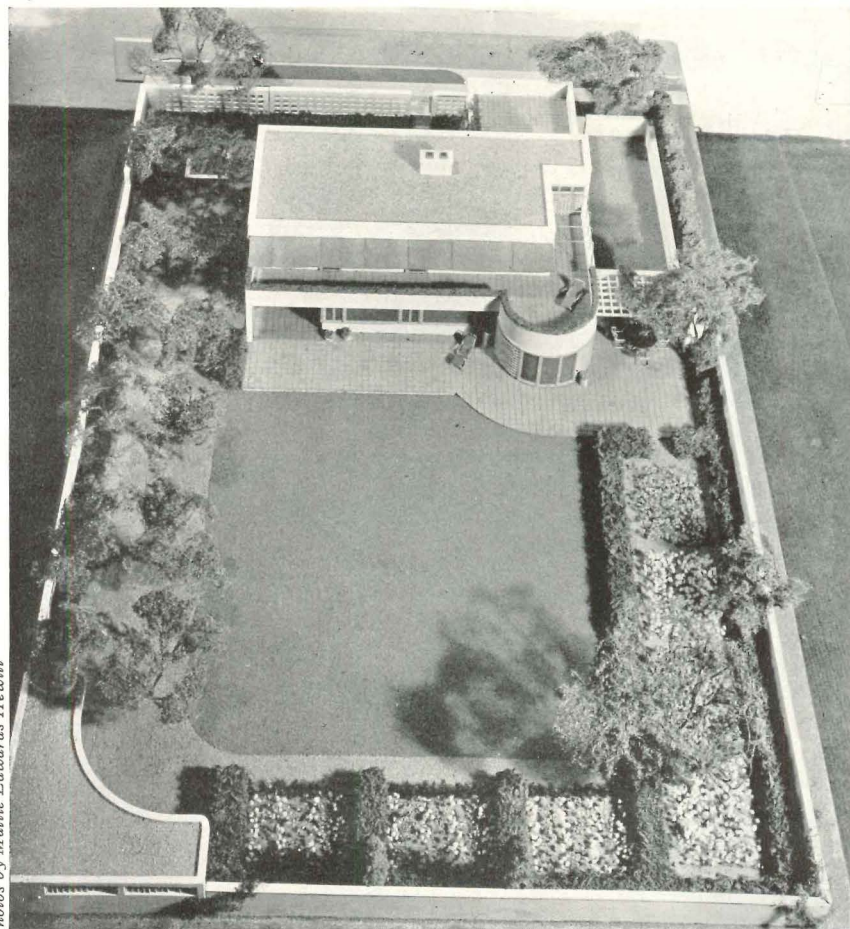

3

Photos by Mattie Edwards Herwitz

Models at the W. & J. Sloane exhibition varied widely in type and size. All, however, proved the value of a three-dimensional design presentation. On this page: 1 is a plot study by Victor Civkin of the General Electric Home Bureau; 2 and 3 were designed by Edward F. Stone for Collier's Magazine; 4 is a small-scale model by Francis Keally for the Lord & Burnham Co.; and 5 is a sketch-model by W. & J. Sloane decorators in which furniture and fixtures are painted on walls and floors. On the facing page: 6 shows a landscape development about a house designed by Bradley Delehanty; 7, a model reproduction of the Old Patton House at Dedham, Mass., made by B. L. Keyes; 8, a country house project by Alfred Hopkins & Associates; and 9, ranch cabins designed by George W. Kosmak, Jr.; 6, 7, and 9 are elaborately detailed and colored to give a striking illusion of reality; 8 is a rough clay study of a preliminary scheme.



Louis Werner

6

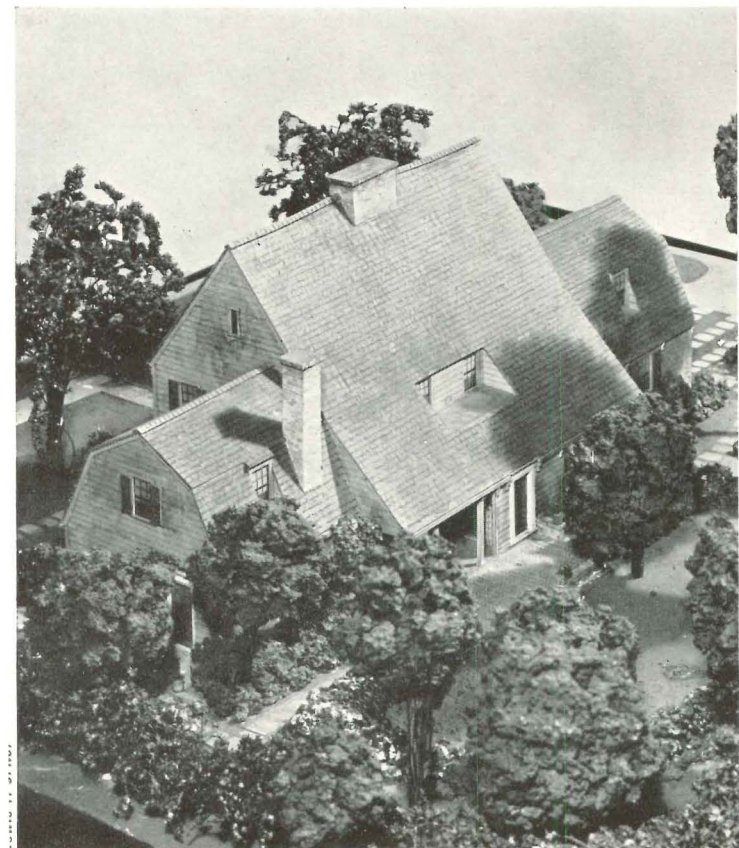

7



Hewitt

8

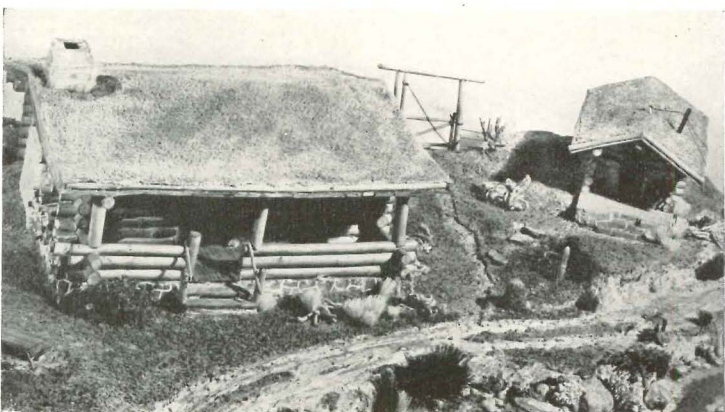

Hewitt

9

Trend Notes on a Building World

By CORRELATOR

Each month these pages record significant developments in the realm of design and in the fields of materials, equipments, and services.

CONTROL OF ATMOSPHERE

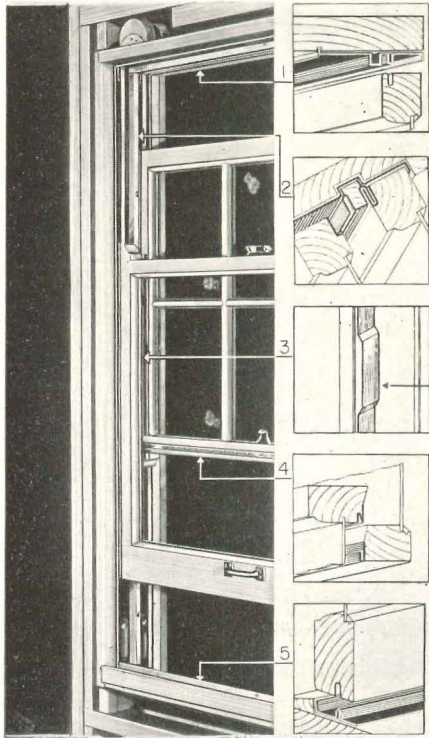

A metal-lined window frame

COMPLETELY METAL-LINED, the Embassy window frame, manufactured by Roach & Musser Company, Muscatine, Iowa, is a factory-fitted unit, for frame, brick or masonry construction. Actual frame is of Ponderosa pine; sills are solid and have a pitch of 3 in. to 1 ft. for quick draining. The head joint (1) is fitted with a metal lock strip which enters a groove in the top of upper sash and provides an all-weather seal. Side jambs (2), metal-clad from inside stop to blind stop, are grooved to receive metal-covered parting stop. Sashes are slide-sealed to the parting stop with special metal strips. A metal dust pad (3), provided where check rails are cut away to clear the parting stop, excludes dust and prevents drafts. Check rails (4) are weather- and dust-sealed by interlocking metal strips. Sills (5), metal-lined to the thickness of lower sash, have a lock strip similar in form and purpose to that on the head joint.

TRENDS IN heating controls have shown an increasing recognition of

the importance of two factors—precision and speed; thus all control equipment has emphasized the importance not only of achieving the predetermined ratio between indoor and outdoor temperature but with as little time lag as mechanically possible. This has proved a relatively simple problem for two of the three major types of heating—forced air and steam. For hot water, however, the problem is complicated by the character of the heating medium itself—not more hot water but *hotter* hot water is immediate need when temperature drops. To solve this problem, Hoffman Specialty Company, Waterbury, Connecticut, last month introduced a “weather-control” for hot-water systems.

The control is designed to maintain uniform room temperature throughout the cold season, using the relationship between outdoor temperature, heat loss from building, and radiator temperature. Operation is entirely automatic: an outdoor bulb connects with control box, which is located between boiler and pump, and a water temperature bulb installed in supply main close to boiler; the boiler is by-passed from the rest of the system, so that hot water is admitted to pipes only when radiator temperature needs to be restored or when outdoor temperature drops to such a degree that the water in the radiators cannot compensate for it. When such a situation occurs, the control valve opens; when temperature has reached the proper point, it automatically closes. Water in the boiler is maintained at a constant temperature which accords with desired B.t.u. emission. Continuous operation of the pump, except when outdoor temperature rises above 65°, keeps water circulating in the system. Temperature rises are gradual since only small quantities of water are admitted at a time. Any desired degree of room temperature can be provided by adjustment of the temperature controller. The system offers also an indirect means of heating domestic

(Continued on page 146)

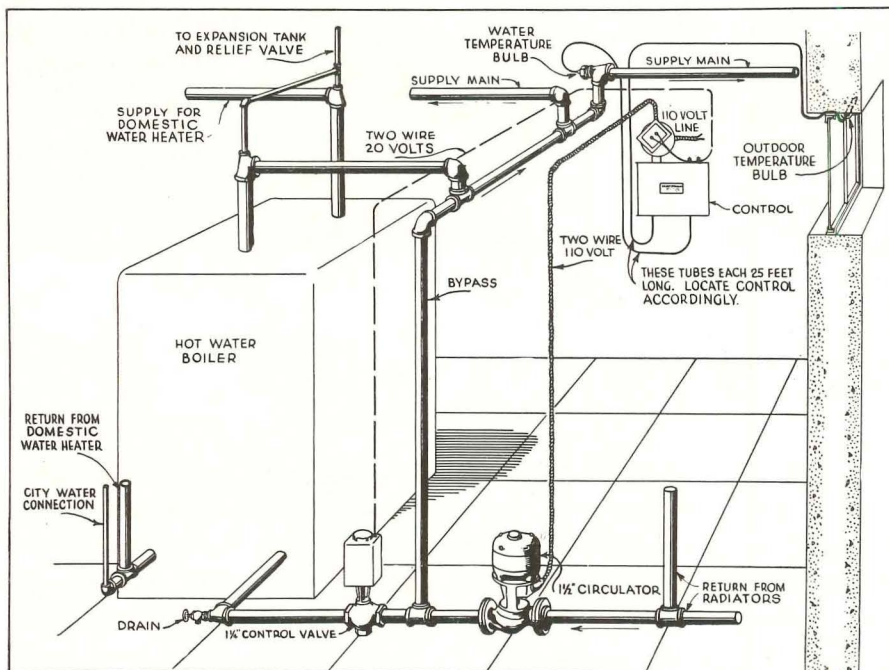

A "weather-control" for hot-water heating systems



ROOM FOR OUTDOOR LIVING

Custom and the character of American family life have made the porch a necessary element of modern residential design. As a sheltered link between the openness of a garden and the privacy of indoors, the porch above admirably serves its purpose. Cameron Clark designed it. Means by which other designers have solved similar problems are presented in the following seven pages.

George H. Van Andra



1

Frances Benjamin Johnston



2



3

SINCE the country's early days, the porch has filled the American family's need of a space for relaxation—a sheltered place disposed for comfort and privacy and easily accessible from both indoors and out. It might almost be said that the porch has become a distinctly American institution. Such a statement is, of course, open to personal interpretation. But the fact remains that designers in this country have brought the porch to a high state of development, proof of which is offered here. Apparently, rooms for outdoor living constitute an important trend in residential design. From the early 18th century examples, progressive developments seem to be making closer and closer contact between porch and enclosed living areas. As suggested by some of these pictures, the ubiquitous porch is becoming—in effect, at least—a kind of garden room in which the privacy of the house is actually merged with the freedom of outdoor, gardened areas.

On this page: 1 is a house at Fall Village, Conn., built in the early 18th century; 2, one of the earliest log farmhouses near Roanoke, Va.; and 3, a porch in Maryland that dates from 1730. On facing page: 4 is in Ashland, Ohio, Louis Andre Lamoreux, architect; 5 is at Greenwich, Conn., Frank J. Forster and R. A. Galimore, architects.



Mooney

4



Robert MacLean Glasgow

5



Samuel H. Gettscho

6

On this page: 6 is an outdoor living room at University, Va., James W. O'Connor, architect; 7, a rear porch of an old stone house in Bucks County, Pa.; and 8, a terrace shelter in Sanderstown, R. I., Alexander D. Knox, architect. On facing page: 9 is at Beverly Hills, Calif., Roland E. Coate, architect; 10, an all-metal porch at Locust Valley, L. I., Bradley Delehanty, architect; and 11, a guest-house porch at Salisbury, Conn., Wyeth & King, architects.



Richard Tabb

7

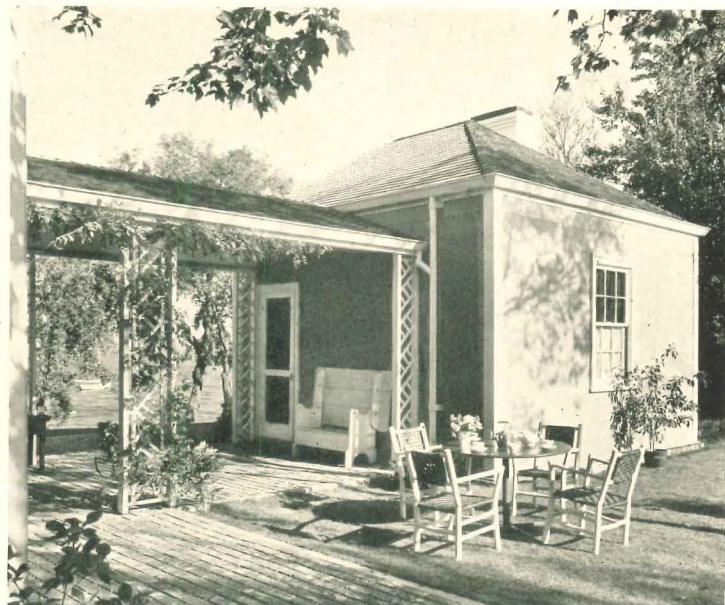

8



George D. Haight

9

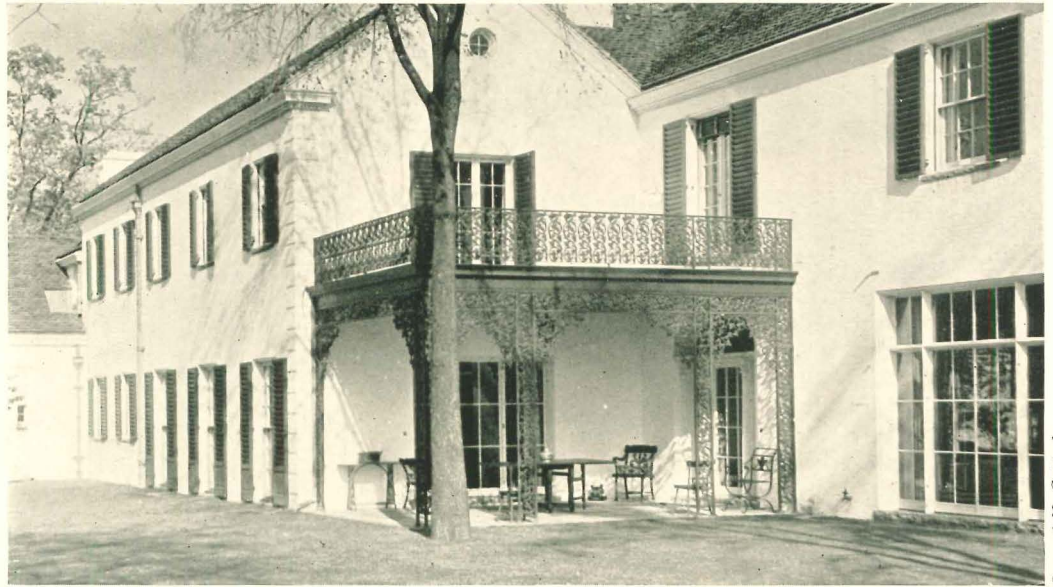

Samuel H. Gottscho

10

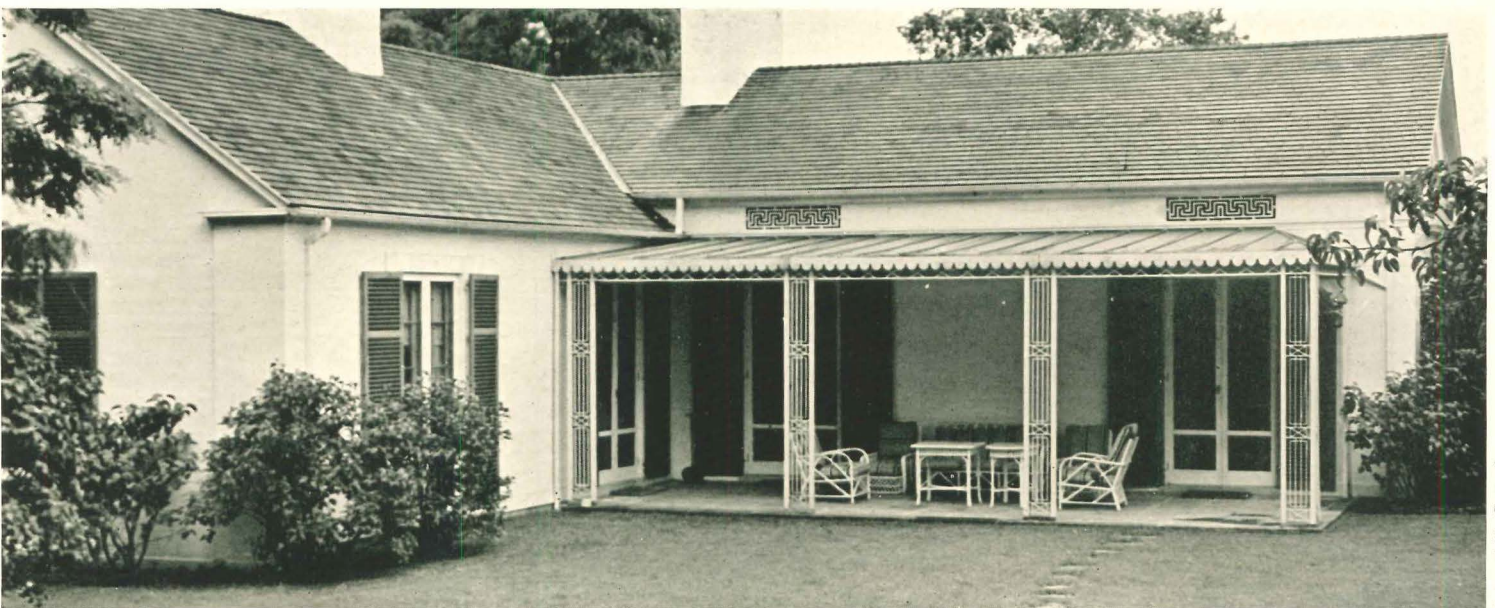

Samuel H. Gottscho

11

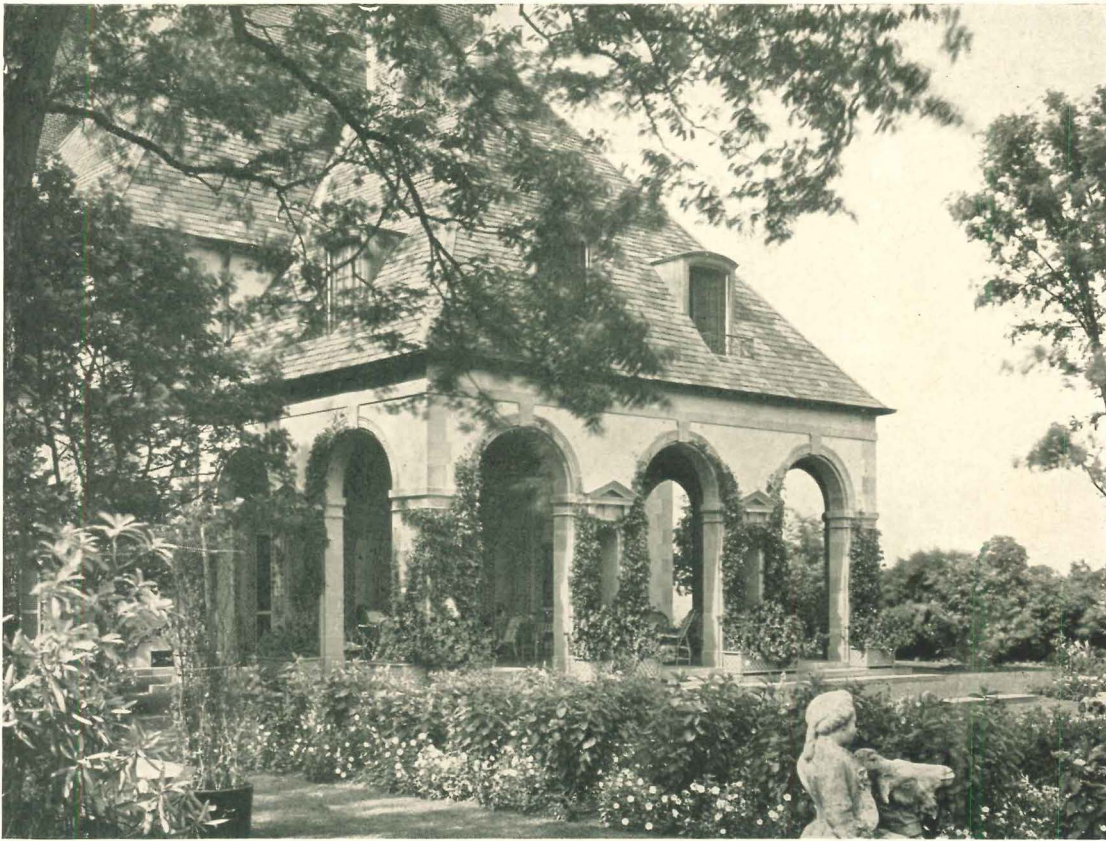

12



13

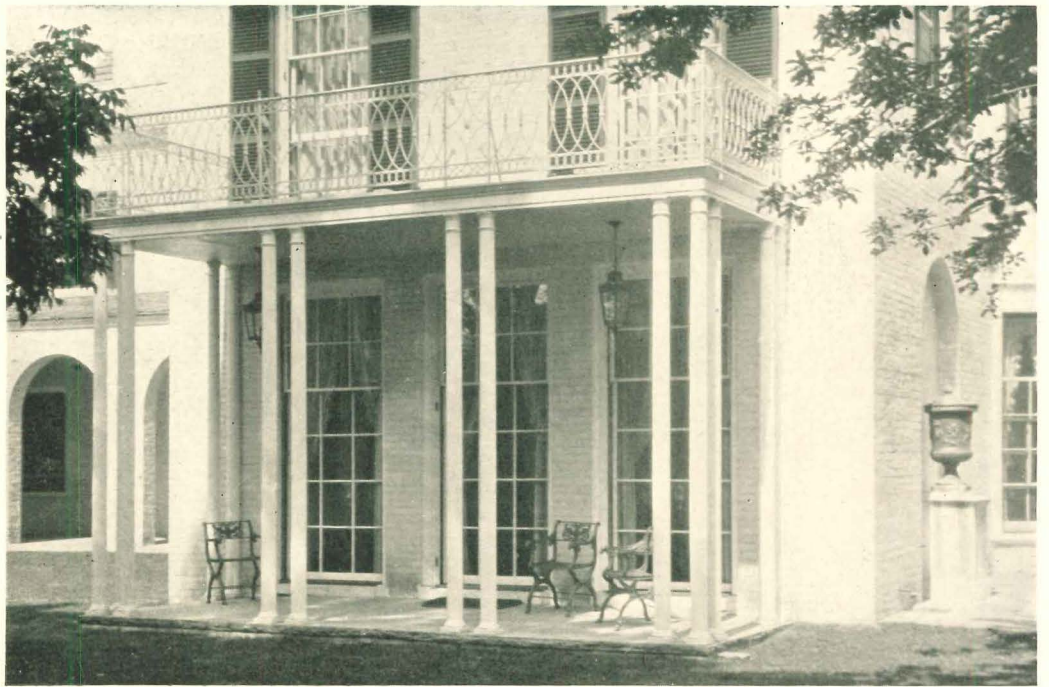

14



15

Laura Gilkin



16

Robert MacLean Glasgow

On facing page: 12 is at Newport, R. I., Office of John Russell Pope, architects; and 13, at Bedford, N. Y., Phelps Barnum, architect. On this page: 14 is a porch with cast-iron posts at Purchase, N. Y., Leigh French, Jr., architect; 15, a patio at Colorado Springs, Colo., William E. and Arthur A. Fisher, architects; and 16, a timber porch of a hillside house at New Haven, Conn., Carina Eaglesfield Mortimer, architect.

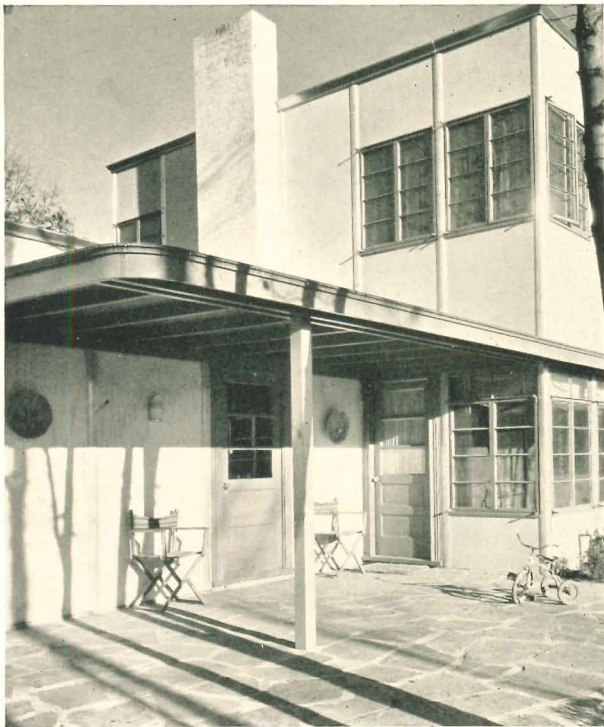

17

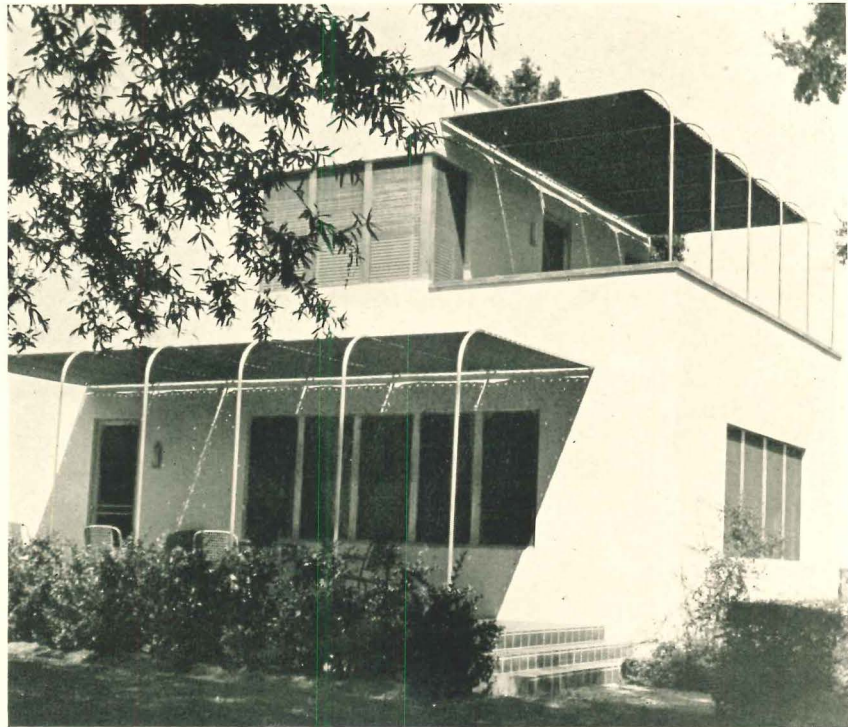

18



19



20

17 and 18 are more shelters than living porches, 17 being at Hicks-ville, L. I., Holden, McLaughlin & Associates, architects, and 18 at Houston, Texas, Wirtz & Calhoun, architects. The other two pictures are of English houses and suggest the close merger of house and garden through the porch. 19 is at Farnham Common, Harding & Tecton, architects; 20, at Bourne, Connell, Ward & Lucas, architects.

Current Trends of Building Costs

Compiled by Clyde Shute, Manager, Statistical and Research Division, F. W. Dodge Corporation, from data collected by E. H. Boeckh & Associates, Inc.

CURVES INDICATE control trends in the combined material and labor costs in the field of residential frame construction, the monthly curves being an extension of the local cost averages during the years 1935, 1936, and 1937. The base line, 100, represents the U. S. average for 1926-1929.

Tabular information gives cost index numbers relative to the 100 base for 9 common classes of construction, thus showing relative differences as to construction types for this year and last.

Cost comparisons or percentages involving two localities can easily be

found by dividing one of the index numbers into the difference between the two. For example: if index A is 110 and index B, 95, $(110-95) \div 95 = .16$. Thus costs in A are 16% higher than in B. Also costs in B are approximately 14% lower than in A: $(110-95) \div 110 = .14$.

CONSTRUCTION COST INDEX U. S. average, including materials and labor, for 1926 - 1929 equals 100.

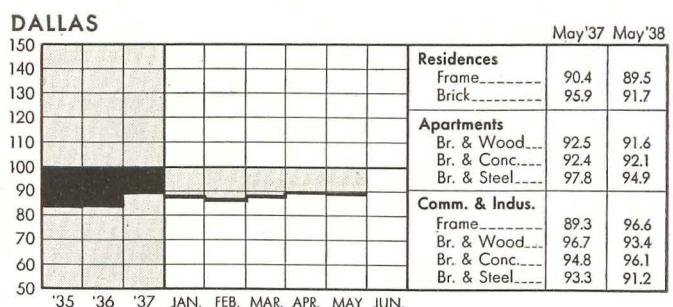
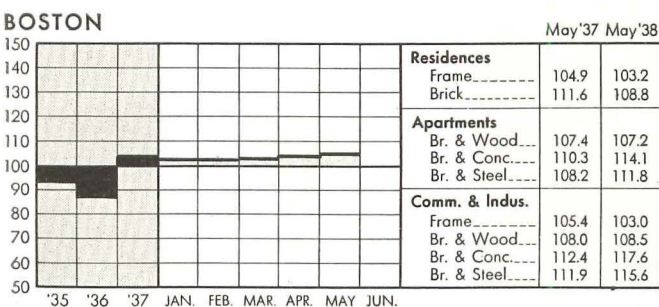
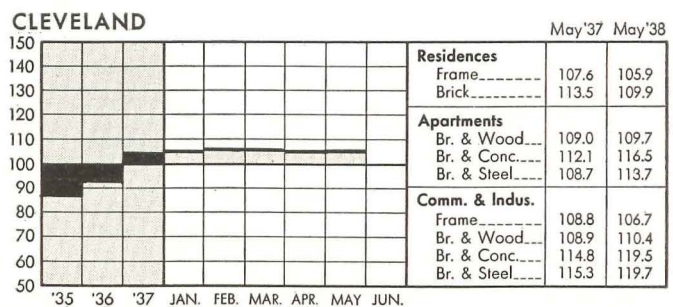
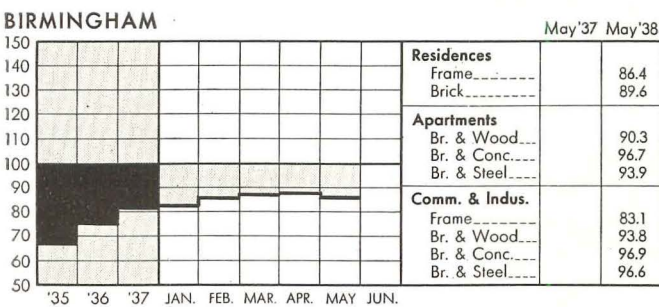
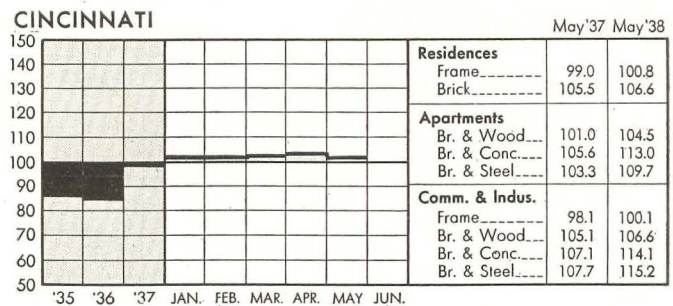
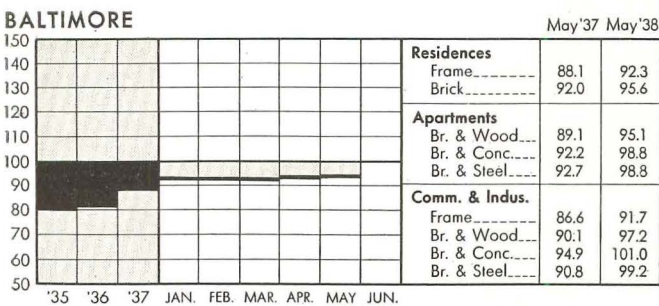
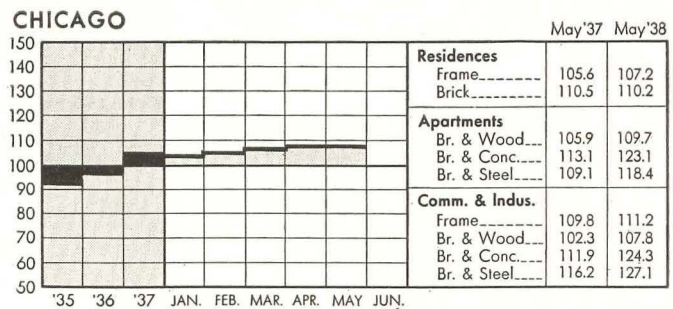
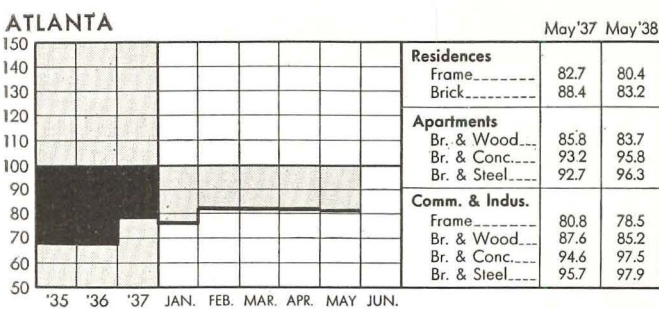

DENVER

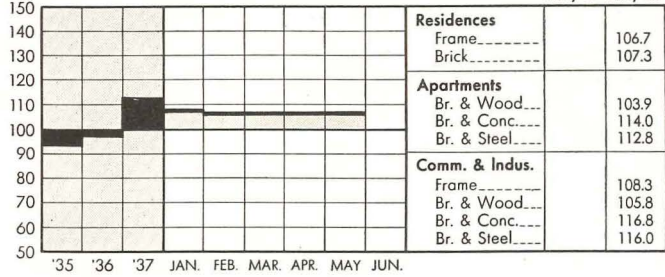

NEW YORK

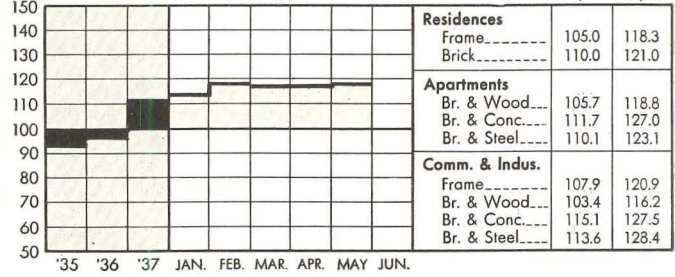

DETROIT

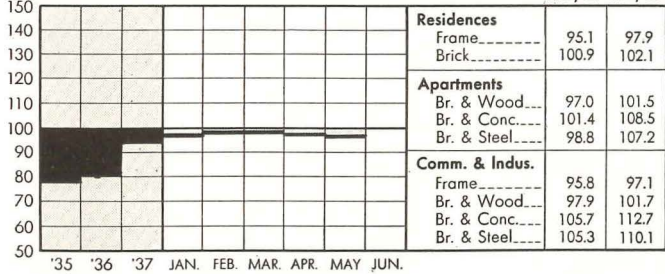

PHILADELPHIA

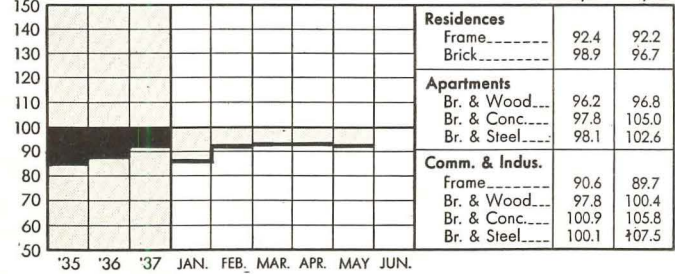

KANSAS CITY

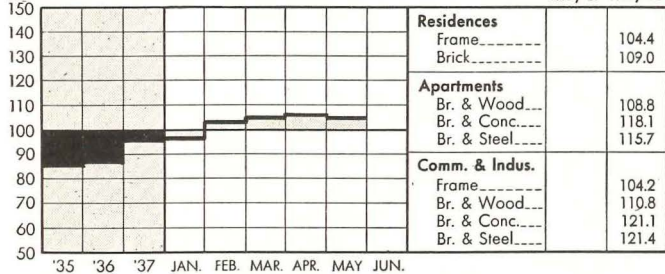

PITTSBURGH

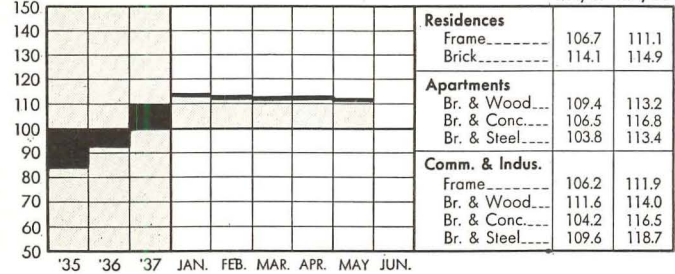

LOS ANGELES

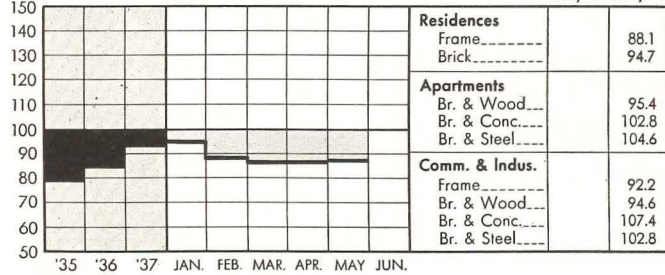

ST. LOUIS

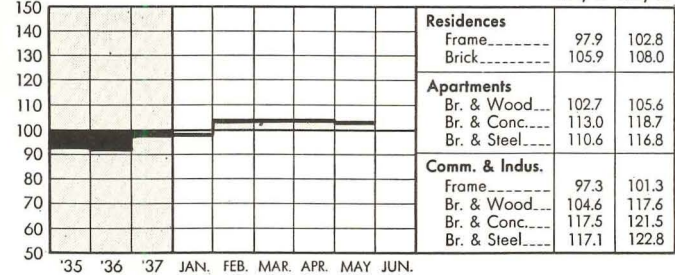

MINNEAPOLIS

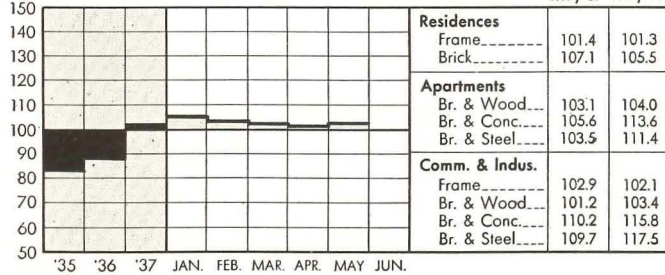

SAN FRANCISCO

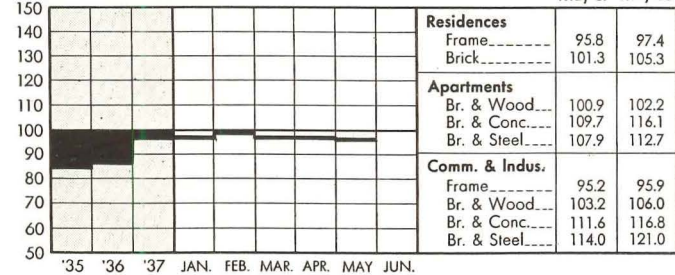

NEW ORLEANS

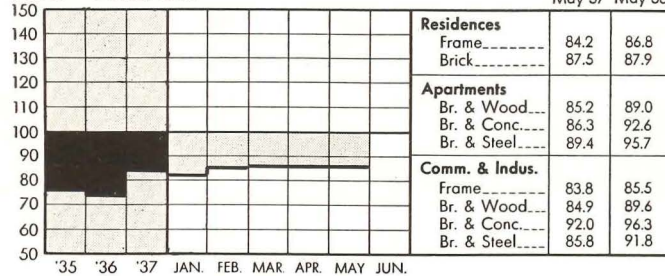

SEATTLE

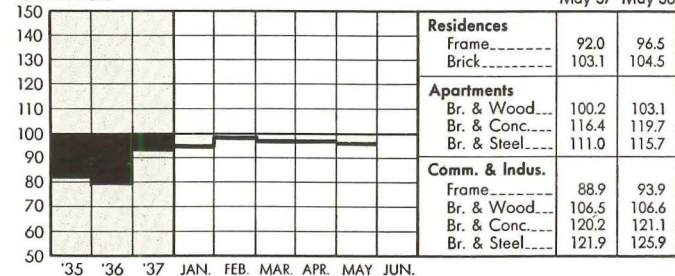

Reviews of New Books

URBAN BLIGHT AND SLUMS. By Mabel L. Walker, with special chapters by Henry Wright, Ira S. Robbins, W. Philip Shatts, Kenneth H. Zabriskie, A. C. Shire, and Richard V. Ratcliff. Harvard University Press, Cambridge, Mass., 1938. Illustrations from line drawings. 7 1/4 x 10 in. 442 pages. Price, \$4.

TO THE ARCHITECT, the attack upon urban blight and slums has become today's vital issue. In the words of the sponsors, Mr. Harold S. Bутtenheim and Mr. Lawson Purdy, "This book is concerned with a major problem of most American cities—the present extent and continued spread of blighted areas and slums. It seeks to analyze and answer the puzzling problem which such areas propound to property owners, national and local officials, and civic welfare groups: 'What can be done by public and private effort to reclaim these decadent districts and to prevent their future inception and contagion?'"

One has become accustomed to pamphleteering whenever the subject of slums and blighted areas is broached. Dr. Mabel L. Walker's realistic analysis of the problem throws a great deal of light on a subject which has been accorded much attention. Dr. Walker believes that there is no single solution to the problem, but many possible lines of attack, each of which offers considerable promise. The most important objectives are listed as follows:

1. An adequate city plan
2. More logical zoning regulations
3. More effective control of subdivisions
4. Better and more standardized building regulations
5. Clear and sufficient legal powers for the creation of state and local housing authorities
6. More effective methods of land assembly at fair prices and of the exercise of eminent domain for housing purposes
7. Reform in the system of taxation
8. Wider use of excess condemnation for replanning purposes
9. Improvement of home-financing policies
10. The creation and rationalization of a real home-building industry
11. Extensive government research in various aspects of the problem
12. Government demonstration projects
13. An intelligent and informed public opinion

It is significant that in the prosecu-

tion of any slum-clearance program, a large part of the tasks suggested by the list above would devolve upon the architect. Thus would be offered him a bright and vital future in the work of rebuilding America.

Dr. Walker states that there are three possibilities for achieving good housing for the masses: (1) By the Government undertaking to defray a substantial part of the cost of housing one-third of the people; (2) By raising the level of incomes; (3) By lowering the cost of housing. Her conclusion is realistic: that "Government subsidies on such a large scale would be fiscally impossible without a change in methods of a revolutionary nature", and that "The raising of the level of incomes will probably be a slow and uncertain process." Dr. Walker concludes, therefore, "that our most promising attack is the creation and rationalization of a large-scale home-building industry which can meet the people's housing needs and strict governmental regulations concerning planning and building with a vigorously enforced condemnation and demolition policy and a reformed tax system."

These conclusions have been reached through Dr. Walker's close application to the problem for many years. The information contained in her book reflects the thoroughness of her study and is a valuable and objectively presented collection of data. In compiling it she has enlisted the aid of a banker, an architect, a housing economist, a city planner, an engineer, and a lawyer, all of whom are experts in their phase of the subject.

THE MASTER PLAN. By Edward M. Bassett. Russell Sage Foundation, New York, 1938. 6 x 9 1/4 in. 151 pages. Price, \$2.

IF "URBAN BLIGHT AND SLUMS" is a broad analysis of the city's problem areas and proposals for their improvement, then "The Master Plan" is a blueprint of one part of the machine which may be utilized to do the job. The author brings many years of active experience in zoning and planning work to this simple exposition

of what may be done under the law. He has been connected with zoning and planning legislation since its inception in this country.

Mr. Bassett contends that the master plan should be confined to showing the seven elements of a community land plan: streets, parks, sites for public buildings, public reservations, zoning districts, routes for public utilities, and pierhead and bulkhead lines. He claims that "there is an increasing tendency to make master plans diffuse and to ossify them", and pleads for flexible plans which cannot be tied up by red tape.

All the elements to which Mr. Bassett would confine the master plan have only recently become considered proper spheres for local government control. Zoning, for example, has only recently been accepted as a prerogative of local government and has not yet been legally approved throughout the nation. Likewise, the right of local government to condemn land for a public use, e.g., parks, has only been recently won and not in all parts of the United States. In brief, there is a growing tendency for local government to control a greater part of the land within its confines, and it is gradually being extended to provide more control over the use of private property.

The usefulness of private property is dependent upon community-contributed facilities to a greater extent than formerly. These take the form of public utilities, facilities for transportation, education, recreation, etc. Fully half of the value of land for single dwelling use is due to community-contributed services and therefore the community should have a greater share in its control.

Hence, we should expect Mr. Bassett's seven elements to be plastic and to change with the changing relationship between the community and its individuals. The provisions in the New York City Charter which Mr. Bassett considers superfluous may become commonly accepted in the future. These provisions are that the master plan shall "provide for the improvement of the city and its future growth and development and afford adequate facilities for the housing, transportation, distribution, comfort,

(Continued on page 150)

A PERIODIC TEMPERATURE CHECK ASSURES COMFORT AND LOWER COST!

WHEN you install a Brown Indicating Resistance Thermometer in your building your engineer can, from any convenient place, tell at a glance the precise temperature condition at any or all of the strategic points in your building. It shows immediately where and when waste occurs, enabling him to maintain uniform temperatures in all parts of the building. Thus it assures comfort and permits the elimination of wasteful overheating. The Chrysler Building in New York City used 15% less steam last year with the average outside temperature 7% colder. The Brown Indicating Resistance Thermometer eliminates imaginary complaints on the part of occupants and gives you a positive means of checking the correct temperature throughout the entire building. Let the Minneapolis-Honeywell Engineer show you why you can't afford to be without a Brown Resistance Thermometer to check comfort and operating costs. Minneapolis-Honeywell Regulator Co., 2804 Fourth Avenue South, Minneapolis, Minnesota. Branch and distributing offices located in all principal cities.

BROWN RESISTANCE THERMOMETERS
TELL THE TEMPERATURE ANYWHERE
IN THE BUILDING *Instantly!*

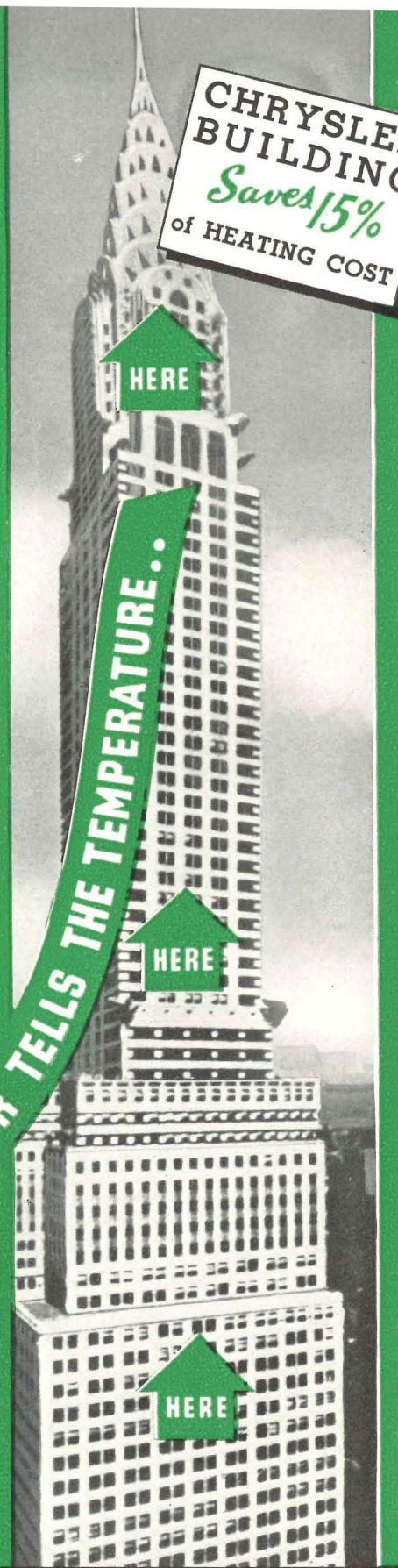
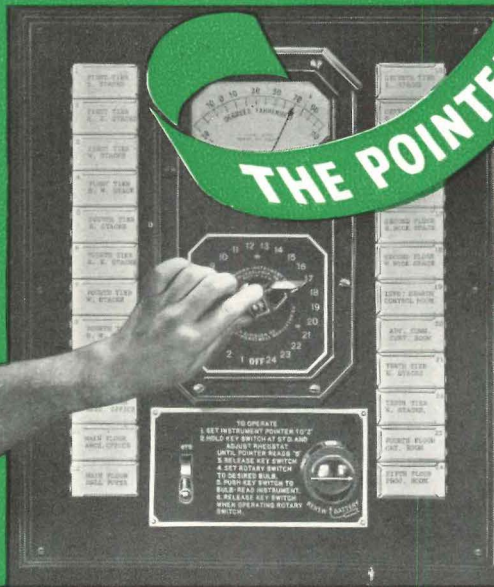

**CHRYSLER
BUILDING**
Saves 15%
of HEATING COST

MINNEAPOLIS-HONEYWELL

BROWN INDUSTRIAL INSTRUMENTS
NATIONAL PNEUMATIC CONTROLS

CONTROLS
AUTOMATIC
MH

Control Systems

BUILDING TYPES

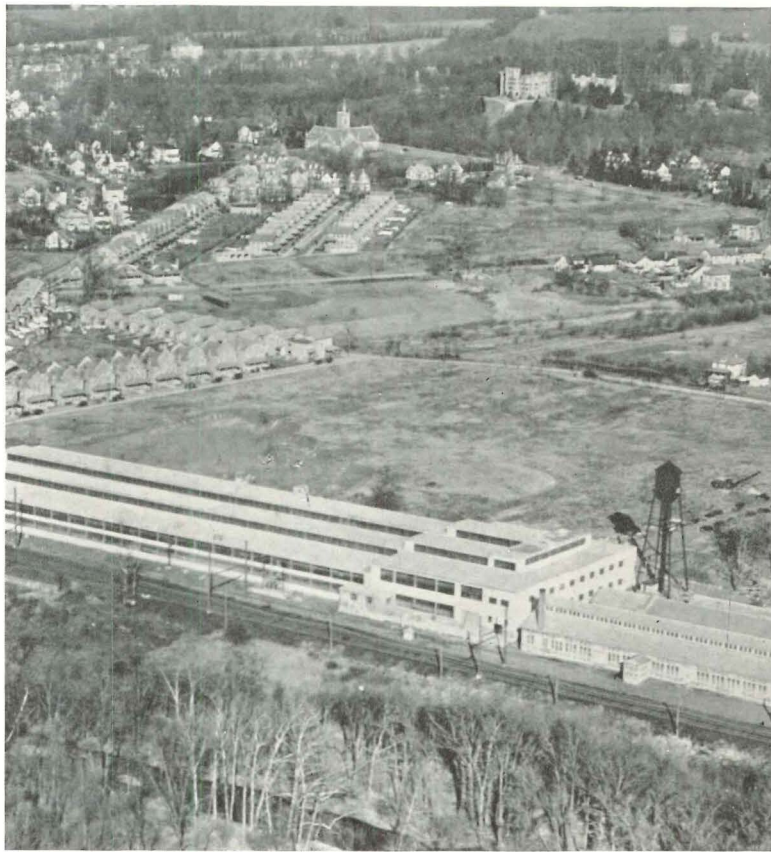

F A C T O R I E S

ARCHITECTURAL
RECORD

COMBINED WITH
AMERICAN ARCHITECT AND ARCHITECTURE

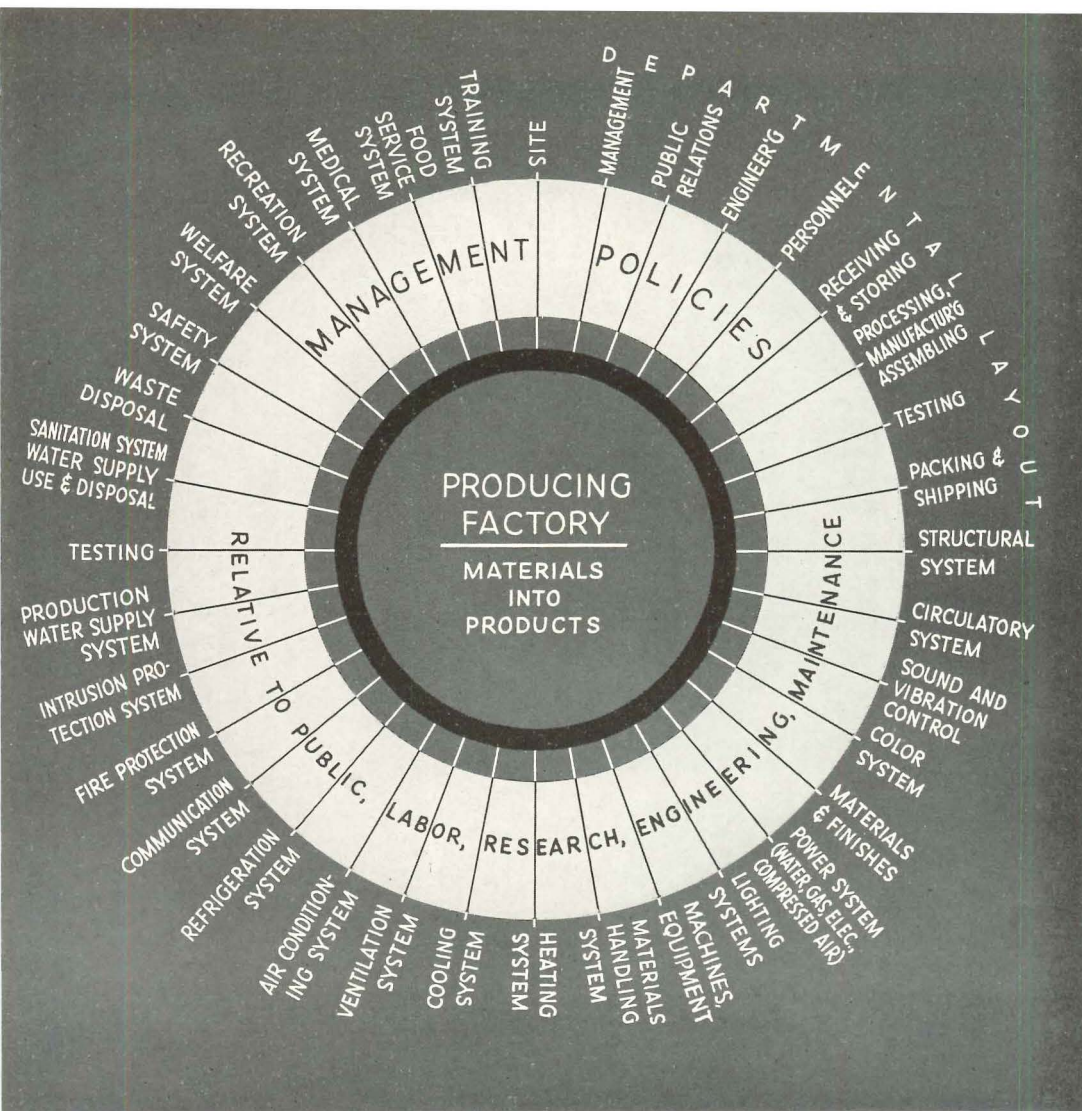

In an adequate, economically sound industrial building, designed as an integral part of the business of production, each of the factors in the organization chart receives proper consideration. Also related to the producing unit are such specific factors as apply only to the project at hand. All are studied from the viewpoint of management policies modified by experience and the knowledge of specialists. The factory designer serves as a co-ordinator.

The Factory Designer's Job

INDUSTRIAL BUILDINGS constitute the third most important type of construction activity in total annual expenditure. They are foremost of all types in percentage of architect-engineer planned structures. The strength of this position stems directly from the precise control which is required in a factory, not only in its production cycle but also in its housing. In order to evolve this precision in relationship of space requirements, environment, mechanical and human traffic, the special requirements in each consideration must be collected, studied, and correlated. Time and the relation of operations to it are of ever-increasing importance in reducing production costs. Finally—and this consideration while not always an apparent one is nonetheless demanding more adequate expression—provision for worker welfare,

safety, comfort, and social facilities will promote morale and production.

Selection of site

In selection of the site, the industrial architect can assist in analyzing advantages and disadvantages offered by kind and cost of labor available, sources of material and power, transportation facilities available and obtainable; refuse disposal; legal and other restrictions; markets and competitive enterprises. Occasionally advertising factors may determine selection of a site. Where the site is already selected the architect can consider these factors in developing their fullest possibilities.

Planning

In common with other investigators of these items, the architect can attempt to foresee future changes.

Site development flexible enough to permit the most economical revision will reduce later expenditures of time and money.

This flexibility to provide for future needs is essential to an efficiently planned structure. Processes and production cycles are in a state of constant evolution in most plants; rates of obsolescence are high; new products and the elimination of older ones must be anticipated. Structural systems which define the space provisions can likewise be designed to facilitate change. For instance, where change of use or extension is likely, a floor system can be so laid out that it will prove structurally sound when partially removed for changes in conveyor or materials-handling systems. Floors in the Swift Refinery (page 126) are designed so that whole bays can be removed in order to

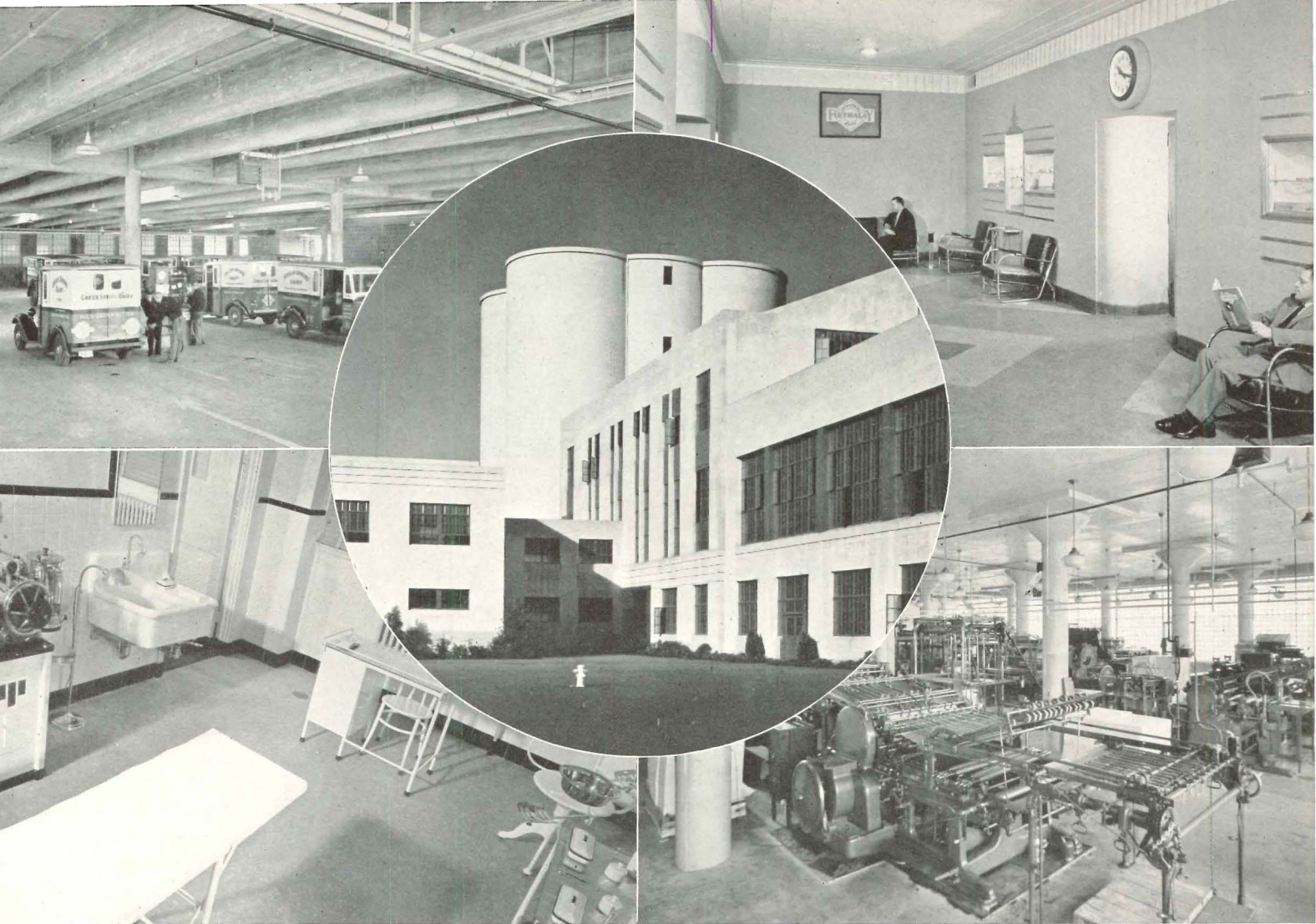

photo by J. H. Schaefer & Son, lower left by Ezra Stoller, lower right by Baker Art Gallery

install additional two-story tanks when the plant's present capacity is exceeded. Structural and mechanical production systems—the latter with its power and other services—are inseparable considerations.

In many instances it becomes desirable to use new ideas and materials, or old materials in a new way, to solve new problems. As an example, hangar doors on the Glenn Martin Assembly Plant (page 102) were designed after much research into effects of weather conditions, required operating power, stresses developed in framing, etc.

Services, finishes, and production

Environmental considerations—lighting, air conditioning, ventilation, sound control, surface finishes, etc.—usually bear a direct relation to the manufacturing process. Their inclu-

sion should be established on a basis of specific relationships. For instance, paper shrinks or swells as the atmosphere changes. The necessity for maintaining a constant temperature and humidity, and the high level of illumination required for perfect register in color printing, caused the architect of the Western Printing Co. plant to provide a complete air-conditioning system and to select glass block for exterior and monitor side walls (page 104).

Again, the Government keeps a close watch on food factories. Portions of the Ruppert Brewery (page 110) must be surfaced with impervious materials, so that floors and walls can be hosed down between working periods. This requirement also necessitates floor drains. A Government cellar is also included; in other types of food plants, inspectors'

offices must sometimes be provided.

Sometimes advertising value determines the type of structure, as in the case of the Brown-Bevis Company's plant (page 118). The colored terra-cotta front of the Galvin Manufacturing Company's factory (page 116) is another illustration. In each case the technical specialists of the industry must bring to the industrial architect the precise standards of environment which he is to develop.

Since a factory must pay, economy is foremost. Those materials and resultant forms which most appropriately achieve and express this quality, both in first cost and in maintenance, will result in an architectural composition free from the superfluous or wasteful.

For an extended bibliography and other references, see preceding Building Types studies devoted to Factories, AR, 2/37, and AR, 8/37.

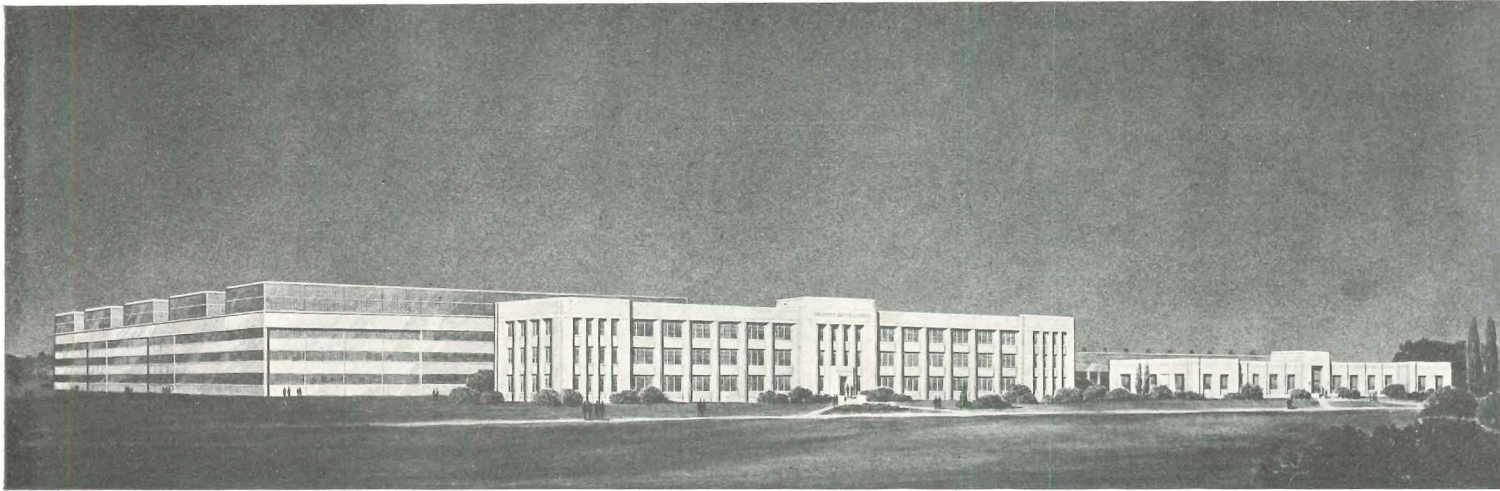

AIRPLANE FACTORY

THE GLENN L. MARTIN CO.
MIDDLE RIVER, BALTIMORE, MARYLAND

ALBERT KAHN, INC.
Architects and Engineers



Upper: Facade of the Administration Building, with the Engineering Building in the background. Lower: Interior of the Assembly Building, 300 ft. wide, 450 ft. long, 40 ft. clear headroom throughout.

THE ADMINISTRATION BUILDING and factory portion at the right of the general view above were previously built. An addition to the factory space, seen in the plot plan, was built next. Most recent are the Engineering and Assembly Buildings, center and left in the general view. The Assembly Building is probably the most interesting, as it contains several valuable developments. Roof trusses are built up of latticed members and span the full building width. Monitors run parallel to and encase the trusses, thus diminishing the total height of the building without decreasing interior headroom. Hangar doors are discussed below and illustrated in detail on the following page. Heat loss through extensive glass areas and openings is counteracted by hot-air outlets in the perimeter of the floor, with return inlets down the center.

Assembly Building

In the Assembly Building, in addition to the necessity for a clear span, the hangar doors opening to the full width of the building presented problems in heating and in door operation, space-saving, weathering strips, control, and support. While a saving in initial cost of approximately \$1,500 would have resulted from installing slide-type doors, operation of such large sliding doors would have cost the equivalent of one ton of coal for

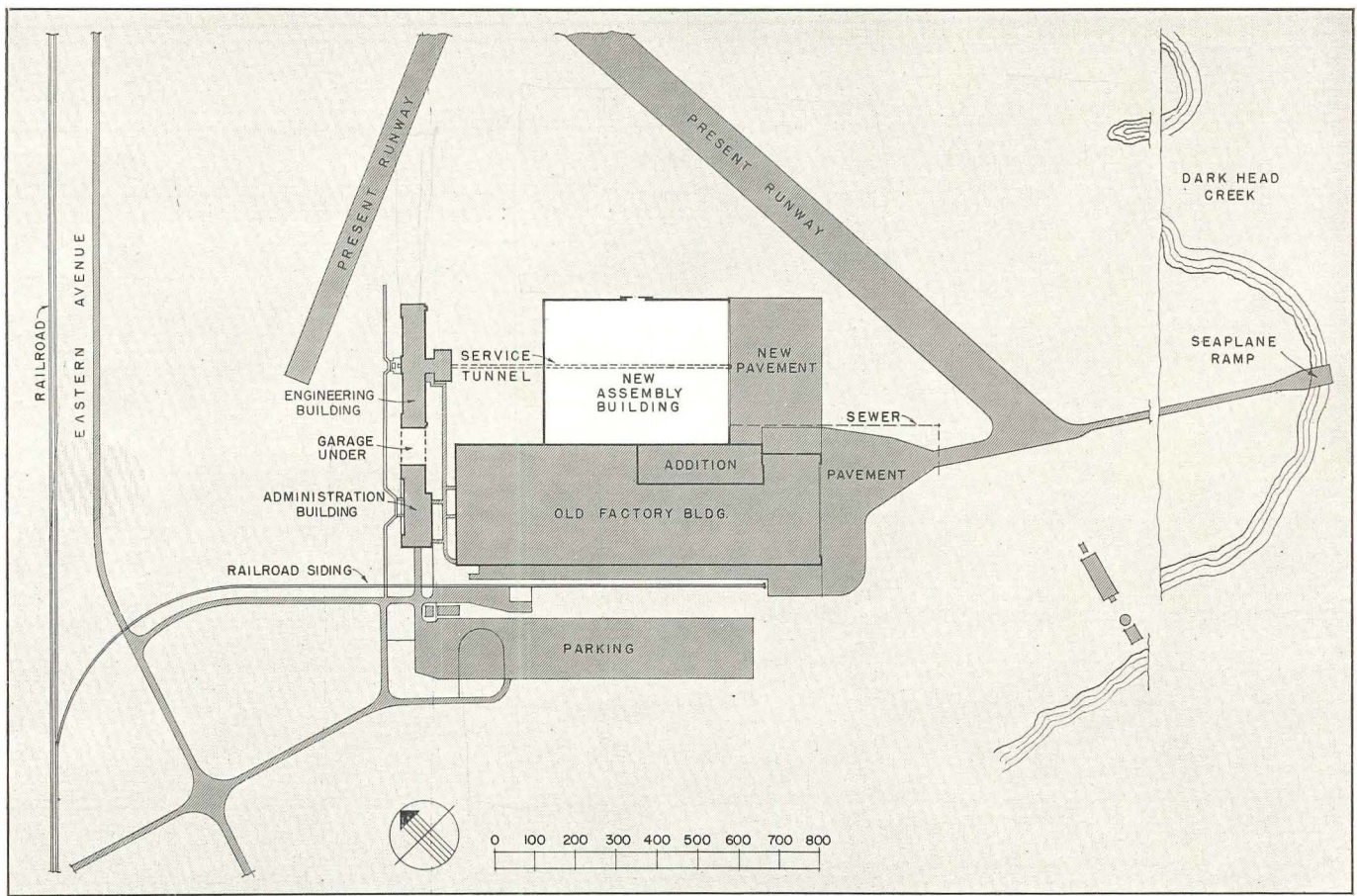

Plot plan, showing relationship of plant to railroad, highway, waterway, and landing field. The underground garage is entered beneath the Administration Building.

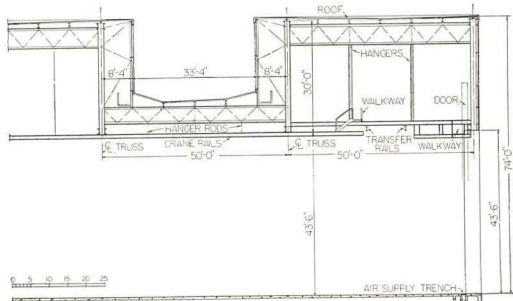

Partial Longitudinal Section, Assembly Building

each time of opening. Consideration of maintenance costs and other conveniences led to development of the telescopic cantilever door shown in detail on next page. These may be opened half or full height, occupy no floor or apron space until half open, and impose little strain upon roof trusses—all essential considerations.

Also noteworthy are the service trench from the Administration Building, and the floor outlets supplying services at intervals over the entire floor area.

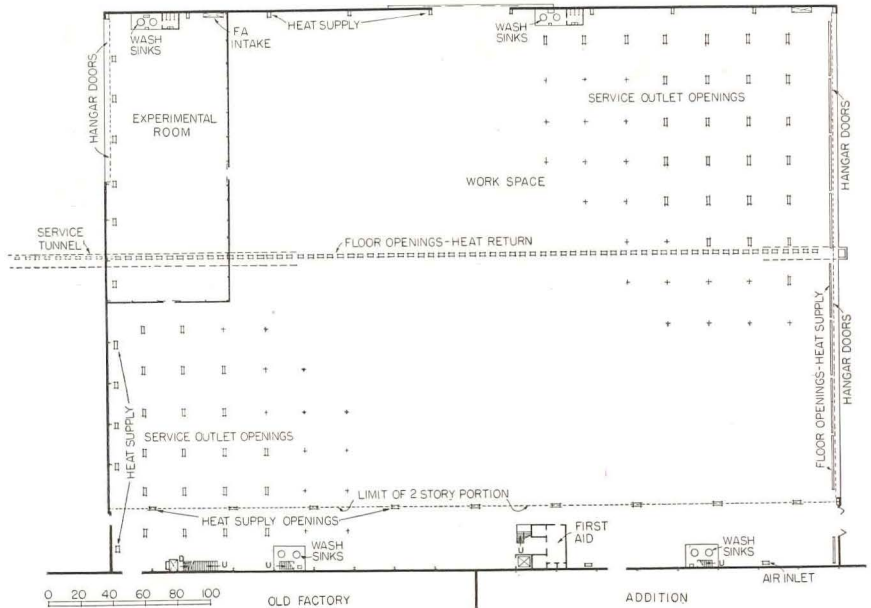

First Floor, Assembly Building

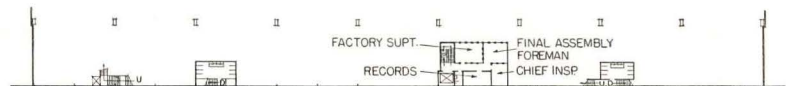

Mezzanine

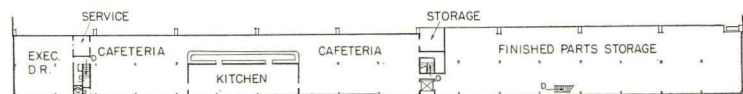

Second Floor

GLENN L. MARTIN AIRPLANE PLANT

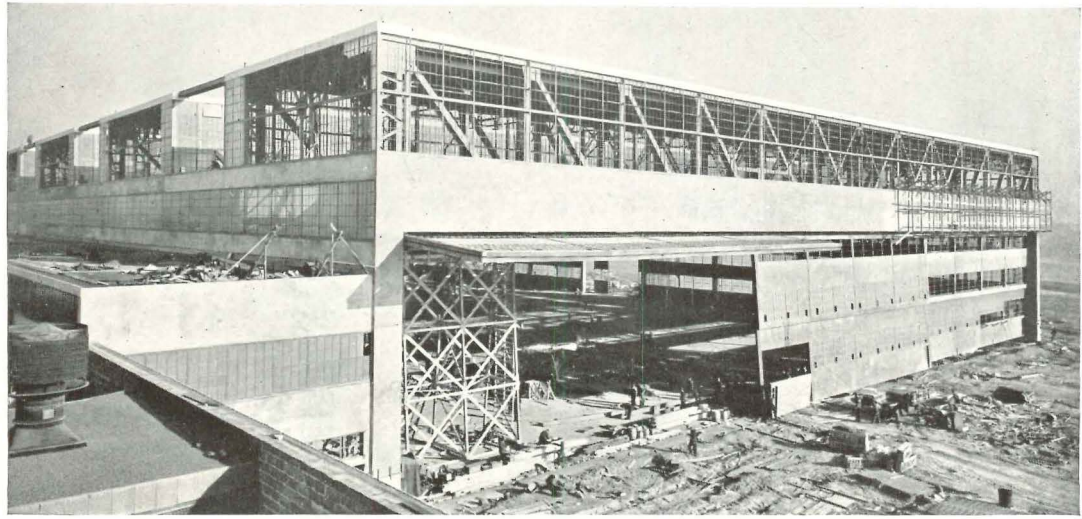

SCHEDULE OF EQUIPMENT AND MATERIALS

FOUNDATION

Reinforced concrete; cement, Capitol Cement Co.; limestone, Ingalls Stone Co. **Roof:** Steel deck, Truscon Steel Co.; 2-in. cork insulation; tar and gravel surface, Ehret Roofing & Mfg. Co.; flashing, sheet metal, W. A. Fingles Co. **Sash:** Steel, Truscon Steel Co. **Glass:** Pittsburgh Plate Glass Co. **Hangar Doors:** Truscon Steel Co. **Bronze Work:** American Bronze Co. **Miscellaneous Iron:** Grundy Iron Works, Dietrich Bros.

STRUCTURE

Steel frame, 300-ft. clear span roof trusses, Bethlehem Steel Co.

EXTERIOR

Walls: Gunite; face brick, Kittanning Fire Clay Co.; limestone, Ingalls Stone Co. **Roof:** Steel deck, Truscon Steel Co.; 2-in. cork insulation; tar and gravel surface, Ehret Roofing & Mfg. Co.; flashing, sheet metal, W. A. Fingles Co. **Sash:** Steel, Truscon Steel Co. **Glass:** Pittsburgh Plate Glass Co. **Hangar Doors:** Truscon Steel Co. **Bronze Work:** American Bronze Co. **Miscellaneous Iron:** Grundy Iron Works, Dietrich Bros.

INTERIOR

Floors: Wood block in Assembly Building, Southern Wood Preserving Co.; in offices, Armstrong's Linotile. **Partitions:** Metal office partitions, E. F. Hauserman Co.; toilet stalls, Sanymetal Products Co., Inc. **Hollow Metal Doors:** Dahlstrom Metallic Door Co. **Paint:** Lucas Bros., Du Pont Co., Inc., Truscon Laboratories

EQUIPMENT

Plumbing: L. E. Mitchell Co.; fixtures, Standard Sanitary Mfg. Co. **Industrial Piping:** L. E. Mitchell Co. **Heating:** Forced hot air, Lief Lee system; oil burner, Todd Combustion Co. **Ventilation:** Exhaust system, Paul J. Vincent Co. **Hardware:** Sargent Lock Co. **Sprinkler System:** Grinnell Co. **Acoustical Treatment:** 1/2-in. Celotex, Celotex Corp. **Lighting:** 110-220-volt elec., single phase, 60 cycle; fixtures, 1,000 watts each.

Approximate total cost of structure, excluding Administration, existing Factory Buildings and Addition, \$2,250,000; approximate cost of Assembly Building only, \$1,250,000.

Right: Details, hangar doors, Assembly Building. The telescopic cantilever type was evolved after thorough study of all available slide and lift doors. A clear opening 300 ft. wide and 40 ft. high is obtained.

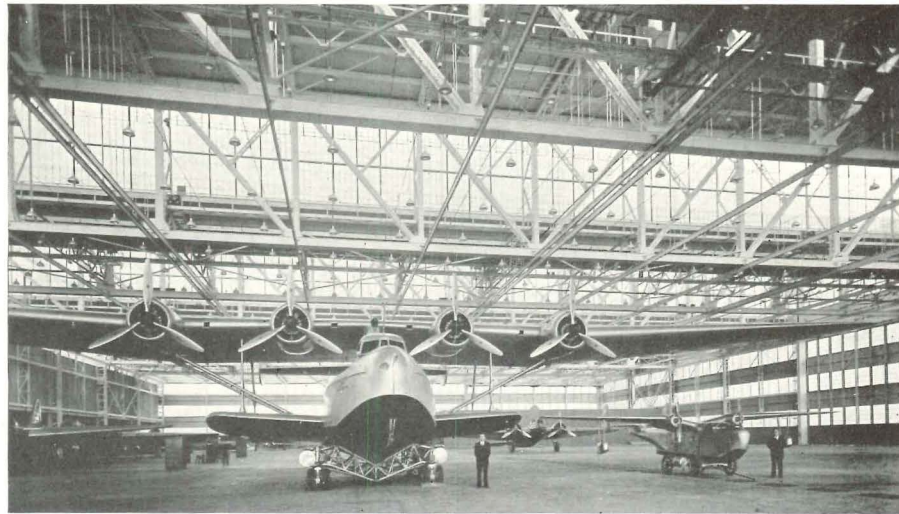

Exterior and Interior, Assembly Building

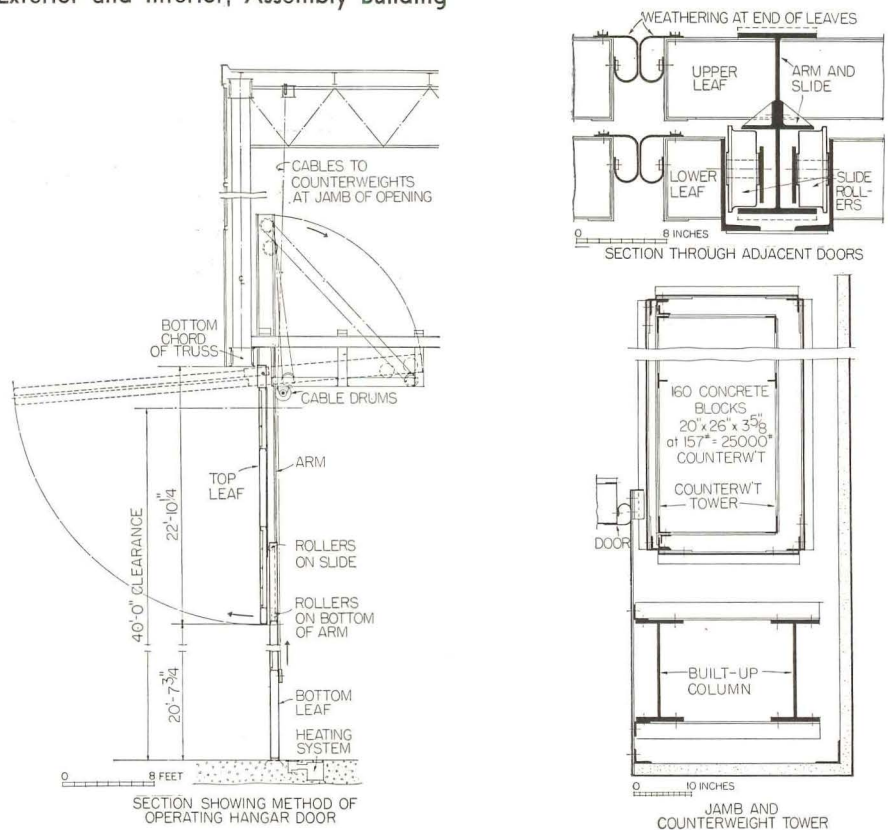



PLANT AND OFFICE

FOX LAUNDRY & CLEANERS
SAN ANTONIO, TEXAS

LAUNDRY AND dry-cleaning departments are independent portions of the building. A future addition to the laundry portion is provided for at the rear. Roof is framed on wood trusses 30 in. o. c., with a low ventilated metal monitor.

SCHEDULE OF EQUIPMENT AND MATERIALS

FOUNDATION

Concrete

STRUCTURE

Concrete-slab floor, concrete walls; wall-bearing wood roof trusses

EXTERIOR

Walls: Reinforced concrete Roofs: Wood deck; built-up roofing, The Barrett Co. Trim: Carrara glass, Pittsburgh Plate Glass Co. Doors, Metal Trim, and Casements: The Kawneer Co. Sash: Steel, William Bailey Co. Plate Glass: Pittsburgh Plate Glass Co.

INTERIOR

Floors: Working space, cement; office space, terrazzo Doors and Trim: Walnut and white pine Office Fixtures: Walnut Counter Tops: Micarta, Westinghouse Manufacturing Co. Hardware: Sargent & Co. Partitions: 2 in., plastered Ceiling: Office, weather-wood, U. S. Gypsum Co.

ELECTRICAL

Fixtures: Westinghouse Electric Co.

PLUMBING

Fixtures: Kohler Manufacturing Co.

EQUIPMENT

Laundry: Troy Laundry Machine Co. and Prosperity Laundry Machine Co.; boiler, Fitzgibbons Boiler Co., Inc. Dry Cleaning: San Antonio Dry Cleaning Machine Co. and Hoffman Press Co.

Total cost, including office counters, bundle and dry cleaning package furniture, \$11,000.

SPILLMAN & SPILLMAN
Architects

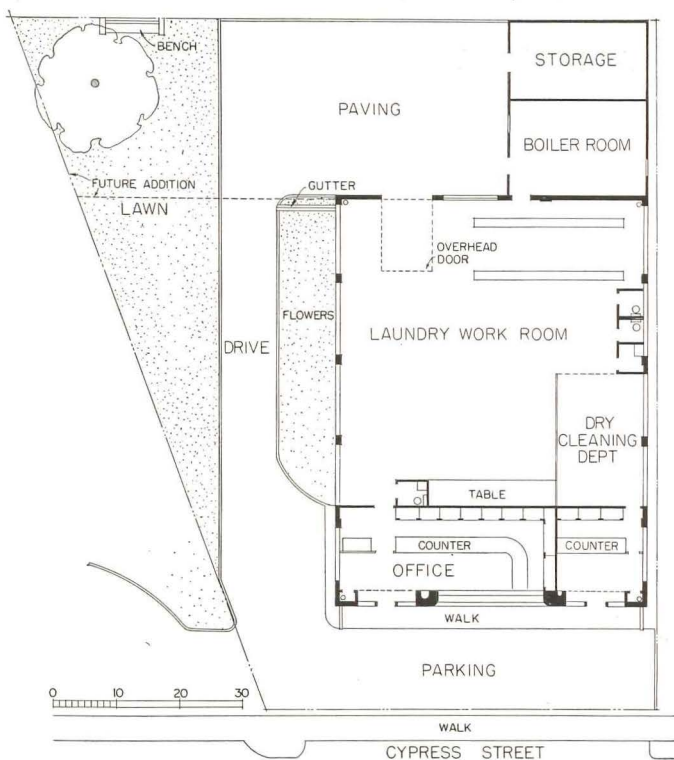

Plot Plan and First Floor

BUILDING
TYPES



ADDITIONS TO PRINTING PLANT
WESTERN PRINTING & LITHOGRAPHING CO.
RACINE, WISCONSIN

EDWIN J. KRAUS
Architect

ACCORDING TO THE architect, "One of the first things considered in planning this structure was recent progress in the technique of printing, particularly with reference to offset lithography. High, as well as economical, levels of illumination were an essential factor, to facilitate making of plates, make-ready of printing presses, typesetting, proofreading, matching of colors and register, and similar operations requiring visual precision for high quality of product.

"In addition, there was need for close control of temperature and humidity conditions inside the plant because paper shrinks and swells with atmospheric variations. When this occurs, loss in production time and quality is likely; many printing plants

are compelled to suspend production on high-class work on humid days. The Western Printing & Lithographing Company seasons all paper stock on arrival and maintains it under constant atmospheric conditions.

"With the humidity thus determined, hollow glass block affords sufficient insulation value to prevent condensation in all except extreme cases. This type of construction also prevents infiltration of dust and dirt and reduces loss of conditioned air.

"Face design of the block was selected to give maximum light diffusion and good light transmission. Glass masonry for exterior and monitor walls is so installed that it is free from structural contact at jambs and head. Mortar joints between blocks

were completely filled.

"The first addition to the plant was designed for production and handling of tally and greeting cards, and for steel die engraving. The second addition contains additional lithographic press space, bindery facilities, and space for production of playing cards. Both operations require extreme accuracy and precision. Close inspection of playing cards is requisite to eliminate the slightest variation in color, pattern, or other detail.

"High natural lighting intensity is also necessary in the ink chemists' laboratory maintained by the company to mix and prepare its own ink colors and to match, inspect, and approve colors on presses for uniformity throughout any press run."

On opposite page, exterior, and right, interior, first addition



PLANS AND DETAILS, FIRST ADDITION

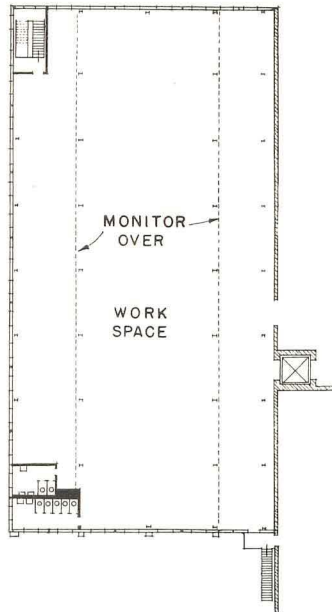

Second Floor

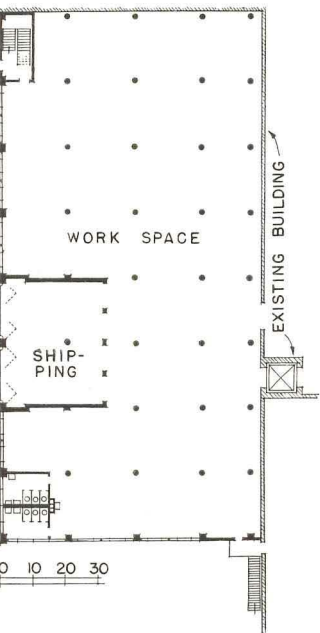

First Floor

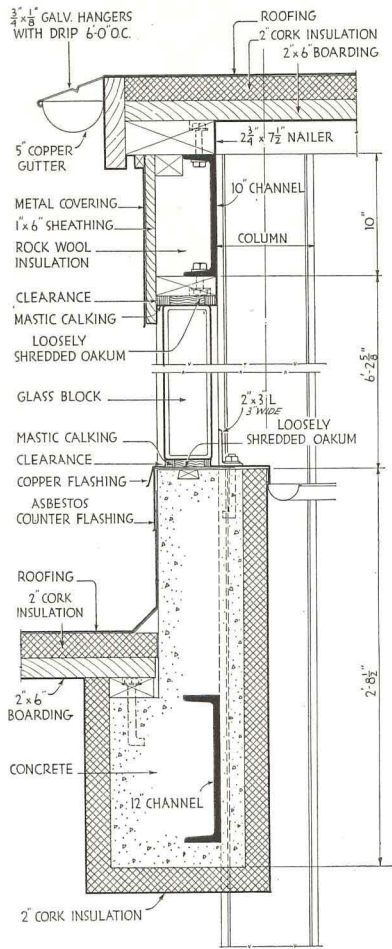

SECTION THRU SIDE OF MONITOR

SCALE IN INCHES 1 2 3 4 8

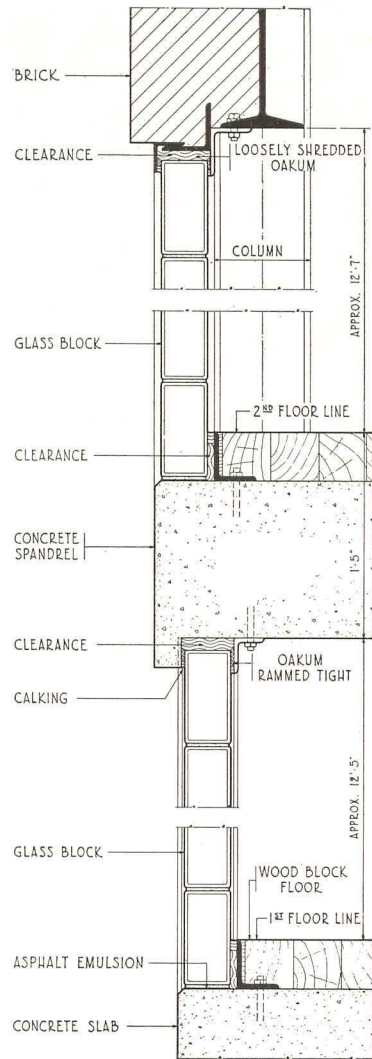

TYPICAL WALL SECTION

SCALE IN INCHES 1 2 3 4 8

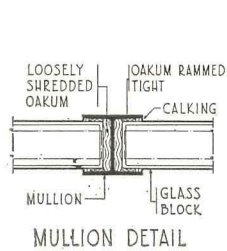

MULLION DETAIL

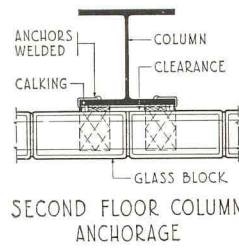

SECOND FLOOR COLUMN ANCHORAGE

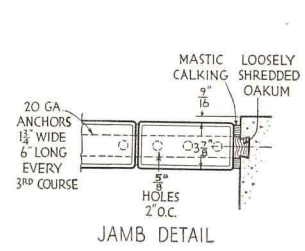

JAMB DETAIL



SECOND ADDITION TO PLANT

WESTERN PRINTING & LITHOGRAPHING CO.
RACINE, WISCONSIN

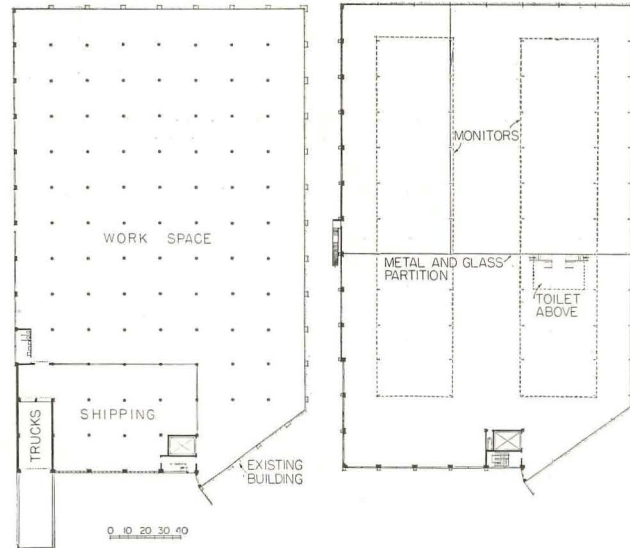

First Floor

Second Floor

At left, above: Interior view, first floor of the recently completed second addition, which will house lithographic presses, playing-card manufacturing, ink laboratory, and bindery. Left, below: Eastern exposure, second addition

SCHEDULE OF EQUIPMENT AND MATERIALS

First Addition

FOUNDATIONS

Concrete footings, quick-setting concrete, Aetna Portland Cement Co.

STRUCTURE

First Floor: Reinforced concrete columns, piers; reinforced concrete second-floor slab
Second Floor: Steel framing, Bethlehem Contracting Co. Concrete forms, Deslauriers Steel Mould Co.

EXTERIOR

Walls: Concrete; glass masonry, Owens-Illinois Glass Co.; expansion joints, Armstrong Cork Products Co.; calking, Pecora Calking Compound, Pecora Paint Co., Inc.
Sash and Doors: Aluminum, Aluminum Co. of America.

Roofs: Built-up, Barrett Co.
Overhead Doors: Electrically operated, Barber-Colman Co.

INTERIOR

Partitions: Glazed tile, Arketex Ceramic Corp.

Fire Doors: Richmond Fire Door Co.

Floors: Wood block, Kreolite Co.

Insulation: Cork, Armstrong Cork Products Co.

EQUIPMENT

Elevators: Otis Elevator Co.
Plumbing: Fixtures, Crane Co.
Electrical: Fixtures, General Electric Co. and Westinghouse Electric & Mfg. Co.
Heating and Air Conditioning: B. Offen Co.
Sprinklers: American Automatic Fire Protection Co.
Cooling and Condensing Coils: Trane Co.

Second Addition

FOUNDATIONS

Concrete footings, quick-setting concrete, Aetna Portland Cement Co.

STRUCTURE

First Floor: Reinforced concrete columns, piers; reinforced concrete second-floor slab
Second Floor: Steel framing, Bethlehem Contracting Co. Concrete forms, Deslauriers Steel Mould Co.

EXTERIOR

Walls: Concrete; glass masonry, Owens-Illinois Glass Co.; cork expansion joints, Sprinkman Bros.; calking, Pecora Calking Compound, Pecora Paint Co., Inc.

Sash and Doors: Aluminum, Aluminum Co. of America

Roof: U. S. Gypsum Co.

Overhead Doors: Electrically operated, Barber-Colman Co.

INTERIOR

Partitions: Glazed tile, Arketex Ceramic Corp.

Fire Doors: Richmond Fire Door Co.

Insulation: Cork, Sprinkman Bros.

Floors: Wood block, Kreolite Co.

EQUIPMENT

Elevators: Otis Elevator Co.
Plumbing: Fixtures, Crane Co.
Electrical: Fixtures, General Electric and Westinghouse Electric & Mfg. Co.
Heating and Air Conditioning: B. Offen Co.
Sprinklers: American Automatic Fire Protection Co.
Cooling and Condensing Coils: Trane Co.



WAREHOUSE

CHASE BRASS & COPPER CO., INC.
DETROIT, MICHIGAN

SCHEDULE OF EQUIPMENT AND MATERIALS

STRUCTURE

Steel frame, brick and cement block walls

EXTERIOR

Walls: Office portion, iron spotlight gray face brick; warehouse, sand-lime brick

Trim: Artificial stone

Marqueses and Lettering: Brass, Chase Brass & Copper Co., Inc.

Sash: Steel, Detroit Steel Products Co.

Warehouse Doors: Wood, overhead type

Roof: Built-up, on wood deck over steel frame

Flashing: Copper, Chase Brass & Copper Co., Inc.

Inc.

INTERIOR

Walls: Plastered and painted, wood trim

Floors: Offices, asphalt tile on concrete; warehouse, cement finish

HEATING

Low-pressure two-pipe gravity return with pump and receiver serving offices; warehouse, overhead unit heaters; offices, wall-hung radiators, cabinets by Chase Brass & Copper Co., Inc.

Boiler: Pacific-Electrol oil-burning, low-pressure steel boiler

PLUMBING

Piping: Brass tubing, Chase Brass & Copper Co., Inc.

Fixtures: Enamelled metal, Briggs and Kohler

EQUIPMENT

Depressed loading dock served by 2½-ton transfer rail-type crane

SMITH, HINCHMAN & GRYLLS, INC.
Architects and Engineers

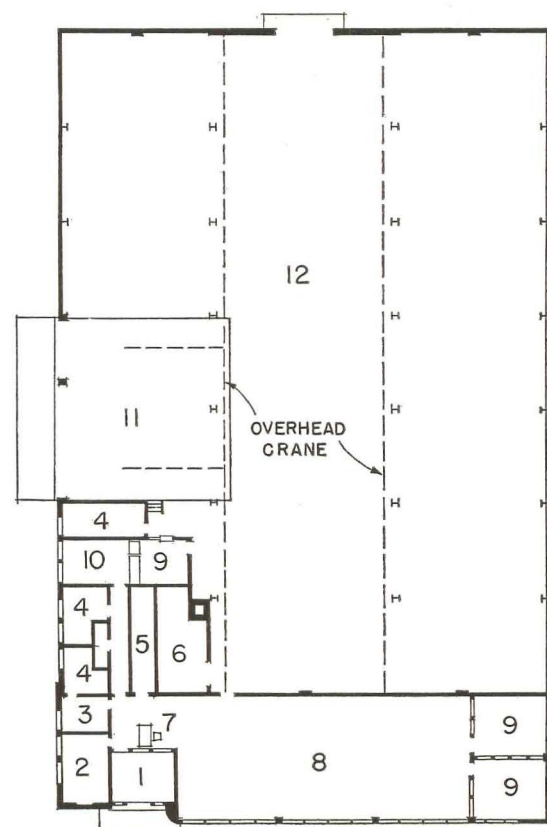

- 1 Lobby
- 2 Sales
- 3 Rest room
- 4 Toilet
- 5 Storage
- 6 Boiler room
- 7 Telephone switchboard
- 8 General office
- 9 Private office
- 10 Display room
- 11 Depressed truck area
- 12 Warehouse area

BUILDING
TYPES

Richard Garrison

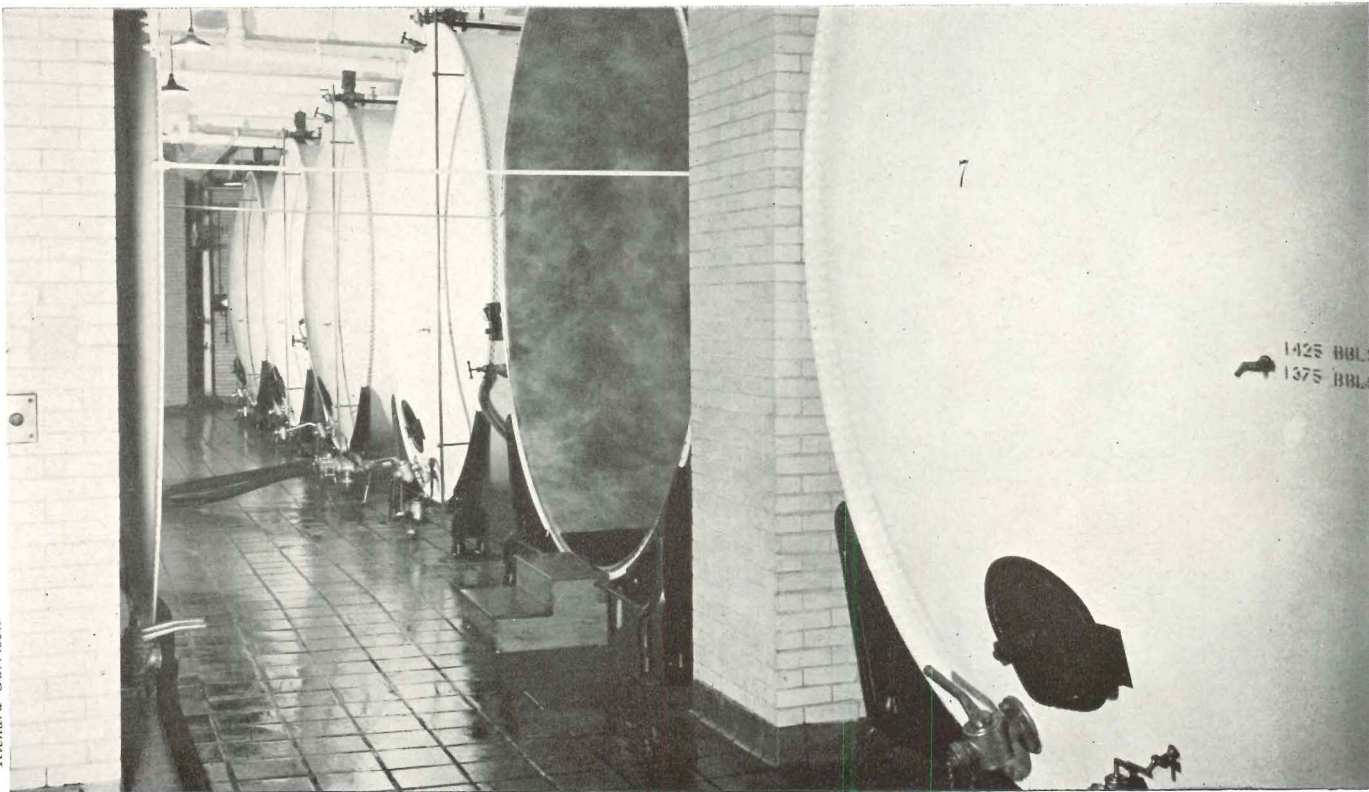

Tank aisle, 7th floor

SCHEDULE OF EQUIPMENT AND MATERIALS

FOUNDATIONS

Concrete; integral waterproofing, A. C. Horn

STRUCTURE

Frame: Structural steel, New York Steel Corp.

Arches: Stone concrete and cinder concrete.

EXTERIOR

Walls: Granite base; face brick, Fredenburg & Lounsbury. **Sash:** Steel, projected and factory types, Detroit Steel Products Co.; inside double-glazed wood sash in tank storage space. **Roof:** Built-up pitch with slag finish, Arrow Roofing Co.; quarry tile finish in setbacks. **Waterproofing:** Entire subbasement floor and sidewalk vaults, membrane; cement waterproofing on walls against earth banks, Master Waterproofing and Roofing Corp.; colorless waterproofing on exterior walls, A. C. Horn. **Insulation:** All exterior walls, subbasement floor, and roof completely insulated with sheet cork, Armstrong Cork Products Co. **Glazing:** 1/4-in. polished plate on street front; D. S. glass in penthouse, Marks Bros. **Hardware:** P. & F. Corbin

INTERIOR

Partitions: Brick; face brick in tank aisles from Hanley Co. **Finish Floors and Bases:** Asphalt mastic, Master Waterproofing and Roofing Corp.; Welsh quarry tile in tank aisles, elevator, and stair halls, Atlas Tile and Marble Works; cement in unfinished areas. **Walls:** Walls and ceilings plastered, Portland cement plaster. **Doors and Bucks:** Hollow steel, Atlantic Metal Products, Inc. **Stairs:** Steel, Williams Iron Works, Inc.; cement treads. **Lighting:** Direct lighting, Fischbach & Moore, Inc. **Elevator:** Otis Elevator Co. **Rolling shutters:** J. G. Wilson Corp. **Automatic Fire doors:** Tin-clad, Atlantic Metal Products, Inc. **Painting:** Lead and zinc and lead and oil paint, Barker Painting Co.

Extreme variations between constant low interior temperature and changing seasonal exterior temperatures necessitated designing interior column and floor structure independently of exterior shell, which is self-supporting. Continuous expansion joints were required at setbacks where structure carries walls. Live load varies seasonally from 0 to 500 lb. Installing a curtain wall at tank heads eliminated expensive finish in unused tank spaces.

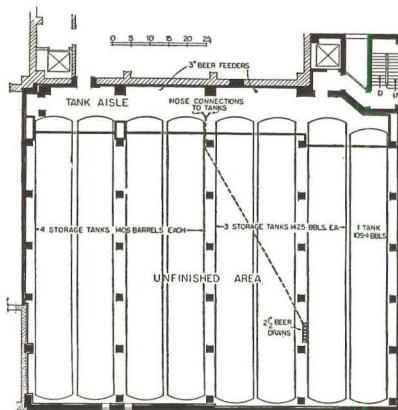

EQUIPMENT

Air-conditioning System in tank aisles: J. L. Murphy & Co.; fans, pumps, airwasher, Buffalo Forge Co.; Johnson thermostatic control for brine mixing valves; Johnson static pressure regulator; Zig Zag water cooler, Frick. **Refrigeration Coils:** In tank spaces, Vilter Mfg. Co. **Motors and Starters:** Westinghouse. **Beer Storage Tanks:** The Pfaudler Co. **Beer Piping:** Ruppert Brewery copper-smiths. **Beer Cocks:** Walworth. **Air Counter Pressure Lines and CO₂ Counter Pressure Lines:** J. L. Murphy. **Indicating Thermometers:** Tagliabue. **CO₂ and Air Pressure Gauges:** United States Gauges. **Vacuum and Pressure, Beer Tank Safeties:** Mechanical Valve Co. All pipe-work was welded except brass piping brazed

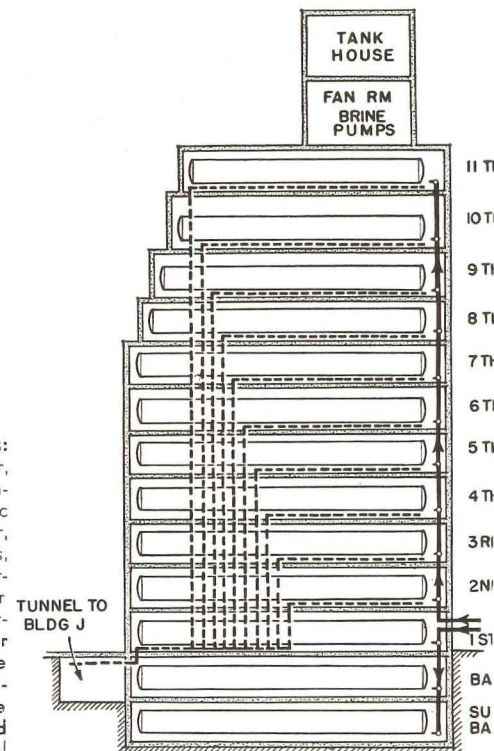

Above: typical plan and section

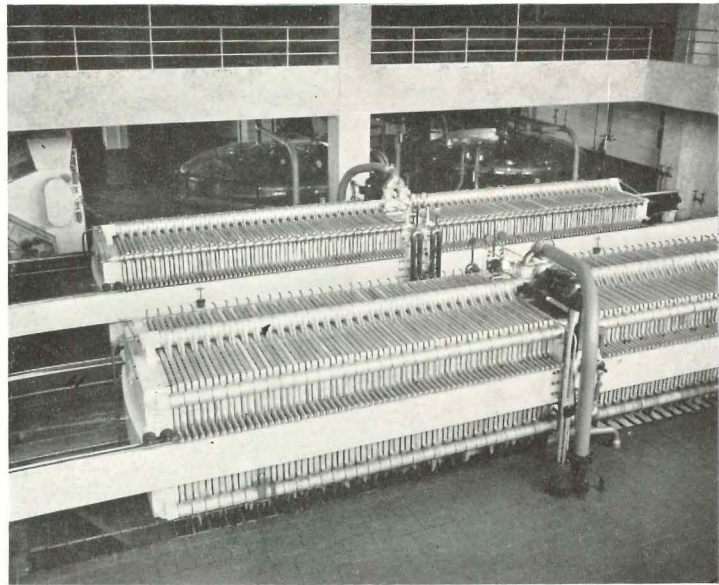

Left: Bierstube on sixth floor, looking toward bar. Large parties of visitors are entertained here semipublicly; the adjoining lounge and large dining room are for more private entertainment. Right: New filters, second floor.

Spent grain drops to hoppers below. Open well above allows steam to rise; compare photo on page 110, right center, where steam from filters is confined by low headroom.

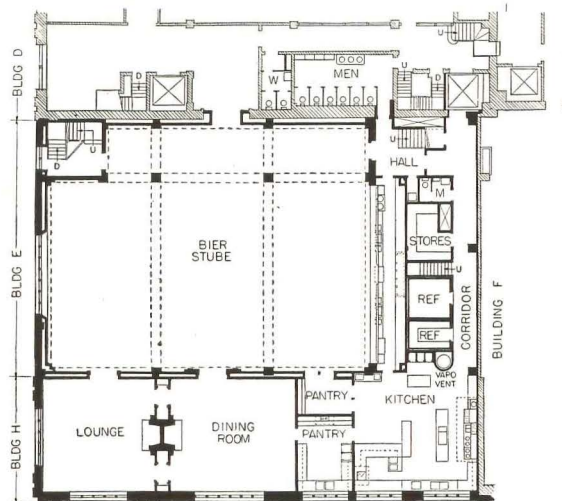
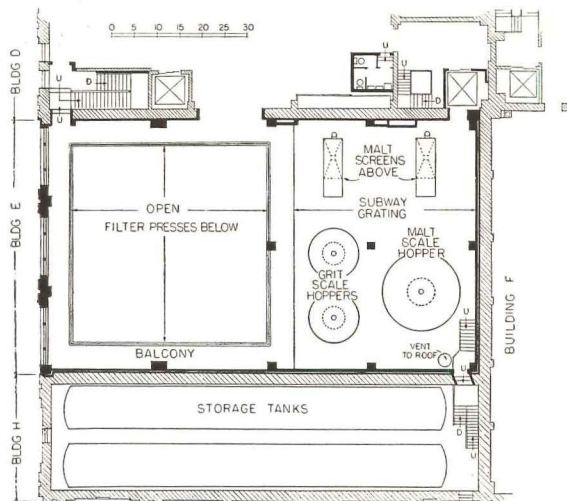

Plans, 3rd floor at left, 6th floor at right. Plans also show the existing stock house, H.

SCHEDULE OF EQUIPMENT AND MATERIALS

FOUNDATIONS
 Concrete

STRUCTURE
Frame: Structural steel, Fassler Iron Works
Floors: Stone concrete, cinder concrete

EXTERIOR
Walls: Granite base; face brick walls, Hanley Co.; architectural terra cotta, Federal Seaboard Terra Cotta Corp. **Sash:** Copper kalamein, Atlantic Metal Products, Inc.; steel casements, Hope's Windows, Inc.; factory sash, J. S. Thorn Co. **Roofs:** Built-up, slag and quarry tile surfaces; skylights and flashings, copper, Tuttle Roofing Co. **Waterproofing:** Hydrolithic cement below grade; membrane over vault, Tuttle Roofing Co. **Insulation:** Sheet cork, 2 in. on roof, 4 in. on east and south walls, United Cork Co. **Glazing:** 1/4-in. polished plate, D. S. glass, Abbot Glass Co. **Plumbing Fixtures:** Standard Sanitary Mfg. Co. **Hardware:** P. & F. Corbin

INTERIOR
Partitions: Terra cotta. **Finish Floor:** Asphalt blocks, Hastings Pavement Co.; asphalt mastic, Gorman & Lees, Inc.; quarry tile, Atlas Tile & Marble Works; cement, Zima and Stanis; subway gratings, third floor; ceramic tile, Atlas Tile and Marble Works; parquet wood floors, James F. Nuno. **Walls:** Bianca Fiorito marble, McGowan Marble Co.; machine-made glazed terra cotta, Federal Seaboard Terra Cotta Co. **Ceilings:** Cement plaster on concrete slabs, gypsum plaster on metal lath, James A. Patterson, Inc. **Stairs:** Steel, Fassler Iron Works; cement treads. **Doors and Bucks:** Hollow steel, Atlantic Metal Products Co.

BUILDING EQUIPMENT
Air Conditioning: Baker Smith Co.; controls, automatic compressed air, Powers Regulator Co. **Kitchen Equipment:** Nathan Straus-Duparquet, Inc. **Lighting:** Fixtures, Simes Co. **Heating:** Direct radiation, Baker Smith Co. **Dumb-waiters:** Electric, Otis Elevator Co.

Rolling Shutters: Steel, Cornell Iron Works. **Painting:** Industrial enamel, Detroit Graphite and Truscon Paints

PLANT EQUIPMENT
 Filters, Permutit; Zig Zag cooler, Frick; shell and tube brine cooler, Frick; house water pumps, Ingersoll-Rand; low- and high-pressure steam piping, Baker Smith & Co.; copper beer piping, Revere Copper and Brass, Inc.; dust-collection apparatus, Holly Pneumatic and Builders Sheet Metal Co.; motors, Westinghouse; controls, Cutler Hammer; electric interlocking, Empire Switchboard Co.; mash tub, grits cookers, spent grain hoppers, scale hoppers, Turl Engineering Co.; scales, Fairbanks, Morse & Co.; malt mills, Bühler (Switzerland); mash filters, Meura (Belgium); Liebra malt scale, Miag; malt conveyors, agitators, driving mechanisms, etc., Schock Gusmer; valves, Jenkins; vapor vents, hot-water tanks, Keller Copper Works; lockers, Lyon Metal Products, Inc.

Photos by Richard Garrison

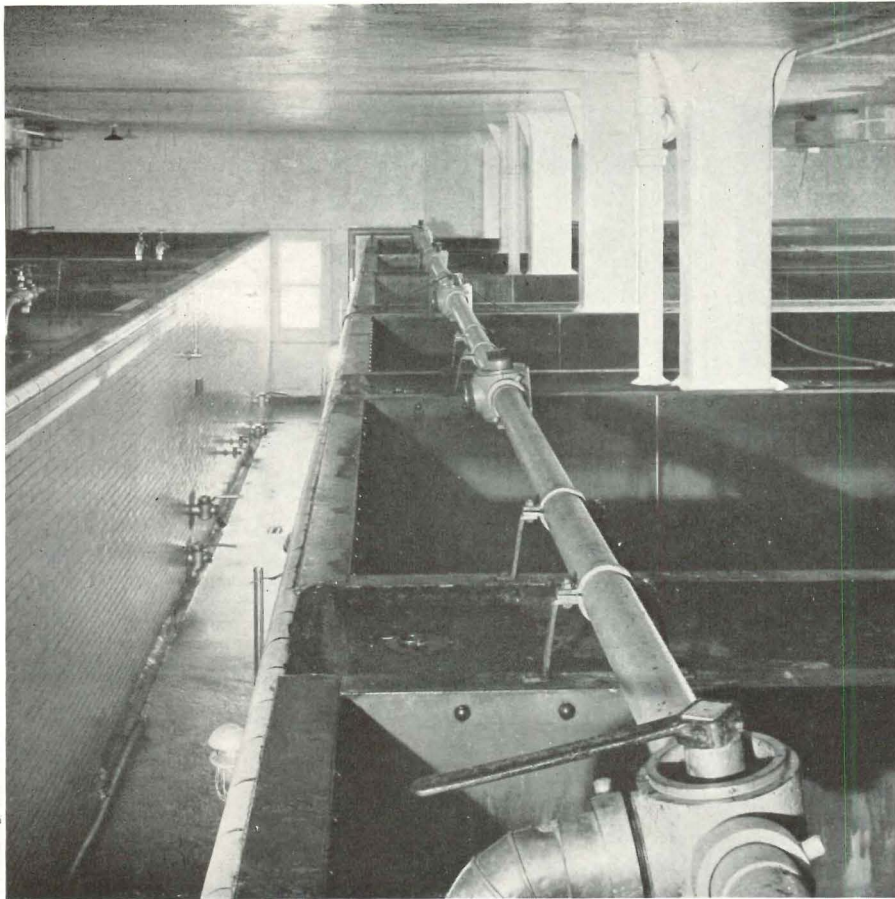

**RUPPERT BREWERY
FERMENTATION BUILDING, C,
and BREW HOUSE, D**

Briefly, the process of making beer here consists of mixing rice grits with malt, crushing the mixture, and separating the starch into hot water. The mash is filtered, and brewed in steam-jacketed kettles. Hops are added, and the result is known as "wort." The wort is cooled and that reserved for ale piped to the ale brewery, the bulk going to beer fermentation tanks where yeast is added. After a period of open-tank fermenting followed by closed-tank fermenting, the beer is stored and drawn off into the bottling and keg-racking plants as needed. Ale is similarly treated but in a separate building to preserve its distinctive flavor.

At left, open fermenting tanks, 10th floor, Fermentation Building, C. Tanks are glass-lined steel, faced with tile.



Plan, 11th floor:
1, air conditioning;
2, experimental
brewery; 3, water
cooler; 4, experi-
mental cellar; 5, 6,
yeast rooms; 7, 8,
laboratories; 9, li-
brary; 10, drafting;
11, superintendent.

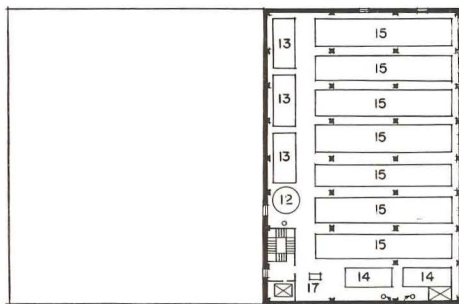

Plan, 10th floor:
12, yeast tank; 13,
14, 15, open fer-
menting tanks (re-
spective capacities,
399,364,926 bbl.
each); 16, hose
connections; 17,
portable yeast
pump.

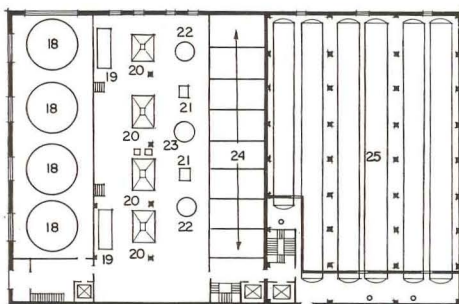

Plan, 2nd floor:
18, brew kettles,
700 bbl. each; 19,
laundry washers
(for filter cloths);
20, spent grain
hoppers; 21, mash
pumps; 22, grits
agitator; 23, mash
tub agitator; 24,
malt and grits stor-
age; 25, closed fer-
menting tanks,
1,383 and 1,921 bbl.
each.

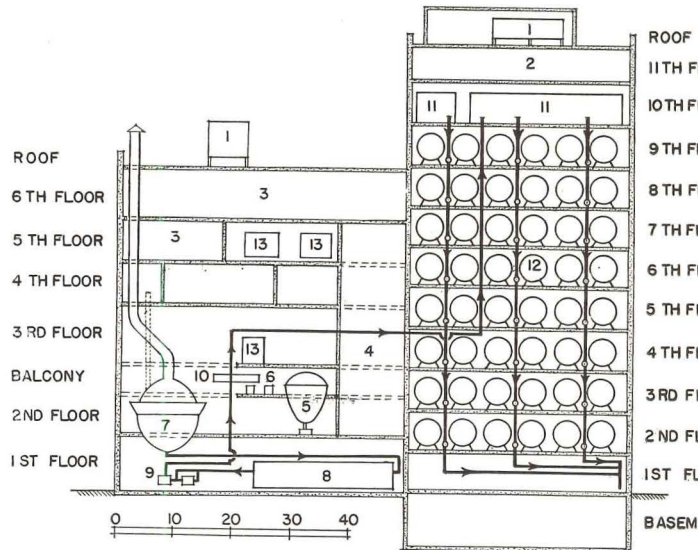

Section through both buildings—Brew House at right, Fermentation Building at left. From here, fermented beer goes to Stock Houses F and H. Legend: 1, house tanks; 2, laboratory, etc.; 3, offices; 4, grain storage; 5, mash cooker; 6, mash filters; 7, brew kettles; 8, hops strainer; 9, wort pumps; 10, wort cooler; 11, open fermenting tanks; 12, closed fermenting tanks; 13, hot-water tanks.

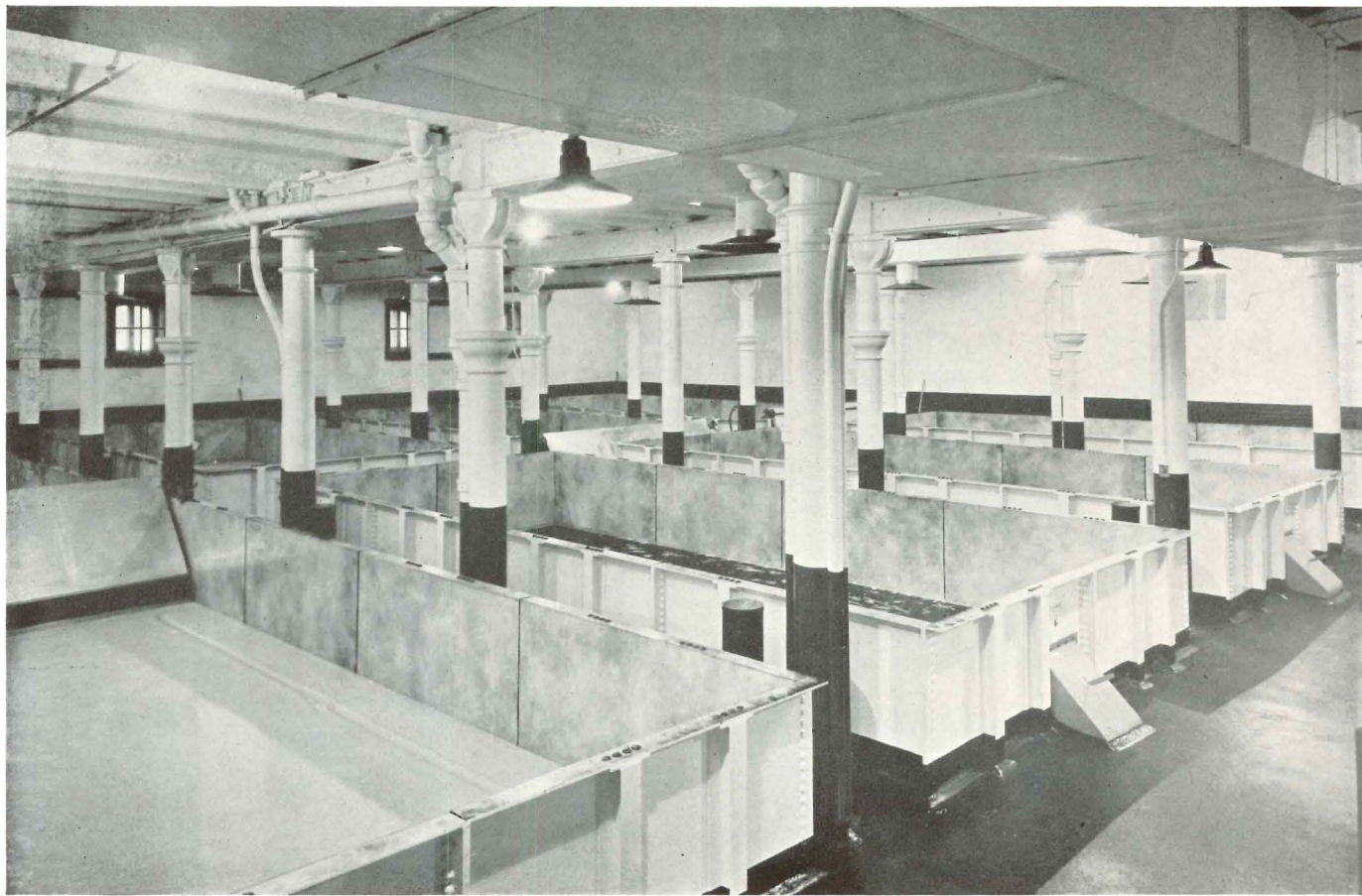

Russell & Co.

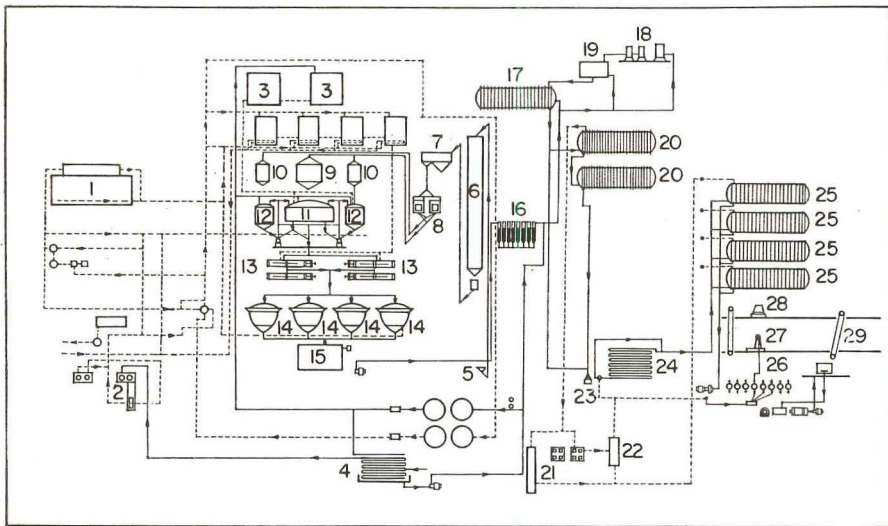

EQUIPMENT LAYOUT:

1, steam boiler; 2, steam and refrigerator engines; 3, hot-water tanks; 4, water cooler, wort-cooling systems; 5, grain funnel, leading to grain elevator to bins; 6, malt storage; 7, malt cleaning; 8, malt mills; 9, malt; 10, rice; 11, mash tub; 12, cooker; 13, mash filters; 14, brew kettles; 15, hop press and wort receptacle; 16, enclosed wort cooler; 17, starting vessel; 18, yeast, pure culture; 19, starting tub; 20, fermenting tanks; 21, carbonic acid high-pressure tanks; 22, low-pressure tanks; 23, carbonating device; 24, enclosed pipe cooler; 25, storage tanks; 26, beer filters; 27, keg-racking apparatus; 28, keg cleaning; 29, conveyors.

Open fermenting tanks shown above are new equipment installed in the Ale House, Ee. Being sectional, tanks were easily placed between existing columns. A mezzanine walkway was built close to tops of tanks for easy inspection and cleaning. Compare with installation in building C, opposite page. Government regulations require, among other things, that portions of the plant be so surfaced that they can be frequently hosed down; that a public thoroughfare intervene between brewing and bottling or racking plants; and that beer for bottling, which is subject to tax, pass through Government measuring tanks.

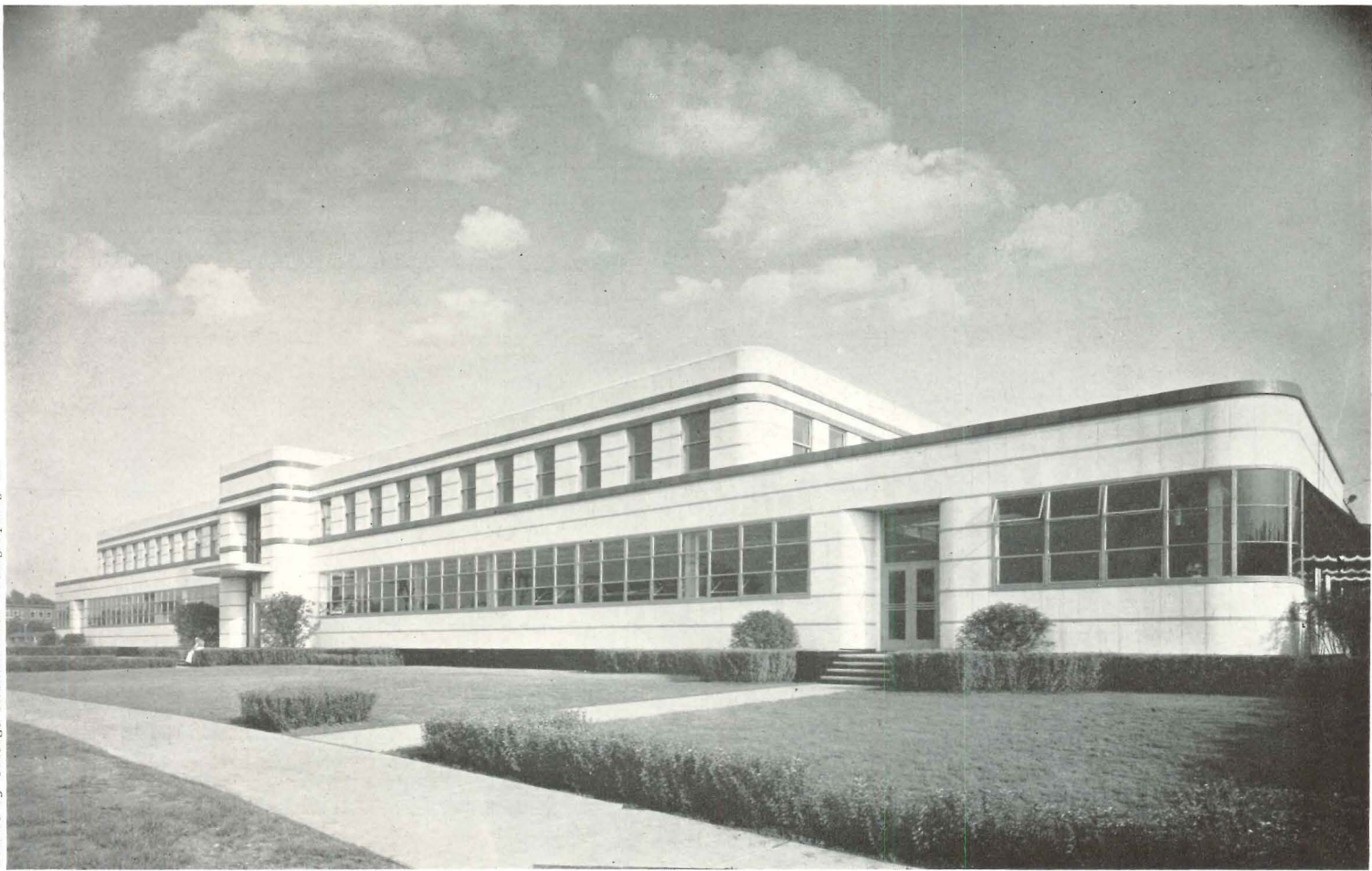

RADIO FACTORY

GALVIN MANUFACTURING CO.
CHICAGO, ILLINOIS

VICTOR L. CHARN
Architect

MOTOROLA RADIOS for automobiles and homes are the products of this plant. Offices, display space, and factory are included. Exterior is of white terra cotta with bands of blue, the colors being repeated on the floors of the entrance hall and corridor in rubber tile.

The display room (No. 5, second floor) is treated in Georgian style to provide a domestic setting for home radios. Experimental laboratories and a testing room were added in the factory after completion of building plans. The testing room required complete isolation from outside electrical interference. This was obtained by screening walls, floor, and ceiling with copper. Supervision of landscaping and selection of furnishing were done by the architect.

At right, detail of main entrance. Terra-cotta facing is placed with both horizontal and vertical joints aligning, no attempt being made to simulate masonry.



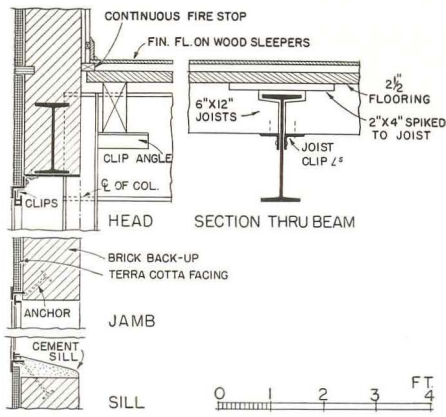

DETAIL: Window, Exterior Wall and Second Floor, Office Building

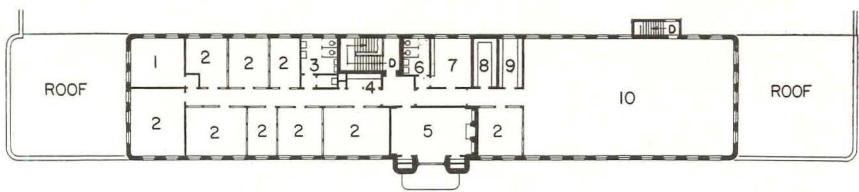

Second Floor

- | | |
|-------------------|-------------------|
| 1 Conference room | 6 Women's room |
| 2 Office | 7 Rest room |
| 3 Men's toilet | 8 Vault |
| 4 Coatroom | 9 Supply room |
| 5 Display room | 10 General office |

SCHEDULE OF EQUIPMENT AND MATERIALS

FOUNDATION
Concrete

STRUCTURE
First Floor: Concrete, steel columns
Second Floor and Roof: Steel framing; wood purlins, decks, and floors

EXTERIOR
Walls: Brick, faced with terra cotta on office portion; American Terra Cotta Co.
Roof: Wood decks, built-up roofing
Sash: Standard side wall type in manufacturing areas; projected type for office portion; Voigtmann Metal Windows Corp.; aluminum windows by Kawneer Co.; factory sash, Concrete Engineering Co.
Insulation: Formica Insulation Co.
Granite Entrance Feature: John Clark Co.
Ornamental Metal Work, Aluminum Marquises, etc.: Western Architectural Iron Co.
Metal Doors: Voigtmann Metal Windows Corp.
Landscaping: C. D. Wagstaff & Co.

INTERIOR
Floors: Concrete; reinforced concrete over boiler room; rubber tile, asphalt, and carpets, O. W. Richardson Co.
Partitions: In factory, Acorn Wire & Iron Works; toilet partitions, Fiat Metal Mfg. Co.; office partitions, brick, terra cotta and 2 x 4 in. stud
Hardware: Lind Hardware Co.
President's Office: Bleached white oak trim and furniture
Sprinklers: Viking Automatic Sprinkler Co.

Approximate total cost, including landscaping and furnishings: \$300,000

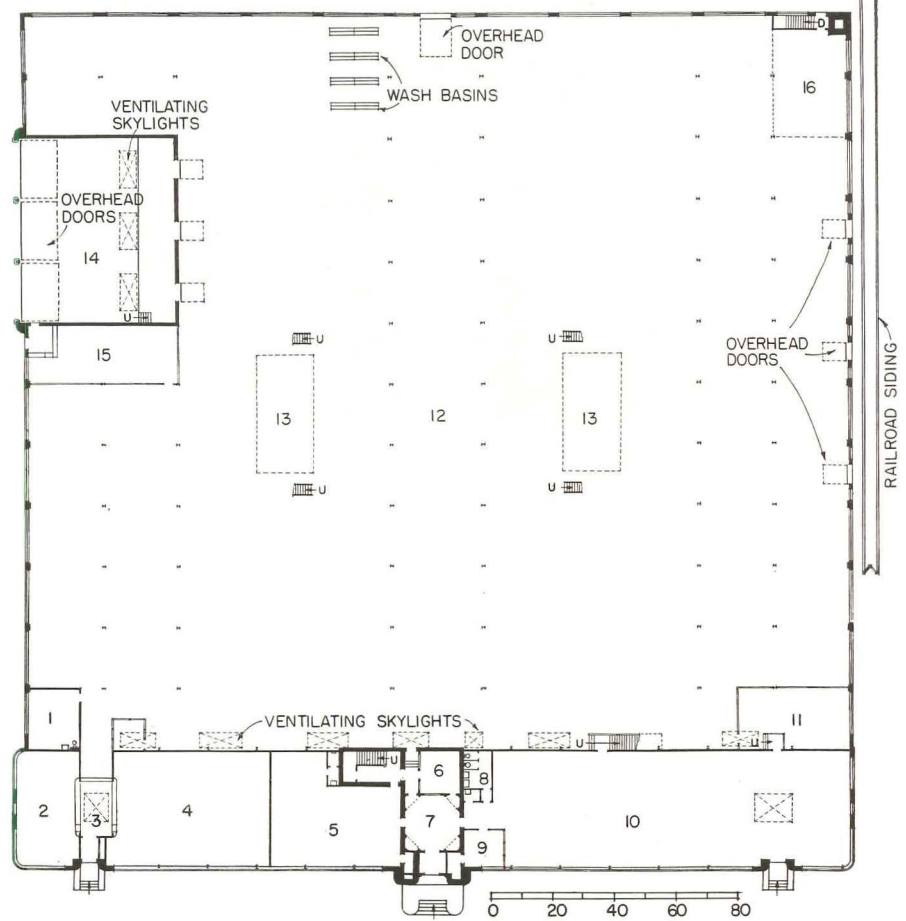

First Floor

- | | |
|-------------------------|---------------------------|
| 1 Sick room | 9 Office |
| 2 Men's coatroom | 10 Engineering department |
| 3 Factory entrance | 11 Machine shop |
| 4 Women's coatroom | 12 Manufacturing space |
| 5 Purchasing department | 13 Toilets above |
| 6 Switchboard | 14 Truck shipping |
| 7 Reception room | 15 Repair department |
| 8 Men's toilet | 16 Boiler room under |

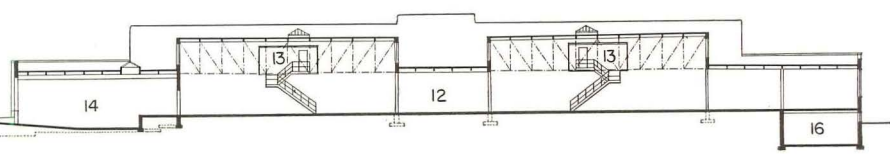

Reflected section, looking toward office portion. Numbers correspond to plan of first floor.



REMODELED MACHINERY PLANT

BROWN-BEVIS EQUIPMENT CO.
LOS ANGELES, CALIFORNIA

W. F. RUCK
Architect

ZARA WITKIN
Civil Engineer

S. B. BARNES
Structural Engineer

BECAUSE OF the size of the equipment manufactured—mining, hoisting, construction, and other machinery—display space is as large as the actual manufacturing portion of this

plant. Except in the president's office on the second floor, concrete was painted directly on both interior and exterior. Receiving of materials and shipment of orders are by truck.

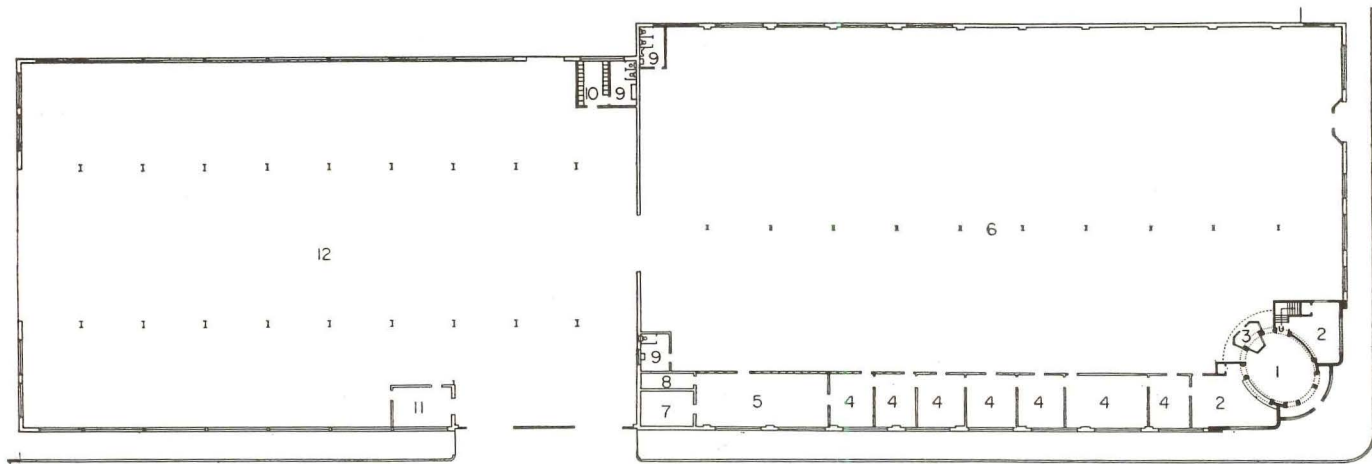

Ground Plan

- | | | | |
|-------------|-------------------|------------|----------------|
| 1 Reception | 4 Private offices | 7 Vault | 10 Locker room |
| 2 Salesmen | 5 General office | 8 Catalogs | 11 Shop office |
| 3 Clerk | 6 Display space | 9 Toilets | 12 Work space |

Small photograph on opposite page shows buildings before remodeling. Executive offices were relocated in tower and wings, which were designed to carry a sign pylon. Tower portion serves as a trademark used on stationery, advertising and products. Right, plywood-paneled president's office.



W. P. Woodcock

The elliptical tower was designed to resist earthquake stresses and is, in effect, a reinforced cylinder with the second-floor slab acting as a diaphragm to resist lateral stresses. A reinforced concrete ring at the second-floor ceiling carries structural steel which will support the future sign, thus developing combined bending and ring tension stress. The entire new corner structure including the tower and wings is intended to absorb possible future lateral stresses from the remainder of the building.

SCHEDULE OF EQUIPMENT AND MATERIALS

FOUNDATION

Concrete

STRUCTURE

New portion: reinforced concrete, keyed to old masonry. Structural steel for old truss supports and sign framing only

EXTERIOR

Walls: Painted directly on masonry

Roof: Composition, Coast Roofing Co.

Glass and Glazing: Plate glass, Golden State Glass Co.

Ornamental Metal: Atlas Ornamental Iron Works

Sheet Metal: Atlas Cornice Works

Steel Windows: Mesker Bros. Iron Co.

INTERIOR

Partitions: Plywood paneling

Walls: President's office, mahogany plywood

Floors: Linoleum, concrete

Decks: Interior and exterior balconies: Mastic, Olcott's

Painting: Plywood stained, concrete floors stained

Ceilings: Exposed concrete generally; acoustic plaster and metal lath in president's office

Heating and Ventilating: Payne Furnace Co.

Electric Fixtures: Built-in; designed by architect

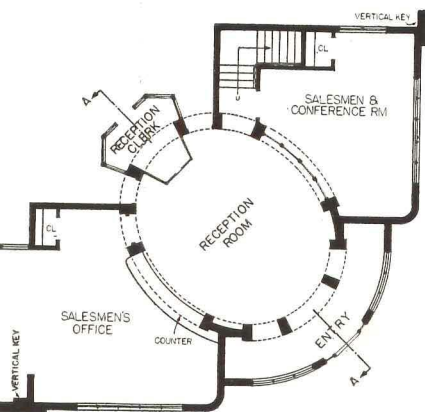

First Floor, Tower

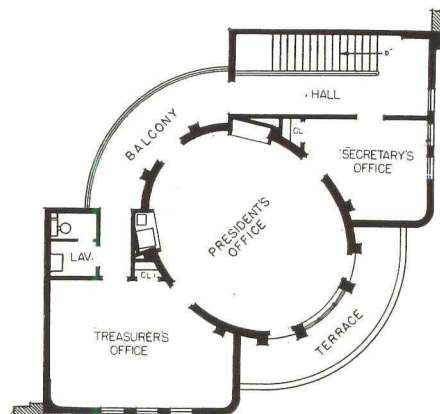

Second Floor, Tower

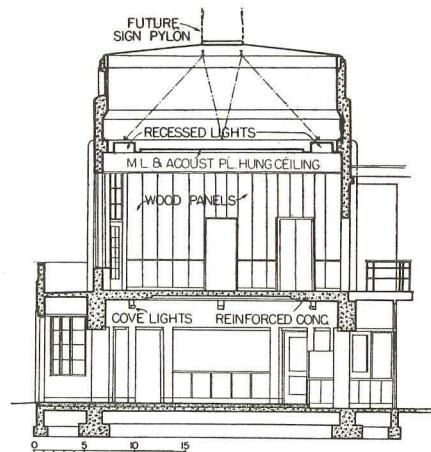

Section A-A, Tower

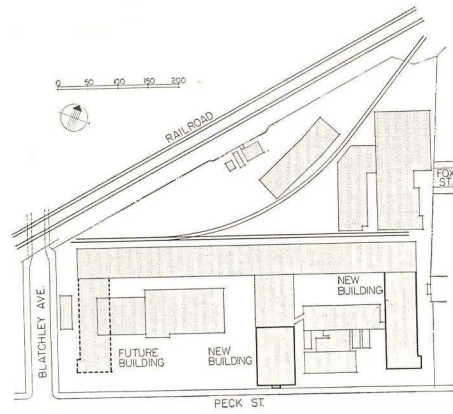
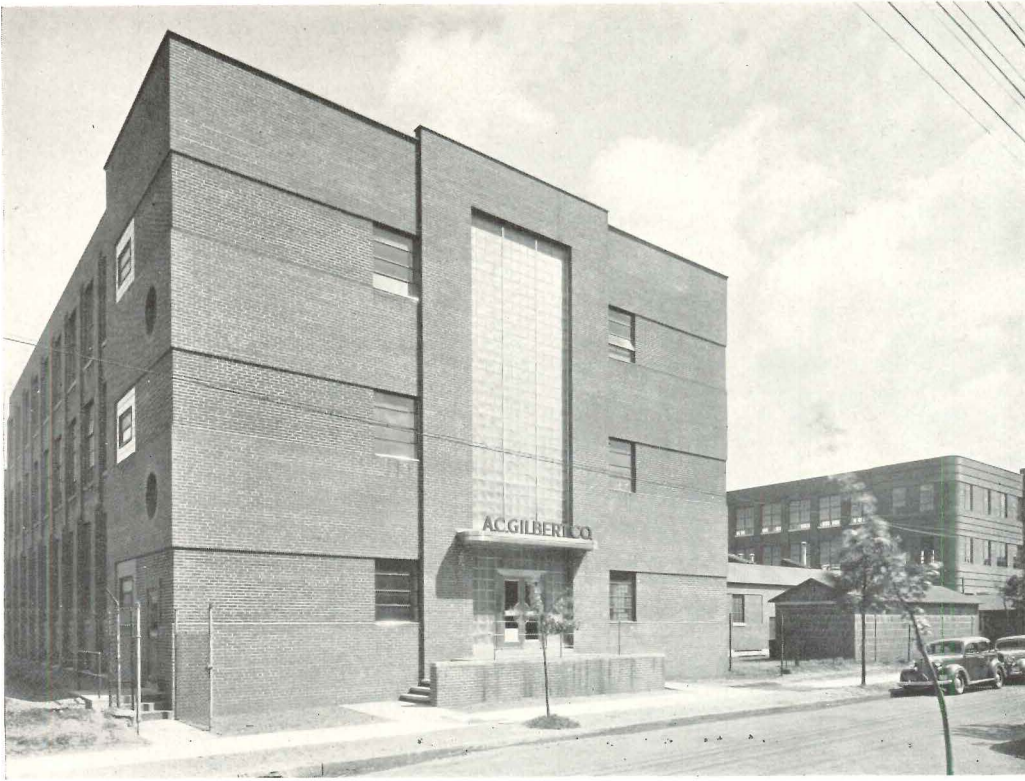

Plot Plan

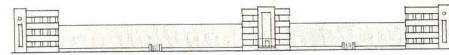

Schematic Elevation

Of the three buildings, the center and right end units are completed. Left: General view

ADDITIONS TO FACTORY

THE A. C. GILBERT CO.
NEW HAVEN, CONNECTICUT

BOTH BUILDINGS shown are extensions of existing units. Eventually the street frontage will consist of the symmetrical scheme shown above in diagram. The center building, No. 2A, contains offices and manufacturing space. The end unit,

No. 2B, is devoted to manufacturing only.

Products of the A. C. Gilbert Co. include various types of toys and clocks. In Building 2B, manufacturing processes necessitated installation of exhaust systems to carry metal

dust from buffing jacks, and provision of an acid-resisting floor in certain portions. The glass-block panels in Building 2A was installed in accordance with standard details, no unusual precautions being needed beyond normal provision for support.

WESTCOTT & MAPES, INC.
Architects and Engineers

BUILDING 2B

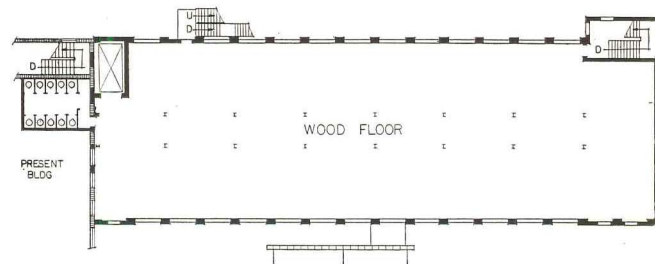

Second Floor

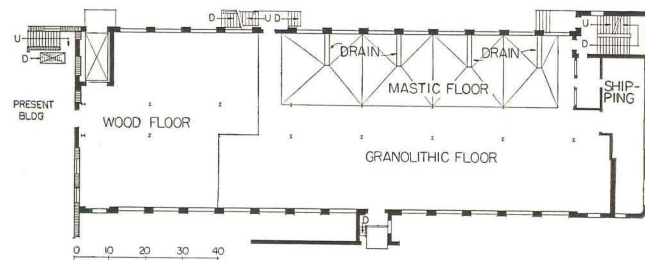

First Floor

BUILDING
TYPES

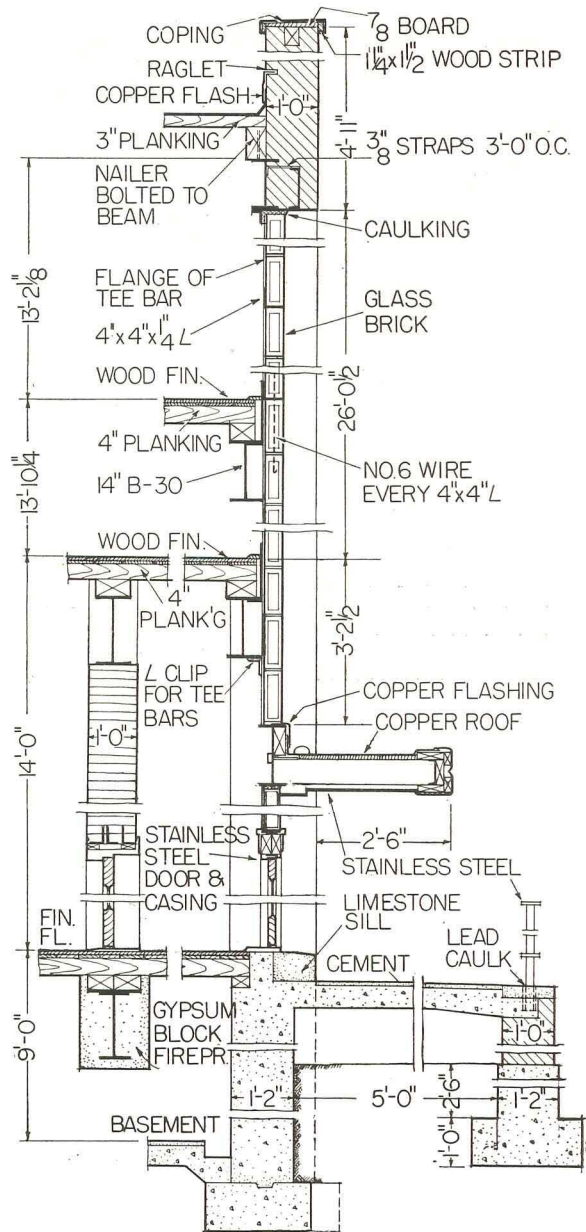
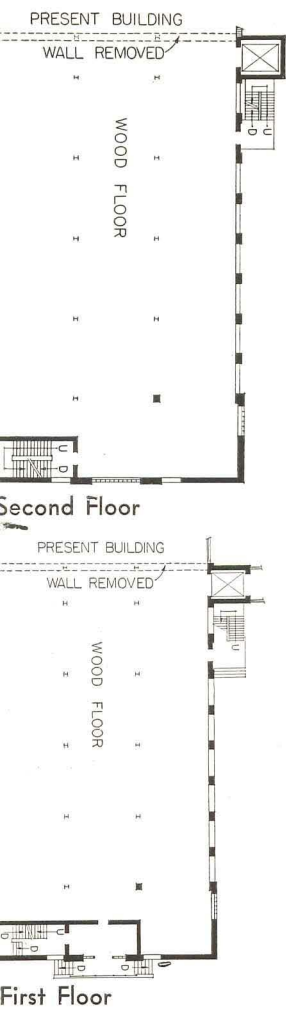

BUILDING 2A

SCHEDULE OF EQUIPMENT AND MATERIALS

Building 2A

FOUNDATION
Concrete

STRUCTURE
Structural steel frame, Connecticut Steel Erecting Co.

EXTERIOR
Walls: Brick, I. L. Stiles & Son Brick Co.; mason materials, Connecticut Adamant Plaster Co.; glass block, Deforest & Hotchkiss Co.
Roofs: Built-up, Barrett Co.
Sash: Steel, Truscon Steel Co.

EQUIPMENT
Freight Elevator: Electric-traction type, 5000-lb. capacity, 50 ft. per min. speed, Eastern Machinery Co.
Elevator Doors: Richmond Fireproof Door Co.
Heating and Sprinkler Systems: Installed by Foskett & Bishop Co.; unit heaters in offices and manufacturing space, L. J. Wing Mfg. Co.
Kalamein Doors: A. R. Kirschner

Building 2B

FOUNDATIONS
Concrete, C. W. Blakeslee & Sons, Inc.; Portland cement, Penn Dixie Cement Co.

STRUCTURE
Structural steel, Berlin Construction Co.; reinforcing steel, Concrete Steel Co.

EXTERIOR
Walls: Brick, I. L. Stiles & Son Brick Co.
Roofs: Built-up, Barrett Co., installed by Southern New England Roofing Co.
Sash: Steel, Truscon Steel Co.; calking by D. I. Chapman Co.; glass by Fourco Glass Co., Mississippi Glass Co.
Skylight: General Sheet Metal Works
Sills: Slate, Hartford Cement Co.
Overhead Doors: Overhead Door Co.

INTERIOR
Floors: Acid-resisting, Johns-Manville; wood

floors treated with Lignophol, L. Sonneborn Sons, Inc.
Partitions: Terra-cotta tile, Brighton Clay Products; steel and glass, Earl R. Smith; toilet partitions, Sanymetal Products Co., Inc.
Rolling Steel Door: Kinnear Mfg. Co.
Interior Finish: Tile in some portions, Olean Tile Co.
Kalamein and Sliding Tubular Doors: Earl R. Smith

EQUIPMENT
Freight Elevator: Electric-traction type, 5000-lb. capacity, 50 ft. per min. speed, Eastern Machinery Co.
Elevator Doors: Richmond Fireproof Door Co.
Exhaust System: From buffing jacks—Air Systems Mfg. Co.
Portable Elevator: Electrically operated, 60x72 in., 5-ft. lift, Barrett-Cravens Co.; installed by Equipment Engineering Co.
Heating and Sprinkler Systems: Installed by the Hartwell Co., Inc.; unit heaters, L. J. Wing Mfg. Co.

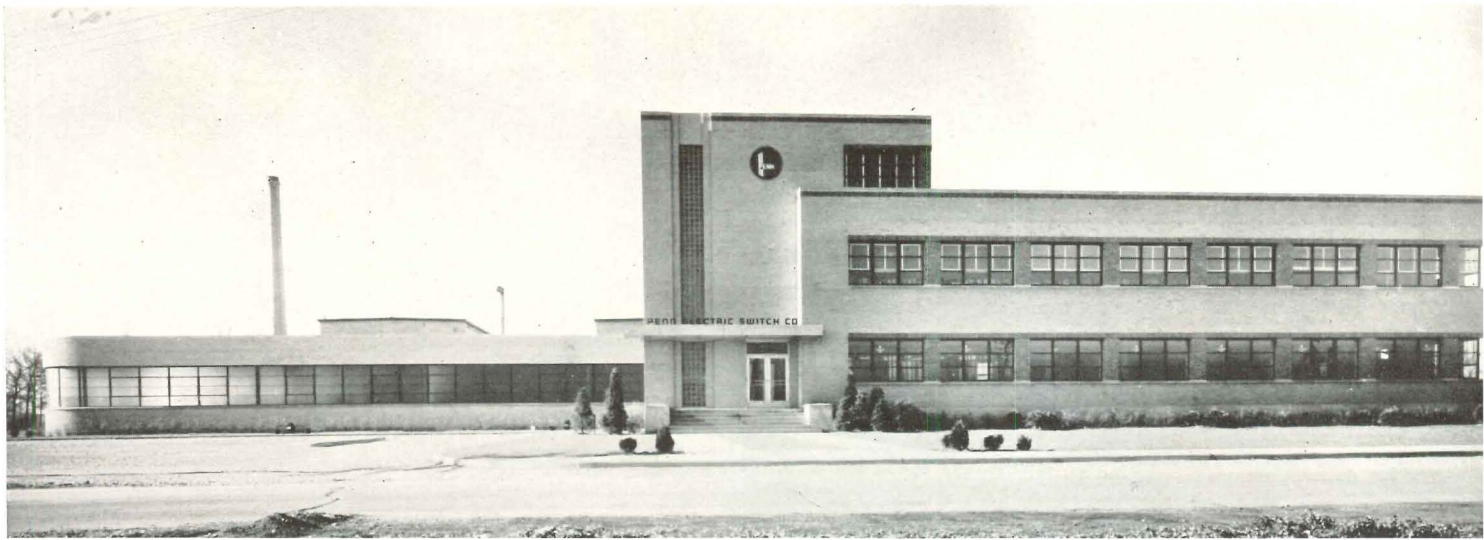

NEW PLANT AND OFFICES

PENN ELECTRIC SWITCH CO.
GOSHEN, INDIANA

THE AUSTIN CO.

Designer

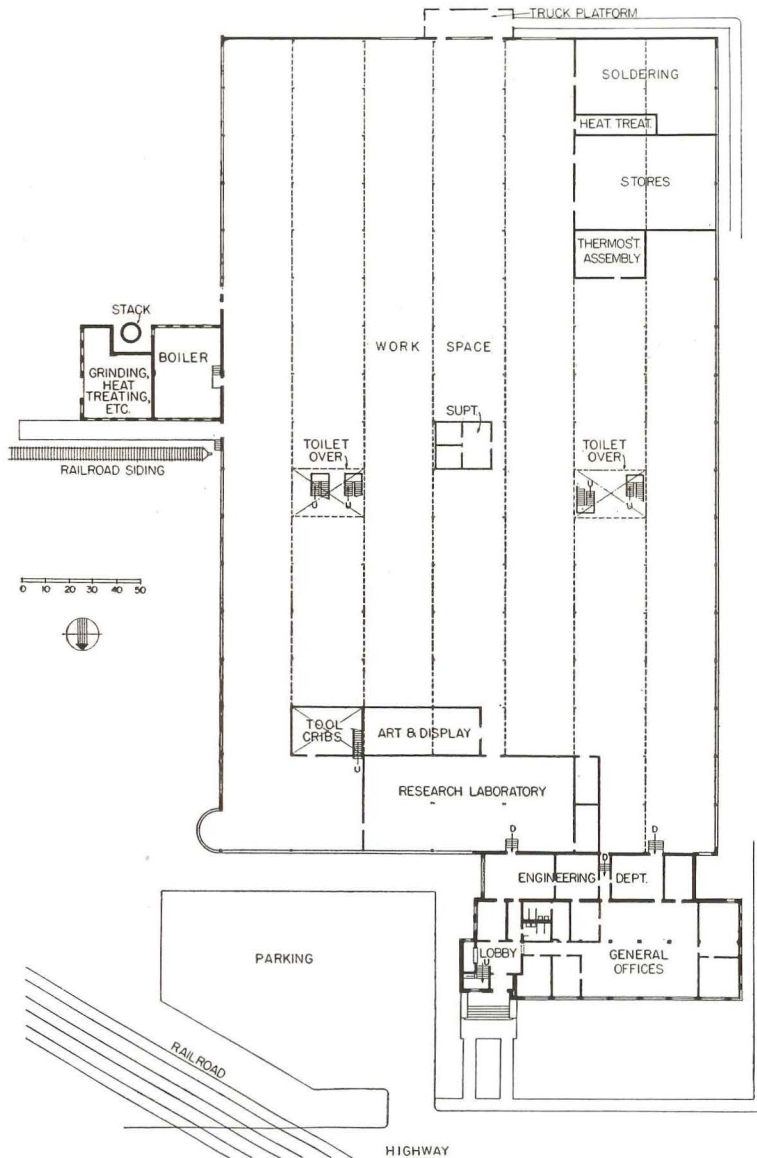

First Floor and Plot Plan

PRODUCTS of this plant include some 40 types of controls for domestic water-supply systems, service station pumps, and refrigeration, heating, and temperature.

The factory portion is provided with continuous sash, monitors, and skylights for maximum natural lighting. Rooms for testing thermostats are kept at constant temperatures, one at 72° F., the other at 104° F. Stamping and machine operations are isolated. Soldering is centralized in a brick-walled space so that acrid fumes will not spread.

Artificial illumination is provided by vaporized mazda lighting units in factory, tool and die departments. Factory heating is hot-water radiators in offices, steam. Unit heaters and coolers are installed in the factory, and in summer the factory roof is cooled by spraying. Manufacturing power is electricity, taken off an enclosed Flexopower conduit containing 110- and 220-volt supplies.

An interesting provision for employee comfort is the penthouse recreation room.

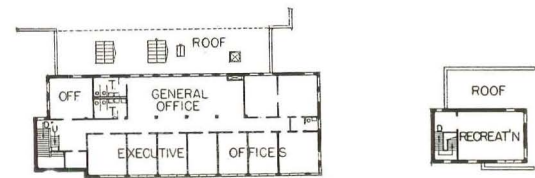

Second Floor, Offices

Penthouse



Transverse Section

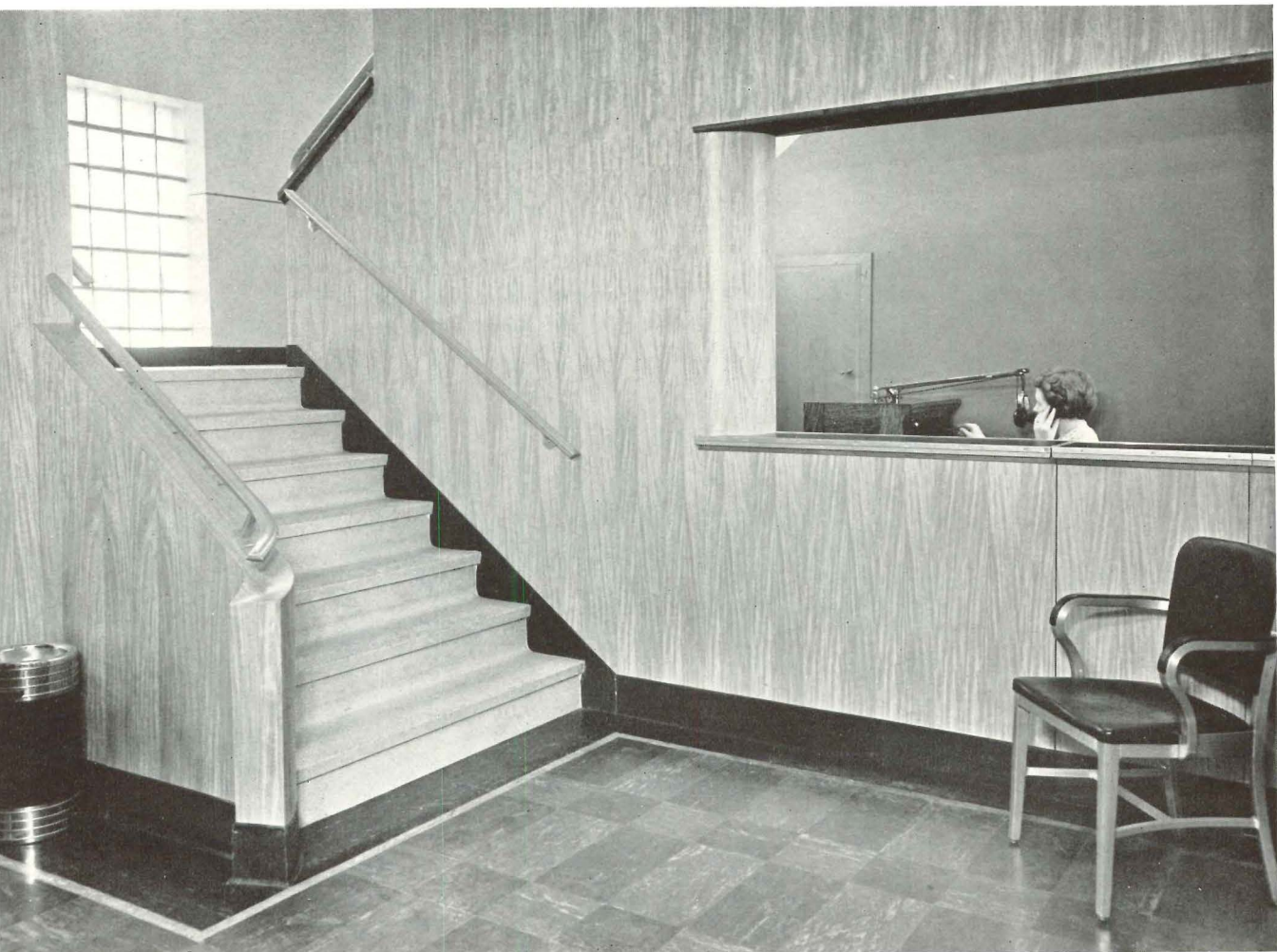

Reception Lobby: Walls covered with processed wood; trim, architectural glass; acoustical plaster ceilings

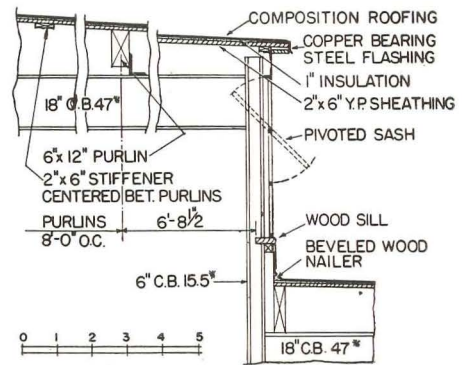
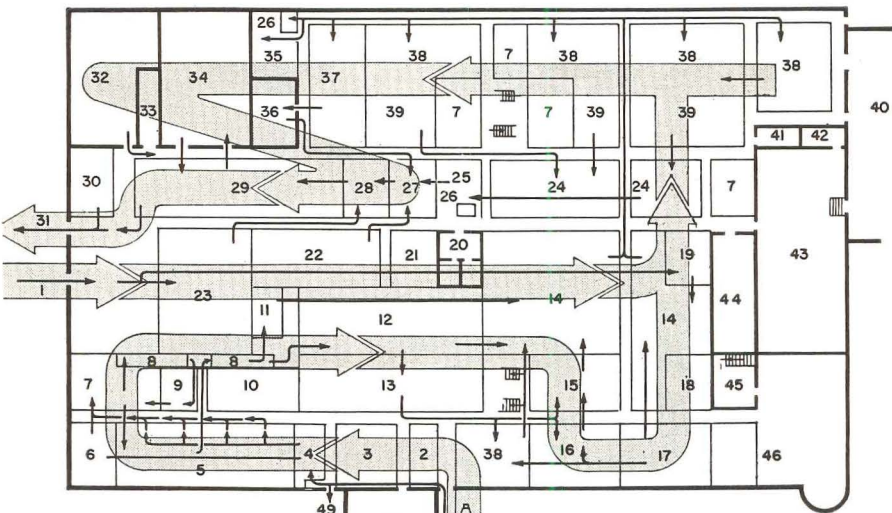

Roof Detail

Process flow diagram. Materials may be shipped as well as received by rail. The gray band indicates the general routing of material through the factory.

- | | | | |
|--------------------------------|----------------------------|-------------------------------|---|
| 1 Incoming | 19 Inspection | 31 Outgoing | 42 Blueprints and Photostats |
| 2 Shears | 20 Superintendent's Office | 32 Soldering | 43 Research |
| 3 Sheet-steel storage | 21 Maintenance | 33 Heat-treating room | 44 Art and Display Shop |
| 4 Blanking | 22 Repairs | 34 Finished Stores | 45 Tool Crib |
| 5 Form and Piercing | 23 Carton Storage | 35 Assembly and Parts Storage | 46 Toolroom |
| 6 Deep Drawing | 24 Testing | 36 Final Thermostat Assembly | 47 Boiler Room |
| 7 Parts Storage | 25 Final Painting | 37, 38, 39 Assembly | 48 Miscellaneous Grinding, Heat Treatment, etc. |
| 8 Washing Machines | 26 Spray Booth | 40 Administrative Offices | 49 Scrap |
| 9 Trimming | 27 Final Inspection | 41 Testing Equipment Shop | |
| 10 Die Storage | 28 Packing | | |
| 11 Paint-Baking Oven | 29 Shipping | | |
| 12 Udylite and Nickel Plating | 30 Shipping Storage | | |
| 13 Storage of Parts in Process | | | |

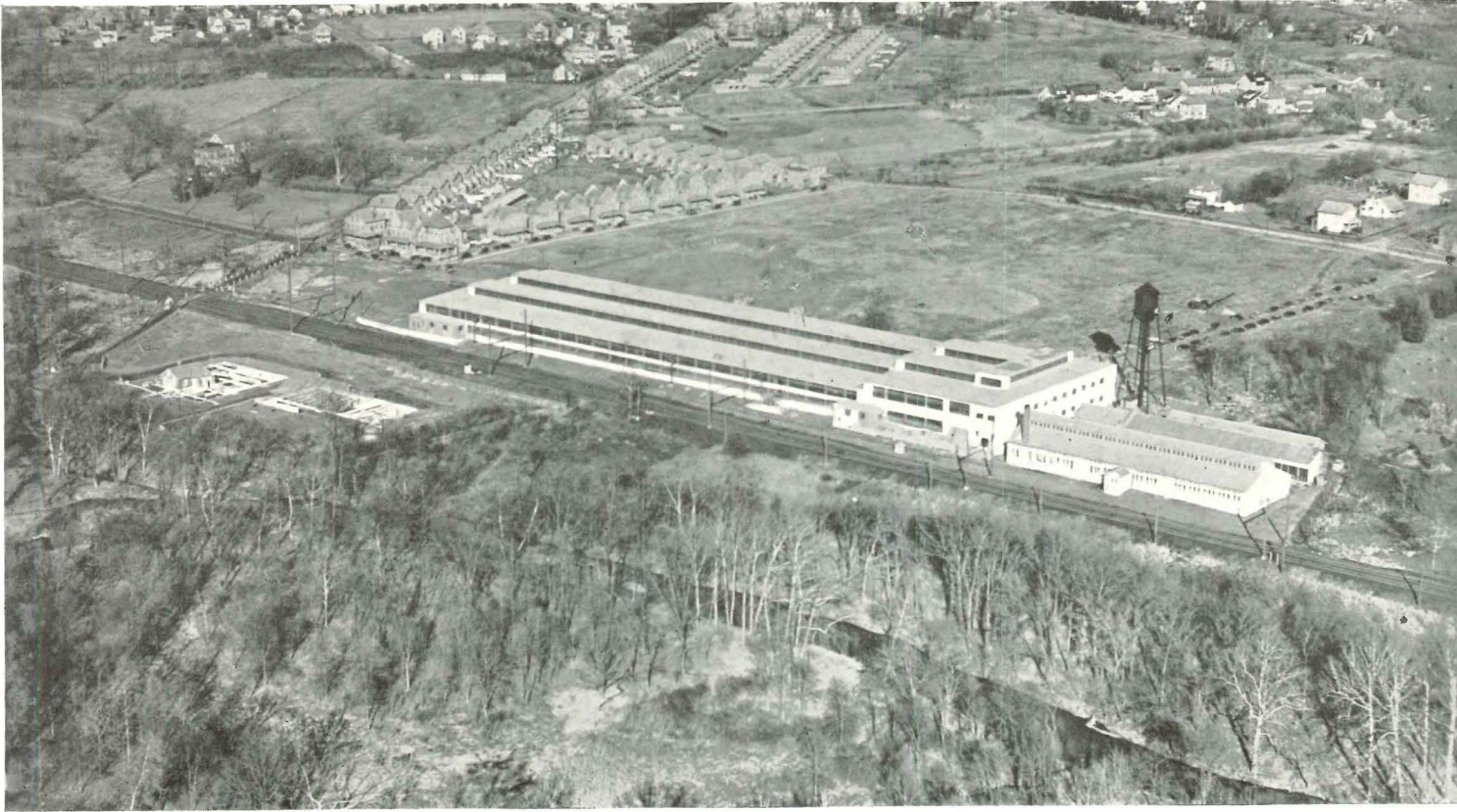

BUILDING MATERIALS PLANT

KEASBEY & MATTISON CO.

AMBLER, PENNSYLVANIA

UNITED ENGINEERS AND
CONSTRUCTORS, INC.

Designers

ASBESTOS AND CEMENT are mixed with water and processed to form asbestos-cement board, pipe, and other products. Water eliminated from the mixture in "Dalmine" machines contains a high percentage of asbestos and cement in suspension

and so is pumped into a cone above the mixer for re-use. A new type of process and equipment housed in "Building No. 7" and "Machine Shop" made it necessary to design these on the job as work progressed.

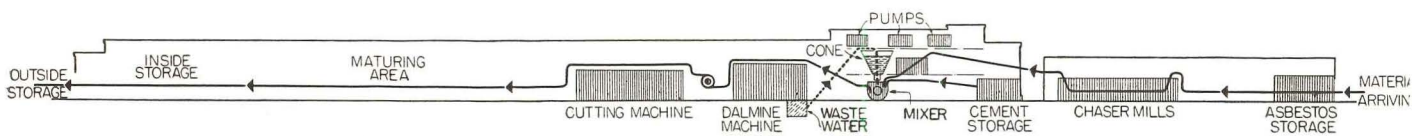

Section

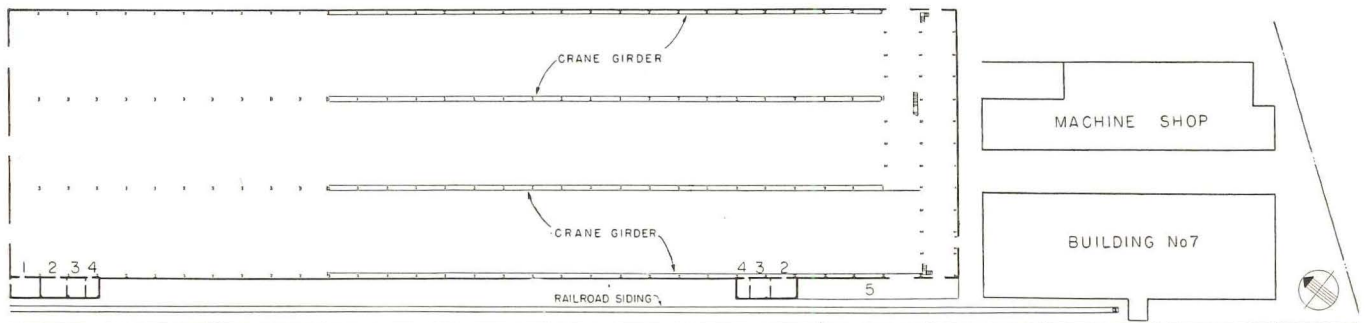

Plan

1 Office 2 Locker room 3 Washroom 4 Toilet 5 Receiving platform

BUILDING
TYPES

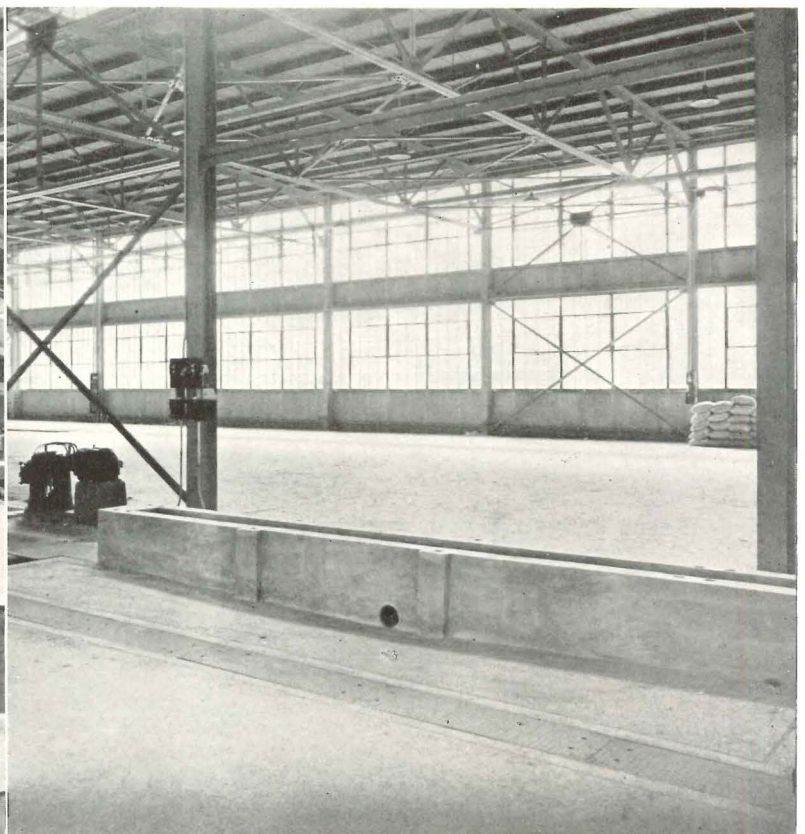
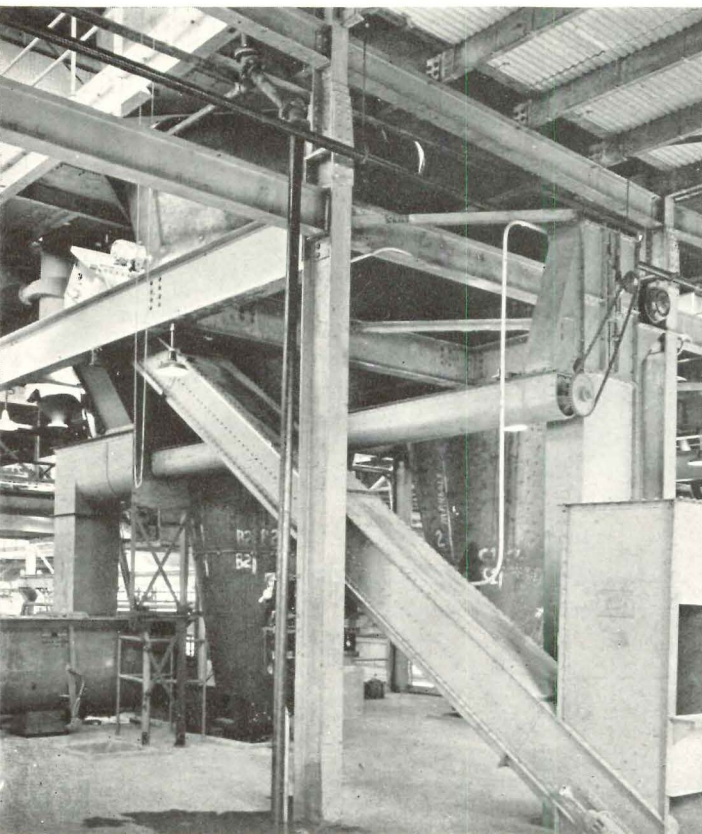

Left, above: A conveyor carries asbestos fiber to one of the cones or hoppers above the mixer. Use of gravity flow for raw materials necessitated a three-story building at this point. Top floor contains hydraulic pumps.

Right, above: Storage space looking toward southwest. A single story was needed here, height being determined by space requirements for the traveling cranes and the necessity for even, general illumination.

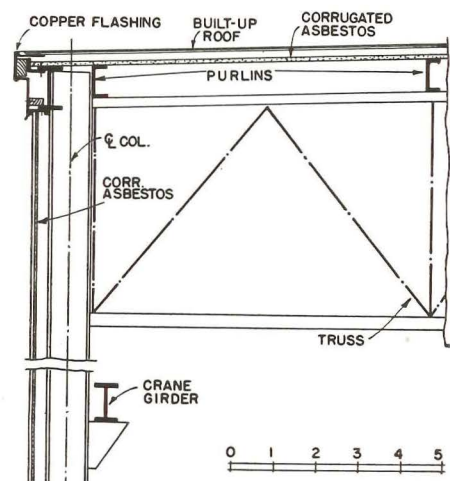

Section, main cornice

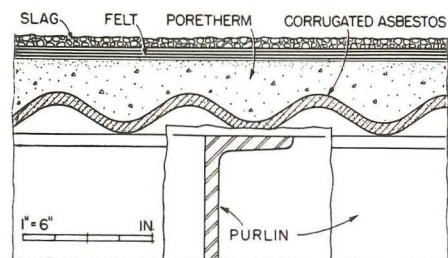

The unusual roof detail was developed to utilize Keasbey & Mattison products in a logical way. The corrugated asbestos-cement board and aerated concrete have here proven to be a satisfactory heat insulator.

SCHEDULE OF EQUIPMENT AND MATERIALS

FOUNDATION

Reinforced concrete, McNichol Paving & Construction Co.

STRUCTURE

Steel, Bethlehem Steel Co.

EXTERIOR

Walls: Corrugated asbestos, Keasbey & Mattison; yard office, toilets, and locker rooms, selected common brick, artificial stone trim
Roof: Corrugated asbestos, Keasbey & Mattison; asphaltic slag surface, Barber Asphalt Corp.; Poretherm insulation

Sash: Industrial-type steel, motor-operated ventilators, Campbell Metal Window Corp.

INTERIOR

Floors: Reinforced concrete slabs, granolithic finish

HEATING

Steam, American Blower Corp. unit heaters

LIGHTING

Direct

DOORS

Rolling, steel, Kinnear Mfg. Co.; tubular, steel, Campbell Metal Window Corp.

HARDWARE

H. S. Getty & Co., Inc.

PAINTING

DuPont Dulux Primer No. 67-706 on steel followed by lead and oil

PLUMBING

Fixtures: Hajoca Corp.

GLASS

Pittsburgh Plate Glass Co. "Hylite"

CRANES

Shepard-Niles Crane & Hoist Corp.

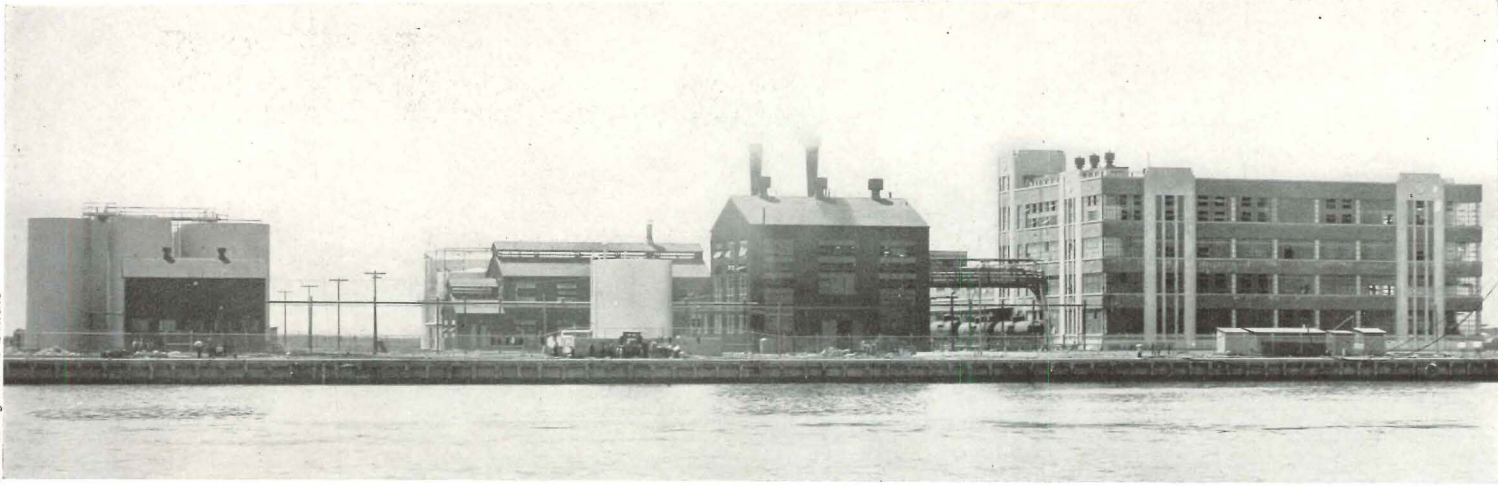

VEGETABLE OIL REFINERY

SWIFT & COMPANY
PORT NEWARK, N. J.

LOCKWOOD GREENE ENGINEERS, INC.
SWIFT & COMPANY CONSTRUCTION DEPT.

Designers

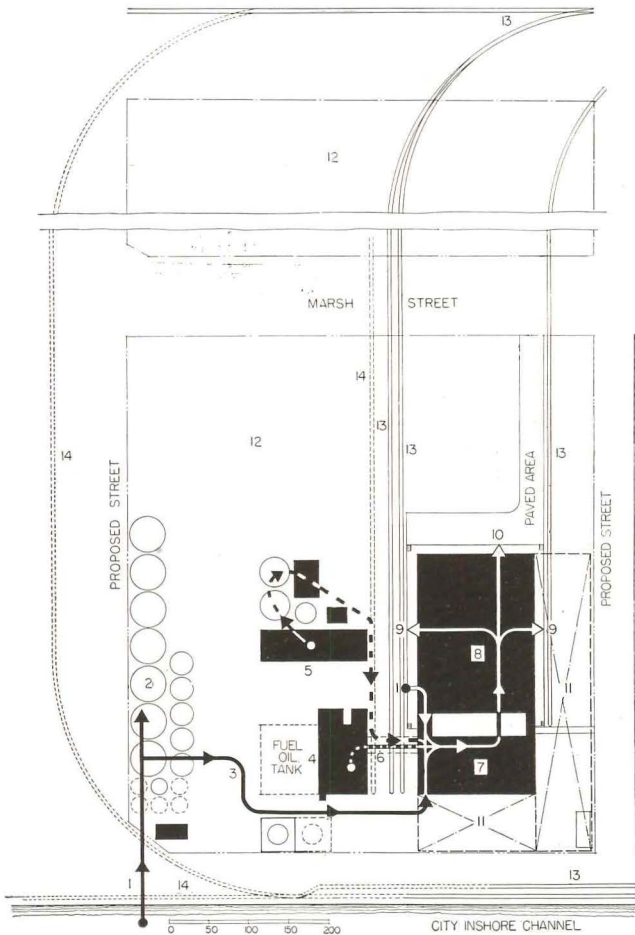

Plot Plan: 1. Vegetable oils arrive by rail and boat. 2. Oil stored in tanks. 3. Pipe line to refinery building. 4. Boiler house and power plant. 5. Hydrogen plant. 6. Pipe bridge carrying services to refinery. 7. Refinery: oils are converted to vegetable shortening and bleached. 8. Storage and filling. 9. Products shipped by rail, and 10, by truck. 11. Space for future additions to present buildings. 12. Space for future buildings. 13. Present railroad. 14. Future railroad extensions.

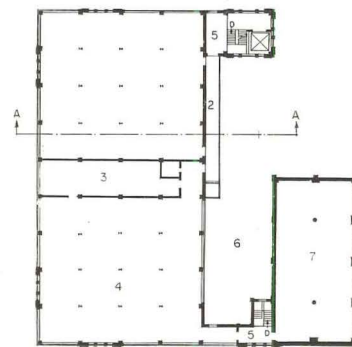

Fourth floor. 1. Hydrogenation tanks, pumps, presses, etc. 2. Gallery. 3. Filtering Materials Storage. 4. Bleaching Room. 7. Seeding Room.

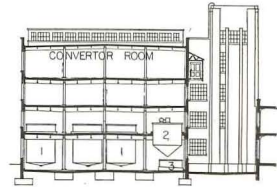

Section through refinery building: Note that tanks are suspended, leaving bases clear for piping, valves, etc. 1. Holding tanks. 2. Refining tanks. 3. Foots tanks. Converter room is equipped with explosion-proof lighting fixtures.

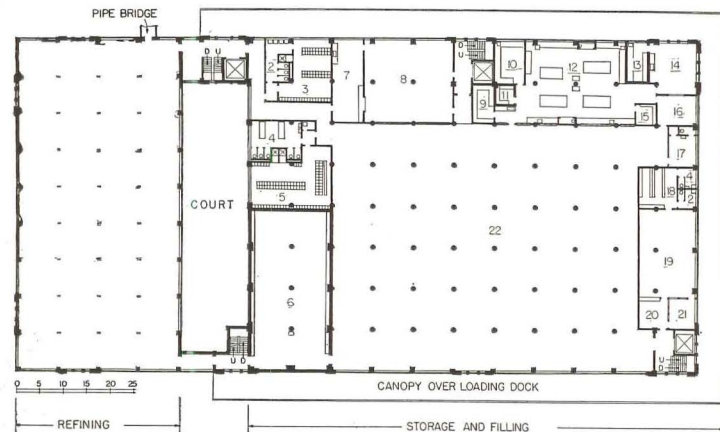

Second floor. Refinery: 1. Present and future storage, refining and scale tanks. Storage and Filling Building: 2. Women's Toilet. 3. Women's Dressing Room. 4. Men's Toilet. 5. Men's Locker Room. 6. Salad-oil Press Room. 7. Experimental kitchen. 8. Cafeteria. 9. Sample Room. 10. Bacteriology laboratory. 11. Cooler. 12. Testing and Control Laboratory. 13. Constant Temperature Room. 14. Experimental Bakery. 15. Supply Room. 16. Meeting Room. 17. Gov't Inspectors' Office. 18. Record Room. 19. General Offices. 20. Reception. 21. Private Office. 22. Supplies.

LOCATION OF THIS plant at Port Newark is convenient for concentration of shipments and for distribution to both Eastern domestic and certain export markets. The present plant proper contains 110,000 sq. ft. of floor space, and is served by the deep-water dock on the north and railroad sidings. Oils are pumped directly from tankers to storage tanks. The plant includes, besides refinery and manufacturing equipment, refrigeration, and air conditioning for some departments, a complete electrified experimental bakery and a food-testing laboratory. Portions of the storage and filling building are in effect huge refrigerators, cork-insulated.

Future expansion is provided for, not only by the spaces allotted for additions and new buildings, but also in methods of floor construction. In the refinery building, floor framing in portions not now occupied by tanks is laid out to support future tanks, floor slabs being removable without damaging the structure. Tanks are provided with lugs secured to their upper perimeters; from these the tanks hang from upper tiers of floor framing, eliminating necessity for supports below.

Because Newark Airport is immediately adjacent, natural draft stacks were not used on the boiler house; Venturi stacks save approximately 130 ft. in height.

Right, top: Refinery, storage, and filling buildings from the northwest. Center: First floor, storage building. Shortening packed in drums is kept at a constant temperature by air-conditioning unit at rear. Bottom: Meeting room and experimental bakery. Thirty visitors may be accommodated to watch operations in the bakery.

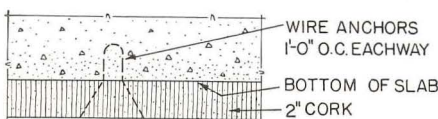

DETAIL OF ANCHOR FOR CORK ON CEILING

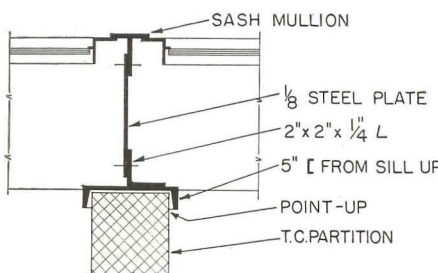

DETAIL OF CLOSURE PLATE WHERE PARTITIONS FRAME TO SASH

SCHEDULE OF EQUIPMENT AND MATERIALS

FOUNDATION

Piling, Raymond Concrete Pile Co.

STRUCTURE

Structural steel, reinforced concrete and brick

EXTERIOR

Roofs: Concrete; covering, Johns-Manville Corp. Sash: Fenestra, Detroit Steel Products Co.

INTERIOR

Floors: Burned packing-house floor tile, concrete. Partitions: Terra-cotta tile

HEATING

Unit heaters, Carrier Corp.; boilers, Edgemoor Iron Works; boiler settings, Laclede-Christy Clay Products Co.; oil burners, Todd Combustion Equipment, Inc.; combustion con-

trols, Republic Flow Meters Co.; induced draft stacks, Prat-Daniel Corp.; feed-water heater, Hoppes Mfg. Co.

AIR CONDITIONING

Heating and cooling units, Carrier Corp.

INSULATION

Roof and Refrigerated Storage: Cork

SANITARY EQUIPMENT

Fixtures: Standard Sanitary Mfg. Co.

EQUIPMENT

Refrigerating machines, Ball Ice Machine Co., General Electric motors; outdoor oil-storage tanks, Hammond Iron Works; indoor storage and processing tanks, Steel and Alloy Tank Co.; hydrogen manufacturing equipment, W. F. H. Schultz

Color Systems for Factories

Color may be used for increasing illumination intensities, improving working conditions, promoting safety, and identifying materials.

Illustration

THE VALUE of the use of color in increasing illumination levels depends on its ability to reflect light. Highly reflective color can increase lighting levels at working planes sometimes as much as 100%, taking into account distance from light source and height of windows or lighting fixtures. In test cases this has proved to be true, without the necessity for increasing glass area, wattage of lamps, or number of fixtures. The procedure followed consisted in refinishing discolored upper wall and ceiling surfaces in white.

In the following table, percentages of light reflectivity are based upon paint colors. These, it is recognized, vary from manufacturer to manufacturer, and their interpretation by individuals, in the absence of absolute identification such as color chips or Munsel notations, is also variable; but they will serve as a general guide.

Percent of Reflectivity of Colors

Magnesium oxide white*	98%
"Mill" white	89%
Ivory	82%
Canary yellow	77%

*Not a paint pigment

Cream	77%
Orchid	67%
Cream gray	66%
Light tan	66%
Light blue	65%
Buff	63%
Pale green	59%
Light pink	55%
Silver gray	46%
Dark tan	43%
Dark green	22%
Dark brown	16%
Black	2%

Working conditions

There are two ways in which it is believed that working conditions, including worker comfort as well as operating efficiency, are improved by using satisfactory color. One has to do with the general well-being and morale of the worker. It has been stated that not only will output be increased but also that maintenance costs will be reduced, in that workmen will tend to keep their surroundings in better condition. While there is little doubt that plant "housekeeping" is easy in factories whose maintenance standards are high, findings resulting from tests conducted at New York University indicated little or no improvement in bodily comfort or output of workmen when colors other

than white surrounded them. The only appreciable effect was nervous excitation except in the presence of white.

As for the other and more easily measurable consideration, it has been demonstrated that eyestrain is reduced when relief from intense white is afforded by dadoes and floors of other colors. Also, when output depends upon continued and precise vision, work tables or other backgrounds of a different color than the material in process make tasks easier, and reduce rejections and fatigue.

Safety

Use of color in promoting safety is related to its use in identification of materials conveyed or stored. Other applications include demarcation of traffic thoroughfares and other circulation, use of colored arrows to indicate traffic flow, and identification of dangerous materials or locations as well as apparatus for special use. In many plants, controls are different in color than their background. In fact, all methods of increasing visibility, particularly at danger points, have resulted in lowered accident rates.

STANDARD COLOR CHART

Developed by Bauer & Black Division of the Kendall Company

Factory and Warehouse Interiors

Ceilings and walls	white
Dadoes (54 in. high)	gray
Machinery, machine equipment	green
Handrails, guards, motors, controllers, switch boxes, janitors' trucks	black
Fire-fighting equipment	red
Table tops, cabinets, lavatory equipment	white
Shaft hangers, table legs, tool and stock cabinets, shelving, stair risers, trucks other than janitors'	gray
Radiation, etc.	aluminum

Office Interiors

Ceilings	{ Ivory*
	{ Green
Walls	{ Cream*
	{ Green

Dado (40 in. high)	{ Brown*
	{ Green
Wood trim, etc.	{ Brown*
	{ Green
Metal furniture and fixtures	Green
Wood furniture and fixtures	Oak

All Exteriors

Metal	black
Wood and Masonry	red

Piping

Process oil	yellow
Fuel oil	yellow-black-yellow
Gas	yellow-blue-yellow
Acid and Alkali	yellow-red-yellow
High-pressure steam supply	orange
High-pressure steam return	orange-black-orange

Low-pressure steam supply	orange-white-orange
Low-pressure steam return	orange-blue-orange
Freon	purple-yellow-purple
Ammonia	purple-red-purple
Fire-protection mains	red
Brine	green
Hot Water	green-red-green
Cold Water	green-white-green
Refrigerated Water	green-black-green
Hydraulic	green-yellow-green
Compressed Air	green-aluminum-green
Tube Carrier	green-gold-green
Salvage Water	black-green-black
Waste Drain	black-red-black
Electric Conduit	gray
Light and Power panel boxes same as adjacent dado.	

*Preferred

Indication

The diagrams and data on this page are taken from American Standards A 13-1928, "Scheme for the Identification of Piping Systems", which is available from the American Standards Association in New York City. In considering such indication in relation to illumination and other factors affected by color, various other authorities recommend that piping be banded in the colors noted, the greater portion of the piping being of the same color as the background against which it is seen. This is permitted by the standards.

Starting with these standard recommendations as a basis, it is possible for the designer to develop a color system for an entire plant. It is suggested that identifying legends be placed on the color bands, lettering being black on the main classification color and black on a light rectangle when the classification color is dark. For pipes smaller than 3/4 in., etched metal tags or other identification may be wired to the pipe. When a knowledge of the direction of flow is valuable, arrows may be included with the legend.

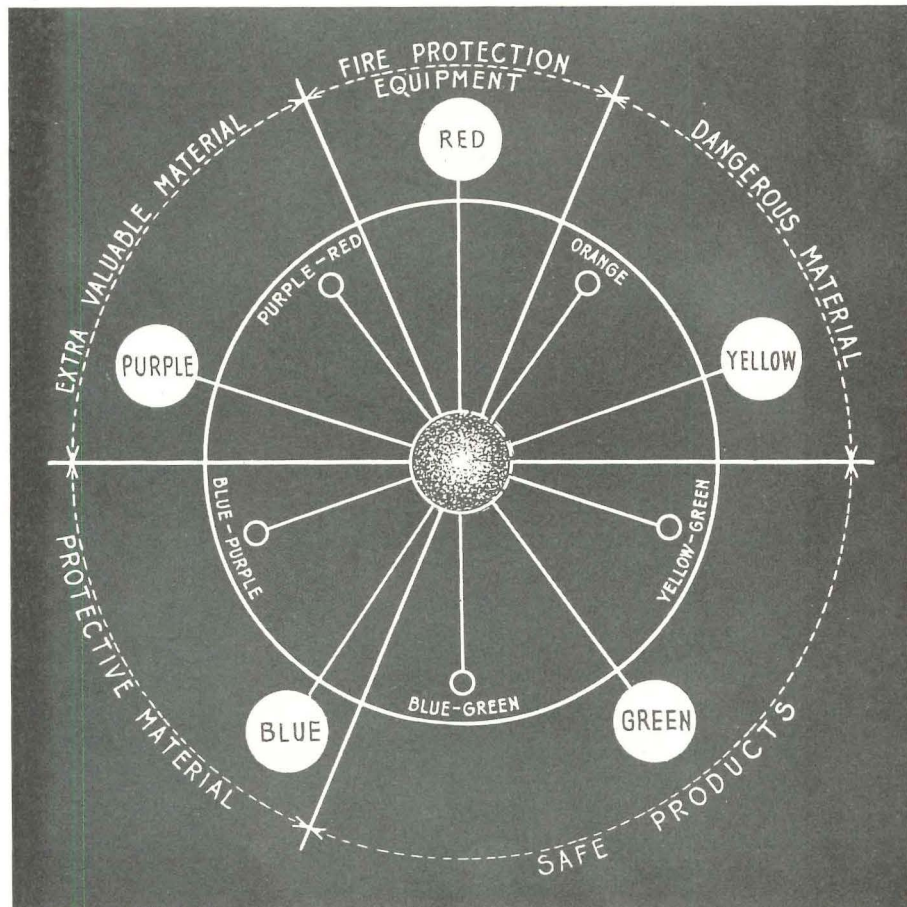

**SIZES OF STENCIL
LETTERS FOR PIPING**

Outside dia. of pipe or covering	Size of stencil letter
3/4"	1/2"
1"	1/2"
1 1/4"	1/2"
1 1/2"	3/4"
2"	3/4"
2 1/2"	7/8"
3"	7/8"
3 1/2"	1 1/4"
4"	1 1/4"
4 1/2"	1 1/2"
5"	1 1/2"
6"	1 3/4"
7"	2"
8"	2 1/2"
9"	2 1/2"
10"	3"
11"	3"
12"	3 1/2"
13" and over	3 1/2"

METHOD OF APPLYING LETTERING TO PIPING

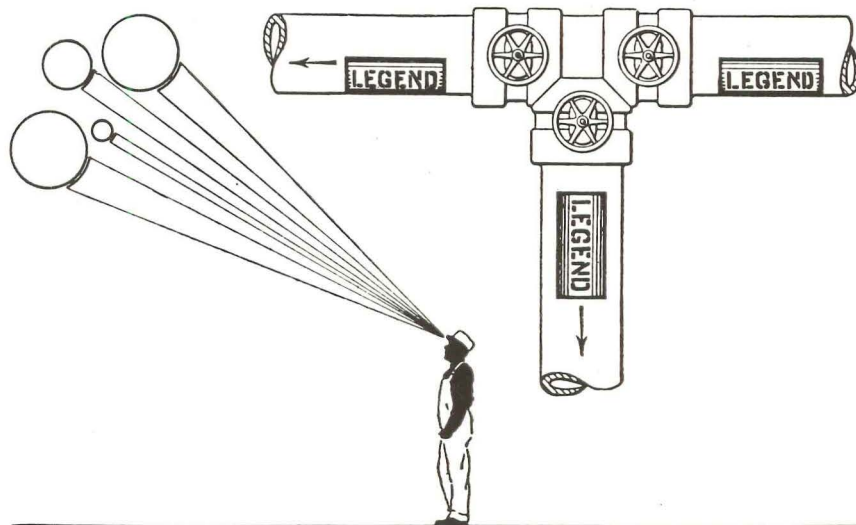

Construction types

Mill construction consists in so disposing solid masses of timbers and planks constituting the framing that the least number of corners or ignitable projections are exposed to fire, so that no concealed spaces exist, and so that when fire occurs it may readily be reached. Floors are isolated from one another by incombustible stops, automatically closing hatches and stairs encased in incombustible partitions. Slow-burning properties of heavy timbers in many cases cause reduced insurance premiums, but initial cost is at present high unless timbers are built up of smaller pieces.

Fire-resistive construction consists of protected-steel-frame types and all-reinforced-concrete types. Based on the number of hours of fire resistance provided by the protective or structural materials used, those having a one-hour rating are usually classified as "fire-retardant", higher ratings as "fire-resistant."

Exposed framing of steel is common in most types of industrial plants, particularly those requiring large clear floor areas or long spans which would be uneconomical in other types of construction. Choice of construction method from the fire-protection point of view is modified by such considerations as: initial cost; occupancy—hazardous or comparatively safe; maintenance; insurance rates; local building codes, fire regulations, and other governing restrictions.

Openings and shafts

Exterior openings of industrial plants adjacent to other buildings and consequently subject to exterior fire hazard are protected in several ways: by tin-clad shutters, dependent on fallible human operation; by solid steel or sheet-metal shutters, subject to the same disadvantage but more efficient, especially when asbestos-lined; by rolling steel shutters, which are better adapted than swing-types to automatic control; by fire windows, wire-glazed, in fire-resistant sash; by water curtains, which consist of outside open sprinklers, automatically controlled, and which, when connected to adequate water supplies and used in conjunction with fire

windows, are given high insurance ratings.

Interior openings are protected by fire doors to prevent spread of fire from one portion of the plant to another. Insurance codes and most building codes specify their use and equipment. Sliding doors mounted against walls occupy little floor area but are not effective in serving exits. Swinging doors are used at exits and are generally hung to open in the direction of travel. Self-closing doors, normally closed, are often preferred at exits. Fire doors are also classified by construction as: tin-clad, plate steel, sheet metal, rolling steel, metal-covered (or Kalamein), and hollow metal.

Shafts, which might convey flame from floor to floor through a building or furnish a draft similar to chimney action, are commonly completely enclosed in noncombustible partitions with fire doors at openings. Preferable locations are usually at outside walls. These conditions apply, particularly in mill construction, to shafts for belts, drives, conveyors, stairways, or elevators.

Fire prevention and fire fighting

Protective devices: There are two general classes of alarms: those operating at a predetermined (fixed) temperature; those operating when the rate of rise of temperature exceeds a fixed minimum, but which are unaffected by normal temperature rise. Automatic alarm systems are usually combined with strategically located manual stations, and are installed in two ways: so that a single ground in the circuit does not disrupt the system; and so that any ground will interrupt service. The latter is not usually recommended for industrial plants. Private systems may also be combined with public systems.

Automatic sprinkler systems are divided into Class A, required for most industrial buildings; and Class B, permissible in less hazardous, usually nonmanufacturing, occupancies. Differences consist principally in spacing of sprinkler heads, in most cases fixed by insurance or code requirements. Both classes are available in "wet" pipe systems contain-

ing water under pressure; and in "dry" pipe systems containing air under pressure, which, when released, opens a valve and floods the system. Operation may be controlled by individual fusible-link heads or by automatic rate-of-rise thermostats. Thermostatic systems include "Deluge" types, in which one valve may flood up to 75 open sprinkler heads; and "Pre-action" types, which flood normally dry pipe, but individual heads are further controlled by fusible links. Automatic alarms may be combined with any sprinkler system.

Fire-control systems, consisting of manually operated or automatic fire-fighting devices, employ carbon dioxide, soda-acid, foam, calcium chloride, carbon tetrachloride, plain water, or dry chemicals. Automatic thermostats are either fixed or rate-of-rise type. Such extinguishers or control systems are considered a necessary adjunct to other equipment, particularly when water supplies are inadequate or undependable.

Automatic releasing devices for fire doors and other protective equipment and systems consist of fusible links composed of metal which will fuse at a predetermined temperature; or of thermostats of either fixed or rate-of-rise type. The latter were developed to meet the need for more rapid operation, particularly of fire doors, than was formerly available.

Stand pipe and hose systems are generally prescribed by law or by insurance codes. Industrial plants without sprinkler systems, and multi-story buildings above certain heights, whether sprinkler-equipped or not, are usually required to have stand pipe and hose systems.

Maintenance and installation

Since this *Building Types* study is intended for the building designer, maintenance problems in themselves are not considered. However, proper methods of building construction and equipment installation will reduce later maintenance charges and increase efficiency of operation of all fire-protective methods and devices.

Sources for data contained herein include Crosby-Fiske-Forster's "Handbook of Fire Protection", National Fire Protection Association, and similar authorities.