

BUILDING NEWS



C. V. D. Hubbard

Cypress and field stone on the site of an old quarry . . .

ARCHITECTURAL
RECORD

COMBINED WITH
AMERICAN ARCHITECT AND ARCHITECTURE

Photos by C. V. D. Hubbard

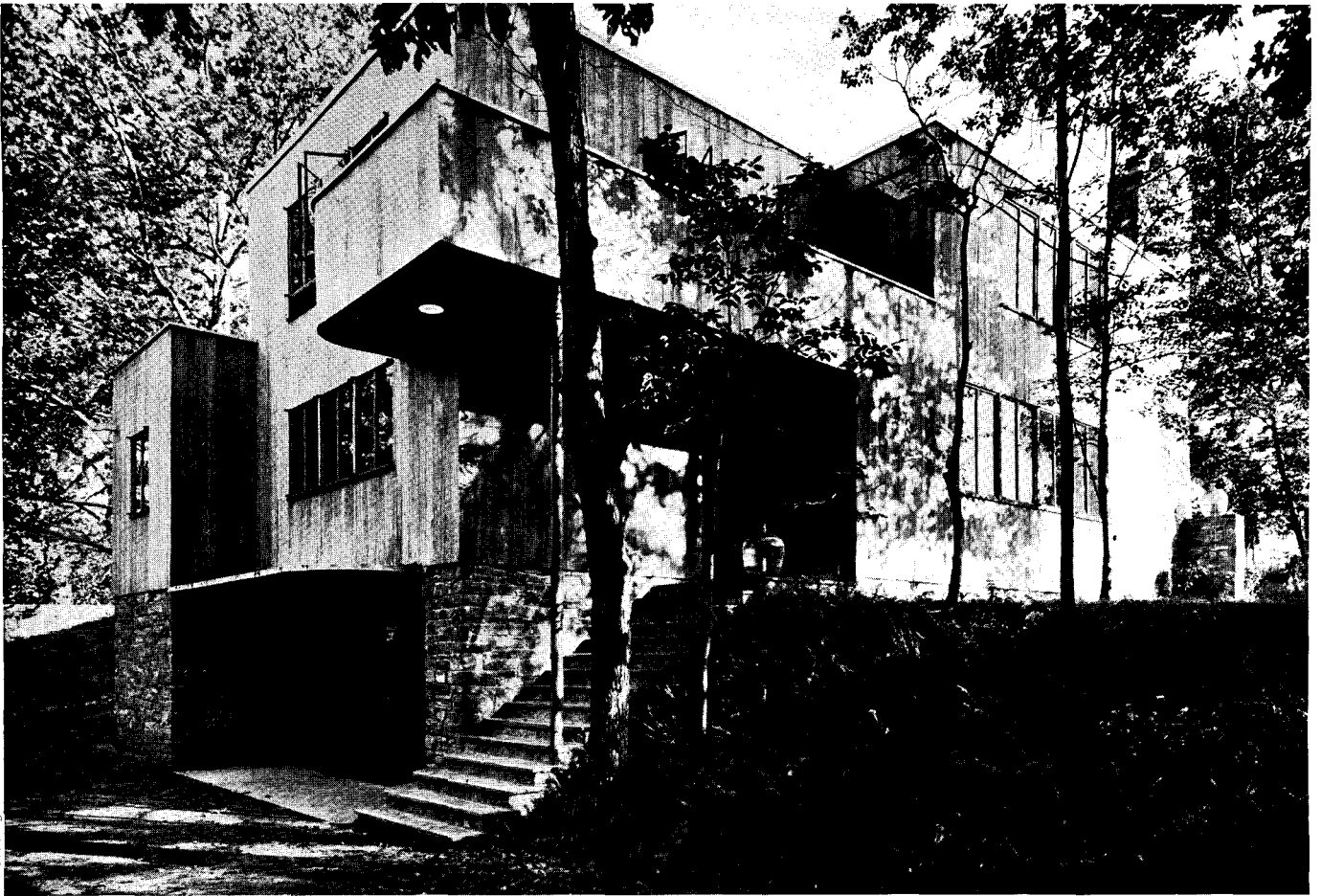

Taking advantage of previous excavations, the entrance court and garages (top) are located one level below the main living floor with its walled garden (below).

NEW HOPE, PA.: OLD QUARRY SITE EXPLOITED IN NEW CONSTRUCTION

KENNETH DAY, Architect

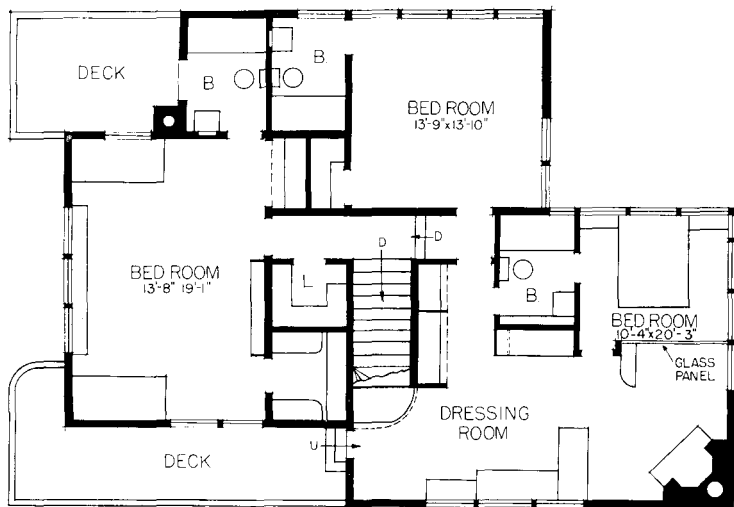

Second Floor

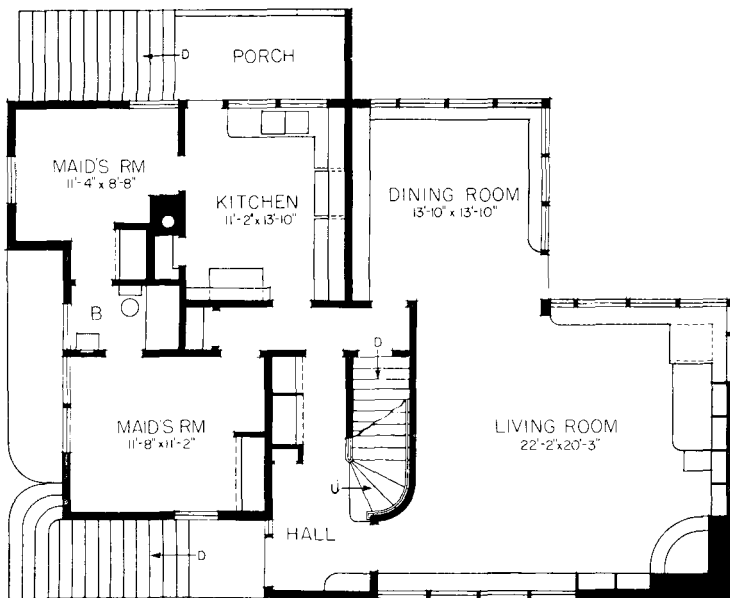

First Floor

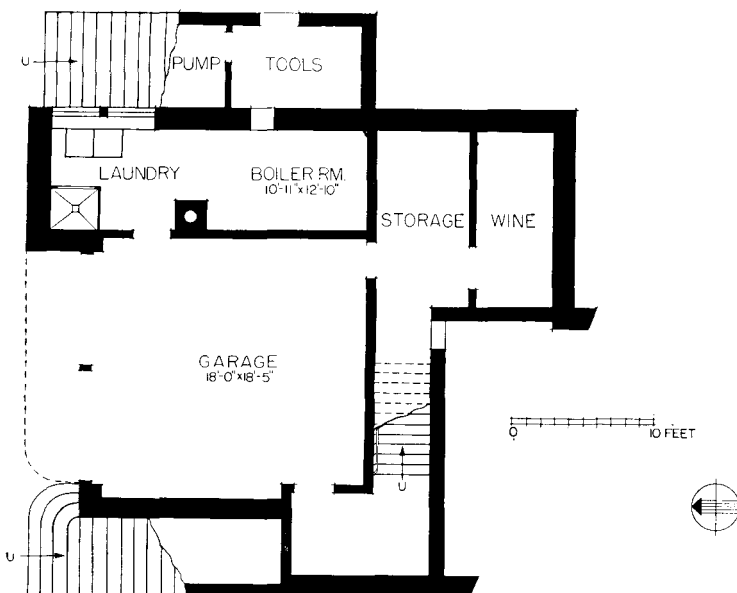

Basement

ON THE SITE of a long abandoned quarry at New Hope, Pa., overlooking the rolling plain of the Delaware River, stands this new residence for Mr. and Mrs. Marshall Cole. The actual plot on which the house stands is small and heavily wooded; the problem was therefore to design a house which would adequately meet the owners' needs and at the same time harmonize with the surroundings in both color and scale. For this reason the architect used rough materials for the exterior: richly colored stone, taken from the old lime kilns, was combined with unfinished planed swamp cypress whose natural yellow color is rapidly assuming a silver tone. Extensive lime kilns on the property also had a part in determining the location of the house and the character of the finished terrain; the ruined walls were incorporated in the landscaping wherever possible.

The owners desired a plan which would eliminate as much waste space as possible and an arrangement of units so efficient that the house could be run with a minimum of service or none at all. Dining and living rooms are treated as one large space; the kitchen and maids' rooms, although integral with the house, constitute a separate service wing; and the owners' quarters on the second floor are actually a careful organization of bathing, dressing, sitting and sleeping units.

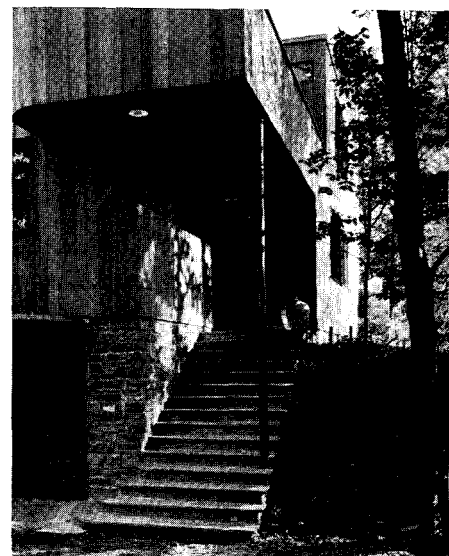

HOUSE AT NEW HOPE

Photos by C. V. D. Hubbard

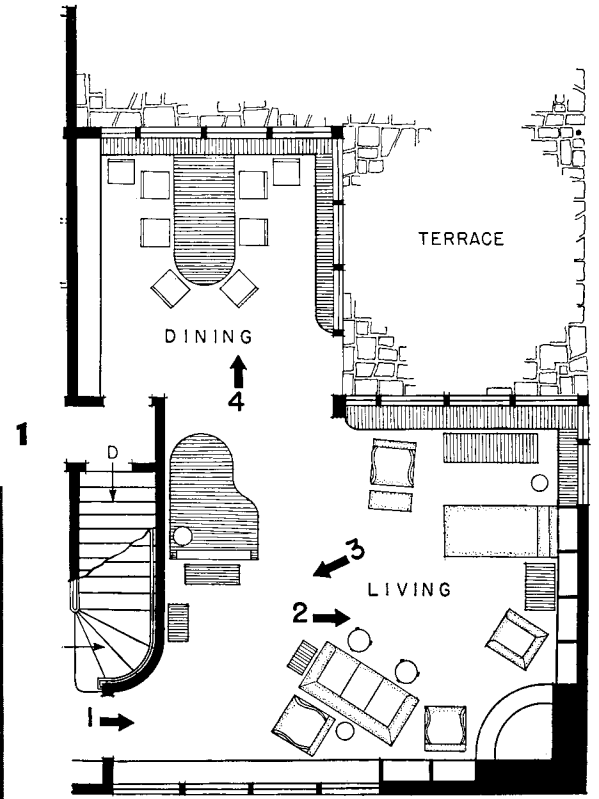
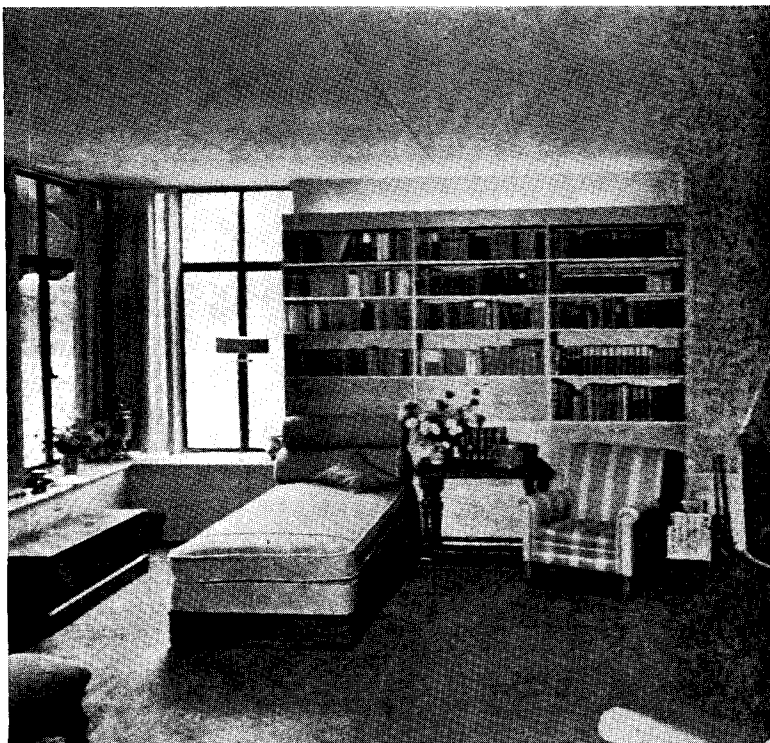
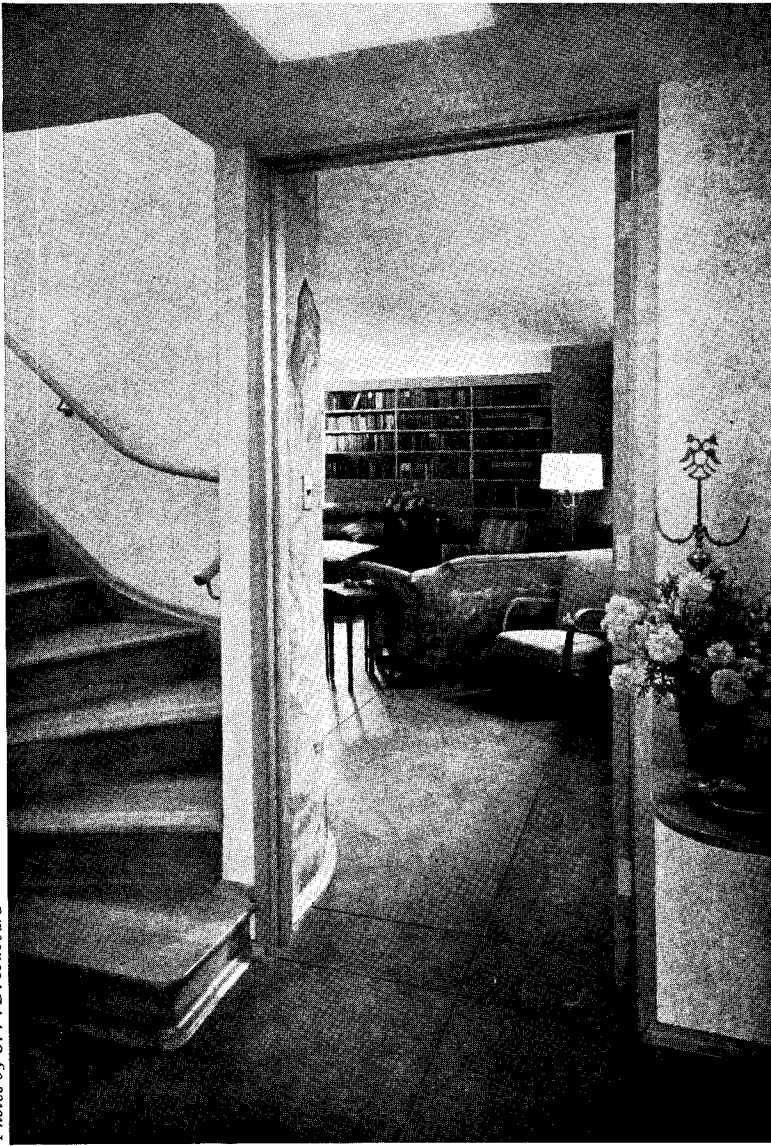

LIVING AND DINING AREAS are arranged for maximum flexibility of use, planned in detail so that not only the owners' habits but also their books and furniture are adequately provided for. Glass in large areas is disposed for three purposes—view, exposure, and adequate daylighting; artificial illumination is largely achieved by concealed tubular lighting atop the cases and is supplemented by lamps. The Chinese landscape on the north wall (3) is a genuine fresco by Charles Childs. Woodwork, including cases, is in natural red beech; plaster walls and ceilings are neutral; concrete floors have a terracotta metalichron finish.

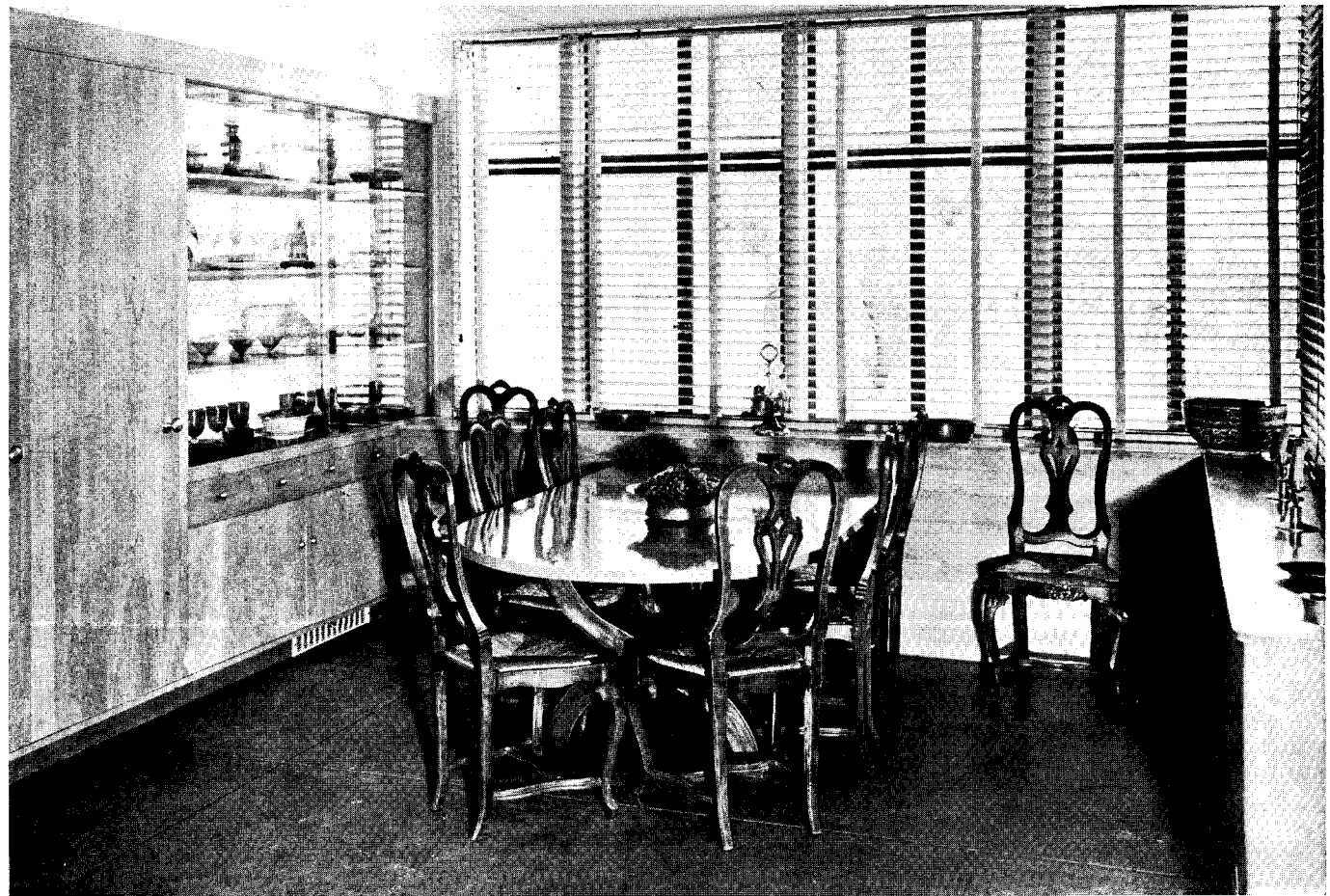
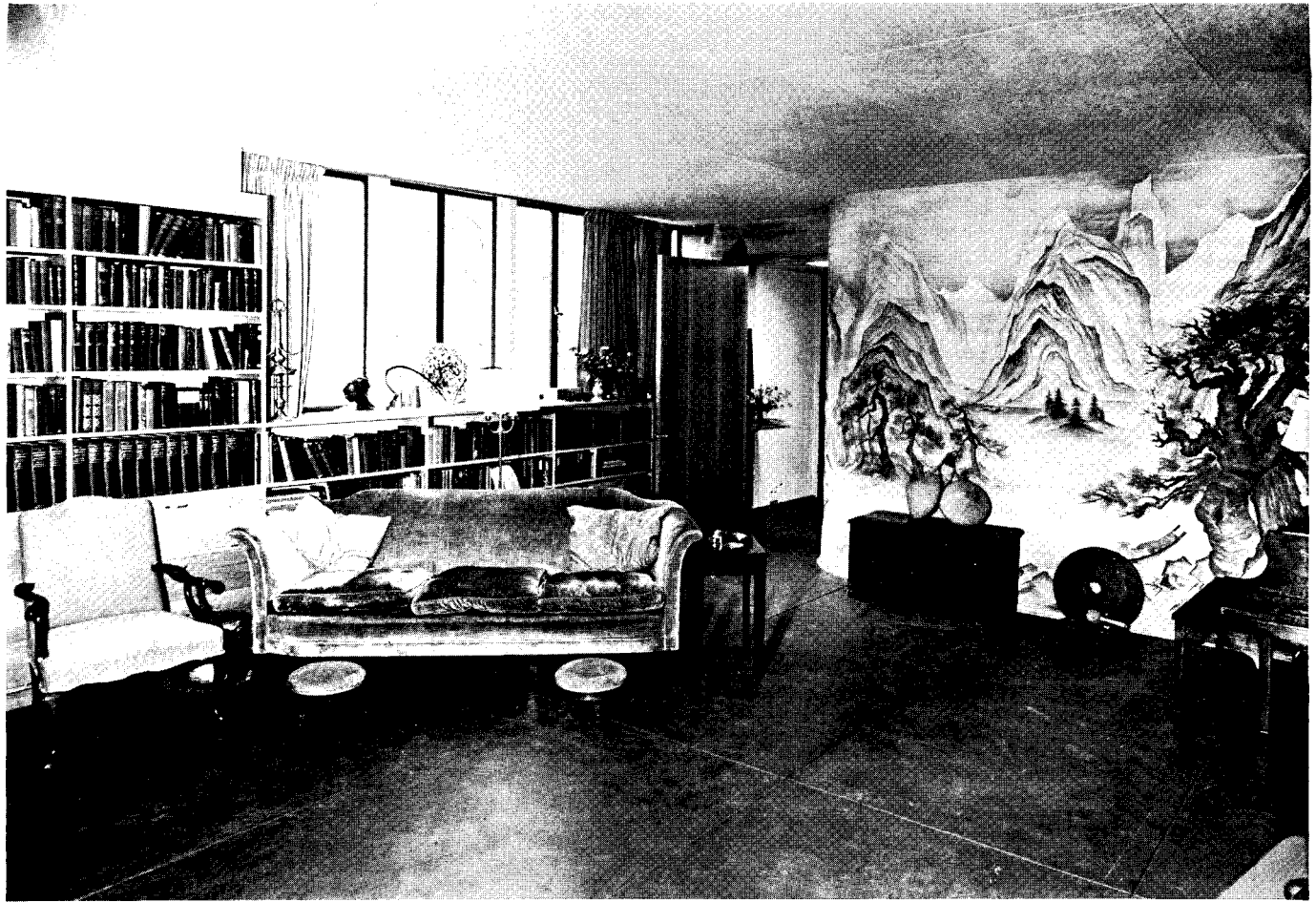

HOUSE AT NEW HOPE

Photos by C. V. D. Hubbard

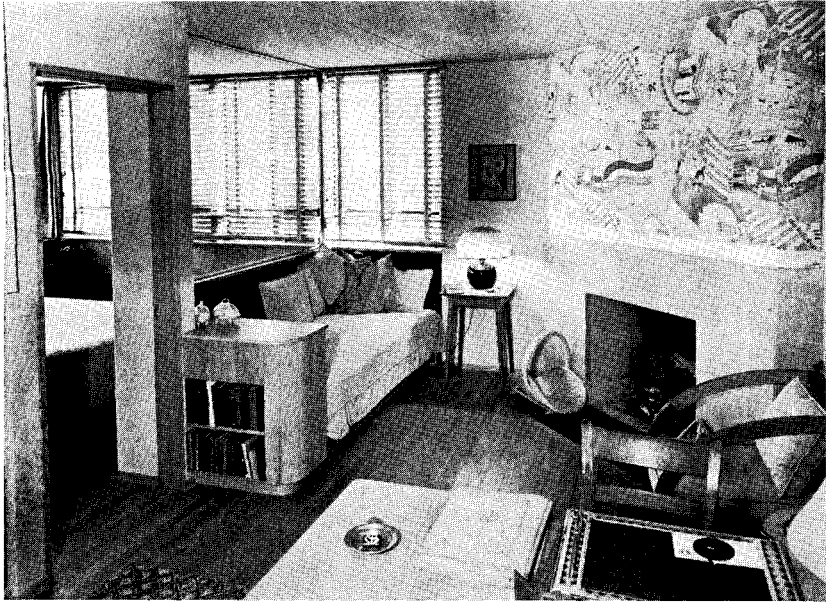

1

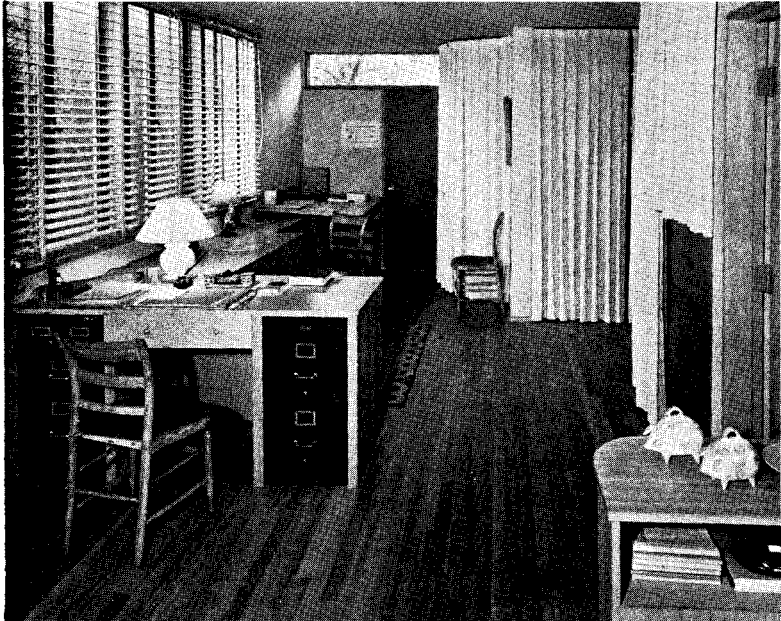

2

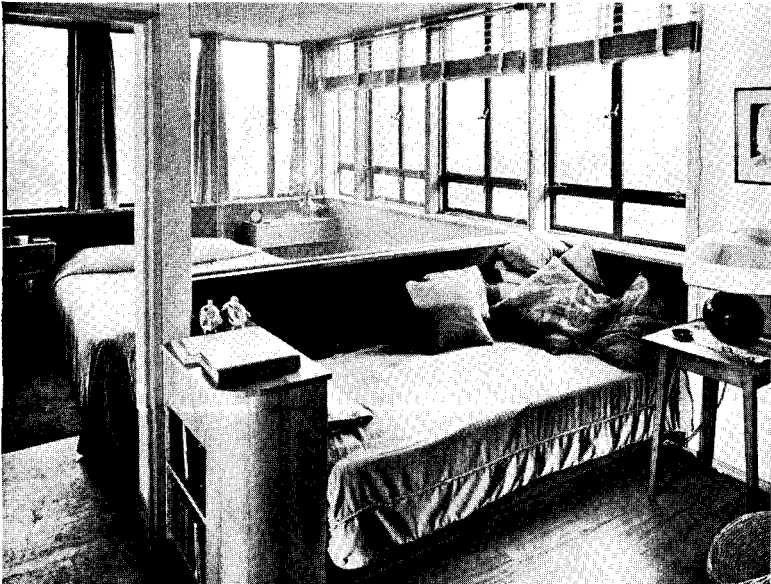

3

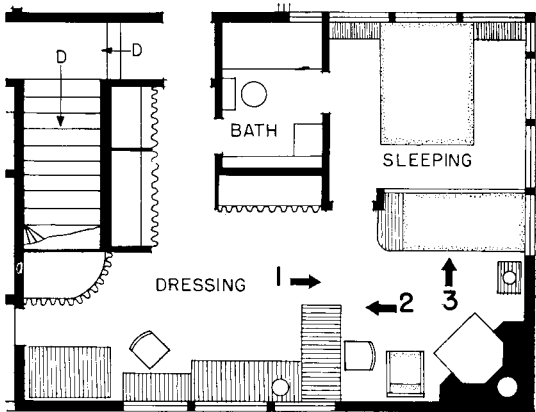

OWNERS' SLEEPING AREA: Here again the architect has avoided a conventional "suite" in an effort to organize the same floor area into a more flexible system. The work area (1) is equipped with desk, files, drawing table, and counter space; the southwest corner, with bookshelves, couch, and fireplace, becomes a sitting area (2), separated from the sleeping room only by sliding glass panels behind the couch (3). A bath and elaborate dressing cases along the east side complete the owners' unit.



L. McBlane

BARSHA HOUSE ACHIEVES VIEW, KEEPS PRIVACY, ON NARROW LOT

RICHARD J. NEUTRA

Architect

PETER PFISTERER

Collaborator

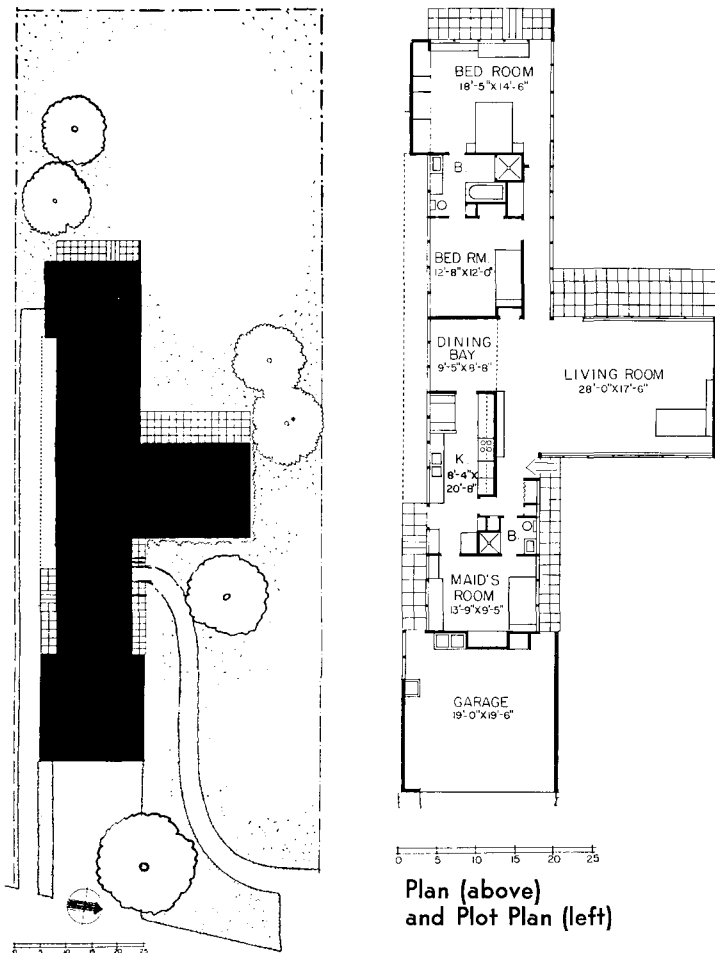

0 5 10 15 20 25

Plan (above)
and Plot Plan (left)

CHARACTERISTICALLY Neutra's in both plan and execution is this small house for Mr. and Mrs. Leon Barsha in North Hollywood, California. Beginning with a narrow, interior lot, whose chief merit was a view into a park across the street, the designers planned a house whose placement and internal organization are designed to exploit the lot's chief assets. Thus the north wall of the living room is solid, while east and west wall are entirely of glass, affording views of park and rear garden. The south wall of the house is almost all glass; overhangs protect rooms along this side, as well as on the west, from excessive sun and glare. On the north side of the bedroom wing, windows are placed high both for privacy and from lack of view. The T-shaped plan shows careful organization: garage and service are in one wing, sleeping quarters in the other, while the central portion is given over to living and dining activities. Connecting the two ends of the house is a corridor which also separates inconspicuously the living room and dining alcove. Main entrance to the house is from a covered porch on the north side, through the corridor at the service end of the house.

BARSHA HOUSE

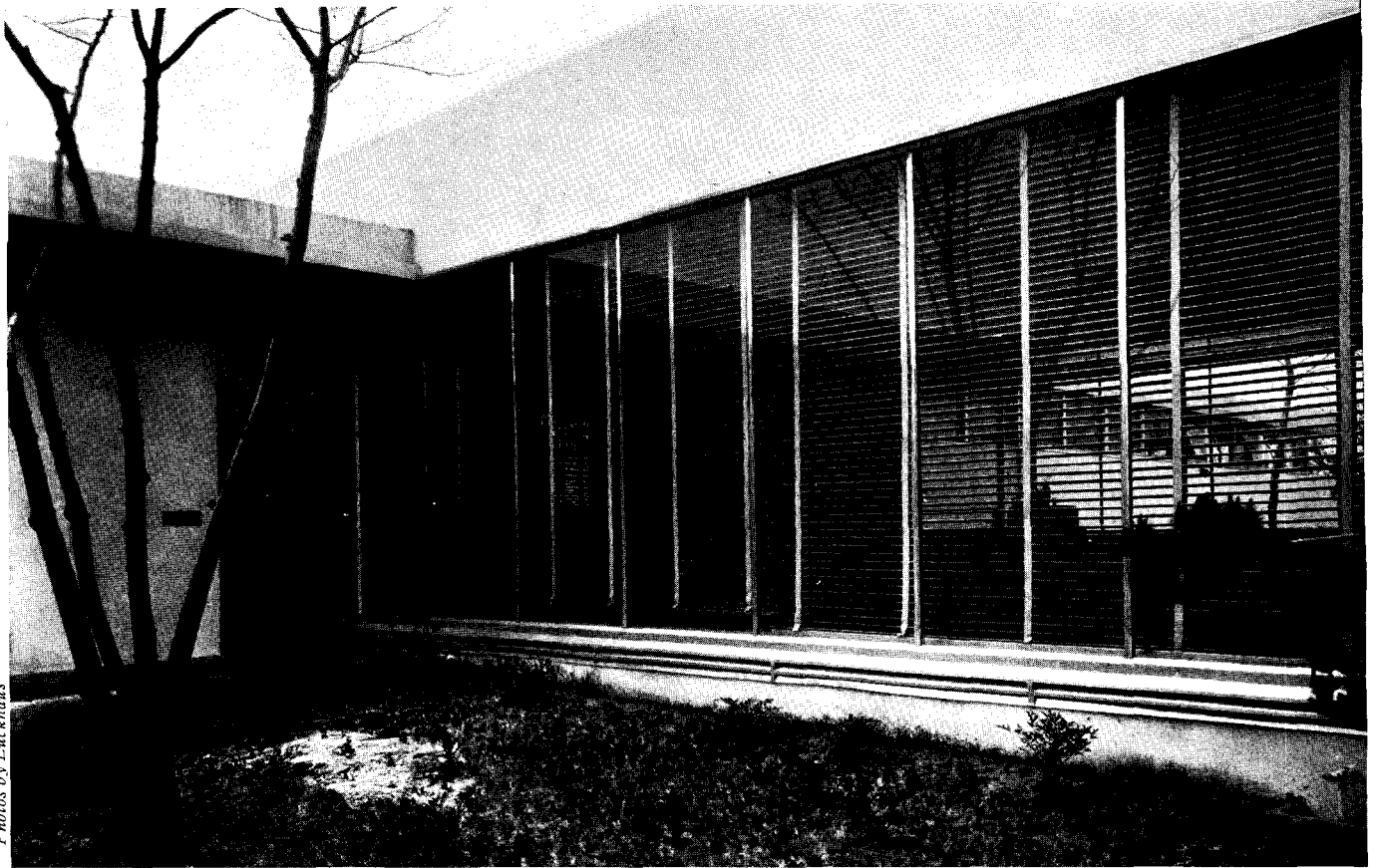

Photos by Luckhaus

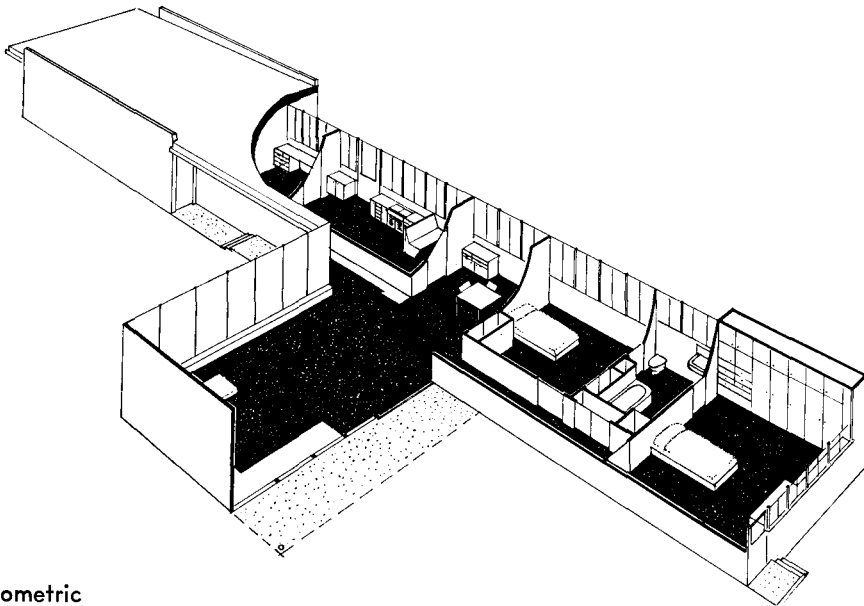

Isometric

Landscaping, furniture layout, and furnishings were all designed by the architect: a detailed analysis of the owners' requirements enabled him to reduce the furniture to a minimum — largely through the use of a wide variety of built-in case and cabinet work. All of the larger movable pieces are from the architect's designs.

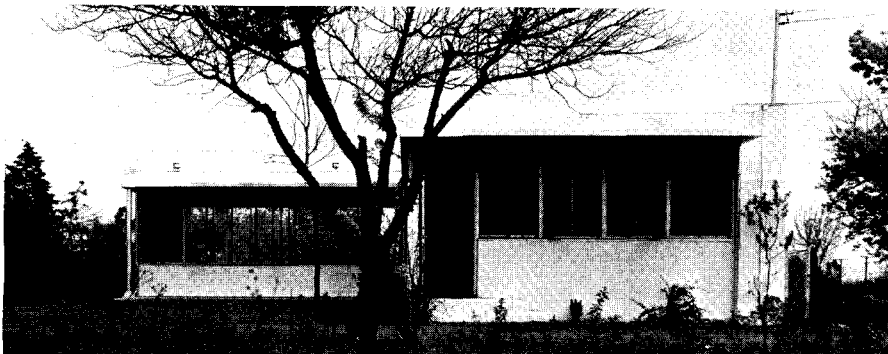

View from west

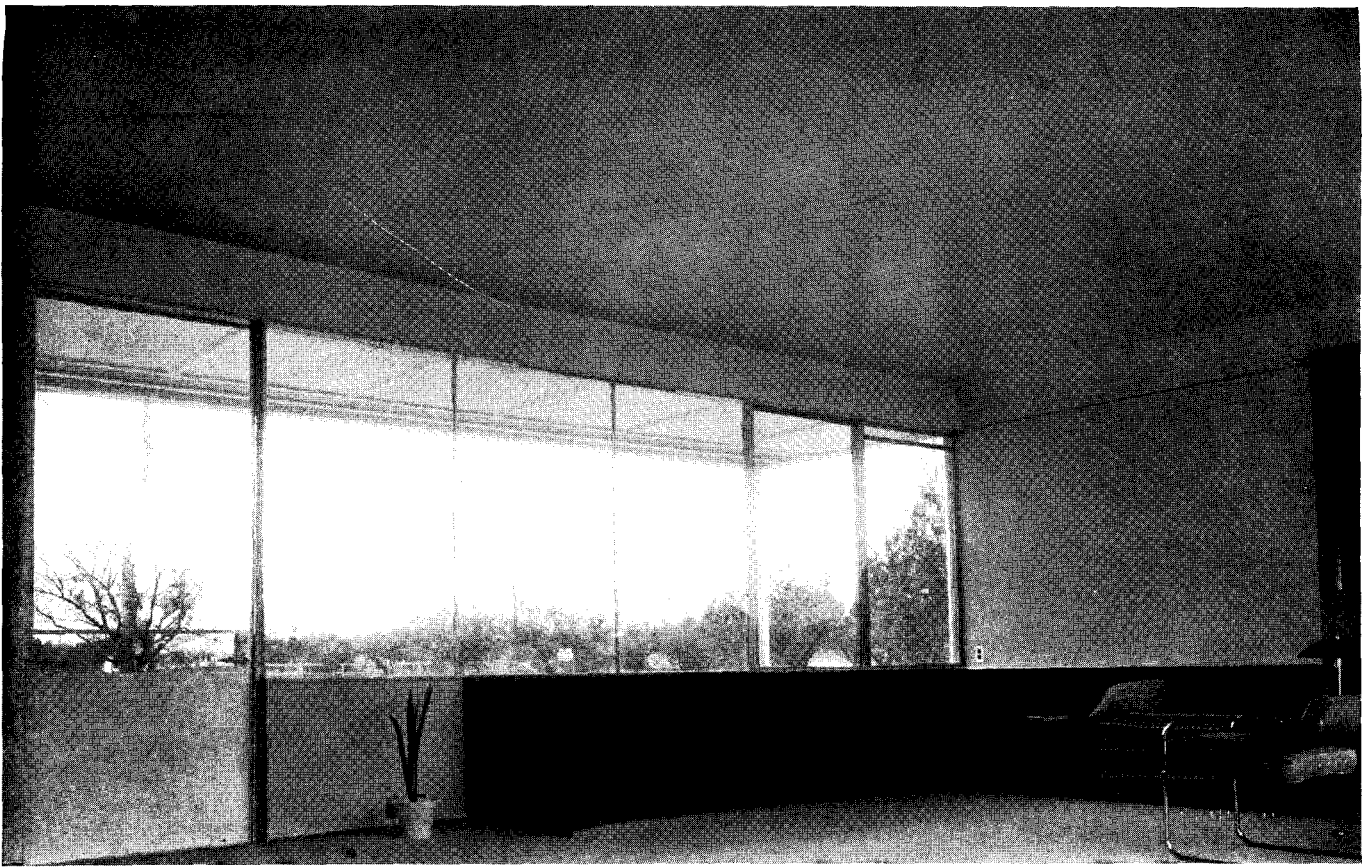

LIVING ROOM: Northeast corner, top; south wall with dining bay, bottom



MICHIGAN: SHORT-LIVED SHOPPING CENTER FOR UNSTABLE LAND

LELAND F. CHAMPLIN

Designer

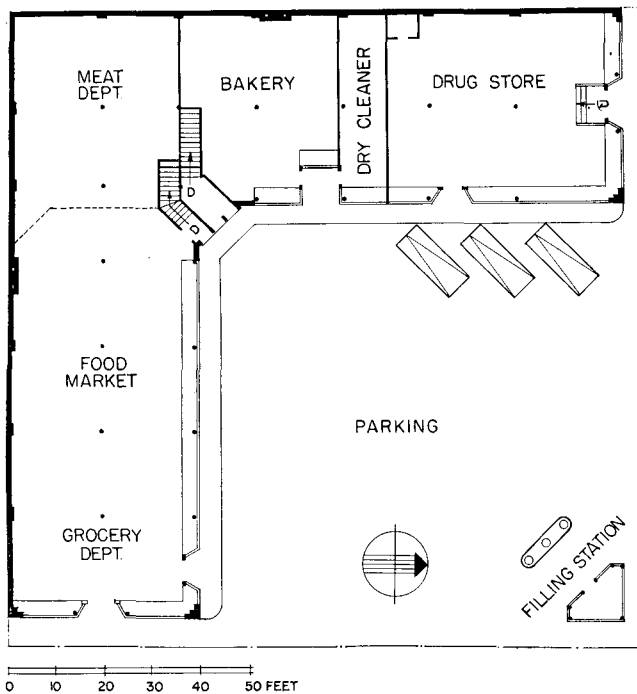

Ground Floor

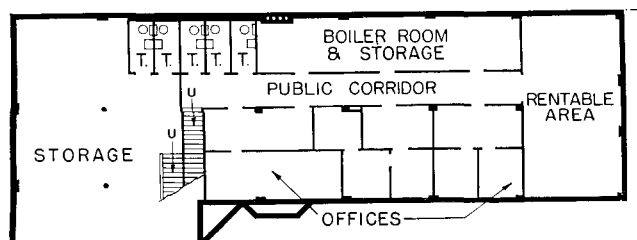

Basement

THE new shopping center for Dey W. Wilcox in Battle Creek, Michigan, was designed and built for temporary use, as a source of income until such time—estimated by the owner at 10 years—as more stable conditions in the neighborhood may justify a more permanent building. The building is situated on a main thoroughfare from Battle Creek's business district at the intersection of 5 streets—a site estimated to serve 20,000 people—and is designed specifically for motorists. Hence the L-shaped plan, which provides adequate parking space for shoppers' cars. At night the building and parking space are brilliantly illuminated by floodlights of 8,000,000 candlepower each. Planned for the future are permanent signs of aluminum, studded with amber prismatic glass and a 20-ft. tower of glass brick surmounted by a beacon.

Construction was kept simple for high salvage ratio. Materials used on the front elevations, selected with an eye toward easy cleaning, are almost exclusively glass: show windows are plate, pier facings are of black Carrara and the glass-block bulkheads serve the secondary function of admitting light to the basement stores. Foundations and basement walls are of reinforced concrete; retaining walls on lot interior above grade are of cement blocks, with furring strips and gypsum board on the building interior. Exterior finish of this cement-block wall is stucco. The projecting canopy is sheathed in burnished aluminum. Cost of the building was \$0.12 per cu. ft.

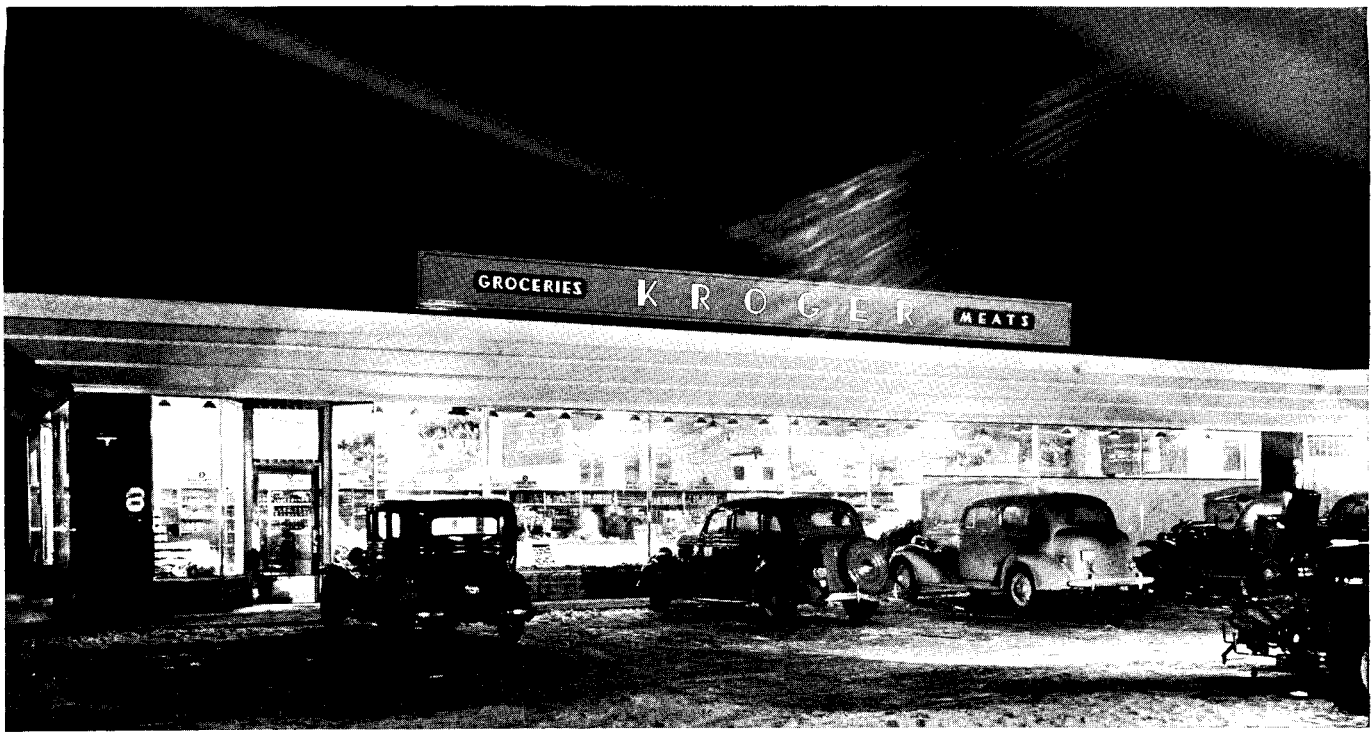

Night view of stores (above) and views from north and northeast (below)



Glass-walled service station



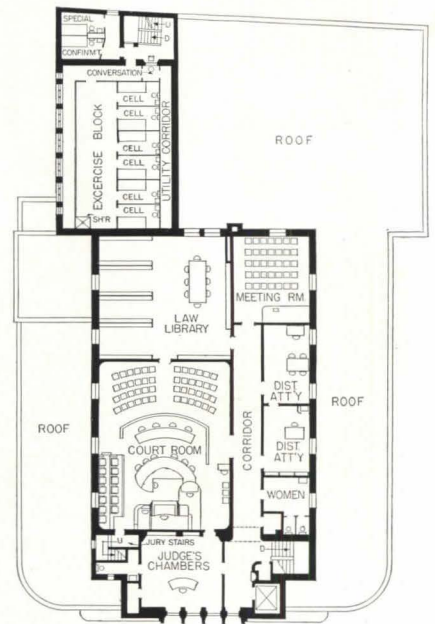

Third floor

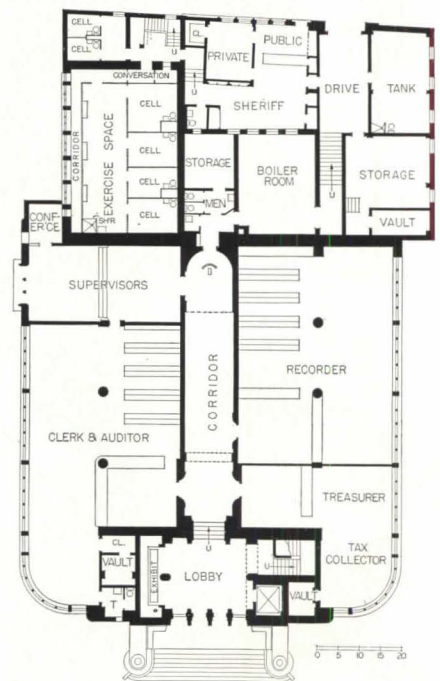

First floor



Maurice

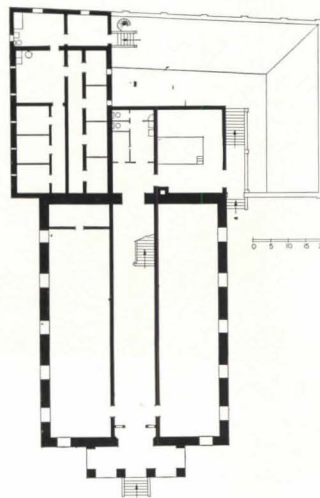

Original first floor

The original courthouse, built in 1864, remodeled in 1900, was of granite and painted brick, with galvanized iron trim. In the most recent remodeling of the building, rearrangement of interior and addition of two wings to the original plan more than doubled the usable office area.

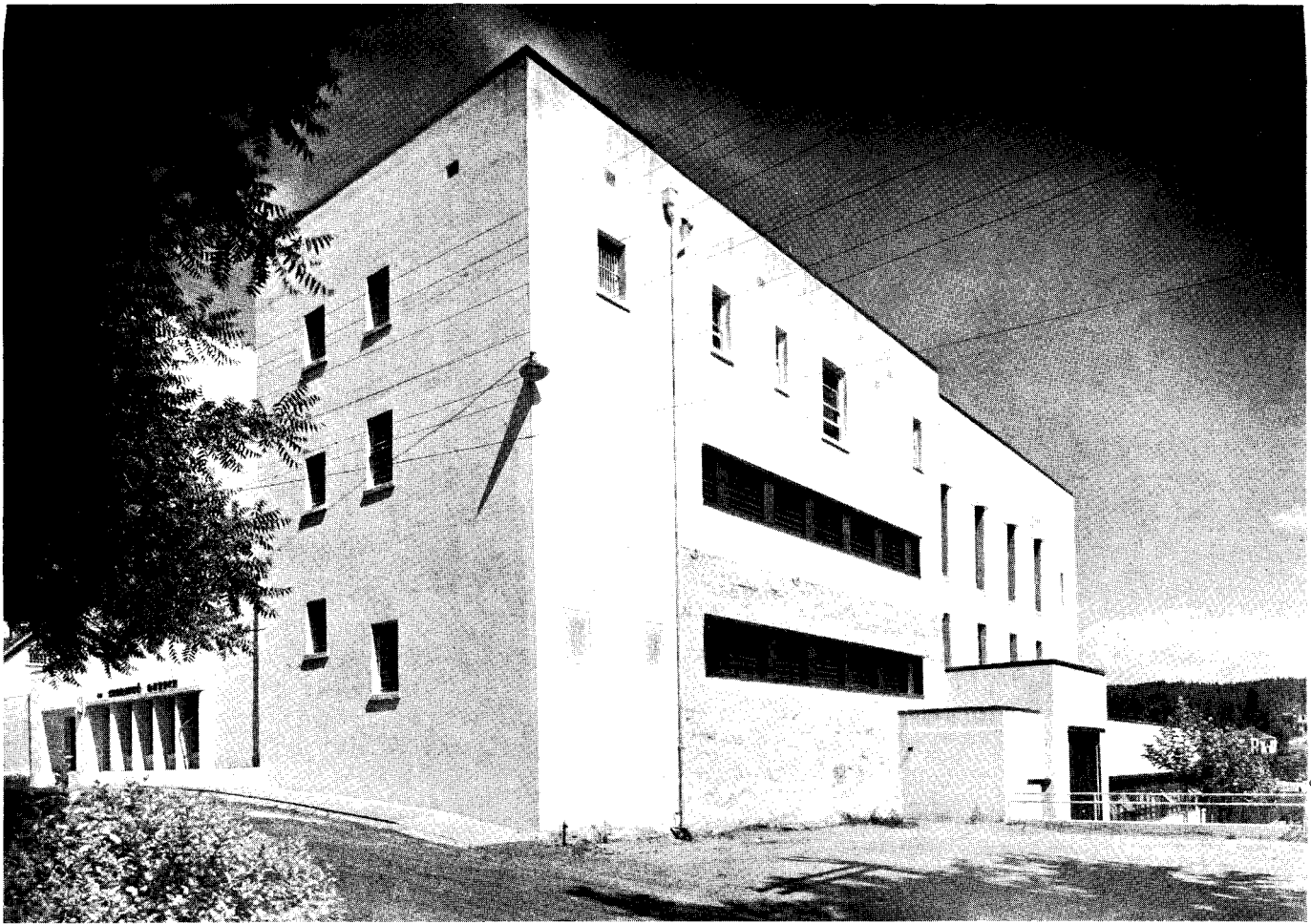

View from northwest showing jail section

CALIFORNIA GOLD RUSH COUNTY STREAMLINES ITS COURTHOUSE

GEORGE C. SELLON
Architect

NEED FOR MORE and modern office space prompted the remodeling of the old Courthouse at Nevada City, California, erected in 1864 when California was still a mecca for gold prospectors, and Victorian was the prevailing architectural style. Still the center of a heavy gold mining district, Nevada City found its physical equipment for law enforcement inadequate, and again remodeled its courthouse—for the second time in 35 years.

In providing additional office space, the whole character of the building was changed so that the present structure bears little resemblance to the Courthouse of early gold mining days. The elaborate galvanized-iron trim, and the granite and brick walls have been replaced by copper copings and smooth concrete surfaces. The original courthouse, built for impregnability, had three-foot granite walls up to the second floor, and interior partitions of brick. By removing the east and west walls (superstructure was supported by steel) and adding one-story wings on each side of the building, ample open work space was obtained on the first floor. The granite walls at the north end of the original building

have been retained and serve as an effective barrier between jail and office sections; at the south end, the granite wall has been incorporated into the construction of the main lobby which projects beyond the old building line. The frame construction of the jail interior was changed to steel and concrete, and cells were modernized and equipped with Invisigard windows on exterior walls. A new office for the sheriff and a jail tank were built on the north front.

The interior underwent similar changes; all the old trim was removed, and new walnut trim and doors installed. Windows were changed from wood to steel. New furniture, of oriental woods, upholstered in blue leather, was designed by the architect especially for the building. Floors in public spaces are terrazzo; other floors are linoleum except in the Judge's Chamber, Courtroom, and Supervisor's Room, where carpet is used. All ceilings are covered with acoustical tile; lighting is indirect. Modernization included installation of an air-conditioning system to serve the entire building, and new plumbing and electrical systems. Total cost of the work came to \$210,000.

NEVADA COUNTY COURTHOUSE

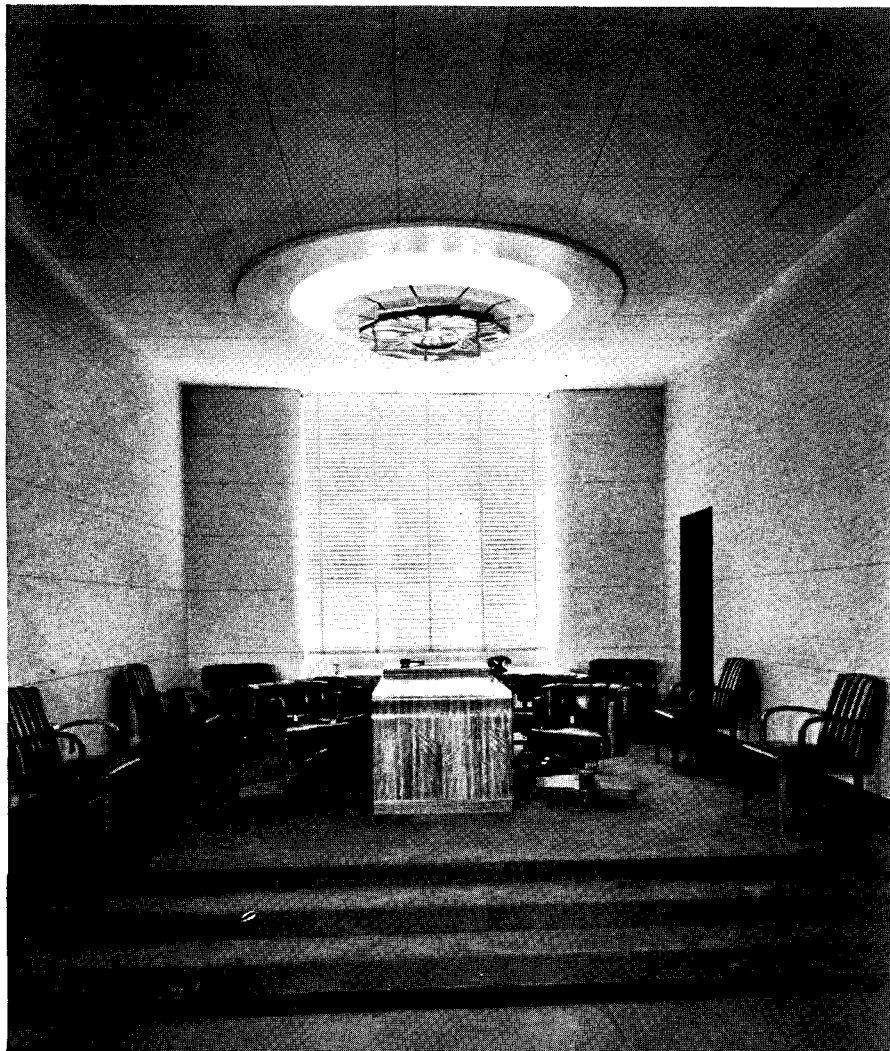
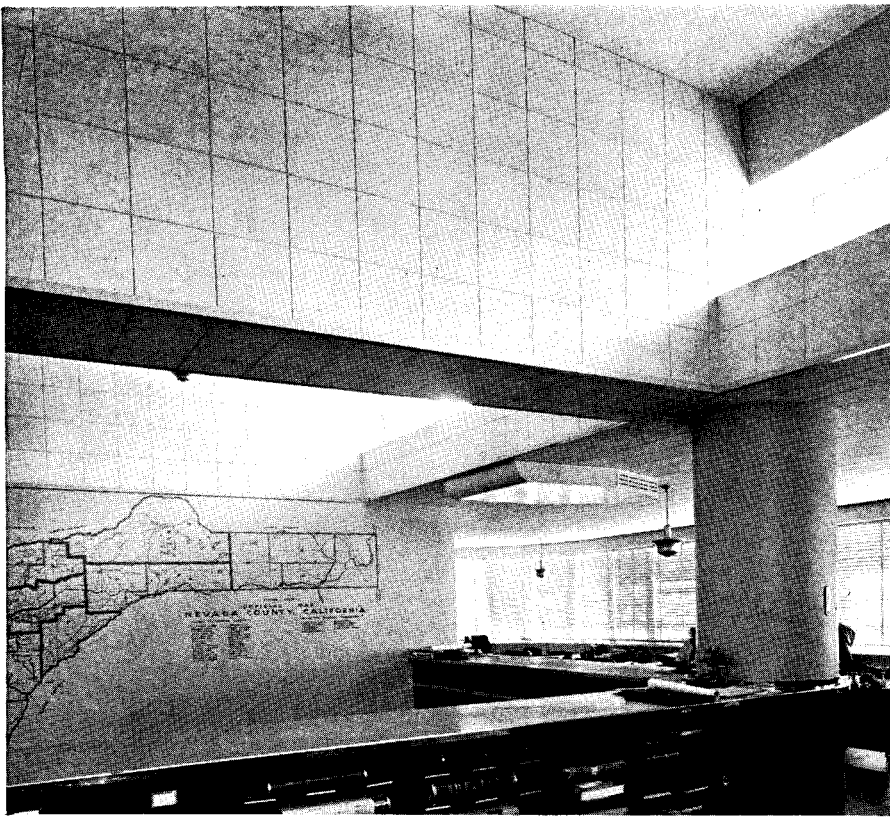

COUNTY CLERK'S OFFICE (above, left): Clerestory windows light the inner section of the first-floor office space. SUPERVISOR'S ROOM (below, left): walls, gray-green with cream striping; ceiling, cream; carpet, dark apricot. LOBBY (below): walls, gray-green; ceiling, burnished aluminum leaf; floor, terrazzo in green and red design; light fixtures and all trim, satin aluminum.



PLANNING DETAILS



The stair is built of $\frac{3}{8} \times 1\frac{1}{4}$ in. chrome-plated steel bars for the frame and seven $\frac{5}{8}$ -in. chrome-plated rods to each tread, and hangs from pins in the joist, one for each vertical member; the entire assembly is bolted. Rigidity is achieved by fixing the stair to the wall at four points. Airplane wire, laced through the vertical members, serves as handrail.

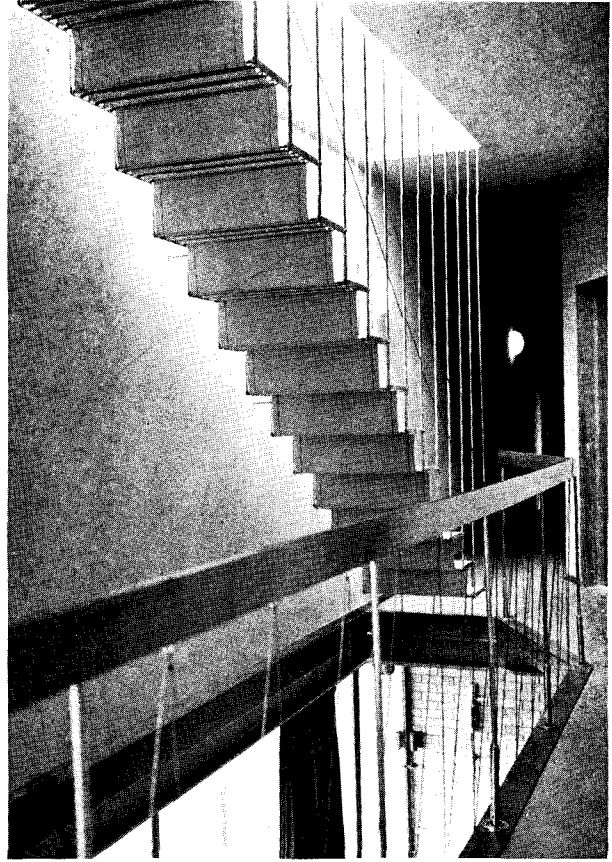

Eriksson & Westerblad

Swedish Architect Builds Canvas Stair

SIGURD LEWERENTZ
Architect

FACED WITH the problem of providing easy and permanent access to a roof deck which was to be used only for occasional sun-bathing, Architect Lewerentz arrived at this novel solution in a recent seaside house at Falsterbo, Sweden. His central design problem was to reduce the weight—both physically and psychologically—to an absolute minimum, without at the same time resorting to the conventional attic ladder. Thus, he borrowed light-metal members, wire, and fabric from the airplane designer and achieved a finished product which meets the original requirements. Because the riser in a well-proportioned stair serves a largely psychological purpose and need not be of rigid material, Mr. Lewerentz hit upon the idea of threading the steel skeleton with canvas. This involved no misuse of material since the entire load (including that on the treads) is carried by the skeleton; it also gave him a semi-translucent stairway.

FAIRS: IN TIMES OF WAR THREE NATIONS SHOW THE PEACEFUL ARTS

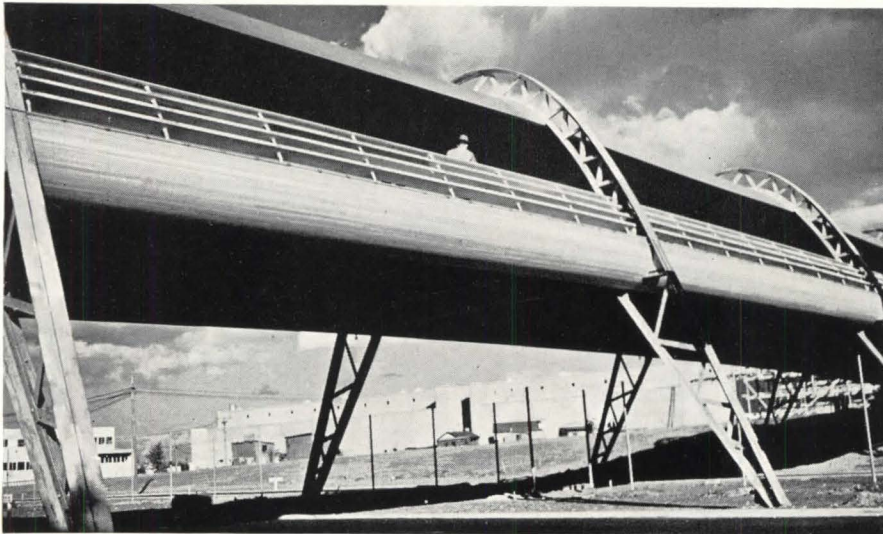
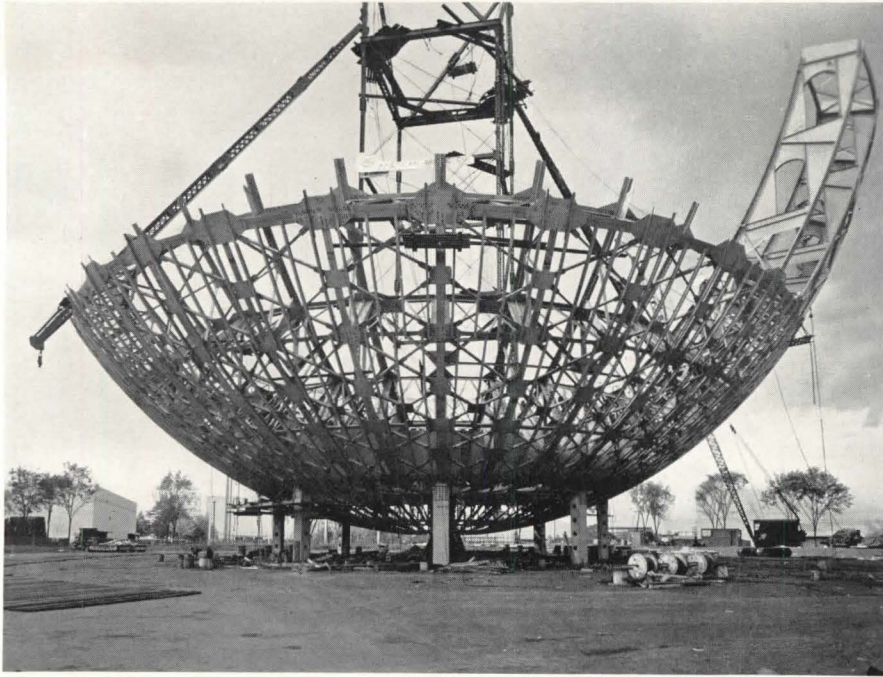

St. Thomas



Courtesy Claude Neon Lights, Inc.

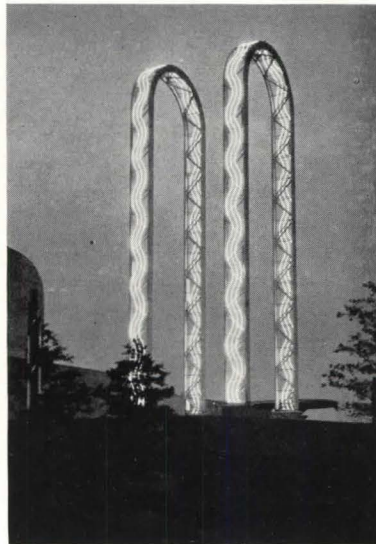

New York

With most of its own buildings already up or under way, emphasis in the New York World's Fair construction program is now shifting to commercial and foreign exhibitions. The Administration Building has been occupied for some time by the staff, and the Communications and Public Health Buildings are now temporarily used as exhibit halls for various competitions held in connection with Fair projects.

Steel framework for the Perisphere (top) is now practically complete, while that of the Trylon, just visible behind the Perisphere, is finished. Of novel design is the covered pedestrian overpass (center) which connects Administration and Communications Buildings. Framework, roof, and railings are metal; floor and sides are wood-sheathed. The Fair plans extensive use of the recently perfected fluorescent tube lighting. Two of the structures on which this new light source has already been installed are the Information Booth (bottom, left) and the towers of the Textile Building (bottom, right).

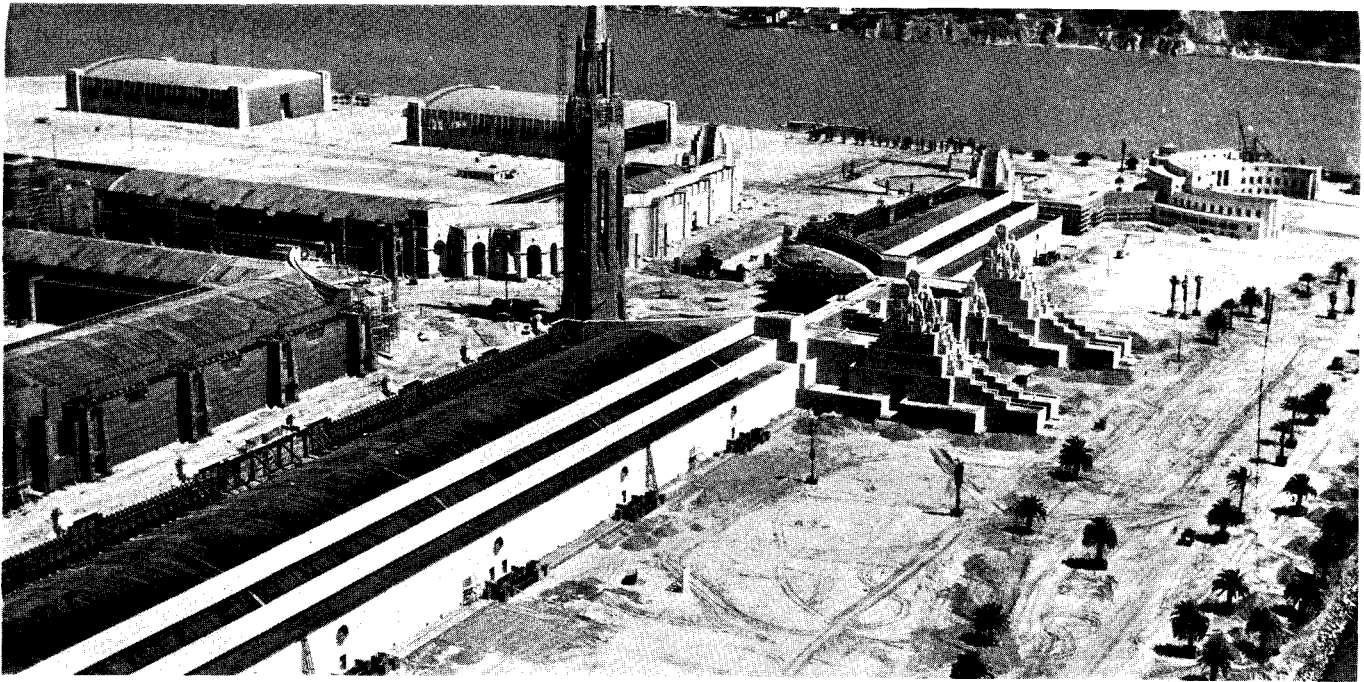

Frednag

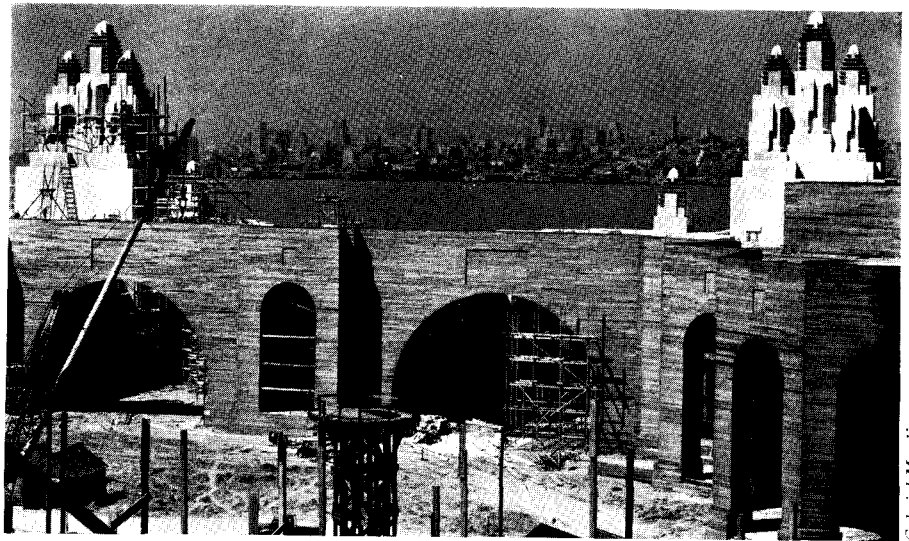

Gabriel Moulin

San Francisco

On the opposite side of the continent, the Golden Gate Exposition, having reclaimed its site from the bottom of the Bay, is hurrying to complete both architectural and horticultural work in time for the scheduled opening on February 18, 1939. Rapidly approaching completion is the Tower to the Sun (top), which stands in a circular court whose entrance is flanked by the massive Elephant Towers. The San Francisco skyline is seen (center) between the wood-framed Elephant Towers. After a barge trip over the Bay, palm trees (right) are towed into place. The thousands of palm trees now being transplanted onto Treasure Island represent only part of the Exposition's \$1,500,000 horticultural program.

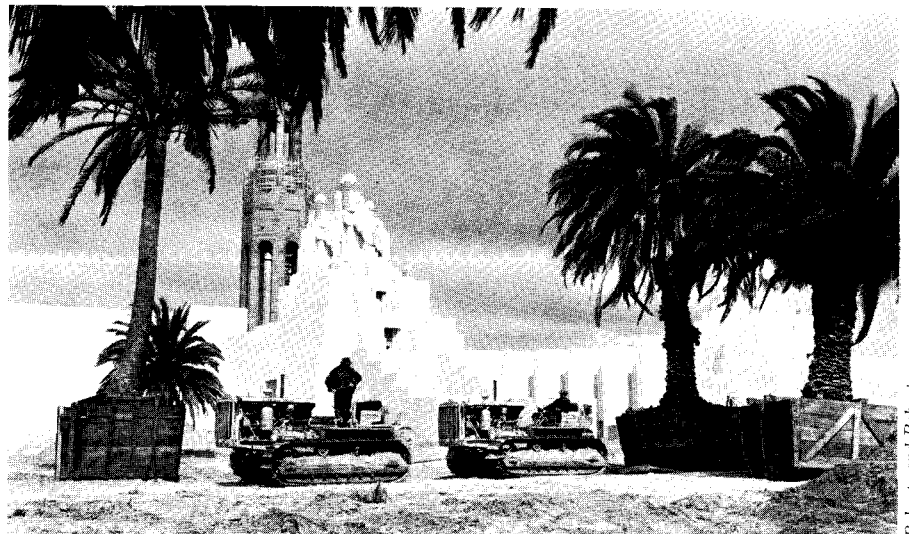

Roberts and Roberts

FAIRS



Globe

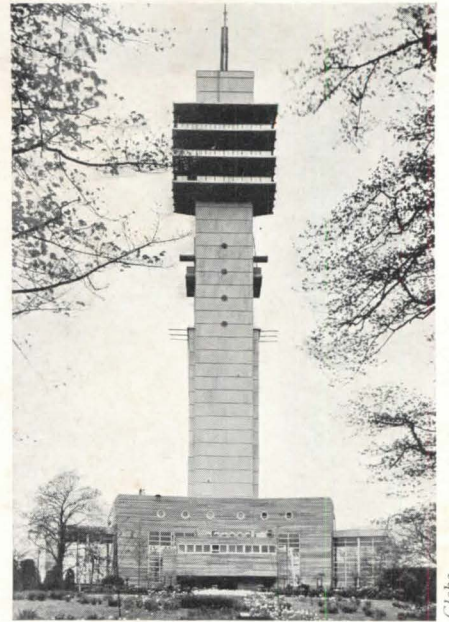

Globe

Glasgow

Scotland's Empire Exhibition, officially opened on April 26 by the English King and Queen, is situated on Bellahouston Hill, one of Glasgow's parks: "Tait's Tower" (above)—so named for the architect, Sir John Tait—employing an all-metal structural system novel to England, which has attracted considerable attention. At left is a night view from the Tower.



Courtesy, Museum of Modern Art

Moscow

Rapidly approaching completion are the exhibition buildings for U.S.S.R.'s All-Union Agricultural Exposition scheduled to open August 1. Nearly 100 pavilions are being built to house exhibitions on the science, practice, and mechanization of agriculture throughout the Soviet Union. The buildings will stand on extensive grounds—350 acres—in Pushkinskaya, a suburb of Moscow. Planned in two sections, the Exposition will be divided, first, according to republics, territories, and provinces of the U.S.S.R., and, second, according to various specialized agricultural subjects. At left is a perspective drawing of the Pavilion of Agricultural Mechanization.

PROPOSED BUILDINGS

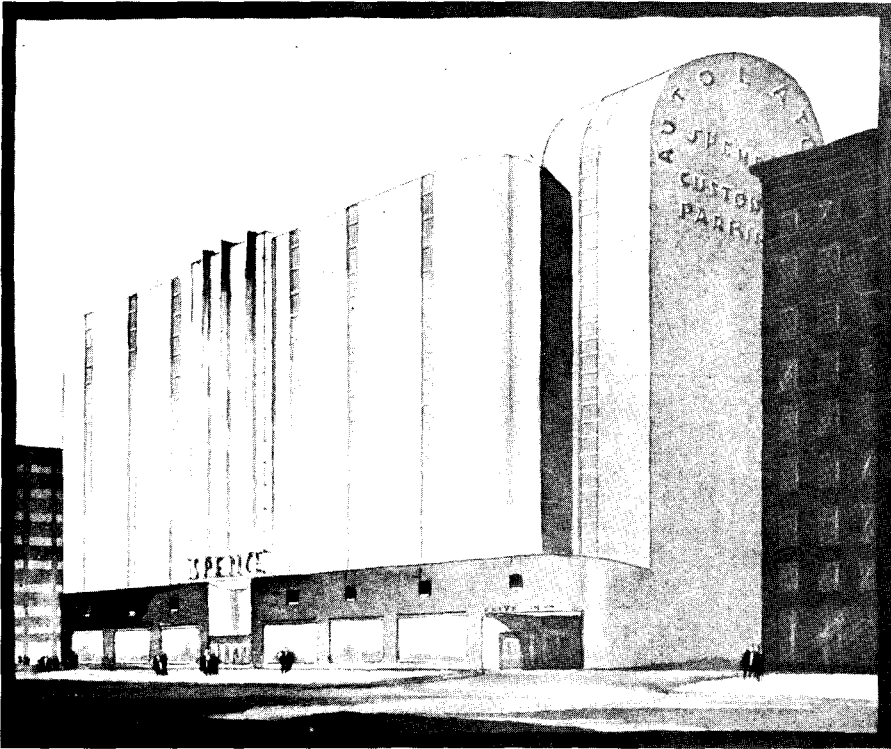

General view of a proposed department store installation.

E. PAUL BEHLES & ASSOCIATES, INC.
Architects

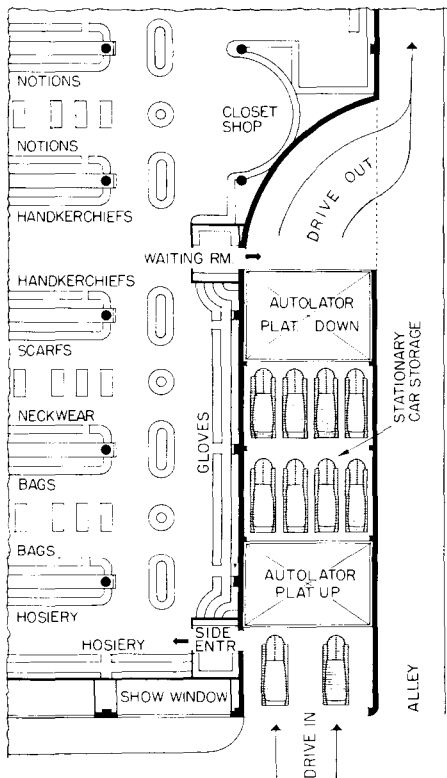

Ground-floor Plan

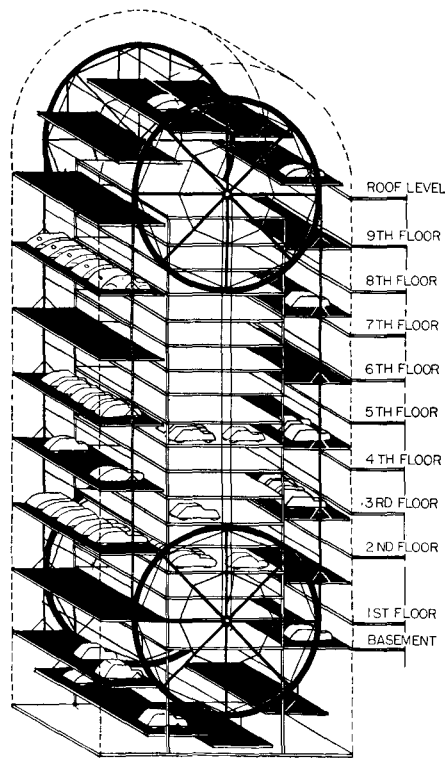

Isometric view of mechanism

Baltimore Architects Design Ferris Wheel Garage

EXTENSION and refinement of the "Ferris wheel parking" evolved several years ago in the Middle West (see AR, 5/31, pp. 94, 96; 1/33, p. 69), the Autolator is more flexible, more convenient, and has greater capacity, according to Paul Behles & Associates, Baltimore architects, who designed the Autolator. Developed especially for use in conjunction with large department stores, the Autolator is adaptable to buildings from 3 to 12 stories high, and may be constructed within the existing store building or directly adjoining. Access must be provided, on all floors, directly from the Autolator into the store. Local conditions and capacity required determine the size of the Autolator, but 400 cars can be parked on an Autolator, 30 x 80 ft., attached to a nine-story building. Since the device is estimated to attain 6 turnovers a day, it is possible to accommodate 2,400 cars daily in about one-fourth the usual space required.

Most unusual feature of the device is the rapid service it makes possible: maximum time required for a full revolution of the Autolator is one-and-a-half minutes. The customer drives directly onto the Autolator at street level, is lifted to whatever floor he desires, and there disembarks. When his business is completed, he goes to the first floor and presents his check; in less than two minutes his car is delivered to him. Exit is directly to street or alley. The service is specialized: short-term parking is handled on the revolving platforms, while long-term parking is on the intermediate stationary platforms. Delivery of a car from one of these platforms takes from 1 to 4 minutes.

Safety devices protect the customer against every possible accident: platforms automatically stop level with the floors, and platforms cannot be set in motion until all safety switches have been set at the entrance and exit. Signal lights for the various operations are located on every floor. There is no fire hazard involved in the installation, claim the designers, as the entire mechanical equipment is of steel and is self-contained within a fireproof shell. Entrances and exits are provided with double automatic fire doors.

Construction cost varies with the location and the capacity of the Autolator; in general, however, the cost is approximately \$300 per car. Several projects are being surveyed for possible installation of the Autolator, the largest of which will have a capacity of 800 cars.

NEW STRUCTURAL SYSTEMS

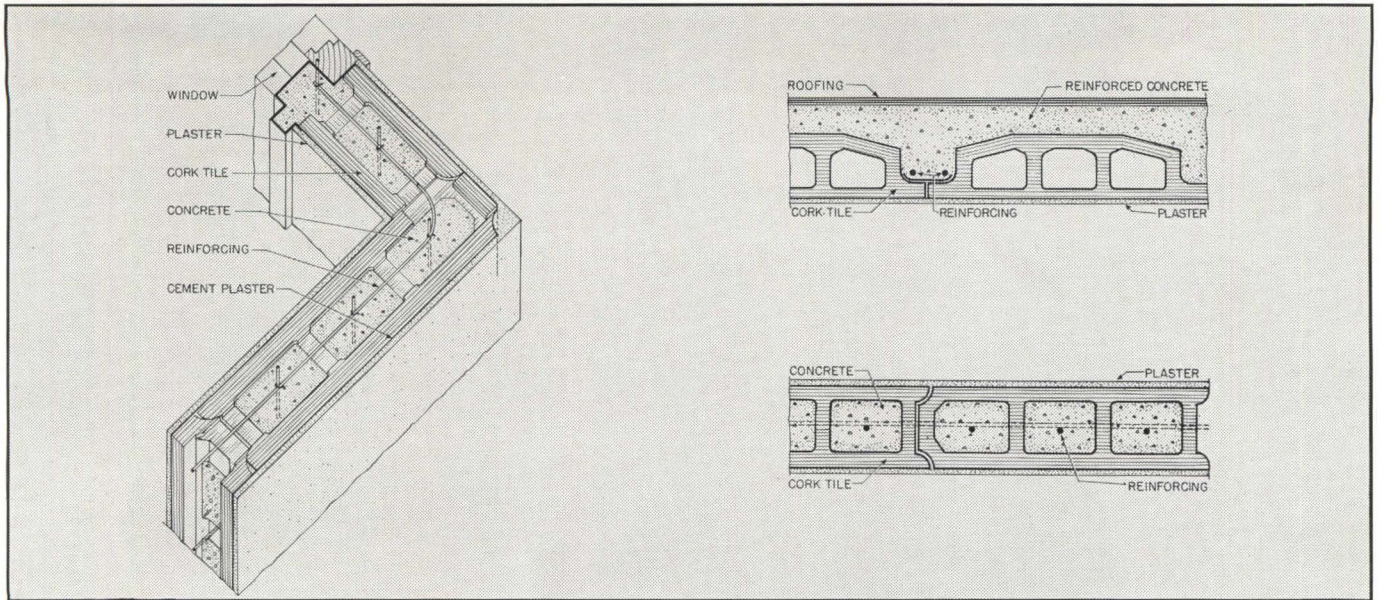

Concrete-filled cork tile system reduces wall thickness, provides insulation

MORE FAMILIAR in Europe than America is a system of wall and roof construction which uses hollow cork tiles, similar in form to hollow concrete blocks or hollow clay tile units. The wall tiles are filled with concrete, for strength and solidity, and are laid up in courses just like their better-known prototypes. Roof units act as filler blocks for concrete slab and beam construction. Advantages claimed for the system are insulation from cold, heat, and noise; speed in erection and consequently lower building costs because of the light weight of the cork tile; and reduction in wall thickness, which allows a gross area 6 to 10% smaller than in usual masonry construction.

After foundations are built and first-floor concrete slab is poured, temporary wooden wall bracing and shoring for second story and roof are erected, and scaffolding, for use of tile setters and concrete conveyors, is placed around exterior of building. Door and window frames and trim are attached to the temporary exterior wall facing. The first course of cork tiles is laid on the floor slab against the wall bracing; voids in the tiles are filled with concrete, and well tamped for a dense compact fill. The same procedure is used for succeeding courses until second-floor level is reached. At this point the second-story floor slab is poured, wall bracing and roof shoring erected, and tile courses laid as before.

At roof level, cork roof tiles are placed on a temporary roof platform, and act as a filler which supports the concrete roof slab and provides the form

for the reinforced-concrete roof beams. Precast concrete girders are used to carry roof construction where necessary.

An exterior finish of clean sand, Portland cement, and slaked lime, applied directly on cork surface, is recommended. This plaster mix should be applied in a thin coat and must be made with a minimum amount of water, since

no appreciable amount of moisture is absorbed by the cork. Gypsum plaster is preferable for interior finish and can be applied in one or two coats. Where two coats are used, the first consists of gypsum and slaked lime; the second is gypsum only for a smooth finish, or gypsum and slaked lime for a rough finish.



Slum clearance—1938 style

One constructive use for these instruments of war was recently discovered when a row of condemned cottages at Dorset, England, was demolished to prevent further habitation. Charging full speed ahead, the tanks made quick and spectacular work of wrecking the houses, while ex-tenants looked on.

NEW MATERIALS

Fluorine-free water obtained by bone filter

THAT FLUORINE in drinking water can cause chalky bones and mottled teeth is a long-known fact, but until recently the widespread presence of this most reactive of elements was unsuspected. Waterworks in affected areas have had no means of filtering out this destructive gas—one part of fluorine in a million of water is sufficient to cause defective bone structure—and it was not until Prof. H. V. Smith of the University of Arizona began to work on a bone filter that a feasible means of defluorinating water was established. According to Prof. Smith, bone baked at a high temperature can easily be wet and will effectively remove all traces of fluorine from water. Basing his experiments on the assumption that a filter made from the very bones which fluorine attacks would be the best, Prof. Smith found that the surface of bones becomes altered after being baked in an oven at 1000°, so that henceforth they are not water-repellent. Subsequent experiments proved the correctness of this assumption, for after filtering water through bone no traces of fluorine remained.

An ample source of bone filter is the bone meal made by packing plants. In laboratory production, however, the bone filter costs from one to two cents a pound. Two pounds of this filter will remove the fluorine from 500 gallons of water; the used bone can then be washed with chemicals and used over and over. Small filters for private homes have already been made by University of Arizona scientists, and have proved satisfactory in use.

Rubber-derived coatings protect materials from corrosion

FOR USE where exposure to moisture, alkalis, acids, etc., would cause corrosion or deterioration of metal, wood, or concrete, a series of protective coatings have been developed by the Good-year Tire & Rubber Co., Inc., Akron, Ohio. Known as Plicote Laboratory Paints, these coatings are derived from a rubber base which contains more than 92% by weight of rubber hydrocarbon and is claimed to have most of the advantages of rubber without some of its disadvantages. The most salient characteristics of the material, according to the manufacturer, are extreme hardness and density of film which make it especially resistant to abrasion. Maximum hardness is reached in approximately 10 days, at which point oxidation is com-

plete. Luster of the film varies with the type of coating—an important consideration where light conditions are poor: Aluminum Plicote has a reflective factor of 61% against 68% for White Plicote. Light metal coated with a film of Plicote can be fabricated without danger of cracking or flaking of the film, it is claimed. Application is by spraying, brushing, or dipping. Plicote will cover, on an average, from 50 to 75% more area than oil paints, according to the Fisher Scientific Laboratories, Pittsburgh, Pa., distributors for the products.

Spongelike glass is newest acoustical material

“FOAM” GLASS, filled with millions of tiny pores which absorb and dissipate sound waves, is the latest development in acoustical insulation materials. The exposed surface of the block is covered with these pores; sound waves enter the block but are dissipated before they can penetrate the building. Although developed primarily for its practical application, the glass is readi-

ly adaptable for decorative purposes as well, since it can be molded in any shape, and colored to harmonize with furnishings. Patents for the glass have been granted to Games Slayter of Newark, Ohio; actual development of the product took place in the laboratories of Owens-Illinois Glass Company.

Soap used in electroplating produces nontarnishing silver

ADDITION OF SOAP and such chemicals as carbon bisulphide to a silver electroplating bath produces a silver plating which needs no polishing, according to two British inventors, Alan R. Powell and Emyr C. Davies of London. The nature of the soap used determines the necessary amount, but this should be sufficient to produce a permanent lather when the solution is shaken. The complex reaction of soap and other chemicals deposits silver in minute “sub-microscopic” crystals of a fine-grained structure. Patents for the use of this process have been assigned to the firm of Johnson, Matthey and Company, London, England.

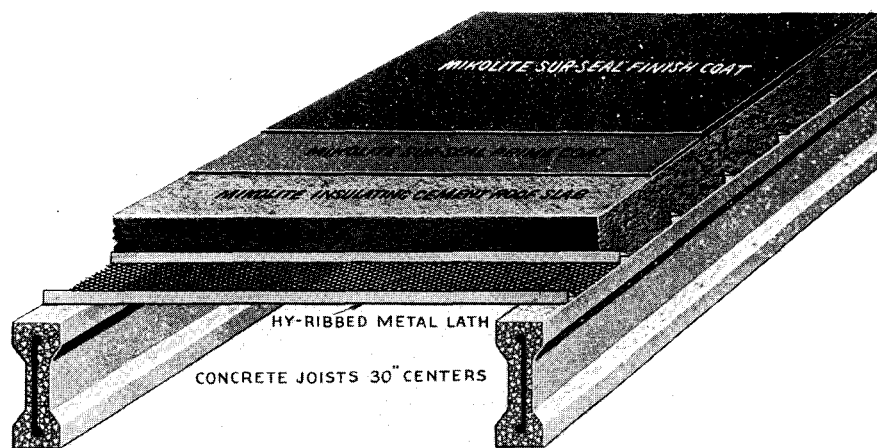

Insulating cement roof requires no built-up finish

POURED DIRECTLY on steel lath, this monolithic cement insulating roof requires only two coats of waterproofing. The system is a development of the Mikolite Co., 1100 S. Mill St., Kansas City, Kans., which recently became a subsidiary of Lehigh Portland Cement Co. In tests conducted early this year where a load of 1,300 lb. was carried for 18 hrs., no fracture or failure occurred, nor was bond between Mikolite plaster and concrete joist broken. A total deflection of .0468 in. was found after 18

hrs. of concentrated load. Load per square for the tests was 530.61 lb. Although the test slab was poured on concrete joists, Mikolite Insulating Cement may be applied monolithically on wood or steel roof decks or on old built-up roofs. There is no expansion or contraction, and the material is fire- and decay-proof, the manufacturer claims. Built-up felt or paper-finish surfaces can be used if preferred, but, according to the manufacturer, two coats of waterproofing are sufficient protection.

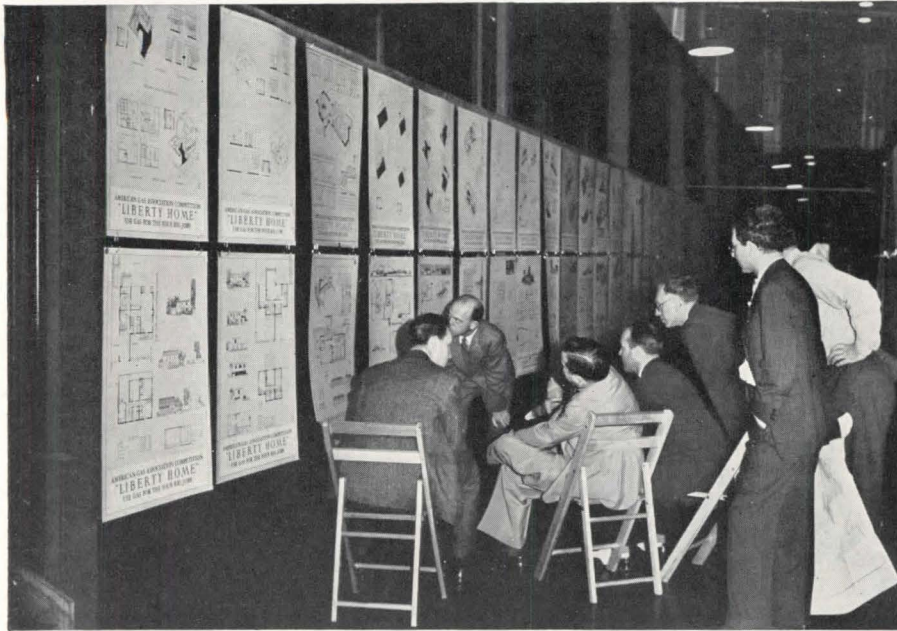

Picking 27 winners out of 675 contestants, a jury of architects, developers, and town planners: (left to right) Otto Teegen, Roy Kelley, Hugh Potter, Waverly Taylor, W. J. Collett, Clarence Stein and Eric Haldenby

American Gas Awards Reveal Modern House Trend

To A VICTORIOUS twenty-seven architects and designers went prizes totaling \$13,700, spoils of American Gas Association's small homes and neighborhood planning competition, which closed late last month. The designs—from all parts of this country and from Canada as well—"revealed a distinct trend in

domestic architecture—that of determination to get away from stereotyped designs of homes, to be definitely creative instead of merely reproductive of long-used types," according to H. Roy Kelley, chairman of the jury.

Since the competition is the main feature of AGA's campaign to boost the

use of gas in the home, the use of gas equipment was a primary requirement of the designs. In this respect, says Dean Joseph V. Hudnut of Harvard University, who was a member of the jury, "the competition as a whole illustrates that the central problem of architecture is the necessity of reconciling one's preferences in form with a new technology. Architecture must make a unit of technical and aesthetic forms."

The competition was divided into three classes. Class I called for design of a completely gas-equipped residence for an average American family, containing 18,000 to 24,000 cu. ft. Class II was similar to Class I, except that the residence was to contain 24,000 to 32,000 cu. ft. The third division of the competition was devoted to neighborhood planning; contestants were given a hypothetical plot plan for the layout of a community in which each house was a unit of the whole.

Winners of the four first prizes of \$1,000 each in Class I, were: W. C. Houtz, Arthur McVoy, and Leonard Wayman, Bloomfield Hills, Mich.

John Stenken, Leonia, N. J.
Clarence W. Jahn and Edwin A. Wagner, Milwaukee, Wis.

Alden Becker, Los Angeles, Calif.
In Class II, four first prizes, also of \$1,000 each, were awarded to:

J. Byers Hays, Russell Simpson, and Byron Hunsicker, Cleveland, Ohio.
Joseph Shilowitz, Jersey City, N. J.
Hugh Stubbins and Marc Peter, Jr., Boston, Mass.

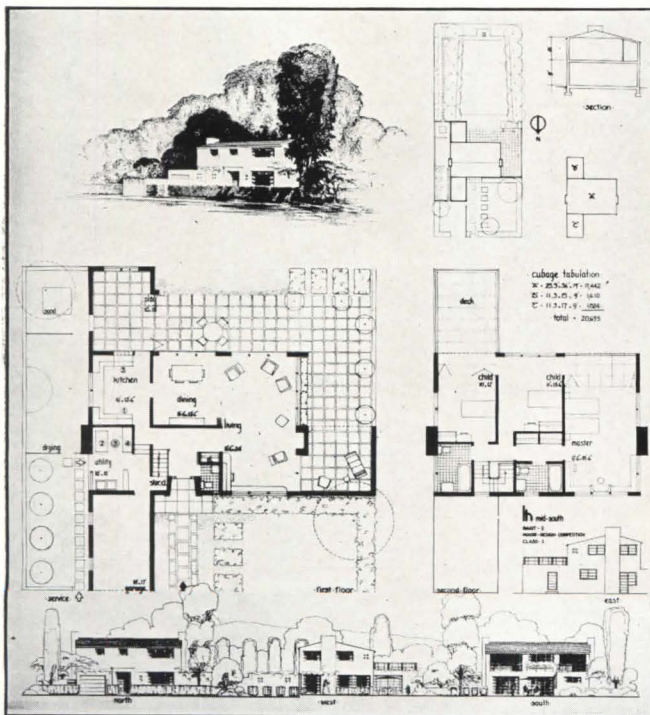

Part I, Class I: John Stenken, Leonia, New Jersey

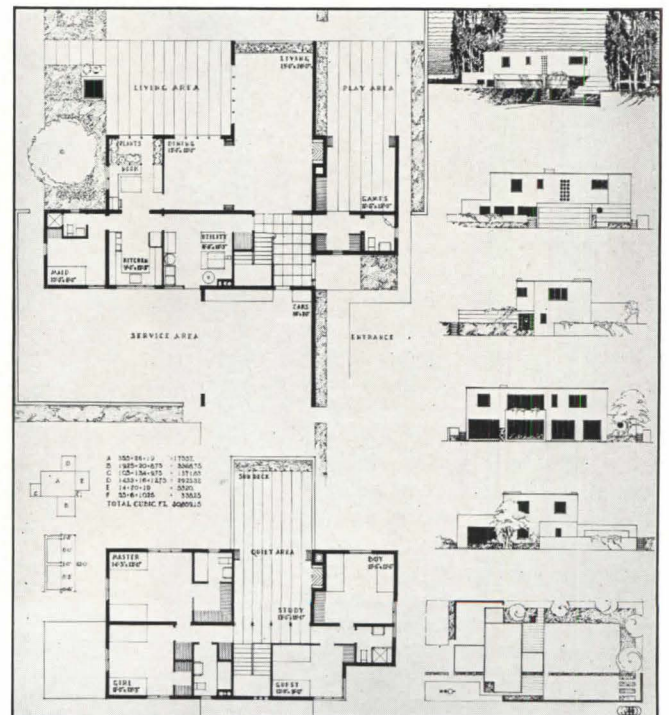

Class II: Jahn and Wagner, Milwaukee, Wis.

Clarence W. Jahn and Edwin A. Wagner, Milwaukee, Wis.

Four \$300 prizes and four \$200 prizes were also awarded in both Class I and Class II.

For the best solution to the problem proposed in the Neighborhood Planning competition, W. Stuart Thompson, Donald McLaughlin, and Joseph Whitney, New York, N. Y., won first prize of \$1,000. In addition, there were awarded in this class three second prizes of \$500 each, and one third prize of \$200.

Members of the jury represented all parts of the country and a number of fields of the building industry. H. Roy Kelley, Los Angeles architect, was chairman of the jury; other members were Dean Joseph V. Hudnut, of Harvard University; Eric W. Haldenby, Toronto, Canada, architect; Richard Koch, New Orleans, La., architect; Alfred P. Shaw, Chicago, architect, president of the Metropolitan Housing Council, and member of the Executive Committee of the Chicago Plan Commission; Otto Teegen, New York, coordinating architect for the New York World's Fair Shelter Section; Walter Collett, Scarsdale, N. Y., president, Collett Construction Co.; Hugh Potter, Houston, Tex., chairman, Houston City Planning Commission; Waverly Taylor, Washington, D. C., president, Operative Builders Association of the District of Columbia; Clarence S. Stein, New York, town planner.

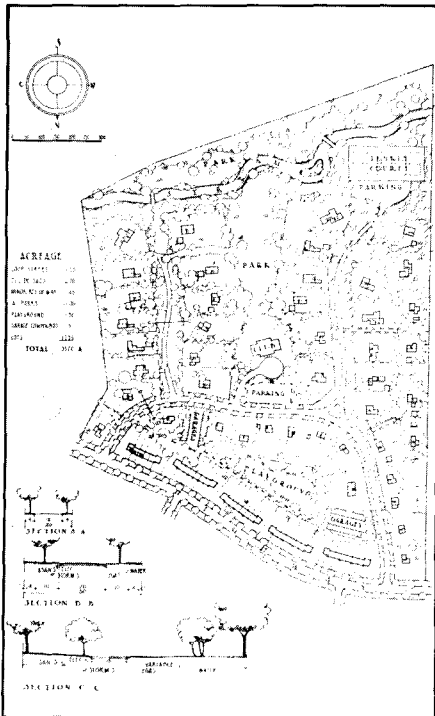

Part II: McLaughlin and Whitney, N.Y.C.

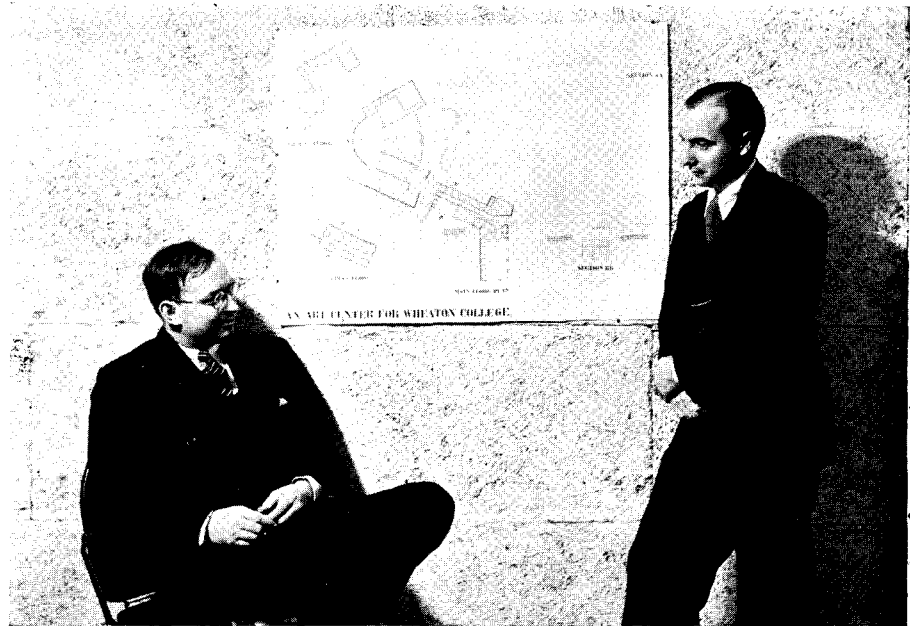

Courtesy, Museum of Modern Arts

Richard M. Bennett (left) and Caleb Hornbostel (right), co-winners of the Wheaton competition, with their prize-winning design (center)

Invited Participants Trail in Wheaton College Awards

TWO NEW YORK draftsmen, Richard Bennett and Caleb Hornbostel, last month startled the architectural world by running away with the Wheaton College Competition—leaving behind a field which included not only four famous invited participants but also 238 other entrants from all over the United States. The competition, run jointly by The Architectural Forum and the Museum of Modern Art, was distinguished from the start by several factors. It was being run for one of the country's oldest and most conservative schools (see AR, 6/37, p. 27); it had invited (and paid) participants; it wore an uncompromisingly modern bias, a preference which was emphasized by the choice of invited participants—Gropius, Lescaze, Lyndon and Smith, and Neutra.

And as if further to emphasize the point, John McAndrew, curator of architecture for the Museum and chairman of the jury, said: "Recent college building in America has been chiefly pseudo-Gothic or pseudo-Colonial. Neither style is fitted to solve the contemporary problems of recitation hall, gymnasium, or dormitory. True Colonial architecture rarely had to deal with large-scale buildings of complex function comparable to those our colleges need, and the old style loses a majority of its virtues when 'adapted' to meet conditions unsuited to it. With Gothic it is even worse, for this style was developed from a special type of construction and whole way of life so for-

eign to us that any attempt to build in the style today is a pathetic travesty."

Requirements for the art center, which might be either a single building or a related group of buildings, included an auditorium seating 500, a smaller theater for concerts, lectures, etc., a music and art library, exhibition galleries, studios for music and art, workshops, and classrooms. The Bennett-Hornbostel design embodied these requirements in a single building—the auditorium block fan-shaped, with the classrooms and library in a long wing. The many diverse needs of an art center, said the jury, "are provided for and related to one another with a maximum of efficiency and a minimum of cubic space and maintenance expense. The plan allows for the individual operation of any single unit apart from the others: the library can be kept open at night with the rest of the building closed off, unlighted and unheated. This can also be done with other units, such as the theater, lecture rooms, etc."

Close second in the competition was the design submitted by Walter Gropius and Marcel Breuer, now of the architectural department of Harvard University.

Awards were also made to the following: *Third place*: Paul Wiener, John W. Stedman, and Pierre Bezy, New York, N. Y. *Fourth place*: Alexis Dukelski, New York. *Fifth place*: Percival Goodman, New York, N. Y., Lyndon and Smith, Detroit, and Eero Saarinen, Bloomfield Hills, Mich.

WITH THE PROFESSION

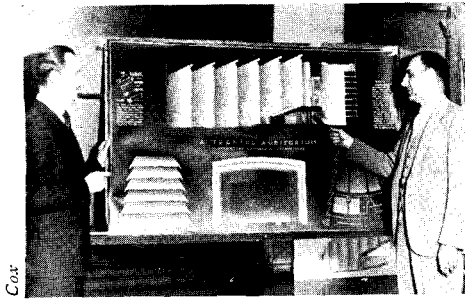

For his design of a theater auditorium to be built in a residential section, A. S. Pawlan, architectural student of the University of Illinois, received first prize in the annual competition sponsored by the Illuminating Engineering Society and the Beaux Arts Institute of Design. Otto Teegen (left), director of the BAID, and J. W. Barker (right), dean of Columbia's College of Engineering, are shown above examining the winning design.

Michigan graduate wins Booth fellowship

ROBERT C. MAY, 1938 graduate of the University of Michigan, is the winner of this year's George G. Booth Traveling Fellowship in Architecture. Mr. May's design for a repertory theater was placed first in a competition for the award.

Seven get Langley scholarships

SEVEN EDWARD LANGLEY scholarships for advanced study, travel, and research in architecture have been awarded by the American Institute of Architects for 1938-39.

The grants went to the following: Elizabeth Coit, architect, New York City, for continuation of research in economical design and construction of single-family dwellings and apartment houses undertaken under a Langley scholarship awarded to her in 1937; Clement Johnston Ford, architect, Atlanta, Ga., for travel in Europe to study housing; Jack Donald Gilchrest, architectural draftsman, Santa Barbara, Calif., for study at Harvard, Columbia, or the University of Pennsylvania; John T. Jacobsen, architect, Seattle, Wash., for travel in northern Europe and eastern United States to study low-cost housing; James D. Murphy of Pontiac, Ill., graduating student at the University of Illinois, for study under Dr. Walter Gropius at Harvard University; James L. Murphy, Jr., Andalusia, Ala., graduating student at the Alabama Polytechnic Institute, for study toward a master's degree in architecture at an American college of architecture; and Charles A. Pearson, Jr., architec-

tural draftsman, Pittsburgh, Pa., for study at Harvard University.

WPA sculptor awarded first place

FIRST PLACE in the Metropolitan Life Insurance Company's competition for a statuary group to be used in its New York World's Fair exhibit has been awarded to Thomas G. Lo Medico, New York sculptor. The competition called for a sculptured group of not less than three persons which would be symbolic of the American family. The winning design will be executed in plaster for the exhibit and later in marble or bronze for permanent display in the Company's offices.

West Virginian wins U.S. sculpture award

WINNER OF the \$10,000 prize for a piece of sculpture to adorn the U. S. Government Building at the New York World's Fair is Harry Poole Camden, Parkersburg, W. Va. Mr. Camden's model of a statue depicting "Unity" was chosen over 430 entries from all parts of the country. The statue will be 36 ft. high and will stand on a corbel above and to the right of the Hall of Legislature of the Federal Building. The winner will also execute a similar statue symbolic of Peace which will be placed over the door to the Hall of Judiciary. In addition, Mr. Camden will design an American eagle to be used over each entrance to the Federal Building, and four rectangular panels symbolizing Animal Industry, Agricultural Industry, Manufacture and Natural Resources.

U.S. announces mural competition

OPEN TO ALL American painters is a national competition for designs of mural paintings to decorate the two Great Halls of the U. S. Government Building at the New York World's Fair. Subject matter of the paintings is to symbolize or be related to the functions of the Judicial and Legislative branches of the Government. The space to be decorated is centered over the door to the Exhibit Hall, and will be artificially lighted by a continuous cove lighting strip. Each artist must submit two full-color paintings, one showing the mural design in $\frac{3}{8}$ -in. scale, and one showing the mural in relation to the surrounding architecture of the Hall. An award of \$5,000 will be made for the winning design for each Hall. Artists should signify their intention of competing by writing to Edward Bruce, Section of Painting and Sculpture,

Treasury Department, Procurement Division, Washington, D. C. The competition closes September 1, 1938.

Rockefeller Center to hold first national competition

A NATIONAL competition for a decorative panel depicting "News," to be used on the Associated Press' new building at Radio City, has been announced by Rockefeller Center, Inc. This is the first such competition in the architectural history of Rockefeller Center. It is open only to sculptors who are American citizens. The panel, showing the collection and distribution of news throughout the world, is to be 18' x 23', and will be cast in bronze. First prize is \$1,000, second prize \$500, and third prize \$250; in addition, if the winning design is approved both by Rockefeller Center and The Associated Press, the sculptor will be awarded \$6,500 for carving the design over the doorway to the building. Closing date of the competition is September 30, 1938.

Yale to expand curriculum

AS PART OF its plan for expansion and modernization of the architecture curriculum Yale University School of Fine Arts last month announced appointment of three men to its faculty. These are Wallace K. Harrison, New York architect, associated in the design of Rockefeller Center, who will be professor of architectural design; William Parsons, Chicago, who will extend the scope of the program in town planning; and Max Abramowitz, formerly design critic at New York University, who will provide a continuity of criticism. Yale's new policy is designed to take full cognizance of the fact that individual buildings are no longer designed without regard for surrounding buildings, according to Dean Everett V. Meeks of the School of Fine Arts; hence, additional emphasis will be placed on group and town planning.

N.Y.U. gets industrial design course

DONALD DESKEY, New York industrial designer, has been appointed head of the Department of Industrial Design of New York University's School of Architecture and Allied Arts. Under Mr. Deskey's direction courses will be given in Product and Textile Design, Furniture, Packaging, Tools and Materials of Industrial Design and Advertising Art. Collaborating with Mr. Deskey in presenting these courses will be Winold Reiss, Edward D. Stone, Albert C. Schweizer, Rene Chambellan and Estelle M. Armstrong.

DESIGN TRENDS

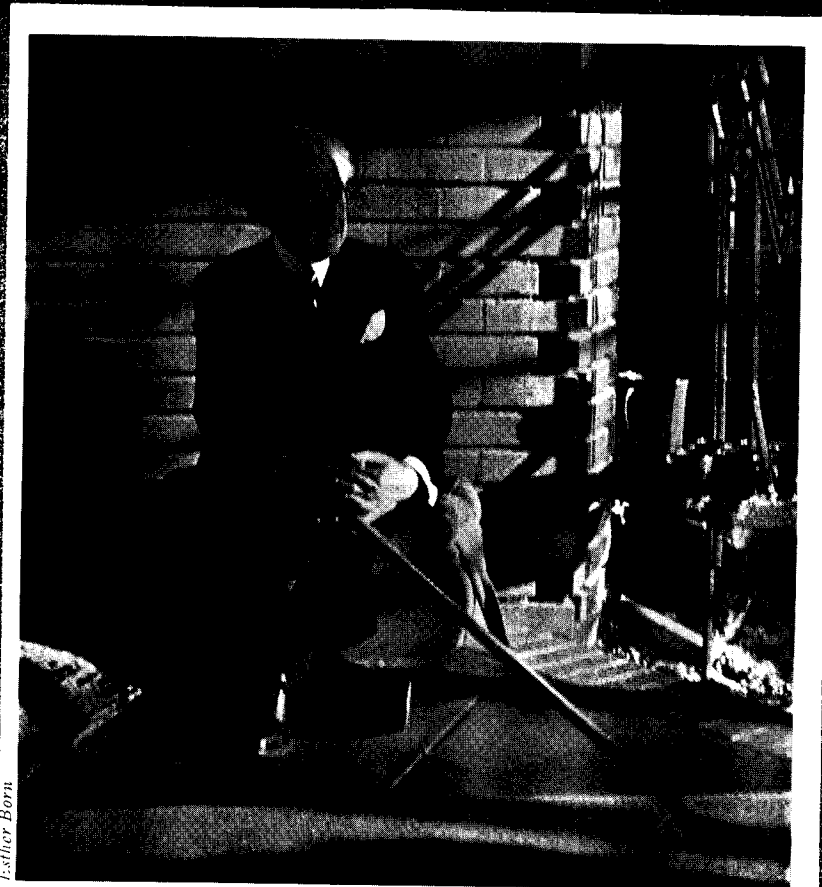

Estlier Born

Frank Lloyd Wright Designs a Honeycomb House

ARCHITECTURAL
RECORD

CONTRIBUTED BY
AMERICAN ARCHITECT AND ARCHITECTURE

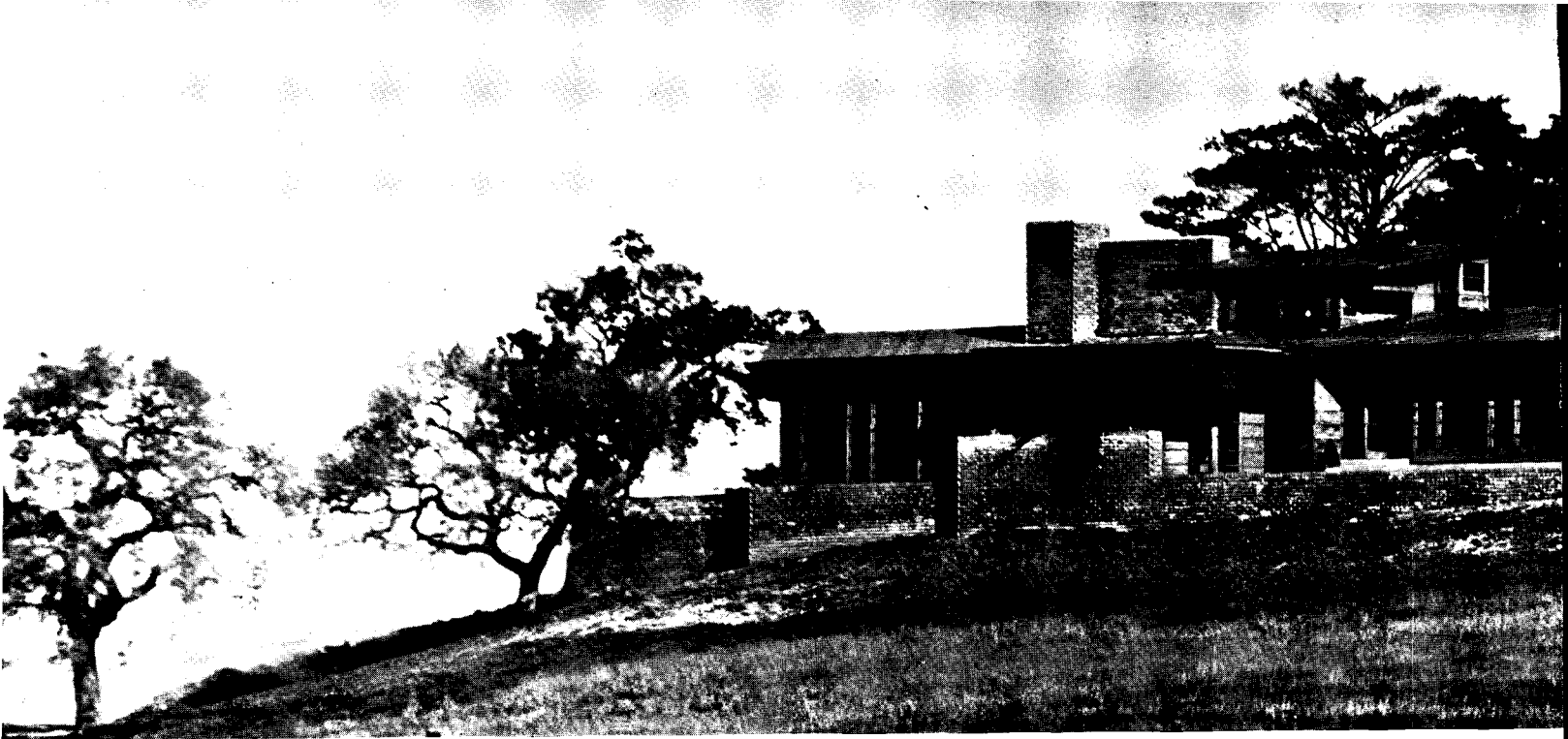

THIS PLAN IS WORKED OUT ON THE HEXAGON INSTEAD OF THE USUAL RECTANGLE. THE INTENTION WAS TO BUILD ECONOMICALLY A HUMAN MOVEMENT IS THE RESULT. INTERIORS HAVE MORE REFLEX, THEREFORE MORE REPOSE. ALTHOUGH AT FIRST SIGHT THE PLAN A WALLS ARE THIN, YET STRONG BECAUSE OF CONFORMATIONS NATURAL TO THE HEXAGON. THE WHOLE STRUCTURE IS A STUDY FOR

HONEYCOMB HOUSE

FRANK LLOYD WRIGHT, ARCHITECT

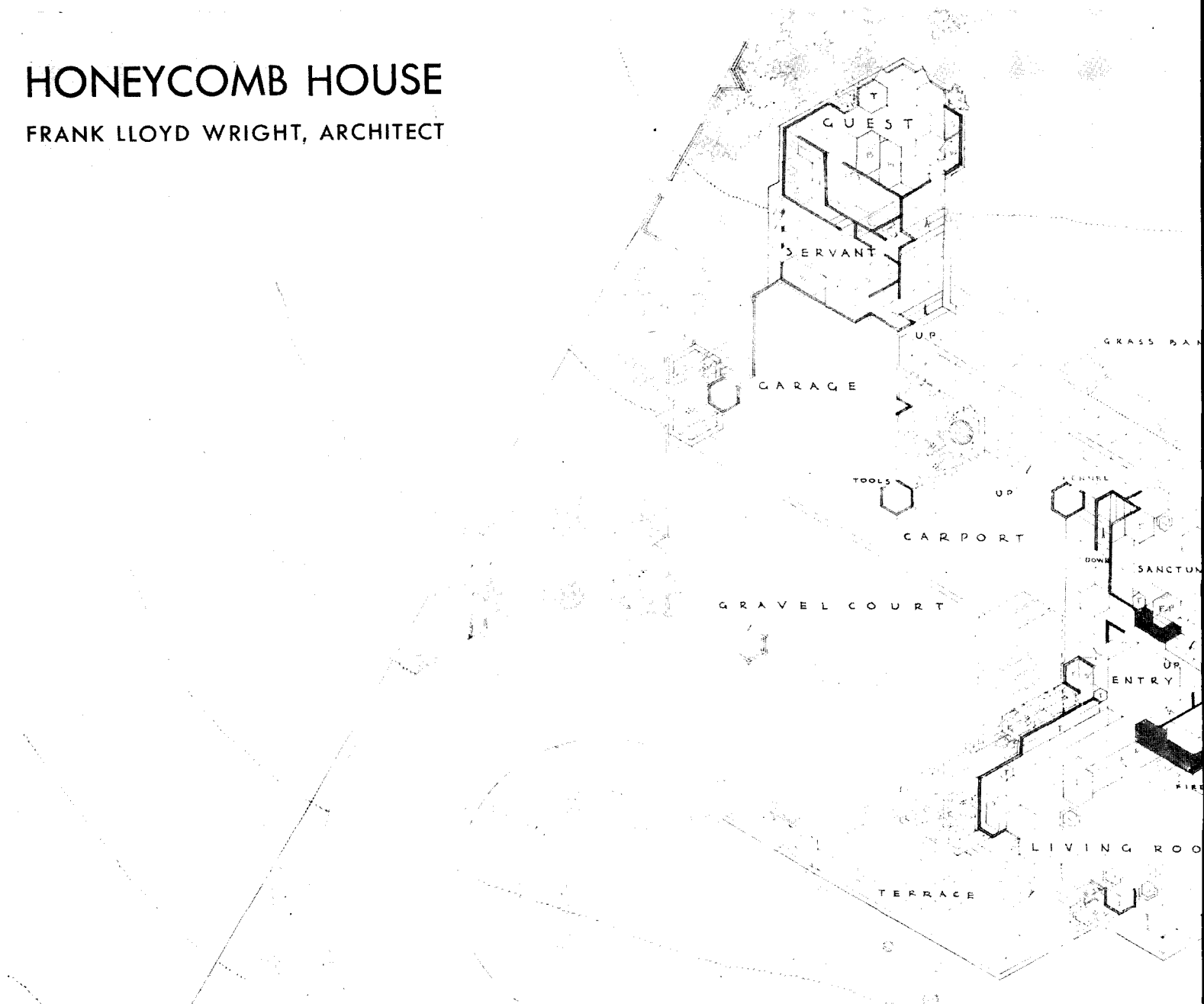



CONSISTENTLY WITH A MORE HUMAN RHYTHM. ALL CORNERS ARE OBTUSE AS IN A HONEYCOMB, THEREFORE A PATTERN MORE NATURAL TO COMPLICATED, THE MORE IT IS STUDIED THE MORE ITS PRACTICAL SIMPLICITY APPEARS. THE STRUCTURE ITSELF IS OF LAMINATED WOOD. ONLY FABRICATED STANDARDIZATION, FREE IN CHARACTER, WITH INDIVIDUALITY. FRANK LLOYD WRIGHT

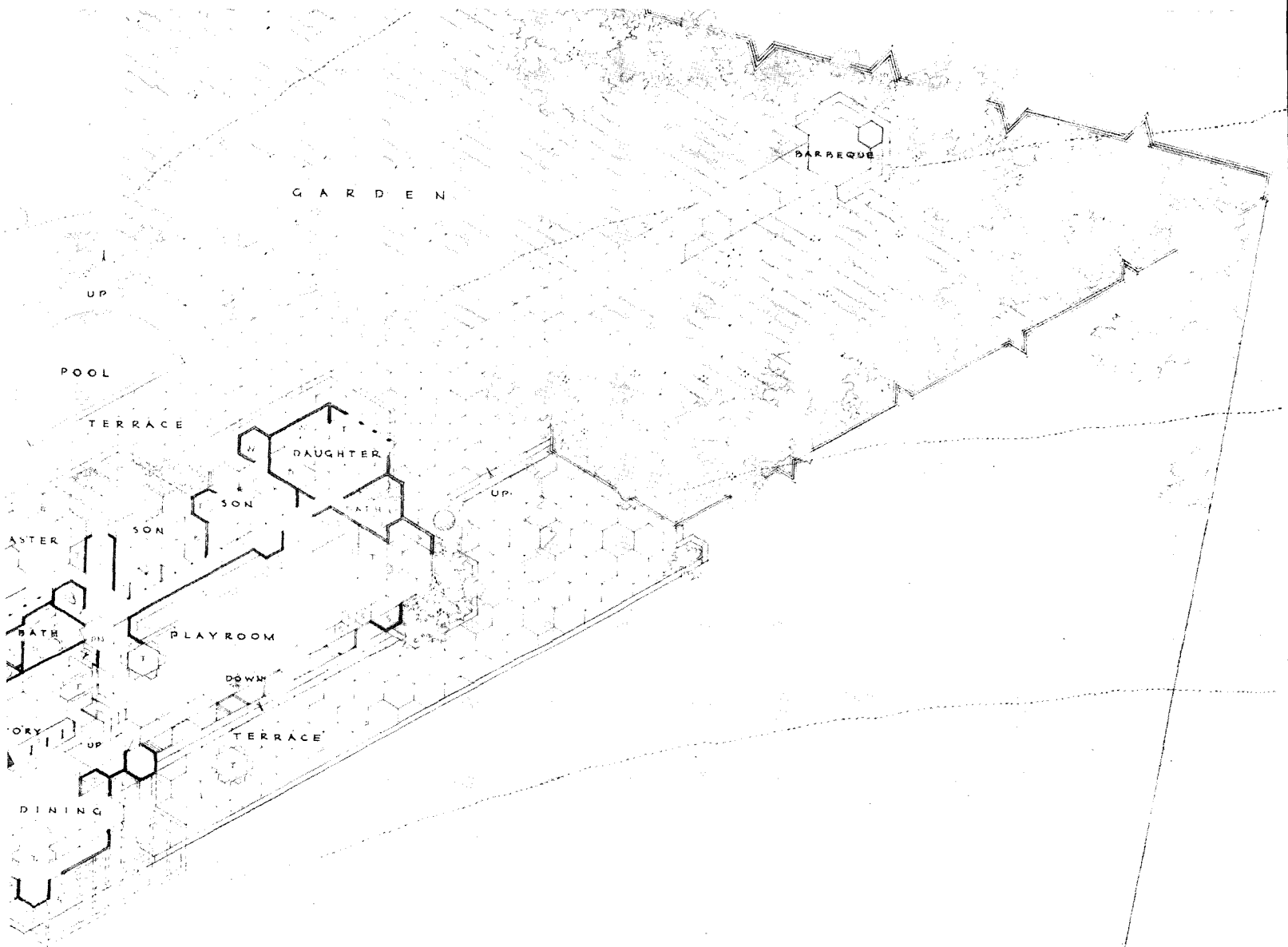

HOME OF PAUL R. AND JEAN S. HANNA, STANFORD UNIVERSITY, PALO ALTO, CALIFORNIA.

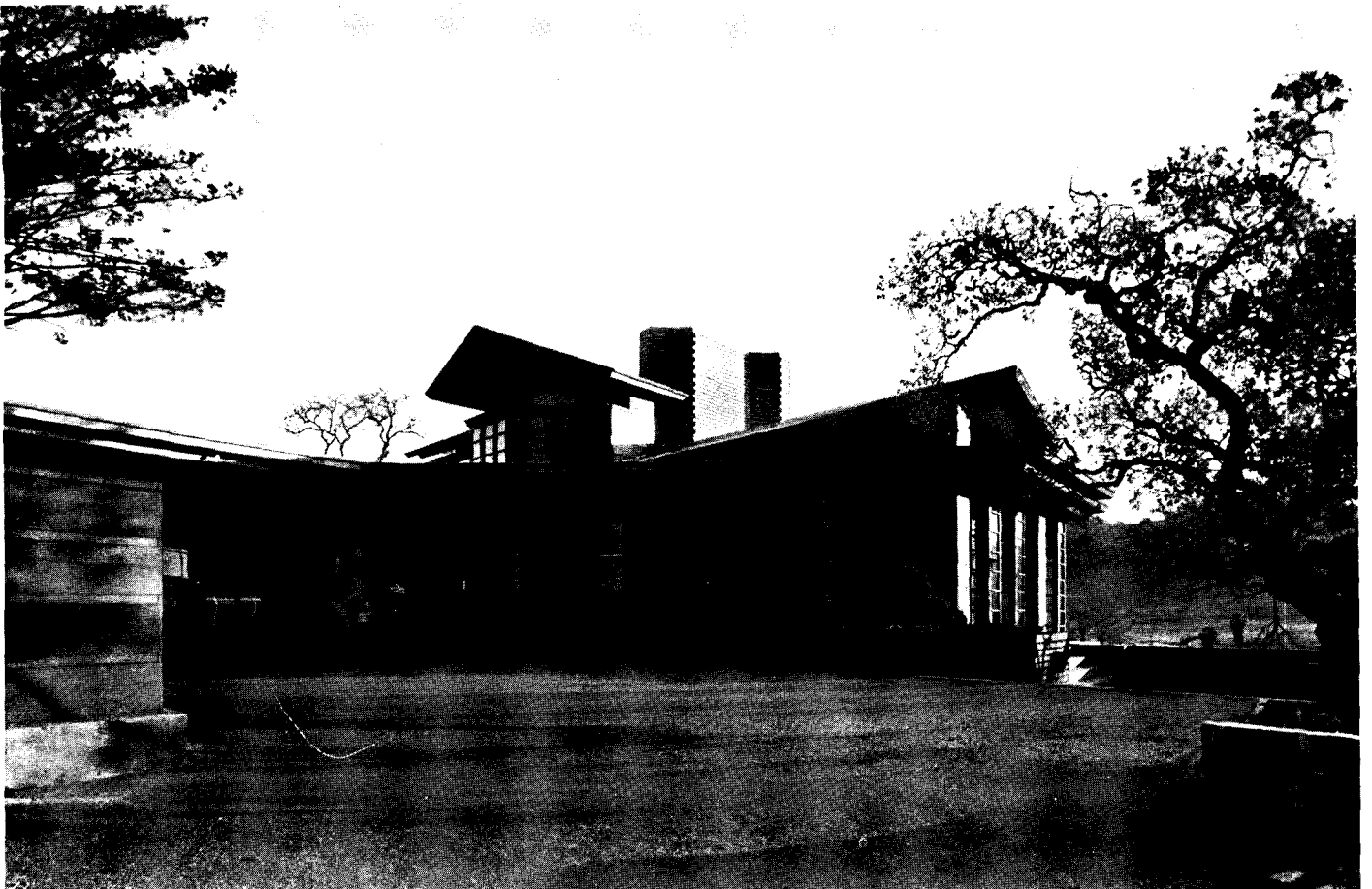

APPROACHING THE HOUSE . . . TO THE LEFT OF ENTRANCE COURT CAN BE SEEN THE CARPORT AND GARAGE, TO THE RIGHT THE LIVING ROOM TERRACE WHICH IS SHADED FROM THE SUMMER SUN BY AN OAK TREE

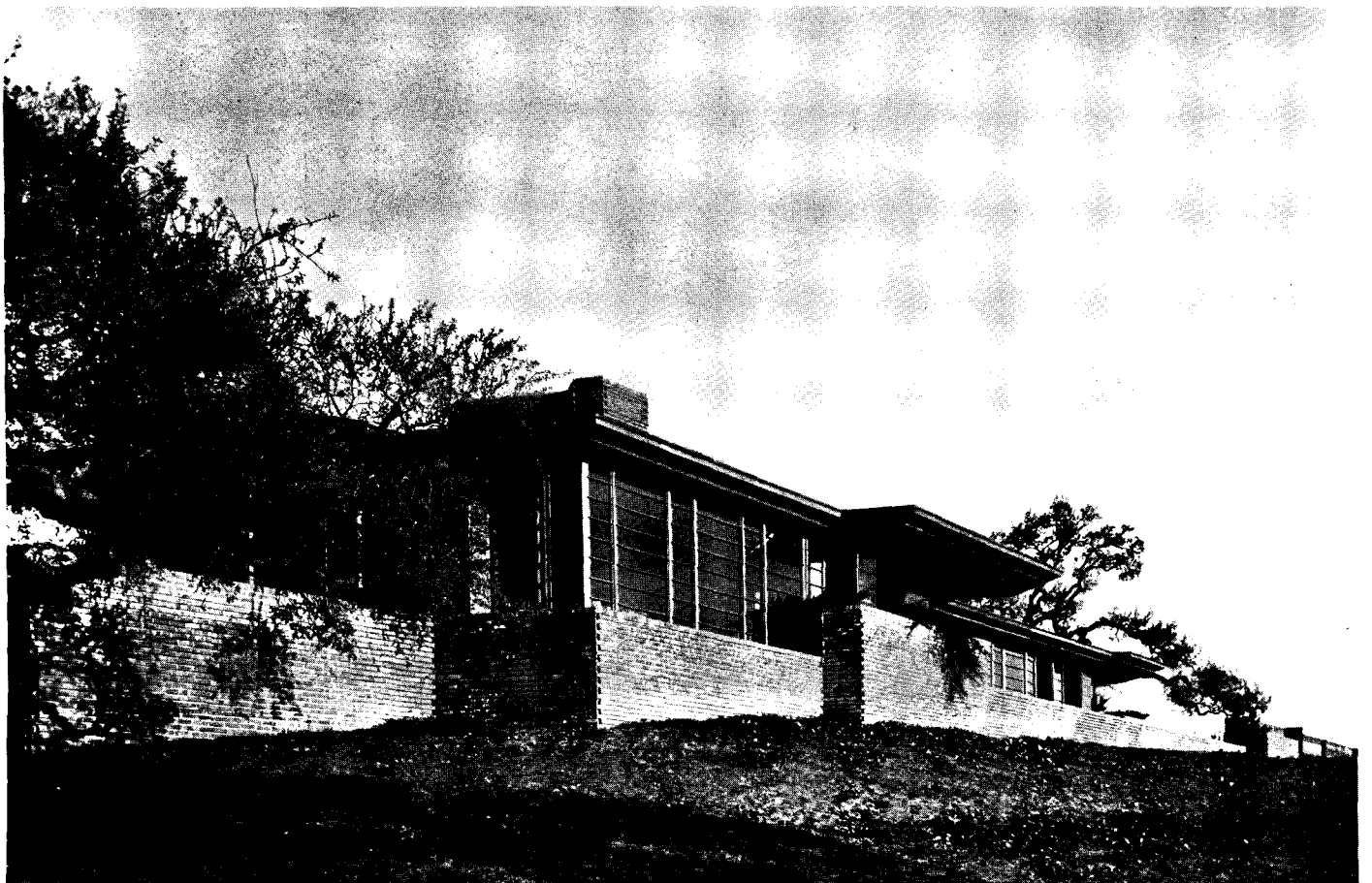

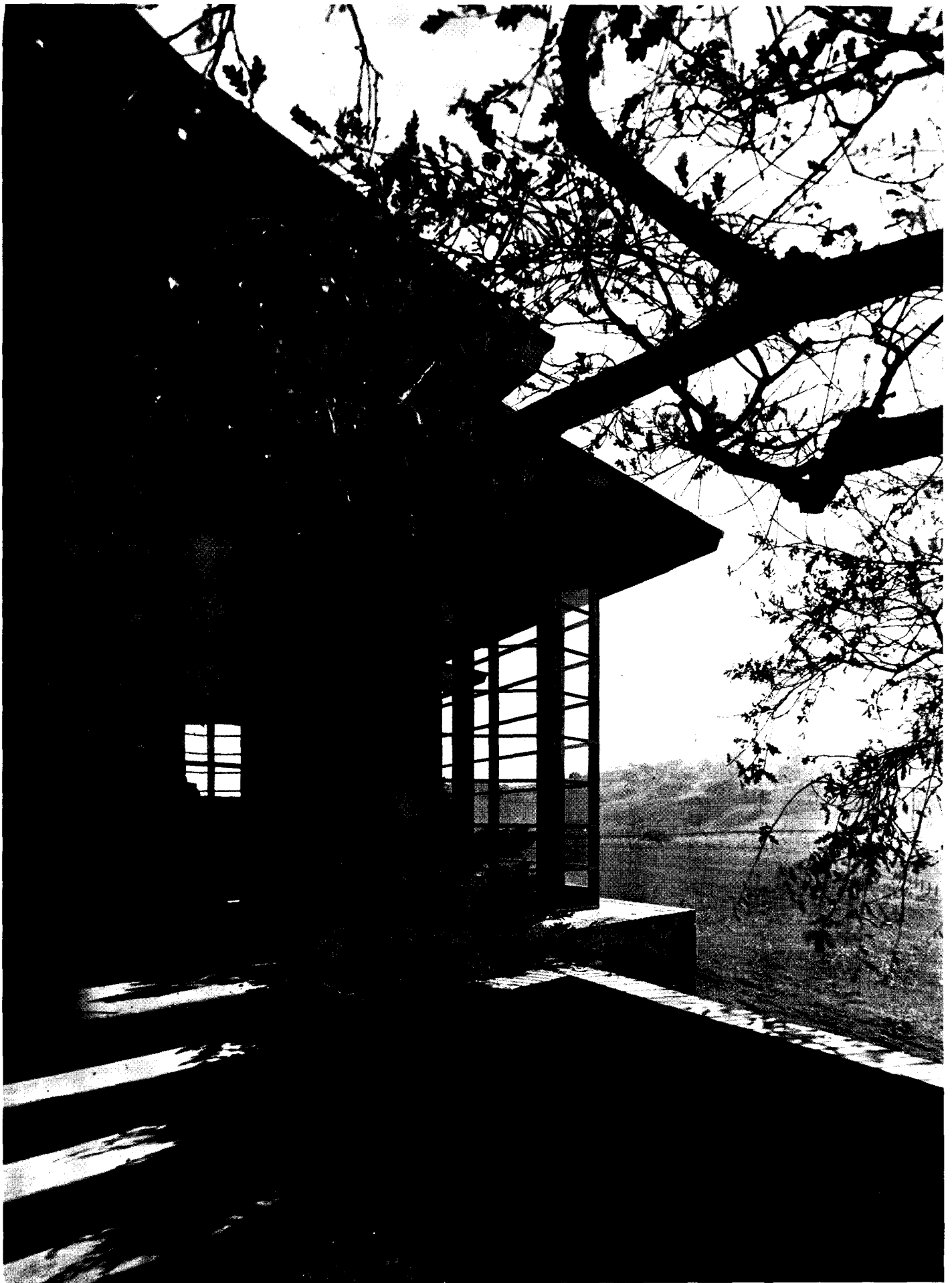

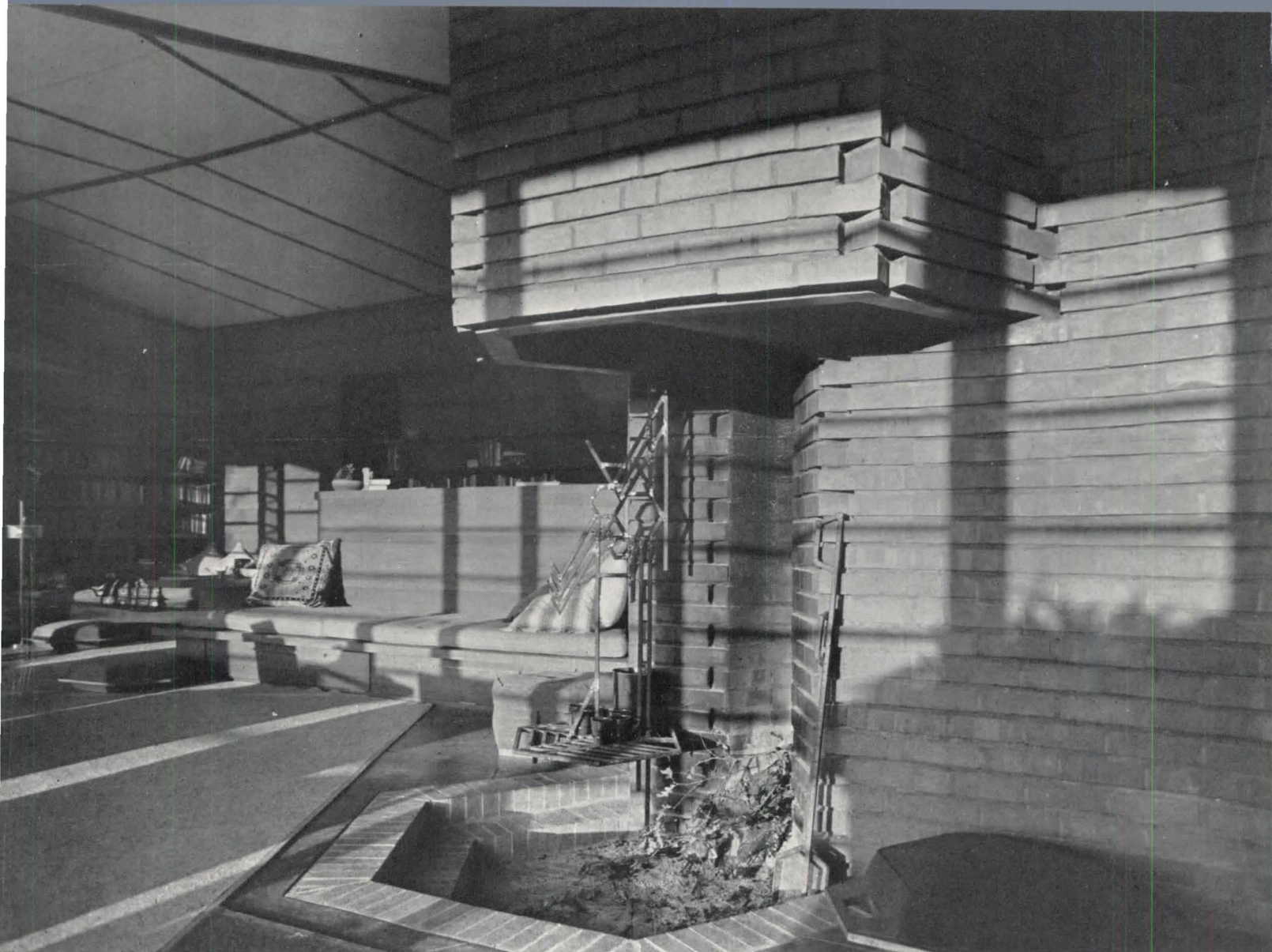

INSIDE THE LIVING ROOM . . . SUNLIGHT STREAMS INTO DEEPEST CORNER. LONG FIRESIDE SEAT IS COVERED WITH GOLDENROD MAT

The hexagon as a pattern in design becomes an event of significance when handled by a master craftsman like Frank Lloyd Wright. It calls for critical examination. How successful is the honeycomb-unit system in this new home for Paul R. Hanna, associate professor of education at Stanford University, and his family? The Record editors have turned to those who live in the house as best qualified to answer this question, and on the following pages Dr. Hanna and his wife, Jean S. Hanna, take the reader through their new home and comment critically on various features of the design. (All photographs are by Esther Born.) Concerning the house as a whole the Hannas say: "In the new surroundings we are learning to live by new patterns. The most noticeable change is the lessening of tension—the increased sense of repose. The house is quiet. Traffic flows naturally and easily from one part of the house to another and does not leave irritated nerves. One can step out of every room (except the kitchen, or laboratory) directly onto a terrace. . . . On the terraces we eat two and often three meals daily. . . . The landscaping is only started, but eventually the living will be extended beyond the terraces to the grass plots under the fruit trees."



MATCH KLEARFLAX CARPET OF SIMILAR COLOR WITH BLUE TRIANGLE INSET . . . FURNITURE ALSO BUILT ON HEXAGON PATTERN

Concerning the living room: "It's all so much a part of everything else; it always seems to flow on in rhythmic beauty. The ceiling, not too high; the lower decks; the furniture snuggled into the walls. For once, plenty of shelf room for our ever-expanding library. The table at the end of the fireside seat disturbs some visitors. The pure functionalists would cut the end off; as one professor of architecture remarked, 'You either hit it or miss it.' We miss it, because we conform to the rhythm of the house. . . . The fireplace works. Our friends love to gather informally in this room, some stretched out on the couches, some on floor cushions, others merely sitting on the steps of the fireplace. It is a huge room, but versatile. It will accommodate a group of seventy-five and not seem crowded or noisy, or two can sit alone in the evening by the fire and read or turn out the lights to look through the plate-glass walls to star-studded sky or moonlit hills. . . . Chairs, tables, and ottomans are all built on the hexagon pattern. Scarcely noticeable is the dining equipment at one end of the room. The buffet and table flow out of the hexagon, as normal a part of the room as the walls. The stationary table seats five; an extension table adds five places."



STEPS LEAD FROM TERRACE TO LIVING ROOM . . . ON SUNNY WINTER DAYS THE TRANSPARENT WALLS ARE ROLLED BACK

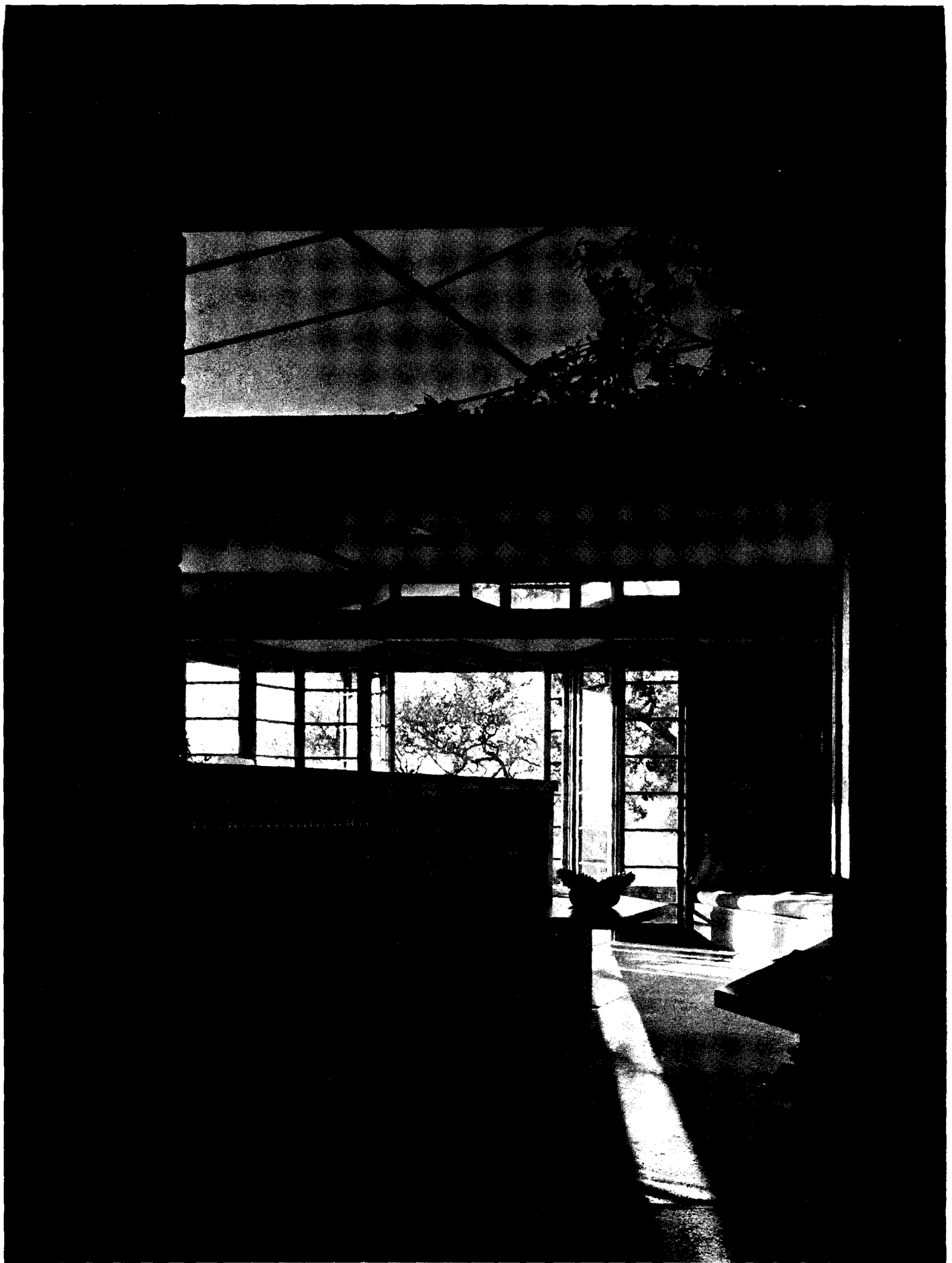

ENTRY TO LIVING ROOM BEHIND FIREPLACE SEAT . . . EIGHTEEN-FOOT CEILING CONTRASTS WITH LOW-HANGING EAVES OUTSIDE

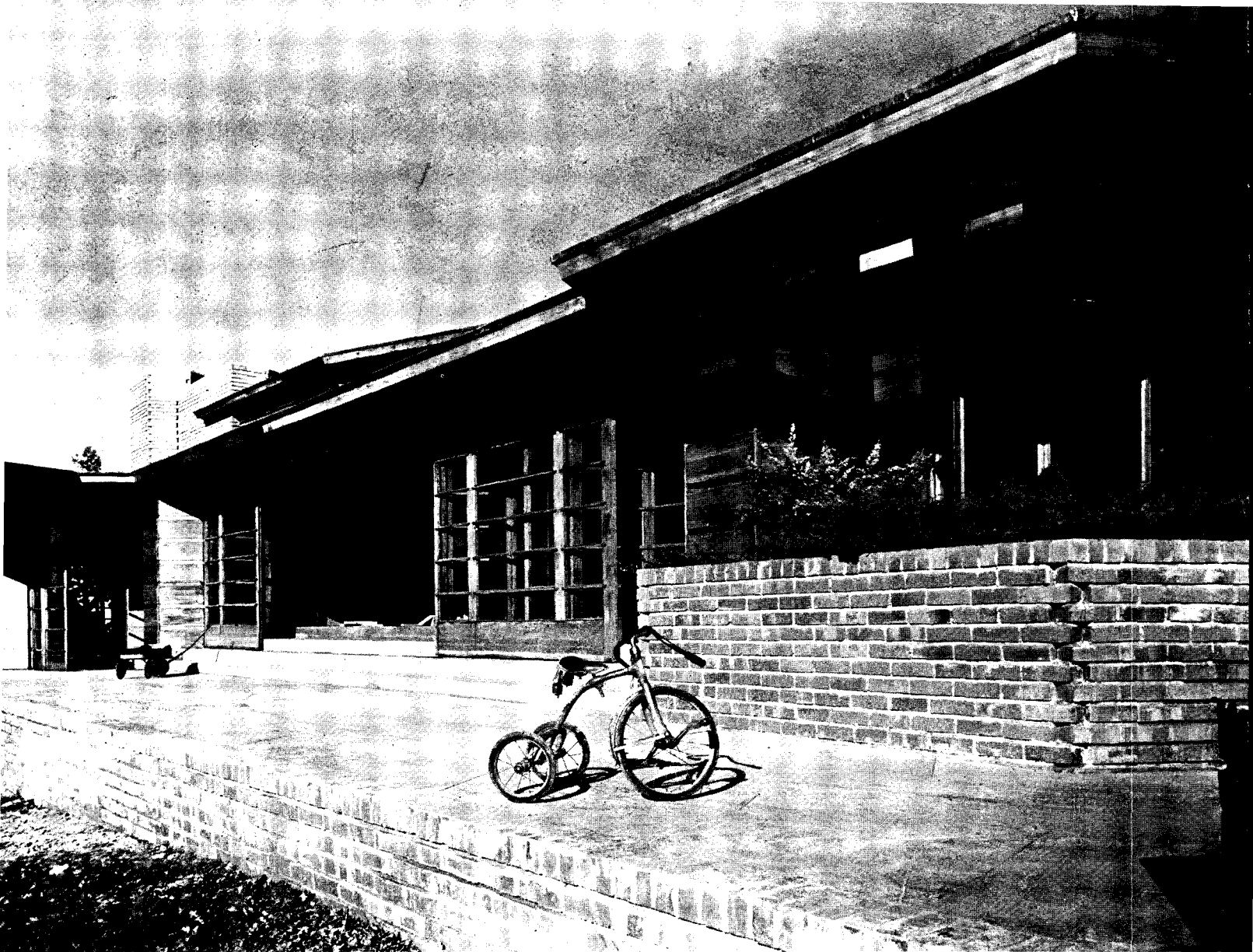

PLAY AREAS, OUTSIDE AND INSIDE . . . TRELLISES OVERHEAD FOR TRUMPET VINES . . . WINDOWS OPEN FROM PLAYROOM READ

Concerning the children's quarters: "Here the children never feel shut in. The playroom and its outside terrace become one huge play area when the dividing wall of glass is rolled back. Even when the wall is closed, there is a sense of being outdoors. The children build great cities with blocks, dance, express themselves creatively with saw, loom, clay, and collections. The cement floor is warm in winter—a heating pipe tunnel runs underneath—and cool in summer. . . . The children's bedrooms are small, but why should they be larger? We can walk from our bedrooms directly onto the terrace. We don't have to get our feet muddy during the rainy season, and it's a grand place for the children to ride their wheels, skate, play marbles, house, train, and so on. . . . Have you ever lain in bed and watched the sunrise or the full moon come up? You couldn't in most houses. We can. We recommend it for tired nerves. . . . The baths are high and well ventilated. We don't have to pull down shades; the windows are all at the top. We have sunken tubs, but our prize is a shower large enough to accommodate the whole family at one time."



ER ON A JUNIPER-FILLED FLOWER BOX



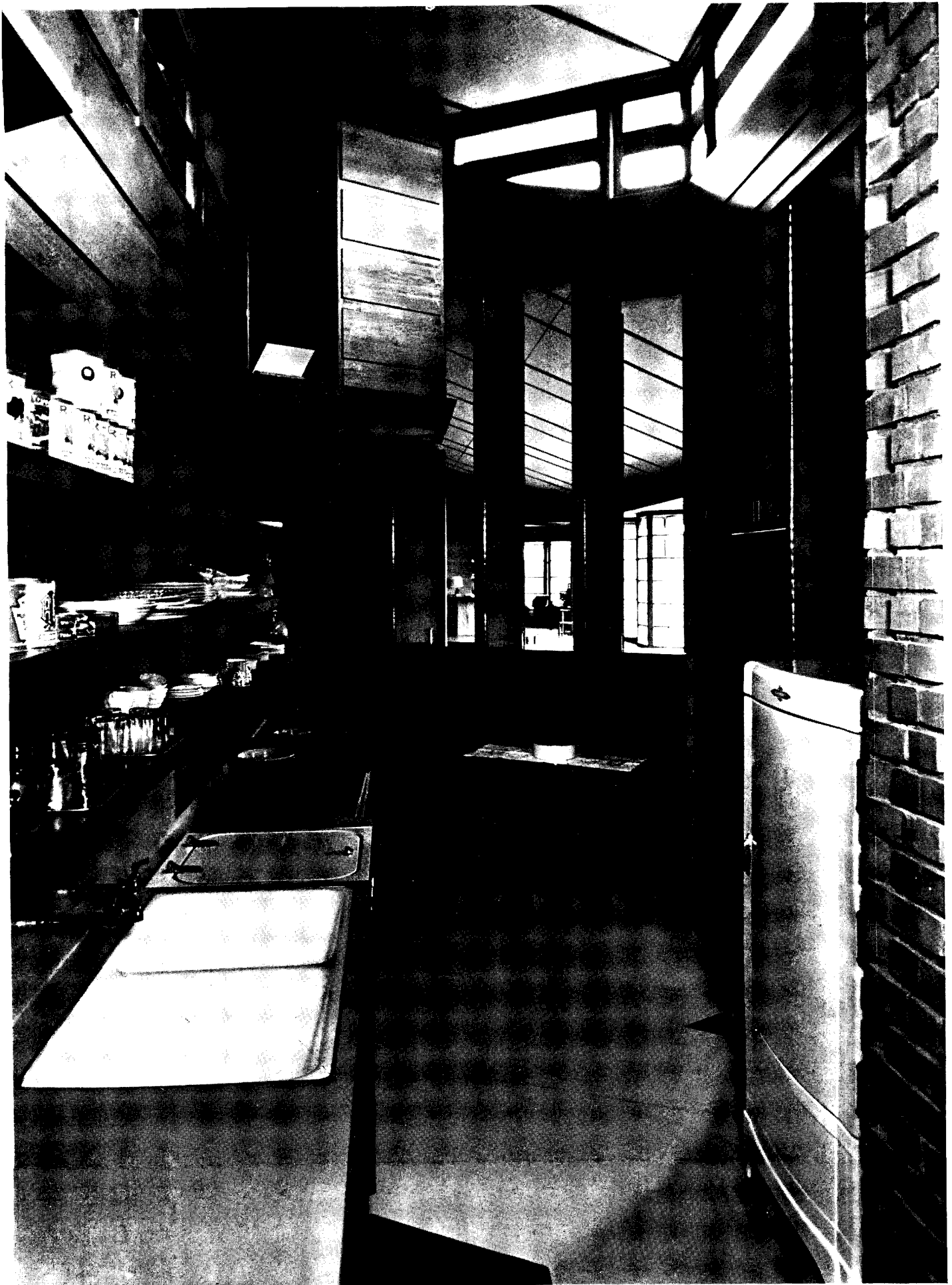

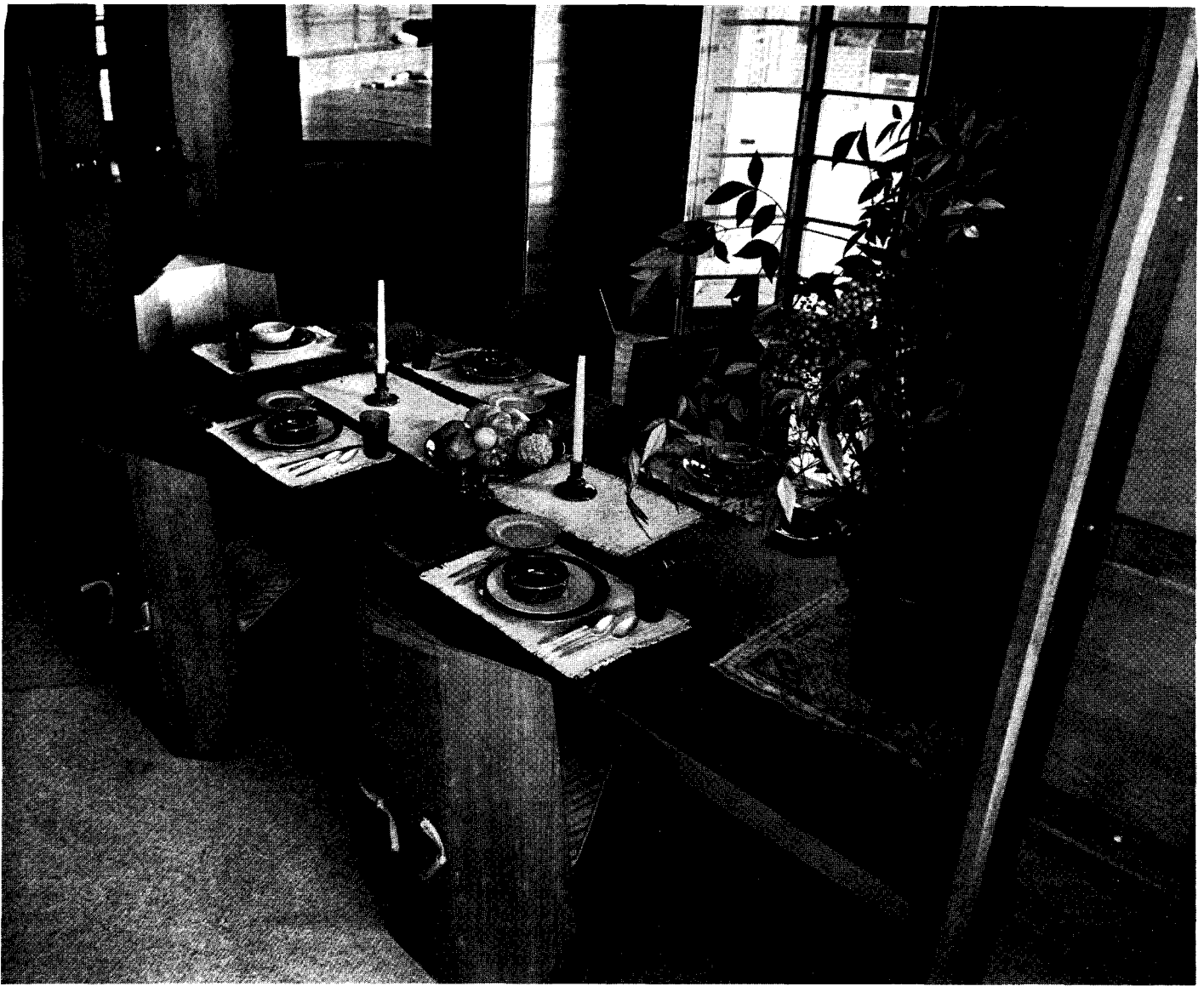

LABORATORY AND BUFFET . . . VERTICAL FINS WITH HINGED DOORS OPEN TO PROVIDE SERVICE FROM KITCHEN TO DINING AREA

Concerning the service areas Mrs. Hanna comments: "Swinging doors admit us to the laboratory, precisely in the center of the house. I don't mind working here where I am not isolated from the family. I can look through fins into the dining room; I can look through other fins into the children's playroom and on through the glass walls to the hills. I'll match the view from my laboratory with anyone's! . . . The story-and-a-half ceiling keeps the laboratory cool and odorless. Six vents work on a simple pull cord. Windows at front and back admit sunlight all day long. The gold-and-blue linoleum floor and sink tops are cheery and easily cleaned. . . . Everything is compact, easily at hand. It takes but ten minutes a day to wipe down the open shelves with a damp cloth. Dishes not used every day are kept in cupboards in the dining room. It isn't drudgery to keep the shelves in presentable order. I also like the laundry at one end of the kitchen. Sometimes I operate the mangle while the dishwasher is doing my dishes. . . . A buffet opening is used for everyday service for the family and for buffet service at Sunday night gatherings."

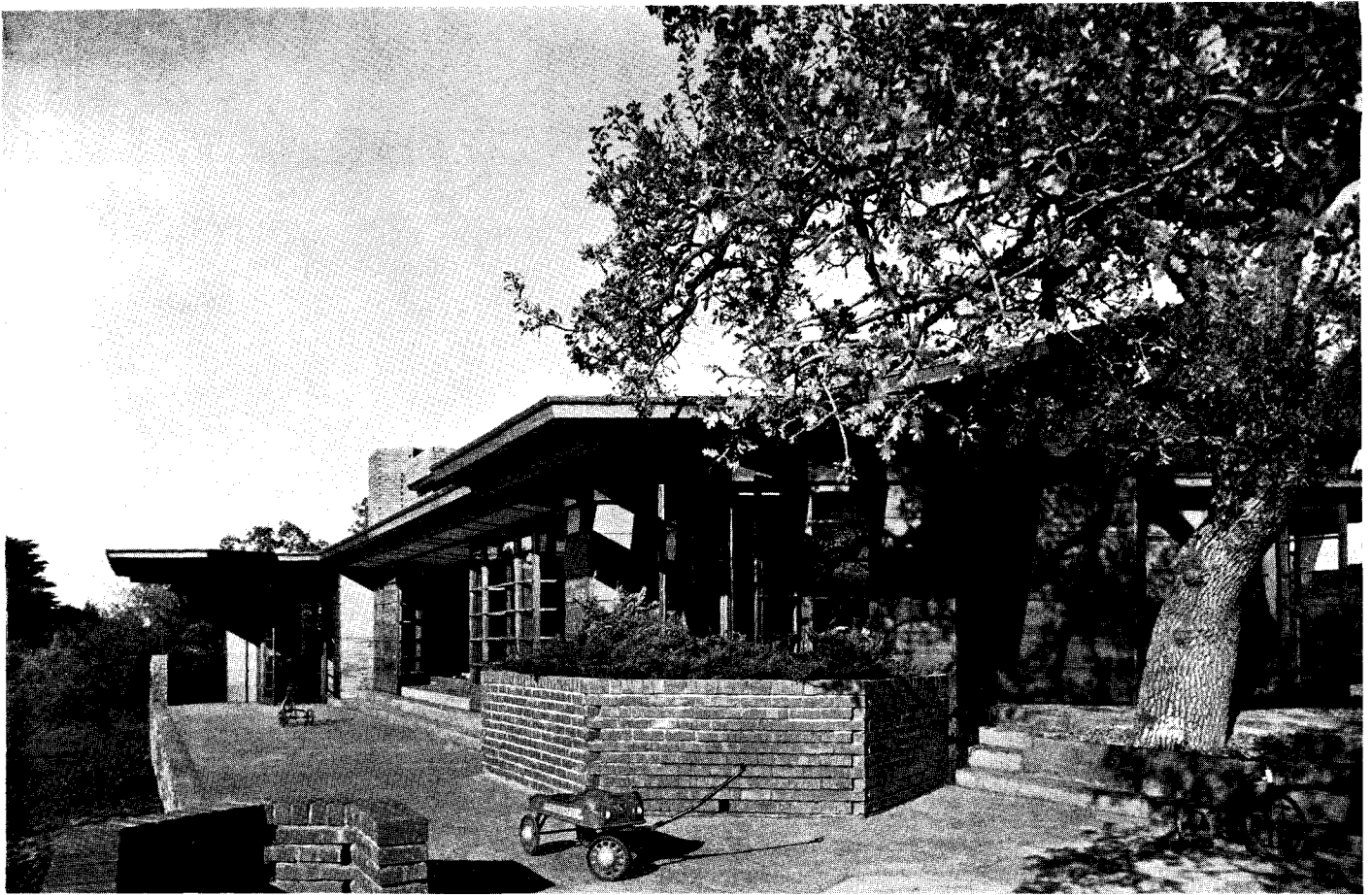

LONG ROOF LINES GENEROUS OVERHANGS PROTECT AGAINST WIND AND RAIN AND SUPPORT CREEPING VINES UPPER HALF STORY PROVIDES LIGHT AND VENTILATION FOR BATHS AND LABORATORY COPPER SHEET COVERS ROOF

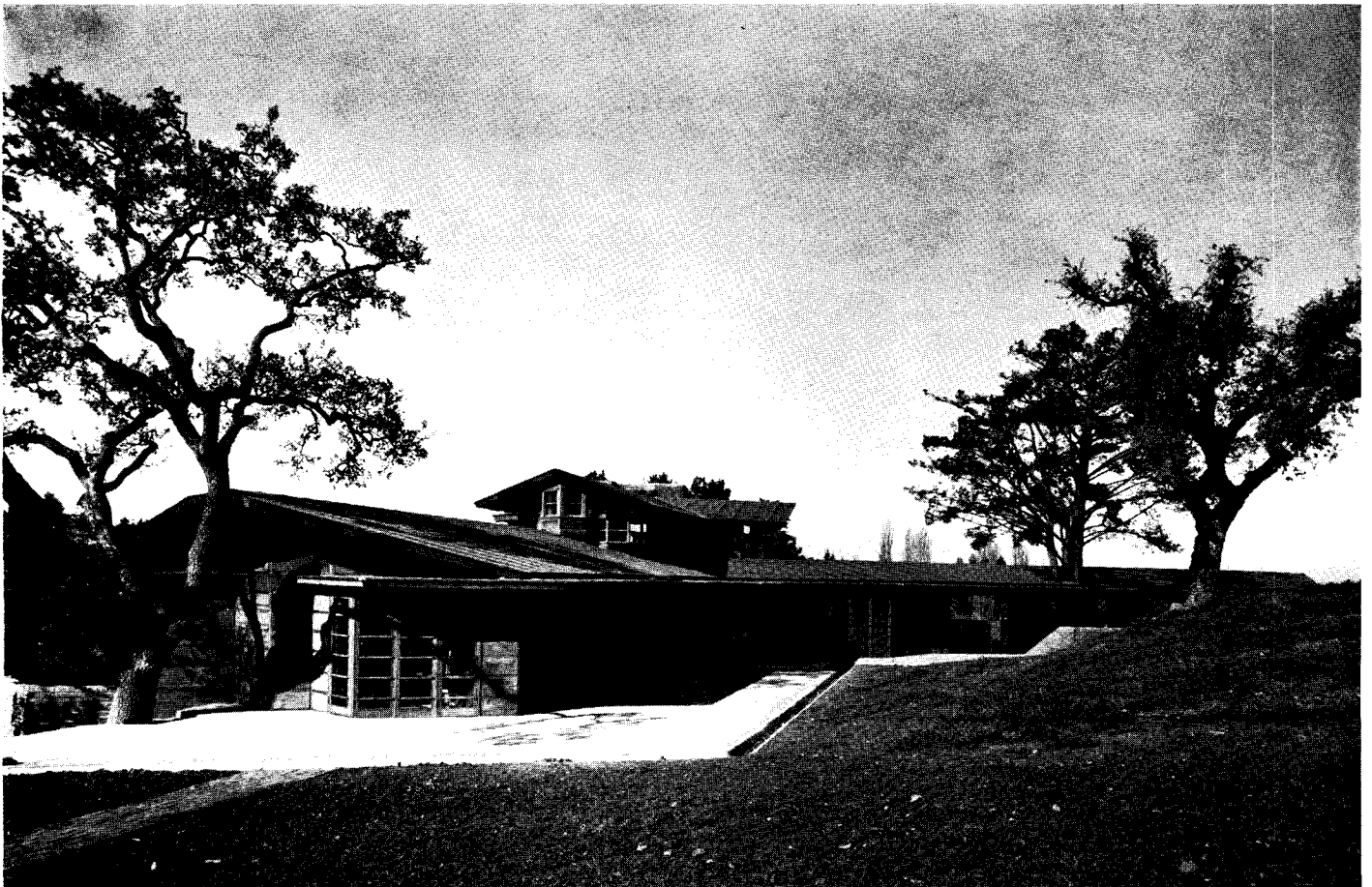



CONCRETE TERRACES WITH UNOBSTRUCTED VIEWS INTO HOUSE OR OFF TO DISTANT HILLS . . . ALL BEDROOMS OPEN DIRECT ON MORNING TERRACE . . . THE SUN SERVES AS ALARM CLOCK IF THE AEROSHADES ARE NOT LOWERED ACCORDINGLY



We aren't sure when or where this adventure of building a home started. Probably as children roaming the hills and fields of Minnesota villages we grew to value the freedom of outdoor space as contrasted with the restrictive limitations of buildings to which we returned unwillingly when play was ended. Surely these childhood experiences with spring flowers growing in the meadows, green trees swaying against a blue sky, birds nestling, or cattle grazing on the hills—all of these experiences—meant far more to us than any attempt to catch these sights and moods on canvas and freeze them in picture frames to be hung on the walls of dwellings.

But what have these experiences to do with our present home? A great deal! For when we read Mr. Wright's Princeton University lectures on Modern Architecture we realized that the values of childhood experiences could be built into human habitation. Mr. Wright showed us that shelter could be so designed that the outdoors could be brought indoors. During the next few years we spent a great deal of our time studying architecture and absorbing ideas about functional housing. In the spring of 1934 we asked Frank Lloyd Wright if he would work with us as our architect. Many hours were delightfully passed in his Taliesin home, or in our home, to the purpose that he might get a measure of the family for whom he was to build. Together we evolved a set of objectives or general requirements, among them the following:

- a. A piece of land on a hill for view and drainage, large enough for gardening, playing, and assuring privacy.
- b. A home that would organically tie into this hillside, nestling into the hill's contour.
- c. A home enclosing enough space in which to carry on a variety of human activities of three young children and the parents without crowding.
- d. A home that would be warm dry shelter in bad weather, but could be thrown open by rolling away walls when the sun or stars shine and breezes blow.
- e. A home with walls of glass so that the family could at least visually always be conscious of sunrise or sunset, the fog bank rolling over the hills, or flowers and trees in the fields.
- f. A home so constructed and equipped mechanically that electricity and modern labor-saving machinery do the drudgery, leaving time and fresh strength for the more creative aspects of home life—no fires to tend, no temperatures to regulate, no crossing the room to turn on illumination, no hand dishwashing, no carrying out garbage, and so on.
- g. A home in which the furniture and the furnishings are planned to carry out the simple and unified pattern of the house as a whole.

In the spring of 1936, we found the appropriate hilltop and were ready to draw plans. Mr. Wright spent several days with us on the new site, then returned to his Wisconsin drafting rooms. In an amazingly short time we received a dozen sketches and drawings. Hours and days were absorbed in poring over the sketches. Our files contain scores of letters exchanged with Mr. Wright as we raised questions or suggested modifications or additions.

Some of this correspondence shows our impatience at our architect for not giving in to our requests for "wider interior doors" or "beds that have right angles." His replies were the acme of patience as he tried to educate us to his new conception. If he couldn't convince us of the "rightness" of his proposal after several attempts, he usually gave in to our whims when so doing did not basically change the fundamental pattern of his "symphony"; but when our request served to discord, Mr. Wright was firm. In many instances we reluctantly wired him that we would "build as he directed", but we crossed our fingers and hoped we wouldn't regret our "compromise" too greatly in the end.

In January of 1937, we agreed on a builder, Harold P. Turner, who had for years been interested in functional architecture and harbored an ambition to build a "Wright" house. We paid him a monthly salary to devote full time to superintend the construction. The first dirt was turned with deep feeling of adventure, for we realized how little we knew about the outcome.

It was impossible to estimate the actual costs. The figures of superintendent, owner, architect, and others varied as much as one hundred percent. We thought we had a fairly close estimate upon the basis of drawings in hand at the moment; but constantly Mr. Wright was working out details and mailing them on to us and these new plates (approximately 80 in all) usually meant a revision of the estimate upwards. The house matured and was refined as it rose from its foundation. We could not afford the expanding adventure financially and it meant borrowing heavily against the future; but each day gave us fresh courage to continue because we could see more accurately that the finished house would mean far more to us than the financial sacrifice.

The construction moved along without major serious setbacks. True, the usual early spring rains retarded work; the brick subcontractor left us in the middle of his work, (paid almost in full) with unpaid bills for materials; the redwood could not be milled to length as we had planned, and the costs of hand carpenter labor on the job mounted. Both of us, husband and wife, worked along with the laborers and craftsmen on the job. We took a part in every type of construction. We worked ourselves into the house as a family.

In October the house was nearing completion. The new furniture was taking shape and furnishings were beginning to arrive. We held a sale to get rid of all the furniture and furnishings we had accumulated during ten years of married life—nothing from the old living pattern could go with us into the new home, except clothing, library, and personal possessions.

The day we moved from a conventional house to our new home will remain an anniversary. Mr. Wright has given us a home that will leave an imprint on the lives of our children. They will know the subtle but true relations of materials and purpose, of site and dwelling. For them, beauty will be a way of living rather than "pictures to hang on walls." We can say that our home for us is meeting the acid test of family life. Every month we are conscious of new assets and new values. We could never again be contented in a conventional house.

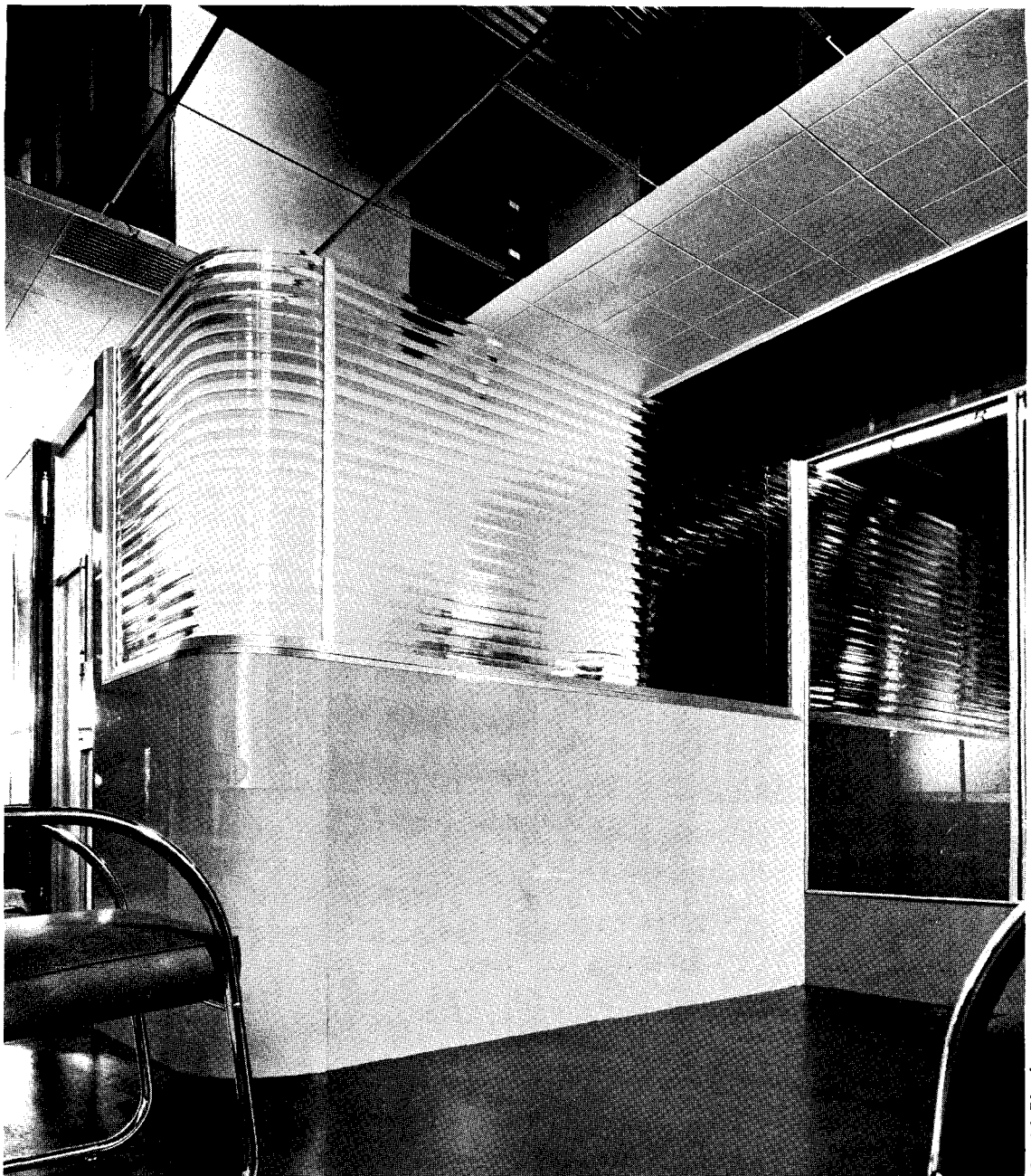

Hedrich-Blessing

Customers' Conference Room in the Libbey-Owens-Ford's Chicago office. Bruce Goff, Architect.

The Showroom as a Design Problem

Sales efficiency increasingly involves the display in use of the product to be sold. Thus, the design of showrooms for building materials presents this problem: to display those materials as integral parts of the structure itself, and not as independent exhibits. Within a relatively limited area, the showroom must demonstrate the uses to which a product can be put, the forms it can take, its superior properties. And in exploiting the product, the designer may clarify its functional potentialities. Three design solutions of such showrooms are given on the following pages.

Photos by Hedrich-Blessing

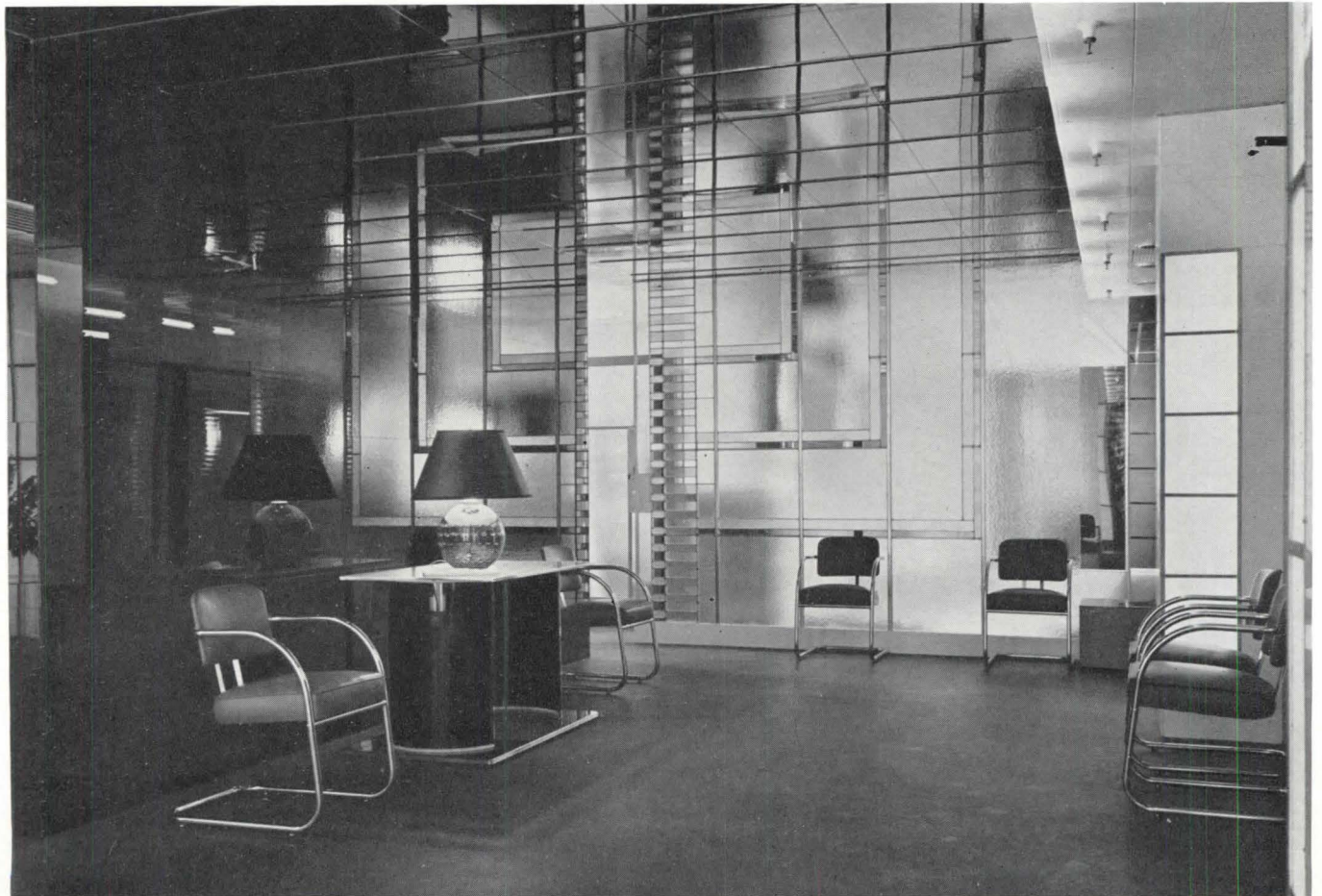

SHOWROOM FOR GLASS PRODUCTS: Reception room, Libbey-Owens-Ford's Chicago office. Bruce Goff, Architect. Top: West end of room, showing luminous pylon; note glass table in front, and Vitrolite wall of

information booth at right; ceiling is plate glass. Bottom: East end of room. Far wall is built up of glass products. Luminous panel at right is facing for pillar separating plate-glass windows opening onto corridor.



SHOWROOM FOR LINO-
LEUMS: Congoleum - Nairn,
Inc., Kearny, New Jersey.
Top: Reception room, viewed
from foyer. Walls and floor
are covered with linoleum.
Bottom: Conference room.
The table top is linoleum.
Note the rounded profiles
of window reveals and the
sparing use of painted wood-
work.

Photos by Mack & Co.

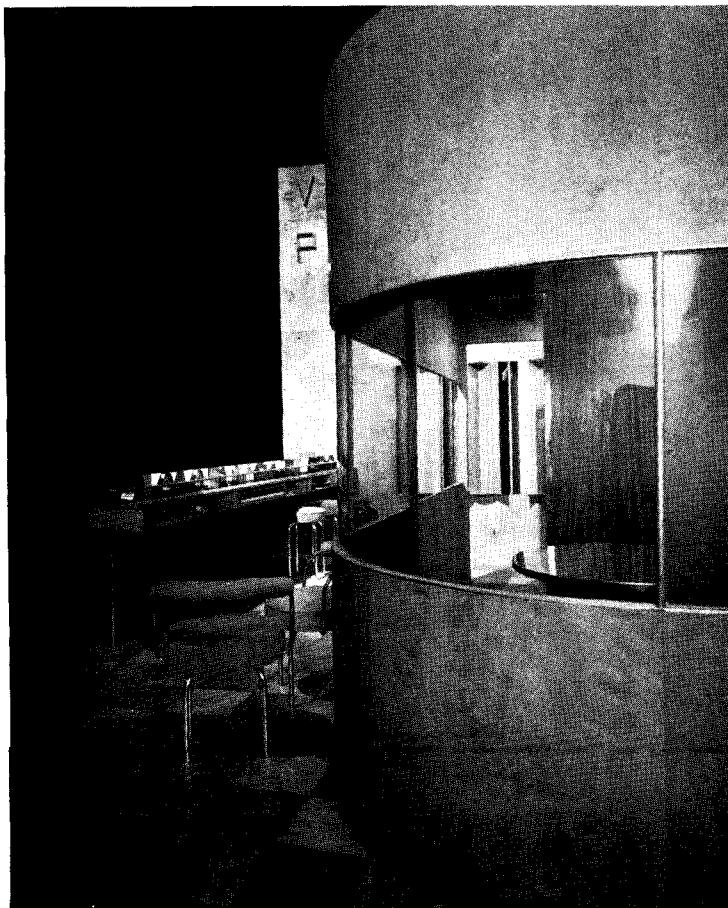

SHOWROOM FOR PLYWOODS: Manchester Building Trades Exhibition. Wells Coates, Architect. This was the winning design in the Venesta Competition for English architects, 1931. The back screen, the floor, the exterior of the office enclosure are all faced with birch plywood, the inner office with Sapele plywood, and the typist's office with oak plywood. The box cupboards (typist's office) are in teak plywood. Sliding doors and tables are in polished copper plymax (metal-covered plywood), all edges sealed with copper. The counter top is in one sheet of oak-veneered battenboard. The large letters on the back screen are in 1/2-in. copper plymax; the letters on counter top are copper.

What Has Kept Costs Down During England's House Building Boom?

By EDITH ELMER WOOD

The British Government and people have experimented with many different methods of stimulating public and private housing activity. Their efforts have been comparatively successful in both fields. Consequently, any phase of their experience is apt to illuminate and clarify the problems Americans are fumbling with today. Dr. Wood's article describes how housing costs were pegged in England by "gentlemen's agreements" between building contractors, building labor, and manufacturers and distributors of building materials. Dr. Wood's career as social worker, university lecturer, housing consultant, and writer has placed her in the front rank of recognized authorities on the many phases of the housing problem.

A GOOD DEAL has been said recently about the sensible and effective way in which the British Government prevented rising building costs when launching its program in 1924 to build two-and-one-half million subsidized working-class houses, through the various local authorities, within 15 years. But not so much has been said about what happened before. And with good reason.

British wisdom did not spring fully developed from the brain of Zeus. It was acquired as the result of rather costly experience. We may learn as much from Britain's mistakes as from Britain's successes.

Before the World War, Great Britain was already well embarked on a policy of building and renting working-class houses by housing authorities, with loans from national sources, but no national subsidy, though with charges against local taxes, whenever slum clearance was involved.

The World War and the national concentration on war activities halted residential building, public and private, except where the Ministry of Munitions built war houses for war workers.

"Homes fit for heroes"

Remember that the British went through years of war without conscription. Beside private appeals to patriotism, there were promises, explicit and repeated, of an extensive national housing program, abolition of slums, and "homes fit for heroes",

as soon as the war was won.

While the war was still in progress, the Tudor Walters Commission and others estimated needs and discussed ways of meeting them. There was probably a numerical shortage of nearly one million working-class and lower middle-class homes without touching the slums. Due to war causes, most things cost twice as much in Great Britain after the Armistice as they did in 1914. Rent was an exception, because of rent restriction laws, which could be lifted only gradually. Since the cost of building a workingman's cottage had approximately doubled since 1914, the program could not be undertaken without national subsidy. The program adopted was to build 500,000 working-class cottages through local authorities within three years. They were to be of good standard, not more than 12 to the acre, with the National Government supplying sufficient subsidy to produce working-class rents, after the local authorities had contributed one penny on the pound from the local taxes.

At the same time that the labor group was at the Prime Minister's elbow, pressing for homes worth fighting for, in quantity and quickly, the businessmen's group was equally close to the other elbow, insisting on the lifting of war restrictions and an immediate return to "business as usual." He tried to satisfy them both, with interesting results to the housing program.

The big public housing program got under way in 1920, intelligently, efficiently, in an admirable spirit of public service. But by order of the Prime Minister, the determination of building costs was left entirely to supply and demand. The Minister of Health, Dr. Addison, was not permitted (until the very end, when the damage was done) to exert even the ordinary buyer's prerogative of declining to approve bids which he deemed excessive. Therefore, within a year the cost of building a workingman's cottage had again approximately doubled, becoming four times what it was before the war, and the national subsidy had become so large that the whole program was abruptly halted in response to economy pressure, after 170,000 houses had been built or contracted for. In the skyrocketing of building costs, operative builders, material producers, and union labor all had a share.

The artificial stimulus of the government program (without safeguards) having ended, supply and demand worked, first to restore the 1919 level and gradually toward stabilization at somewhere near 50% above the pre-war level.

After a 1923 Conservative attempt to stimulate private enterprise into the low-cost housing field, we find the stage set for the wise procedure of the Labor government in 1924.

The Labor government makes a beginning

Following the failure of the hous-

AVERAGE COST OF 3-BEDROOM NONPARLOR HOUSES FOR WHICH CONTRACTS WERE LET BY BRITISH AUTHORITIES DURING MARCH*

Year	Average Cost	Year	Average Cost	Year	Average Cost
1920	£863	1926	£442	1932	£317
1921	700	1927	425	1933	295
1922	436	1928	368	1934	286
1923	351	1929	339	1935	295
1924	416	1930	335	1936	307
1925	438	1931	345		

*Ministry of Health figures in Monthly Labor Review (U. S.), October, 1937.

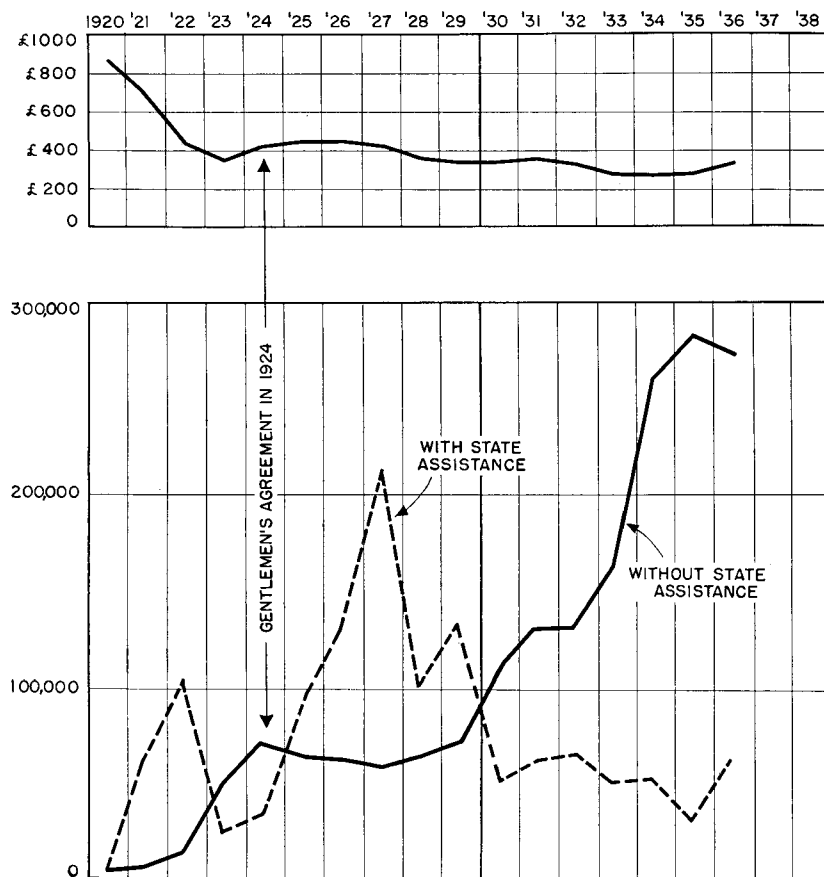

NEW HOUSES PROVIDED IN ENGLAND AND WALES THROUGH PUBLIC AND PRIVATE ENTERPRISE, 1919-1936*

Year ending Sept. 30	With State Assistance	Without State Assistance	Total
1920	6,127	6,000	12,127
1921	67,945	9,000	76,945
1922	106,165	15,000	121,165
1923	25,989	52,749	78,738
1924	36,459	73,032	109,491
1925	92,291	66,735	159,026
1926	131,895	65,689	197,584
1927	212,916	60,313	273,229
1928	101,791	64,624	166,415
1929	133,774	71,083	204,857
1930	51,324	110,375	161,699
1931	62,035	132,909	194,944
1932	67,676	132,886	200,562
1933	50,433	167,880	218,313
1934	52,260	261,168	313,428
1935	32,887	284,409	317,296
1936	64,065	275,473	339,538
	1,296,032	1,849,325	3,145,357

*Excluding houses of over £78 ratable value—£105 in greater London.

Graphs indicate the number of new houses provided in England and Wales during the period 1920-1936 and their cost, with and without state assistance. The corresponding figures are given in the tables.

ing program under the Conservative government, the Labor government decided to make a new start in housing with these three facts in mind:

- (1) The effect of a housing subsidy, provided on the basis of a given construction cost to make possible a stated rent, will be wiped out, partly or completely, by a rise in construction cost.
- (2) Increased building activity, public or private, has a natural tendency to increase building costs through the action of supply and demand.
- (3) Building contractors, union labor, manufacturers and distributors of building materials will usually all take part in creating such increases, but will inevitably pass the buck back and forth in respect to responsibility.

The pegging of construction costs over a term of years, whether arrived at by agreement or legal compulsion, presents great difficulties in a democracy. The British experience from 1920 to 1938 shows that it is not impossible.

Similar differences between employers and workers, between conservatives and progressives, between advocates of private-enterprise-housing-for-profit and subsidized public-housing-for-health-and-welfare are found on both sides of the ocean. It may help us to look at the British experience once more with this purpose in mind. It is not always easy to make out exactly what happened or why, nor can an account necessarily be accepted because its origin is British.

The following narrative has been compiled as far as possible from official reports, with background supplied by parliamentary debates and publications by British authors of divergent political philosophy. It has been submitted for criticism and correction to one whose position in British housing entitles him to judge.

What preceded the Labor government

Private enterprise building showed no signs of life in 1924, and building costs, *which had started down before the halt called on the government program*, continued downward.

Sir E. D. Simon says ("The Anti-Slum Campaign", p. 12, quoting 3rd Report of the Ministry of Health): "After the passing of the Addison Act prices rose till the houses which could

have been built in pre-war days for £250 were costing in many cases over £1,000 each." Elsewhere one finds comparisons of £235 with £1,100 and of £250 with £1,200.

Maximum prices were reached in February, 1921, according to the anonymous former Housing Commissioner who published the little book, "The Housing Question" (according to other sources, peak prices were reached in 1920), when the Ministry of Health was permitting local authorities to award contracts for subsidized parlor-type houses at £950 and over. At this point, Dr. Addison let it be known that he would approve no further bids above £800. Within a fortnight, he was receiving them at £795. By further pressure before his retirement as Minister of Health shortly after, he had reduced prices another £50. According to a rather widespread impression in England at the time, Dr. Addison had wanted to take this stand on prices earlier, but had been restrained by higher authority.

Dr. Addison's own narrative in "The Betrayal of the Slum" avoids the first person singular as much as possible, and mentions the trade slump and increasing unemployment, which were doubtless factors in the price drop. He does, however, insist on the large proportion of total price reduction which took place before his retirement. He criticizes vigorously the failure to adopt the recommendations of Sir James Carmichael's committee on the supply and prices of building materials, and refers frankly to the "unnecessary inflation of prices" which resulted.

There had been a Departmental Committee on the High Cost of Building early in 1921, which found that, aside from isolated cases, contractors had not been making excessive profits. The "Former Housing Commissioner" challenges this finding by asking how, in that case, the contractors could afford to reduce their bids by £150 in the course of a fortnight? That sounds fairly unanswerable. Simon was probably correct (op. cit. p. 11) in saying: "Materials were scarce and kept rising in price; contractors formed rings and, genuinely scared by the instability of markets, demanded and obtained high profits as a safeguard against great risks; labor worked shorter hours than in pre-war days

and produced less for increased wages." There was a real shortage of building trade labor because of casualties, transfers to other work, and failure to train apprentices. Apart from shorter hours, the reduced output per man was partly due to loss of skill through lack of practice. How much basis, if any, there was for the frequent accusation of "ca' canny", or voluntary limitation of work on labor's part, need not concern us here. Output was admittedly low at the beginning of the period and admittedly greatly increased as time progressed, which was an admitted factor in keeping down costs.

The admonitions in Dr. Addison's chapter on Future Policy (op. cit., 1922) are of interest:

"Unless the country is to be needlessly exploited, there must be a more effective check on the high cost of building. . . . Neither the associations of master builders nor the trade unions concerned, as they exist today, can be relied on to check extravagant costs. In any future scheme, covering a long period of effort, the community should be equipped with more effective powers. They would, perhaps, rarely require to be exercised because the fact that they existed would often suffice, as has been the case in other instances."

The Lloyd George ministry fell and the Conservatives under Bonar Law came in with a big parliamentary majority in November, 1922. They tried to forget about housing, but were not permitted to do so by the voters, who, finding that home building had dwindled to a vanishing point, made themselves articulate at byelections, defeating three members of the cabinet in quick succession on the housing issue. As a result, Mr. Neville Chamberlain, who had long been interested in housing in his own conservative way, was made Minister of Health with instructions to prepare a new housing bill.

The Housing Act of 1923 was the result. It offered subsidies to private builders for small houses sold to office workers and skilled artisans. It also provided a small fixed subsidy (£6 for 20 years) to Local Authorities building working-class houses to rent. Although building costs by now were well reduced (see table, p. 80), and the subsidy provisions of the new act were much more prudently framed than in 1919, and although

the Government urged the national organizations of building employers and building workers to prevent cost rises, the curve in fact started upward as soon as the program was announced.

How far it might have gone is a matter of conjecture, because a new element came into the picture before the end of the year. The Conservative Ministry was short-lived. The first Labor Ministry came into power, and the new Minister of Health, Mr. Wheatley, engineered his celebrated "treaty" or "gentlemen's agreement." As a Labor man, he was in a good strategic position to do so. But that does not detract from the credit due him. His agreement has proved remarkably useful. In fact, it is hard to see how either the great public housing program or the private-enterprise building boom could have been carried through without it.

What the Labor government did

Wheatley proposed a 15-year program of 2½ million working-class houses. He was prepared to ask Parliament for a more liberal subsidy to Local Authorities than was provided in the Chamberlain Act, but only *if he was assured that it would produce lower rents, not higher profits.* Mr. Chamberlain had already asked the national organizations of master builders and trade unionists to study these questions. There was also a committee appointed by the Building Materials Manufacturers and Suppliers, appointed at the request of the Minister of Health.

As Sir E. D. Simon says, the requisites for success were:

- (1) A Government that really meant business.
- (2) A considerable increase in the amount of labor in the building trades which could only be obtained by an agreement with trade unions.
- (3) A considerable increase in the supply of building materials.
- (4) Prices and costs must not be allowed to increase.

Confidence in a continuous program was necessary, if the unions were to admit and train a large number of apprentices and if the manufacturers of building materials were to expand their plant capacity. The Wheatley proposals inspired this confidence.

The 37-page Report of the National House Building Committee was transmitted to Parliament, April 10, 1924, with a note from Mr. Wheatley saying that it had been prepared "in response to a request made on behalf of the Government to representatives of the employers and workers in the building industry and of the manufacturers of building materials that they should assist the Government by advice as to what the industry itself considers can be done in the way of producing working-class houses."

A gentlemen's agreement

After an assembly of the facts, estimates were submitted that the industry could not produce more than 90,000 houses the first year, but could increase its capacity gradually until 225,000 could be reached in 1934 (it was actually reached in 1927) and maintained thereafter. An apprentice-training plan was offered. Wages in the building trades were already determined every 6 months, it seems, by the National Wages and Conditions Council for the Building Industry on the basis of variations in the cost-of-living index. But it appears that there had been considerable undercover variation from this scale, both up and down. The joint committee suggested that it be made an offense for a contractor on a Government housing scheme to pay either more or less than the amount set by the Council. A spread of contracts to the maximum number of small local builders was advised, use of local building materials, cheapest satisfactory building material, etc. The creation of a "statutory committee" to which cost increases could be referred was suggested, but not carried out.

It was generally understood at this time that the Government had really a bill to establish control over the prices of building materials and profits at all stages by the Board of Trade. If manufacturers did not care to produce under the conditions laid down, the Government could take over their business and operate it in the public interest.

With this in mind, the following quotations from the Report of the Committee of Building Materials Manufacturers and Suppliers have especial interest:

"The Committee is in the happy position of being able to pledge the

whole of the organized Manufacturers and Suppliers of Building Materials to a policy of nonexploitation of the Government Housing Scheme for purposes of inflation of prices. . . . As to the question of control of prices, the Committee is of opinion that the best way to keep prices at a reasonable level is to enlist the good will of the Manufacturers and Suppliers, and to institute no system of Government control, until, at any rate, there is definite evidence that the Manufacturers and Suppliers are not 'playing the game'. . . . Given the confidence of your own and succeeding Governments, the co-operation of the Manufacturers and Suppliers will achieve what no Government Departmental control or system of organization could ever achieve."

The bill was withheld and the pledge was kept. All the pledges were kept. And a record-breaking building period followed with private enterprise eventually outstripping the government program in volume.

To be sure, as already mentioned, there was a moderate rise in building costs from 1923 to 1925, but most of it took place under the stimulus of the Chamberlain Act before the Wheatley agreement was adopted.

What England built

For its completion, the picture needs the record of the number of small and smallish dwelling units built in England and Wales, with and without subsidy (see page 80). It should convince anyone not willfully blind that subsidized public housing, far from killing private enterprise, appears to stimulate it, and that no such volume of building could have continued if building costs had not remained low. It should be emphasized that British success in price-pegging was only secured through *simultaneous* agreement by building contractors, building labor, and the manufacturers and distributors of building materials. The materials manufacturers and distributors were brought into line by the threat of legislation limiting price and permitting the National Government to take over and run their plants. Behind this was a known majority in Parliament and all articulate public opinion outside.

Is there a lesson here for the United States?

Current Trends of Building Costs

Compiled by Clyde Shute, Manager, Statistical and Research Division, F. W. Dodge Corporation, from data collected by E. H. Boeckh & Associates, Inc.

CURVES INDICATE control trends in the combined material and labor costs in the field of residential frame construction, the monthly curves being an extension of the local cost averages during the years 1935, 1936, and 1937. The base line, 100, represents the U. S. average for 1926-1929.

Tabular information gives cost index numbers relative to the 100 base for 9 common classes of construction, thus showing relative differences as to construction types for this year and last.

Cost comparisons or percentages involving two localities can easily be

found by dividing one of the index numbers into the difference between the two. For example: if index A is 110 and index B, 95, $(110-95) \div 95 = .16$. Thus costs in A are 16% higher than in B. Also costs in B are approximately 14% lower than in A: $(110-95) \div 110 = .14$.

CONSTRUCTION COST INDEX U. S. average, including materials and labor, for 1926 - 1929 equals 100.

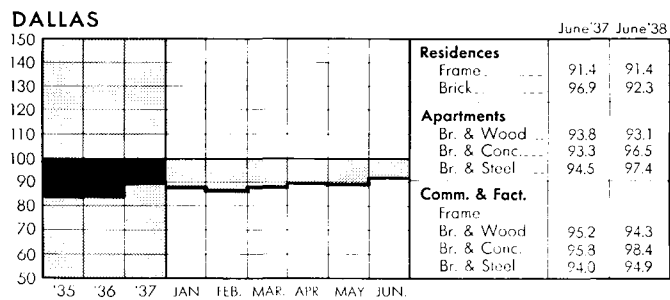
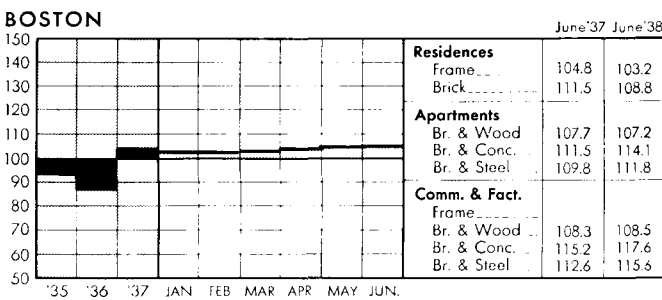
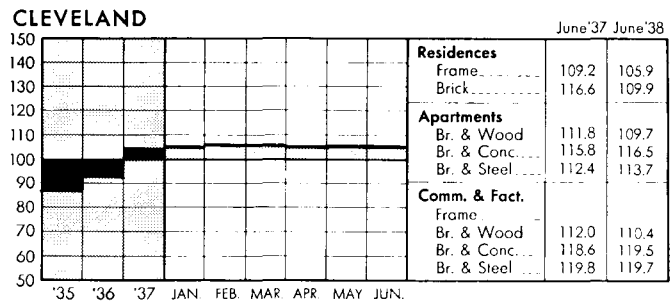
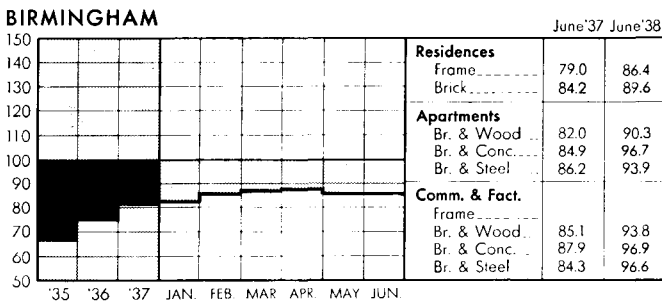
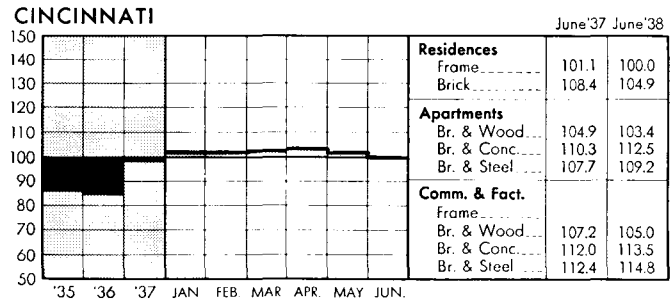
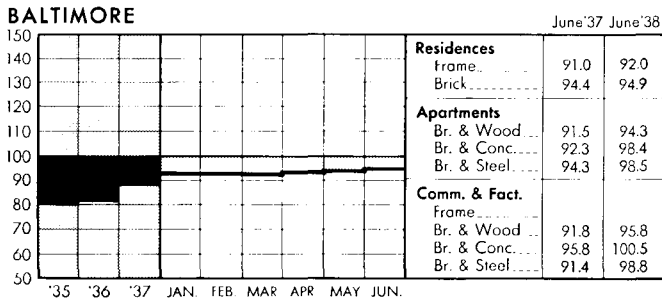
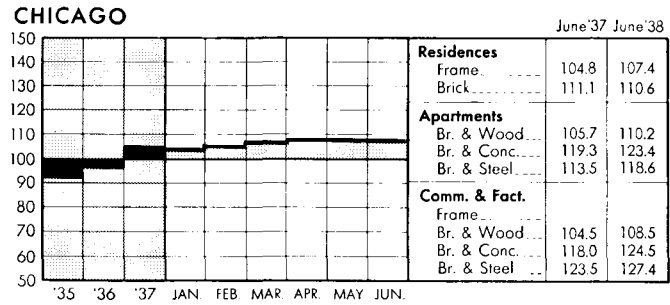
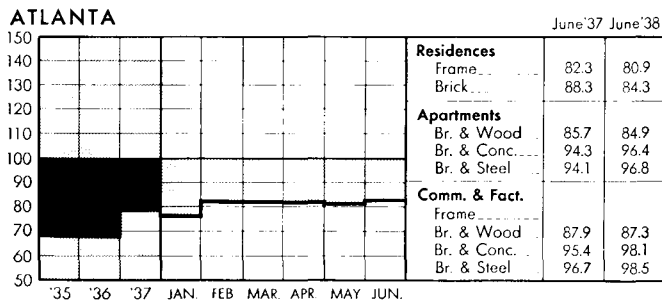

DENVER

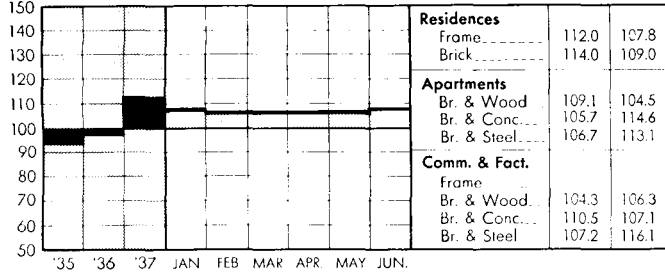

NEW YORK

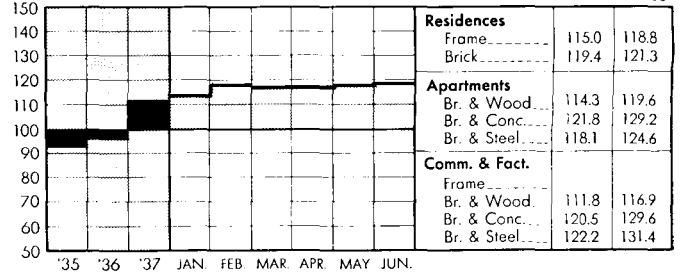

DETROIT

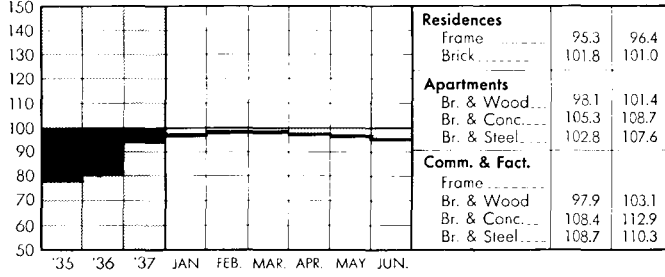

PHILADELPHIA

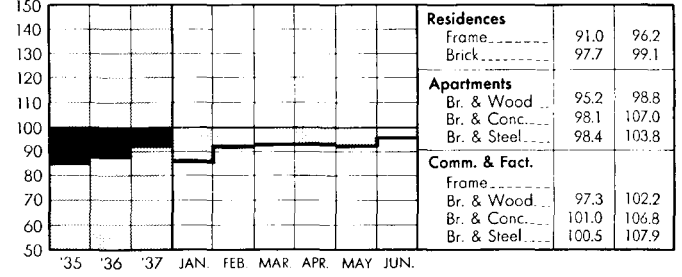

KANSAS CITY

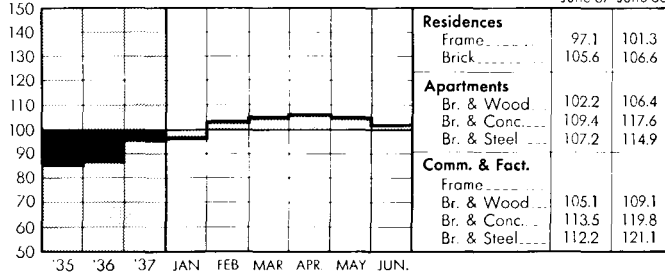

PITTSBURGH

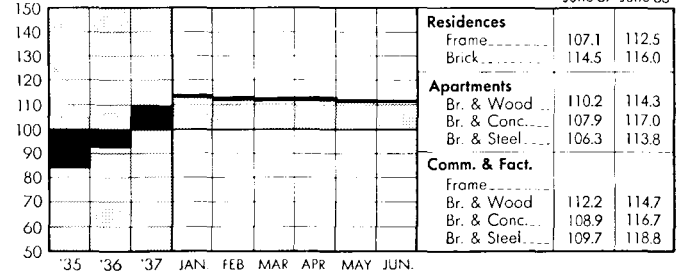

LOS ANGELES

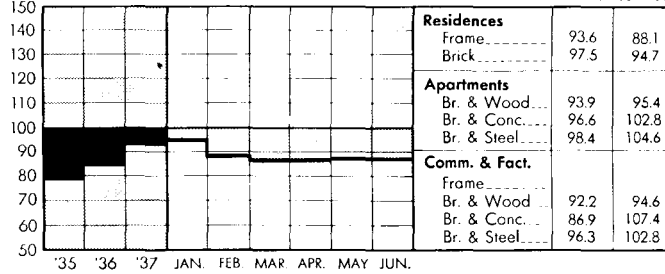

ST. LOUIS

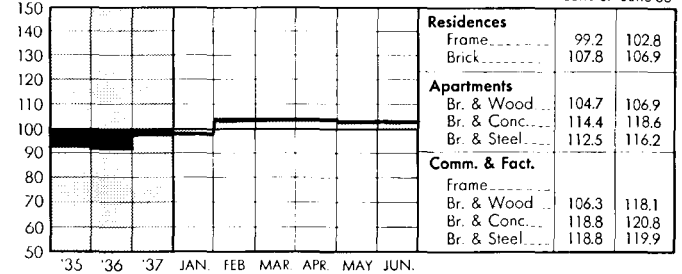

MINNEAPOLIS

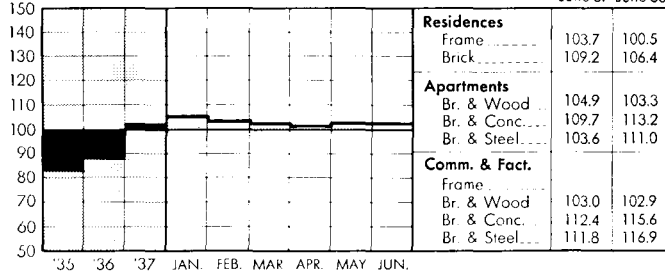

SAN FRANCISCO

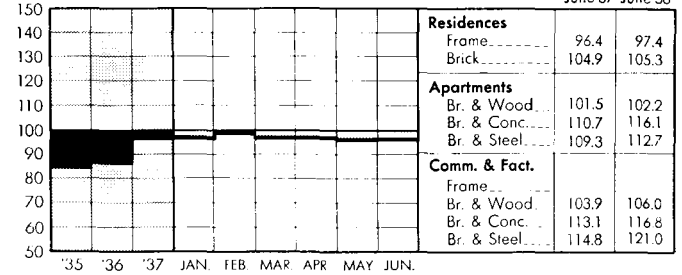

NEW ORLEANS

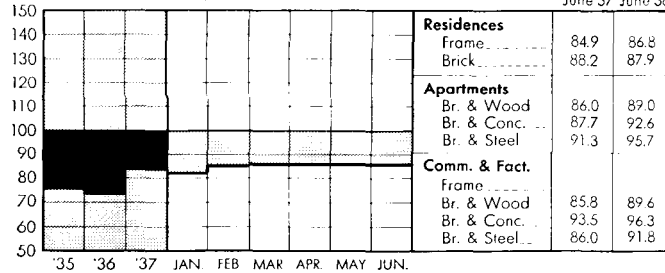

SEATTLE

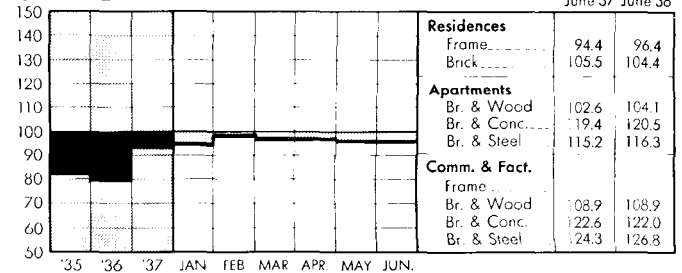



R. Tebbs

FIREPLACES

As a necessary means for heating interiors or for cooking food, fireplaces have become obsolete in most parts of this country. But psychologically they hold a great attraction for many; and according to tastes and pocketbooks are subject to a wide variety of forms, as suggested by illustrations on the following pages.



Kneill

1



Lincoln

2

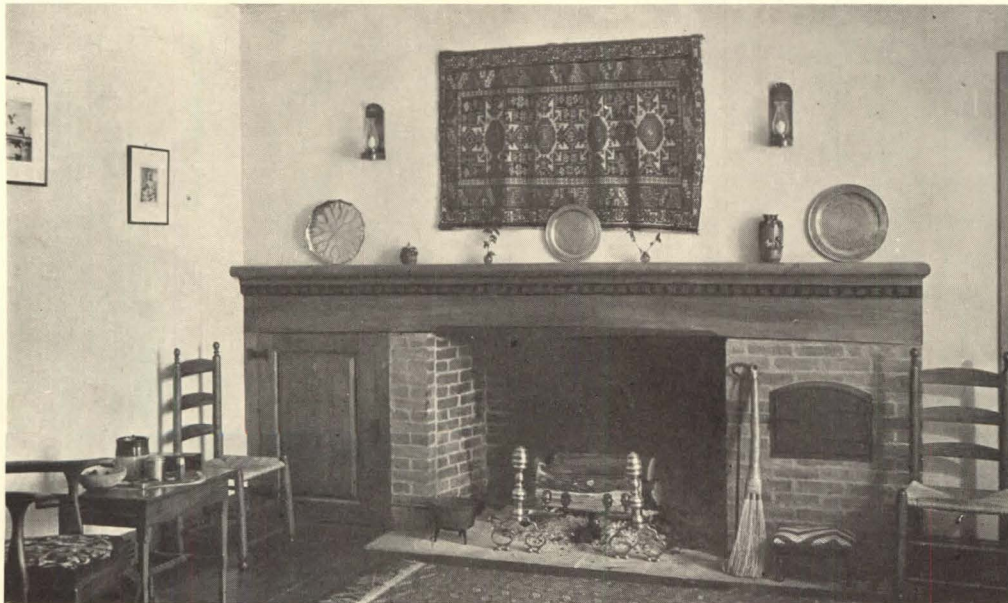

Van Anda

3

ON THIS PAGE: 1, main fireplace of an 18th century mill house at Old Lyme, Conn., remodeled by G. Harmon Gurney, architect; 2, dining-room fireplace at Paoli, Pa., adapted by A. W. Suplee, builder, from an original in the John Bartram house, an early Colonial structure in Philadelphia; 3, in a house at Cooperstown, N. Y., designed by Greville Rickard, architect.

ON FACING PAGE: 4, late 19th century fireplace in a remodeled house at Upper Marlboro, Md.; 5, in a living room at Scarsdale, N. Y., for which Joseph D. Weiss was architect and Eleanor Horst interior designer; 6, play-room fireplace at Fisher's Island, N. Y., designed by Eric Kebbon, architect; 7, in one of the bedrooms of a house at Paoli, Pa., the dining room of which is shown in 2 on the facing page.



4



5



6



7

Lincoln

Grottscho

Lincoln

Lincoln



Schnall

8



Gottscho

10



Haight

9



Gottscho

11



12



13



14

ON FACING PAGE: 8, fireplace in living room of a summer home at Harvey Cedars, N. J., designed by J. Joshua Fish, architect; 9, living-room fireplace at San Marino, Calif., H. Roy Kelley, architect; 10, fireplace in a master's bedroom in a house at Old Chatham, N. Y., designed by Polhemus & Coffin, architects; 11, library fireplace at Old Westbury, Long Island, N. Y., Noel & Miller, architects.

ON THIS PAGE: 12, living-room fireplace of a house in Roxbury, Conn., Greville Rickard, architect; 13, living-room fireplace designed by Henry Corse, architect, for a house in Oyster Bay, Long Island, N. Y.; 14, fireplace in the library of a large house in Lehman Township, Pa., designed by Francis A. Nelson, architect.

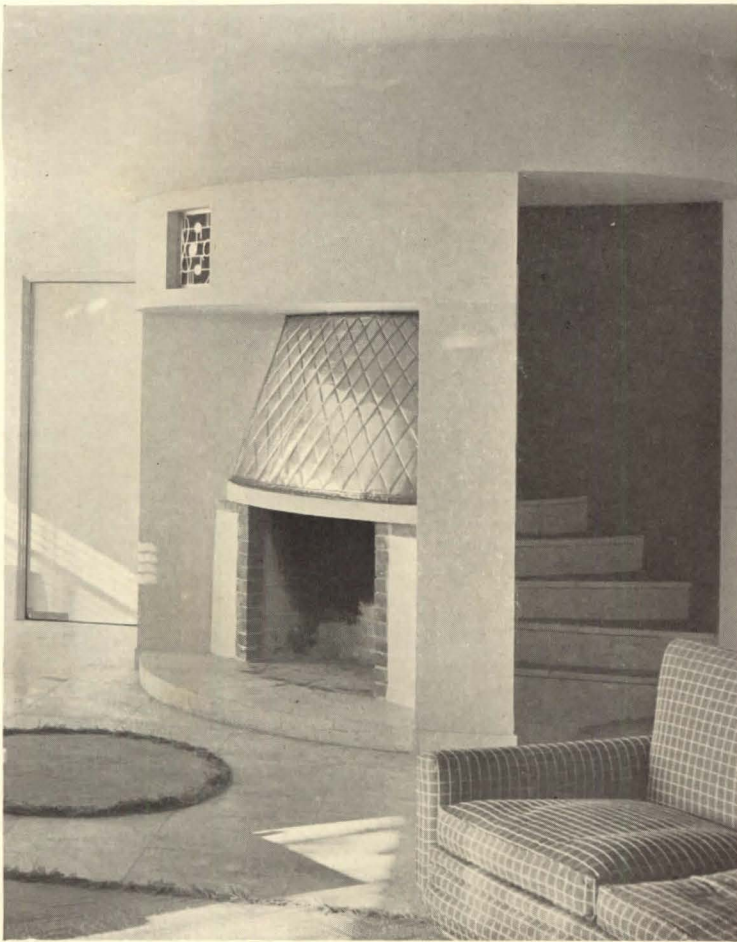

15

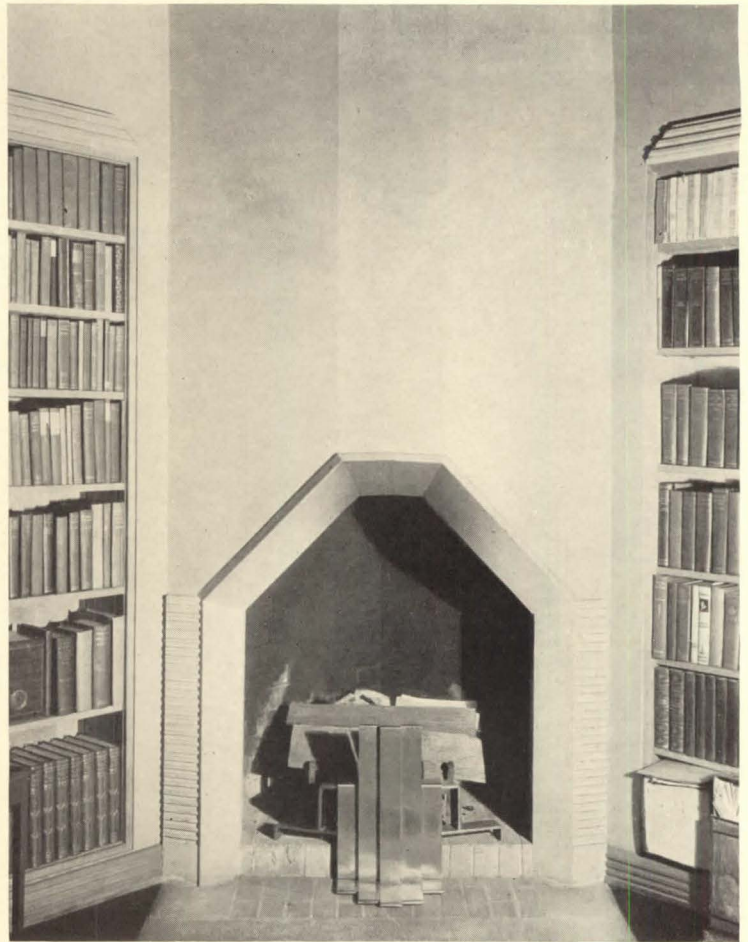

17



16



18

Gottscho

Fred Dapprich

Lincoln



19

Anderson



20

Lincoln

ON FACING PAGE: 15, fireplace at the corner of both living and dining areas in a house at Miami Beach, Fla., designed by Robert Law Weed, architect; 16, fireplace in a living room at Los Angeles, Calif., designed by Harwell Hamilton Harris; 17, library fireplace in a house at Highland Park, Ill., designed by Barry Byrne, architect; 18, bedroom fireplace designed by Henry Varnum Poor, architect, for a house at New City, N. Y.

ON THIS PAGE: 19, in the living room of a house at Fargo, N. Dak., designed by Paul W. Jones, architect; 20, living-room fireplace in a New York City apartment designed by Joseph Aronson, architect; 21, demonstration fireplace designed by Frederick Kiesler for a showroom in a New York City furniture store.

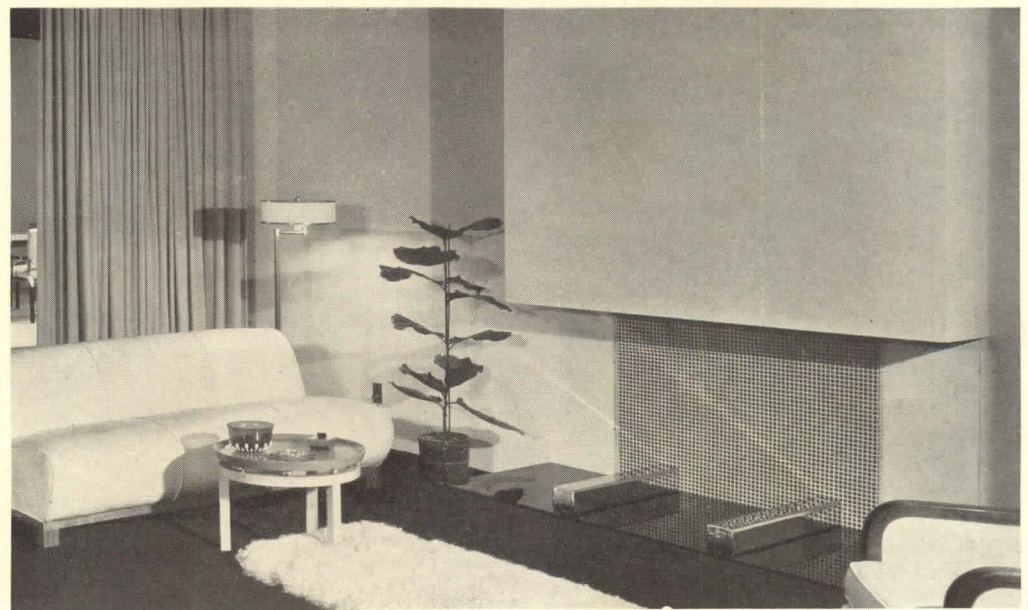

21

Lincoln

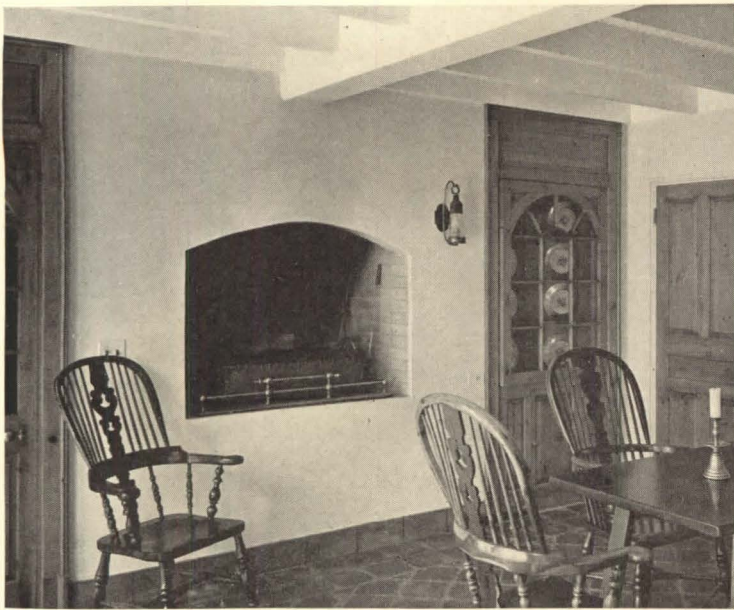

Gottsch

22

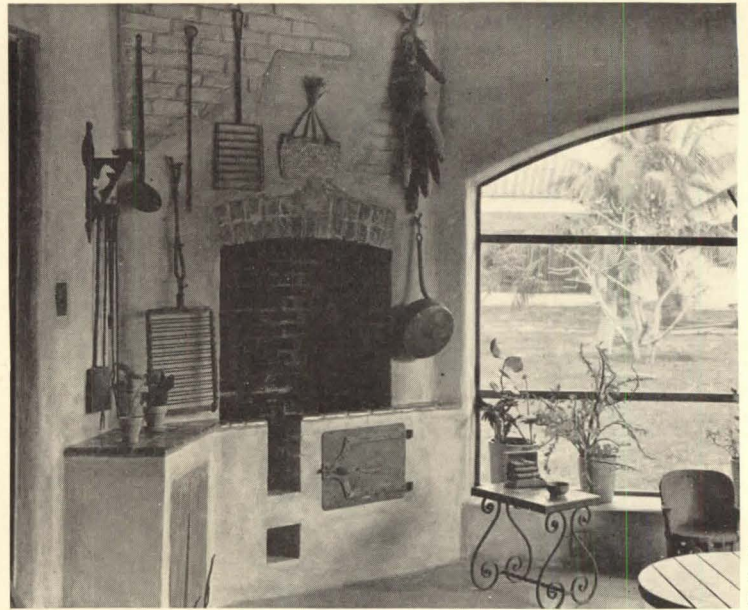

Gottsch

23

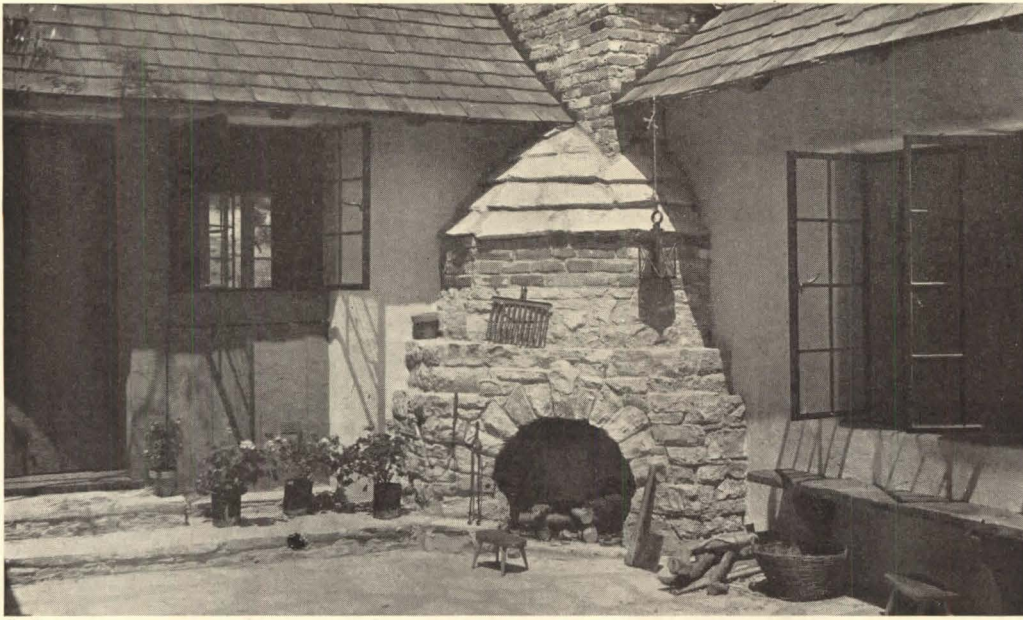

Robert Carwood

24



Van Andia

25

22 and 23 illustrate a form of fireplace used as a cooking grille. Both examples are in Florida, 22 being in the dining room of a Palm Beach house designed by John L. Volk, architect, and 23 on the porch of a house at Miami Beach designed by Schoeppl & Southwell, architects. The other two pictures suggest the elimination of the fireplace as a utilitarian unit and its employment out-of-doors as a garden structure. 24 is at Beverly Hills, Calif., and was designed by Allen G. Siple, architect. 25 was designed by H. L. Miller, architect, for an estate at Mamaroneck, N. Y.

Trend Notes on a Building World

Each month these pages record significant developments in the realm of design and in the fields of materials, equipments, and services.

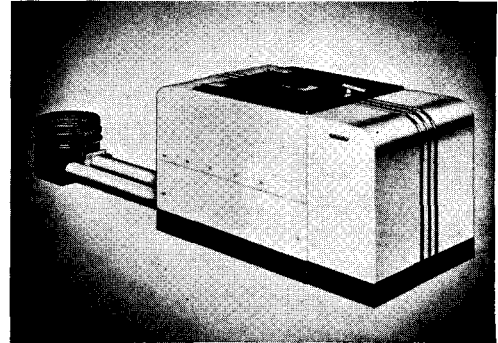
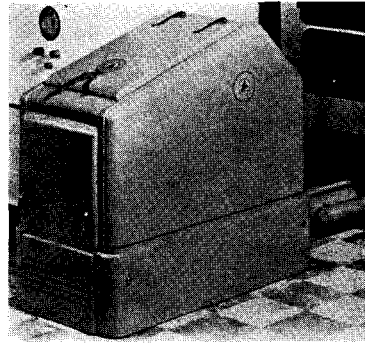
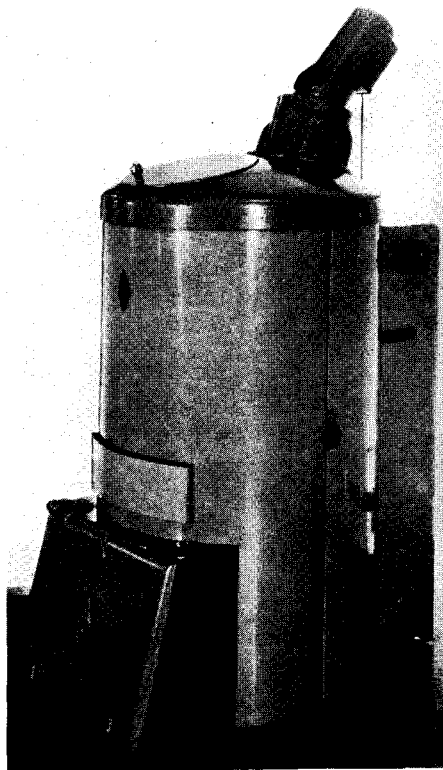

3

4

COMFORT CONDITIONING

VARIOUS PHASES of comfort conditioning are more and more becoming subject to precise mechanical control. This is particularly true in the heating field, for which a number of novel units have been developed as a result of efforts to produce mechanical simplification and increased convenience and efficiency in operation.

ENGINEERS HAVE perfected also a method of automatic ignition in a coal-burning, stoker-fed plant. A Cal-rod electrical unit—the same as those used in electric stoves—is placed at the base of the stoker retort; and when a button is pressed, fuel is fed into the retort and the fire ignited.

AMONG THE NEW STOKERS recently announced by manufacturers is: 1. The "Deluxe Heatmakers" by The Iron Fireman Manufacturing Co., of Portland, Ore. These are hopper models with capacities ranging from 30 to 150 lbs. of coal per hour; 2. The "Econ-O-Col" by the Econ-O-Col Stoker Division of the Cotta Transmission Corp., of Rockford, Ill. Models range in capacity from 20 to 1,200 lbs. per hr. and include 2 bin-feed units, 5 models for residences and small commercial buildings and 8 heavy-duty stokers; 3. The "Challenger" by the Kol-Master Corp. of Oregon, Ill. This is a hopper model with a 300-lb. capacity and a burning capacity from 6 to 40 lbs. per hr.; and, 4. The "Peerless Stoker" by the Peerless Manufacturing Corp., of Louisville, Ky. Models are of the hopper type with three rates of coal feed and complete automatic controls.

SPURRED, probably, by the wide public acceptance of oil and gas heating units, research on coal-burning plants has produced several ingenious results. The "Anthra-Heat" steel boiler (see cut) was developed at the Anthracite Industries Laboratory for heating small houses. It is a magazine-feed boiler for a hot-water heating system. It is semiautomatic in operation, holding enough coal for one to three days—depending on weather conditions. Air for combustion flows from the sides over a spiral, cone-shaped grate, instead of upward through the grate. Ashes are thrown off at the rim when the coal is fed from the top and need be removed only about once a week.

AND IN ALBANY, N. Y., the Wm. McEwan Coal Co. built a "modern Anthracite home" in which a coal-burning hot-water boiler has been

(Continued on page 146)

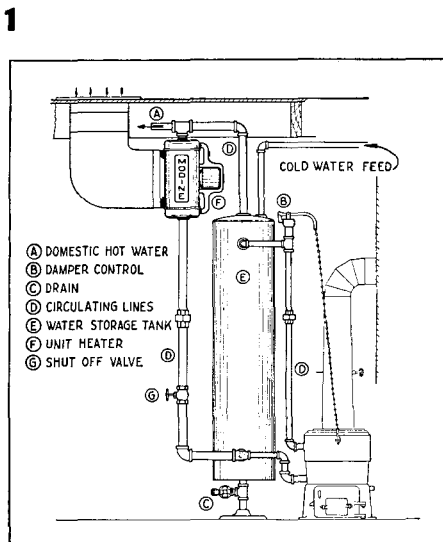

1, "Anthra-Heat" steel boiler designed by Anthracite Industries Laboratory; 2, diagram of supplementary heating system using a Modine Unit Heater; 3 and 4, new coal stokers for residential use. 3 is the Iron Fireman "Deluxe Heatmaker"; 4 is the "Econ-O-Col" made by the Cotta Transmission Corporation.

A SUPPLEMENTARY heating system for residences has been developed by the Modine Manufacturing Co. in collaboration with the Anthracite Industries Laboratory. A Modine unit heater is linked to the domestic hot-water supply and furnishes heated air to an area through a small duct.

The Nicollet Hotel, a Hitz Property in Minneapolis . . . Completely Equipped with a Weatherstat Control System.



WEATHERSTAT
Saves 40% OF FUEL
FOR HITZ HOTEL

WEATHERSTAT CONTROL greatly improves temperature conditions. It saves fuel by zoning, by discouraging the practice of opening windows, by speeding steam distribution, and by providing automatic night shutdown . . . Weatherstat Control will improve temperature and save fuel in any building, old or new, large or small. In the first year of its operation in the Nicollet Hotel, Weatherstat outside temperature control effected a direct saving on steam consumption of \$4,247, based on comparative degree days according to G. M. Grossen, Chief Engineer. Compared with the former average annual steam cost of approximately \$10,000, this represents an actual saving of more than 40% . . . Investigate the Weatherstat System. Call in the Minneapolis-Honeywell Engineer. Let him show you how Weatherstat will pay for itself over and over again out of fuel savings. Minneapolis-Honeywell Regulator Company, 2804 Fourth Avenue South, Minneapolis, Minnesota. Branch and distributing offices in all principal cities.

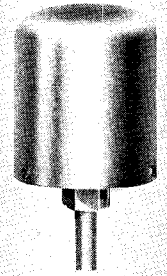

The
WEATHERSTAT

MINNEAPOLIS-HONEYWELL

BROWN INDUSTRIAL INSTRUMENTS
NATIONAL PNEUMATIC CONTROLS



Control Systems

BUILDING TYPES



Photo by Hedrick-Blessing. G. W. & George L. Rapp, Inc., architects

THEATERS (With Time-Saver Standards Data)

FORTHCOMING 1938 STUDIES: Hospitals—August; Apartments—September; Houses (\$15,000–\$25,000)—October; Houses (\$25,000 and up)—November; Office Buildings—December. **PRECEDING 1938 STUDIES:** Factories—June; Schools—May; Houses (\$7,500–\$15,000)—April; Houses (\$7,500 and under)—March; Retail Stores—February; Hotels—January.

ARCHITECTURAL
RECORD

CONSIDER WITH
AMERICAN ARCHITECT AND ARCHITECTURE



THEATERS

CINEMA, ☆ ☆ ☆
☆ ☆ COMMUNITY,
BROADCASTING

THE THEATER, in spite of the ubiquitous radio, is still one of America's first recreational preferences. The advent of television, when, if, and how it is merchandized, may and undoubtedly will have a profound effect upon show business. However, repeated assurances have indicated that the day of general television entertainment is not an immediate tomorrow. Serious technical and commercial difficulties have yet to be resolved. When television does arrive and its special needs are established, one may expect a new theater type.

A great majority of the 16,000 or more theaters now operating in the United States are presenting motion pictures exclusively. There are, however, definite indications that community and broadcasting theaters will receive an increasing amount of attention from building designers. This study presents reference information related to the three types—*Cinema, Community, Broadcasting*—because these are most important economically and socially. Certain elements, systems, and considerations such as projection and acoustics are common to all three. The studies, otherwise,

are presented separately because of the varying requirements.

The commercial cinema has, according to exhibitors, a drawing power for about ten years, at which time modernization is imperative if patronage is to be maintained. This would indicate that roughly 1,500 theaters are, or should be, redesigned annually. We have all but eliminated the "atmospheric" treatment of the auditorium and its indefensible competition with the exhibition. Still, many theaters have but substituted copper jigsaw for gilded plaster, abstractions for angels. Frequently, the resultant confusion is more distracting than the one-time hanging gardens of Babylon which adorned the walls. Let first things be first: let the screen be the focus of attention. Environmental control ought to be based on a coordination of desirable seeing, hearing and comfort systems. During the past ten-year cycle, more and more attention has been focused on the definite standards which determine optimum visual and auditory characteristics.

The community theater, through its integration with educational, cul-

tural and recreational activities, offers the assured continuance of the spoken drama. It can and will absorb the best traditions of the professional trouper and the legitimate production. Heretofore, many of these theaters have been so restricted in their planning and so inadequate in their equipment systems that the full development of the theater's place in the community has been greatly handicapped. Now, increasing numbers of this type of theater afford the most complete plants to be found anywhere. The Wisconsin Memorial Union, now being completed, is an outstanding example.

Broadcasting theaters, of which Station KNX is a most recent illustration, are entirely distinct from other types in the relationship of audience to performance. As a theater its position is still transitional but designers may expect a further development, based on standards set forth, which may result in a wider availability of such exhibitions. Perhaps, as indicated, it will develop as a form adapted to coincident entertainment like dancing or cafe divertissement.

References

Acoustic Forms as Decoration. Architectural Review, April, 1938, pp. 207-212
American Architect. July, 1937
An Objective Study of the Case of the Cinema Auditorium and of the Sources of Its Decoration. Architectural Review. Feb., 1938, pp. 91-100

Architecture for the New Theater. Theater Arts, Inc. 1934
Official Bulletin of the Acoustical Material Association. Bulletin No. VI, Mar., 1938
Theater Acoustics Today. C. C. Potwin. Copies are available for distribution

Theater Arts Monthly. Apr., 1934
Theater and School. Hume. 1932
Theater and Stage. Edited by Harold Downs. 1934
Theater Lighting. Nela Park Engineering Department, General Electric Co., Cleveland. 1938

Current Projects

CINEMA—SEATING 1,430

RHODES THEATER
CHICAGO, ILLINOIS

C. W. & GEO. L. RAPP, INC.
Architects

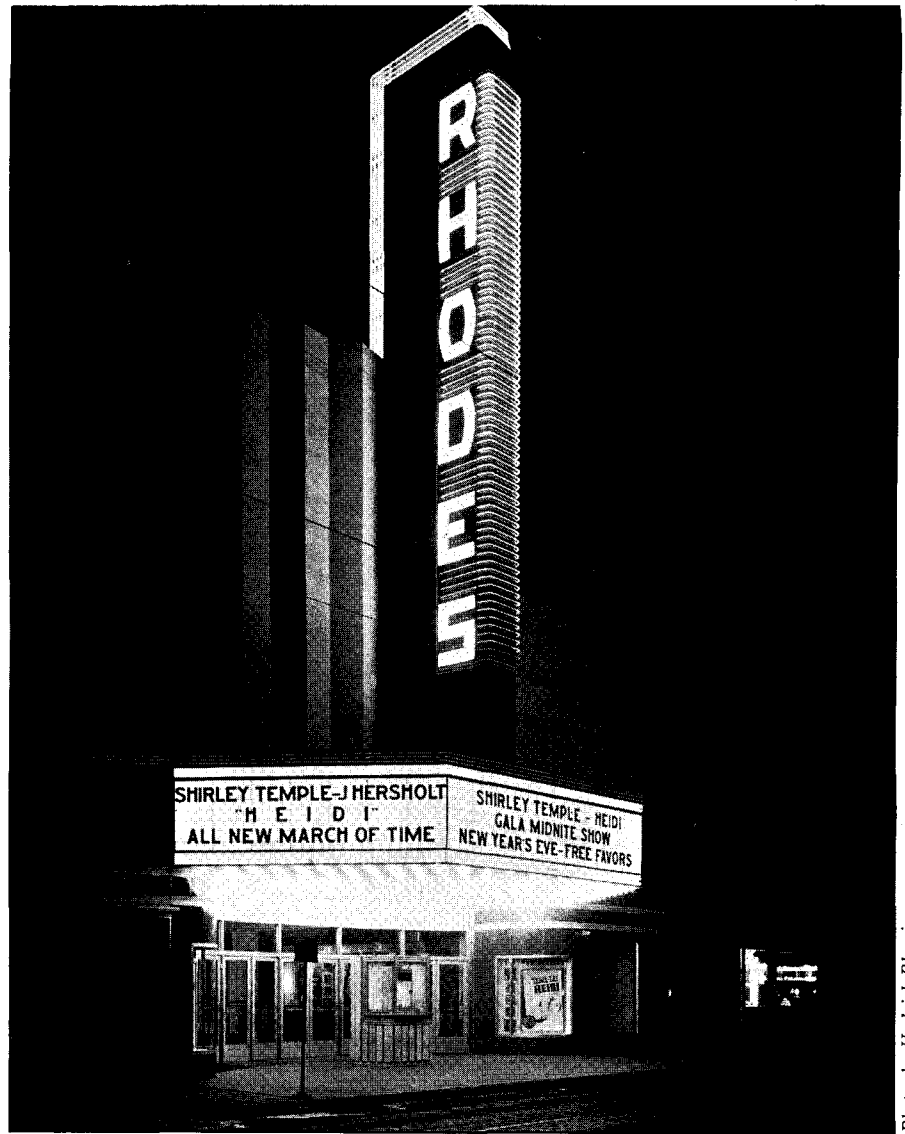

Photos by Hedrich-Blessing

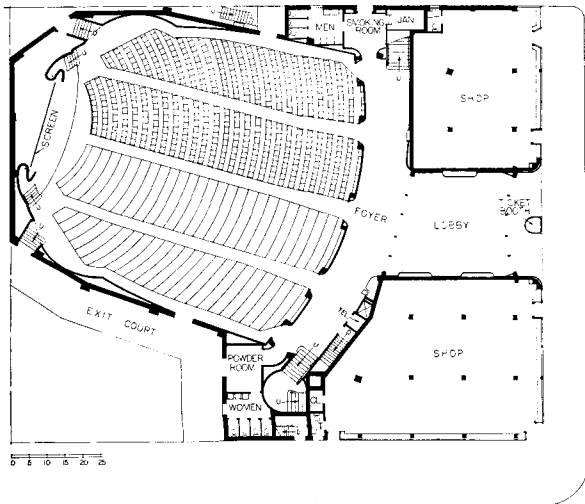

Ground Plan

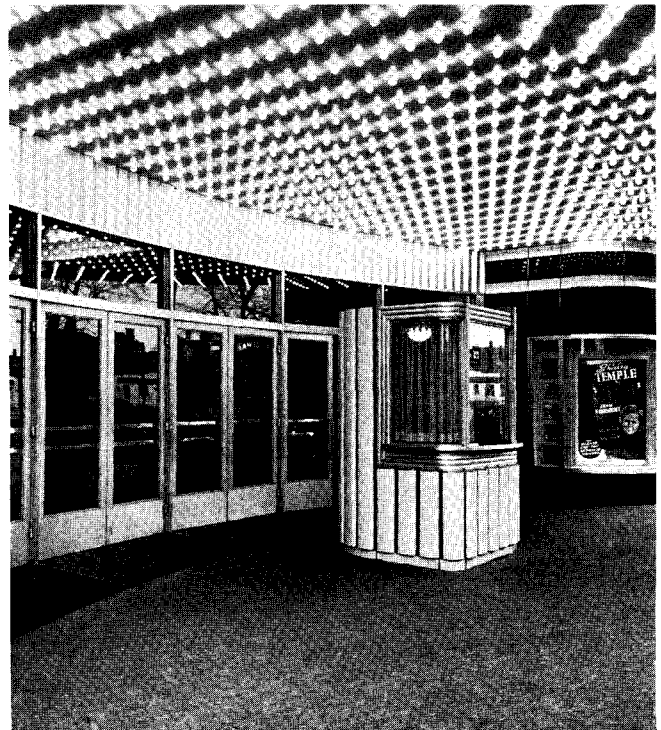

Photos by Hedrick-Blessing



HORIZONTAL LIGHT coves focus attention on the screen, which is surrounded by a velour-covered frame. Velour "takes" overflow light from projected rays and reflected light from concealed blue neon tubing in such a way as to soften harsh definition of the picture's limits. In this way actual vision of objects is approximated, points in focus being acutely perceived and surroundings vaguely discerned. Also, the cost of proscenium is avoided. Acoustical tile bands between light coves are champagne-colored.

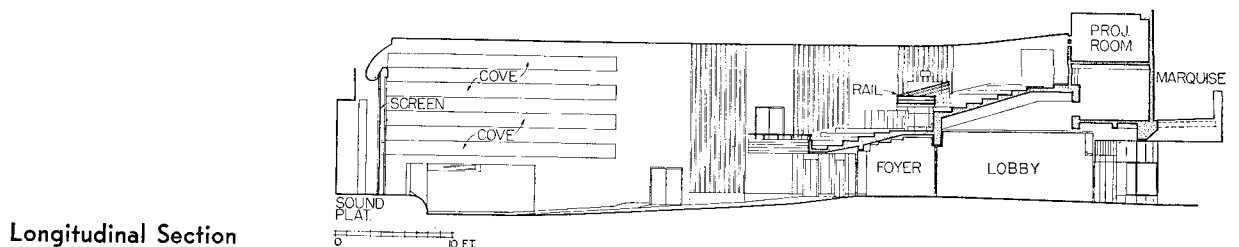
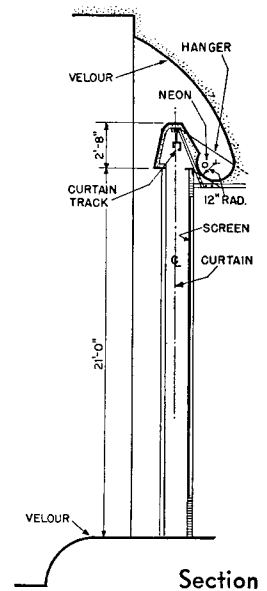
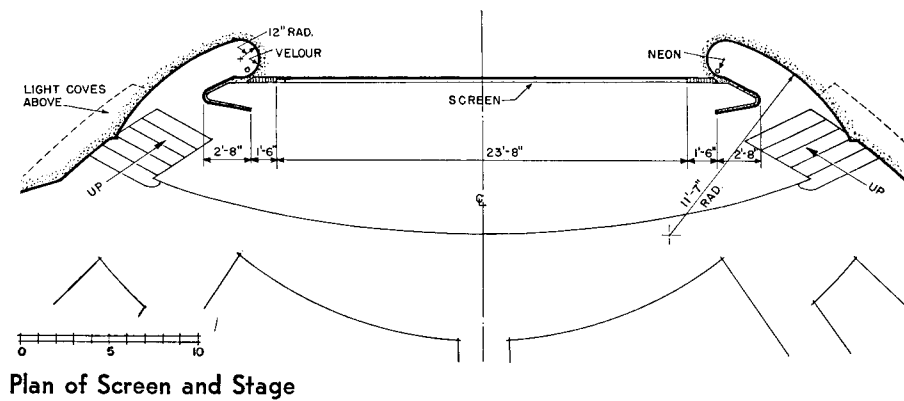

CINEMA—SEATING 1,430

RHODES THEATER
CHICAGO, ILLINOIS

Foyer lounge wall surfaces are plastic-bonded veneer in Hawaiian Koa wood. The ceiling and doors are both done in turquoise blue. These are combined with the henna rose coloring of the Sealtwist carpeting.

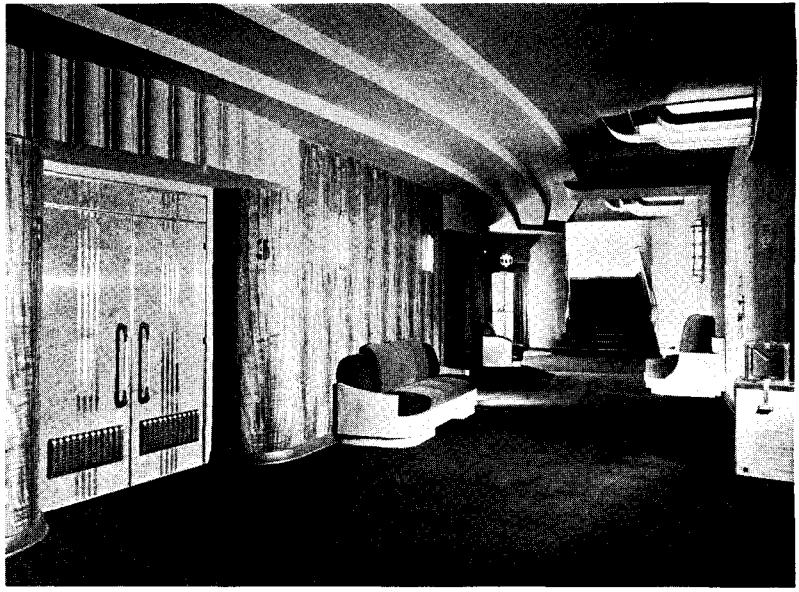

In the outer lobby one wall is reserved for display of 30 stars whose hand- and footprints are impressed in the floor below, authenticated by identification in picture panel.

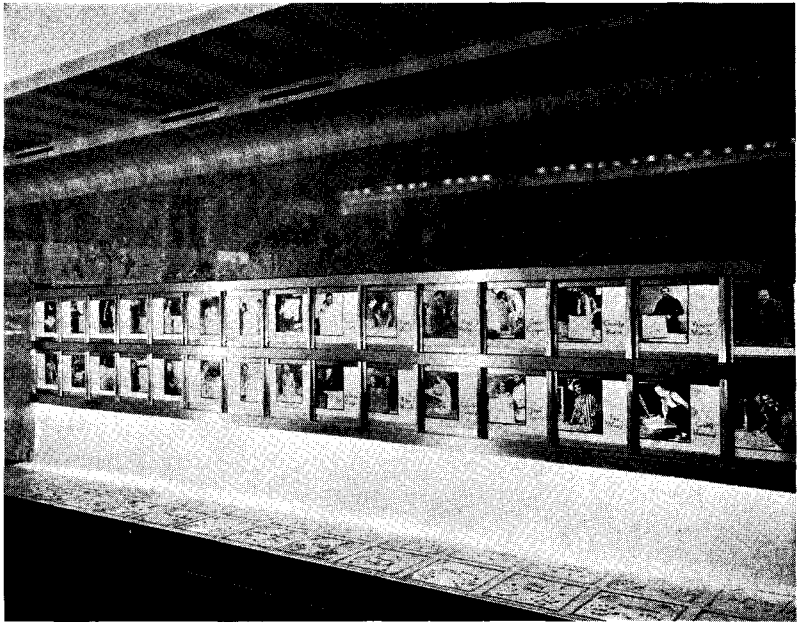

SCHEDULE OF EQUIPMENT AND MATERIALS

FOUNDATIONS

Plain and reinforced concrete

STRUCTURE

Front walls reinforced concrete; structural steel frame, Duffin Iron Co.; reinforcing steel, Ceco Steel Products Corp.

EXTERIOR

Walls: Reinforced - concrete front walls, Macotta; sand-lime brick rear walls
Trim: Granite, Thomas J. Vernia & Co., Inc.
Roof: Poured gypsum roof deck, U. S. Gypsum Co.; composition roofing, Esko Roofing Co.
Sash: Metal windows, The Ruda Co.; hollow metal windows, Lionel Vallas Co.
Metalwork: Bronze and aluminum

WATERPROOFING

Integral

INTERIOR

Walls: Marble lobby facing, Peerling Marble Co.; auditorium—Acoustone acoustical tile, U. S. Gypsum Co.; elsewhere, clay and gypsum tile

Ceilings: Plaster, Harold I. Sutton

Floors: Carpet; rubber tile, Wm. Slater, Jr., Inc.; ceramic tile in toilets

Doors and Trim: Exterior: hollow metal, fire-proof, The Ruda Co. Interior: hollow metal and wood, B. R. Ringwald & Sons Co.; trim, Formica Insulation Co.

HEATING

Low-pressure vacuumatic steam system, A. Kilander Co.; boiler, Kewanee Boiler Corp.; Todd oil burner; temperature control, Johnson Service Co.; radiators, American Radiator Corp.; vacuum pump, Chicago Pump Co.

VENTILATING

Geo. E. Mathis & Sons; fans, Clarage Fan Co.

AIR CONDITIONING

Compressors, General Electric Co.; coils, Fedders Manufacturing Co.

PLUMBING

Fixtures, Kohler Plumbing Co.; water heaters, General Heater Corp.; floor and roof drains,

Wade Iron Sanitary Mfg. Co.; bilge pump, Chicago Pump Co.; piping, steel pipe

ELECTRICAL

Wiring and neon, L. H. Lamont & Co.; conduit, Revere Electric Co.; light fixtures, Solar Light Co.; attraction and display signs, White Way Electric Sign & Maintenance Co.; emergency lighting, Exide Battery Co.

HARDWARE

Clark & Barlowe Hardware Co.

EQUIPMENT

Metal toilet partitions, Henry Weis Mfg. Co.; auditorium seats, Ideal Seating Co.; furniture, Mandel Bros.; sound equipment, Radio Corporation of America; automatic ticket chopper, Newman-Budd; projection equipment, Ashcraft Lamp Houses; curtain control, Vallon Equipment Co.; screen, Daylight Screen Co.

GLAZING

Glass and store fronts, H. M. Hooker Glass & Paint Mfg. Co.



CINEMA—SEATING 1,040

JAMES E. CASALE
Architect

PENN THEATER
BUTLER, PENNSYLVANIA

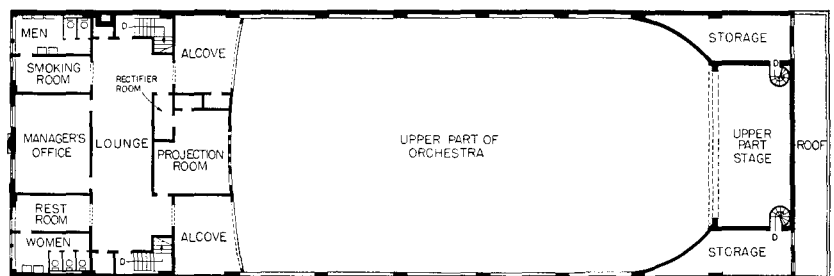

Balcony

THE OUTER LOBBY is of ivory Micarta and stainless steel. Display cabinets, ticket booth, and marquise are also of stainless steel accented by red, ivory and blue baked-enamel finish. Base of ticket booth is maroon.

As shown in plan, on either side of the projection booth are two loge sections. Each of these contains 24 movable chairs and was included primarily for the use of groups desiring to engage the entire section.

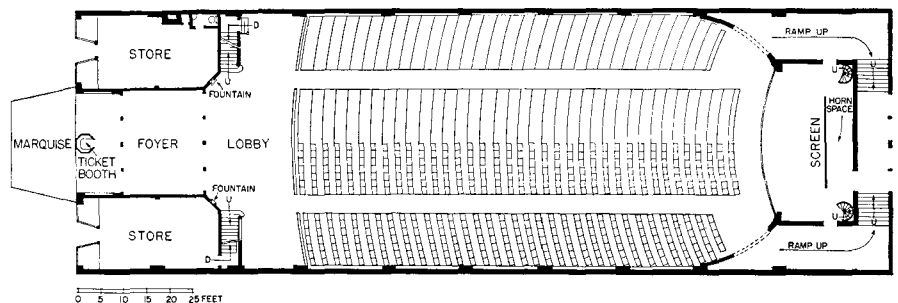

Ground Floor

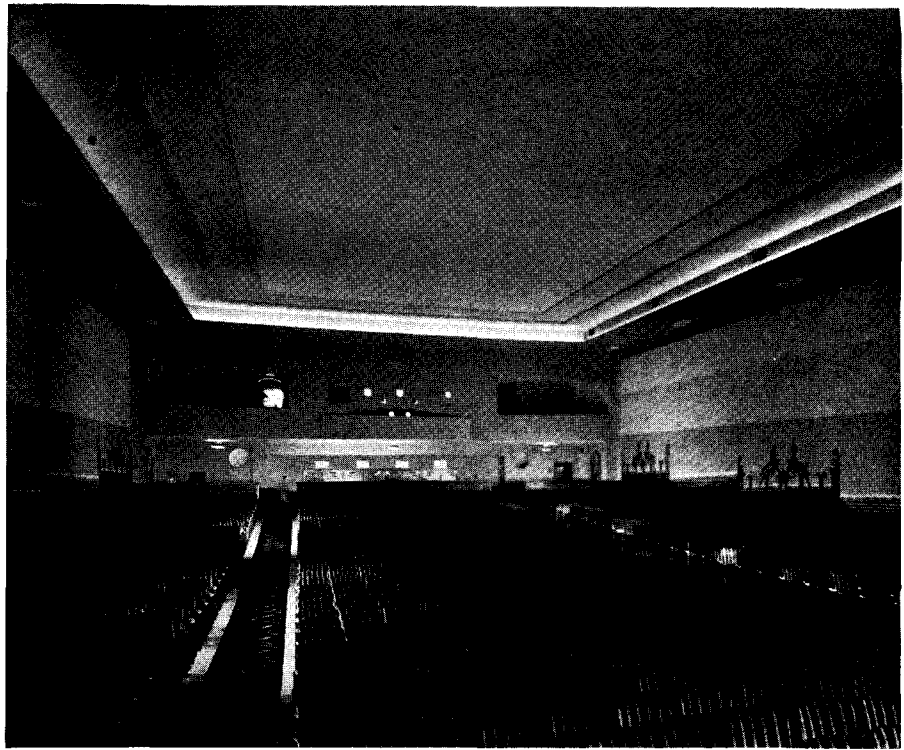

Lower portion of side walls painted deep maroon with three broad bands of gray salmon, diminishing in tone, above. The ceiling is in four shades of pink salmon. Seating is upholstered in tan and red frieze, and the carpet is executed in a black-and-red pattern on a taupe field. Curtain is silver-colored, framed in a proscenium of blue and terra-cotta color. Doors, as well as interior wood trim, are finished in satinwood.

SCHEDULE OF EQUIPMENT AND MATERIALS

FOUNDATION

Concrete

STRUCTURE

Masonry bearing, structural steel

EXTERIOR

Walls: 8-in. common brick, 4-in. terra-cotta back-up; front of glazed terra cotta, Atlantic Terra Cotta Co.; base of mottled black

Roof: Gypsum plank, U. S. Gypsum Co.; 20-yr. bonded built-up asphaltic, Barrett Co.

Sash: Steel-projected, Truscon Co.; store windows, Pittsburgh Plate Glass Co.; stainless steel moldings

Metalwork: Copper; display cabinets and ticket booths, stainless steel, Lobby Display Frame Corp.; sign and marquee, stainless steel and baked enamel, Superior Sign System, Inc.

Glass block: Libbey-Owens-Ford Glass Co.

Lighting: Neon signs

INTERIOR

Floor: Cinder concrete on grade; aisles, office, lobby, and lounge, carpeted, Hardwick-Magee Co.; stage, maple; rubber tile in toilets; terrazzo in outer lobby

Doors: Solid oak

Walls: Acoustical plaster in auditorium ceiling and rear wall, walls and ceiling of balcony and lobby; foyer, Flexwood; remainder, hard plaster; ivory Micarta and stainless steel in outer lobby

LIGHTING

Emergency direct lights at edge of ceiling; indirect in auditorium; fixtures, Joe Hornstein, Inc.; lounge fixtures, chromium and opaque glass; emergency lighting operated by natural gas generator

PLUMBING

Fixtures, Standard Sanitary Mfg. Co.; brass pipe, Chase Brass & Copper Co.; drinking fountain, Standard Sanitary Mfg. Co.

HEATING

Complete air conditioning, except stores, Typhoon Air Conditioning Co.; well water (220 gal. p. m. at 54°) cooling; pump, Tranter Mfg. Co.; direct radiation in stores and lavatories, American Radiator Corp.; boiler, Titusville

PAINTING

Novelty Scenic Paint Co.; Pittsburgh Plate Glass Co.

PROJECTION

Simplex, International Projector Corp.; sound, RCA system

PANEL BOARDS and SWITCHES

Frank Adams Mfg. Co.; control, Century Lighting Co.

Photos by George H. Van Ande

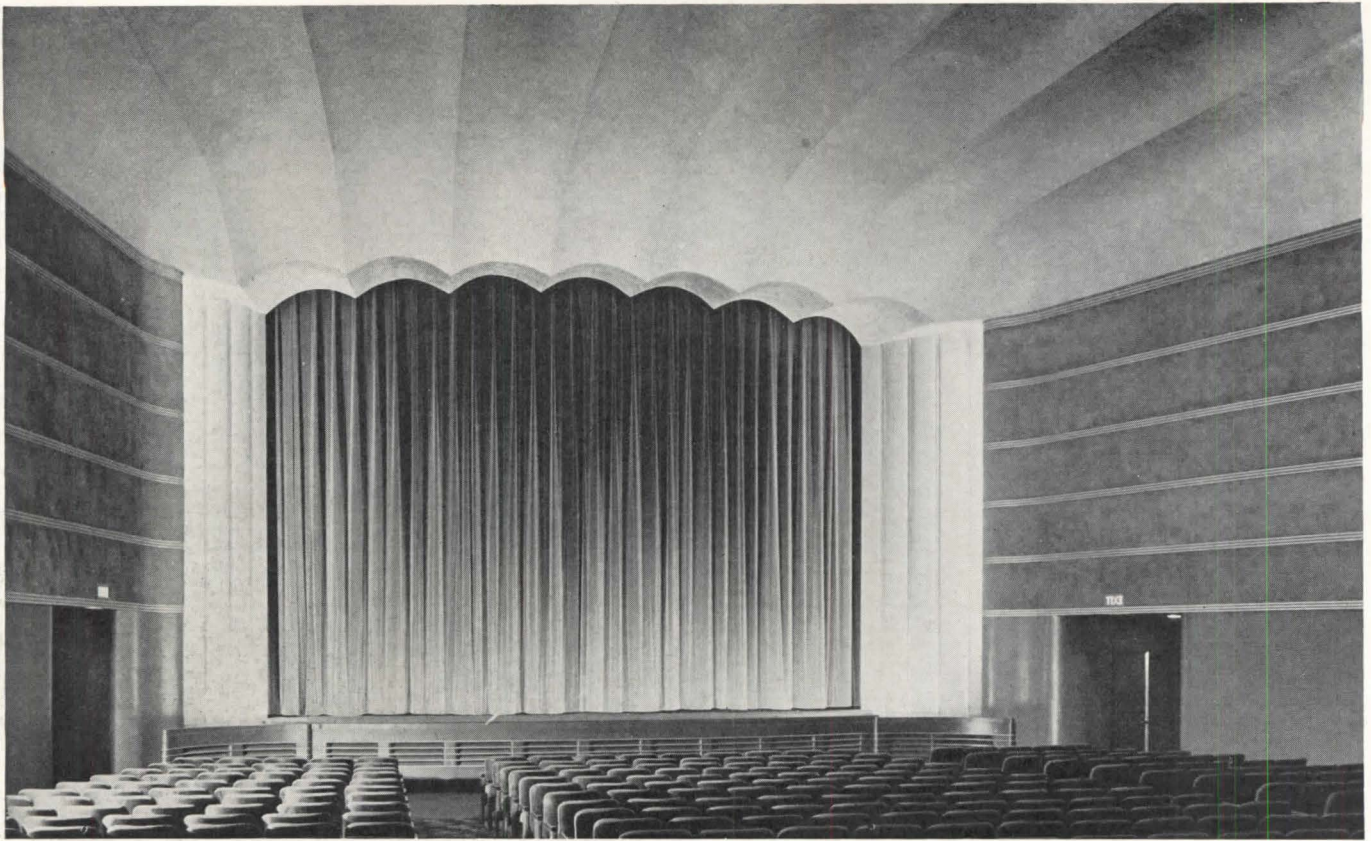

CINEMA—SEATING 1,226
PRINCETON PLAYHOUSE
PRINCETON, NEW JERSEY

THOMAS STAPLETON
Architect

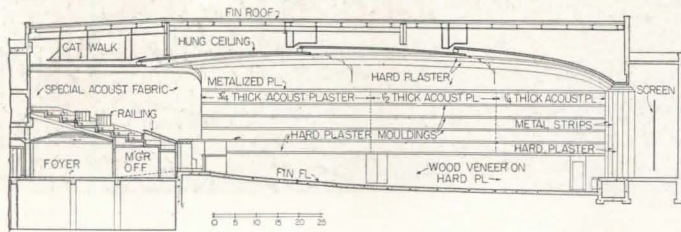

Section

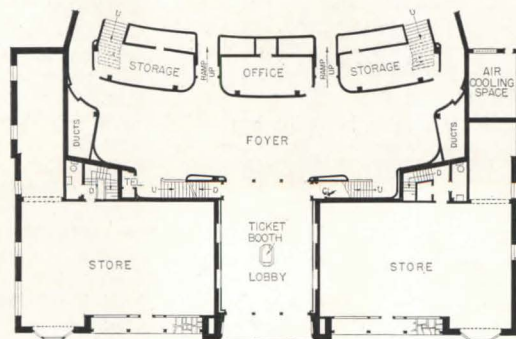

Plan at entrance

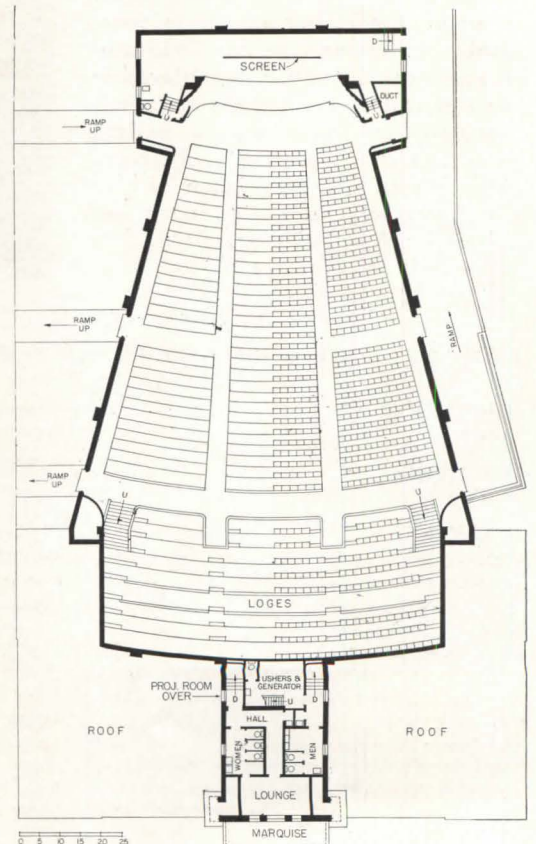

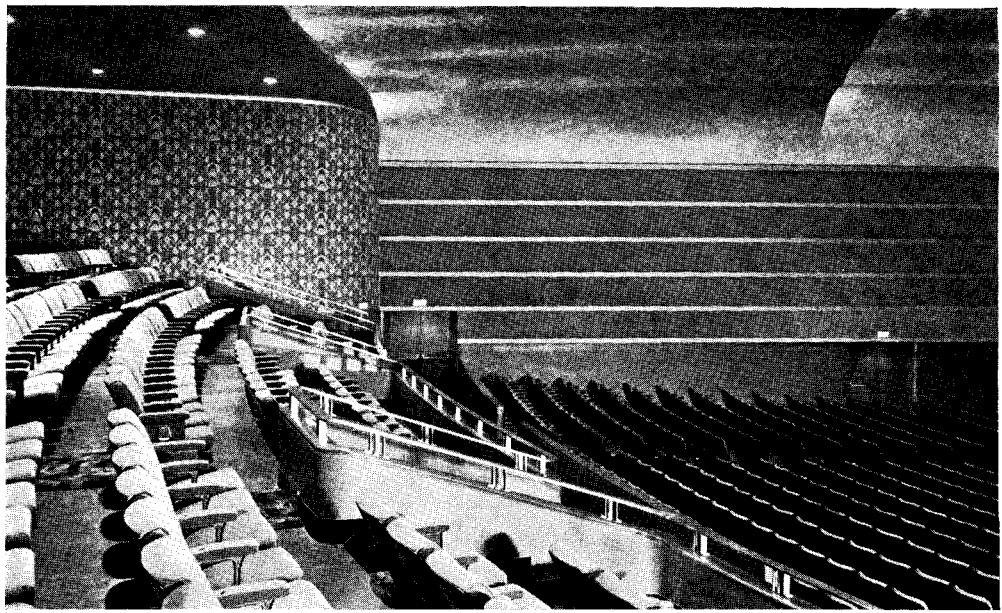

AUDITORIUM: Lower walls are of hard plaster, canvas-covered and painted in warm brown tones. Above are five bands of acoustical plaster with integral red-brown coloring and texture to represent suede leather. Isophonic-curve ceiling is finished in metallic silver paint, stepped for forward lighting.

Acoustic analysis

ACOUSTICALLY, the Princeton Playhouse auditorium seems well designed. The splay of side wall surfaces, carried from the proscenium line to the first offsets of the stadium section is a contributing element. Such an arrangement of surfaces overcomes the undesirable multiplicity of sound reflections which frequently occurs between strictly parallel walls. It also aids in controlling the destination of those reflections which lend vitality and naturalness to cinema presentations.

Convex offsets at the rear of the auditorium, as well as the elevated arrangement of the seating area at this point, have two distinct advantages. First, they effect a partial "break-up" of the direct sound pattern for frequencies of long wave lengths. Second, they reduce the actual amount of plain or unbroken wall area that is subject to high levels of direct sound incidence and reflection.

The ceiling surface is divided into segmental sections of broken contour which are generally nonparallel to the plane of the floor. Since the floor surface is highly sound-absorbent, reflections of relatively short path length originating at the ceiling are beneficial. Therefore, the ceiling is finished as a hard surface throughout, and acoustic treatment is confined to rear and side wall areas.

Sound-absorbing materials for the

wall surfaces were selected to meet four fundamental requirements: (1) to reduce time of reverberation to the correct value; (2) to eliminate objectionable sound reflections of both long and short path lengths; (3) to insure correct balance of sound absorption between low, middle-range and high frequencies throughout the auditorium; (4) to produce proper gradation of both "liveness" and absorption from front to rear sections of the seating area.

In auditoriums where sound-reproducing systems are used, treatment of the rear wall with a material of high sound-absorbing efficiency is usually essential, unless the major portion of this surface is well broken in contour.

In the Princeton Playhouse auditorium, the area of plain rear wall surface retained is sufficient to require a highly effective sound-absorbent material. Applied to this surface and to the side walls in the stadium section, is a 2-in. reinforced rock wool blanket; the latter is mounted on furring strips providing a 2-in. air space behind it. The rock wool is in turn covered with a thin, porous fabric. In addition to contributing a high degree of sound absorption throughout the entire frequency range, this is also efficient insulation for heating and air conditioning. Horizontal bands of acoustic plaster were applied to the furred construc-

tion, gradually tapering in thickness from $\frac{3}{4}$ in. at the rear to $\frac{1}{4}$ in. at the front of the auditorium. Rock wool fill is installed in the air space between furred walls and outer structural walls. The same type of fill is also used over the entire suspended ceiling. This material not only provides effective insulation but also contributes to the absorption of sound at the lower frequencies in the basic construction of surfaces.

As a result of design, construction methods, and materials used, sound-absorption coefficients of wall surfaces gradually increase from relatively small values at the front to very high values at the rear of the auditorium, creating necessary gradations of "liveness" and absorption throughout the seating area. Acoustic efficiency of this treatment at various frequencies, as well as the sound-absorption properties of seats and other furnishings installed, produces an excellent frequency reverberation characteristic. Sufficient absorption is provided at low frequencies by the treatment and by the basic construction of surfaces to insure a correct balance in relation to absorption of middle-range and high frequencies; hollow or "boomy" conditions, so often encountered in auditoriums where sound-reproducing systems are used, are eliminated.

This analysis was prepared by C. C. Potwin, Technical Consultant, Electrical Research Products, Inc.

CINEMA—SEATING 1,226

PRINCETON PLAYHOUSE

PRINCETON, NEW JERSEY

Photos by George H. Van Anda

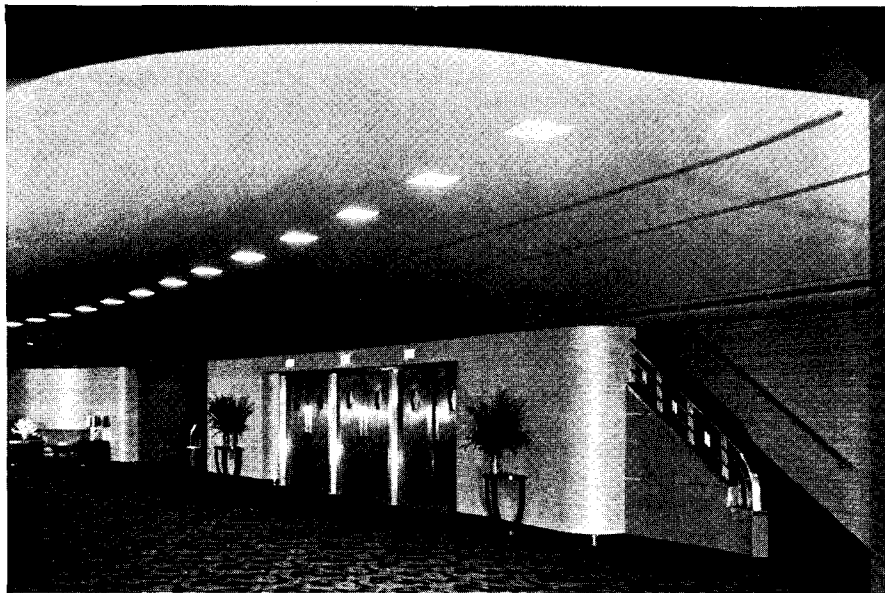
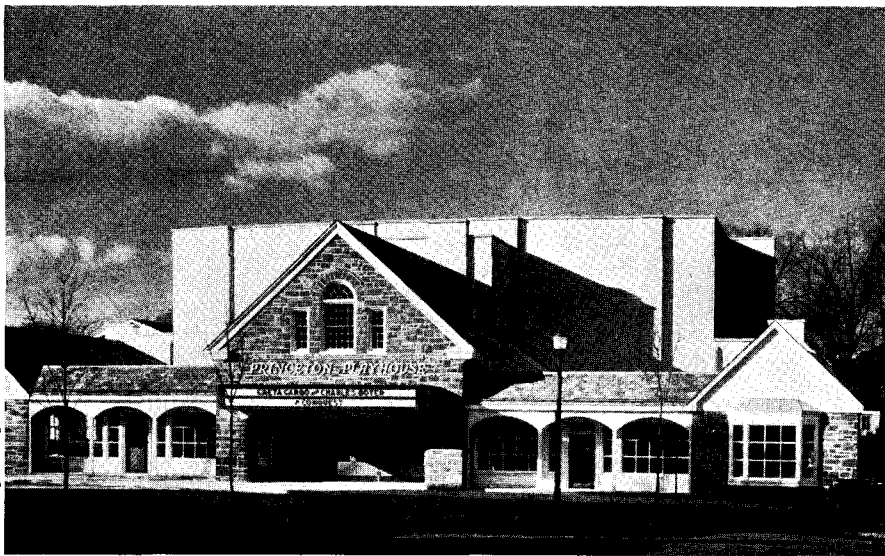

LOBBY: Walls are finished in metallized paper of tan and silver; stair cheeks of red Formica matching doors; metal trim of bronze and nickel bronze. Decorative band at spring line of ceiling conceals air-conditioning ducts.

SCHEDULE OF EQUIPMENT AND MATERIALS

FOUNDATIONS

Concrete and rubble stone

STRUCTURE

Steel frame, Bethlehem Steel Co.; reinforced concrete ribs and tile fillers in floor and roof of store sections, "Nassau" system

EXTERIOR

Walls: Job-dressed field stone and common brick; cinder concrete block back-up

Roof: Gypsum plank, U. S. Gypsum Co.; 4-ply asbestos composition roofing, Johns-Manville; variegated slate over entrance and shop portions

Windows: Double-hung, wood

Metalwork: Copper flashing, downspouts, etc.

INTERIOR

Floors: Two layers of concrete, 1 in. of cork between; carpeted except in seating areas,

Bigelow-Sanford Carpet Co., Inc.; tile in toilets, Robertson Art Tile Co.

Walls: Acoustical plaster, U. S. Gypsum Co.; antique pine paneling, oak-beamed ceiling in entrance lobby; metallized paper in foyer, "Tekko", Frederick Blank & Co., Inc.

Doors and Trim: Hollow metal doors, Jamestown Metal Corp.; trim, balustrades, etc., Penn Brass & Bronze Works

HEATING and AIR CONDITIONING

Steam and hot water from central plant; vacuum heating system; complete air conditioning; grilles, Tuttle & Bailey, Inc.; control, Minneapolis-Honeywell Regulator Co.; compressors, Carbondale Corp.; motors, General Electric Co.; fans, American Blower Co.; drives, Allis-Chalmers Mfg. Co.; radiators, American Radiator Co.

PLUMBING

Crane Co. fixtures; Jenkins Bros. valves; brass

water lines, Phelps Dodge Copper Products Corp.

ELECTRICAL

All house lighting is indirect on dimmers; a series of down-lights concealed in ceiling for clearing house; exterior floodlighted, "Major" reflectors; ceiling spotlights, Century Lighting, Inc.; exit lights, Viking Products; foyer lighting, Macbeth-Evans prismatic plates

EQUIPMENT

Upholstered seating, American Seating Co.; hearing aids located in loge section, Western Electric Co.; Flexlum Co. marquee with oxidized copper finish, underside checkered with alternate panels lighted; sound system, Western Electric Co.; Simplex Projector, International Projector Corp.



Photos by William Rittase

CINEMA—SEATING 500
DANTE THEATER
 PHILADELPHIA, PENNSYLVANIA

ARMAND CARROL
 Architect

Marquee and sign constitute the entire front and are of blue and ivory structural glass with aluminum trim.

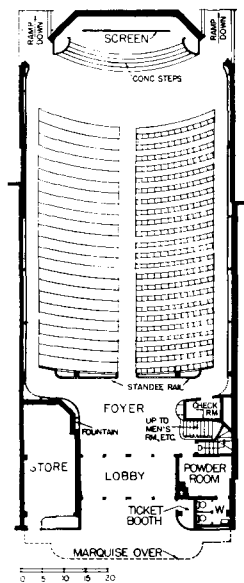

Photos by William Rittase

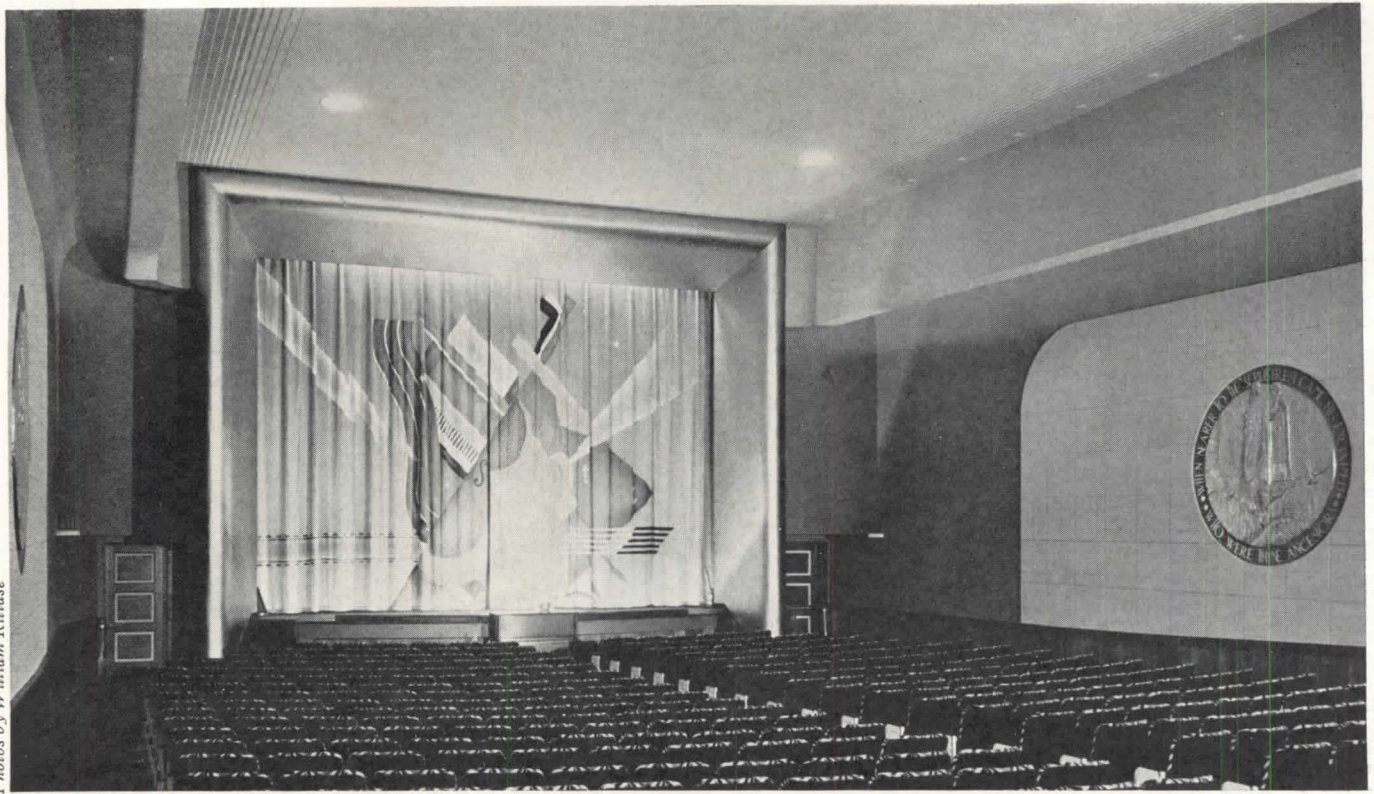

AUDITORIUM AND FOYER: Color scheme in the auditorium—gray-blue plaster surfaces and canary yellow on the acoustone blocks. The ceiling is beige with terra-cotta stripes. A painted gold sateen curtain is framed in the burnished gold leaf on the proscenium. The foyer is executed in white oak flexwood with a silver leaf ceiling. The flush doors to the lobby are in white oak veneer. The carpet is predominately rust and black in a pebble weave.

CINEMA-SEATING 500

DANTE THEATER
PHILADELPHIA, PENNSYLVANIA

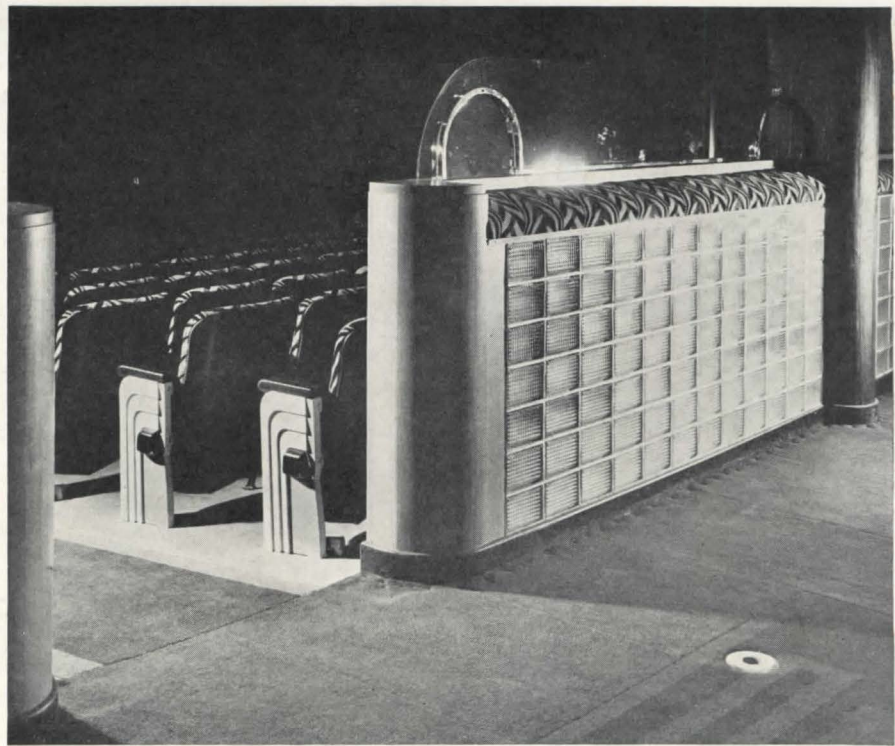

STANDEE RAIL: Construction Details, Scale: $\frac{3}{4}'' = 1'-0''$

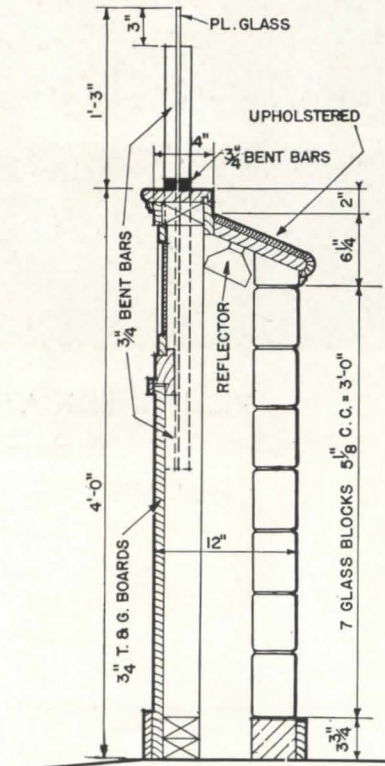

Section

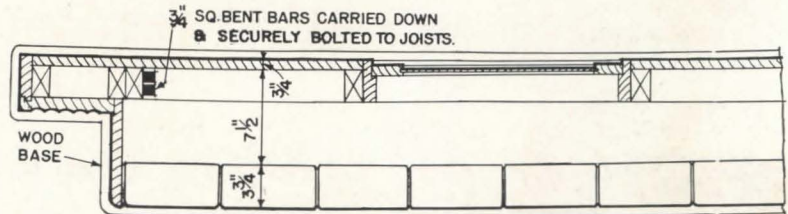

Plan

SCHEDULE OF EQUIPMENT AND MATERIALS

FOUNDATIONS

Concrete walls, piers and footings

STRUCTURE

Steel frame; brick curtain walls; concrete slabs

EXTERIOR

Walls: Blue and ivory Carrara glass, Pittsburgh Plate Glass Co.; aluminum trim; glass block, Owens-Illinois Glass Co.

Roof: Built-up asphaltic

Sash: Steel; poster frames, wood

Sign and Marquise: Porcelain enameled stainless steel, Neon tubing, Philadelphia Sign Co.; letters, Adler Sign Letter Co.

INTERIOR

Floors: Vestibule, terrazzo with inset rubber mats by Stockwell Rubber Co.; foyer and auditorium, concrete; carpet in foyer and aisles, pebble weave, rust and black, Chas. P. Cochrane Co.

Walls: Side and rear of auditorium, Acoustone tile, U. S. Gypsum Co.; foyer, quartered white oak Flexwood, U. S. Plywood Co.

Columns: Ebony Flexwood finish

Ceiling: Hard plaster, painted in auditorium silver leaf in foyer

Stairs: Metal, cement treads, aluminum rail and brackets

Doors: Flush-type, white oak veneer; Rixson aluminum thresholds

Standee Rail: White oak, glass block, upholstered arm ledge

LIGHTING

Foyer: Strip lighting, Klemm Reflector Co.

Auditorium: Coves, continuous-burning blue "picture" lights and flame-tinted, dimmer-controlled house lights

Projection Booth: Lamps by J. E. McAuley Mfg. Co.

AIR CONDITIONING

Well-water cooled, 120-gal.-per-minute well, American Heating & Ventilating Co.; grilles, wood, backed with 1/4-in. mesh bronze screening

SEATING

Auditorium: Upholstered, spring edge, padded back, American Seating Co.

Other Furniture: N. Snellenburg & Co.

STAGE

Set: Curtain, gold sateen, painted, National Drapery Co.; curtain controls, Vallen Co.

Sound System: Microphone, Western Electric

Floor and Steps: Concrete

Screen: Walker Sound Screen, Walker American Co.

PROJECTION

Generators: Hertner Electric Co.

Projectors: Super Simplex machines and pedestals, International Projector Corp.



BROADCASTING THEATER—SEATING 1,050

CBS STATION KNX
HOLLYWOOD, CALIFORNIA

WILLIAM LESCAZE
Architect
EARL HEITSCHMIDT
Associate

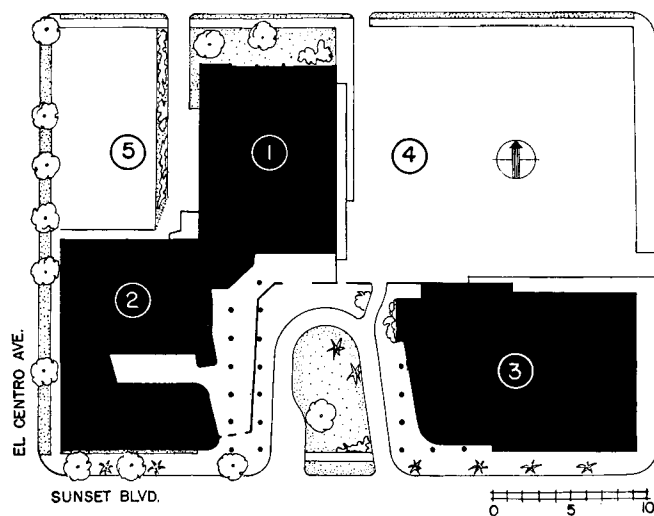

Plot Plan

- 1. Theater
- 2. Small studios and offices
- 3. Commercial occupancy
- 4. For future television

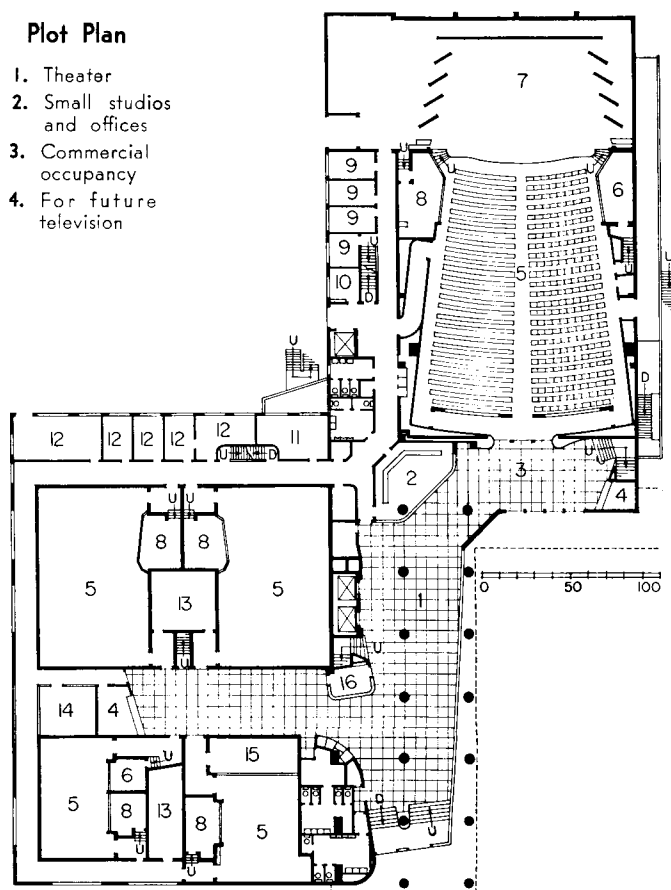

Theater and Studios

- | | |
|------------------------------|-----------------------------|
| 1. Arcade | 9. Dressing |
| 2. Master control | 10. Building superintendent |
| 3. Theater foyer | 11. Musicians' lockers |
| 4. Checkroom | 12. Offices |
| 5. Theater and small studios | 13. Storage |
| 6. Clients' booth | 14. Artists' lounge |
| 7. Stage | 15. Organ chamber |
| 8. Control booth | 16. Information |

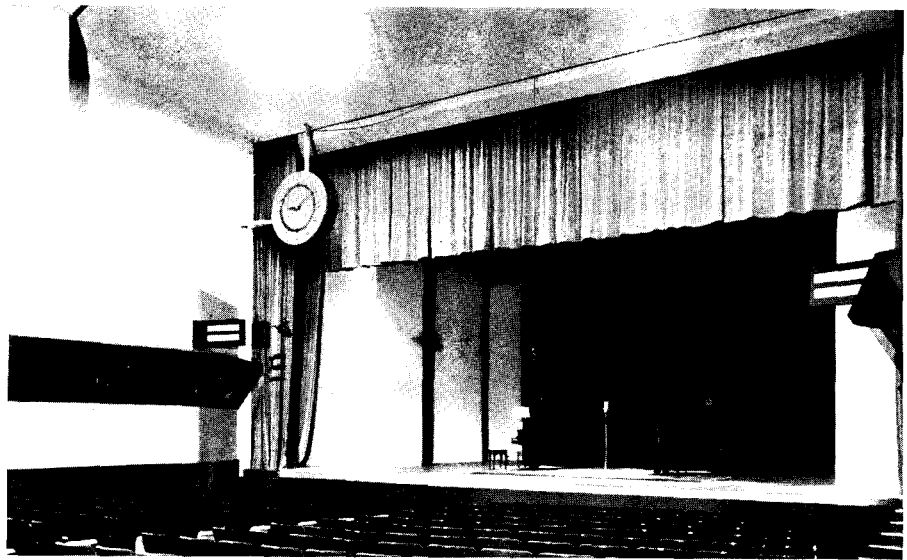

W. P. Woodcock

Location provides convenience for artists from movie studios, advertising agencies, and the business district, and also space for future expansion and parking. In the theater almost the entire rear wall is of glass, permitting latecomers to see and hear the show, the latter made possible by loudspeakers placed in the wall. On stage,

footlights are omitted, lighting being furnished by spotlights above the control booth. Control of reverberations is by acoustical plaster, isolation and by heavily upholstered seating. In the smaller studios walls were inclined vertically one foot in ten in order to avoid parallelism and resulting periodic reverberations.

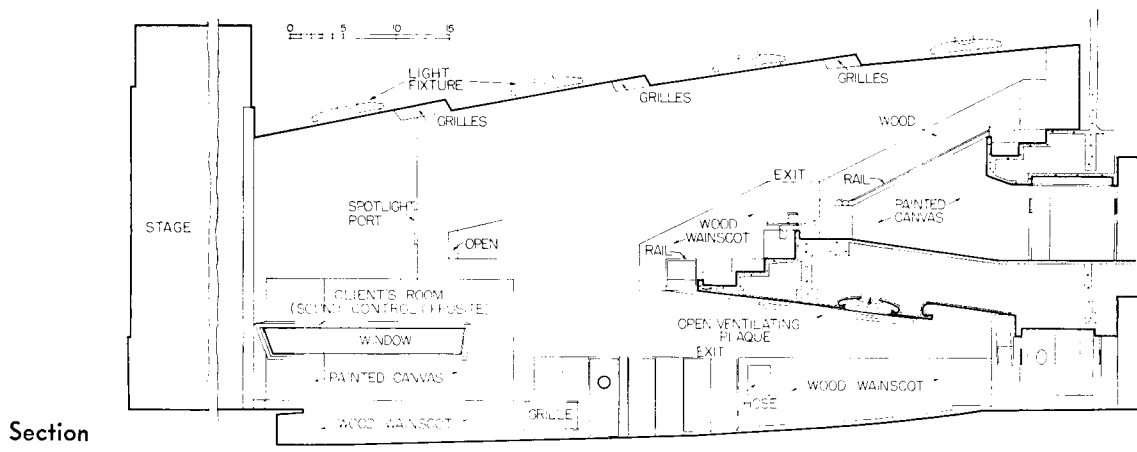
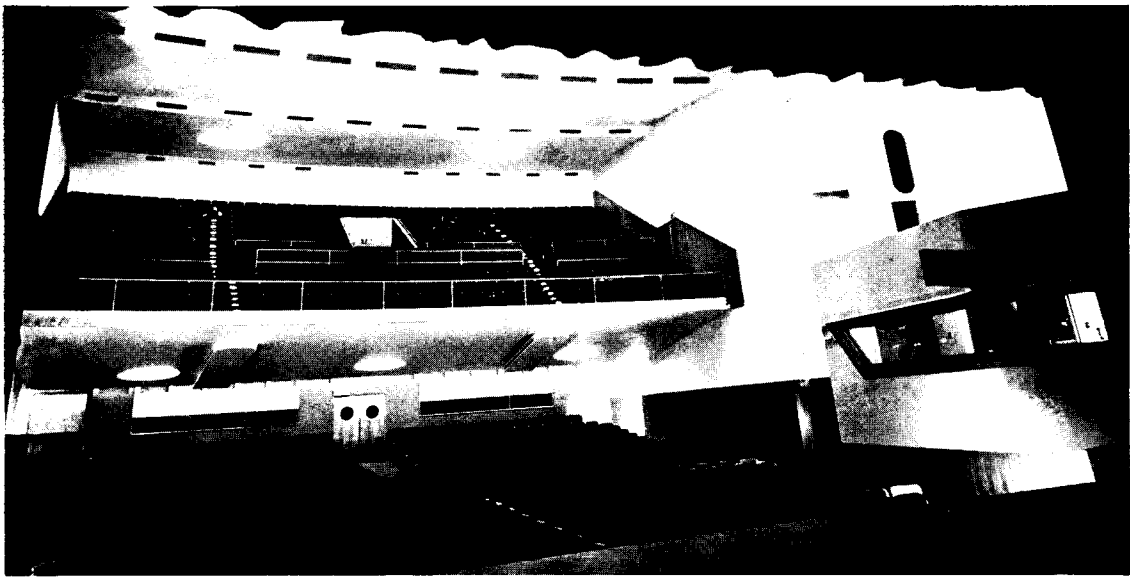

Section

BROADCASTING THEATER SEATING 1,050

CBS STATION KNX
HOLLYWOOD, CALIFORNIA

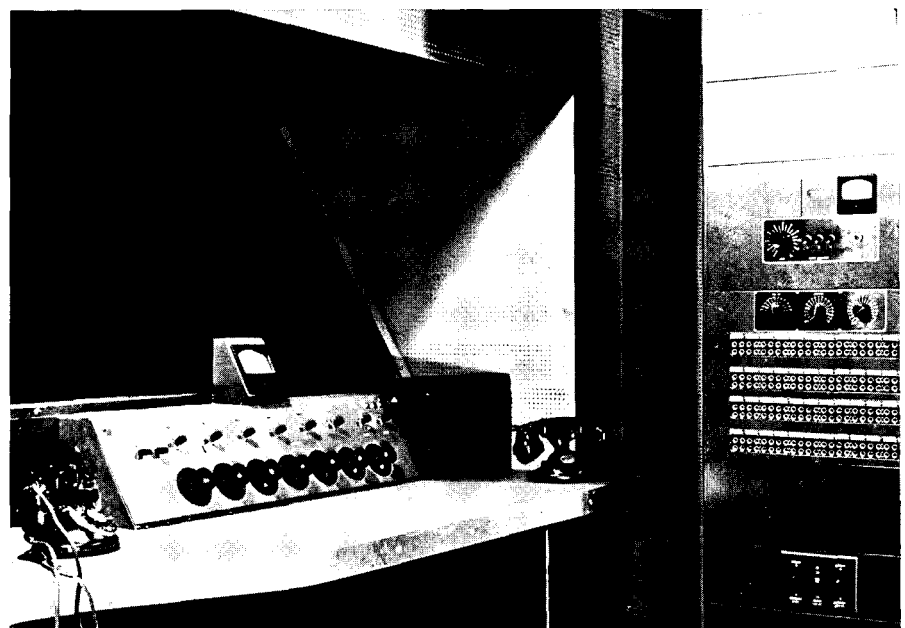
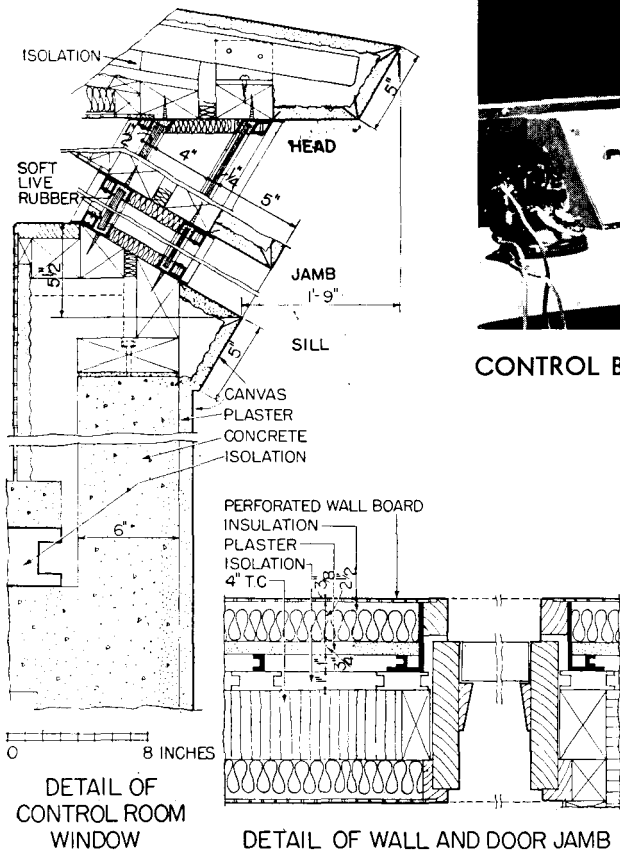

CONTROL BOOTH: Construction details showing sound isolation

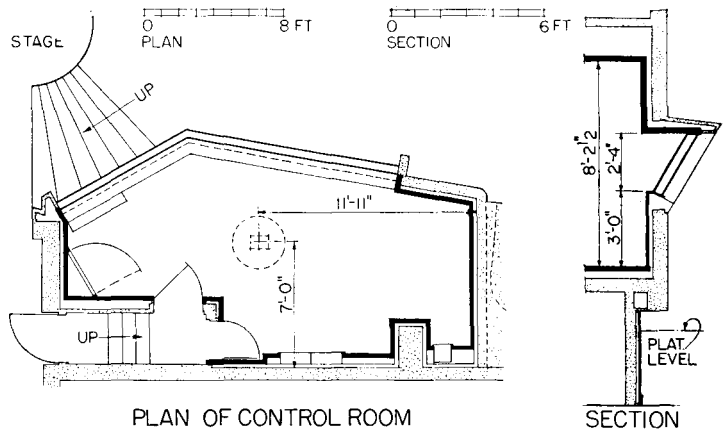

SCHEDULE OF EQUIPMENT AND MATERIALS

FOUNDATION

Reinforced-concrete mat under office portion, spread footings elsewhere

STRUCTURE

Reinforced concrete; plywood forms with vertical units

EXTERIOR

Walls: Concrete

Roof: Concrete slab with built-up asphaltic roofing over 2-in. Celotex, The Celotex Corp.; structural steel over auditorium

Windows: Hope's Windows, Inc.

Metalwork: Lead-coated copper flashing and louvers; stainless steel and aluminum earthquake joint

INTERIOR

Floors: Pan system reinforced concrete with rubber tile in public areas of first floor, Goodyear Tire & Rubber Co.; linoleum in studios,

offices, and corridors above first floor, Armstrong Cork Products Co.; asphalt tile in service corridors on grade, Armstrong Cork Products Co.; carpet in auditorium and executive offices, Mohawk Carpet Mills, Inc.

Walls: Rubber wainscot in studios, Goodyear Tire & Rubber Co.; Transite, Johns-Manville Corp.; walnut wainscot in auditorium

Doors: Soundproof for studios, Robert E. Mitchell, copper, coated with Goodyear Tire & Rubber Co. rubber; flush Philippine mahogany in interior elsewhere

WATERPROOFING

Basement wall exteriors, A. C. Horn Co.

INSULATION

Studios sound-isolated and insulated; floors, Holmes Isolators; walls and ceilings, Isolators, Transite and Rockwool, Johns-Manville; ceilings of offices, corridors, Kalite plaster

AIR CONDITIONING

Complete, Carrier Corp.; Enterprise oil burners

PLUMBING

Standard Sanitary Mfg. Co. fixtures; water lines, American Tube Co.; Mueller Brass Co.; Youngstown Sheet & Tube Co.

ELECTRICAL

Office fixtures, Westinghouse Electric & Mfg. Co.; studio fixtures, Holophane Co.; neon signs, Truad Co.; structures floodlighted

HARDWARE

P. & F. Corbin Co.; Oscar C. Rixson Co. floor checks

GLASS

Pittsburgh Plate Glass Co.; Mississippi Glass Co.; Owens-Illinois glass block

ELEVATOR

Otis Elevator Co.

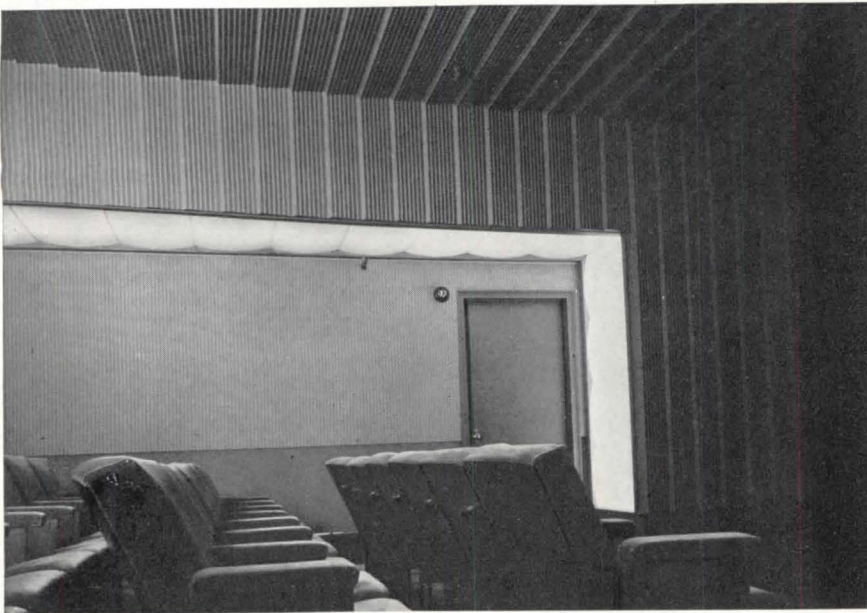

United Artists Preview Theater, Ben Schlanger, Architect. Auditorium wall and ceiling surfaces are shaped to control reflected screen light. Disturbing ceiling reflections are eliminated, but useful reflections directed downward furnish general illumination during performance.

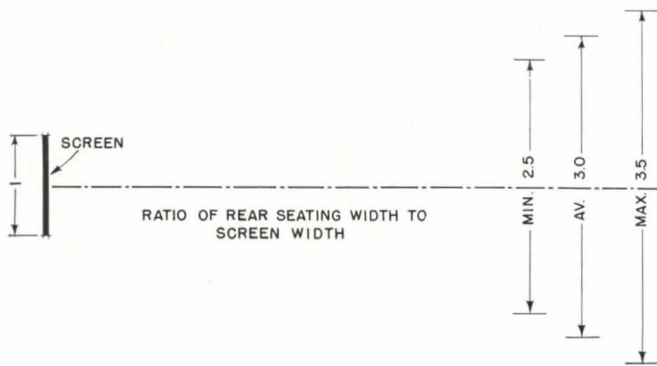
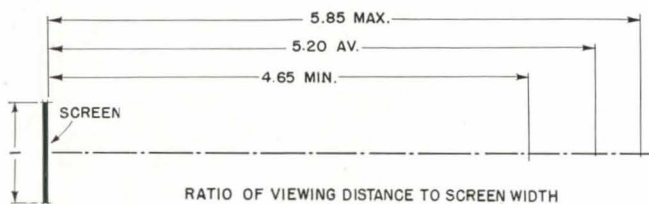

FIGURE 3: Above and right, seating and screen relationships developed from S.M.P.E. survey (see text).

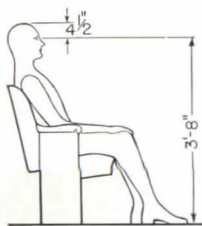

FIGURE 4: Human figure dimensions used in determining sight-line clearances.

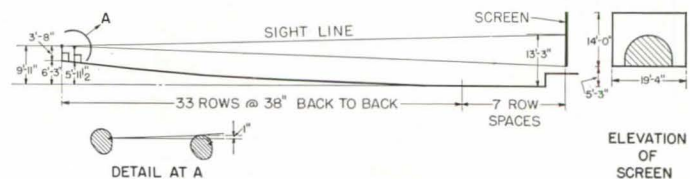

FIGURE 5: Modified downward floor slope and resulting sight-lines, showing objectionable obstruction occurring when used without staggering seats.

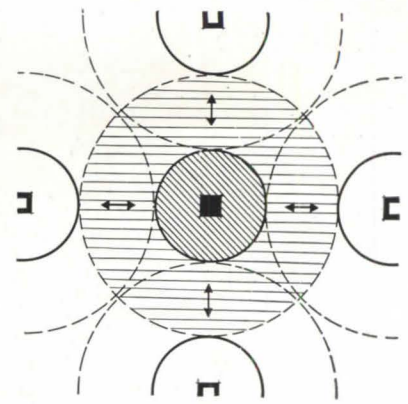

FIGURE 1: Theater location; heavily shaded area represents patronage dependent on proximity; light portion, migratory patronage.

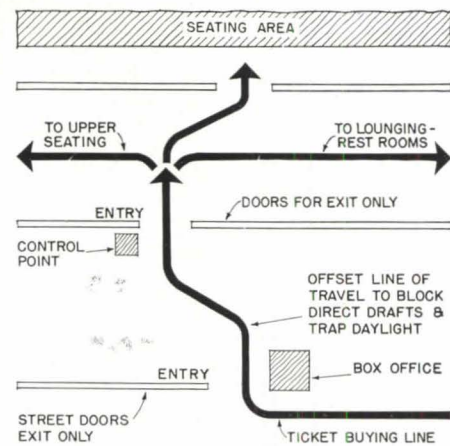
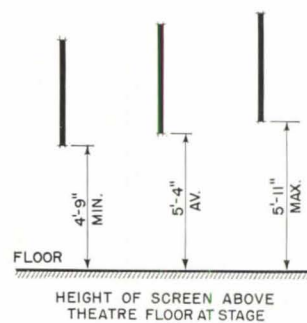
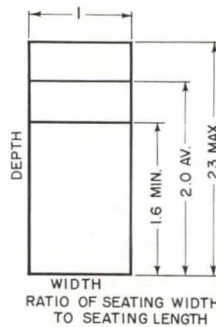

FIGURE 2: Circulation diagram, showing relation of street lobby, foyer and auditorium doors.



By BEN SCHLANGER, Architect

REQUIREMENTS for cinemas, including auditory and visual considerations combined with showmanship and economy of structure, indicate the necessity for a type of building entirely distinct from stage theater types. The success of a commercial cinema is subject to its ability to present good films in an effective manner, affording the maximum volume of patronage at minimum admission prices to insure an adequate return. All patrons expect: proper vision of the screen image, true reproduction of sound effects, and such comforts as will enable them to give undivided attention to the presentation.

The cinema must have a minimum amount of cubic feet per seat. This not only insures economic construction costs but also provides for minimum maintenance charges.

Location

Factors determining the cinema site are: accessibility, land costs, and potential patronage.

Housing groups suggest a study of within-the-development locations in conjunction with other recreational or shopping facilities.

Size

For ideal visual conditions a cinema should not seat more than 1,000, and a 600-seat capacity represents the approximate optimum. Recent surveys reveal a marked tendency toward theaters seating between 500 and 1,000, the average being 623 seats.

Capacities of 500 and less show a tendency to decrease in number because such units are uneconomical. Initial and operating costs of mechanical equipment are largely the same for a 250- or a 500-capacity.

Cinemas with capacities of much over 1,000 seats do not function satisfactorily and are more costly to erect. Longer spans, excessive circulation areas, more elaborate mechanical equipment, etc., become necessary.

Only the cinema operator in congested city locations, depending on transients and controlling *first-run* film products, is justified in constructing houses of over 1,000-seat capacity.

Shape

Two-dimensional screen images and electrically amplified sound are better accommodated in auditoriums approaching elongated rectangles in plan and section, than in the more nearly square shapes of stage theaters. Shape is determined by fixing visual standards which enable each viewer to see the picture satisfactorily. The picture must appear undistorted, its view must be unobstructed and its details discernible. The quality of the reproduction of the picture depends on the shape of the cinema, which in turn is dependent on projection characteristics.

Satisfactory projection results from:

1. Proper illumination of screen.
2. Suitable reflective qualities of screen.
3. Minimum magnification of 35 mm film (over magnification of film reveals undesirable film structure graininess.)
4. Contrast values in cinematography.

Limitations of projection are (1) 35 mm film, (2) light sources producing a maximum of approximately 18 foot-candles incident at screens not wider than 20 ft. Available projection facilities make possible a satisfactory maximum screen image 22 ft. wide.

Reference to illustrated auditorium shape characteristics (from the S.M.P.E. Survey) will indicate averages and minimum and maximum limits. The limits shown are those of 50% of the theaters surveyed, centered around the average, and therefore represent tolerable present practices.

Multi-level seating reduces elongation, avoids excessive viewing distances and undesirable large screen images. The elongated rectangular shape of a single-level theater usually results in a larger required ground

area; where such cannot be had, an upper level is obviously the solution for providing maximum capacity.

Floor slopes and seating

In designing floor shapes and upper-level steppings for cinema seating, it is necessary to establish physical dimensions of the seated patron and standards for vision of the screen image. Primary concern is elimination of objectionable screen obstruction caused by persons seated in front of the viewer. Past practice has permitted conditions requiring spectators to look between the heads of those in the row in front of them and over the heads of the ones two rows in front ("second-row vision"). This necessitates uncomfortable adjustment to shifting obstacles in front especially when action images shift from one side of the screen to another.*

Seating arrangements which permit completely unobstructed vision are: (1) a floor sloping sufficiently downward toward screen. (This system requires hazardous aisle slopes except in theaters having 20 rows of seats or less, and results in excessive structure height; in the case of upper levels, excessive stepping results in difficult access and poor seating position in relation to screen.) (2) modified downward pitch illustrated in Fig. 5, if used in conjunction with staggered seating. This also causes needlessly excessive stepping heights in upper levels. (3) A combination of downward and upward slope further reducing pitch. (4) A combination of downward and upward slope with staggered seating resulting in a minimum departure from the horizontal. Both (3) and (4) permit desirable minimum balcony stepping heights.

The two latter systems have been employed considerably in America as well as other countries. For best development the rate of slope must be carefully determined for each successive row of seats.

The screen must be located at a level which will not cause any strained upward vision. The maximum subtended angle formed by the top of screen and the horizontal, from eye

*The Projection Practice Committee of S.M.P.E. disapproves of any noticeable and unpleasant obstruction of the screen view of one patron by other normally seated patrons, no matter where located.

PERCENTAGES OF TOTAL NUMBER OF THEATERS SURVEYED

SEATING CAPACITY	Motion Picture Herald	Society of Motion Picture Engineers
	Percent of existing theaters in U. S.	Percent of theaters erected 1933 and after
500 and less	52½	18
501-1,000	31½	59
1,001-1,500	10	20 (most are nearer 1,000)
1,501 and more	6	3

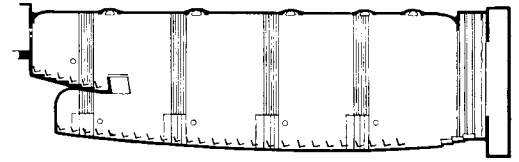
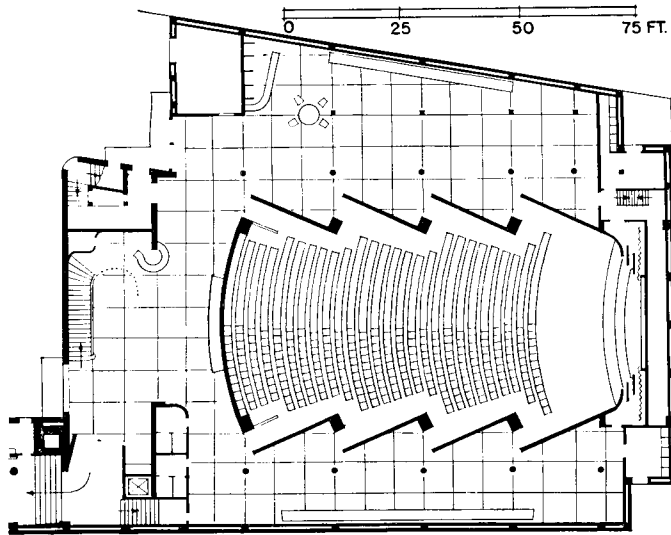

Cinema at Turku, Finland. Erik Bryggman, Architect. This example is planned according to Scheme 4—reverse-curved floor with staggered seating.

TICKET - BOOTH PLANNING

At left, locations and clearances for main ticket-booth types (New York Code). Ticket buyers almost universally, after purchasing ticket, turn to the left to enter the theater. The third diagram, which seems to contradict this theory, shows a booth installed on the left-hand side of the lobby to attract attention when the bulk of the patronage habitually approaches from the right. Diagram 4 shows counter type in foyer of "intimate" theater. Below, arrows indicate confusion of traffic around a booth with three windows. Better practice provides a maximum of two windows.

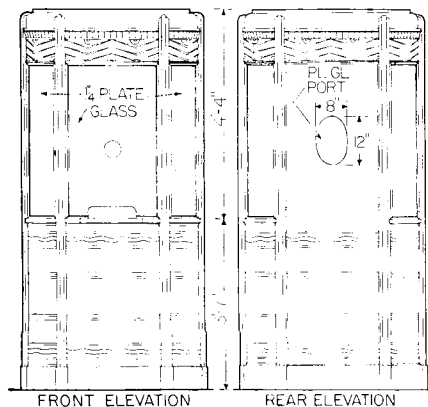
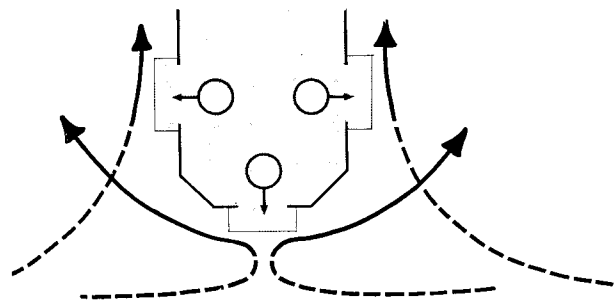
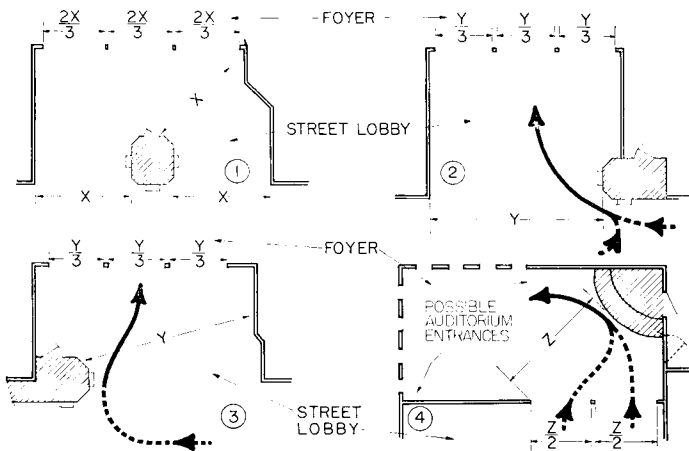

Details of ticket booth for Cataract Theater, Niagara Falls, New York. Eugene De Rosa, Architect

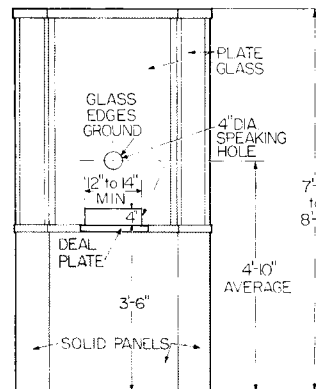
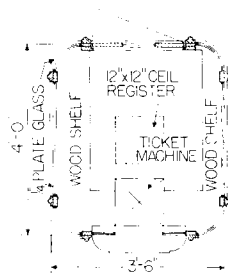

DOOR 1'-6" x 6'-4" ABSOLUTE MINIMUM, 1'-10" x 6'-8" PREFERRED MINIMUM

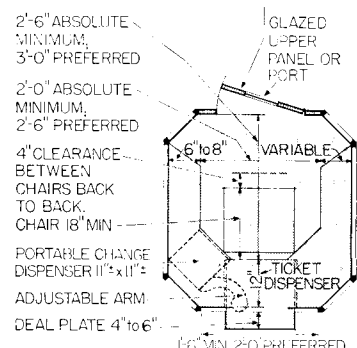

Plan and front elevation, typical single-attendant booth. Dimensions hold for two-attendant booths, if indicated chair clearance is maintained.

of the viewer in the first row, is 30°.

Seat measurement back to back varies from 32 in. to 38 in.; 34 in. is minimum for desirable heavily upholstered seats; 38 in. is preferable. Upper levels should have at least 36 in. back to back where seats are stepped. Spacings from center to center of arm block may be 19 in. to 22 in. with the wider recommended.

Lounges and toilets

Lounge areas, on either level, serve to separate toilets from seating. For capacities over 600 seats, at least two such areas should be provided and arranged so as to be partially or wholly visible from the lobby, foyer, or circulating areas. It is also desirable to have some part of the lounge command a view of the seating or screen in order that waiting patrons may follow seat availability as well as performance progress.

Minimum toilet fixture requirements are:

	MEN		WOMEN	
	Up to 400 Seats			
1 basin	1 w.c.	1 basin	1 w.c.	
	400 to 600 Seats			
	1 urinal			
1 basin	1 w.c.	1 basin	2 w.c.	
	2 urinals			
	600 to 1000 Seats			
2 basins	2 w.c.	2 basins	3 to 4 w.c.	
	3 urinals			

Screens

Screens are classified according to construction, surface and reflective characteristics: solid, porous, perforated (completely or at speaker area only), and translucent (for rear projection only). Surfaces, except translucent type, may be diffusive or specular, the latter being used in narrow and relatively deep auditoriums where light is concentrated on seats immediately in front of the screen. The diffusive type is appropriate to wider theaters.

Screen widths vary from an acceptable minimum of 16 ft. to a maximum of 21 ft., the average being 18 ft. 6 in.; width to height ratio is 8.25 to 6.

A space of at least 5 ft. is required in back of screen for the installation and servicing of necessary sound reproduction equipment.

Ticket booths

The location of the ticket booth depends on the space available, character and direction of street and

pedestrian traffic, volume and habits of patronage. It may be isolated, as an island, centered or included in the corner of the entrance. It should, of course, be readily identified with its function. In metropolitan areas ticket booths are almost universally placed as close to sidewalks as building codes permit in order to attract casual passersby. In suburban and other centers where patrons leave their homes with the express purpose of attending the cinema, ticket booths may be removed from sidewalk lobbies and placed either within secondary lobbies or in foyers. It is possible to adopt a continental custom—use of an open counter located conveniently to the manager's office—in an effort to achieve "intimate" atmosphere. When operated by only one person an area approximately 4 x 4 x 8 ft. is adequate; for larger theaters, where there are generally two ticket sellers, required clearances are shown on drawings opposite.

Heating is often provided from the theater heating system if the theater cellar extends under the ticket-booth space. While electric heaters are sometimes used, they are not always satisfactory in that they concentrate great amounts of heat in single spots without providing general heating. Natural ventilation is usually provided, by ventilators in roofs and louvers in doors. Occasionally air-conditioning ducts are run to booths from theater systems. Space requirements for change makers and either electrically or manually operated ticket dispensers are given in the drawings. It is almost universal practice to install an outside telephone for the attendant's convenience in answering calls about the program. This telephone is usually connected to another in the manager's office, with a two-way signal.

Lighting

The lighting of a cinema auditorium serves three separate functions: (1) emergency and decorative lighting, available or used during screen presentation; (2) lighting needed during intermission—usually for only a minute or less and frequently without interruption of the performance; (3) lighting of sufficient intensity needed for announcements, clearing the house, or other rare occasions.

Types and sources of light for these needs are: (1) light reflected from screen, of varying intensity dependent on film density; (2) wall and ceiling surface illumination may be standard lamps or tubes installed on the surface to be illuminated; (3) light projected on walls, ceiling, or audience from remote or concealed positions. During the presentation all normally required lighting is supplied in the front half of the auditorium by screen-reflected light. The rear portion must be illuminated by other light sources, placed so that the source is not within spectators' normal range of vision. Placement choices are: first, at the junction of ceiling and side walls; second, ceiling; third, side walls. The side walls rarely offer acceptable location because, here, even low intensities are often objectionable.

Lighting during a performance should consist of a low-intensity, evenly diffused bath of light completely covering all surfaces in view, rather than either complete darkness or spotty lighting.

In considering the utilization of screen-reflected light it is important that areas immediately surrounding the screen should not cause a lack of clarity in the projected image. Surfaces closest to the screen can be shaped, finished, and related to the screen surface so as to enhance the picture.

Emergency lighting is generally required to be separately provided. Where separate service lines are available, one may be used with an emergency motor generator. Alternative means of providing energy are battery systems kept charged automatically, gasoline, Diesel or gas engine generators, water turbines, etc.

Exit signs are connected to the general emergency lighting circuit and these should be legible from any point viewed. Lettering is usually a minimum of 8 in. high. All circulation areas, including foyers, lounges, and lobbies should likewise be on the emergency circuit.

References

Motion Picture Theaters. Ben Schlanger. *Architectural Record*, Feb. 1937, pages 17-24.

Auditorium Seating and Horizontal Sightlines. Frederic Arden Pawley. *American Architect*, July 1937.

Wm. Rittase

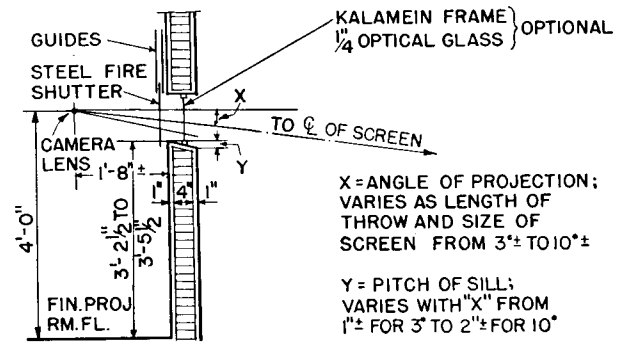
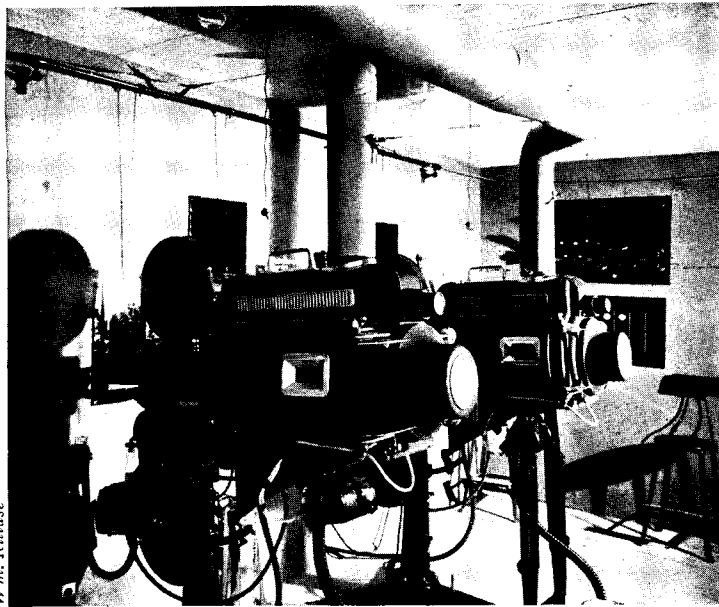

Location and pitch of sill, projection port

Dante Theater, Armand Carrol, Architect

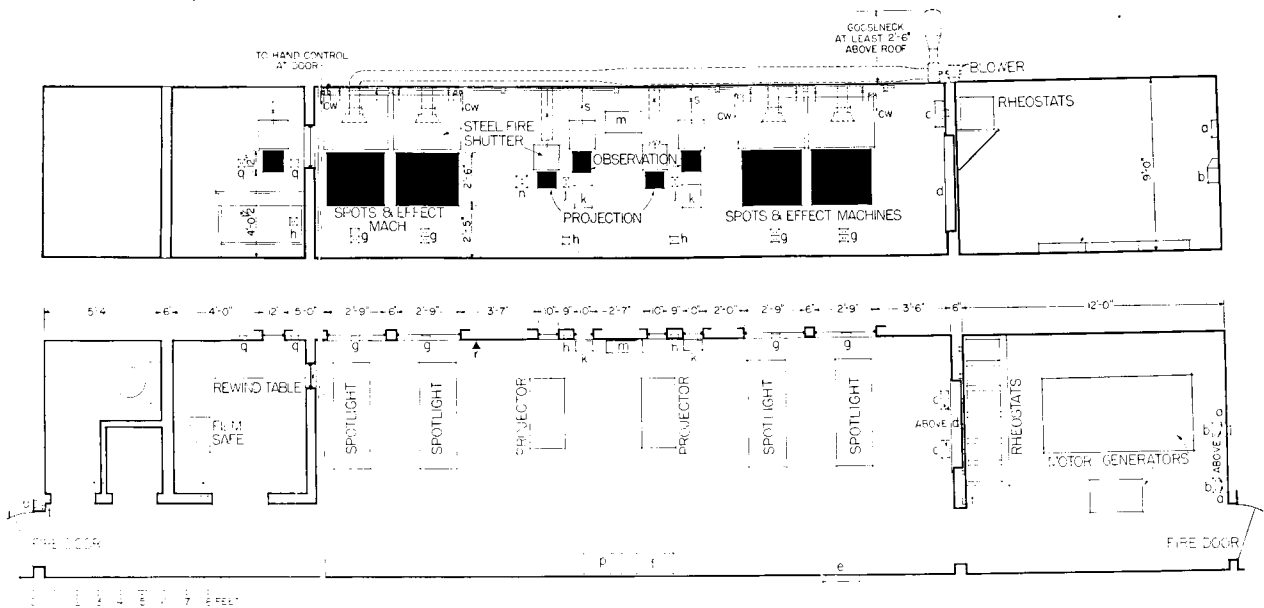

LARGE PROJECTION ROOM (above)

- a. Line switch
- b. Motor starter
- c. Instrument panel
- d. DC panel box
- e. AC panel box
- f. Power unit
- g. 2-gang receptacle
- h. T-L receptacle
- j. Curtain control
- k. Volume control
- m. Monitor
- n. Auditorium lighting
- p. Amplifier
- q. Vaporproof fixture
- r. Interphone
- s. Fuse link for steel fire shutter
- t. Light switch
- u. Blower exhaust switch

SMALL PROJECTION ROOM (left)

- a. Line fuses
- b. Line switch
- c. Line switch
- d. DC panel box
- e. AC panel box
- f. Motor starter
- g. Booth exhaust blower control and pilot
- h. Dimmer
- j. Light switch
- k. Arc blower switch
- m. 15A Duplex receptacle (twist lock)
- n. Signal buttons
- p. Sound control
- q. Amplifier
- r. Vaporproof fixture
- s. T-L receptacle
- t. Interphone
- u. Fuse link support for steel fire shutter
- v. Blower receptacle

Plans with elevations of auditorium walls

PROJECTION ROOMS. Usual code requirements are: 48 sq. ft. for first projection machine, 24 sq. ft. for each additional projector. Dimensions based on necessary clearances around projectors are given in the accompanying drawings.

Rewinding. While at least one state law requires that film rewinding be done in the projection room, a separate rewind room adjacent to the projection room is usually considered advisable. Rewinding is done upon a small table; observation ports opening to both the projection room and the auditorium permit a single operator to supervise a presentation easily while rewinding used film.

Film storage. Up to 12,000 ft. of film is permitted in most cases to be stored in metal containers. Film safes are required for greater amounts, 24,000 ft. being the usual maximum. Location should be convenient to the rewind table.

Toilet, containing water closet and basin, is for convenience as close as possible to projection room but, to reduce fire hazard, usually opens on a passageway rather than directly from the projection room.

Power equipment is housed in a generator room or closet, opening on the projection room proper, with space for rheostats.

Ventilation

Ventilation provisions are made for the general area and, independently, for each projection machine, film safe, and for the motor generator room. For general areas, 6 to 10 air changes per minute form the usual minimum desirable, 4 per minute the absolute minimum. Ducts are not cross-connected to auditorium supplies in any way which will permit entry of smoke or flame from possible projection room fires.

Ventilation for machines consists of 6-in. round metal ducts to convey fumes and heat arising from action of arc lamps on film. Ducts exhaust directly to outer air, and are equipped with exhaust fans. Maximum desirable fan capacity is usually 50 cfm per arc. Types of fans in which motors are not mounted in duct space are preferred, as carbon and dust blowing across motors soon cause motor failure. A minimum of 4 air

changes per minute is recommended for the motor-generator room. Film safe ducts are 8 in. round or 8 x 10 in., exhausting direct to outside air.

Fire protection

Fire-protective measures include materials and methods of construction and finish, in most cases prescribed by codes. Legal and insurance requirements for fire doors, dimensions, and other regulations, are in most cases outdated, reasonable modern provisions usually far exceeding minimum legal provisions. In some cases automatic sprinklers are required in projection and rewind rooms, although the value of water in combating film fires is debatable. More valuable are portable chemical extinguishers, one per machine, and sand, one bucket per machine. The latter also serve as safe depositories for used carbon stubs from arc lamps.

Doors are required to be fire doors, usually Kalamein, those which isolate projection room areas (including generator, rewind and projection rooms) being self-closing, opening outward, and equipped with fusible link releases. One such door, 2 ft. 6 in. by 6 ft. 8 in., is commonly provided; two doors, at opposite ends of the hazardous area, are preferable. All ports opening to other than projection areas have vertical sliding shutters whether the ports are glazed or not. Typical shutter releases are shown in the drawings.

Floors must have at least a "4-hr." rating as prescribed by insurance codes. Usual material is reinforced concrete, slab thickness averaging 4 in. One inch of cement finish is ordinarily applied but almost always necessitates cutting the slab to accommodate conduits. Two inches of finish accommodate most conduit without cutting.

Walls and ceilings are subject to the same conditions as floors. Four-inch hollow tile, terra cotta, etc., are used for walls; 4-in. reinforced concrete or precast materials for ceilings. Cement, 1 in. thick on both sides of walls and $\frac{3}{4}$ in. thick on ceilings, is the usual finish.

Ports may be glazed to prevent sound from entering auditoriums, plate glass being used in observation ports and optical glass in projection

ports. Frames must be fireproof.

Equipment

Operating equipment consists of projectors, spots, effect machines, and possible stereopticon dissolvers. Minimum equipment is two projectors; usual average, two projectors and one spot; usual maximum, two projectors, one spot, and one effect machine. Installations exceed these items if special features are expected.

Power equipment for common modern types of arc-lamp projectors, etc., consists of 45-volt DC motor generators. Since all types of operating equipment are now available for use with the same voltage, varying voltages formerly required are not now necessary. Rectifiers may be used on AC supply lines.

Control of operating equipment requires a DC panel board, usually wall-mounted at convenient operating height; and a rheostat for each projector, spot, and effect machine. Sound equipment volume controls and monitor, wall-mounted, are usually close to projector sound heads. Sound amplifier and power units may be mounted on any clear wall space. Ventilator fan motors and lighting require a separate panel, AC or DC according to current supplied. Auditorium light controls are so located that operators can conveniently manipulate them while attending projection machines. Emergency controls for ventilating systems and lights, not always required by law, are placed outside fire exits, with pilot light indicators. Ventilation emergency controls may be powered by independent emergency wiring.

Signal system consists of a house telephone from the projection room to the manager's office or the ticket booth. In cases where operation is not controlled solely from the projection room, a buzzer or annunciator or both are required.

Lighting and convenience outlets are indicated as to type and location on accompanying drawings. Fixtures are vaporproof; those not mounted in locations giving automatic protection against lamp breakage are protected with wire guards.

—
Data furnished by Mr. John J. Seifing of the National Theatre Supply Company.

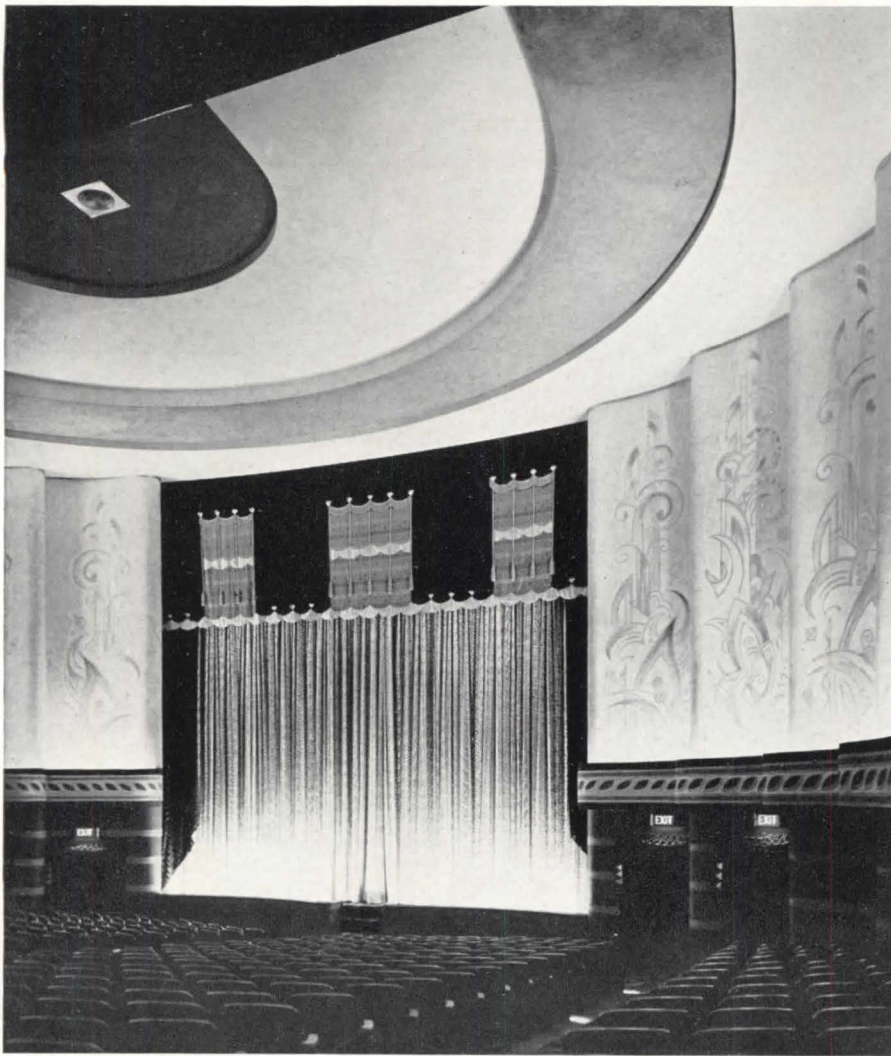

Rembrandt Studio

Shape and surface treatment enhance sound projection.

Harris-Dennis Theater, Pittsburgh, Pa.
Victor A. Rigamont, Architect

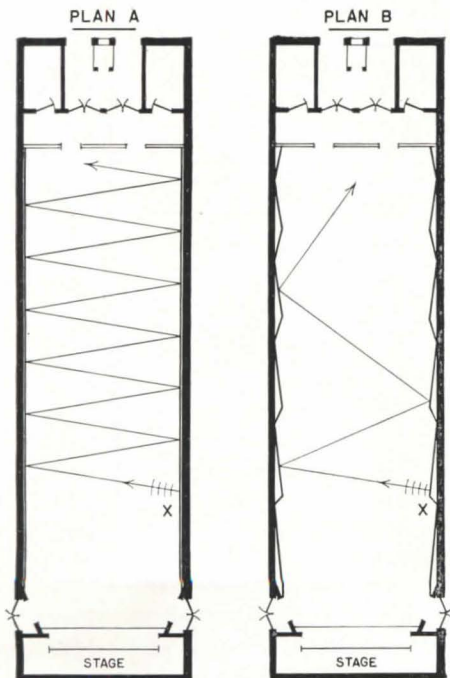

Plan B illustrates nonparallel side walls which disperse multiple reflections.

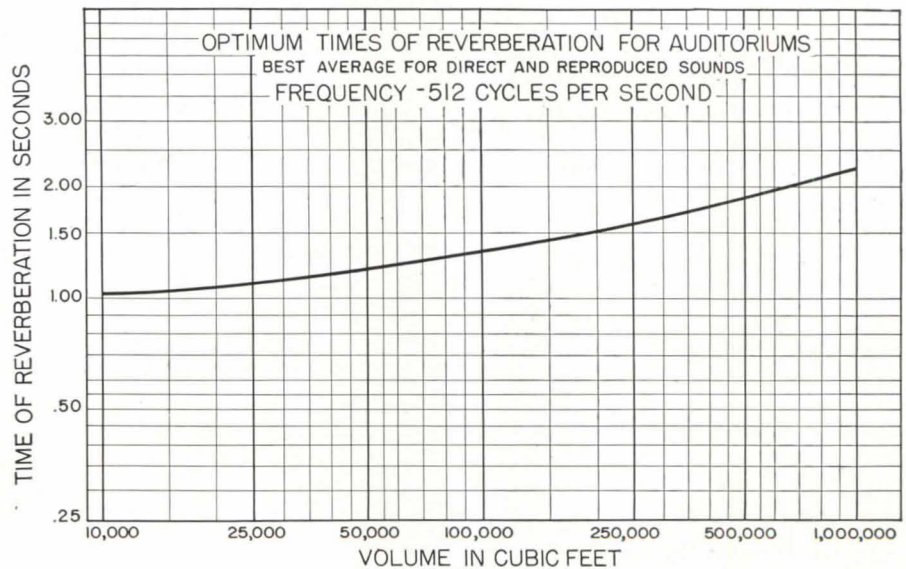

To insure proper balance of sound absorption, between low, middle and high frequencies, the time of reverberation at 64, 128, and 256 c.p.s. should not exceed time at 512 c.p.s. by more than $\frac{3}{4}$, $\frac{1}{2}$, and $\frac{1}{4}$ respectively.

By **C. C. POTWIN**, Technical Consultant of Electrical Research Products, Inc.

THREE important factors are: (1) size or cubical content of auditorium in relation to seating capacity; (2) basic form which establishes proportions of length, width, and height; (3) shape of individual surfaces in their relation to stage and to seating.

Size

Cubic-foot volume per seat determines reverberation characteristics. If a large volume per seat is established, the time of reverberation may be too long, requiring extensive acoustical treatment of surfaces. If, on the other hand, a small volume per seat is maintained (consistent with the other planning requirements), a short time of reverberation usually results. This may permit the total elimination of acoustical treatment. Volume for auditoriums of average size (exclusive of stage and outside lobby space) should not exceed 150 cu. ft. per seat. Volume per seat below this limit will determine the extent to which sound-absorbing materials (exclusive of such acoustically effective equipment as upholstered seats, aisle carpetings, and other usual furnishings) can be eliminated.

Capacity of sound-reproducing and amplifying systems is also dependent upon the volume or cubical content of the auditorium. As the volume is increased, the power output of the system must be increased to insure the proper level of sound over the entire seating area. Slight reduction in volume may permit the use of a smaller and more economical sound system.

Form

In considering the floor plan proportions in relation to acoustics, practice has shown that the best distribution of sound energy is obtained where the ratios of width to length fall within the limits of 5:7 and 1:2. Where the ratio of width to length is greater than 1:2, the design becomes a so-called "shooting gallery", and when surfaces are strictly parallel, a multiplicity of sound reflections are created between the side walls. Where the ratio of width to length is less than 5:7, the floor plan approaches a square. Two major acoustical difficulties are usually encoun-

tered in such a design: (1) inadequate sound coverage for the side sections toward the front of the seating area; (2) high level of sound reflection from the rear wall, particularly if the auditorium is of the single-floor type and the rear-wall surface is largely unbroken in contour.

Minimum and maximum ratios desirable do not imply that purely rectangular floor plans should be adopted, but rather that the outline of the auditorium should have proportions falling essentially within these limits. The rectangular plan does not always suggest the best acoustical form because nonparallelism and irregularity of surfaces are fundamental elements favorably affecting the control of sound.

Excessive ceiling heights, because of the resulting high volume per seat, are frequently a contributing factor to a long time of reverberation. A ceiling height which is too low is equally undesirable because it gives "tubular" effect to the design. This shape not only impairs the proper distribution of sound energy, but it also produces a rapid diminution in sound level from front to rear.

On the basis of the 5:7 ratio for the floor plan, the average auditorium height should not be greater than one-half the dimension of the width. For the 1:2 ratio, it should not be greater than two-thirds the width.

Surface shape

Surfaces (or sections of surfaces) should disperse or "break up" the increments of sound energy which form the direct wave pattern and also control the destination of beneficial and harmful sound reflections.

A sound wave striking an irregular surface or one which is broken by obstruction tends to disperse or change in form, depending upon the magnitude of surface irregularity. This effect is shown when a balcony is provided. Without the balcony the shape of the direct sound-wave pattern will not be materially altered when it strikes the rear-wall surface. If this surface is comparatively regular in contour, the direct wave will be reflected back into the seating area in its true form and with practically

undiminished power. However, when a balcony is provided, the direct sound-wave pattern is broken in contour before it strikes the rear-wall surface and, consequently, both the power and magnitude of the reflected wave are diminished.

Wall or ceiling irregularity may take the form of angular sections, convex curvatures, or nonsymmetrical broken offsets. The size of each unit and its degree of projection, 1 in. to 2 in. from a vertical or horizontal line, will depend upon the requirements of the individual design. Generally, the width of an angular or convex section will not be greater than 10 ft. Surface of angular or convex projections may also be broken for dispersion of very high frequencies.

Areas along the wall and ceiling surfaces near screen or stage produce reflections which help in lending vitality and naturalness to stage presentations. If these reflections are eliminated through the use of excessive quantities of sound-absorbing material, an auditorium will lack in part the acoustical characteristics contributing to the best sound quality. Through the proper arrangement of surfaces and the planning of surface contours, the beneficial sound reflections can be retained and their destination controlled. Similarly, the reflections which are definitely harmful and produce multiple echoes, sound concentrations, and areas of excessive or deficient loudness can either be dispersed initially or directed to points outside the limits of the seating area, where they will be absorbed or dissipated at the second incidence. This control of reflections may be accomplished through the use of segmental wall and ceiling splays, full or partial surface tilts, or by angular or broken contours of special design.

When planning segmental wall and ceiling splays for example, sections of surfaces are shaped and "turned away" from the source of sound in such a manner that a part of the reflected energy is evenly distributed over the seating area and the remainder is either dispersed initially or directed to other surfaces where it is absorbed or dissipated.

THE COMMUNITY THEATER usually contains 500 to 1,000 seats and serves amateurs, semiprofessionals, and visiting professional groups. Most of the scenery and costumes are designed and made at the theater and require a special type of workshop. Because of its varied use, and the rather indeterminate responsibility of its management, its planning should be as simple and as foolproof as possible. This study will not include experimental theaters, since these present special problems.

A properly selected site offers: 1. Accessibility by normal means of transportation. (A central location is essential for walking only. Automobiles should not have to traverse congested traffic zones when this can be avoided.) 2. Sufficient separation from bus and streetcar lines, principal highways, and other sources of noise. 3. Parking space. 4. Convenience to complementary community activities, educational or recreational, in order to reduce inter-building traffic and minimize supervision and maintenance.

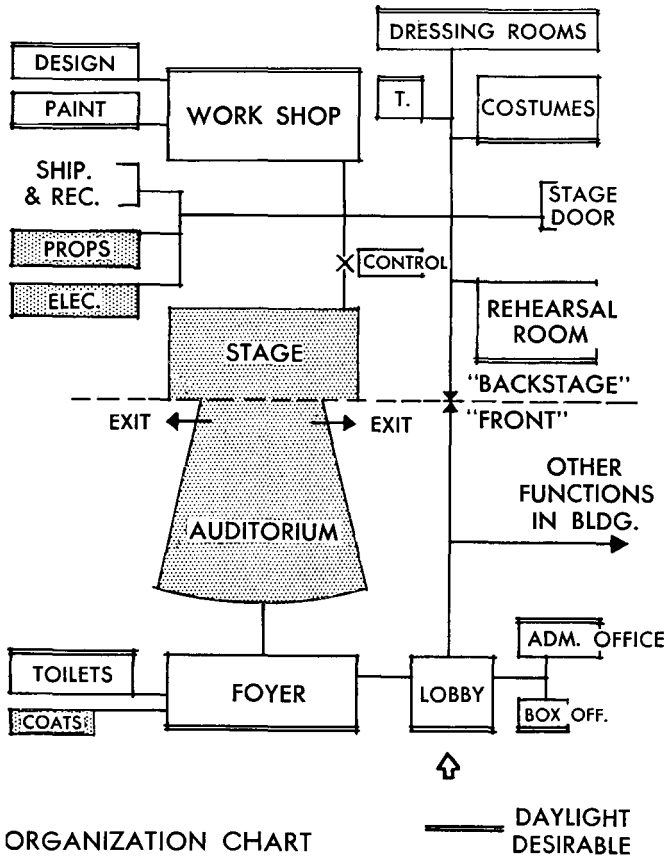

ORGANIZATION CHART

ARRANGEMENT

"Front" or public areas, and "backstage" or work groups, constitute the two major elements. Spectators should find everything necessary for their needs accessible from the foyer once they have presented tickets. Included are toilets, coatrooms, drinking fountains, lounges, and smoking areas. The lobby should provide waiting space and circulation to areas other than the theater, which may be contained in the building. The manager's office is convenient if adjacent to the box office and accessible from the lobby. In the work group, control of the stage entrance will avoid interference from unauthorized persons and facilitate accounting of players, properties, and scenery. Rehearsal rooms are part of the work area and should be near other work elements. Movement of heavy furniture and other properties demands close relation between work spaces and stage proper. Dressing rooms may be more remote but within supervisory distance.

STAGE DIAGRAMS

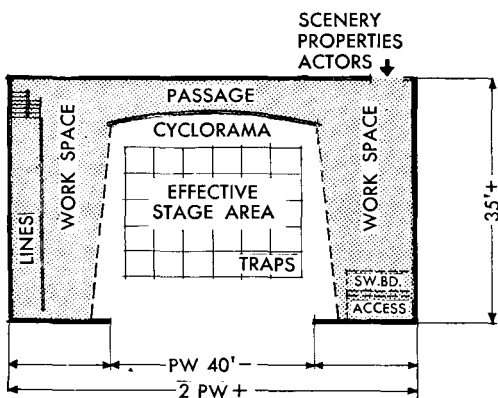

PW, Proscenium Width
PH, Proscenium Height
Pin rail is located at lines gallery

Plan

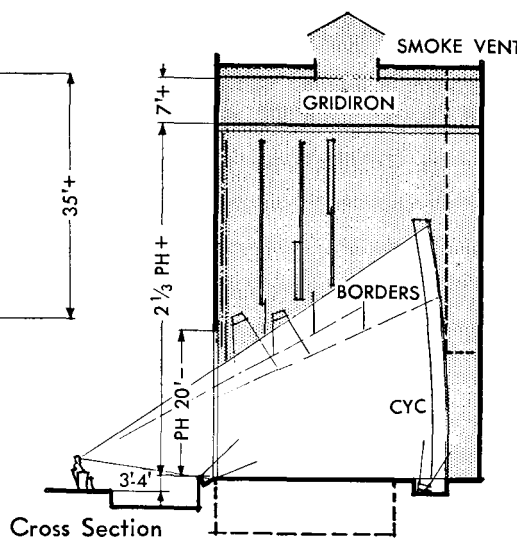

Cross Section

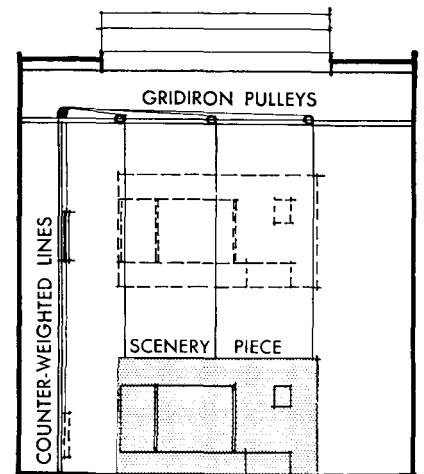

Rigging Diagram

By **MAYNARD LYNDON**, of Lyndon & Smith, Architects

Stage

THE STAGE is a limited working area, visible to the audience from a fixed viewpoint. Its width is at least twice the width of the proscenium, or approximately equal to auditorium width at its widest point. Storage, other than "between-act", is undesirable on stage. Effective depth of scene desired plus passage back of the cyclorama determines depth of the stage. Ordinary productions require a depth of 35 to 50 ft. Stage loft must be high enough to hoist out of sight pieces of scenery and drop curtains not in use. Exact height is determined by the critical sight line from the front row of seats. For economy, this sight line is often effectively lowered by introducing louver-like "borders" hung parallel to the back wall. In interior sets, a ceiling piece usually limits the sight line to approximately 15 ft. With these accessories, clear loft space need be little more than the height of pieces hoisted. Moderate-sized stages have a gridiron height of 45 ft., approximately $2\frac{1}{3}$ times proscenium height.

Equipment

Gridiron consists of an open-framed steel floor near the top of the stage loft, for rigging hoisting cables and pulleys for drops. Access should be provided to all parts of the gridiron, as well as headroom for working above it.

Lines. Improved methods provide counterweighted lines operated from the stage floor. Lines are desirable for most of the stage depth and should be located so as not to obstruct the workshop entrance, scene dock, etc.

Cyclorama is a smooth, unbroken surface capable of so taking light as to give an illusion of undefined space. The cyclorama may be a permanent surface, such as plaster, curved both horizontally and vertically to permit even distribution of light, usually from "trench lights" located below the stage-floor level. In some cases top and side lights are used. Any cyclorama should be wide and high enough to reach beyond sight lines. If a per-

manent shell is impractical, fabric back drops are usually mounted on special frames which can be hoisted or moved aside.

Platforms and traps. Platform units, needed to raise the stage-floor level for choral groups or special settings, are available in easily handled sizes. Provision for storage is necessary. Back of the curtain, the stage floor should be finished with 2-in. soft pine flooring to permit easy fastening of sets. Part or all of this portion in the effective area is usually built in sections or "traps", which may be removed for scenes in which space below the stage floor is necessary.

Fire curtains are required by insurance codes and fire ordinances. The stage is required to be enclosed in fire walls with the proscenium protected by a steel or asbestos curtain running in smoke channels at the side of the proscenium. A fusible link mechanism is required to close the curtain by gravity in case of fire.

Smoke vent should be provided in the top of the stage loft, designed to open automatically an area equal to one-eighth the stage area when released by a fusible link. This may operate by gravity, the sides being sloped outward at top and hinged at bottom.

Dressing rooms should accommodate the probable maximum number of players. A few small units for stars or guest artists should have private toilet, shower and wardrobe space. All require dressing tables, mirrors, make-up lights, changing and hanging space.

Rehearsal rooms

One or more are needed if the theater is used frequently or by different groups. A large rehearsal room is usually the same size as the effective stage area, preferably slightly larger, with ceiling height accommodating necessary action only. Natural light and good ventilation are desirable.

Workshops

Adequate space must be provided for building large frames, commonly 6 ft. wide and 18 ft. high, which have

to be assembled, covered with canvas or other finish, and painted. Ample natural light and ventilation and large unobstructed wall areas are essential. Ceiling height at least equal to the proscenium height is desirable. A scene dock is necessary for permanent scenery storage. Facilities for receiving and handling scenery and properties for visiting productions are also required.

Making of costumes requires storage for materials and completed items, fitting areas, cutting tables, and sewing machines.

Storage

Properties consisting of furniture, sound and other effect devices, and small portable furnishings require 200 sq. ft. minimum. Paint and electrical equipment each require small separate space allotments. Permanent costume storage requires 300 to 600 sq. ft.

Lighting. Footlights may be permanently installed in recesses or arranged in continuous units which disappear into the floor. They usually comprise from 3 to 5 color circuits with interchangeable glass or gelatine frames. Border lights, hung in horizontal strips back of the proscenium, are arranged in color circuits to match the footlights. Portable lights, strip lights, and small spotlights require stage pockets spaced at intervals on either side of the stage floor.

Control. Lighting, including that of auditorium, should be controlled from one panel for maximum utility. A remote-control panel may be located in the orchestra pit, or preferably, in a control room near the projection booth, where the operator may see the stage much as the audience sees it. If backstage, the panel is most satisfactory above stage level, so the operator may see stage action and so that tampering with the panel is minimized. Dimmers are used on all control circuits. Several types are available for any loads and some specially designed for remote control. Dimmer control should allow individual or group operation of circuits as well as master control.

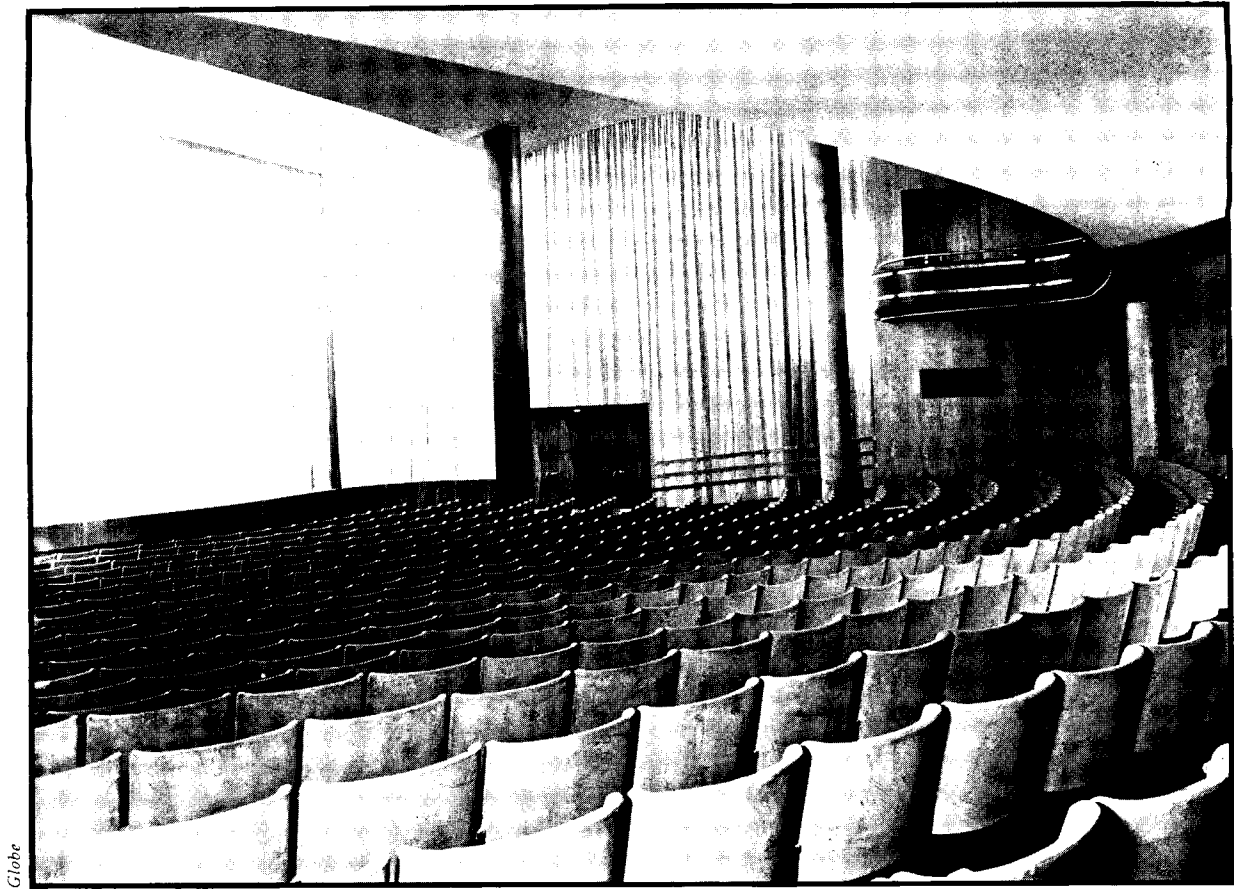

Europe prefers "Continental" seating. Rival Theater, Stockholm, M. M. Lorentzen, Architect

SEATING AND AISLE ARRANGEMENTS: Heavily shaded areas represent stage and seating area losses from comparative visual position in various systems.

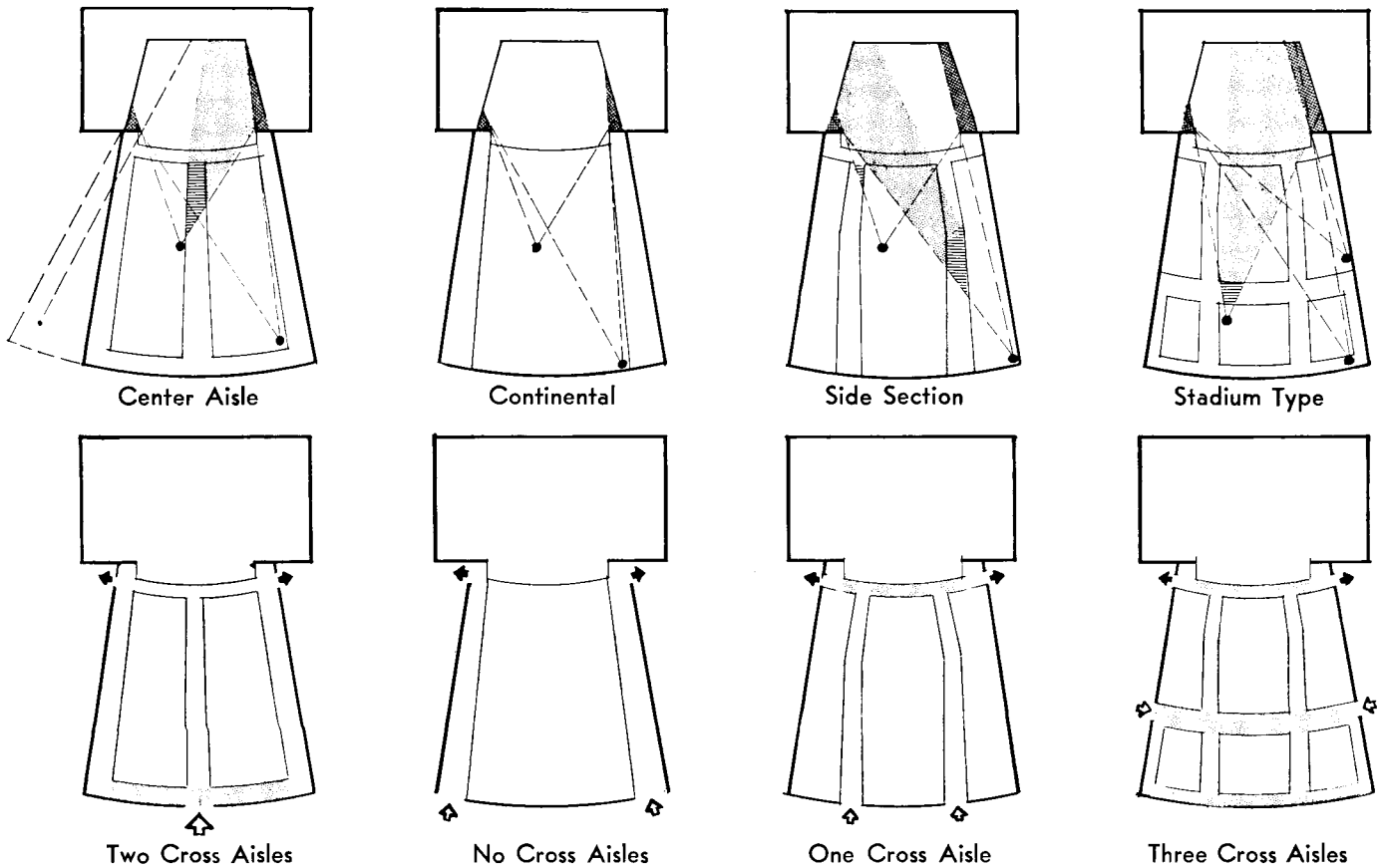

Seating

Preliminary studies may be made on the basis of 6 to 8 sq. ft. per person for the auditorium. Distance from stage to farthest spectator should not exceed 100 ft., which is ordinarily the maximum range of the human speaking voice; less than this distance is preferable. Lateral spread of seating must be narrow to maintain good vision for acting or projected pictures. Seats beyond a 10° angle, measured from the side of the proscenium, are usually unsatisfactory. Stage productions and dance dramas need sight lines which include the performers' feet. Balcony sight lines usually include the orchestra pit.

Seats may be arranged in two ways: in banks of 13 or 14 chairs between aisles; or in continuous rows, a system known as continental seating. The latter is not permitted by many building codes, which require that no seat be more than 6 or 7 seats distant from an aisle. Audiences are usually made up of even-numbered groups, making odd seats less saleable; hence layouts should not include many short rows with odd numbers of seats. In either type of seating, curved rows permit all spectators to face the proscenium. If curved to a radius, the arc center should be behind the back wall of the stage.

Seats are available from 18 in. to 24 in. wide, most being 22 in. Seat-spacing back to back may be as close as 32 in. for seats between aisles. Continental seating eliminates aisles in valuable parts of the auditorium and provides more general comfort; but total required floor area is often greater and circulation is usually more difficult to plan. Rows are spaced to allow passage between occupied seats (40 in. to 48 in. back to back). Rows may be spaced closer at the middle than at aisles.

Chairs having a spring edge and box spring seat, although the most expensive, are generally the most satisfactory type of fixed seating. Backs have box springs or are simply padded. Satisfactory cushion rubber foundations are still in the experimental and, consequently, expensive stage. Fully upholstered chairs with the best seat and back construction available cost about 50% more than

cheaper upholstered types. Wood seats and backs are not recommended. Deep pile fabrics on fully upholstered chairs have sound-absorption values when empty comparable to occupied seats, facilitating acoustic control. Slope of the auditorium floor is compensated for by varying the length of each row of standards.

Finishes. Finishes of the auditorium should not be distracting. Enveloping surfaces should enclose the necessary space, provide reflecting or absorbing surfaces for light and sound as needed, and should be of a quality which makes maintenance economical. Metallized or glossy finishes are usually unsuitable for surfaces which receive light because of their reflection behavior. Flat finish, paint which is washable and neutral in color, is desirable. Very light colors are undesirable; they reflect light from the stage, and maintenance costs are high. Acoustic materials offer natural surfaces acceptable in texture, but usually must be painted.

Circulation

The foyer serves two purposes: first, as a distribution area for ticket holders entering at a relatively restricted control point; and second, as a social area between acts or before and after performances, thus having to accommodate a large part of the audience at one time. When the building is to be used for daytime presentations, foyer windows are recommended for light and vista. Finishes should be durable and easily cleaned, the floor carpeted.

Aisles are emergency areas as well as means of access to seats. They should lead either directly to exits or to cross aisles which lead to exits. Number and dimensions of aisles and exits are usually established by codes. Because of inevitable latecomers, cross aisles may be very disturbing unless seats back of them are sufficiently elevated. Aisle carpeting is essential to reduce noises.

Exit requirements demand adequate openings to empty the building in about three minutes. Calculations may be based on 120 persons per minute passing a given point in a double line. Emergency exits should lead through fireproof passages to open areas outside the building and

should have a minimum number of changes in direction, and in elevation by stairs or ramps.

Services

An anteroom is essential to each toilet. For women a powder room or similar area may serve as the anteroom. Size of the coatroom depends on character and size of the audience. Some groups require space for half the spectators. The delivery counter should be large to minimize waiting.

Lighting

Lighting for lobby, foyer, and auditorium should progress from high exterior intensities to relatively low values in auditoriums, giving spectators' eyes an opportunity to adjust themselves. Usual intensities are 10 to 15 footcandles in lobbies, 5 in foyers, and from 3 to 5 in auditoriums between acts. During the presentation, adequate auditorium lighting need not exceed ½-footcandle. In auditoriums, cove lighting and controlled down-lighting are satisfactory; cove lighting is satisfactory if arranged to avoid spotty effects or too high intensities. Down-lighting may be supplied either by lens-controlled units, mounted above very small ceiling openings, or by parabolic reflectors with silvered-bowl lamps and concentric louvers. High intensity sources such as exposed lamps or bright diffusing glass panels, if visible to the spectator, are not considered satisfactory. Lighting must be accessible for maintenance.

Emergency systems, either completely separate service lines or battery systems, are often required by law, particularly for exit light circuits. Exit signs should be legible from every part of the auditorium served.

Mechanical facilities

Audiences expect air conditioning. This will automatically compensate for heat lost or gained while the space is occupied and will keep humidity at desired levels. Six to ten air changes per hr. or a volume capacity of 20 to 33 cu. ft. per min. per seat, along with heating and cooling units, are necessary under most conditions.

Cost factors

Buildings represent 75 to 85% of total investment. Cubic-foot costs of structure average from 40 to 75 cents. Costs per seat vary from \$400 to \$700.

Community Theaters

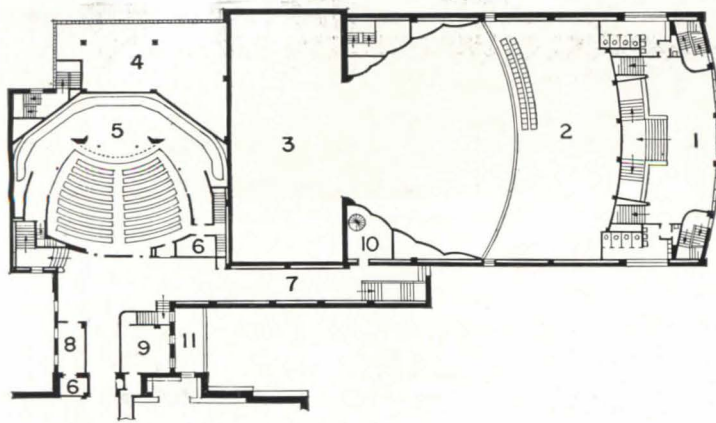

First Floor

- | | | |
|--------------------|---------------------------|-------------------|
| 1. Balcony lobby | 4. Upper part, stage shop | 8. Board room |
| 2. Balcony seating | 5. Laboratory theater | 9. Manager |
| 3. Stage house | 6. Storage | 10. Stage manager |
| | 7. Gallery | 11. Terrace |

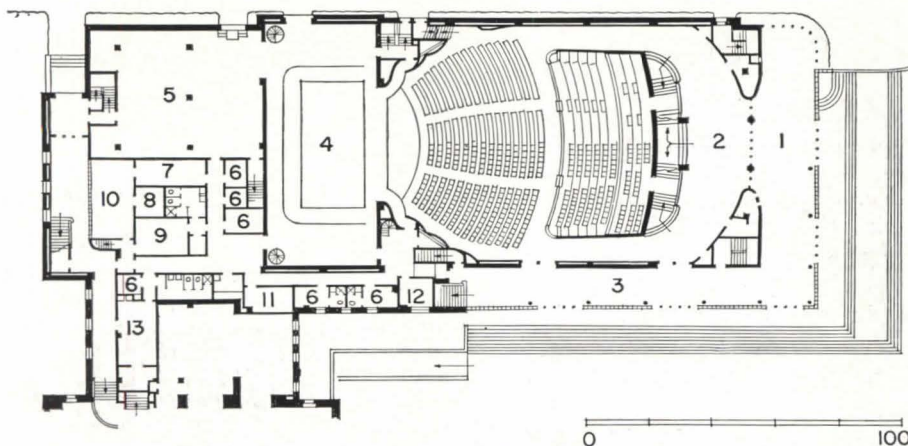

Ground Floor

- | | | |
|--------------|--------------------|-----------------------|
| 1. Vestibule | 4. Stage | 9. Chorus |
| 2. Lobby | 5. Stage shop | 10. Costume workshop |
| 3. Gallery | 6. Dressing rooms | 11. Make-up |
| | 7. Costume storage | 12. Assistant manager |
| | 8. Dyeing room | 13. Green room |

Theaters in Memorial Union, University of Wisconsin, Madison, Wisconsin.

Michael M. Hare, Project Designer
Lee Simonson, Theater Consultant
Corbett & MacMurray, Architects
State Bureau of Engineering, Resident Architect

Unusual flexibility and almost constant employment of facilities were required by the joint use of Madison's 60,000 population and the 11,000 students of the university. Seating capacity of the large auditorium may be varied from 700 to 1,300 by drawing curtains. The laboratory theater, seating 185 persons, accommodates experimental work in speech, stage technique, cinema projection, radio rehearsal, and broadcasting. Observation, viewing and projection rooms, occupying laboratory theater balcony, permit class discussion of performances in progress. Stages, shops, and theaters, being interrelated and keyed to student and civic activities, result in economic initial costs; maintenance charges may be reasonably apportioned.

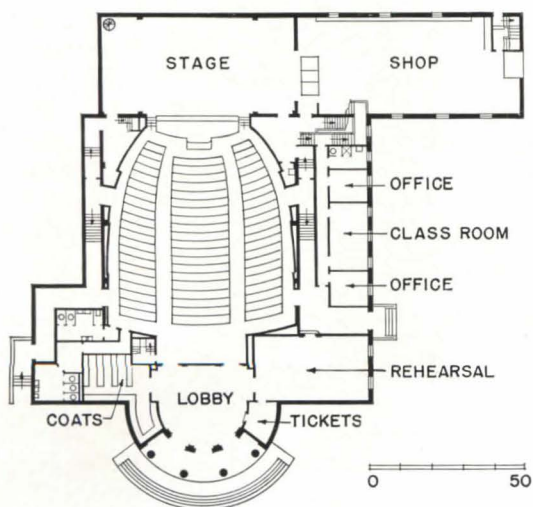

Kirby Memorial Theater, Amherst College, Amherst, Massachusetts. McKim, Mead & White, Architects

The auditorium will seat 430 persons. Workshop and classroom are included for use of the Department of Dramatic Art, whose scope may be enlarged to include courses in stage and costume design, acting, direction, playwriting, and stage mechanics.

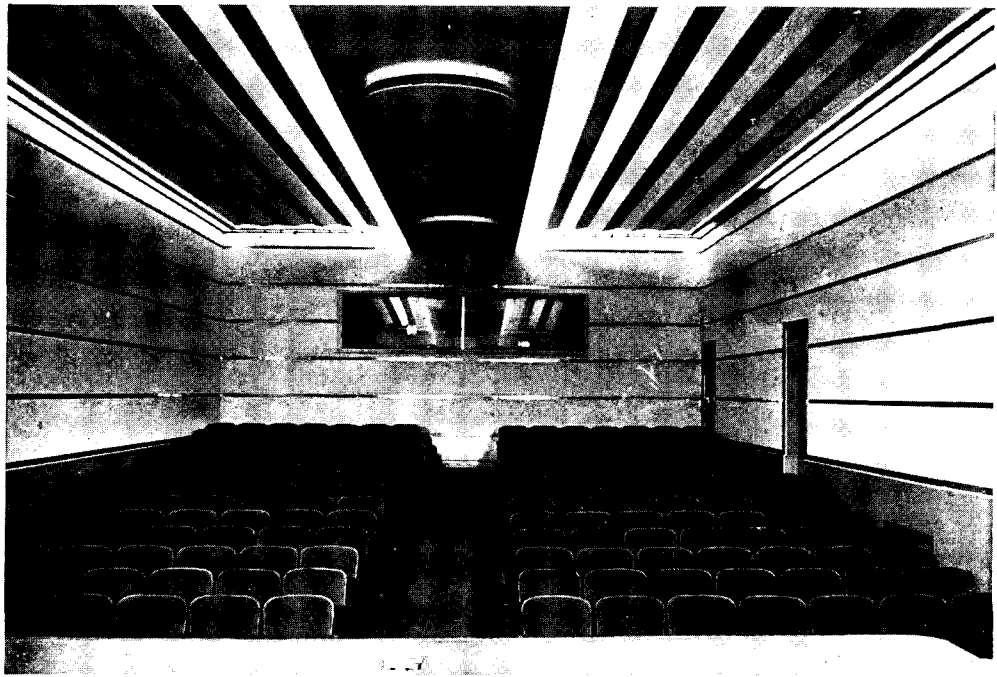

Courtesy N.B.C.

Auditorium studio, Station KYW
Philadelphia, Pennsylvania

Broadcasting Theaters

By **NORMAN BEL GEDDES**

**With interpolated data and notes on
NBC practice, prepared by Leif Eid,
National Broadcasting Company**

OBSERVERS (the studio audience) of radio broadcast programs may not continue on present lines as to numbers, type, or accommodations. Greater use of electrical transcription may conceivably eliminate audiences entirely. (Upon investigation, NBC has discarded this possibility.) On the other hand, enlarged "entertainment centers" affording facilities for dining and dancing during programs stimulate attendance as well as produce additional revenue. The former would result in small, acoustically ideal studios; the latter might produce centrally located studios surrounded by viewing spaces, restaurants and ballrooms.

Television is still in the experimental stage; therefore, its requirements are not considered here.

Production requirements

Present radio requirements are based on variable factors which have tended to produce two types of studios. Stage-trained radio performers usually need visible and audible audience reactions to induce good performances. Sponsors, who at present finance radio broadcasting, have

a firm belief in the value of studio audiences. These factors have led to the development of radio theaters patterned somewhat after existing theater and auditorium stage practice. Acoustical engineers and radio technicians, together with performers trained primarily in radio technique, prefer studios accommodating performers only, audience facilities being limited to observation booths. Such studios are capable of more perfect acoustical and electrical control of reproduction. In the latter connection, voices and other media entirely unsuitable for long-range auditory perception can be electrically modulated and integrated with other parts of the performance to achieve entirely satisfactory broadcasting results. In many cases, and considered from technical viewpoints only, such voices or media are often more satisfactory when reproduced than any other type.

Considering future radio studio design in relation to both commercial and technical factors, it becomes apparent that studios can be developed to fulfill many requirements not at present accurately determined, or

capable of fulfillment on the basis of present acoustical or electrical knowledge. Such requirements include:

1. Standardization of highest quality reproduction and sonic effects.
2. Maximum efficiency for rehearsal and performance.
3. Improved facilities for program production.
4. Wide variability in type and size of program.
5. Audience considerations—possibility for expansion and improvement—or possible limitations.
6. Possible technical changes, including: (a) electrical transcription and (b) binaural (double microphone) reproduction.

Conventional auditorium and theater design practices limit possibility of entirely satisfactory solutions. This indicates two methods of attack:

1. Further work on improved studios of conventional design following general theater, auditorium and studio practice.
2. Development of ideal studios, disregarding present limitations and taking advantage of technical advances indicated as possible of realization.

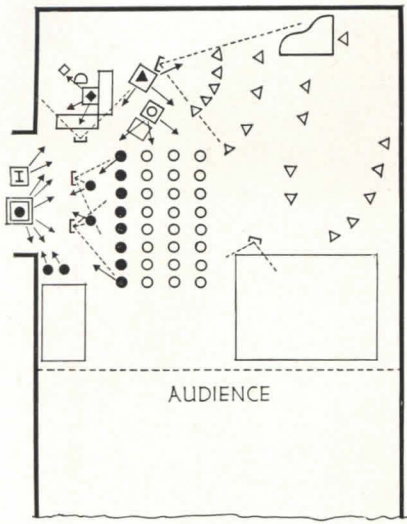

TYPICAL "B" PROGRAM
(Orchestra, Actors, Sound effects)

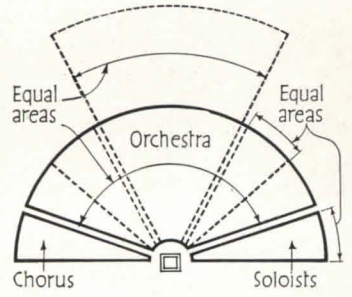

DESIRABLE ARRANGEMENT
for EASE OF DIRECTION

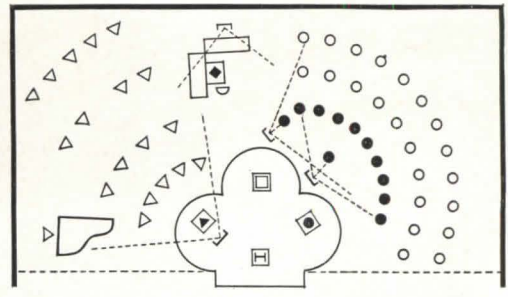

ADAPTATION of TYPE "B"
to DESIRABLE ARRANGEMENT

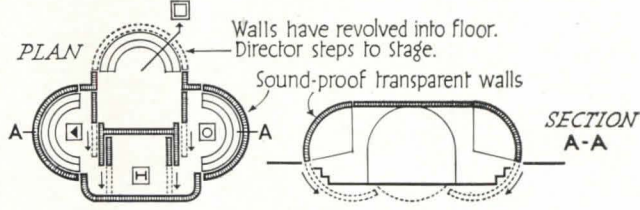

CENTRAL
CONTROL BOOTH

- SYMBOLS
- ⊏ Condenser Microphone
 - ⊏ Ribbon Microphone
 - ⊏ Production Director
 - ⊏ Musical Director
 - ⊏ Control Engineer
 - ⊏ Effects Director
 - ⊏ Chorus Director (Singing & Crowd)
 - ⊏ Loud Speaker
 - ⊏ Musicians in Orchestra
 - ⊏ Soloist Musician
 - Soloist, (Vocal, Acting or Announcing)
 - Chorus (Singers or Crowds)
 - ◇ Effects Director
 - Line of required Visibility
 - Line of Sound Direction

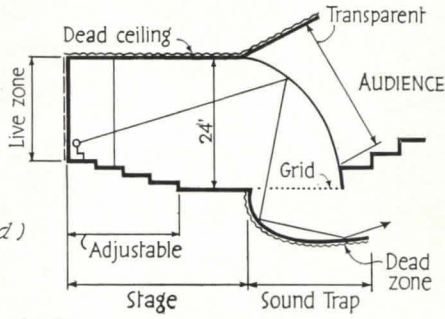

POSSIBLE TYPES OF SOUND TRAP STUDIOS

Transparent reflecting surface separating audience from stage reflects program sound to well for acoustic control.

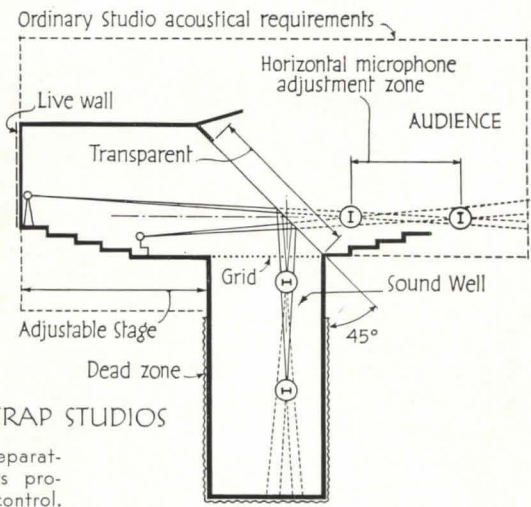

©Norman Bel Geddes & Co.

Studio forms developed by Norman Bel Geddes, based upon performer, director and acoustic requirements.

Typical "B" program illustrated in the top row contains two awkward ensemble groups rather than the single, easily controlled group shown in the desirable arrangement. Maximum ease of control by program director is assumed to be attained when performers are arranged in an arc subtending 160°, with director at center.

Central control booth illustrated satisfies the following demands: 1, intimate working contact between, and maximum control by, program, musical and acting directors and sound engineer; 2, opportunity for directors to hear programs as reproduced while directing production; 3, good vision and possibility for more personal direction.

In sound trap studios reverberation and overtones are added to the fundamental tones electrically, giving any desired sonic effect. Because they are compact and can be completely insulated acoustically from their audience, sound trap studios can be surrounded by dining, dancing and viewing spaces.

Broadcasting Theaters

(continued)

Auditorium studio arrangement, with facilities for performers, technicians, and clients segregated from audience accommodations; an idealized scheme prepared by the National Broadcasting Company. Note that stage depth can be reduced by means of curtains for small presentations. Foyer in this case acts as the "sound-lock."

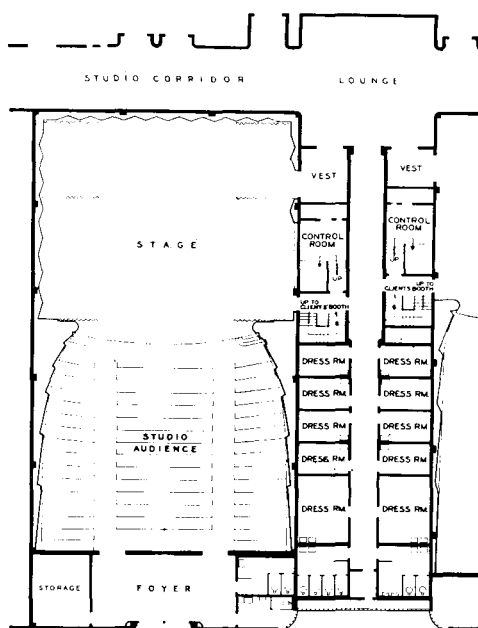

Auditorium forms

It is possible logically to develop studios for complete control over sound from its inception to its ultimate broadcasting. This implies that such developments will be governed by requirements of sound production rather than visual effect. Such a studio would be so designed as to control sound waves in order to add all necessary factors of space effect and auditory perspective—factors normally associated with large auditorium space and available audiences. Such sound wave front might conceivably be picked up by a microphone "screen" replacing the normal proscenium opening. Sound modulations received on the screen might be electrically controlled before being transmitted, or might be mechanically controlled after being reproduced in acoustically perfect chambers. Neither electrical nor mechanical control has yet been perfected, but both are indicated as being possible.

Another solution might be to reflect sound waves directly to an acoustical control chamber. This method would keep sound energy in its original physical form until it enters the control chamber.

The fundamental sound would then be "doctored" by adding electrically produced sonic effects desired. For instance, reverberation determines the effect which conveys to the listener the size and shape of the space from which the broadcast is being made. This effect may be

added by a second broadcast with a split-second lag over the first. This would mean that the original broadcast might be made from a very small room and, with the addition of the proper reverberation quality, give the effect to the listener of a broadcast from a great concert hall. Many other sonic effects could be developed and added as the program demands them. This type of studio would revise the entire technique of broadcasting and make it much more flexible. The Columbia Broadcasting and other Systems are conducting an interesting series of studies of broadcasting based on studios of this kind.

Such solutions make possible the elimination of present technical difficulties in the form of variable audience size and consequently varying auditorium conditions. Audience requirements form a separate consideration affecting but not interfering with such studio development. For instance, sound-reflecting walls might very well be transparent so that the stage might be surrounded by dining, dancing and viewing spaces mentioned before.

Arrangement

Direction of programs requires a stage layout which will permit the program director to control the performing cast while being himself subject to control from the technicians' booth. In the case of programs involving various types of performers, there may be separate directors for orchestra, chorus, actors, and soloists,

all subject to the program director. Arrangement of performers on different levels will permit complete visual control of the entire cast.

Sq. Ft. Allowances for Performers

Violins, viola, wind instruments, except bass....	9 sq. ft.
Cellos	16 sq. ft.
Bass viol, tuba.....	25 sq. ft.
Tympani	36 sq. ft.
(more if chimes, xylophone, etc., are included)	
Concert grand piano....	6 x 11 ft.
Celeste	4 sq. ft.
Harp	3 x 8 ft.
Chorus, per person.....	1 1/2 ft. square
Dramatic performers, seated	2 ft. per seat, rows 40 in. back to back
Sound effects	10 ft. square

Types of programs

Auditorium studios should provide for the following types and sizes of programs:

(A) Orchestra	41 persons
Choir	18 persons
Soloist	1 person
Total	60 persons
(B) Actors	22 persons
Orchestra	18 persons
Sound engineers	3 persons
Agency men	3 persons
Total	46 persons
(C) Orchestra	24 persons
Chorus	12 persons
Soloists	2 persons
Pianist	1 person

Total 39 persons

The foregoing are average types of programs involving large casts. Smaller programs are usually presented in studios with limited or no audience space.

Broadcasting Theaters (Continued)

Spaces surrounding the studio include observation booths, clients' booths, control booths, storage space, and, for studio theaters, dressing rooms. Rehearsal rooms are in some cases necessary, although in many stations studios not in use serve as rehearsal rooms. Circulation (as developed by NBC) ideally provides entirely independent means of access for stage performers, directors, control men, etc., and audience.

Stage practice followed by CBS indicates that a total usable stage area of 1,250 sq. ft. may accommodate as many as 60 performers, although the stage will be crowded. Larger stages with movable rear walls of drapes or partitions would be more satisfactory.

Desirable stage shape depends chiefly on performers' arrangement, of which the most satisfactory is shown in the diagrams.

Booths

Control booth size depends upon equipment sizes.

CONTROL BOOTH EQUIPMENT (High-Level Monitoring System)

1. Cut-in and cut-out switch for each microphone
2. Pre-amplifier for each microphone
3. Volume control for each microphone
4. Speak-back system between control room and studio

All necessary equipment is mounted on a panel or "rack" which comes in three sizes, varying in height only.

Depth: 1 ft. 2 $\frac{5}{8}$ in.

Width: 1 ft. 8 $\frac{3}{8}$ in., 6 ft. 10 $\frac{7}{8}$ in.

Height: 6 ft. 3 $\frac{7}{8}$ in., 5 ft. 8 $\frac{7}{8}$ in.

Access to back of racks must be provided. More than one rack may be required.

Observation booth size depends on future policies regarding conducted tours and similar observer requirements. Present practice frequently accommodates 40 to 80 people per observation booth. Client booth provides ample space for 10 to 12 persons in movable easy chairs. As to shapes of control booth, client booth, and observation booth, these are in effect small auditoriums and are subject, on their interior surfaces, to the same governing conditions as large auditoriums. Control and client booth windows should provide a view of

both stage and audience. Auditorium faces of all booths should be coordinated with auditorium treatment to satisfy acoustical requirements.

Storage

Storage space must be adequate for musical instruments, music stands, directors' podium, platforms for altering stage levels and equipment for changing set-ups, as well as for orchestra and performers' properties. Doors between storage and stage spaces should be large enough for easy passage of all equipment stored. One device for storing valuable instruments safely is a specially designed rack to hold and lock instruments. Such a rack can probably be located within the studio.

Environmental considerations

Air conditioning required for studios depends largely on the number of people on stage and in audience, on lighting equipment, and on the studio practice as regards smoking in various spaces. Air conditioning and fireproofing of studios should permit smoking in client booths.

Six air changes per hour is the minimum. During summer months an average dry bulb temperature of 70° F. and 45% relative humidity is maintained unless outdoor dry bulb temperatures are above 80° F. In such cases indoor temperatures should not be more than 10° F. lower than outside temperatures. In winter, systems should maintain 40% maximum relative humidity. Auditorium studio controls should be independent of all others and air distribution sources must create no objectionable drafts. Baffles and deflectors should be arranged so as not to direct flow of conditioned air against valances and other stage equipment. Sound transmission from one studio to another through ventilating ducts can be prevented and machinery noises eliminated by wrapping all concealed supply ducts for their entire outside length with sound-insulating material such as hair felt, and by lining ducts for approximately 16 ft. within studio limits with sound-insulating tubes, baffles, or other devices. Where ducts change direction, vanes should

be installed to prevent swirling air. Supply outlets and exhaust grilles are acoustically treated.

Lighting which provides a general high level of illumination is preferred to isolated lights for music stands, conductor, etc. General illumination should be such that musical scores do not lie in musicians' shadows. NBC studios require a minimum light level of 15 to 20 foot-candles at working planes.

Soundproofing methods in present use are considered adequate. The usual type consists of structural steel shapes, hung from the main walls of the studio on steel spring clips, insulated, from the main structure by felt pads. On this framework, wire lath and plaster are applied. On top of the plaster is 2-in. rock wool covered with perforated asbestos-cement board, which in turn is finished with a fabric covering. Main structural walls consist of aerated concrete blocks. The entire wall construction "breathes" and fabric finishes may become soiled in spots, repeating perforation patterns. To avoid this fabric is often mounted on frame which hold it away from asbestos-cement board. Floor construction is similar to walls, except that the outside layer consists of 2 in. of concrete, covered with linoleum or carpet. Entrances have vestibules with double soundproof doors which create desirable "sound locks." Booth windows have double or triple glazing and are so constructed that a glass can be easily cleaned.

Audience requirements

Capacities are usually limited to a maximum of 299 people. Seating dimensions and spacing for broadcasting theaters should be more liberal than standard practices and leg minima permit in other theater types. Seats 24 in. wide, 38 in. back to back are more comfortable and induce less audience noise. They also permit more rapid filling and emptying of the auditorium. Auditorium proportions, established through NBC experience, are 2-3-5 for height, width-length. A typical example, seating 270 persons, is 19 x 50 x 89 ft.—total volume 84,550 cu. ft.