

# BUILDING NEWS

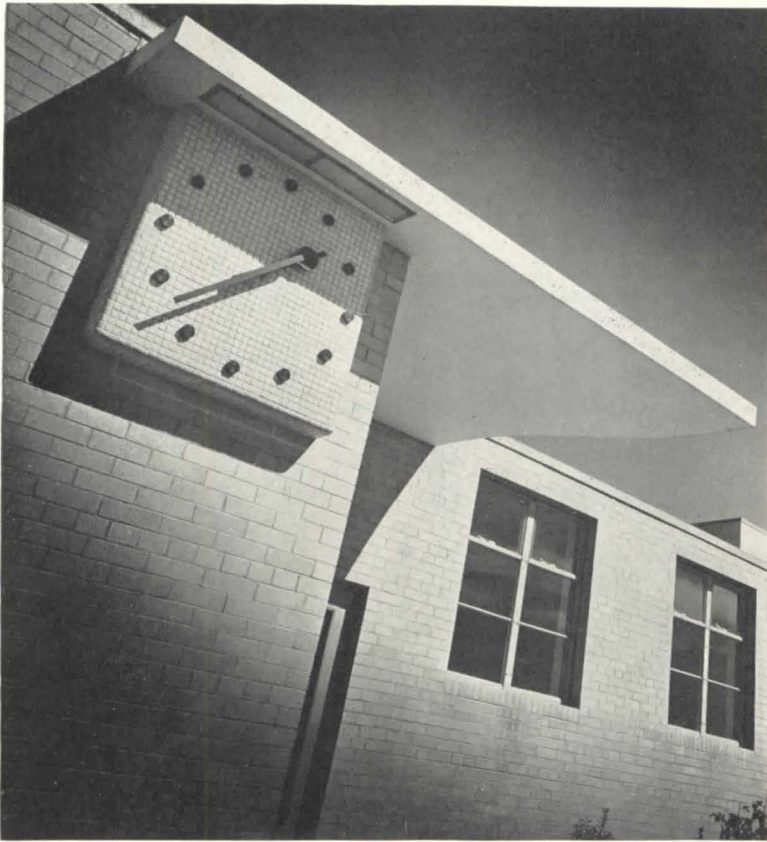

*Erin Stoller*

**M.I.T. Fieldhouse in Cambridge, Mass. ... See pages 40-43**

ARCHITECTURAL  
RECORD



Photos by Hedrick-Blessing

# DUPLEX UNIT INCREASES RENTABLE AREA IN MILWAUKEE APARTMENT

HERBERT W. TULLGREN

Architect

J. EDWIN QUINN

Consulting Architect

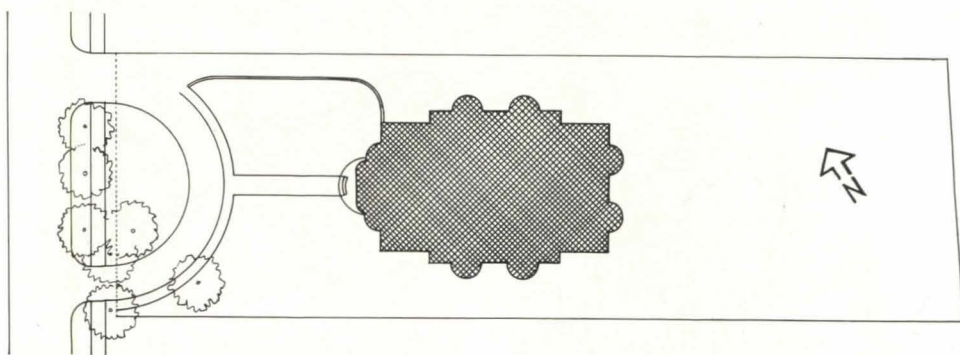

No garages are included in the project since ample accommodations are available in the immediate neighborhood. The entire plot is landscaped, the rear being developed for tenants' private use.

AN ESTIMATED 10% increase in rentable space over conventional plan types is achieved in this new apartment building at 1260 North Prospect Avenue, Milwaukee, Wis., by use of a duplex as the basic apartment unit. This permits an elevator system which serves only alternate floors, thus reducing by one-half the usual capital and maintenance costs of public areas. Important economies are introduced by this plan, which permits the grouping of baths and kitchens around central service stacks. (See pp. 36-37.)\*

Occupying only 22% of a large plot located on Milwaukee's residential lake shore, the Prospect Avenue building has 32 five-room duplexes and 2 six-room single-level penthouses. This unusual concentration of relatively large units springs from the owner's careful analysis of the local tenant market, where prejudices were felt to be in favor of single-family houses and against highly serviced apartments. Since it was expected that the tenants would be drawn largely from single-family houses (rather than other apartment buildings), the five-room duplex was taken as a minimum. For the same reasons, the service staff was held to an operating minimum—there are no doormen or elevator operators; the desk and central switchboard are eliminated.

Rents are approximately \$25.00 per room per month.

\*Both the technical and management aspects of this type of plan have been thoroughly tested in another apartment designed by the same architect and built in Milwaukee in 1933. The plan has been patented by Mr. Tullgren.



Frame is reinforced concrete construction cantilevered over bays and corner windows.

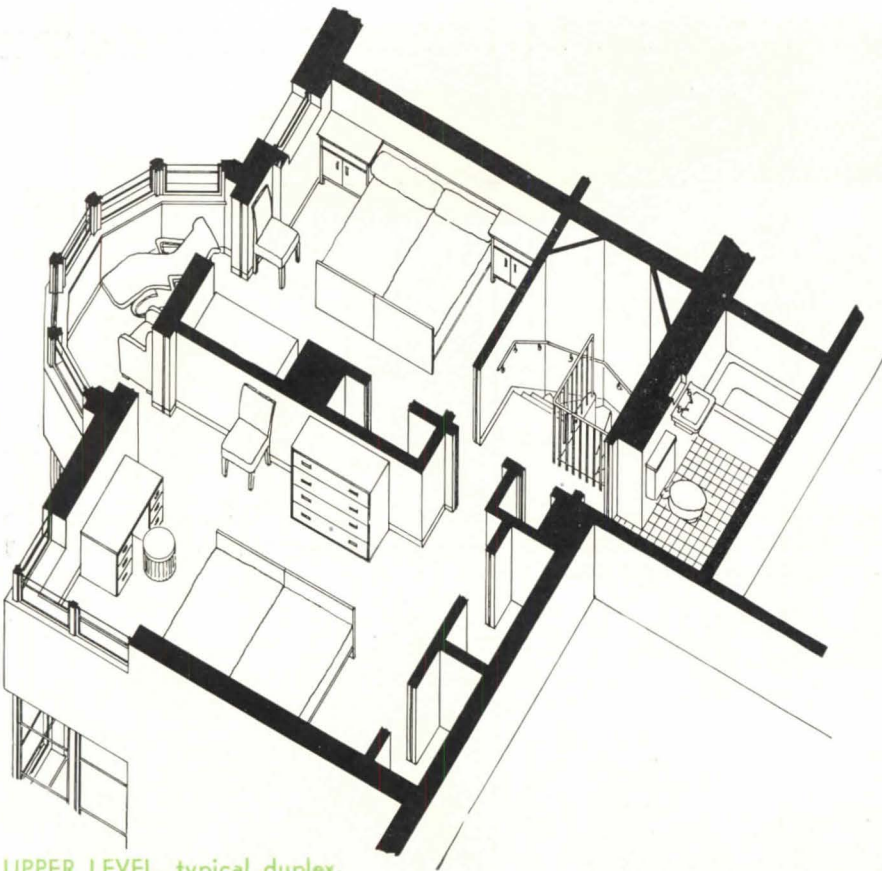

UPPER LEVEL, typical duplex.

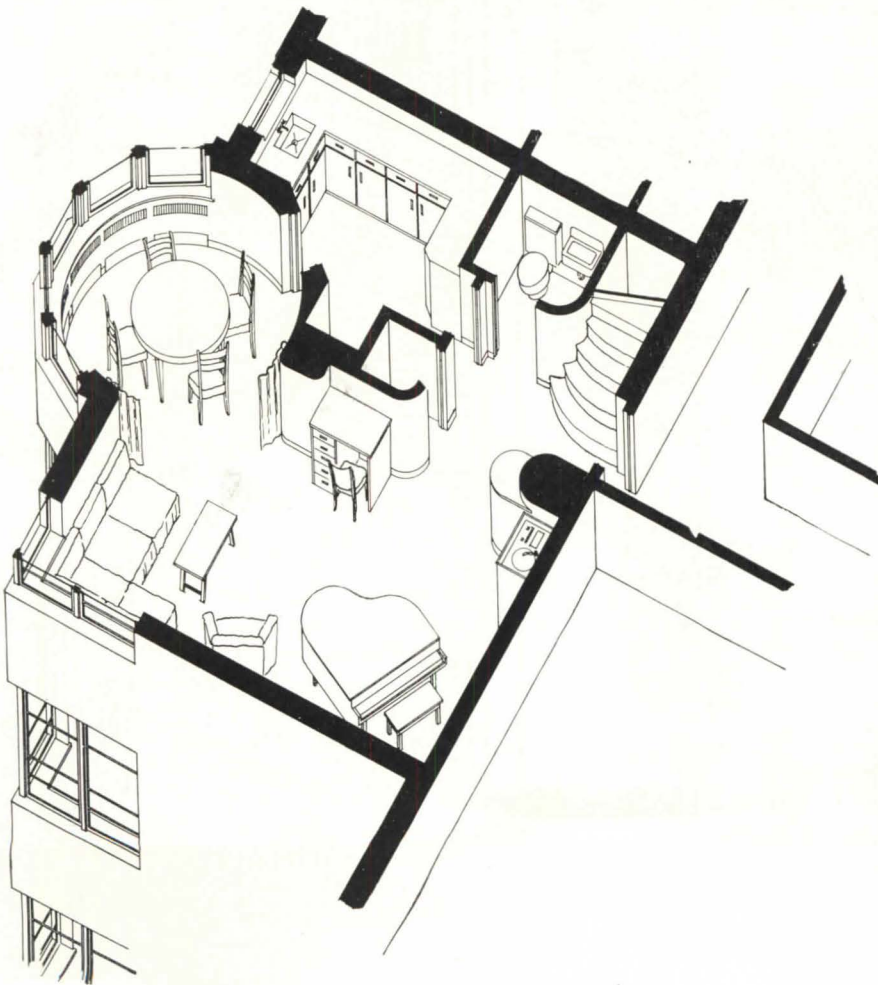

LOWER LEVEL, typical duplex.



Hedrich-Blessing

Design of the individual units reflects the owner's desire to reproduce as far as possible the accommodations of the single-family dwelling. Thus, there is a lavatory in the entrance foyer; the kitchen is unusually complete, and the dining room separate. At the bedroom level, the semicircular bay becomes a solarium. All ceilings are flush, and the cantilevered floor slabs eliminate all columns at outside corners. Trim is practically eliminated.

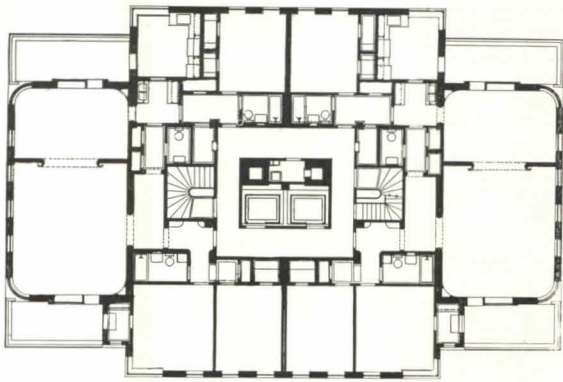

Ninth floor.

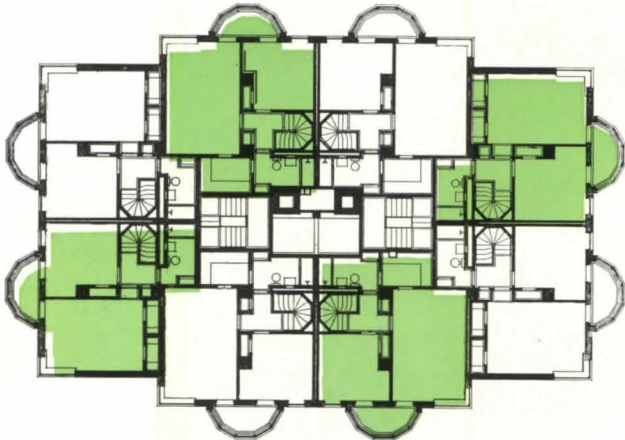

Eighth, sixth, fourth, and second floors.

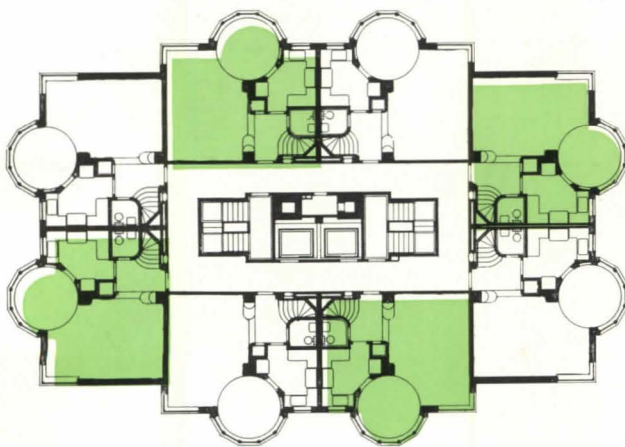

Seventh, fifth, and third floors.

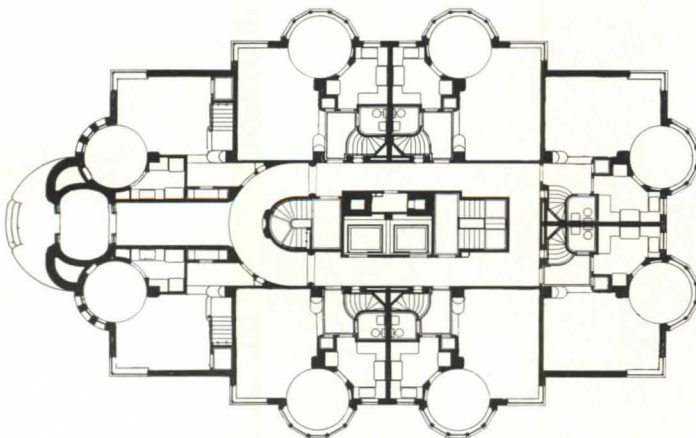

First floor.

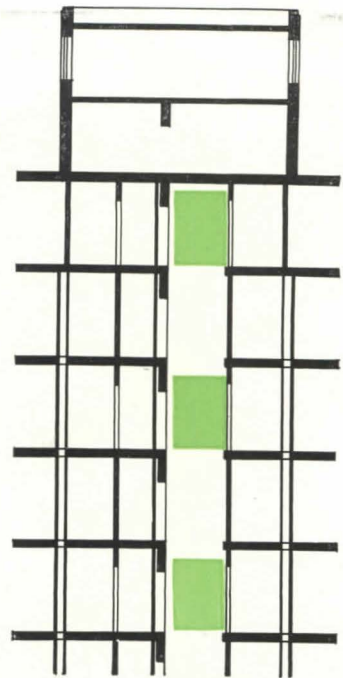

Section through elevator shaft.

USE OF THE DUPLEX as a basic unit frees Mr. Tullgren's plans of the long public corridors, private halls, and passageways common to most apartment houses made up of large units grouped around a single bank of elevators. It also provides a more compact and efficient unit plan, giving all rooms direct access to one central stair hall. This also permits grouping baths and kitchens so that four main service stacks serve all 34 apartments.

The two elevators at the center are flanked by fire towers and backed by furnace and incinerator flues (access to the latter is not from the main corridor but from a small room off it). The elevators themselves are Haughton automatic, so regulated that if one car is serving the seventh and ninth floors, the other automatically sets itself to serve the third and fifth. In addition, the cars will stop for passengers in their direction of travel, and will subsequently respond to signals for travel in the opposite direction.

Sound insulation is provided for by double walls between all units and between each unit and all public spaces. In addition, the location of baths and stair halls isolates main living areas of each apartment from public corridors and elevators.

All public corridors are carpeted and indirectly lighted with fluorescent tubes.

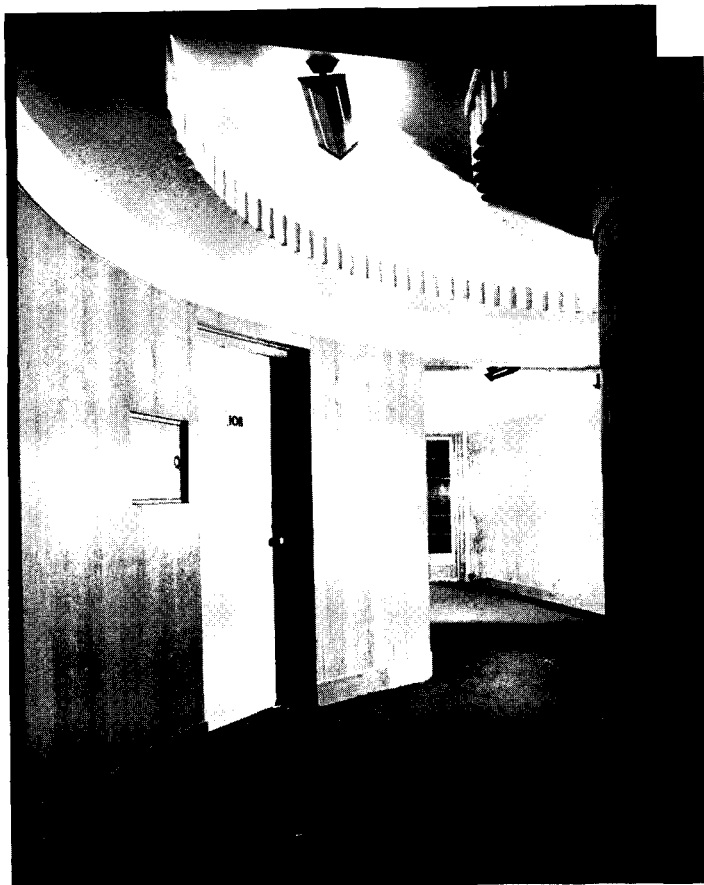

First-floor corridor looking towards lobby. Here, as elsewhere, all floors are carpeted, all lighting indirect. Receivadors are installed alongside the entrance door of each apartment.



Typical kitchen: specially-designed cabinets incorporate electric range and refrigerator; counters are finished in Masonite, floors in linoleum. All ranges are vented by forced draft.



Photos by Heinrich-Blessing

Penthouse: modernfold accordion doors are used between dining and living rooms; a vertical light trough is concealed behind pilasters at either side.



Typical dining room: a built-in circular curtain track permits use of curtain either across windows or across opening between living and dining rooms.



Typical living-room window

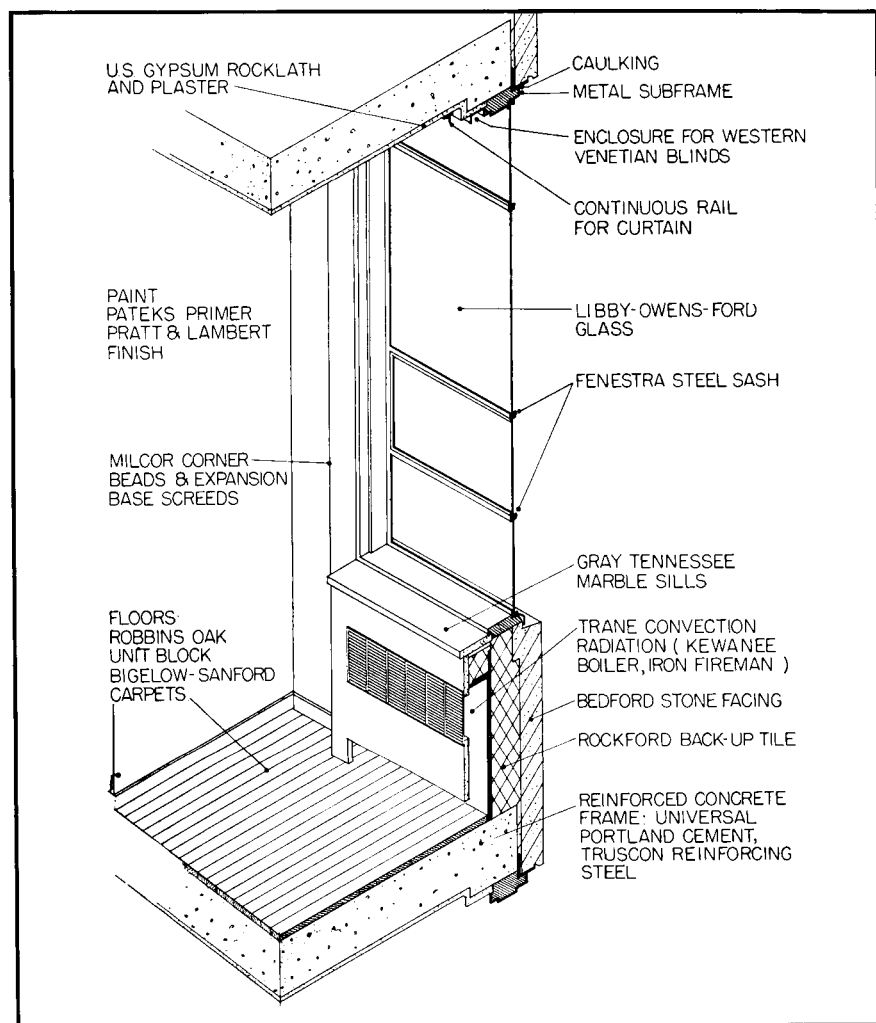

Construction, typical bay

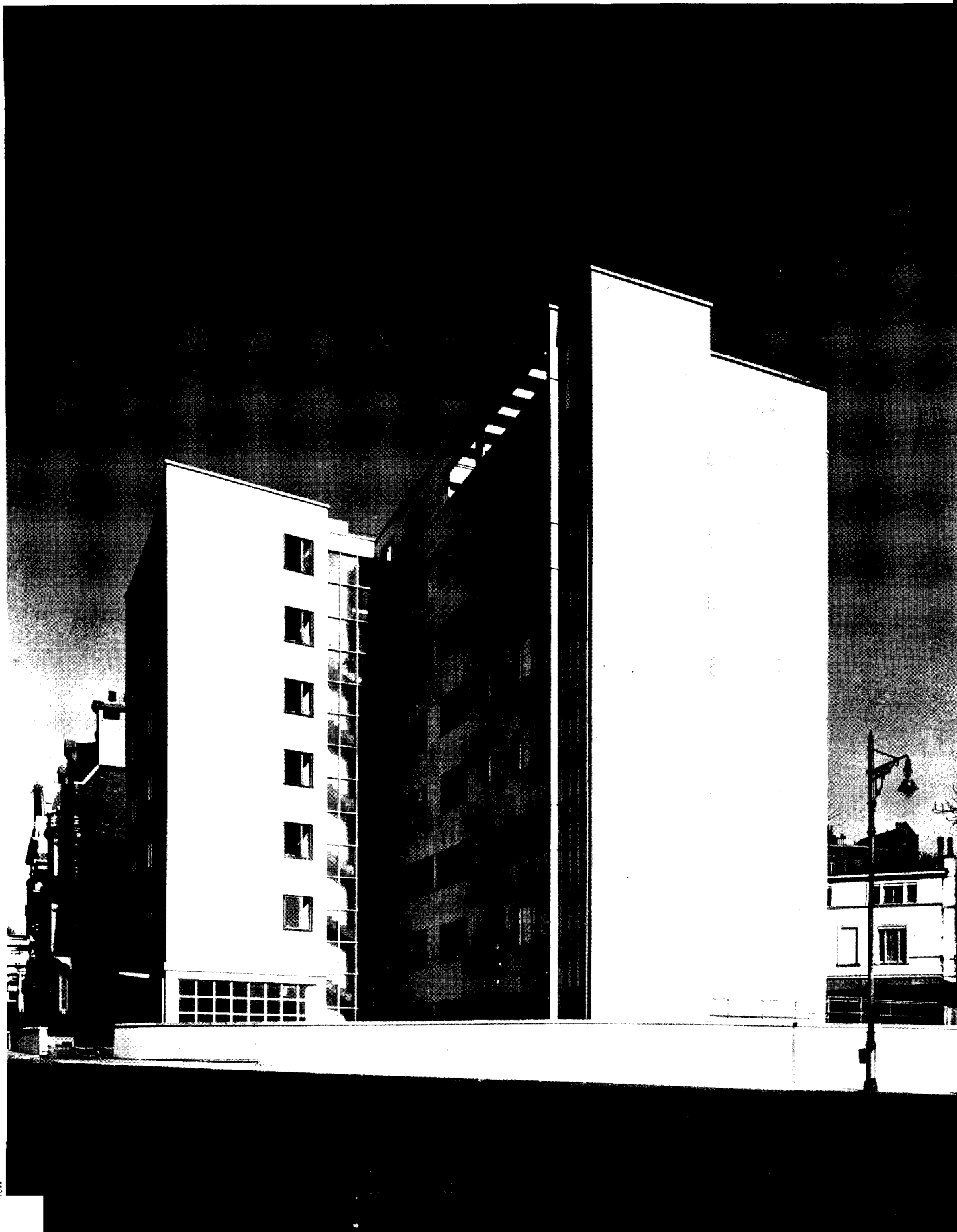

Wall

The two upper galleries mark the entrance or access level to each repeating bank of interlocking duplex apartments.



# "3-DIMENSIONAL" UNITS YIELD FLEXIBILITY IN LONDON APARTMENT

WELLS COATES, Architect

"THREE-DIMENSIONAL" planning—which yields extraordinary flexibility in interior layout and reduces elevator stops to *every third floor only*—is a feature of this new apartment building in Palace Gate, London. First application of a principle evolved several years ago by the architect (See AR, 3-37, p. 22), the "three-two" planning system consists of using 1½-story living rooms with single-story rooms elsewhere, so designed as to yield two interlocking but completely separate duplexes in each multiple of three floors (pp. 36-37). With entrances to the interlocking units at the middle of these three levels, circulation is simplified and the amount of public space reduced by approximately two thirds. The system has the further advantage of permitting a wide variety of accommodations—i.e., variations in both size and arrangement of rooms—without structural alterations.

Because of the shape and size of the plot on the one hand, and the necessity for fixed revenue on the other, it was not possible to use the "three-two" system throughout; consequently the stem of the T-shaped plan consists of a bank of 2½-room units, one to each floor. A luxurious single-level 6-room penthouse occupies the eighth floor of the main building, while two single-level 4-room units occupy the first floor.

Structurally, the building is also of great interest. A reinforced concrete skeleton, employing the principle of continuous design, has an exterior wall system of precast concrete units whose design and installation closely parallels that of the Navy's new Testing Basin in this country (AR, 9-39, pp. 34-37). Elaborate precautions against sound and temperature transmission are included in both exterior walls and interior partitions.

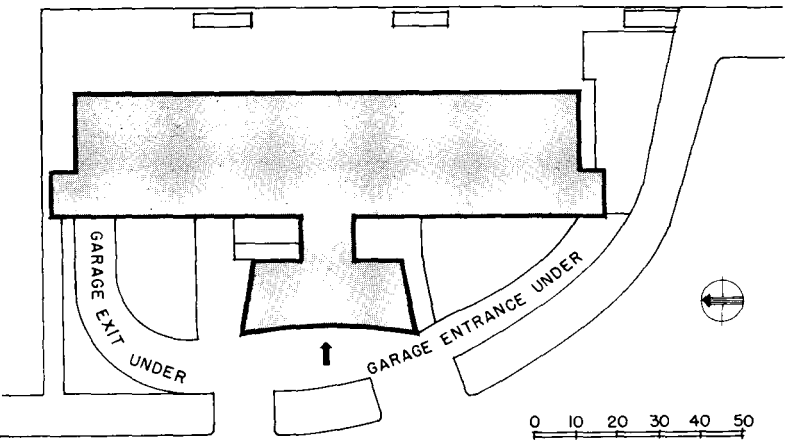

Plot plan, showing entrance (right) and exit (left) to the garage.

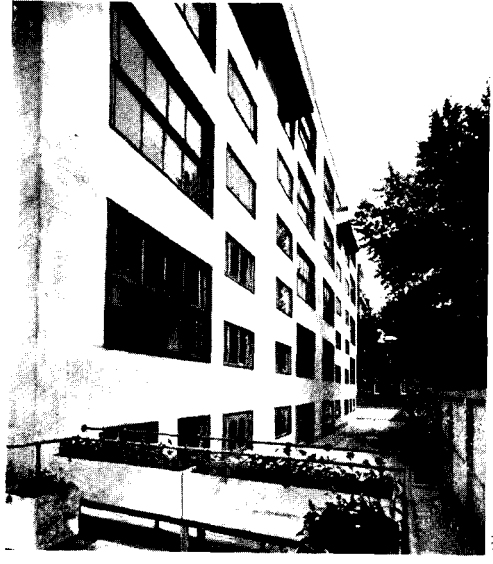

Large windows mark 1½-story living rooms.

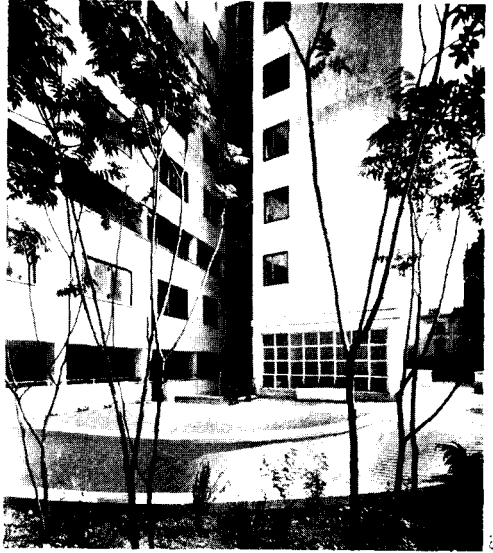

Entrance front, showing exit from garage.

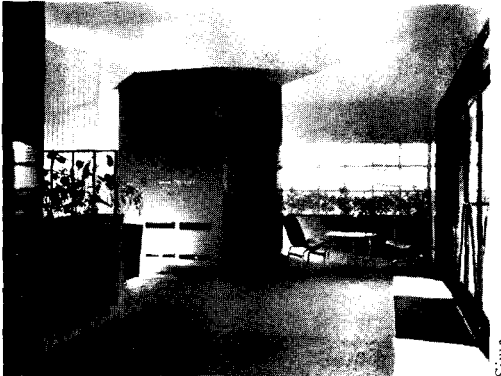

View of entrance lobby.

# THREE-DIMENSIONAL PLANNING

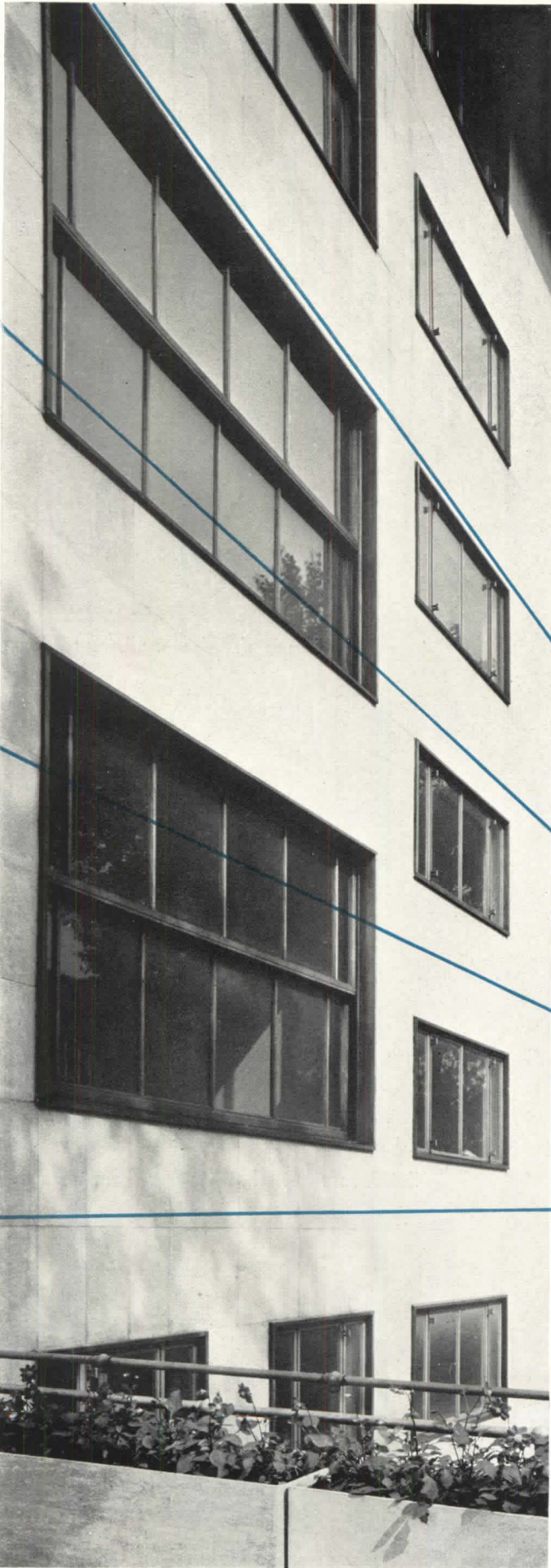

Photos by Sims

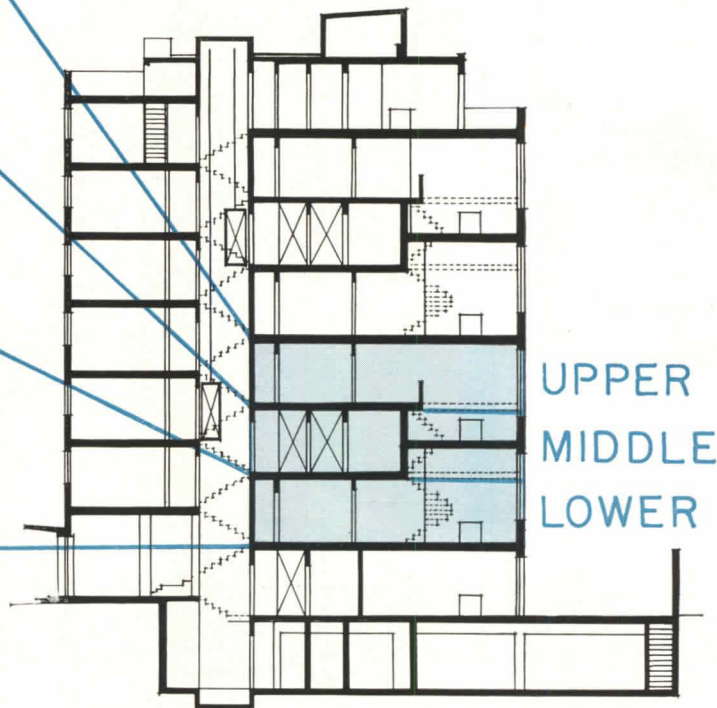
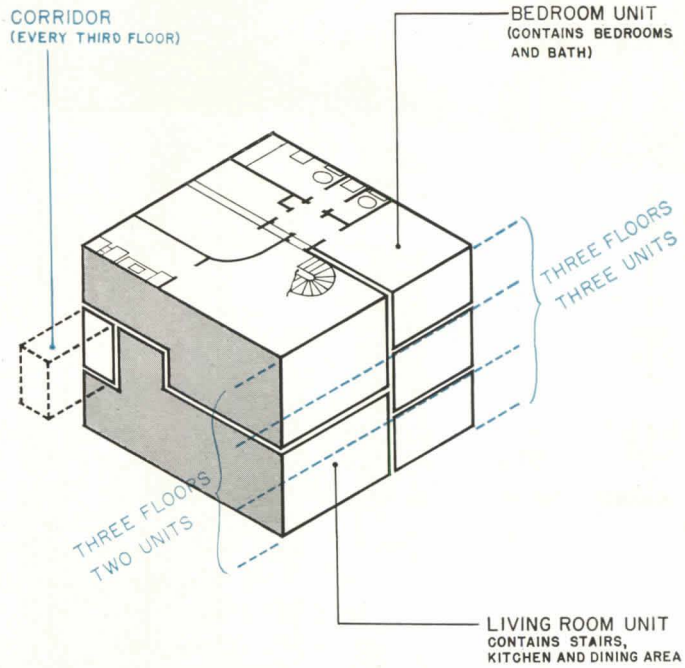

Two "THREE-TWO" UNITS interlock vertically with each other and horizontally with three "three-three" units to form two apartments every three floors. Flexibility within the individual apartments is thus possible with minor structural changes. Within this basic unit accommodations can be easily varied from two bedrooms and bath to six bedrooms and two baths.

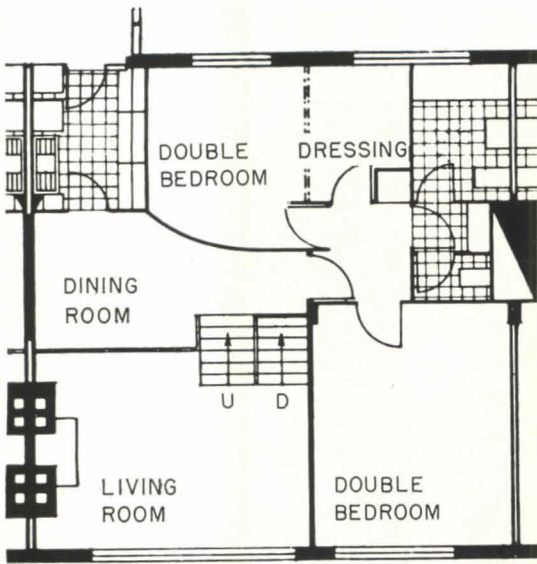

UPPER LEVEL, typical "three-two" unit.

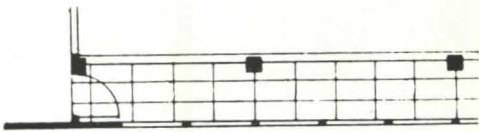

CORRIDOR

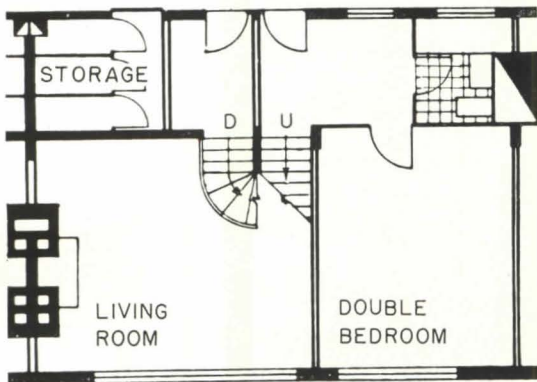

MIDDLE LEVEL, typical "three-two" unit.

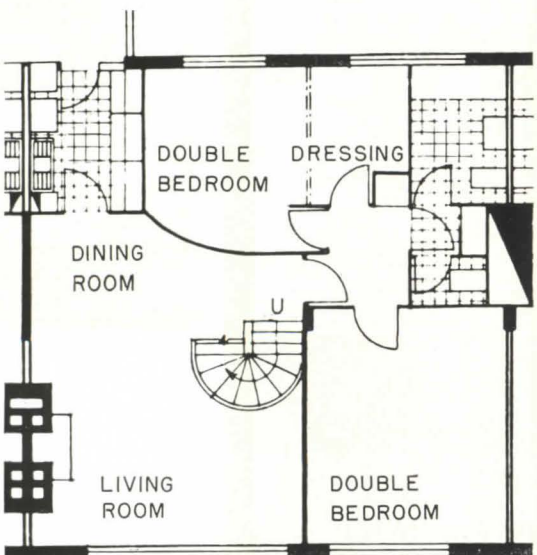

LOWER LEVEL, typical "three-two" unit.

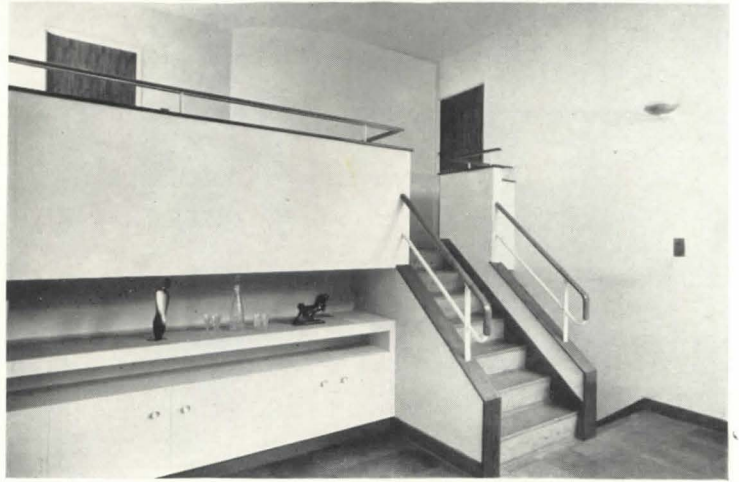
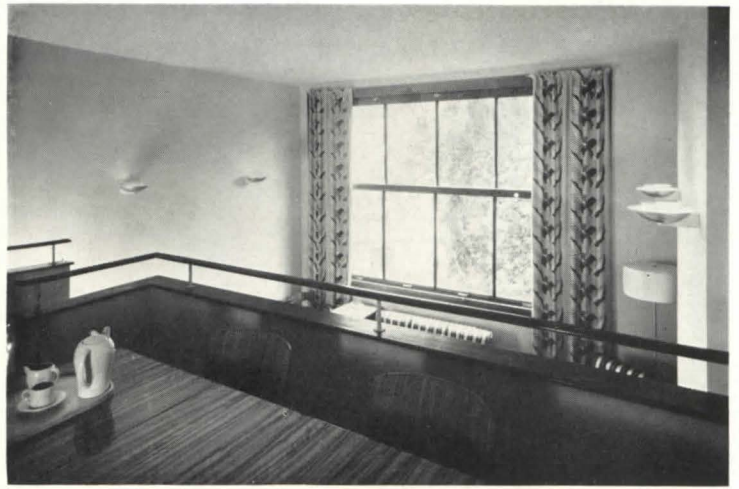

Two views of typical living room.

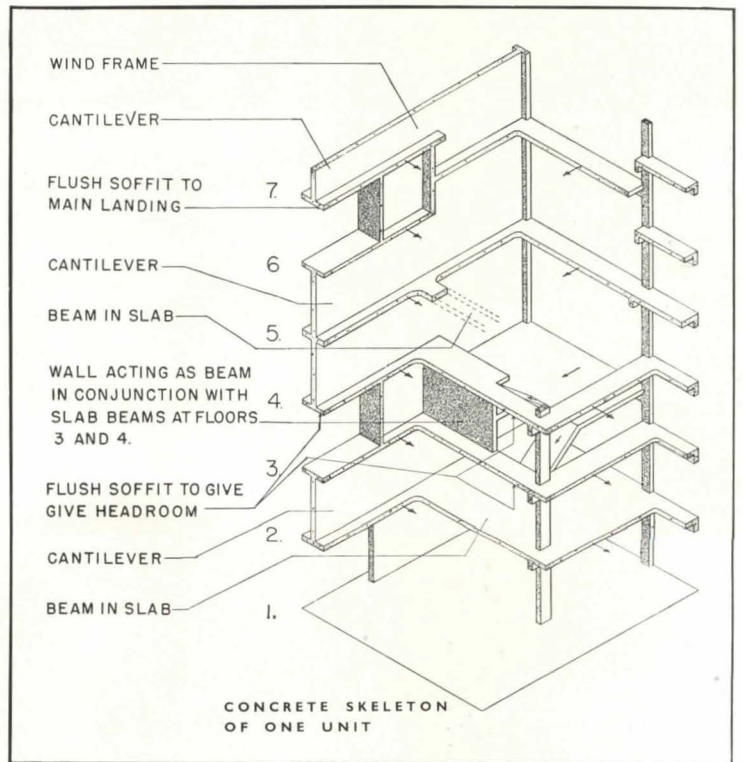

Continuous concrete frame frees interior space.



Cracknell

The garden front of the Palace Gate building gives a graphic picture of the "three-two" planning system. Although superficially reminiscent of the "studio type" plan, the Coates system provides much more flexible and satisfactory organization of interior space.

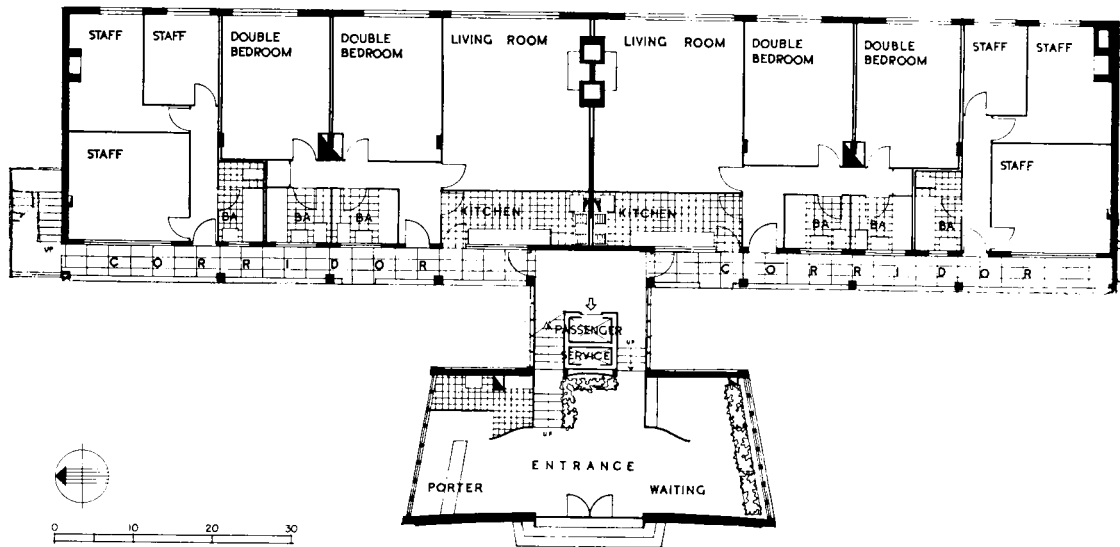

The first floor contains the entrance lobby, two dormitories for the staff, and two 4½-room single-level units. Ramps at either side lead down to and up from the garage.

Eighth floor: the pent-house—like the bank of 2½-room units in front of the elevator shaft—is planned on one level.

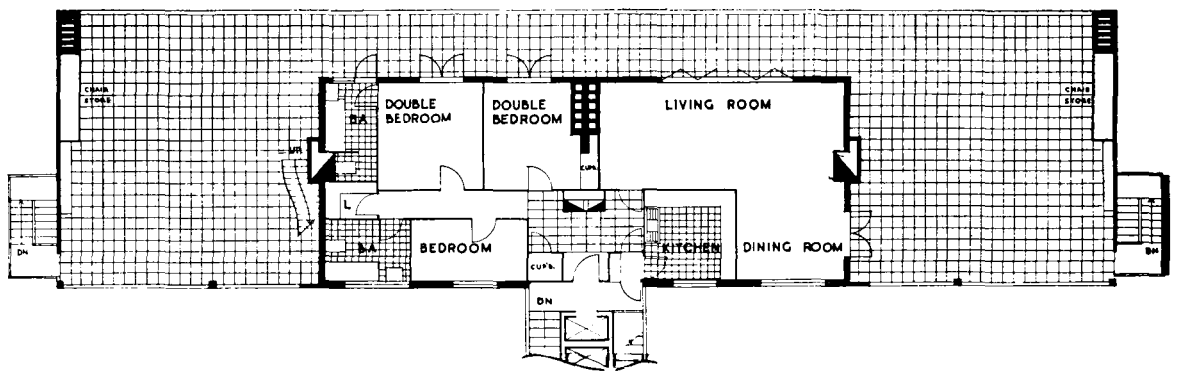

UPPER LEVEL

Seventh and fourth floors: at these levels are concentrated the major rooms of the upper of the two interlocking units—living and dining, kitchen, two (or three) bedrooms, etc.

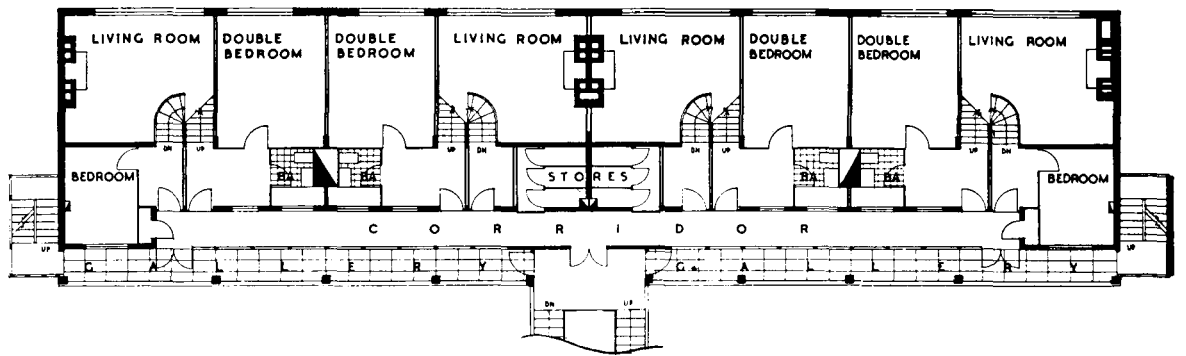

MIDDLE LEVEL

Sixth and third floors: these constitute the entrance or access levels to each series of interlocking units and are the points at which passenger elevator stops. It should be noted, however, that the service elevator stops at every floor, and stairs at either end provide similar service access to end units.

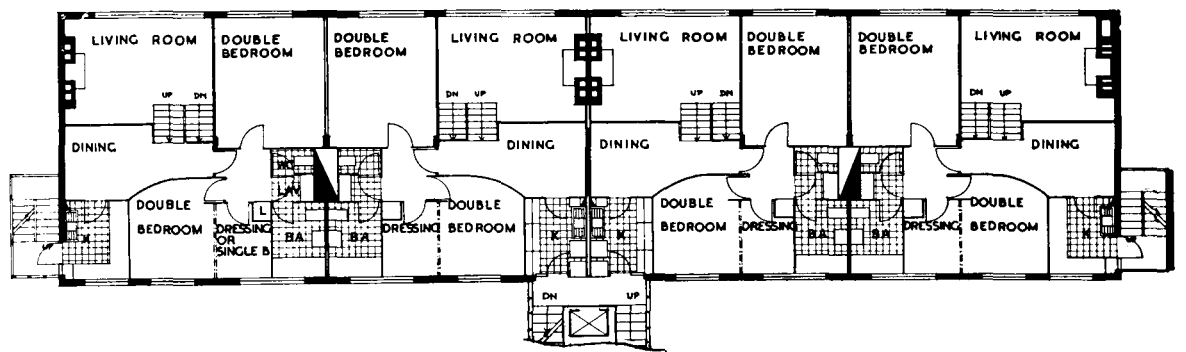

LOWER LEVEL

Fifth and second floors: at these levels are concentrated the main rooms of the lower of the interlocking units—thus repeating with minor changes the plan of the seventh and fourth floors. The 2½-room unit in front of the elevators (bottom, right) is repeated at each floor.

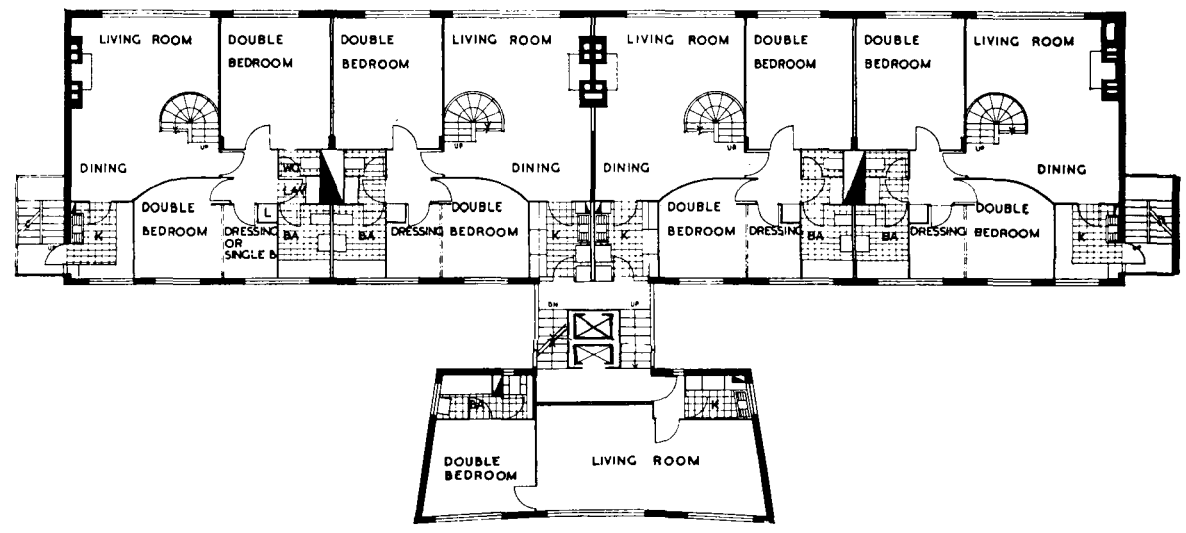

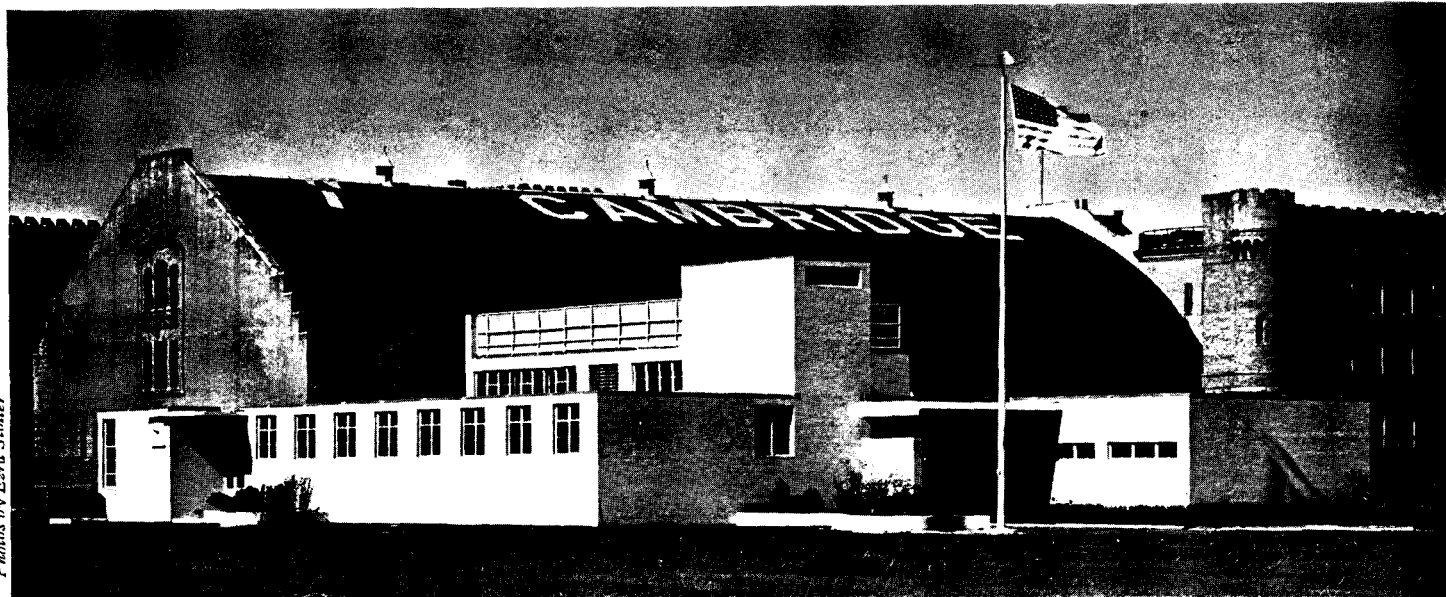
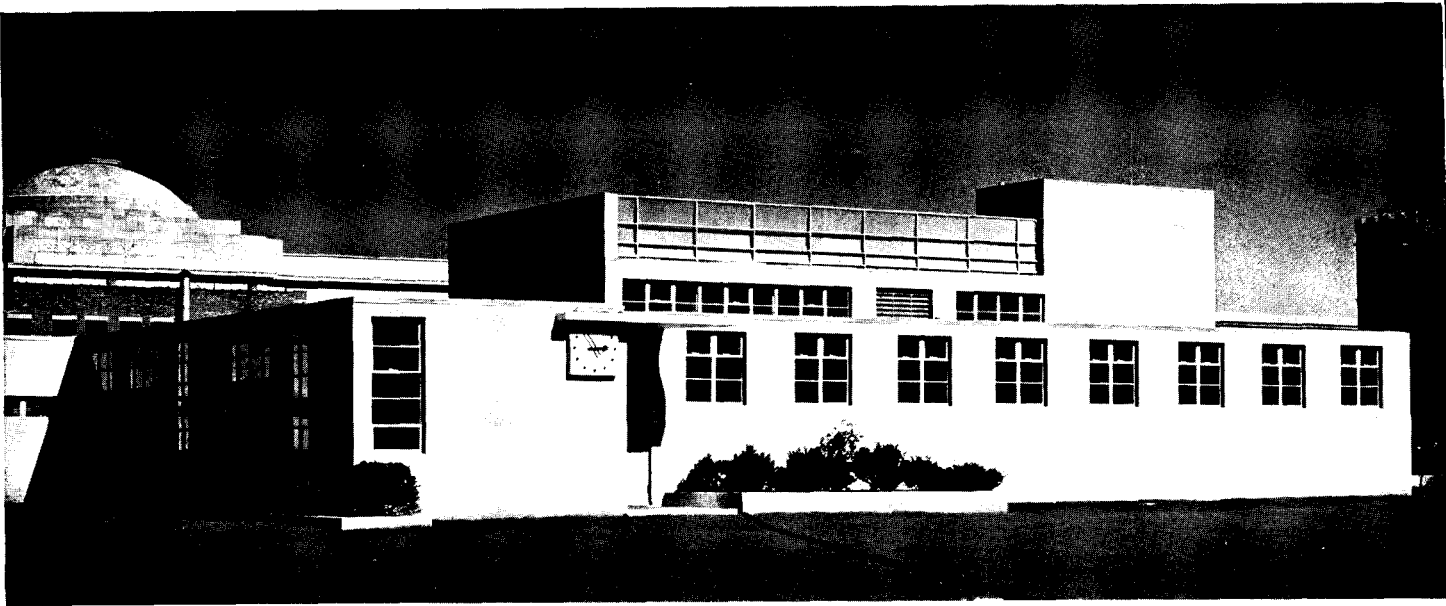

Photos by Ezra Stoller

## EXHAUST DUCTS REMOVE ODORS FROM LOCKERS OF NEW FIELD HOUSE

LAWRENCE B. ANDERSON and HERBERT L. BECKWITH, Architects

A NEW FIELD HOUSE for the Massachusetts Institute of Technology in Cambridge is the first of several buildings which are to make up an athletic center.

All lockers in the main locker room are connected to an exhaust ventilating system, assuring continuous removal of odors and rapid drying of equipment. All services in the building—pipes, ducts, conduits, etc.—are concealed in furred spaces, which also serve as exhaust plenums.

The main locker room accommodates 450 men: plenty of locker space was needed because the Institute's curriculum does not permit the distribution of practice periods throughout the day. The room is divided into 13 alcoves formed by tiers of lockers. Each alcove is lighted by a 5 by 10-ft. window in the east wall, high enough to afford privacy without the use of obscure glass. Although generous in capacity, lockers are low in height, which gives a light and open character to the room. Walls are gray, lockers red.

The main shower and toilet rooms have been placed in the center of the building for easy accessibility from both the visiting-team rooms and the main locker room. This location also makes it possible for the plumbing to be concentrated on either side of a central utility space. The ceiling of this central section has been set higher than ceilings of adjacent areas, and windows in the clerestory wall thus formed give adequate light. This same clerestory wall is also used for the air intake and exhaust of the heating and ventilating system, the fans and heaters being located directly above the utility room. A stairway leads to the roof of this higher level; protected on the north by a brick wall, and equipped with a wood floor, mats, and a movable semicircular colored-canvas wind screen, this area has been designed for sun bathing.

The building is supported on caissons and grade beams and concrete floors are poured on grade. The roof is reinforced-concrete beam-and-slab construction insulated with cork.

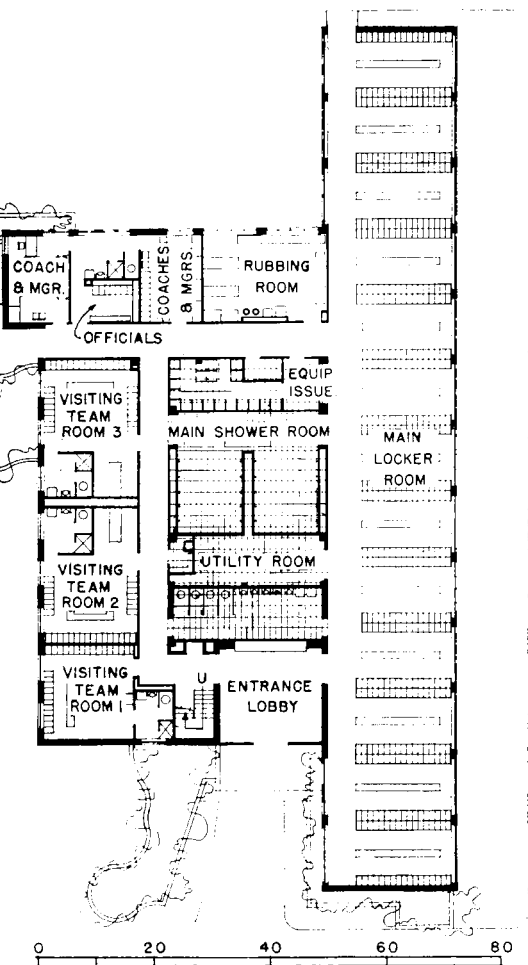

First floor

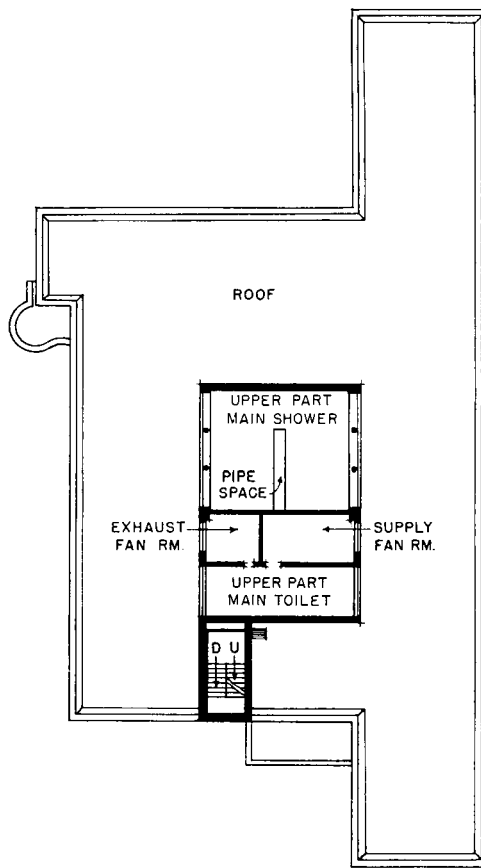

Roof

Sun deck



Entrance on south. Circulation is from the lobby to the right into main locker room, to the left into corridors leading to visiting-team rooms, coaches' offices, officials' room, and track entrance on west.

Photos by Ezra Stoller

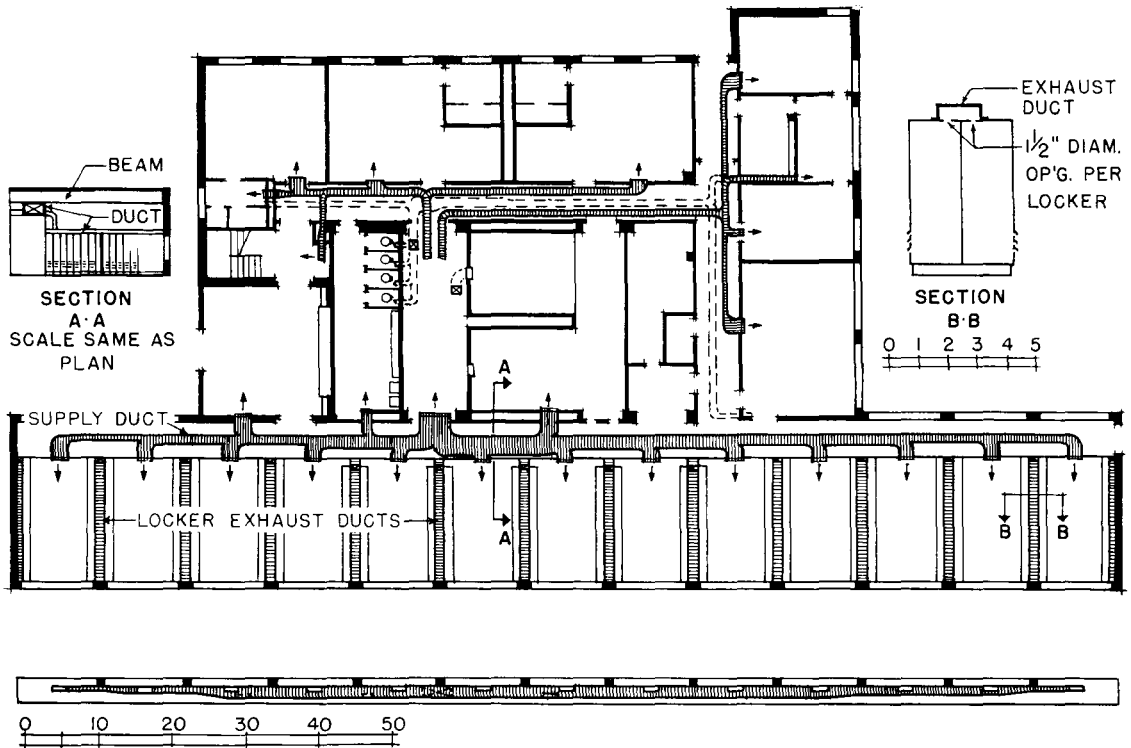
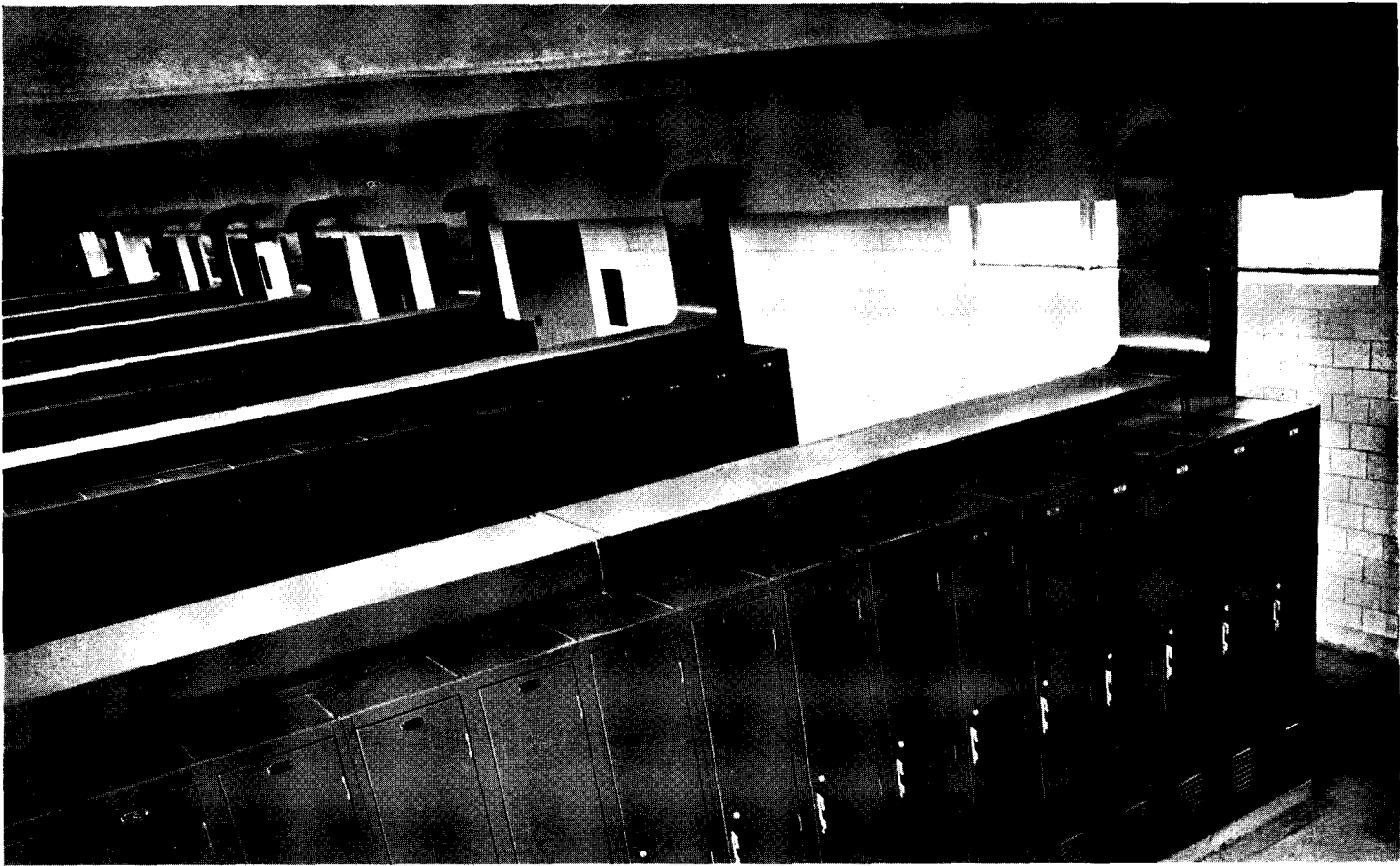

Plan and sections showing ventilating system.





Rubbing room is adjacent to lockers, coaches' and managers' room, and equipment-issuing department.

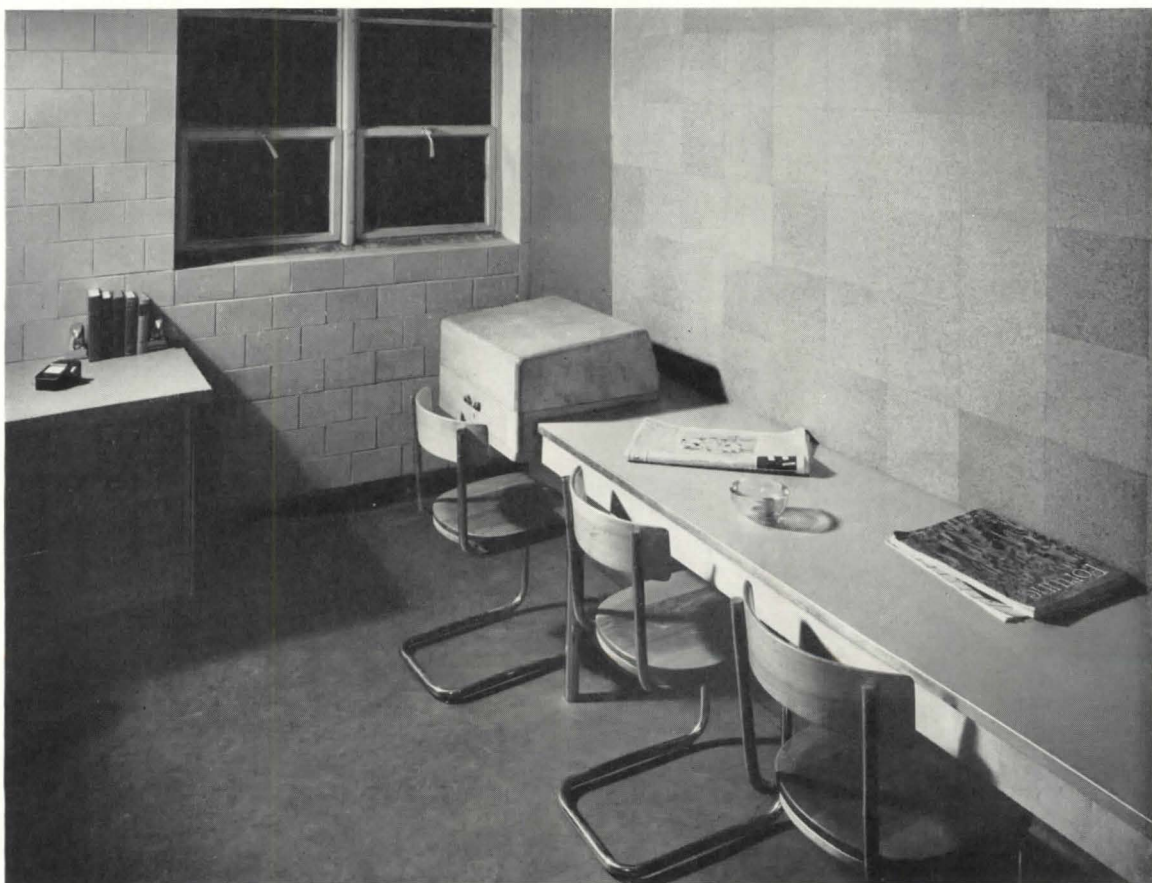

Office of coach and manager off track entrance on west; door adjoining window leads to toilet.

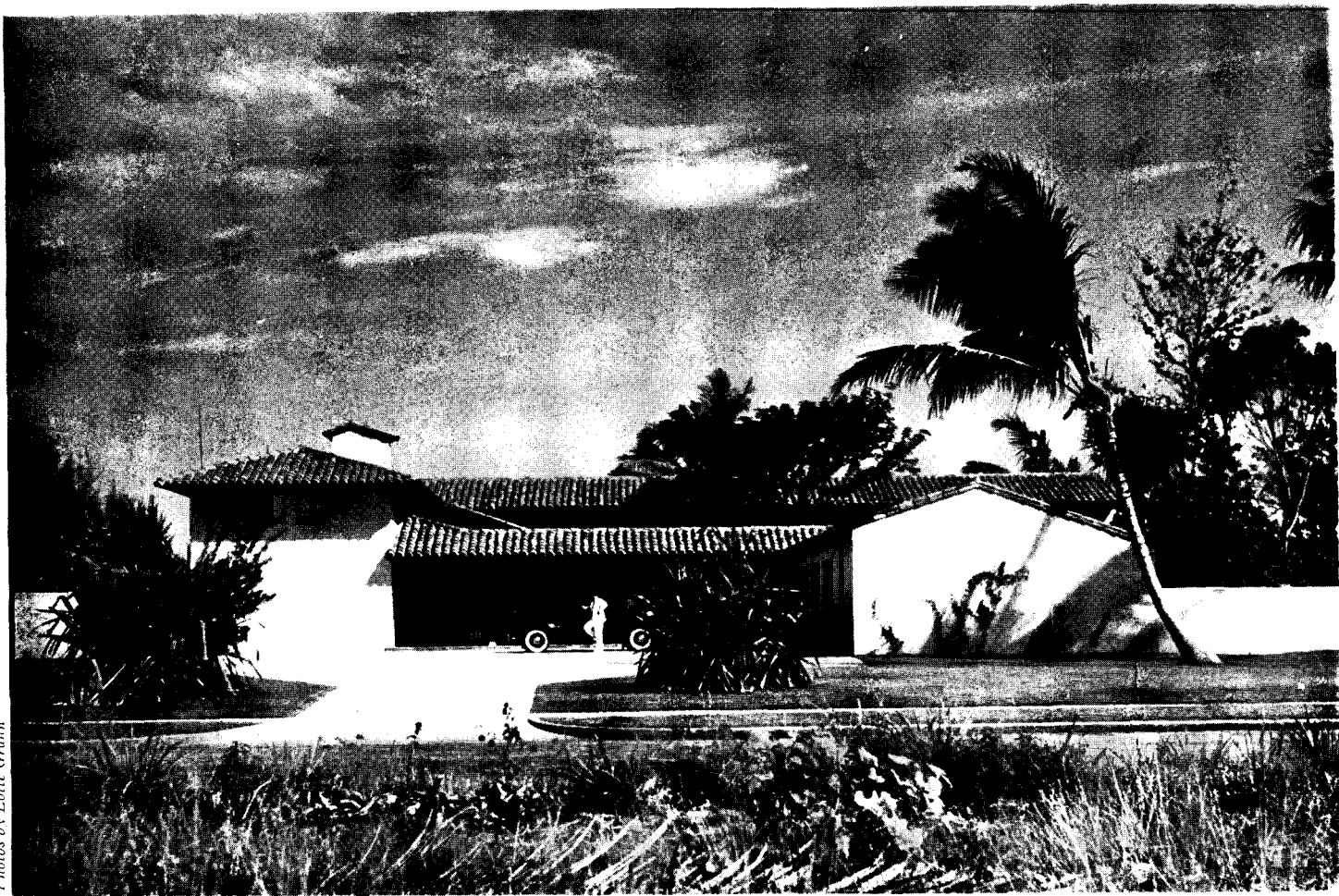

The main entrance is on the east side; a covered porch leads past the patio to living rooms.

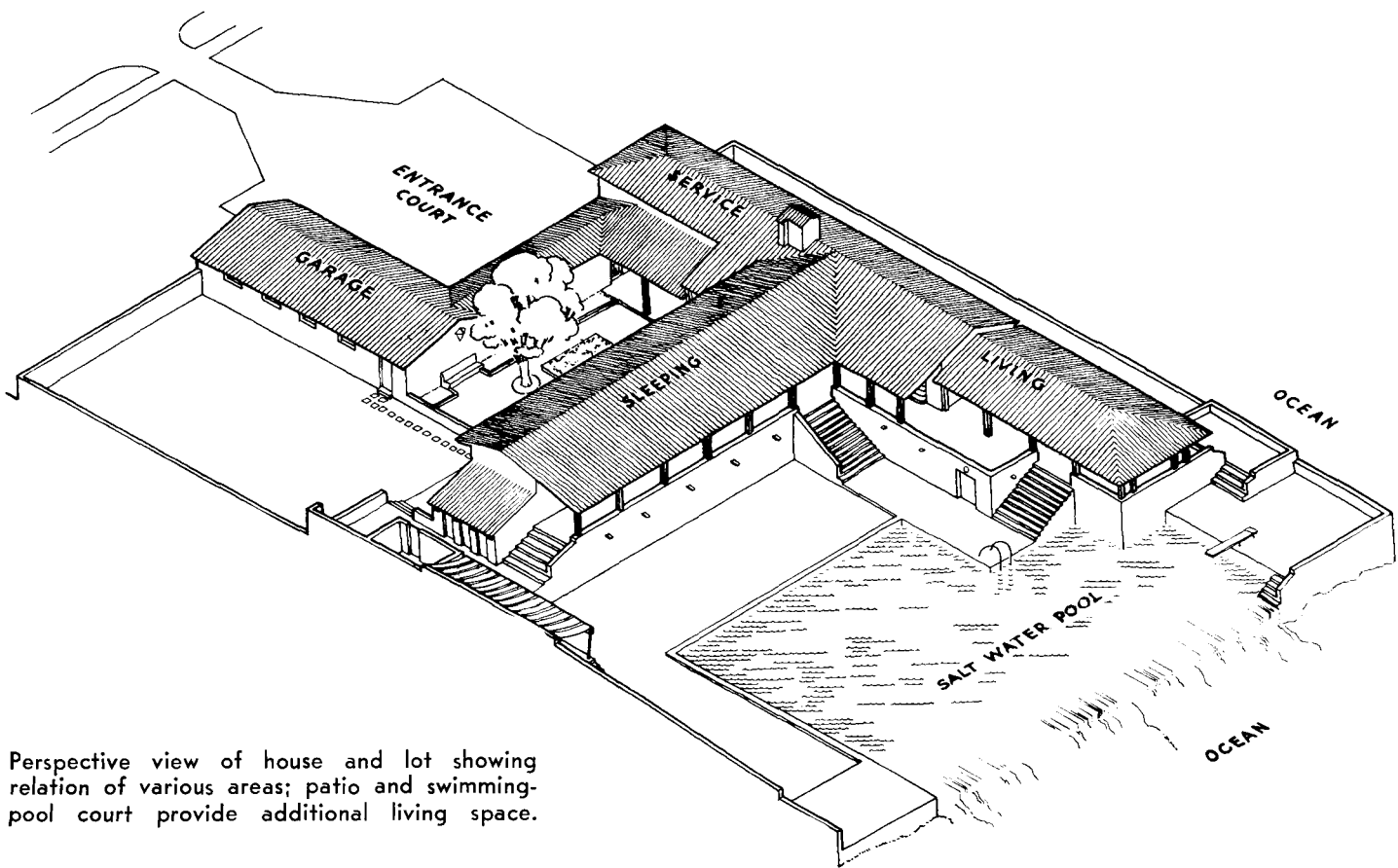

Perspective view of house and lot showing relation of various areas; patio and swimming-pool court provide additional living space.

# HAVANA, CUBA: ALL ROOMS IN THIS HOUSE OPEN ON COURTYARDS

EUGENIO BATISTA, Architect

AQUILES MAZA, Landscape Architect

ERNESTO BATISTA, Engineer

THIS WEEKEND HOUSE for Eutimio Falla in Havana, Cuba, posed for the architect a number of unusual problems, both in planning and construction. Although these are common problems in Cuba, they also occur in parts of this country. The owner's one requirement was that the house should provide a plan which would not force his guests to keep together in a single group all the time. Thus the plan devotes considerable space to living and lounging area, leaving the bedrooms relatively small. The open, rather spread-out plan resulted from the fact that the house is only one room deep—a solution which permits a free flow of air; circulation is almost entirely by open porches. A large living porch opens off the living room. Other porches are ample for lounging at times when the western (seaside) exposure produces uncomfortable heat.

Less easy to solve were the construction problems, for climate and seaside location imposed limitations not only on methods but on materials as well. Proximity to the sea made it inadvisable to use reinforced concrete, since the salt air penetrates to the reinforcing and corrodes it, causing the concrete to flake off. Consequently, the house is constructed of a soft local brick with a stucco facing to protect it. The tropical climate of Cuba (and of nearby places such as Florida) necessitates anti-insect construction and precludes the use of in-

sulation and of hollow wall construction. Instead of furring (which would have made ideal conditions for insect-breeding, since it is inaccessible for periodic cleaning), the architect built in as much furniture as possible along the west wall—kitchen and pantry cabinets, bookcases, radio-phonograph, sofa, and cabinets in the living room, all of which can be cleaned easily. The wide roof overhang keeps the upper part of the wall in shade. The roof is of wood and tile; these materials, readily available in the locality, were not selected from romantic motives but for highly practical reasons. By using these materials, a flat reinforced concrete roof was avoided, and much better insulation against heat was obtained. Marble floors are used throughout, as is the custom in Havana.

Adequate ventilation in a tropical country is further complicated by the need for protection against intrusion. Hence all Central and South American houses use grilles. For a clean sweep of air, casement windows are the most satisfactory, but, since they swing outward, the required grilles must bulge in order to permit them to be completely opened. This, in some cases, is esthetically and practically undesirable, as for instance, on the vestibule porch. Here windows are five feet above floor level and pivot at the center instead of swinging out from the side. All other windows in the house are full-length casements.

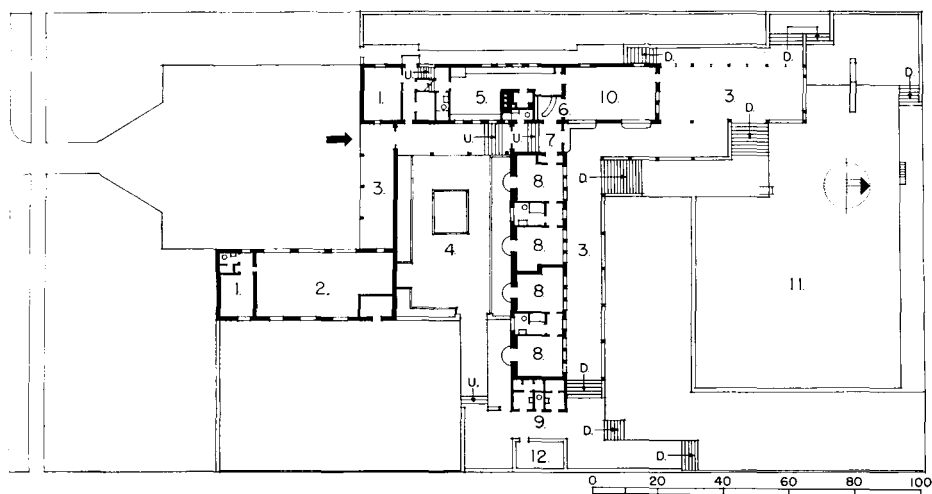

Plan 1. servant's room 2. garage 3. living porch 4. patio 5. kitchen 6. bar 7. vestibule 8. bedroom 9. outside showers 10. living room 11. pool 12. drying yard

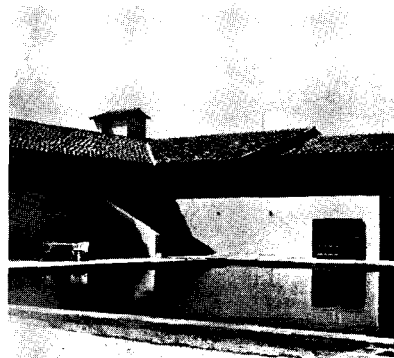

Steps lead from porches to pool . . .



which is protected from sharks . . .



and was built on porous coral rock.



The patio opens off the vestibule.

# HAVANA RESIDENCE



Photos by Lottie Grahn

The indoor living area is kept at a comfortable temperature by the use of built-in furniture instead of furring, and by black marble floors which do not reflect glare. The walls are of white plaster; the ceiling is of natural sabicu. The draperies and upholstery are of fabric in white, green, and brown colors.



Built-in furniture is of bleached and scraped cedar.

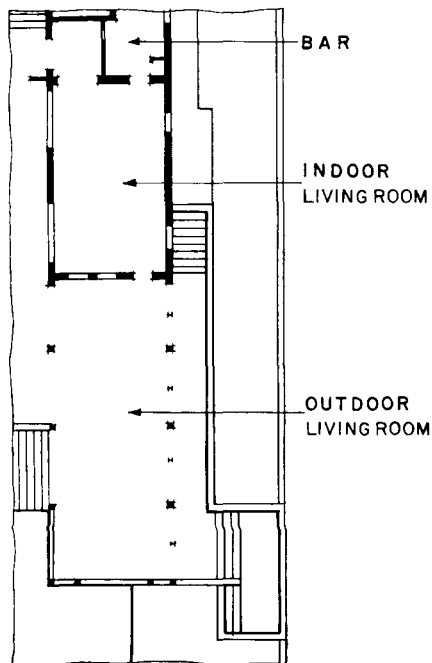

Plan

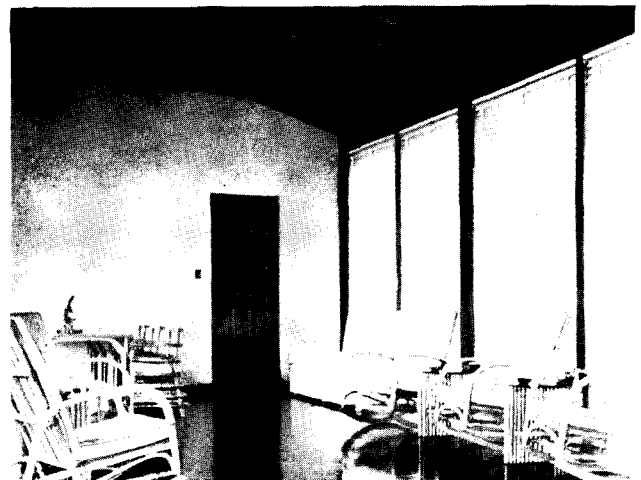

The outdoor living area opens to the sea; Venetian blinds cut down glare. Floors are of red tile.



When the time-delay relay clicks, the doors start to close but reopen at a touch of the sensitive edges of the doors.

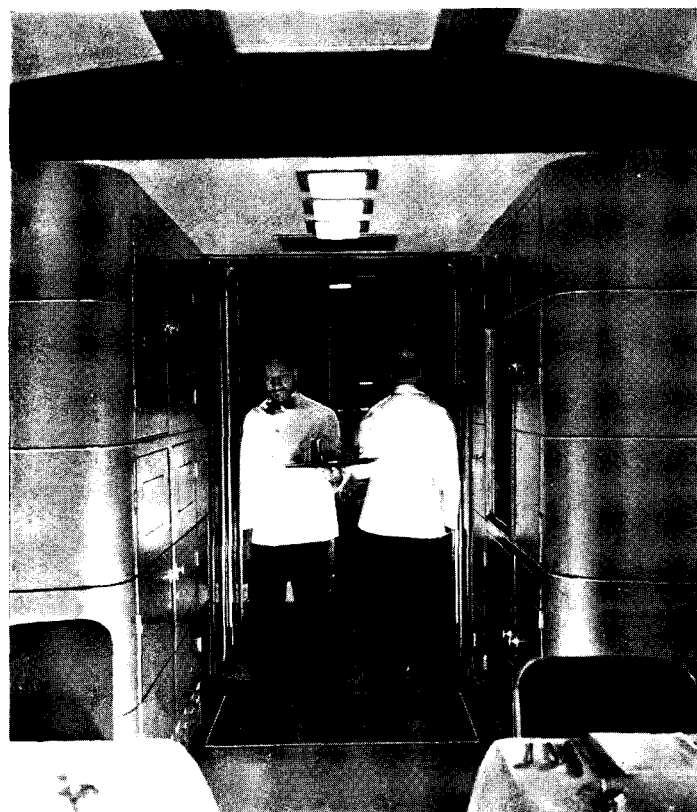

Opened by stepping on an electrically operated treadle, these sliding doors permit two waiters to use passageway together.

## Use of treadle-operated doors on new trains offers hint to building designers

PENNSYLVANIA Railroad engineers, in collaboration with the National Pneumatic Company of New York City, have installed automatic sliding doors between kitchen and diner units in the new "Trail Blazer" and "The Congressional" trains. These double doors—which minimize drafts, noise, odors, and make air conditioning more effective—are air operated and electrically controlled by rubber treadle mats set into car floors on either side of the doors. When a mat is stepped upon, an electric circuit operates magnet valves which actuate the two door engines (air) and open both sliding doors. When all weight is removed from the treadle mat the doors automatically close.

Because the treadle mat on the kitchen side of the doors cannot extend over the movable floor plate of the connecting section between cars, there is a space of several feet between mat and doors. In order to prevent the doors from closing during the brief time required to pass them after leaving the treadle, a time-delay relay holds the doors open for a predetermined period after the passenger or waiter has stepped off the treadle mat.

If anyone should obstruct the closing doors, electrical contacts mounted inside the flexible rubber nosing which extends from top to bottom of abutting edges of both doors will reverse them at a slight touch. When the doors reopen completely they will reverse automatically and close if unobstructed. Otherwise, they will continue the cycle of reopening and closing up to the obstruction until it is removed.

At each side of the doorway on the kitchen side of the doors, there are push buttons which will reopen one door independently of the treadle-mat control. These are for the convenience of anyone who may have stopped after passing the mat and thus allowed the doors to close.

The treadle mat on the diner side extends practically to the doors, obviating need for time-delay device and push buttons. It is long enough to start the doors opening well before the average passenger gets close enough to attempt to open them himself. For hurrying waiters there is a floor switch located a short distance ahead of the treadle mat and to one side of the car. When a waiter steps on this on the way to the kitchen, the doors start opening immediately and will be completely open by the time he reaches them.

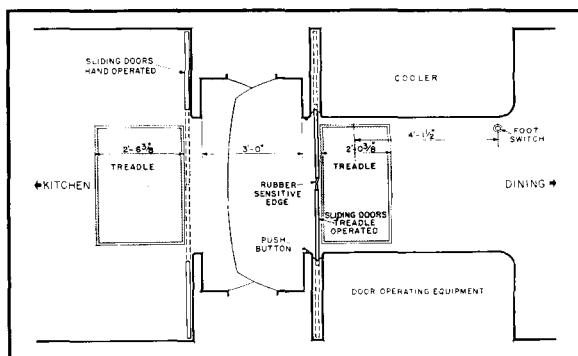

Diagrammatic plan, showing location of important elements.

## NEW EQUIPMENT



### Fluorescent lamps decrease heat of hospital operating-room illumination

DEMAND FOR maximum concentration of light on the working planes and minimum glare from reflection led to the development and installation by the Polarizing Instrument Company of New York City of this new light unit in the Caledonian

Hospital in Brooklyn, New York. For high concentration, each tube had to be mounted in its own reflector. For greater efficiency and because of the low wattage, the reflector had to be of such contour as to pick up the light from the back of the tube and send it forward. This was accomplished through the use of the Hy-Par reflector, the section of which might be described as being part of a parabola with a reversed, concave apex. The glare reflected from a smooth type reflector is too intense for this use and may cause retinosis. Reflectors were therefore made of Hy-Par shape with a diffusing surface of minute panoramic mirrors, thus breaking up the surface brightness and improving light quality for the surgeon.

The five housings of the unit each contain four 20-watt tubes, total 400 watts. The central housing is mounted parallel to the table, the four others radiate at a slight angle down from the four sides of the central square. With the center five feet above the table, a light-meter showed a reading of 350 foot-candles concentrated on the working surface from this canopy of light.

Two problems in this installation were the elimination of the usual stroboscopic effect of gaseous tube lamps and proper color value rendition with special reference to red. The pulsations were smoothed out by using the General Electric Tulamp choke. Tests for the second characteristic were first made with a complete set of the new white tubes, but the red of blood appeared too red. With all daylight tubes, the blood appeared too pale. The final arrangement consisted of four whites in the center and sixteen daylights in the other four housings.

The resulting unit gave a high intensity of light in an even distribution and without annoying surface brightness. The light comes to the operating table from all directions, thus not only eliminating shadows but also providing depth and penetration. The hospital's chief surgeon reports that the doctor feels more relaxed during an operation under this unit than under incandescent light. It is suggested that this may be due to the great reduction of radiant heat and the improved light quality.



Otto Haael, courtesy "Life Magazine"

This polaroid window, installed in the diners of the Pennsylvania's new "Trail Blazer", holds obvious implications for the building field. Besides eliminating glare when "open", it eliminates necessity for shades or curtains when "closed". Operated by a small handle (as shown in three views above), changes in the angle of polaroid glazing regulate the amount and character of light from blackout to clear vision without dazzling reflections. Thus a complete range of visibility is achieved in one element.

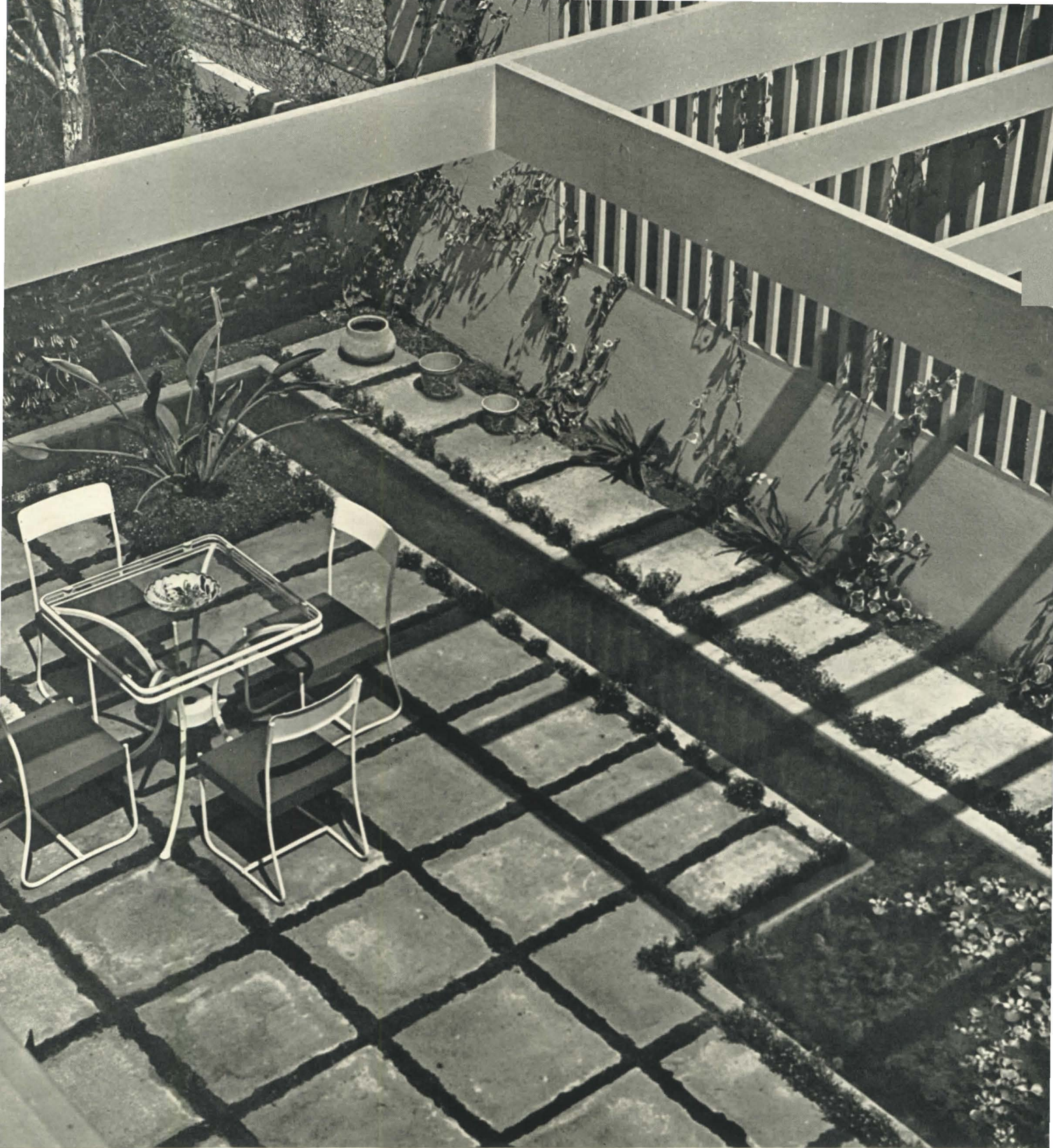

Redwood pergola overhead and grille at side contribute to the character of this outdoor dining unit. J. R. Davidson, Designer

**NEW DWELLING UNITS  
INFORMAL**

**DINING**

*Drawings by Torben Muller*

# NEW DWELLING UNITS: INFORMAL DINING



George Hare

## 1. BLEY and LYMAN

### Architects

DESIGNED FOR flexibility, this dining unit features an adjustable (and also entirely removable) breakfast bar. Since the bar is located strategically between kitchen and playroom, it offers many advantages in serving and comfort while eating. There is ample room for moving the chairs, and the usual crowded feeling of a nook is completely avoided. In addition, the table can be used for other purposes between meals, as there is a shielded light fixture immediately above; or it can be entirely removed, enlarging the play area. The adjustability of the table presents obvious advantages. For very small children the table is lowered to a convenient height for eating or studying. When at its maximum height, its level is equal to that of the kitchen counter, thus extending kitchen working space.

#### Materials and equipment

Woodwork: breakfast bar, solid white pine counter, 1 in. thick; cupboards, white pine; stain, Silver Gray acid, Pratt & Lambert. Floor: black and cream marbled linoleum, Armstrong Cork Co. Adjustable shelf supports: Knap & Vogt.

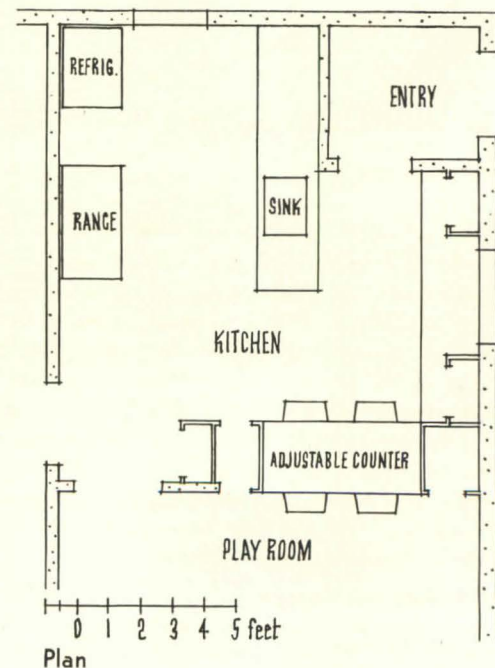





L. H. HARRIS

## 2. WAHL SNYDER and WILLARD LOWRY Architects

THIS INFORMAL UNIT is well related to the living area it supplements, and to kitchen. Used variously as breakfast room, pantry, bar, and game room, it offers a permanent but flexible arrangement for informal eating. Walls on three sides of the actual dining unit are entirely glazed, except for necessary supports, so as to take advantage of the good outlook. Furnishings are simple, in keeping with the purpose of the room. Woodwork is walnut in a wheat-colored finish; tables have black tops, and chairs are upholstered in white leather with black leather piping. The built-in sofa is covered in red cotton fabric with black piping. Draperies are white with figures in green, coral, yellow, and black. The floor is white marbled linoleum with a red border.

### Materials and equipment

Floor: linoleum. Armstrong Cork Products Co. Venetian blinds: Bostwick-Goodell Co. Windows: Vento Steel Products Co. Hardware: Schlage.

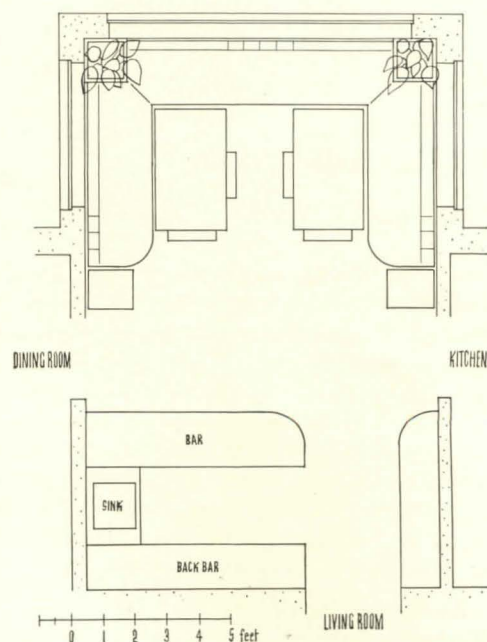

Plan

# NEW DWELLING UNITS: INFORMAL DINING

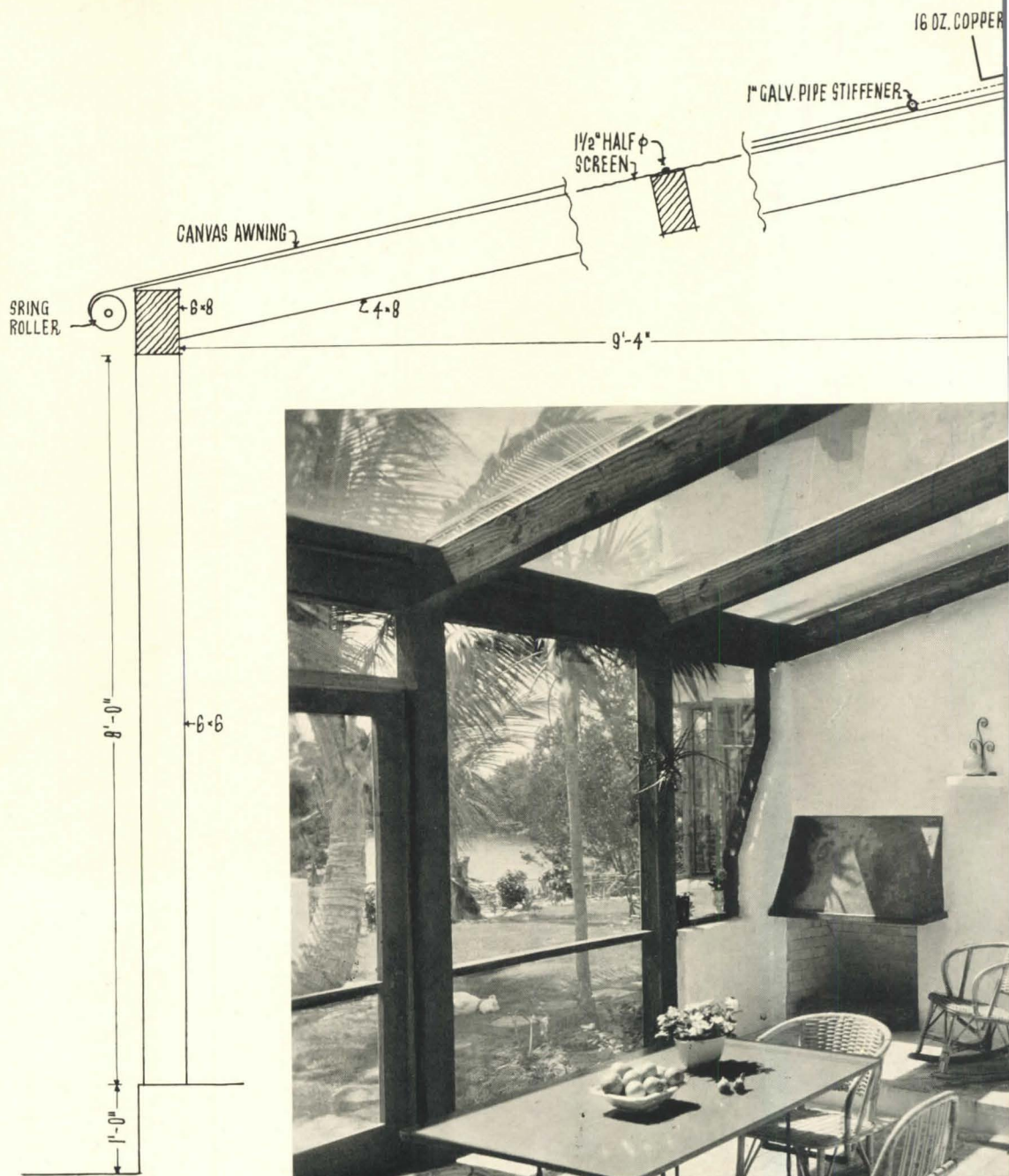

Ernest Graham

**3. ROBERT M. LITTLE**  
Architect

PRIMARILY A UNIT for informal dining, this semienclosed porch is adaptable to other activities as well. Its signal feature is a screened-over roof which admits the morning sun; if less sun is desired or if the weather is inclement, an easily

operated water- and mildew-proofed awning can be lowered. Rafters are of yellow pine, covered with No. 18 bronze mesh screening which prevents insect intrusion. The awning has an interior control, and rolls up to any desired

point. An outdoor fireplace, adjacent to the living-room fireplace, provides for open-hearth cooking. The location of the porch on the plan permits major rooms to take full advantage of the prevailing breeze and of a good outlook.

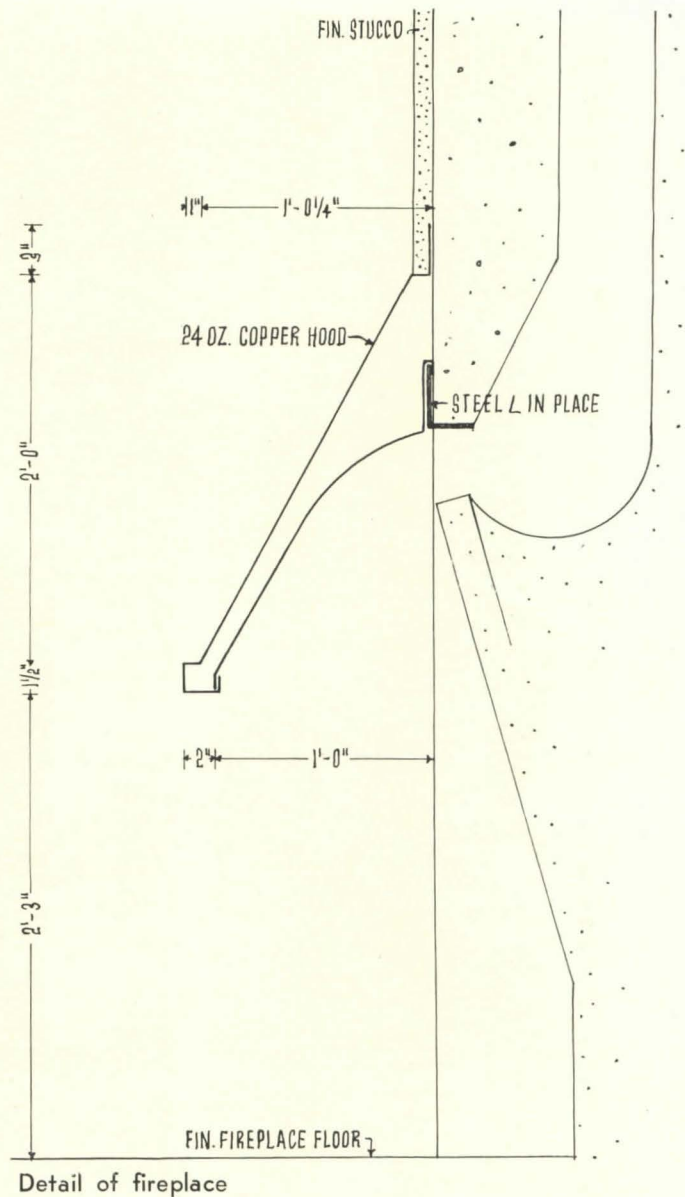
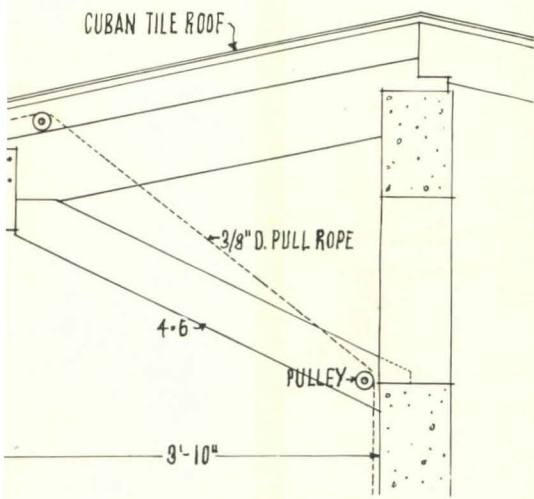

**Materials and equipment**

Floors: Keystone Art Corp. Awning; The Astrup Co. Waterproofing: integral, Crystex of Florida, Inc.; decorative, Somay Mfg. Co. Fireplace: 9-in. Bessemer fire brick; flue, 8½ by 17 in. Furniture: table, Royal Palm Furniture Co.; chairs, Reed Furniture Co.

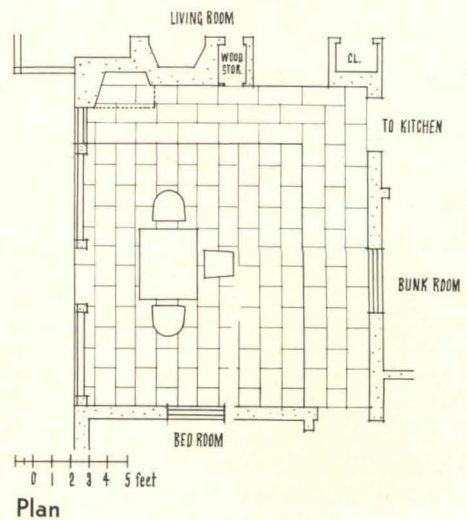

## NEW DWELLING UNITS: INFORMAL DINING



Handwerkliches Lichtbild—Julius Scherb

### 4. ALFRED ADLER and M. J. SCHMID

#### Architects

SITUATED IN an alcove off one end of the living room and one step above is this informal dining room. All seats are built-in, but the table is movable; the same wood is used for both, and recalls the ceiling and trim. The floor is of linoleum, waxed. The window is placed on the side which has the best orientation for light and view. Although the kitchen adjoins the dining unit, an opening in their common wall further facilitates serving. A built-in cabinet in the other wall is for storage of glassware, special china, etc. The light fixture is adjustable in height above table.

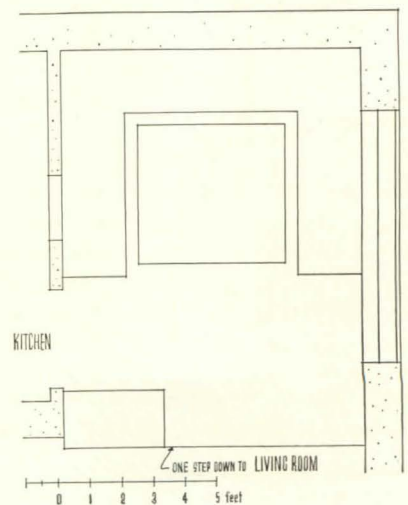

Plan



## 5. MICHAEL GOODMAN

Architect

THE TANDEM ARRANGEMENT of these two informal dining units (one of which is used in summer only) was dictated by the fact that they were added, at different times, to a house located on a very narrow hill crest. The completely enclosed dining unit is the more recent of the two. An integral part of the kitchen, it is separated from the living room by a low hollow tile wall. There are separate fireplaces in kitchen and summer dining "shed"; the latter has a barbecue rack against the tile wind-break. Two walls of the shed are entirely given over to French windows, arranged in pairs between posts, to take advantage of a very fine view.

### Materials and equipment

Walls: hollow reinforced tile, natural finish, waxed, Gladding McBean Co. Floor: quarry tile 6 by 6 in. laid on concrete slab. Fireplace: clinker brick; damper, Miller. Windows: sash, Detroit Steel Co.; glass, Libbey-Owens-Ford.

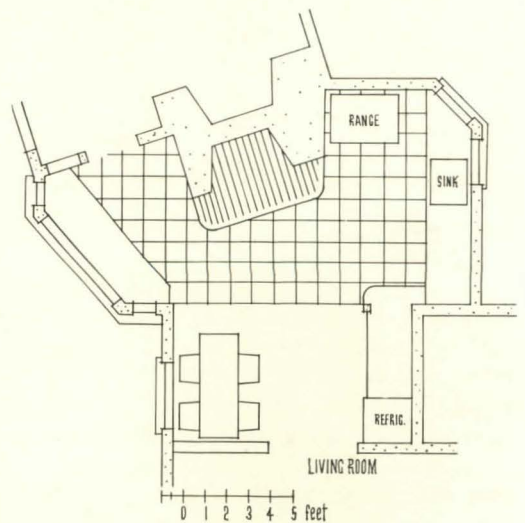

Plan

## NEW DWELLING UNITS: INFORMAL DINING

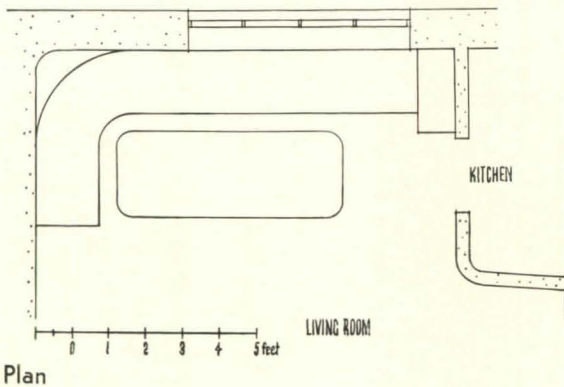

### 6. JAMES F. EPPENSTEIN Architect

ACTUALLY A PART of the living room, this informal dining unit has a built-in bench which serves as seating for two sides of the table. This arrangement gives increased living space when the unit is not being used for dining, and avoids a sense of enclosure during meals. The kitchen is conveniently located for serving.



### 7. ERLE WEBSTER and ADRIAN WILSON Architects

FOR VERY INFORMAL dining this unit provides a convenient place for quick meals for child or servant. The table top pulls out of the built-in cabinet and is supported on ball-bearing extension slides. Drawers, as well as cabinet doors, open through to the adjoining dining room.

#### Materials and equipment

Floor: linoleum, "Driftwood," jaspe field, blue border, Armstrong Cork Products Co. Paint: walls and ceiling, soft yellow; cabinets, lighter yellow; Columbia Varnish Co. Slide: ball bearing, Grant Pulley and Hardware Co.

# DESIGN TRENDS

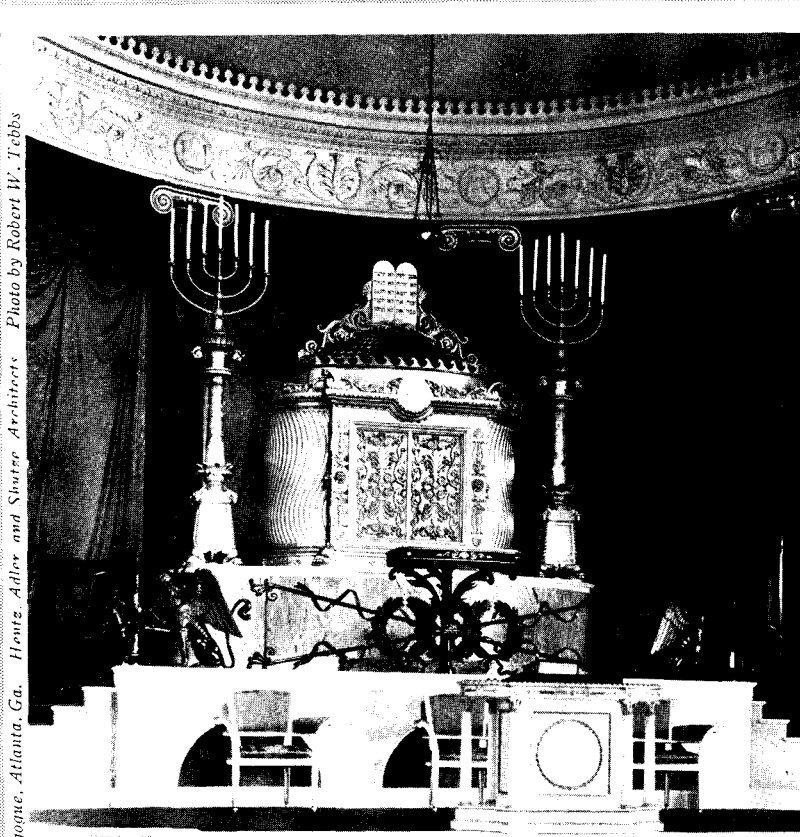

*Synagogue, Atlanta, Ga. Hentz, Adler and Shuter Architects Photo by Robert W. Tibbs*

**Synagogue Design in America . . . pp. 58-65**

ARCHITECTURAL  
RECORD

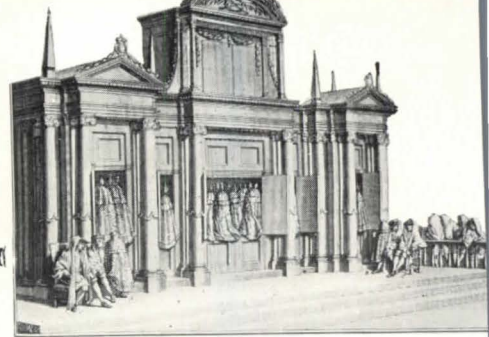
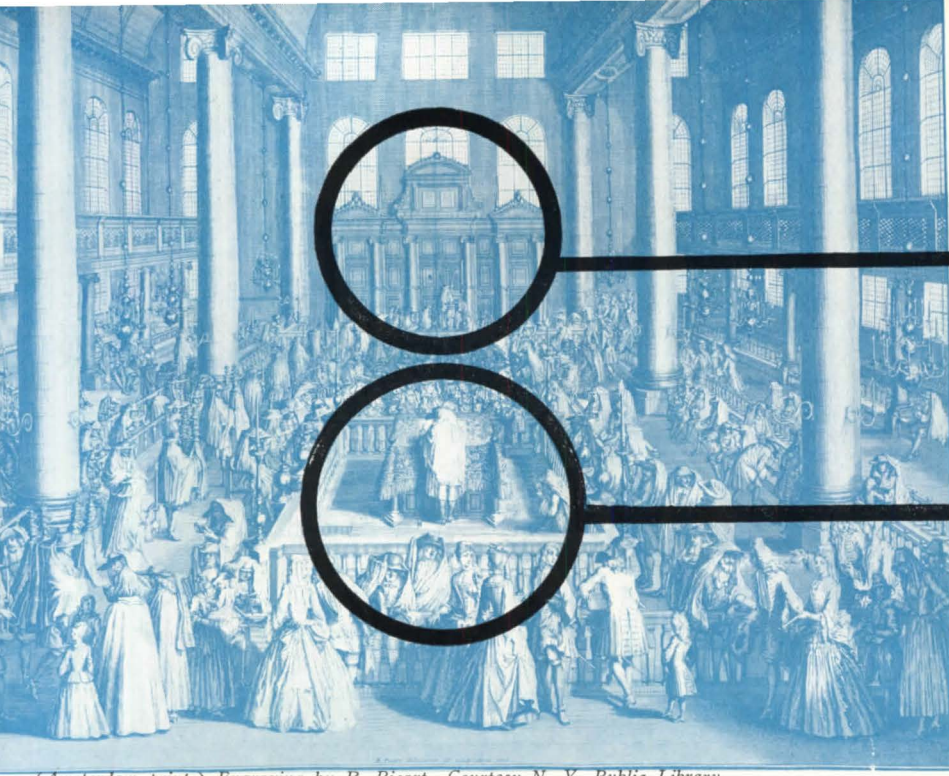

THE ARK. Inside are the scrolls of the cloaked in rich fabrics and surmounted silver crowns. Two scrolls have already been removed from the Ark for the procession to

(Amsterdam prints) Engraving by R. Picart—Courtesy N. Y. Public Library.

1675. Portuguese Synagogue, Amsterdam, Holland.

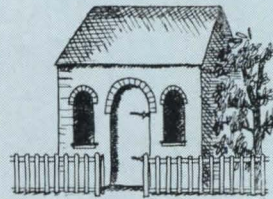

1729. Mill Street Synagogue, New Amsterdam.

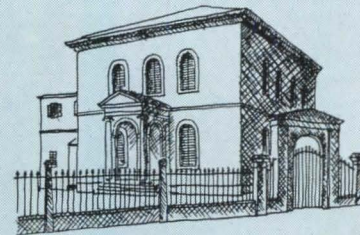

1762. Touro Synagogue, Newport, R.

The first American synagogues follow closely the Amsterdam pattern, but on a much smaller scale, proportionate to the size and wealth of the congregation . . .

The exterior of these early examples resembles a private dwelling

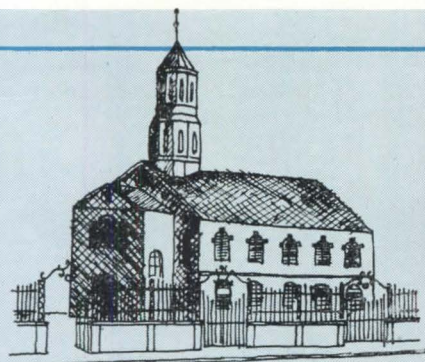

1794. Beth Elohim, Charleston, S. C.

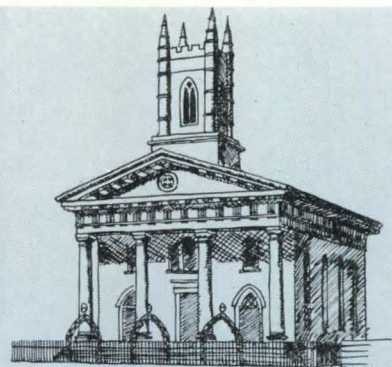
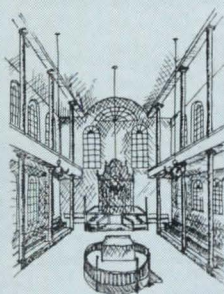

1826. Elm Street Synagogue, N. Y.

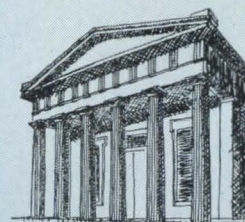

1840. New Beth El, Charleston, S. C.

By the end of the 18th century, synagogues began to assume a churchlike character, . . . first in the exterior . . .

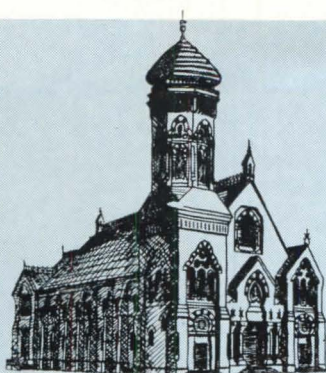

1868. Temple Emanu-El, N. Y. 1870. Temple Rodef Shalom, Philadelphia

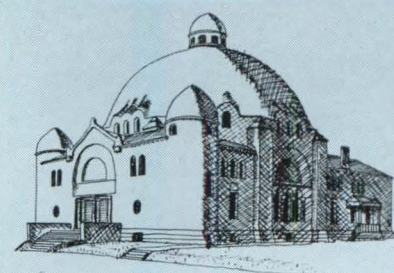
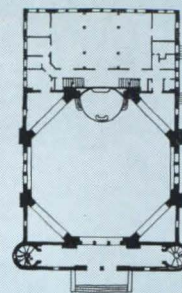

1890. Temple Beth Zion, Buffalo, N. Y.

By the second half of 1900, Moorish decorative forms impose themselves on synagogues, the general design remaining that of a church.

At the turn of the century, the central dome takes place as a typical feature of American synagogue design



# AMERICAN SYNAGOGUE DESIGN: 1729 TO 1939

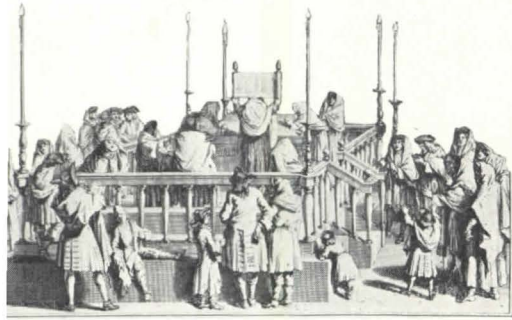

THE ALMEMAR. Reader exposes the Law to people before beginning to read. Mantle and crown, removed from scroll, are at left.

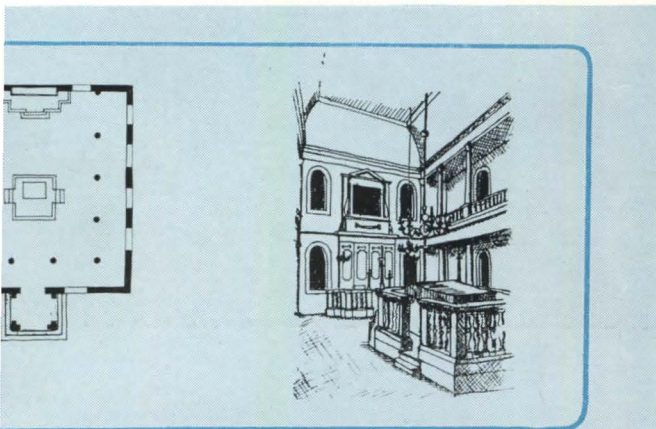

does not suggest refinement of interior.

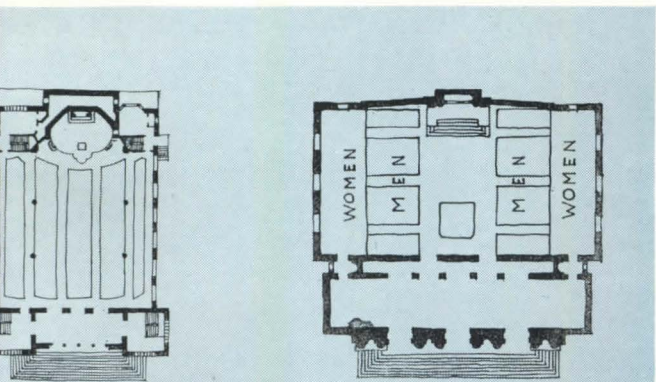

Temple Beth-El, N. Y. 1909. Mikveh Israel, Philadelphia

also in plan . . . . except in orthodox congregations.

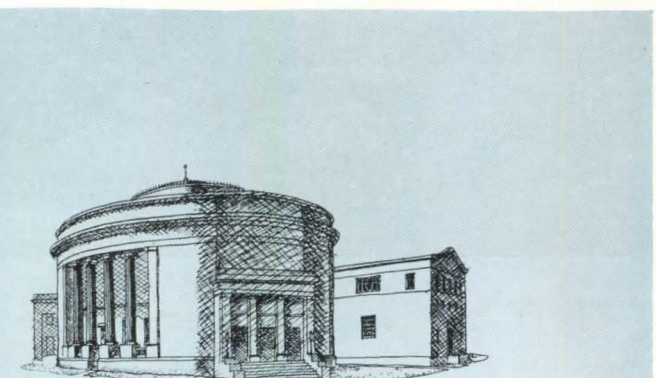

1924. B'nai Abraham Synagogue, Newark, N. J.

. . . and, with variations, is still characteristic of today's trend in American synagogue design.

In the comparatively short period since the first synagogue was built in America (1729), Jewish life has undergone its greatest changes since the collapse of the Palestinian state and the destruction of the Temple of Jerusalem (135 A.D.). Synagogue design in America reflects these changes—magnified by the swift tempo of American history. In this study—last of a series of three on American church design—Architectural Record has asked Mr. Bruno Funaro of New York City to survey the subject.

UNTIL THE 18TH CENTURY the Jews had been living throughout the world as an exiled minority with its own religion. The national character of the Jewish faith, which made it difficult to conceive of a separation of religion and nationality, and the religious intolerance of most countries, which to a certain degree closed the rights of full citizenship to members of a different faith, made impossible the assimilation of Jews with other peoples. Thus the Jews had been living in a condition of seclusion which—from time to time and from country to country—varied from that of a respected and flourishing colony to that of a persecuted minority.

During this time the synagogue had lost the monumental character of a temple elevated to the glory of God by a free people, as was the Temple of Jerusalem. It had become instead the house of prayer, the cultural and social center—sometimes even the place of refuge and defense—of a people in exile, still mourning the destruction of their temple and the loss of their country. The ritual had lost the spectacular oriental pageantry of Palestinian times, the abstract concept of divinity becoming more and more accentuated.

This state of things still existed when the first Jews settled in America. Although in this country there was far more religious freedom and respect for human rights than in most of Europe, the Jews still lived in a certain seclusion. Indicative of this is the fact that because of the opposition of the local government, the Jewish community in New Amsterdam (now New York City) had to wait 70 years before building its synagogue, which was probably the first ever erected in this country (see Mill Street Synagogue, p. 58).

This state of seclusion, and the consequent lack of necessity for such exterior elements as bell towers and prayer towers, was architecturally reflected in an almost complete disregard for external appearance. The architectural program had actually been reduced to compliance with a few special rules in the interior layout, thus almost reducing it to a problem of "interior decorating." The building on the whole was subject only to the practical considerations of the country in which it was built: and if the synagogue sometimes achieved architectural value, this was largely due to the high cultural level of a given country.

Only two elements in the synagogue can be considered as fixed, because to them is assigned the very essence of the Jewish religion—the preservation of the Law. One is the *Ark* or *Tabernacle*, the receptacle in which are kept the holy scrolls of the Law; the other is the reading desk or *Almemar*, the pulpit from which the Law is read and commented upon. Rules concerning their requirements as to form and location have always been dictated by contemporary circumstances

Acknowledgment is made to the following for valuable assistance: Dr. David de Sola Pool, Rabbi of Congregation Shearith Israel, New York City; Dr. Jacob S. Raisin, Rabbi of Congregation Beth Elohim, Charleston; William G. Tachau, Architect; Charleston Chamber of Commerce; Bettman Archive; Jewish Theological Seminary; New York Historical Society.

SYNAGOGUE DESIGN

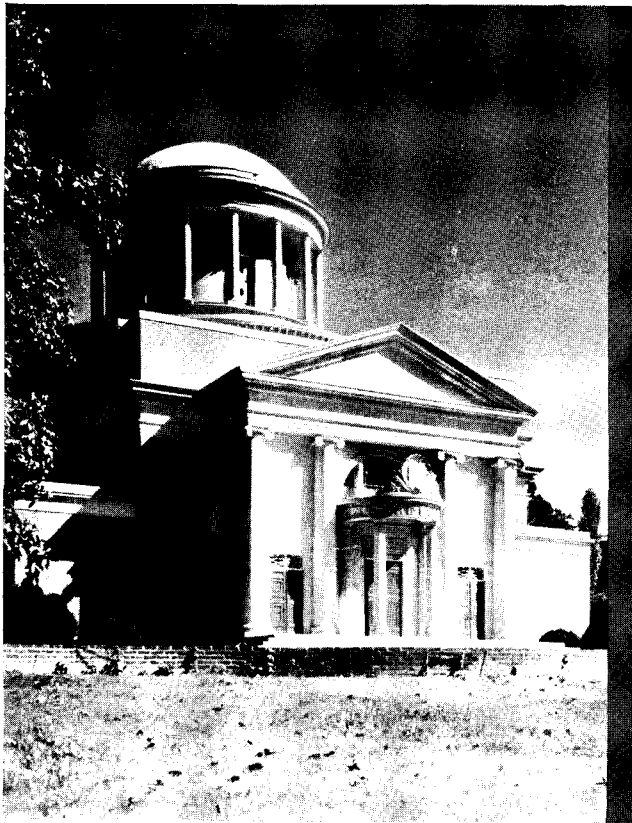

Robert W. Tebbis

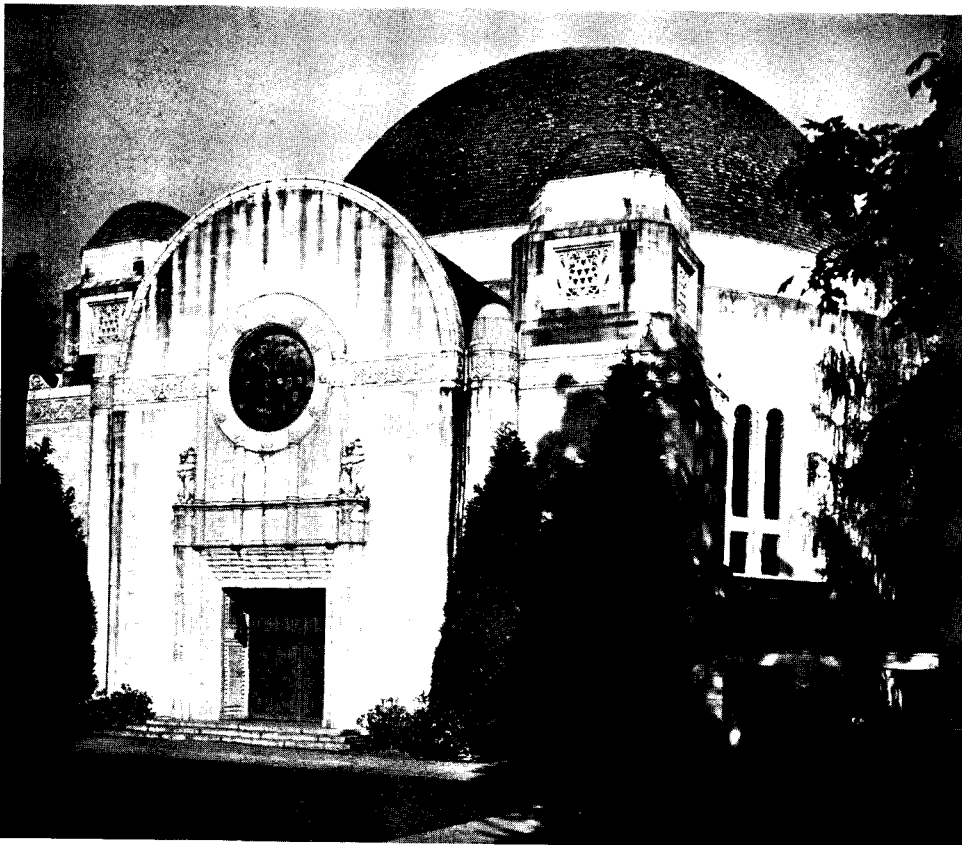
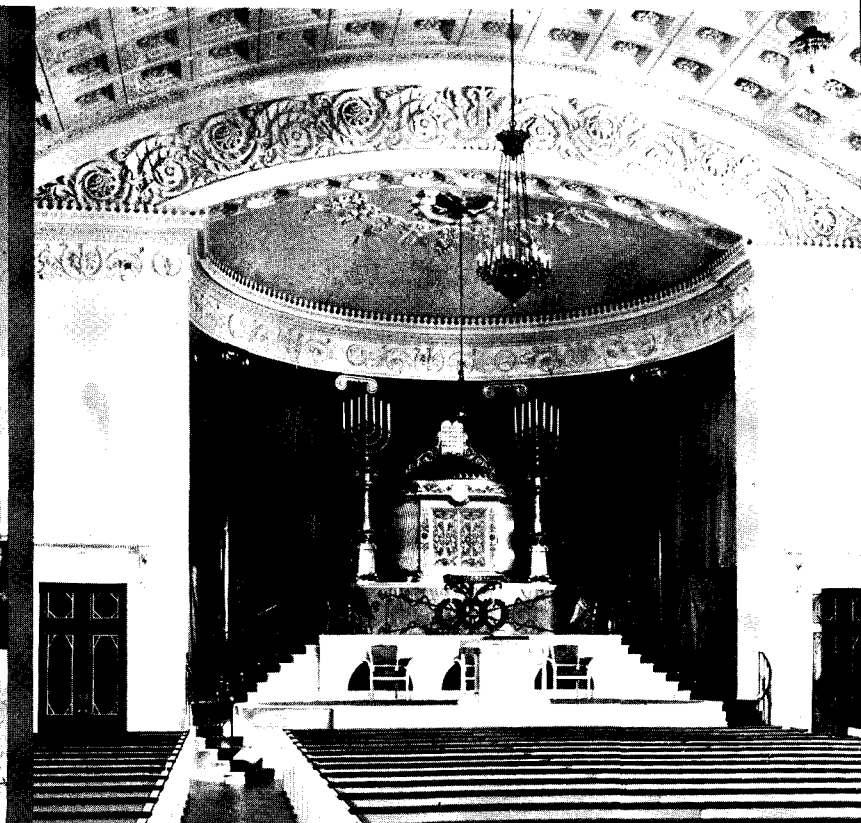

W. Boychuk

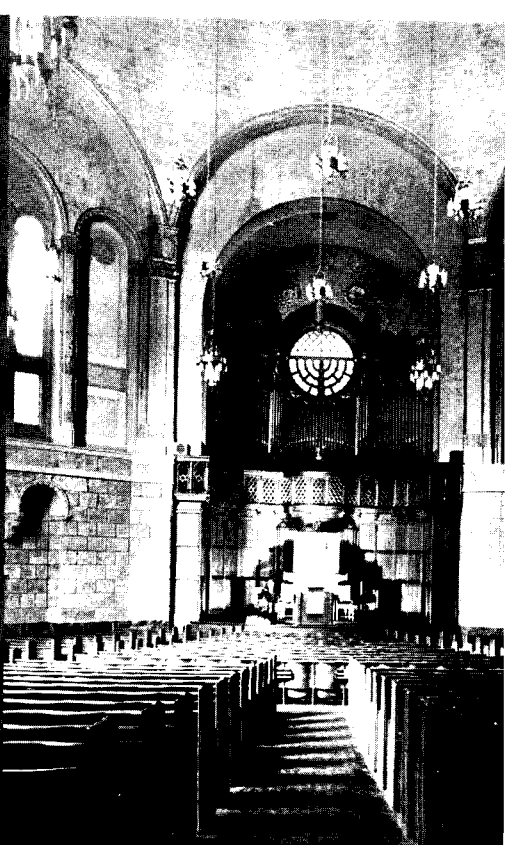

without being deeply rooted in the Law. They are always subject to change, without offending in any way the spirit of the religion.

The Portuguese Synagogue of Amsterdam, Holland (1675) was perhaps the outstanding example of the period and served as a prototype for the first American synagogues. The plan of these early American synagogues consisted of a rectangular room against whose east wall stood the Ark, with a gallery supported by columns along the other three walls. The Ark was a large wooden cabinet, lined with fine fabrics, which was placed on a platform elevated by a few steps from the floor. Inside this were the scrolls of the Law, rolled around wooden sticks, covered by mantles, and surmounted with silver crowns. In front of the Ark burned the "Eternal Lamp." The Almemar was a large desk, covered with a richly embroidered cloth, which stood on a platform either in the middle of the room or near the west wall. There were only a few benches, usually placed along the south and north walls; these were reserved for men, while women were relegated to the gallery and were often shielded by screens. The central portion of the room was left open, so that the scrolls of the Law could be brought in procession from the Ark to the Almemar. Also, when the Law was read from the desk. The whole of the building was simple and severe; no figurative arts were exhibited, and no music was allowed, thus stressing the sorrow of the exile. The synagogue proper was enclosed in a courtyard—following the example of the Temple of Jerusalem—and connected with rooms for study and houses for the head of the congregation and for the caretaker. In the yard stood a frame for the *Succah*, a temporary tent erected once a year for ceremonial banquets.

Toward the end of the 18th century—after the first synagogues had already been built in America—the great social changes which followed in the wake of the industrial revolution put an end to discrimination against Jews throughout the civilized world, and placed their religion in a position of parity with other creeds. As a consequence, there were great changes in the attitude of Jewry toward the people among whom they lived, and toward their own tradition; both were reflected in the synagogue design of the period. The first change was from seclusion to proud activity in public life and was immediately reflected in the exterior appearance of the building. The second change—slower and deeper—was from strict orthodox ritual to reformed movements; this changed the interior layout of the building. These two influences, one on the exterior treatment, the other on the interior layout, acted for a long time separately, due to the architectural practice of the period which considered them as almost two independent problems. For analytical purposes, it is therefore easier to consider them separately.

#### Change of exterior aspect.

The synagogue had now no more necessity for remaining obscure and secluded; rather it began to stress its position of parity among the other religious buildings of the community. In the new American towns, where the houses of many religious sects, which in Europe had been enemies, were already standing as good neighbors, the tendency towards making the exterior aspect of the synagogue that of a church is easy to understand. So the "Jewish church," as the synagogue was often called at that time, suitably adds its steeple to the skyline of American towns in the first half of the 19th century. Typical of the tendency to make the exterior aspect of a synagogue similar to that of a church is the fact that

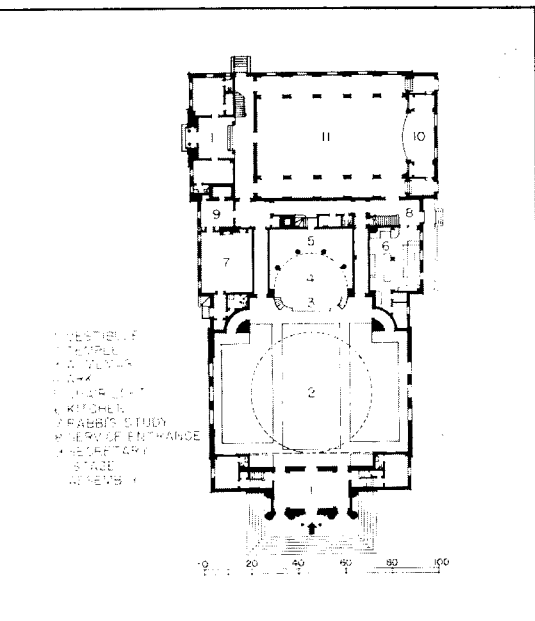

synagogue in Atlanta, Ga. Hentz, Adler, and Putze, Architects. The Georgian character of the architecture stresses the "Americanness" of the congregation, but the profusion of symbolic detail, directly drawn from the Bible, emphasizes the foundations of the Jewish religion.

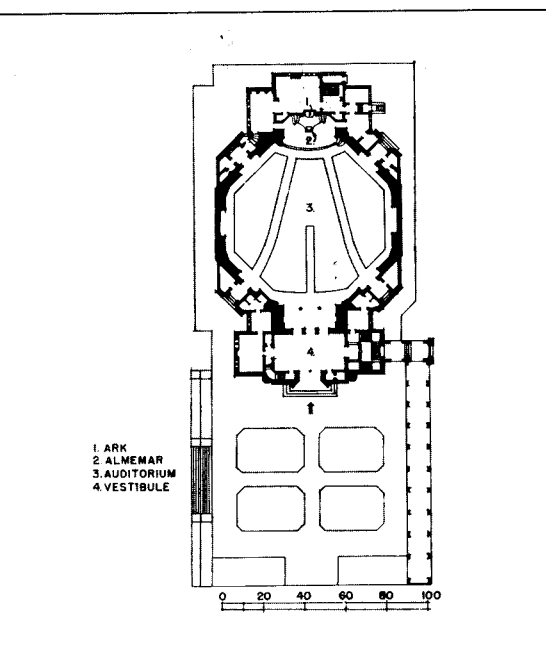

Temple Beth Israel, Portland, Ore. Morris H. Whitehouse and Herman Brookman, Associated Architects; Bennes and Herzog, Consulting Architects. Similarity to Beth Zion Temple in Buffalo (p. 58) indicates the widely accepted recent trend toward use of a domed structure on polygonal plan.

SYNAGOGUE DESIGN



Gabriel M. Galin



DeMott Studios



many congregations did not at all object to using existing church buildings as synagogues. To such a group belong the fine Elm Street Synagogue in New York City (p. 58), and the Touro Synagogue of Hartford, Conn., both transformed from Presbyterian churches.

It was toward 1850, when architectural eclecticism had reached a state of pseudo-logicality and each building had to have its own appropriate style, that the first touches of oriental decoration appeared on synagogues to distinguish them from Christian churches. The connection between Judaism and Moorish architecture requires a good deal of specious syllogism: the Jews came from the Orient; Moorish architecture came from the Orient; therefore, Moorish architecture is Jewish. There are of course the old examples of Moorish synagogues built in Spain during the Middle Ages; but there are also the Gothic synagogues of Germany, the classic of Italy, and the Chinese of China. The real reason for the mid-century obsession with oriental forms lies more in literature than in history. Oriental forms were in the beginning confined to decorative elements, often diluted with Gothic or Romanic forms. Although this "oriental adventure" has always been opposed by the more conservative congregations, it had a vogue for some time; then it declined in popularity, so that today the synagogue with minarets and Moorsque detail is definitely outmoded. It was only toward the end of the century that the new planning requirements of the synagogue, having developed independently in the interior layout, made themselves felt in the whole structure of the building. Only then did synagogue design begin to rely on well-defined architectural forms, instead of on purely decorative styles. (See interior, San Francisco synagogue, p. 62.)

#### The evolution of the plan

At the beginning of the 19th century, the Jews were faced by a multiplicity of changes in respect to their own tradition. The center of interest for the new generation shifted from its community to the country of which it was a part. The separation of nationality and religion—which heretofore had been inconceivable—now became natural through a new concept of nationality. (See Atlanta synagogue, p. 60.) As a logical consequence of the fact that Jews were now considered full citizens of a nation, the attitude of the exile ceased to exist. A number of congregations began to feel the necessity for eliminating many of those traditions which had been acquired through long adaptation to exile. The Reformist Movement, which was founded in Hamburg, Germany, in 1817, has since developed widely in America, where it was introduced by the Reformed Society of Israelites of Charleston, S. C., in 1824. The Reformists reverse the process which began with the destruction of the Temple of Jerusalem and the concomitant exile. Again the synagogue becomes a monument elevated to the glory of God in the new country as the Temple of Jerusalem was in Palestine. (Hence the name Temple given to reformed synagogues.)

The organ and instrumental music, which had already been used in Jerusalem but were later dropped as a sign of mourning, have been reinstated in Jewish services, notwithstanding the great opposition of orthodox congregations, which saw in it only an imitation of Christian form. (See Portland synagogue, p. 62.) New provisions were made to bring the temple up to date by means of the following expedients: adoption, in services, of the spoken language of the country, inclusion of women in the main seating area, simplification and shortening of services, more emphasis on the moral guidance of the community through sermons. These reforms are

1. ARK
2. ALMEMAR
3. AUDITORIUM
4. VESTIBULE (GALLERY OVER)
5. ENTRANCE COURT
6. ASSEMBLY ROOM
7. STAGE
8. CLASSROOMS

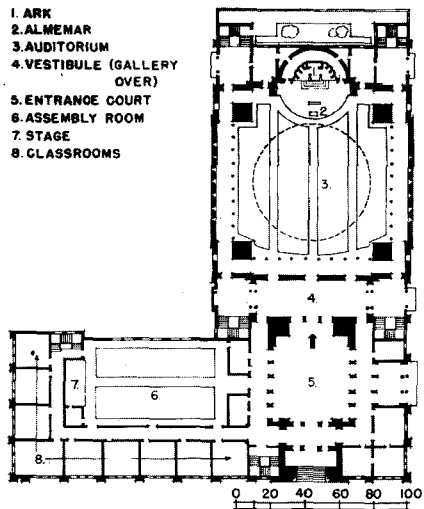

Temple Emanu-El, San Francisco, Cal. Bakewell and  
own, Sylvan Schnaittacher, Architects. Distinctly  
Byzantine in origin, this dome, realized with modern  
structural means, retains an architectural quality  
which transcends both time and style. The essen-  
tially structural quality of the dome contrasts with  
cal "Mission" forms applied to the exterior.

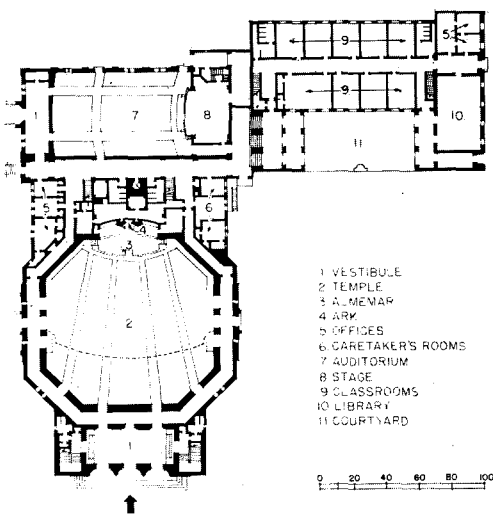

Temple B'nai B'rith, Los Angeles, Calif. A. M.  
delman, Architect; Allison and Allison, Consulting  
Architects. Similar to above in structural solution,  
but approached from the standpoint of style. Intro-  
duction of figurative art in the frieze over wains-  
coting and above organ grille indicates trend away  
from traditional rules of severity and abstraction.

Photos by Walter Steinhard

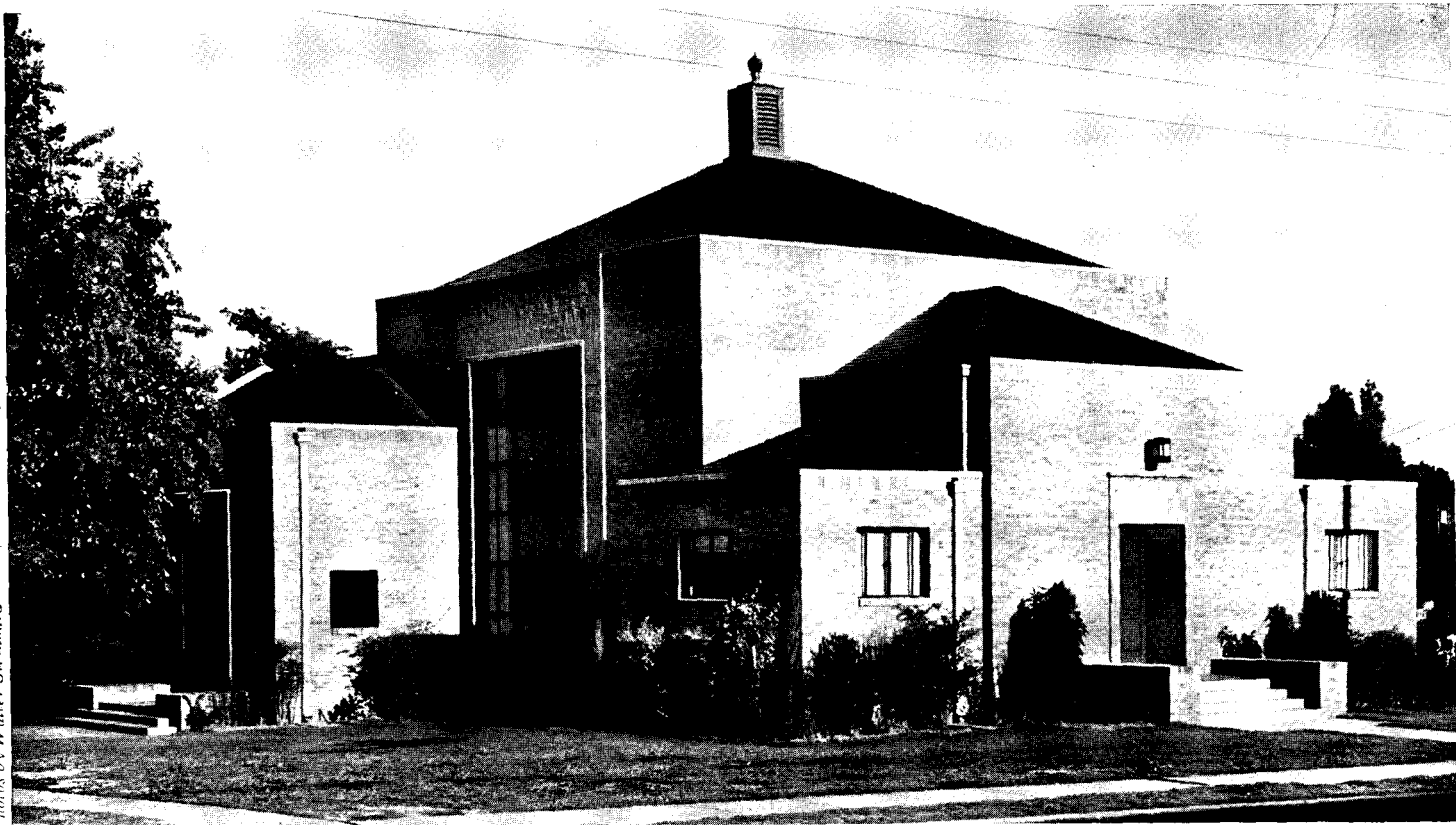

Temple Beth-El, Tyler, Tex. Howard R. Meyer, Architect; Charles J. Pate, Associate Architect. Here the need for flexibility of seating space has been the motivating principle behind the plan solution. Sliding doors between temple and social hall make possible the expansion of the temple in case of an unusually large audience. The main feature of the building is its character of intimacy suited to a small congregation, achieved with the refined application of simple unpretentious materials, such as plywood and wall-board. The design as a whole is straightforward and free from any stylistic influence. The unnecessary prominence of the rabbi's entrance in the exterior design, prompted by site conditions, might have been more successfully solved.

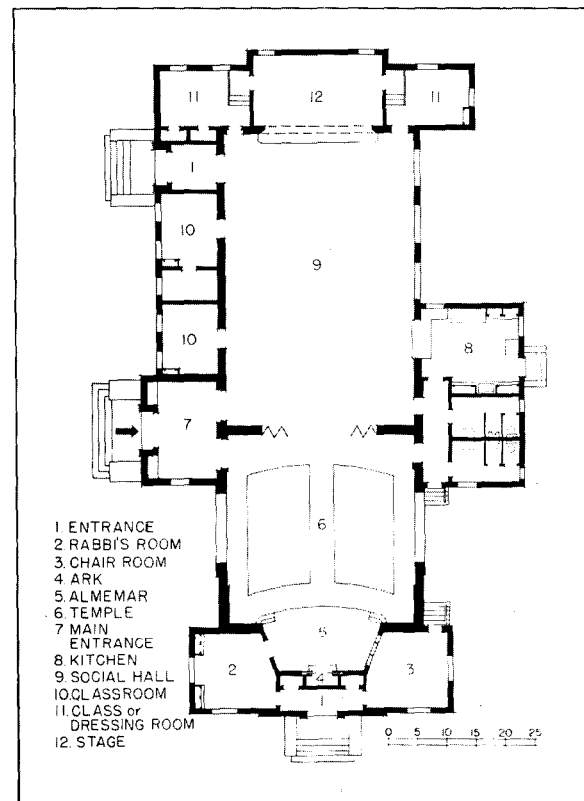

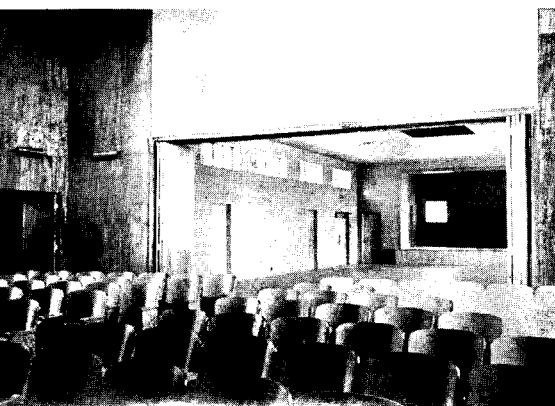
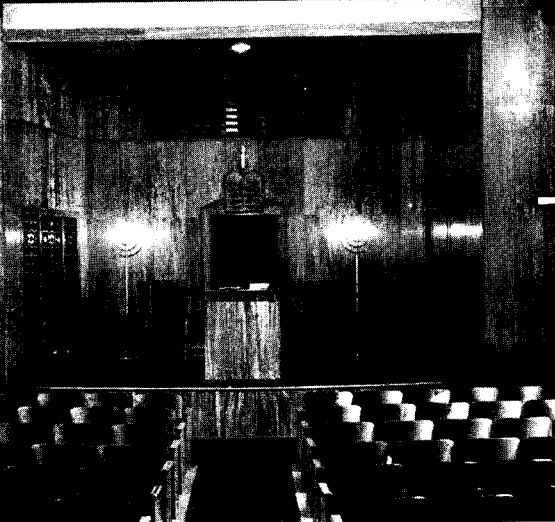

not confined to the most progressive congregations; they are, in fact, becoming the general rule. The design of synagogues had necessarily to assume new aspects as a consequence of reforms. This evolution has been facilitated in America also by the fact that the quick growth and metamorphosis of cities made necessary the frequent demolition and reconstruction of buildings on different sites.

The architectural program, freed of its traditional restrictions and combined with new technical requirements, thus presents itself in an entirely new light. With the increase in size of congregations, fixed seats become necessary. Consequently, since the audience can no longer shift its position according to the focus of the service at a given point, Ark and Almemar must assume a position satisfactory to every member of a mixed audience. The organ and the choir become integral parts of the plan. The plan of the building as a whole reflects the place of the synagogue in the life of its congregation: its flexibility allows for a varying audience—small at week-day services, medium-sized on Saturdays, and very large for the holidays of the church and for the increasing social and community affairs sponsored by the congregation itself. Rooms are provided either in the synagogue building proper, or in an adjoining building, for classes in Hebrew studies, and for the same kind of extra-religious activities (gymnastic, dramatic, social, etc.) that are a part of the program of other religious organizations (see pp. 64-65). For the architect, the problem is that of designing a building which is not a masonic or concert hall, but is essentially the spiritual center of American Jewry.

In the beginning the solution to these new requirements was much influenced by the typical present-day church layout. From its former place of isolation, the Almemar has been shifted to the platform in front of the Ark. A separate pulpit for the sermon proper is often built and fixed pews are provided. The elongated basilical plan, the first type adopted, did not prove satisfactory because a good many seats were too far from the Almemar; in addition, it did not give the synagogue a character of its own.

The necessity for a more compact plan finally brought about the adoption of a centrally placed auditorium with curved rows of seats centered on the axis of the united Ark and Almemar, which are located against the east wall. The natural roof for such a structure is the dome—not an original idea, but a practical solution of a real problem. One of the first examples of this type of building is the Temple Beth Zion (p. 58) in Buffalo, N. Y., built in 1890. Here a technically sound layout is realized in a well-defined architectural form, which in its compactness, suitably represents the non-evangelical character of the Jewish religion. Of the recently constructed synagogues in this country, the most successful have followed this type, but have improved on it with such new structural devices as cantilevered galleries. Although site and other particularities often affect the solution, the general acceptance of this type proves its satisfactoriness.

The adoption of the central plan with the dome did not stem from a preoccupation with fashion and style (as was the case in the oriental decoration of the last century); indeed it is so independent of fashion that when stylistic decoration is superimposed, the structural essence of the architecture remains the most important feature of the building. A still further step in synagogue design will be attained when the architect realizes this fact and is able to use as his means of expression the essential architectural qualities of the structure and free himself entirely of literary and stylistic decoration.

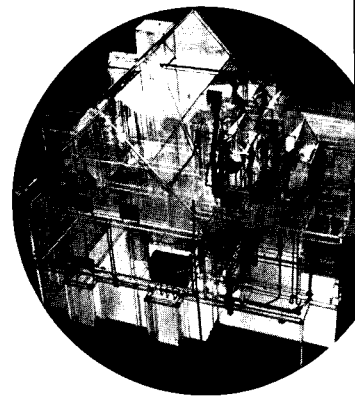

Sanitation systems are often little related to structure.

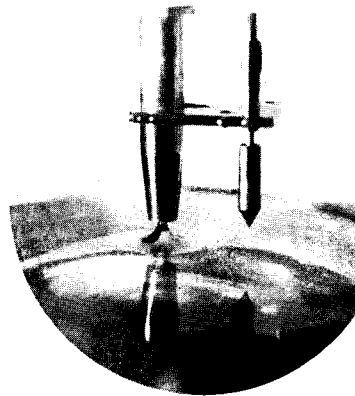

Back-siphonage in plumbing systems may cause epidemics and deaths.

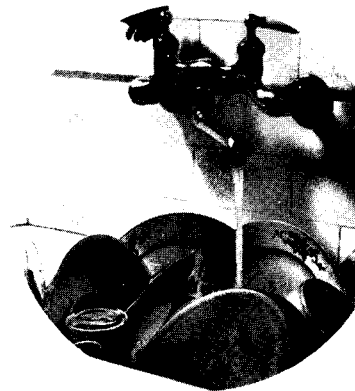

Tests have shown "dishwater" to be ineffective as a sanitizing agent.



Non-continuous surfaces offer crevices and pores to germs and dirt.



# TRENDS IN SANITATION

AMERICANS USE approximately twice as much water as do Europeans. Moreover, increased urbanization and wider use of water-using equipment between waterworks and sewers tend to increase this load. A new technic of garbage disposal, for example, by which garbage is crushed to a fine pulp in a grinder under the kitchen sink, mixed with water, and discharged to the sewers, places an additional burden on water supply. (Add to this that, by habit and relatively higher living standards, Americans apparently produce more garbage.) Wastes are diluted with 99 parts of water drawn from waterworks systems and deposited into lakes, rivers, and coastal waters. With the increase of sewage, pollution of streams has advanced until many now carry considerable organic matter in various stages of putrefaction.

But water treatment has achieved a sharp reduction in the incidence of water-borne diseases; the national death rate from typhoid fever fell from 35.8 per 100,000 in 1900 to 2.1 per 100,000 in 1937; and there have been comparable reductions in the incidence of other water-borne infections. To accomplish these results, great care and sums of money have been expended to insure that the water going into a distribution system was safe. Until several years ago, it was generally thought that once a safe water supply was put into the distribution mains, the possibility of its being contaminated was practically negligible. But the 1933 outbreak of water-borne amebic dysentery in Chicago was traced to defective plumbing, and resulted in an investigation of plumbing in Federal buildings by the U. S. Public Health Service and the WPA. Of 24,664 plumbing fixtures examined, 16,896 or 68.5% were "disapproved" as hazards to public health; practically all toilets and 85% of the lavatories were found to be potential agencies for the spread of disease. There is no essential difference between the plumbing of Government buildings and that in other structures; in fact, specifications of equipment for Government buildings are likely to be relatively more strict. The conclusion drawn by "The Ladle," organ of the plumbing industry, was that "All plumbing in the United States, perhaps remotely but none-the-less potentially, is a menace to public health." Progress has been made in eliminating the defects found by these investigators; but the U. S. Public Health Service still reports epidemics and deaths which have their origin in faulty plumbing.

In 1938, somewhat more than half the people in the United States—73,000,000 persons—disposed of their body wastes through public sewerage systems. And between 600 and 700 municipalities were disposing of their rubbish and garbage by incineration. Systems which combine sewage- and garbage-disposal are increasing. In addition to the technic of sending household-ground food wastes directly into the sewerage system, garbage is sometimes ground at a central station and the pulp discharged to the sewers. Or the grinding is done at the sewage-treatment plant. Still another trend involves combinations of incinerator and sewage-treatment plants.

In 1938, approximately 55% of all municipal sewage in the United States was receiving treatment. Today, the greater part of this sewage is, as far as possible, destroyed; utilization of by-products, has been incidental. But in recent years there has been greater emphasis on such utilization and on the possibility of returning plant food values to the soil. Sludge is now used more widely as fill and as fertilizer. The combustible gases produced by the bacterial action of the sludge-digestion process are used as a source of heat and power in treatment plants. Sewage gas is used in combustion engines; in Germany and Finland, it is used as a motor fuel. The number of potential by-products is much larger; for chemical and biological processes now used to destroy or stabilize can theoretically be adapted to produce usable by-products—fertilizers, alcohol, acetone, organic acids, insecticides, hydrogen, carbon, etc.

Such developments, still for the most part in the laboratory stage, may in the future affect the design of sanitation systems in buildings.

Acknowledgment for aid in the preparation of this study is made to Mr. F. H. Whitley, Instructor in Sanitary Engineering, New York University; Mr. A. R. McGonegal, former President, American Society of Sanitary Engineering; Mr. M. A. Pond, Instructor in Dept. of Public Health, Yale University; R. H. Zinkil, Consulting Engineer, Crane Co. Advice has been received from numerous persons and sources. But none of these are responsible for specific assertions or conclusions made here, unless it is so stated.



Courtesy "The Bettman Archive"

Look out below! A hazard to passersby: sewage disposal about 1810.



Courtesy "The Bettman Archive"

A cold shower, early 19th century style. Lithograph by Daumier.

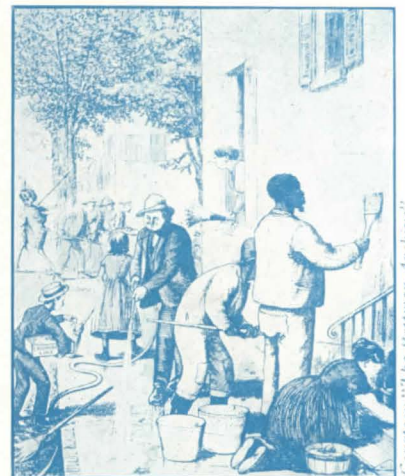

Courtesy "The Bettman Archive"

New York, 1860: disinfection with chloride of lime against cholera.



Courtesy "Louisville Herald-Post"

Public health and plumbing, 1939: cartoon in "Louisville Herald-Post".

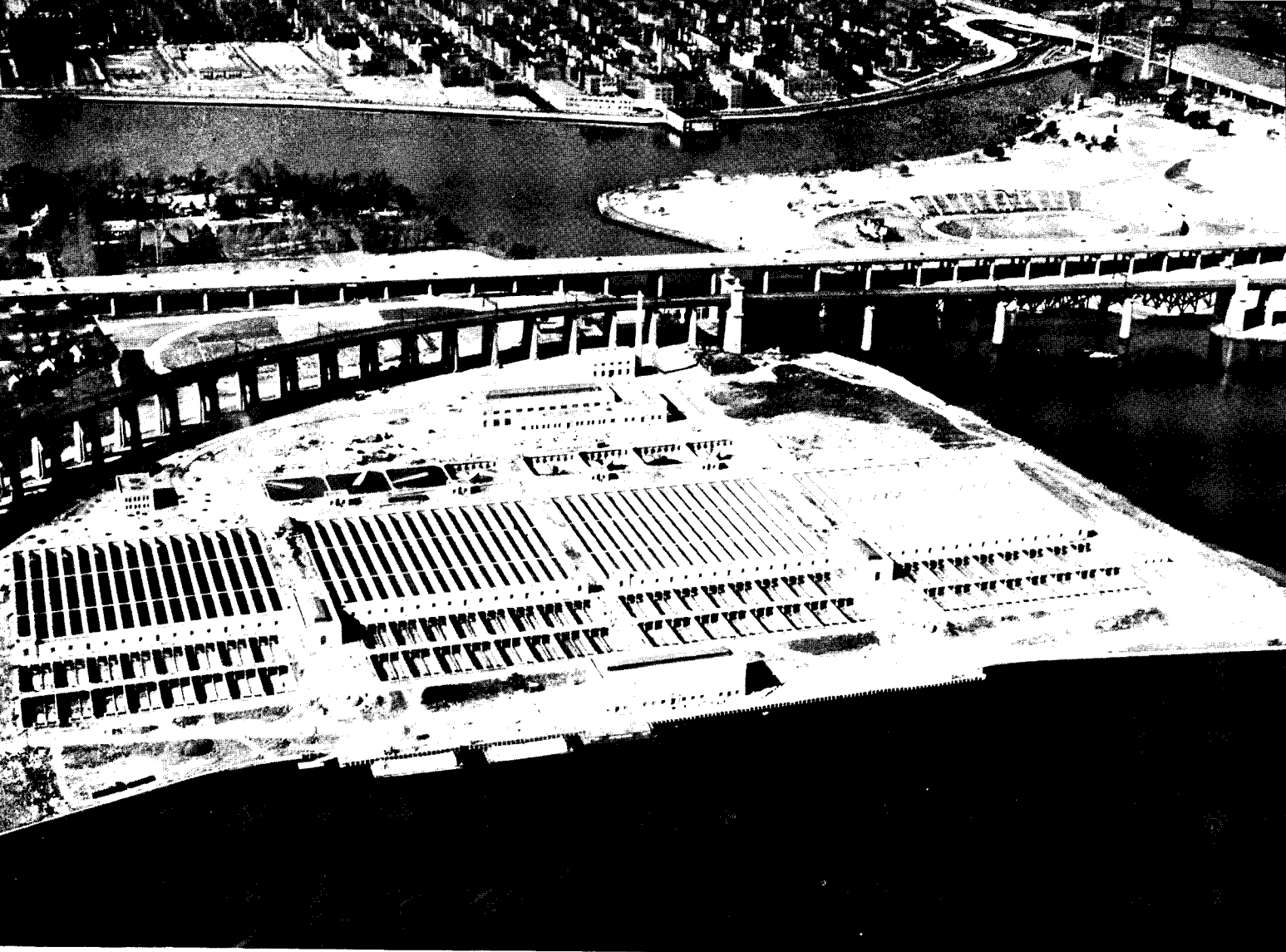

*Fairchild Aerial Surveys, Inc.*

The new sewage-disposal plant on Ward's Island, New York City: this plant is one of what is to be a chain of similar plants in which of New York City's sewage will ultimately receive treatment. About 55% of all municipal sewage in the U. S. now receives treatment

*Courtesy Calcinator Corporation*

*Courtesy Ewing Incinerator Co.*

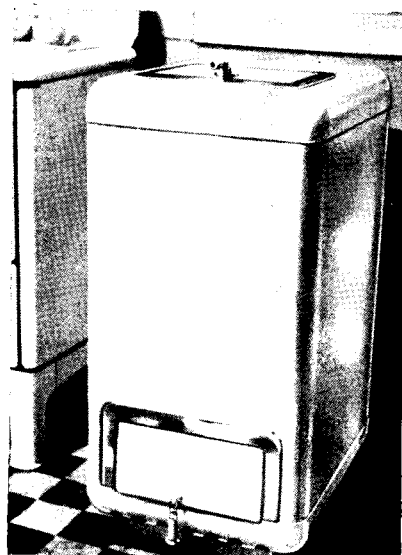

*Courtesy General Electric*

*Acme Photo*

Kitchen grinding of garbage

Kitchen incineration of waste

Basement incinerator

Door of incinerator chute

## Trends in Waste Disposal\*

THE DISPOSAL of wastes—solid, liquid, or gaseous—incidental to man and his mode of living is essential in the maintenance of a sanitary environment. It has been frequently observed that the incidence of typhoid fever and other intestinal diseases in a community bears a direct relation to the extent and efficiency of the provisions for sanitary excreta disposal.

### Systems of waste disposal

Systems of waste disposal are: (1) water carriage and drainage for excreta and other body wastes, for waste wash water, and in some cases, for the transportation of garbage; (2) incineration of combustible wastes; (3) collection and removal of heavy or bulky wastes which will not burn or be handled by sewerage systems, such as ashes, bottles, cans, etc.; (4) dilution to acceptable concentrations, as in ventilation for the control of odors and other waste products of respiration.

Water is an important vehicle for the removal of wastes. Properly designed house drainage and sewerage systems are efficient in the removal of liquid wastes, and do not offer any hazard to the health of the people served by them, provided that adequate treatment is given at the point of ultimate disposal or discharge. Besides removing excreta, house plumbing and sewers take the waste water from bathrooms, kitchens, laundry rooms, air-conditioning equipment, slop sinks, and sometimes receive waste food. The function of the drainage systems today is the removal of those liquid wastes which may have a harmful effect on man.

The two prevailing methods of disposing of garbage and refuse from buildings are: complete removal of wastes by the use of collection vehicles; incineration of the wastes to a residual ash, with a greatly reduced volume, and the subsequent removal of this ash. It is only in small buildings that removal of the wastes as collected is considered practical. Large buildings are commonly provided with incineration equipment in order to reduce the volume of waste material to be taken away. Where refuse is removed in the volume in which it is collected, there need be only storage capacity for waste materials during the time intervals between collection. Consideration is given to incidental nuisances: undesirable odors, litter, and insect and rodent harborage are controlled within practical limits. But unless there is daily removal of accumulated wastes, it is not always possible to eliminate all of these nuisances. Seasonal changes in character of wastes and in temperatures—particularly the occurrence of high summer temperatures—often result in conditions favorable to the production of odors and breeding of insects. This method of waste disposal is gradually being superseded.

In large buildings, including apartment houses, office buildings, and hospitals, incineration is the usual method of disposal for combustible wastes. Improvements in the use of incinerators in apartment buildings cover such items as better layout of receiving chutes, better design of chimneys or stacks for the elimination of fly ash, and better combustion chambers. The changes which will have the greatest effect on building design are those relative to the location of receiving chutes. The installation of charging doors in each apartment makes it possible for the user to drop waste

materials into an incinerator without going into a hall to reach a common chute. The adoption of this layout probably will necessitate a greater number of incinerators in the basement and may require the planning of a building around the waste-disposal equipment.

The increased use of air conditioning raises problems relative to the disposal of wastes resulting from the operation of air-conditioning equipment. In a majority of installations there are no waste-disposal problems affecting public health; there is, however, a potential health hazard. Many installations use water for cooling. A need for conserving water has brought the suggestion that cooling water be taken from public mains, provided the water supply is cold enough, and returned to the mains or reused within the building after it has passed through or over the coils of the air-conditioning equipment. This method of reusing the cooling water, which is essentially waste water from air-conditioning equipment, is disapproved by health authorities and waterworks officials because of the danger that some other waste pipe might be connected to this pipe line. Another method of disposal of waste cooling water consists of returning it to the ground water by means of diffusing wells. The objection to this method of disposal is that possible pollution of ground water may occur unless the cooling water is disinfected. Usually the recharging of a ground-water supply with the waste cooling water from air-conditioning equipment may be done safely. In the New York area there has been some movement along this line; theaters and other large buildings using independent ground-water supplies for their air-conditioning installations have employed diffusion wells for the disposal of cooling water. It is probable that mechanical refrigeration of water and the improved methods of reusing cooling water will ultimately eliminate the need for discharging any cooling water. While installations of air-conditioning equipment have waste water for disposal, it seems safest to dispose of this water into a sewer. Return water lines in a closed air-conditioning system must be under strict control to prevent cross-connections and to eliminate pollution of drinking-water lines. Where buildings are served by a municipal water supply for domestic and sanitary purposes, but provide their own water supply for air-conditioning use, strict care should be exercised to prohibit cross-connections between the two, since the private supply may not be of the same quality as the drinking water; most states have laws which make cross-connections illegal.

Air pollution and smoke nuisance are linked closely. Smoke is a waste product of combustion, resulting from the incomplete combustion of any fuel. The best method of controlling smoke is the complete elimination of it. This is gradually taking place with the increased use of gas, oil, or electricity in heating systems and in industrial plants. This results not only in a cleaner atmosphere, but obviates the need for frequent removal of ashes. In some industrial plants where large power plants are used, it has been suggested that the smoke be cleaned of dust, sulfur dioxide, and other gases by passing it through a scrubber combining atomized spray with centrifugal separation. In others, electrical precipitators are used to reduce the discharge of fly ash and dust.

\* F. H. Whitley, Instructor in Sanitary Engineering, New York University.

Courtesy Briggs Co.

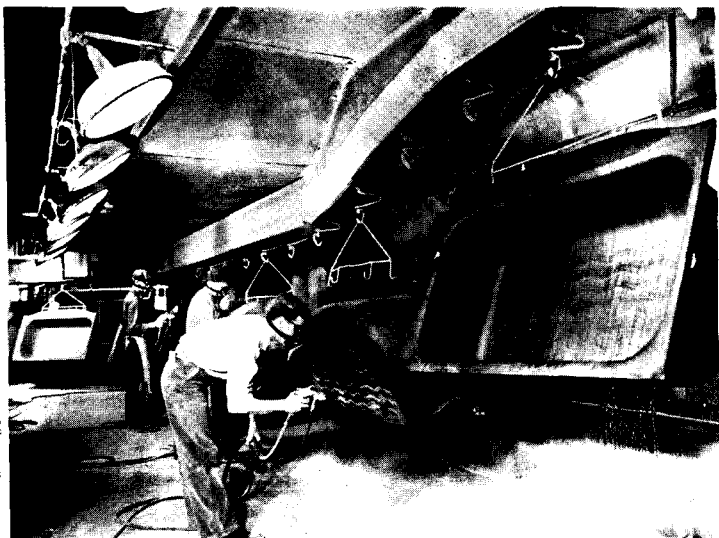

Use of controlled materials and fabrication makes possible greater continuity and more favorable strength-weight ratios.

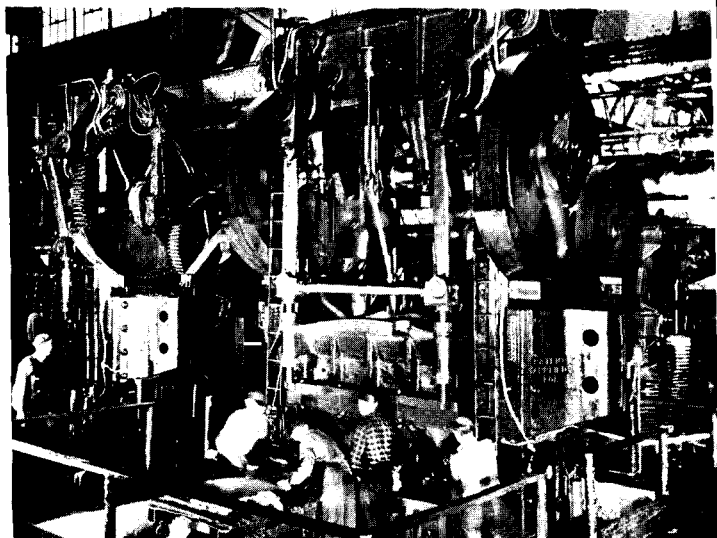

A press which forms cold ingot iron blanks into sanitation equipment under pressures as high as 1,500 tons.

Courtesy Westinhouse

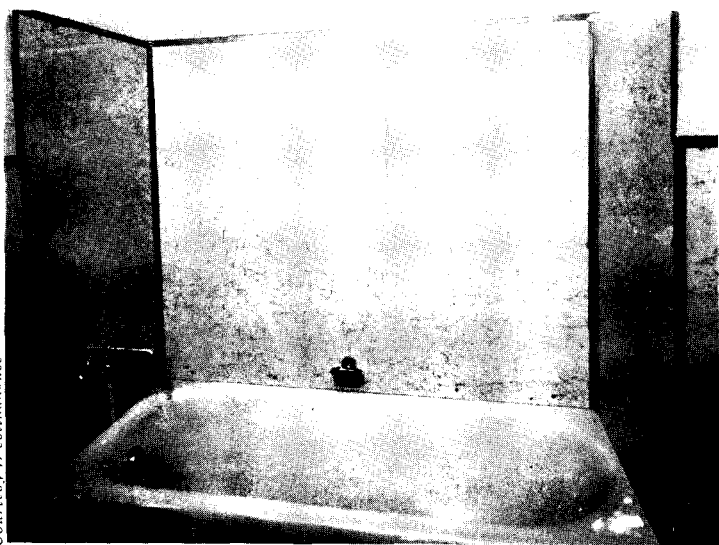

Plastics: lightweight materials, affording surfaces with a minimum of joints in which dirt and bacteria may lodge.

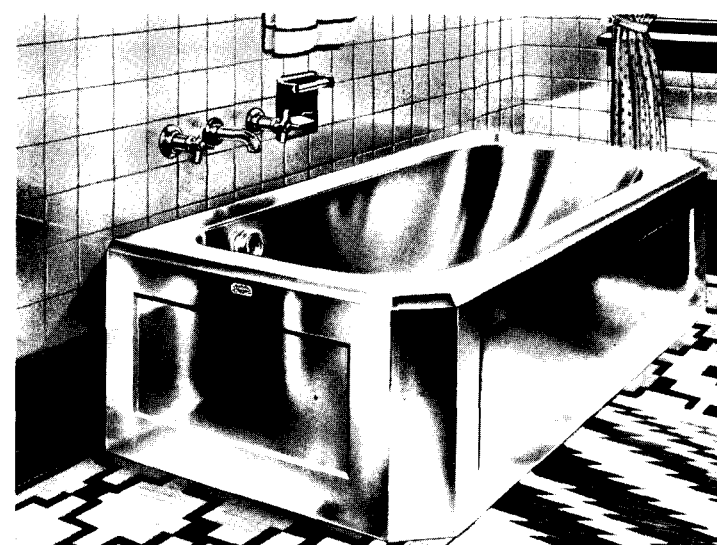

Stainless steel: experimental bathtub lighter than cast iron or porcelain and impervious to staining by hard water.

Soichi Sunami, courtesy Museum of Modern Art

St. Thomas

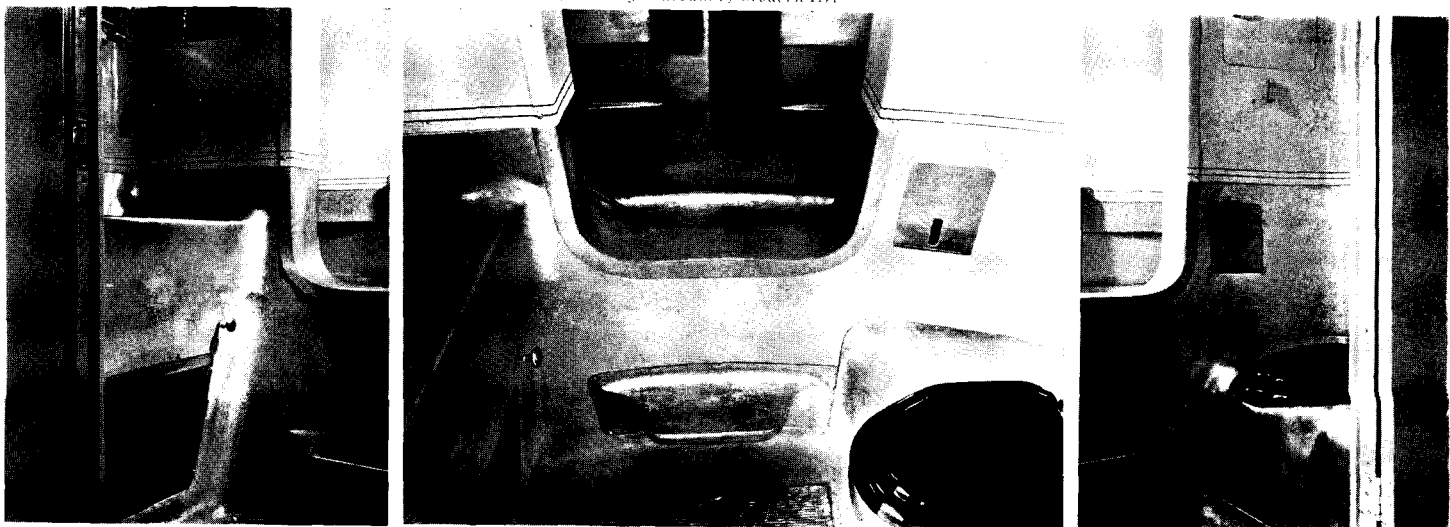

A bathroom designed by R. Buckminster Fuller; 5 by 5 ft., its total weight is about one-quarter that of usual bathrooms.

### Further possibilities

A recent development in the disposal of garbage is a small high-speed grinding unit, which is incorporated into the kitchen sink drain, with its outlet connected to the waste stack of the plumbing system. This unit will shred food wastes into a pulp, the shredded food being washed through the grinder into the drain, and then into the sewer system along with sewage. It provides a means for the individual householder to dispose quickly and inoffensively of putrescible kitchen wastes, thus reducing the odor nuisance which may arise from the storage of garbage. This machine will not eliminate the use of household or apartment-house incinerators; nor will it do away with the necessity of periodic removal of rubbish or like materials. The machine does not take such waste materials as cans, bottles, bones, newspapers, etc., and these must be disposed of by other means.

A recent application of water-carriage disposal of garbage, employing this equipment, has developed in New York where several apartment buildings have installed kitchen garbage grinders. These buildings still have need for incinerators to burn waste materials, but the use of the grinders will aid in the elimination of offensive odors when the incinerator is in operation. For, although odors are considered undesirable for their nuisance characteristics rather than for pathogenic reasons, much effort is being expended toward the control of odors. Although there has been favorable reception of the individual household garbage grinder by most users, universal use of this device can hardly be expected to occur at any early date. The cost is likely to be a deterrent. In addition, municipal ordinances in many places must be revised before any installation of such a grinder can be made. It is estimated that about 7,000 of these grinders are now in use.

The adoption of grinders for a more convenient disposal of food wastes raises the question of the effect of such a step on the design of house drainage systems. During the development period considerable attention was given to the effect of ground food wastes on the plumbing system. It was found that if the plumbing system was properly installed and in good condition, no changes were required to handle ground food wastes.

Incinerator design for buildings employing a combination of independent grinding and disposal of garbage, together with incineration of the remainder of the waste materials produced, may be modified somewhat as a result of the adoption of sewer disposal of garbage. Incinerator design is based on the characteristics of the material to be burned. The elimination of wet organic substances reduces the amount of evaporation during the burning operation. There will then be less need for auxiliary burners, and drying hearths may not be required in some installations, as now they sometimes are.

In the future, methods of refuse removal may be provided by systems of conduits under the streets, connecting each building to a hidden collection system, in which all solid waste is transported to some central point for ultimate disposal. Transportation may be furnished by means of water carriage, or by compressed air in much the same manner as it is now used in distributing mail between the main post

office and branch post offices in New York City.

The removal of refuse from the household by such automatic means has received close attention in some European countries; the Garchey system of waste collection has been used successfully around Paris for a number of years; and during the past year, a large Garchey installation has been made in an apartment development in London. This system employs the wash and waste water of the household to flush the domestic refuse into the downpipes to a special pneumatic main. A reservoir is located under the sink in the kitchen for the storage of waste water and refuse. An overflow pipe, incorporated into the plug of the outlet, prevents overfilling the reservoir. To discharge the contents of the reservoir, the overflow pipe is lifted, allowing the water to flush the refuse through the downpipes to main drains and on into collecting chambers, which are connected by suction pipes to a main collecting pipe. Surplus water drains from the collecting chamber to the sewer. At intervals, when the refuse is to be evacuated from the collecting chambers, valves are operated by remote control, and the refuse is drawn to the central disposal plant by vacuum or is forced there by compressed air. After additional water has been removed, the refuse is incinerated.

Criticism of this method of waste removal centers about the limitations of it as well as the cost. As with garbage grinders, materials such as bones, bottles, cans, and other bulky objects cannot be dropped down the drain, but require separate storage and removal. There has been considerable trouble in the operation of the system with respect to stoppages of the collection system. The advantage of this method of refuse disposal is the absence of any open-air removal of putrefactive organic materials. Even the disposal plant is clean and free of dust, differing considerably from the usual incinerator.

An underground system of waste removal capable of handling all garbage and refuse would mean the elimination of many individual incinerators, each discharging smoke, fly ash, and fumes into the air regularly; there would be no necessity for garbage, ash, and refuse trucks in the streets in the future, thus eliminating the noise and litter accompanying their operation; air pollution would be reduced with a corresponding reduction in haze and in the deposition of soot and grime. A method for cleaning surfaces, furniture, and other equipment in buildings that is comparable to such a system is a central vacuum-cleaning system, in which dirt and dust are drawn through a piping system to a central collector in the basement.

One of the most desirable methods of ash and waste removal is that utilized by many industrial and commercial buildings in Chicago. A freight tunnel with electric trains is far beneath the city streets in the Loop district, serving practically every large building within the area at the sub-basement level. Large amounts of ashes and waste materials are handled by this subway system, never reaching street level until far out from the central business district. A waste removal system of this type, while economically unsuited for residential areas, does offer a rapid and clean method of removing bulky wastes originating in large buildings within the larger cities.

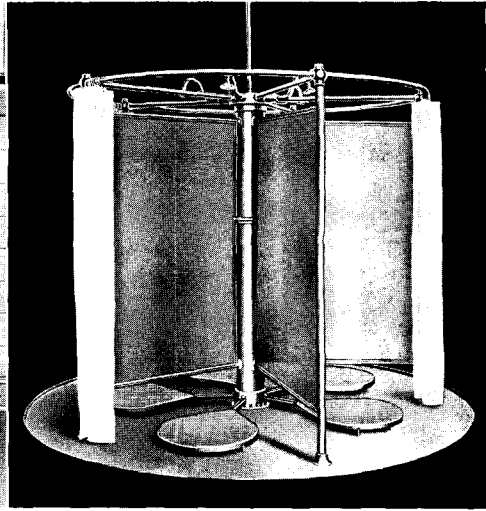

Erving Galloway

Infection that may be spread by contact with a fixture in common use . . .

is minimized by the use of treadle-operated group-washfountains and . . .

group showers; use of treadles is also reported to reduce water consumption.

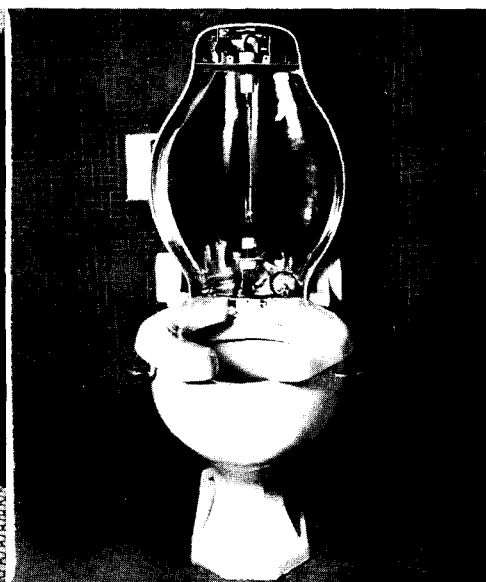
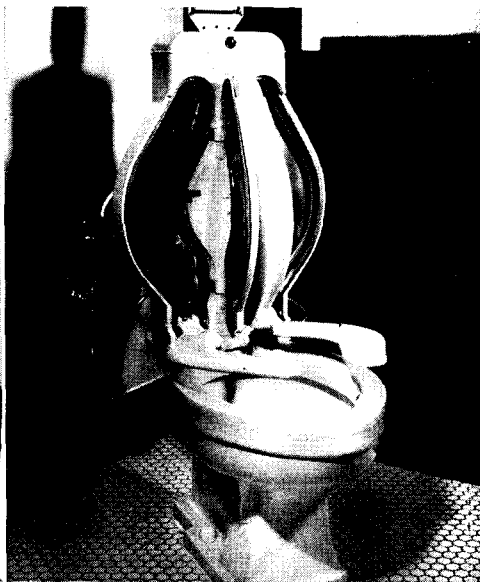

Protection against infection is attained by reducing area of contact . . .

by use of live steam as sterilizing agent (Seat is locked when not in use.) . . .

by use of ultraviolet; equipment may be installed on any standard closet.

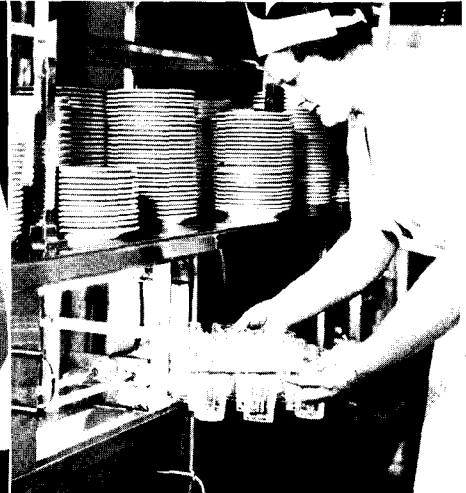
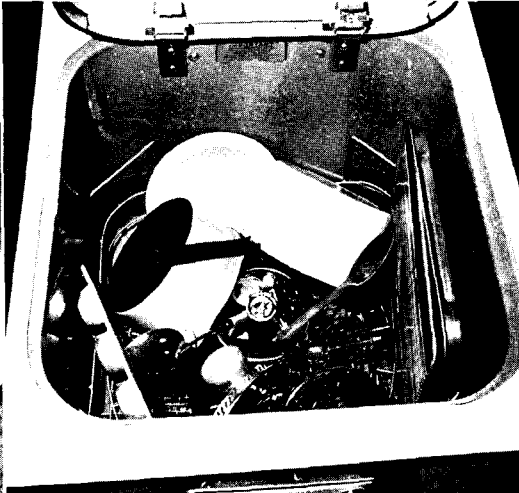
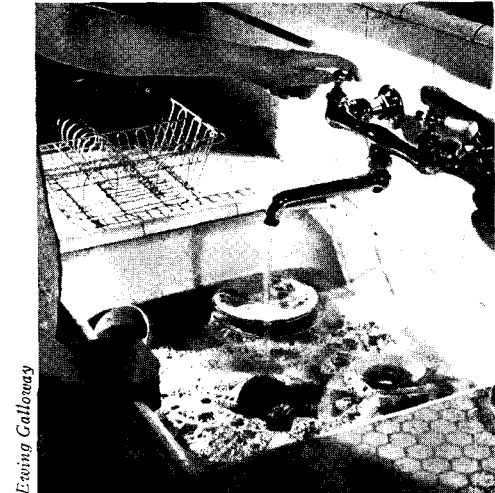

Erving Galloway

Courtesy Westinghouse

Lukewarm, soapy dishwater is relatively inefficient in removal of bacteria . . .

Mechanical dishwashing is more effective if process is automatically controlled.

Use of ultraviolet for keeping kitchen utensils sterile is increasing.

## Design of sanitation systems

A PRIME CONSIDERATION in the design of a sanitation system is the disposal of waste without infection of the system's users. Advances in production methods and wider use of sterilizing agents (superheated steam, ultraviolet radiation) have made it increasingly possible to achieve this; such advances are incorporated in the design of materials and equipments, and finally in integrations of equipments.

### Materials

Sanitary fixtures have been fabricated mainly of enameled cast iron, pressed steel, vitreous china, and porcelain, with stainless steel and, more recently, plastics, increasingly important competitors.

Steel equipments weigh about one-third as much as cast iron; their higher tensile strength permits the use of a relatively thin gauge. (Producers of cast-iron equipment declare the thinner gauge makes steel fixtures easily dented and "tinny.") Their lighter weight makes them easier to handle and install. Vitreous china is impervious to checking, crazing, or staining, and is therefore easily cleaned; but because of the very high temperatures at which it must be fired for complete vitrification, the sizes in which vitreous-china fixtures can be produced without considerable warping are limited. Porcelain fixtures can be made in larger sizes but are not impervious to checking or crazing. Stainless steel and plastics in sanitation equipment offer surfaces that are relatively more continuous, smooth, and corrosion-resistant, with fewer crevices or pores in which dirt and bacteria may lodge and multiply. For the floors of bathrooms, shower and locker rooms, however, smoothness is not ideal; abrasive properties to prevent slipping are desirable.

### Equipment

The report by the U. S. Public Health Service on "Public Health Hazards in Plumbing" found the chief defect to be direct or indirect connections between pipes, fixtures, etc., containing sewage- or otherwise-contaminated water, and a potable water supply; the danger to health from such installations is that, through excessive back pressure or negative head, or both, such polluted water may be siphoned or forced into the potable supply.\* Progress has been made in eliminating these hazards, but scores of water-borne epidemics and hundreds of deaths which have their origin in faulty plumbing are still reported. Typical instances of such cross-connections may be cited: (1) a safe water supply separated from contaminated water by a valve; such a valve may be partly open or leaky, and a partial vacuum on the safe side of the valve will cause the polluted water to be siphoned back into the pure water supply; (2) the supply outlet to a plumbing fixture so located that it can be submerged under contaminated water; if a vacuum develops in the supply line, the unsafe water will be drawn back into the safe water supply. To remedy these and similar cross-connections: (1) water inlets should be raised a safe distance above the top of the fixture; (2) vacuum-breaking devices should be used—vents or automatic flush valves; (3) supply pipes should be large enough to take care of maximum discharge.

\*Studies of back-siphonage were published in the RECORD in January (1937), p. 43; August (1938), pp. 71, 72. See also April (1938), pp. 120-123.

Other potential sources of infection are plumbing fixtures which become contaminated with disease-producing organisms through contact with the user, transmitting these organisms to subsequent users. The hand, for instance, is never bacteriologically "clean"; even after disinfection, it retains microorganisms upon it. Surgeons, before operating, cover their hands with sterilized rubber gloves, lest they introduce these bacteria into wounds with their fingers. A surgeon's lavatory is, for the same reason, pedal- or knee-operated. More recently, this sanitary precaution has been extended to the design of group fountains, showers, urinals, water closets, and even doors. (See page 47.) In the design of water closets, still greater precautions have been taken. The danger of infection has been minimized by reducing the area of physical contact and by the use of sterilizing agents.

The design of equipment for cleansing of dishes, glasses, and other eating utensils also presents a sanitary problem of primary importance; according to Dr. James G. Cumming, chief of the Washington, D. C., Bureau of Preventable Diseases, the respiratory or saliva-borne infections, responsible for 25 to 45 percent of our mortality, are transmitted "in nasal or mouth excretions by way of the air-borne route and by indirect contact through food, hand-to-mouth, or eating-utensil transmission."

Several years ago, an investigation of 46 different restaurants found that one-third of the organisms on used eating utensils remained after the utensils were washed; soiled spoons, for instance, held 150,000 bacteria, washed spoons 50,000 bacteria. The use of mechanical dishwashers can improve this condition: but the entire process—temperature of the wash- and rinse-water, length of time of washing and rinsing—must be automatically and not manually controlled; with precise control of the process, practical elimination of the contaminating organisms can be obtained. Ultraviolet radiation is also used increasingly—especially in restaurants, soda fountains, etc.—for sanitizing eating and drinking utensils, and particularly in protecting them from air-borne bacterial contamination after they have been washed and stored away.

### Integration

By use of production processes like welding, centrifugal casting, etc., greater continuity and more favorable strength-weight ratios are attainable. It becomes feasible, for example, to produce simplified piping systems, with a minimum number of joints, of materials that are less corrosible, in larger units and lighter weights. In an experimental house recently built by the John B. Pierce Foundation, for example (see AR 9/39, pp. 41-45), waste and vent piping was so laid out that it could be preassembled with only two field connections needed. Such increased continuity of piping systems could reduce the hazards of leaks and cross-connections.

Greater integration of bathroom and kitchen equipments is similarly made possible by advances in production methods. The design of the Integrated Bathroom (see AR, 1/37, pp. 40, 41), for example, consists of stamped-metal bath, lavatory, and toilet, so fabricated that each is integral with walls, floor, and ceiling.



Mechanical equipment is thrown into high relief in this model house in the Crane Company's exhibit at the Home Building Center, New York World's Fair, 1939. Fabricated of transparent plastic, it illustrates current heating and plumbing practice in an average house. From one point of view it is a dramatic commentary on technical ingenuity which has made such equipment a commonplace in American life. From another viewpoint, the model reveals a complex mechanism and suggests, through integration of the needs and means of modern living with simpler, more economical forms, new design possibilities.



# EQUIPMENT FOR THE MODERN HOUSE

**TRENDS IN CURRENT PRACTICE: A report based on numerous interviews with architects, engineers, housing research technicians, and specialists in the field of plumbing, heating and air conditioning, and electrical work. Other sources include material in recent technical and trade publications.**

RECENTLY ANNOUNCED IMPROVEMENTS in design, production processes, and installation techniques of currently available residential equipment are not radical enough to produce compensating fundamental effects on house design as a whole.

Many experiments are being conducted in all fields of house equipment. Some are of such a character that their ultimate acceptance by the various factors of the building industry would conceivably produce important economies and vastly better houses. But, since not all these experiments have yet resulted in commercially available products, it is possible at present only to outline a trend of future development, results of which might extensively affect all phases of residential design and construction.

Precisely what these effects will be, how far they may alter current practices, and how soon the equipment that is to cause them will be generally available, are questions for which building technicians apparently have no common answers.

Reasons for such divided opinion lie in the fact that improvements in residential equipment involve such matters as technical production, commercial development, consumer and trade acceptance. These often result in powerful opposition to quick development and general availability of a new product. Production may involve complex problems relative to plant and process. Characteristics of a new unit may be such that present distribution and sales channels are inadequate, and new ones must be evolved. Form and operation may be so radically different from that to which the house-building public has become accustomed that sales-resistance is great. Installation may involve techniques which, by virtue, perhaps, of technical simplification or some mechanical innovation, conflict with established trade practices and jurisdictional arrangements.

These obstacles to commercial de-

velopment constitute the chief reason for an *apparent* lack of initiative on the part of inventors and manufacturers of mechanical units, in contrast to the productivity—at least in experimentation—evidenced in the field of residential construction (AR, Building Types, 7/39). However, inventors and manufacturers have been—and are—busy perfecting plans for and testing models of a great variety of new products. Though many of these have not been publicly announced, enough is known about them to chart a trend of probable progress in design.

## Trend toward integration

Common to all significant developments is an objective compounded of lowered cost; quicker, easier installation; simplified operation with consequent reduction of maintenance; and safer, more positive controls. As a result, residential equipment is inevitably emerging into the "system" category. Products formerly manufactured and sold as separate items are being redesigned and combined for integrated performance. Pre-cutting and the fabrication of relatively large subassemblies are being adopted to increase efficiency—and lower cost—of manufacturing, merchandising, and installation. In some instances, factory production of complete units is possible; this, on a large scale, might radically reduce costs. But in almost as many instances, trade customs and jurisdictional rulings—held by a large body of technical opinion to be the bottleneck of the building industry—have been a barrier to economies which technicians say are possible.

Apparently, only sporadic attempts are being made to integrate equipment systems with structural systems. Reasons include lack of any single, standard, industrially produceable type of construction which would prove generally satisfactory in all sections of the country, and the fear that "individuality of design" might be lost.

THIS IS THE THIRD of a 1939 series of *Building Types* studies on Houses. The first, in May, dealt with planning units for house design; the second, in July, was concerned with systems of construction. This one surveys trends in current practices relating to mechanical equipment for single-family dwellings and, in addition, presents several case studies of well-equipped, recently completed private residences.

## INDEX

<b>Equipment for the Modern House</b>	<b>76-83</b>
Trends in current practice	77-80
Built-in equipment	81-83
<b>Case Studies</b>	<b>84-104</b>
Fourteen-room house, Pennsylvania	84-88
Hillside house in Washington	89-91
House without basement, California	92, 93
One-story house in Oregon	94-97
Brick house in Colorado	98, 99
Artists' house in Illinois	100, 101
House of concrete, Massachusetts	102-104

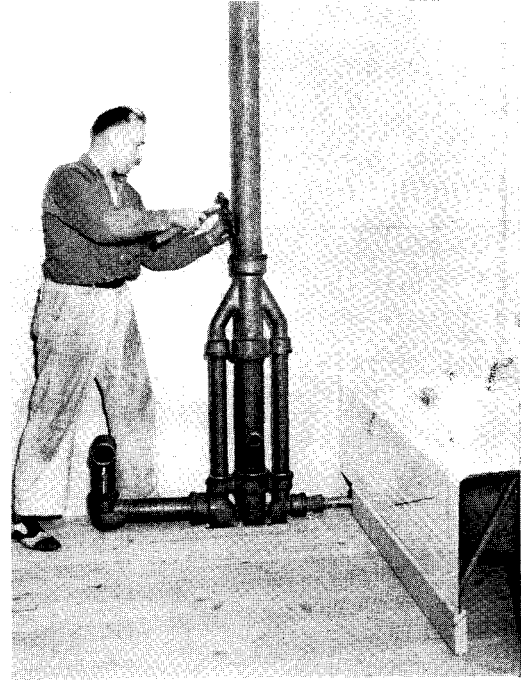

The kitchen (left) of the experimental house of the John B. Pierce Foundation at Lebanon, N. J. (AR, 8/39, pp. 41-45) contains a single large prefabricated unit embodying sink, icebox, storage cabinets, and shelves. All plumbing is in one wall; and bathroom waste pipes (right) are compactly assembled in a single unit above the floor.



Eric Baker

Dining space and kitchen of the experimental house. Dark strips at counter, at base of bookshelves, and at kitchen windowsill are a new type of electric service strip, prefabricated in standard lengths with integral plug-in outlets. Strip provides flexible electric service in every room.

**Electrical work.** Establishment of wiring adequacy standards and the application of these to the development of a complete electric system—which embraces not only the wiring, but also circuit-breaker controls and fixtures—have brought this field of house equipment to a comparatively high state of development. With a few exceptions, however, the recent improvements in this field have been in the “gadget” classification. A large number of new and efficient portable electrical units are now available; but these do not constitute improvements of basic integral significance to the design of the house as a whole. According to technicians, few basic improvements have become available since the announcement of the zoned wiring system, and it is held that future basic changes must relate primarily to methods of integrating electrical service systems with elements of residential construction.

This is now the subject of extensive experimentation and testing. Electrical heating panels, for example, have shown encouraging results in the laboratory, but have not yet been made available on a commercial basis, except as por-

\*See National Electrical Code requirements and the Industry Committee's Handbook of Interior Wiring Design. Also Sweet's Catalog File, Sections 23, 24, and 25.



Left, kitchen in a Lake Forest, Ill., house, Elmer W. Marx, Architect, wherein a variety of equipment units made as separate parts have been integrated by the designer. Right, a first-floor utility room in one of the New York World's Fair houses which provides space for a compact air-conditioning plant and various units of laundry equipment.

table units or small, built-in space heaters of minor capacity. As another example, part of the finish construction is being utilized to provide greater flexibility of service, through employment of coves and bases containing wires, or through installation of continuous-strip outlet members, one form of which is illustrated in the living room of the John B. Pierce Foundation experimental house.

**Plumbing and sanitary units.** Technically, a great number of improvements have been developed which ultimately will have an important basic effect on house design. Designing and production effort that has gone into the development of kitchen and bathroom units, new and simpler types of piping layouts, and other sanitary equipment devices, in which the efficient integration of structural and mechanical parts was accomplished, has, according to technical opinion, been thwarted so far by commercial problems incident to merchandising and conflicting trade practices incident to installation.

In spite of this fact, kitchens, bathrooms, and, to a somewhat lesser extent, laundries—or “utility rooms” that often house also a heating plant—have become almost completely standardized in function, layout, and equipment. These

spaces have been the subject of such intensive study, experimentation, and testing on the part of progressive manufacturers and design specialists that they constitute, in themselves, large units of equipment and, in all ordinary cases, require only specification relative to space and performance standard on the part of the architect.\*

Because such rooms utilize common services, effort is being made to develop simplified supply and waste layouts that will minimize pipe runs and permit rapid and economical job assemblies. The “mechanical core” containing all house equipment is still a laboratory product; but efficient devices similar in character to the rough plumbing manifold shown on the opposite page—which is now commercially available—are being perfected to permit economical grouping of various sanitary units about common supply and disposal means. In respect to hot-water systems, experiments at Purdue University tend to show that for small houses, direct piping runs and small pipe sizes increase economy and efficiency of service.

**Heating and air conditioning.** Experiments with heating methods radically different from those in current use point to future developments of potentially

\*See Sweet's Catalog File, Sections 21, 27, and 28.

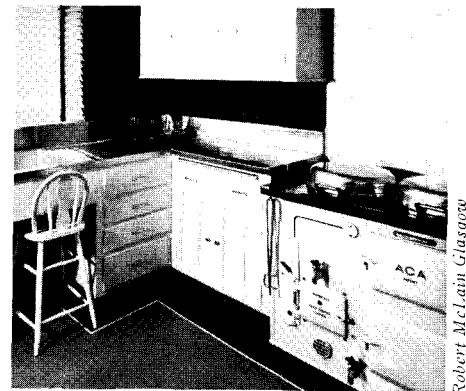

An improved type of coal range used exclusively for cooking, in a kitchen designed by Frank J. Forster, Architect.

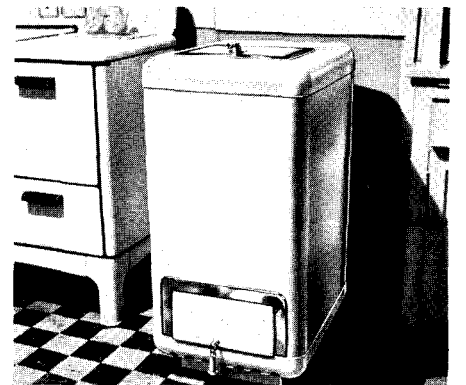

New kitchen waste-disposal unit, finished to match other kitchen units, has either gas or electric burner.

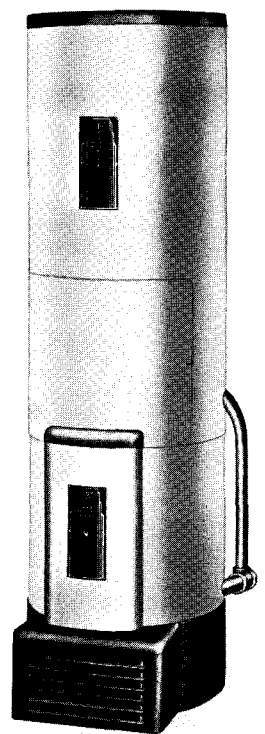
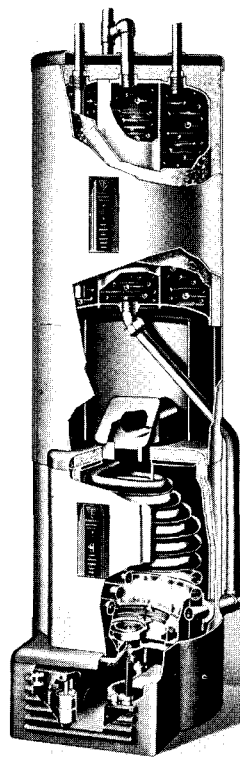
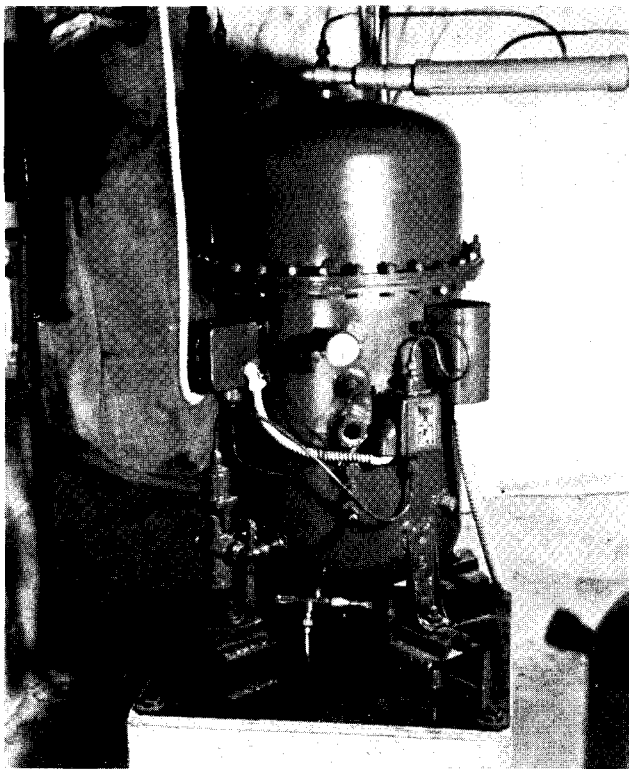

Left, heat-generating unit of an experimental "reverse cycle" heating installation in a six-room house in Boise, Idaho. It is an electrically operated compressor that extracts heat from well water. Heat distribution is through copper tubes imbedded in plaster to produce radiant panels. Right, phantom and front views of a new oil-fired hot-water heating plant for small houses that contains a built-in tank for domestic hot-water supply.



New gas-fired winter air conditioner for five- to seven-room houses occupies less than 5 sq. ft.; it heats, cleans, humidifies, and distributes air.

far-reaching importance. For example, heat generation by the "reverse cycle" process, in which a compressor takes the place of a steam or hot-water boiler has proved successful in at least one experimental installation (see AR, 6/39, pp. 49-52). Heat is distributed through a series of copper tubes embedded in plaster to form radiant panels. Operation of such "heat pumps" is too novel at present to warrant conclusions; and radiant panel heating, though successfully installed in large buildings has not yet been developed as an economical method of heating small houses, largely because of the difficulty of integrating currently necessary structural and mechanical elements.

Improvements that are now being developed in warm-air, steam, and hot-water heating installations are of two general types. First, much effort is being expended to raise efficiencies of heat-generating plants, to reduce their physical dimensions, and to simplify their operation. Plants are now being manufactured as compact "packages" that include—in the case of steam or hot-water—burner, boiler, domestic hot-

water supply unit, and all necessary controls. Methods of distributing heat from such plants follow established practices—radiators, convectors, or ducts.

The second type of improvement relates to the trend toward combining the various parts of a heating installation into a more precisely engineered "system" with standardized and interchangeable parts of related capacities and known performances. In such systems mechanical characteristics are increasing. Forced flows of steam, water, or air are supplanting gravity flows, thus eliminating the basement as a necessary location for a heating plant. Automatic control of firing and of heat supply is rapidly becoming the rule in installations of all types of central heating plants.

Hot-air, gas- or coal-fired space heaters are being radically improved for installation in small dwelling units; and one type is now available to replace a living-room fireplace. Prefabricated of insulated metal, it is fitted with ducts and in tests has proved efficient in heating upper and lower floors of small houses.

**BUILT-IN FURNITURE:** equipment designed to save both space and time

**DRESSING ALCOVE IN A CALIFORNIA HOUSE:** MICHAEL GOODMAN, Architect



The built-in chest contains two 4-in. drawers, six 6-in. drawers, and three 8-in. drawers; one of the latter is double-length for sport clothes, woolens, etc. Exposed surfaces are of naturally finished Duali plywood. Shelves are Oregon pine. Mirrors and dressing-table top are of Libbey-Owens-Ford plate glass. Hardware is hand-rubbed bronze. Lights are Lumiline lamps set in chromed Wallmould strips.

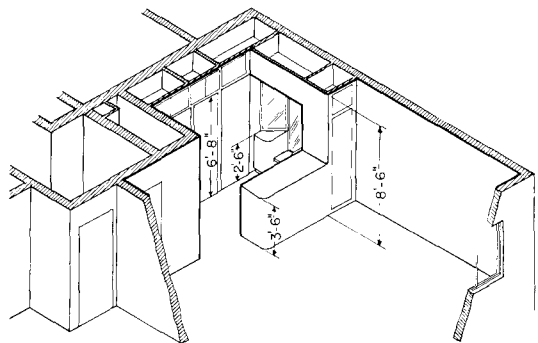

Isometric

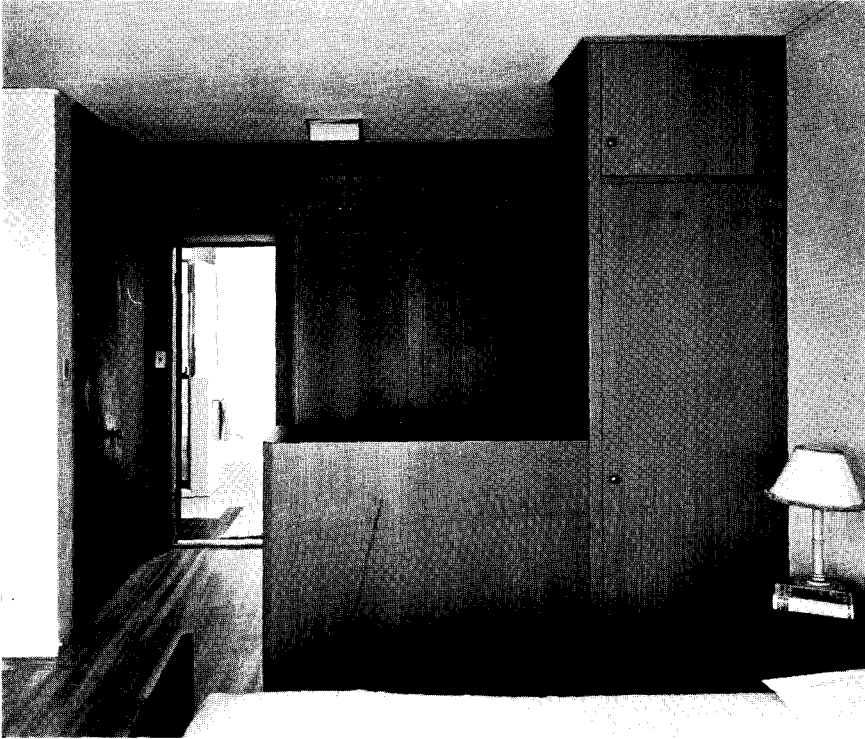

Top view shows dressing table; lower view, through to bath.

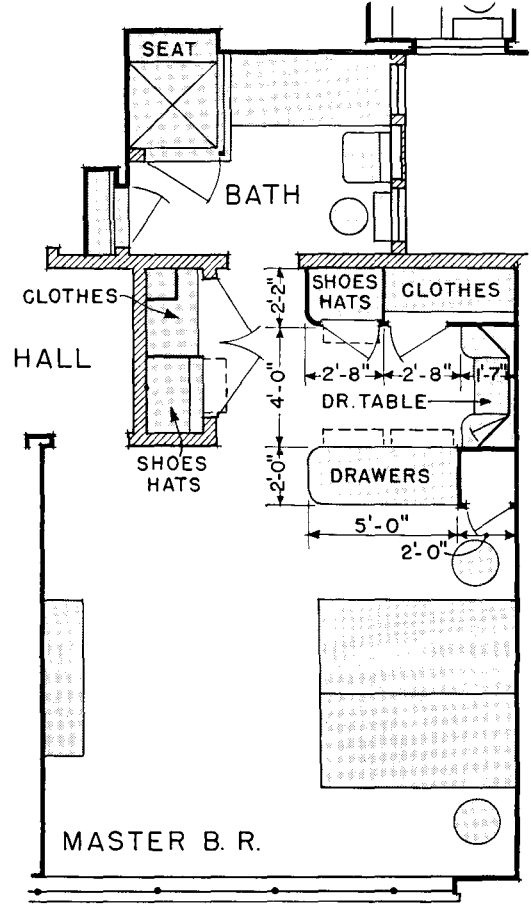

Plan

# CONVERTIBLE LIVING-SLEEPING UNIT IN NEW YORK APARTMENT



Photos by Frank Randt

HANS N. WORMANN, Architect

In order to transform this pair of comfortable couches into beds, back cushions are removed, revealing cabinets in which bed linen and pillows are stored during the day. Each couch is pulled out from beneath its cabinet and becomes a full-width single bed. Built-in lights serve as reading lamps and night-table lamps. Radio, magazines, telephone, etc., are accommodated on sliding shelves. Trays in one bed cabinet are sized for men's clothing: shirts, ties, etc. Walls are covered with light peach solid-color wallpaper. Upholstery is of hand-woven fabrics, in chartreuse and dark brown. Curtains are also hand-woven in shades of brown, terra cotta, peach, and chartreuse. Rug is oyster-gray chenille. All the woodwork is of walnut veneer.

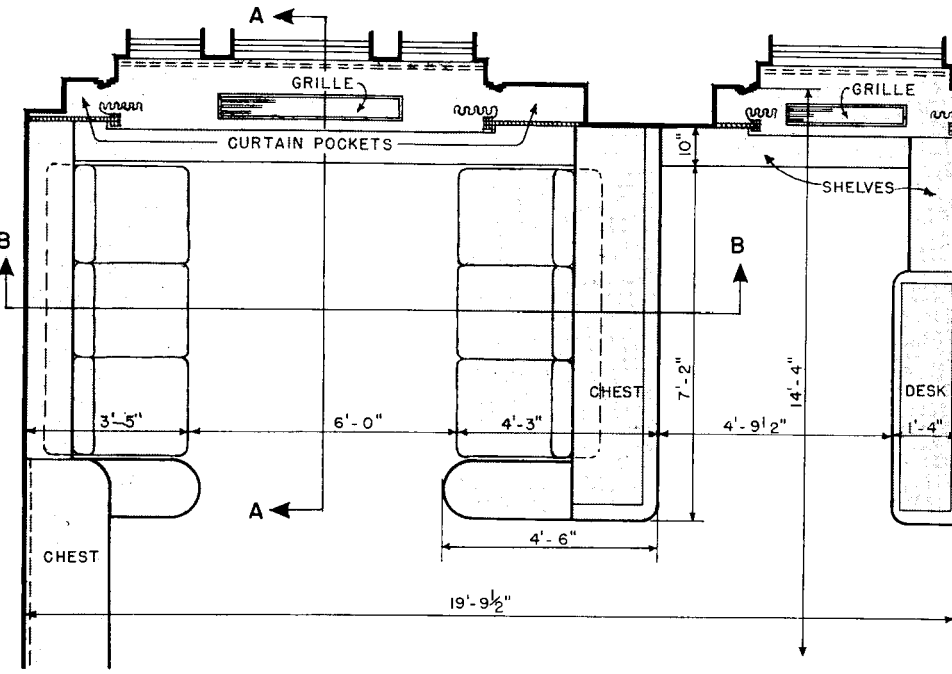

PLAN SCALE  $\frac{1}{4}'' = 1'-0''$

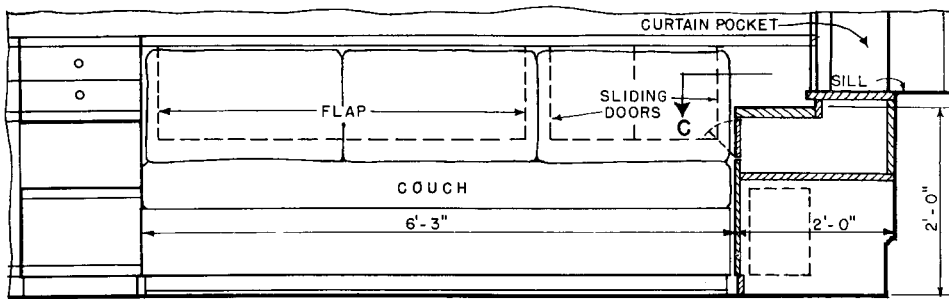

SECTION A-A SCALE  $\frac{1}{2}'' = 1'-0''$

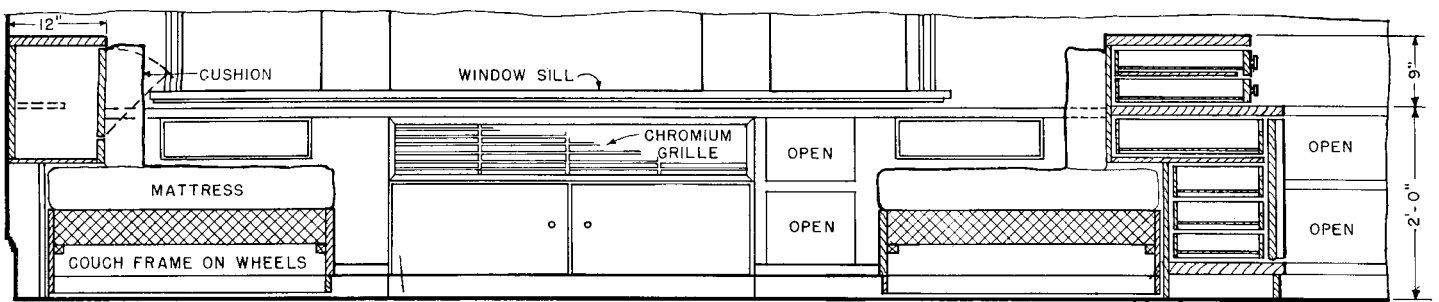

SECTION B-B SCALE  $\frac{1}{2}'' = 1'-0''$

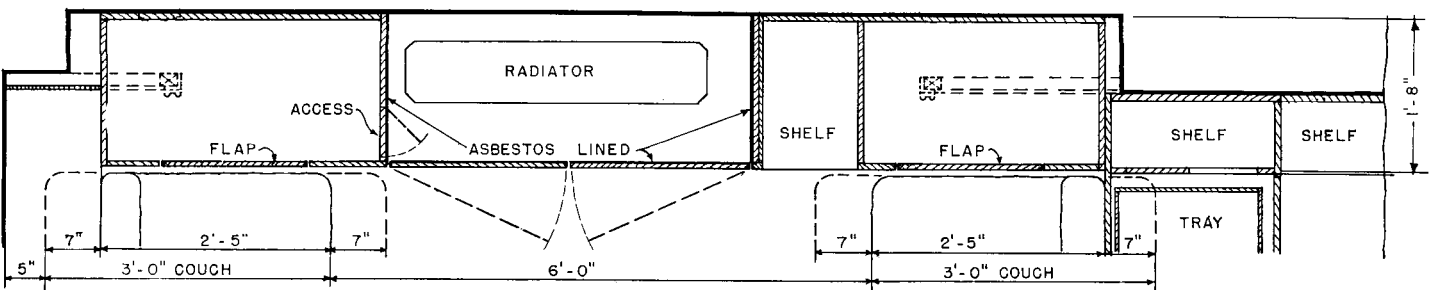

PLAN AT C SCALE  $\frac{1}{2}'' = 1'-0''$

# CASE STUDIES: seven houses with varying requirements

## A FOURTEEN-ROOM HOUSE IN PENNSYLVANIA

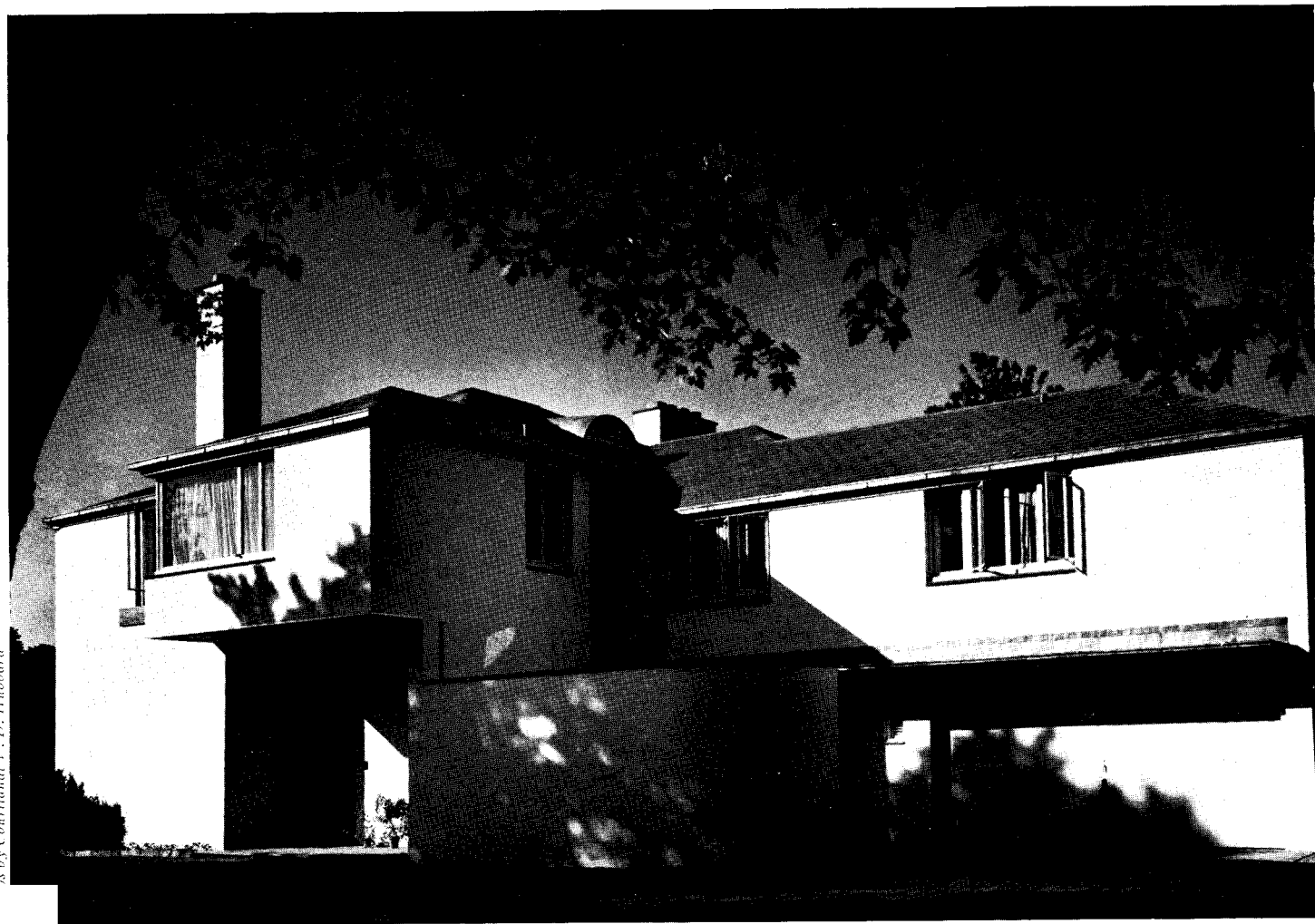

PHOTO BY COURTESY OF F. D. HUBBARD

### HOUSE FOR CHARLES WOODWARD, PHILADELPHIA, PA.

KENNETH DAY, Architect

THE OWNERS wanted a "modern" house with a pitched roof, and asked if the request was a contradiction in terms. The reply was in the negative, particularly since, in this solution, the typical A-frame truss was considered the most economical method of roofing. Second-floor ceilings are carried up the under sides of the rafters to the collarbeams.

Foundations are of local stone, water-proofed with Ironite. Exterior walls are solid brick, 13 in. thick, with 1-in. insulating lath on interior. Second-floor supports are structural steel. Floors, partitions, and roofs are wood-framed. Roof is green Vermont slate. Metal work is lead-coated copper. Sash are

Lundell-Eckberg steel casements. Glass is A-quality or plate, depending on glass area. All glass is by Owens-Illinois; glass block is Pittsburg-Corning. Interior and exterior doors are Morgan, of birch, flush type. Exterior woodwork is cypress. Kitchen cabinets are stock, of wood. Sinks in kitchen and pantry are by Crane and Whitehead, other plumbing fixtures by Kohler. Heat is supplied by a Hershey air-conditioning system, with Kelsey heater and Esso oil burner. Heat for sunny portions of the house is controlled independently from the remainder of the building. Domestic hot-water heater is by Ruud. Electric wiring is B-X cable.



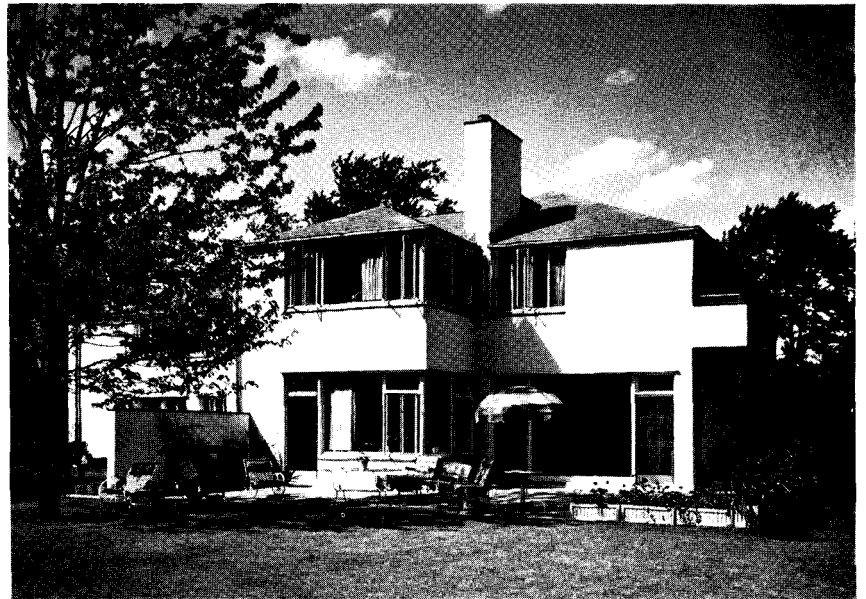

Exterior from south, showing living terrace.

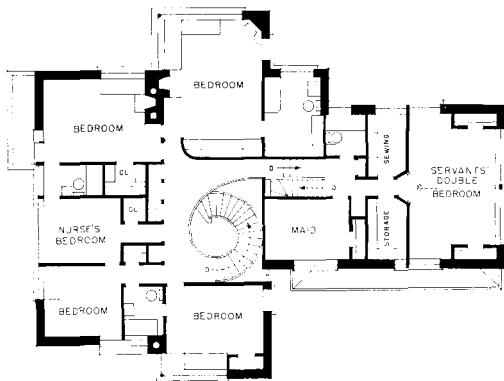

Second floor

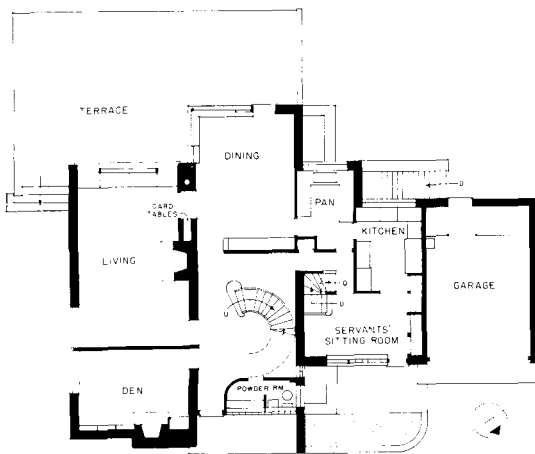

First floor

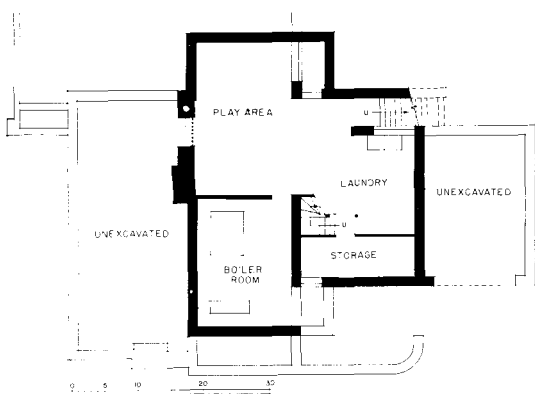

Basement



Looking from living room to terrace; note heating grille.



Photos by Corlandti V. D. Hubbard

Stair hall, toward dining room; stair rail, treads, risers are mahogany; parapet is white maple, lacquered and waxed.



Dining room has built-in sideboard on wall not shown. Floors in master portion of first floor are finished in 6-in. mahogany planks.



Bookcases in den are mahogany. Both den and dining room were designed, to a certain extent, as backgrounds for some eighteenth-century furniture which the owners possessed.



Master bedroom; much of the furniture is built-in. Wardrobe closets occupy one wall.

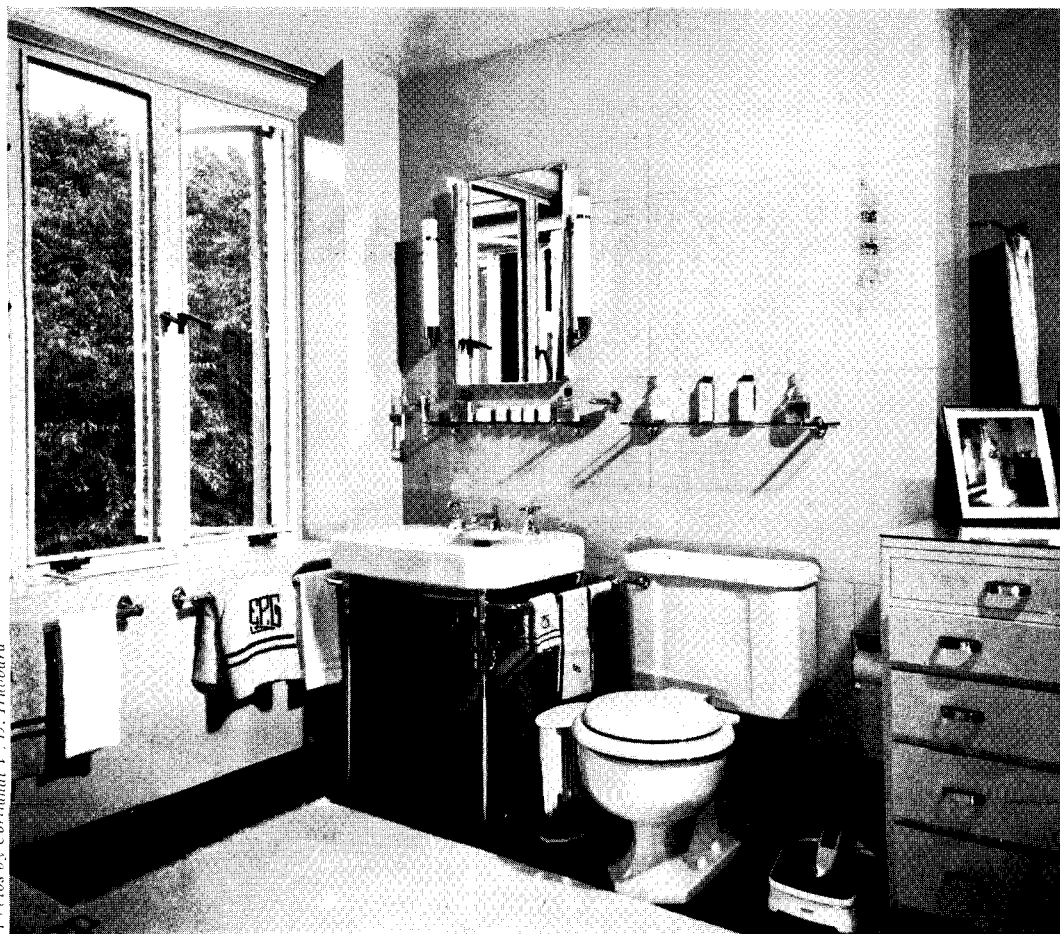

Master's bath; walls are Vitrolite. The bedroom's wardrobe closets are repeated in the bath.

Photos by Corlandt F. D. Hubbard

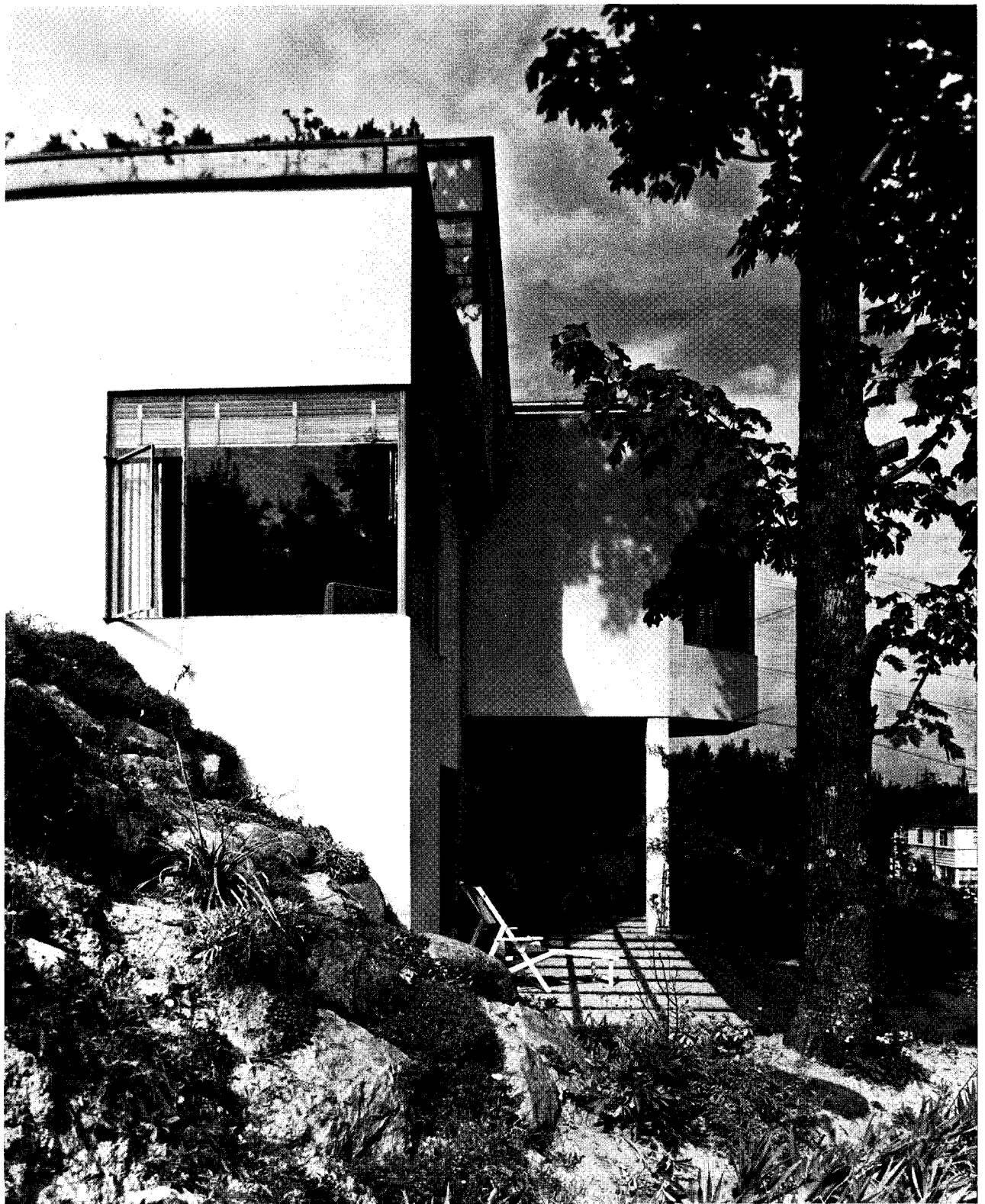

**HOUSE FOR MR. AND MRS. FRANK J. BARRETT, SEATTLE, WASHINGTON**

PAUL THIRY and ALBAN A. SHAY, Architects

**BARRETT HOUSE (continued)**

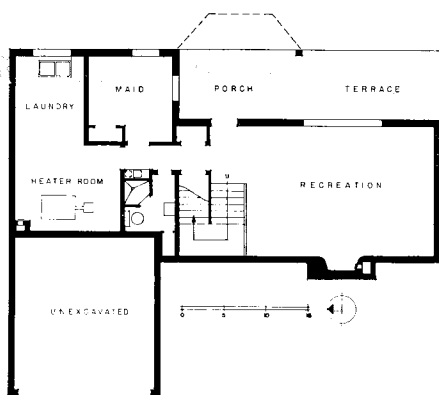
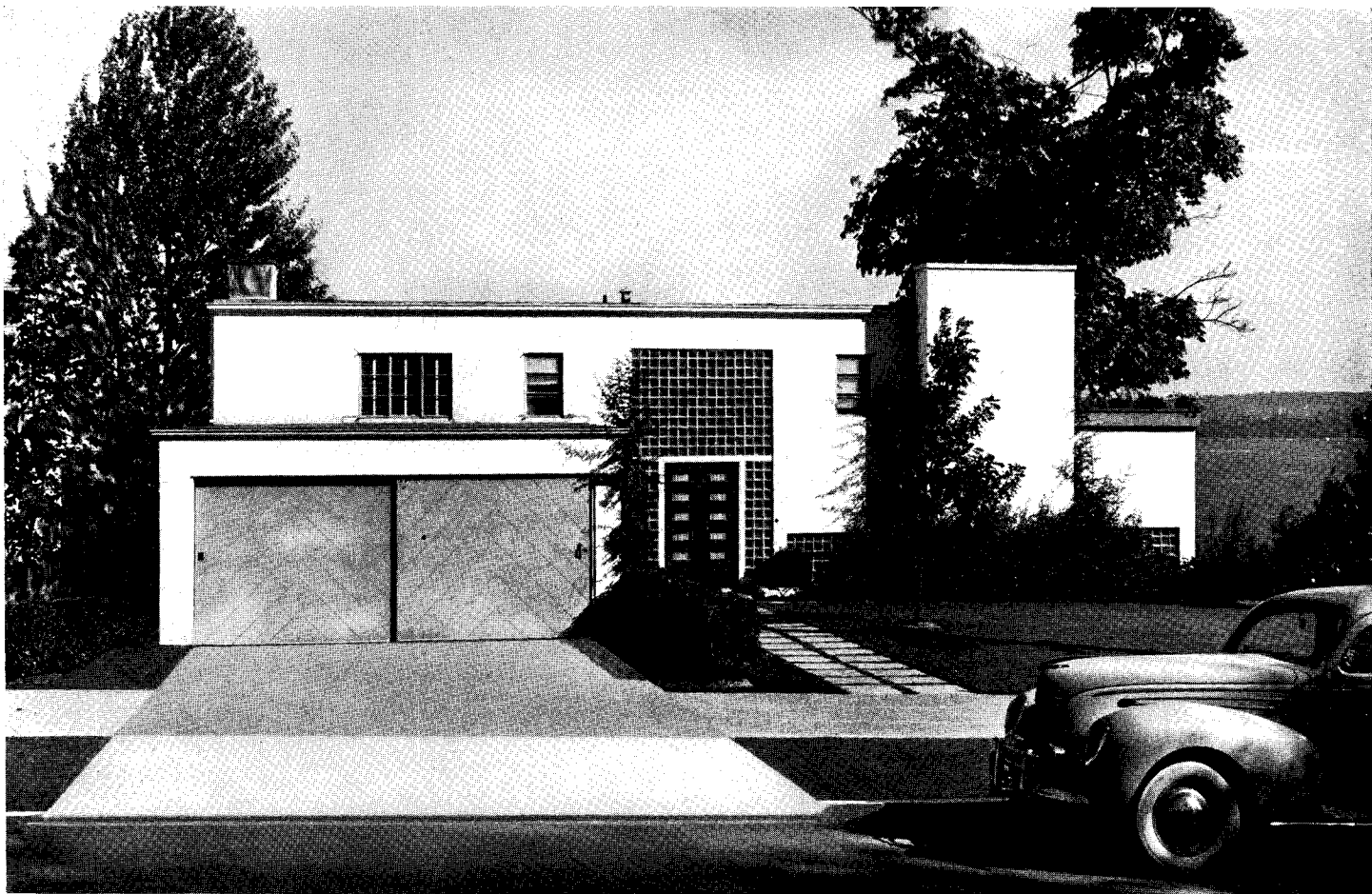

**Basement**

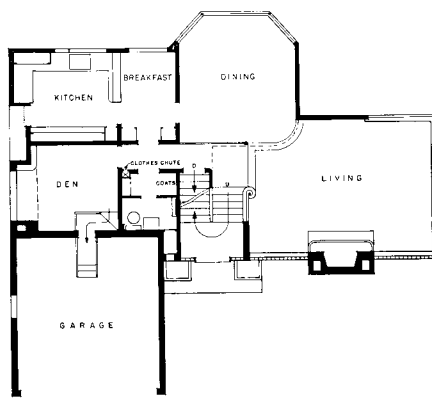

**First floor**

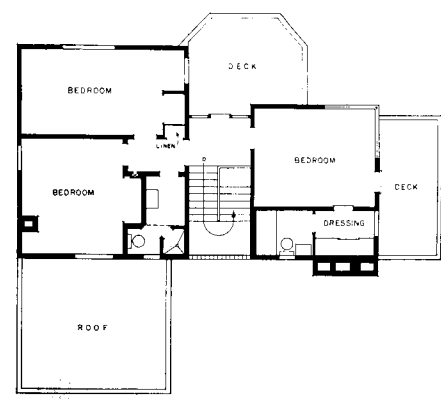

**Second floor**

INSTEAD OF PLANNING this house on a series of varying levels, as is often done for hillside plots, it was decided to use exposed portions of the basement for a laundry, maid's quarters, and recreation room. From the porch and terrace at basement level there is an extensive view over a lake. The garage floor is at a slightly higher level than those of

the remaining rooms on the first floor. Construction of walls of basement and portions of upper stories is concrete. Remainder of walls is of frame. All exterior walls are stuccoed. Basement floor is concrete; first floor is concrete slab on prefabricated concrete joists; second floor and roof are wood-framed. Roof is surfaced with built-up roofing

and insulated with Reynolds Metallation. Gutters are of wood. Windows are steel sash. Interior plaster is U. S. Gypsum.

Heat is supplied by a specially designed air-conditioning system. Crane Co. plumbing fixtures are used. A package receiver is built-in beside the recessed kitchen entrance.

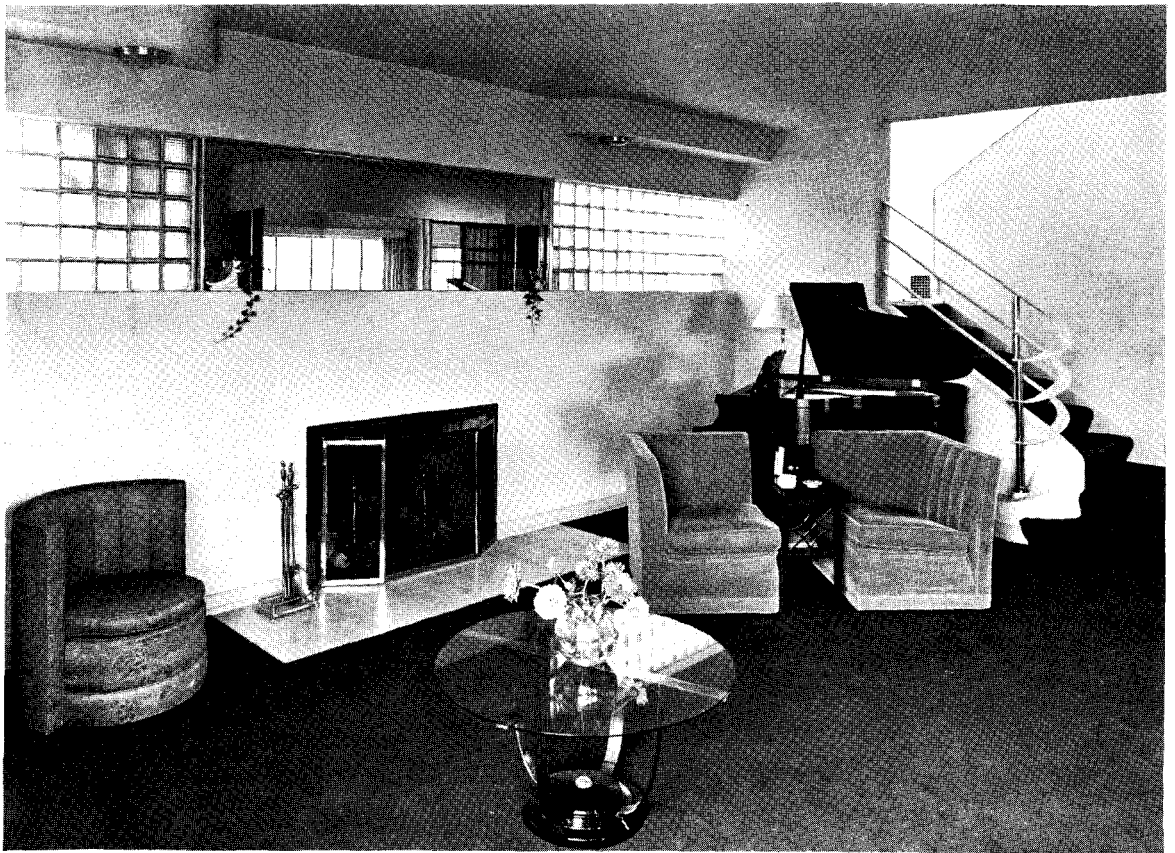

Fireplace side of living room, showing built-in soffit lights above.

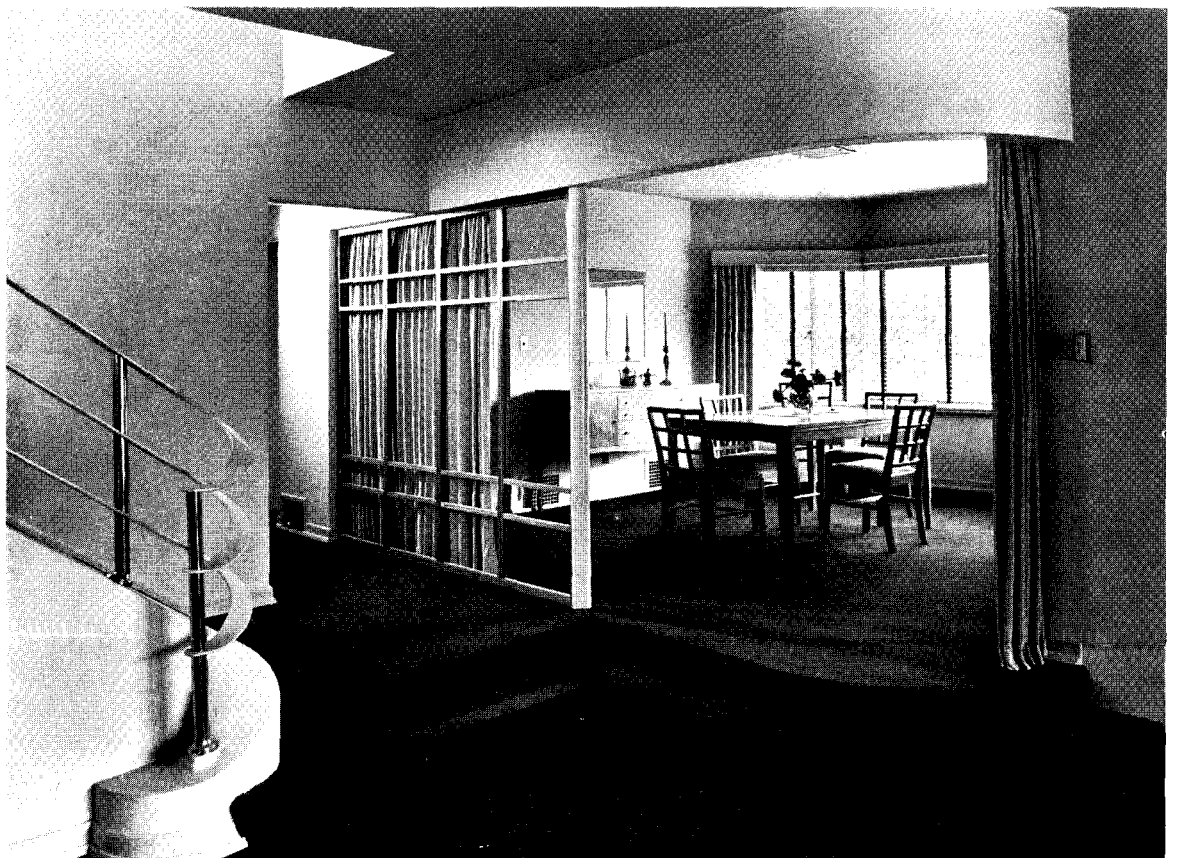

Change of level, furred beam, curtains, and lattice segregate the dining room.

# CALIFORNIA HOUSE WITHOUT A BASEMENT

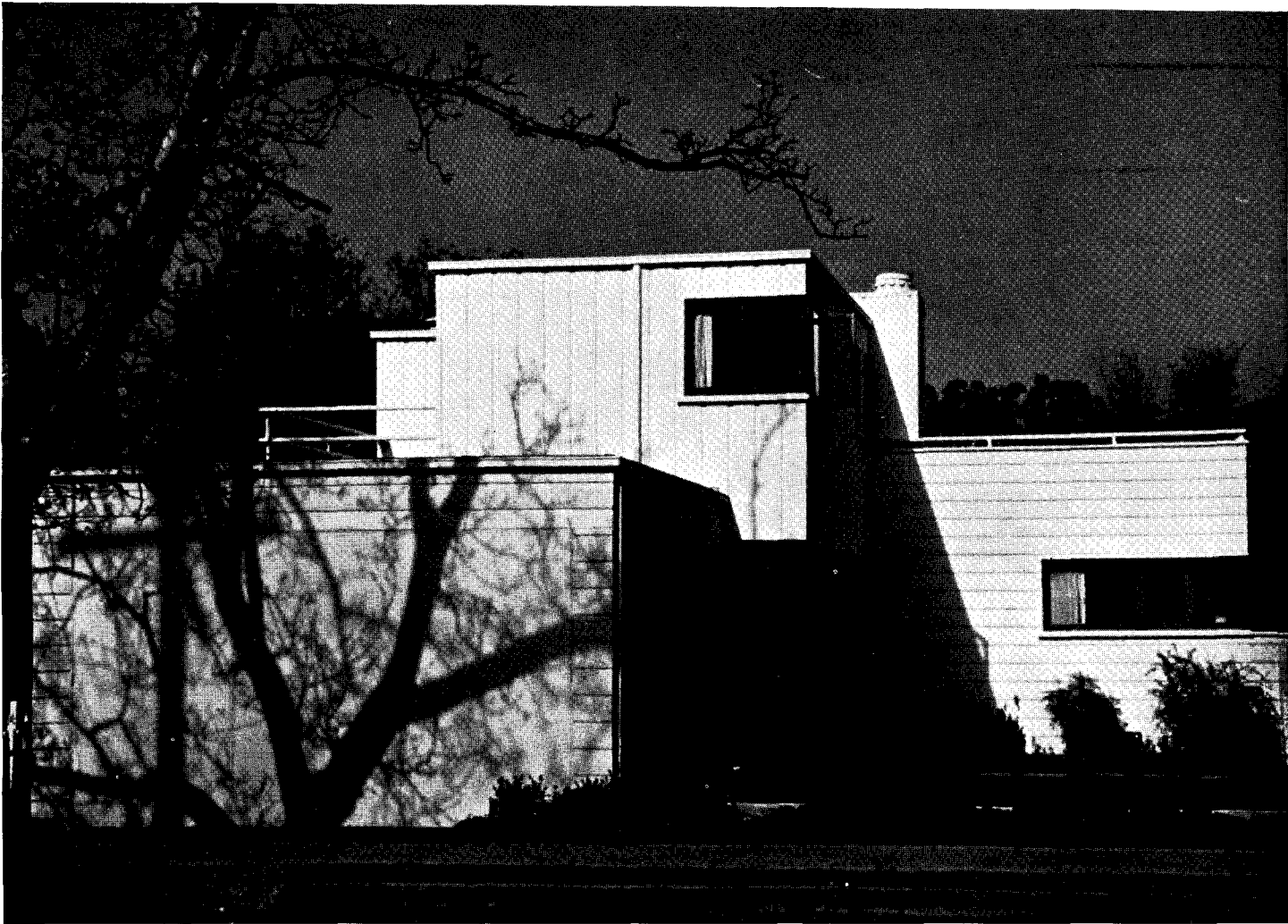

**HOUSE FOR MR. E. S. KENYON  
HAYWARD, CALIF.**

GEORGE PATTON SIMONDS, Architect



View of  
kitchen

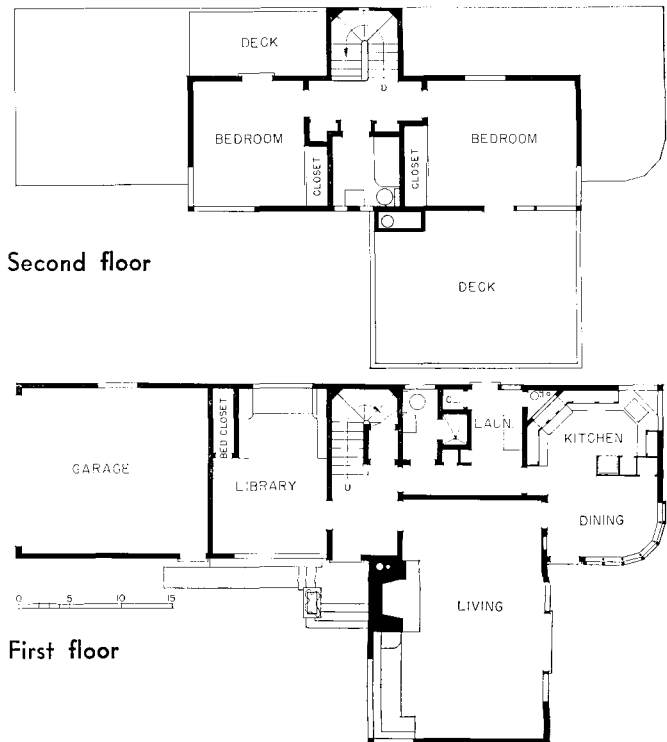



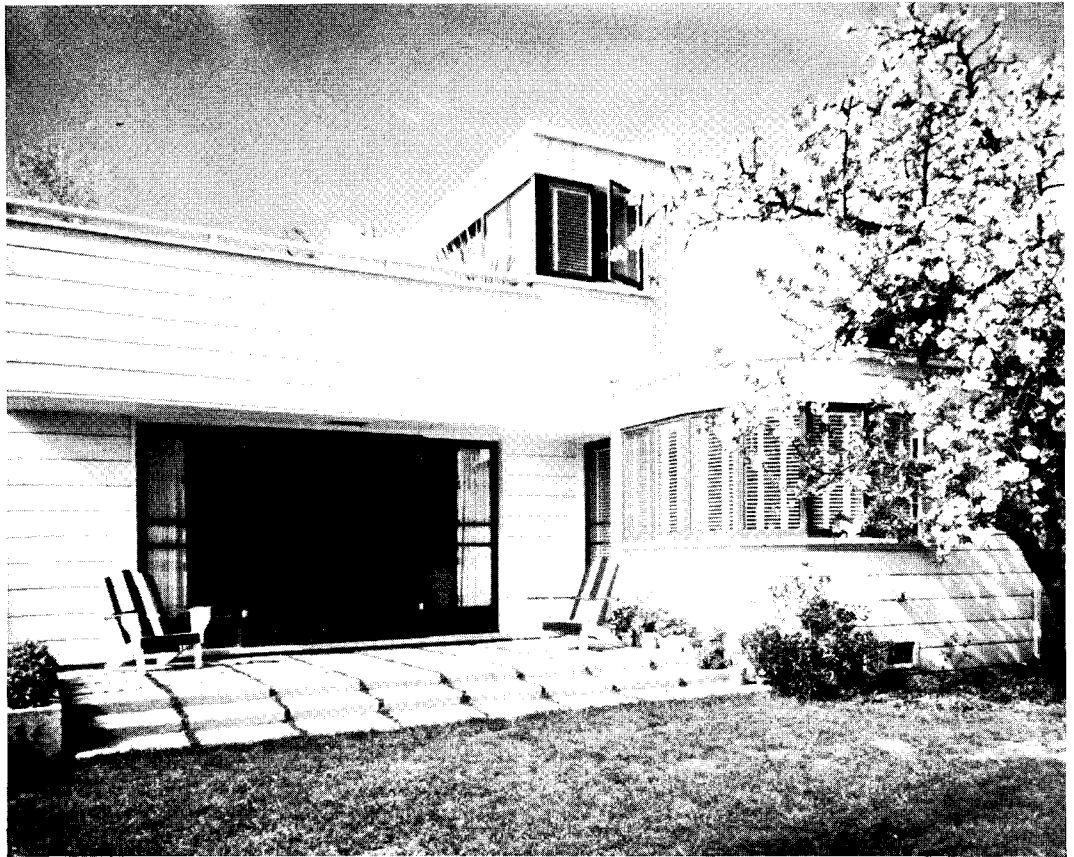

Living terrace on east side of house overlooks a creek at the rear of the property.



Living-room walls and ceiling are Ponderosa pine plywood with mahogany inlay.

THIS HOUSE has no basement with the exception of a heater room beneath the entry, reached from an access door under the stairs. Construction is frame, with redwood exterior siding and gutters, painted white. Roof is Certainteed, built-up. Floors are oak. Armstrong's linoleum is used on kitchen, dinette, laundry, and bathroom floors and kitchen drainboard.

Heating is forced warm air, with a gas-fired furnace. In the kitchen an ingenious arrangement draws air from subfloor areas to pass over the electric refrigerator's condenser coils; the warmed air passes through a towel-drying cabinet before it is exhausted through the roof.

# ONE-STORY WOOD HOUSE IN OREGON MOUNTAINS



Photos by W. Boychuk

## HOUSE FOR J. F. SUTOR, PORTLAND, OREG.

A. E. DOYLE & ASSOCIATE, Architects

WINDOW GROUPINGS in the hall, living room, and principal bedroom of this house command an excellent view over a wide valley, with the Cascade Range, Mt. Adams, and Mt. Hood in the distance.

Construction is wood frame. Exterior walls are covered with rough spruce siding, and the roof with rough cedar shingles laid  $1\frac{1}{2}$  in. to the weather. The soffits of roof overhangs are finished with plywood. Plaster surfaces throughout the interior of the house are white sand-floated. Portions of the interior are surfaced with straw paper, fir panels, Flexwood, and mirrors.

The usual services, including a two-car garage, are contained in the cellar. It is noteworthy that the living-room interior is boldly divided into two almost equal parts by the fenestration and by built-in furniture. The division permits furniture to be grouped intimately around the fireplace; and the view is not only brought into the living room, but also, since curtains are substituted for the wall between dining room and living room, into the dining room as well. Kitchen, pantry, and maid's room form a compact unit, with the maid's bath accessible from the entrance hall, for use as an additional lavatory.

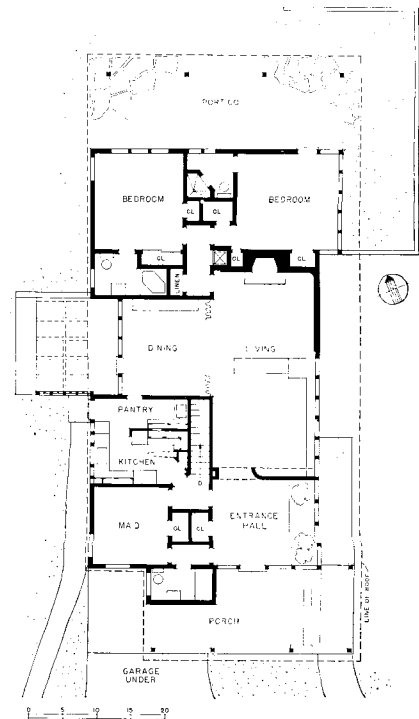



Detail at entrance. Rough spruce timbers and siding are treated with iron chloride stain and with Minwax.



View from west, showing dining terrace in relation to service portion of the house.



Entrance porch. The entire house is planned to take advantage of a commanding view of the Cascade Range.



Entrance hall has two walls entirely glazed. Curved wall is surfaced with gold Japanese straw paper. Ceiling is of 3-in. woven fir slats.

Photos by W. Boychik



Walls at fireplace end of living room are boldly treated with matched Zebra Flexwood.



Mirrored wall in dining room reflects light from terrace and, when curtain is open, from living room.

# BRICK HOUSE OVERLOOKING ROCKY MOUNTAINS

Photos by Hedrich-Blessing

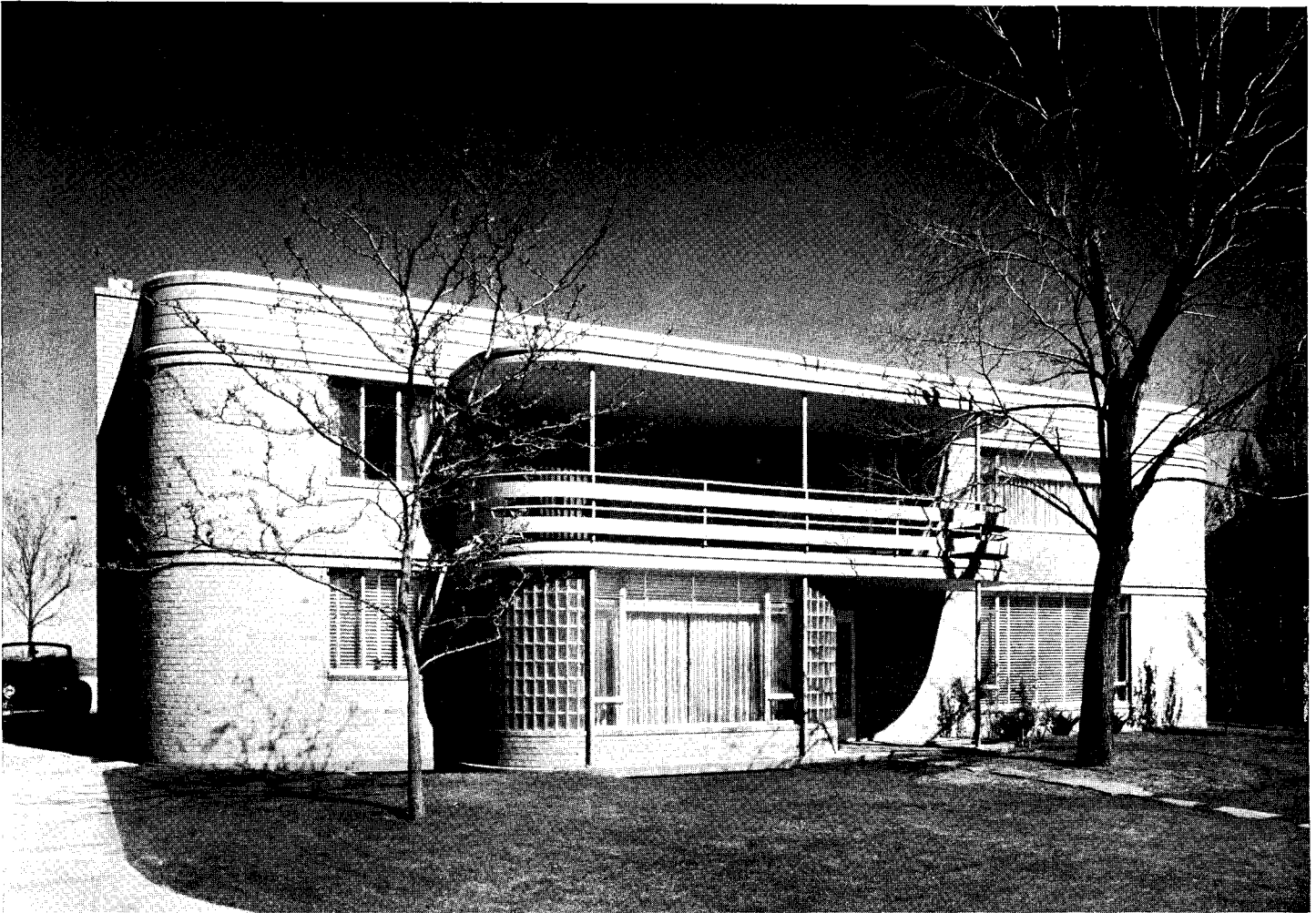

## HOUSE FOR MRS. H. M. THORP, DENVER, COLO.

BURNHAM HOYT, Architect

WALLS ARE brick to second-floor window heads, wood above, insulated with rock wool. Roofs are surfaced with Elaterite. Owens-Illinois glass brick is used in dining room. Most floors are Sealex linoleum. Plumbing fixtures are Crane; copper pipe, Mueller; heating system, forced warm air, gas-fired, with Bryant furnace and Minneapolis-Honeywell control. Elgin steel cabinets are used in kitchen.

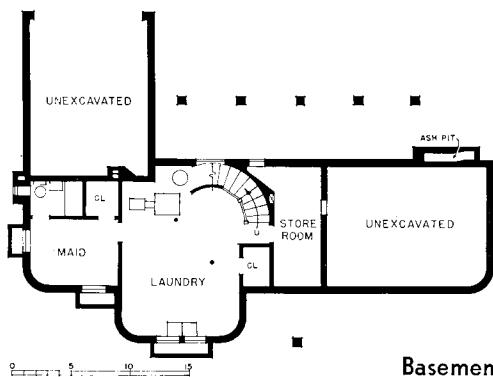

Basement

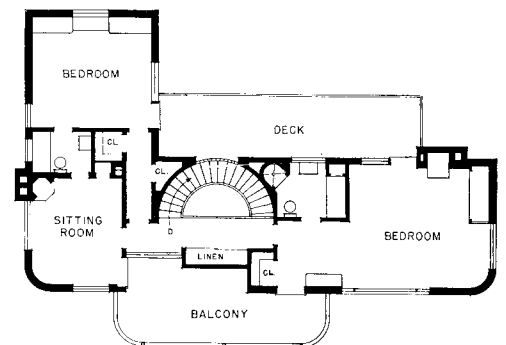

Second floor

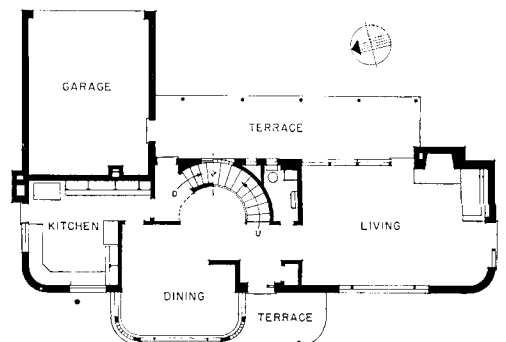

First floor



View from rear, showing living terrace which has colored cement floor, canvas-covered deck over.

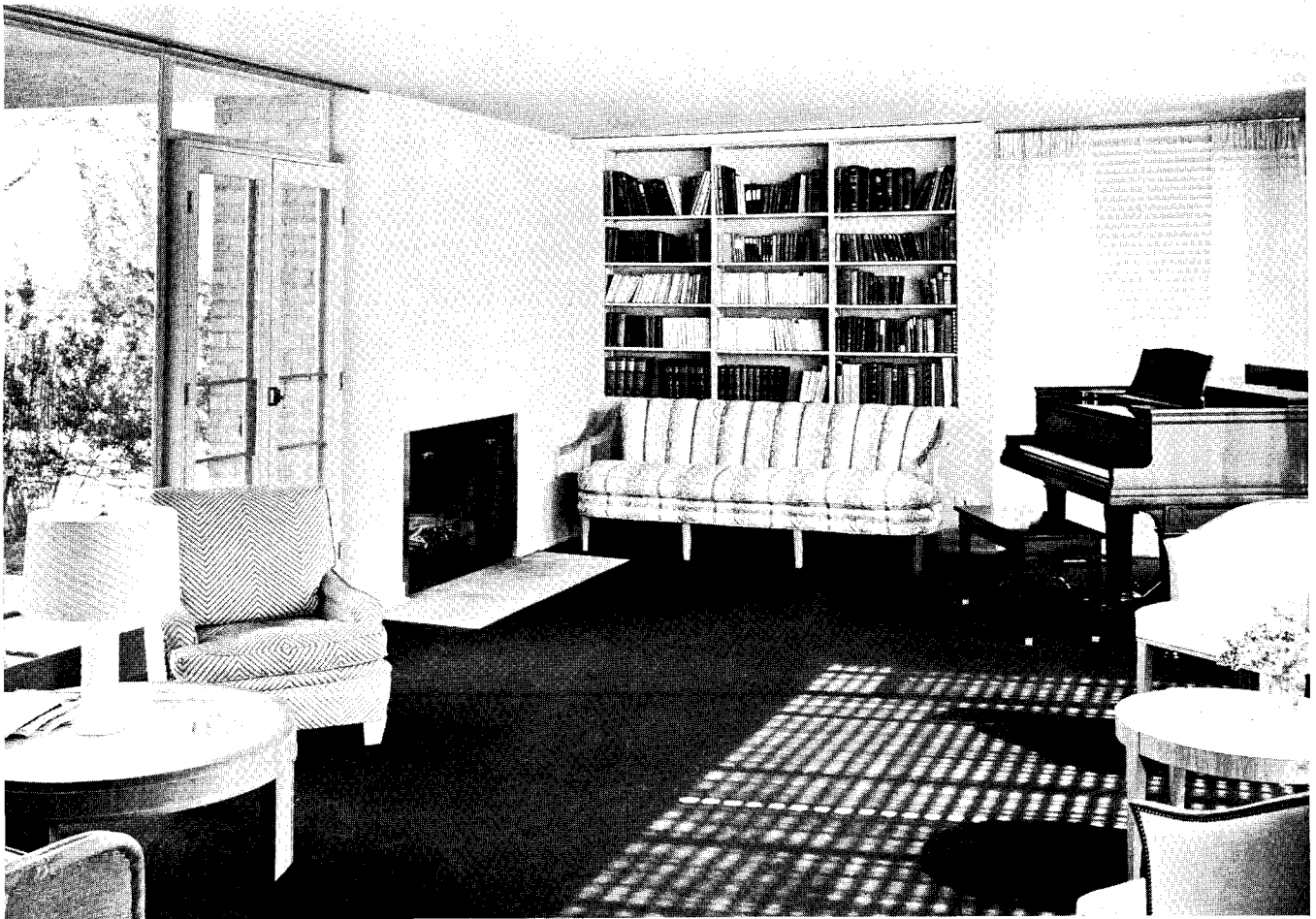

Living-room fireplace has steel angle facing. Floor is oak.

# ARTISTS' HOUSE IN ILLINOIS

Photos by Hedrich-Blessing

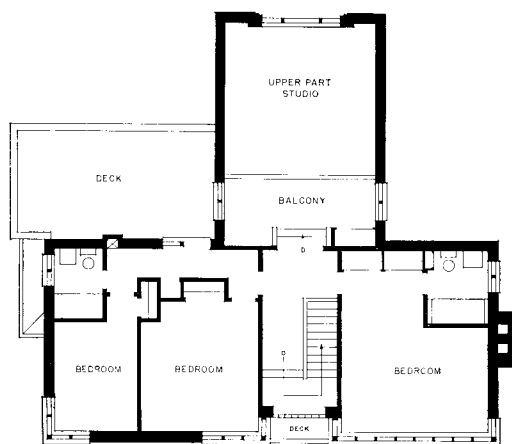

Second floor

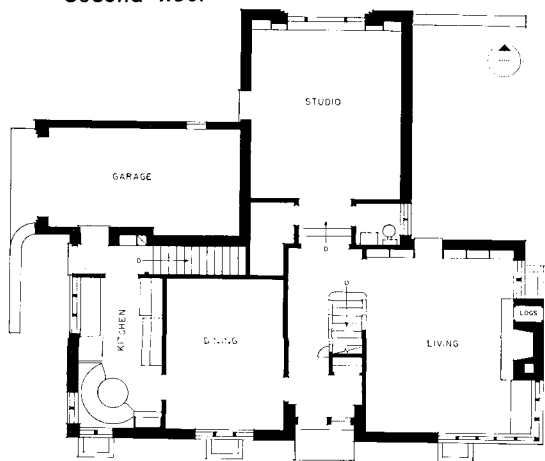

First floor

## HOUSE FOR MR. AND MRS. SAVIN HIGHLAND PARK, ILL.

DUBIN & DUBIN, Architects

PLANNING REQUIREMENTS included provisions for a family of two adults—both artists—and one child. A two-story studio, darkroom, and large outdoor living room were needed. Dark-room is under the balcony; outdoor living room is in north-east angle of house; the studio balcony contains sleeping accommodations for guests.

Exterior walls are brick, backed with slag-concrete blocks and insulated with Cabot's Quilt secured to furring. Roof is cedar shakes, insulated with 4-in. rock-wool batts. Metal work is copper. Interior walls and ceilings are partly sand-floated plaster, partly plywood. Plumbing piping is copper, asbestos covered. Kitchen sink is Standard; closets, Briggs; lavatories, Kohler. Heat is supplied by a humidified forced warm-air Waterman Waterbury unit, with Williams oil burner. Electric wiring was specified to conform to standards of the American Institute of Electrical Engineers.





Living room, from entrance hall. Plywood on walls is quarter-sawn white oak. Plaster has silica sand-floated finish.

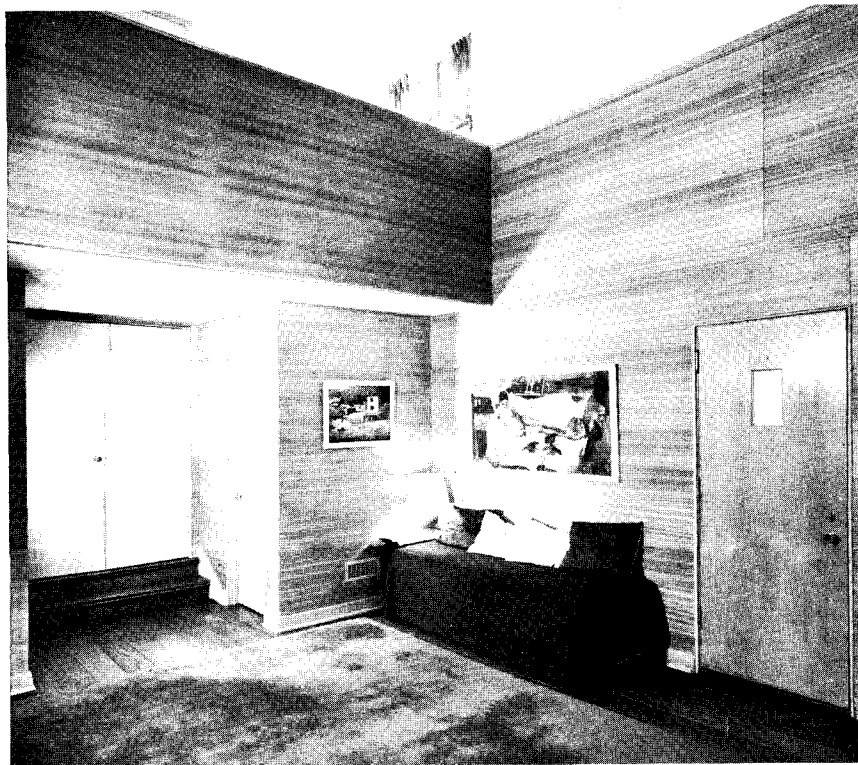

Studio walls are finished with Luan plywood.



In dining alcove, plywood is red birch.

# CONCRETE HOUSE IN MASSACHUSETTS

Photos by Ezra Stoller



## HOUSE FOR ALBERT A. LIST, FALL RIVER, MASS.

SAMUEL GLASER, Architect

FOUNDATIONS ARE concrete, walls cinder block, and first and second floors concrete on precast joists. Attic floor and partitions are wood-framed, with wire lath and U.S.G. plaster. Exterior walls have Reynolds Metallation between double furring strips. Roof is wood-framed, insulated with Metallation and U.S.G. rock wool, and Anaconda lead-coated copper surface. Exterior doors and windows are Detroit steel sash. Interior doors are Johns-Manville, flush-panel, birch veneered. Schlage hardware is used. Walls, ceilings, and pine woodwork are painted; natural wood is stained. Electric wiring is G-E B-X cable and conduit. Special built-in direct and indirect lighting fixtures are by Kurt Versen. Air-conditioning system, refrigerator, and electric stove are by General Motors; kitchen sink, with dishwasher and garbage Disposall, is by G-E. Remainder of plumbing fixtures are Crane. Pipe is Anaconda copper.

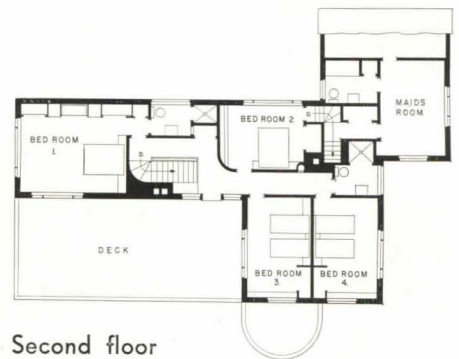

Second floor



Basement

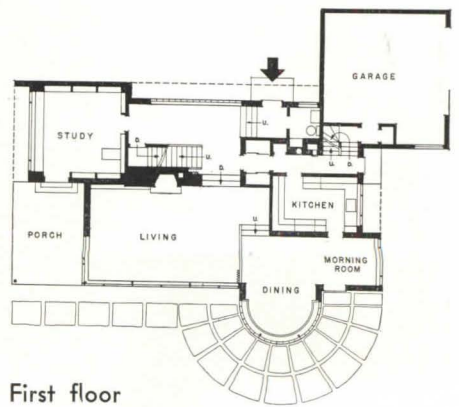

First floor

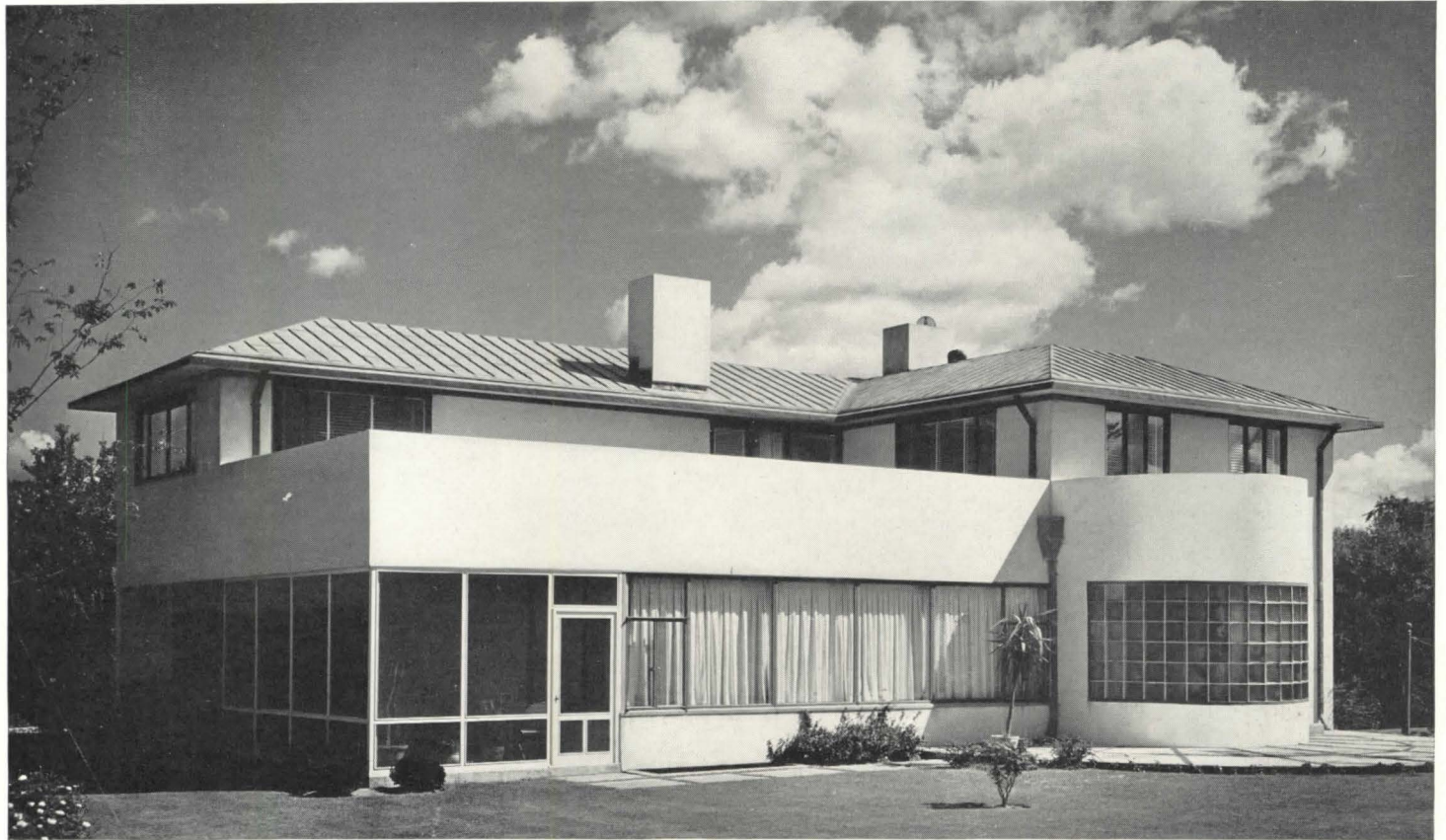

Garden side of house; concrete-surfaced play yard shown on facing page was required by the owner for his children.

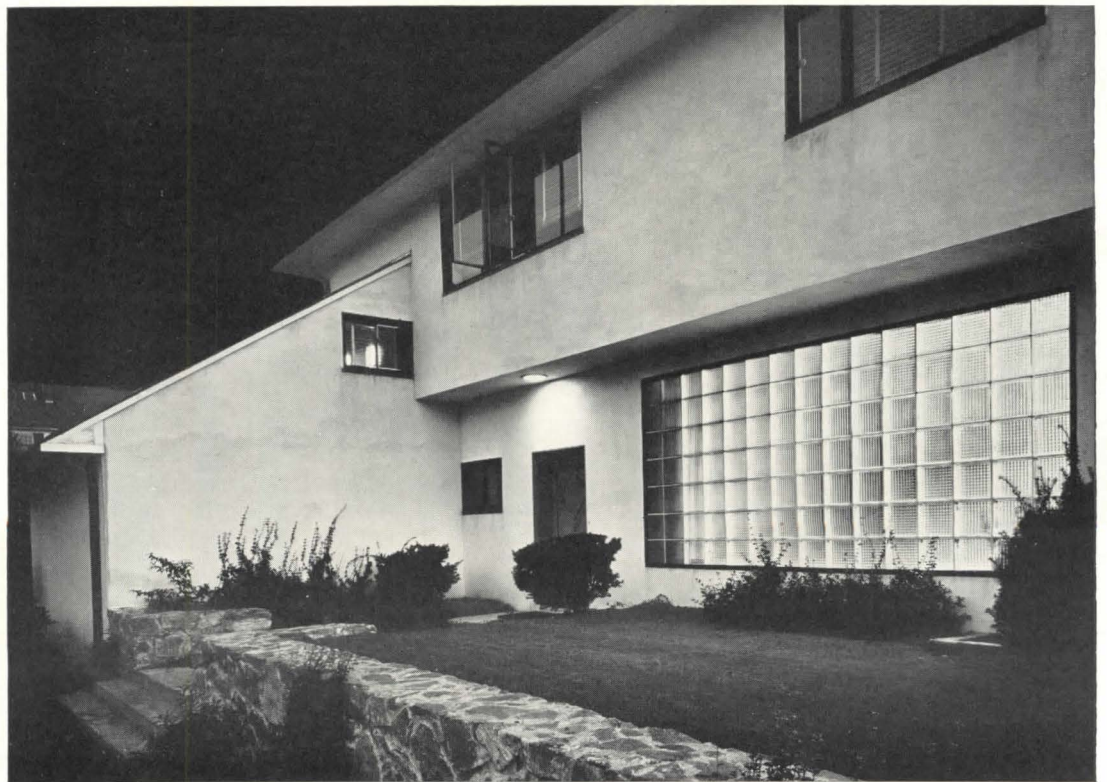

Entrance front; the glass-block window in hall admits light yet maintains privacy.



Interior of living room. Entire first floor is surfaced with Armstrong rubber. Walls and ceilings are painted.



Living-room fireplace is faced with Belgian black marble. Stairs are concrete with aluminum rails. Cabinet work is rosewood.



Dining-room bay is of Corning glass block, with a Vitrolite-faced flower box beneath.

Photos by Ezra Stoller