

When you need copies...



You need OZALID!

Duplicate in seconds! Simply put your original against a sheet of Ozalid material and feed into the Ozalid print-making machine. An intermediate step is necessary only with absolutely opaque originals.

Change in seconds! Make alterations or additions on your translucent Ozaprint... transfer title blocks or even whole sections... then you can use the changed print as a master!

Combine in seconds! Make prints of your material on transparent Ozalid film, overlay them on a sheet of Ozalid material (paper, cloth, foil, or film), feed into the Ozalid machine for a composite print in 25 seconds!

Replace in seconds! Use any translucent Ozalid print for a duplicate master. Make shop or field prints on Ozaplastic. Clean with a damp cloth.

Color Code in seconds! Ozalid materials offer black, blue, red, or sepia lines on white or tinted backgrounds. Light, standard, and heavyweight papers are available for any job.

Anyone can make prints with Ozalid in seconds! Reproduction can be made any length and almost any width. All Ozaprints are made in the same manner—all are delivered dry, positive, and ready to use.

Write on your letterhead for a **FREE** booklet that tells the full Ozalid story. Or consult your classified directory for local distributor.

Don't copy... use **OZALID!**

Johnson City, N. Y. Dept. 69
A Division of General Aniline & Film Corp.
"From Research to Reality"

CECO

An Invitation

CECO invites members of the Building Industry to write for help on construction problems. Send for any one or all of the bulletins listed below. Check those you want and mail coupon today.

R. S. V. P.

CECO STEEL PRODUCTS CORP.—AR-7
5601 W. 26TH ST., CHICAGO 50, ILL.

- Concrete Joist Construction Steel Joists
 Steel Windows and Doors Screens and Storm Windows

NAME _____
TYPE OF BUSINESS _____
FIRM _____
ADDRESS _____
CITY _____ ZONE _____ STATE _____

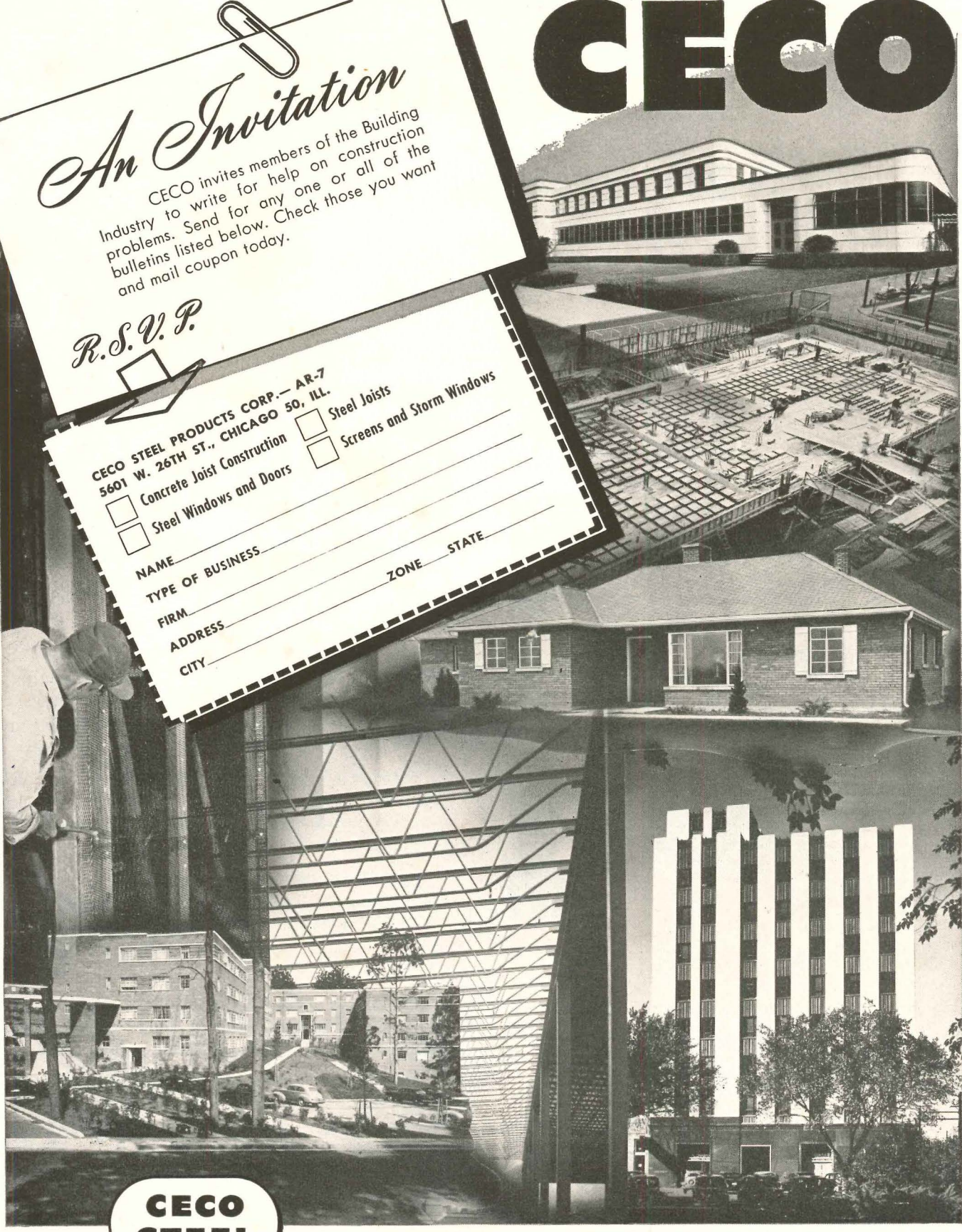

**CECO
STEEL**

In construction products **CECO ENGINEERING**

covers the construction field

**One source, one order fills
your metal building needs . . .**

With metal products for every building purpose, Ceco indeed covers the field. And whatever your building need, one order takes care of it all. Ceco can supply you with the finest in engineered steel products for monumental buildings, for institutional buildings, for commercial buildings. Ceco metal products also fit economically into the small home—cut fire hazards—increase building strength—reduce installation costs. For Ceco builds small with the same engineering precision they build big. Years of pioneering . . . years of on-the-job experience in the construction field have given Ceco engineers a sure grasp of all building problems. Ceco's plants, too, are strategically located to give fast coast-to-coast service. For detailed information, accept Ceco's invitation. Write for FREE Bulletins on Ceco Products today.



Ceco literature is full of installation tips and product data. It is FREE to all building men. Fill out coupon and mail today. Also see Ceco literature in Sweet's Architectural and Builders Files.

CECO STEEL PRODUCTS CORPORATION

General Offices: 5601 West 26th Street, Chicago 50, Illinois

Offices, warehouses and fabricating plants in principal cities

makes the big difference

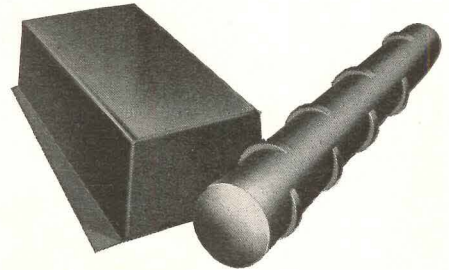

CONCRETE JOIST CONSTRUCTION

Building costs are cut with Concrete Joist Construction. Concrete is kept to a minimum for any span or live load. Removable Meyer Steelforms permit using the forms again and again. Above is pictured a Meyer Steelform and Reinforcing Bar.

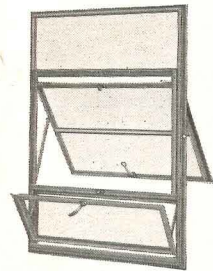

STEEL WINDOWS

Full line—monumental, industrial and residential. Steel windows are economical. They cannot stick, warp or swell. They afford ample view, admit more daylight . . . are fire-resistant, provide means of escape in emergency.



STEEL JOISTS

Ceco Open-Web Steel Joists offer the most economical method of building. They assure fire and sound resistive structures. They're light, easy to install and self-centering. Ducts, wiring and piping can be concealed.

Partial List of Ceco Products

METAL RESIDENCE CASEMENTS • INDUSTRIAL WINDOWS AND DOORS
• METAL FRAME SCREENS • ALUMINUM FRAME STORM WINDOWS •
ALUMINUM COMBINATION STORM WINDOW AND SCREEN UNITS
• METAL LATH AND ACCESSORIES • STEELFORMS • REINFORCING
BARS • STEEL JOISTS AND ROOF DECK • HIGHWAY PRODUCTS •
CORRUGATED ROOFING • ATTIC AND ROOF VENTILATORS

Avoid "Weak Links" in your piping systems—

use **WROUGHT IRON NIPPLES**

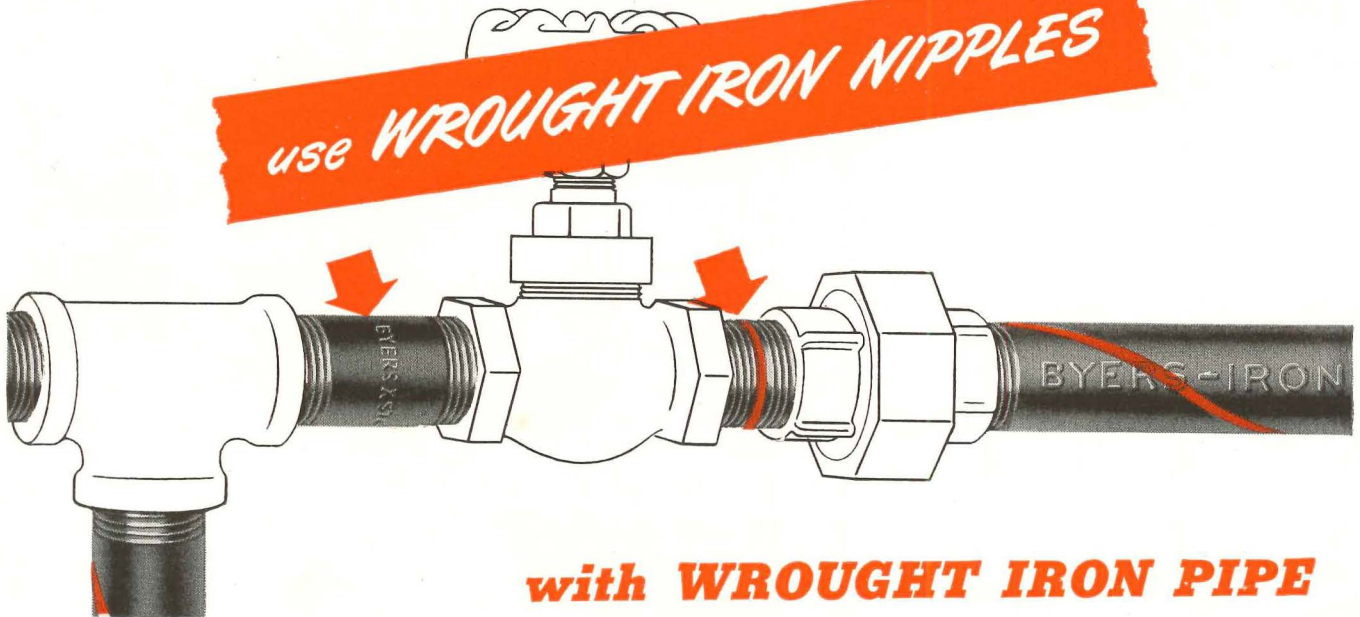

with **WROUGHT IRON PIPE**

When you specify wrought iron pipe to lick some corrosion problem, assure 100% protection by specifying that the pipe nipples also must be wrought iron. Neglect of this simple precaution will leave weak spots in your lines, and set the stage for maintenance headaches.

METHOD OF SPECIFICATION

Merely stating that the piping "system" is to be black or galvanized wrought iron is not enough; the use of wrought iron nipples should be specifically designated. This may be done by requiring that the wrought iron nipples shall be made of pipe conforming to the requirements of A.S.T.M. Specification A72-45, Federal Specification WW-P-441a, Navy Specification 44P11k, or any accredited proprietary specification.

WIDE RANGE OF SIZES

Byers Wrought Iron nipples, both standard weight and extra strong, are available in a wide range of sizes and lengths, either black or galvanized. They are manufactured from new, tested, full-weight wrought iron pipe in accordance with the standards established in the specifications of leading technical organizations. All nipples are furnished with right-hand threads unless otherwise specified; nipples with right and left-hand threads are also available. Nipples are furnished "close" or to length as specified.

IDENTIFICATION

The word "Byers" and the weight—either "Std." or "X Stg." are machine stamped around the circumference of Byers Wrought Iron nipples. On close nipples, where it is impractical to stamp on the threads, a red band is used. These markings provide quick, positive identification of Byers Wrought Iron nipples, and help to avoid any danger of accidental substitution of non-durable nipples in the line.

IN WELDED SYSTEMS USE WROUGHT IRON WELDING FITTINGS

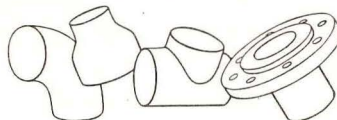

Wrought iron welding fittings are available in a wide range of types and sizes from leading fitting manufacturers. Just contact your supplier.

Wrought iron nipples are also available from a number of manufacturers. The identification used on such nipples may be learned by consulting the supplier.

INHERENT CORROSION RESISTANCE

The superior resistance of wrought iron nipples comes from the unique composition and structure of the material. Tiny threads of glass-like silicate slag, distributed through the body of high-purity iron, halt and "detour" corrosive attack, and so discourage pitting. The fibers also anchor the initial protective scale, which shields the underlying metal.

The best guide in applying wrought iron is a knowledge of its character and properties. The complete story is presented in the booklet, "The ABC's of Wrought Iron". Ask for a copy.

A. M. Byers Co., Pittsburgh, Pa. Established 1864. Boston, New York, Philadelphia, Washington, Atlanta, Chicago, St. Louis, Houston, Salt Lake City, Seattle, San Francisco. Export Division: New York, N.Y.

CORROSION COSTS YOU MORE THAN WROUGHT IRON

BYERS
GENUINE WROUGHT IRON
TUBULAR AND HOT ROLLED PRODUCTS
ELECTRIC FURNACE QUALITY ALLOY AND STAINLESS STEEL PRODUCTS

ARCHITECTURAL RECORD



Copyright 1949 by F. W. DODGE CORPORATION, with all rights reserved • Publishing Director, Magazine Division, H. Judd Payne • **EDITORS:** Editor-in-Chief: Kenneth Kingsley Stowell, A.I.A.; Managing Editor, Emerson Goble; Associate Editors, Robert E. Fischer, Florence A. van Wyck; Washington News, Ernest Mickel;

Contributing Editor, Arthur McK. Stires; Western Editor, Elisabeth Kendall Thompson; Special Editorial Representative, Western Section, William C. Rodd; Associate in South America, Edmund J. Whiting, A.I.A.; Editorial Assistants, Jeanne Davern, Cornelia Reagan • **ART DEPARTMENT:** Myron S. Hall, 3rd, Director; Frances Torbert, Assistant; Sigman-Ward, Drafting • **CONSULTANTS:** Industry Relations Consultant, Thomas S. Holden; Statistical Consultant, Clyde Shute; Building Economics Consultant, Norbert Brown; Field Research Consultant, Clifford Dannels, Jr.

Architectural Record (combined with American Architect and Architecture) is published monthly by F. W. Dodge Corporation, 10 Ferry St., Concord, N. H., with Editorial and Executive Offices at 119 West 40th Street, New York, N. Y. Western Editorial Office, 2813 Channing Way, Berkeley, Calif. Thomas S. Holden, Pres.; Howard J. Barringer, Vice-Pres. and Treas.; Irving W. Hadsell, Vice-Pres.; Chauncey L. Williams, Vice-Pres.; Sanford D. Stockton, Jr., Secy.; Walter F. De Saix, Asst. Treas.; Edwin H. Freed, Asst. Treas. Member Audit Bureau of Circulation and Associated Business Papers, Inc. Architectural Record is indexed in Reader's Guide, Art Index, Industrial Arts Index and Engineering Index. Subscription rates: United States and Possessions, Canada, Cuba, Mexico, Central and South America, and Spain, \$4.50 the year, \$7.50 for two years, \$9 for three years; elsewhere, \$6.50 the year, \$11.50 for two years, \$15 for three years. Single copy, \$1. Circulation Manager: Marshall T. Ginn. Every effort will be made to return material submitted for possible publication (if accompanied by stamped, addressed envelope), but the editors and the corporation will not be responsible for loss or damage. Other Dodge Services: Real Estate Record & Builders' Guide, Sweet's Files, Home Owners' Catalogs, Dodge Reports & Dodge Statistical Research Service.

IN CLOISTERED HALLS OR DRAFTING ROOMS	83
An Editorial . . . by Kenneth K. Stowell	
PLANNERS OF AMERICA'S LARGEST PORT	84
The Port of New York Authority is a Highly Specialized Regional Planning Agency Employing 300 Architects, Engineers and Draftsmen	
MEMENTOS OF MEXICAN BEAUTY AND HOSPITALITY	96
From the Post-Convention Tour of the American Institute of Architects, March 19-27, 1949	
PITTSBURGH REDISCOVERS AN ARCHITECT PIONEER, FREDERICK SCHEIBLER	98
From a paper by John Knox Shear	
BUDGET HOUSE NEAR PITTSBURGH	101
Residence of Mr. and Mrs. Robert Kirkpatrick, Bradfordwoods, Pa. Mitchell & Ritchey, Architects	
NATION'S BUILDERS REPORT ON COSTS AND MATERIALS	104
ECONOMY AND EFFICIENCY IN SPALDING'S CONSOLIDATED PLANT	106
Williamsett, Mass. Lathrop Douglas, Architect; Guy B. Panero, Engineer; John B. Harris Associates, Builders	
WELL DESIGNED COMMERCIAL BUILDING IN MEXICO	110
Vladimir Kaspé, Architect. Mexico City, D. F.	
BUILDING TYPES STUDY NO. 151 . . . BUILDING FOR ATHLETICS AND RECREATION	116
Prepared under the Editorial Direction of Frank G. Lopez	
PROJECTS	
Stadium for All Municipal Functions, Kinston, N. C. John J. Rowland, Architect; James M. Simpson, Associate	122
Seattle High School Memorial Football Stadium. George W. Stoddard & Associates, Architects and Engineers	124
Gymnasium, Lincoln Hall, Lincolnale, N. Y. Van Der Gracht & Kilham, Associate Architects	126
Gymnasium, Solebury School, New Hope, Pa. William Hunt, Designer; Morgan C. Rulon, Engineer	128
Packaged Building for Gymnasium or Recreation Center. Dynar Buildings, Dynar Corp., New York, N. Y.	131
High School Gymnasium, Flagstaff, Ariz. Edward L. Varney, William F. Cody, Frederick K. Weaver, Architects; L. W. Wiese, Structural Engineer	133
Auditorium-Gymnasium, Goshen College, Goshen, Ind. Bauer & Eash, Architects	134
Proposed Recreation Building, Weirton, W. Va. Sponsored by The Weirton Steel Co. National Recreation Association; Donald G. Kline, Planner; Caleb Hornbostel, Architect	136
ARCHITECTURAL ENGINEERING . . . Technical News and Research	139
ULTRAVIOLET AIR SANITATION	139
By L. J. Buttolph	
DOWNFEED HEATING CUTS COST IN APARTMENTS	144
By Lewis Smith	
PRODUCTS . . . for Better Building	146
TIME-SAVER STANDARDS . . . Dressing-Locker Room Suites	149
MANUFACTURERS' LITERATURE	152
THE RECORD REPORTS . . . News from the Field	7
NEWS FROM CANADA . . . By John Caulfield Smith	10
CONSTRUCTION COST INDEXES	26
REQUIRED READING	28
EMPLOYMENT OPPORTUNITIES	214
INDEX TO ADVERTISEMENTS	232
COVER: Gymnasium, Solebury School, New Hope, Pa.; William Hunt, Designer; Morgan C. Rulon, Engineer. J. H. Melford Photo	

Fine Flush Valves for Fine Buildings

For complete
information on
Watrous Flush Valves
see Sweet's Catalog

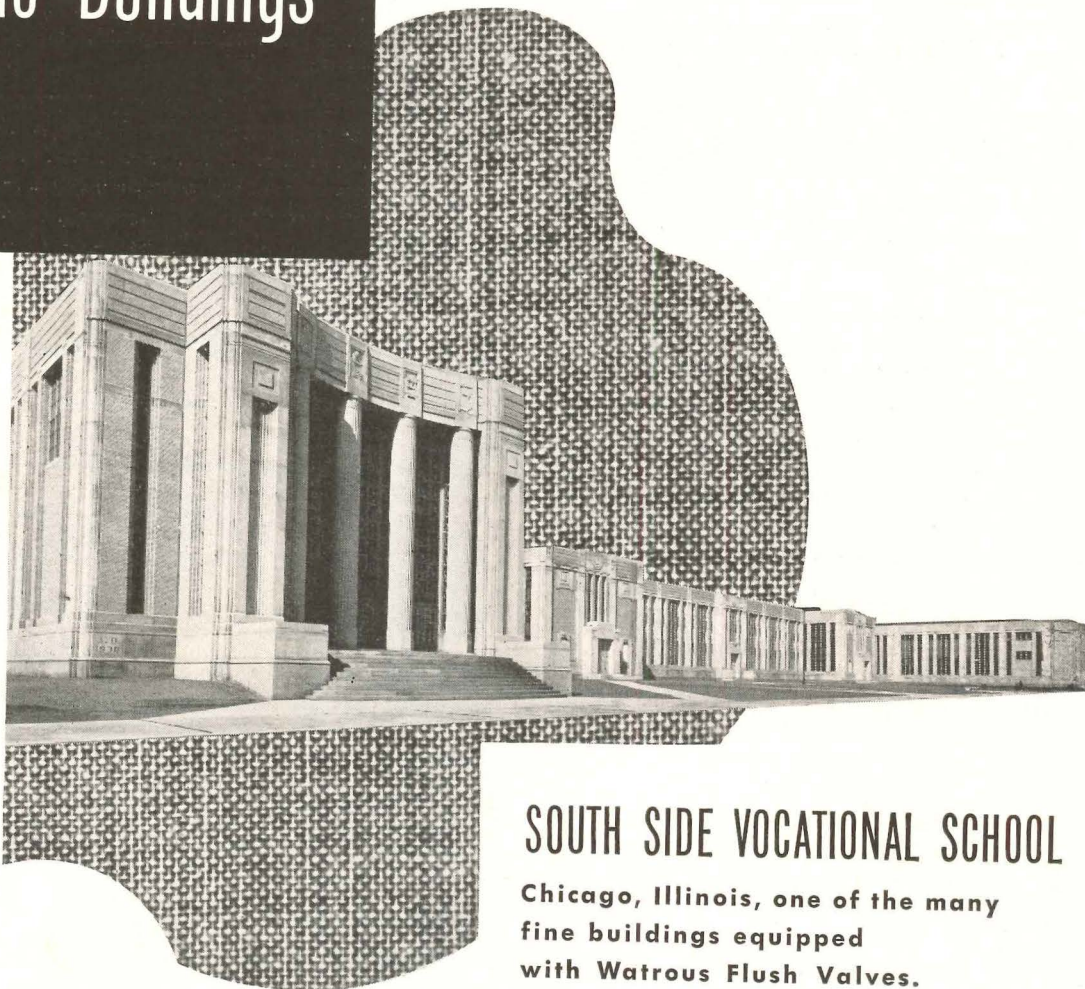

SOUTH SIDE VOCATIONAL SCHOOL

Chicago, Illinois, one of the many
fine buildings equipped
with Watrous Flush Valves.

JOHN C. CHRISTENSEN
Architect

DVORAK & GAZIN
Plumbing Contractor

Watrous



ADJUSTABLE FLUSH VALVES
BOTH DIAPHRAGM AND PISTON TYPES

THE IMPERIAL BRASS MANUFACTURING COMPANY
1240 W. Harrison Street, Chicago 7, Illinois

THE RECORD REPORTS

Floor Debate on Housing Aids Delayed by Rules Committee; Petition for Hearing Filed; Action On 'Private Enterprise' Bill Urged by Industry

Sponsors of the Administration's public housing bill (H. R. 4009) encountered more formidable opposition than they had expected during the last stages of the House fight. Perhaps they were misled to some extent by statements from the opposition made following Senate passage of S. 1070 late in April. The top-heavy Senate vote of 57 to 13 on the public housing measure prompted leading opponents to say they might give up the strong battle to defeat — the fight waged so successfully by them in former years.

But rather suddenly a new strategy developed just before the House Rules committee began talking about H. R. 4009 and trying to decide whether to give it a rule for floor debate. Rep. Brent Spence (D-Ky.), who fathered the Administration's housing principles in this first session of the 81st Congress, never expressed any doubts that the bill providing for construction of 1,050,000 public housing units in seven years would sail through the lower chamber. Evidently he anticipated only mild efforts to amend it during debate. It came as something of a surprise, therefore, when opponents led by Rep. Jesse Wolcott (R-Mich.), launched an all-out drive to defeat the legislation. This new strategy first became openly apparent when Wolcott stated the negative position before the Rules Committee.

From then on, the factions squared off and observers followed a contest reminiscent of 1947 and 1948.

During three days of hearings, Rules Committee opinion shaped up against giving the bill a go-ahead for floor consideration. This was the point at which similar legislation was killed previously after passage by the Senate on two occasions. But this time, Rep. Spence had recourse to a new parliamentary procedure adopted early in the session. (ARCHITECTURAL RECORD, Feb., 1949, p. 14) He could by-pass Rules by petitioning for recognition on the floor after 21 legislative days beyond the time the Rules Committee failed to acquiesce. And as the House wrote the new procedure, the committee chairman was assured of getting the bill before the full

House on the second or fourth Monday following the lapse of the 21 legislative days. Phrasing covered this as follows: "the Speaker shall recognize the member seeking recognition for that purpose as a question of the highest privilege."

Confirmation that the Rules group was not disposed to permit an earlier airing of H. R. 4009 on the House floor came when its chairman, Rep. Sabath (D-Ill.), advised Spence to take action under the new parliamentary method. Sabath told Spence this action should be taken the first of June. Filing of the petition at that time would place the legislation on the House floor no earlier than June 27. The Kentucky legislator again, however, expressed his confidence with these words: "In a matter of such general importance and interest I don't think the Rules committee will try to usurp the functions of the House."

But he failed to reckon with log-rolling tactics among Rules members — another surprising development that spelled delay.

Little Said about Research

Whether or not any significance attaches to the fact, there was very little said in the Rules Committee debate on Title III of H. R. 4009, the research sections. And no objection was raised to it. Similarly, before the House Banking Committee, most witnesses directed their barbed criticisms to other sections of the bill, though research in housing was more thoroughly discussed than before Rules members.

Some observers take the view that potentially there may be as much political dynamite in Title III as in other parts of the legislation. Certainly architects will have a major interest, as a profession, in the expanded research sections. This statement from the House Banking committee report pretty well summarizes what new responsibilities enactment places on the housing agency:

"This section authorizes the Housing and Home Finance Administrator to undertake and conduct a program with respect to technical research and studies concerned with the development, demonstration, and promotion of the acceptance and application of new and improved techniques, materials, and methods which will permit progressive reductions in housing costs and stimulate the increased and sustained production of housing, and concerned with housing

(Continued on page 10)



"There! Now do you still roll?"

— Drawn for the RECORD by Alan Dunn

SCIENCE'S GREATEST ACHIEVEMENT

Selectomatic . . .

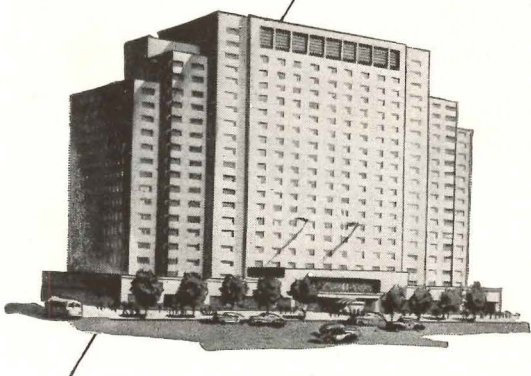
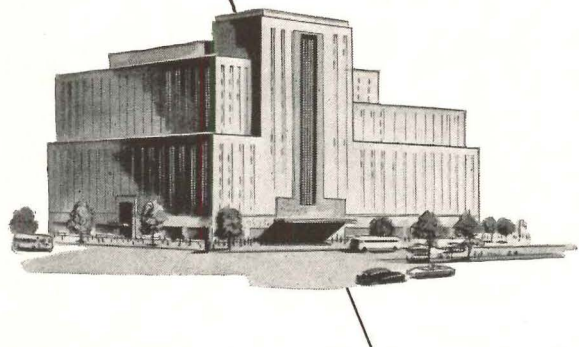
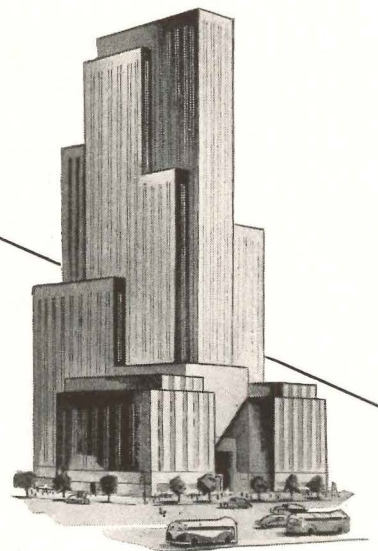

CHECK . . . AND YOU'LL SELECT

IN ELEVATOR TRANSPORTATION

Science has found the answer to a long-standing challenge . . . how to control the operation of an entire bank of elevators so that every passenger on every floor gets uniformly fast service . . . fully automatically.

• • THE FIRST ELEVATOR SYSTEM WITH THE “INTELLIGENCE” TO SOLVE ANY PASSENGER SERVICE PROBLEM . . . AUTOMATICALLY

Selectomatic is a proved elevator system that, by means of a unique electric brain, instantly and continuously senses changes in elevator demand—then automatically times and regulates the entire bank to answer each call quickly. An exclusive Westinghouse development, Selectomatic is the result of 25 years of leadership in vertical transportation engineering. Write for your copy of book B-3597. Westinghouse Electric Corporation, Elevator Division, Jersey City 4, N. J.

YOU CAN BE SURE . . . IF IT'S
Westinghouse

Selectomatic Elevators

J-98516

THE RECORD REPORTS

(Continued from page 7)

economics and other housing market data." This is an extremely broad statement in itself, and has led to fears on the part of a few that it might oversubscribe the responsibilities of the housing administrator in the field of developing new materials and methods in housing.

The research Title goes a step further in blanketing the authority of HHFA to improve and standardize building codes and strive for their more uniform administration. Standardized dimensions and methods for assembly of home building materials and equipment come under the same category. This authority was first spelled out in the Housing Act of 1948, passed in the closing hours of the 80th Congress.

Generally, the building industry regards these research provisions as being far from a serious threat to activities in its own province. It recognizes the effort of Congress to pin down HHFA to a path of close cooperation with private research interests in all its endeavors in this field.

One new argument came from the Banking Committee in its proposal of this Title; the argument that HHFA needs a laboratory of its own for carrying out these investigative functions to their logical conclusion. An excerpt from the Report explains the stand:

"The HHFA has no laboratory of its own and must utilize other government agencies and contract with eligible agencies of state and local governments, educational institutions and other non-profit organizations for laboratory research; however, such laboratories are frequently reluctant to tie up their facilities in short-term projects offering no assurance of completion. Many research problems are complex and require for their solution a series of time-consuming successive steps. This provision is therefore necessary in order that a research program can be undertaken with some assurance that the projects initiated will be carried to a conclusion."

With its responsibilities so broadly outlined, the technical division of the housing agency was reluctant to talk of detailed plans for the future in carrying out Congress' intentions. It was apparent though that the research sections as written would permit HHFA to probe

(Continued on page 12)

HOSPITAL CONFERENCE

Perhaps the biggest news from the Southern Conference on Hospital Planning is in the simple attendance figures bearing witness to the interest in this topic in the Deep South, where the federal aid program is beginning to dot the landscape with new hospitals for the "medically indigent." Some 360 architects laid down \$25 to hear a rather impressive list of speakers hold forth on various aspects of planning hospitals. This figure represents over twenty per cent of the total invitations, a pretty high batting average for a convention on a specialized topic.

There are those, of course, who simply explained the high percentage by saying that Moreland Smith, conference chairman, and his committee (with the spirit of Marshall Shaffer hovering around in the background) just did such a good job of lining up everybody, coupled with a natural southern urge to get together in Biloxi to drink "bourbon and branch water."

In any case the gathering was a notable success, the more notable because it was something just sort of thought up to speed the hospital program in the South, without any real precedent, and prob-

(Continued on page 172)

NEWS FROM CANADA

By John Caulfield Smith



Steffens-Colmer Ltd. Photo

Vancouver Shopping Center

A \$1.5 million drive-in shopping center is announced for West Vancouver by British Properties Ltd. To be Canada's largest, it will cover 11.5 acres and contain super-market, retail stores, arena and theater. Buildings will have a frontage of 1300 ft. and a floor area of 150,000 sq. ft., with parking space for 700 cars. Site plan and architecture will be in the West Coast Modern tradition.

British Properties Ltd. has extensive realty holdings in British Columbia. It is owned by the famous Anglo-Irish brewing family, Guinness.

Mortgage Loans Scale Peak

Institutional mortgage lending reached a record total of \$343 million in 1948, Central Mortgage & Housing Corporation reports in its annual review "Mortgage Lending in Canada." The previous high of \$258 million was established in 1947.

The review, which is intended to provide factual information on the volume and conditions of real estate financing, estimates that 1948's mortgage loans amounted to nearly 19 per cent of total institutional assets. While this ratio is considerably below 1939's 24.4 per cent, "the assets of the lending institutions have increased rapidly in the last decade and are currently approaching the \$4.5 billion mark." In 1939 they were \$2.8 billion.

Will Study Rental Housing

A four months study of planning standards for low-rental housing is to be undertaken by the staff of the School of Architecture, University of Toronto, for Central Mortgage & Housing Corpora-

tion. Professor Eric R. Arthur is the chairman of the committee in charge.

Projects in operation in Canada and the U. S. will be visited, and it is hoped that results of the study will be published in the fall.

Labor-Management Cooperation

At the beginning of 1949 there were 600 labor-management production committees in operation in Canada, 57 more than at the beginning of 1948, it has been announced by the Labor-Management Cooperation Service of the federal Department of Labor.

The committees are made up of representatives from management and labor and function in an advisory capacity on all matters affecting industrial productive efficiency. They do not deal with subjects covered by collective bargaining agreements.

A breakdown by industrial groups of the 600 committees in operation shows that recognition of their value is not confined to any specific industry. Manu-

(Continued on page 154)



Kwikset
LOCKSETS

Hardware beauty that's more than skin deep!

- Kwikset Locks look good...are good! That's why more than 4,000,000 are already in use.

Externally, they're cleanly designed and handsomely hand-finished in polished or satin brass, bronze or chrome. Inside, they're efficiently designed, too... and sturdily constructed of brass stampings or pressure-cast Zamak No. 5, the rugged, high-test alloy* that stands up under years of heavy service. They are *unconditionally guaranteed* against defective materials or workmanship!

And for economy, these Kwikset Locksets can't be topped! Engineered craftsmanship makes volume

production practical, keeps unit cost low. Easy 2-hole installation reduces time and labor on the job to a minimum. Substantial savings are the rule with Kwikset!

Specify Kwikset... for beauty, dependability, and economy!

Authentic design for every traditional or modern residence. Available for all standard residential installations and in all popular U. S. finishes, with or without deadlatch. Write for file-size catalogue.

*Tensile strength, 45,400 lbs./sq. in.; compression strength, 87,000 lbs./sq. in.; impact strength, 18 ft. lb.

Manufactured by KWIKSET LOCKS, INC. Anaheim, California

Distributed by **PETKO INDUSTRIES, INC.**, 1107 East Eighth Street, Los Angeles 21, California

My two architect sons included Webster Baseboard Heating in the design of my new home. I like the comfort and cleanliness of Webster Baseboard Heating . . .

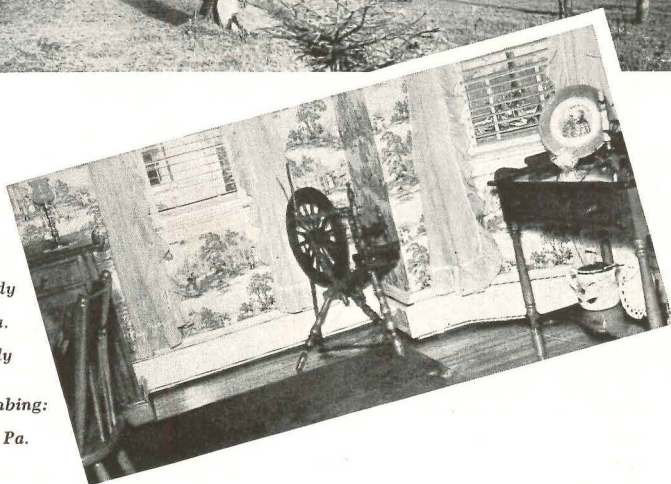

Dr. Cyrus W. Fridy
residence
Collegeville, Pa.
Fridy • Gauker
Truscott & Fridy
Architects and
Engineers
Heating and Plumbing:
Leonard Kehs,
Schwenksville, Pa.

When Dr. Cyrus W. Fridy, retired physician, told his two architect sons he wanted a modern comfortable home, they included Webster Baseboard Heating in the design.

Webster Baseboard Heating brings comfortable even heating temperatures to every room of the house. Dr. Fridy is pleased with the comfort and cleanliness of this finer, modern heating.

Modern Hot Water Heat

Webster Baseboard Heating is dependable, perfected hot water heating installed behind a specially-designed attractive metal baseboard around the exposed walls of the house. Floors and walls are warm so fuel costs are low. More than 10,000 installations completed!

Tests of room temperatures have shown *less than 2 degrees variation* between floor and ceiling even in *sub-zero* weather!

Write for booklet, "Questions and Answers about Webster Baseboard Heating." Address Department AR-7, Warren Webster & Company, Camden 5, New Jersey.

Webster
BASEBOARD HEATING

Webster Baseboard Heating is *clean* heat, *radiant* heat, *convected* heat. Gives you complete freedom in arranging room interiors because there is nothing to interfere with drapes, curtains or furniture. Makes rooms easier to clean, and you have more room. Less piping in your basement, too.

Economical, Uniform Heating

In Webster Baseboard Heating, air circulating in the room goes in at the floor line, passes over the hot water heating element, is warmed and comes out at the top of the baseboard, supplying a constant screen of warm air over walls, ceilings and floor.

Here is *modern* heat, *uniform* heat for new homes or homes being modernized, costing far less than you think. Webster Baseboard Heating is a development of Warren Webster & Company, an organization with a record of more than 60 years leadership in heating systems.

THE RECORD REPORTS

(Continued from page 10)

far more deeply than it has so far into development of new materials and methods of assembly in home construction.

Industry Expresses Views

Watching the juggling processes in Congress, private home builders took the position that leaders were deliberately forestalling action on the so-called private enterprise bill (S. 712) to force through a public housing scheme for a few favored families. S. 712, a measure backed strongly by all segments of the building industry and by the federal housing agency, would provide what the home builders term adequate mortgage insurance on loans on small homes with a five per cent down payment. This would carry through the present Federal Housing Administration's program of mortgage insurance.

Coincident with the annual spring meeting of the directors of the National Association of Home Builders, President Rodney M. Lockwood, of Detroit, stated that industry's program aimed at building economy homes for a million persons this year was blocked for months by the shelving of S. 712 in Congress. He accused Administration leaders of devoting their time to passage of a socialized housing bill while deferring action on the home building measure which would immediately start a flood of low cost housing throughout the country.

These views were pretty generally supported by Bureau of Labor Statistics figures covering the first quarter of this year. BLS reported on urban housing starts reflected by permit business. This disclosed that more than 15,000 fewer housing units were started in the first three months of 1949 than in the same period of 1948. Average dollar value rose slightly over the one-year period. BLS lists 102,493 urban housing units started in January, February and March of this year valued at \$689,665,000. Comparative figures for 1948 — 117,504 units valued at \$739,494,000. This represents a drop now of 15,011 units and \$49,829,000 in overall value.

Lockwood put the responsibility up to the lawmakers themselves with this statement:

"If Congress wants to see full employment continue in the home building

(Continued on page 14)

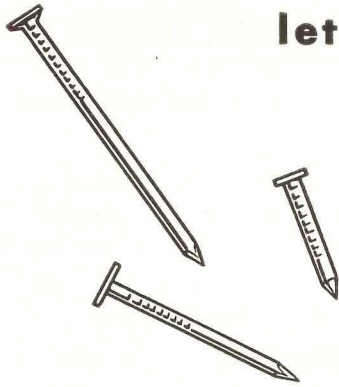

let these
Lifetime
nails point
the story
of

NON-STAINING

RUSTPROOF

aluminum

Take a look at recently built homes... see how many show ugly stains below every nail in the siding. There is no excuse for this. There is not even any need for deep-setting and puttying to prevent nail stains. *The trouble is in the nails...* in rustable steel nails... in galvanized nails that lose their protective coating under hammer blows.

Specify aluminum nails for all exposed uses. They drive well. They cannot stain by rusting at the head. They

cannot loosen by rusting in the wood. And Reynolds *Lifetime* Aluminum Nails are available in a full range of sizes and types.

Let the nail point the further story of aluminum. Rustproof gutters and downspouts at about half the price of other rustproof materials... non-staining, too! Rustproof windows that need no painting, cannot rot, swell or warp. Roofing and siding that practically eliminates maintenance. And a versatility

in design that is best evidenced by Reynolds Architectural shapes.

Write or call for descriptive literature in A.I.A. File Form... offices in 32 principal cities.

Write for free sample packet of Aluminum Nails. Reynolds Metals Company, Building Products Division, 2030 So. Ninth St., Louisville 1, Ky.

REYNOLDS **Lifetime** ALUMINUM

IF YOU SEE RUST
YOU KNOW IT'S NOT
ALUMINUM



REYNOLDS
Lifetime ALUMINUM
BUILDING PRODUCTS

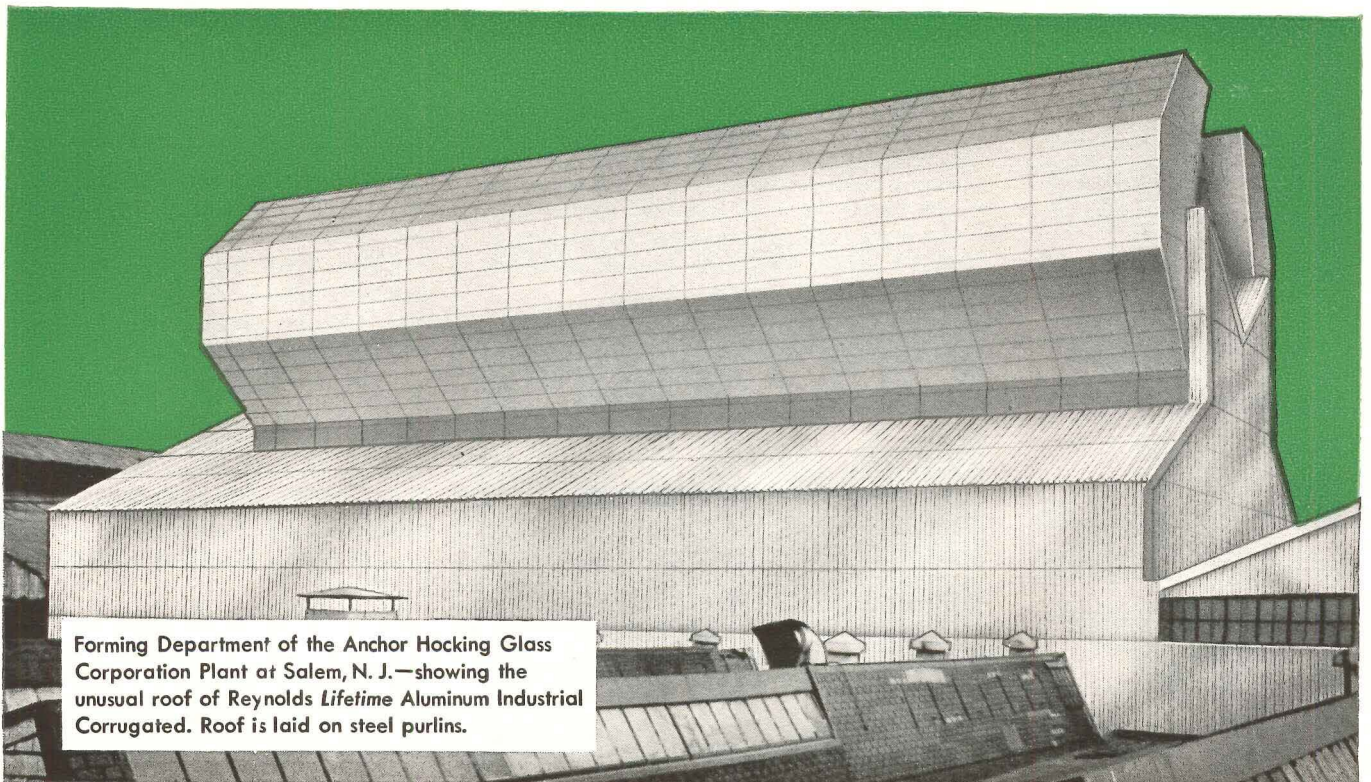

Forming Department of the Anchor Hocking Glass Corporation Plant at Salem, N. J.—showing the unusual roof of Reynolds *Lifetime* Aluminum Industrial Corrugated. Roof is laid on steel purlins.

THE RECORD REPORTS

(Continued from page 12)

field, if it wants to see a strong and steady supply of good, lower cost homes, then the home building measure, S. 712, must be enacted at once. The people of America who are waiting for new homes or good rental dwellings are being sold out while certain Congressional leaders try to put over a foreign socialized idea in housing."

NAHB also complained that the public housing bill sought to sanction construction of four and one-half room apartment units at a ceiling cost of \$15,000 each, including land. This was bitterly criticized by the home builders in the face of federal government pleadings that private industry erect comparable housing at a cost of \$7,000 per unit or less. This just doesn't make sense, said the home builders. Why should housing intended for families in the welfare class be built at a cost more than double the cost of small single family homes? To date there has been no adequate answer to this question from Capitol Hill.

Public Buildings Planned

Both houses of Congress passed the public buildings bill with minor differences. It was assured of conference committee clearance and quick enactment. This is the measure that calls for eventual construction of a new federal building in each Congressional district in the country which needs one; a fair illustration of its easy course through Congress.

It is important to note that no construction funds for new structures are provided. An appropriation of \$40 million is authorized for acquisition of sites and preparation of plans for public buildings. These projects are to be distributed equitably throughout the country "with due regard to the comparative urgency" in various sections.

Another part of the measure provides for \$30 million for a repair and renovation program affecting existing federal buildings. This would be established as a three-year plan with expenditure of \$10 million each year. Only those remodeling projects costing \$25,000 or more would be affected.

The well-known bid advertisement procedures of the Public Buildings Administration will be followed in carrying out provisions of the Act. Furthermore, the Commissioner of PBA is authorized

(Continued on page 16)

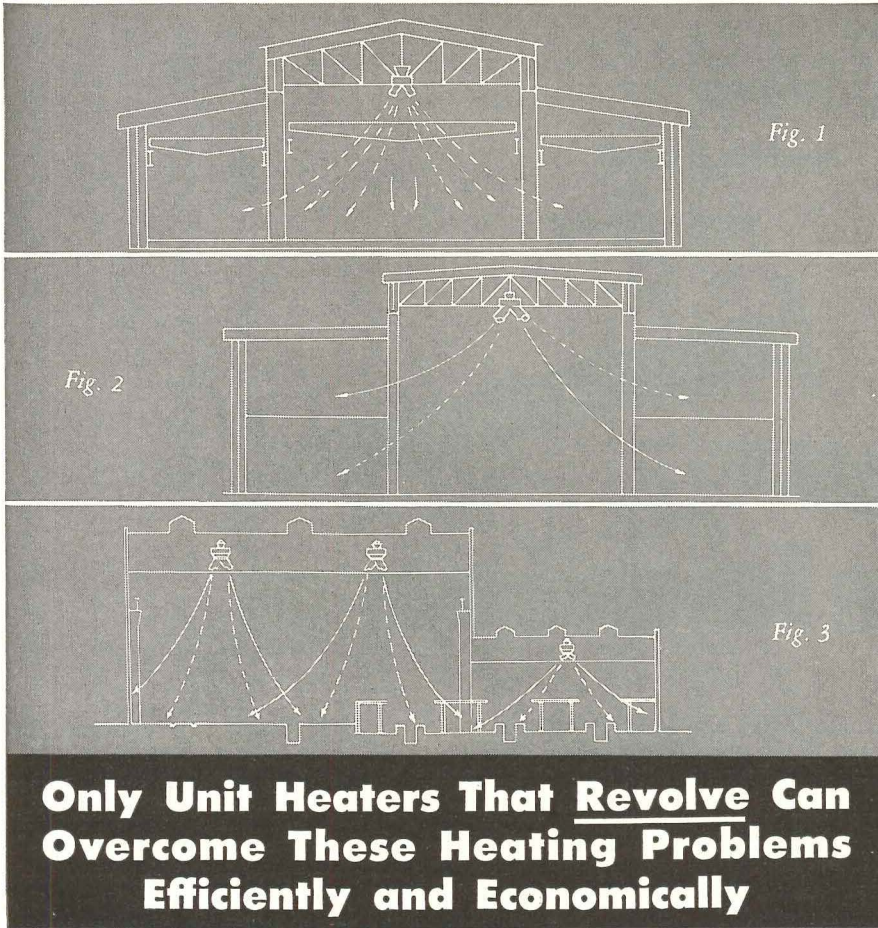

Only Unit Heaters That Revolve Can Overcome These Heating Problems Efficiently and Economically



The Wing Revolving Discharge Outlets turn slowly through a complete circle about once every two minutes, affording complete coverage, avoiding concentrated blasts of air and providing a pleasant, healthful working atmosphere.

Illustrated above are three typical buildings which present heating problems that cannot be overcome by ordinary unit heaters with efficiency and economy. In Fig. 1, Wing Revolving Unit Heaters are located high in the center and out of the way of cranes. From this height they project the heated air slowly through 360 degrees, covering successively the central portion and the bays with equal thoroughness. The heated air moves around and under obstructions, reaching to walls and remote corners. Every part of the plant is thus kept at an even, comfortable temperature.

In Fig. 2, two floor levels are perfectly heated with only one line of Wing Revolving Heaters. This is accomplished by adjusting the discharge outlets so that one outlet covers the upper floor or balcony while the other covers the ground floor.

Fig. 3 is a railroad repair shop. This building is perfectly heated despite the massive obstacles, repair pits, etc., in it.

For further details write for Bulletin HR-5.

L. J. Wing Mfg. Co.

151 W. 14th St., New York 11, N. Y.

Factories: Newark, N. J. and Montreal, Can.

Manufacturing Licensee for Wing Unit Heaters in Western Europe—**WANSON**

9, rue Mogador, Paris 9e, France
222, rue Royale, Brussels, Belgium



Wing

Revolving UNIT HEATERS

Rolling Steel DOORS

Manually • Mechanically • Power Operated

The advantages of a good rolling steel door are manifold. Their vertical coiling action occupies less space adjacent to the door opening than any other type of door . . . they provide more positive protection against intrusion and fire, and the permanence of all-steel construction assures a lifetime of continuous trouble-free service. In Mahon Rolling Steel Doors, you will find the latest developments in doors of this type—exclusive Mahon features in door construction and operating devices which have proved conclusively their desirability in everyday operation. See Sweet's File for detailed information and complete specifications.

THE R. C. MAHON COMPANY

Detroit 11, Michigan • Western Sales Division, Chicago 4, Illinois

Representatives in All Principal Cities

Manufacturers of Rolling Steel Doors, Grilles, and Underwriters' Labeled Rolling Steel Doors and Fire Shutters; Insulated Steel Walls; Steel Deck for Roofs, Partitions, Walls, Acoustical Ceilings, and Permanent Concrete Floor Forms.

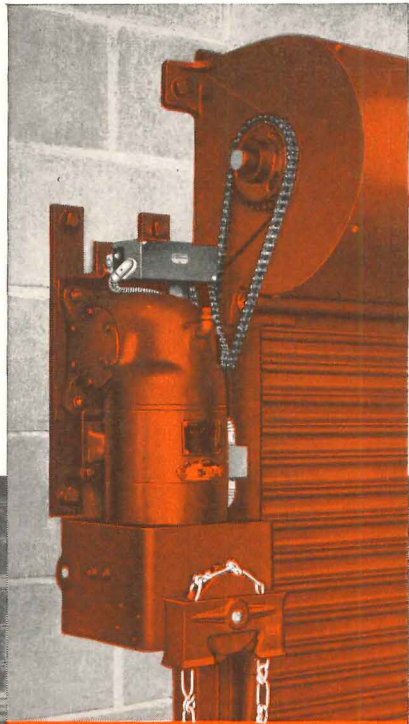

**MAHON STANDARD
POWER OPERATOR 920-P**

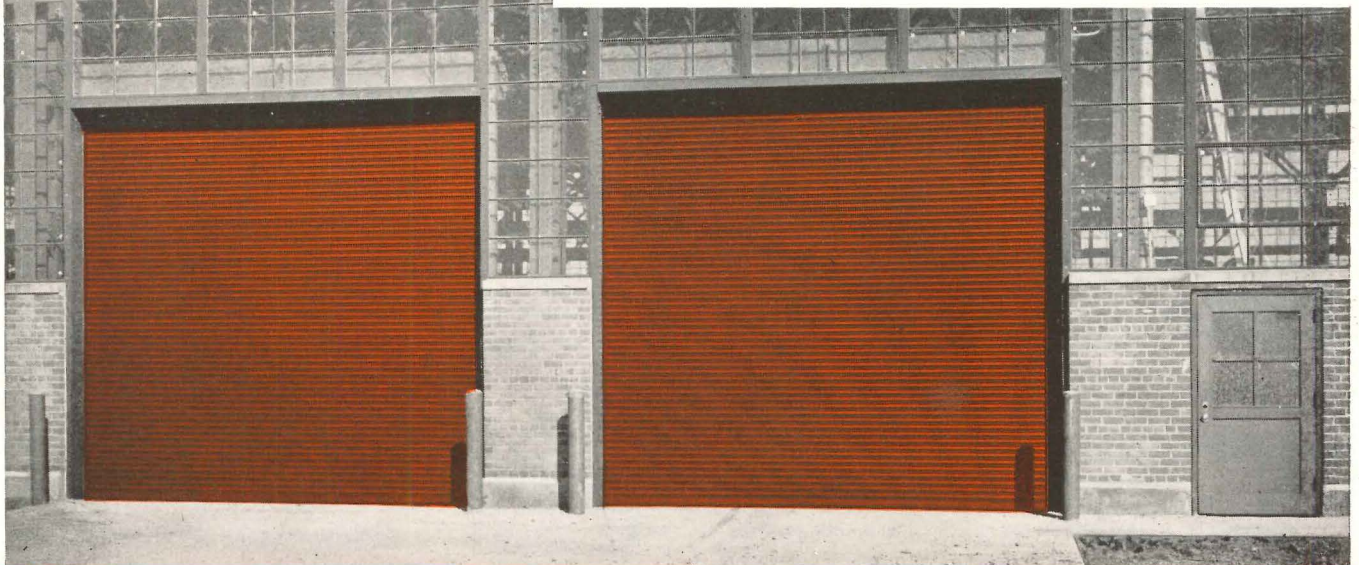

ROLLING STEEL DOORS, SHUTTERS AND GRILLES TO MEET EVERY REQUIREMENT

Two of Nine Mahon Power Operated Rolling Steel Doors Recently Installed in a New, Modern Industrial Plant.

MAHON



GENERAL PETROLEUM BUILDING, LOS ANGELES, CALIFORNIA

for an Harmonious Blend

SEAPORCEL PORCELAIN ENAMEL WAS SELECTED

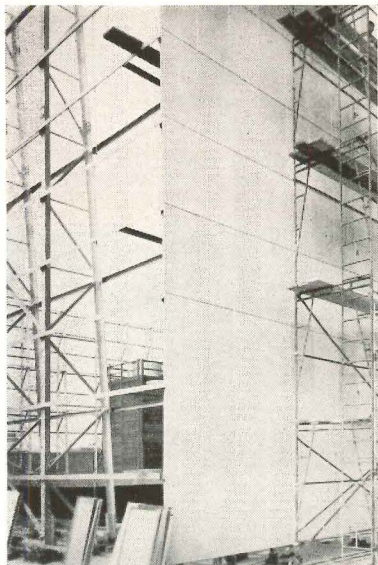

Topping this new magnificent building is an installation of over 24,500 square feet of Seaporcel Porcelain Enamel . . . yes, virtually 30 tons of this mechanically fastened material of permanence and beauty.

Matching the varied shades and textures of this structure's terra cotta exterior, lightweight Seaporcel Porcelain Enamel completes in perfect harmony the impressive dignity of this distinctive new building.

Holes to accept letters and Pegasus figures were burned in by gas torch on the job after porcelain enamel was erected.

**FOR JOBS LARGE OR SMALL
SEAPORCEL IS PRACTICAL • EASILY CLEANED
DURABLE • ECONOMICAL • FIRE RESISTANT**

Write today for catalogue showing application and current jobs.

SEAPORCEL METALS, INC.

Formerly Porcelain Metals, Inc.

28-06 BORDEN AVENUE, LONG ISLAND CITY 1, N. Y.

Complete A. F. of L.-Metal Fabricating & Enameling Shop

West Coast Representative: McFarland & Co., 1206 West 7th Street, Long Beach 13, Calif.



*Reg. U. S. Pat. Off.

Seaporcel

Member Porcelain Enamel Institute, Inc.

THE RECORD REPORTS

(Continued from page 14)

to employ by contract or otherwise, temporary architectural and other professional and technical service by negotiation without regard to the Classification Act of 1923, or civil service regulations.

Post offices will comprise the bulk of construction whenever the actual building is started. Congress acted on the bill with the conviction that this construction will begin when rising unemployment demands it, not before. The Federal Works Agency said it wanted no such comprehensive nationwide building program at this time — but it did want an adequate backlog of planned public buildings so that such a program could begin quickly.

There was evidence in the PBA Commissioner's testimony that terms of the new law would provide for approximately 450 projects or additions to be planned. This is only around one-tenth of the proposed buildings on the agency's eligible list.

The legislation continues in force the public buildings policy established by the basic law passed in 1926. This delegates authority for selection of building projects to the executive agencies, at the same time retaining for Congress full control over policy and the appropriation of funds.

Shorts

- A national plumbing code, applicable to housing, commercial and industrial buildings, moved closer to realization with appointment of a coordinating committee to tie together the loose ends of efforts made toward this goal so far. Its objective is to push forward on all fronts toward effecting national adoption. The housing agency has issued a uniform code which is being used by some cities but responses indicated a regulation applicable to housing alone did not go far enough. The Commerce Department, through its Bureau of Standards, the University of Iowa, the housing agency and a dozen interested private organizations are continuing the work. They hope to have a comprehensive uniform plumbing code drafted soon; one that will serve all types of structures.

- The Veterans Administration continued to have its money problems, and this affected the military hospital construction program. With the House al-

(Continued on page 18)

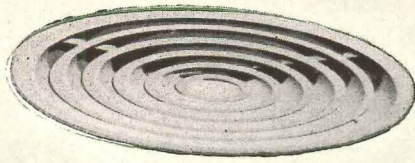

Aerofuse IN NEW YORK

TYPICAL INSTALLATIONS IN THE NEW YORK AREA

New York Times

Textron, Inc.

New York Telephone Co.

Wm. Iselin Co.

Best & Co.

Saks Fifth Ave.

Federal Building, N. Y. International
Airport

Seamprufe, Inc.

Sterling Winthrop Research Institute

Riverside Memorial Chapel

Atomic Energy Commission

Memorial Cancer Hospital

Victoria Theatre

Cove Theatre

Madison Square Garden

Commercial Delcalcomania Co.,
Mt. Vernon

G. E. Research Laboratory,
Schenectady

Bell Telephone Laboratories,
Murray Hill, N. J.

AEROFUSE
IN MACY'S

ENGINEERED to meet the most exacting specifications at the vital point of air delivery, Aerofuse Diffusers have an outstanding record of performance in the "who's who" of buildings — commercial, institutional, industrial — from coast to coast. The partial list of installations in the New York Area is typical of Aerofuse acceptance.

The competent engineers, architects and contractors responsible for specifying and installing these jobs know from experience that Aerofuse Diffusers measure up to every requirement of efficient, satisfactory performance . . . meet every demand for equipment that harmonizes in appearance with modern interiors . . . and answer the need for cost savings!

For details of the complete Aerofuse line, size selection information and complete engineering data . . . write for a copy of Catalog 102.

Typical of the advanced engineering that is an important part of the Aerofuse line, TYPE EAC is equipped with a manually-operated auxiliary effective area control ring. Provides a simple method of varying performance by adjustment of throw . . . on the job. No. 4 Control Unit assures minute regulation of volume.



TUTTLE & BAILEY inc
NEW BRITAIN, CONNECTICUT

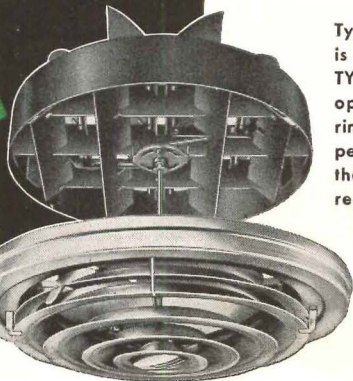

No. 4 CONTROL UNIT

TYPE EAC

(Continued from page 16)

ready having restored \$237 million to permit the building of the 16,000 beds which President Truman had ordered cut from the authorized total, members of Congress turned to the Senate in asking that the full amount be given. Sen. Claude Pepper (D-Fla.), whose Senate Labor subcommittee heard extensive testimony on the cut-back and its possible effects, said the Budget Bureau used "cold figures" in recommending that the President curtail the program. But VA had new worries in a budget slash that threatened its volume of personnel to staff these new hospitals. Unless the Senate restored many millions cut out by the House for hiring medical and surgery personnel, it would have trouble staffing the hospitals to be completed this year and next, VA said. Through April five new hospitals had been completed in the gigantic construction program. Sixty-two others were in various stages of progress, 30 of them with contracts awarded.

- There was every indication that supplies of building items offered no more major problems to the industry and this was particularly evident in steel. The Office of Industry Cooperation relaxed its hold on voluntary allocations programs, suspending altogether that for steel for manufacture of housing items. Walter S. Tower, president of the American Iron and Steel Institute, said prospects were suggestive of potential surplus, that supply may now be running ahead of actual consumption. The issue of government intrusion into the steelmaking field has not passed in spite of these trends, Tower warned.

- The wholesale prices of building materials continued to move fractionally downward in the closely-watched index of the Bureau of Labor Statistics.

- The supply of lumber has overtaken demand. This is shown in the 72nd quarterly report of the Lumber Survey Committee to the Secretary of Commerce. Lumber prices have been dropping steadily (an average of one per cent a month) for the past seven months. Hundreds of small mills have discontinued operations. Larger mills have shortened hours.

- The highly touted industry-labor arrangement for handling jurisdictional labor disputes within the construction industry is headed for the rocks after

(Continued on page 20)

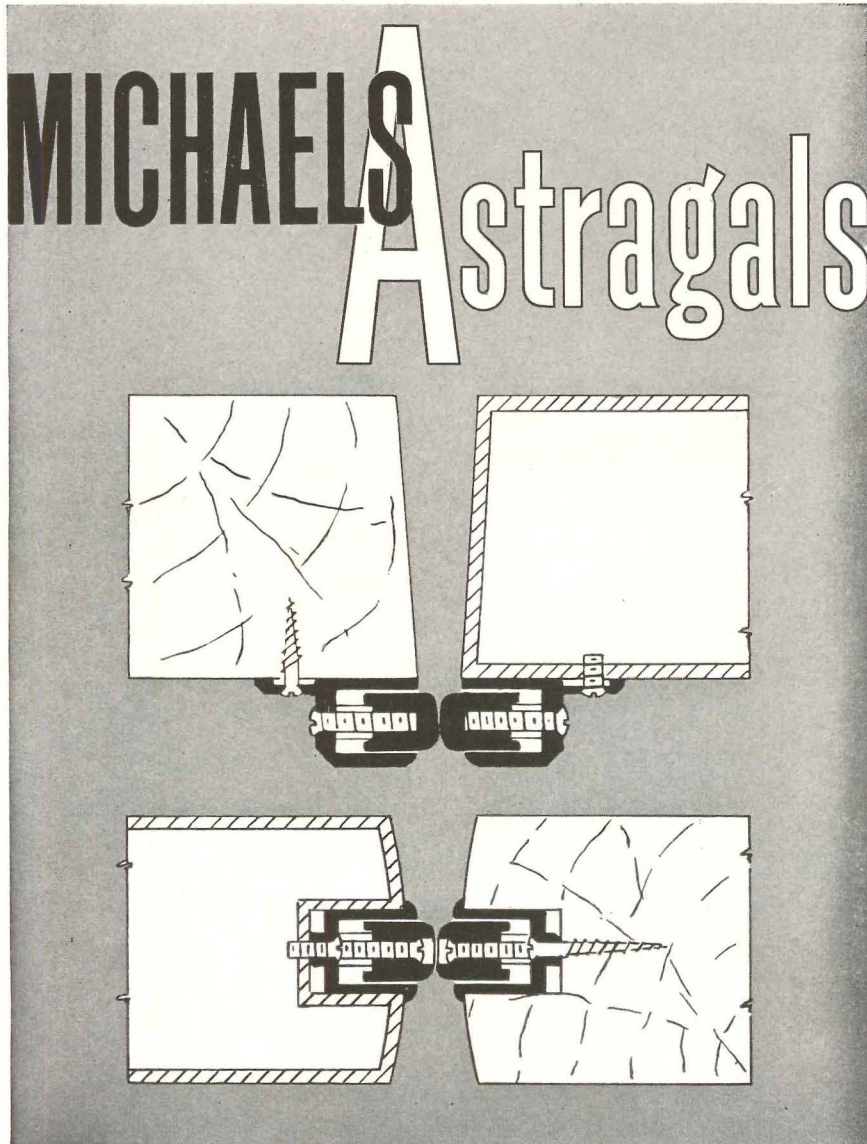

Write today for information and prices on Michaels Adjustable Astragals. Made of extruded bronze, aluminum or nickel, they are simple, practical, rugged, easily installed and adjusted, and available in several styles. Two are shown above. Type A (top illustration) may be applied to either wood or hollow metal bevel doors. Also used as a stop bead. Type E (lower illustration) is for bullnose hollow metal or wood double doors. Both types may be used at the bottom of doors. Michaels Astragals help keep doors closed tightly . . . eliminate drafts and air currents . . . keep out dirt and dust. Write for details. Astragals are only one of many items in the Michaels line. So whatever building product you need, if it's made of metal, we may have it or can make it.

MICHAELS PRODUCTS

- | | |
|---------------------------------|-----------------------------------|
| Bank Screens and Partitions | Astragals (adjustable) |
| Welded Bronze Doors | Stair Railings (cast and wrought) |
| Elevator Doors | Wrought and Cast Radiator Grilles |
| Store Fronts | Grilles and Wickets |
| Lettering | Kick and Push Plates |
| Check Desks (standing and wall) | Push Bars |
| Lamp Standards | Cast Thresholds |
| Marquises | Extruded Thresholds |
| Tablets and Signs | MI-CO Parking Meters |
| Name Plates | Museum Trophy Cases |

The MICHAELS ARTS BRONZE CO., INC., 234 Scott St., Covington, Ky.

Member of the National Association of Ornamental Nonferrous Metals Manufacturers

A Time-Tested Switch that's...

Still the Pioneer
of BETTER, SAFER SWITCHING!

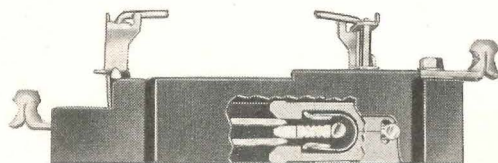
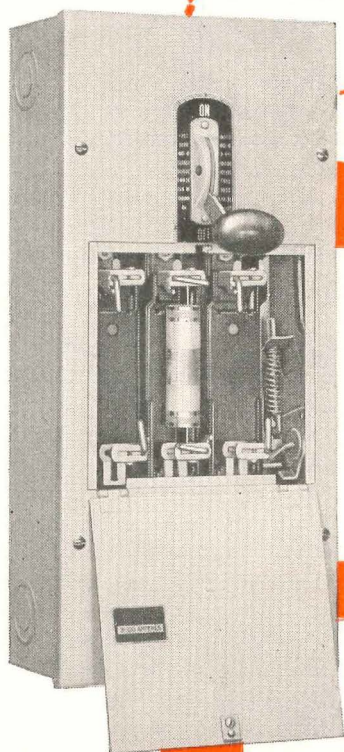

1

BASES—**FA** Shuttbrak Switch bases are of cold molded material. These bases house the shuttle mechanism and have excellent properties for insulation and mechanical strength.

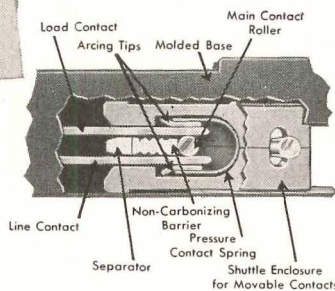

2

SHUTTLE DETAILS—The enclosed shuttle contains the U-shaped spring which keeps the auxiliary contacts and main contact roller under pressure in "on" position. The main contact roller is a heavily electro silver-plated round copper rod which presents a new contact surface at each operation.

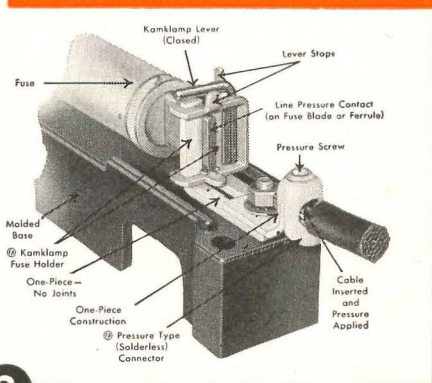

3

KAMKLAMP FUSEHOLDER — For both ferrule and knife blade type fuse terminals, the **FA** Kamklamp fuseholder has pressure type contacts to reduce heating, and eliminates the need for auxiliary means of obtaining pressure between fuse terminals and the fuseholder.

SHUTTLE MOVEMENT, the still-new but time-tested feature found only in **FA** Shuttbrak Switches, continues to provide safer, sounder switching for industry.

FA Shuttbrak Switches embody the latest in design and construction... with such features as a barrier between the line and load contacts that *resists arcing* at all times... quick make and break connections... and heavily silver-plated copper contacts which actually improve with use.

It's an ideal switch for motor control, for service entrance, for any industrial job that demands safe and dependable switching. And, of course, it is approved by Underwriters' Laboratories.

Write for Bulletin No. 501 or see your nearest **FA** Representative (he's listed in Sweet's).



Frank Adam Electric Co.

ST. LOUIS 13, MISSOURI

Makers of BUSDUCT • PANELBOARDS • SWITCHBOARDS • SERVICE EQUIPMENT • SAFETY SWITCHES • LOAD CENTERS • QUIKHETER

TRIBUNE SQUARE DEVELOPMENT Installs BRADLEY WASHFOUNTAINS In New Building

• Every inch modern and efficiently planned, the new Tribune Square Development has incorporated the finest in materials, machinery and equipment.

Selection of Bradley Washfountains for economical, sanitary employee wash-up service is in keeping with this building program of using only proved and reliable facilities. BRADLEY WASHFOUNTAIN CO., 2227 W. Michigan St., Milwaukee 1, Wis.



Tribune Square Development—Architect, Leo J. Weissenborn, Building Contractor R. C. Wieboldt Co. Plumbing Contractor, M. J. Corboy Co.

BRADLEY Washfountains

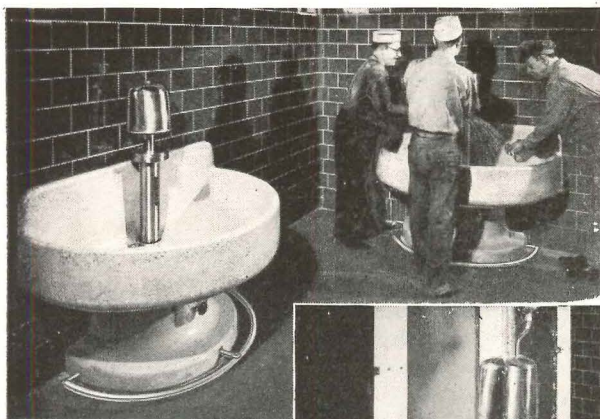

The Tribune Square Development includes the new building which extends from No. Michigan Ave. back to St. Clair Street and from Hubbard St. to Illinois Street.

LEFT: View of modern sanitary Pressmen's Washroom showing two Bradley Semi-Circular Washfountains.

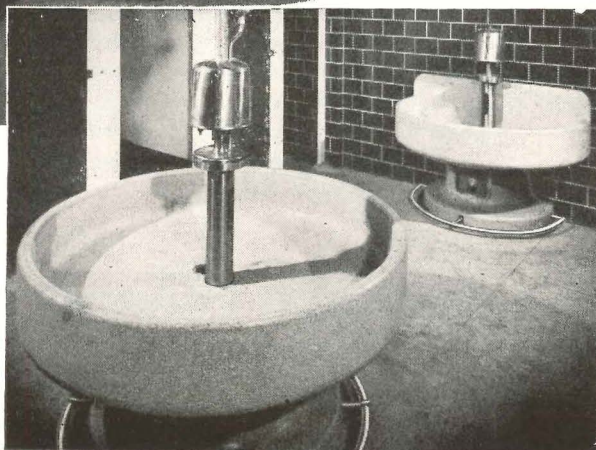

Interesting Catalog 4701 illustrating the complete Bradley line of modern Wash Equipment will be sent upon request.

Bradley Full-Circle Washfountain used with a Semi-Circular Unit in new Mailing Room washroom. (A total of 4 Circular and 11 Semi-Circular Bradleys have been installed in this Chicago Tribune addition.)

THE RECORD REPORTS

(Continued from page 18)

14 months of moderately successful operation. The story is that labor no longer cares to play along as a party to the Joint Board for Settlement of Jurisdictional Disputes. The American Federation of Labor building trades have notified the contractors that they want the agreement terminated. July 1 was given as the date. The AGC can do nothing but acquiesce and little hope for any reconciliation was held in prospect.

- There were sudden and surprising developments on the basing point pricing front. The Senate hurriedly put through an entirely new substitute plan proposed by Sen. Joe O'Mahoney (D-Wyo.). This would permit building material producers to absorb freight and use a delivered price system as long as they did it independently. All attention had been on the so-called moratorium bill which would have exempted sellers from anti-trust prosecution for a year — until Congress could decide what to do about the industry-wide controversy. The O'Mahoney bill, however, was given little chance of success in the House where opposition to any type of industry exemption has been led by Rep. Wright Patman (D-Tex.). And the O'Mahoney measure certainly is far more sweeping than the milder moratorium provisions.

- Civil Aeronautics Administration revised its procedures to make it easier to build airports under the federal-aid program. Now local sponsors may award contracts under \$2000 without competitive bidding. Limit on payments of grants to sponsors is raised from 85 to 90 per cent and sponsors no longer must submit evidence of title, itemized cost estimates, survey maps and abstract of bids. Airport project contractors now may certify that labor laws have been complied with. Formerly, CAA district airport engineers had to make such certification.

- There is a full volume of work ahead for the contractors who built water conservation projects if Interior carries out its present plans for the second century of its operation. Under-Secretary Oscar L. Chapman said Interior will "urge and encourage" private and public construction of 80 million kilowatts of added power capacity by 1970, 30 million of it to be federally constructed. And Interior wants to effect basinwide development

(Continued on page 22)

IMMEDIATE AVAILABILITY*

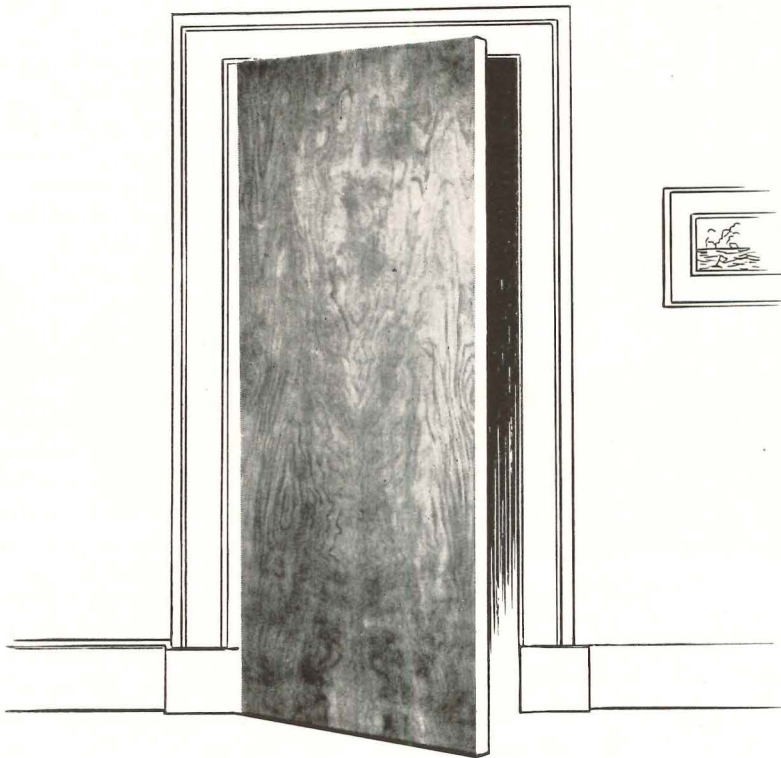

KENNEBEC NEW ENGLAND

HOLLOW CORE FLUSH DOORS

There's nothing difficult about getting delivery on Kennebec doors. We keep plenty on hand in all types and sizes, and our distributors are well supplied. What's more, we are equipped to produce 1000 doors per day and ship them fast from nearby Maine.

You'll never go wrong when you specify or use Kennebec doors. They are just about the finest made—in appearance, construction and serviceability—as anyone who has used them will tell you.

And there's a reason. Kennebec hollow core doors are manufactured in Maine from the pick of northern Maine birch. They're made *right*, inside and out. Solid birch edges (an exclusive Kennebec feature), sturdy lock blocks and fibre accordion cores. No waving and rippling, no delamination to wreck appearance after installation.

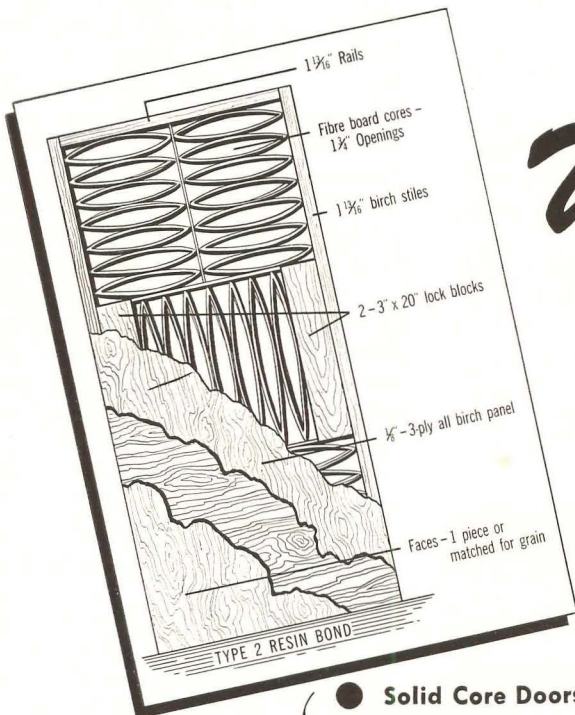

We'd like

to tell you more about these New England doors—how they are constructed,

how they can be finished, what independent tests show they will do. So, why not clip the handy coupon and mail it now?

and remember!

YOU CAN GET THEM AT ONCE!

ALSO →

- Solid Core Doors
- Birch Plywood
- Hardwood Plywood Flooring Squares

KENNEBEC, INC.

Factory; Bingham, Maine

KENNEBEC, INC.

53 Exchange St., Portland, Maine

GENTLEMEN:

Please send me file data on Kennebec New England Flush Doors.

I am also interested in the following specific information (fill in)

.....

Name

Address

City

State

NOTE: This applies only to the New England states, New York, New Jersey, and Pennsylvania. For quantity deliveries in other areas, write to us for information.

You're Always Safe and Safe ALL Ways On

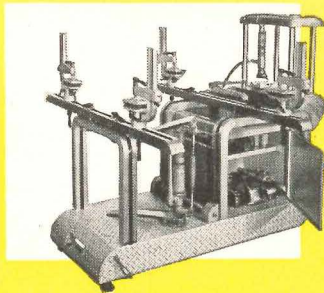
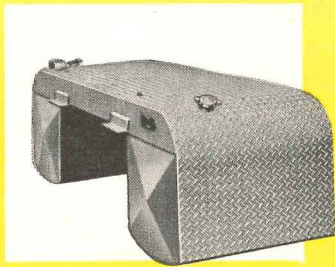

AW SUPER-DIAMOND FLOOR PLATE

A BETTER FOOTING FOR PRODUCT AND PLANT

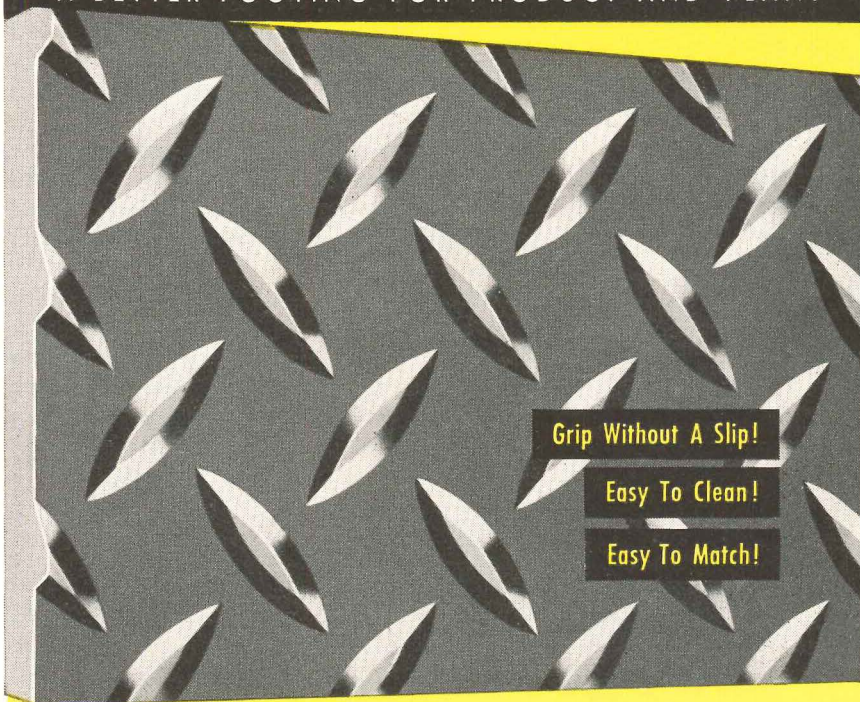

Grip Without A Slip!

Easy To Clean!

Easy To Match!

Install AW Super-Diamond Floor Plate in your plant and say goodbye to costly slipping accidents and floor maintenance bills. The exclusive engineered pattern provides maximum skid resistance regardless of how the plate is laid or the angle from which it is approached. More and more architects are specifying AW Super-Diamond Floor Plate, and leading Product Designers are using it for machine tool bases, saddle tanks and similar products on which men walk and climb. For safety's sake specify AW Super-Diamond Floor Plate for your plant and products. Write for more information and 16-page, fact-packed catalog.

AW SUPER-DIAMOND
FLOOR PLATES THAT GRIP



FREE—16-Page
Catalog L-33,
Write for your
copy now.

A Product of **ALAN WOOD STEEL COMPANY**
CONSHOHOCKEN, PENNA.



OTHER PRODUCTS: Permaclad, Stainless Clad Steel • AW Super Grip, Abrasive Floor Plate • Billets • Plates • Sheets (Alloy and Special Grades)

THE RECORD REPORTS

(Continued from page 20)

of major western rivers, hopes to add 17 million more acres of irrigated land and realize increased yields on nine million more acres by supplemental water. He promised an all-out effort to expand the synthetic liquid fuels program which means construction of more commercial scale plants if it is successful.

- A joint committee conference reached agreement on the public buildings bill which headed for final Congressional approval and signature by the President. No major features were changed; it still provided for total authorization of \$70 million, \$40 million of it for site acquisition and advance planning of federal structures, primarily post offices, and \$30 million for an extensive renovation plan for existing buildings beginning soon and carrying on for three years.

- The Federal Trade Commission issued its proposed trade practice rules for the oil heating industry of New England.

- Congress took a look at a new St. Lawrence Seaway and power development bill (by Sen. Scott W. Lucas, D-Ill.), a perennial renewal of the attempt to get approval by Congress but the first such bill in the current session. There is new interest in the matter, however, with the discovery of large deposits of proved reserves of high grade iron ore in Labrador. More attention was focused on the St. Lawrence seaway plan at the recent opening of the Second Annual International Trade Fair at Toronto, Canada. U. S. Secretary of Commerce, Charles Sawyer, at Toronto to officially open the exposition, said the Administration still desired full-cost construction of both navigation and power aspects of the waterway project.

PHILIP SAWYER

Philip Sawyer, Architect, and senior partner in the firm of York & Sawyer, died May 21 in New York City, following a long illness.

The firm, which was founded in 1898 by Mr. Sawyer and Edward P. York, has constructed many government buildings, banks and hospitals. Among the buildings personally designed by Mr. Sawyer are the Greenwich Savings Bank and the Guaranty Trust Company buildings in New York City, the Children's Village in Dobbs Ferry, N. Y.,

(Continued on page 164)

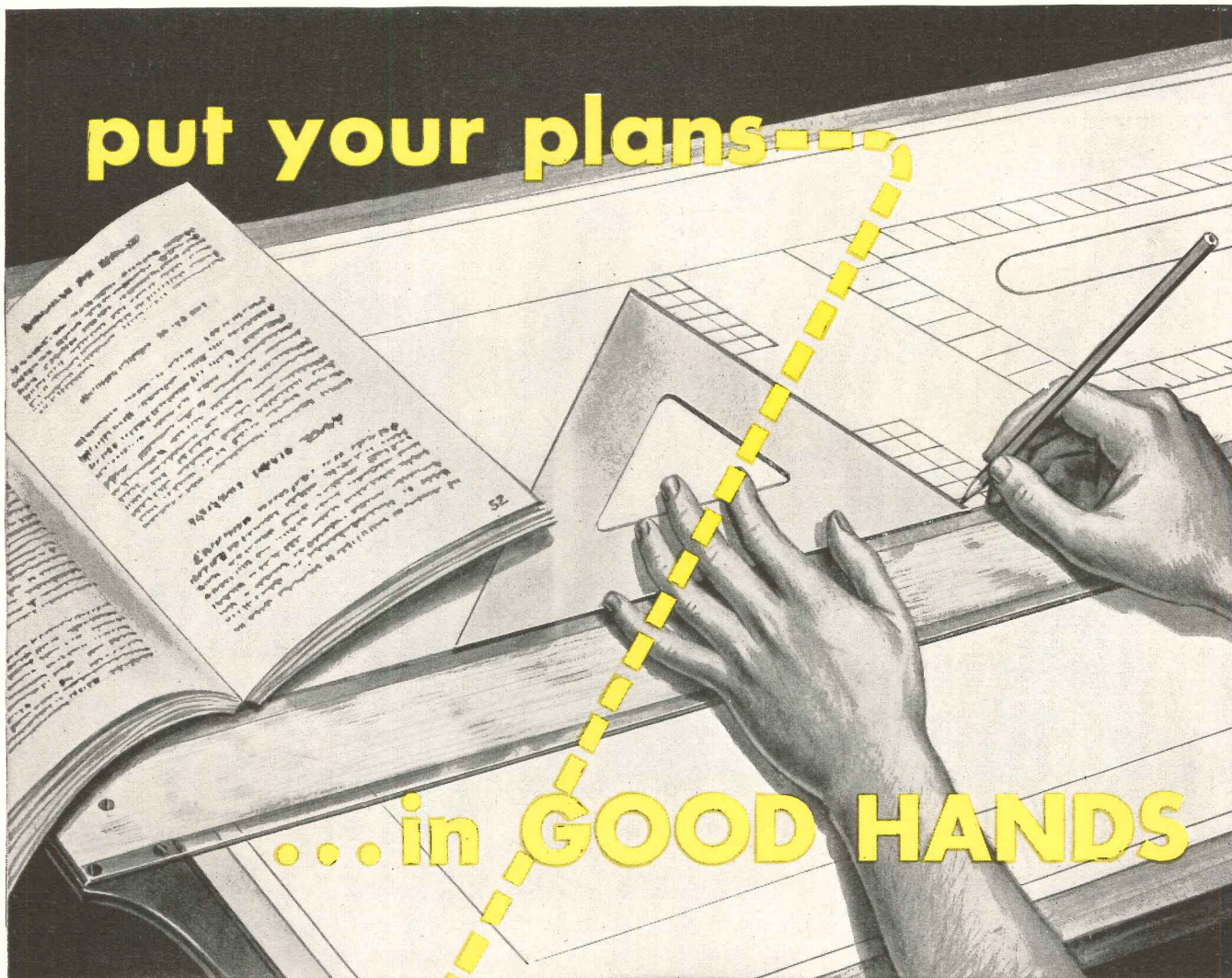

put your plans---

...in **GOOD HANDS**

rely on Medart... for complete planning service

MEN still debate the question of the chicken or the egg. But for the right kind of installations there's no question that planning comes *first!* The use of Medart planning and engineering facilities, for honest, unbiased analysis of your problems adds no cost to the job. BUT... the savings in cost in arriving at the proper kind of installation based on your architectural requirements... are likely to be considerable.

Whether you're planning a complete installation or partial replacements... it costs no more and results are sure if you let Medart help you plan.

MEDART MAKES

- Gymnasium Apparatus
- Basketball Backstops
- Telescopic Gym Seats
- Basketball Scoreboards
- Acromat-Trampolin
- Steel Lockers
- Steel Lockerobes



FRED MEDART PRODUCTS, INC.

3535 DE KALB ST.

ST. LOUIS 18, MO.

LEADERS FOR OVER 75 YEARS IN THE MANUFACTURE OF SCHOOL EQUIPMENT

WHY WORRY ABOUT FABRON
WALL COVERINGS NOW?
WE'RE ONLY JUST PLANNING

NOW IS THE TIME! FABRON
CALLS FOR A DECISION BEFORE
SPECS ARE WRITTEN!



Timing is vitally important when considering FABRON, the canvas-plastic-lacquer wall covering. Unless it is discussed *before* specifications are written, the chances of obtaining reasonable cost figures are mighty slim – for reasons which we'll gladly explain on request. This course may differ slightly from standard specification procedures, but it involves no complications and insures elimination of prohibitive "extras".

Meanwhile, why not let us help you visualize FABRON's possibilities for your next project? We'll gladly draw up an itemized estimate of rollage requirements and costs based on blueprints. If desired, we will also prepare for your approval a suggested decorative scheme, complete with samples. No obligation or cost, of course.

But remember – the time to consider FABRON is *before* specifications are written. It's the *only* way to insure that FABRON's cost falls within your budget!

FREDERIC BLANK & CO., INC. • Est. 1913 • 230 PARK AVE., NEW YORK 17, N.Y.
Represented in Canada by The Robert Simpson Company Limited—Special Contract Division

- In one operation, FABRON hides plaster blemishes, prevents expensive plaster repairs, assures complete washability and color fastness. Saves money to the owner by eliminating periodic redecorations. Initial cost falls within present-day budget. Furnished in double rolls. Applied like wallpaper. Easily repaired by invisible inlay method. More than 160 colors, textures and patterns offer a decorative latitude unmatched by conventional treatments. And – FABRON prevents the spread of fire, carries the label of the Underwriters' Laboratories, Inc.

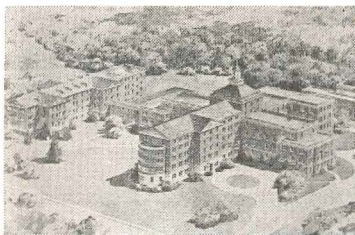

FITKIN MEMORIAL HOSPITAL, Neptune, N.J.
FERRENZ & TAYLOR, *Architects*;
NEERGAARD & CRAIG, *Hospital Consultants*;
GEORGE A. FULLER COMPANY, *General Contractors*.

FABRON, first used at this hospital in 1942, was included in original specifications for the new wing in which it is being installed throughout. One of more than 1000 hospitals using FABRON.

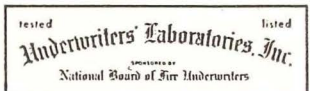

Fabron®



The canvas-plastic-lacquer wall covering for institutions

Why I prefer
to sell fixtures
equipped with



Certified Ballasts!

As a contractor, I hear the complaints when fixtures prove unsatisfactory.

I can't afford repeated customer gripes, so I handle only fixtures that are equipped with Certified Ballasts.

They assure me—

Full lamp life

Quiet operation

Rated light output

Reliable performance

Certified Ballasts are made to rigid specifications—then tested and checked by impartial Electrical Testing Laboratories, Inc. That's why they're really reliable.

By insisting on Certified Ballasts I keep service worries to a minimum and keep my customers happy.

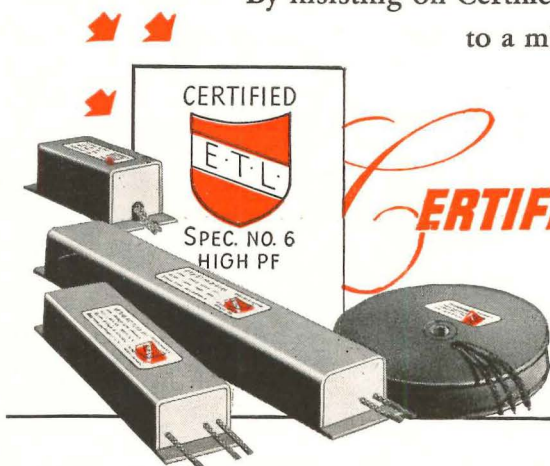

CERTIFIED BALLAST MANUFACTURERS

Makers of Certified Ballasts for Fluorescent Lighting

2116 KEITH BLDG., CLEVELAND 15, OHIO

CONSTRUCTION COST INDEXES — Labor and Materials

United States average 1926-1929 = 100

Presented by Clyde Shute, manager, Statistical and Research Division, F. W. Dodge Corporation, from data compiled by E. H. Boeckh & Associates, Inc.

NEW YORK

ATLANTA

Period	NEW YORK					ATLANTA				
	Residential		Apts., Hotels, Office Bldgs. Brick and Concr.	Commercial and Factory Buildings		Residential		Apts., Hotels, Office Bldgs. Brick and Concr.	Commercial and Factory Buildings	
	Brick	Frame		Brick and Concr.	Brick and Concr.	Steel	Brick		Frame	Brick and Concr.
1925	121.5	122.8	111.4	113.3	110.3	86.4	85.0	88.6	92.5	83.4
1930	127.0	126.7	124.1	128.0	123.6	82.1	80.9	84.5	86.1	83.6
1935	93.8	91.3	104.7	108.5	105.5	72.3	67.9	84.0	87.1	85.1
1939	123.5	122.4	130.7	133.4	130.1	86.3	83.1	95.1	97.4	94.7
1940	126.3	125.1	132.2	135.1	131.4	91.0	89.0	96.9	98.5	97.5
1941	134.5	135.1	135.1	137.2	134.5	97.5	96.1	99.9	101.4	100.8
1942	139.1	140.7	137.9	139.3	137.1	102.8	102.5	104.4	104.9	105.1
1943	142.5	144.5	140.2	141.7	139.0	109.2	109.8	108.5	108.1	108.7
1944	153.1	154.3	149.6	152.6	149.6	123.2	124.5	117.3	117.2	118.2
1945	160.5	161.7	156.3	158.0	155.4	132.1	133.9	123.2	122.8	123.3
1946	181.8	182.4	177.2	179.0	174.8	148.1	149.2	136.8	136.4	135.1
1947	219.3	222.0	207.6	207.5	203.8	180.4	184.0	158.1	157.1	158.0
Feb. 1949	252.0	250.8	246.9	251.4	245.0	197.8*	198.8†	184.9**	185.5	183.4
Mar. 1949	252.3	249.7	247.9	252.6	246.3	196.5	197.3	183.8	184.9	180.3
Apr. 1949	247.2	245.0	243.5	246.8	242.2	194.7	195.1	183.0	184.3	179.5
	% increase over 1939					% increase over 1939				
Apr. 1949	100.2	100.2	86.3	85.0	86.2	125.6	134.8	92.4	89.2	90.0

Period	ST. LOUIS					SAN FRANCISCO				
	Residential		Apts., Hotels, Office Bldgs. Brick and Concr.	Commercial and Factory Buildings		Residential		Apts., Hotels, Office Bldgs. Brick and Concr.	Commercial and Factory Buildings	
	Brick	Frame		Brick and Concr.	Brick and Concr.	Steel	Brick		Frame	Brick and Concr.
1925	118.6	118.4	116.3	118.1	114.4	91.0	86.5	99.5	102.1	98.0
1930	108.9	108.3	112.4	115.3	111.3	90.8	86.8	100.4	104.9	100.4
1935	95.1	90.1	104.1	108.3	105.4	89.5	84.5	96.4	103.7	99.7
1939	110.2	107.0	118.7	119.8	119.0	105.6	99.3	117.4	121.9	116.5
1940	112.6	110.1	119.3	120.3	119.4	106.4	101.2	116.3	120.1	115.5
1941	118.8	118.0	121.2	121.7	122.2	116.3	112.9	120.5	123.4	124.3
1942	124.5	123.3	126.9	128.6	126.9	123.6	120.1	127.5	129.3	130.8
1943	128.2	126.4	131.2	133.3	130.3	131.3	127.7	133.2	136.6	136.3
1944	138.4	138.4	135.7	136.7	136.6	139.4	137.1	139.4	142.0	142.4
1945	152.8	152.3	146.2	148.5	145.6	146.2	144.3	144.5	146.8	147.9
1946	167.1	167.4	159.1	161.1	158.1	159.7	157.5	157.9	159.3	160.0
1947	202.4	203.8	183.9	184.2	184.0	193.1	191.6	183.7	186.8	186.9
Feb. 1949	227.3	228.3	214.7	217.8	214.7	218.6	214.3	215.2	221.5	218.1
Mar. 1949	225.9	226.6	214.6	217.7	214.7	217.2	212.5	214.9	221.3	217.7
Apr. 1949	224.3	225.0	212.8	216.2	213.5	216.9	212.2	214.9	219.8	217.9
	% increase over 1939					% increase over 1939				
Apr. 1949	103.5	110.3	79.3	80.5	79.4	105.4	113.7	83.0	80.3	87.0

The index numbers shown are for combined material and labor costs. The indexes for each separate type of construction relate to the United States average for 1926-29 for that particular type — considered 100.

Cost comparisons, as percentage differences for any particular type of construction, are possible between localities, or periods of time within the same city, by dividing the difference between the two index numbers by one of them; i.e.:

index for city A = 110
index for city B = 95
(both indexes must be for the same type of construction).
Then: costs in A are approximately 16 per cent higher than in B.

$$\frac{110-95}{95} = 0.158$$

Conversely: costs in B are approximately 14 per cent lower than in A.

$$\frac{110-95}{110} = 0.136$$

Cost comparisons cannot be made between different types of construction because the index numbers for each type relate to a different U. S. average for 1926-29.

Material prices and wage rates used in the current indexes make no allowance for payments in excess of published list prices, thus indexes reflect minimum costs and not necessarily actual costs.

These index numbers will appear whenever changes are significant.

* Erroneously reported in May as 193.8, giving a % increase over 1939 of 124.6% instead of 129.2%.
† Erroneously reported in May as 194.8, giving a % increase over 1939 of 134.4% instead of 139.2%.
**Erroneously reported in May as 179.9, giving a % increase over 1939 of 89.2% instead of 94.4%.

HONEYWELL COMFORT

begins with the Blueprint

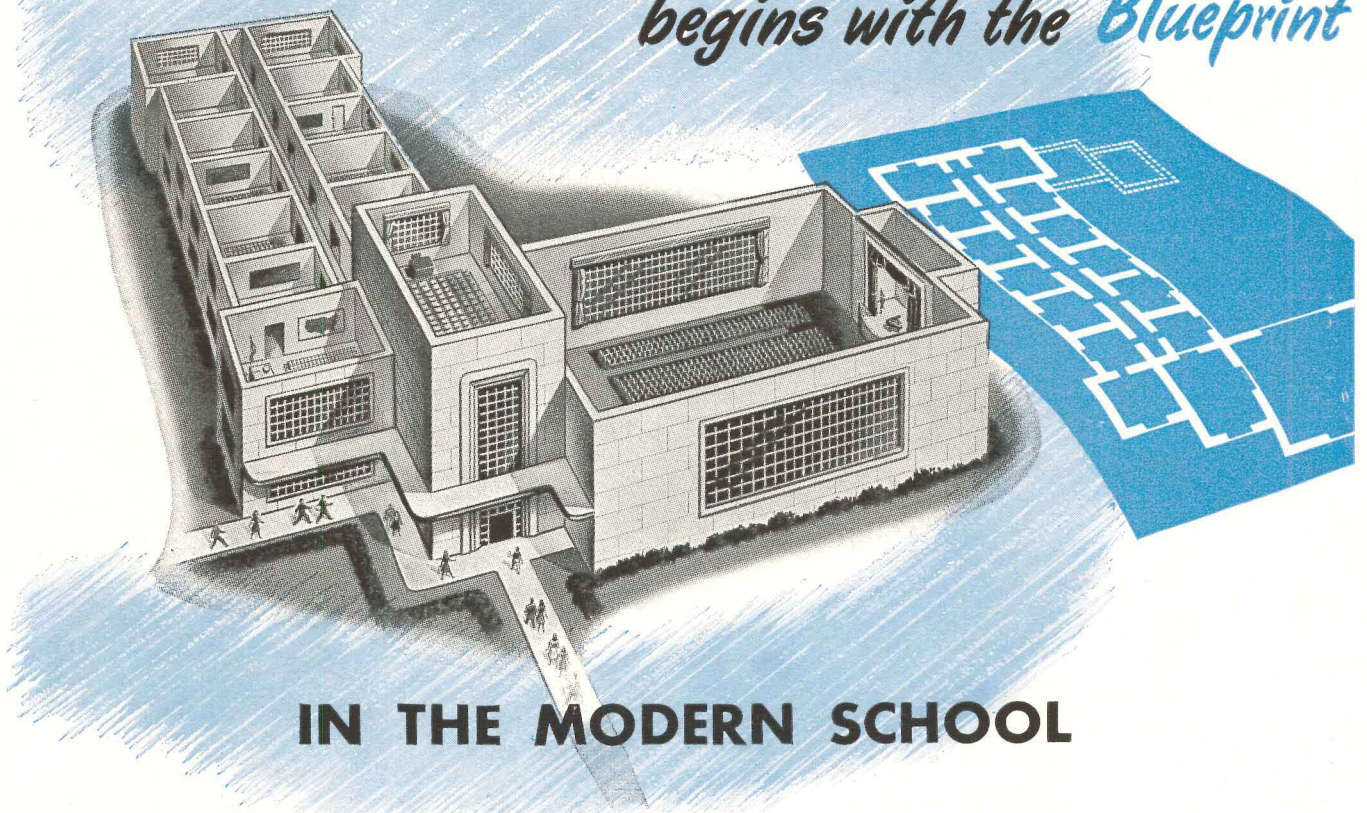

IN THE MODERN SCHOOL

Nowhere is personal comfort more important than in the schoolroom. And, to maintain the highest standards of comfort, health and working efficiency, modern schools are installing the very latest developments in heating and ventilating equipment.

Whether you specialize in schools or hospitals, hotels and apartments or industrial and commercial buildings, we suggest you specify the heating and air conditioning control equipment when the building is in the blueprint stage. And remember, no heating or air conditioning plant can be better than the controls that govern it.

Since 1885, Minneapolis-Honeywell has pioneered in the development of controls, both pneumatic and electric, for residential, commercial and industrial use. Experienced Honeywell engineers are available for consultation on any automatic control problem . . . Just contact the Honeywell branch office in or near your city, or write to Minneapolis-Honeywell Regulator Company . . . Minneapolis 8, Minnesota.



ROOM THERMOSTAT
The Symbol of Modern Temperature Control

For up-to-the minute information on school heating and ventilating systems, mail the coupon for booklet "Automatic Controls for the Modern School" — just off the press.



MINNEAPOLIS-HONEYWELL REGULATOR CO.
2600 Fourth Avenue S. • Minneapolis 8, Minn.

Please send my free copy of "Automatic Controls for the Modern School."

Name _____
 Title _____
 Company Name _____
 Address _____
 City _____ State _____



73 BRANCHES FROM COAST TO COAST WITH SUBSIDIARY COMPANIES IN: TORONTO • LONDON • STOCKHOLM • AMSTERDAM • BRUSSELS • ZURICH • MEXICO CITY

REQUIRED READING

PLANNING FOR RECREATION

A Guide for Planning Facilities for Athletics, Recreation, Physical & Health Education. By Participants in National Facilities Conference. The Athletic Institute, Inc. (209 S. State St., Chicago, Ill.), 1947. 8½ by 11 in. 128 pp., illus. \$1.50.

The recommendations incorporated in this concise little volume are the result of a conference held several years ago by specialists in planning athletic facilities (architects, city planners, engineers, etc.), representatives of national organizations concerned with athletic programs, and school and college administrators engaged in planning athletic activities. The pooled knowledge of the group forms the basis of the GUIDE and offers the architect interested in the field the benefit of valuable first-hand experience.

The recommendations are based on the theory that community planning is essential to efficient recreation and athletic areas. Each type of facility discussed, therefore, is described in terms of the type of community which it must serve (rural, urban, consolidated, and so on), the existing resources of the area, the social and economic conditions prevalent, and provision for possible future changes within the area. Material covered includes health service, administrative arrangements, swimming pools and stadiums.

Of particular interest to architects are the various plans and diagrams such as the locker room details reproduced in this month's Time-Saver Standards (pages 149, 151). Tables of recommended dimensions for gymnasiums, pools, and other facilities, and the check lists and lists of "blaring errors" also will be of distinct use to the architect.

TREASURE CHEST ON SCHOOLS

The American School and University: 1948-1949. American School Publishing Corp. (470 Fourth Ave., New York 16, N. Y.), 1948. 8½ by 11 in. 732 pp., illus. \$4.00.

Once again the book of the year for the school architect turns out to be THE AMERICAN SCHOOL AND UNIVERSITY yearbook, which, now in its 20th annual edition, seems to be bigger and better than ever.

As always, the yearbook contains a number of articles by well-known school architects. Among them: "Designing Beauty into the Educational Building," by Lawrence B. Perkins; "Planning

Problems of Colleges and Universities," by Carl Feiss; "Integrated University Plant Planning," by Hermann H. Field; "The Evolution of the School Building," by N. L. Engelhardt; "Designing Educational Buildings for Tomorrow's Needs," by T. Norman Mansell; "Building for School and Community Needs," by Henry S. Churchill; "College Architecture in Transition," by Lorimer Rich; "Germicidal Light in Classrooms," by Isadore Rosenfield; "The Planning Process behind the Blueprint," by Robert E. Alexander.

Other articles, by school administrators, treat such numerous vital subjects as plant research; requirements of the secondary school, the college and university; school building survey techniques; school landscape architecture; playground surfacing; school lighting and plumbing; special needs of home-making department and health suite; equipment lists for nursery and kindergarten and elementary school classrooms.

Design features include dormitory projects, Wayne University's new plant, two grade schools, Milwaukee's and Illinois Wesleyan's building programs.

The second half of the book, as usual, is given over to a manufacturers' catalog section, followed by cumulative editorial and authors indexes.

WHAT MAKES A SCHOOL GOOD

Guide for Planning School Plants: 1949 Edition. National Council on Schoolhouse Construction (Peabody College, Nashville, Tenn.), 1949. 6 by 9 in. viii + 174 pp., illus. \$1.25.

"It is hoped," modestly says the Foreword to this volume, "that the GUIDE will prove stimulating to the school administrator and architect in designing functional school plants." The hope seems entirely reasonable: the GUIDE is jam-packed with the type of good, basic information which should prove not only stimulating but also helpful to both administrator and architect.

The book is divided into logically arranged chapters starting with the pre-planning stages such as determining the objectives to be met, raising the necessary funds, and selecting the site, and continuing with a progression through elementary and secondary schools to the larger community school. Each of these chapters is subdivided into sections, making the book easily

adaptable for reference work. Later chapters discuss general facilities such as administrative rooms, library, auditorium, etc., service facilities, school plant safety, acoustics. There are no plans, however, and there has been no attempt at plan analysis beyond an occasional remark that rooms for heart cases should be on the first floor, that a room planned for multiple use should be provided with an outside entrance, that the swimming pool may be so located as to be served by the lockers and dressing rooms provided for the gymnasium.

This, then, is exactly what it says it is — a guide for planning, a reminder for the architect and administrator of the many items to be considered and the goals to be achieved if possible.

FOR SCHOOL ADMINISTRATORS

American School Buildings: 27th Yearbook. American Association of School Administrators (1201 Sixteenth St., N.W., Washington 6, D. C.), 1949. 6 by 9 in. 526 pp., illus. \$4.00.

Despite the fact that this is a yearbook meant chiefly for the school administrator, much of the material it includes will be of vital interest to the school architect as well. It was written by a 10-man commission of educators headed by Warren T. White, Superintendent of Schools, Dallas, Texas, with architect Howard Dwight Smith serving as the official A.I.A. representative. The text has been revised, says the foreword, until every chapter represents the judgment of the commission as a whole.

Chapters which will be of special interest to architects are those on planning instructional features and auxiliary facilities, mechanical and service facilities, safety, materials and construction, light and color, furniture and equipment. Plans and illustrations are numerous enough to be of real value.

SCHOOLS IN BRITAIN

The Modern School. By C. G. Stillman and R. Clastle Cleary. The Architectural Press (13, Queen Anne's Gate, London S.W. 1, Eng.), 1949. 7 by 9 in. 152 pp., illus. 21s.

To open this book is to realize, with a pleasant shock, the tremendous progress school architecture has made in the past century or so. For the authors have begun their discussion with a background chapter including illustrations of oldtime schools, and have dropped in here and there throughout the book other photos dating back to the

(Continued on page 30)

floor plan for living!

Take any room in the house . . . a Sloane-Blabon floor covering will make it more livable! For Sloane Quality Linoleum Products mean added beauty through "better design and truer color"—less work for homeowners because these floors are easier to keep bright and clean. And, there's a Sloane-Blabon floor covering for every need and specification. Write for further information.

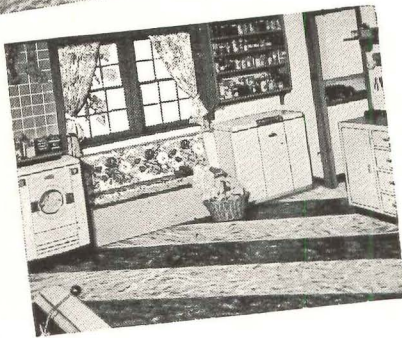
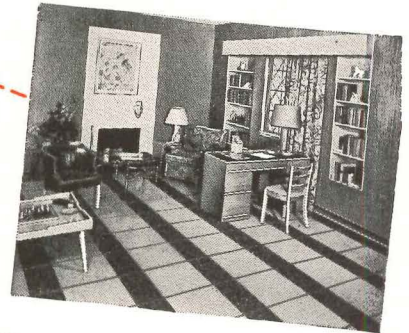
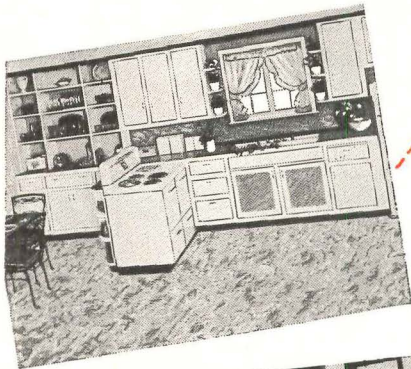
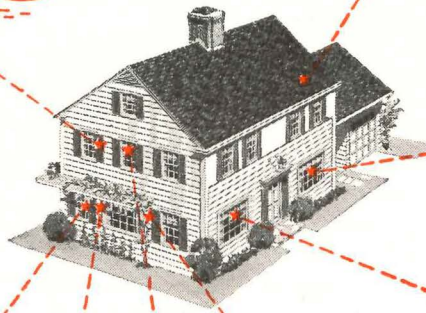
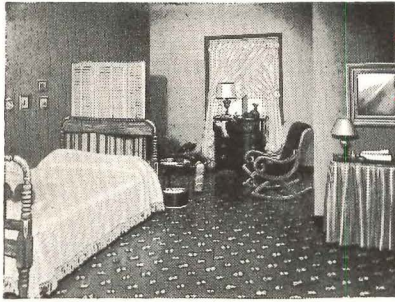

floor coverings for every specification

- Inlaid and Marbled Linoleum
- Linoleum Tile
- Koroseal* Tile, Cove Base and Cove Molding
- Improved Asphalt Tile
- Resilient Enamel Floor Coverings
- Resilient Enamel Rugs
- Resilient Enamel Wall Coverings

For further information and samples, write Dept. AR-4

SLOANE-BLABON CORPORATION
295 FIFTH AVENUE, NEW YORK 16, N. Y.



*© B. F. Goodrich Company



GUTH TEAMWORK
takes the "quest"
out of your
lighting questions

The science of lighting becomes more complex...and more important: it takes closer teamwork between planner, manufacturer and supplier to assure top-quality illumination.

When you join hands with **Guth**, you'll find that teamwork. Every fixture is **precision-planned** for functional efficiency in operation, installation and maintenance. What's more, you'll find your nearby **Guth** Distributor and **Guth** Resident Engineer competent and cooperative...a mighty big help in producing precision-planned installations you can be proud of.

Do you have a time-saving **GUTH** Lighting Calculator and Layout Guide 33-J? They're yours for the asking, with the compliments of



YOUR TEAMMATE IN *precision-planned* LIGHTING

Guth

LIGHTING

THE EDWIN F. GUTH COMPANY / ST. LOUIS 3, MISSOURI

Leaders in Lighting Since 1902

REQUIRED READING

(Continued from page 28)

turn of the century. Unfortunately, as the authors point out, many of these schools are still in use, despite their overcrowded and poorly lighted classrooms, and their completely outdated arrangement.

Messrs. Stillman and Cleary, both architects, have surveyed the school field from end to end, and have given us in this book a comprehensive analysis of not only the problems to be solved and the needs involved, but the progress made to date. They discuss in detail the legislation governing school building in England; they discuss environment, the classroom unit, special instruction rooms, assembly halls, gymnasiums, construction trends, lighting and ventilation; and above all they have been generous with their illustrations, including dozens of photos of schools in various parts of the world, and innumerable plans.

HOSPITAL EQUIPMENT

General Electric Hospital Handbook for Architects and Engineers. General Electric Co. (Schenectady, N. Y.), 1949. 11 by 8 3/4 in. 277 pp., illus. \$19.75.

Here is a book devoted exclusively to the complicated electric equipment needs of the hospital. Although prepared by the various departments of General Electric, and concerned primarily with the products manufactured by that company, it contains much basic planning information for the selection and installation of electric equipment. Floorplans are based largely on the recommendations of the United States Public Health Service. Architectural consultant for the book was Theodor K. Rohdenburg of the Columbia University School of Architecture.

The text is divided into 10 sections: x-ray, kitchen, appliances, lighting, chemical (surfacing material), clocks, air conditioning and refrigeration, power distribution, secondary distribution systems for light and power, wiring systems. Most of the sections contain general design data as well as product specifications.

A supplementary pamphlet, "Buyer's Guide for Hospital Equipment Using Radiant-Energy Sources," inserted in the back cover of the volume, lists light, infrared, ultraviolet and germicidal equipment available from well over a hundred manufacturers.

ROOMS
426 TO 438
←

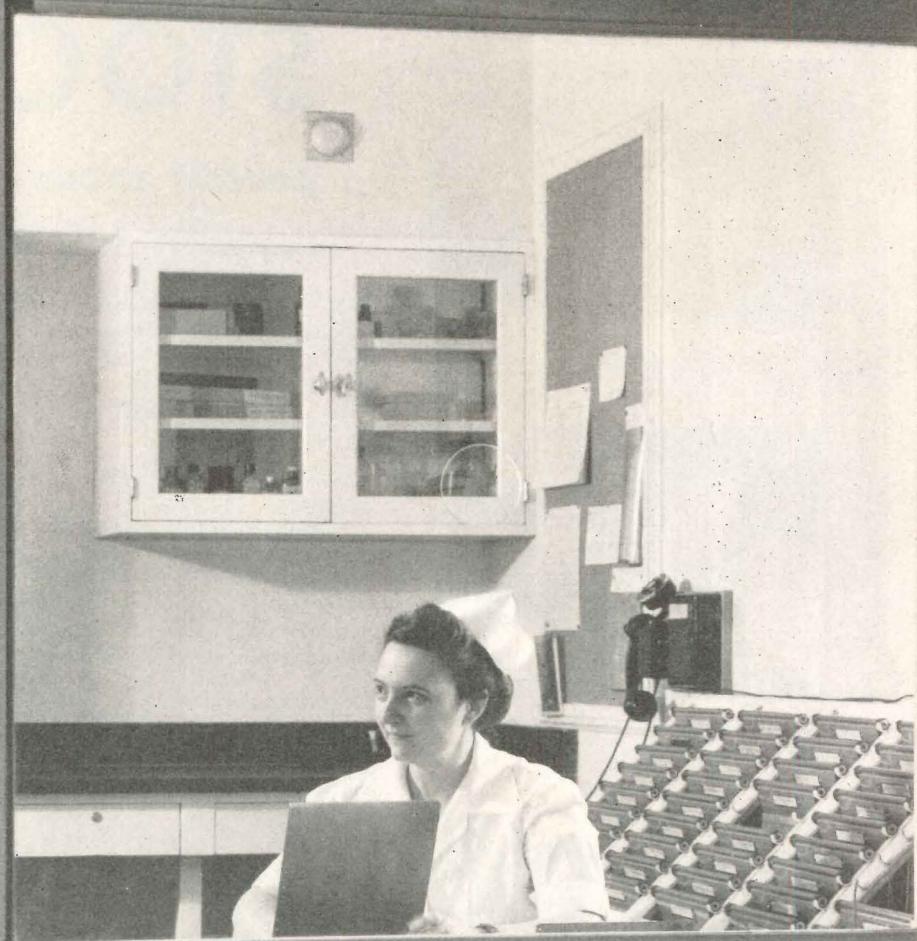

DOOR CLOSERS BY *LCN*

CLOSER CONCEALED IN DOOR

MEMORIAL HOSPITAL, SPRINGFIELD, ILLINOIS

LCN CATALOG II-E ON REQUEST

LCN CLOSERS, INC., 466 WEST SUPERIOR STREET
CHICAGO 10, ILLINOIS

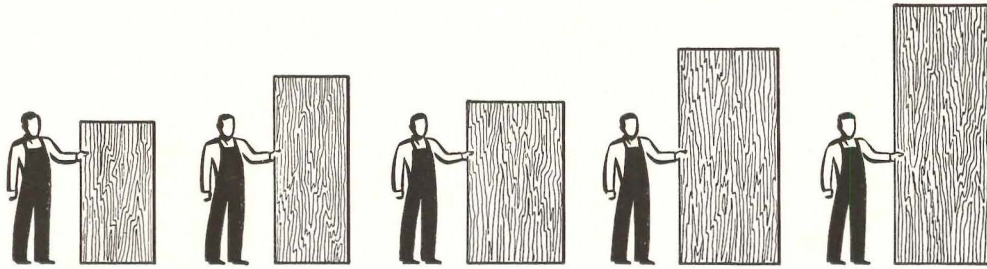

Douglas Fir Plywood's STOCK SIZES*

permit more exact specification
...with full material utilization



For lapped-siding, some stock sizes other than 4 x 8-foot are ideal. Eighteen inch siding, for example, cuts out of 3-foot wide panels exactly.



Cabinets, built-ins, storage-walls, sliding doors—whether shop-fabricated, built on-the-job, or constructed by the home owner—all can utilize stock plywood panel sizes.

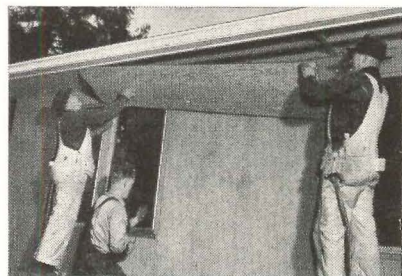

Soffits, gable-ends, fascias, other architectural treatment—all can utilize varying stock sizes with economy and ease of application.



For remodeling . . . for refinishing attics and basement rumpus rooms . . . stock sizes other than 4 x 8 are often ideal—saving installation time and labor.

BECAUSE big, rigid, durable 4 x 8-foot panels of Douglas fir plywood are so easy to use, so versatile and so perfectly suited to so many applications, this "modern miracle wood" ranks as one of America's preferred building materials.

Other stock sizes, too (see below) now mean even *greater* usefulness for remodeling and new construction alike.

For many applications, you'll find a stock size that will fit the need exactly—without cutting, without trimming—and with full utilization of the material. Many other needs will be

met with less sawing and fitting—a substantial saving of both on-the-job and mill-work costs.

Complete data on stock sizes, thicknesses and grades of Douglas fir plywood are detailed in Sweet's File, Architectural. Or you may write for the 1949 Basic Plywood Catalog (a reprint of Sweet's). Other ideas for using plywood's stock sizes are contained in "The Wood of 1,000 Uses." For your copy, address the Douglas Fir Plywood Association office nearest you: Tacoma Bldg., Tacoma 2, Wash.; 848 Daily News Bldg., Chicago 6; 1232 Shoreham Bldg., Washington 5, D. C.; The 500 Fifth Avenue Bldg., New York City 18.



★ LENGTHS:

60" 72" 84" 96" 108" 120" 144"

WIDTHS:

30" 36" 42" 48"

(Some grades limited to fewer sizes)



Douglas Fir PLYWOOD

LARGE,
LIGHT,
STRONG

Real Wood Panels

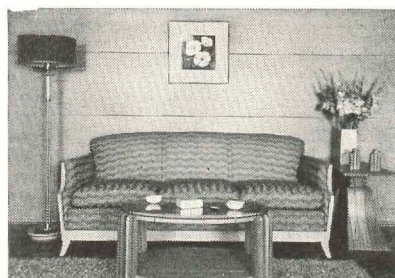

Interesting wall treatments are made easier when planning with various plywood stock sizes. In remodeling, such panels are especially convenient.



For scores of farm uses, stock sizes of varying length and width will meet many building needs exactly. Here again—Exterior should be used.



FLEXIBLE MINDS ACCLAIM THESE
Flexible Interiors..

"Movable Transite* Walls answer the problem of our changing space needs," say executives and building owners who like the idea of "rooms when and where you want them."

TODAY many of the most modern buildings literally have *miles* of these movable asbestos-cement partitions. Their unique appeal to forward-looking architects lies in the fact that Transite Movable Walls are attractive, solid, and durable.

They are completely salvageable, and can be relocated with little or no interruption to business routine.

Architects often combine Transite Movable Walls with two other Johns-

Manville products: noise-quieting Acoustical Ceilings, and resilient Decorative Floors. The combined use of these three materials is called J-M Unit Construction. It makes the *complete interior* available under *one* specification, *one* manufacturer's responsibility.

Write for the brochures describing these important steps forward in building design. They may help you on your next project. Address Johns-Manville, Box 290, New York 16, N. Y.

*Transite is a registered Johns-Manville trade mark.

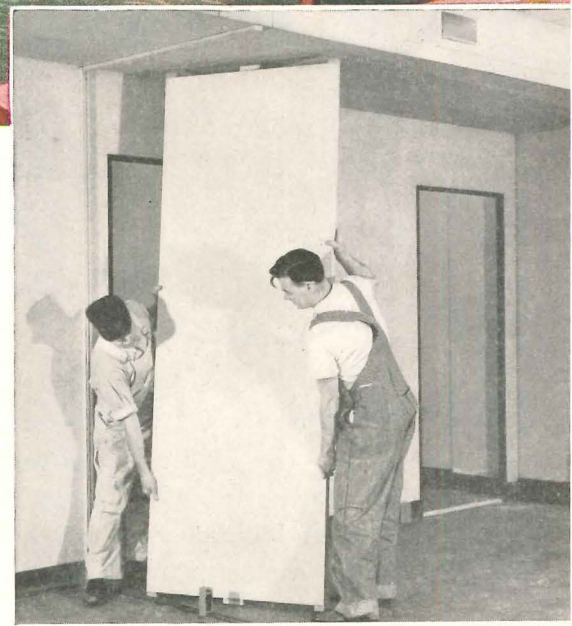

2 Types of Transite Walls

Shown above in process of erection is the Universal type of J-M Transite Wall. The finished wall consists of a sealed core faced on both sides with asbestos-cement sheets and is 1 3/4" in thickness. It is one of the easiest and most economical of all walls to erect and relocate.

A second type of Transite Wall is called Imperial. Here the asbestos-cement panels are hung on steel studs, forming a 4" double-faced partition.

Both types are fire-resistant, rotproof, hard-to-mar, easy to maintain, and highly resistant to shock and abuse.

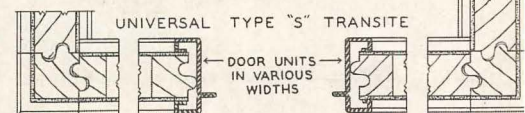

Johns-Manville Unit Construction

MOVABLE TRANSITE WALLS • ACOUSTICAL CEILINGS • DECORATIVE FLOORS (ASPHALT TILE AND TERRAFLEX)

A Good plan for

**INDUSTRIAL and
COMMERCIAL
WIRING
INSTALLATIONS**

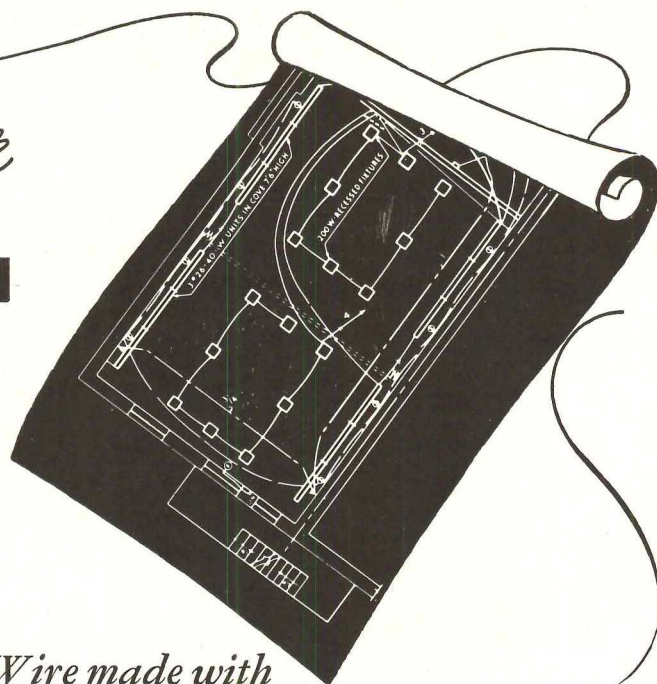

Use Rubber-Covered Building Wire made with

FIBERGLAS*
Yarns

*EASIER INSTALLATION and LONGER LIFE
at NO PREMIUM*

For permanence . . . and for customer satisfaction . . . on industrial and commercial wiring installations . . . it's a good plan to use rubber-covered building wire made with Fiberglas glass yarns . . . because Fiberglas yarns:

- **DON'T ROT**
- **DON'T ABSORB MOISTURE**
- **DON'T BURN**
- **DON'T PROVIDE FOOD FOR RODENTS**
- **DO HAVE THE INHERENT CORROSION-RESISTANCE OF GLASS**

For your satisfaction, too, you can depend on

Fiberglas yarns to perform to your credit whether you are the architect, the engineer, or the contractor on the job—or the wire manufacturer.

Consider, too, that rubber-covered building wire made with Fiberglas yarns:

- **PULLS EASIER**
- **LASTS LONGER**

Nonmetallic—sheathed building cable made with Fiberglas yarns offers the same advantages.

Consult your supplier and satisfy yourself about the superior performance of building wire and cable made with Fiberglas yarns.



Yarns

*Fiberglas is the registered trademark of Owens-Corning Fiberglas Corporation for a variety of products made of or with glass fibers.

OWENS-CORNING FIBERGLAS CORPORATION, Textile Products Division, Dept. 831, 16 East 56th Street, N.Y. 22. In Canada, Fiberglas Canada Ltd., Toronto, Ontario

BUILDING-
PLUMBING
DRAINAGE
INSTALLATION
EXPERIENCE



What ZURN

Building-Plumbing Products

Have that can't be duplicated

Practical ideas! Any idea which when embodied in a building-plumbing product does one or all of these two things: (1) reduces time-wasting grief on installations, and protects the contractor's time-cost cushion on the job, (2) provides a greater degree of sanitation, and protection to buildings, and to people who live, work or play in them.

Professionally trained Zurn Engineers, enlightened by over 40 years of experience, are continually developing and incorporating into Zurn building-plumbing drainage products ideas that can't be duplicated. A recent example of the application of practical ideas conceived by Zurn Engineers is presented in the features of the Zurn Easy Level Floor Drain.

Zurn Engineering is engaged continually in research to discover new and unusual drainage requirements common to modern types of buildings. Thus do Zurn Engineers conceive practical ideas for building-plumbing drainage products that can't be duplicated.

J. A. ZURN MFG. CO. • PITTSBURGH AVE., ERIE, PENNSYLVANIA, U.S. A.
And its Affiliate: AMERICAN FLEXIBLE COUPLING COMPANY
Sales Offices in all Principal Cities of the United States



PROVIDES BETTER WAYS TO...
drain waste and rain water,
THROUGH RESEARCH AND ENGINEERING

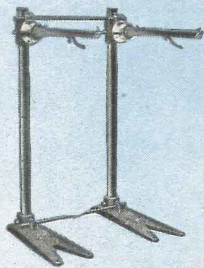

Z-1231 Chair Carrier for Wall Type Lavatories



Z-506 and Z-507 Zurn Easy Level Floor Drain



Z-542 Zurn Continuous Flow Solids Retaining Floor Drain



Z-1171 Zurn Deluxe Cast Iron Greaseceptor

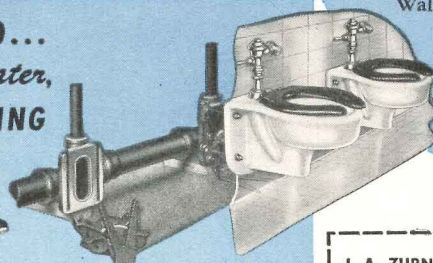

Zurn Wall Closet Fittings for Installation of Batteries of Wall-Type Closets



Z-1090 Zurn Backwater Sewer Valve with Clean-sweep Water Ways

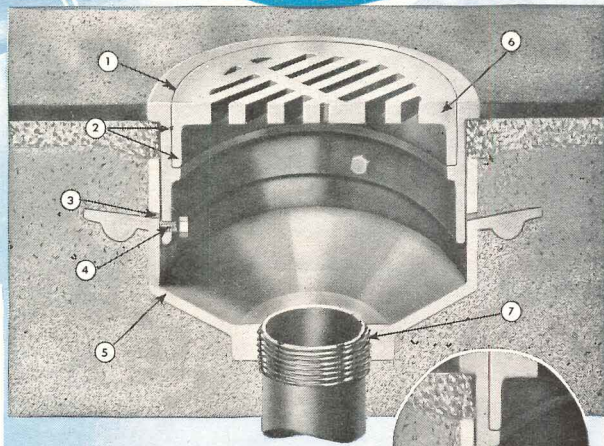

ZURN Easy Level Floor Drain

Z-506 and Z-507 Zurn Easy Level Floor Drain

- | | |
|---|---|
| 1. Weight of frame and grate supported by flanged frame | 5. Heavy duty dura-coated cast iron body |
| 2. Entire frame and grate have been raised to new level | 6. Extra heavy deep flanged grate |
| 3. Seepage orifice | 7. Pipe connection undisturbed in floor resurfacing operation |
| 4. Adjustable locating bolt—one of three | |

Zurn Engineers designed the Easy Level Floor Drain to solve an old and troublesome problem — how to make quick and easy and accurate adjustment of drains to floor level when floors are re-surfaced. Their greatest use is in floor areas subject to heavy wear, such as in manufacturing plants, industrial plants, garages, hangars, laundries, and large open areas.

Easy Level Floor Drains are designed for both new and old construction. Adjustment is made without "trial and error" chipping of the concrete. To raise the Easy Level Floor Drain, simply loosen the strainer from the cement, remove grate, loosen locating bolts on the frame, raise to desired level, and tighten bolts. It's that quick and easy. Foolproof and positive adjustment is on the inside of the drain.

Special features incorporated in the Easy Level Floor Drains by Zurn Engineers include deflecting bar type grate with the area of the openings in the correct ratio (or better) to the pipe size to handle water faster, low over-all height for shallow construction, streamlined design — no close fitting parts or pockets to become fouled with concrete, and pipe connections are not disturbed in making adjustment.

For floor areas with neat, smooth and level junction at the drain when re-surfacing is done, specify Zurn Easy Level Floor Drains for the original installation.

Everything for Drainage Systems

except the pipe The complete line of Zurn Building, Plumbing, Drainage Products includes: Floor and Roof Drains for every type of installation • Grease Interceptors • Oil Interceptors • Plaster and Solids Interceptors • Swimming Pool Equipment • Backwater Valves • Wall Fixture Carriers • Wall Closet Fittings • Plumbing-Drainage Fittings • Cleanouts • Bath Traps • Hydrants • Street Washers.

Zurn Drainindicator saves time and work for engineers, architects and plumbing contractors, who are eligible for a complimentary copy.

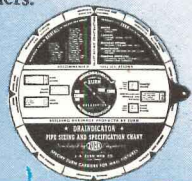

J. A. ZURN MFG. CO., Pittsburgh Ave., Erie, Pa., U. S. A.

Please send the following literature:

- Catalog 47-1 of Zurn Building, Plumbing, Drainage Products
- Zurn Drainindicator (Drainage Pipe Sizing Chart)
- Zurn Booklet on Wall Closet Fittings
- Zurn Handbook on the Proper Sizing and Selection of Grease Interceptor
- Zurn Carriers Catalog No. 49

Name Position

Company

Street

City State

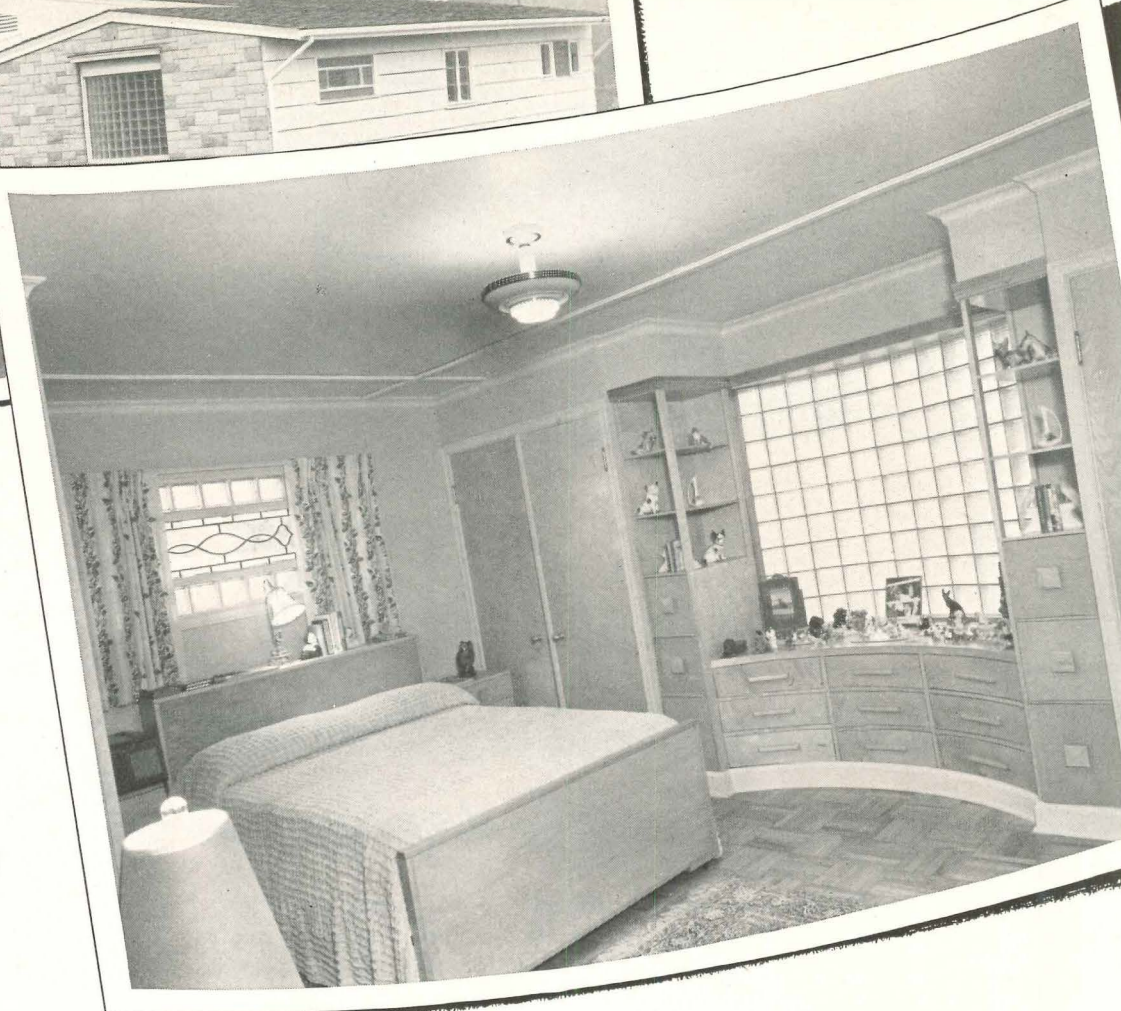
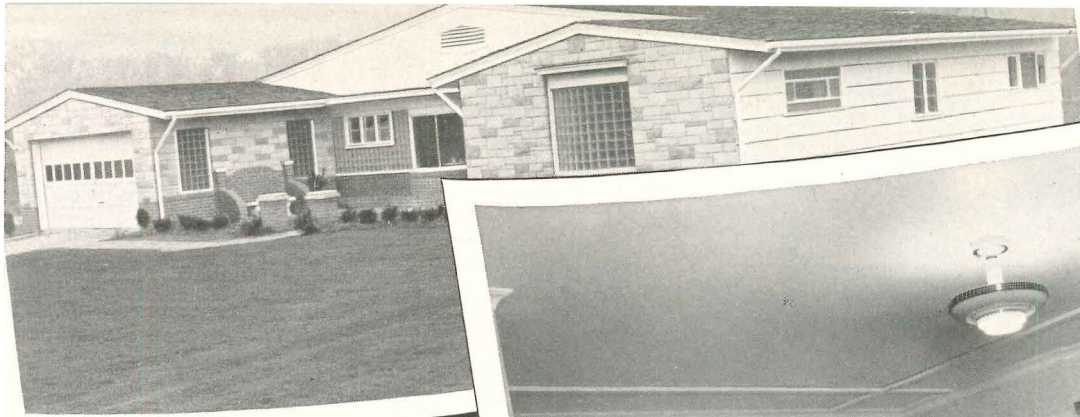

NOTES - ON DRY-BUILT FULL-WALL CONSTRUCTION

ADVANTAGES - BEAUTY · PERMANENCE · ADDED INSULATING VALUE

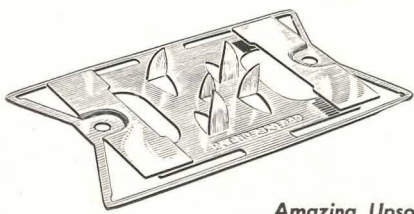

Amazing Upson Floating Fastener anchors panels securely from the back. Designed to compensate for normal structural movement. No visible face nailing! No nails to countersink. No nail holes to fill! No joints to tape!

Nearly every architect sees something different in Upson dry-built full-wall construction.

Some see the most beautiful walls and ceilings they have ever specified for a client. Smooth, warm, inviting walls with no plaster marks showing!

Others see the solution to cracked plaster troubles—permanence achieved by resiliency. Still others see exciting new ways to use a proven new material. And all see their jobs speeded up, time saved. Added dollar value, without additional cost.

Upson Strong-Bilt Panels are made in *full wall* sizes. Carpenters, already on the job, go right ahead with the application of interior walls and ceilings, any month of the year in any climate. No water, no plaster, no drying out period.

Here truly is a major improvement in wall and ceiling quality that does not add to either material or labor costs. A construction method demonstrated in more than 50,000 homes. A material proved by 10 years of use. F. H. A. accepted!

Strong-Bilt is a sturdy, 6-ply panel approximately $\frac{3}{8}$ " thick—laminated for strength and rigidity. Beautifully pebbled surface presized at the factory. Made in standard and *full wall sizes*—8' by 14', 16' and 18' long.

Independent authoritative tests show insulation value 3.2 times greater than boards with a mineral core. Impact resistance—up to 6 times greater!

See Sweets Catalog File A.I.A. 23

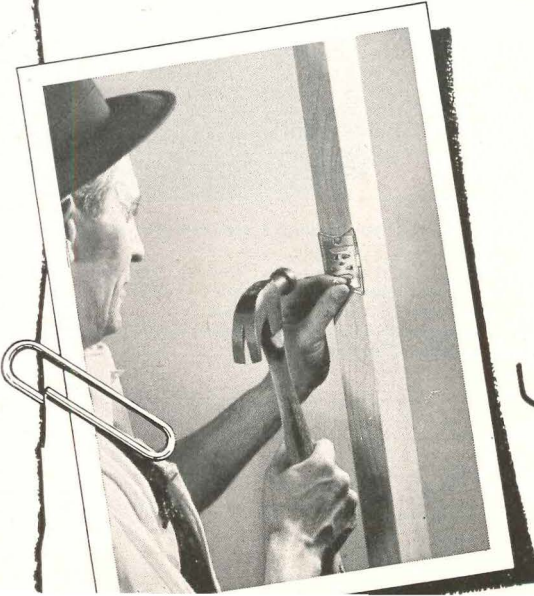

UPSON STRONG-BILT PANELS IN FULL-WALL SIZES BY THE UPSON COMPANY

546 Upson Point
Lockport, New York

Kawneer

STOCK ENTRANCES

offer handsome styling
and expert workmanship.

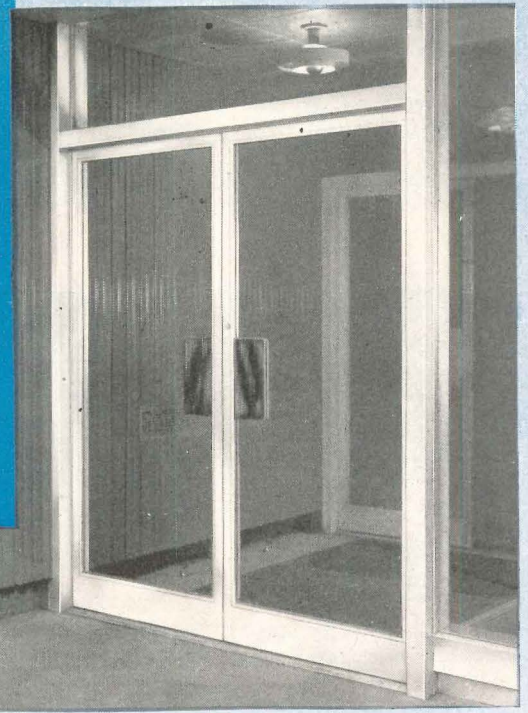

Narrow stile entrance

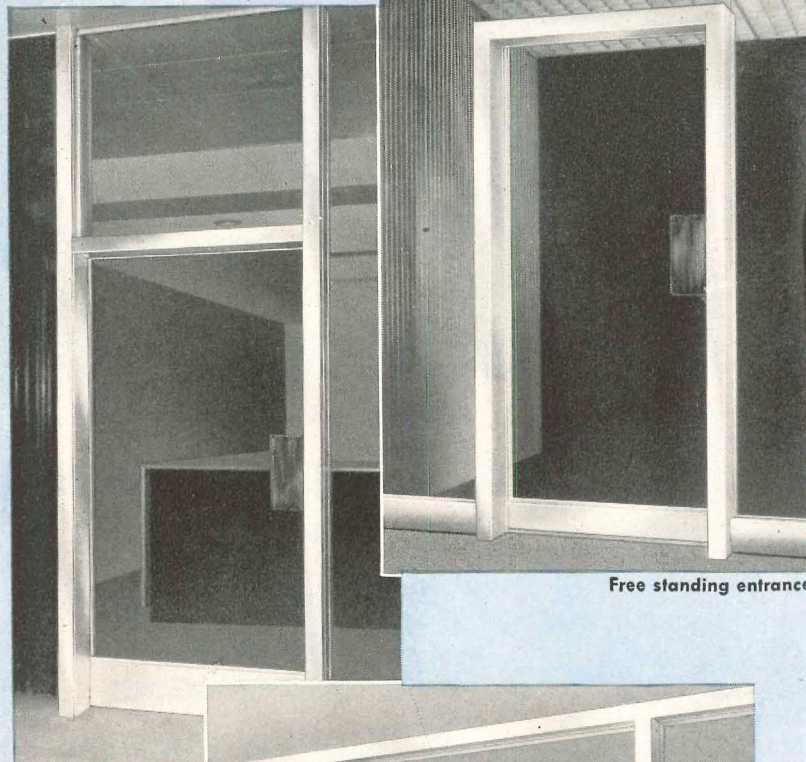

Free standing entrance

Full vision
entrance

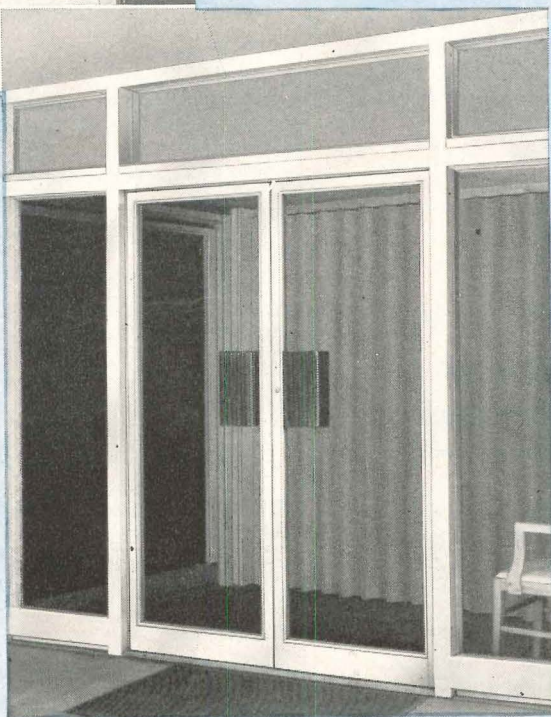

Narrow stile entrance with
side lights and transom

Plus

**MAJOR ECONOMIES in
price, availability, installation**

You save money for your client and yourself when you specify Kawneer Stock Entrances, Doors, and Glass-Door Frames.

Kawneer Stock units cost far less than custom-made entrances—they reduce the expenses of drafting and detailing—they eliminate costly delays.

Your local Kawneer distributor stocks these units and they are immediately available as complete packaged units with all hardware and accessories included. Installation is quick and simple.

The clean lines, smooth surfaces, and narrow silhouettes of a Kawneer Entrance reflect the highest standards of modern architecture.

Careful engineering and workmanship insures smooth, trouble-free operation year after year. All doors and frames are inside welded for long-service rigidity and uniform finish.

Kawneer metal-glass construction protects interiors against drafts, dust, soot, and rain—it also helps prevent the escape of warmed air in the winter and cooled air in the summer. Write for construction details. 241 North Front Street., Niles, Michigan; 2541 8th St., Berkeley, Calif.; 817 East Third St., Lexington, Ky.

THE
Kawneer
COMPANY

Store Front Metals • Modern Entrances
Facing Materials • Aluminum Louvered Ceilings
Aluminum Roll-Type Awnings

ANNOUNCING

Pushmatic

PUSH — it's ON!

PUSH — it's OFF!

PUSH — it's ON again!

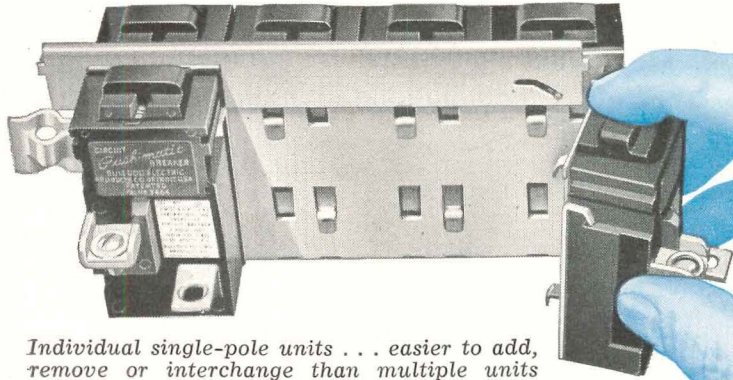
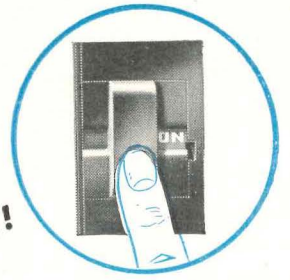

Individual single-pole units . . . easier to add, remove or interchange than multiple units



Beautifully styled—Functionally perfect!

featuring . . .

PUSH-BUTTON CONTROL and AUTOMATIC PROTECTION for ELECTRIC CIRCUITS

Now BULLDOG's revolutionary, new *Pushmatic* gives you *positive* finger-tip control and *automatic* protection against overload and short circuits!

A push of the finger makes or breaks the circuit. There's no resetting manually when the circuit is broken by short or overload. Just PUSH—and service is restored.

Pushmatic is compact, sturdy, simple . . . the most versatile and flexible unit available today. It will meet every new or changing load condition.

And *Pushmatics* are easy to install.

There are no complicated group mountings . . . individual single-pole units make additions and changes a simple matter.

There are four types of *Pushmatics*: THERMAL ONLY, THERMAL MAGNETIC, or either of these types with AMBIENT COMPENSATING FEATURES. All are identical in size and contour, in ratings of 15, 20, 30, 40 and 50 amperes, 120 V., 1 pole, or 120-240 V., 2 poles, AC. All are interchangeable for rating and type.

Find out about *Pushmatic's* outstanding features before you specify or buy any circuit breaker.

BullDog Electri-Centers with

Pushmatic

**NEW, BEAUTIFULLY STYLED LINE OF
PROTECTIVE CONTROL CENTERS**

THESE sensational, new ELECTRI-CENTERS, featuring *Pushmatic*, provide electrical control centers that are the last word in efficiency and protection.

They are attractive, compact, simple . . . easy to wire. There's plenty of gutter room even in the smallest cabinets.

With ELECTRI-CENTERS there are no fuses to buy, no complicated operations or installation techniques to remember. You get versatility and adaptability, ease of installation and operation *never before obtainable in any panelboard.*

See the new ELECTRI-CENTERS at first opportunity, or send in the coupon today for *Pushmatic* Bulletin #493. This descriptive bulletin, liberally illustrated, contains complete information and prices on BullDog ELECTRI-CENTERS and the new *Pushmatics*.

BULLDOG ELECTRIC PRODUCTS COMPANY
Detroit 32, Michigan—Field offices in all principal cities
In Canada, BullDog Electric Products of Canada, Ltd., Toronto



BULLDOG

HEADQUARTERS FOR ELECTRICAL DISTRIBUTION

Check these NEW Features

- Positive protection against overloads and short circuits
- Push "ON" and "OFF" for normal manual switching. Push "ON" after automatic tripping—no so-called reset position.
- Trip-free of the handle
- All types and ratings interchangeable, quickly, easily
- Permanent calibration by amperes in one precision-formed part

BULLDOG ELECTRIC PRODUCTS CO.
Detroit 32, Michigan

Please send me your *Pushmatic* Bulletin #493 giving full information and prices on your *Pushmatic* ELECTRI-CENTERS.

Name _____

Company _____

Street Address _____ Zone _____

City and State _____

DON'T BUY UNTIL YOU HAVE SEEN THE LATEST AND FINEST

Why play "hide and seek" with buried pipes?



Every house needs at least one Milcor Steel Access Door. Public buildings need hundreds!

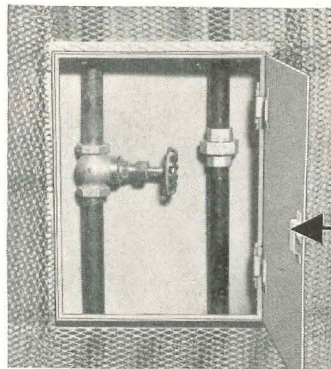

Instant Access to Key Points in plumbing, heating, electrical, and refrigeration systems.

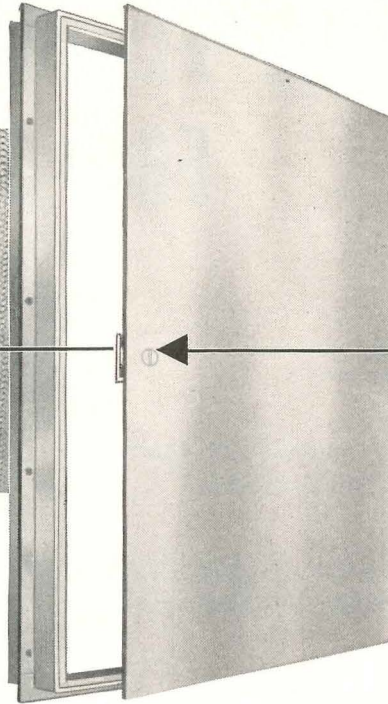

A SCREW DRIVER DOES THE TRICK!

Ready to install • No special framing • Painted with rust-inhibiting prime coat • Concealed hinges • Flush, screw-type lock • 11 Sizes — from 8 $\frac{3}{8}$ " x 8 $\frac{3}{8}$ " to 24 $\frac{3}{8}$ " x 36 $\frac{3}{8}$ " • For plastered or non-plastered walls • With or without expanded metal wings.

MILCOR STEEL ACCESS DOORS

give instant access to key points

—and they last longer, cost less, help you deliver a job to be proud of

Convenience is a prime factor in any modern building. And maintenance convenience calls for Milcor Steel Access Doors.

They're flush to the wall — you can paint or paper right over them. No ugly frame protrudes. They eliminate dust-catching projections. They can't warp, crack, shrink, or rot.

Installation is quick and easy. And Milcor Steel Access Doors actually save so much on building

time that they actually cost less than the old style doors with their special wood-framing!

So, for convenience and economy that really sells the client on your jobs — specify Milcor Steel Access Doors. Consult the Milcor Catalog in your Sweets File for complete information.

Milcor — the complete line of fireproof metal lath and steel building products.

INLAND STEEL PRODUCTS COMPANY

FORMERLY MILCOR  STEEL COMPANY

MILWAUKEE 1, WISCONSIN

Baltimore 24, Md. • Buffalo 11, N. Y. • Chicago 9, Ill. • Cincinnati 25, Ohio
Cleveland 14, Ohio • Detroit 2, Mich. • Kansas City 8, Mo. • Los Angeles 23, Calif.
New York 22, N. Y. • Rochester 9, N. Y. • St. Louis 10, Mo.



TEAR OUT THIS COUPON AND MAIL TODAY!

INLAND STEEL PRODUCTS COMPANY, 4101 West Burnham Street, Milwaukee 1, Wisconsin
Send me (without obligation) a Milcor Manual with full details on Milcor Steel Access Doors and other products in the complete Milcor Metal Lath line.

Name.....Title.....

Company.....

Company Address.....

City.....(.....) State.....

F-324

KENTILE FLOORS GIVE YOU FREEDOM FOR DESIGN—AT LOW COST

Because...

KENTILE can be installed on concrete in direct contact with the ground.

KENTILE can be laid over double T & G wood floors—or directly over firm plywood.

KENTILE is ideal for installation on radiant-heated concrete slabs.

KENTILE is laid square by square—meaning installation and labor costs are cut to the minimum. No bulky rolls that require two men for handling.

KENTILE, with 23 different colors and unlimited scope of design, enables you to achieve custom-built effects...floors which blend with any background.



LUSTRON HOMES FEATURE KENTILE
These nationally-famous homes feature Kentile Floors in every room for easier cleaning, long-time beauty. Kentile helps Lustron slash building costs by permitting direct installation over concrete on grade.

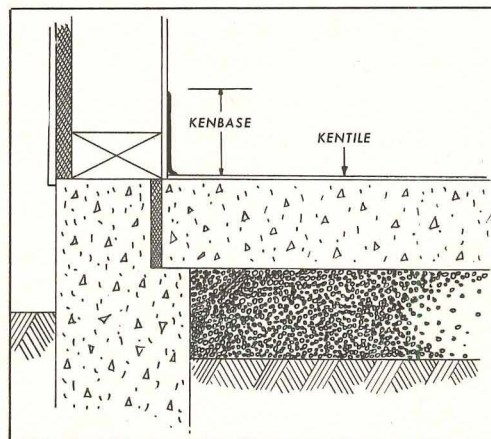

LASTING BEAUTY...
Kentile's rich, attractive colors can't wear off—they go clear through the material. This flooring resists stains and scuffing—comes clean and sparkles like new with minimum care. Resilient as well—quiet and comfortable. The many advantages of Kentile are continuously advertised in nationally read magazines and local newspapers.

Installs directly on concrete in contact with the earth (see above)
Kentile's fillers, binders and pigments are highly resistant to alkali present in concrete which is in contact with the ground. Effective insulation against the dampness and cold of concrete floors is provided by Kentile's asbestos filler. Kentile "seats" well; moisture or dampness will not cause it to curl.

KENTILE®

The Permanently Beautiful
Asphalt Tile



DAVID E. KENNEDY, INC. 58 Second Avenue, Brooklyn 15, N. Y. • 1211 NBC Bldg., Cleveland 14, Ohio • Bona Allen Bldg., Atlanta 3, Ga. • 452 Statler Bldg., Boston 16, Mass. • 705 Architects Bldg., 17th and Sansom St., Philadelphia, Pa. • 4532 So. Kolin Avenue, Chicago 32, Ill. • 350 Fifth Avenue, New York 1, N. Y. • 1440 11th Street, Denver 4, Colo. • 2201 Grand Avenue, Kansas City 8, Mo. • 1855 Industrial St., Los Angeles 21, Calif.

an entirely new concept of elevating

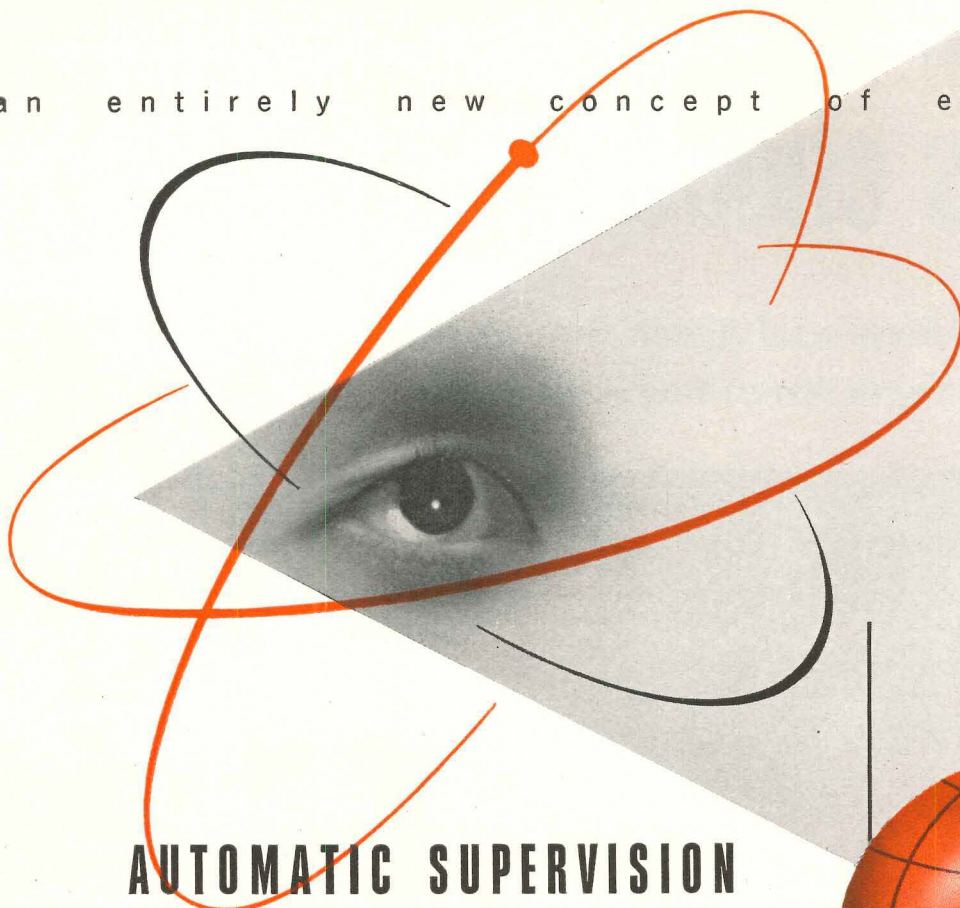

AUTOMATIC SUPERVISION throughout 6 traffic patterns

With AUTOTRONIC supervision, an elevator system automatically matches the dispatching and operation of the cars to surges and lulls in traffic . . . rebalances the cars when the traffic pattern is changed . . . rebalances the cars if an attendant leaves ahead of the dispatching signal . . . rebalances the cars when the number of cars in service is changed . . . and automatically measures and limits waiting passenger time.

All the starter has to do is set a traffic flow dial to one of 6 traffic patterns . . . place the proper number of cars in service . . . set the dispatching interval . . . then devote practically all of his time to doing a better job as a front line public relations man for the building!

OTIS AUTOTRONIC Traffic-Timed ELEVATORING can be applied to NEW or EXISTING groups of elevators. It is the only elevating system that is timed to the 6 daily traffic patterns of busy office buildings, hotels, hospitals and department stores.

Otis Booklet B-721-F explains the details—interestingly.

Address: Otis Elevator Company, 260 11th Avenue, New York 1, N. Y.

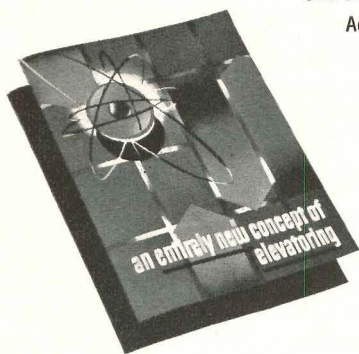

Otis...first with Electronic Signal Control...
again first with Traffic-Timed Elevating

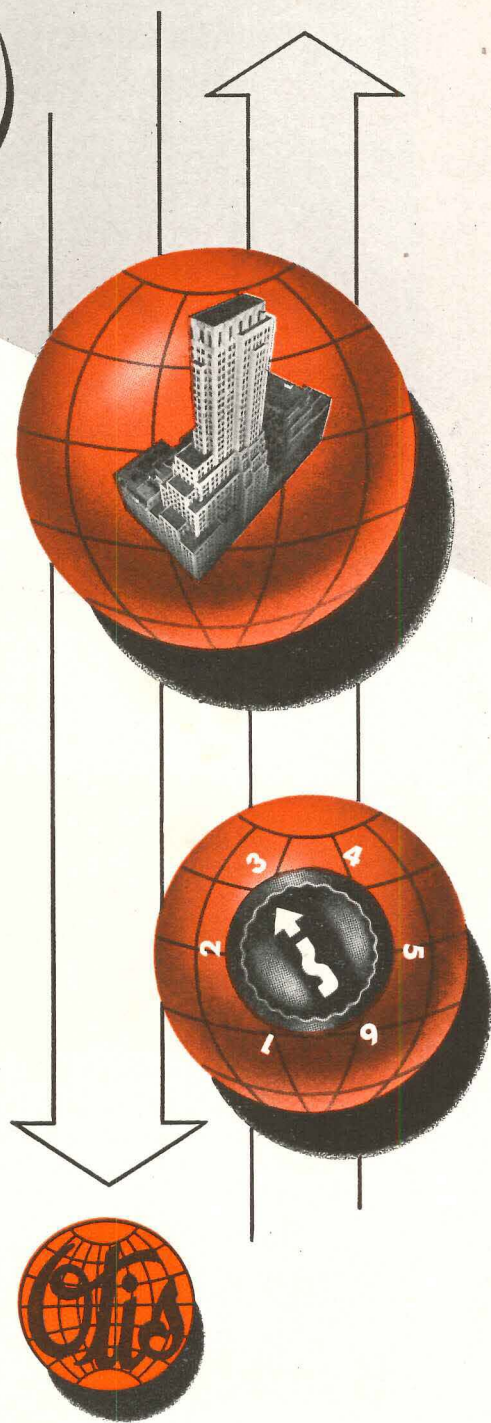

OTIS AUTOTRONIC *Traffic Timed* ELEVATORING

FOR ROOFING THAT MUST ENDURE . . .

Always choose REVERE COPPER!

**A Famous Memorial Again Proves That
Copper Roofs Make Common Sense**



Finished double pitched roof on front.

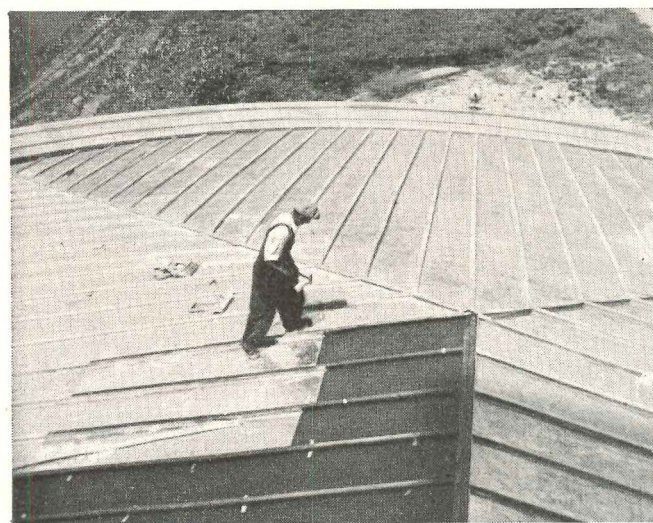

*Back roof, where double pitched roof
and dome roof meet.*

IN Alexandria, Virginia, Gichner Inc. of Washington has been constructing the roof on a truly beautiful and stately building . . . the famous George Washington Masonic Memorial.

Because the roof obviously had to be permanent, enduring and impressive, common sense demanded copper. Thus, more than 13,000 pounds of Revere lead-coated copper were specified for the batten seam installation.

Regardless of whether it's a small or large job on roofs, flashing or gutter, Revere copper and the

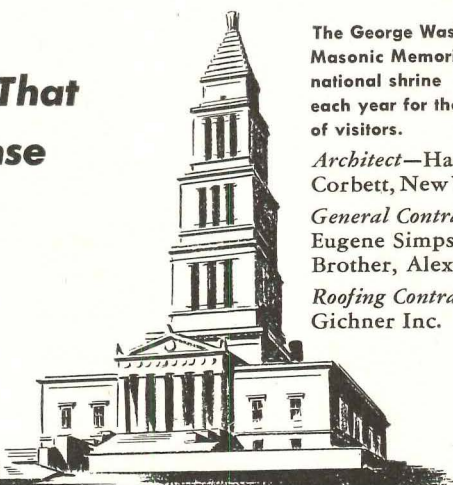

The George Washington Masonic Memorial . . . national shrine each year for thousands of visitors.

Architect—Harvey W. Corbett, New York, N.Y.

General Contractor—Eugene Simpson and Brother, Alexandria, Va.

Roofing Contractor—Gichner Inc.

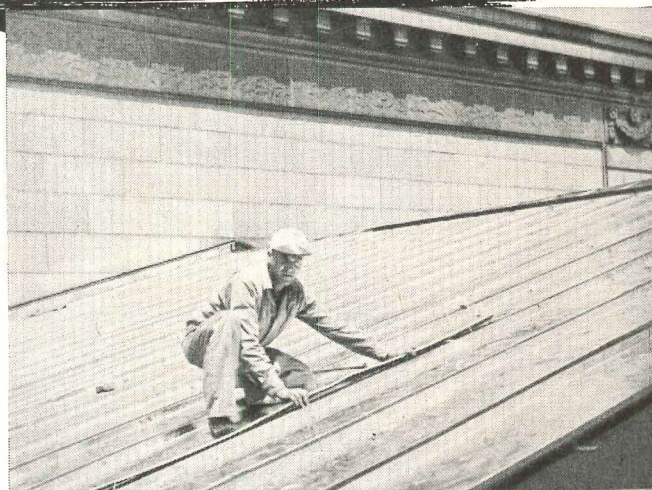

Installing caps on batten as roof nears completion.

Revere manual on sheet copper installation will help guide you to finer, more durable construction.

Revere sheet and roll copper, lead coated copper and other Revere quality materials are available through leading distributors. A Revere Technical Advisor stands ready to consult with you without obligation.

For 50 years, Gichner Inc. has installed Revere Copper on many of Washington's most impressive buildings.

REVERE

COPPER AND BRASS INCORPORATED

Founded by Paul Revere in 1801

230 Park Avenue, New York 17, New York

Mills: Baltimore, Md.; Chicago, Ill.; Detroit, Mich.; Los Angeles and Riverside, Calif.; New Bedford, Mass.; Rome, N. Y.—Sales Offices in Principal Cities, Distributors Everywhere.



SHELBORNE

SCHLAGE...first name in cylindrical locks

Florida's Shelborne Hotel... Miami Beach

a Schlage installation of heavy duty
cylindrical locks.

Architects: Polevitzky and Russell.

The Schlage Lock illustrated is

Astra Design

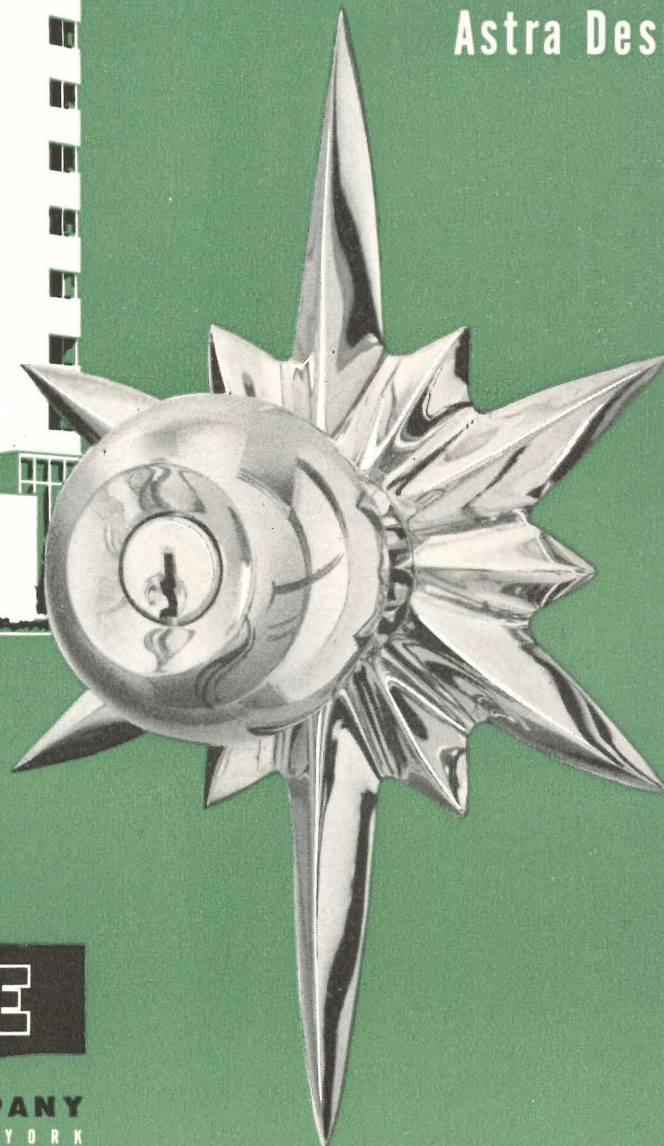

SCHLAGE

SCHLAGE LOCK COMPANY
SAN FRANCISCO • NEW YORK

Remember! Celotex Insulating Sheathing is ... double-waterproofed

The Exclusive Celotex Way

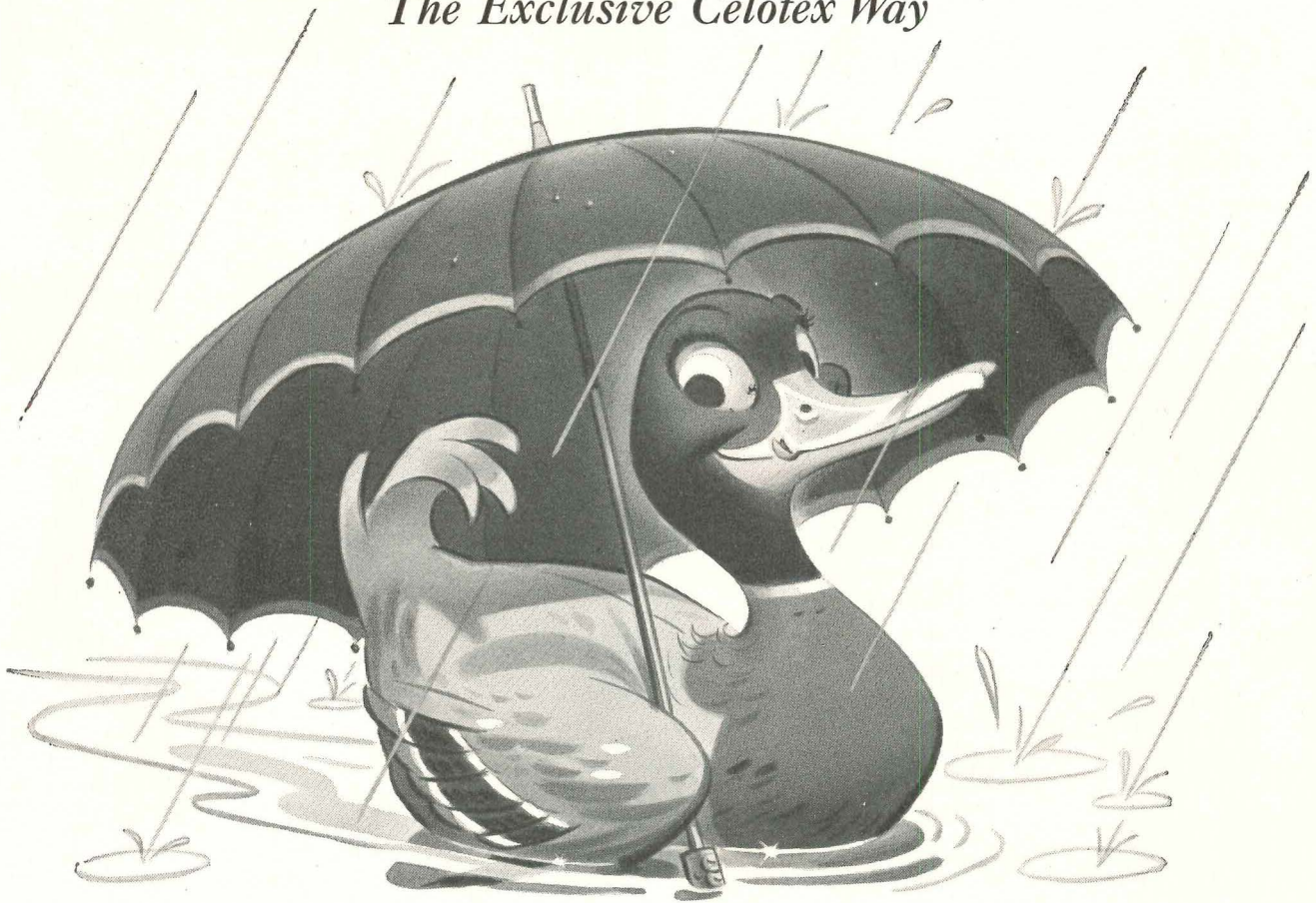

1 WATERPROOFED INSIDE!

Every one of the millions of tough cane fibres which make up its insulating core board is coated with a waterproofing agent during manufacture.

2 WATERPROOFED OUTSIDE!

This remarkably strong, durable insulating board is then coated on both sides, and on all edges, with a thick, enduring "raincoat" of specially-treated asphalt which seals out moisture.

*The
Ideal
Wall*

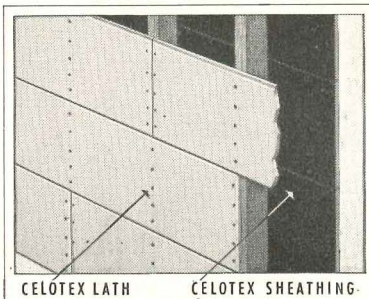

Celotex Insulating Sheathing, double-waterproofed for greater moisture protection – and *Celotex Insulating Lath*, the superior plaster base – used in combination on opposite sides of the framing give you the "Ideal Wall," a superior wall structure plus *built-in* insulation.

- ★ Yes, *double-waterproofed*, yet it has more than twice the vapor permeability advocated by government agencies!
- ★ Safe even under severe exposure during construction! Even cut edges are highly resistant to moisture penetration.
- ★ Enables contractor to resume work more quickly after the heaviest rain, thus cutting costly delays.
- ★ Protected against dry rot, termites, and fungus by the exclusive Ferox process.
- ★ Combines exceptional structural strength and rigidity with high thermal insulation.
- ★ Builds and insulates, all at *one* low cost.
- ★ Yet costs no more than ordinary sheathing.
- ★ Write today for full details!

Double-Waterproofed

CELOTEX

REG. U. S. PAT. OFF.

THE CELOTEX CORPORATION • CHICAGO 3, ILLINOIS

**CELOTEX
INSULATING
SHEATHING**

How building designers can
 get an **electrical
 layout that fits**
 ...and save time and money
 doing it!



1 Before your draftsmen touch pencil to paper, call, wire or write your nearest General Electric Office; an experienced building specialist will contact you.



2 Outline to him your preliminary plans and problems; show him the type and location of all electrical loads, special conditions which must be met.



3 At his disposal are many General Electric product engineers . . . authorities in the fields of power distribution, lighting, motors and control.

RESULTS: You save planning time and come up with electrical plans that fit your structure . . . plans that embody all up-to-the-minute electrical developments . . . specifications that assure the building owner maximum operating economies over the years, and establish your reputation for future jobs. Try this easy, 4-step planning method on your next job . . . you'll find it both profitable and enjoyable to work with a General Electric building specialist. *Apparatus Dept., General Electric, Schenectady, N. Y.*

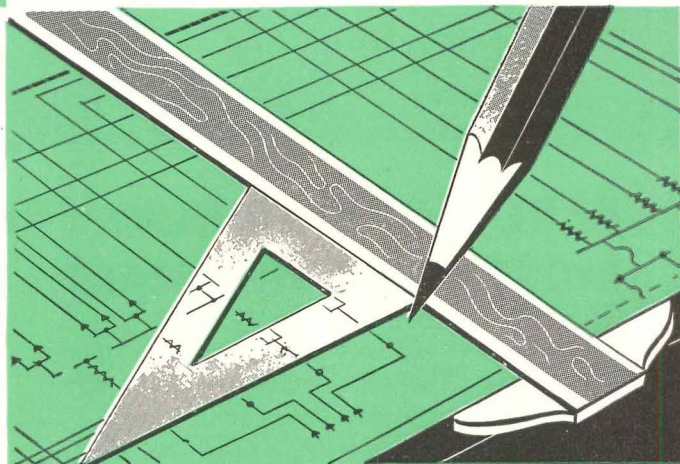

4 Using this wealth of G-E know-how, he will help you plan an integrated electrical system, around which you can easily draw up plans and specifications.

Electric Equipment for Commercial Building

GENERAL  **ELECTRIC**

665-106

BLESSING OR CURSE?

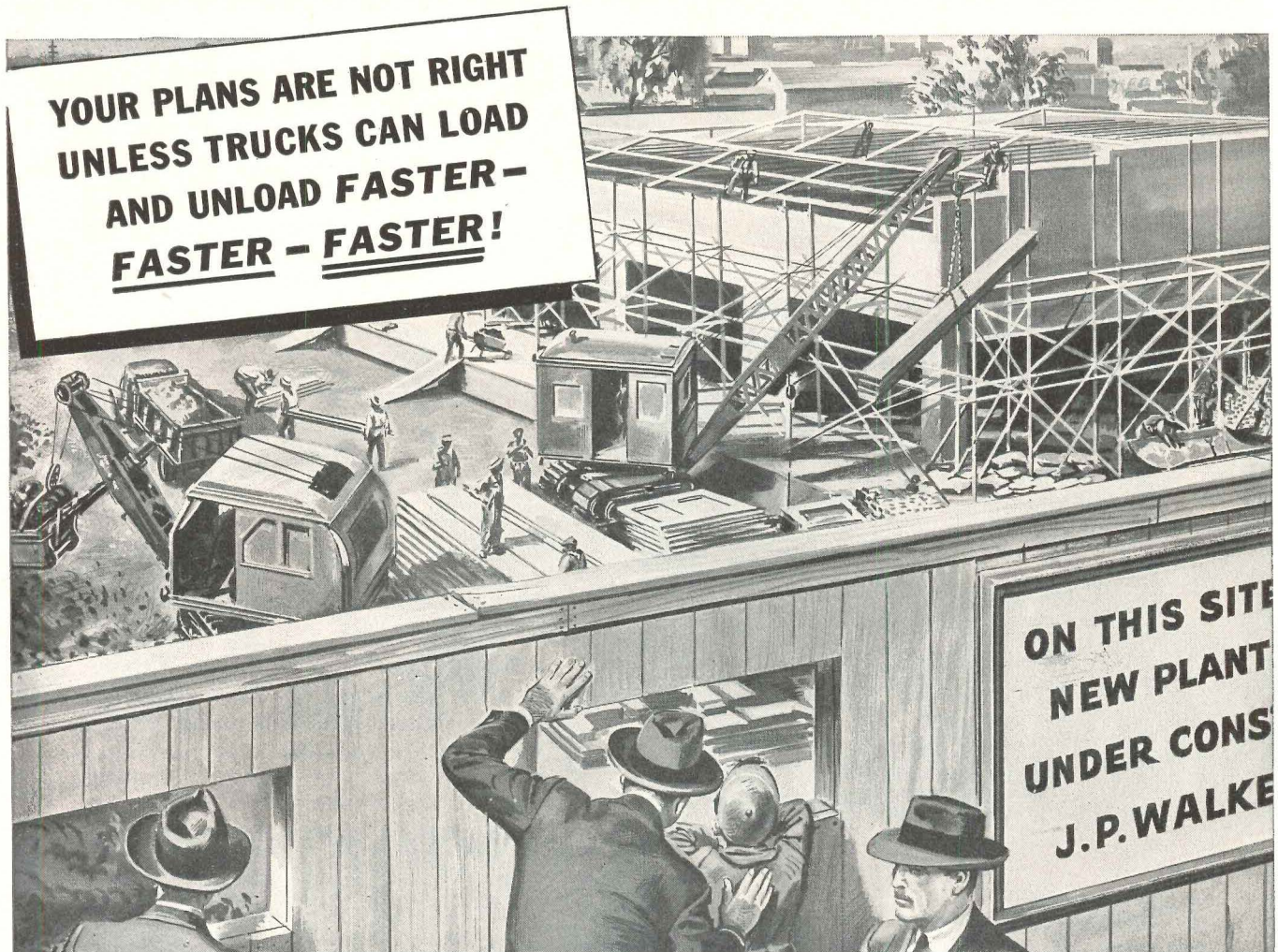

HERE'S HOW TO PLAN YOUR LOADING DOCK SPACE RIGHT FROM THE START:

There's only one way to get rid of traffic jams around your new plant. That's to plan adequate dock space *now*—before the plant goes up.

Otherwise, the great new modern plant you thought would be a blessing to your business, can turn out to be a curse—no matter how efficient it is inside.

If that sounds like a strong statement, just imagine goods bottlenecked at your loading platform, day after day, because the

trucks can't get in and out on time.

So plan *right*—plan *now*—for loading dock space that can measure up to the job it has to do.

Call in your traffic manager. Your architect. Your engineer. Your shipping men.

And let them *tell you* how to plan your new plant—or remodel your present shipping facilities—so today's modern trucks don't have to squeeze in one-at-a-time.



THE **AMERICAN TRUCKING** INDUSTRY

AMERICAN TRUCKING ASSOCIATIONS, WASHINGTON 6, D. C.

BRIXMENT FOR STUCCO

—IN THE NATION'S CAPITAL!

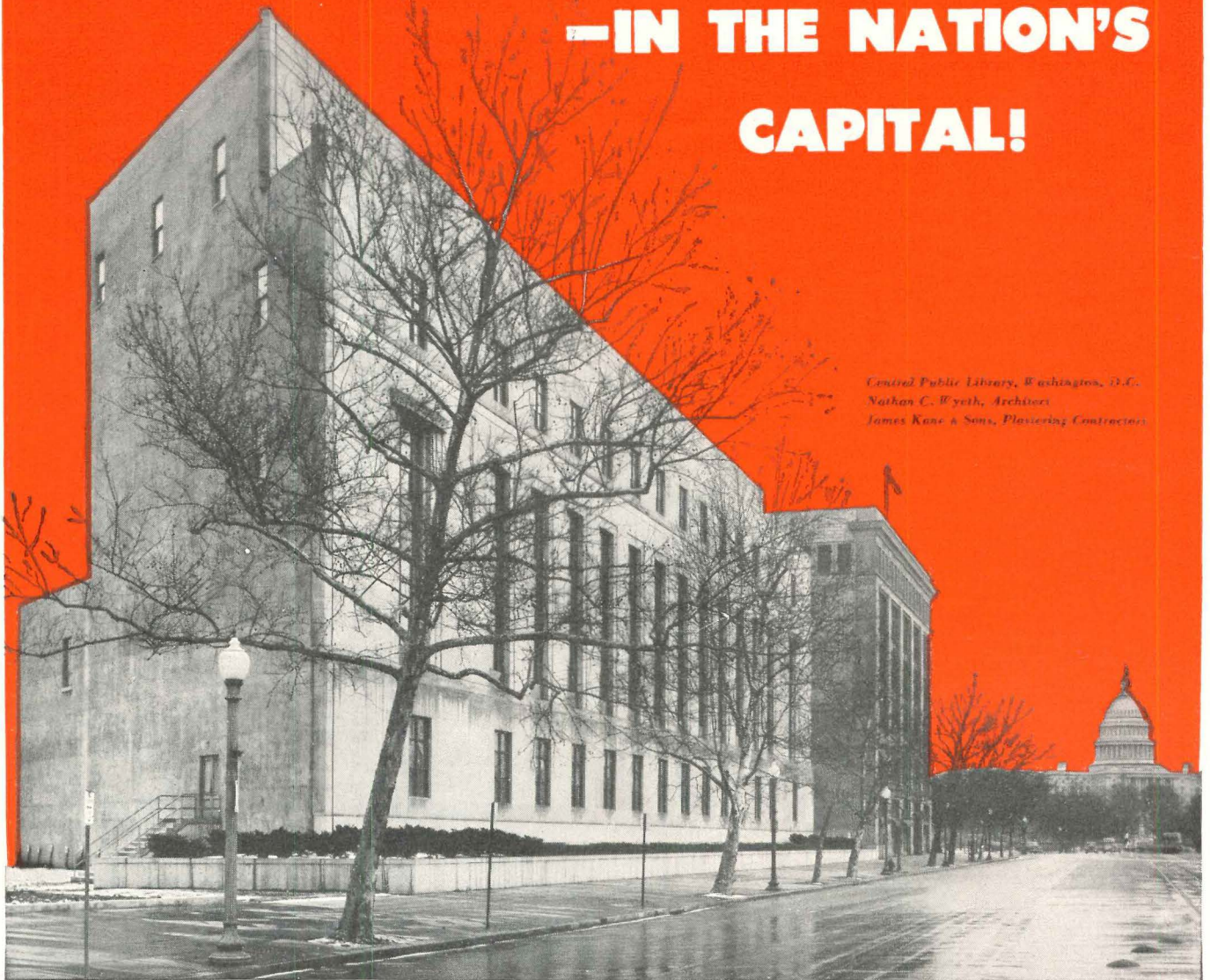

*Central Public Library, Washington, D.C.
Nathan C. Wyeth, Architect
James Kane & Sons, Plastering Contractors*

Everybody in the building industry knows about Brixment for masonry. But do you know that Brixment also makes a very superior stucco?

When the new Central Public Library was built in Washington, D. C., stucco was specified for each of the building's tremendous ends (96' high by 120' and 140' wide). Materials and workmanship of the highest quality were of course required.

After due consideration and experimentation, Brixment was selected for the stucco. James Kane & Sons, Inc., the plastering contractors, report that the job is entirely satisfactory, that

they have now used Brixment stucco with equally good results on several other jobs, and that they "do not hesitate to recommend Brixment as a completely satisfactory stucco mortar."

Brixment stucco is mixed and used exactly like portland cement stucco, except that no lime is required. It makes better stucco, however, because it is more plastic, has a more convenient hardening time, resists moisture and is less liable to hair-checking and crazing. And Brixment stucco costs less than any comparable mix of portland cement and lime. Ask your dealer for "Brixment for Stucco and Plaster"—or write us direct.

LOUISVILLE CEMENT COMPANY, Incorporated, LOUISVILLE, KENTUCKY

"Hospitality you can't forget"

with LEES Contract Carpets

THERE are many reasons why fine hotels everywhere are turning to Lees Carpets as the basis of their decor—from the lobbies to the bridal suites—all through the dining rooms, bedrooms and halls. Here are a few of those reasons!

Lees Contract Carpets are designed to fit your special needs, no matter how complicated. When you have a Lees installation you have a made-to-order creation, not just an assembly-line job!

Lees gives you the *most* value for your carpeting dollar. These fine carpets are specially woven to withstand heavy traffic, and loomed from 100% imported wool dyed in stainless steel vats by Lees special dyeing formula.

Lees Contract Carpets look like a million. Their styling offers you a wide variety of exquisite colors, patterns, fabrics and textures to choose from—including traditional, modern, or individual custom designs for special interiors.

Send for samples and specific information from James Lees and Sons Company, Contract Carpet Division, Bridgeport, Penna.; or Showroom No. 1814 Merchandise Mart, Chicago, Ill.



*Carpet shown is
Lees luxurious Glowtuft.*



JAMES LEES AND SONS COMPANY, BRIDGEPORT, PENNA. • MAKERS OF LEES CARPETS, COLUMBIA AND MINERVA HAND-KNITTING YARNS

NEW! Day-Brite's FOUR-BY-FOUR unit

Incorporating the most advanced principles of integrated lighting... offering new architectural possibilities

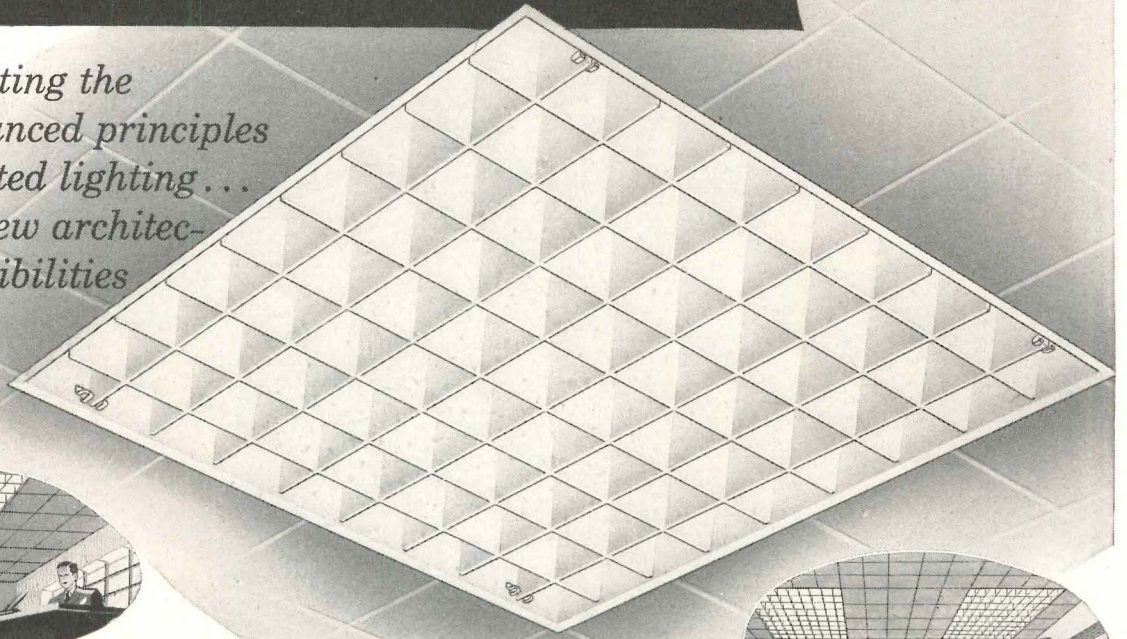

FOR OFFICES

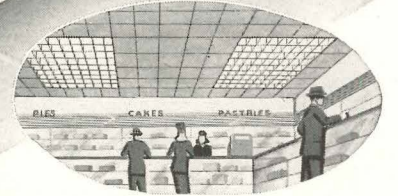

SMALL RETAIL STORES

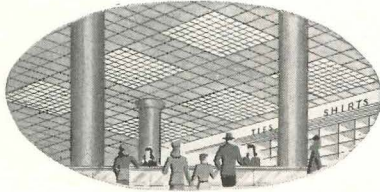

LARGE DEPARTMENT STORES

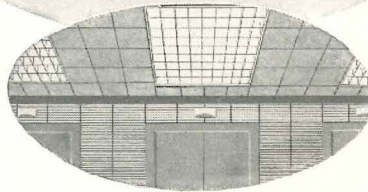

ENTRANCES, LOBBIES

Day-Brite's Four-by-Fours are engineered for both recessed and surface mounted applications. They can be used with 6, 8, and 10 40-watt fluorescent lamps. Knockouts are provided for feed connections. Plaster frames are available for use when fixtures are recessed.

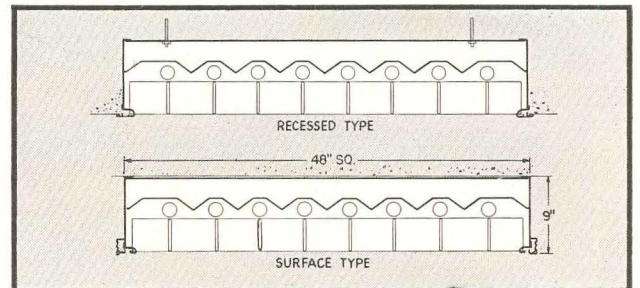

Separable hinges on both sides of louvers allow hinging from either side for easy servicing. Exclusive Day-Brite BOXCO louver assembly has double-wall louvers interlocked for extreme strength and rigidity. Fixtures are rust-inhibited and finished in Hot-Bonded Super-White enamel throughout.

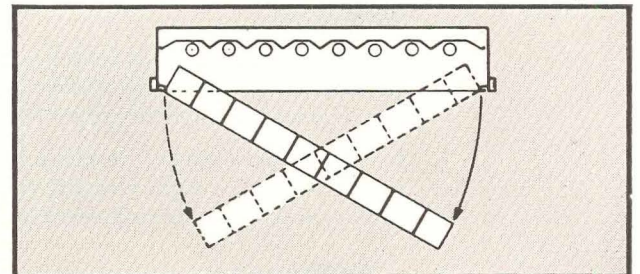

IT'S EASY TO SEE WHEN IT'S

DAY-BRITE
Lighting



Write NOW for descriptive Bulletin 20-C

Day-Brite Lighting, Inc., 5465 Bulwer Avenue,
St. Louis 7, Missouri

In Canada: Amalgamated Electric Corp., Ltd.,
Toronto 6, Ontario

239

Day-Brite fixtures are engineered for every seeing task. Distributed nationally through leading electrical wholesalers.



STAINLESS STEEL SETS THE SCENE in many a cafe, salon, lounge and foyer where an atmosphere of luxury prevails. Surface patterning increases the strength of the metal, while adding a decorative motif—and is easily done. Quilting (as illustrated), fanning and fluting are ordinary braking operations done in sheet metal shops: more complex designs are accomplished by rolling or stamping. The skillful architect . . . with patterned ENDURO and light location, can create a symphony in reflections—soft and alluring or regal in brilliance.

Enduro-THRIFTY METAL OF 10,000 USES

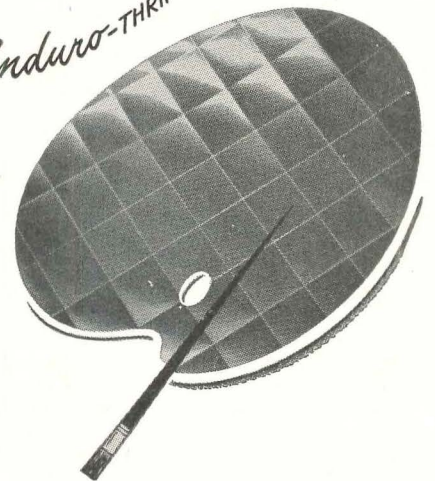

ARCHITECTURAL PALETTE of MANY VALUES

One of the most versatile of materials at the command of the architect, Republic ENDURO Stainless Steel lends itself decoratively and structurally to the full gamut of his creative imagination.

Its decorative values are legion . . . its ease of contouring, shaping and surface-patterning, its satin lustre and subtle reflection of light and color.

Its structural values are no less important to the architect . . . its high strength-to-weight ratio making it practical in thin section, its resistance

to corrosion, its resistance to heat and cold, and its unusually long life. Stainless through and through, there is no surface to age, chip or peel. ENDURO is the *architect's metal!*

If you are not fully conversant with ALL of ENDURO's characteristics, see Sweet's Architectural File or write direct to:

REPUBLIC STEEL CORPORATION

Alloy Steel Division • Massillon, Ohio

GENERAL OFFICES • CLEVELAND 1, OHIO
Export Department: Chrysler Building, New York 17, New York

Enduro **STAINLESS STEEL**

REG. U. S. PAT. OFF.



✓ **Check ALL 12 advantages:** • RUST AND CORROSION-RESISTANCE
• HEAT-RESISTANCE • HIGH MELTING POINT • LOW COEFFICIENT OF EXPANSION •
• HIGH STRENGTH • GOOD DIMENSIONAL STABILITY • NO METALLIC CONTAMINATION
• EASY TO CLEAN • EASY TO FABRICATE • EYE APPEAL • LONG LIFE • LOW END COST

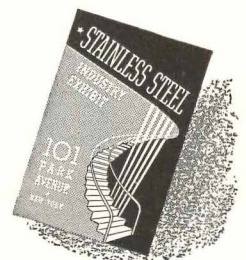

STORE



HOME



FACTORY



Wherever
Comfort Counts—

SARCOTHERM

HOT WATER HEATING CONTROL

For an apartment or home, Sarcotherm is an inexpensive luxury, that is talked about among friends. In a store it provides that comfortable, expansive feeling that increases sales. And for office efficiency, there is nothing better according to users in industrial as well as commercial buildings.

NO "COLD SEVENTIES"

and no "on and off" control with Sarcotherm. It's a simple three way valve that mixes hot water from the boiler with the cooler return water.

ZONE CONTROL

Architects and Heating Engineers like Sarcotherm because it is so flexible. Zone control, split systems, set-backs and double switch lines are easily applied. Lower boiler temperatures, less fuel used and invariably a lower cost of installation, make Sarcotherm the ideal for engineers who are in daily competition.

RADIANT HEAT

Continuous circulation with modulated control is ideal. Inside control is by the exclusive Sarcotherm heat-loss thermostat. Thirty years of experience with Radiant Heating is built into every layout and every Sarcotherm.

INSIDE-OUTSIDE CONTROL

The Sarcotherm Control outside the building determines how warm the radiators should be on any particular hour of any day. Sarcotherm holds this temperature at all times, always with lower fuel costs, particularly in the Spring and Fall.

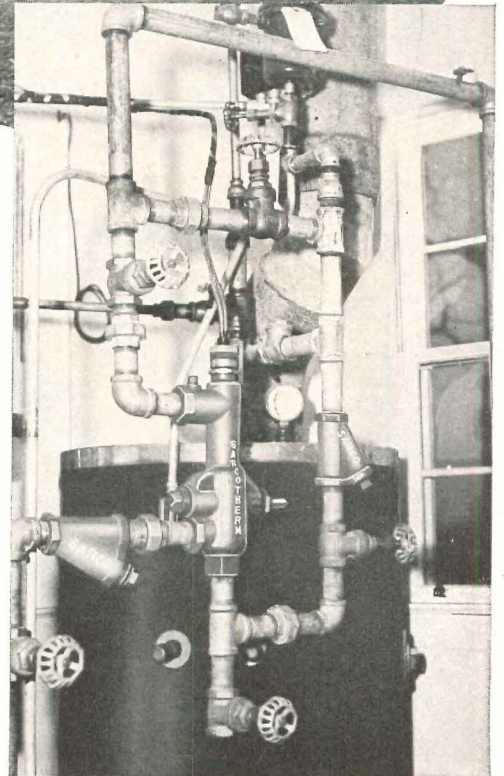

Sarcotherm in a small home

ASK FOR THE NEW CATALOG, ENGINEERING DATA AND SALES HELPS

Sarcotherm



SARCOTHERM CONTROLS, INC. • Empire State Bldg. • NEW YORK 1, N. Y.

YOU CAN BE SURE.. IF IT'S Westinghouse



Heating, Cooling, Ventilating Equipment



Precipitron*



Unitaire*
Room Coolers



Home
Coolers



Ventilating
Fans



Portable
Fans



Portable
Heaters

Kitchen Equipment



Refrigerators



Electric
Ranges



Roasters



Mixers



Home
Freezers



Toasters



Waste-Aways*



Wire and
cable



Wiring
devices



Meters



Load
Centers

Power Distribution Equipment



Power
Centers



Transformers



Panel-
boards

Laundry Equipment



Laundromats*



Clothes
Dryers



Vacuum
Cleaners



Fixtures
and Lamps



Radios



Television
Receivers



Sterilamps*

Other Electrical Equipment



Irons



Water
Heaters



Hot
Plates



Electric
Comforters



Passenger
Elevators



Freight
Elevators



*Reg. U. S. Trademark

ONE SOURCE

for ALL electrical needs

For residential construction—both apartment buildings and housing projects—Westinghouse offers one source . . . one responsibility for *everything* electrical. You can benefit from this fact, whatever your part in the project may be.

Architects and engineers: We can help you develop the most efficient ways to distribute, control and utilize electric power. Our engineering specialists have broad experience covering all types of applications.

Contractors and builders: Simplify your buying procedures by ordering all electrical equipment and supplies from Westinghouse. Our organization is geared to give you prompt delivery for integrated installation.

Owners and operators: You get top performance from your electrical equipment because we co-ordinate the design and manufacture of related apparatus. And our nationwide chain of Renewal Parts Warehouses and Manufacturing Repair Plants provides unmatched maintenance service. If electrical appliances are included in the original project, you have the added assurance of ready acceptance by prospective buyers, or tenants. As the maker of nearly 40,000,000 electric home appliances, Westinghouse has won millions of loyal friends.

When you have CONSTRUCTION AHEAD . . . whether residential, commercial or industrial . . . call your nearest Westinghouse District Office or Distributor for full information. Westinghouse Electric Corporation, P. O. Box 868, Pittsburgh 30, Pa.

J-94783

Practical, Easy-to-Use Buying Data

This 362-page book contains detailed information on Westinghouse products for the construction industry. It was designed specifically to meet the requirements outlined by Architects and Engineers.

Industry-wide distribution has already been made. If you do not already have your copy, ask your nearest Westinghouse District Office to send you B-2161-D.

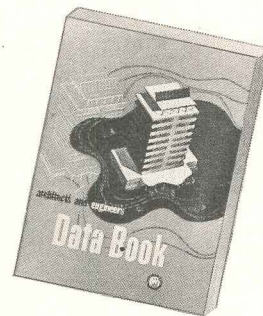

Westinghouse

FOR
ECONOMICAL-
CONTROL OF
FORCED HOT WATER
HEATING SYSTEMS

USE-

Mastrol

DEPENDABLE, LOW MAINTENANCE COST SYSTEM
of Pneumatic Temperature Control
FOR SCHOOLS • HOSPITALS • COMMERCIAL,
INDUSTRIAL AND APARTMENT BUILDINGS

WITH a Powers MASTROL System of control, comfortable indoor temperatures can be obtained at a low initial cost. Fuel savings alone resulting from elimination of OVER-heating payback a large return on a relatively small investment.

HOW IT WORKS—The Powers MASTROL system consists of two controllers. The outdoor instrument is the Master control and the indoor hot water controller is the Sub-Master regulator. The master control, conveniently located inside the building, has a thermal system consisting of armored flexible tubing and a sensitive bulb placed on an outside wall. The master control quickly responds to changes in outdoor temperature and pneumatically resets the control point of the sub-master regulator which varies the hot water temperature in direct relation to the outdoor temperature.

Users report "Very Low Maintenance Cost and Dependable Operation". When you want these advantages in a control system for forced hot water heating contact our nearest office or write 2720 Greenview Ave., Chicago 14, Ill.

MA

THE
POWERS
REGULATOR COMPANY
OVER 55 YEARS OF TEMPERATURE CONTROL
Offices in 50 Cities • See Your Phone Book

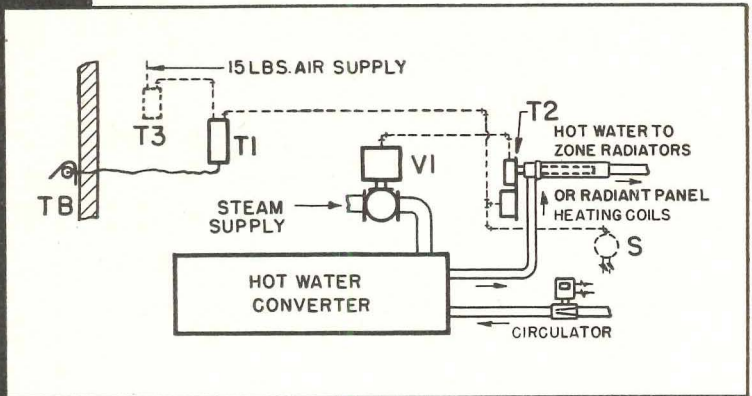

Above, **POWERS MASTROL System Controlling Hot Water Supply for Single Zone with Pilot Room Thermostat.** TB-Outdoor thermal bulb and shield. T1-Master control, T2-Sub-master regulator. T3-Pilot thermostat 68°F. for quick warm up (optional). V1-Diaphragm control valve for steam. S-Switch to automatically stop circulator when outdoor temperature is above 60°F., (optional).

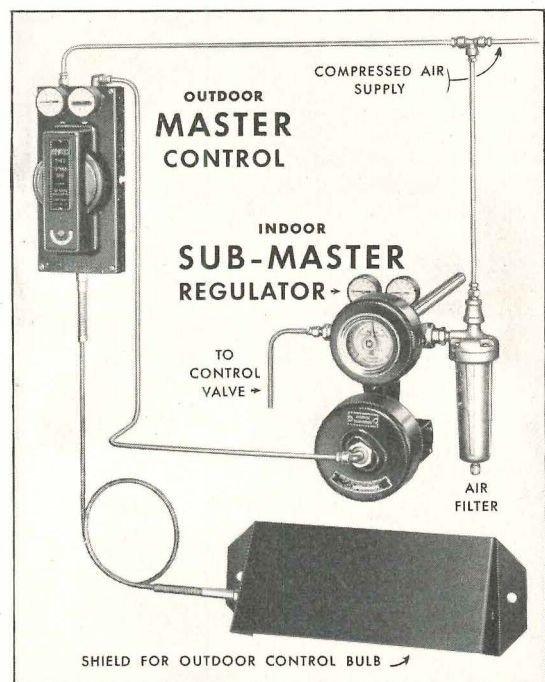

Powers MASTROL Control System—One of several combinations of Powers Master-Sub-Master controls for Forced Hot Water Heating Systems.

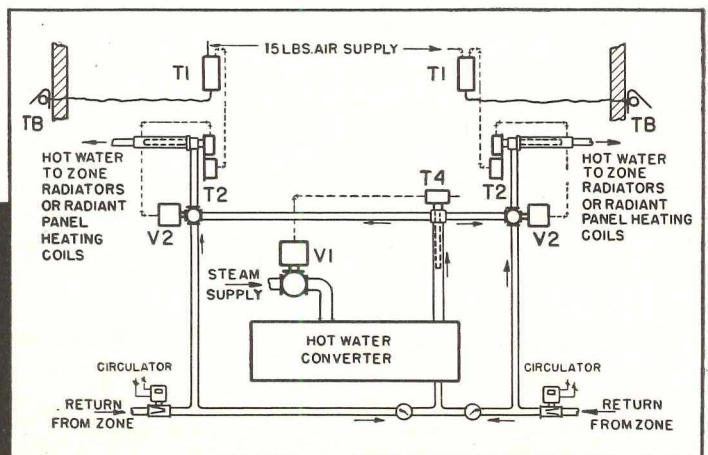

MASTROL System Controlling Hot Water for Multiple Zones Using 3-Way Water Mixing Valves—TB-Outdoor thermal bulb and shield. T1-Master control. T2-Submaster regulator. T4-Regulator for Maximum hot water control. V1-Diaphragm Control Valve for steam. V2-Three-way water mixing valve.

MACOMBER ROOF DECKING

THE PERFECT
SUPPORT FOR
BUILTUP JOBS



MADE FROM
Copper Bearing
STEEL

We don't know whether YOU ever used a product like Macomber Decking or not.

But maybe you've watched workmen who suddenly discover they can do a bang-up job with a very little effort.

These fellows lay a few Macomber Deck plates. They try their weight on them and feel the solid support for their work. They see how perfectly the plates fit together — how easy it is to do a workmanlike job.

First thing you know, they are taking pride in what just a little while ago was just another deck job. They find that insulation and builtup roofing adhere to this perfect surface in a way that adds solid accomplishment to the day's work.

When Macomber supplies the entire steel structure, you get coordinated engineering from the ground up. A deck like this is the crowning glory of a building and a builder who wants results — not alibis. Forward drawings for quotation.

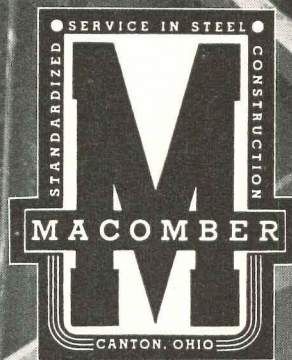
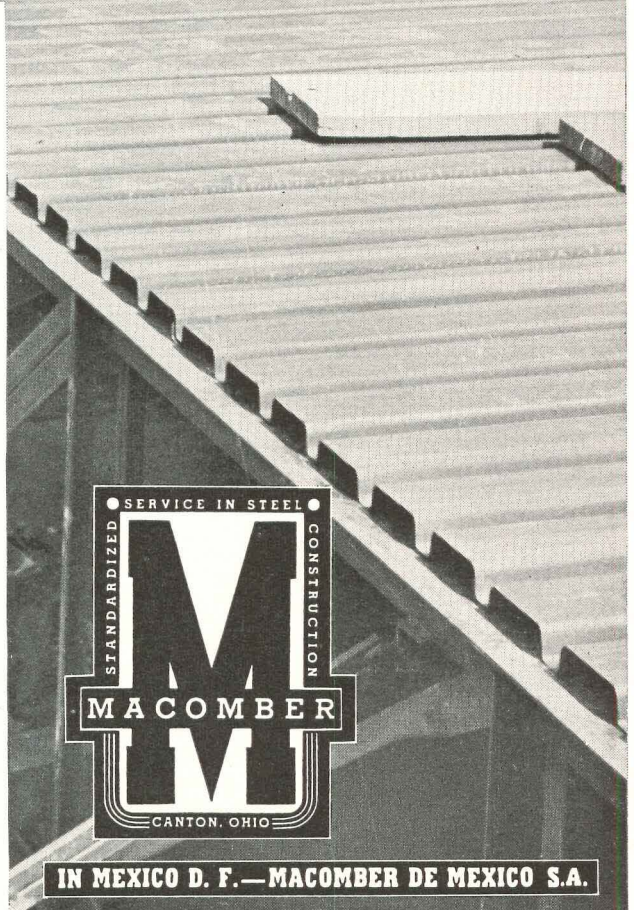

IN MEXICO D. F. — MACOMBER DE MEXICO S.A.

MACOMBER
INCORPORATED
CANTON, OHIO

CLIP THIS NOTICE and forward for your copy of new DECK CATALOG containing the new steel deck specifications. A MUST for your files. Ready shortly. Add your name and address.

STEEL JOISTS • LONGSPANS • ROOF TRUSSES • STEEL SIDING

UP IN NEW ENGLAND

Practical people with choose interiors

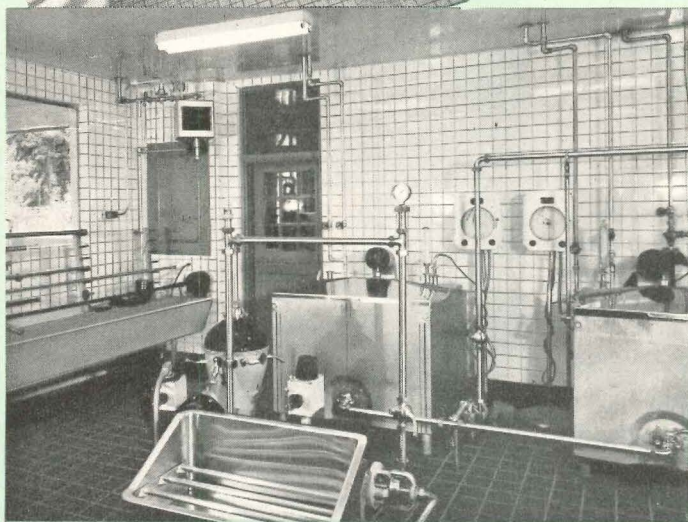
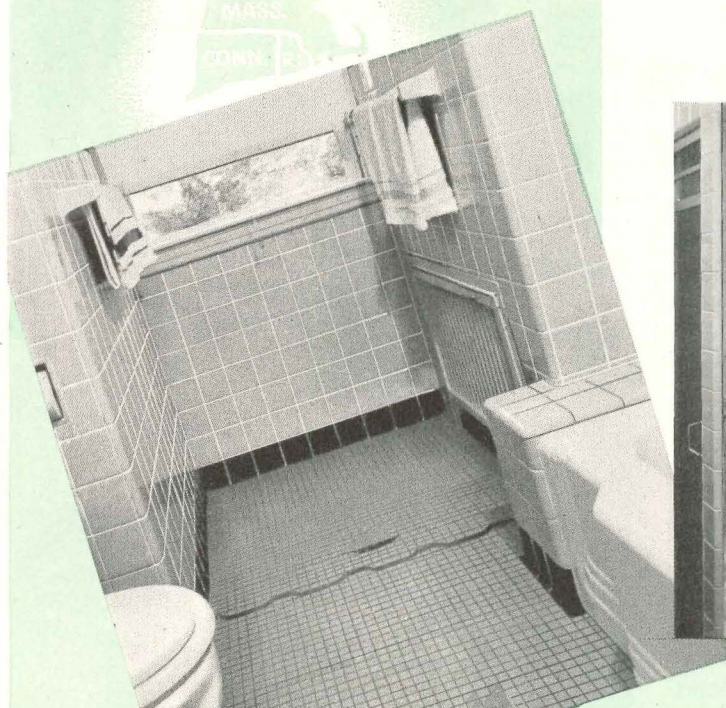

Dairy Farm, Canton, Mass. Authorized Suntile Dealer, David W. Colburn, Quincy, Mass.

UPPER LEFT—Residence, New Haven, Conn. Architect, Charles Abramowitz. Authorized Suntile Dealer, Earl B. Warner, Inc., New Haven.

ABOVE—Residence, Milton, Mass. Architect, Joseph A. Cicco. Contractor, Howard D. John Co. Authorized Suntile Dealer, Galassi Company, Brighton, Mass.

COLOR BALANCED

Suntile

..... A real clay tile
.... Bright with color
..... Right for life



Suntile OFFERS YOU BOTH —

an eye for *Beauty* of color-balanced *Suntile*

New Englanders don't waste words:

These practical people don't waste building or decorating dollars, either.

Many of them use just one word to get interiors that give full value—in durability, beauty, convenience and economy of maintenance.

They simply say, "Suntile"!

When you say "Suntile", you automatically get quality-controlled excellence in form and finish. You get *real clay* tile that resists chipping and cracking.

When you say "color-balanced Suntile", you get fadeless, easy-to-blend colors—colors that *keep* their

bright, new beauty with simple soap and water cleaning. There's no need for painting, redecorating, or other costly maintenance.

Say "Suntile" and you can be sure of expert installation, performed by a man carefully selected and trained for the job... your Authorized Suntile Dealer.

Please write us at Dept. AR-7 for the name of the Suntile dealer in your area. He'll give you tile and workmanship *you'll both* be proud of.

For more complete information see data in Sweet's Catalog. The Cambridge Tile Manufacturing Company, Cincinnati 15, Ohio.

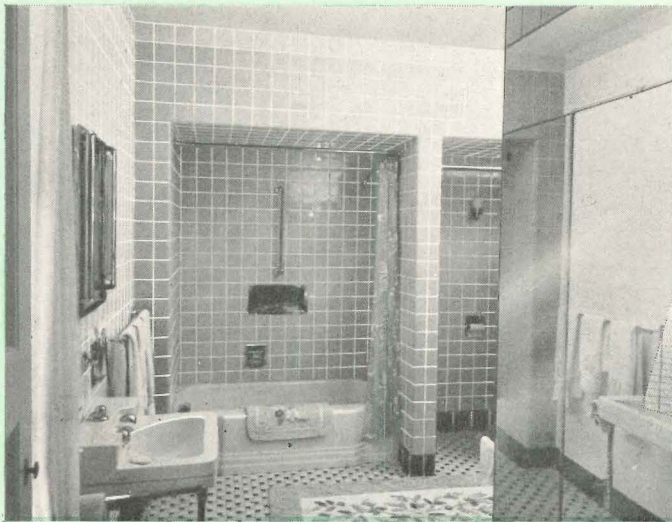

Residence, Milton, Mass. Architect, Joseph A. Cicco. Contractor, Howard D. John Co. Authorized Suntile Dealer, Galassi Company, Brighton, Mass.

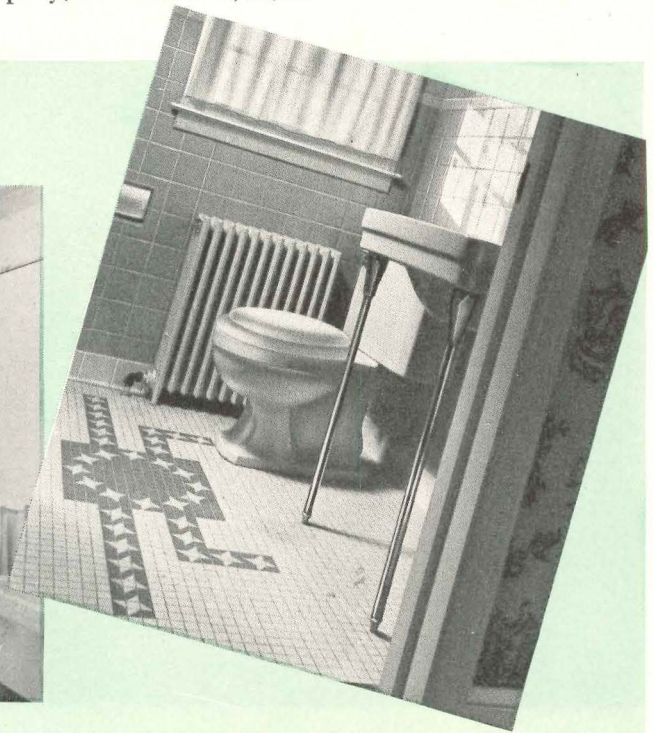

Residence, Hamden, Conn. Contractor, Veggo F. Larsen, Hamden. Authorized Suntile Dealer, Earl B. Warner, Inc., New Haven.

Better Tile.... Better Installation

Here's what people are saying about the NEW Modine Convector



"It's beautifully styled . . . yet so unobtrusive. And what superb heating comfort. I don't blame our friends for insisting on the new Modine Convector, too."

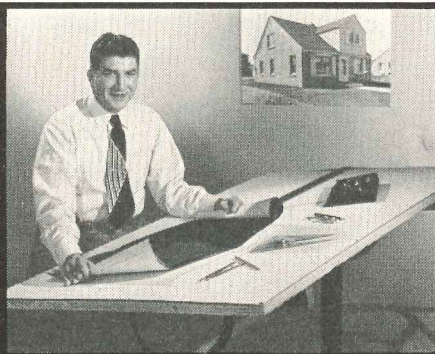

"Seeing a sample sold me on the new Modine Convector. Here's a product I can specify with confidence for my finest jobs because it's quality all the way."



"Since I began installing the new Modine Convector, I've learned what satisfied customers really are. Every job I've put in has sold others for me."

NEW . . . Convenient Air Venting that's out of sight, yet instantly accessible.

NEW . . . Optional Dual-Purpose Damper—for finger-touch temperature control — conceals outlet grille when closed.

NEW . . . 5-Second 16-Gauge Removable Front for faster installation, easier cleaning.

NEW . . . Snap-in Lower Grille conceals piping, simplifies floor and carpeting treatment. Optional.

ALL-COPPER Heating Unit gives you higher capacity, greater durability.

CUTAWAY VIEW OF MODINE TYPE F CONVECTOR.

Design and Mechanical Patents Pending

Yes — investigate, and you'll see why architects, contractors and owners everywhere are saying, "The new MODINE Convector is my first choice!" Examine a sample . . . compare it . . . and you'll agree that Modine's *exclusive* new features make Modine Convector the *better* way to heat modern apartments, homes, schools, offices or hospitals. Choose from three types in standard and institutional models, for one- and two-pipe steam and hot water systems. For full story and a sample demonstration, call your Modine Representative. He's listed in the "Where-to-Buy-it" section of your phone book. Or write direct. Modine Manufacturing Co., 1510 Dekoven Ave., Racine, Wis.

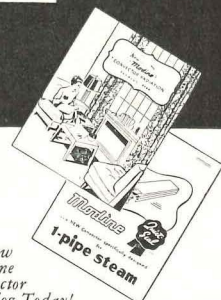

Send for new Modine Convector Catalog Today! Special 1-Pipe Steam Convector Bulletin also Available

Modine CONVECTORS

R-1026



View of vertical sliding door (closed) that conceals cigar stand in lobby of Mirror Building. Anaconda Architectural Bronze Extruded Shapes are employed in sliding door and ceiling moulding (which has been machined). Architect, Rowland H. Crawford, Beverly Hills; General Contractor, P. J. Walker Co.; bronze work by Cochran Izant Co.—both of Los Angeles, Cal.

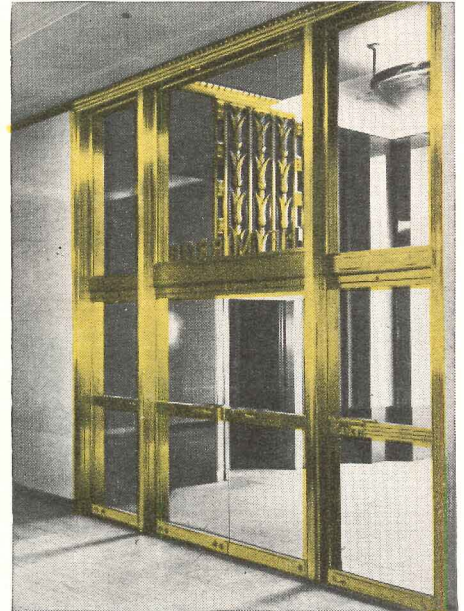

Doors and trim at entrance utilize extruded Anaconda Architectural Bronze Shapes. Glynn-Johnson door holders are also bronze. Bronze shape used for ceiling moulding has been machined.

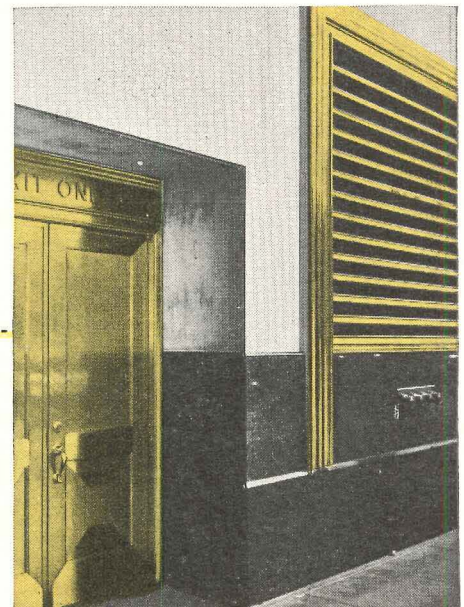

Exterior view—door consists of extruded bronze shapes with color matching panels of copper base alloy sheet. Extruded bronze shapes are used for trim around window; louvers are of copper alloy strip.

BRONZE BEAUTY *at the* MIRROR BUILDING, *Los Angeles*

At this modern building, the new home of the Los Angeles *Mirror*, the very pulse of a fast-changing world is taken. It evidences again that traditional concepts, methods, materials, *metals*, must be of proved value to find acceptance today.

Architect Rowland H. Crawford of Beverly Hills, has made interesting use of Anaconda Architectural Bronze Extruded Shapes for doors, windows and trim at the Mirror Building. For both the exterior and the impressive lobby, satin smooth bronze conveys a feeling of warmth, assurance and permanence. Bronze was selected for its timelessness . . . its ability to withstand the years gracefully . . . its dignity and uni-

versal acceptance as a metal of quality and beauty. Anaconda Architectural Shapes were chosen for their possibilities in decorative effect, ease of fabrication and economy.

49003

The American Brass Company has hundreds of dies from which your architectural shapes may be extruded or drawn. We will be glad to help you select the shapes—and the alloys—to best suit your plans.



Anaconda

ARCHITECTURAL BRONZE

THE AMERICAN BRASS COMPANY
 General Offices: Waterbury 88, Connecticut
 Subsidiary of Anaconda Copper Mining Company
 In Canada: ANACONDA AMERICAN BRASS LTD.
 New Toronto, Ont.

*“Designing with Carrara Glass
means lifelong satisfaction to my clients”*

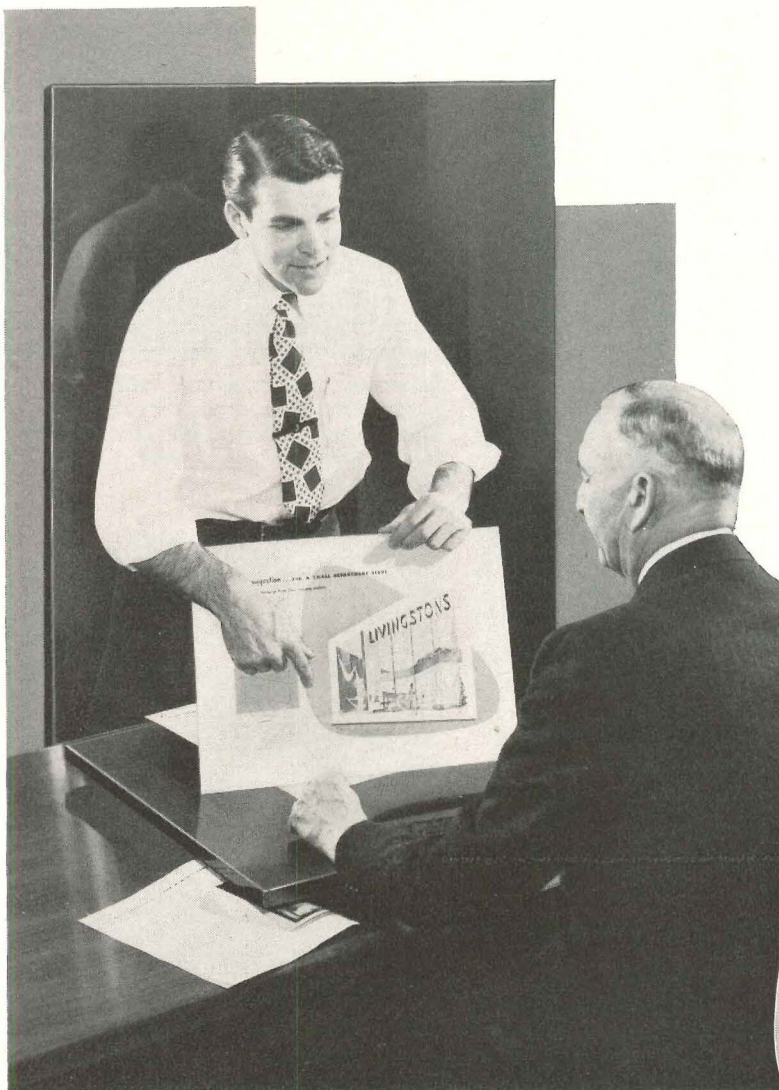

● How true that is! For this structural glass is a finely-machined product. It has a closely knit structure. It will not check, craze, fade, or stain. Weather, moisture, chemicals, grease, and pencil marks cannot affect it. It's an ever-lasting material of undeniable beauty. And the ten distinctive colors in which it is available offer the creative designer limitless opportunities for outstanding effects. Carrara Glass is easily handled. There is no lippage—its joints are true and even. We suggest you design with Carrara Glass—a perfected material that's the result of Pittsburgh's intensive research, aimed at helping to solve architectural problems by supplying products that will produce better jobs. Give permanence to your creations; lifelong satisfaction to your clients.

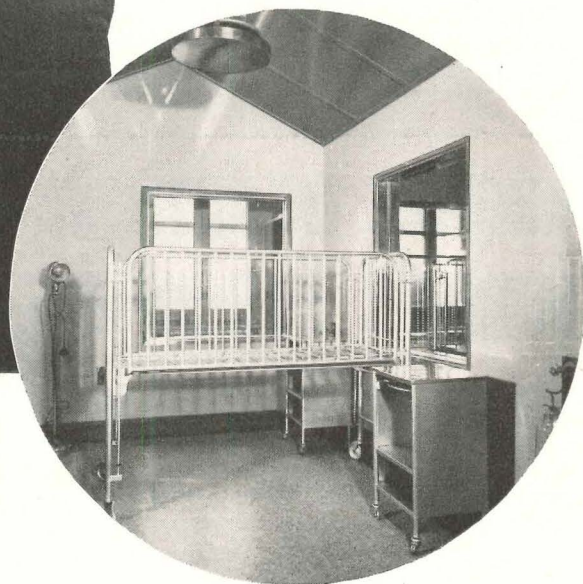

Carrara Glass was selected for the walls in the treatment rooms of the Children's Memorial Hospital, Chicago, Illinois, because it can withstand so well the extremely severe humidity conditions prevailing during treatment of patients.

Architects: Puckey & Jenkins, Chicago, Illinois.

Carrara *the quality structural glass*



PAINTS • GLASS • CHEMICALS • BRUSHES • PLASTICS

PITTSBURGH PLATE GLASS COMPANY

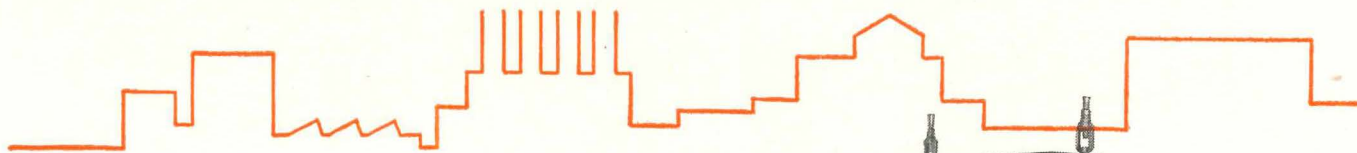

UNIT HEATING... its uses and advantages

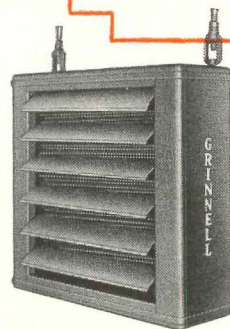

Where it is used Unit heating is widely used in industrial plants and warehouses, garages, stores and public buildings where the following advantages are important.

Low first cost Unit heaters are so efficient and so compact that their heating capacity is often equivalent to the capacity of cast iron radiation or pipe coils of twice the cost. Additional savings are effected because the system requires a proportionately smaller amount of pipe, fittings and accessories.

Economy of operation Heat is forced down to the working level... not banked uselessly at the ceiling level. Heat is turned on and off merely by throwing a switch either manually or automatically by simple thermostatic controls. The rapid response means that heat is furnished only when and where it is wanted... no heat is wasted.

Heating comfort Unit heaters provide quick heating from a cold start. Desired temperatures are easily maintained within a close range. Heat is uniformly distributed in the working zone by forced air circulation. It

is a very flexible system because different or changing heating requirements are easily satisfied by means of different models, a range of capacities, single- or two-speed motors and individual thermostatic controls.

Adaptability to equipment and floor layout The units and the simple piping are overhead where they do not interfere with arrangement of operating machinery or equipment and do not take up valuable floor or wall space. Units are easily relocated at any time to meet changes in plant layout or heating requirements.

Thermolier unit heaters have important construction advantages The design of Thermolier unit heaters is the product of Grinnell Company's ninety-nine years of heating experience. Both architects and contractors like Thermolier's durability, freedom from maintenance troubles and dependable operation. Typical of its construction features is the patented internal cooling leg which permits the use of a plain thermostatic trap, the simplest, least expensive kind of trap. For full details on Thermolier features, capacities and types, see your Sweet's Files.

THERMOLIER *Unit Heaters*

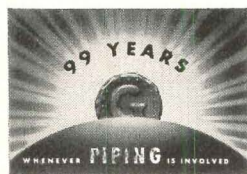

GRINNELL

Grinnell Company, Inc., Providence, Rhode Island. Branches: Atlanta • Buffalo • Charlotte • Chicago • Cleveland • Cranston • Fresno • Kansas City • Houston Long Beach • Los Angeles • Milwaukee • Minneapolis • New York • Oakland • Philadelphia • Sacramento • St. Louis • St. Paul • San Francisco • Seattle • Spokane

“ and believe it or not
ROOM-DARKENING too! ”



Columbia Window Shades and Venetian Blinds are sold only in leading department and furniture stores and shade shops designated as Columbia Authorized Dealers. May we send you samples of our room-darkening shades and the name of the Columbia Authorized Dealer nearest you? Write today.

Ask a Columbia Authorized Dealer

Columbia
WINDOW SHADES
AND VENETIAN BLINDS

Columbia's room-darkening window shades revolutionize light control. They're decorative and functional, too. Sturdy, long-wearing... with the additional special talent of shielding a room from light.

Look for room-darkening shades in Columbia's REGAL grade. Made of high-count cambric, with a truly beautiful "hand" and a smooth, dust-shedding surface. Economically priced... and easily washable for thrifty maintenance. In light as well as dark colors.

See Columbia's VELLMO, too, a super quality grade, so completely lightproof that it's standard for such uses as X-ray rooms. And here's the surprise... VELLMO boasts high-style pastels and dazzling white. Any size you need up to 150 inches wide!

PERFECT FOR

- hotel rooms.
- hospital rooms.
- housing projects.
- school rest rooms, auditoriums.
- recreation and convention rooms with television sets.

**FIGURE IT IN
ALUMINUM**

THE METAL THAT *Lasts*

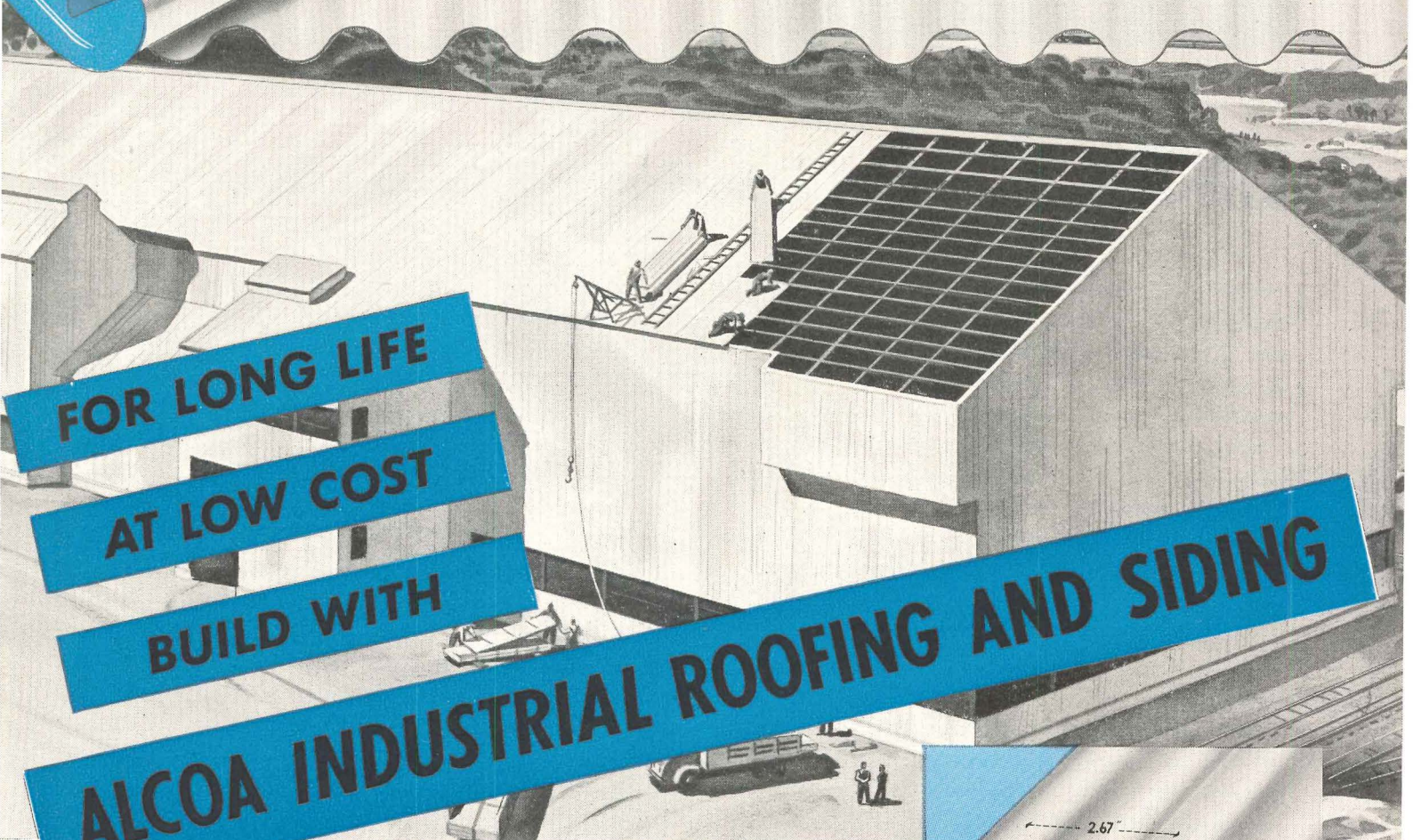

FOR LONG LIFE

AT LOW COST

BUILD WITH

ALCOA INDUSTRIAL ROOFING AND SIDING

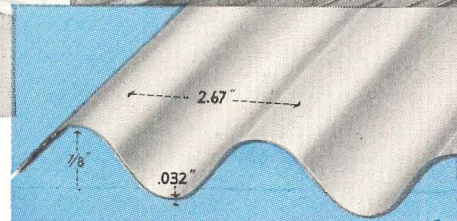

Here are the Details

THICKNESS: .032 inches.
LENGTHS: 5, 6, 7, 8, 9, 10, 11 and 12 feet.
WIDTHS: Roofing sheet, 35 inches. Siding sheet, 33 $\frac{3}{4}$ inches; coverage 32 inches.
CORRUGATIONS: $\frac{7}{8}$ inch deep. 2.67 inches, crown to crown.

Load-Carrying Capacity

PURLIN SPACING	CLEAR SPAN	UNIFORM LOAD p. s. f. (Safety Factor; 2)
6'6"	76"	29
6'0"	70"	35
5'6"	64"	41
5'0"	58"	50
4'6"	52"	63
4'0"	46"	80

Here is the answer to the need for long-lasting roofing and siding that can be erected quickly and at low cost . . . thick, strong Alcoa *Industrial Roofing and Siding*.

Compare costs with other building materials of comparable quality. Low in first cost, it slashes erection costs, too. Properly engineered and installed it does not require painting or expensive maintenance; will give years of trouble free service.

Alcoa *Industrial Roofing and Siding* is made of an Alcoa Alloy that is unexcelled in resistance to atmospheric corrosion by any aluminum alloy now made. It withstands smoke and common industrial fumes. It can't rust-streak, rot, warp or shatter. It provides a maximum of attractive appearance and long life at minimum cost.



Write for Engineering and Application Data

This free book gives detailed information on engineering and erecting buildings using Alcoa *Industrial Roofing and Siding*. Call your nearby Alcoa Sales Office or write, ALUMINUM COMPANY OF AMERICA, 1867-G Gulf Bldg., Pittsburgh 19, Pennsylvania.

ALCOA INDUSTRIAL ROOFING AND SIDING

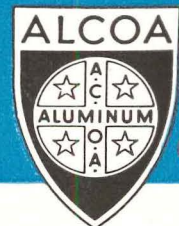

INGOT • SHEET & PLATE • SHAPES, ROLLED & EXTRUDED • WIRE • ROD • BAR • TUBING • PIPE • SAND, DIE & PERMANENT MOLD CASTINGS • FORGINGS • IMPACT EXTRUSIONS
 ELECTRICAL CONDUCTORS • SCREW MACHINE PRODUCTS • FABRICATED PRODUCTS • FASTENERS • FOIL • ALUMINUM PIGMENTS • MAGNESIUM PRODUCTS

FACTS ABOUT RESILIENT FLOORS

LINOTILE — an outstanding commercial floor

Linotile is an exceptionally durable resilient flooring made exclusively by Armstrong. Over a period of thirty-five years, it has gained a reputation with architects and building owners as a highly desirable floor for use where traffic conditions are most severe. A number of Linotile floors installed twenty to twenty-five years ago are still in service today. It is not at all unusual for a floor of Linotile to perform satisfactorily for fifteen to twenty years in busy department stores, hospital corridors, and in entrance lobbies of schools and other types of public buildings.

Composition

Although Linotile is manufactured from the same raw materials as linoleum—finely ground cork and wood flour, oxidized linseed oil, and color pigments—there is a basic difference in formulation. Furthermore, Linotile is cured from three to five times longer than linoleum. All this combines to give added denseness and toughness to Linotile—the reason for its unusual durability.

Because of its highly compressed composition, Linotile in its finished form does not have a backing of any kind. During the various manufacturing processes, however, the Linotile mix is carried on a supporting backing. This backing is stripped off the Linotile as it is taken out of the curing stoves. The material is then cut into squares of various sizes. The Linotile colorings run all the way through from the face to the back of each tile.

Performance Characteristics

In addition to Linotile's high resistance to abrasive wear, this flooring also has unusual resistance to indentation. The 200 pounds per square inch resistance to furniture loads in Linotile is almost three times greater than linoleum and eight times that of asphalt tile.

Linotile will not crumble or dust under heavy traffic or rolling loads. And if any unusual accident should mar a section of a Linotile floor, it can be repaired easily by replacing the damaged tile.

Floors of Linotile are exceptionally easy to keep clean. Dust and dirt do not readily stick to the unusually smooth surface of this material. This surface smoothness is another result of the long curing period given to the Linotile mix.

The precision cut edges and square corners of Linotile also contribute to the ease with which this floor can be

cleaned. Each tile can be fitted snugly against the others and dirt-catching joints are eliminated.

Linotile can be specified as a flooring on all types of suspended subfloors—concrete, wood, or metal. It is not recommended for installation over concrete subfloors in direct contact with the ground because of the alkaline moisture that's always present to some degree in such subfloors.

Decorative Advantages

Because it is made in a variety of sizes, Linotile is a true custom flooring material. Although the most popular size, 9" x 9", is carried in stock at 132 wholesaling points strategically located throughout the country, more than eighteen other sizes can be quickly cut to order at the factory for individual jobs.

The fifteen marbled colors in the Linotile line, in combination with the variety of sizes available, make the design possibilities of this floor almost unlimited. All Linotile colors have been styled to harmonize with each other as

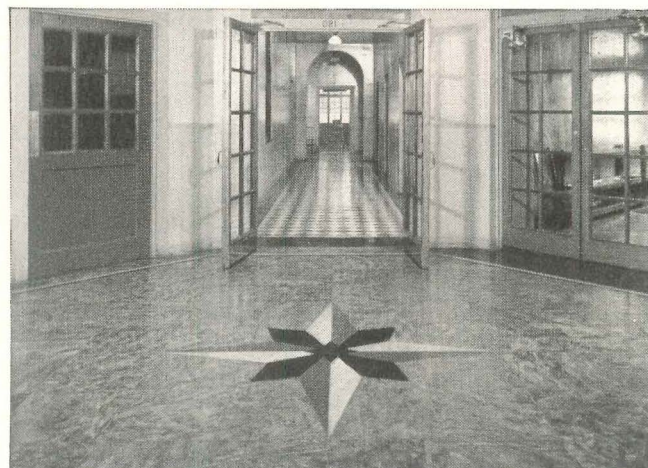

This unretouched photograph of the Linotile floor in one of the corridors of the Elizabethtown, Pa., Hospital for Crippled Children was taken seventeen years after the floor was installed. Little wear is evident on this floor today, although the installation was made in 1930.

well as with all types of furnishings included in the decorative scheme. Recent improvements in color pigments used in the manufacture of Linotile make it more resistant to fading and the effects of alkaline soaps.

Sizes and Gauge

Squares of Linotile are available in 2", 3", 4", 6", 8", 9", and 12" sizes. Rectangular tiles are produced in 3" x 6", 3" x 12", 4" x 16", 6" x 12", 6" x 18", 9" x 18", 12" x 24", 12" x 36", and 18" x 36" sizes. Diagonal half tile of any of these sizes and irregular shaped tile also can be supplied. Feature strips, 1" to 3" in width with a maximum length of 36" also are available.

All sizes of Linotile are made in 1/8" gauge only.

Cost

Linotile is slightly higher in price than linoleum of comparable gauge and about equal in price to rubber tile. When judged by its exceptional service and minimum maintenance requirements, Linotile is generally considered to be moderate in cost. The wide variety of sizes that are available makes it possible to obtain minimum installation costs for custom-designed floors because little time is required for on-the-job cutting.

For samples and specifications on Linotile or information on other Armstrong's Resilient Floors, write to any Armstrong district office or direct to Armstrong Cork Company, Floor Division, 2407 State St., Lancaster, Pa.



This floor of Armstrong's Linotile contributes much to the modern appearance of the offices of Best Foods Company, New York City. Linotile is ideally suited for offices because it has an extremely high resistance to indentation from desks and other office furniture.

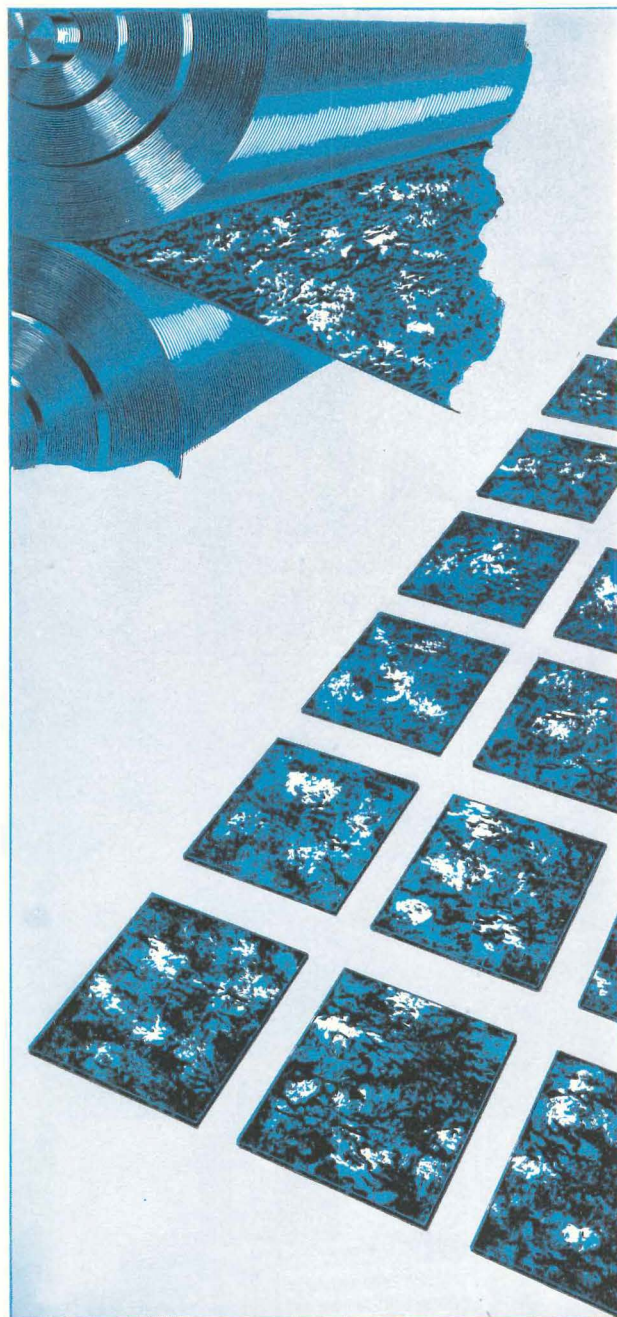

After the raw materials in Linotile are thoroughly mixed and blended, the mixture is passed between a series of heavy steel rolls accurately controlled to produce uniform thickness. In one stage, the sheet is cut into sections and turned to obtain Linotile's distinctive swirl marblization. While passing through a huge rotary press to improve surface smoothness, the mix is put on a carrier for stoving purposes. The long battens of material are then baked from one to two months, during which time Linotile matures and obtains its rugged qualities.

ARMSTRONG'S FLOORS

LINOLEUM • LINOTILE® • ASPHALT TILE



RUBBER TILE • CORK TILE • CORLON TILE®

Here's the Story ON AEROFIN...

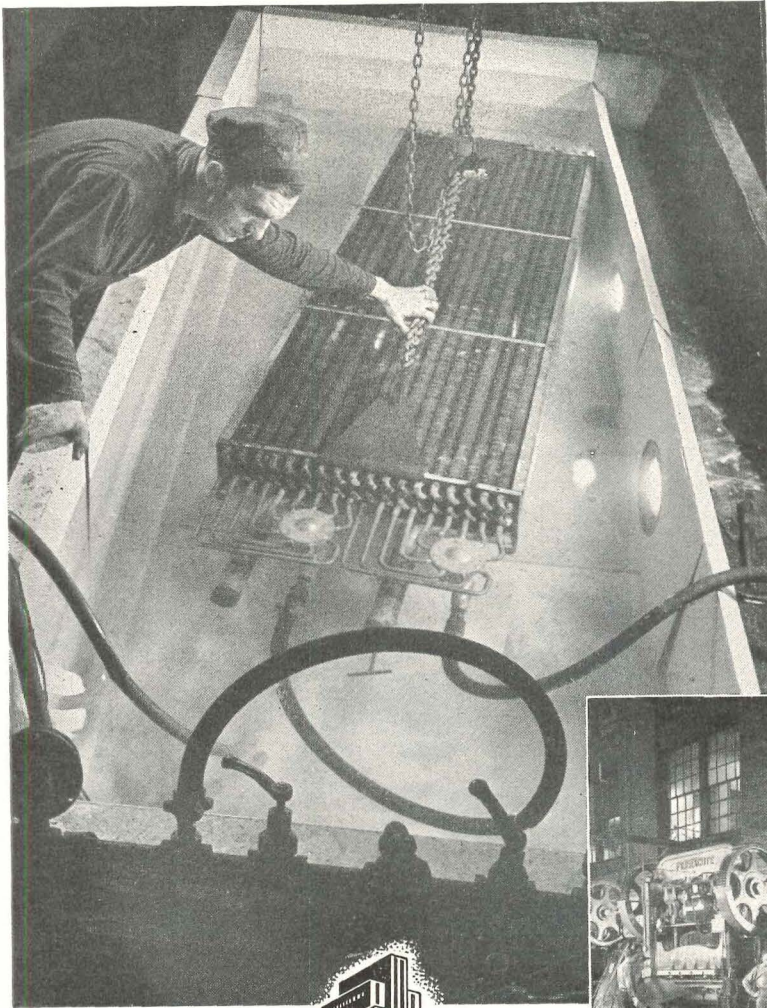

This man is completing one of the many tests used to control the quality of Aero-fin finned heat-transfer surface. He is looking for air bubbles in a specially illuminated tank. If there are no bubbles, it means the immersed Aero-fin unit has withstood the terrific strains of steam and hydrostatic pressure tests and is ready to give you long, efficient service.

Such rigid specifications and inspection, backed up with over 25 years of experience in manufacturing finned heat-transfer surface, assures you of Aero-fin dependability, durability and maximum efficiency.

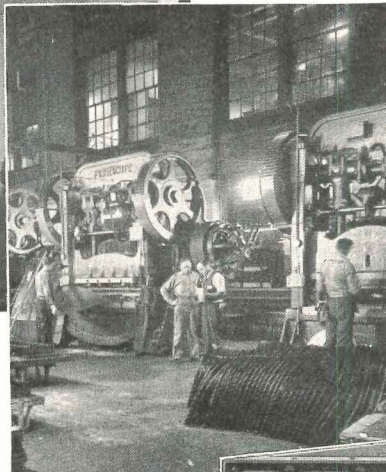

Aero-fin is devoted exclusively to the production of finned heat-transfer surface. This specialization enables Aero-fin engineers to select just the right surface and materials for the job, enables expert workmen to assemble these materials into a highly efficient unit.



The end result of Aero-fin research, engineering and specialized production is the Aero-fin Finned Heat-Transfer Unit. Day after day, thousands of units like this one demonstrate their superiority under the most severe conditions. Complete research and accurate ratings allow you to install Aero-fin at full rating with confidence. You can depend on Aero-fin to give you long, efficient service.

*Throughout the
Air Conditioning Industry—*
Aero-fin units do the job Better, Faster, Cheaper

AEROFIN CORPORATION

410 South Geddes St., Syracuse 1, N. Y.

NEW YORK CHICAGO CLEVELAND DETROIT
PHILADELPHIA DALLAS MONTREAL

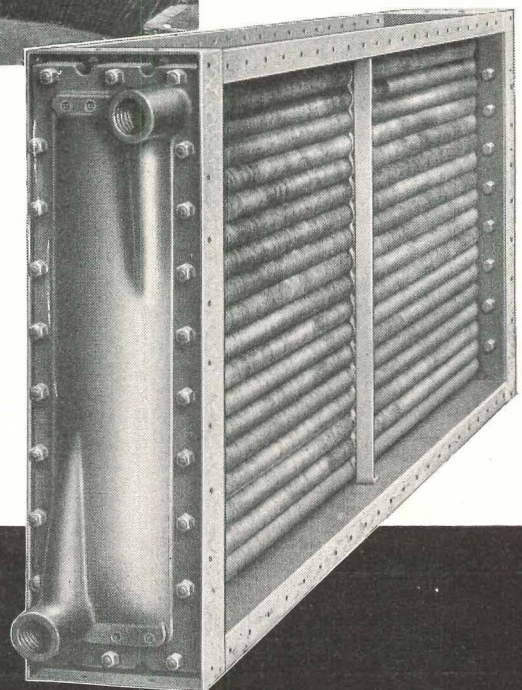

Modular Exposures for Roofs and Sidewalls with Stained Cedar Shingles and Shakes

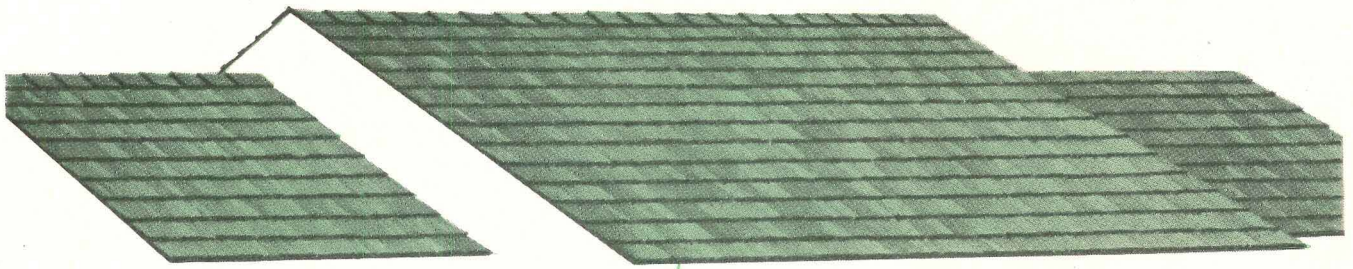

Roof and sidewall designs are never limited by fixed exposures when stained shingles or stained cedar shakes are employed. These products offer perhaps the greatest exposure variables of any home-building material available. Note from the table below how application is adapted to scale and proportion.

Stained cedar shingles permit modular roof exposures from 3¾ inches to 7½ inches, scaled to pitch. Handsplit shakes extend this freedom of scale to 10 inches for roofs rising 5½ inches or more in 12 inches.

Roof Pitch	Exposure 16" Shingles	Exposure 18" Shingles	Exposure 24" Shingles
½ to ⅓	3¾"	4¼"	5¾"
¼ to ⅓	5"	5½"	7½"

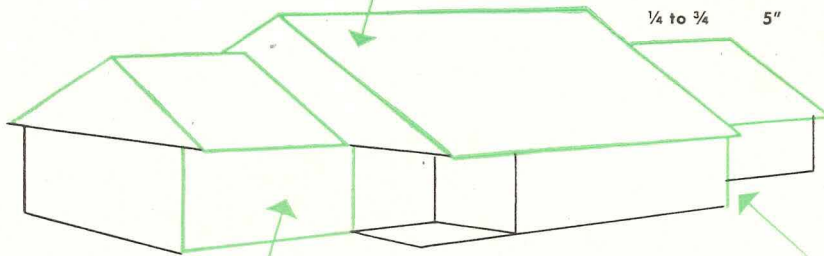

Length of Shake	WALL EXPOSURE RANGE	
	Single-Course	Double-Course
16"	6" to 7½"	8" to 12"
18"	6" to 8½"	9" to 14"
24"	8" to 11"	12" to 16"

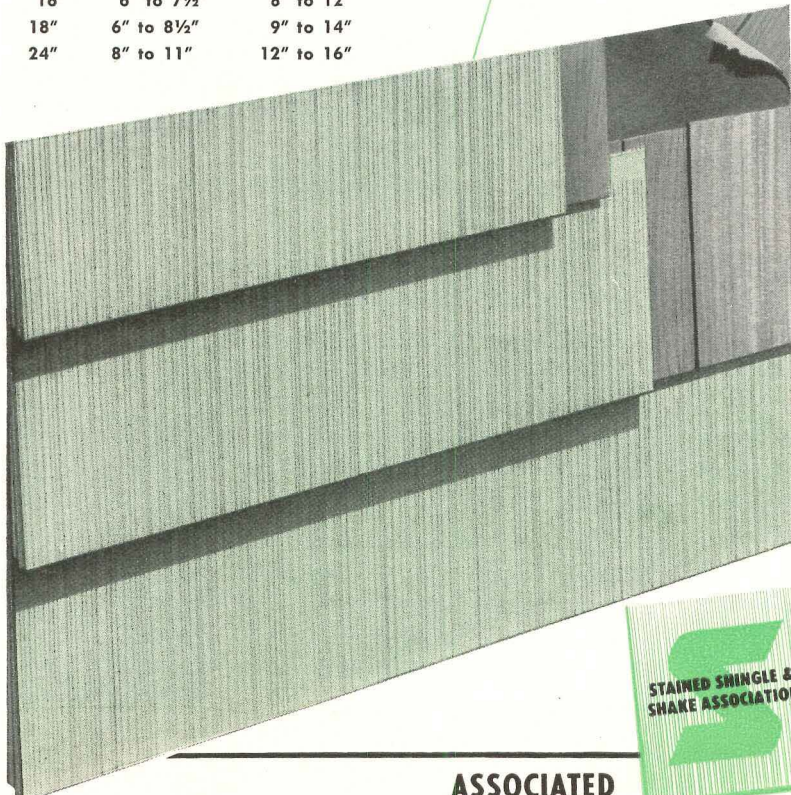

Pre-staining impregnates all surfaces with preservative oils... adds surface "seal" to the excellent weather resistance of cedar shingles.

Double-coursing extends exposure maximums. Economical use of second grade shingles, covered by exterior courses of stained cedar shakes, permits 12-inch exposure of 16" shake length. 18" shakes are similarly applied on 14-inch exposures.

Shake edges are machined parallel and vertical to butts, insuring straight horizontal course-lines. Parallel edges permit tight joints which blend with processed grooves, eliminating the "shingled" vertical breaks.

Edge view illustrates double-coursing application. First course is tripled, eliminating costly drip-cap. Corners are mitered. Application is simple, rapid, economical. Rabeted shiplap strip guides both under and outer courses for butt-nailing.

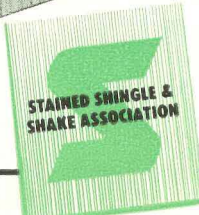
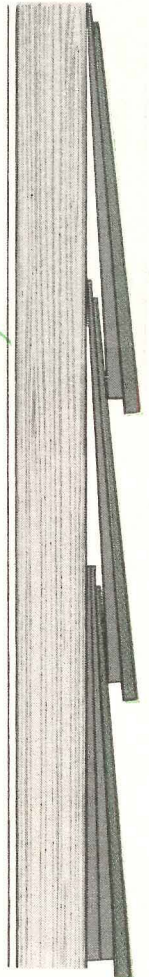

Complete application instructions and specifications for all shingle and shake products in Sweet's File **8b** **7a**

ASSOCIATED

MANUFACTURERS

- Wood Beautifiers, Seattle, Washington • Colonial Cedar Co., Inc., Seattle, Washington • M. R. Smith Lumber & Shingle Co., Seattle, Washington • Canadian Forest Products, Ltd., Vancouver, British Columbia • The Robert McNair Shingle Co., Ltd., Vancouver, British Columbia • Creo-Dipt Company, Inc., North Tonawanda, New York • Everett Shingle & Shake Company, Everett, Washington • Capilano Timber Company, Ltd., Vancouver, British Columbia • Perma-Products Company, Cleveland, Ohio • West Coast Stained Shingle Co., Seattle, Washington • Portland Shingle Company, Portland, Oregon

Looks good...

Sells goods!



The new Hochschild Kohn store in Baltimore, Maryland. It was designed by the office of James R. Edmunds, Jr., Architects, Baltimore. Contractor: Morrow Brothers. Signs and storefront by: George R. Habgood Company, Philadelphia; Triangle Sign Company, Baltimore.

EYE APPEAL and UTILITY—that's what the architects wanted for the new Belvedere branch of the Hochschild Kohn Department Store in Baltimore, Maryland. This was a good reason for specifying ARMCO Stainless Steel.

This handsome rustless steel went into the front entrance, hoods, letters, and main thoroughfare show window. It was also used in the vertical signs, and enhances the decorative work in the inner vestibule.

Strength, beauty, corrosion resistance and ease of cleaning make ARMCO Stainless a natural choice for numerous applications in modern architecture. Roof drainage systems, mullions, spandrels, interior and exterior trim, push plates, elevator doors and a long

list of structural and equipment uses look better and last longer when constructed of ARMCO Stainless.

Architects know that ARMCO Stainless is a truly economical metal. They know that maintenance costs are negligible. Labor costs—the largest single charge in construction—are amortized over a longer period of years.

See SWEET'S CATALOG for additional information. Or write to Armco Steel Corporation, 245 Curtis Street, Middletown, Ohio. Export: The Armco International Corporation.



STAINLESS STEELS

LOOKS... SELLS... and PERFORMS...

Like Magic!



**THE *New* BURNHAM
PACEMAKER**

**A SUPER-EFFICIENT SMALL-HOME BOILER
FOR OIL-FIRING EXCLUSIVELY**

Engineered to out-perform competition. Designed for easy handling and installation. And, even with all the "extras" the PACEMAKER provides, it is competitively priced.

PACEMAKER is not "just another new boiler." Our engineers and designers were given instructions to produce an oil-burning, *cast-iron* boiler "better than those now on the market."

And how they came through! Many features of the PACEMAKER are original with Burnham—features not found on other boilers. Exhaustive tests, too, have shown that these exclusive features make PACEMAKER the outstanding low-cost boiler on the market today.

Note these important points:

HIGH EFFICIENCY — Two crown sheets — not one — provide more prime heating surface. Enables PACEMAKER to literally scrub all the heat from the fuel. Vertical fire-travel, too — usually found only in more expensive boilers.

BOILER SHIPPED ASSEMBLED — A big cost saving item in these days of high labor.

PRE-CAST COMBUSTION CHAMBER — Insulation and refractory fitted and cemented in boiler base at factory — another labor saving feature.

DOMESTIC HOT WATER — Specially designed to deliver *abundant* hot water, summer and winter, at low cost. Built-in all copper water heater — tankless or storage type.

CONTROLS — All controls, mounted in front of boiler *directly above oil-burner*, assure easy wiring.

GAS TIGHT CONSTRUCTION — All sections machine ground for tight fit — no air leakage or escape of oil fumes.

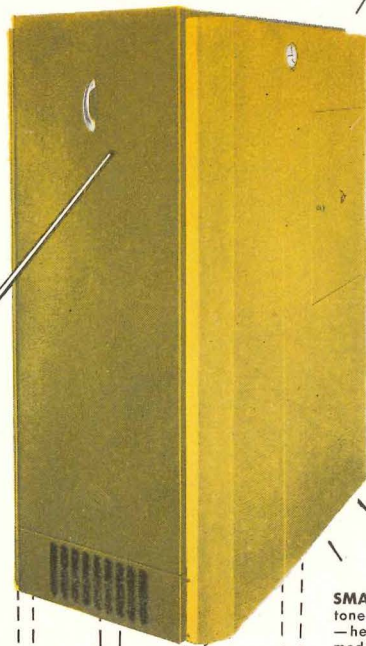

SMARTLY STYLED two-tone Sarasota Tan jacket — heavily insulated. TWO models: Flush Jacket conceals all controls. Extended Jacket (illustrated) conceals oil burner.

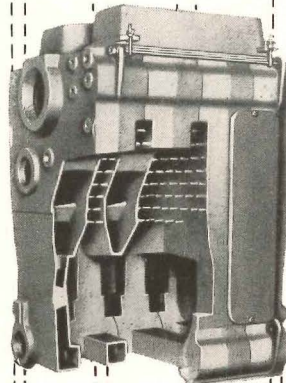

EASY TO INSTALL — Can be bolted to base while lying on its side. Easily raised to vertical position. (Cutaway illustrations show construction).

EXTRAS
that save time
on the job!

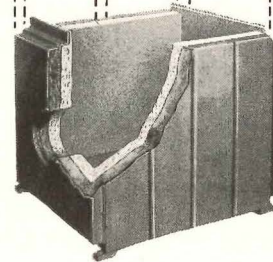

PRE-CAST COMBUSTION CHAMBER — Insulation and refractory fitted and cemented in boiler base at factory.

CONTROLS — Controls are directly above oil-burner, and mounted on front of boiler.

Get all the facts on PACEMAKER — the oil-burning boiler that simplifies installation and delivers what you promise.

Burnham Corporation

"PIONEERS OF RADIANT BASEBOARD HEATING"

IRVINGTON, N. Y., Dept. AR-79



BURNHAM CORPORATION
Irvington, New York Dept. AR-79

Please send me literature on PACEMAKER.

Name _____

Address _____

City _____ State _____



O'Brien's, overlooking the beautiful Chemung River Valley at Waverly, New York, seasons its food with a vista, clearly seen through *Thermopane* windows. Outer pane is Heat Absorbing Plate Glass.

Want Country Quiet . . . on a City Street?

Where you have a vista, *Thermopane** will assure that it can be seen—*always*. You won't be troubled by frost or condensation on your windows.

On the other hand, if you want to shut out the traffic din of a busy street, *Thermopane* will muffle it for you—and still give you light, and interesting action to watch.

In either case, *Thermopane* provides greater comfort: more efficient air conditioning in summer, less heat loss in winter, and freedom from downdrafts. Washing this double-glass insulating windowpane

is a simple matter of cleaning only the two exposed surfaces.

This combination of plus features adds up to one result: better-satisfied clients. Like more facts and figures? Ask your local Libbey-Owens-Ford Glass Distributor, or write us direct.

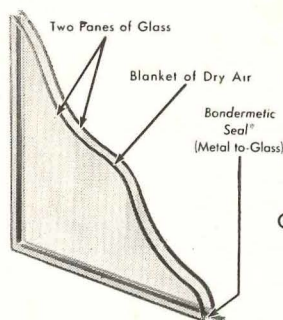

Cutaway view of *Thermopane*

FOR BETTER VISION, SPECIFY THERMOPANE
MADE WITH POLISHED PLATE GLASS

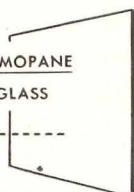

Thermopane

MADE ONLY BY LIBBEY-OWENS-FORD GLASS COMPANY
2679 Nicholas Building, Toledo 3, Ohio

1ST

A. O. Smith was first to offer complete built-in protection against rust...because GLASS cannot rust.



Extreme Thermal Shock—far more severe than ever encountered in actual service—has no effect upon the glass surface on the inside of a "Permaglas" steel tank. Alternately pouring scalding water and ice water on the head from a Permaglas Water Heater tank is dramatic proof that the glass will not crack or chip.

FOR HOT WATER MAGIC
GAS has got it!



Permaglas

TRADE MARK REG U. S. PAT OFF

A SMITHway WATER HEATER*

* Also quality zinc-lined Duraclad and Milwaukee Automatic Water Heaters

A. O. SMITH CORP.
Dept. AR-749
Water Heater Division
Kankakee, Illinois

● Without obligation, send us complete information on SMITHway Water Heaters.

Electric Gas
 Both

Name _____

Firm _____

Street _____

City _____ State _____

Extreme Thermal Shock Will Not Crack or Chip This Glass-Surfaced Water Heater Tank

The Thermal Shock Test, pictured here, the Multiple Flex Test, and other conclusive demonstrations prove the durability and resilient toughness of the glass-surfaced heavy steel tanks of Permaglas Automatic Water Heaters. The fact that the diamond-tough inner glass surface will not crack or chip under even extreme shipping, installation, and operating conditions is also proved by the performance record of hundreds of thousands of installed units.

This dependable, built-in protection against rust forming in the tank is a major reason why Permaglas Water Heaters provide completely satisfactory automatic hot water service, at the lowest actual cost. For ALL the reasons why "Permaglas" means complete satisfaction, send the coupon today.



"PERMAGLAS"
Dealers Display
This Emblem

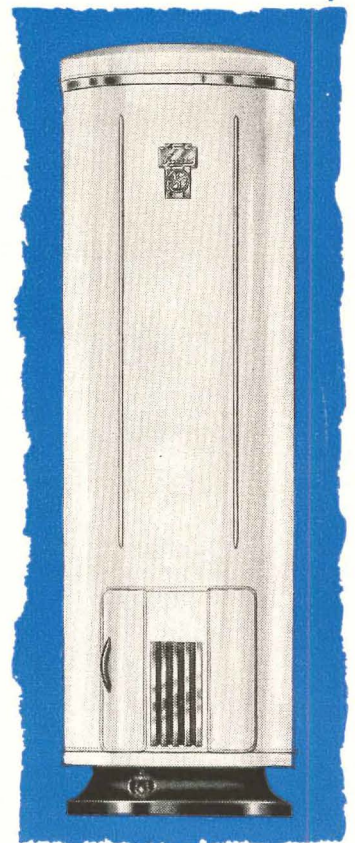

Electric and gas models...new electric table-top...in sizes for all home needs.

A. O. SMITH Corporation
Atlanta 3 • Boston 16 • Chicago 4
Clayton 5, Mo. • Philadelphia 3
Denver 2 • Detroit 2 • Houston 2
Los Angeles 14 • New York 17
Dallas 1 • Midland 5, Texas
Pittsburgh 19 • San Francisco 4
San Diego 1 • Seattle 1 • Tulsa 3
International Division:
Milwaukee 1
Licensee in Canada:
John Inglis Co., Ltd.

the end of horse and buggy days

*for
stainless
sheet
and strip*

Automobiles were once designed as horseless carriages—even to the dashboard socket for a needless whip. Stainless steel production, too, once struggled thru horse and buggy thinking. More power, heavier rolls, more care in surface finish—and stainless sheet and strip came forth a step-child of carbon steel methods. Today's modern strip mills have changed this, giving stainless production new concepts of quality.

CRUCIBLE, one of the pioneers in stainless steel, has gone still further. Now, *for the first time*, hot and cold rolled stainless steel is made a *specialty product*, by specialty production methods, in a mill built specifically for this purpose—in widths from ½" to 50" inclusive, and in all gauges, grades and finishes.

This is more than merely another source of supply. For, with this new mill at the Midland Works and the Trent Tube Co. joining the organization, CRUCIBLE can now supply you with *every* form of stainless. And, in sheets, plates, strip, bars, tubing, forgings, wire and castings, you can rightly expect the best that modern facilities and generations of *specialty product* leadership can provide.

CRUCIBLE STEEL COMPANY OF AMERICA,
405 Lexington Ave., New York 17, N. Y.

Branches, Warehouses and Distributors in Principal Cities

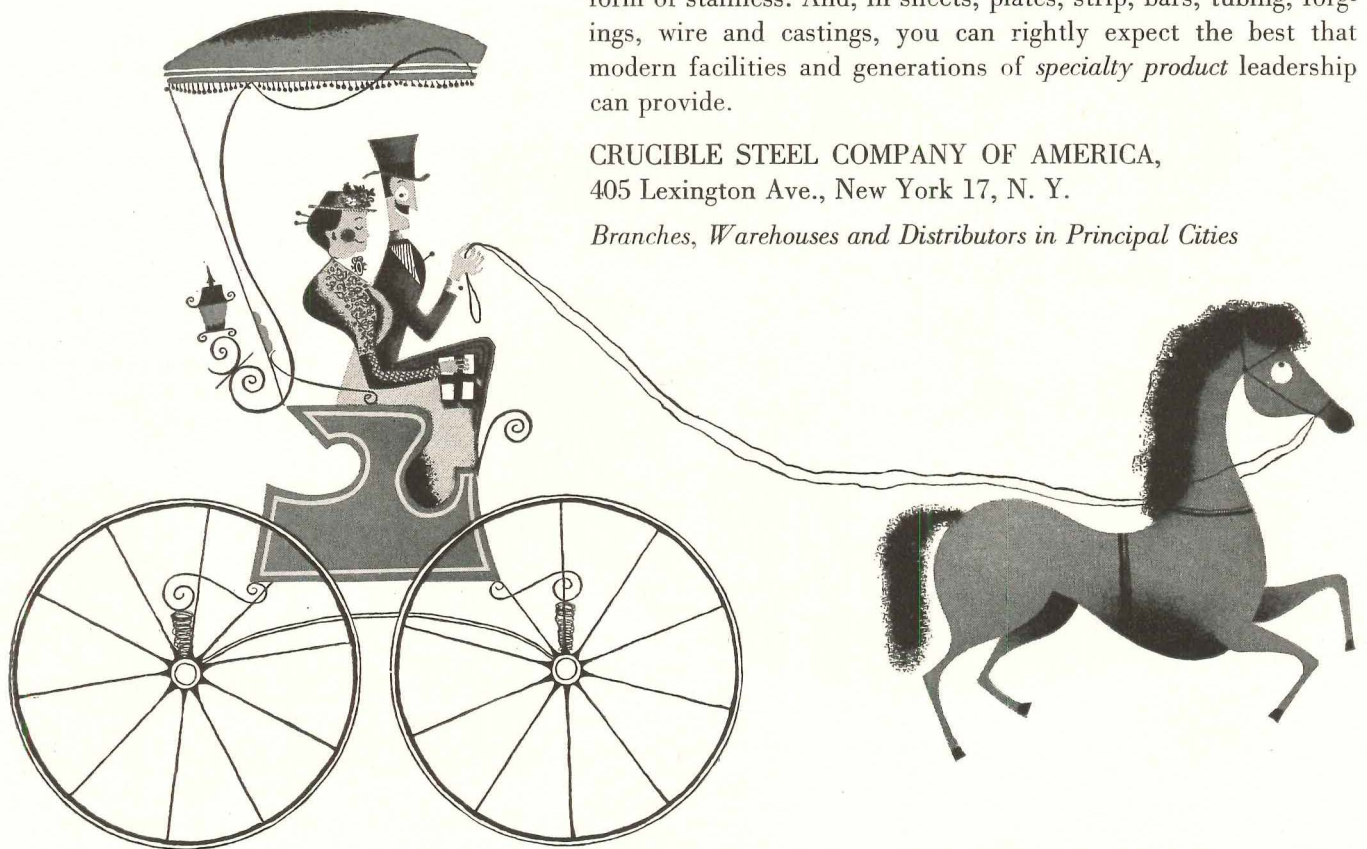

CRUCIBLE

hot and cold rolled

first name in special purpose steels

STAINLESS SHEET AND STRIP

STAINLESS • HIGH SPEED • TOOL • ALLOY • MACHINERY • SPECIAL PURPOSE • STEELS

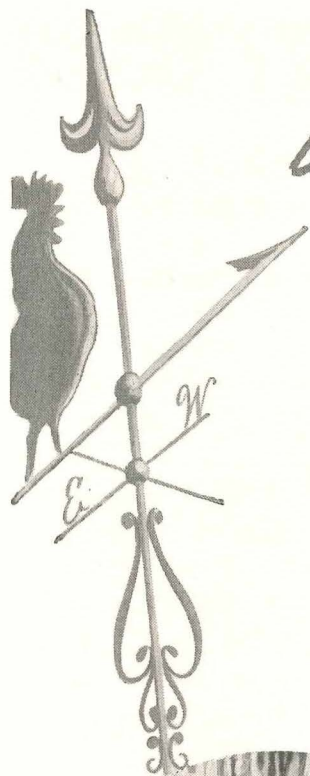

bring in the beauty

but . . . shut out the weather!

Today, you can give home-owners plenty of "view"—*plus* new, scientific protection from wind, dust, heat and cold! That's why Curtis Silentite windows are so often first choice where comfort and fuel savings are important. These Curtis windows are truly *weather-tight*.

Curtis Silentite double-hung windows have exclusive weather-stripping features, such as the patented "floating"

weather-strips that press snugly against the sides of the sash...yet allow easy movement. Silentite windows, too, are *wood*—with the natural insulating qualities for which wood is well-known. Made of Ponderosa Pine, toxic and water-repellent treated, Silentite windows also provide extra durability and long-lasting value. And, of course, they have no weights, cords or pulleys to get out of order.

for better casements — SILENTITE!

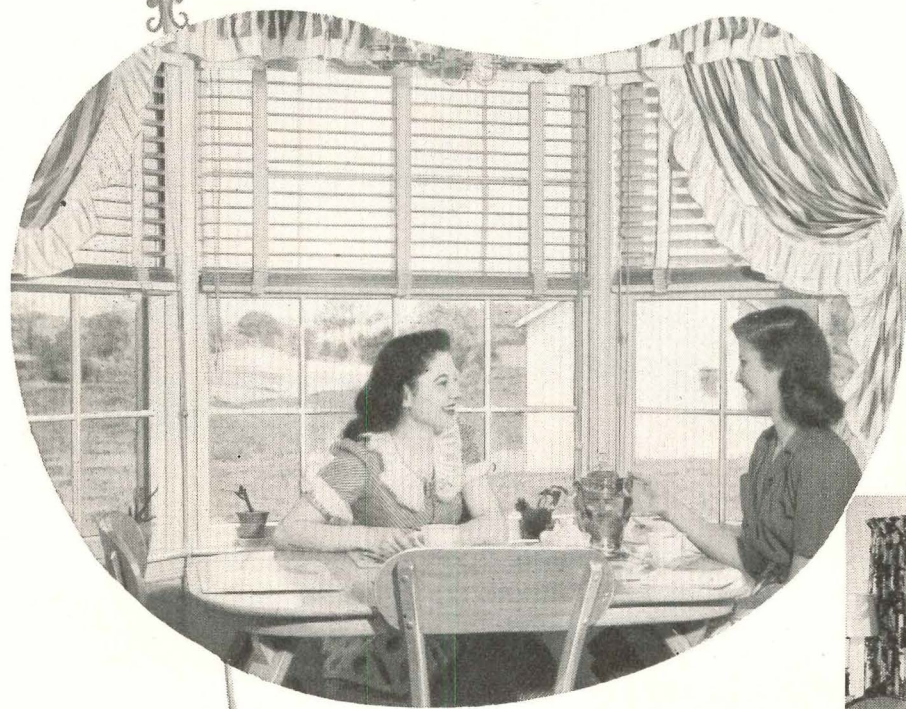

If the owner's choice is casement style windows—investigate the Silentite casements. Here is an insulated *wood* casement with special features that assure less air infiltration than other types.

A major improvement in casement design provides draftless ventilation. The sash is thoroughly trouble-free—can't rattle, vibrate or swing in the wind. No bulky hardware on the inside—no exposed hardware on the outside. Made in several sash styles.



When in New York, visit the Curtis Woodwork Display at Architects' Samples Corporation, 101 Park Ave.

You'll want our book on Silentite windows, including casements. Just mail the coupon!

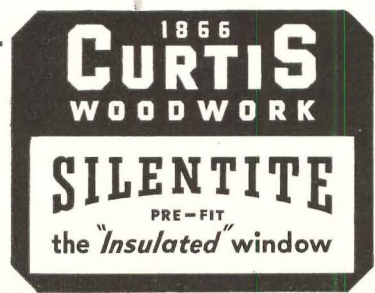

CURTIS COMPANIES SERVICE BUREAU
'AR-7S, Curtis Building, Clinton, Iowa

Please send me book on Silentite Windows, including casements. I am
 Architect, Contractor, Prospective Home Builder, Student. (Please check above)

Name.....
 Address.....
 City.....State.....

DON'T HOG THE SKYLINE!

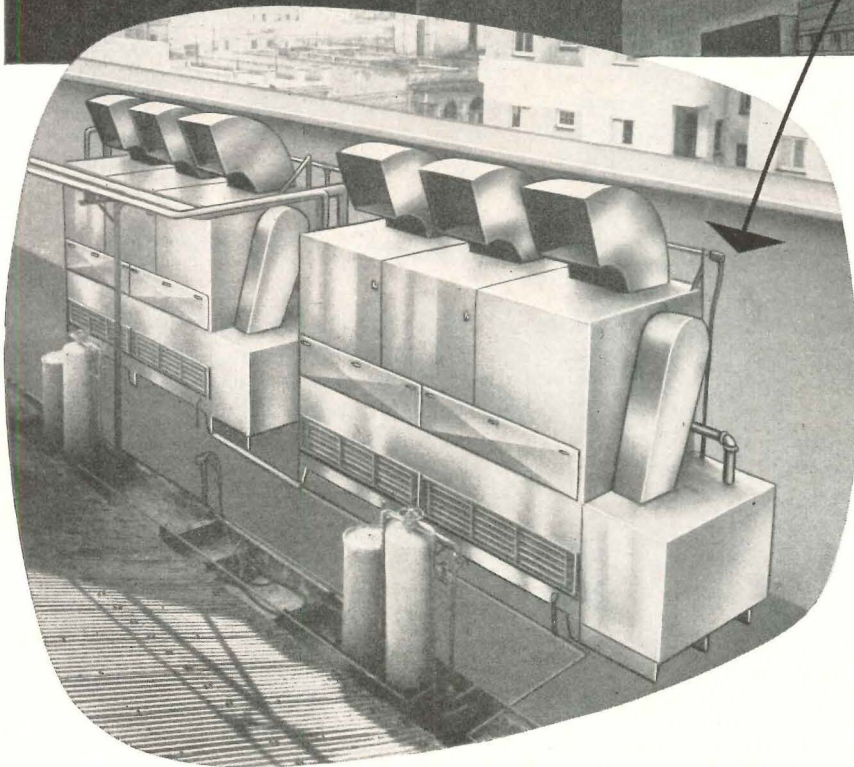
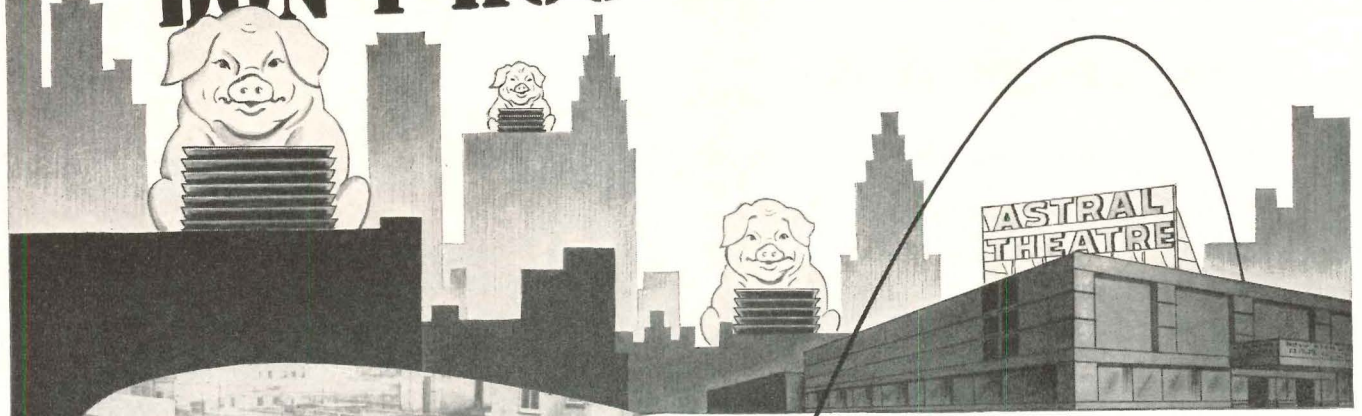

specify

below-the-parapet

MARLO

cooling towers

in your designs

A below-the-parapet installation of two Marlo EC-80 (160 tons capacity) Evaporative Condensers on the roof of the Astral Theatre, Havana, Cuba.

Installed with Chrysler equipment by La Antillana, S. A. Havana.

Installed below the cornice — or even indoors — Marlo Evaporative Condensers and Cooling Towers do not alter the architectural beauty of your designs.

Contours retain their unbroken, harmonious appearance — unmarred by projecting equipment.

Efficient Marlo units offer other *plus* features that add up to better, more economical installations for you.

Compact . . . easy to install . . . they assure silent, dependable operation — as well as a 95% saving of the normal water demand.

MARLO - HEAT TRANSFER
Since 1925

Send for complete data on MARLO Evaporative Condensers and Cooling Towers

Marlo COIL CO. • 6135 Manchester Rd. • St. Louis 10, Mo.

YOU CAN BE **SURE**.. IF IT'S
Westinghouse

Announcing...

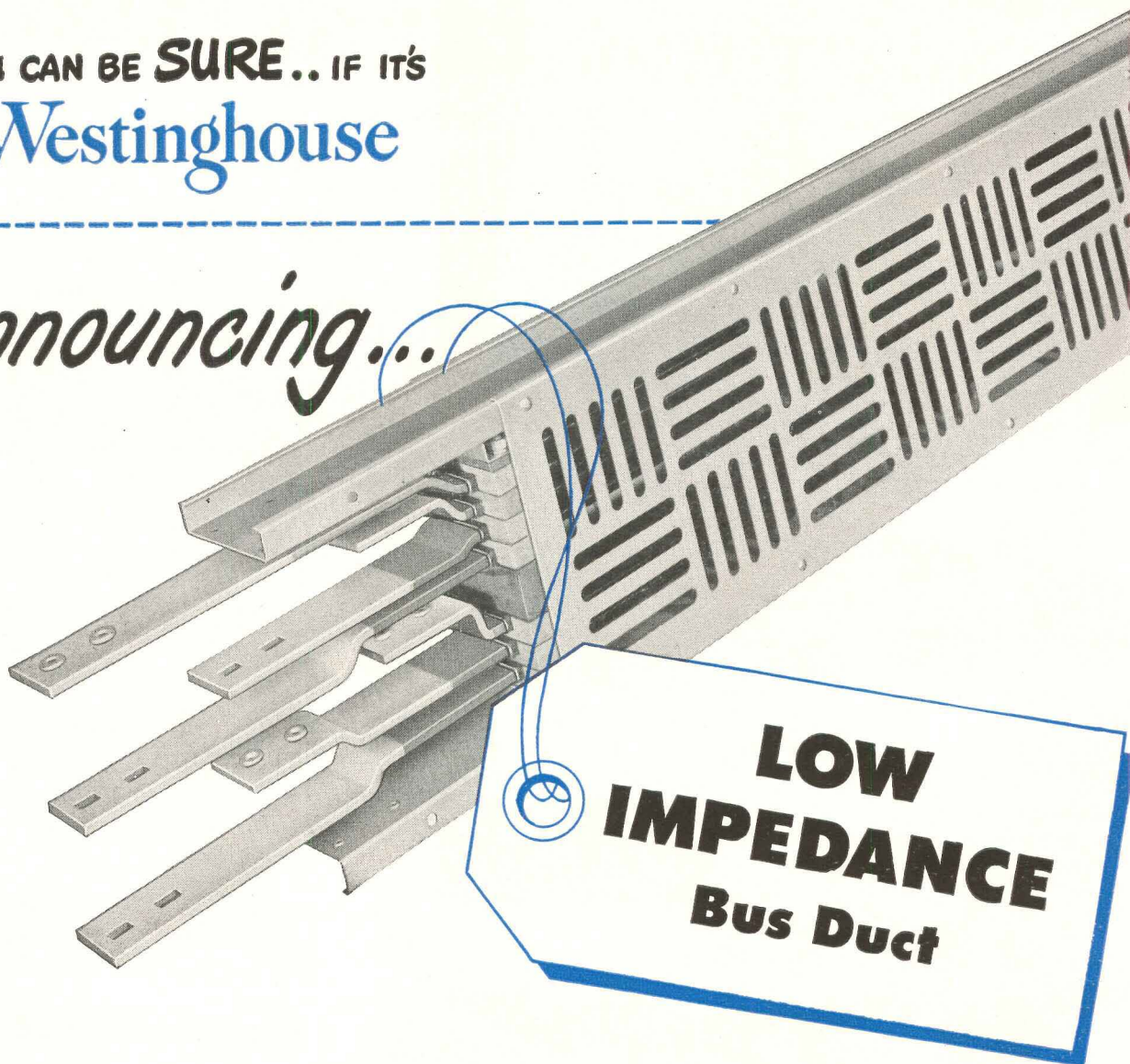

... for better "long haul" power distribution

Now you can lick the problem of excessive voltage drop in long feeder runs. New, Westinghouse Low Impedance Bus Duct is the equipment you need.

Close spacing and interlacing of busbars in low impedance duct assure *low* voltage drop . . . actually about one-half of that for conventional plug-in or feeder duct. This permits more efficient operation of electrical equipment served by long feeder runs.

Low impedance duct safely withstands high short-circuit stresses and is economical on high-capacity circuits. Its steel housing is *small* to conserve space . . . *ventilated* to

decrease temperature rise . . . *Bonderized* to prevent rust and corrosion.

Don't gamble with a crippling low-voltage condition. Be *sure* with Low Impedance Bus Duct!

For full details write Westinghouse Electric Corporation, P.O.Box 868, Pittsburgh 30, Pa.
J-30002

Westinghouse
Bus Duct



Specify

METLWAL

Smart, distinctive

PANELING

of enduring beauty!



UPPER: LUCY WOOD CAFETERIA
ATLANTA, GA.

LOWER: RICE & MILLER COMPANY
BANGOR, ME.

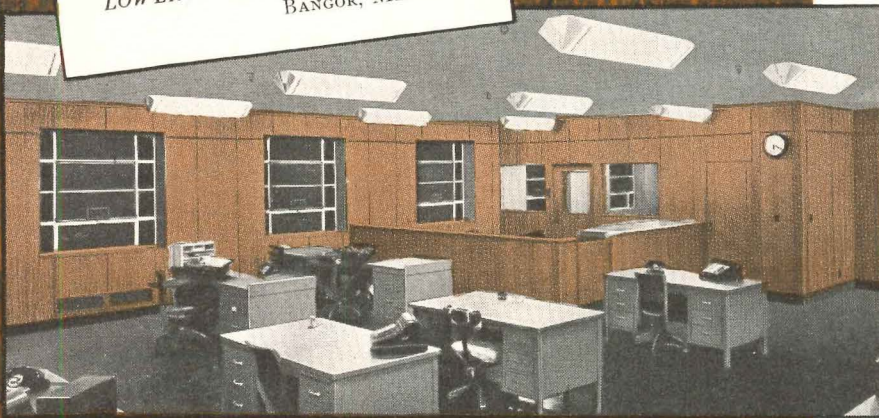

It's the

BUY-WORD for

Modern

Construction!

DESIGN opportunities *unlimited*—that's what revolutionary new Metlwal Paneling gives you! Smart, modern show rooms that crackle with sales appeal. Traditional designs for restaurants that create a mood of good living. Soft, restful paneling for institutions. Metlwal Paneling helps you plan any of these and hundreds of other beautiful interiors! You have your choice of a wide variety of *natural, life-like* wood reproductions and beautiful pastel shades for harmonious good taste!

Famous for its *low erection costs*, Metlwal Paneling is installed easily and quickly. It can be applied directly to wood studding or masonry walls with an exclusive, continuous clip. It saves time and money by eliminating the use of plaster in new construction. All parts and panels can be cut to fit *on the job*. Only a few standard parts from warehouse stock!

WRITE TODAY for your free copy of our latest catalog, A-7, containing Metlwal specifications, drawings and installation photographs. See how long-wearing, easily-maintained Metlwal gives you a full rein in planning distinctive interiors. Address: MARTIN-PARRY CORPORATION, Toledo 1, Ohio.

DESIGNED FOR INTERIORS OF EVERY TYPE

THEATERS: Lobbies, foyers, existing offices, powder rooms, smoking rooms, auditoriums

INSTITUTIONS: Existing offices and wards, corridors, kitchens, dining rooms, operating rooms

SERVICE STATIONS: Sales rooms, rest rooms, lubricatorium, offices, counters, displays

FACTORIES: Medical rooms, cafeterias, reception rooms, conference rooms, existing offices, washrooms, displays

HOTELS: Kitchens, corridors, rest rooms, lobbies, grills, dining rooms, cocktail rooms

USED IN THOUSANDS OF INSTALLATIONS

69 Years of service

MARTIN PARRY

MP
PRODUCTS

METLWALS

ALL-FLUSH
PANELING
MOVABLE
PARTITIONS

ENGINEERING AND ERECTING SERVICE AND
WAREHOUSE STOCKS FROM COAST-TO-COAST

extra whiteness

for mass or contrast in architecture

Trinity White—the *whitest* white cement—is made to ASTM and Federal specifications. It is a true portland cement made from selected raw materials. It has all the excellent portland cement qualities of strength, endurance and workability. Use Trinity by itself for whiteness—with pigments for purer, truer color values. Use it in cast stone, architectural concrete units, terrazzo, stucco, light-reflecting floors; in cement paint.

TRINITY WHITE Portland Cement

As white  as snow

plain or waterproofed



Trinity Division, General Portland Cement Co., 111 W. Monroe St., Chicago; Republic Bank Bldg., Dallas; 816 W. 5th St., Los Angeles.

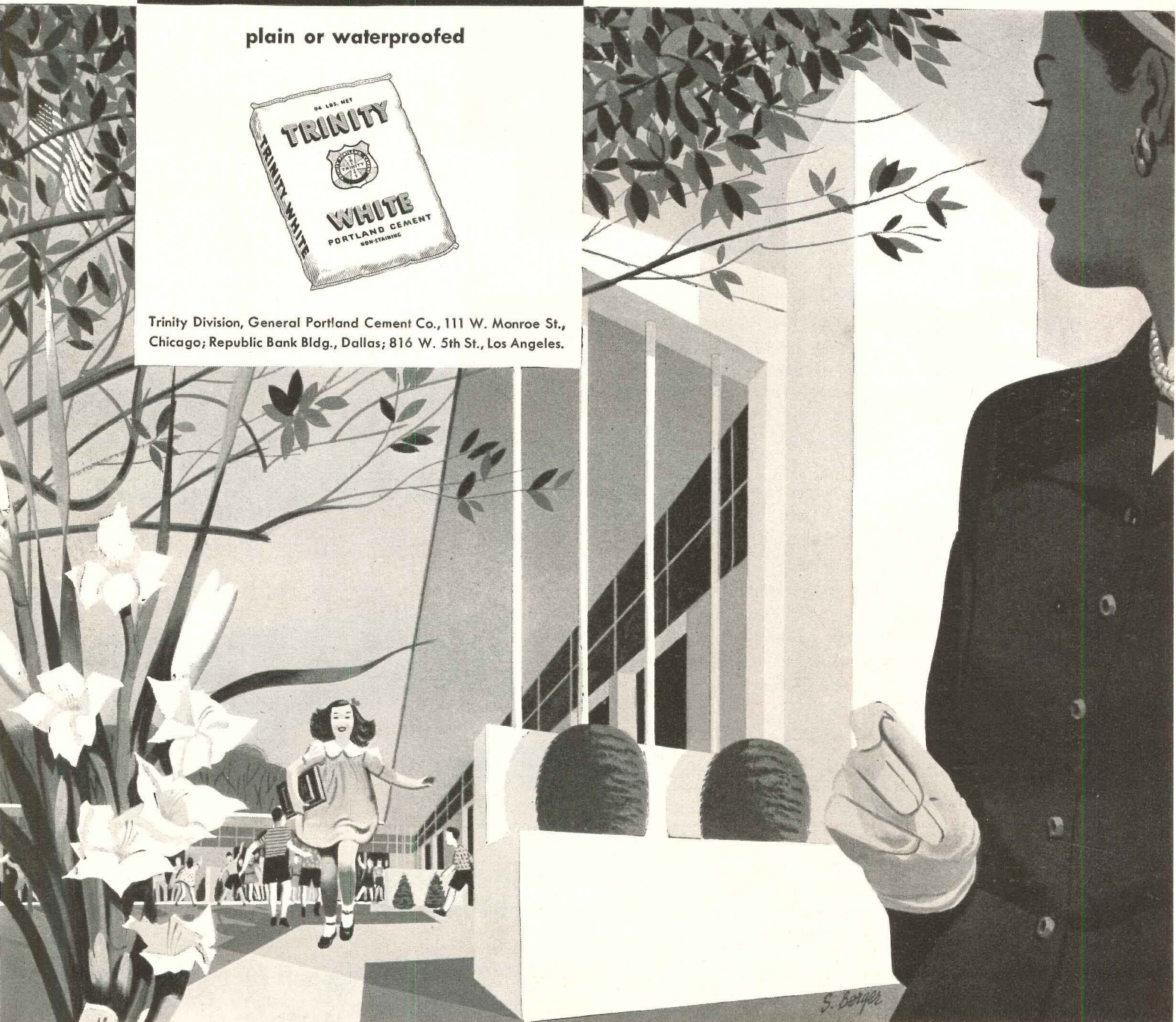

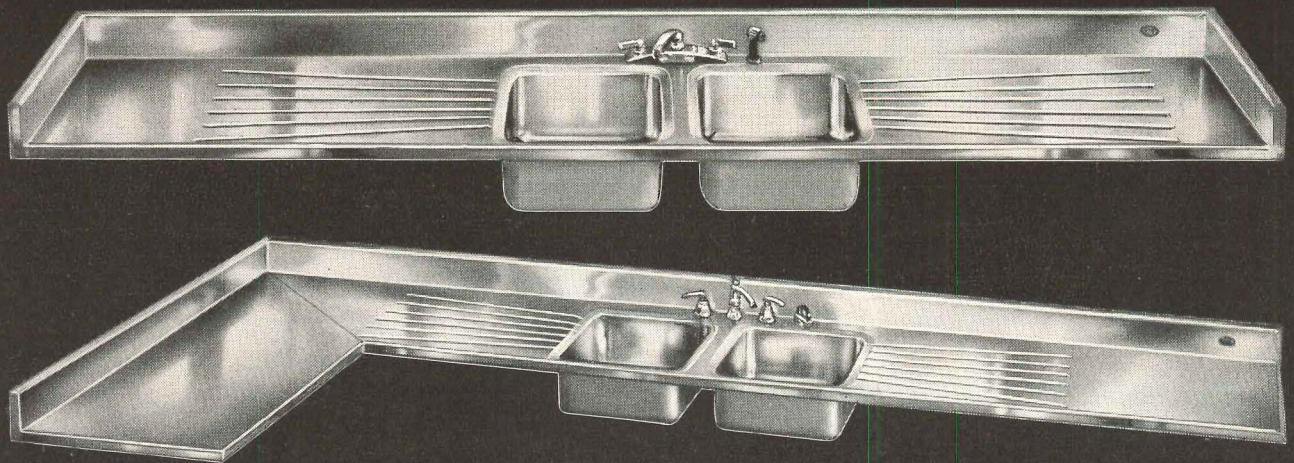

For homes of distinction

CUSTOM-BUILT *Tracy* SINKS

...in lifetime stainless steel

Design the appeal and beauty of America's most famous sink into the kitchens of your better modern homes. Whatever your plan, we'll build a Tracy sink to fit it perfectly, flatteringly.

You know how a whole house takes on new glamour through the wear-defying beauty of these famous Tracy sinks and counter tops. And you know Tracy quality. They are fashioned with the painstaking craftsmanship that has distinguished Tracy sinks for over 20 years. Tracy sinks cannot crack, chip or warp. They are impervious to heat, food acids and hard usage. They never stain or discolor.

No wonder a recent survey shows that over 60% of American home owners have a definite preference for stainless steel equipment in their kitchens.

Tracy custom-built sinks offer you complete design flexibility. L and U shapes; special height back and end splashers; bowls and faucet holes located in various positions; special cut-outs provided. 30 day delivery from receipt of order. Send sketches and dimensions for complete information and prices.

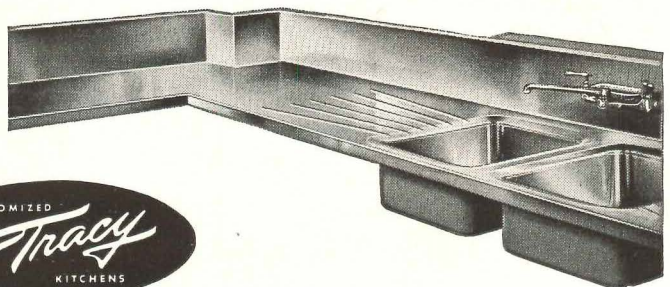
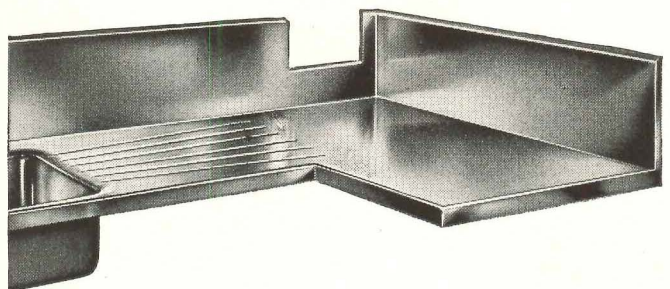
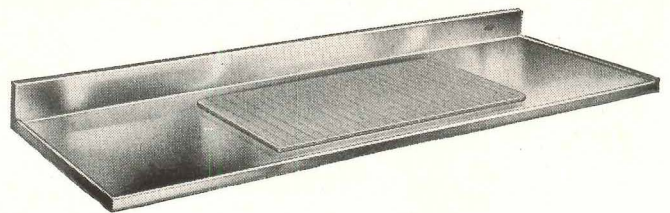

Tracy manufactures a complete line of enameled steel kitchen cabinets and sink tops in stainless steel and deluxe porcelain.



TRACY MANUFACTURING COMPANY • PITTSBURGH 12, PENNSYLVANIA

World's Largest Manufacturer of Stainless Steel Kitchen Sinks

INEXPENSIVE IDEA GIVES HOMES AND APARTMENTS

*That
"Luxury Look"*



**BRUCE
BLOCK FLOORS**
In Living and
Dining Rooms

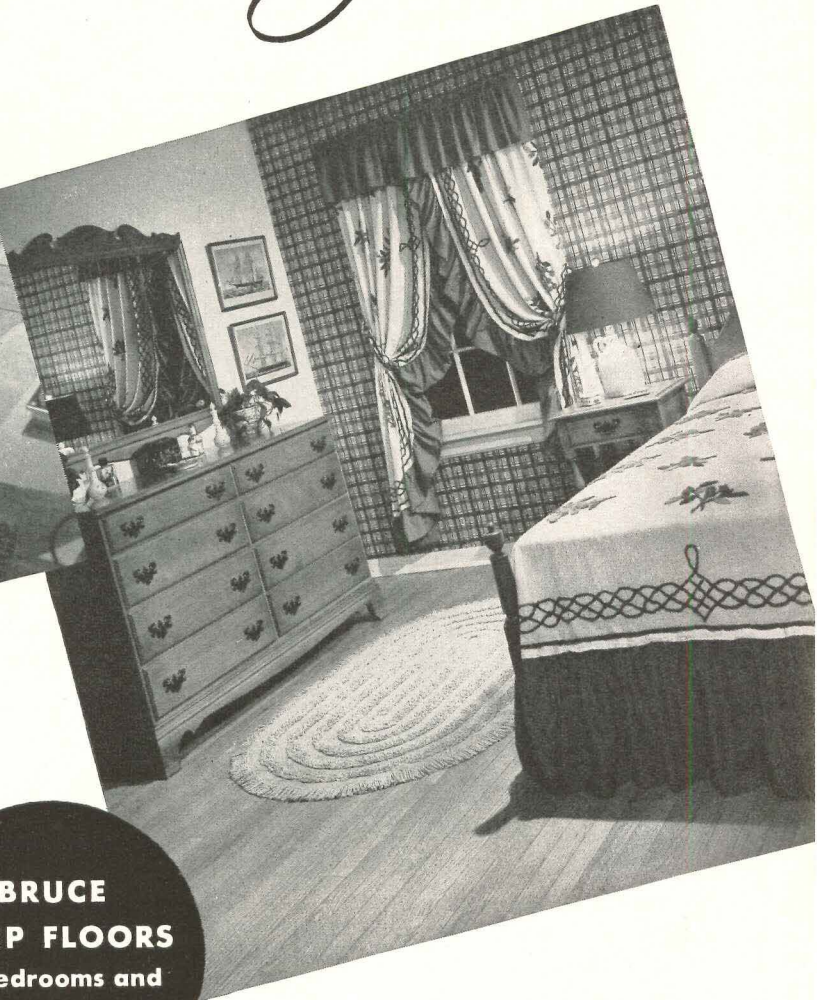

**BRUCE
STRIP FLOORS**
In Bedrooms and
Hallways

**Combination of block and strip floors
adds style and variety to any home**

Why use the same type of hardwood floor throughout a home when you can get so much extra style and beauty with this inexpensive idea: Use modern Bruce Block Floors in the living and dining rooms, and use beautiful Bruce Strip Floors in bedrooms and hallways. You'll find this distinctive "floor plan" one of the most admired and popular features of your homes. It's just the sort of touch that marks a home as "architecturally designed." Mail the coupon for literature and information. E. L. BRUCE CO., Memphis, Tenn., World's Largest Maker of Hardwood Floors.

Bruce Hardwood Floors

• **Bruce prefinish gives more beauty, longer wear**

Both types of Bruce Floors (Block and Strip) are available with a factory-applied finish that brings out all the natural beauty of the wood grain. It's a penetrating seal finish that resists abuse because it's "in the wood"—not a surface finish that scratches, chips and wears away.

Mail coupon for more information



E. L. BRUCE CO.
Memphis (1), Tenn.
Send literature on Bruce Hardwood Floors
(Block and Strip) to:

Name.....
Firm.....
Address.....
City and State.....

Fewer wires for Weyerhaeuser!

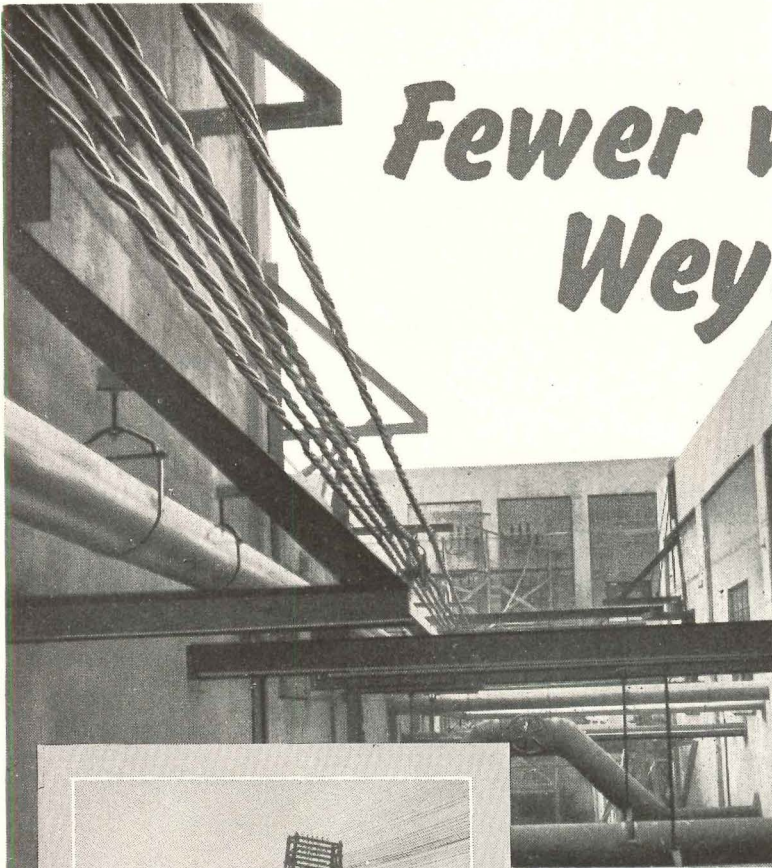

- ... space saved
- ... installation cost lowered
- ... all-weather dependability assured with

OKOLITE-OKOPRENE SELF-SUPPORTING AERIAL CABLE

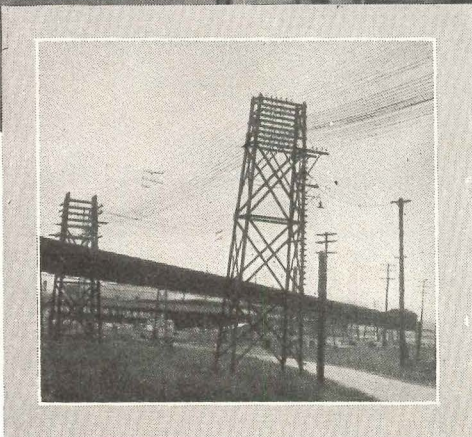

▲ Contrast the congestion shown in lower picture with the compact, simple installation of Okolite-Okoprene Self-Supporting Aerial Cable (above) at Weyerhaeuser's new pulp mill at Longview, Wash. Recently-erected generating plant is in background. Installation was made by Western Electrical Construction Co., Portland, Oregon.

At Longview, Wash., the new MgO sulphite recovery and new sulphate pulp processing plants of the Weyerhaeuser Timber Company typify the advantages of self-supporting cable in industry for the transmission and distribution of power. Here, Okolite-Okoprene Self-Supporting Aerial Cable serves between a new generating plant and an old one. It contrasts strikingly with the congestion of open wiring.

With Okolite-Okoprene Self-Supporting Cable, *self-evident space economy* is matched by installation economy as it requires no separate stringing. Further savings result from the long life of this storm-safe all-weather cable assembly.

Another feature of Okolite-Okoprene Self-Supporting Cable that makes it valuable in industrial plants is this fact: *safe as well as easy handling* is assured. The cable is fully insulated with Okolite high-voltage moisture and heat-resisting insulation and protected with weather-resistant non-conducting Okoprene. For 52-page Self-Supporting Cable book available to electrical engineers and plant executives, please address The Okonite Company, Passaic, N. J.



7305



OKONITE



insulated wires and cables

THE BEST CABLE IS YOUR BEST POLICY

Nature made Asbestos . . . Keasbey & Mattison has made it serve mankind since 1873

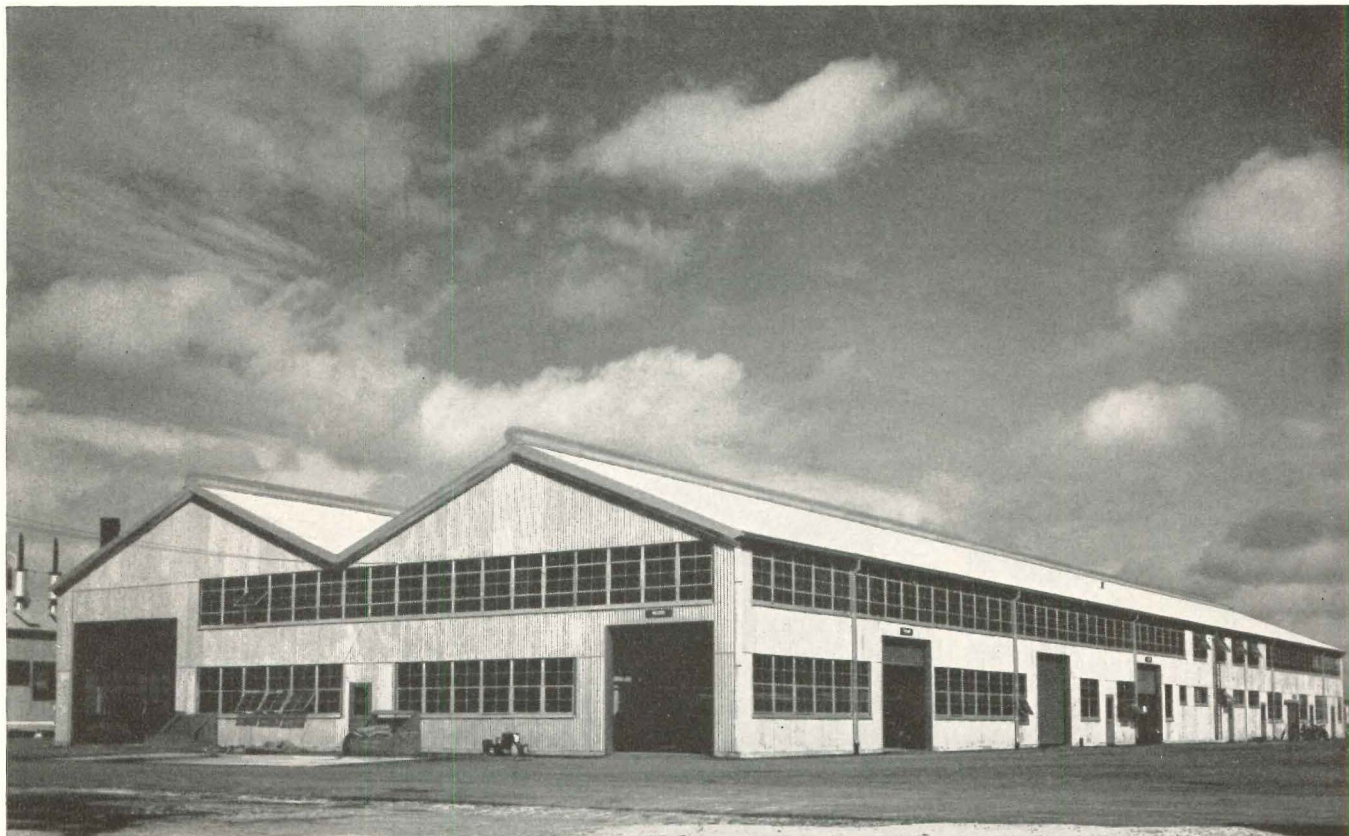

Owner: Celanese Corporation of America

Roofing and Siding Applicator: Arthur Brothers, General Contractors, Kingsville, Texas

The weather can't do anything about **K&M "Century" ASBESTOS CORRUGATED** —on the job for Celanese

Looks like some Texas weather coming up. But it is sure to be licked—and will stay licked—by the roofing and siding on this Mechanical Shop Building of Celanese Corporation of America's Chemcel Plant at Bishop, Texas. This job won't invite fire loss either. It won't rot or rust; won't permit galvanic action and won't feed termites.

The favorable economics of K&M "Century" Asbestos Corrugated begins with its ample

structural strength. Ease of application, including ready workability and adaptability, makes for fast, shipshape erection. That multiplies savings.

Exterior and interior architectural effects which would be too costly otherwise, are now being carried out successfully by architects who capitalize on the structural, shelter and cost advantages of K&M "Century" Asbestos Corrugated.

No scaffolds . . . no workmen beneath . . . when the roof is applied with "TOP-SIDE"* Fasteners. Available only with K&M "Century" Asbestos Corrugated, they do a better job at lower cost. Details on request.
*Trade-mark

KEASBEY & MATTISON
COMPANY • AMBLER • PENNSYLVANIA



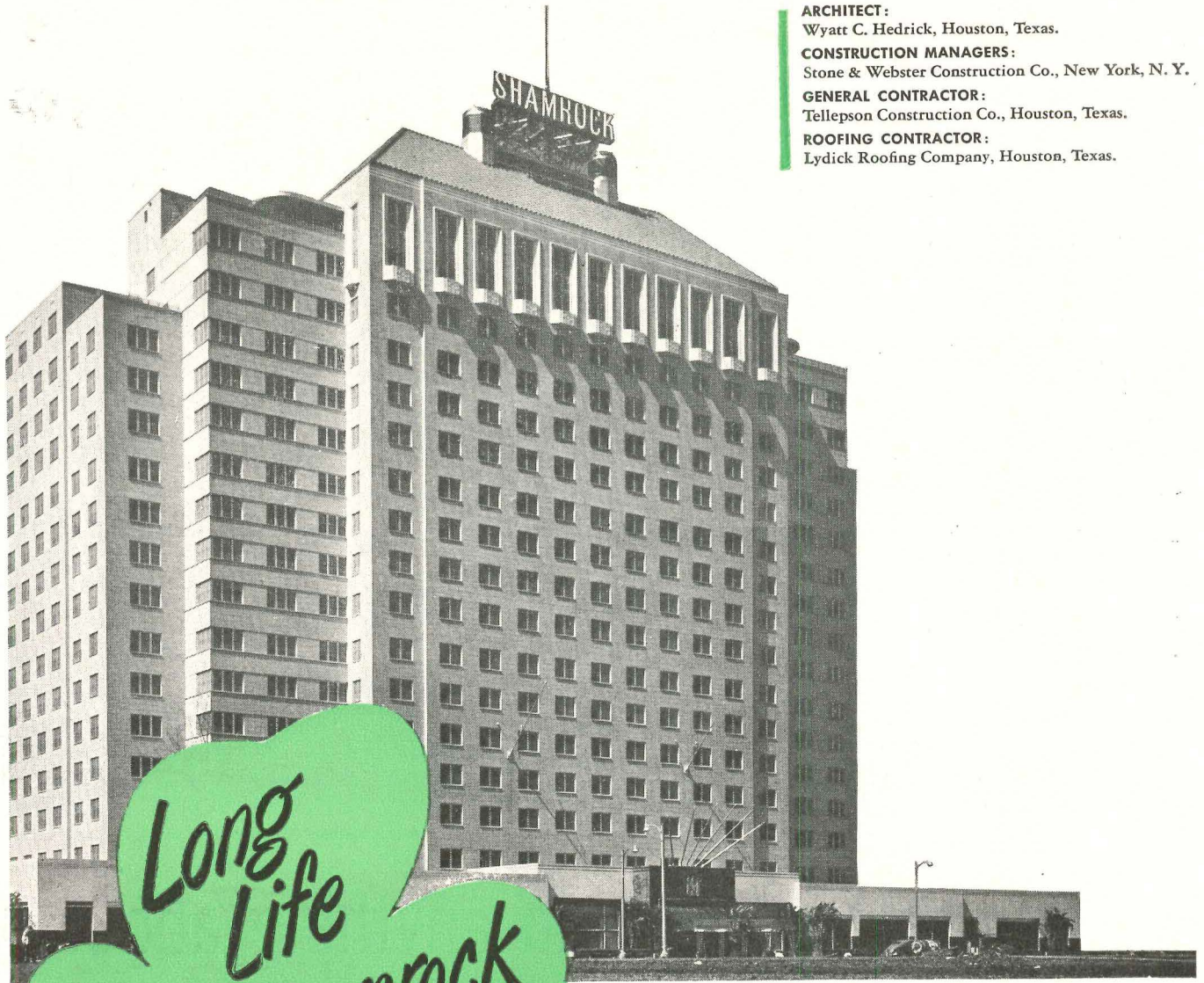

ARCHITECT:
Wyatt C. Hedrick, Houston, Texas.
CONSTRUCTION MANAGERS:
Stone & Webster Construction Co., New York, N. Y.
GENERAL CONTRACTOR:
Tellepsen Construction Co., Houston, Texas.
ROOFING CONTRACTOR:
Lydick Roofing Company, Houston, Texas.

Long
Life
to the Shamrock
...and its
roof!

nation's newest, most lavish hotel chooses Ruberoid built-up roofing

No service, no material—irrespective of cost—was spared in making the 21 million-dollar Shamrock Hotel at Houston, Texas, the finest in the land.

Hence, their choice of Ruberoid pitch and gravel built-up roofing for all composition roof coverings tells its own quality story.

Equally significant . . . to the architect on a job where cost *is* a factor . . . is Ruberoid's

unexcelled record for delivering more trouble-free years for your roofing dollar.

And since Ruberoid makes every type of built-up roofing there can be no question of bias for or against any single type.

You can be certain—as is the magnificent new Shamrock—of the right roof for the building, of the efficient, economical service made possible by centralized responsibility.

The **RUBEROID** Co. **built-up roofings**

Building Materials for Industry, Home and Farm • Executive Offices: 500 Fifth Avenue, New York 18, N.Y.

IN CLOISTERED HALLS OR DRAFTING ROOMS . . .

YOU must remember that our function and objective is to train men to be *architects*, not mere draftsmen to be exploited by plan-factory operators."

"I didn't hire that chap to conduct seminars on the philosophy of esthetics in there; we've got to get out those working drawings and he can't either draw straight or think straight."

There you have two points of view — exaggerated, perhaps, but not untypical statements — one from a professor, the other from a practitioner. Both speak from conviction and experience, and both have good reasons for their attitudes. But it does seem that both attitudes could be modified if the professor and the practitioner could really get together and objectively discuss the problem of architectural education in both cloistered halls and drafting rooms. For there need be no conflict of interest or point of view when both realize that the education of the architect is necessarily "from the college to the grave."

There can be no conflict in objective, which is, after all, the ever-increasing competence and usefulness of the profession. And certainly the program and method for this life-long education of architects can and should be worked out by professors and practitioners sitting down together — and soon. There need be no recriminations, rather an agenda of constructive recommendations, a discussion of the respective functions of the schools, the offices, the professional organizations and the publications.

Understandings could be reached that would eliminate the harsh statements just quoted — and would ease the jolt to the young hopeful graduate when he seeks a foothold in his profession. Mutual understanding then will bridge, or rather close, the gap between the cloistered halls and the drafting-galleys. (In this connection we commend your reading Sidney Wahl Little's vigorous article in the May Journal of the A.I.A.)

The A.I.A. and the Association of Collegiate Schools of Architecture would seem to be the logical initiators of the conferences which will bring about the necessary understanding and the subsequent coordinated program for the continuing education of architects. The preliminary conferences might well result in making Education, with a capital E, the major theme of an A.I.A. Convention — not only academic or school education but adult and continuous education. The far-reaching and stimulating effects of such convention emphasis can hardly be over-estimated. When, if and as both cloistered halls and drafting rooms realize they must be coordinated and integrated in one continuing and never-ending process, the profession will be really competent to be "of ever-increasing service to society."

Kenneth K. Stowell
EDITOR

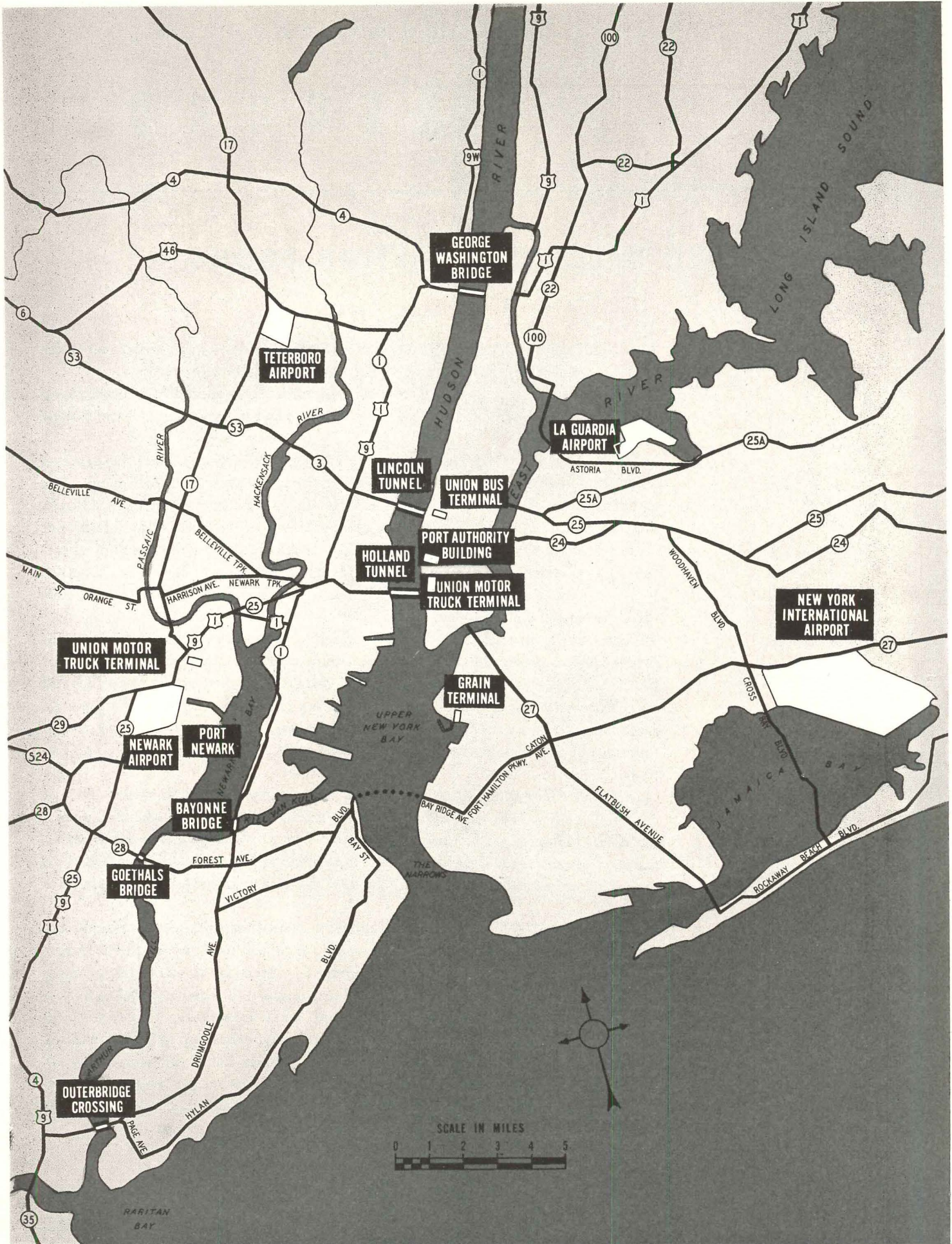

Aviation was still in its infancy when the state legislatures of New York and New Jersey set up the Port of New York Authority in 1921, but the Authority nonetheless was directed to provide facilities for the handling of aircraft. The bi-state agency has complied in good measure, most spectacularly with the new New York International Airport, opened a year ago (pp. 86-87). Right: the interim Terminal Building at International proudly bears the Port Authority seal

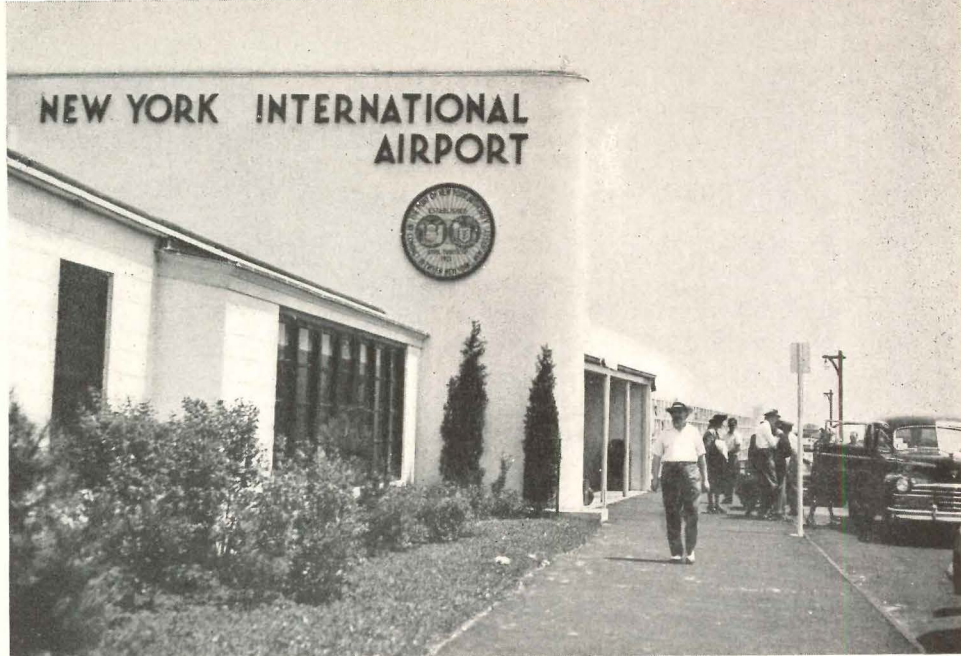

PLANNERS OF AMERICA'S LARGEST PORT

The Port of New York Authority is a highly specialized regional planning agency employing 300 architects, engineers and draftsmen

ONE of the knottiest of all regional planning problems is the integration of transportation facilities in a major harbor area spreading across a state boundary. The vast and sprawling port of New York years ago became such a problem for the two states between which it lies — New York and New Jersey. In its early days it was the cause of frequent squabbles between the states, one so sharp that New Jersey actually mobilized troops to march against New York. Then in 1834 a treaty was drawn up to settle the difficulties and all was serene until the first part of the present century. By 1917, however, harbor lighterage rates had become such a serious issue between the states that it was obvious something more must be done. A survey of the port's needs was conducted under the direction of the two state legislatures and the two governors, and a detailed report was published, recommending the setting up of a bi-state agency to handle the port's development and welfare. The 1834 treaty was supplanted in 1921 by a new compact which created the Port of New York Authority and vested it "with full power and authority to purchase, construct, lease, and operate any terminal or transportation facilities" within the port district. By 1922 the new agency had submitted a comprehensive plan of regional development which was promptly adopted by the two legislatures.

"To purchase, construct, lease and operate any terminal or transportation facilities" within the huge New York port area is a tall order. Bridges and tunnels,

airports, grain and freight terminals, and the eternal struggle against the problem of New York's traffic — these are some of the jobs falling within the Port of New York Authority's jurisdiction. Handling the resultant mass of detail is a staff of about 2500 employees, headed up by 12 commissioners (six appointed by the governor of each of the two states concerned) who serve without pay for overlapping terms of six years each. The Authority is a corporate, self-supporting agency — and a large-scale business venture. In the past 27 years it has sold \$567,000,000 of revenue bonds on its own credit; it has built, or currently has under construction, \$300 million worth of the transportation facilities which it was created to build and maintain.

Most of the projects shown on the next 10 pages were designed by the Port Authority's own large staff of architects and engineers. Heading up the design departments are: John M. Kyle, Chief Engineer; Rudolph F. Schaefer, Engineer of Design; Walter P. McQuade, Architect; and Thomas M. Sullivan, Engineer of Airports. In addition, an Engineering Board, composed of outside consultants, serves the Authority in an advisory capacity. Board chairman is J. C. Evans, of the Authority staff; architect member is Max Foley, of the New York architectural firm of Voorhees, Walker, Foley and Smith. Engineer members are: Frederick R. Harris, Engineer; William H. Mueser, of Moran, Proctor, Freeman and Mueser; George W. Burpee, of Coverdale and Colpitts; and Ernest C. Johnson, of Gibbs and Hill.

The terminal building at New York International Airport is temporary, but boasts over 40,000 sq. ft. of space and a 2000-car parking lot immediately adjacent. Across-page: huge steel-arch hangars now under construction at N. Y. International; each has a clear span of 300 ft. and a special tail door above the sliding doors to permit entry of planes with tails as high as 62 ft.; Gordon Lorimer, Architect; Roberts and Shaffer, Engineers

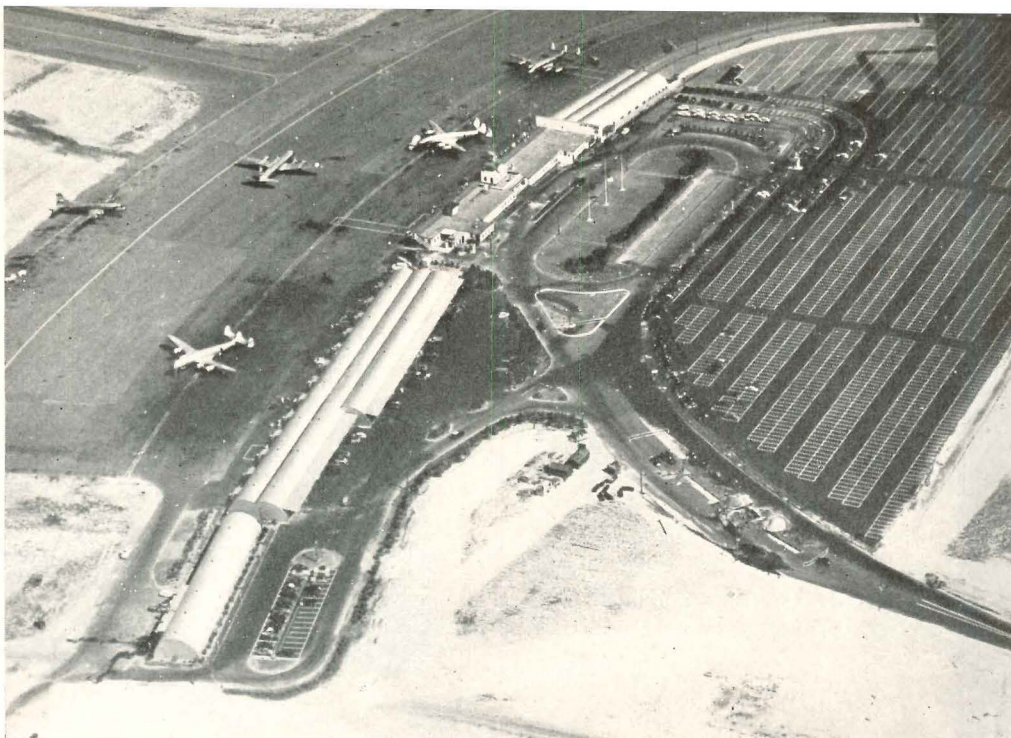

AIRPORTS—THE PORT AUTHORITY NOW HAS FOUR

As the map on page 84 shows, the Authority at present has four airports under its wing: La Guardia to the northeast of Manhattan, New York International to the southeast, Newark to the southwest, and Teterboro (acquired only last April) to the northwest. In 1948 La Guardia alone handled more than 145,000 plane movements, nearly 2,750,000 passengers, and more than 46,000 tons of cargo; Newark and New York International (the latter in operation only since last July) swelled the total to 241,449 plane movements, 3,487,392 passengers, and 108,720,516 lb. of air express and freight. Construction contracts awarded at the three airports during the year totaled \$12,659,780.

Port Authority operation of La Guardia began in

June, 1947. The airport at that time, of course, was in full swing, and required no immediate new construction. Progressive settling of the silt sub-surface on which it was built, however, had reached a point where seasonal high tides had on several occasions flooded portions of the runway and apron system. To correct this condition, the Authority constructed a million-dollar marginal dike around the airport and installed 1200 sand drains to drain and consolidate the underlying silt. The 2-mile dike is 28 ft. wide and at some points as high as 6 ft.

Newark Airport was taken over by the Authority in March, 1948. Like La Guardia, it was already a busy and well-equipped airport, but needed certain repairs

First permanent building at New York International is the \$4,500,000 Federal Building, formally opened on July 1; three stories in height, it will house offices of the Weather Bureau, CAA, etc. Reinhard, Hofmeister and Walquist, Architects



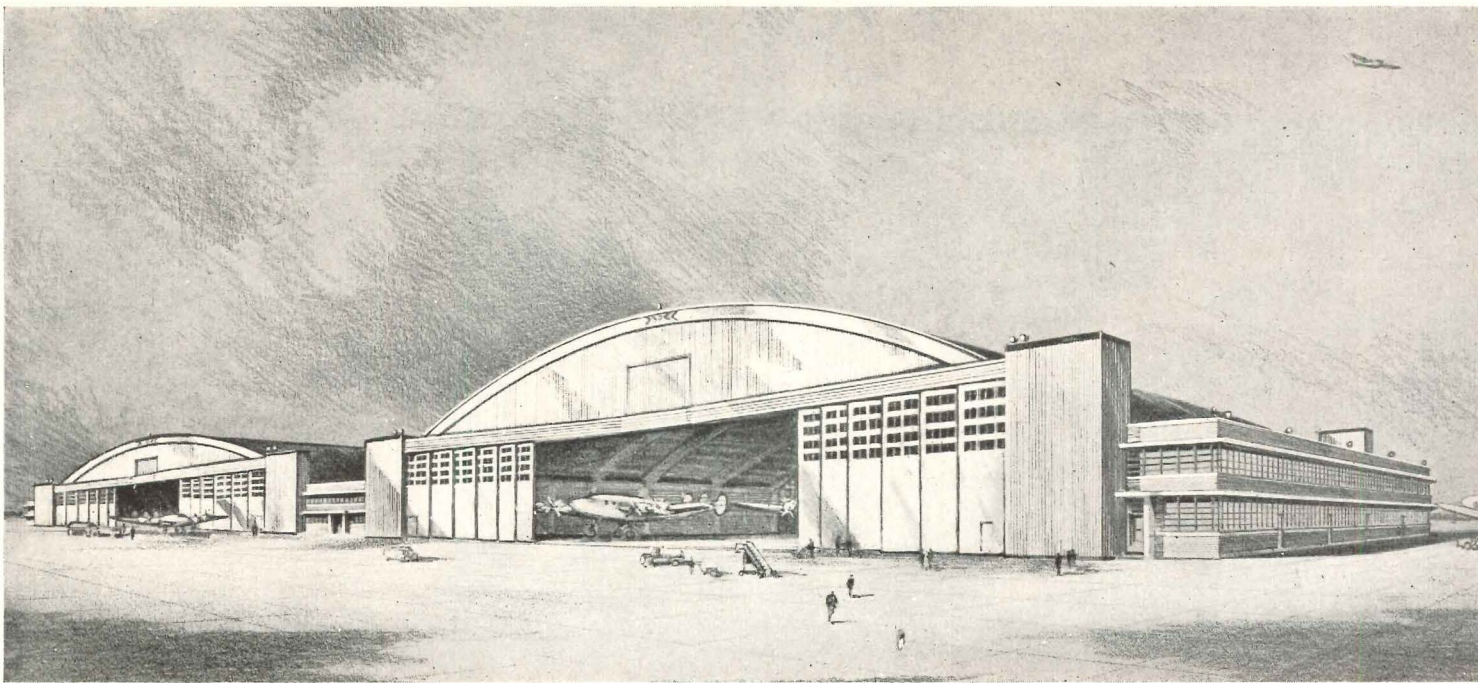

to runways and aprons. The Authority completed this work last year, rehabilitated the so-called Army Air Freight Terminal for use as an air cargo center, and is now working on a master plan for the expansion of the whole airport area. Plans also are being drawn for new terminal, hangar and other facilities.

The third airport to fall under the Authority's jurisdiction was New York International, construction of which was begun by New York City and taken over by the Authority. It was opened in July, 1948, under Authority operation, but is still far from being complete. Construction now under way includes the \$4.5 million Federal Building (opposite page) which will house the 13-state regional and local offices of the United States Weather Bureau, the Civil Aeronautics Administration, and other federal services; and three mammoth steel-arch hangars, each able to accommo-

date four Boeing Stratocruisers. The original interim terminal building has been expanded from 17,000 to 40,090 sq. ft.; an additional 12,830 sq. ft. of space have been provided for federal inspection services; a 39,200 sq. ft. cargo building has been erected; and a 2000-car paved parking lot adjacent to the terminal building has been established. The airport now has seven runways, including the new 8000-ft. instrument approach.

The fourth and most recently acquired of the Port Authority's airports is Teterboro, in Bergen County, N. J. This 500-acre airport was purchased by the Authority last year, and taken over last April. With a new control tower and CAA operation of an instrument runway, Teterboro completes the plan for regional airport facilities specified by New York and New Jersey state legislatures in a 1947 amendment to the Port Treaty of 1921.

Below: 8000-ft.-long instrument runway V, N. Y. International Airport, parallels the instrument approach at La Guardia. Right: an Air France plane taxis across the new underpass at N. Y. International Airport

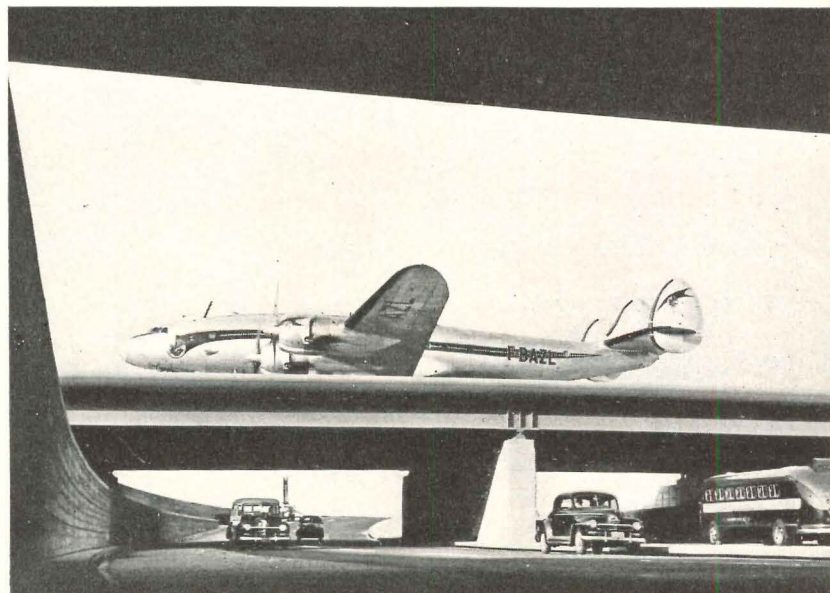

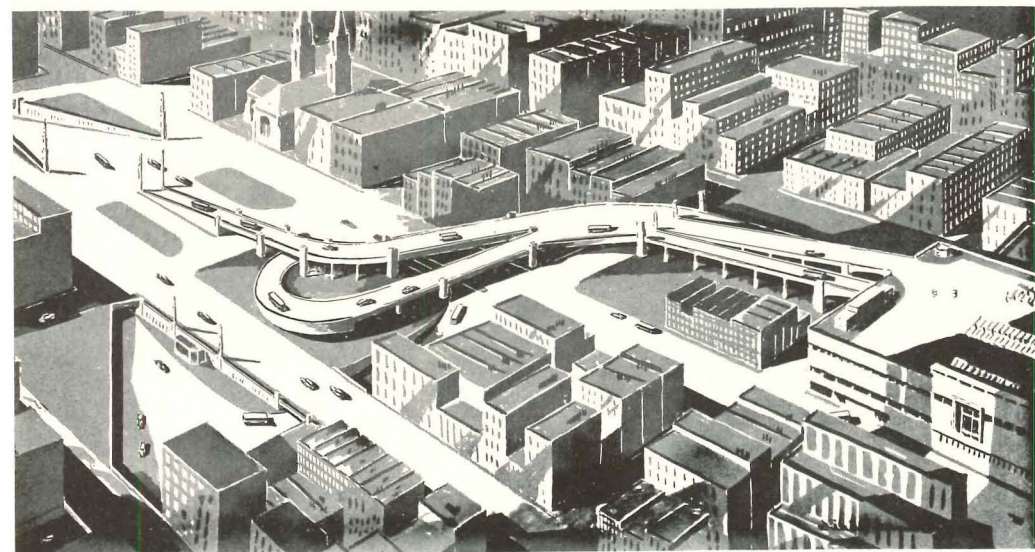

The Union Bus Terminal will occupy the entire block between Eighth and Ninth Avenues, 40th and 41st Streets, will be connected with nearby Lincoln Tunnel by an overhead ramp. Only the long-distance buses will approach the Terminal at street level

BUS TERMINAL AND OVERHEAD RAMP TO LINCOLN TUNNEL

ONE of the most widely publicized of the Port Authority's recent activities is the huge new Port Authority Union Bus Terminal now being constructed in midtown Manhattan to serve the 60,000 New Jersey bus commuters and long-distance bus passengers who enter and leave the city daily. An overhead ramp will connect the

terminal with nearby Lincoln Tunnel, keeping the unwieldy buses off the city streets. Long distance and suburban traffic will be carefully separated, the long distance buses using the basement level, the suburban buses the upper (see cross section opposite). Roof parking will be provided for 450 cars.

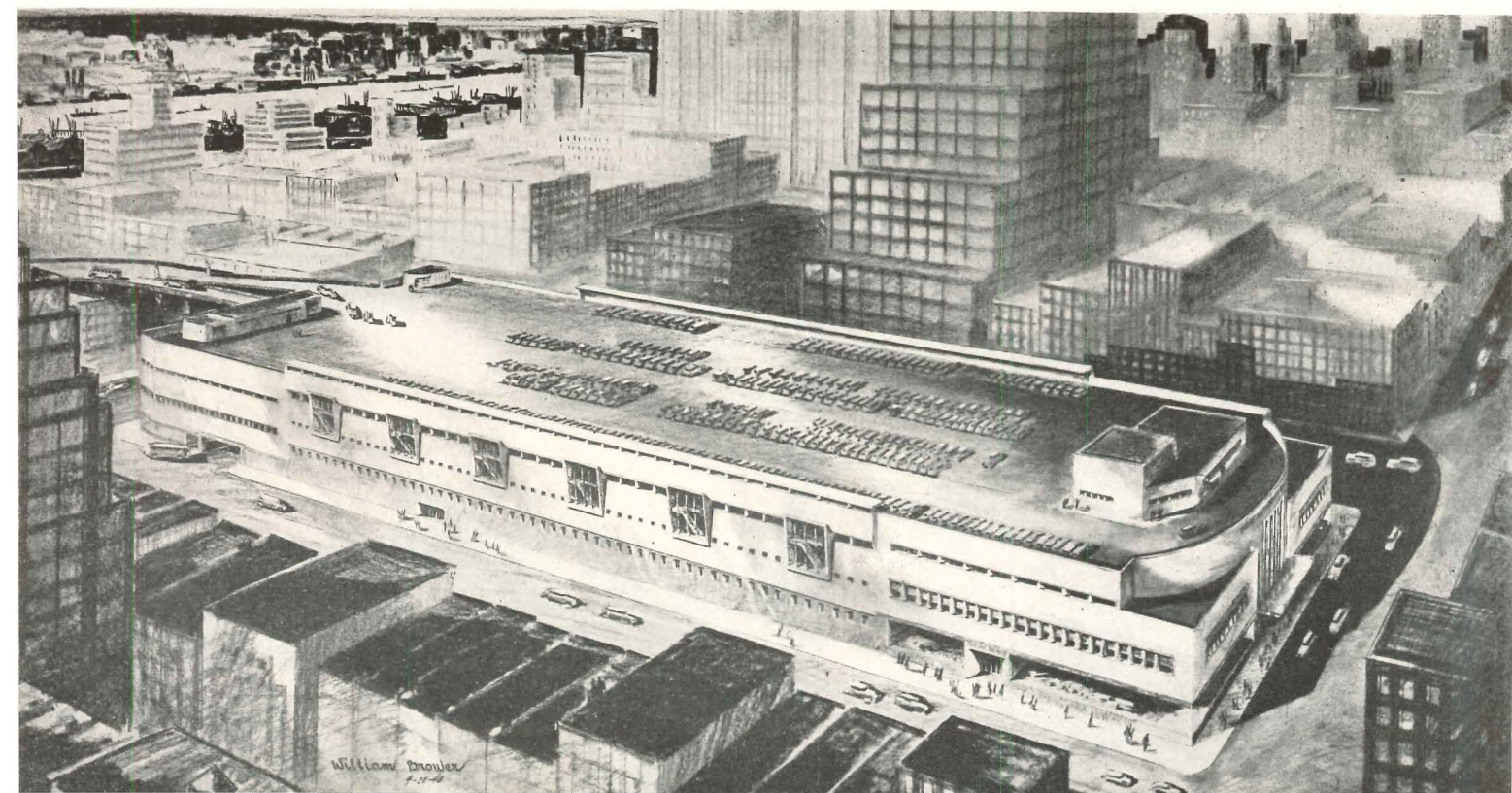



The Terminal site in October, 1948, during demolition proceedings

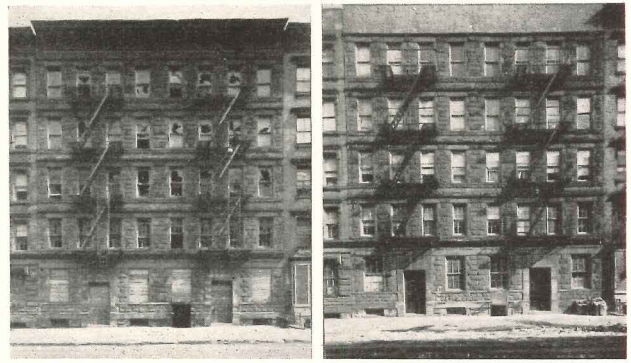

Relocation of the 600 residential tenants on the Terminal site proved so difficult that the Port Authority (after special enabling legislation by both New York and New Jersey) acquired several vacant buildings in Manhattan, and turned them into well-equipped apartments for 225 families. The Authority must dispose of these buildings by 1951

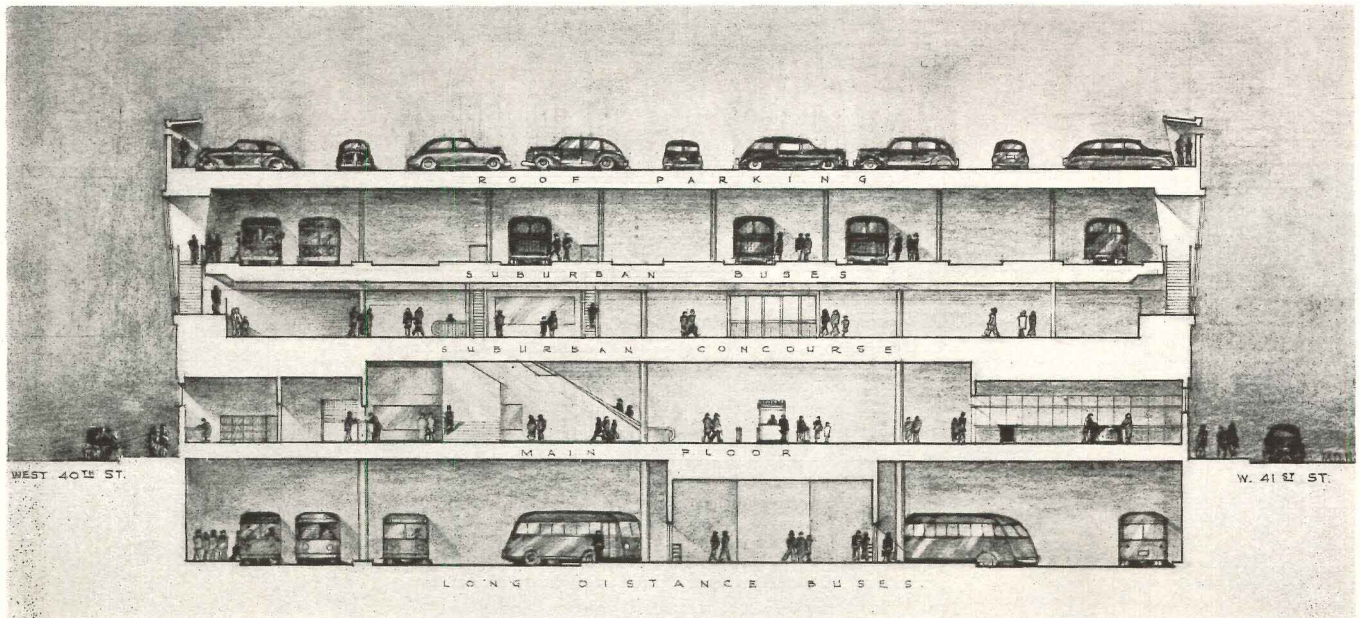

Long-distance passengers will reach their buses at the basement level directly from the main concourse. Suburban passengers will have their own concourse above, will load on the upper level. Right: the Eighth Avenue, or main elevation

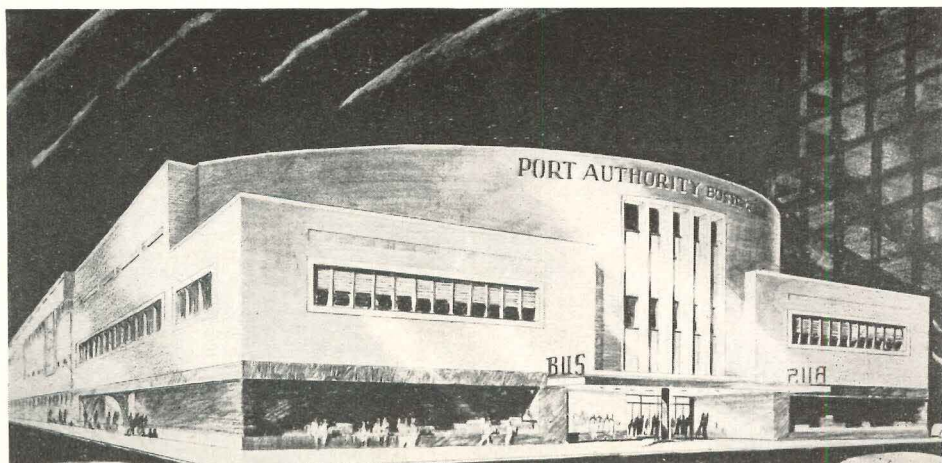

The impressive ramp shown below winds its way between New Jersey's high Palisades and the Lincoln Tunnel (entrance in center of photo), which connects midtown Manhattan with Weehawken, N. J., and links Manhattan with the main cross-country and north-south arteries. Right: the north tube of the dual-tube, four-lane tunnel, and a closer view of the New Jersey entrance

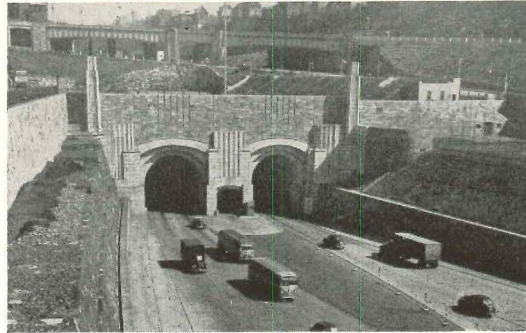

APPROACHES TO TUNNELS AND BRIDGES





ONE of the Port Authority's chief concerns in the operation of the two tunnels and four bridges now under its care is the provision of adequate approaches to handle a volume of traffic which in 1948 totaled 47,041,975 vehicles. The Authority already has spent \$63 million on such approaches, and has another \$10 million worth under construction. In addition, the agency is cooperating closely with the various highway

authorities in order to integrate its crossings with the through parkway systems.

The Authority's present six crossings are: the Holland and Lincoln Tunnels under the Hudson River; the George Washington Bridge spanning the Hudson; the Outerbridge Crossing, and the Bayonne and Goethals Bridges connecting New Jersey and Staten Island (see map, page 84). All are inter-state.

Top of page: the George Washington Bridge (foreground) will be connected directly with the main roads to New England when the second of the two tunnels indicated by the superimposed lines has been completed and the proposed cross-Bronx Expressway has been built. Right: the new Holland Tunnel exit viaduct, Jersey City

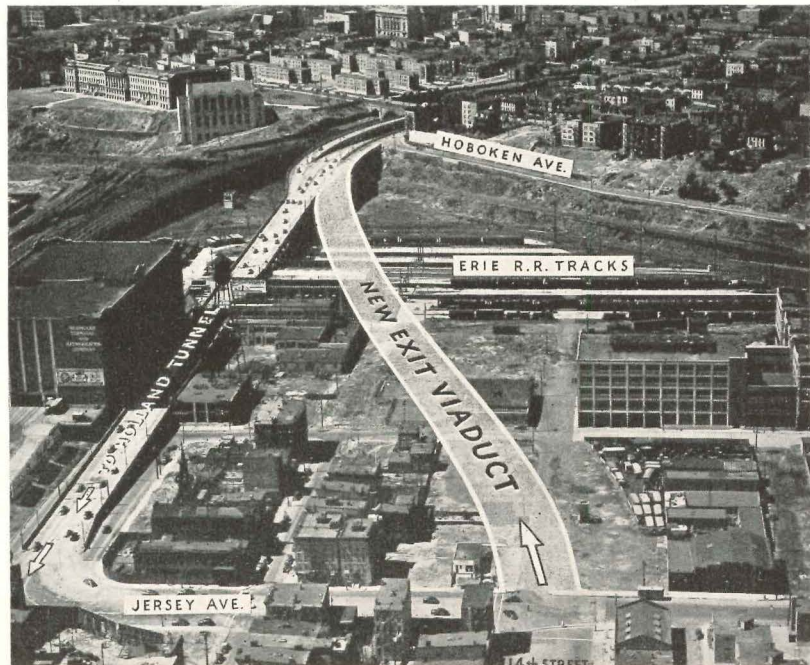

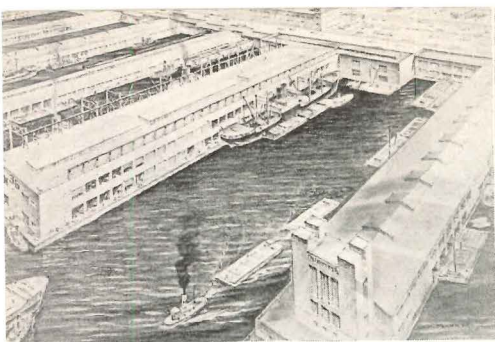

NEW PIER 36 (CARGO), HUDSON RIVER

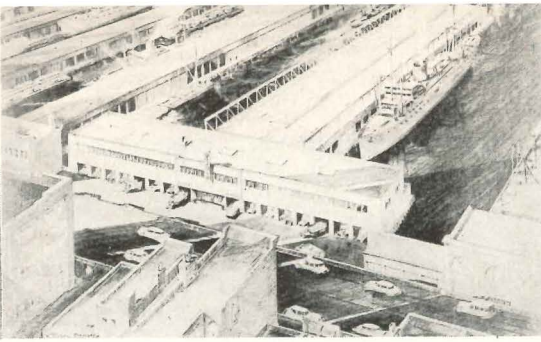

NEW PIER 40, HUDSON RIVER

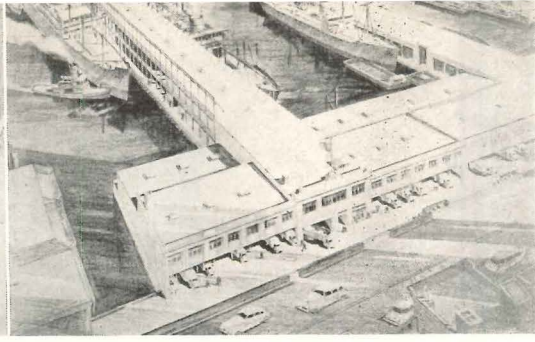

MODERNIZED PIER 45, HUDSON RIVER

PROPOSED NEW YORK HARBOR PIER DEVELOPMENT

In 1947 the Port Authority submitted to Mayor William O'Dwyer of New York, at his request, a detailed plan for the development of the city's waterfront. This plan was shelved a year later when the Board of Estimate voted to adopt instead a city-financed program proposed by the Department of Marine and Aviation. Last December, however, three months after the Board's vote, the Mayor requested the Port Authority to review its proposal and re-submit it. The revised proposal also, shown on these two pages, has been rejected by the city.

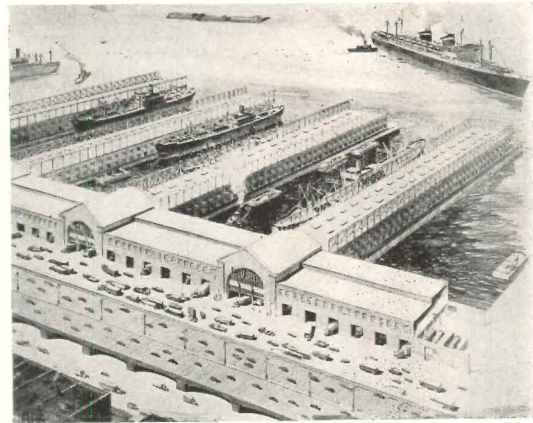

MODERNIZED PIERS 60 AND 61, HUDSON RIVER (PIERS 53, 54, 56, 58 SIMILAR)

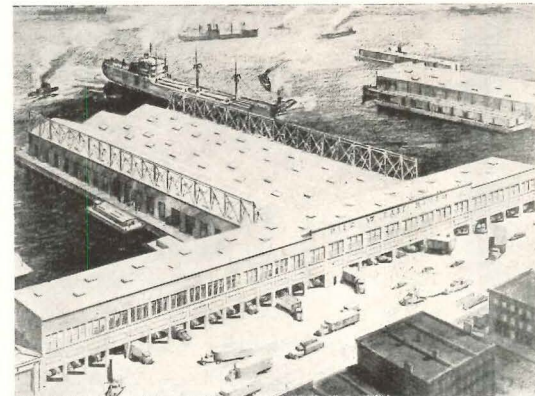

NEW PIER 37, EAST RIVER

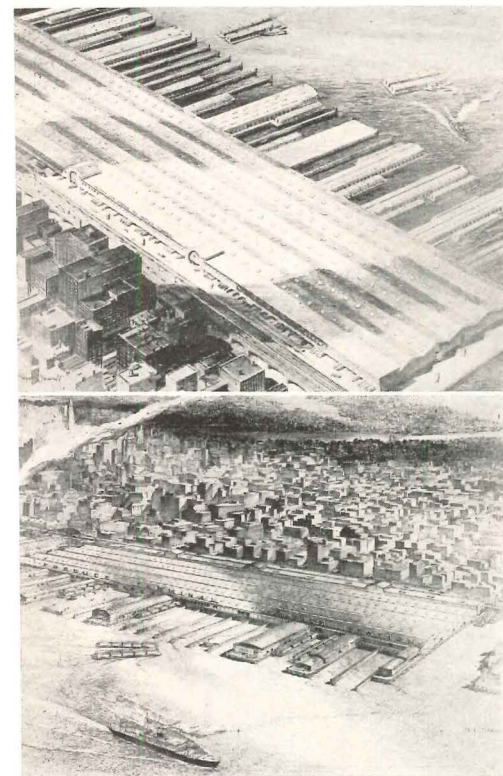

Above: two views of proposed Union Produce Terminal, extending from present Pier 22 to Pier 30, Hudson River. A Union Railway Carfloat Station would adjoin the Terminal at its southern end (right in lower photo)

THE Port Authority's proposal covers the financing, constructing, rehabilitating and operating of city-owned piers and other waterfront facilities. It hinges in large part on the relief of present waterfront congestion by providing off-street parking for trucks. It would increase the number of Class A shedded berths from 129 to 136, and would build a Union Produce Terminal and four carfloat railway stations, three of the latter on the Hudson River and one on the East River.

The accompanying sketches show a few of the highlights of the Port Authority's plan, including the proposals made for the New Jersey waterfront at the request of Governor Alfred E. Driscoll.



PRESENT PIER 50, HUDSON RIVER



PRESENT PIER 51, HUDSON RIVER



PRESENT PIER 58, HUDSON RIVER

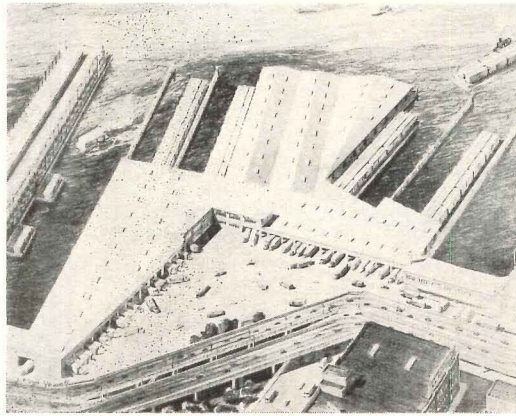

PROPOSED UNION RAILROAD CARFLOAT STATIONS AT 23RD AND 33RD STREETS, HUDSON RIVER

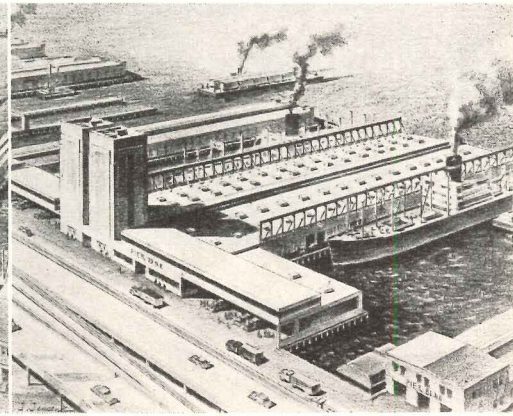
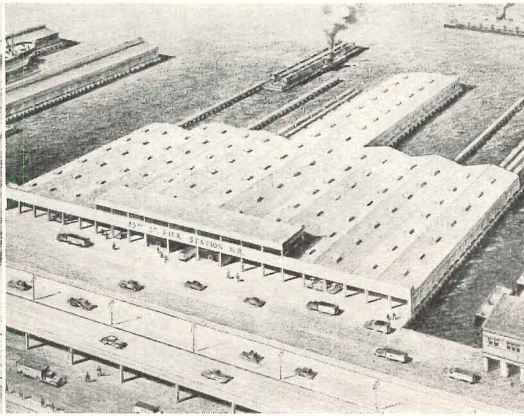

NEW PIER 79, HUDSON RIVER

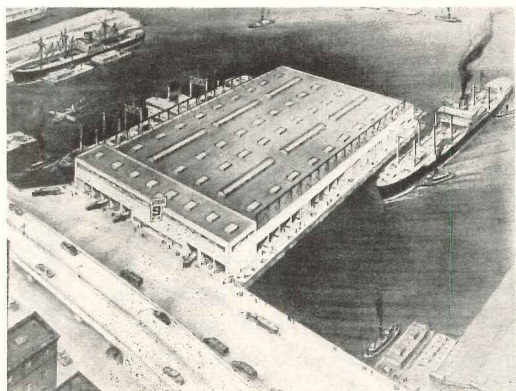

NEW PIER 9, EAST RIVER (LEFT) AND PROPOSED UNION RAILROAD CARFLOAT STATION, EAST RIVER

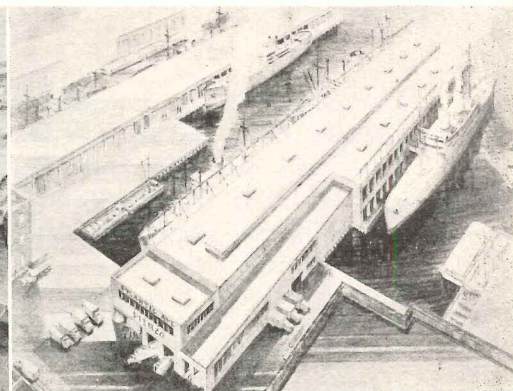
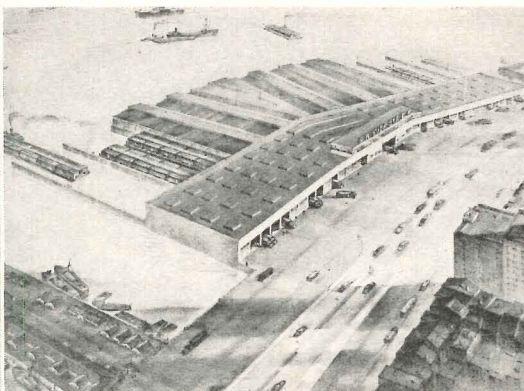

NEW PIER, ATLANTIC AVE., BROOKLYN

NEW JERSEY PIERS

Upper left: two proposed new piers for Jersey City. Upper right: the site proposed for immediate development, Jersey City. Lower left: Jersey waterfront, looking up Hudson River; Jersey City in foreground, the site proposed for the new marine terminal. Lower right: a proposed long-range six-pier development for Jersey City, incorporating the two piers shown above

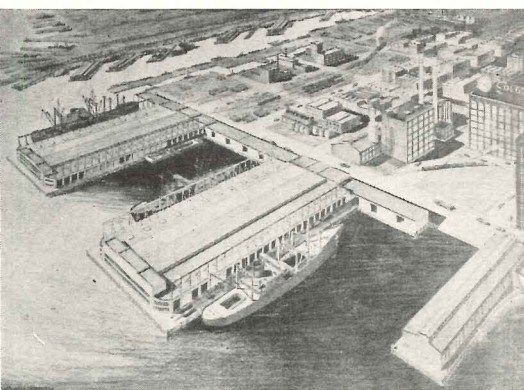



TRUCK AND GRAIN TERMINALS

To accommodate the thousands of tons of freight and produce which pass through the New York area by truck daily, the Port Authority currently has under construction two Union Motor Truck Terminals, one in Manhattan (above), the other in Newark, N. J. (opposite). The two — said to be the world's largest — will be much alike in plan, featuring off-street bays for the trucks, long freight platforms, and roof parking for complete tractor-trailer units. Both will be readily accessible to main truck routes.

The Port Authority Grain Terminal on Gowanus Bay, Brooklyn (below) was transferred to the Port Authority by the State of New York in 1944. Since then it has been completely rehabilitated, and augmented by a new grain pier and gallery, opened for use in January, 1948. The new gallery is located on the pier, permitting the loading of grain direct from the elevator to the ships. It is equipped with an electric thermometer system in the storage bins. In 1948 the Terminal handled 3,732,000 bushels.

Below, left: loading grain at the Port Authority's new pier at the Gowanus Bay Grain Terminal. Below, right: air view of the Terminal

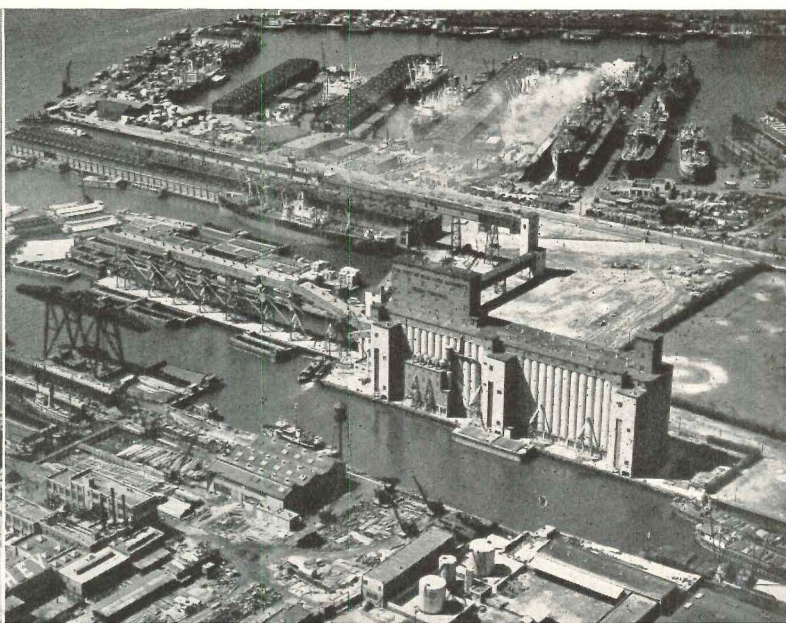
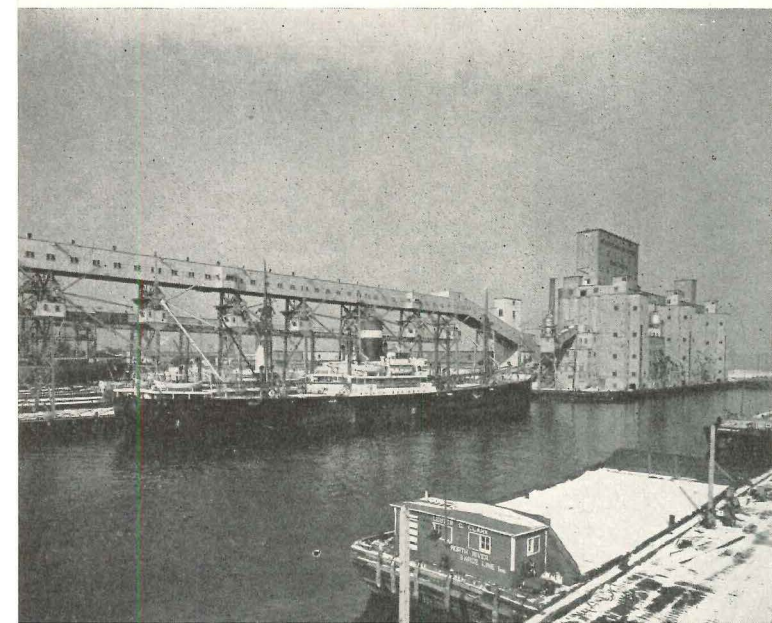

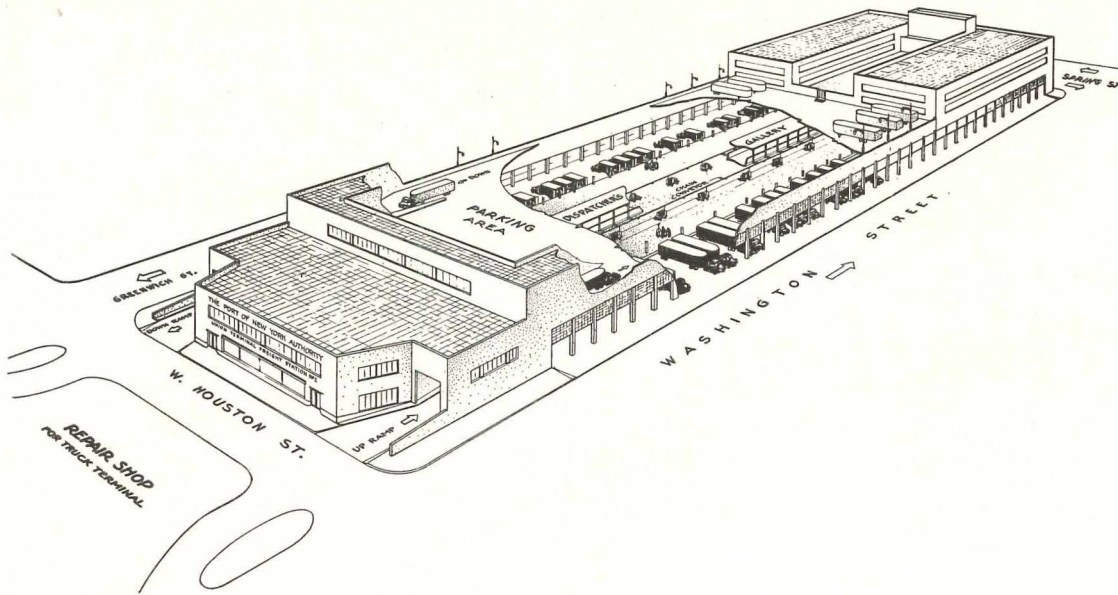

The Manhattan truck terminal (above) will be 1000 ft. long, 160 ft. wide, with off-street bays for 144 trucks. It will be able to handle over 2000 tons of freight a day

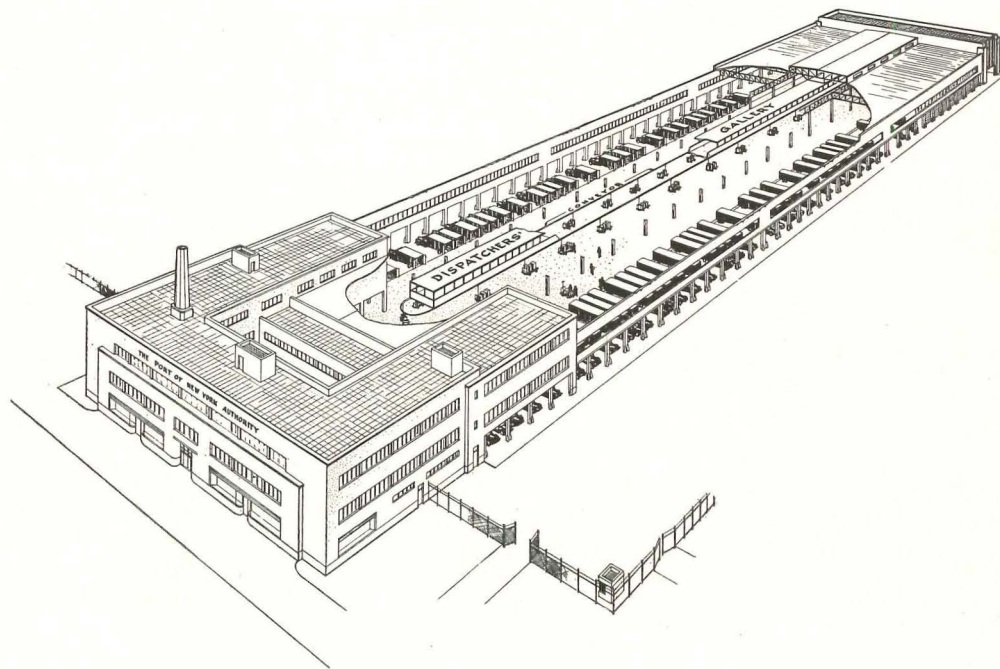

The Newark truck terminal (right and center) will be 1158 ft. long, 200 ft. wide, with off-street bays for 160 trucks. Its island freight platform will be 1000 by 100 ft. in size, equipped with an overhead chain conveyor serving both sides. Daily freight capacity, 2500 tons

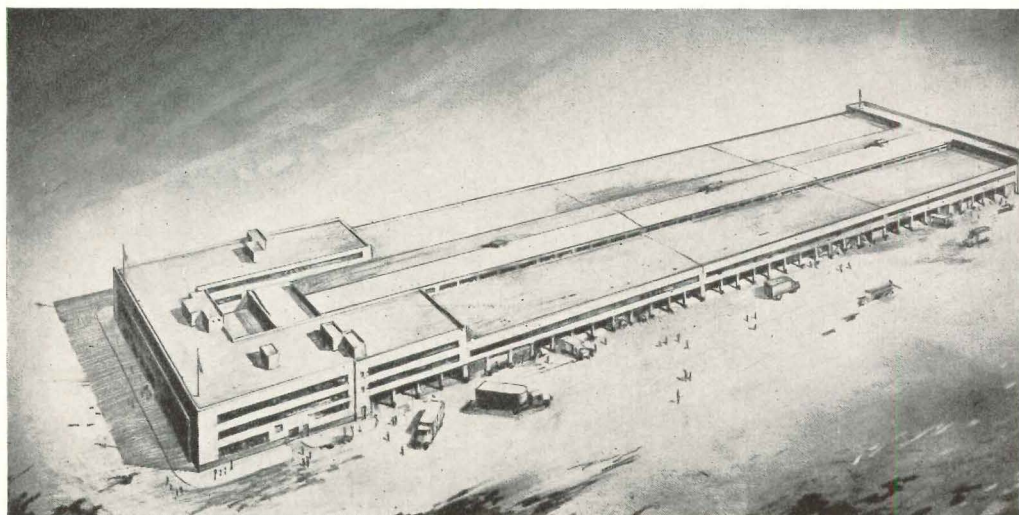



1



2



3



MEMENTOS OF MEXICAN

from the Post-Convention Tour

1. Hotel del Prado, Mexico City, the comfortable, modern headquarters of the peregrinating professionals

2. The architectural sightseers are briefed on historical backgrounds before entering the Cathedral, Mexico City

3. Boatloads of gay architects are taken for a ride on the placid waters at Xochimilco, the famous "floating gardens"

4. Looking over the tiled roofs to the parochial church at picturesque, colorful Taxco from the terrace of the Rancho Telva

5. The enriched facade of the church at Taxco glows golden-red in the light of the setting sun

6. The harbor of Acapulco, landlocked and surrounded by palms, hotels, and sandy beaches where swimming, sunning, fishing and relaxing are the order of the day

7. At the Colegio de Niñas in Mexico City, the peripatetic party is enlightened and amused by the erudite Professor Federico E. Mariscal

8. Diego Rivera's historical murals on the National Palace courtyard walls form the background for a group of admiring architects

9. Some of the party pause to pose on the stairs which are flanked by Rivera's monumental allegorical murals

10. After visiting the Toltec pyramids of Teotihuacan, the crowd feasted and fraternized with their Mexican hosts in the great cave



7



8

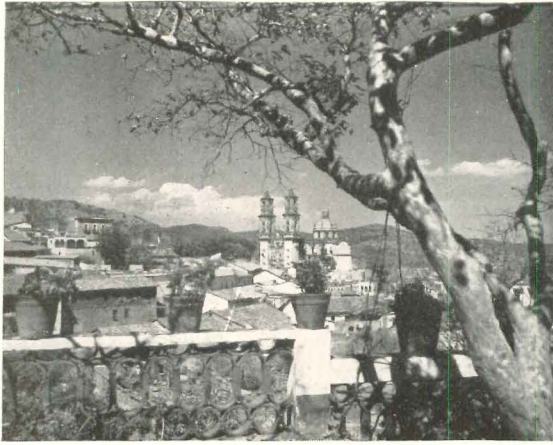

4



5



6



BEAUTY AND HOSPITALITY

of the American Institute of Architects, March 19-27, 1949

Bob Bailey Photos

1. El Hotel del Prado, Ciudad de Méjico, es el confortable y moderno cuartél general de los peregrinadores profesionales

2. Los observadores de arquitectura son brevemente orientados acerca del pasado histórico antes de entrar a la catedral, Ciudad de Méjico

3. Botes cargados de joyales arquitectos son paseados sobre las quietas aguas del Xochimilco, los famosos "jardines flotantes"

4. Mirando sobre los tejados a la Iglesia en el pintoresco y colorido Taxco desde la terraza de la Rancho Telva

5. La adornada fachada de la iglesia en Taxco resplandece a la luz del sol poniente

6. El puerto de Acapulco cercado de tierra y rodeado de palmas, hoteles y playas arenosas donde la natación, la pesca y el descanso son la orden del día

7. En el Colegio de Niñas en la Ciudad de Méjico, el grupo peripatético es instruido y a la vez divertido por el erudito Profesor Federico E. Mariscal

8. Los murales históricos de Diego Rivera sobre las paredes del patio en el Palacio Nacional sirven de fondo al grupo de arquitectos aficionados

9. Algunos del grupo se detienen para posar en las escaleras, las cuales están flanqueadas por los monumentales y alegóricos murales de Rivera

10. Despues de visitar los pirámides de Toltec en Teotihuacan los concurrentes festejaron y fraternizaron con sus huéspedes mejicanos en la grande cueva cercana

9



10



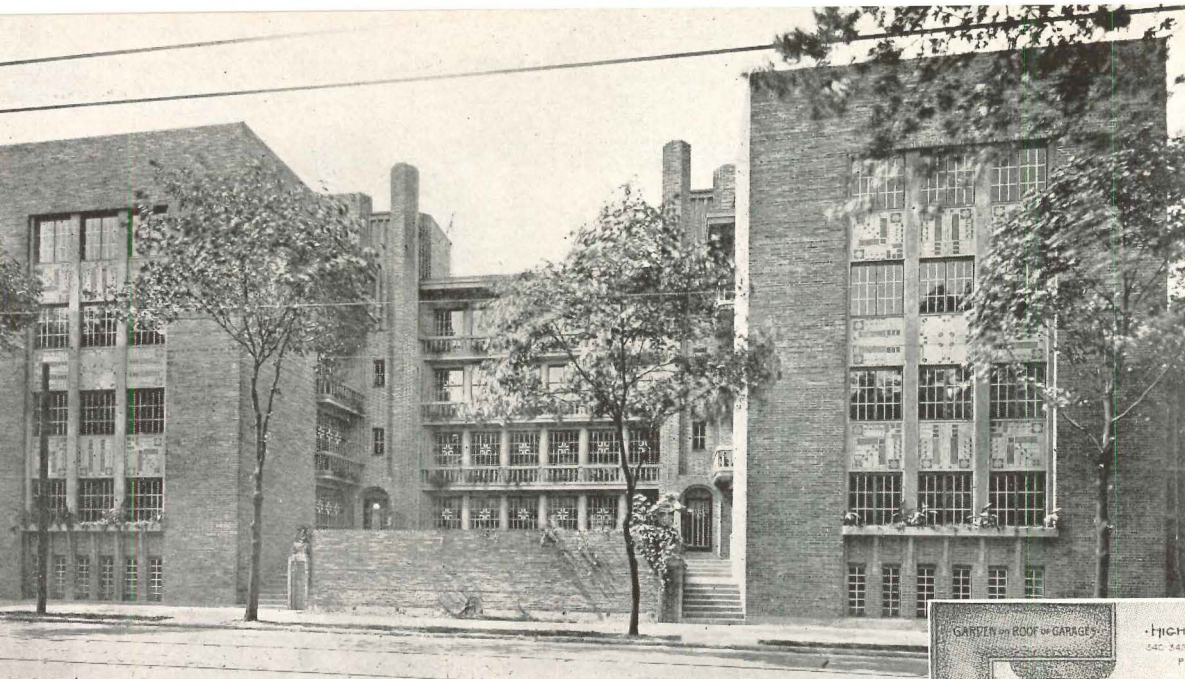

PITTSBURGH REDISCOVERS AN ARCHITECT PIONEER, FREDERICK SCHEIBLER

From a paper by John Knox Shear

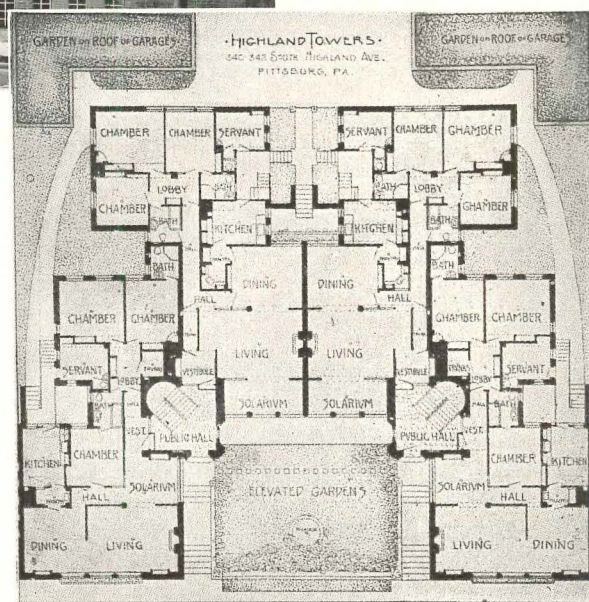

At a time when contemporary architecture is threatened with conventional thinking, which produces clichés instead of reasoned original work, it is refreshing to dig back among the early pioneers. There were a good many more of them than the choice few who have been so widely publicized. Frederick Scheibler of Pittsburgh, for example, had scarcely been heard of until an associate, Robert W. Schmertz, aroused the interest of John Knox Shear of the Carnegie Institute of Technology Department of Architecture and a report was written in *Charette*, Pittsburgh's Journal of Architecture.

"In 1888 Fred Scheibler, then 16 years old, left the old Pittsburgh High School, to go as an apprentice into the office of Henry Moser." There, for 10 years, he worked, asked questions, listened.

For 50 years since then Scheibler has produced "group cottages" (his most frequent assignment) and apartment houses, individual homes, and other works of architecture, all in a manner broad and original and still full of interest today.

The "Old Heidelberg Apartments" built before 1900 carried the naturalistic ornament of the architect's early "half-and-half" period. He had the usual battles with contractors and workmen to get the new ornament executed. Once he had to tell the builder he "had found a man" who could do for \$100 a detail in concrete that had been declared flatly "impossible," and when the offer was accepted he climbed the scaffold himself "and in two hours made a hundred dollars and did not even get his hands dirty."

The Highland Towers Apartments at 340 South Highland Avenue, as seen in accompanying photographs, are quite an astonishing creation for the year of 1913. Although the use of small panes and "art glass" in the windows, and the free "diaper" treatment of spandrels, is reminiscent of the early date, yet the detailing is remarkably contemporary, with frames pushed tight against the ceiling and the round columns, and the effect is of a pleasant enrichment to an orderly, and strongly plastic, structure.

Back in 1913 Scheibler was already using balconies as aids to open planning, and achieving smart detailing plus vitality of texture that has renewed interest today. Highland Towers, 340 S. Highland Ave.

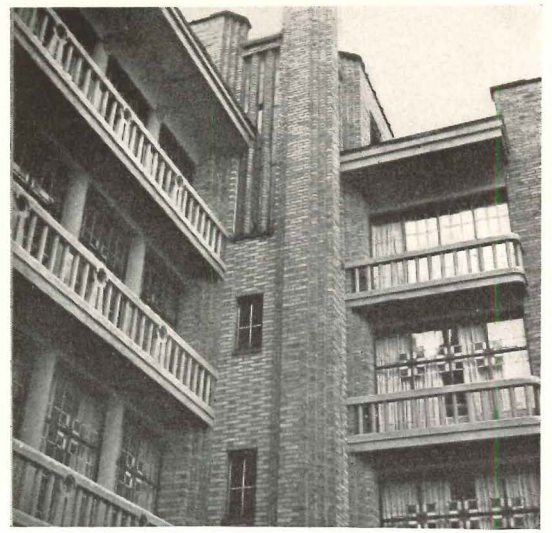
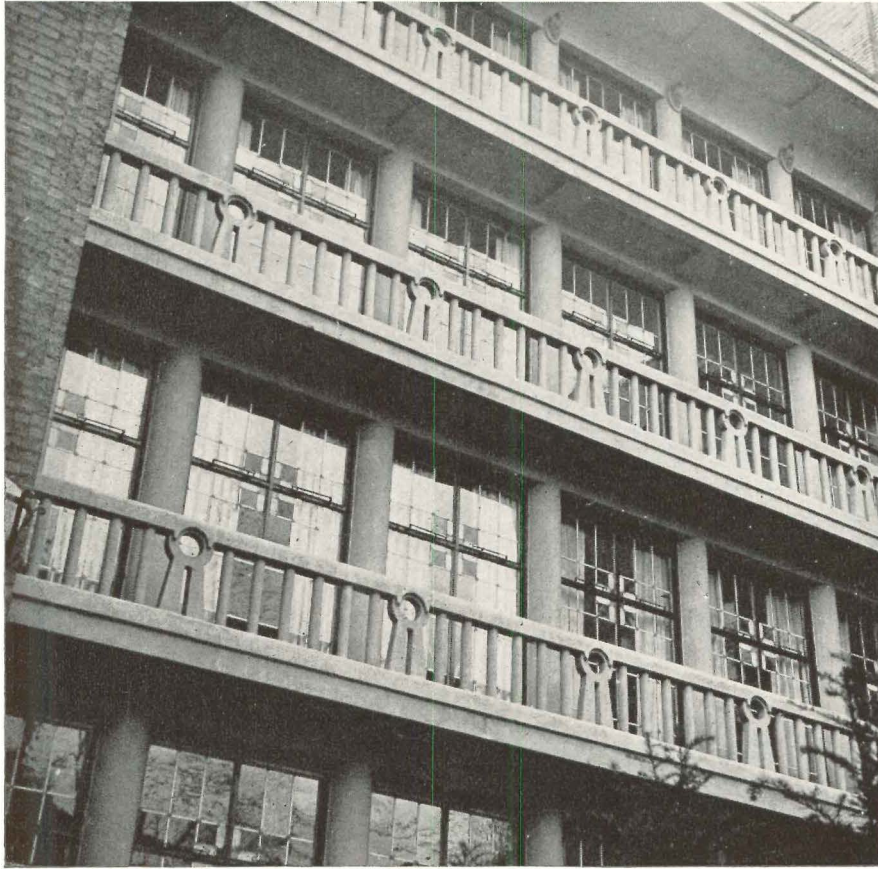

The whole is more convincing today than many an "advanced" building of the intervening years.

Among Scheibler's many group housing schemes before the first World War, the only one shown here is the Vilsack row, erected in 1912, a date which, in the words of Mr. Shear, "is difficult to believe." Not only is it true, as he says, that "the alternation of blank wall and great glass areas, the simple slab-form roofs, the slight canopy supports, and the clean lines of the well proportioned shapes are far in advance of their time," but also it is true that they escape their time altogether as good architecture regardless of date. Such treatment would come as a fresh innovation again today. And the plans, too, carry today's articulation.

Scheibler more often produced work like the "Hamilton Cottages" of the same date, on Beacon Street, in the East End, of more conventional general type but unmistakable distinction. "Red brick, casement windows, low eaves ramble expressively and efficiently through their environment of trees and grass and shrubs,"

writes Shear. ". . . In their scale, warmth, and expression of comfortable habitation they are rivalled perhaps only by the Chatham Village group of much later date and greater cost."

"'Meadowcots,' another group on King Street, each unit modified by site and building budget and hence varying in appearance and quality, are consistent in simplicity, good scale, and honest use of materials . . . and likely to be long remembered. . . ."

Scheibler, like Frank Lloyd Wright, was influenced by the Japanese — through direct association with Kantero Kato, son of the then Postmaster-General of Japan and a theatrical designer of great ability. In consequence, and with Kato's collaboration, Scheibler always "took charge of all the visual aspects of his work. Sculpture, color, flat decoration, and landscaping are an integral part of his buildings and to him perhaps their most fascinating challenge." Especially noteworthy was the "delicacy of his gardens."

Occasionally Scheibler's naturalism created results

Among numerous "group cottages" this "Vilsack row" on Jancey Street in the East End (cheaply built and now deteriorated) shows perhaps the most daring and satisfactory innovation. Other such groups, less striking, are fine "in scale, warmth, and expression of comfortable habitation"

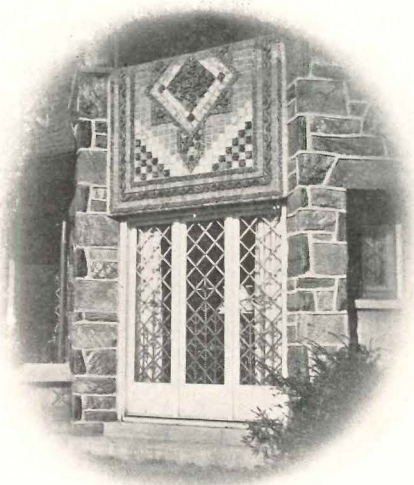
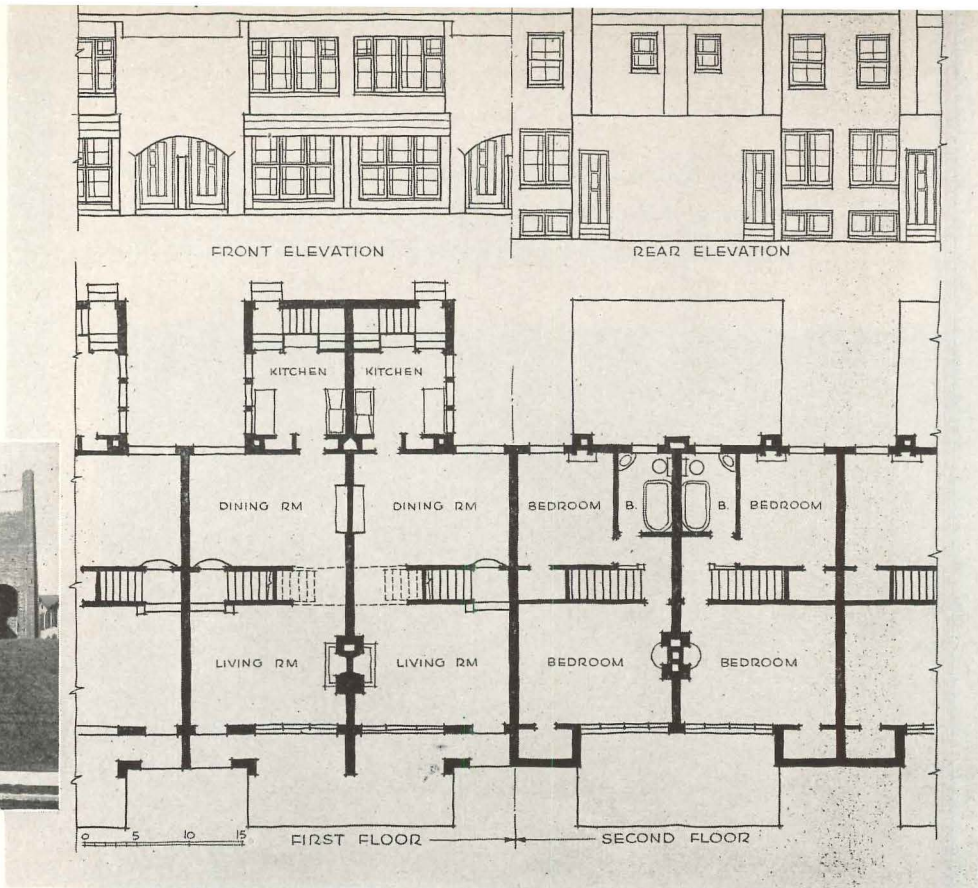
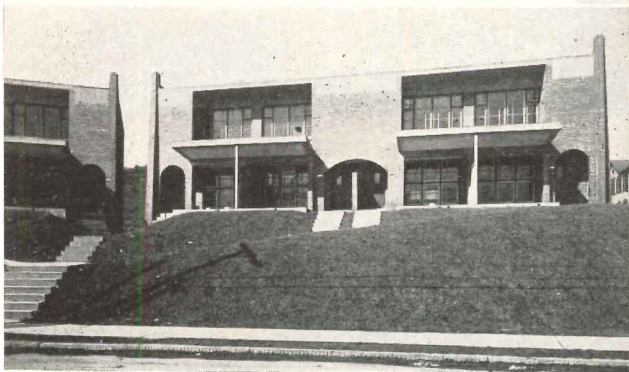

which now look amusing, like the tile "rugs" draped over the balconies of the "Parkstone" duplex on Penn Avenue (illustration at left). At least, unlike some later fantasies on the part of others, they have been harmless.

Fred Scheibler, now nearly blind, living in a small cottage with his charming wife, is building no more. His only regret is said to be "that I didn't take on a young man who could keep these things going."

The "Parkstone Duplex" on Penn Avenue, built 1919, expresses the times, and the naturalism of the tile "rugs" is today amusing; yet the house shows the architect's strong hand

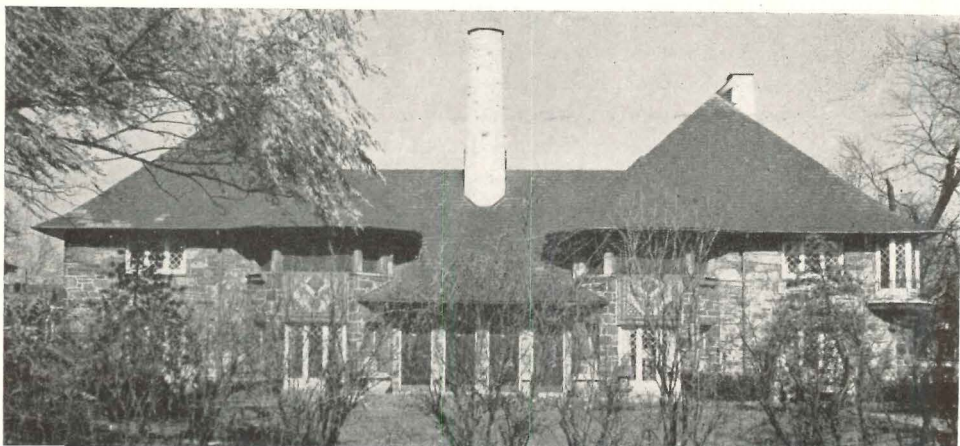
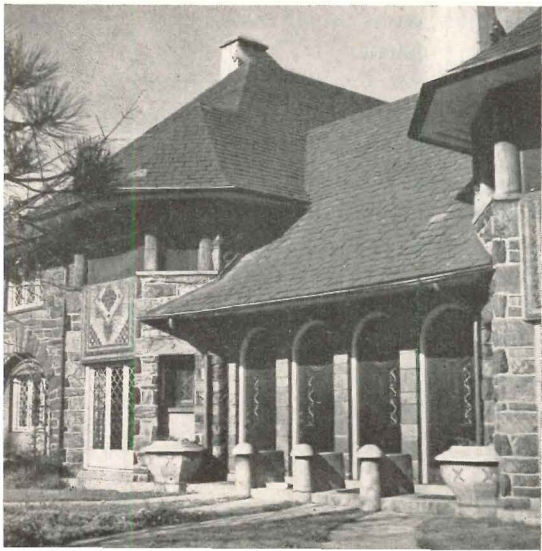



BUDGET HOUSE NEAR PITTSBURGH

Residence of Mr. and Mrs. Robert Kirkpatrick, Bradfordwoods, Pa.

Mitchell & Ritchey, Architects

Newman-Schmidt Studios

A TIGHT budget and an urgent housing problem were prime factors in the design of this small Pennsylvania house. The owner, an Army pilot during the war, had just been released from service when he contacted the architects; his wife and two children were living separately with relatives, and the family could not be united until the house was finished. For this reason, in view of the limited budget, the house was designed for two-phase construction, with one bedroom to be built immediately and the other two to be added later. Bunks were added temporarily in the utility area to take care of the children in the interim.

Native stone was used for the rubblestone walls. The fir siding is in natural finish.





Single plate glass was used in the living areas, with the details developed so as to provide for future double glazing if desired, but the radiant heating has proved very satisfactory with the single glass even in the coldest weather. Interior walls are stone and birch plywood; floors are concrete and flagstone; ceilings are plywood, painted a chartreuse yellow; trim is ivory white

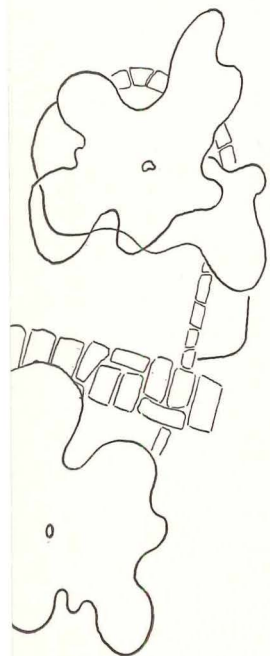
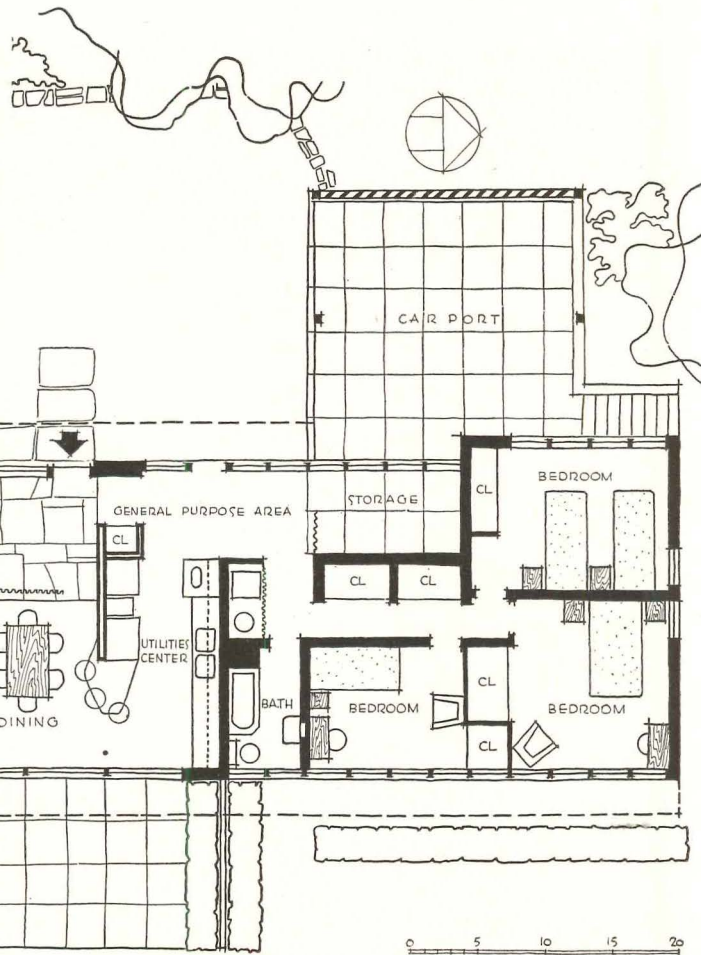

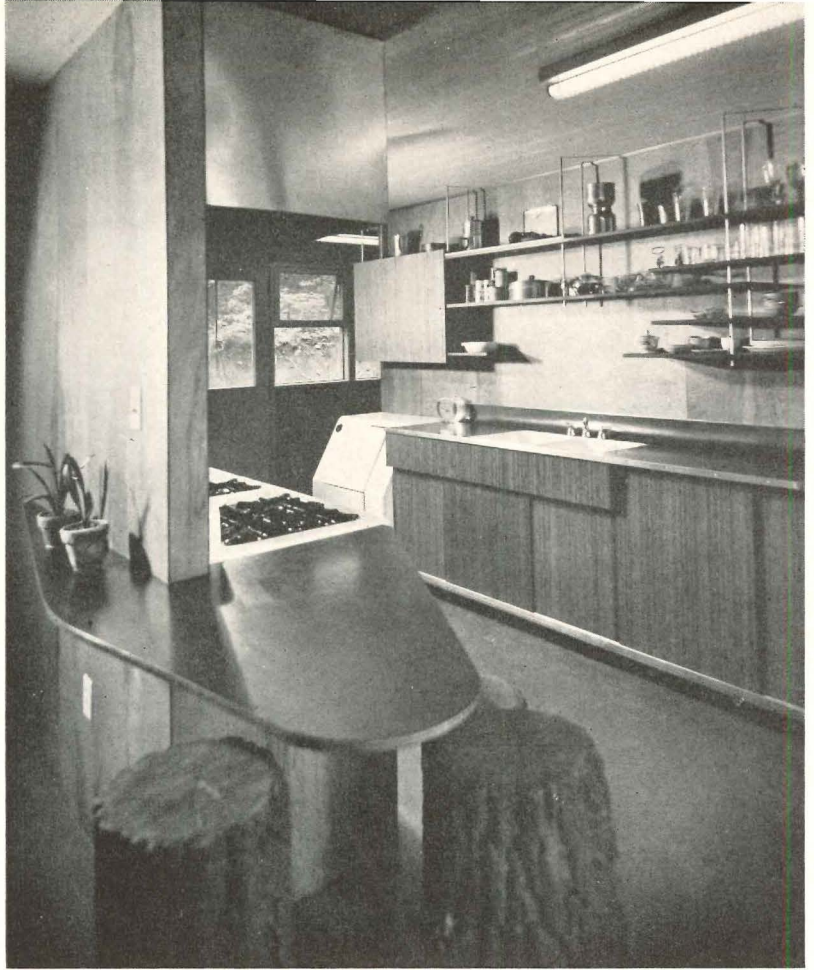

The only special requirements laid down by the owner were a small breakfast bar opening from the kitchen (right) and a general purpose and play area off the kitchen where the children can play under supervision (upper photo, opposite page)

Newman-Schmidt Studios



NATION'S BUILDERS

ONE sure topic of conversation and speculation in the building field is "Where are costs going — and how far?" Because builders and contractors are dealing with costs, labor and materials every day, F. W. Dodge Corporation conducted a "grass roots" survey * by mail among the nation's builders to get their answers to that and other pertinent related questions.

Adjustments which have taken place in the building industry since the peaks in dollar volume and costs were reached last year are reflected in the results given here. As might be expected, the picture differs slightly from one region to another, but in general builders reported that:

1. *Costs of single-family houses and large-type buildings declined about 5 per cent between May 1 of last year and May 1 of this year. Costs continue their downward trend, and most builders expect them to decline until next November to a point 8 per cent below the May level.*

2. *Materials, one is led to believe on the basis of the builders' reports, are by no means entirely out of the tight supply category. While about three out of ten builders report adequate supplies of all materials and equipment, the remaining 70 per cent are still hampered in their operations by short supplies of one or more of the metal or metal product items, or one or more of the masonry materials, or one or more of the lumber and millwork items. About 25 per cent of the builders report that no materials continue at peak price levels or continue to rise, but the remaining 75 per cent find one or more of the masonry items, or one or more of the metals or metal products, or lumber and millwork items still at the peak price level or going higher.*

3. *Labor productivity of on-site workers has improved by 10 per cent in the past year, in the judgment of a large majority of builders, and most of them expect further improvement in the productivity of both skilled and unskilled workers during the remainder of the year.*

4. *Lump-sum contract letting has returned as general practice to replace the preponderant war and immediate postwar period practice of cost plus fixed fee contracts. Seventy-two per cent of the builders reported that three quarters or more of their current work is being done under lump-sum contracts.*

The questions asked, summaries of opinions, and important regional variations follow:

1. In the area of your operations, are building costs higher or lower than they were twelve months ago?

(a) Single-family houses

Analysis: 74.80 per cent of those answering the question re-

ported costs *lower*. The median percentage decline, including those answering *higher*, *lower* and *same*, was 5 per cent. The extremes were reported by the Mountain States where 46.14 reported costs *lower* with the median there showing no change, and the Pacific States where 81.40 of those answering reported costs *lower* with the median decline reported as 10 per cent.

(b) Large-type buildings

Analysis: 77.28 per cent of those answering the question reported costs *lower*. The median percentage decline, including those answering *higher*, *lower* and *same*, was 5 per cent. The extremes were reported by the Mountain States where only 49.5 per cent reported costs *lower*, with the median indicating a decline of 3 per cent, and the South Atlantic States where 94.60 per cent reported costs *lower* with the median for all answering being a decline of 8 per cent.

2. If the current trend is downward in your area, how long (in months) do you expect the downward trend to continue?

Analysis: 73 per cent of those returning the questionnaire answered *downward*, the remainder giving no answer. The median expectancy of length of the downward movement was six months. The most extreme regional variation was reported in the South Atlantic States where 87.93 per cent of those returning the questionnaire answered *downward*, with the median duration being six months.

3. If the current trend is downward, how far do you expect it to go (in percentage below present costs)?

Analysis: 69 per cent of those returning the questionnaire answered *downward*, 9.27 per cent answered *stable* and 21.94 per cent did not answer the question. Of those answering, 88.11 replied *downward* and 11.88 per cent replied *stable*. The median downward cost trend was estimated at 8 per cent, including the figures from the *downward* and *stable* answers. Several areas reported a downward cost drop expectancy of 10 per cent, namely, New England, East North Central, West North Central, South Atlantic, West South Central, and Pacific Coast States. The Middle Atlantic, East South Central and Mountain States estimated the decline expectancy at 5 to 6 per cent.

4. Do either of the following factors affect costs in any significant way at the present time?

(a) Excessive time required in shopping for and obtaining materials

Analysis: 82.86 per cent reported *no* and 17.13 per cent reported *yes*. In no region was the percentage of *yes* answers more than 27.50.

(b) Irregular deliveries of materials

Analysis: 68 per cent reported *no* and 32 per cent reported *yes*. However, more than 55 per cent reported *yes* to the question in the West North Central States. In the Pacific Coast States 77 per cent considered irregular deliveries of materials a factor affecting costs.

REPORT ON COSTS AND MATERIALS

5. What materials, if any, are still tight in your markets?

Analysis: 28.18 per cent answering the question reported *none*. However, one or more metals and metal products were indicated in short supply by 61.51 per cent of those answering, 20.09 per cent mentioned one or more masonry materials, and 13.72 per cent listed lumber and millwork. Many reported shortages in the three generic classifications. Metals and metal products were reported in especially tight supply in the Mountain States.

6. What materials continue at peak price levels or continue to rise?

Analysis: 24.75 per cent of those answering the question reported *none*. However, 66.17 per cent mentioned one or more masonry materials, 60.78 mentioned one or more metals or metal products, and 14.21 listed lumber and millwork. The materials price picture was somewhat uniform in all regions except in the Mountain States where it appeared more intense.

7. Has the productivity per man hour of on-site workers improved this year as compared with 1948? (Answer in percentage of improvement, if the answer is yes.)

Analysis: 84.18 of those answering the question answered *yes*, and 15.81 per cent answered *no*. Only 2.7 per cent of the respondents failed to answer the question. The median percentage of improvement in the year was 10. Those regions reporting less than 10 per cent improvement were New England, 5; Middle Atlantic States, 5; East South Central, 7.5; Mountain States, 5. No regions reported more than 10 per cent improvement.

8. With regard to the remainder of 1949, do you expect increased output per man hour?

(a) Skilled building craftsmen

Analysis: 67.05 per cent of those answering said *yes* and 32.95 per cent said *no*. There were no exceptional regional differences of opinion. In each area more than half of the respondents expected the improvement to continue.

(b) Unskilled labor

Analysis: 67.28 per cent of the respondents said *yes* and 32.71 per cent said *no*. In all areas excepting the Mountain States a majority answered *yes*. In this region 55.5 per cent said *no*.

9. Is overtime pay a significant cost item in your current operations?

Analysis: 89 per cent of the respondents said *no*, and 11 per cent answered *yes*. Only in the West North Central region did overtime pay figure rather prominently. Here 35 per cent listed it as a significant item in costs.

10. What percentage of your current dollar volume of work is being done on a lump-sum contract basis?

Analysis: 24.01 per cent reported that all of their work was being done on a lump-sum contract basis; 26.55 per cent reported 90 to 99 per cent on a firm bid basis; 21.01 per cent reported 75 to 89 per cent on lump-sum basis; and 28.40 per cent reported less than three quarters of their current work on lump-sum contracts. There did not appear to be inordinate regional differences in contract letting practices.

* MECHANICS OF THE SURVEY

The builders' opinion survey was directed by mailed questionnaire to 2500 builders of whom about 30 per cent answered. Every effort was made to obtain a true reflection of opinion within a given region.

The returns were separated by regions, and a check made through F. W. Dodge Corporation facilities on the dollar volume of work done last year by the respondents.

In order that the returns from no region outweigh another quantitatively, a quota of responses for each region was set up on the basis of percentage of the national volume of construction work undertaken in the area last year. This procedure also eliminated a possible distortion of the national picture brought about by unusual regional differences.

The replies in the tabulations were selected on the basis of individual company volume performed in 1948. Where a selection had to be made within a region, the larger-volume builders only were included in the group from which responses were tabulated.

The regions, and the percentage of national construction volume performed in 1948, are as follows:

New England—Maine, New Hampshire, Vermont, Massachusetts, Rhode Island, Connecticut—4.95 per cent.

Middle Atlantic—New York, New Jersey, Pennsylvania—15.97 per cent.

East North Central—Ohio, Indiana, Illinois, Michigan, Wisconsin—19.12 per cent.

West North Central—Minnesota, Iowa, Missouri, North Dakota, South Dakota, Nebraska, Kansas—8.95 per cent.

South Atlantic—Delaware, Maryland, District of Columbia, Virginia, West Virginia, North Carolina, Georgia, Florida—13.16 per cent.

East South Central—Kentucky, Tennessee, Alabama, Mississippi—4.71 per cent.

West South Central—Arkansas, Louisiana, Oklahoma, Texas—11.25 per cent.

Mountain—Montana, Idaho, Wyoming, Colorado, New Mexico, Arizona, Utah, Nevada—4.20 per cent.

Pacific—Washington, Oregon, California—17.69 per cent.

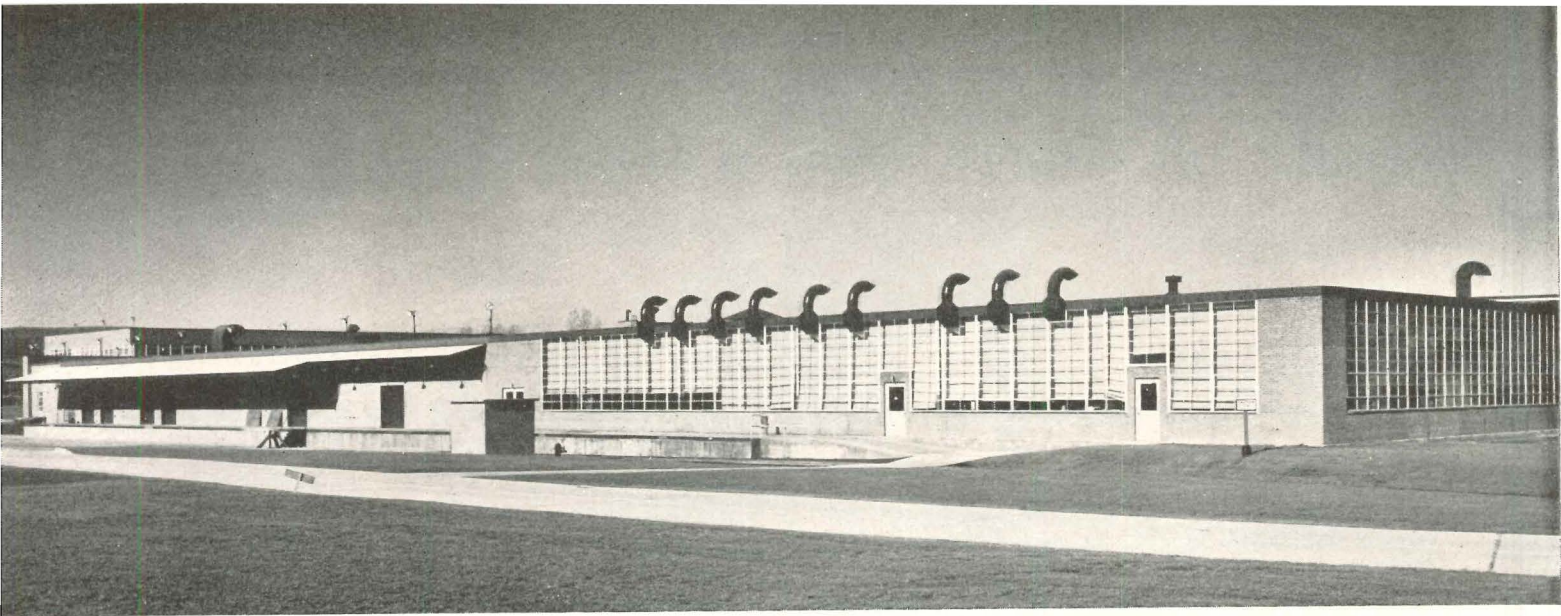

Gottscho-Schleisner Photos

ECONOMY AND EFFICIENCY IN SPALDING'S

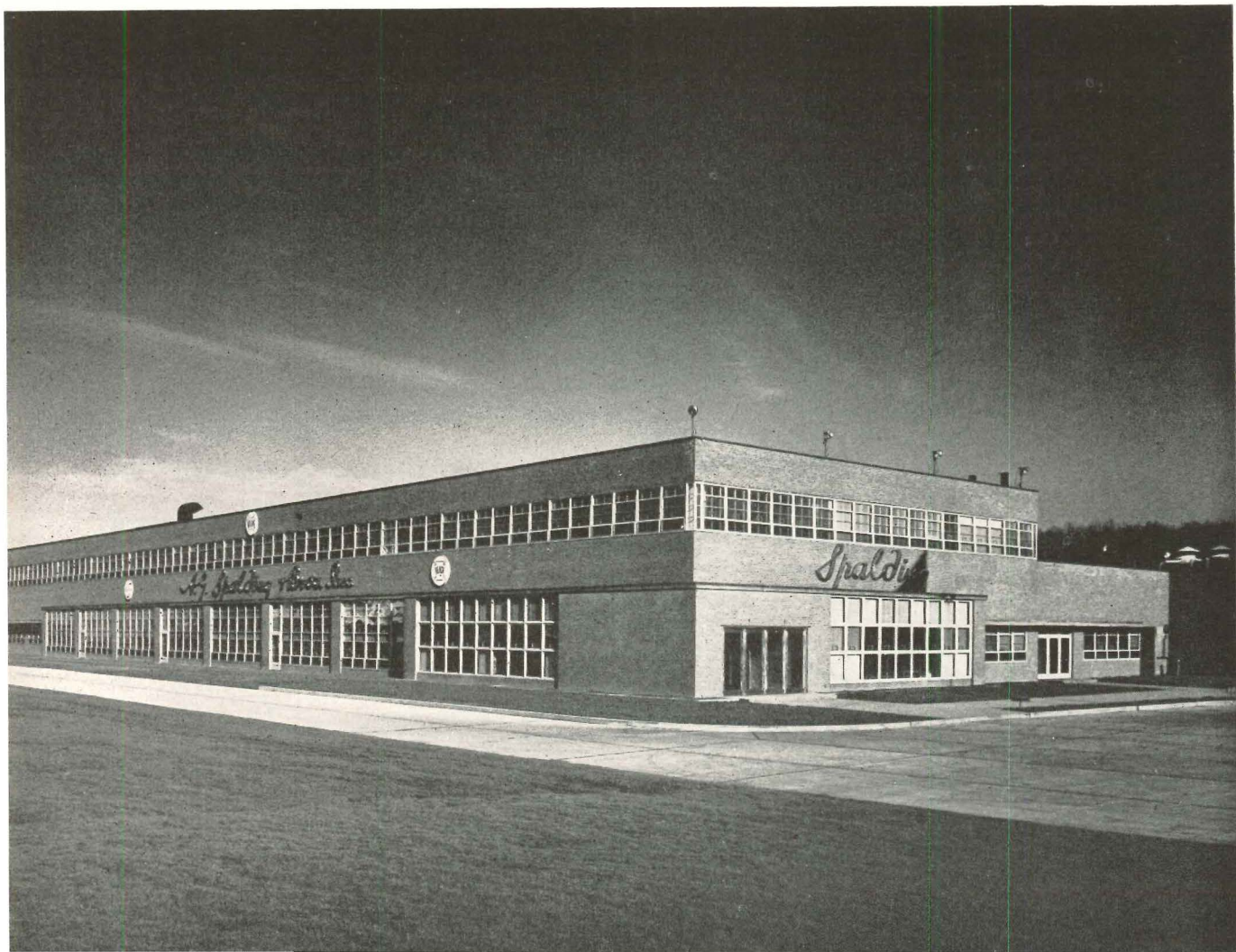

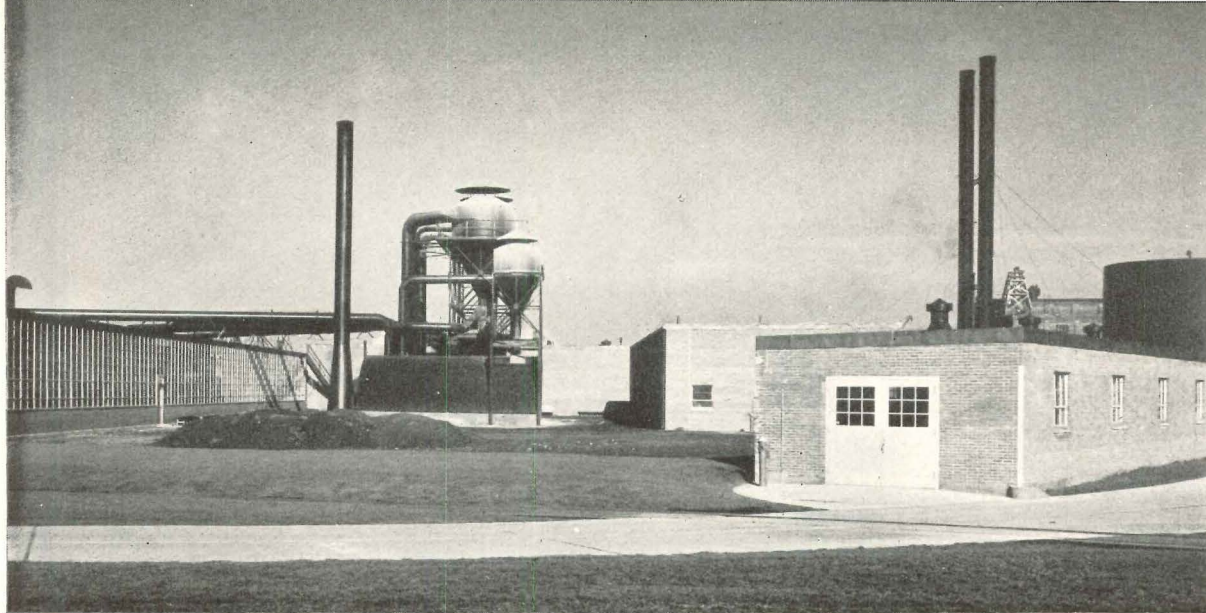

CONSOLIDATED PLANT AT WILLIMANSETT, MASS.

Lathrop Douglas, Architect

Guy B. Panero, Engineer

John B. Harris Associates, Builders

THE purpose of the new plant for A. G. Spalding & Bros., Inc., was two-fold: to consolidate Spalding's improved manufacturing operations at one plant site instead of the present four; and to provide additional warehousing space to accommodate seasonal inventories. The program took full cognizance of economy in design, operation and maintenance consistent with maximum functional efficiency and an enlightened employee and public relations policy.

The new manufacturing section, which contains 250,000 sq. ft. of floor space, is devoted to warehousing and to lumber processing for wood golf club heads and for tennis, squash and badminton rackets. The rackets are manufactured in their entirety in this new plant, which is the largest in the world devoted to this purpose. Lumber is loaded directly from box cars into steam-operated kilns, and it eventually leaves the building as completed tennis rackets.

The intervening process involves literally scores of

separate operations. From the standpoint of building design, two of the most interesting involve the wood-working and lacquering phases. In the woodworking department where sawing, sanding and drilling operations are conducted, a large sawdust collecting system has been installed. Dust is taken out of the air, removed to large hoppers in the rear of the plant and burned. In the lacquering section where the racket frames are sprayed, a special ventilating system has been designed to remove obnoxious fumes from the air.

For economy a standard bay — 25 by 25 ft. — was determined for the entire structure. A dead level roof was chosen also to reduce cost. The continuation of steel sash from the brick spandrel wall to the roof line not only reduced the presently high cost of the brickwork, but it also eliminated the necessity of erecting scaffolding, had brick been continued above the sash to the roof.

Wall and roof construction were completed in November 1948 just before winter set in. While masons were



erecting walls, unit heaters, supplied by steam from the owner's existing plant, were placed in their permanent positions. Consequently, interior craftsmen were able to work without auxiliary heaters or loss of time.

Just off the two story lobby is a model sporting goods store. Also in this section are the cafeteria, kitchen,

the employees' recreation room, the health center, as well as the executive offices and conference rooms.

A complete research laboratory is included for the chemical and physical testing of all products produced, as well as for the development of new products, new rubber compounds, plastics, new lacquers, new finishes.

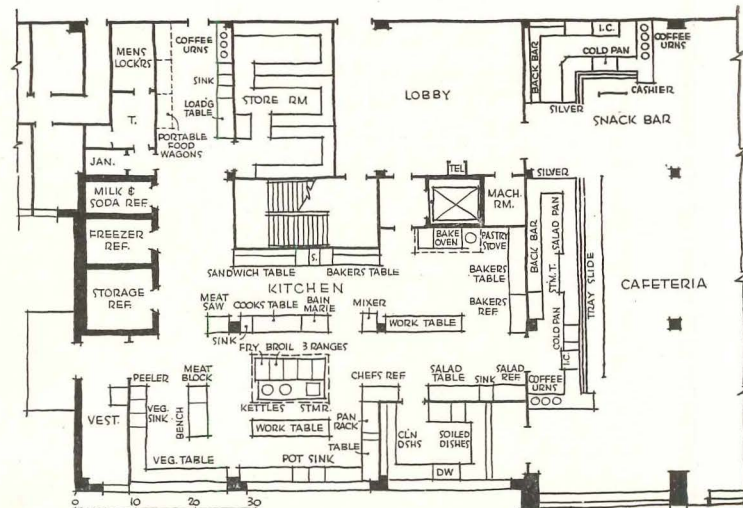

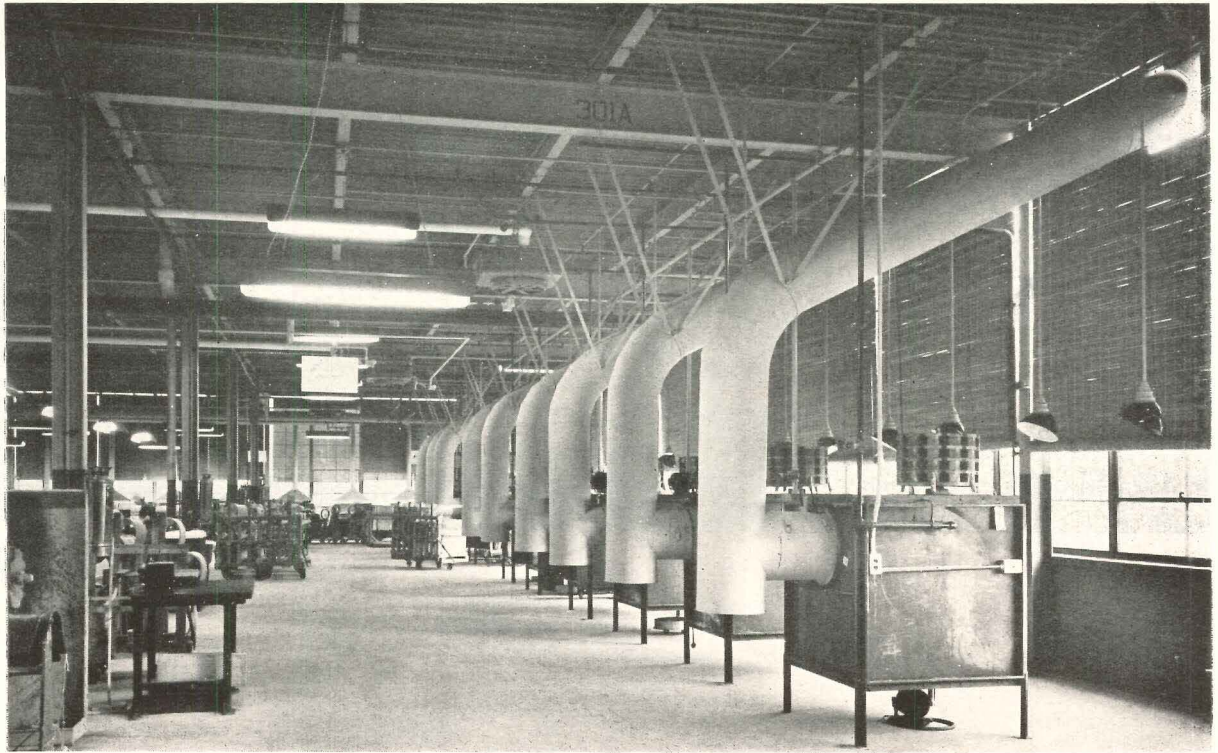

Gottscho-Schleisner Photos

Opposite page, top: the spacious lobby with its information desk and stairs to the offices and conference rooms above. Bottom, the cafeteria serves both office and manufacturing employees. Above, the battery of lacquer cabinets with their exhausts. Below, the racket manufacturing area. Right, the interesting, economical wall, window and roof section

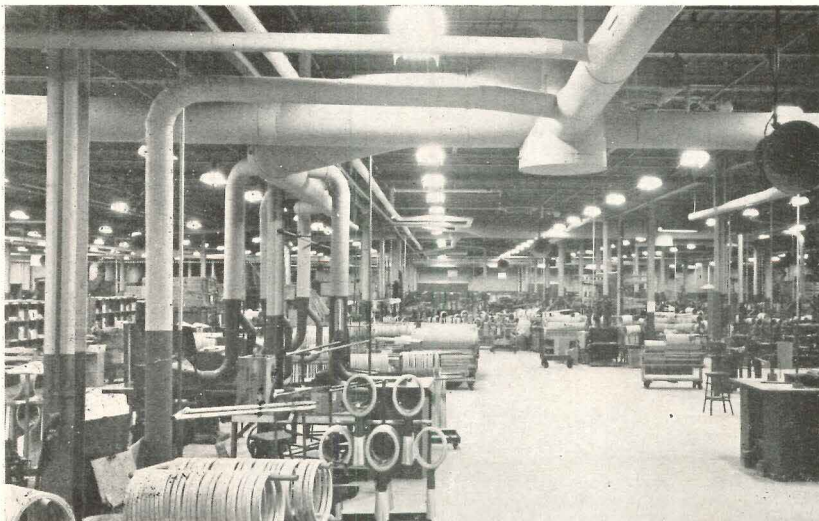
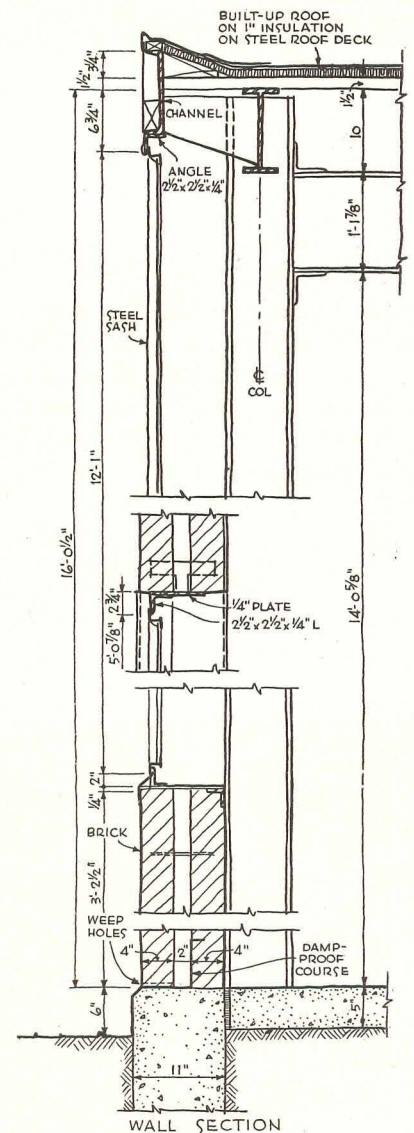



Zamora

WELL DESIGNED COMMERCIAL BUILDING



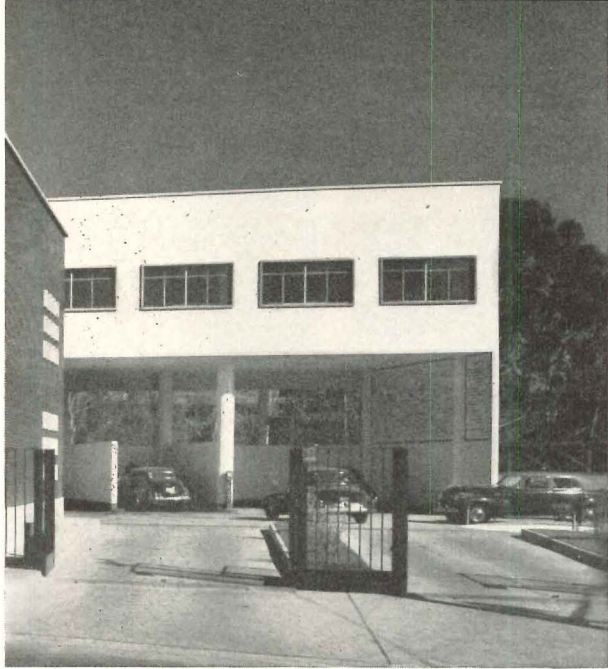

West façade, left, shows glass wall of bank at far left, gas station in center, auto sales-room, and in rear wing, car washing and lubrication space. Upstairs are the restaurant and dance floor, kitchen, facilities for band and entertainers and, in the rear wing, rentable space. Photo at bottom of page shows interior court which separates the two wings

Vladimir Kaspé, Architect

Mexico City, D. F.

IN MEXICO

As an example of what can be done practically as well as esthetically, this multi-purpose commercial building, situated at the entrance to Lomas de Chapultepec, a luxurious residential section of Mexico City, should cause serious thought. Its parts are not uncommon in the American scene: a gasoline station, auto salesroom, branch bank, stores and offices, and a small night club. The felicity with which they have been united into a structure which not only is good looking, but also functions well and returns a profit on the investment, puts its American counterpart, the ubiquitous taxpayer, to shame. For example, an almost fiendish ingenuity has been exercised in organizing the building so that banking service, auto sales space, washing, lubrication, etc., are visible from the gasoline station. At the same time, access from the street to each function of the building is direct.

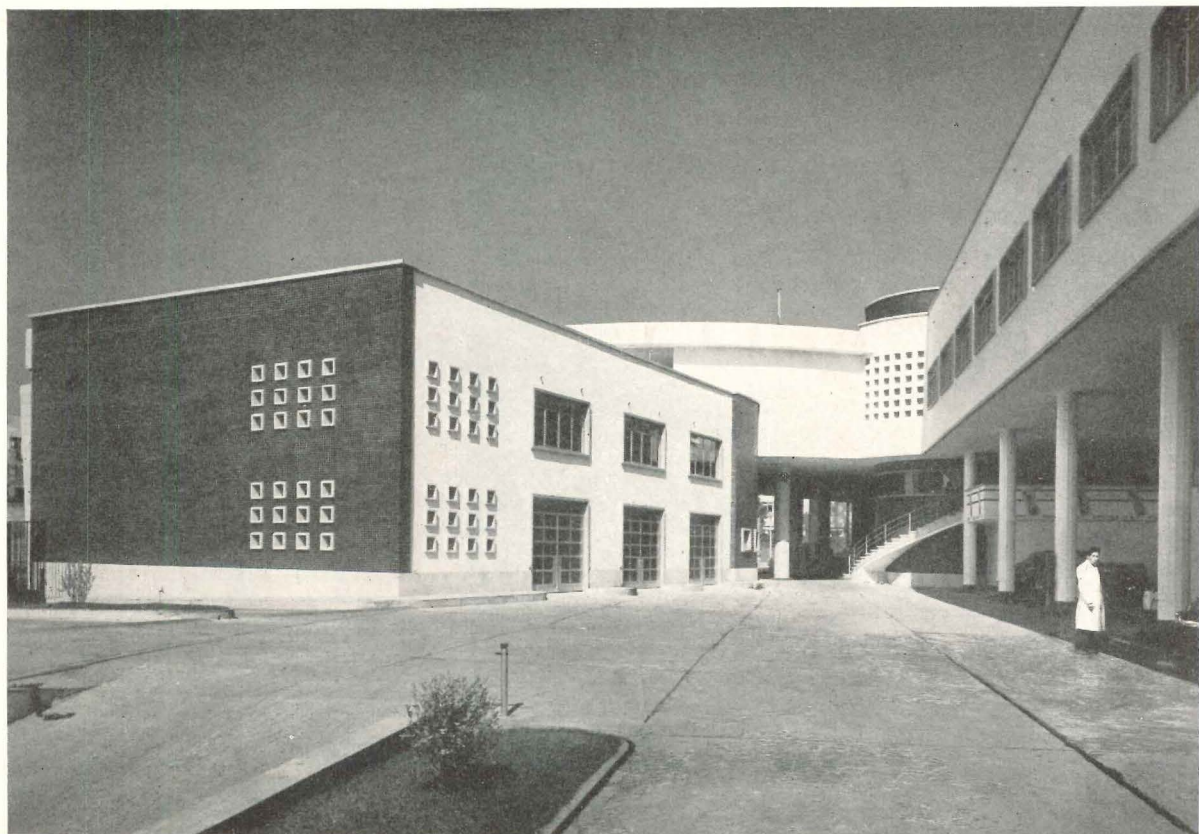



Zamora

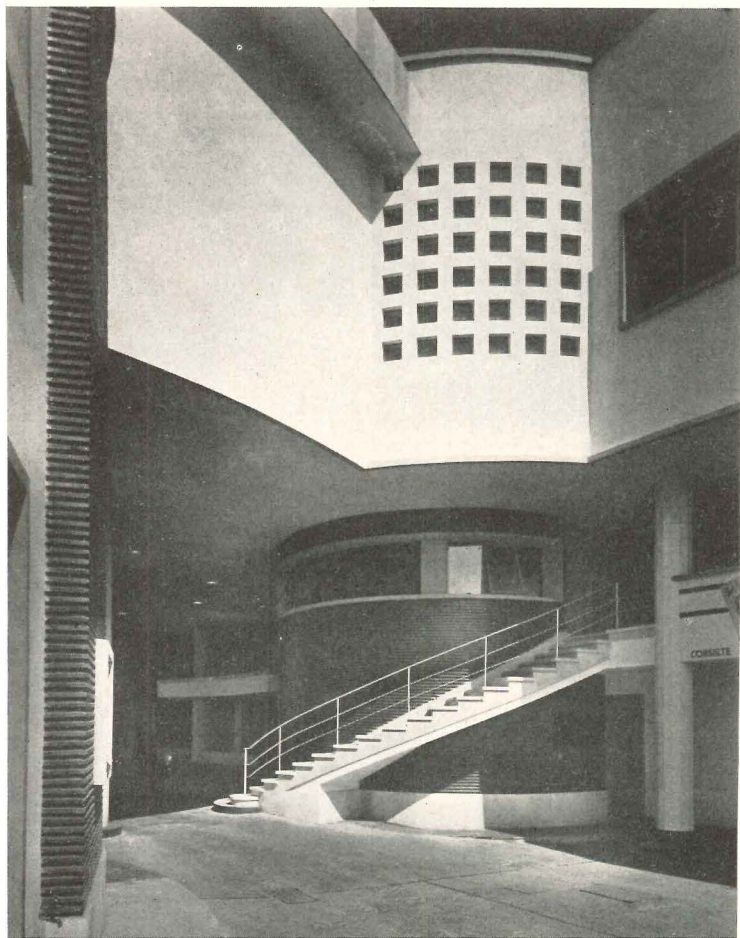

Two streets intersect directly opposite the gasoline station which forms the center of the building, and north, an undesirable orientation in Mexico, corresponds to the closed-in point of the banking room; to the south, which is too warm for the comfort of the employees, the building presents solid walls. Manager's office is reached by a curving stair to the mezzanine (photo at left); through the office's continuous window, ground-floor activities can be supervised. From the second-floor restaurant-night club and its terraces there is an excellent view of park and mountains

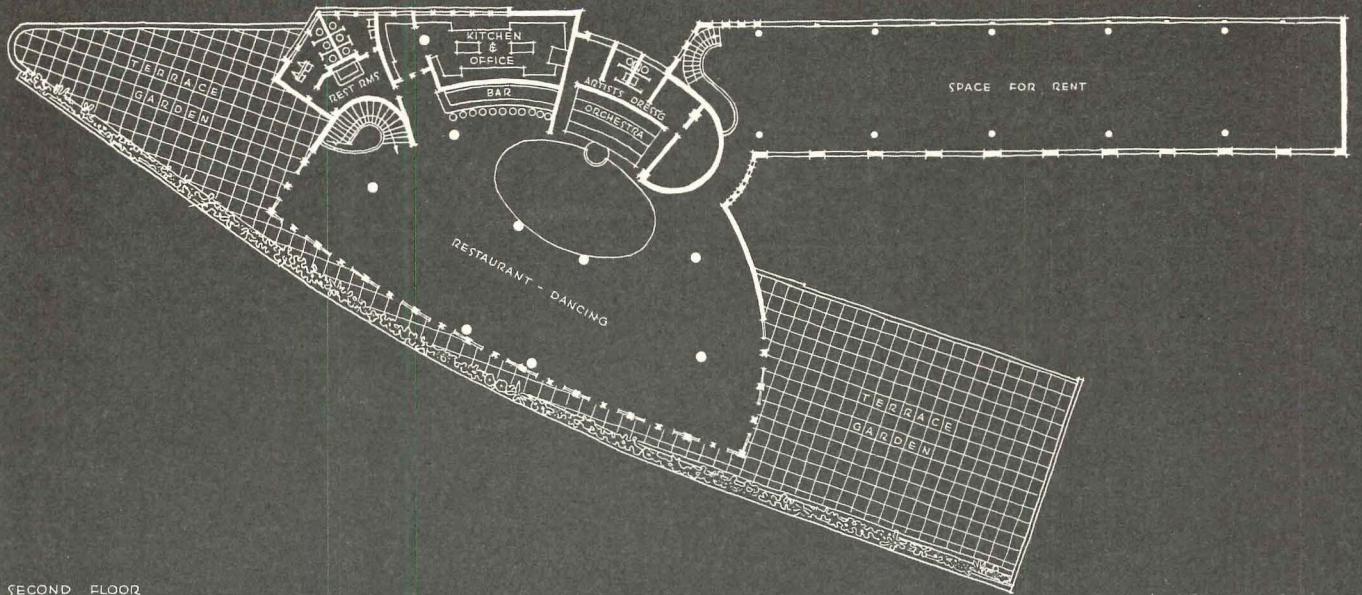

SECOND FLOOR

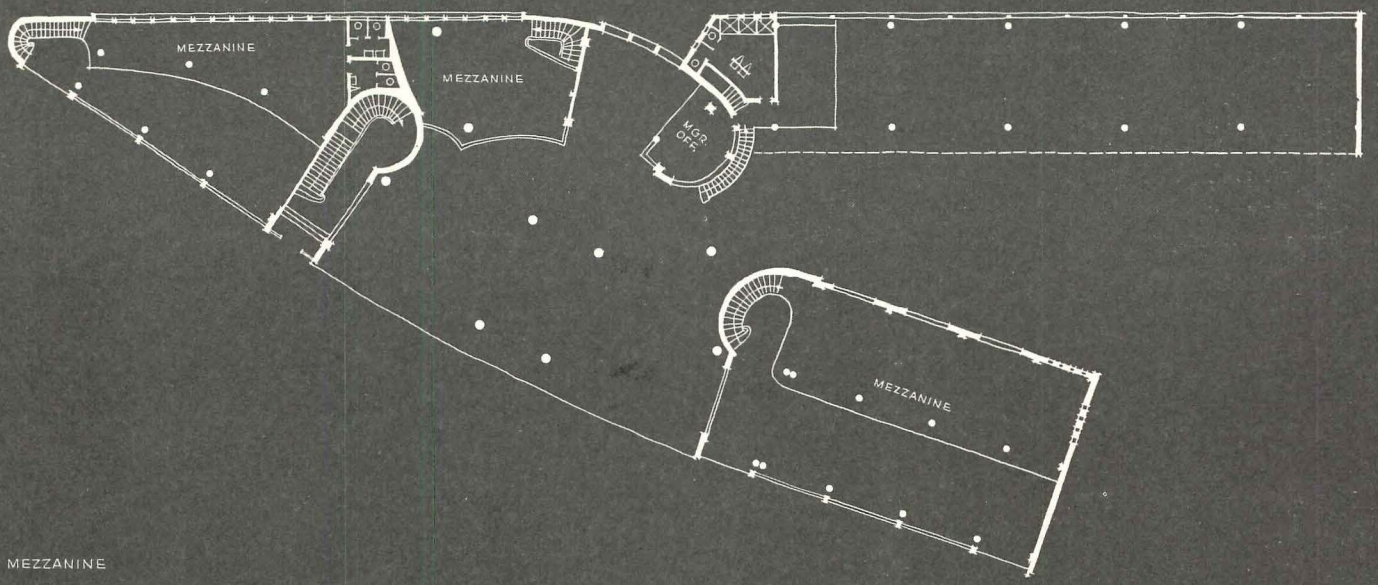

MEZZANINE

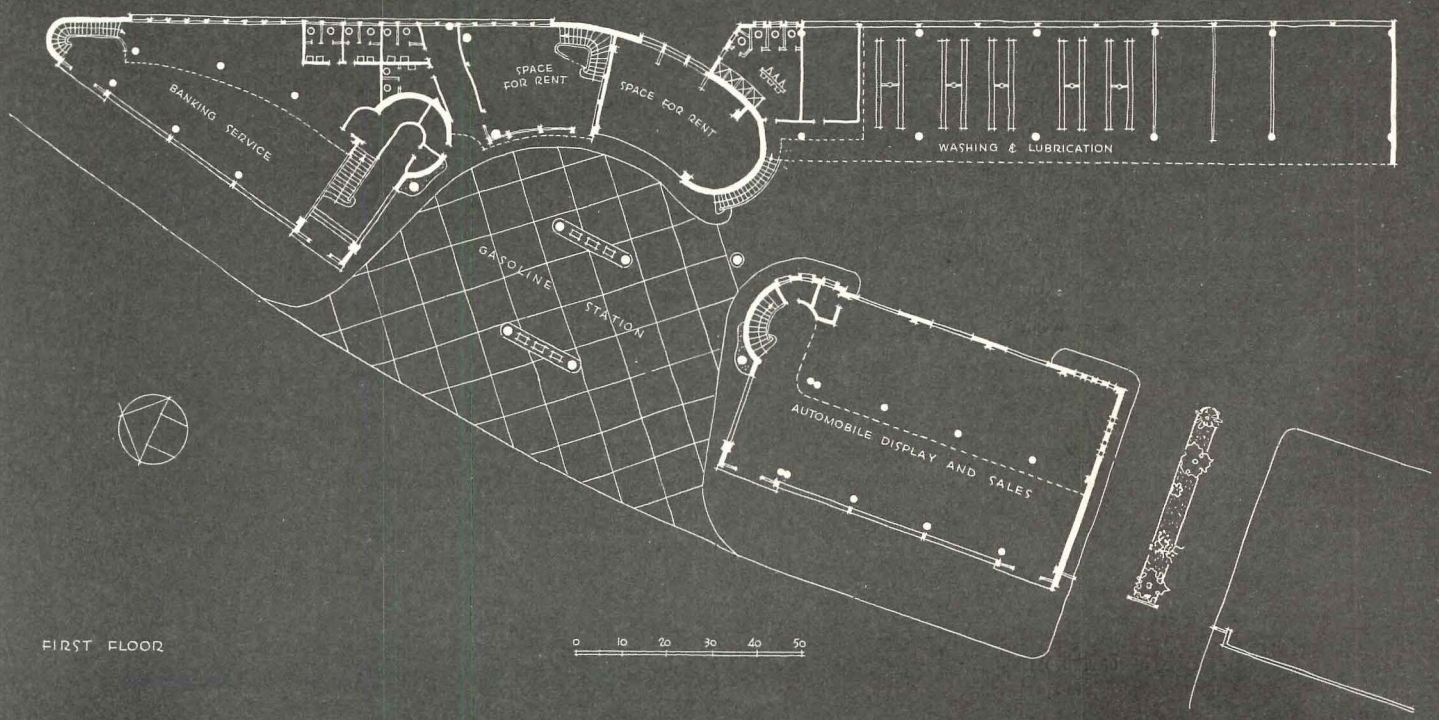

FIRST FLOOR

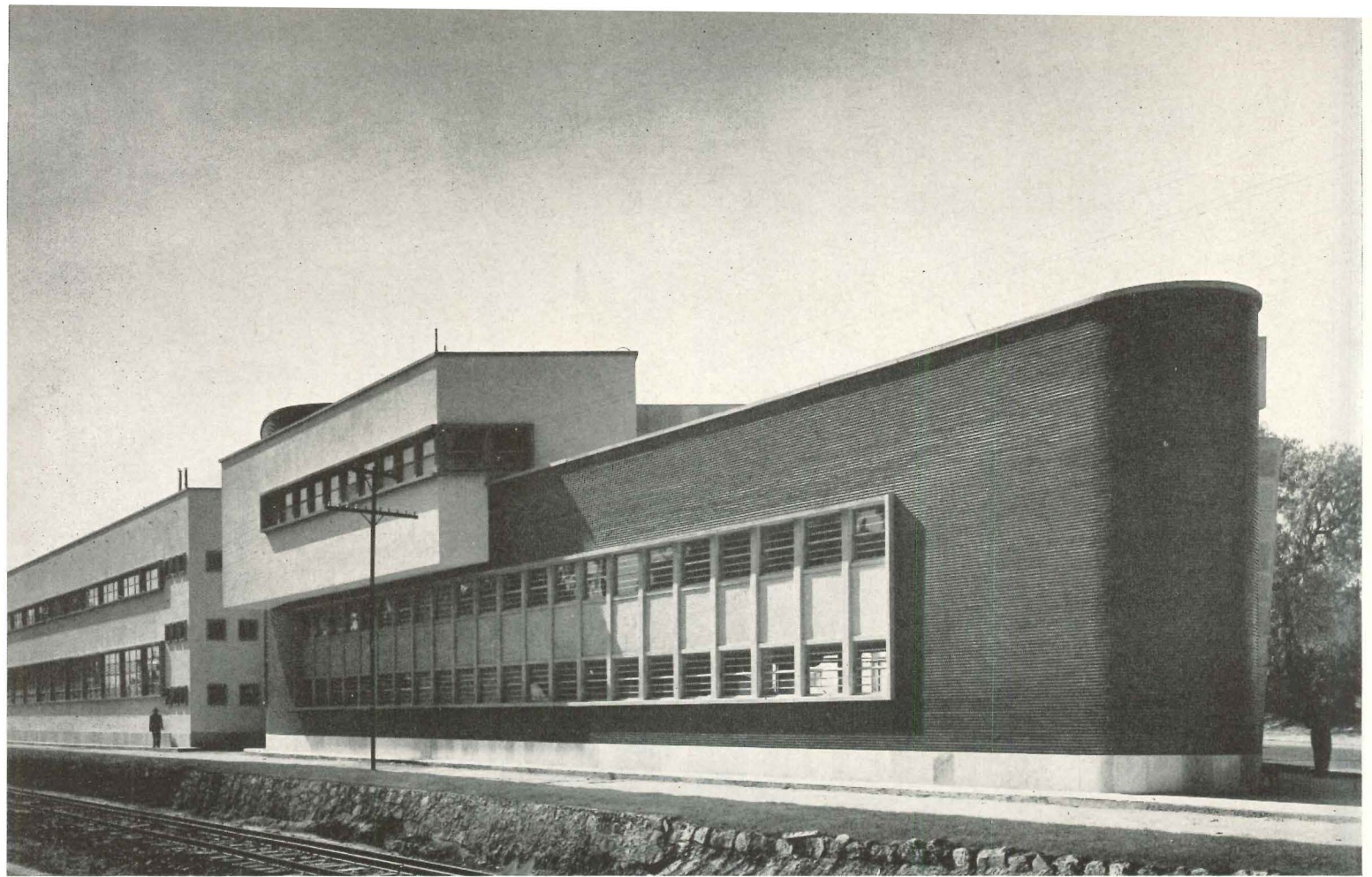

Zamora

Framing is concrete and steel. Columns, as few as possible in number, are independent of walls and windows. Almost all walls are faced with special brick of great durability, and exposed concrete is covered with a natural green stone quarried in Guanajuato. In the gasoline station the lower third of the columns is covered with artificial granite of the same color as the Guanajuato stone, and the joint between the artificial stone and the upper portion of the column finish is covered with a ring of bronze. A red surface finish on the flooring of the central portion provides color accent. Columns and walls in lubrication space are covered with white tile.

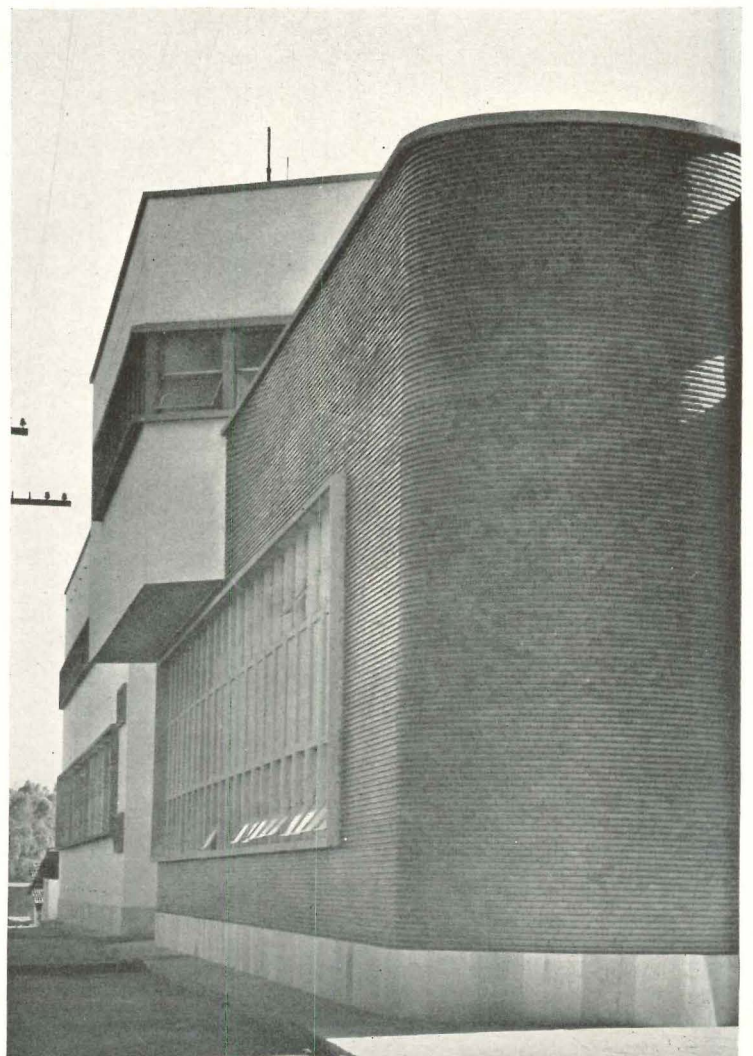



All portions of the building are lighted by recessed ceiling spotlights. At night, the exterior is flood-lighted, making it visible from the adjacent park. Photos on these two pages show, above, east and west façades; at left, north end of banking space

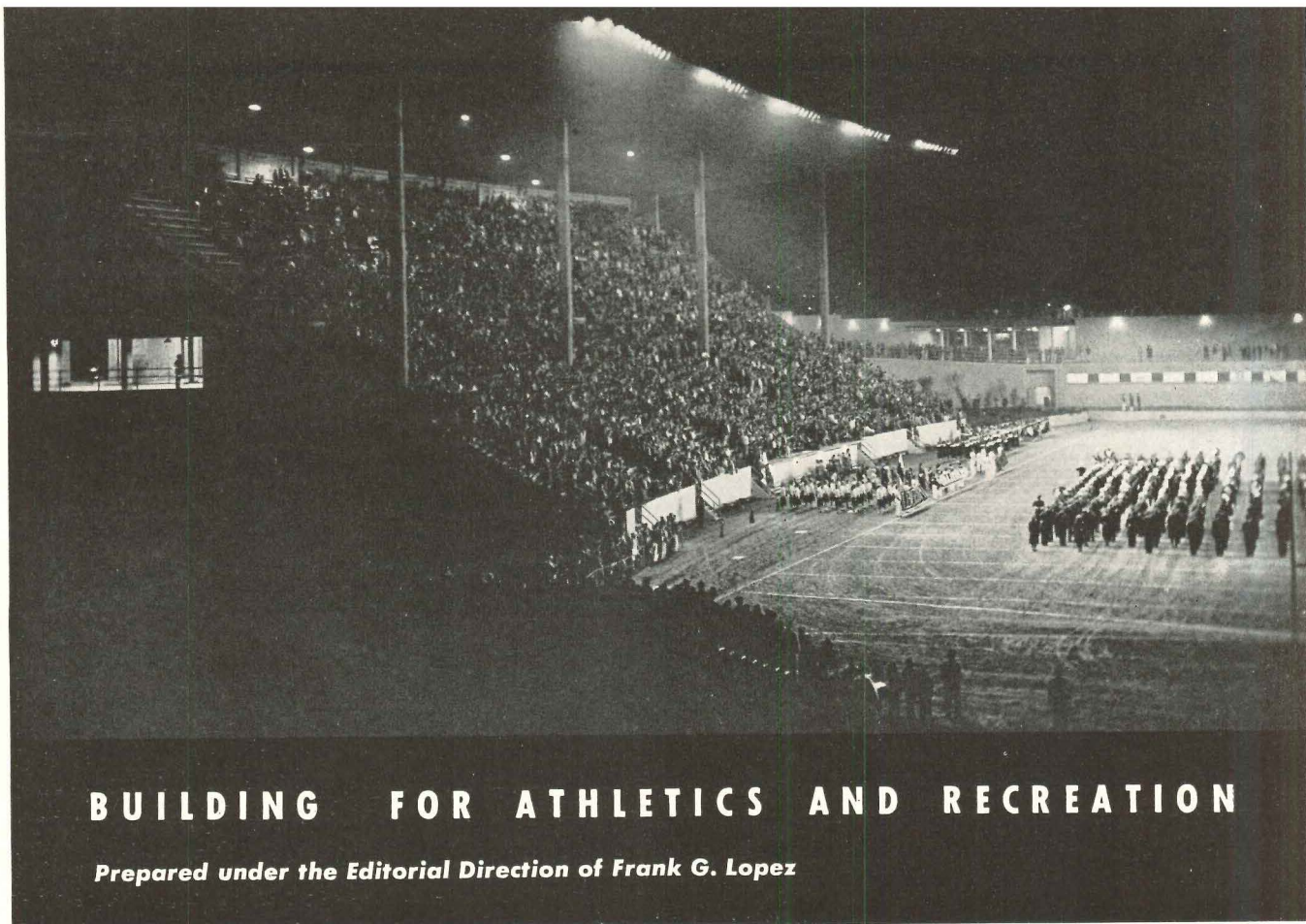

BUILDING FOR ATHLETICS AND RECREATION

Prepared under the Editorial Direction of Frank G. Lopez

OUT of the formerly accepted idea of athletics as an extra-curricular scholastic or collegiate activity, or as a big-time professional spectacle, there is emerging a concept of athletics, recreation, physical and health education all closely inter-related, closely tied into all phases of community life and planning. In such a concept the provisions of an industrial concern for its workers, of a community group for its members, of a city park department, a school district, a college, all have importance. There is ample evidence, of course, that the concept is not universal; the spectator sport, emphasis and de-emphasis of football and basketball in our educational institutions tell us as much.

At the same time, the city of Seattle is building a series of fieldhouses of several types, as part of a city-wide program based upon a sound community master plan in which park department and school district facilities supplement one another. Arenas and stadiums are being erected, some municipal, some privately operated. Industrial plants are acquiring recreation buildings. Public schools are finding that the expense of building a gymnasium can be justified if the structure is usable by the entire community. A small college in Goshen, Indiana, is completing a gymnasium building which is to be not only a focal point of college life, but also a center for the religious body which established the college.

Many such developments have been independent; though aims have been parallel if not identical, sources of information have been scattered and often contradictory. In April, 1945, there started a movement to coordinate the aims and findings of educators, planners, recreation, and health organizations, which culminated in December 1946 in the National Facilities Conference at Weston, West Virginia; out of this came the "Guide" noted in the bibliography, which is a comprehensive and valuable compilation of planning information, and building and equipment data.

The space limitations of a Building Types Study preclude thorough treatment of all the structures involved. Therefore attention is here centered upon two kinds of buildings which dominate such a program: gymnasiums and stadiums.

Gymnasiums planned to house basketball courts are adequate to provide for all activities in the normal school or recreation program. There are several interesting developments: in elementary schools, cost and unsuitability are, in some sections, causing authorities to discard the complete gymnasium in favor of smaller *playrooms*, which are approximately 40 by 60 ft., have lower ceilings than true gymnasiums, and are in general more fitted to the smaller size and more limited activities of elementary school students. If *gymnasiums* are used, they are usually divisible with

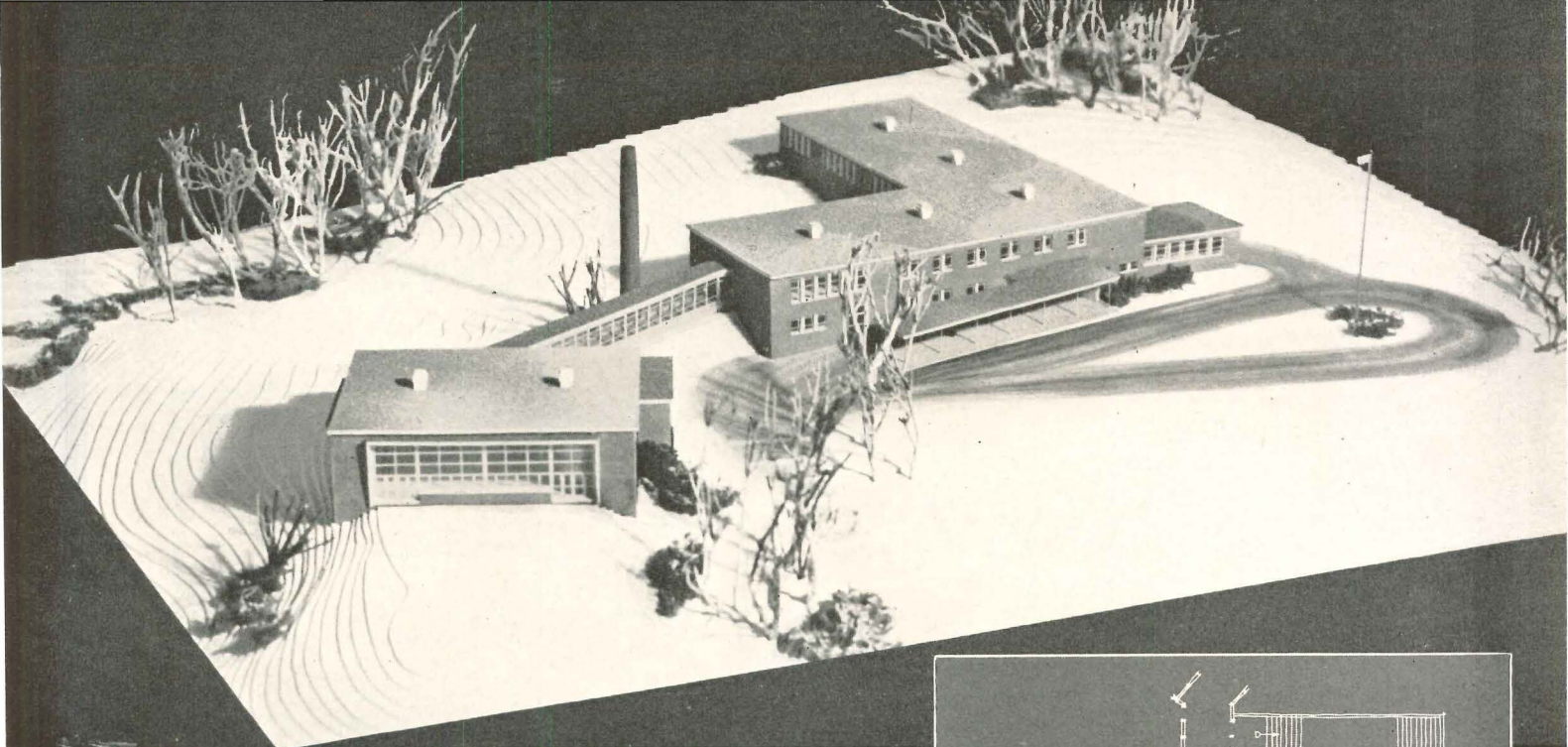

**ARCHITECTURAL RECORD'S
BUILDING TYPES STUDY NUMBER 151**

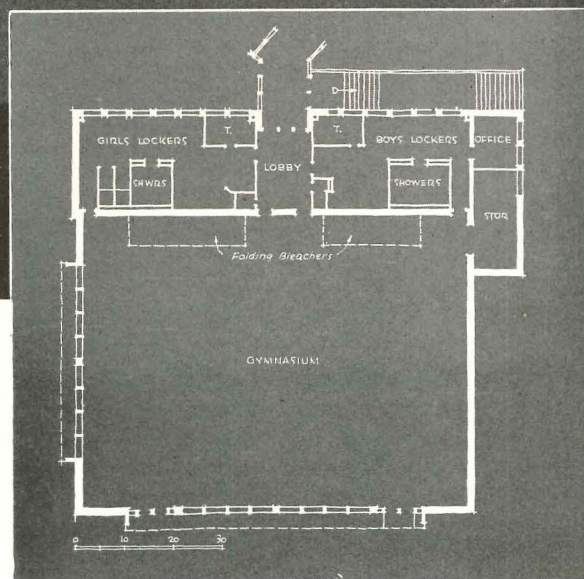

folding partitions; a gym 50 by 80 ft. provides two teaching areas each 40 by 50 ft. For high schools, the American Association of School Administrators suggests a gym 50 by 84 ft.; the "Guide" previously referred to suggests 65 by 90 ft. for junior high schools, 65 by 102 ft. for senior highs, and larger sizes for special conditions. *Locker, dressing, shower, and drying rooms* are considered as integrated suites, not separate units (see Time-Saver Standards). A growing practice is inclusion of *laundry facilities* within the school physical education unit, to reduce laundering cost and wear and tear on uniforms and towels.

Facing page: Seattle High School Memorial Stadium, Seattle, Wash.; G. W. Stoddard & Associates, Architects and Engineers (described on page 124). Above: Gymnasium building, Wilton, Conn., public schools, takes advantage of a rolling, 65-acre site; O'Connor & Kilham, Architects. Below: Gymnasium, part of a gym-classroom addition to grade school, Lincoln County, Colo., has low-pitched wood plank roof supported by rigid steel frames, with acoustic absorbent applied directly to underside of planks; Henry A. Koch, Architect

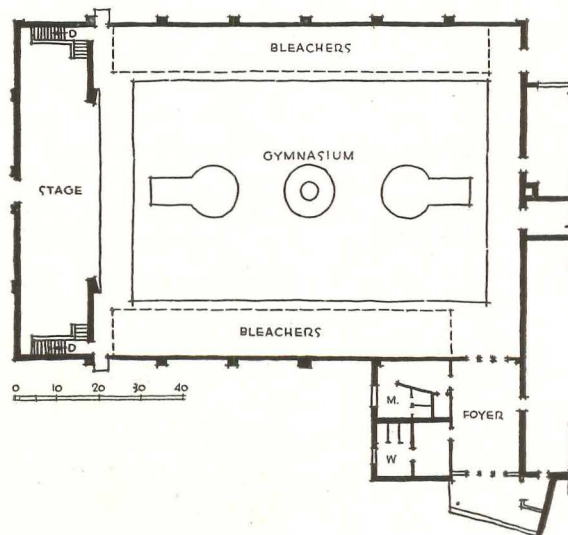

The editors acknowledge with thanks the assistance of The American Association of School Administrators, who have generously given permission to quote from their 27th Yearbook, "American School Buildings"; The Athletic Institute, who as publishers for the National Facilities Conference have given equally generous permission to quote from "A Guide for Planning Facilities for Athletic, Recreation, Physical and Health Education"; Dr. Walter Cocking, Editor, "The American School and University"; Dr. Jay B. Nash, Professor of Physical Education, New York University; Dr. Karl W. Brookwall, Director, Bureau of Service & Research, School of Health, Physical Education and Recreation, Indiana University; Francis J. Moench, Director of Training, State Teacher's College, Cortland, N. Y.; Horn Brothers Co.; Fred W. Medart Co.; American Iron & Steel Inst.; Portland Cement Ass'n.; National Recreation Ass'n.

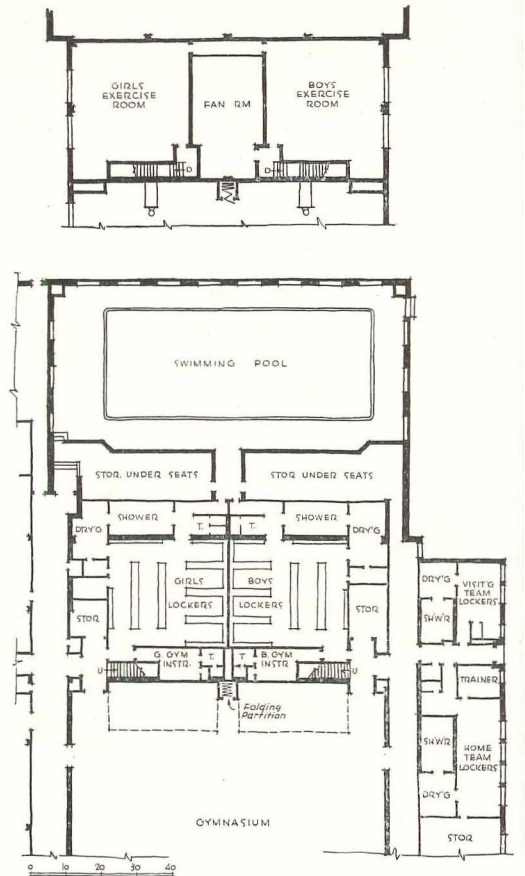
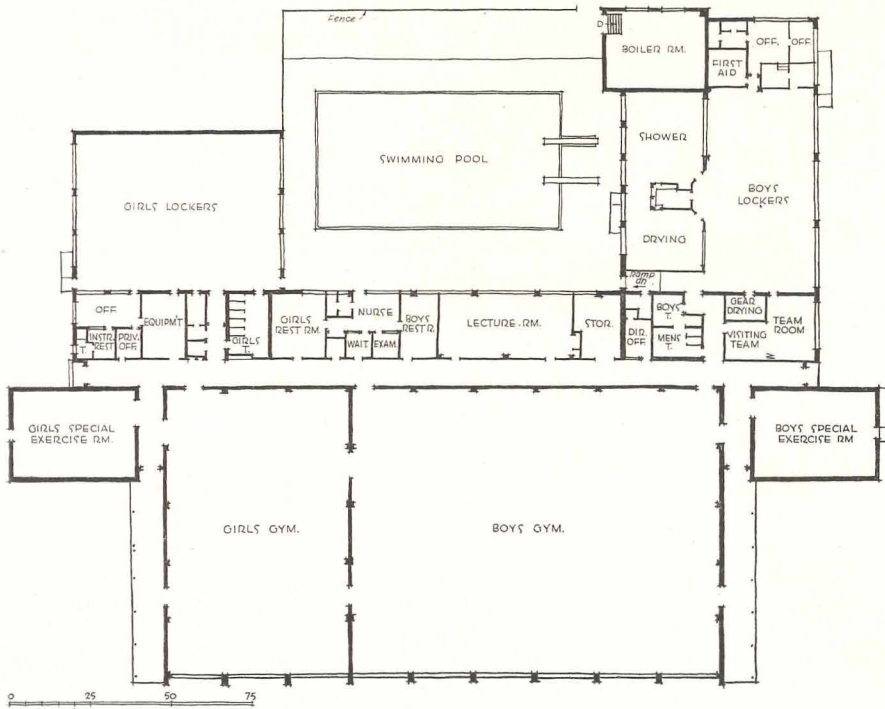

Above, circulation problems, high school locker-room-gym-pool suites. Left, gymnasium and outdoor pool, Mt. Diablo Union High School, Concord, Calif. Extensive outdoor court game space determines locker room location; Reynolds & Chamberlain, Archts., Bamberger & Reid, Associated. Right, junior-senior high school, Cheektowaga, N. Y., has athletic facilities in center of building, classrooms surrounding. Locker rooms serve both pool and gym on ground floor; interior stairs lead to exercise rooms on floor above; Earl Martin, Archt. Below, Department of Parks, Seattle, Wash., has an extensive athletic and recreation building program including two types of fieldhouses: Class A has gym 60 x 90 ft., social and game rooms, serves 20,000 population within 1 to 1 1/2-mile radius, is located on neighborhood playfields preferably adjoining high schools. Seven are in operation, two under construction, among them West Queen Anne Fieldhouse (rendering below, plan across page) by Narramore, Bain, Brady & Johanson. Class B fieldhouses, on elementary school playgrounds, have social, game rooms, preferably small gyms, serve 5000 to 10,000, 1/2 to 1 mile radius

Adjuncts to the gymnasium include corrective exercise rooms, equipment and apparatus storage space, and swimming pools. As the exercise room requires direct access to locker-dressing suites, it may complicate the circulation problem; two approaches are shown above. Another, not illustrated for lack of space, places exercise rooms at ends of locker suite; this uses more ground-floor area than placing them above as in the Cheektowaga scheme. One type of equipment storage often neglected is space for the gym piano; an alcove protected by a wire screen to prevent damage to the piano is sufficient. The

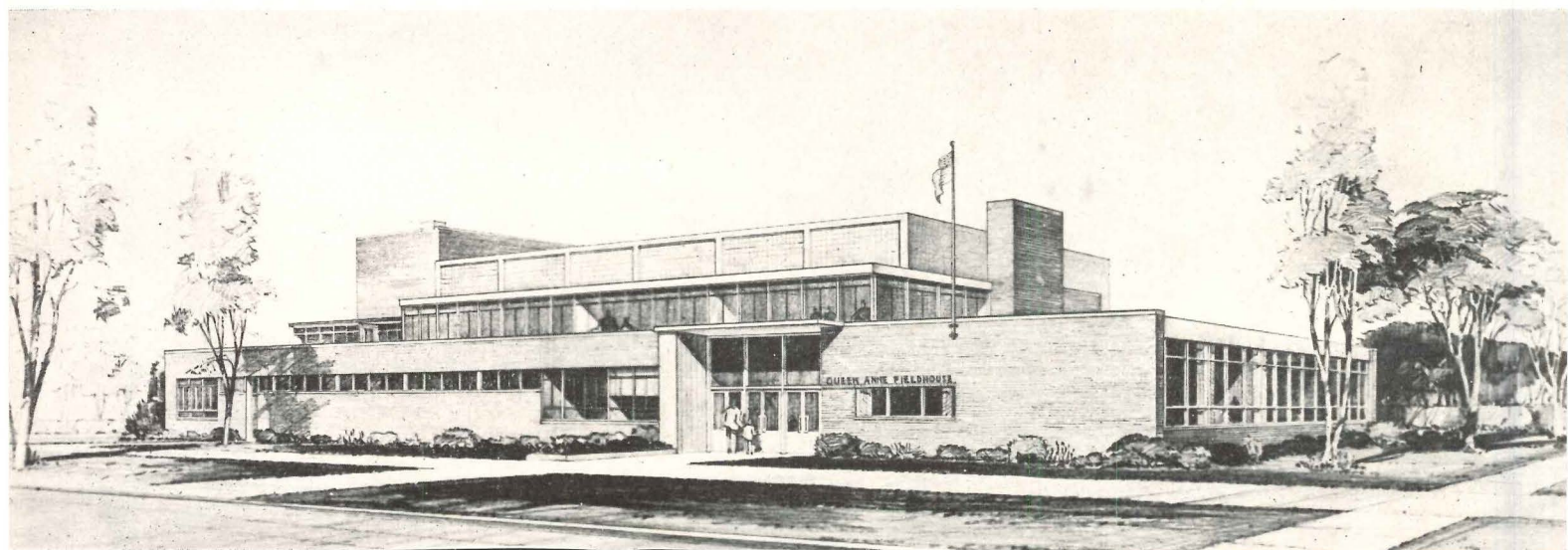

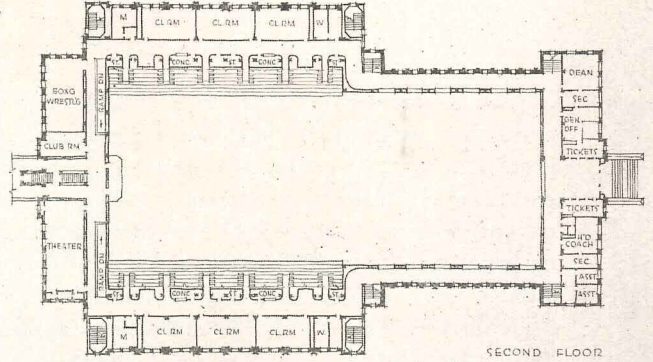
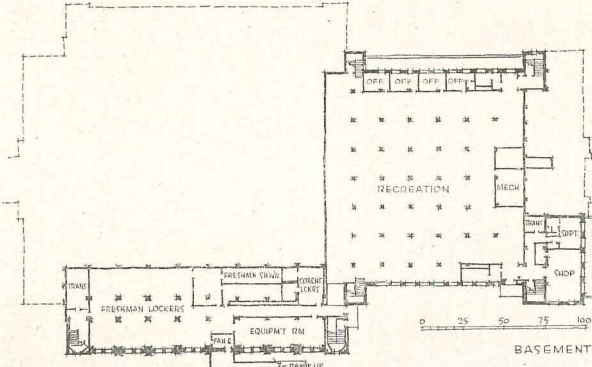
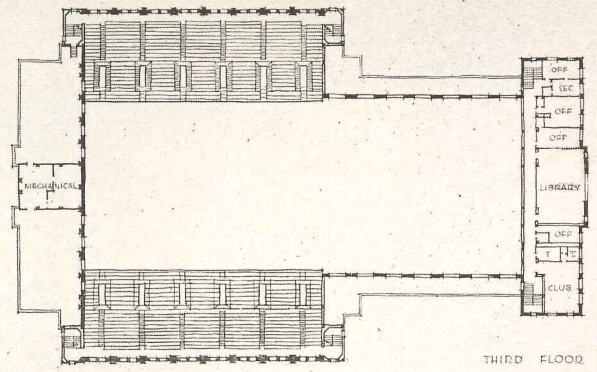
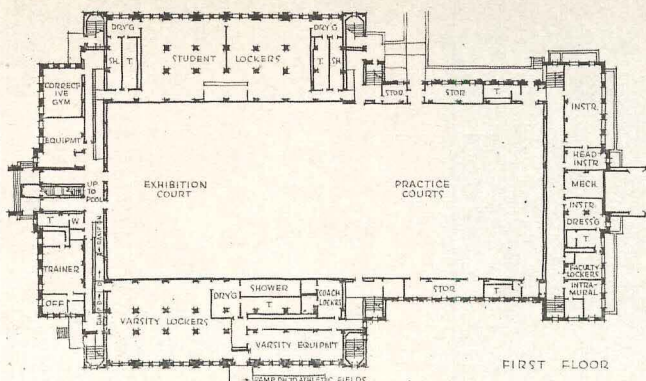

American Association of School Administrators suggests, for swimming pools, use of the non-competitive, constant-depth pool (42 to 46 in. deep throughout) as a means of reducing cost. This should be satisfactory for most swimming-teaching demands. For interscholastic competition a pool should be at least 75 ft.-1 in. long, and in width it should provide from four to six swimming lanes, each 7 ft. wide. Pool details, curbing, drainage, and other details should conform to recognized good practices. Every precaution should be taken to prevent siphoning pool water into the regular water system.

Above, new gymnasium building, University of Florida, has student and faculty facilities, classrooms, club and recreation rooms, theater, speakers' balcony in gymnasium. Athletic equipment is complete in all respects. Cost, exclusive of furnishings, over \$1½ millions. W. Kenneth Miller, Archt., associated with Guy C. Fulton

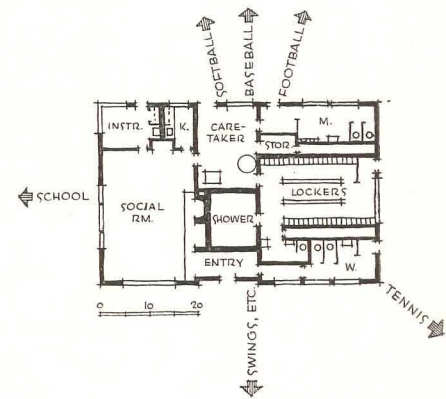
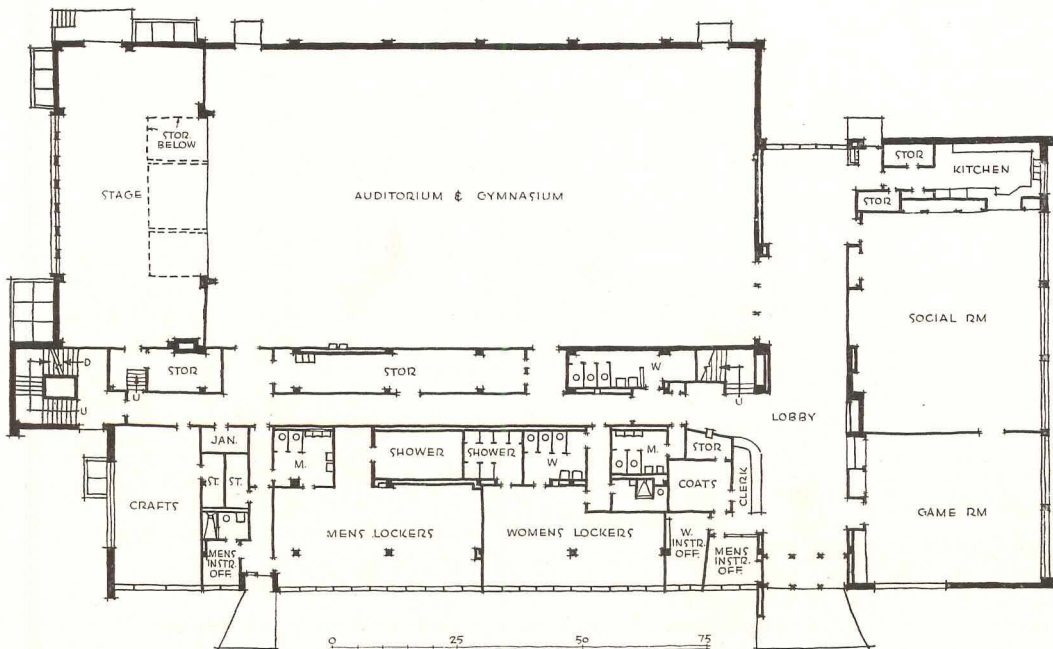

Above, one of Seattle's Class B fieldhouses, Ranier Beach Shelter; Seattle Dept. of Parks, Paul V. Brown, Supt., Alfons V. Peterson, Archt. Left, first floor, West Queen Anne Fieldhouse; second floor contains two more social rooms

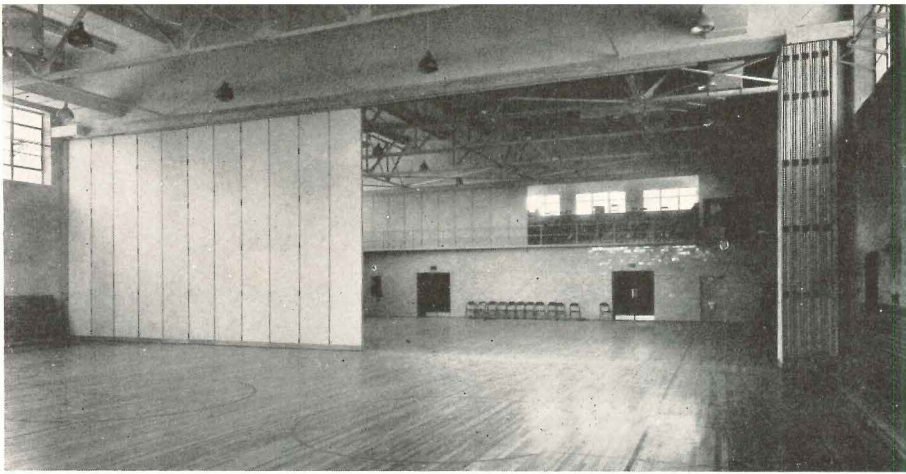

Gymnasium, Glen Burnie Junior High School, Glen Burnie, Md. (Buckler & Fenhagen, Archts.) shows folding partitions, electrically operated in center of gym, manual across balcony; also 5-row folding bleachers, closed against wall

Courtesy Horn Bros.

Stadiums. Based on average tread width of 26 in. and seats 18 in. wide, plus allowances for aisles, ramp openings, etc., football stadiums require a gross area of 4.1 sq. ft. per seat. For capacities up to 4000, unless future expansion is provided for, rectangular stands are most economical; above 4000, curved (preferably elliptical) stands. Side stands should be a minimum of 20 ft., preferably 30 ft., from field sidelines; more than 70 ft. or 75 ft. may improve sightlines but penalizes the view (too distant) unduly. In small stands risers are customarily a constant 8 in. to 10 in.; for more than 20 rows

deep, risers usually increase in rear to maintain 4 in. to 6 in. sightline clearance over heads of seated spectators, the smaller clearance being customary in large-capacity stadiums. Baseball grandstands are usually built as chords or segments of circles, with first- and third-base stands converging toward foul lines from the minimum distance of 60 ft. required at home plate. Orientation differs for baseball. For a comprehensive treatment of stadiums for all sports consult "Grandstand and Stadium Design," published by The American Institute of Steel Construction.

Typical industrial and civic facilities: left, Recreation Building, Electrolux Corp., Greenwich, Conn. (Raymond & Rado, Archts.); right, first floor, proposed building, Community Workers Association, Newburgh, N. Y. (National Recreation Association; Donald L. Kline, Planner; Caleb Hornbostel, Archt.)

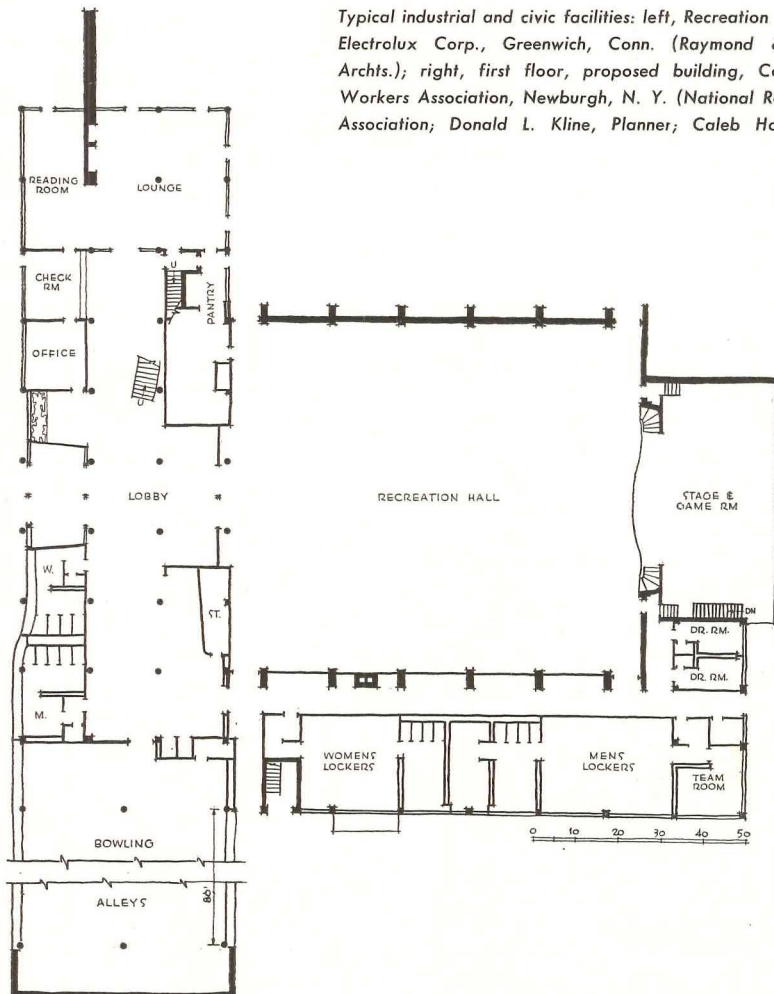

Both contain gymnasium-auditoriums. Newburgh project has stage over long storage space, stadium seating over locker rooms and toilets; ground floor contains main entrance, bowling alleys, billiard room, arts and crafts room, small children's playroom, locker rooms

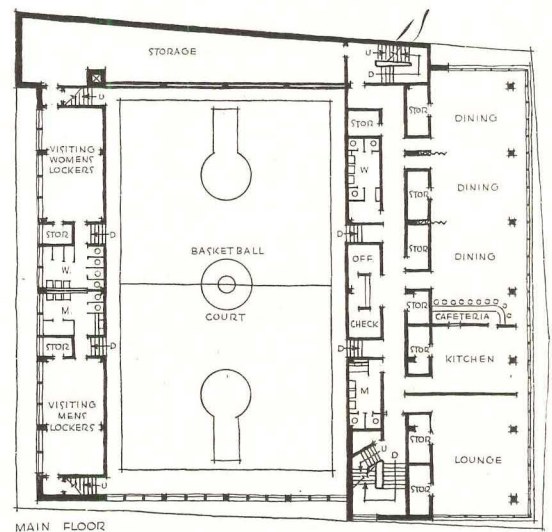

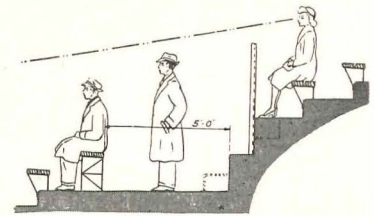
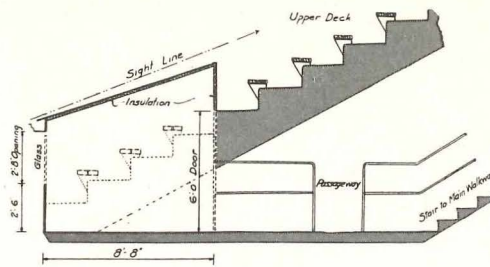
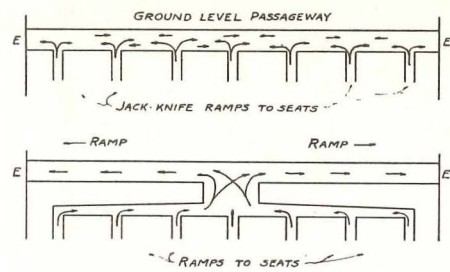

Above, stadium circulation and sightlines: left, scheme B, avoiding two-way traffic and long walkways, is 30 per cent more efficient than A. Center, broadcasting booth at bottom of upper deck. Right, longitudinal aisle depressed so pedestrians are below sightlines. Below, left, elliptical

football stadium emphasizes best view from all seats; size shown has 32,000 capacity. Right, ground level, Municipal Stadium, Kinston, N. C.; space under seats used for dressing rooms, concessions, etc. (John G. Rowland & Assoc., Architects; see page 122)

CONDENSED BIBLIOGRAPHY

Note: Space does not permit publication of a complete bibliography. For additional titles, the editors suggest that the publication, *American School and University*, be consulted; or that information be obtained from The National Recreation Ass'n., New York.
American School Buildings. 1949, American Ass'n. of School Administrators, Washington, D. C. \$4.00.
Construction Standards for Gymnasiums, Grandstands, Swimming Pools. Dept. of Physical Education, Long Beach Public Schools, Long Beach, Calif.
Grandstand and Stadium Design. W. N. Woodbury. 1947, American Inst. of Steel Construction, New York.
Guide for Planning Facilities for Athletics, Rec-

reation, Physical and Health Education, A. National Facilities Conference. 1947, The Athletic Institute, Chicago. \$1.50.
Guide for Planning School Buildings, A. Eugene Elliott. 1945, State Department of Public Instruction, Lansing, Mich. (Bull. 338).
Planning Indoor Physical Education Facilities for Central Schools. 1946, New York State Education Dept., Albany.
Planning the School Health Suite. 1946, New York State Education Dept., Albany.
Planning a Community Recreation Building. National Recreation Ass'n., New York. 25¢.
Proceedings, 24th Annual Meeting, National Council on Schoolhouse Construction, 1947, Tallahassee, Fla.
Space for Teaching. W. W. Caudill. 1941, Agri-

cultural and Mechanical College of Texas, College Station, Texas. \$1.00.
Sports and Recreation Facilities. Extension Service, Colorado Agricultural and Mechanical College, Fort Collins, Colo. 25¢.
Standards for Schoolhouse Construction. West Virginia Council on Schoolhouse Construction. 1945, State Dept. of Education, Charleston, W. Va. \$1.00.

PERIODICALS

The following and other publications in the educational field contain numerous articles on buildings for athletics, health, and recreation: *American School and University*; *American School Board Journal*; *Nation's Schools*; *Recreation*; *School Executive*.

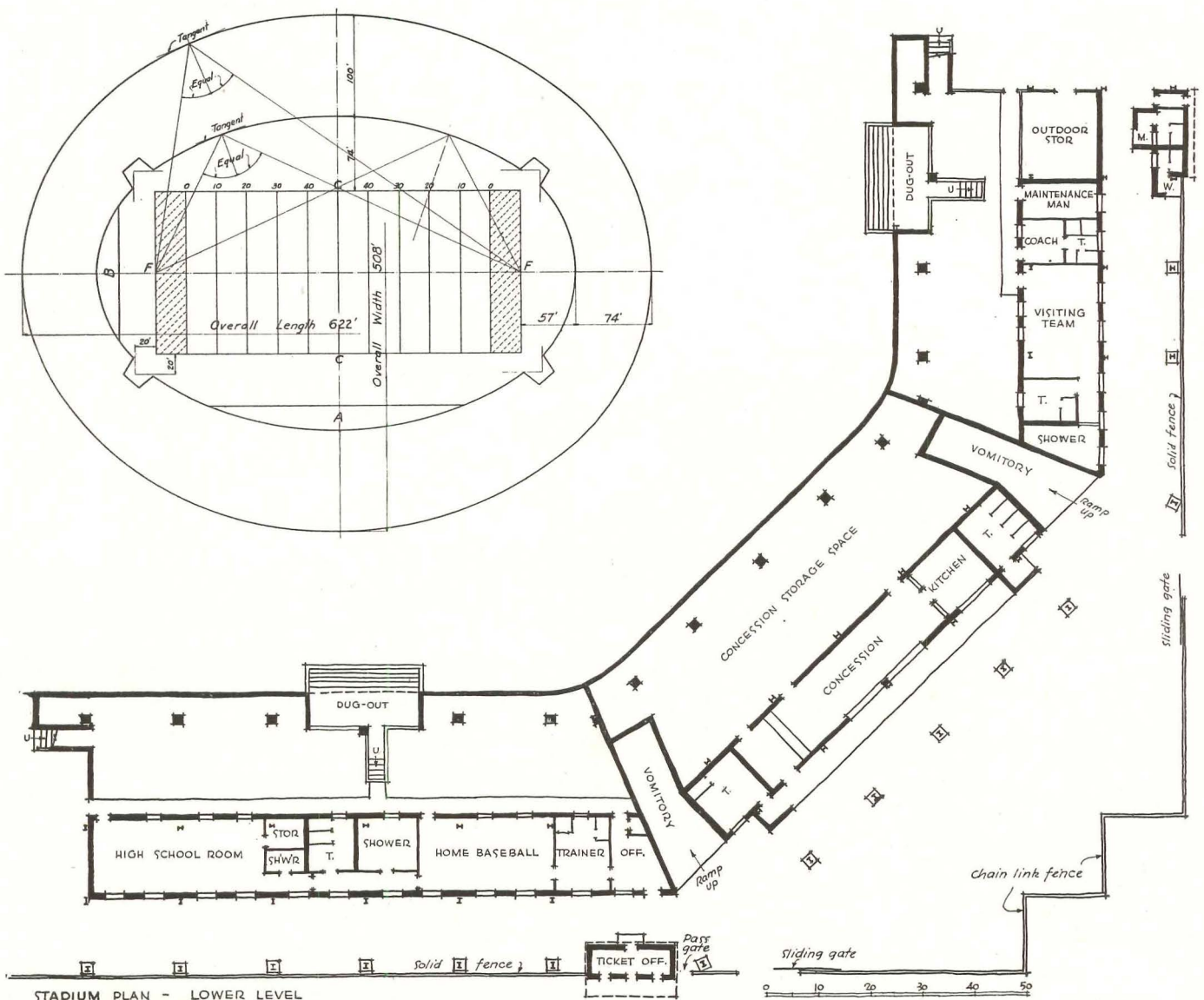

STADIUM PLAN - LOWER LEVEL

STADIUM FOR ALL MUNICIPAL FUNCTIONS,

John J. Rowland, Architect; James M. Simpson, Associate

KINSTON'S Municipal Stadium is designed to provide for community gatherings and rallies of various kinds as well as for high school football and baseball, and professional baseball. Such a design is primarily a baseball scheme with the football field running either diagonally, which would in this instance afford better lighting, or parallel with the third base line, which would provide a better view for a larger part of the audi-

ence. The third base leg of the stadium is the longer. There are 2235 riser seats and 276 box seats — approximately 20 seats per thousand of white population — plus 500 seats for Negro spectators (about half covered) and 400 bleacher seats. Kinston expects to add at least 900 bleacher seats. The method of construction — steel framing with 3/16 in. steel risers and concrete treads on aluminum forms — was selected for economy in first

Construction principally of steel, but with concrete treads, proved economical



KINSTON, N. C.

cost. Team accommodations under the stands include separate locker rooms for high school and professional athletes; toilets and showers are jointly used. The field is lighted at night by 120 open aluminum reflectors and 40 lensed reflectors. Of the total cost of approximately \$170,000, inclusive of everything except land cost, \$150,000 was raised by a bond issue. Just completed, the stadium is in use this summer; planting will be added next year.

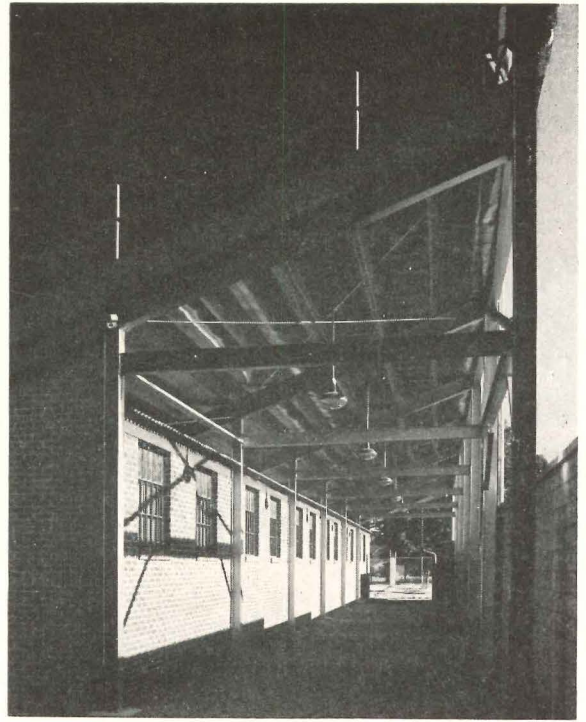

For plan of lower level see page 121. Press box construction shown at lower right

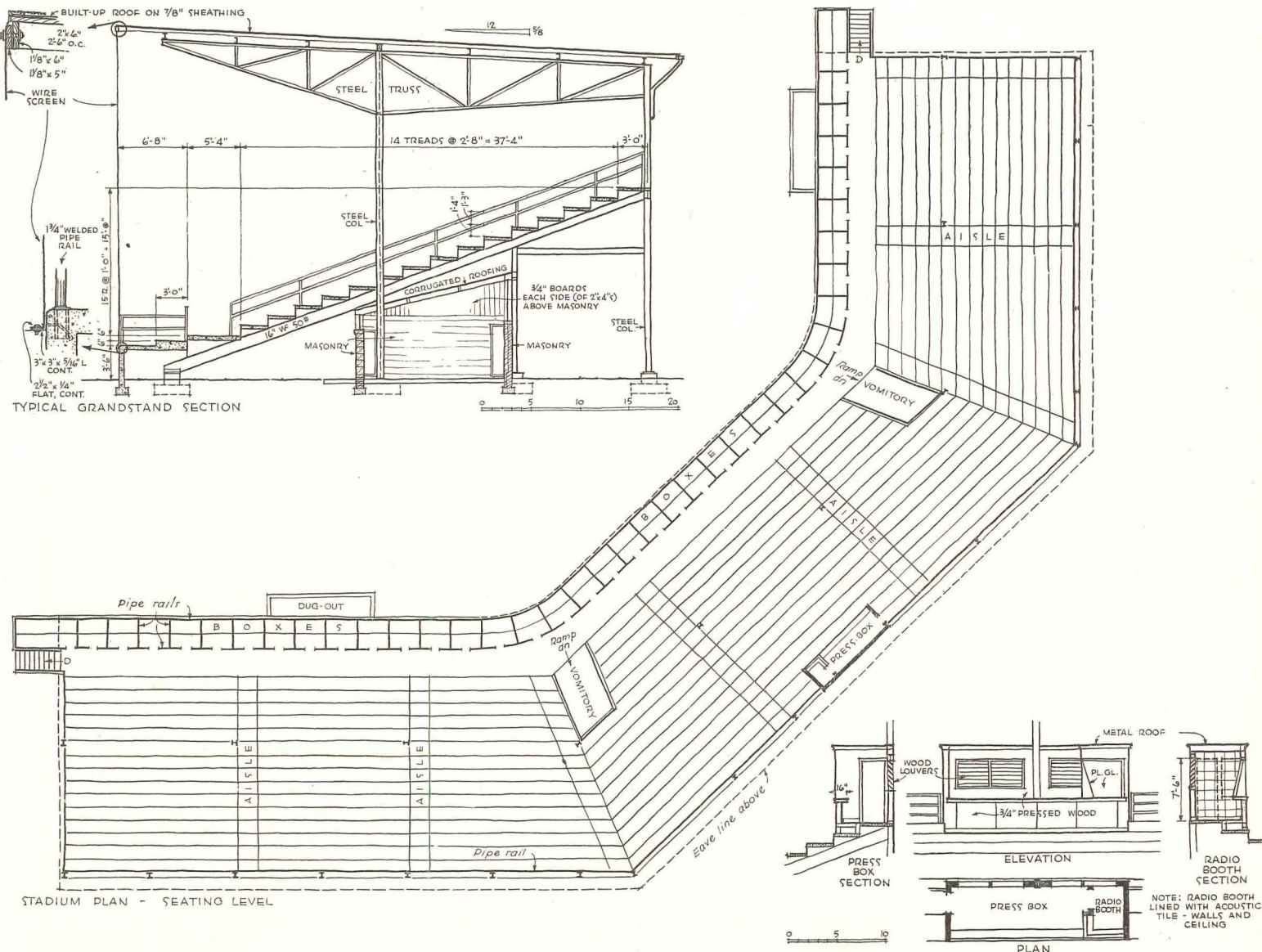
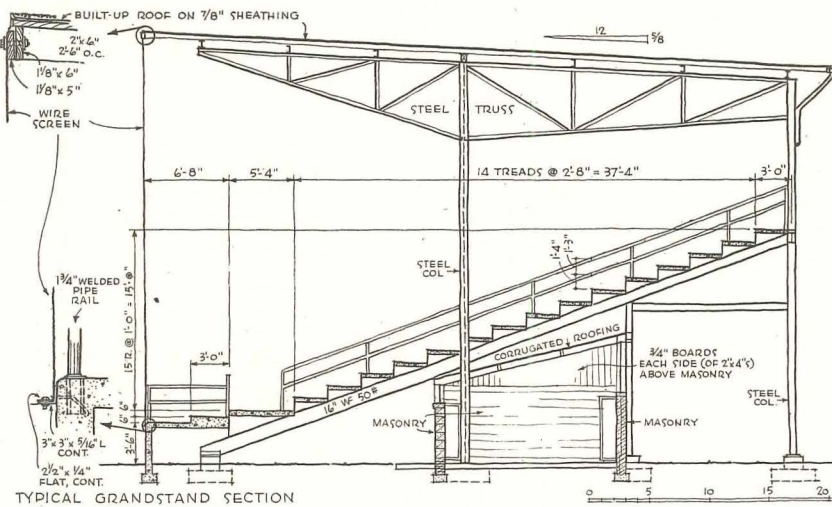

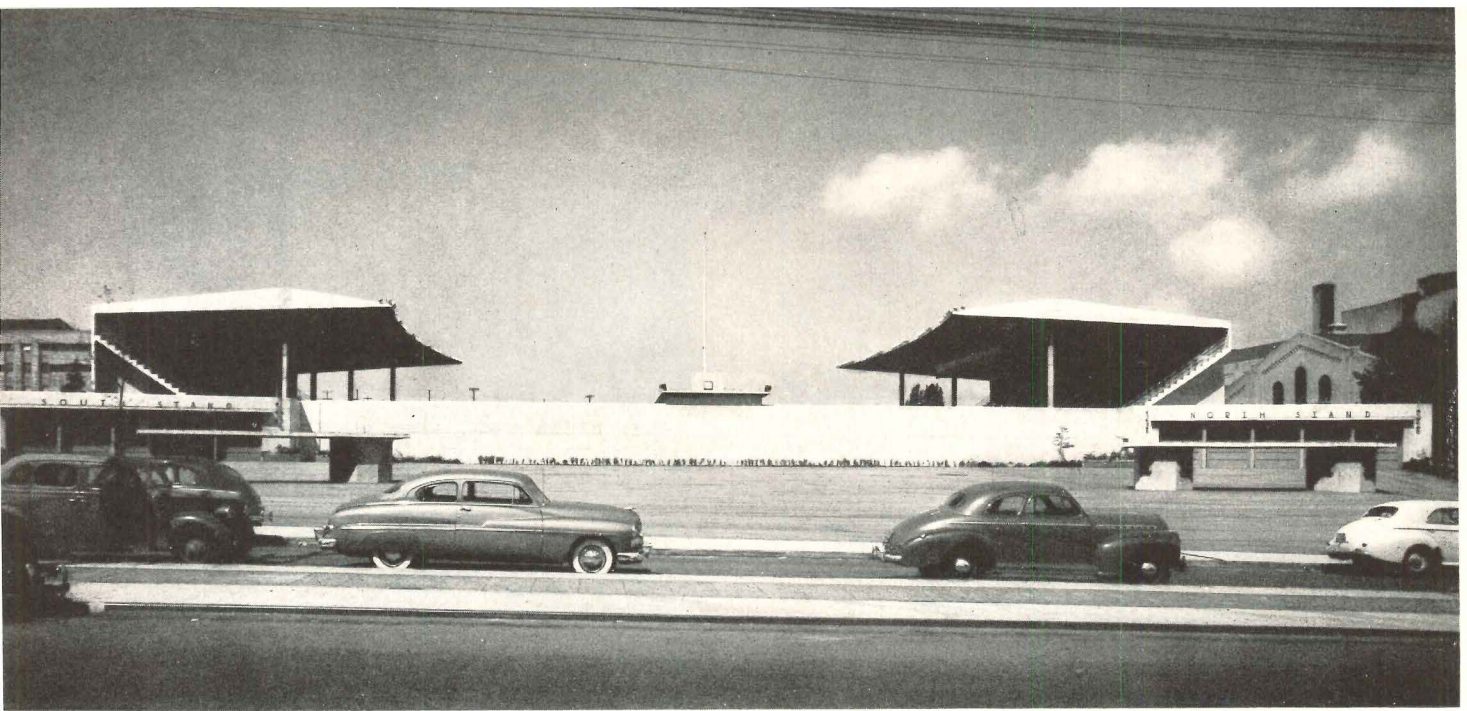

SEATTLE HIGH SCHOOL MEMORIAL FOOTBALL STADIUM

George W. Stoddard & Associates, Architects & Engineers

Built principally of concrete, this football stadium seats 11,500 now and is to be expanded to seat 26,000. The site is sloping, which permits grade-level exits at one end of the concourse under the stands; at the other end, concourse traverses roof of fieldhouse, in which are four identical team suites. Lavatories and concessions

are under stands, fronting on concourse. Stands have risers which increase in height as elevation increases, forming an elliptical rather than a straight-line section; this improves sight lines. Bus lane in plaza permits off-street loading. Pneumatic tubes under plaza convey money from ticket booths to director's office.

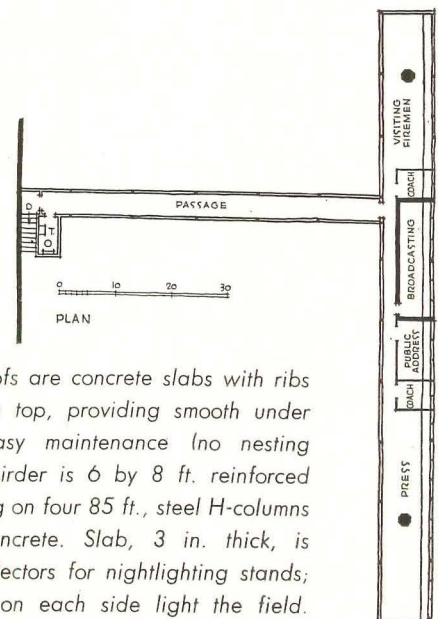
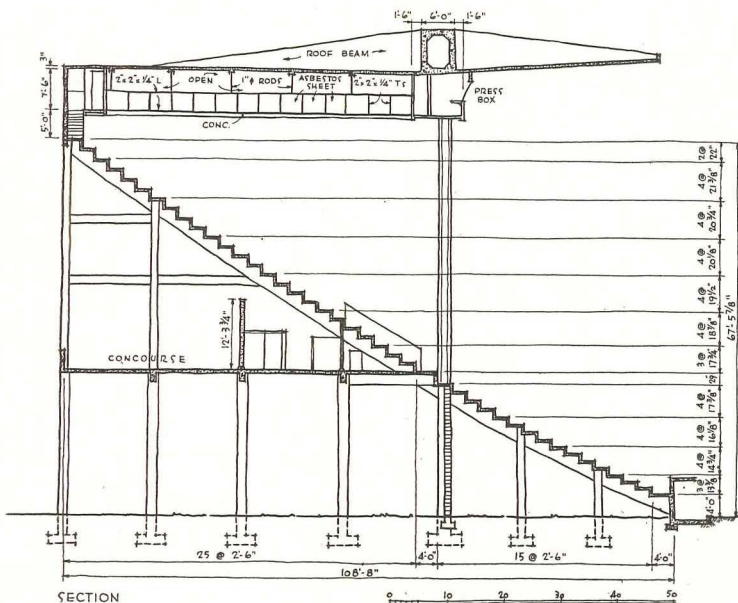

Grandstand roofs are concrete slabs with ribs and girders on top, providing smooth under surface for easy maintenance (no nesting birds). Main girder is 6 by 8 ft. reinforced concrete, resting on four 85 ft., steel H-columns encased in concrete. Slab, 3 in. thick, is pierced for reflectors for nightlighting stands; 42 floodlights on each side light the field. Press box is 109 ft. long

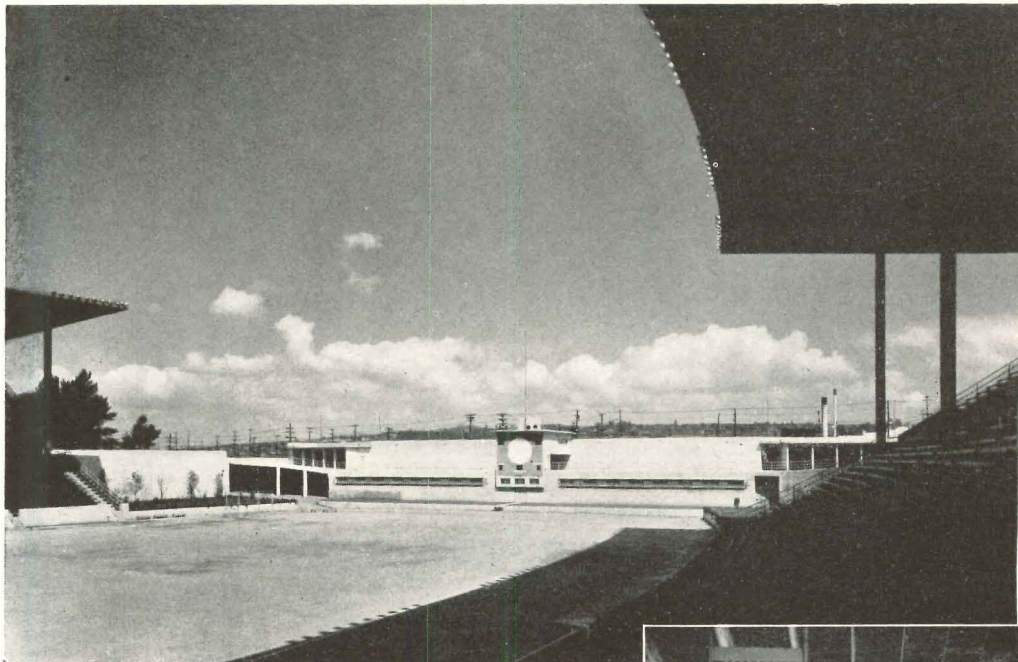

Center portions of north and south stands, also fieldhouse which closes east end, are now completed; stadium is eventually to be extended to form horseshoe enclosing west end

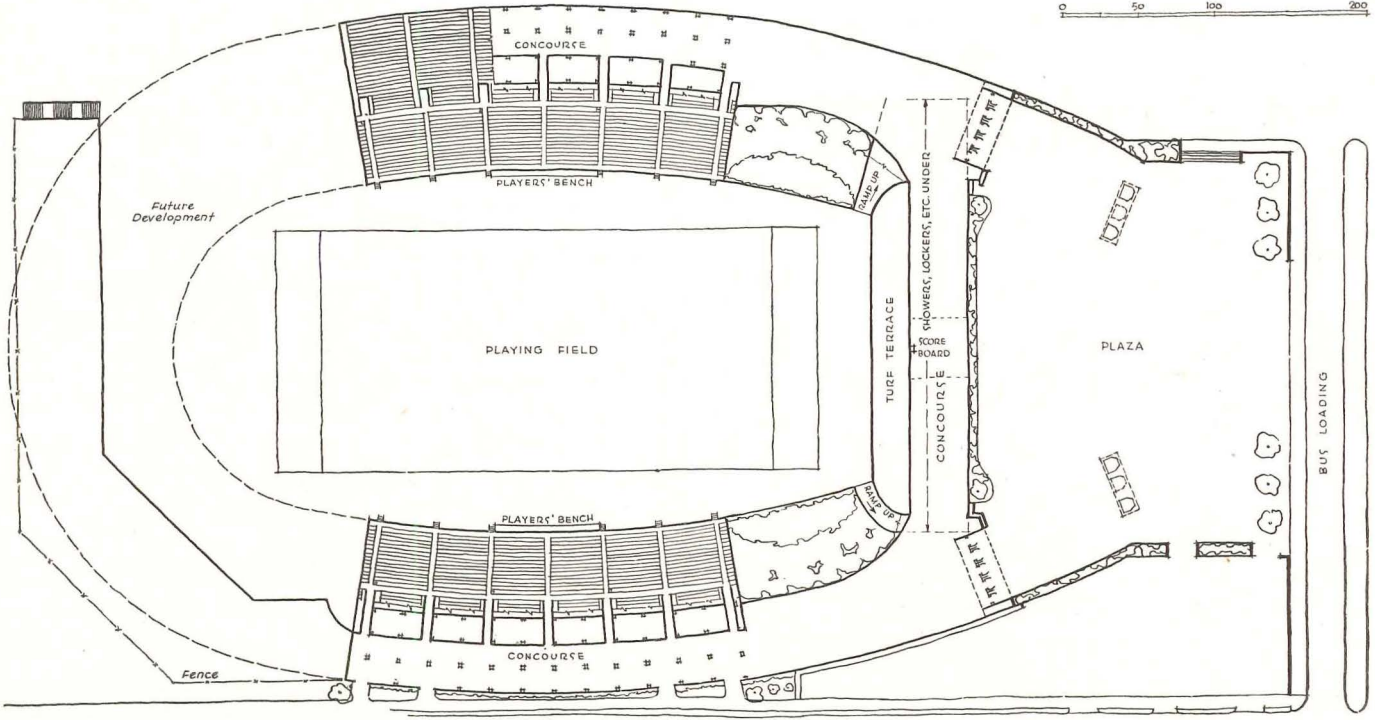
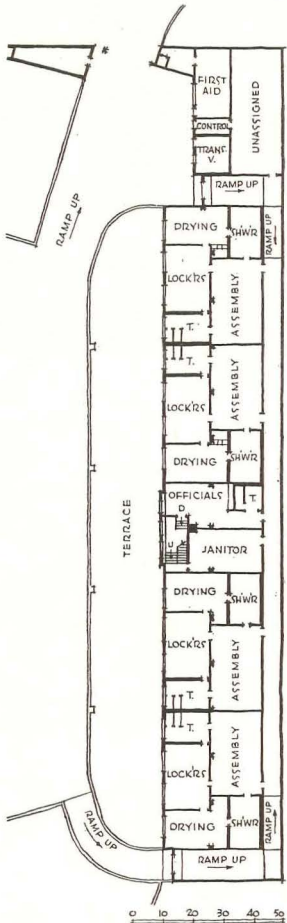

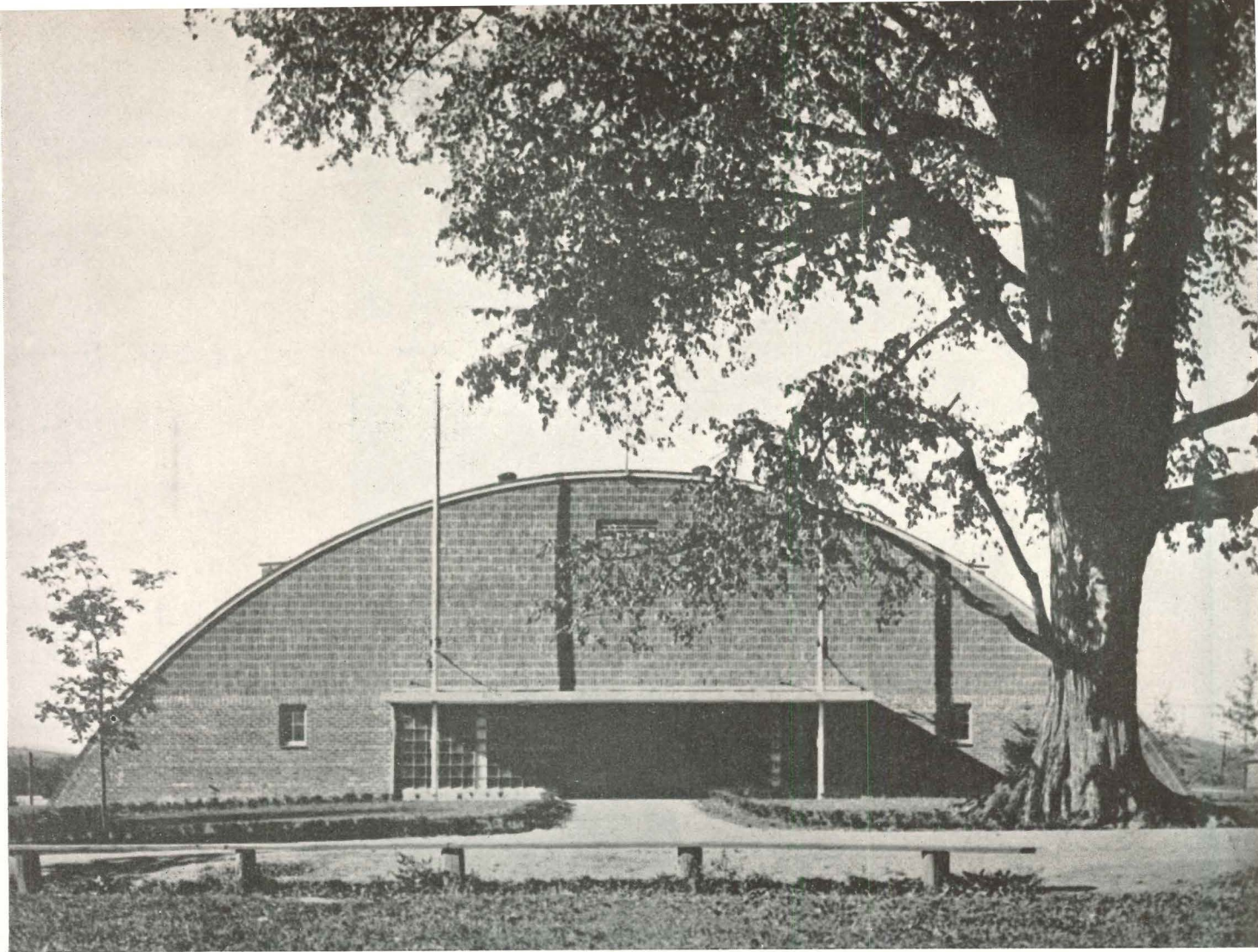

GYMNASIUM, LINCOLN HALL, LINCOLNDALE, N. Y.

Van Der Gracht & Kilham, Associated Architects

THE laminated wood arches which support this gymnasium's roof have a clear span of slightly more than 80 ft., and the under side of the crown is approximately 25 ft. above finish floor. Exterior walls, including the curtain portions between the 2-ft.-thick brick buttresses, are brick-surfaced masonry. The roof is of 2-in. plank, reminiscent of mill construction, which permits the wood arches to be placed nearly 16 ft. on centers. The floor is framed of wood supported on individual posts on footings, a method which provides the resiliency necessary in a gymnasium.

Out of these simple materials, and with a plan equally

uncluttered, the architects have fashioned an unpretentious, thoroughly pleasant building which serves its purpose admirably. Spectators are accommodated on the end balcony and in the space between office and storage room along the west wall. Over the balcony is a movie projection room; the movie screen is suspended on the north wall.

Laminated arches were placed on masonry abutments by means of a simple boom; purlins braced them until the 2-in. plank roofing was applied

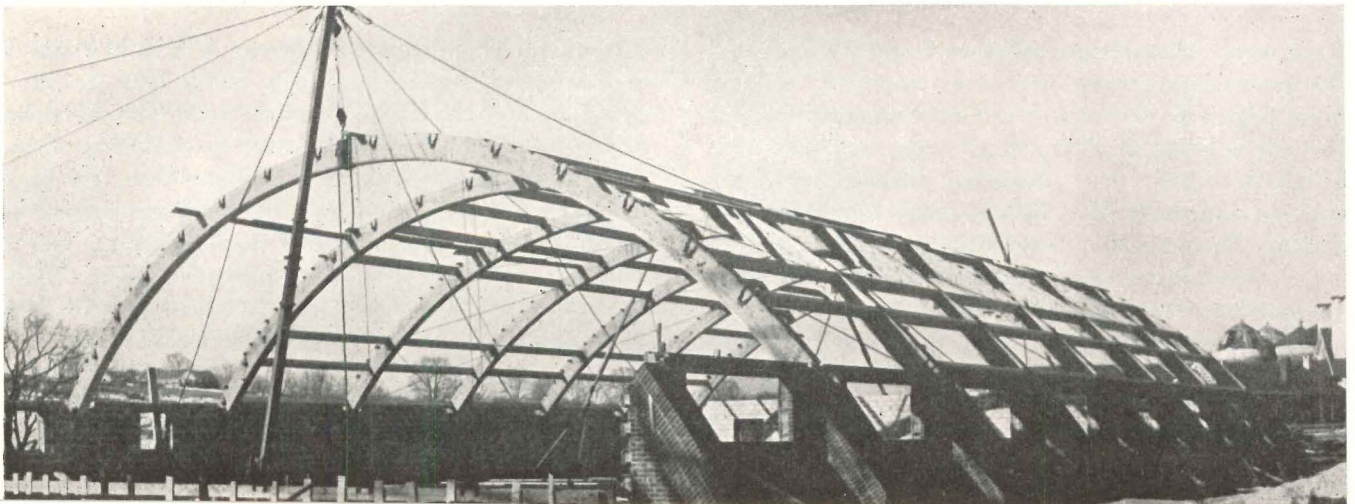
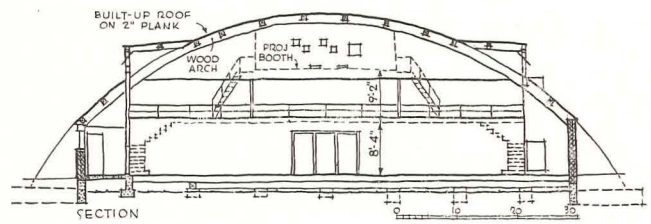
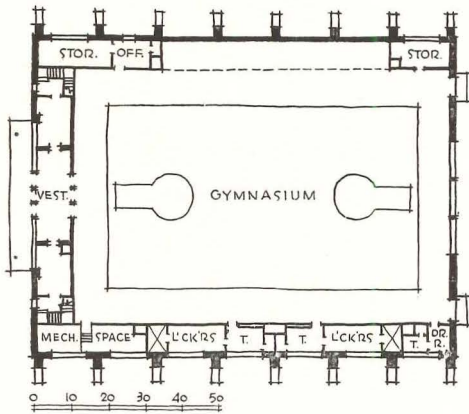

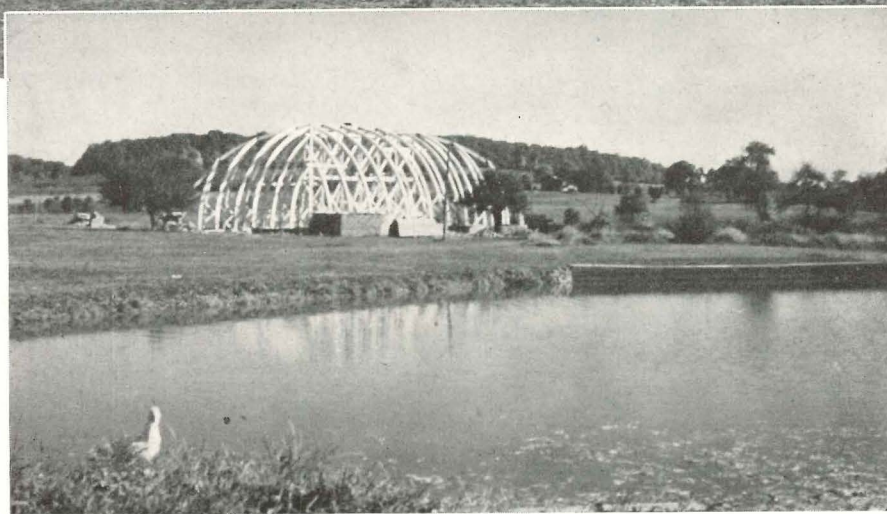

Top Photo: J. H. Melford. Lower Photo: William Hunt

ECONOMICAL STRUCTURE FOR A PRIVATE SCHOOL

GYMNASIUM, SOLEBURY SCHOOL, NEW HOPE, PA.

William Hunt, Designer; Morgan C. Rulon, Engineer

LIKE many other schools, Solebury found that its initial gymnasium scheme was too expensive. William Hunt helped his alma mater find an economical solution to their building problem, which could not have been achieved without the enthusiastic cooperation of the engineer and the builder, Robert Lamb & Son of Philadelphia. There are no non-essentials in this structure; in every respect it is a direct expression of the requirements of function and construction. The laminated wood arches were selected as the most economical means of

spanning the required space; they are bolted, like church roof arches of several years ago, rather than pressure-glued, because the builder found he could fabricate them in his own shop more cheaply than he could buy them. Other economies include the heating system (see page 130) and the elimination from the building contract of partitions, heating, etc., shown surrounding the locker and shower rooms in the accompanying plan. These partitions are being built by the school maintenance staff; heating for these rooms will be installed later.



J. H. Melford Photos

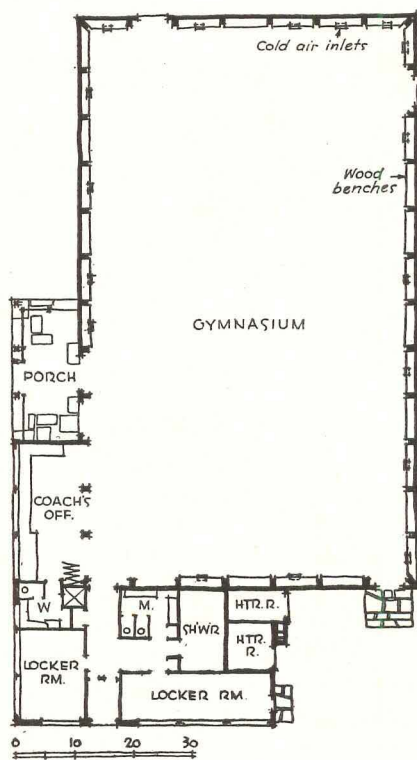

JULY 1949

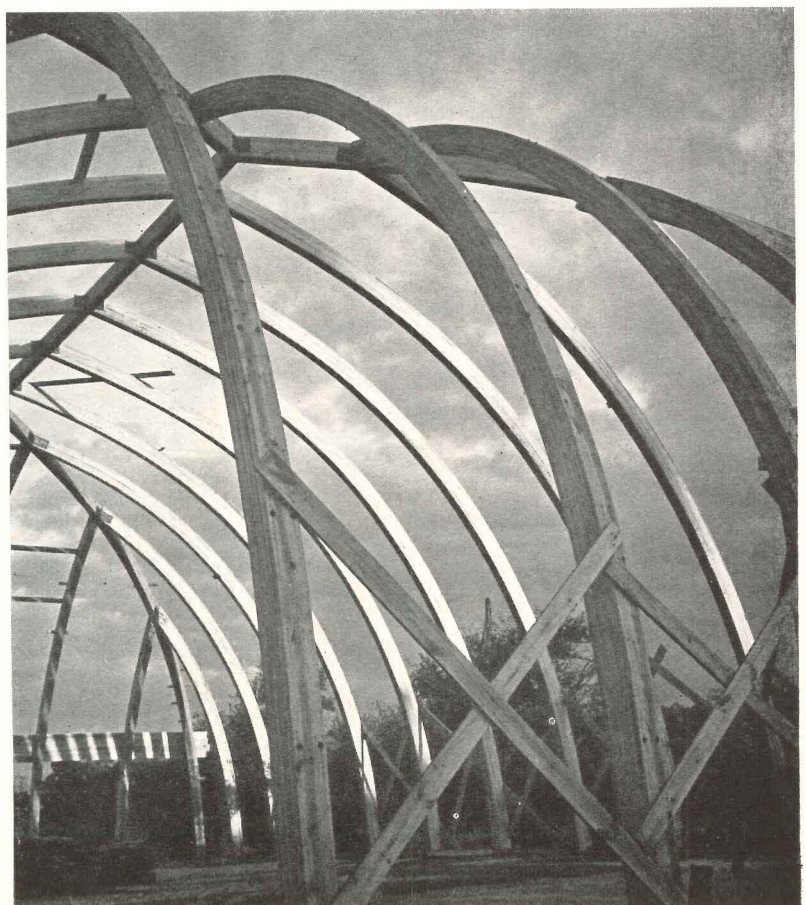

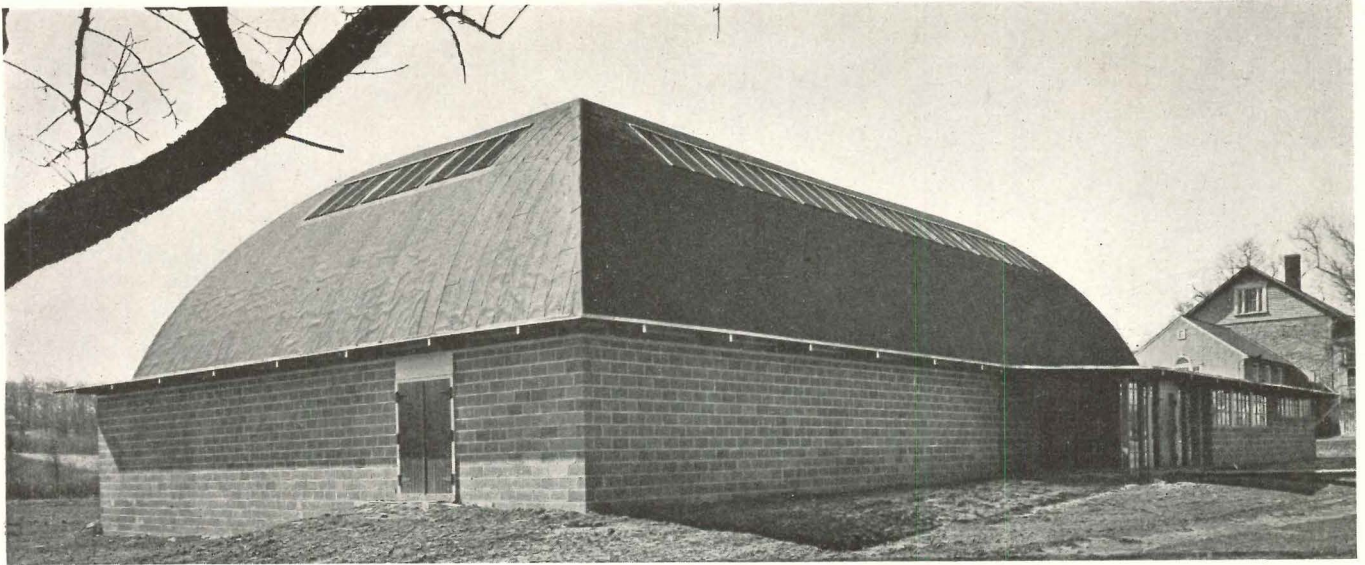

J. H. Melford Photos

The Solebury Gymnasium is heated by a single industrial unit suspended in the heater room at the end of the gym; heated air is discharged through grilles high in the gym wall. Air is returned to the heater through floor ducts around the gym's periphery, through inlets in alternate bays as shown on plan (see page 129). Originally there was an inlet in each bay, but this number was

found to be unnecessary. Tests when the heating system was put into operation showed a maximum air temperature difference of 3° F at opposite ends of the playing floor, taken approximately at head height.

The section below explains the simple structural system, method of tying the laminated arches into the reinforced concrete floor slab, and construction of the concrete-block-walled lean-to which surrounds three sides of the structure, a device which enabled the designer to utilize spaces between the arches for plank seats. This lean-to is extended to cover the entry porch, offices and locker rooms. Total cost, excluding items being installed by the school staff, was approximately \$60,000.

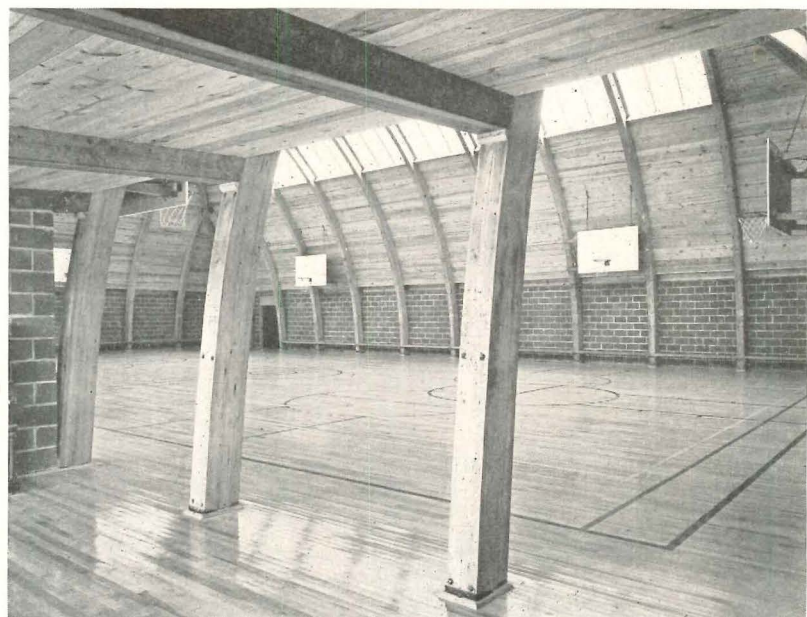
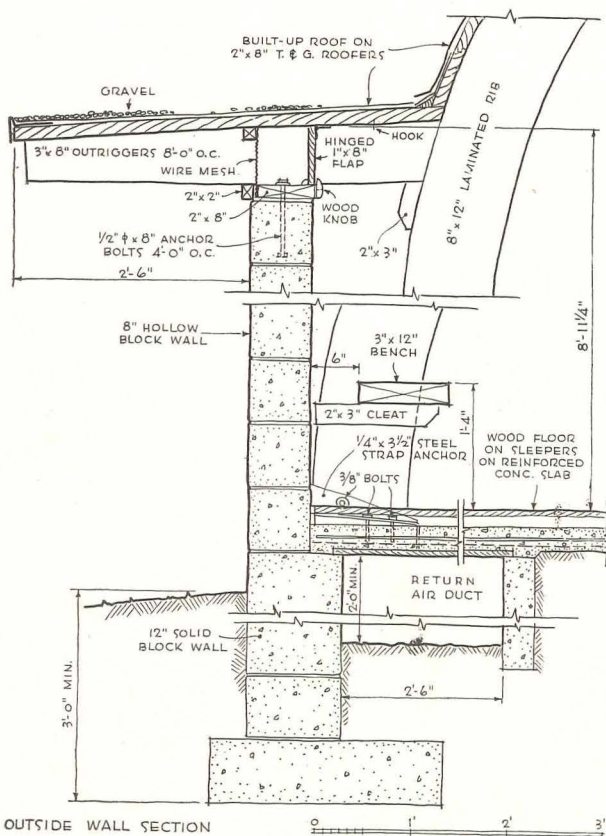

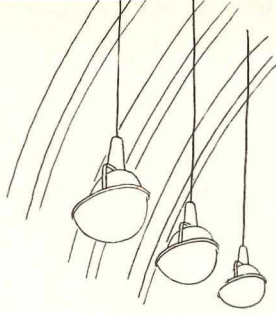

Sold in package form, the 62 by 120 ft. Dynar Recreation Building complete with light and heat generator and insulation, but exclusive of foundations, flooring, and erection costs, carries a price tag of \$25,000; erection cost varies from \$10,000 to \$13,000 at today's prices; operating cost is less than 80¢ an hour

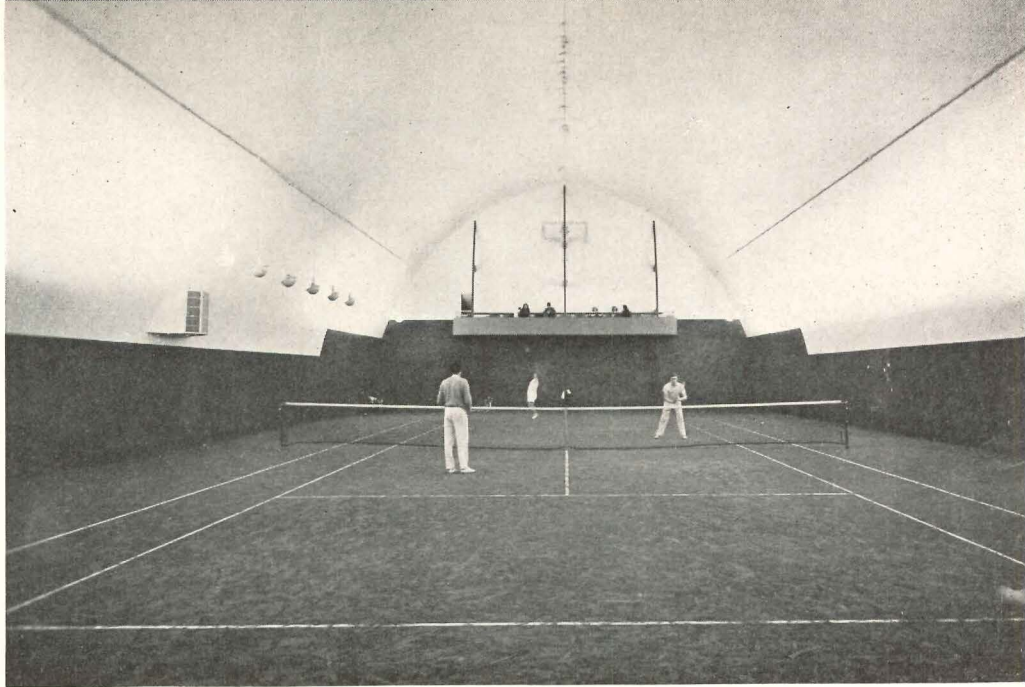

PACKAGED BUILDING FOR GYMNASIUM OR RECREATION CENTER

Dynar Buildings, Dynar Corp., New York, N. Y.

IN 1939 Sherman M. Fairchild, tennis amateur and aircraft designer-manufacturer, wanted an indoor tennis court. Finding that most buildings of this type cost \$75,000 to \$250,000 when built in the 1920's, and \$5 to \$7.50 an hour to operate, Fairchild and another enthusiastic tennis player, Clifton Jones, began the hunt for a more reasonable structure. Glass was first investigated, but massiveness of construction (which means high cost), condensation problems, operating costs, and inadequacy of natural lighting caused this approach to be discarded. High-level, glareless lighting was found essen-

tial, so a windowless, insulated building, lit wholly artificially, was decided upon. An initial tennis building was erected on Fairchild's Long Island estate. During World War II, of course, the idea of a mass-produced building which had emerged from the experiment was shelved. In 1946 the first building was reappraised. In light of war experience, use of aluminum sheets formed in "hat" sections, so that the sheet which excluded weather also became the structural member, was studied. Problems of thermal insulation, acoustical absorption, and condensation arose and were solved;

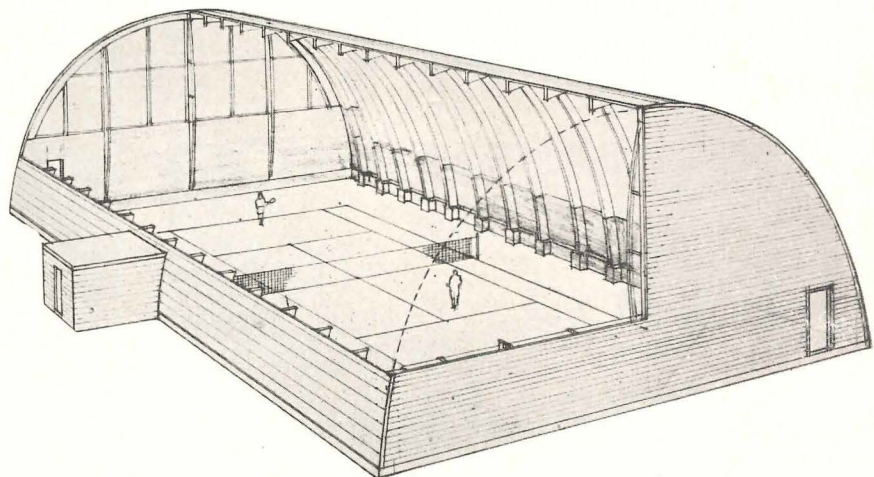

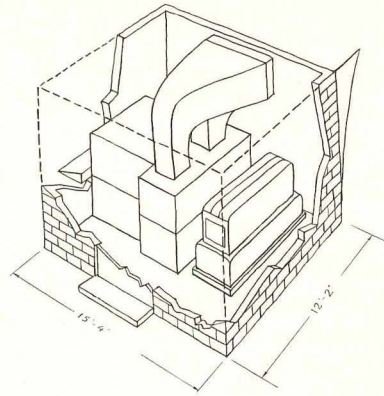
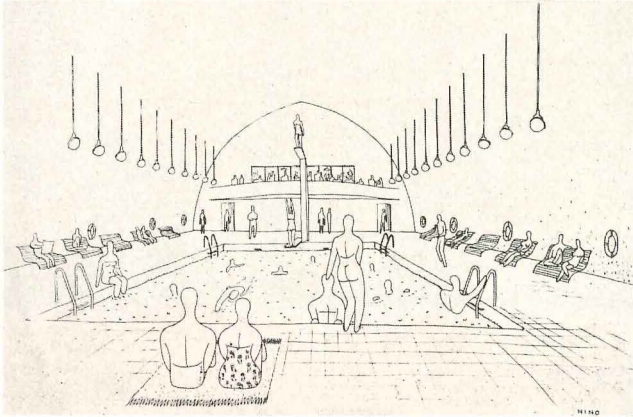
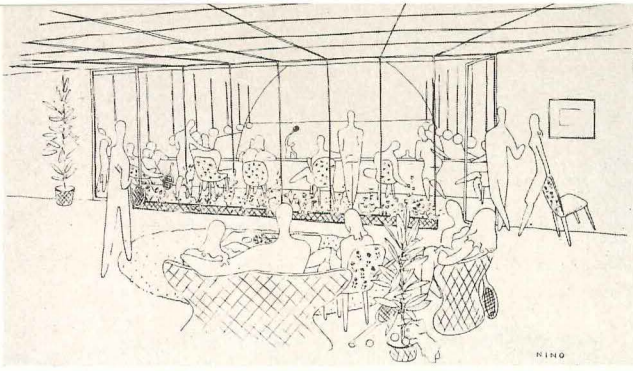

but promising as the method seemed, cost of fabrication proved prohibitive. Attention was then concentrated on arch construction; precast reinforced concrete, rolled steel and rolled aluminum shapes were investigated. The ultimate solution was approaching, but fabricating costs remained beyond reason, at least considering that a true mass market could not be guaranteed. Eventually, after wind load tests (in a wind tunnel) and snow load calculations, after careful determination of the economies attainable at various arch spacings, etc., the present design was determined upon. It consists of laminated, glued wood arches 8 ft. on centers, stiffened and enclosed with 2 in. splined wood planking treated to maintain dimensional stability, and covered on the exterior with aluminum. End walls are bulkheads stiffened by bowstring trusses on end; the whole is much like airplane fuselage construction.

Lighting, designed in consultation with specialists, is provided by 30 special luminaires which produce 40 footcandles at playing level with a maximum variation of 10 footcandles; glare is almost non-existent. The electrical load is great enough so that most power companies would levy a substantial demand charge; hence the building comes equipped with its own generator, gasoline-driven (standard) or diesel powered (optional); being free from road use tax, the fuel is inexpensive. Warm air heating is provided by passing the generator exhaust through a heat exchanger. Air may be totally recirculated, part recirculated and part fresh, or for summer cooling all fresh. The system is designed to warm the building from a cold start — 15 or 20° F — to 68° playing temperature in a little less than one hour. Heating and lighting equipment is contained entirely within the small equipment chamber shown above.

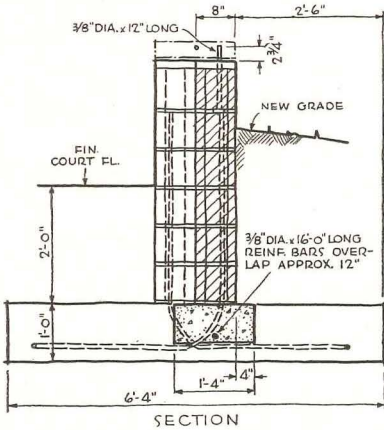

Peak wind loads, up to 105-mile gusts, are transmitted partially through end bulkheads, partially through ribs to foundations shown above. Overturning moment is great; hence wide pier footings. Other sketches on this page, by Nino Repetto, show various uses of the Dynar building; note, below, omission of part of side wall to provide spectator space; above, end balcony hung from bulkhead supports

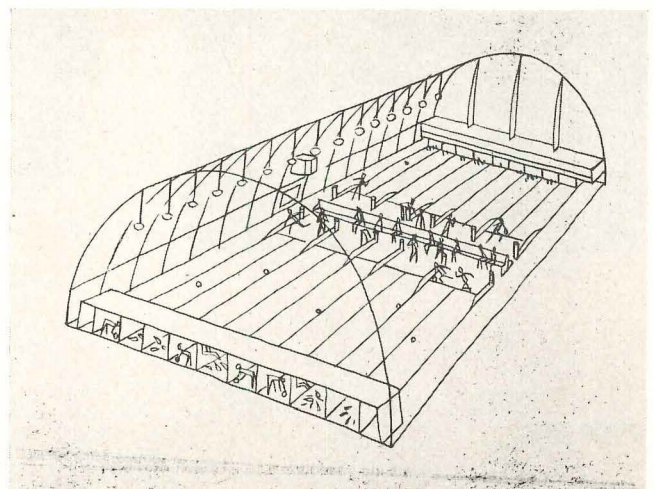
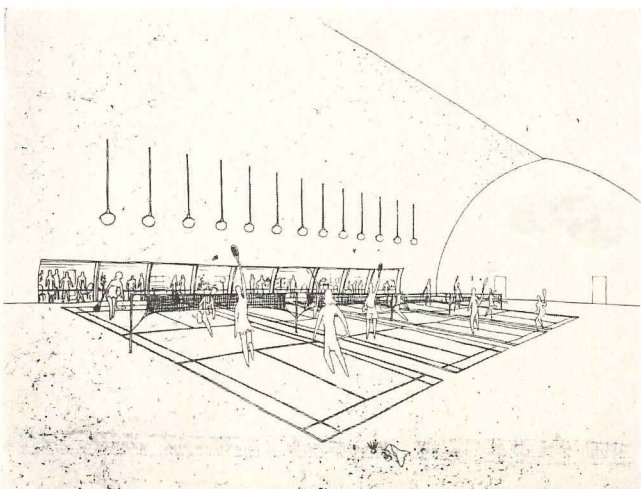

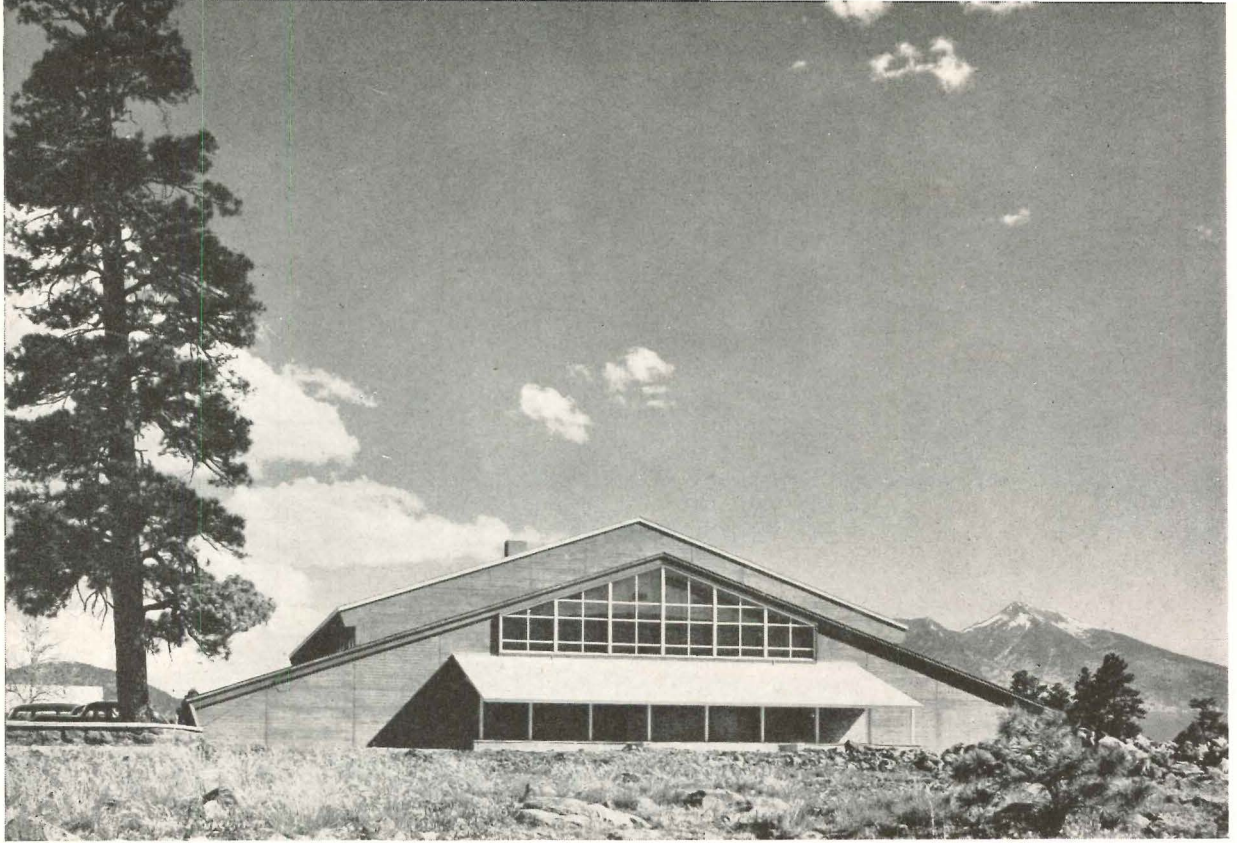

HIGH SCHOOL GYMNASIUM, FLAGSTAFF, ARIZ.

Edw. L. Varney, Wm. F. Cody, Fred'k K. Weaver, Architects; L. W. Wiese, Structural Engineer

THE direct, entirely logical organization of this plan around the central playing floor is deceptively simple. Gym class and home team members can enter at the north end, pick up towels, etc., en route, and proceed to the locker rooms, which are easily supervised from the coaches' offices in the corners. Public entrance at south end has two adjacent lecture rooms which also accommodate visiting teams; these rooms have doors to the locker-toilet-shower suites, and toilets are accessible to entries on east and west sides, so that they may also serve outdoor activities. Public area may be segregated by closing doors at south end of locker room suites. Over locker rooms and main lobby are balconies. Those at the side project 4 ft. over the playing floor and contain concrete bleachers; end balcony contains folding bleachers; additional folding bleachers line the sides of the playing floor. Construction is principally of concrete, with roof trusses supported on $1\frac{1}{2} \times 3$ ft. concrete piers. Roofing is insulating, over wood sheathing; ceilings of main lobby, public corridors, lecture rooms, and playing floor are of sound-absorbent material. Playing floor ceiling is applied to bottom chords of trusses.

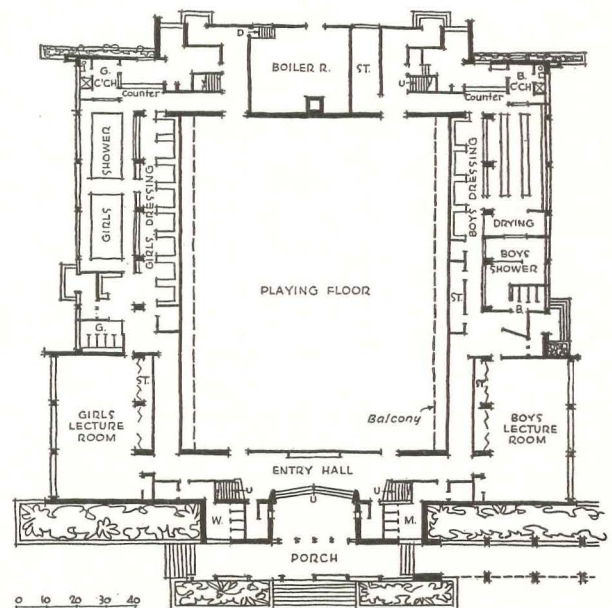



AUDITORIUM-GYMNASIUM, GOSHEN COLLEGE,

Bauer & Eash, Architects

GOSHEN COLLEGE is a coeducational Mennonite institution; its auditorium-gymnasium has to serve several purposes, and simplicity of architectural expression as well as sensible economy were among the basic requirements. The building has been designed to meet the school's daily needs for athletics and recreation, for extra-curricular activities, and for a space in which the entire institution and its connections can assemble. Since so much student interest, in a smaller college, centers around athletic facilities, incorporating a student center in the structure is logical; this is the reason for including the recreation hall, branch post office, bookstore, snack shop, etc., in the scheme. Until this building is completed (expected this summer), commencements, choral programs, etc., are being held in the local high school. Not only will the new auditorium provide a place for these; it also provides space for local Mennonite meetings and for the larger Midwest church community. As an auditorium, the main room accommodates 2,500 people. A folding partition divides the room so one side can be used as a boys' gym, the other for girls. It was decided to omit fixed bleachers, using folding bleachers entirely, to obtain maximum flexibility. Use of the room for meetings entails provision of a large storage space for portable seats and ample coat space. There is no basement except under the stage and at the double-decked locker room area; stairs and corridors at the locker room corner of the plan are arranged for eventual access to a

future swimming pool and to provide separate entrances to gym, athletic fields, etc., for boys and girls. Space under the stage is used for music activities. Construction is steel framing with interior partitions mostly cinder block; ceilings are to be acoustically treated; floors are to be asphalt tile on concrete, except that the finish gymnasium floor will be maple.

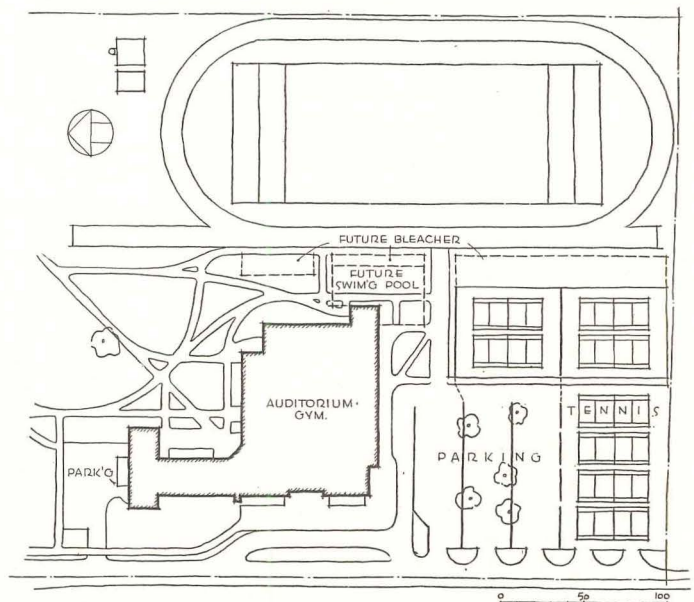

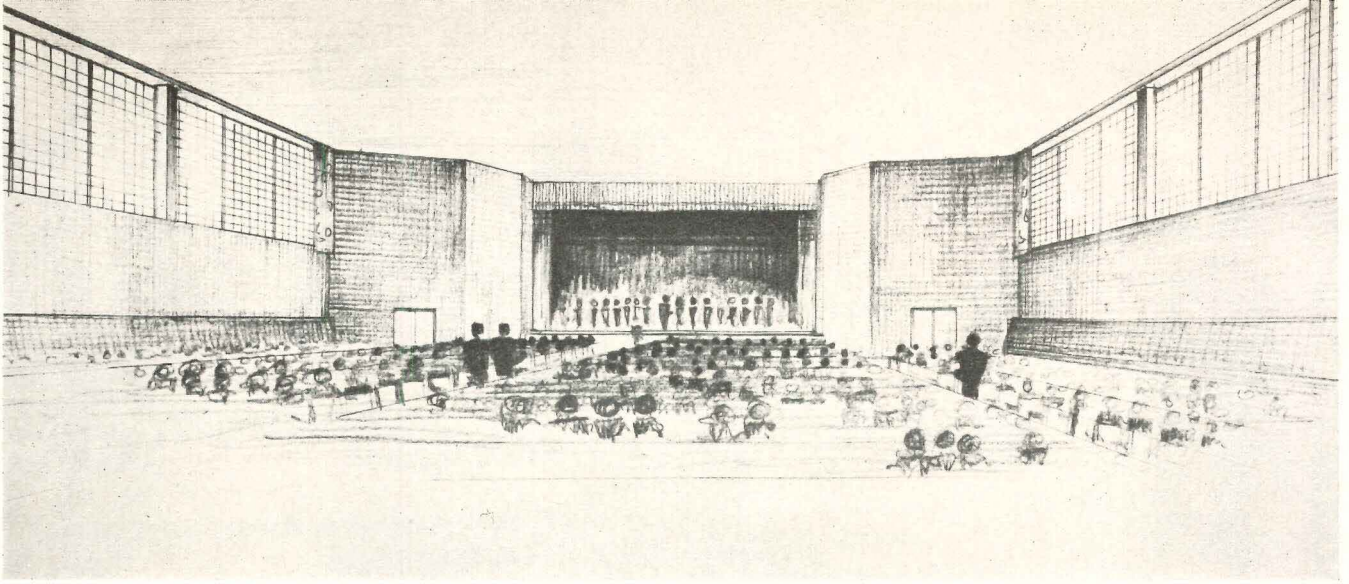

GOSHEN, INDIANA

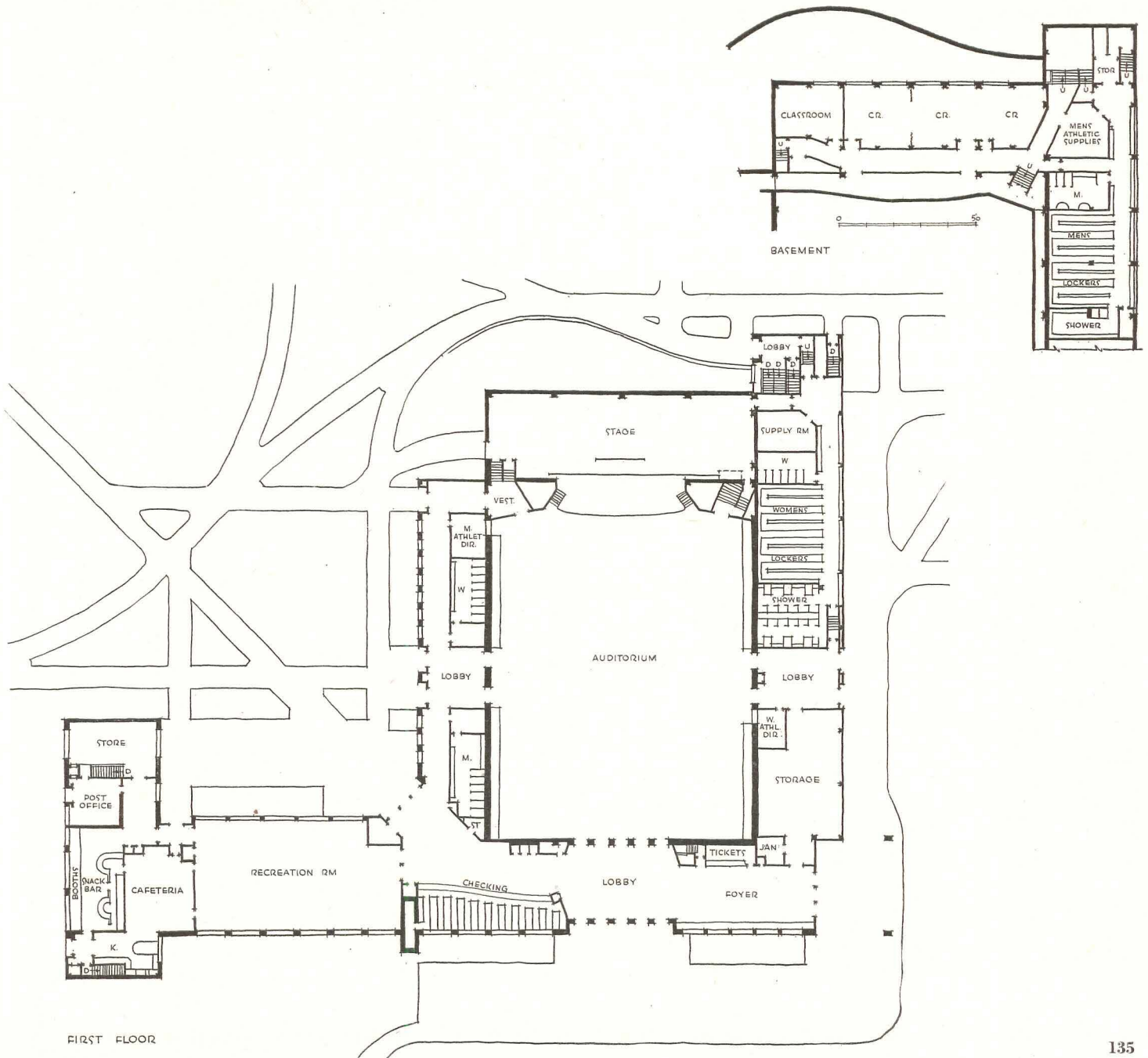

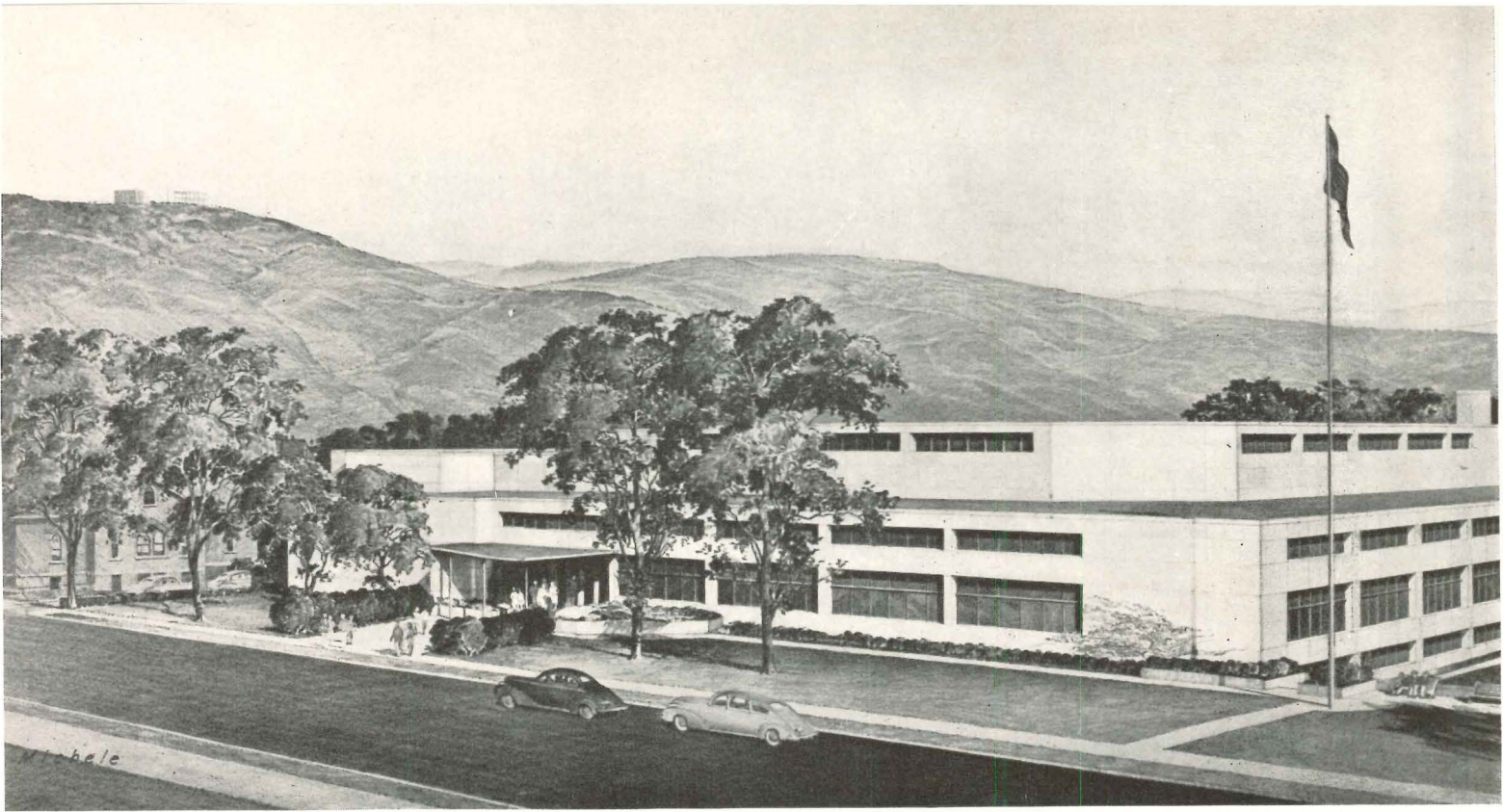

PROPOSED RECREATION BUILDING, WEIRTON, W. VA.

Sponsored by The Weirton Steel Co.

National Recreation Association; Donald L. Kline, Planner

Caleb Hornbostel, Architect

As an example of organization of many different types of activities and functions called for in a contemporary recreation building, this is one of the most complete and most ingenious. The site is sloping; full advantage is taken of this fact in the organization of the several units as well as in providing direct circulation for both the public and the building's operating staff.

The program called for a large arena-type gymnasium, swimming pool with bleachers, locker-dressing suites for both, a theater with the necessary appendages, dining facilities and kitchen, a fair-sized library, arts and crafts room, bowling alleys, billiard room, outdoor space for children's play, an administrative suite, and the usual toilets, checkrooms, etc., for audiences. To combine these in one building, a designer often must sacrifice convenience in the case of one or more of the required units, but few flaws of that kind can be found

here. True, the kitchen is an interior space; however, mechanical ventilation would be required in any event, and the dumbwaiters (one for waste disposal, another serving second-floor meeting rooms as well as extending to the basement) and the service entrance leading directly to the side street are quite efficient. Equally satisfactory are service entrances to both stages — one for the theater and one at east end of the arena; see plans on page 138. From either the main entrance or several secondary entrances, athletes, actors, and those concerned with producing the various functions can proceed to their dressing rooms or work spaces without traversing public areas. From the main lobby, the public can go directly to basement billiard room or bowling alley, to first-floor lounges, dining rooms, theater, or library, or to second-floor meeting rooms or theater balcony.

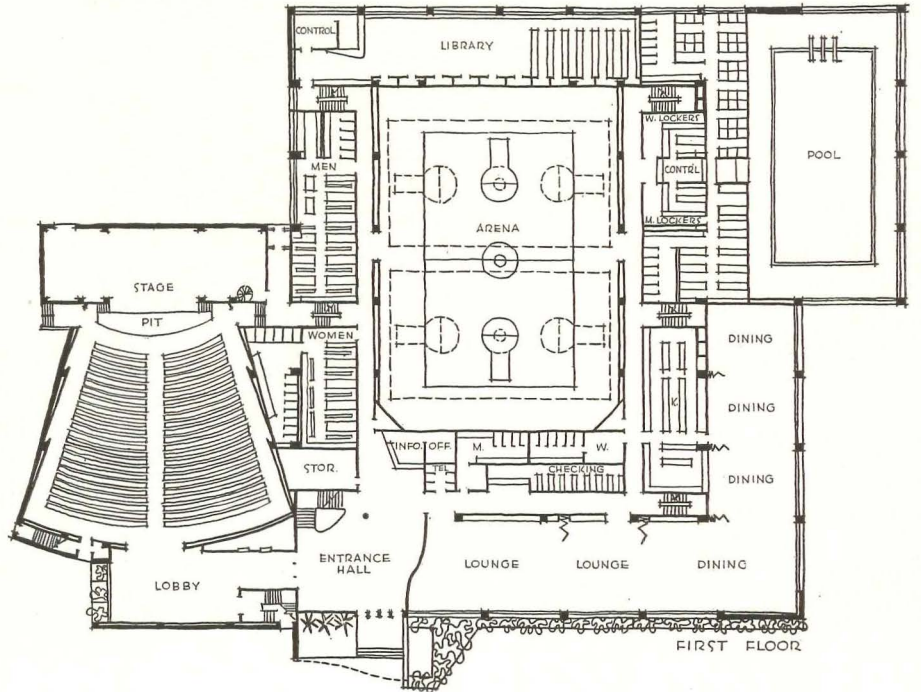
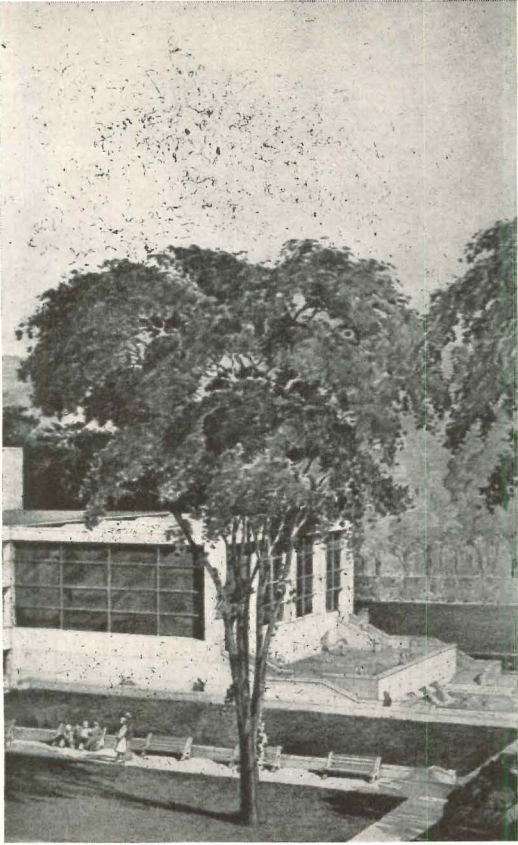

Section helps explain the ingenious use of intermediate levels and of space under the arena seating, where vomitories and corridors are located (see also plans on next page)

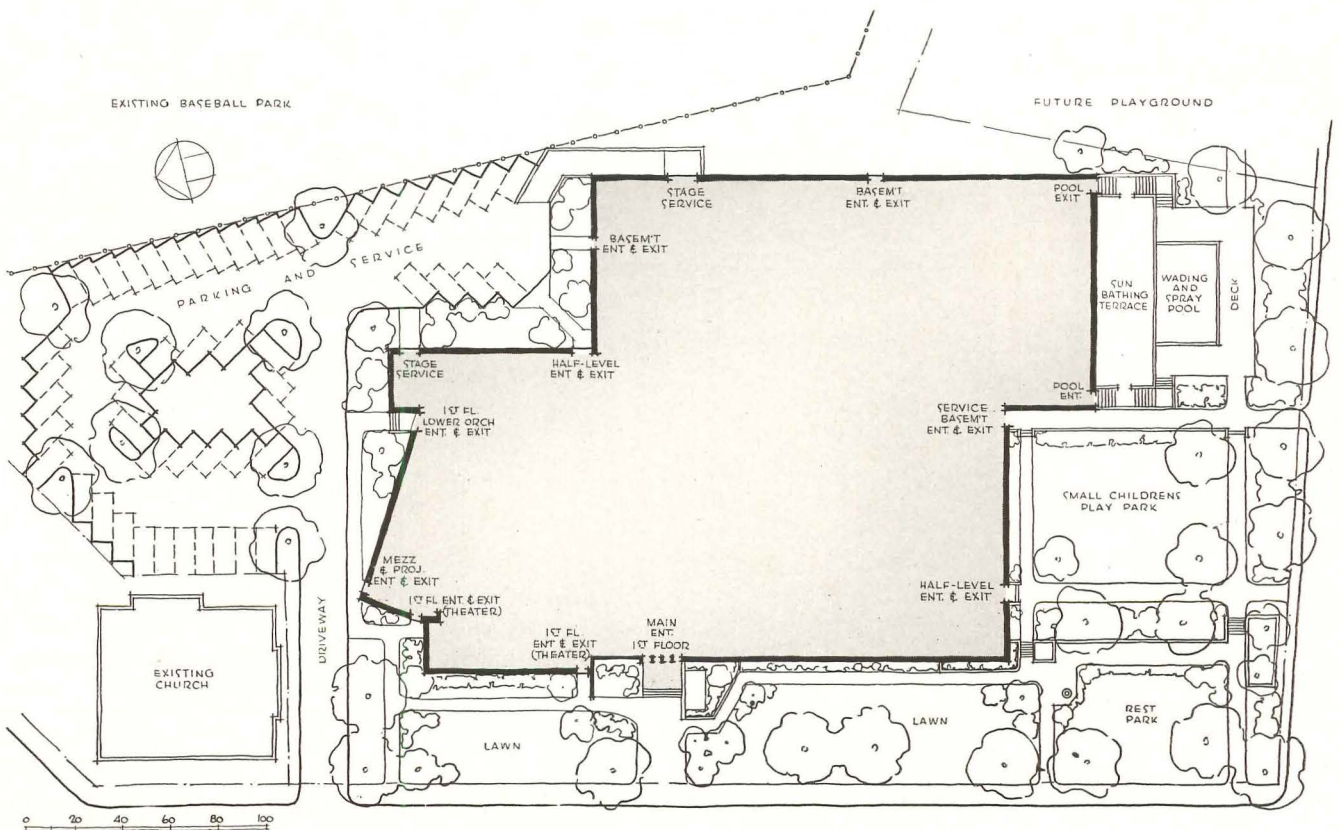
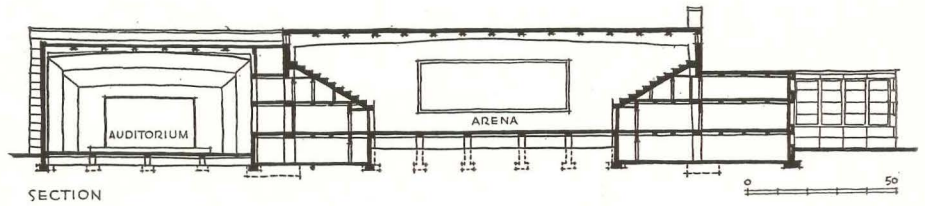

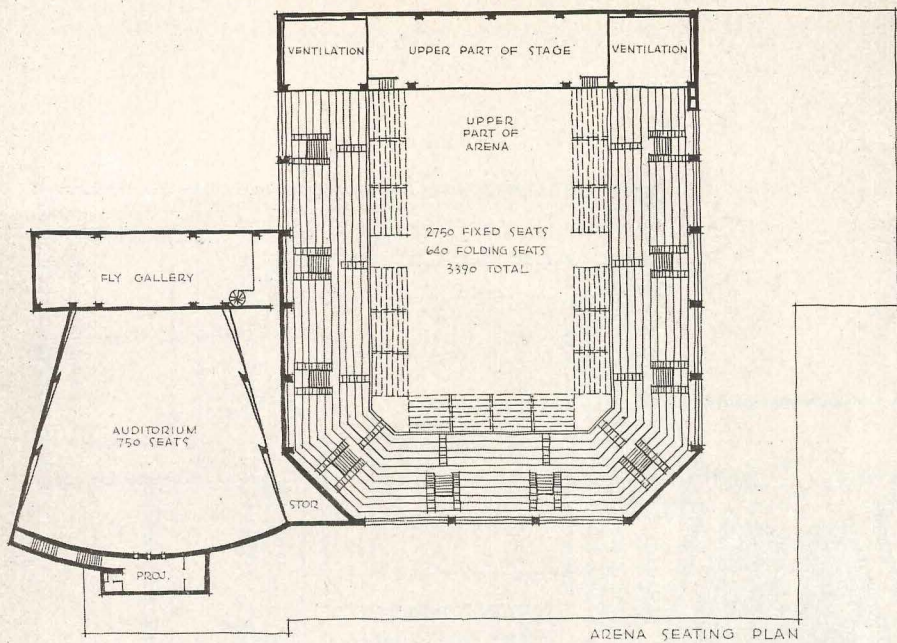

The arena-gymnasium of the Weirton Recreation Building has a combination of fixed stadium seating with vomitories halfway between top and bottom rows, and folding bleachers to be set on the arena floor

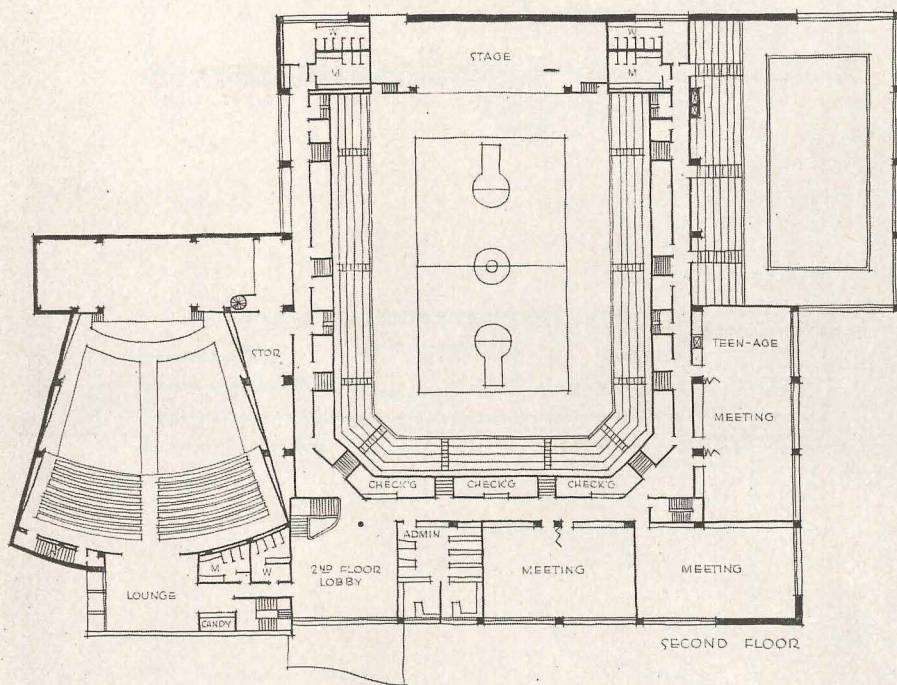

Second floor plan shows circulation under stadium seating, arena stage for pageants or large community meetings, bleachers for swimming pool audience, meeting rooms for adolescents and adults, and administrative offices

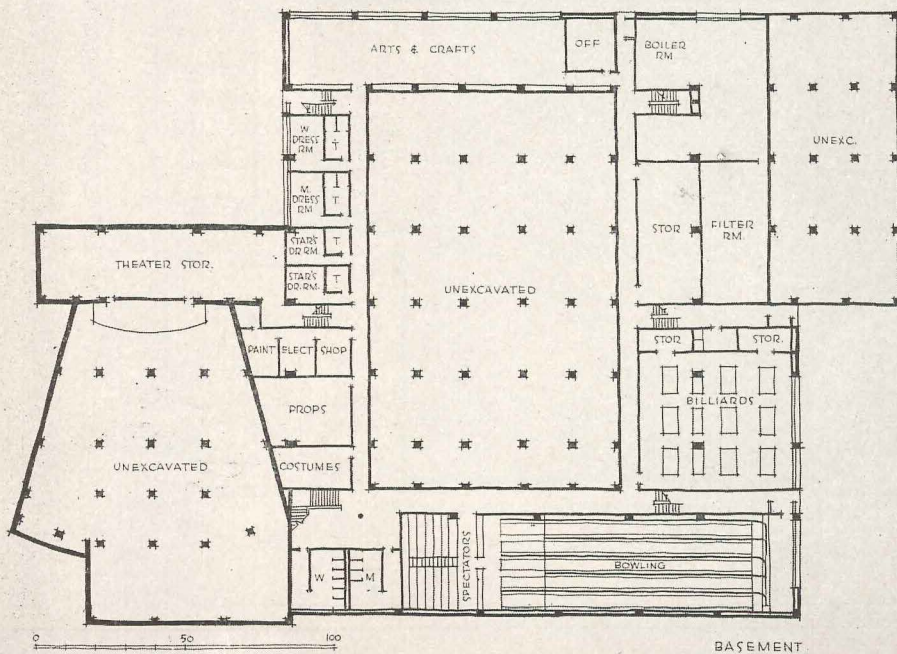

In basement, mechanical plant is located between two areas most difficult to service: arena and swimming pool. Theater has scenery, electrical, prop, and costume shops

ULTRAVIOLET AIR SANITATION

Efforts to reduce the toll of airborne diseases have been resolved in two different methods of air sanitation. The first method to be developed, ultraviolet light irradiation, is described in this article. Next month, air sterilization by a chemical vapor, triethylene glycol, which has only very recently been applied commercially, will be described.

by L. J. Buttolph

Engineering Division, Lamp Department
General Electric Co., Cleveland, Ohio

EACH winter respiratory diseases take a terrific toll in lost working time, doctor and medicine bills and in just plain discomfort. During the summer when people are outdoors more and leave windows open, colds and other airborne infections decrease greatly. So it is believed that for the prevention of respiratory diseases indoors in winter, an air purity such as that of summer living must be provided. This could be accomplished by having 60 to 120 fresh air changes an hour, but such high ventilation rates are not practical from the standpoint of draft, noise and cost.

Tests have shown that the equivalent effect of these high ventilation rates can be obtained by disinfecting the air with ultraviolet light from germicidal lamps. The germicidal effects of ultraviolet light have been known and used for 40-50 years. They are now of renewed interest because of the recent availability of sources having 5-10 times the efficiency of older ones and of a form adapting them to the entirely new application of air disinfection or sanitation.

Acceptance of Air Sanitation

The Council on Physical Medicine of the American Medical Association has accepted the use of germicidal lamps in hospitals on the basis of tests in infant wards. Even such general respiratory diseases as colds and influenza have been reduced by as much as 25-35 per cent in Navy barracks and institutions where it is possible to provide disin-

fecting air most of the time the subjects are indoors. Continuing studies in schools indicate that the spread of such respiratory diseases as measles and chicken pox is modified to the extent of prevention of epidemic or explosive spread of those diseases. It is believed that the spread of colds and influenza is similarly prevented in the school rooms even though they still spread outside of the schools to mask the school prevention. Ultraviolet air disinfection is being used in many schools, offices and factories as a general sanitary precaution in much the same spirit in which natural ventilation, smothering of coughs and sneezes, a minimum of drafts, adequate clothing, dry feet and sleep are all emphasized during the winter respiratory disease season. Even in such public places as theaters where there is no possibility of statistical evidence of value, because of the small amount of individual time spent there, partial sanitary ventilation is being provided in newer theaters by two or three times the usual mechanical ventilation. This again is a sanitary precaution along with improved dust disposal.

The American Public Health Association has a Research Subcommittee on Air Sanitation and the American Society of Heating and Ventilating Engineers has a Technical Advisory Committee on Air Sterilization, and in a recent survey of membership interest its Research Committee found this subject sixth among 33, being exceeded in order of interest only by such timely subjects as radiant heating, radiant cooling, the heat pump, noise control and odor control.

A comparable British interest in air sanitation is indicated by a comprehensive paper titled "Methods for Maintaining Bacterial Purity of Air", by R. E. O. Williams of the Central Public Health Laboratory, *Journal of the Institution of Heating and Ventilating Engineers*, Vol. 16, No. 162, January 1949.

What Air Sanitation Is

While all air cleaning is doubtless of sanitary significance the terms "air sanitation" and "sanitary ventilation" seem to have been preempted to describe air purification for the specific purpose of reducing the spread of disease or the contamination of products. To be of significant sanitary value, ventilation must be equivalent to that of summer outdoor and indoor living and so, for example, 10 to 20 times the ventilation rate that is minimum for odor control and maximum for economy in school rooms, 5-6 air changes per hour (30 cfm per child). The problem is not, however, the simple one of cleaning up the air in vacated rooms but the dynamic one in crowded rooms of killing or removing the bacteria and viruses as

1

Ultraviolet lamps installed inside air ducts disinfect recirculated air, providing an equivalent of 20-30 fresh air changes per hour

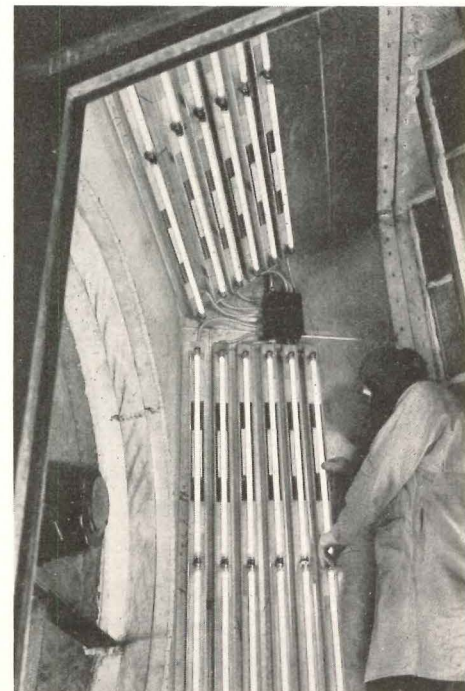

rapidly as they appear from the noses, throats, handkerchiefs and clothing of the room occupants. Specifically it is the problem of maintaining such a condition that no one disease germ has a chance of being alive or in the room more than a minute or two instead of the 30 or more minutes possible with usual good ventilation. The dynamic condition is difficult to show graphically but the theoretical rates of air decontamination in a vacated room, Fig. 2, are instructive.

There has been recent publicity of the sanitary value of sunlight, even after transmission through ordinary window glass, based on British studies of dust contamination in typical hospi-

tal rooms with and without direct sunlight exposures. While it is true that hours of exposure even to filtered sunlight significantly reduce the contamination of the floor dust, this effect is less even than that resulting from the small amount of germicidal ultraviolet reflected downward from the ceiling of any installation of germicidal lamps for disinfection by the upper air method.* Fig. 3 is instructive as to the relative germicidal effectiveness of the 2400-2800A† wavelengths (germicidal lamps

* Carl Erikson reported in the May RECORD ("Tomorrow's Hospitals") that the germicidal lamp can be used to sterilize inside areas more effectively than any amount of sunshine through windows.
† A, symbol for Angstrom unit=one-hundred-millionth of a centimeter.

95 per cent 2537A) and the visible 4000-7000A wavelengths, a ratio of about 10,000 to 1, requiring exposures of hours instead of seconds for comparable germicidal effects.

How Air Sanitation is Accomplished

It is probable that the sanitary ventilation requirement varies about inversely as the cubic feet of space per occupant, which means that in places where there may be 2000 to 3000 cu. ft. of air per occupant as in the home or in spacious offices, instead of 200-300 cu. ft. per person as in standard school rooms, one-tenth as much ventilation may be needed, and 6-12 air changes per hour may be sufficient and practicable although seldom supplied by ordinary ventilation. Sanitary ventilation for various degrees of crowding or occupancy may be by a direct disinfection of all the air by germicidal ultraviolet or germicidal vapors, by dilution with outdoor air, which practically never carries human disease organisms no matter how polluted it may be otherwise, or what amounts to the same thing, by dilution with disinfected recirculated air. Disinfection of a part of the air to be used as a diluent of the remainder, may obviously be by filtration, washing or ultraviolet irradiation. Filtration has not been practical because the more important components of the bacterial population are too small in size to be effectively removed without the use of filters impractically oil wet or of impractically high resistance, or both. Although relatively effective when exceptionally well maintained, electrostatic air filters can be justified for air disinfection only when secondary to an essential removal of dust. Air washing has not been practical because of the impracticality of changing water often enough to prevent it from returning to the air as many bacteria as are removed (interesting cases of air contamination have resulted from the use of contaminated water for air humidification and washing).

Top: theoretical rates of air disinfection in a vacated room. High air change equivalents are attained with ultraviolet lamps. Bottom: illustrates relative germicidal effectiveness of ultraviolet (up to 3800A) and visible light

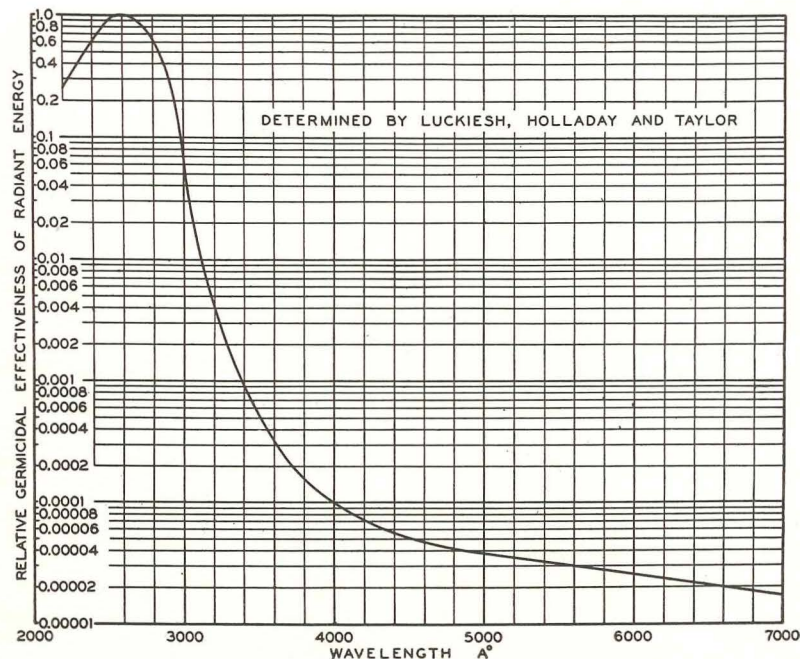
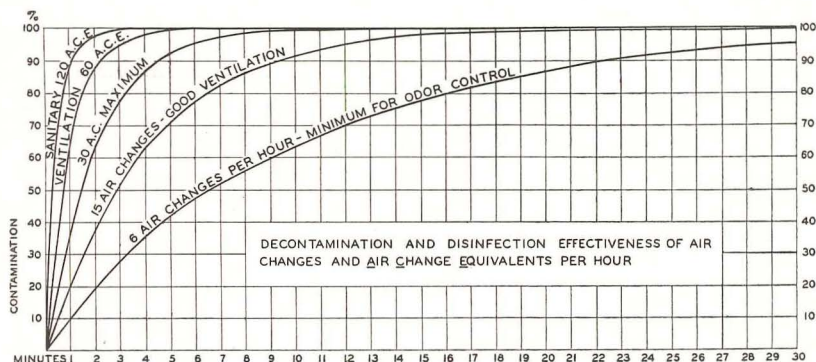

to an infant's continuously exposed face, less than 0.1 ultraviolet milliwatts** per sq. ft., are of a limited value, comparable with that of sunlight filtered through window glass, and equivalent to about 2-3 air changes per hour in reducing the air-borne germs in hospital ward rooms. Intensities tolerated on adult faces exposed 7-8 hours per day, less than 0.5 ultraviolet milliwatts per sq. ft., are of somewhat more value, comparable with direct sunlight perhaps, and equivalent to about 10-15 air changes per hour in a school room. Added to the usual five natural air changes provided by door and window leakages and by the usual make-up air in air conditioning the total of 15-20 may be of sanitary value in uncrowded offices and places of transient occupancy.

Where such places are also served by air heating or conditioning ducts, ultraviolet disinfection of all the recirculated air is of even more value, and equivalent to a total of 20-30 air changes per hour. An ultraviolet intensity sufficient alone to provide the air disinfection equivalent of 60 air changes per hour (2-3 ultraviolet milliwatts per sq. ft.) could be tolerated on the average face for only about one hour. Where ceiling heights permit, it is possible, however,

** A typical, commercially available 30-watt germicidal lamp and its ballast taking approximately 40 watts electrical input will produce 7 watts of germicidal ultraviolet.

to obtain a considerably more effective and economical sanitary ventilation by the upper air method to be described later.

Air Disinfection in Ducts

Contaminated air recirculated in ducts may be disinfected there by ultraviolet irradiation or by vaporization of glycol. Ducts provide a convenient place from which to vaporize and distribute glycol vapor but the air disinfection there is of little value compared to that secured in the rooms served when the glycol content has been built up nearly to saturation. Ducts also provide a convenient place to install germicidal tubes providing ultraviolet intensities high enough, 3-10 ultraviolet watts per sq. ft., to completely disinfect all the duct air in the fraction of a second of passage through the irradiated zone, usually a plenum chamber. It is important to note, however, that in the rooms served by such ducts the air disinfection is limited strictly to the dilution provided by the disinfected duct air. Insofar as any sanitary value may have been credited to the usual provision of make-up air, that value is increased about five-fold by disinfection of the recirculated air.

For ducts whose greater dimension does not exceed the lesser by more than 50 per cent, and with nonreflecting

walls, the ultraviolet watts for a theoretical 99 per cent disinfection of respiratory disease germs and viruses is shown on the Haynes' chart, Fig. 4. Relative humidities in excess of 65 per cent and extremes of air temperature increase the ultraviolet requirements.

The number of germicidal tubes required may be determined by dividing the total watts by the average-through-life rating in ultraviolet watts of any commercially available germicidal lamp. The chart may be interpolated and extrapolated by noting that the ultraviolet watts required are directly proportional to the cubic feet per minute and inversely proportional to the lesser dimension of the duct.

In the frequent case of flat ducts having one dimension two or more times as great as the other there should be reference to more detailed methods of calculation available elsewhere, but the maximum tube requirements may still be determined from the preceding tables by subdividing the duct and the air capacity so that the dimensions of the subdivisions fall within the range of the tables.

The mechanical details of a germicidal tube installation follow closely those of the dust-filter installation and it is anticipated that manufacturers will provide similar standard-unit assemblies. Although there are many ways of in-

Left: ultraviolet energy requirements for duct disinfection. Right: schematics of suggested germicidal lamp installations in air ducts

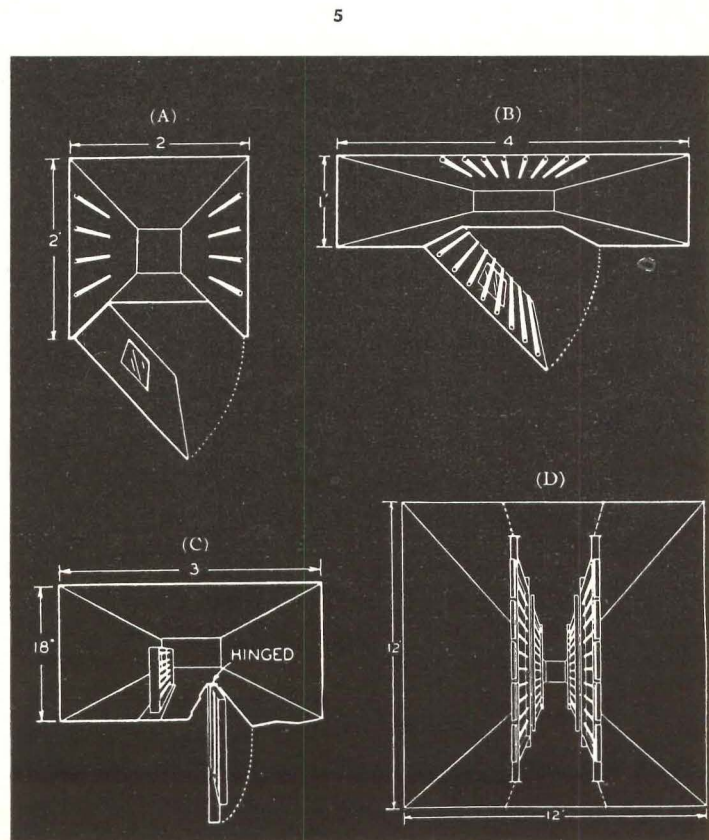
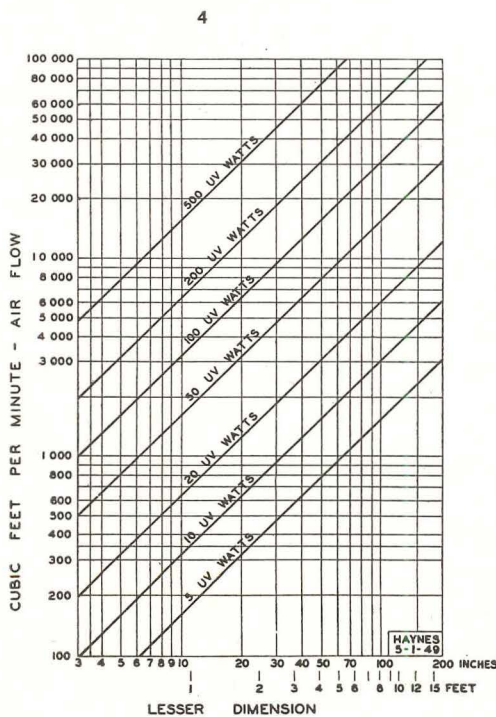

stalling germicidal tubes in air ducts, the best compromise in small ducts is by placing them lengthwise on the duct wall, on 4-to 5-in. centers grouped in the center half of the duct walls and out of the corners of rectangular ducts. The duct walls near the tubes and the duct in both directions from them should be of polished chromium plate or aluminum if the conditions are such that the reflective duct walls can be easily cleaned whenever the lamps are cleaned. Since the germicidal tubes must be kept reasonably free of dust, there must be convenient access for cleaning. This usually can be arranged by hinged panels on the sides or the bottom of the duct, and, if necessary, the tubes may also be mounted on these panels as well as on the stationary duct walls, Figs. 5A and C.

In large ducts and plenum chambers germicidal tubes may be assembled like the rungs of a ladder in vertical frames supported out in the center of the chamber in whatever series or multiple ar-

rangement best fits the local conditions and provides access for cleaning and replacement, Fig. 5D. In very large ducts, where the air speeds are relatively low, the tubes should be so placed, when possible, as to provide a maximum average distance from the tubes to the duct walls in directions perpendicular to the tubes, and regardless of the direction of air movement.

There is a special installation problem in case of flat ducts which may have one dimension four to six times the other. Such a duct cross-section limits the effectiveness of the tubes not only in proportion to the lesser dimension, but also because little of the duct volume beyond the actual location of the tubes is useful for air irradiation. In such cases the tubes should be distributed only over the longer duct wall shown in Fig. 5B.

Fig. 1 shows a typical large duct installation providing a total of 120 ultraviolet watts, average through tube life, from germicidal tubes placed adjacent to the dust filters.

"Upper Air" Method

The free convection in rooms, basic to all warm air heating without forced convection, is by random intramural air currents at velocities of 5-25 ft. per minute or 1-6 in. per second. This imperceptible air movement through a horizontal plane 7 ft. from the floor, for example, is remarkably effective in providing an interchange of air between the room volumes above and below that plane and amounts to an air change per minute or 60 air changes per hour, in the lower air, at an average air velocity of less than 15 ft. per minute (3 ft. per sec.). This may be a difficult concept for those who associate one-tenth that rate of air change with duct air velocities 10-50 times greater.

If it were possible to have all fresh air above the 7-ft. level, with same air interchange as described above, the sanitary ventilation of the remaining lower part of the room would be provided. The bacterial equivalent of this condition can be approximated by ir-

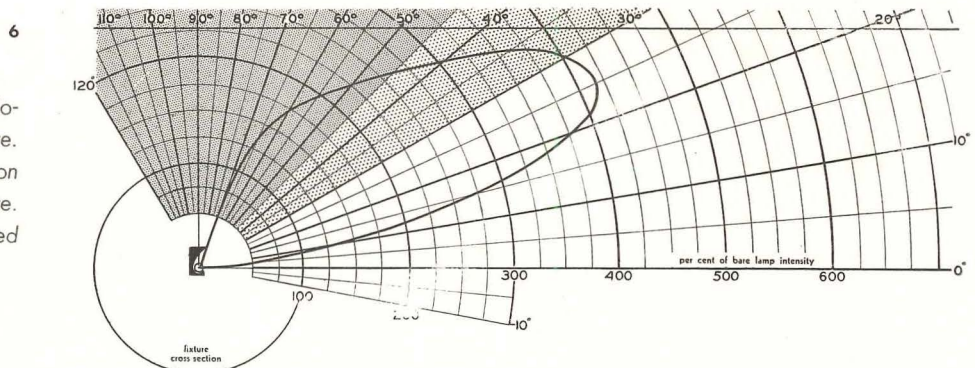
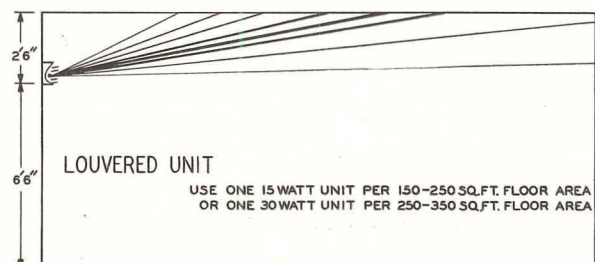

Fig. 6: spatial distribution of ultraviolet light from a typical louvered fixture.
Fig. 7: typical hospital ward installation with louvered ultraviolet lamp fixture.
Fig. 8: installation schematic of louvered fixture, showing correct height



radiating the upper air with ultraviolet of an average intensity of 20 ultraviolet milliwatts per sq. ft. That keeps the average bacterial content down to a few per cent that of the lower air which has already been diluted to a low bacterial content by the reciprocal process of disinfection above and dilution below the effective level of the ultraviolet sources.

Recent studies by M. Luckiesh and Associates have shown dramatically the effectiveness of this two-stage process of air sanitation. They did continuous air sampling of the irradiated upper air at an 8-ft. level and of the diluted lower air at a 4-ft. level, during continuous air contamination, in excess of that humanly possible in a crowded room, by atomization of diluted sputum. The instant the irradiation began, the concentration of bacteria in the upper air dropped rapidly to an undetectable level in about 20 seconds and remained there in spite of the continuous contamination from below, Fig. 9. This disinfection of the upper air made the air interchange immediately effective in diluting the contamination below, to equilibrium at a low level of less than 5 per cent the initial contamination in about 10 minutes. Thereafter this air disinfection by dilution, of over 95 per cent, was maintained indefinitely in spite of the continuous contamination by atomization.

These laboratory results can be duplicated with practical installations of commercially available equipment usually mounted 6½-7 ft. from the floor on side walls or columns. Combined germicidal and fluorescent lighting fixtures are practical only under unusually high ceilings, over 12 ft., because of the objections to suspending such units low enough to make the germicidal tubes effective.

The only general installation problem is that of the low ceiling, less than 10 ft., which reduces the volume of upper air available for irradiation and which increases the intensity of the ultraviolet scattered downward to the faces of room occupants by the ceiling's ultraviolet reflectance which cannot be reduced below about 5 per cent. How serious the problem is is further dependent upon whether there is continuous exposure of room occupants, as in a hospital ward, or only about one-third of the time per day, as in a school room or office.

All germicidal fixtures for upper air irradiation from room side walls must have very carefully designed and fabricated cylindrical parabolic reflectors, of specular chromium plate or preferably of electrolytically treated pure aluminum, to project a fan shaped distribution of energy through the upper air as far as possible before absorption in the ceiling

UPPER AND LOWER AIR DISINFECTION
ONE 30-WATT LAMP IN ROOM 17 X 17 X 11 FT.

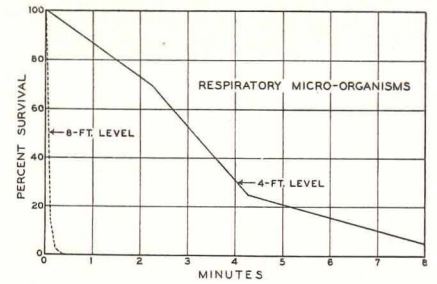

Effectiveness of germicidal tubes in the upper and lower air spaces of a room with continuous bacterial contamination

or reflection from it to room occupants.

Wherever there may be continuous exposure of the occupants, louvers must be added to the reflector to intercept all energy directly from the germicidal tube and above an angle of about 40° from the horizontal. Wherever, further, there may be continuous exposure under ceilings of less than 9 ft. as in home bedrooms, only louvered fixtures containing germicidal tubes of less than 3 ultraviolet watts output rating should be used. Figs. 6, 7 and 8 show the spatial distribution, schematic installation suggestions and a typical hospital installation. Such fixtures project 25-35 per cent of the ultraviolet output of the tube in a direction of maximum intensity 10-15° above the horizontal.

(Continued on page 186)

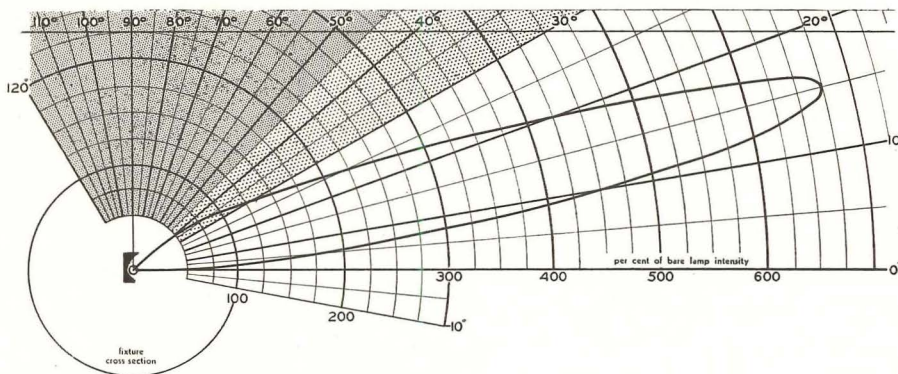

10

Fig. 10: spatial distribution of ultraviolet from a typical open fixture. Fig. 11: installation schematic of an open fixture. Fig. 12: typical school room installation. Note difference in height for the louvered and open fixtures

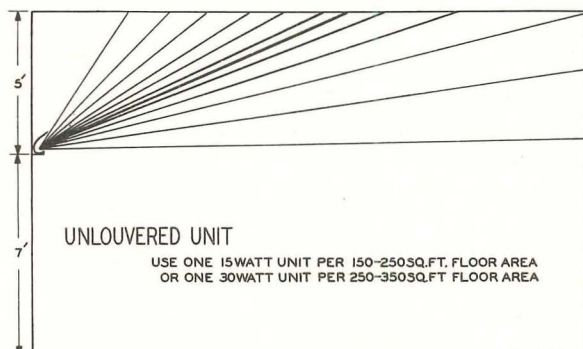

11

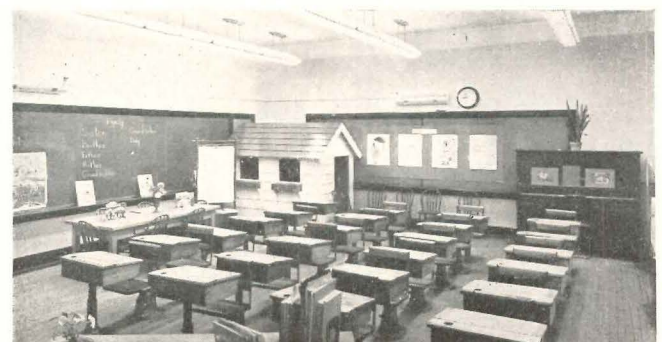

12

By Lewis Smith, C. A. Dunham Co., Chicago

DOWNFEED HEATING CUTS COSTS IN APARTMENTS

Combines installation and operating economies with weather control

WIDESPREAD use has been made in such large-scale apartment projects as Fresh Meadows, Peter Cooper Village and Stuyvesant Town of a steam heating system that approaches the installation economy of a one-pipe steam system, and at the same time automatically responds to changes in the weather and keeps fuel and maintenance costs at a minimum. Demonstrated first at the Parkchester development in the Bronx, New York, it has been applied since at Riverton, Clinton Hill and Webb Housing projects in addition to the ones already mentioned.

The essential departure from ordinary methods is that in the "Metro" * system, as it is called, a riser is run down through a tier of over-lying rooms, and this riser is offset in each room, each offset being made into a convector, thus providing a single and uninterrupted path for the flow of steam from top to bottom (see

* "Metro" is fully covered by patents issued to the author and assigned to Henry G. Schaefer, the present owner. The equipment required is being manufactured and sold by the C. A. Dunham Company under an exclusive license.

sketch). No valves or traps are used at the convectors — the only trap is at the bottom of the riser in the basement. Steam usually is fed to the top of these risers from adjacent heat risers in bathrooms or kitchens, but they may be fed from an attic steam main.

Among the attractive features of this system are: (1) There are no traps or valves in occupied spaces to be serviced or to stir up complaints. All traps are in the basement and can be serviced during the summer. The "handy man" doesn't have to go into the apartments for repairs or adjustment of the heating equipment.

(2) No provision has to be made for expansion. The only possible expansion is that which occurs between floors — about $\frac{1}{8}$ in. — which is absorbed in the flexibility of the risers. Each convector element is supported on each floor (see small sketch).

(3) From the construction and maintenance viewpoints, the most striking feature is the absence of all radiator

branches. These branches are expensive to install, and very often room cannot be found for them without costly furring out of walls or ceilings. It is these branches with their multiplicity of small fittings which are the first to give out from the effect of mechanical strains and corrosion.

Heat output is controlled by circulating steam through the risers and convectors at variable sub-atmospheric pressures. In zero weather and for heating up rapidly on cold mornings, steam is circulated at 2 lb. pressure or 215F. As the weather moderates, an automatic control throttles the steam supply more and more, causing a greater and greater vacuum in the system and consequently a lower and lower steam temperature in the convectors. This reduction may be carried on until steam temperatures of 133F and less are reached in 55 to 60F weather, beyond which it is customary to shut the steam off manually.

The control system consists of a selector, heat balancer and a valve in the steam main. The selector is a resistance-type thermostat, attached to the inner side of a north window (to avoid the sun), regulating the steam temperature according to the outside temperature. The balancer measures the amount of heat being supplied to make sure that it meets the demand of the selector. Whenever the demand and supply are out of balance as indicated by the selector and balancer, the steam main valve is operated to either increase or decrease the steam supply.

A vacuum pump maintains a greater vacuum in the return line than in the steam main causing steam to flow through the risers down through the drip traps at all times.

A small heat exchanger is connected into the return line before it enters the vacuum pump to heat domestic water and condense any vapor in the return, permitting pump operation at exceptionally high vacuum with reduced hours of operation and savings in electricity.

Additional control means are provided at the convector itself in the shape of a

Essential feature of the "Metro" system is the use of a continuous riser running down through a tier of rooms (left). The riser is offset in each room, each offset being made into a finned convector. Riser is trapped in basement. Small sketch shows support of convector at each floor

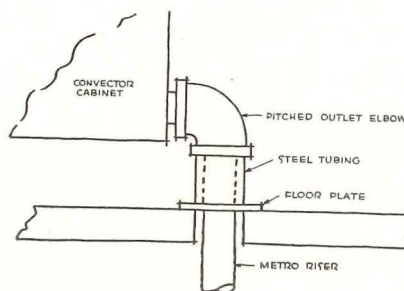
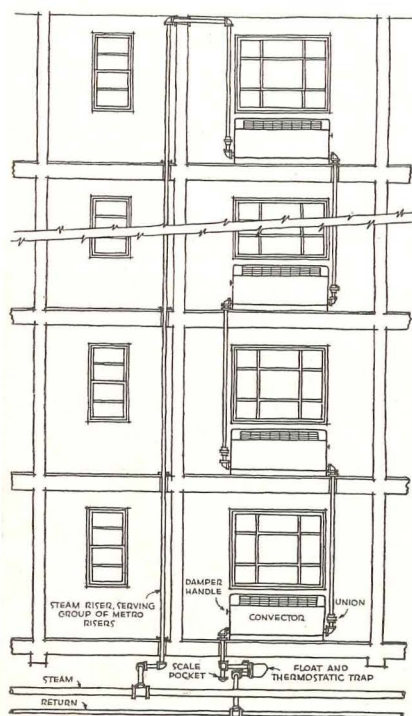

damper. Closing this damper reduces the heat by 30 to 40 per cent which is a greater reduction than any tenant would want, when it is remembered that the steam control has already kept the heat down to conform with the requirements. The tenant may in fact adjust this damper in intermediate positions. If the steam control has been set to give a temperature of say 74 or 75F in the various rooms, the tenant can make his own reduction below that level.

What about cost? This question cannot be answered by giving a cost per sq. ft. of radiation, or per apartment or room, because of the obvious variables. Nor can the answer be made that it costs more or less than other heating systems without first defining the word "other."

If comparison is made with a one-pipe system with radiators in the corners of rooms and no temperature control, then "Metro" will cost more. If, however, comparison is made with 2-pipe systems using convectors or radiators under the windows (where they belong) and with valves and traps, and adequate temperature control, then "Metro" will cost less.

How much less can be answered only by examining a particular project, as to its size, height of buildings, arrangement of rooms and windows, etc. Definite figures have been obtained on some closely similar 13-story apartment buildings with central plant showing that "Metro" actually costs up to 20 per cent less for these completed installations. This saving will obviously be less for low buildings. Even if there is no saving in first cost, the annual saving in maintenance as explained in the next paragraph, justifies its use.

"Cost of installation" cannot be considered alone — cost of operation and maintenance also must be taken into account. It is plain that for a 10-story building there will be only one instead of 10 traps per riser, hence the cost of trap maintenance is reduced 90 per cent. Since there are no radiator valves at all, this item of maintenance is eliminated. With no radiator branches there will be a saving in repairs here, but figures would be difficult to set up. As to fuel cost, the type of control used is credited by reliable sources as resulting in the lowest possible steam consumption and hence fuel cost.

If, then, this system has the advantage of lower first cost, lower maintenance cost and minimum operating cost, coupled with satisfactory heating, why isn't it universally used?

There are a number of reasons. If

buildings are irregular in layout, that is do not have typical floors, or do have frequent set backs, "Metro" may be difficult to apply. Some types of wall construction, particularly as to the windows, interfere with proper installation and either run up the cost or require convectors of larger capacities than can be incorporated in cabinets or handled on risers.

As commonly used, riser pipes are installed exposed along side the windows — alternating on each floor. The cabinets are usually hung from the window sill. An off hand expression of opinion is that exposed pipes could not be tolerated, but this objection usually vanishes upon inspection of an occupied apartment using the system. If the extra cost is not objected to, however, the risers can be concealed and the convectors recessed.

Baseboard convectors may be used to advantage where the windows are very wide and especially with low sill heights.

Some people think that the bottom convector of a riser will fill up with water, and that at best there will be a considerable difference in steam temperature, and hence the heat output, between the top and bottom convector of a high riser. This is not true. Consider a 15-story building with 40 sq. ft. of radiation per room, a total of 600 sq. ft. on the riser. There will be at most only a little over 1 qt. of water per minute passing through the bottom convector

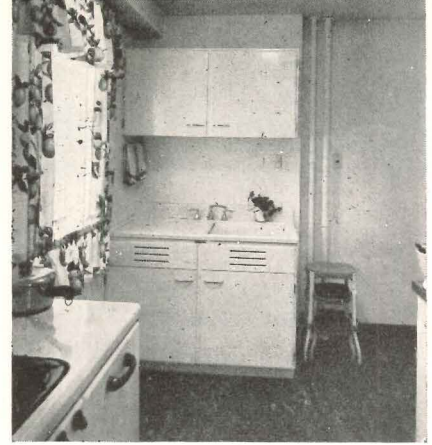

Kitchens, as shown above, and bathrooms are heated by exposed steam risers which connect into downfeed risers at the top of each tier of living rooms and bedrooms

and normally much less. With the drip trap having a capacity of practically 1 gal. per min., it is self-evident that no water will remain in the bottom convector and that such a small trickle of water will be lost in a 1½-in. pipe used in the convector heating element. As to temperature difference, the pressure loss in the riser is the only factor involved and this loss is so small as to be negligible.

While "Metro" has so far been used in apartment houses, there is no good reason why it cannot be used to equal advantage in office and loft buildings and warehouses.

Living room of apartment at Fresh Meadows showing the "Metro" convector. The riser is behind the drape to the left of the window and is sleeved through the concrete spandrel above the window. Heat rising from the convector blankets the window to prevent cold down drafts and cold floors. There is no obstruction under the cabinet; heating element is finned pipe



PRODUCTS for Better Building

LAMINATED WALLBOARD

Sheetrock fireproof wallboard is used in a double-wall system of residential construction developed to give greater fire protection and more resistance to abuse than other types of dry wall.

After conventional vertical application of a layer of Sheetrock to the studs and joists, each board of the face layer is covered and combed with bonding adhesive and then applied horizontally and temporarily held in place with nails to insure bond between the layers.

Nails are countersunk after the adhesive is dry. Joints are concealed with the manufacturer's Per-A-Tape joint system, which is said to render the entire wall and ceiling surface smooth. Use of laminated Sheetrock wallboard is reported to insure stronger walls which will remain crack-free for the lifetime of the house. United States Gypsum Co., 300 W. Adams St., Chicago, Ill.

PLASTIC DAYLIGHTING

An answer to the problem of providing adequate and economical daylighting in a large industrial structure has been found in the adoption by the National Tank Co. in its new plant at Tulsa, Okla., of translucent *Fiberglas-*

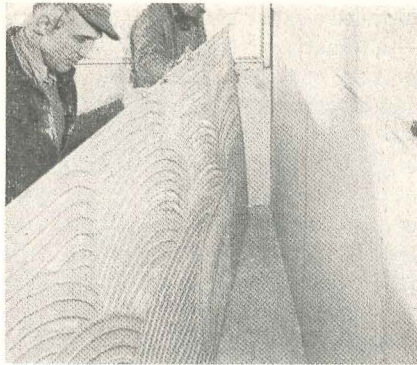

In laminated, dry wall method, first layer of Sheetrock is nailed in customary fashion to joists, studs; second layer is held by adhesive and temporary nailing, later countersunk

plastic sheets for skylights and windows.

Known as *Alsynite*, the corrugated sheets are made of Fiberglas mat impregnated with Laminac resin. They can be sawed and nailed with ordinary tools, punched or drilled and fastened in place with ordinary sheet metal screws or bolts. A special translucent mastic is available for weather proofing lap joints.

Although light in weight — about 8 oz. per sq. ft. — the sheets are described as strong enough to sustain weight of a snowfall and as unaffected by climatic conditions.

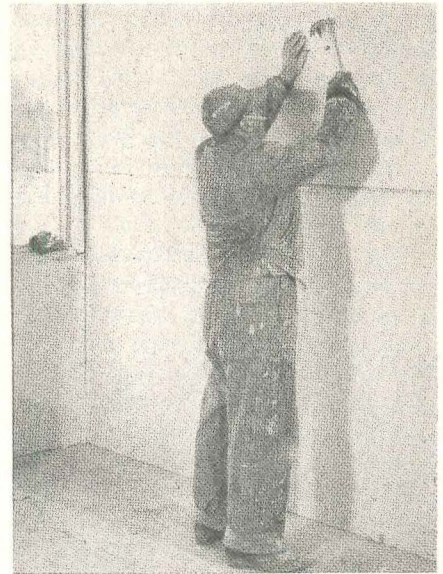

Alsynite is said to admit sufficient natural daylight for most of the operations conducted in the plant. Allied Synthetics Co., San Diego, Calif.

AID FOR DRAFTSMEN

An instrument to simplify the creation of perspective drawings, the *Perspect-O-Metric*, has been designed to be attached to any drafting machine, or to parallel ruling straight edges.

The instrument is reported to guide the draftsman's pencil automatically toward the established vanishing points

(Continued on page 174)

Corrugated Fiberglas-plastic sheets that can be sawed and nailed provide daylighting for Tulsa, Okla. industrial plant. Left: shows how sheets are fastened to steel rafters of entrance to mill building. Right: the translucent sheets used as skylights



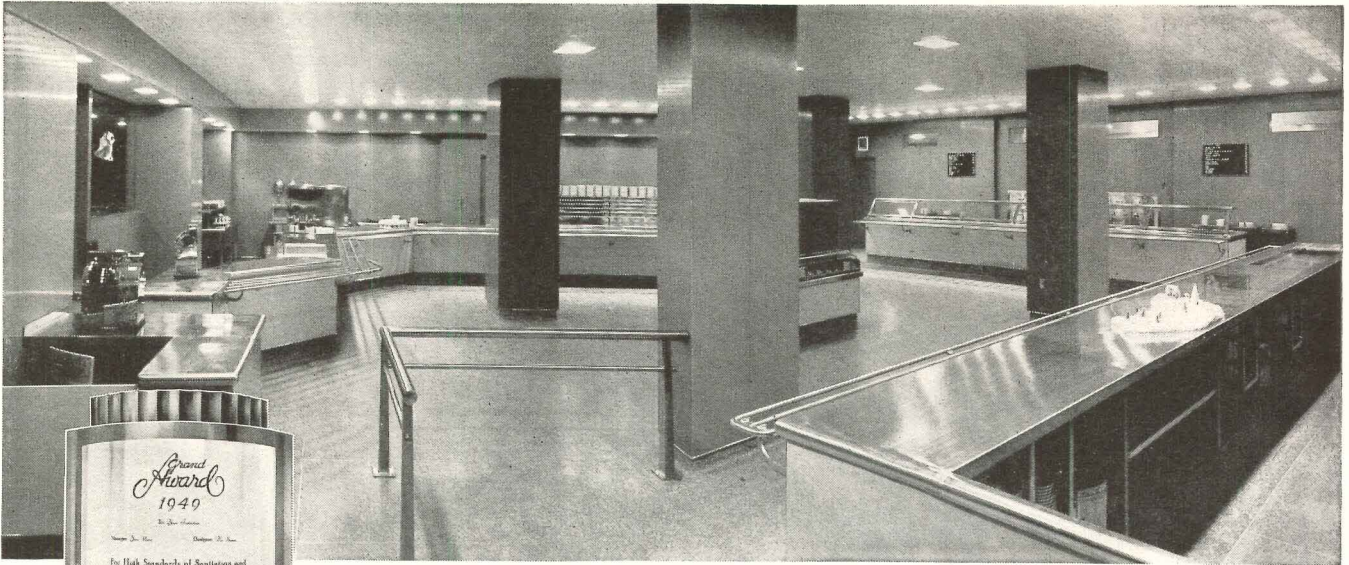

Michigan State College Union Building Cafeteria

Ralph Calder, Architect



Food Service Awards

Prove VAN Versatility

- Van is proud that Van clients have been in the "vanguard" of food service operators recognized by the boards of experts of the magazine INSTITUTIONS in its competitions *since they were inaugurated!*
- A parade of Grand Awards . . . in 1947 Mills Restaurant of Cincinnati . . . 1948 Hotel Roanoke of Virginia . . . 1949 Michigan State College Union Building Cafeteria . . . next year perhaps a hospital Van-equipped!
- Mills Restaurant of Cleveland generously shares with Van credit for its 1949 Award of Merit from INSTITUTIONS.
- The whole three year roll of Van client honors is fresh evidence of that versatility for which Van is famous . . . in all kinds of food service establishments.

- This succession of awards to Van clients has real meaning for hospital administrators, their dietetic staffs and architects, who want the best. Van's pioneering of kitchen equipment design and manufacture has again been given national recognition.
- If you are planning food service equipment improvements, Van will deem it a privilege to share its century of experience.

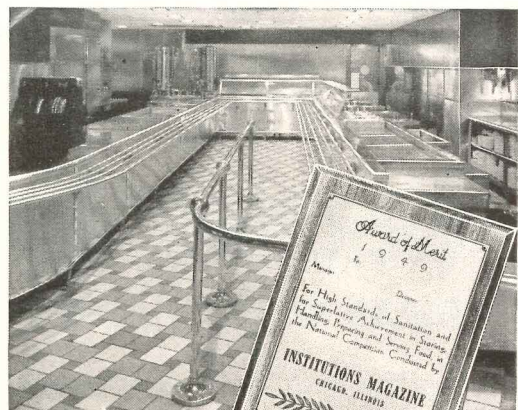

Mills . . . Cleveland

The John Van Range Co.

EQUIPMENT FOR THE PREPARATION AND SERVING OF FOOD

DIVISION OF THE EDWARDS MANUFACTURING CO.

Branches in Principal Cities

429 CULVERT STREET

CINCINNATI 2, OHIO

ELECTRIC EYE ➔
SIGNALS PATRONS
 ... keeps traffic flow-
 ing smoothly around
 auto banking island.

**AUTO BANKING IS
 INSTANT SUCCESS
 IN SAGINAW, MICH.**

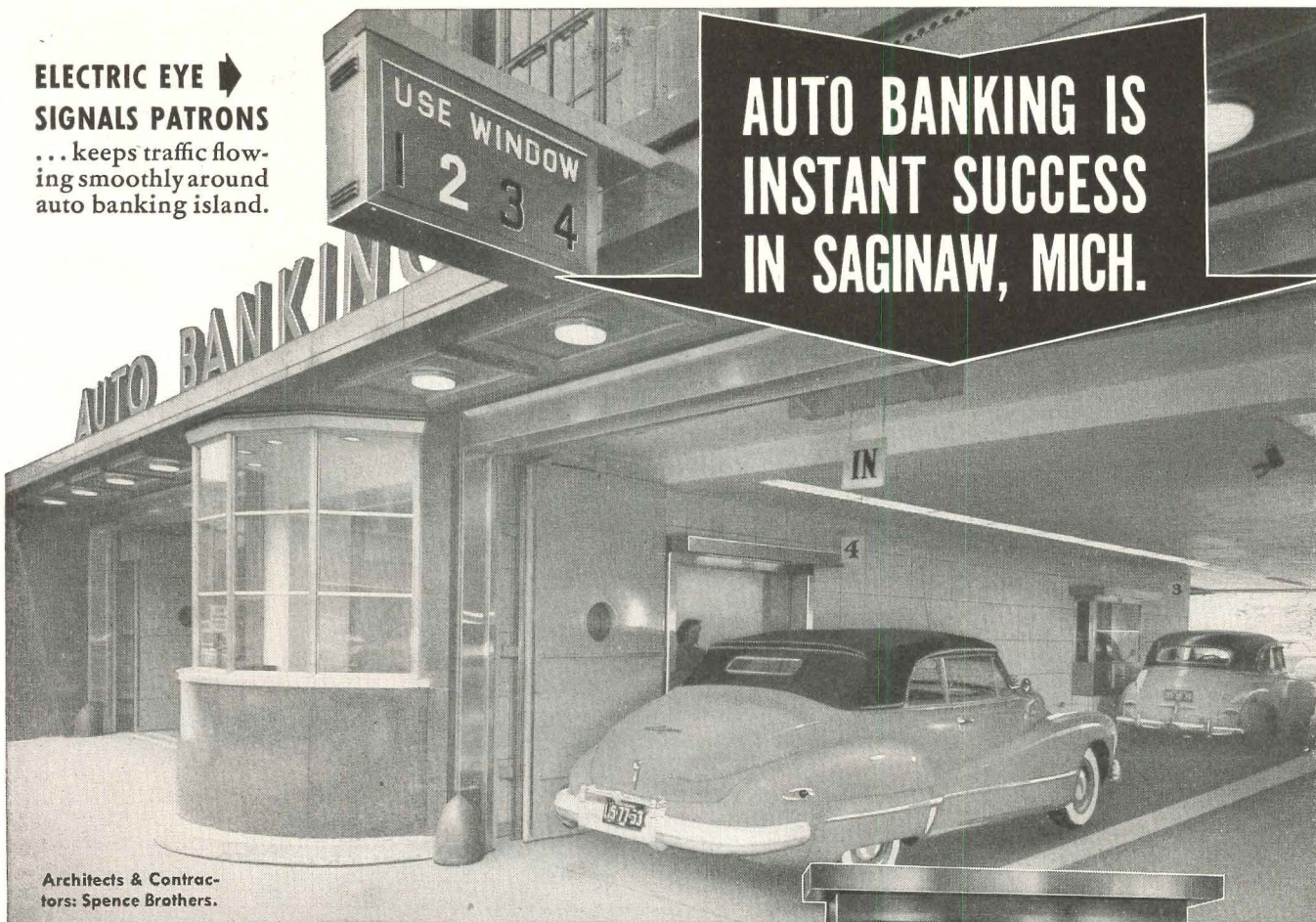

Architects & Contrac-
 tors: Spence Brothers.

HERE'S how John C. Hay, vice-president of the Michigan National Bank, Saginaw, Mich., describes the reception of this new customer convenience:

"Although our drive-in has been in operation only a little over three weeks, it has exceeded our expectations and the volume of traffic is steadily increasing, requiring our four windows to be kept in operation."

SPECIAL NOTE TO ARCHITECTS: The new Herring-Hall-Marvin Drive-In Depository offers greater freedom of design, with a choice of installation, flush-to-wall—or projected, as shown above. It is a compact, complete unit, quickly and easily installed. You simply designate wall opening and a small floor area in your plans; no other provisions are necessary.

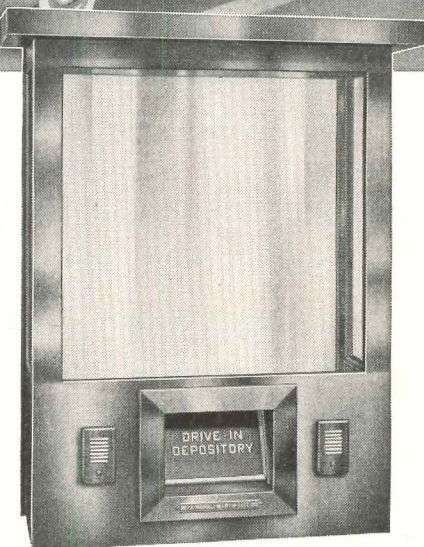

Bullet-resisting glass, stainless steel exterior, two-way speaking system, extra-large package receiver, factory-installed electrical wiring - - are a few of the many other features.

HERRING · HALL · MARVIN SAFE CO.

MAIN OFFICES AND FACTORY IN HAMILTON, OHIO

BRANCH OFFICES in: New York, Chicago, Boston, Washington, St. Louis, Atlanta, Houston, Philadelphia, San Francisco, Los Angeles, Detroit, Pittsburgh, Omaha, Minneapolis.
 OTHER AGENCIES ALL OVER THE WORLD.



DRESSING-LOCKER ROOM SUITES

Based on information from "A Guide for Planning Facilities for Recreation, Physical & Health Education"

*Published by The Athletic Institute, Inc., for the National Facilities Conference

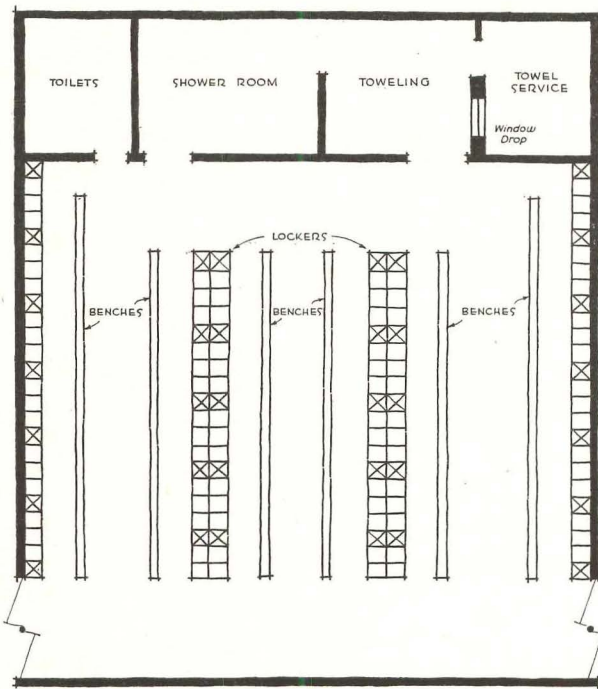

2

DESIGN NOTES

Dressing-Locker Room. An average of 14 sq. ft. per pupil in the designed peak load should be provided exclusive of the locker space so there will be adequate dressing area. Check list: sufficient mirrors, built-in drinking fountain and cuspidor in boys' dressing room, tack board.

Storage Lockers. Each pupil enrolled should have a storage locker, with an additional 10 per cent to allow for expansion. Recommended sizes, in order of preference are: 7½ by 12 by 24 in., 6 by 12 by 36 in., 7½ by 12 by 8 in. These were selected as being the minimum size lockers to store ordinary gym costumes and allow free hanging for ventilation.

Dressing Lockers. Lockers large enough to accommodate street clothes should be provided. The number should equal the peak load plus 10

per cent. Lockers 12 by 12 by 72 in. are recommended for secondary schools and 12 by 12 by 54 in. or 12 by 12 by 48 in. for elementary schools.

Shower Room. In the group or gang type shower, the girls should have a number of shower heads equal to

40 per cent of the designed peak load; for boys 30 per cent.

Shower heads should be at least 4 ft. apart, of a non-clogging type; height of spray should be adjustable by use of a lock. If stationary heads are installed, they should be placed

(Continued on page 151)

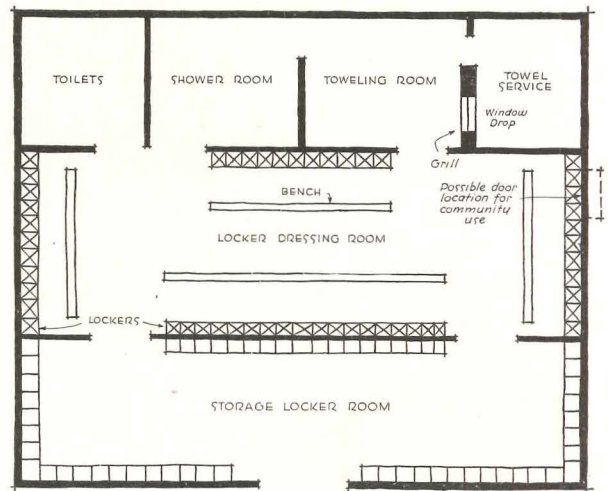

These plans show three dressing-locker room arrangements, each with its own particular advantages. Dressing lockers are marked with X's. Plan 1: storage lockers are grouped in small space for economy in drying uniforms with forced warm air; some congestion may result from dressing lockers being next to one another. Plan 2: distributing dressing lockers over entire area gives each participant ample dressing space. Plan 3: dressing lockers distributed over entire suite; units can be installed in any number desired and lend themselves to group dressing method for girls. By constructing walls A, B, C and D, putting a grille to ceiling above locker tiers and installing grille sliding doors at E, each unit becomes a complete dressing room for community use. Walls A, B, C and D can be omitted and gates F added to get same use and permit towel service and toilet units to be installed at points A and D

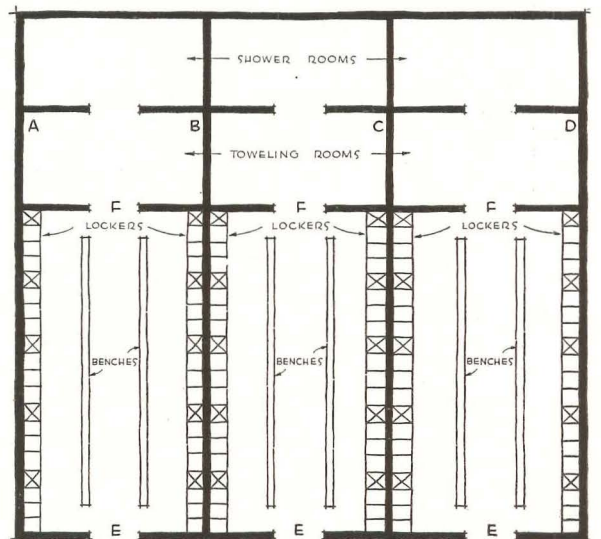

3

**Truscon "O-T" Open Truss Steel Joists
help PUT MANPOWER TO
THE MOST PROFITABLE USE!**

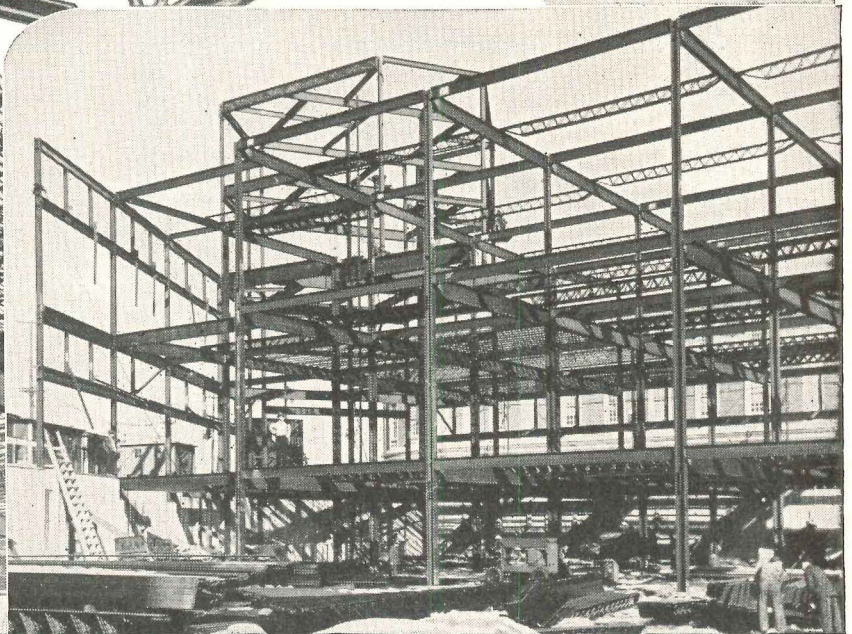
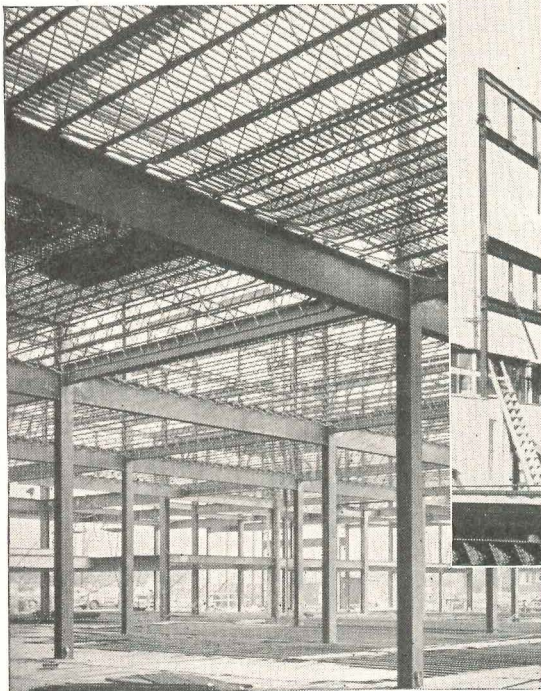

Truscon "O-T" Open Truss Steel Joists used for speedy, safe construction in Mercantile Building, Grandfield Development Company, Detroit, Michigan. Charles N. Agree, Architect. O. W. Burke Co., General Contractor.

The light weight of Truscon Open Truss Steel Joists assures easy handling and speedy erection schedules with a small crew of men and no heavy hoisting equipment. Yet, these joists are extremely strong and rigid. They are ideal for floor and roof requirements in all types of building construction, and are designed with a high factor of safety that will meet every exacting specification.

continuous from end to end of joist and bent up at the ends to form the bearings. These steel joists are fabricated by means of electric machine welding under pressure, making positive connections at all joints. The underslung design of the bearing permits maximum head-room under the supporting beams. The open web allows the passage of pipes and conduits in any direction.

The "O-T" Open Truss Steel Joist is a Warren truss having top and bottom chords of wide tee-shaped members and a plain round continuous web member. The bottom chord is

Truscon "O-T" Open Truss Steel Joists are very simple to install, being completely shop fabricated and reach the job ready for placing. Each joist is marked to correspond with the erection diagram, thus greatly simplifying and speeding construction work.

Put manpower to more profitable use—get your buildings up faster—get the complete mechanical details of Truscon "O-T" Open Truss Steel Joists now. Detailed literature on request.



TRUSCON
STEEL COMPANY
YOUNGSTOWN 1, OHIO
Subsidiary of Republic Steel Corporation
Warehouses and sales offices in principal cities

Manufacturers of a Complete Line of Steel Windows and Mechanical Operators • Steel Joists • Metal Lath • Steeldeck Roofs • Reinforcing Steel • Industrial and Hangar Steel Doors • Bank Vault Reinforcing • Radio Towers • Bridge Floors.

(Continued from page 149)

so that the top of the spray will be shoulder height (usually 4½ to 5 ft.).

One to three individual shower booths, 3 by 3½ ft., should be provided additionally for girls.

For boys, if walk-way or walk-around shower system is desired, the number of shower heads in the shower room can be reduced by one-third. In the walk-way, spray outlets attached to the water pipe must be focused to provide coverage from shoulder height to feet. There must be a continuous spray the length of the walk-way arranged so that there will be warm, tepid and cool water as one progresses along the walk-way. The walk-way should be arranged in U shape with a total length at least 35 ft. and from 3 to 4 ft. in width. An entrance from the group shower soaping space and egress to the towel-ing room and swimming pool should be provided.

Both individual and master control should be provided for all groups or gang showers. The booth showers should have individual control; the walk-way only master control.

Towel-ing Room. The towel-ing room should have the same total area as the shower room and be immediately accessible to both showers and dressing room.

A ledge 18 in. high and 8 in. wide coved at wall and base, with bull nose edge, as foot drying aid is desirable.

If towel distribution is such that hanging of towels in drying room is necessary, a 1-in., non-corrosive towel bar 4 ft. from the floor and 1 to 1½ in. from the wall is recommended.

A non-shatterable, transparent panel for supervision of towel-ing between the towel-ing and dressing room may be desired.

Towel Service and Storage Room. Adjustable shelves in sufficient number to accommodate the load are

required. A check-out window should open into or be immediately adjacent to the towel-ing room. If uniforms are distributed from here, a dutch door or check-out window, with counter, should open into the dressing room.

Toilet Room. Facilities should be provided in proportion to the peak load on the following basis:

Toilets	Girls	1-30	Min. 3
Toilets	Boys	1-50	Min. 2
Urinals	Boys	1-25	Min. 2
Lavatories	Girls and Boys	1-20	Min. 3

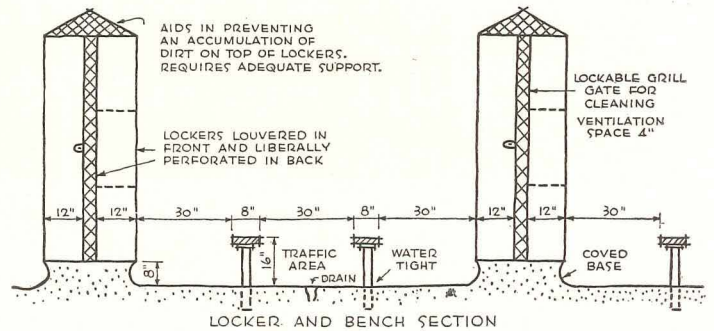

Suggested locker and bench installation. When locker height is kept down to 54 in., entire room can be supervised. Sloping locker top cannot be used, but 4 in. ventilating space should be louvered

TYPICAL COMBINED STORAGE-DRESSING LOCKER ARRANGEMENTS

Area of the Dressing-Locker Room Suite required for different types storage and dressing lockers in a typical unit for 240 girls or 240 boys. Proportionate adjustments to be made for varying school enrollments.

Class Periods Per Day	Size of lockers and Battery Arrangement	Typical Installation	Overall height with base	Number students per day	Peak load per period	Area Required, sq. ft.	Recommendation *
six	6—storage 7½ x 12 x 24" 1—dressing 12 x 12 x 48" or 6—storage 7½ x 12 x 24" 1—dressing 12 x 12 x 72"		54" or 80"	240	40	114.80 or 90.0	1 a. grades 1-12 b. grades 9-12
six	6—storage 6 x 12 x 36" 1—dressing 12 x 12 x 72"		80"	240	40	100.0	3 grades 10-12 only
six	6—storage 7½ x 12 x 18" 1—dressing 12 x 12 x 54"		62"	240	40	90.0	2 grades 1-12
eight	8—storage 7½ x 12 x 18" 1—dressing 12 x 12 x 72"		80"	240	30	67.50	2 grades 9-12
eight	8—storage 7½ x 12 x 24" 1—dressing 12 x 12 x 48"		54"	240	30	105.0	1 grades 1-12

*Numbered in order of Preference

MANUFACTURERS' LITERATURE

Architectural Metals

Architectural Metal Handbook. A thorough guide and handbook covering the whole field of architectural ornamental metals. The handbook was prepared by the National Ass'n of Ornamental Metal Manufacturers to aid architects in the preparation of plans and specifications of architectural metal, to establish uniform standards of construction and to define terms commonly used in the industry. The bulk of the book is devoted to construction details.

Other chapters take up: composition and characteristics of architectural metals; methods of fabrication; metal products to be specified separately from architectural metal; structural steel as related to architectural metal; paints and finishes; suggestions for preparation of specifications; and data on sizes, gauges and weights of metals. The book is being distributed free to architects. 319 pp., illus. National Ass'n of Ornamental Metal Manufacturers, O. J. Condon, Sec'y, 209 Cedar Ave., Takoma Park, Washington 12, D. C.

Air Conditioning

Agitair Square and Rectangular Air Diffusers, Types R-RV-RTC. Contains data to simplify the selection and sizing of three types of Agitair square and rectangular diffusers. Typical applications and available patterns are shown. Detail drawings are included. 6 pp., illus. Air Devices, Inc., 17 E. 42nd St., New York 17, N. Y.

Window Screens

Pella Rolscreen Details. Portfolio of specifications and construction details for application of roll-type screens to wood and metal windows of all kinds. When not in use the screen is rolled up into a steel housing at the top of the window. Details are also given for light-proof shades. 11 pp., illus. The Rolscreen Co., Pella, Iowa.

Public Address Systems

Altec Speech and Music Reinforcement (P. A.) Systems. Shows and describes components for public address systems to serve spaces ranging from a 250 seat church to a 90,000 seat stadium. Sug-

gested combinations of amplifier components for small, medium and large auditoriums are included. 8 pp., illus. Altec Lansing Corp., 161 6th Ave., New York 13 or 1161 N. Vine St., Hollywood 38, Calif.

Soap Dispensers

Soap and Soap Equipment. Newly-designed equipment for dispensing liquid soaps is described and illustrated by photos and schematic diagrams. The booklet also discusses types of liquid soaps available. 16 pp., illus. West Disinfecting Co., 42-16 West St., Long Island City 1, N. Y.

Concrete Forms

Uni-Forms, the Concrete Forming System. Describes a system of concrete forms made of plywood held by steel frames and protective strips. Shows how the forms are used for walls, corners, pilasters, battered walls, slabs, columns and tunnels. Special features for quick assembly and stripping and for accurate alignment are considered. Many on-the-job photos are included. 32 pp., illus., Universal Form Clamp Co., Chicago 51, Ill.

Blaw-Knox Steel Street Forms. Provides information to aid in the selection and use of steel paving forms for the construction of concrete curbs, gutters or sidewalks. Sixteen different types of standardized steel forms are described and illustrated. One section of the folder shows how to set and strip the forms. 28 pp., illus. Blaw-Knox Div., Blaw-Knox Co., P. O. Box 2, Blaw-Knox, Pa.*

Baseboard Heaters

Comfort Heating with Convect-O-Base. Shows how a line of aluminum radiant baseboards is installed. Typical floor plan illustrates how baseboard radiation is distributed and photos cover the step-by-step installation procedure. 8 pp., illus. Minimate Co., 4518 W. Lexington St., Chicago 24, Ill.

Structural Aluminum

Aluminum Structural Design. A technical handbook prepared to enable those familiar with mechanics of materials to design an original structure of aluminum,

or to convert an existing structural design from some other material to aluminum. The handbook describes aluminum alloys and their mechanical properties, takes up structural design considerations (various loads and stresses), and covers fabricating considerations such as riveting, bolting and welding. The handbook is liberally illustrated and contains numerous tables on physical, mechanical and chemical properties. It is being sent free of charge to architects, engineers and designers requesting it on their company letterhead. 124 pp., illus. Reynolds Metals Co., 2500 S. Third St., Louisville 1, Ky.*

Lighting

Lighting by Holdenline. Describes a line of fluorescent fixtures including plastic-louvered luminaires, semi-industrial and industrial fixtures and lighting accessories. Construction features and dimensions are given. 8 pp., illus. Holdenline Co., 2300 Scranton Rd., Cleveland 13, Ohio.

Miller Series-Louwer Slimline Luminaires. Folder on a new louvered fixture for use with the 96-in. Slimline fluorescent lamp in commercial and industrial interiors. Gives dimensional details and illumination performance in various size areas. 8 pp., illus. The Miller Co., Illuminating Div., Meriden, Conn.

Wiring Equipment

The Plugmold Story. A non-technical, descriptive booklet on use of Plugmold, a metal molding with closely spaced electrical outlets, in the home. Pictures applications in the rooms of a typical house. 12 pp., illus. The Wiremold Co., Hartford 10, Conn.

P & S Wiring Devices (Catalog No. 49). Extensive catalog on wall plates, switches, convenience outlets, lampholders, fluorescent lampholders and starters, etc. A new item shown is a wall plate in which outlets, switches and night or warning lights can be combined as desired. 64 pp., illus. Pass & Seymour, Inc., Syracuse 9, N. Y.

LVD Flex-A-Power. Presents features and advantages of a prefabricated busway used principally as feeder lines for transfer of heavy current or as main feeders for power and light. Actual installations are shown in which close voltage regulation was required. Outlines cost-cutting features. 4 pp., illus. The Trumbull Electric Mfg. Co., Plainville, Conn.*

Service Entrance Equipment. Folder on residential fuse puller switches to be used

(Continued on page 188)

*Other product information in Sweet's File, 1949

For rewiring that pays its way

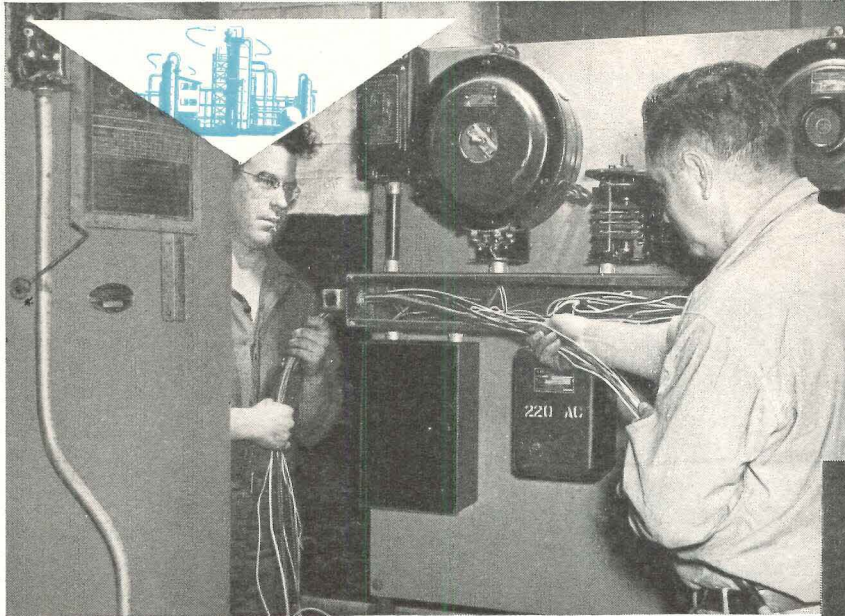

Flamenol Building Wire

Pays today

For rewiring that really pays its way in installation speed and savings on space—you just can't beat General Electric Flamenol® Type TW building wires.

The thermoplastic insulation on G-E Flamenol wires cuts clean, strips off easily. For quick installation, Flamenol wires are wax-coated, to slide easily through raceways. For speed on the job, Flamenol wires are light in weight—easy to handle.

For more current in existing raceways, General Electric Flamenol wires make use of the maximum permissible conduit area. Small-diameter insulation lets you pull through more wires per raceway.

Look to General Electric Flamenol wires for rewiring that really pays its way on the job. For more information, write to Section W34-75, Construction Materials Department, General Electric Company, Bridgeport 2, Connecticut.

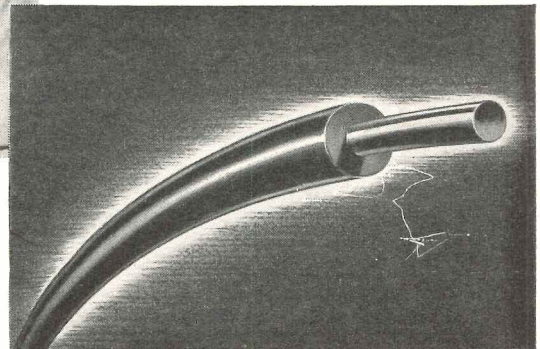

Pays in the years to come

Because this thermoplastic was developed expressly as an electrical insulating material, G-E Flamenol building wires are made to last. Flamenol insulation will keep its smooth surface and maintain its high dielectric strength indefinitely.

These wires also resist the effects of air, acids, alkalis, water, grease, and oil—will not support combustion. A variety of colors makes circuit tracing easy.

... from the complete line of G-E wires and cables—



INDUSTRIAL

Flamenol cable • Flamenol building wire • interlocked-armor cable • Coronol® and Versatol®-geoprene cables • varnished cambric cable • aerial cable • Deltabeston® asbestos and varnished cambric cable • portable cable • boiler room wire • portable cord • parkway cable.



COMMERCIAL and INSTITUTIONAL

Flamenol building wire • leaded building wire • Portable cords • Deltabeston power cable • remote control system wire • boiler room wire.



RESIDENTIAL

PVX® and BraidX® non-metallic-sheathed cables • BX® armored cable • service entrance cable • remote control system wire.

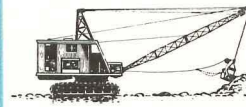

SPECIALIZED INDUSTRIES

mine cables • railway signal wire and line wire • control cable • portable cord and cable • locomotive cables and cab cords.



UTILITY

solid paper-insulated cable • gas-filled cable • oil-filled cable • pipe cable • varnished cambric cable • Coronol- and Versatol-geoprene cables • aerial cable • Flamenol wire and cable • asbestos and varnished cambric cable • boiler room wire.

GENERAL  ELECTRIC

BEFORE YOU SPECIFY ANOTHER FLOOR COVERING

find out about the

TWO DIFFERENT TYPES OF WRIGHT RUBBER TILE

You owe it to yourself — and your clients — to find out all about these two outstanding floor covering materials. When you do, you will find that, in most installations, the best floor covering you can possibly specify is one of *the two* different types of WRIGHT RUBBER TILE.

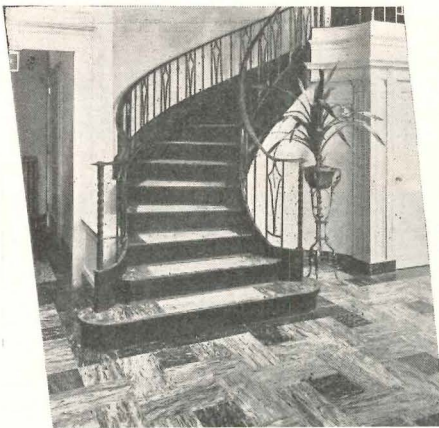

WRIGHTEX Soft Rubber Tile

The longest-lasting, easiest-to-clean soft rubber tile for homes, hospitals, churches and other installations preferring extremely quiet floors. It is available in many gay, bright or soft-toned colors.

WRIGHTEX is the *only* soft rubber tile with a permanent, naturally glossy surface. Installations made in heavy traffic areas over 27 years ago still look as good as new and when measured for wear, show a potential lifetime of over 100 years.



WRIGHTFLOR Hard Surface Rubber Tile

There is no other floor covering material that compares with WRIGHTFLOR in long life, permanent beauty, ease of maintenance and low over-all cost.

Harder than WRIGHTEX, WRIGHTFLOR is the ideal floor covering for stores, restaurants, public buildings and other installations where hard wear is encountered and low maintenance cost is important. One of the world's largest retailers have over 7 million feet of WRIGHTFLOR in their own stores.

WRIGHTFLOR is available in a wide range of sizes and colors, making possible an infinite variety of strikingly beautiful designs.

HERE'S
BIG
NEWS!



WRIGHT-ON-TOP Compression Cove Base is now available in color, as well as black. Write for full information.

Ask for free samples of WRIGHTEX and WRIGHTFLOR, together with details on characteristics, standard tile sizes and shapes. A note on your letterhead will get prompt action. WRIGHT MANUFACTURING CO., 5205 Post Oak Road, Houston 5, Texas.

WRIGHT RUBBER TILE

FLOORS OF DISTINCTION

NEWS FROM CANADA

(Continued from page 10)

facturing had 365 committees, involving 160,470 workers; mining, 41 committees, involving 25,066 workers; communications, 41 committees, involving 10,537 workers; service, 22 committees, involving 12,494 workers; and transportation, 121 committees, involving 56,606 workers.

There were only 2 committees in the construction industry, but 8840 workers were involved.

Ottawa May Get Face Lifted

Most of Ottawa's defects will be eliminated if the federal government acts on recommendations contained in a report recently made by the National Capital Planning Committee.

Unlike Washington, planned in advance and wrested from the wilderness, Ottawa was already in existence when Queen Victoria chose it to be the capital of Canada. Then a small lumber town and military outpost, its development betrays little awareness of the beckonings of destiny. The grandeur of the Parliament Buildings and the beauty of the driveway circling the city fade, but fail to erase a visitor's impressions of cramped streets, mean architecture and strange industrial smells.

The N.C.P.C. report is the result
(Continued on page 156)

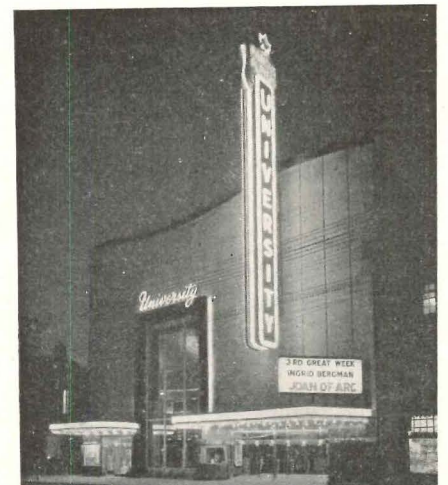

Panda Photo

University Theater, Toronto, Ontario, designed by Eric W. Housom, Architect, A. G. Facey, associate. Architect was also interior decorator, designing sign and marquee, special electrical fixtures and most of the furniture

1 Light weight

Inorganic, fireproof and weighing only about 5 to 6 pounds per square foot, Kaylo Roof Tiles are easy to handle. Their light weight reduces dead load on buildings and saves steel.

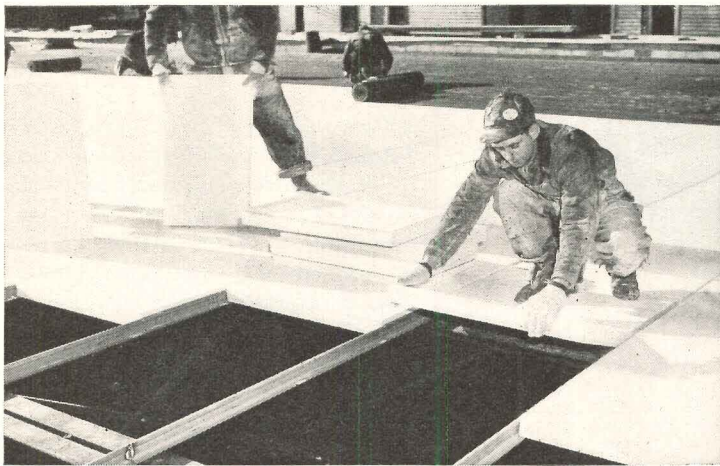

2 Insulation

Kaylo Roof Tile has insulating value equal to an inch and a half of standard insulating board, and eliminates the special operation of applying insulation over the roof deck.

3 Strength

Kaylo Roof Tile is not merely a roof insulation. It is a reinforced structural unit designed for a total load of fifty pounds per square foot with an adequate safety factor.

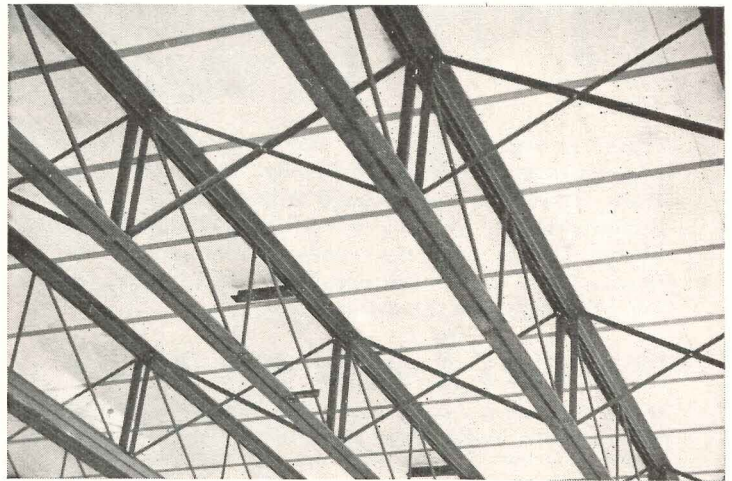

in ONE material

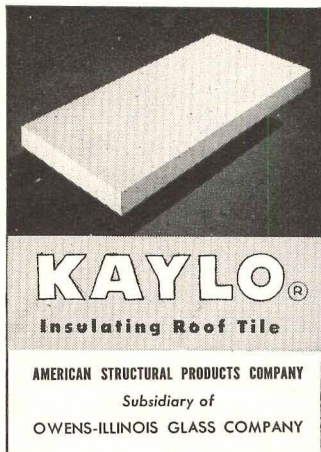

**MAIL
NOW**

American Structural Products Company
Dept. F-404, P.O. Box 1035
Toledo 1, Ohio

Please send, without obligation

- Illustrated booklet, "Kaylo Insulating Roof Tile"
- Free sample of Kaylo Roof Tile
- Have representative call

Name _____

Address _____

City _____ County _____ State _____

Designed for

**RELIABILITY
PERFORMANCE
PROFIT**

**BACK-WIRED
TOP-WIRED**
FOR INSTALLATION
SPEED AND EASE

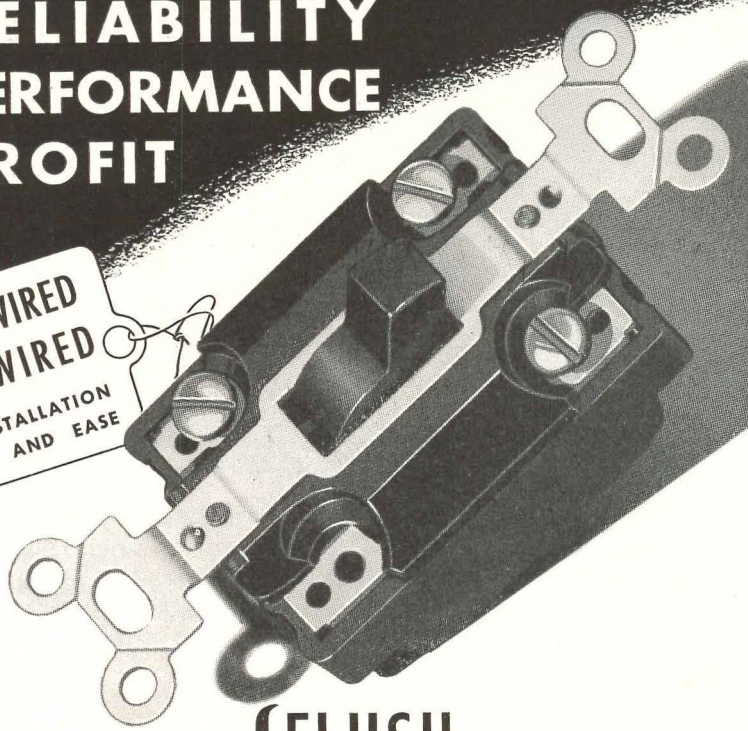

H & H { **FLUSH
TUMBLER SWITCH**
"T" RATED—10 & 20 AMPERES FOR
ALL STANDARD CONNECTIONS

These new back- or top-wired flush tumbler switches give you plenty of performance, profit and reliability. They install quickly and positively. There's no need to bend or loop wire — it goes straight into the unit from the back and is held firmly and permanently by a wire clamp. They're safer, too — there are no exposed wire ends. And they're ideal for use with heavier (10 to 14) wire. Top-wiring with conventional binding screws is optional.

FEATURES ? HERE ARE A FEW

Double switch blades protected by 2 Bakelite barriers to snuff arcing • Self-aligning double switch blades give positive connection with solid, one-piece stationary contacts • Plenty of wiring room in the box • Switch mechanism is totally enclosed • One-piece base plate, with washer type plaster ears, is firmly locked into switch cover.

10 and 20 Ampere sizes are available with Brown or Ivorylite handles or as lock-type units; for 1- and 2-pole, 3- and 4-way, and single pole, quadruple break connections.

WRITE TODAY FOR LITERATURE ON THESE
AND OTHER H & H WIRING DEVICES.
Address: 1907 LAUREL STREET
HARTFORD 6, CONN.

ARCHITECTS
THAT KNOW BEST
SPECIFY

**WIRING
DEVICES**

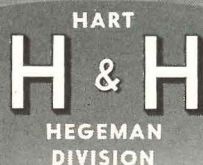

**ENCLOSED
SWITCHES**

THE ARROW-HART & HEGEMAN ELECTRIC COMPANY
HARTFORD, CONNECTICUT

NEWS FROM CANADA

(Continued from page 154)

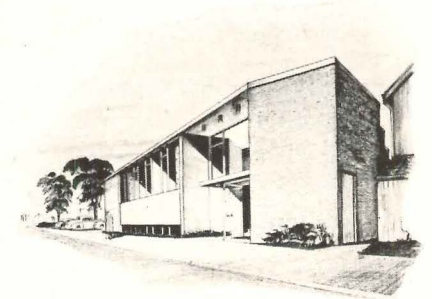

Architect's office building now under construction for designer-owner John B. Parkin Associates, Toronto, Ontario

of three years work by Jacques Greber, distinguished French town planner, and a staff of Canadian experts. Its proposals for Ottawa, for which it forecasts a population of 500,000 within the next 50 years, take into account the preservation of worthwhile existing features. The Rideau Canal, picturesquely bisecting the city, the Parliament Buildings and various other structures are not to be touched. At the same time, adoption of an extensive program of public works is advocated to enable Ottawa to take its rightful place among the world's capitals.

One of the most notable of these improvements is the removal of the railway lines that now divide the city into tiny segments. On the former rights of way a system of boldly designed thoroughfares and boulevards will be created. Of course, moving the railways constitutes a major problem since the factories they serve must go with them. A start has been made in this direction by the acquisition of 2,000 acres of land for new industrial sites.

Another change for the better will result from redeveloping Ottawa's downtown business area. Here is to be built a large auditorium, capable of seating 10,000 persons, which will be surrounded by a hotel, restaurant, and parking space. Other proposed public buildings are a national institute of the arts, to house the National Gallery of Canada and a national theater, a national library and a new home for the National Film Board. Construction of zoological and botanical gardens, and a sports center big enough to accommodate the Olympic games is advocated as well.

The national capital district will

(Continued on page 158)

for appearance...

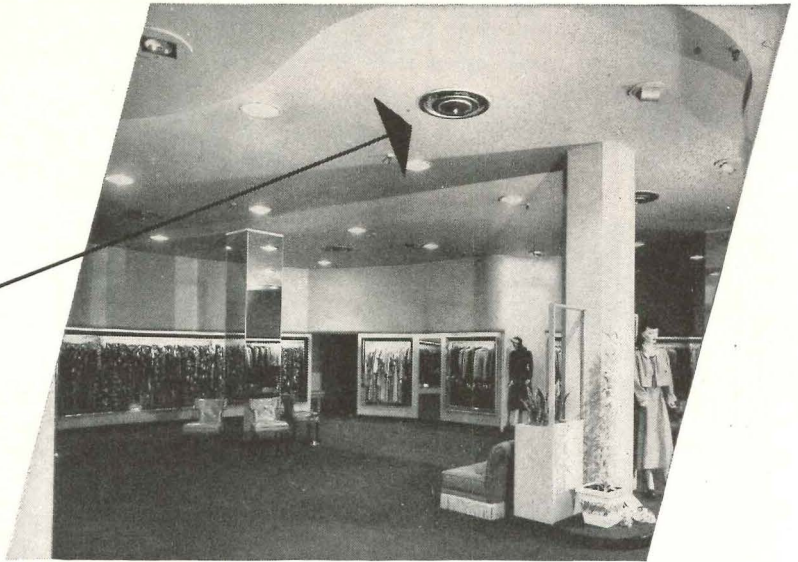

*Simple, unobtrusive design
blends with any architectural treatment.*

for performance



*Adjustment features insure
positive control of air movement.*

Kno-Draft

*... adjustable air diffusers
help solve problems
of both form and function.*

FREE HANDBOOK—Send for FREE copy of new handbook on air diffusion. Complete information on Kno-Draft Adjustable Diffusers and all necessary engineering data to help you create “custom-made” air patterns. Just fill in and mail the coupon.

W. B. CONNOR ENGINEERING CORP.

Air Diffusion • Air Purification • Air Recovery

112 East 32nd Street  New York 16, N. Y.

IN CANADA: Douglas Engineering Co., Ltd., 190 Murray Street, Montreal 3, P. Q.

W. B. CONNOR ENGINEERING CORP.

Dept S-40, 112 East 32nd Street, New York 16, New York

Please send my FREE copy of the new Kno-Draft Handbook on Adjustable Diffusers.

Name.....

Position.....

Company.....

Street.....

City..... Zone..... State.....

BEAT SUMMER SLUMP WITH BURT VENTILATORS

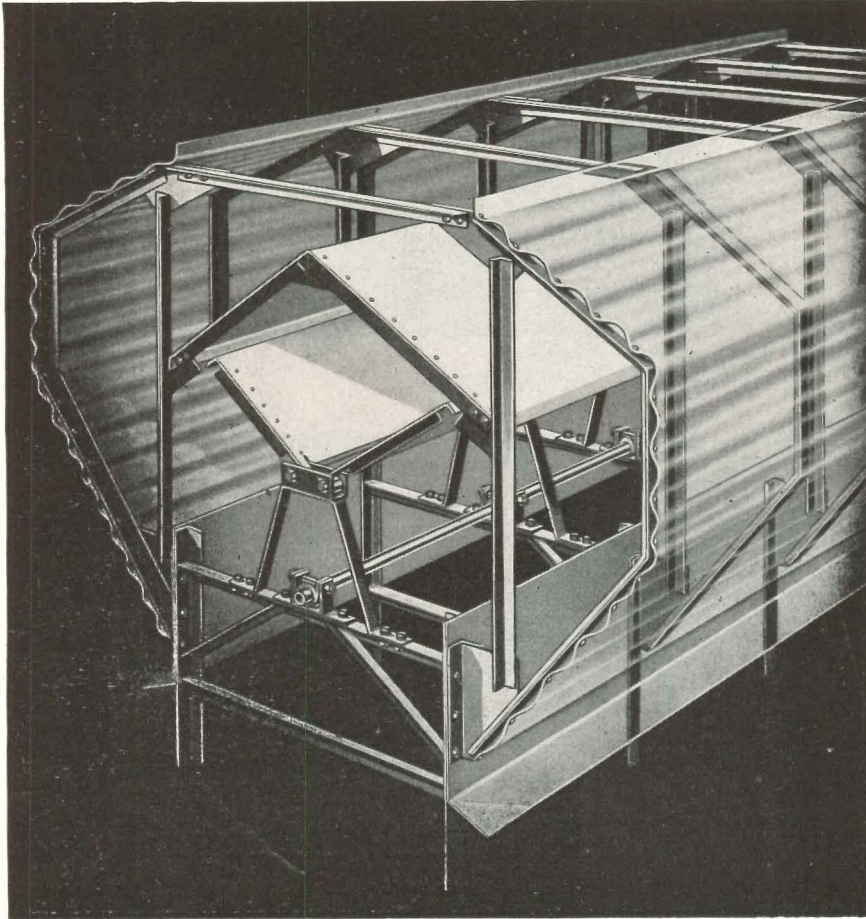

Insufficient ventilation may be responsible for a good share of your clients' hot weather troubles. Often, a sharp drop in production and a rise in rejects, minor accidents and absenteeism may be traced directly to improper plant ventilation. The remedy is simple—a properly engineered and installed Burt Ventilating System. Burt engineers will help you with layouts and specifications. From the complete Burt line of gravity, fan and continuous ridge ventilators, they can recommend the sizes and types that will perform best for you. Special units, if required, can be produced in Burt's highly efficient fabricating plant quickly and economically. Half a century of ventilating experience assures you a properly engineered and efficient ventilating system when Burt does the job. See Sweet's or write for catalog and data sheets on the Burt line—NOW.

WRITE FOR CATALOGS AND DATA SHEETS

The **BURT MFG. Co.**

48 E. South Street

Akron 11, Ohio, U.S.A.

VENTILATORS • LOUVERS • OIL FILTERS • SHEET METAL SPECIALTIES

NEWS FROM CANADA

(Continued from page 156)

consist of an area of 900 square miles. Surrounding the city will be a green belt comprising farm, market gardening and wild land, which will serve to limit future growth and prevent ribbon development. The remainder of the district will be extensively developed with special emphasis laid on hunting, fishing and resort facilities. A comprehensive network of arterial highways, roads and scenic drives is planned.

The proposals put forward by the National Capital Planning Committee affect not only Ottawa, but nearly 30 other municipalities and 2 provinces—Ontario and Quebec—as well. Cooperation at all levels will be essential for the successful realization of the plan. Contrary to the practice in many other countries, the federal government has no administrative authority over Canada's capital and the surrounding district.

Completions and Starts Soar

The first quarter of 1949 saw 17,800 dwelling units completed, according to the latest release from the Dominion Bureau of Statistics. This represents an increase of 54 per cent over the same period a year ago. Starts for the first quarter totalled 8,400 units, an increase of 26 per cent.

The Bureau attributes the larger number of completions to the "unusually higher carry-over at the beginning of 1949." But "in spite of the greatly increased completions, the amount of work in progress remains high."

Socialized Housing Blasted

Members of the Toronto Property Owners' Association were urged to organize to protect private enterprise housing from "inroads of the welfare state," at a recent meeting. The suggestion came from Herbert U. Nelson, executive vice-president of the National Association of Real Estate Boards of the U. S.

"An organized rental housing industry can get the facts about rental property and property ownership to the public, past hollow political promises and economic sleight-of-hand," Mr. Nelson asserted. "Only through such action are we likely to avoid the permanent political capture of the rental housing industry that has been accomplished in France and England."

(News continued on page 160)

Something *Really* NEW in lightingware

CORNING "FOTA-LITE"

*The glass with
sealed-in louvers*

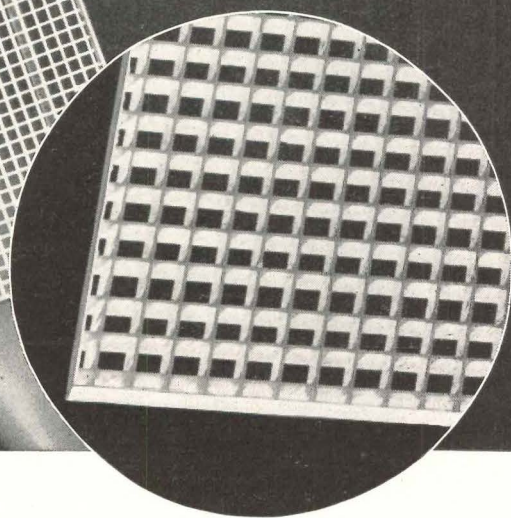
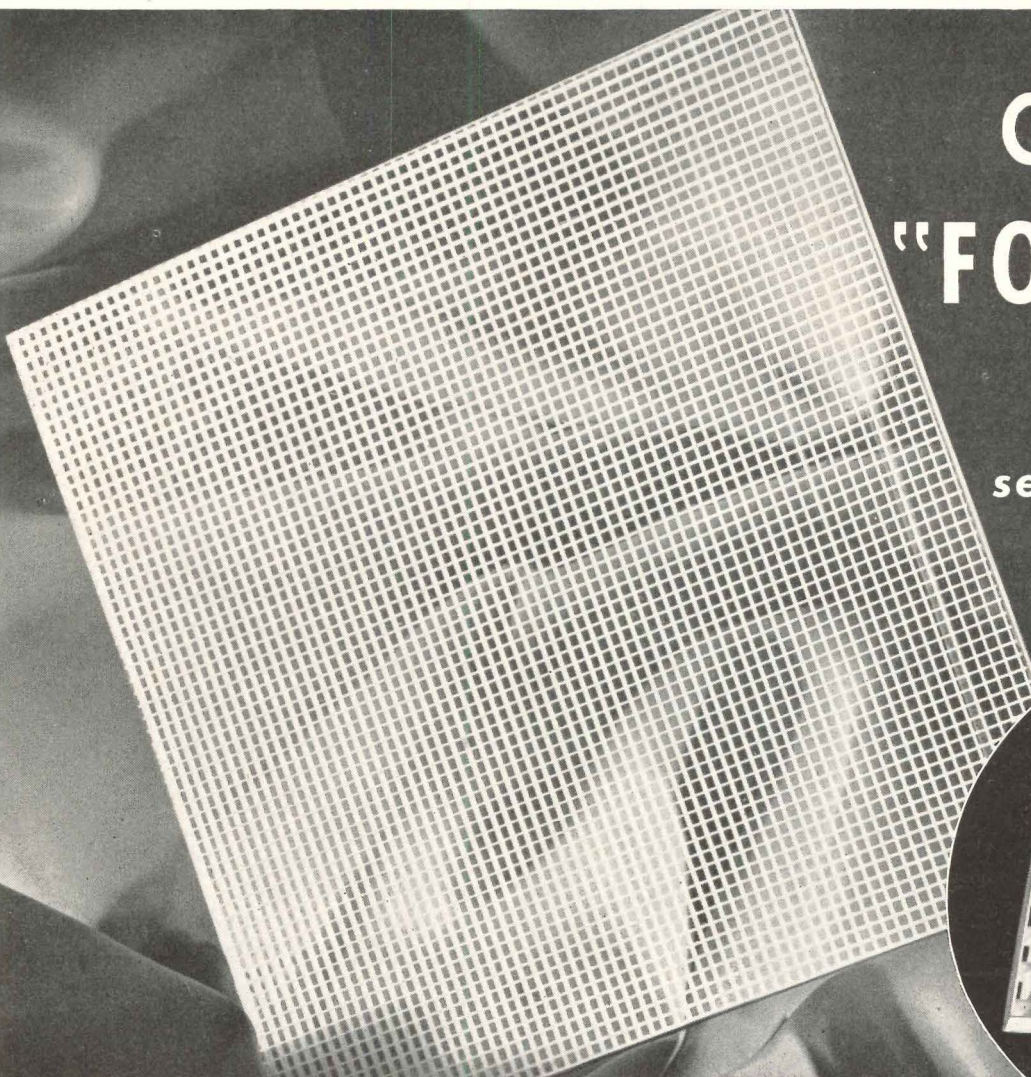

Now you can get "egg crate" fluorescent lighting effect *without the egg crate!* Corning "Fota-Lite" is a new glass in which vertical louvers are photographically transferred to the full thickness of the glass.

EASY TO CLEAN. "Fota-Lite" presents a smooth surface which you can wipe clean quickly—something that is impossible with ordinary exposed louvers. Since you can completely enclose the fixture, both tubes and reflectors also remain clean. Thus, you never lose original efficiency through the accumulation of grime and dust.

HIGH EFFICIENCY. Brightness at high angles is low. Yet, the transparent area is comparable to the finest crystal. Light directed vertically is almost unrestricted but a slight surface diffusion obscures tubes and reflectors. The 45° cut off is obtained within the thickness of the glass ($\frac{1}{8}$ ") instead of bulky and costly louvering materials.

NO COLOR CHANGE. The opalescent louvers are non-selective in color transmission and as they are sealed within the glass surface, discoloration is impossible. This is important in maintaining original color values.

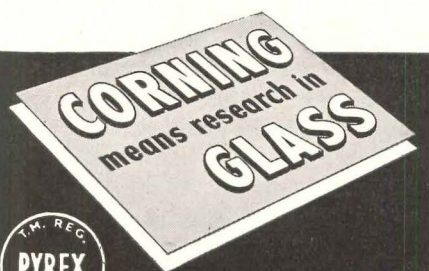

CORNING GLASS WORKS
Lighting Sales Department
Corning, New York

SALES OFFICES:
New York
Chicago
San Francisco

CORNING GLASS WORKS, DEPT. AR7, CORNING, N. Y.

Please send Bulletin LS-19, describing Fota-Lite.

NAME _____ TITLE _____

COMPANY _____

ADDRESS _____

CITY _____ ZONE _____ STATE _____



Elementary school, Valois, Quebec. Barott, Marshall, Montgomery & Merrett, Architects

STONE & THOMAS, THE PEOPLE'S STORE, CHARLESTON, W. VA.
Designed by: George Frei, Amos Parrish & Co., Inc.

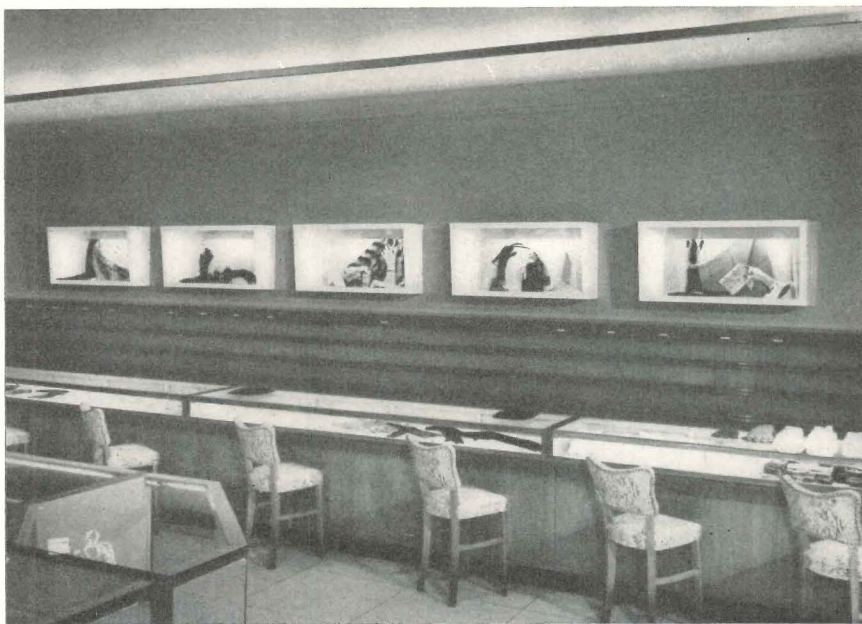

THE PEOPLE'S CHOICE Bergen Elected Again!

Elected again! This time by the People's Store, who now proudly point to the most modern store in the South.

A completely new establishment was erected for them at Charleston, W. Va. The photo above gives but the briefest glimpse of the finest equipment which is an integral part of the entire store. For instance, display counters are illuminated by cold cathode lighting with concealed wireways.

On every hand, one sees evidence of the masterful incorporation of the latest merchandising ideas . . . all translated into physical reality. Enduring reality, in fact, because Bergen's aged-in-the-wood craftsmanship was involved from designer's plans through installation.

North . . . East . . . South . . . West! Bergen Cabinet is elected many times a year . . . to do jobs that give perfect service for decades!

Write for our Portfolio of "Jobs Well Done". It's worth seeing.

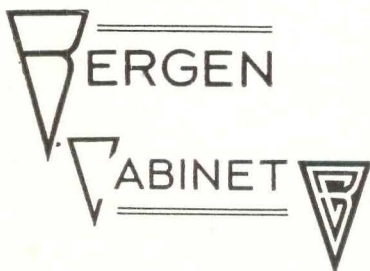

Bergen—sure the success of your modernization program with

Architectural woodwork that makes the designer's plan an enduring reality

1552-56 BERGEN STREET, BROOKLYN, N. Y. • Phone: PResident 2-3121

April Contracts Dip Slightly

Building contracts for April totalled \$76.8 million, according to Maclean Building Reports. This is \$3.9 million less than the amount for the same month last year. Ontario was the culprit. Awards there were off nearly 50 per cent in all classifications. Other provinces showed gains, with Quebec and the Maritimes leading the parade.

The drop is significant because April, May and June are key months in determining whether or not 1948's record total of \$954 million will be surpassed. So far, there's no cause for pessimism. Contracts for the first four months of 1949 amounted to \$280.5 million, or \$71.2 million more than the total for the same period last year. Residential building continued to head the list.

Builders Want Easier Credit

Charges that loan appraisals under the National Housing Act are too low to meet the needs of prospective homeowners were levied at the recent annual meeting of the National House Builders' Association in Winnipeg.

The builders, who have been becoming increasingly restive about this matter, prepared a strongly worded brief for submission to Reconstruction Minister R. H. Winters. It calls for boosting "appraised lending values" to parity with 1949 construction costs, extension of the mortgage amortization period to 30 years, reduction of down payments to 10 per cent of current prices, and elimination of regional differences in making N.H.A. appraisals.

George Prudham of Edmonton, re-elected president of the Association, pointed out that the reluctance of Central Mortgage & Housing Corporation (which administers the Act) to recognize today's costs is creating an unsupportable demand for rental housing. In his opinion, communities are being forced to enter Dominion-municipal agreements to build subsidized projects. The carrying charges of these projects are certain to cost the public more than any loss theoretically risked in raising appraisals.

Raps Government in Housing

"The only justification for the government taking a dollar from the citizen is that it be spent to the greater common good than if spent by the citizen himself," President T. D'Arcy Leonard told the Dominion Mortgage & Investment Association in his annual report. The

(Continued on page 162)

Sanymetal* "PORCENA"

*Trade Mark Reg. U. S. Pat. Off.

(Porcelain on Steel)

TOILET COMPARTMENTS

Sanymetal "PORCENA" CENTURY Type Ceiling Hung Toilet Compartments offer the utmost in sanitation and provide modern, distinctive toilet room environments for schools, institutions, terminals and other public buildings.

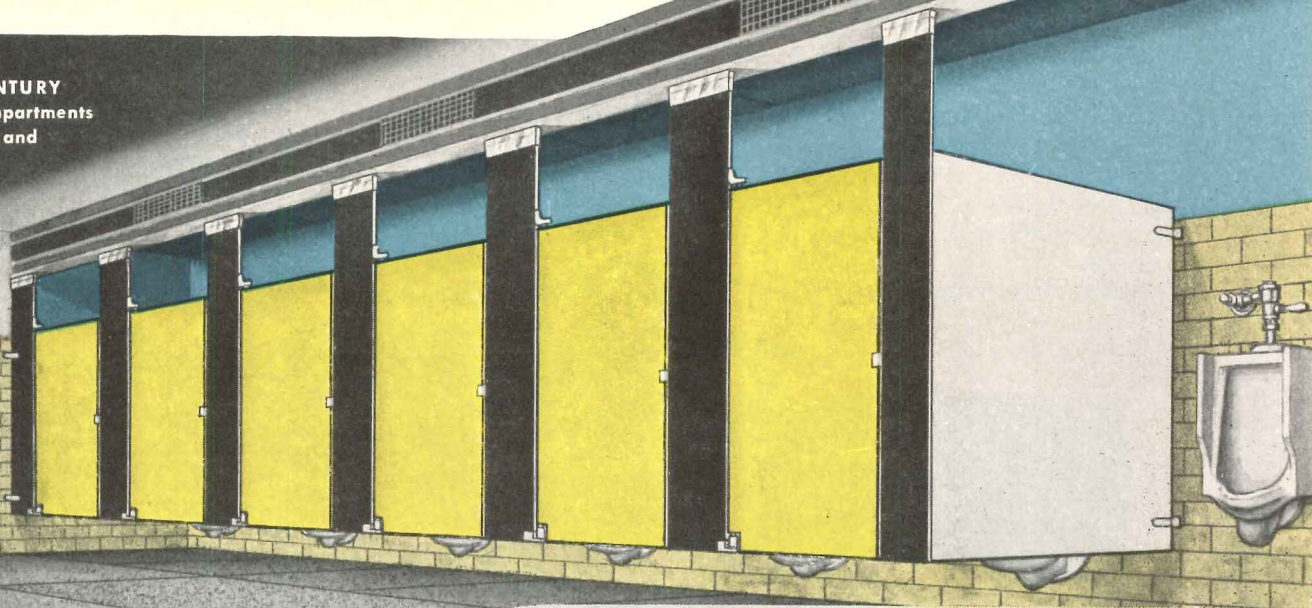

How to Protect a Toilet Room Environment Against Premature Obsolescence

● There is one environment you can protect against premature obsolescence—the toilet room environment.

Toilet room compartments usually dominate a toilet room, influencing the toilet room environment. Sanymetal "PORCENA" (Porcelain on Steel) Toilet Compartments provide a generous measure of protection because of these features. Sanymetal "PORCENA"

(Porcelain on Steel) Toilet Compartments always look new, do not absorb odors, are moisture and rust proof and resist the corrosion of ordinary acids. The glistening, glass-hard, "PORCENA" (Porcelain on Steel) finish can be wiped clean as easily as a porcelain table top, and greatly reduces sanitation and maintenance costs.

Sanymetal "PORCENA" (Porcelain on Steel) Toilet Compartments combine the results of over 35 years of specialized skill and experience in making over 100,000 toilet room installations. Ask the Sanymetal Representative in your vicinity (see "Partitions" in your phone book for local representative) for helpful suggestions about planning suitable toilet room environments . . . Refer to Sanymetal Catalog ^{21B}/₆ in Sweet's Architectural File for 1949.

THE SANYMETAL PRODUCTS CO., INC.
1689 URBANA ROAD • CLEVELAND 12, OHIO

Sanymetal "PORCENA" ACADEMY Type Toilet Compartments are suitable for conservative but modern toilet room environments.



Sanymetal "PORCENA" ACADEMY Type Shower Stalls and Dressing Room Compartments provide the utmost sanitation for tourist camps, gymnasiums, clubs, Y.M.C.A.'s, etc.

Sanymetal*

*Trade Mark Reg. U. S. Pat. Off.

"PORCENA" (Porcelain on Steel)

TOILET COMPARTMENTS, SHOWER STALLS AND DRESSING ROOMS



Write for Sanymetal Catalog 86 which illustrates modern toilet room environments suitable for all types of buildings. Several attractive designs in a wide range of colors available. This catalog is also contained in Sweet's ^{21B}/₆ Architectural File for 1949.

Sanymetal "PORCENA" NORMANDIE Type Toilet Compartments endow a toilet room environment with dignity and good taste.

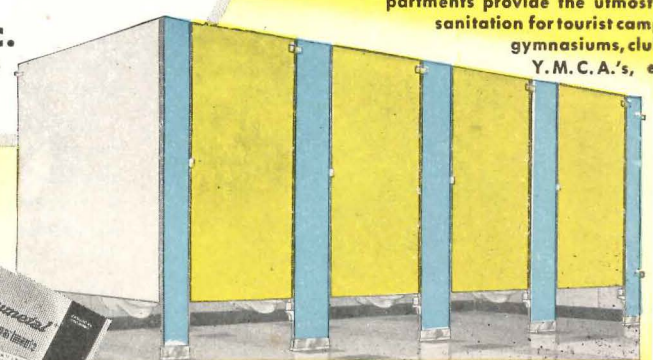

Association's membership is comprised of Canadian life insurance, trust and loan companies.

Examination of expenditures by governments, Mr. Leonard said, reveals that the uses to which much money is put violate the required standard. He felt this was a matter of particular concern in connection with the housing of the people.

"In those parts of this field, such as

slum clearance, which properly belong to government, not a great deal is being done. On the other hand, we find that a good many taxpayers' dollars are being devoted to financing and construction of housing that could be done without government participation.

"At the present time there are ample funds available from sources other than governments for all normal economic housing construction," he declared.

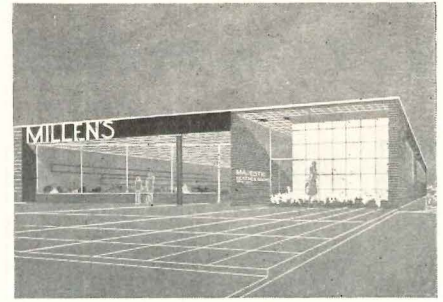

New plant for Majestic Leather Goods, Hull, Quebec, designed by J. S. LeFort et ses Associes

Provides top efficiency with true economy!

Kewaunee
HOSPITAL
FURNITURE

● Kewaunee Hospital Casework, Cabinets and Laboratory Furniture are scientifically designed to give you top efficiency and time-saving convenience. Built completely in our plants, Kewaunee's high standards, plus production-line manufacturing, assure custom quality at lower cost.

Kewaunee Metal Furniture is Bonderized for protection against rusting and chipping. Hospital Laboratory table tops and working surfaces are of KemROCK for resistance to acids, alkalis, solvents, abrasion and ordinary physical shocks.

You are invited to consult Kewaunee's Hospital Engineering and Planning Service without cost or obligation.

C. G. CAMPBELL, President

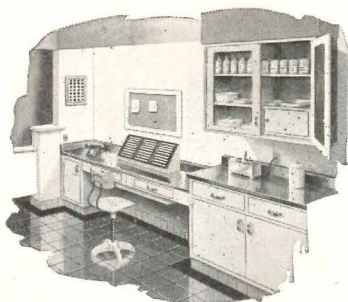

Representatives in Principal Cities

KEWAUNEE MFG. CO., 5046 S. Center St., Adrian, Mich.

Housing Projects Get Bigger

The most marked difference between Canadian prewar and postwar housing schemes is the increase in their size. Of course, this is chiefly due to the entry of Central Mortgage & Housing Corporation into the shelter field. Those of its activities which contribute to large-scale construction operations are two in number: its building of rental housing for veterans and its rental insurance program.

Under the veterans' rental scheme, the municipality requiring housing supplies the land and services and Central Mortgage finances the cost of construction. The municipality agrees to accept a small annual payment per dwelling in lieu of taxes. The insurance program guarantees builders of rental housing sufficient income to look after taxes, debt service, operating expenses, repairs, renewals and replacements. A nominal premium is charged.

A summary of the larger housing projects launched under these two schemes, and now underway across Canada, follows:

RENTAL HOUSING		
Project		No. Units
Calgary, Alta.		275
Edmonton, Alta.		250
Regina, Sask.		300
St. Boniface, Man.		200
St. Laurent, Que.		768
Vancouver, B. C. "Fraserview"		1,200
" " "Renfrew Heights"		586
Windsor, Ont.		500
Winnipeg, Man.		300
RENTAL INSURANCE		
Project		No. Units
St. Laurent, Que.		1,100
Toronto, Ont.		183

Both the St. Laurent and Toronto rental insurance projects are completely planned communities with shopping centers and other facilities. Land coverage is low, and buildings are both one and two bedroom apartments, and row houses.

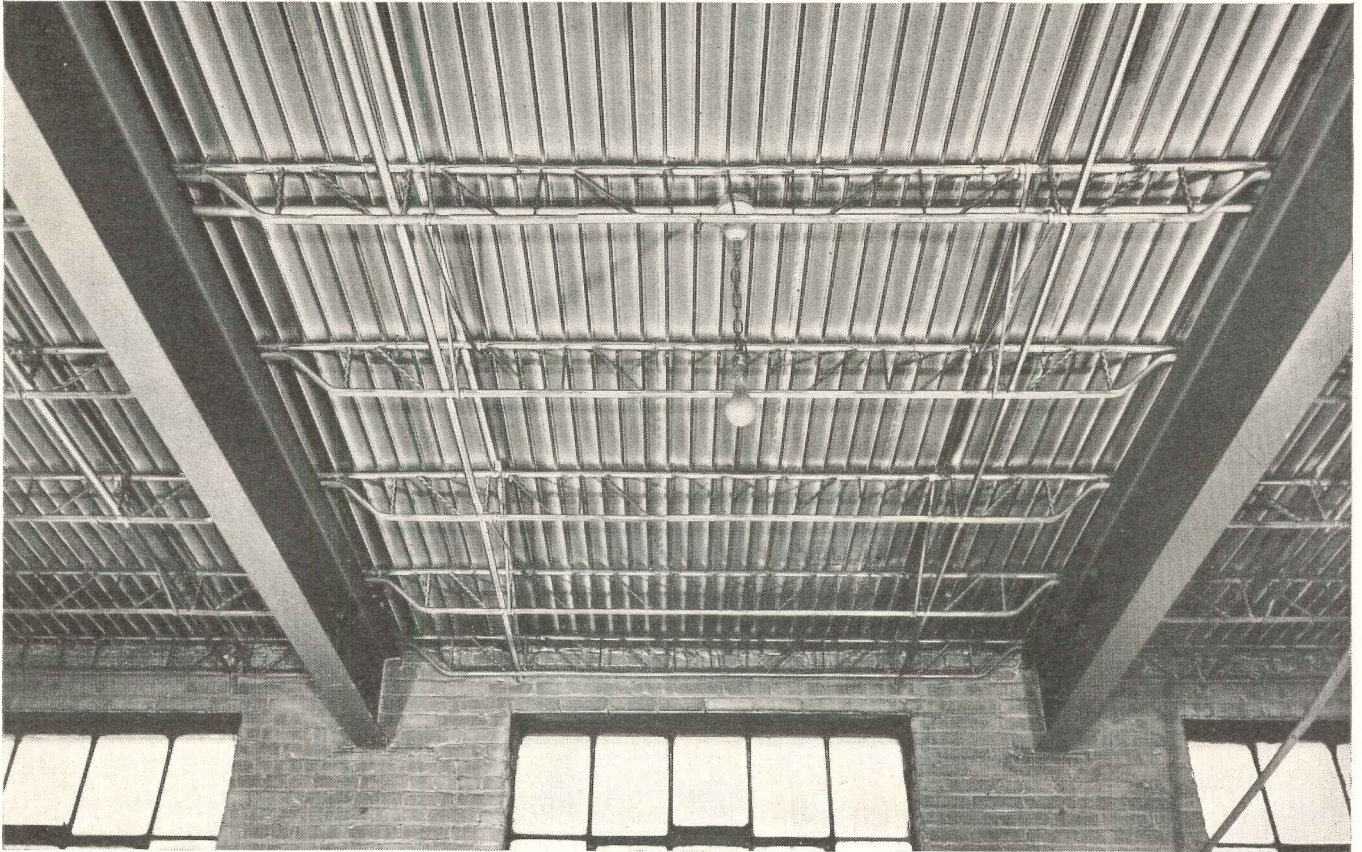

The 25-year Fenestra Holorib ceiling and roof of the P. G. Vincent Cigar Co., Cleveland. Architects—Cavanangh & Baer

AFTER 25 YEARS—*As Good as New!*

Back in 1924, a couple of months before Calvin Coolidge was elected President, the sturdy roof and ceiling you see above was installed for the P. G. Vincent Cigar Company of Cleveland.

Now—25-years-of-wear later, that Fenestra* Holorib roof is *still as good as new!*

In fact, the present occupants of the building say they haven't even noticed the ceiling in the 12 years they've been there. Why should they? It's never given them a minute's trouble. That's something to remember—if you want permanent protection for your buildings.

WHAT HOLORIB STEEL DECK IS:

Strong, lightweight, smooth-surfaced roof sheathing in 18 or 20-gauge sheets 18" wide and as long as required for multiple purlin spacings up to 24'. Each sheet is self-reinforced by three 1½" deep ribs running lengthwise, spaced on 6" centers. The pyramidal rib shape provides a

broad base for bearing and welding, and narrow rib openings minimize asphalt loss during mopping of insulation. Rib shape—plus the exclusive telescoping end-lap and interlocking side-lap features—is the key to the tremendous strength and rigidity of Holorib installations... the key to the 25-year line of successful Holorib installations.

WHAT HOLORIB DOES:

Holorib Roof Deck, welded directly to purlins, forms a flat roof easily covered with insulation and waterproof roofing. Economical and easy to erect, Holorib gives you an attractive, noncombustible, long-wearing ceiling.

Specify Holorib for a roof deck and ceiling that easily passes the 25-year test. Also check on Fenestra D Panels for floors, insulated C Panels for walls. You'll be glad you did. For further information, see Sweet's Architectural File, Section 3c/3. Better yet, call or mail the coupon.

*Trademark

Fenestra

METAL BUILDING PANELS

ROOFS · WALLS · FLOORS

DETROIT STEEL PRODUCTS COMPANY
Building Panels Division
Dept. AR-7, 2252 E. Grand Boulevard
Detroit 11, Michigan

Please have an engineering representative call.

Please send me, without obligation, information on Fenestra Building Panels.

Name _____

Company _____

Address _____

THE RECORD REPORTS *(Continued from page 22)*

federal buildings in Honolulu and the Law Quadrangle of the University of Michigan.

From 1909-13 he was consulting architect to the Treasury Department and since 1907 to the Board of Water Supply of New York City. He went to Japan in 1937 as a consulting architect.

Mr. Sawyer began his technical education with the study of engineering. He studied architecture at Columbia Uni-

versity and the Ecole des Beaux Arts in Paris and later worked and continued his studies with the firm of McKim, Mead & White.

FRANK AYERS WRIGHT

Frank Ayers Wright, A.I.A., and a founder of the Architectural League of New York, died on June 6 in Whippany, N. J., following a long illness. He was 94.

Mr. Wright was the author of "Architectural Perspective for Beginners"

which was widely used as a textbook. He studied architecture at Cornell University, graduating in 1879, and was appointed an instructor in architecture while he was still a student. He was the oldest member of the Cornell Club of New York.

Mr. Wright was also widely known as a golfer and from 1910 to 1912 was one of the top-ranking amateurs in the sport. He won the Cornell Club championship 13 times.

ADDENDA

The theater at the Great Lakes Naval Hospital which was pictured on page 166 of the April issue of the ARCHITECTURAL RECORD was designed by Erwin G. Fredrick, Architect, of Chicago, Ill.

Our apologies to Marr and Holman, Architects, of Nashville, Tenn., for the omission of their name as designers of the Federal Office Building and U. S. Court in Nashville, a photograph of which appeared on page 160 of the May issue of the RECORD.



The jury, under chairmanship of Morris Keitchum, Jr. (center) studies an entry

MODERNIZATION WINNERS

First prize for "The Best Modernized Store of the Year" has been awarded to Kutler's, men's furnishings store of Long Beach, Calif., by the Third International Store Modernization Show. Architect for the store was Victor Gruen, of Gruen & Krummeck Associates. Presentation of the \$150 award was made by John H. W. Evans, managing director of the show. Entries were submitted by Chambers of Commerce in 25 states and Hawaii.

Second prize went to the Pemberton Cadillac Building, an auto sales showroom in Toledo, Ohio, designed by Karl B. Hoke, Architect, and H. B. Carney, designer, both of Toledo. Third place went to the South Bend, Ind., entry, the Frances Shop, women's specialty store. Architects for the shop were Mielke & Smith, of Chicago.

(News continued on page 166)

Sedgwick Multi-Stop Electric Traction DUMB WAITERS

WHERE THERE ARE THREE OR MORE LANDINGS TO BE SERVED . . . specify Sedgwick Electric Traction Dumb Waiters—confident that your clients will be fully satisfied. Proven performance is attested by thousands of installations, operating successfully from coast-to-coast, contributing convenience, efficiency and economy in hospitals, hotels, restaurants, clubs, libraries, schools, stores and other commercial, institutional and industrial buildings. Available to you—from specification to installation—is Sedgwick's 55-year-old experience in planning, engineering, manufacturing and installing of vertical transportation equipment.

Throughout, Sedgwick combines sound, progressive electrical and mechanical engineering to produce a Multi-Stop Dumb Waiter meeting the highest standards of dependable operation, low-cost maintenance and finished appearance.

Machine consists of elevator-type high torque, low starting current motor, with worm gear reduction built as one unit and an adjustable electro-magnetic brake. Gearing operates in a sealed case filled with special lubricant. Control is fully automatic with momentary pressure push buttons at each landing opening, permitting car to be called and dispatched as desired. Each push button station is provided with "open door" and "in use" signal lights to expedite efficient use of equipment. Sedgwick Type "SL" Combination Door Locks and Switches are provided for hoistway doors to prevent opening of any door except that door at which the car is at rest, thus permitting operation of car only when all doors are closed. Other refinements in the control system include reverse phase relay, overload relay and non-interference relay.

In addition to Sedgwick Multi-Stop Electric Traction Dumb Waiters, Sedgwick also builds the Roto-Waiter, designed especially for two-stop service. Both are of all-steel construction. Specify, too, Sedgwick Steel Dumb Waiter Doors for complete satisfaction.

Whatever your vertical transportation problem may be, it is probable that we have case histories on parallel applications in our files. We'll be glad to supply you with such information, prices or any other data you may require.

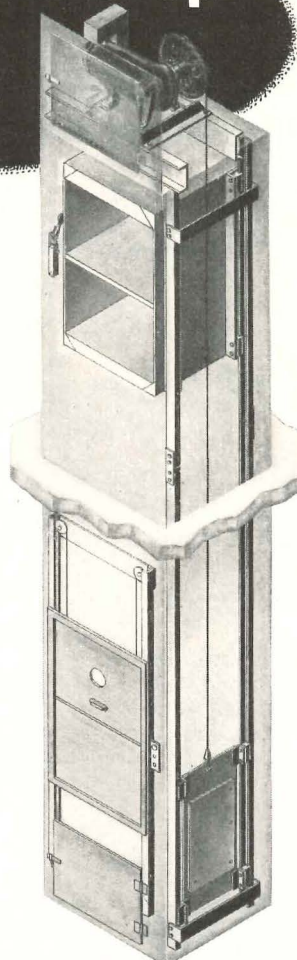

STANDARD DIMENSIONS						
Capacity in lbs.	200	200	300	300	500	500
Speed in F.P.M.	50	100	50	100	50	100
Car Width	24"	24"	30"	30"	36"	36"
Car Depth	24"	24"	30"	30"	36"	36"
Car Height Inside	36"	36"	36"	36"	48"	48"
Clear Inside Hoistway Width	33"	33"	39"	39"	45"	45"
Clear Inside Hoistway Depth	29"	29"	35"	35"	41"	41"

Sedgwick MACHINE WORKS

142 West 15th Street, New York 11, N. Y.
ELEVATORS · DUMB WAITERS · RESIDENCE ELEVATORS · STAIR-TRAVELORS
ROTO-WAITERS · SIDEWALK ELEVATORS · FREIGHT ELEVATORS · DUMB WAITER DOORS

BUILDERS OF VERTICAL TRANSPORTATION SINCE 1893

TRANE

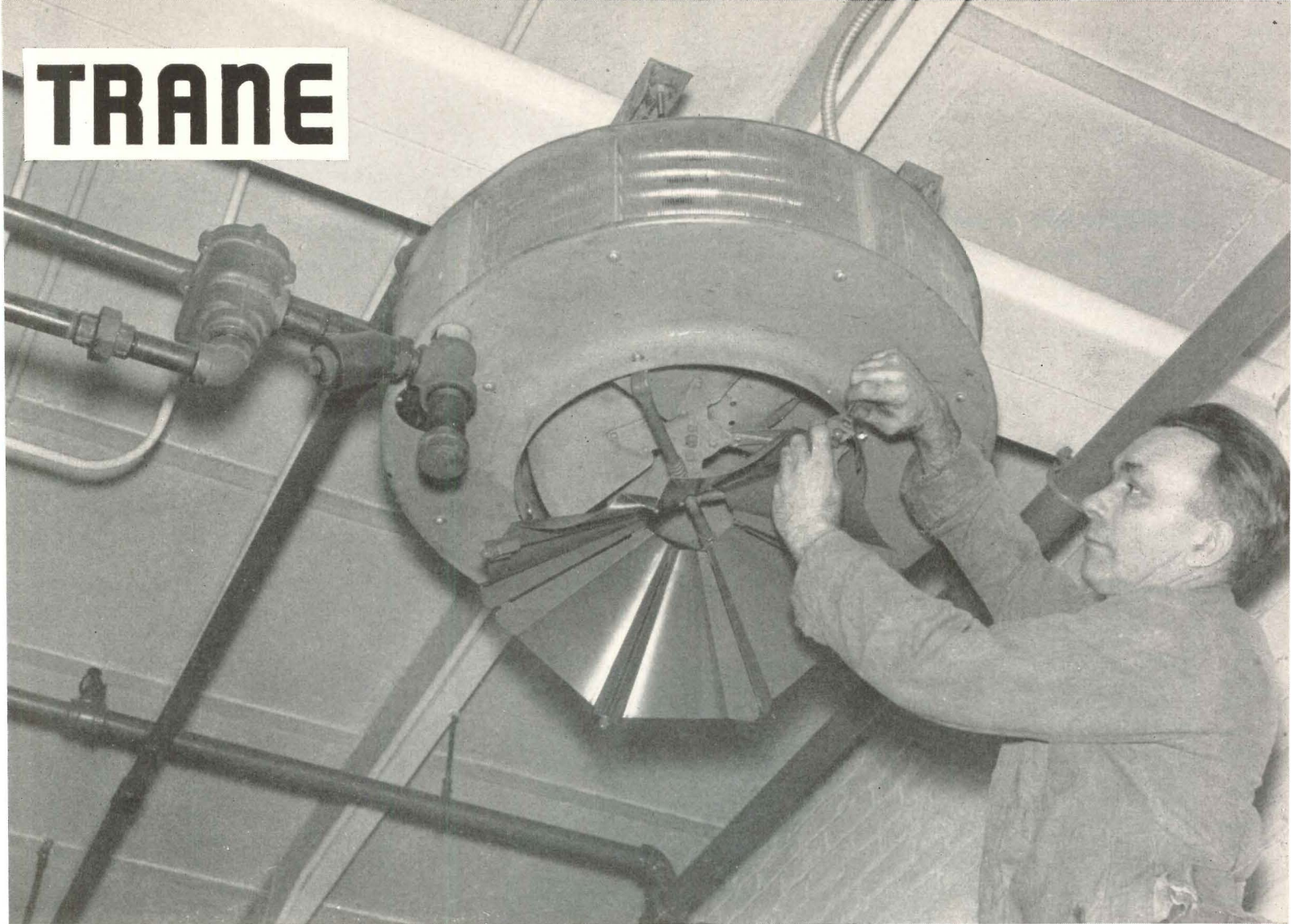

New Cloverleaf Diffuser gives added flexibility to Projection Unit Heaters. Easily adjustable, the diffusion pattern exactly fits the needs of the job.

How do you like your unit heaters...with, or without?

How do you like your unit heaters . . . with or without adjustable diffusers? . . . with or without ductwork? . . . with or without ventilation air? . . . high velocity delivery? . . . low final temperature?

Do you want propeller type . . . blower type . . . vertical discharge . . . horizontal discharge . . . floor, wall, or ceiling mounting?

You can have what you want, *but not in any one type of unit.* Four distinct types are needed to meet requirements encountered constantly on jobs of any scope.

How do you handle such situations? Do you select from limited lines and juggle the job to fit the units? Or do you come to Trane, where *all four* basic types—shown below—are available? Select from this complete line and you won't have to put square unit heater pegs in the round holes of job requirements.

And remember, too, at this one-stop source of supply you can also secure your convectors, coils, unit ventilators, and heating specialties for steam or hot water. One company; one responsibility. And back of it all, on-the-spot cooperation from the best-trained engineering sales staff in the industry.

You have everything to win—with Trane.

THE TRANE COMPANY...LA CROSSE, WIS.

Manufacturing Engineers of Heating, Ventilating and Air Conditioning Equipment—Unit Heaters, Convector-radiators, Heating and Cooling Coils, Fans, Compressors, Air Conditioners, Unit Ventilators, Special Heat Exchange Equipment, Steam and Hot Water Heating Specialties . . . IN CANADA, TRANE COMPANY OF CANADA LTD., TORONTO.

Here are the "Four Freedoms" of unit heater selection: 1. Twenty-four sizes of horizontal units; 2. Sixteen sizes of vertical projection units; 3. Twenty-four combinations of compact force-flo heaters; 4. Sixty-eight standard arrangements of blower units.

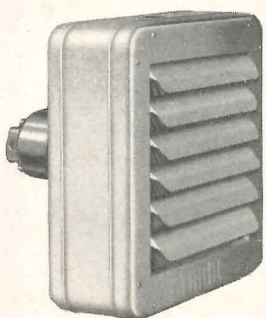

1

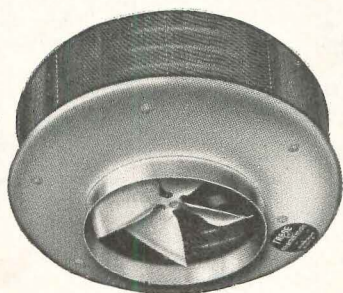

2

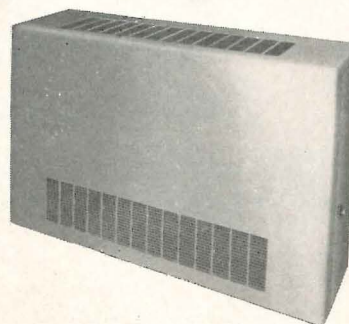

3

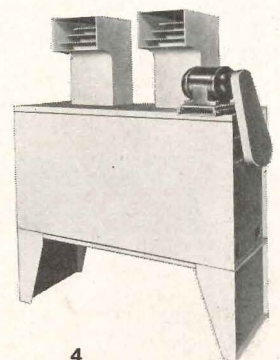

4

PREFABRICATED HOUSES

One out of every 25 houses (new, permanent single-family type structures) put under construction last year in non-agricultural areas in the United States was a prefabricated house, according to a report recently released by Prefabricated Home Manufacturers' Institute.

Prefabricators shipped 30,000 perma-

nent-type homes during 1948. These dwellings represent approximately 4 per cent of the 773,000 non-farm single-family houses which the Bureau of Labor Statistics estimated were put under construction last year.

About 75 producers accounted for the 1948 shipments which put the number of factory-built homes erected in this country since World War II over the 100,000 mark.

ON THE CALENDAR

Through Sept. 30: "Details of the City — Photographs by Godfrey Frankel," Museum of the City of New York, New York City.

July 13-15: Summer Convention, American Society of Civil Engineers, Mexico City.

Aug. 23-26: Pacific General Meeting, American Institute of Electrical Engineers, Fairmont Hotel, San Francisco, Calif.

Sept. 11-17: National Home Week, featuring housing exhibits in cities throughout the country.

Sept. 25-Oct. 2: Construction Industries Exposition, Sam Houston Coliseum, Houston, Texas.

Sept. 26-29: 51st Annual Convention of the American Hospital Association, Hotel Statler, Cleveland, Ohio.

AT THE COLLEGES

Award Winners

The recipients of two cash prizes in the 22nd annual collaborative competition for students of architecture, landscape architecture, painting and sculpture, sponsored by the Alumni of the American Academy in Rome, have been announced. First prize went to the team composed of Robert F. Storey, architect, and J. Sherman Thomas, landscape architect, students at Western Reserve University; Stephen Magada, painter, and Peter Stevens, sculptor, from the Cleveland School of Art. Second prize went to Rolv O. Enge, architect, University of Pennsylvania; Hugh Wiley, painter, and John J. Myers, sculptor, both of the Pennsylvania Academy of Fine Arts.

Sven Markelius, member of the United Nations Architectural Commission, has received the Howland Memorial Prize given by Yale University.

S. S. Granger, Architect, of Glendale, Calif., has been named winner of the nation-wide mission church design competition sponsored by St. Joseph's College. Second prize went to Joseph J. Shearer, Milwaukee, Wis., and third prize to W. J. Ruoff, architectural student at the University of Notre Dame.

Scholarships Established

An anonymous gift of \$20,000 has been received by Columbia University for the establishment of a scholarship fund honoring Miss Lila W. Van der Smissen, former secretary and curator of

(Continued on page 168)

Remember this dependable source of supply



REYNOLDS
Lifetime ALUMINUM
SHAPES
add modern styling to
ARCHITECTURAL PLANS

WAREHOUSED IN YOUR AREA
FOR PROMPT DELIVERY

IT'S "REYNOLDS" FOR LASTING BEAUTY AND ECONOMY

● Obtain smart, modern styling with Reynolds *Lifetime* Aluminum Architectural Shapes. Make your selection from the more than 65 standard shapes, created to meet your design requirements.

They're easy to obtain, too! Most of these bright, light, enduring aluminum shapes are warehoused from coast to coast for fast delivery. Whether it is a standard item — such as doors, jambs, thresholds, copings, windows, window sills or decorative trim — or special aluminum shapes designed to

your specifications, Reynolds is prepared to quote on your requirements.

For complete data call your nearest Reynolds Office, listed under "Aluminum" in your classified directory, or write direct to the address below.

SEND FOR COMPLETE DETAILS

Engineering drawings of all standard shapes in one compact folder. Can be used for direct tracing.

Write to Reynolds Metals Company . . . Aluminum Division, 2572 South Third Street, Louisville 1, Kentucky.



REYNOLDS METALS COMPANY
Aluminum Division, Louisville 1, Ky.

REYNOLDS
Lifetime ALUMINUM

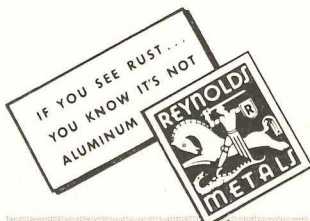

THE COMPLETE ALUMINUM SERVICE FROM
MINE TO FINISHED PARTS



Better Light a Sound Investment

...for New Hampshire Finance Corp.
Manchester, New Hampshire

Lighting Engineer: W. W. Burke, Public Service Company of N. H., Manchester, N. H. • Electrical Contractor: A. L. Franks Co., Manchester, N. H. • Lighting Equipment: Litecontrol No. 9224, 2-lamp surface lens fixture • Lamps: 40 watt, 3500 degree white, fluorescent • Total Wattage: 3,300 • Watts per Square Foot: 2.8 • Footcandles: 45 average maintained.

Working with figures is a pleasure in this modern office recently re-lighted with Litecontrol fixtures. Eyestrain . . . in checking records, in making entries, in filing . . . has been eliminated and each worker's efficiency materially increased.

Though not efficiency experts, Litecontrol engineers are experts in planning better lighting that *always results in better efficiency* in offices, schoolrooms, stores and factories. And they'll be glad to help you with new and unusual lighting ideas or with complete lighting layouts.

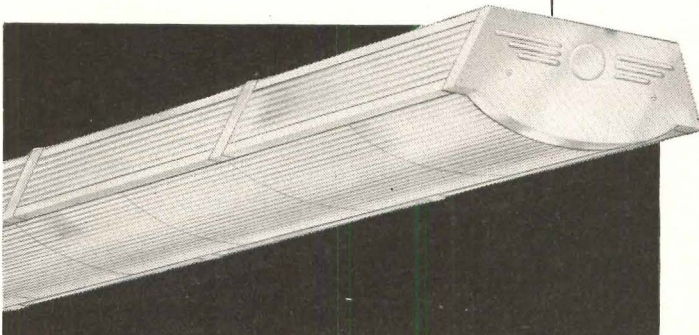

Cat. No.	Lamps	Length	Width	Height
9224	2-40W	48 $\frac{1}{8}$ "	15"	6 $\frac{3}{4}$ "
9234	3-40W	48 $\frac{1}{8}$ "	15"	6 $\frac{3}{4}$ "

9200-3 End cap for individual units or continuous runs

... with LITECONTROL FIXTURE NO. 9224

Ideal for offices is this surface type fixture with intensive, well distributed downlight controlled by the prismatic action of Holophane Controlescent lenses. Luminous slanting side panels give good ceiling illumination and reduced contrast. Special baked, white plastic-type finish will not crack, peel or discolor.



LITECONTROL

Fixtures

KEEP UPKEEP DOWN

LITECONTROL CORPORATION
36 PLEASANT STREET, WATERTOWN 72, MASSACHUSETTS

DESIGNERS, ENGINEERS AND MANUFACTURERS OF FLUORESCENT LIGHTING EQUIPMENT DISTRIBUTED ONLY THROUGH ACCREDITED WHOLESALEERS

the Columbia School of Architecture, who died last year.

An annual award of \$150 for the next five years has been set up by the Cleveland Chapter of the Producers' Council for upper classmen students in architecture at Western Reserve University.

Special Courses Offered

A course in lumber and building materials retailing will be offered for its

first five-week summer session, starting July 25, at the College of the City of New York.

The Institute of Design in Chicago has announced that it will offer a six-week summer session course which will provide intensified teacher training in the Institute's foundation course. The course may be applied to students as preparation for advanced study in architecture and allied fields.

The first regular summer session of architectural courses is being given this summer by the University of Oregon School of Architecture.

A summer seminar in industrial design is being conducted by Syracuse University.

Northwestern University will be the setting of a six-day course, from August 8-13, on hospitals in the planning stage. The Institute on Hospital Establishment, which is sponsored by the American Hospital Association, will be open to hospital administrators and representatives.

A six-week seminar in product design for representatives of manufacturing companies is being held at Lehigh University this summer. Leading industrial designers and product development men will be speakers at the seminar.

Faculty Appointments

Professor Bruce Goff has been reappointed Chairman of the School of Architecture of the University of Oklahoma for the school year 1949-50.

R. Buckminster Fuller, now conducting a seminar at the Institute of Design in Chicago, has been appointed dean of the Summer Institute at Black Mountain College, Black Mountain, N. C. He will bring with him to Black Mountain a group of graduates of that college and members of the Institute who will conduct a comprehensive basic workshop.

Carl W. Ernst, Jr. has been promoted to assistant professor in the Carnegie Institute of Technology department of architecture. He has been a member of the Carnegie faculty since 1946.

OFFICE NOTES

Offices Opened, Reopened

Col. Harry F. Cunningham, Consulting Architect, has opened an office at 1215 P St., Lincoln, Neb.

Eugene A. Dubin, M.A.S.C.E., has opened an office for the general practice of, and offering an advisory service in structural engineering and building design at 105 W. Monroe St., Chicago 3, Ill.

Harold M. Hansen, Architect, has opened an office at 210 Post St., San Francisco, Calif.

Hutchings & Milani, Architects, Engineers and General Contractors, have opened new offices offering services on large hotel, industrial and resort developments. Their address is the Marshall Bldg., Hamilton, Bermuda.

Tom Hutchins, Architect, has an-

(Continued on page 170)



better... lower cost
CONSTRUCTION
with **KORK-PAK**
and Premolded
Para-Plastic!

KORK-PAK
THE IDEAL
JOINT
FILLER

Because:

- WATER-PROOF
- RESILIENT
- NON-EXTRUDING
- HAS GOOD INSULATING QUALITIES

Use KORK-PAK, the water-proof, resilient joint filler between concrete floor slabs and footings in basementless houses and structures with slabs on grade to keep the joint *effectively filled at all times*. KORK-PAK is a good insulator — its cork granules bonded together with asphalt prevent expensive heat loss from the slab through the footings. KORK-PAK is readily handled without breakage — is the least expensive non-extruding joint filler made.

Premolded Para-Plastic Sealing Strips offer the simple solution to sealing vertical and overhead concrete joints. A development of widely used hot-poured Para-Plastic, Premolded Para-Plastic is quickly, easily installed on finished concrete, or it may be attached to the form and concrete poured right up to it. Premolded Para-Plastic is effecting great time and labor savings on every type of construction. Try it on your next job.

Write for illustrated circulars describing the Serviced Line of asphalt, cork and rubber composition products for the construction industry.



Premolded
Para-Plastic
JOINT SEALERS



Premolded
PRESSURE SEAL

SAVES TIME and COSTS in DIFFICULT JOINT SEALING APPLICATIONS

3-TYPES

- Para-Lateral
- Baseal
- Premolded Pressure Seal



See our
Catalog
in Sweet's

SERVICISED PRODUCTS CORP.
6051 W. 65th ST., CHICAGO 38, ILL.



TEN YEARS FROM NOW... the layout will have changed four times... the walls will be the same

Spaulding Co.,
Rochester,
New York

OVER AND OVER AND OVER AGAIN—that's the way Mills Metal Partitions are used. They're made to keep pace with the constantly changing space requirements of modern business.

They're as permanent and solid and beautiful as any walls you'd ever want around you but they can be moved—*quickly, easily and at very low cost*—to fit any new arrangement of space that progress dictates. The entire job can often be done overnight without interrupting business routine.

Dignified and refined in architectural design, they're available in a wide variety of attractive colors in baked-on finishes that keep their fresh new look with a minimum of maintenance. Exclusive features like all-welded panel construction, special treatment that eliminates harsh light reflection, and scientific soundproofing and insulation make Mills Movable Metal Partitions *the demonstrably superior system for flexible division of interior space.*

© The Mills Co.

THE MILLS COMPANY • 961 Wayside Road • Cleveland 10, Ohio

SPECIFY "MILLS" FOR:

All-Welded Panels • Glareless Finishes
Scientific Insulation and Soundproofing
Easy Erection • Maximum Mobility
*Superior Architectural Design

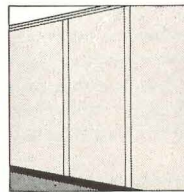

***A CASE IN POINT**

Mills Partitions, because of all-welded panel construction, need only a minimum of lines at panel joints to assure maximum mobility, precision erection.

For all the facts see *Sweet's Architectural File* or write for *Mills Metal Partitions Catalog 49-0.*

★

MILLS

Movable

METAL PARTITIONS

★



nounced the opening of an office for the practice of architecture at 653 Salisbury Rd., Statesville, N. C.

C. J. Kordys, Architect, has opened his own office for the practice of architecture at 264 New York Ave., Newark 5, N. J.

Fay R. Spangler, Architect, has announced the opening of a new office for the general practice of architecture at 225 Anglo Bank Bldg., Fresno, Calif.

New Addresses

The following new addresses have been announced:

Dubin and Dubin, Architects and Engineers, 140 N. Dearborn St., Chicago 2, Ill.

Malcolm Graeme Duncan, A.I.A., 307 Harwood Bldg., Scarsdale, N. Y.

Lawrence and Dykes, Architects, 125 Valleyview Ave., N.W., Canton 8, Ohio.

Levy & Scheingarten, Architects, 1162 E. Jersey St., Elizabeth 4, N. J.

McCoy & Blair, Architects (Robert S. McCoy and G. Norman Blair), 4 Chatsworth Ave., Larchmont, N. Y.

John P. O'Neill, Architect, 522 Columbia Bldg., Spokane 8, Wash.

Rogers & Butler, Architects, 219 E. 44 St., New York 17, N. Y.

Savo Milan Stoshitch, A.I.A., 427 W. Fifth St., Los Angeles 13, Calif.

New Firms, Firm Changes

Henry Otis Chapman and Randolph Evans, Architects, have announced a change in their firm name to include the name of William E. Delehanty. The firm of Chapman, Evans and Delehanty now has its offices at 50 Broadway, New York 4, N. Y.

Robert H. Edwards and Carl B. Stoye have announced the formation of a partnership for the practice of architecture under the firm name of Edwards and Stoye. Address: 22 Main Street, Sayville, L. I., N. Y.

ELECTIONS, APPOINTMENTS

L. C. Cartwright has been elected secretary of Foster D. Snell, Inc., New York consulting firm of chemists and engineers. Elected to serve with him were: Albert F. Guiteras, treasurer, and Louis J. Bowlby, Jr., assistant treasurer.

James R. Edmunds, Jr., past president of the A.I.A., has been reelected chairman of the Construction Industry Advisory Council.

Paul Oppermann has resigned his post as urban planning officer for the Federal Works Agency to become director of the San Francisco City and County Planning Commission. Tracy B. Augur, formerly of the TVA, has been assigned to the FWA to succeed him.

Louis Skidmore, of the architectural firm of Skidmore, Owings & Merrill, has been elected president of the New York Building Congress. Elected to serve with him were, vice presidents: William L. Crow, president, William L. Crow Construction Co.; C. G. Dandrow, vice president, Johns-Manville Sales Corporation; Richard V. Hyland, of Madigan-Hyland; Howard McSpedon, president, Building & Construction Trades Council of Greater New York, Long Island & Vicinity, and Harold R. Sleeper, Architect; A. E. McKenzie, of the Detroit Steel Products Company, secretary; H. C. Turner, Jr., president, Turner Construction Co., treasurer, and O. L. Nelson, vice president, New York Life Insurance Co., chairman of the finance committee.

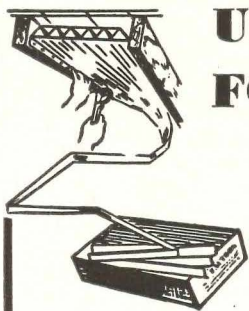

**USE THE COUPON = = =
FOR A Free COPY OF
"Simplified Physics of
Thermal Insulation"**

An authoritative, 32-page booklet

The author, Alexander Schwartz, adds to his own findings those of an impressive list of experts and laboratories. The subject headings include: Heat Transfer; Conduction and Density; Convection; Radiation and Emissivity; Rejection, Reflection and Absorption. Other topics are Vapor, Vapor Barriers, Humidity, and Condensation. Every kind of material, mass fibrous insulations and reflective types, how and where to use them, is discussed and different substances are compared.

Included, is the famous "Chart of Thermal Insulation Values," which has been revised and amplified. It contains specially compiled information on k, C, R and U factors of all insulations, of all thicknesses, on their densities, weights, cubic contents, etc., nowhere else grouped in so convenient form.

Thermal Factors Printed on Every Infra Carton

Infra's multiple separated aluminum sheets provide 4 reflective spaces and 4 reflective surfaces, each non-condensation-forming. Two sheets of aluminum and the accordion partition block convection currents. Infra's triangular reflective air spaces and small mass eliminate conduction as a problem.

INFRA C FACTORS & ROCKWOOL EQUIVALENTS

- C.052 Heat Flow Down, equals 6" Rockwool.
- C.083 Heat Flow Up, equals 4" Rockwool.
- C.10 Lateral Heat, equals 3-1/3" Rockwool.



Infra Insulation, Inc., 10 Murray St., New York, N. Y. Dept. AR

Please send "Simplified Physics of Thermal Insulation" to

NAME _____

FIRM _____

ADDRESS _____



Frank Tyler OF HERMAN NELSON

One of the veterans of Herman Nelson's nationwide organization, Frank Tyler, Manager of the Moline Branch Office, has been in the heating and ventilating business since 1905. During his 30 years' association with The Herman Nelson Corporation, Mr. Tyler has served in many capacities. While in the Product Application Engineer Service Department, Mr. Tyler became well-known to Architects, Engineers and Contractors throughout the country as an expert in the design and application of heating and ventilating systems. Before becoming Manager of Herman Nelson's Branch Office in Moline, he was Chief Product Application Engineer, in which position he was responsible for training all sales personnel for the company. Territory served by his Branch Office includes northwestern Illinois and eastern Iowa.

PRACTICAL KNOWLEDGE . . . technical experience . . . friendly cooperation. You find all three when you consult with a Herman Nelson Product Application Engineer like Frank Tyler of Moline. There are more than 75 of them strategically located in principal cities all over America.

Whether your heating or ventilating problem calls for unit heaters, unit ventilators, propeller fans or centrifugal fans, you'll find that the nearest Herman Nelson Product Application Engineer knows exactly how they should be installed to provide the most efficient operation with maximum economy. He'll furnish you with concise, easy-to-use engineering data and specifications. He regards it as his duty to see that your customers enjoy the results they have a right to expect from Herman Nelson products.

Working closely with Herman Nelson's Branch Managers and Product Application Engineers are more than 200 carefully selected Distributors and Stocking Jobbers with personnel trained in the application, installation and servicing of our products.

Behind Herman Nelson Heating and Ventilating Products . . . recognized nearly half a century for their superiority . . . stands this nationwide organization dedicated to serving you conscientiously and honestly.



THE HERMAN NELSON CORPORATION
Since 1906 Manufacturers of Quality Heating and Ventilating Products
MOLINE, ILLINOIS

ably with no future. It was nevertheless a business-like affair, complete with a competition, a ballroom full of materials and equipment exhibits, a program almost staggering in scope and detail, not forgetting Frank Lloyd Wright as the banquet speaker.

Aside from the last-mentioned item, always productive of some excitement, the most fireworks popped in the compe-

tion judgment, where controversy raged far into the night. Any observer could have seen, even if he didn't already know it, that the judges really tore into each other, merely because so much oil was spread in public. Which is really a way of saying that the competition was a tremendous success and the entries excellent.

An interesting fact about the judg-

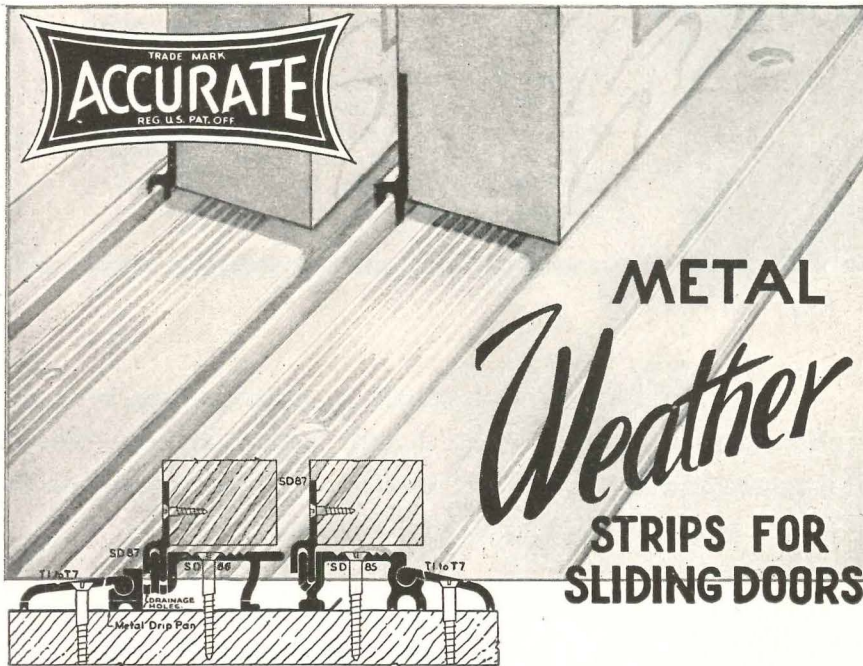

Open Doors to a New Way of Living
EXTERIOR SLIDING DOORS

THERE has been good reason for the definite trend toward exterior sliding doors leading to porches, terraces and patios—for there is a keen desire for as much outdoor environment as possible, yet with quick protection against inclement weather.

Fortunately, Accurate has gone far in making the use of outer sliding doors a practical possibility by better, smoother, trouble-free door movement—plus wholly dependable weatherproof qualities.

Many architects already have discovered the important part that Accurate plays in sliding door operation. We invite you to consult with us whenever you have sliding doors under consideration.

No window, no door, can be better protected against drafts, moisture, termites and heat losses, than with Accurate Metal Weather Strips, as proved by 43 years of experience.

Write for Illustrated Catalog

ACCURATE METAL WEATHER STRIP CO., Inc.
215 EAST 26th STREET, NEW YORK 10, N. Y.

ment was that the jury had a strong representation from the operating side of the hospital, so that architectural niceties could not run away with somebody's enthusiasm. In this case some architects registered primary enthusiasm about one of the other winners, not the first, and could cite strong planning reasons for their choice, but they had to back down against the operating circulation of the first prize winner. In the end the student competitors, the jury, and assembled architects had an educational experience of a high order.

Problem of the competition was a 35-bed general hospital for a small southern city, limited to students in selected southern technical schools. Prize money of \$500 was donated by the Wilmot Castle Company, Rochester, N. Y., manufacturers of hospital sterilizers. Prize winners were:

First, James G. Cheyne, Jr., Alabama Polytechnic Institute;

Second, Carroll C. Harmon, North Carolina State College;

Third, Fred L. Harrison, Georgia Institute of Technology.

Five honorable mentions were given to George J. Wallace, Alabama P. I.; Bond R. Sedberry, Clemson; Byrn E. Haner, Virginia P. I.; and Thomas T. Hayes, Jr., North Carolina State. Drawings submitted to the jury had already won elimination rounds in their respective colleges.

The jury included: Edward D. Stone, chairman; Thomas H. Creighton, professional adviser; A. L. Aydelott, architect; H. G. Hughes, chief, Hospital Design Division, Department of Health & Welfare, Ottawa, Canada; William A. Riley, architect; Everett W. Jones, "Modern Hospital"; Marshall Shaffer, chief, Office of Technical Services, U. S. Public Health Service; and Louise Waagen, chief, Hospital Nursing Section, U. S. Public Health Service.

Another student design was exhibited, though not entered in the official competition. This was a hospital designed by a group of architectural students at Tulane, under the direction of Prof. William R. Allen, Jr. This project was undertaken for the twofold purpose of giving the students a tangible problem—a hospital for Picayune, Miss.—and of accomplishing some public relations advance for the profession in general.

Papers at the convention were designed virtually to prepare a textbook on hospital planning. Arrangements are now being made with a view to publishing them in toto as the permanent record of the conference.

PITTSBURGH PERMAFLECTOR LIGHTING EQUIPMENT.....

"INTERNATIONAL" Favorite



More discriminating users selected Pittsburgh Permaflexor Lighting Equipment for their Gold Seal and Merit Awards than that equipment of any other manufacturer. Over 20% of the Gold Seals awarded at the 3rd International Lighting Exposition for outstanding lighting installations, incorporated Pittsburgh Permaflexor Equipment. This record of achievement is evidence that creatively and practically "Pittsburgh Permaflexor" is preferred by men who know lighting best.

If you too want to achieve superior lighting results, our Engineering Department will gladly assist you. Write today.

GOLD SEAL AWARD to:
J. L. Phillips, Electrical Engineer
for EXCHANGE NATIONAL BANK
Warren, Knight & Davis, Architects

GOLD SEAL AWARD to:
Paul E. Keys, Duquesne Light Co.
for S. H. DEROY, Jewelers
Hyman Rosenberg, Architect



PITTSBURGH REFLECTOR COMPANY

402 Oliver Bldg.

Pittsburgh 22, Pa.

Permaflexor Lighting Engineers in All Principal Cities

PITTSBURGH PERMAFLECTOR LIGHTING EQUIPMENT IS DISTRIBUTED BY BETTER ELECTRICAL WHOLESALERS EVERYWHERE

(Continued from page 146)

from any position upon the drawing board, and to have special scales which instantly reduce distant portions of the subject to their correct proportions.

The scale arms remain oriented to the chosen vanishing points, no matter where the instrument is placed on the drawing board, the manufacturer reports, and brake levers are provided to keep the scales from shifting under the pressure of a pencil.

One edge of the scales is divided fractionally, the other decimally. Charles Bruning Co., Inc., 4754 Montrose Ave., Chicago 41, Ill.

SMALL HOME HEATERS

Especially recommended for the basementless home with its need for quiet burner operation are the new *Four-in-One Hi-Boilers* which combine wall-flame oil burner, heating boiler, expan-

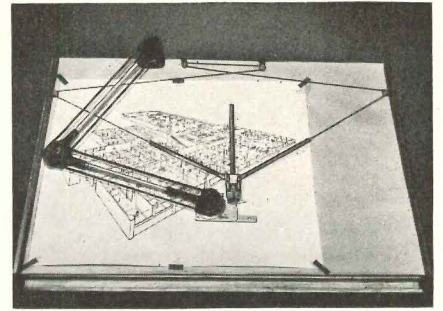

Drafting instrument designed to simplify the task of making perspective drawings

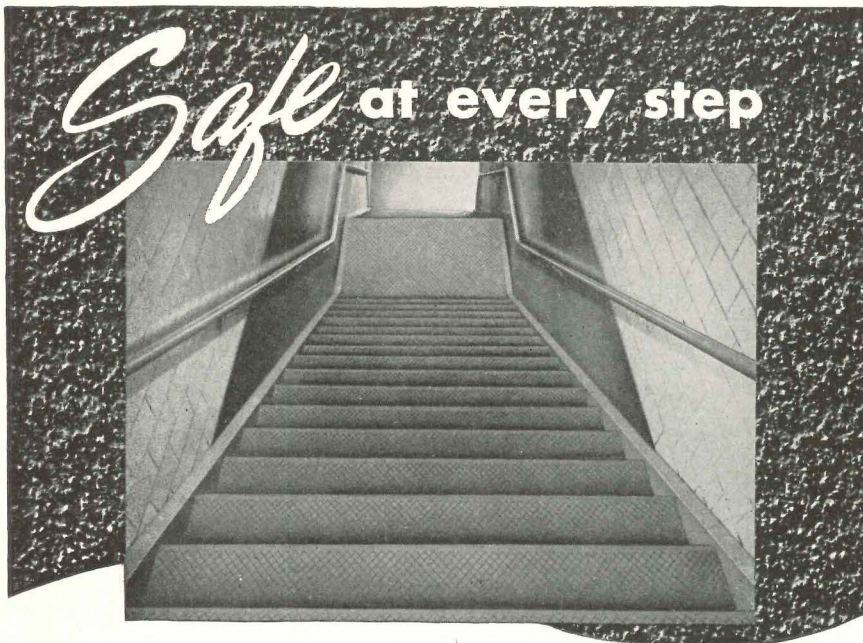

WITH FERALUN SAFETY TREADS

Workmen at the Curtiss Wright Plant, Propeller Division, Caldwell, N. J., go up and down these stairs . . . safe at every step.

Their shoe soles come to grips with non-slip Feralun Safety Stair Treads, cast iron, with wear-resistant abrasive embedded right in the walking surface.

Heavy traffic day in, day out — but Feralun Safety Treads, built to take hard use, stay non-slip . . . last and last.

And that means low maintenance . . . and high safety.

4 TYPES:

Cast iron base FERALUN
Bronze base BRONZALUN
Aluminum base . . . ALUMALUN
Nickel bronze base . . NICALUN

3 SURFACE STYLES:

hatched . . . plain . . . fluted

Use coupon below to get our free, illustrated catalog. Also consult Sweet's File, Architectural, 13 a-8.

AMERICAN ABRASIVE METALS CO.
460 Coit Street Irvington, N. J.

(AR-7-49)

Please send me your catalog on non-slip stair treads, floor plates, thresholds, elevator sills, and safety tile.

Please have one of your safety engineers contact me.

Name.....Title.....

Company.....

Street.....

City.....State.....

sion tank, and domestic water heater in one all-enclosing cabinet.

"Duty-Designed" for small home installation, the new units, fitted with the self-lubricated wall-flame oil burner, are assembled, wired and piped at the factory.

The cabinet is 22 in. wide by 22 in. deep and stands 65 in. high. Timken Silent Automatic Div., Detroit 32, Mich.

PLASTIC TEMPLATE

The new *No. 22 ABC Template*, made of plastic sheet with matte finish, has indelibly-printed callouts and calibrations to prevent wearing off, shows outside dimensions for tubs, showers, etc., and has a placement guide as well.

Features of the instrument also include a variety of rectangular lengths, in scale, with widths from 4 in. to 24 in., circles from 3 in. to 3 ft. in diameter, and an architects' 1/4-in. scale, 4-in. module scale, and furniture and fixture elevation scale.

Actual size of the instrument is 4 1/8 by 8 3/4 in. Rapidesign Inc., P. O. Box 592, Glendale, Calif.

FOUNTAIN COMBINATION

Unusual workboard and sterilizing facilities are said to be features of a new bobtail-type soda fountain made for installation within a counter, in conjunction with an ice cream cabinet, sandwich unit or steam table.

An extra-size sink for sterilizing purposes, besides the usual two dishwashing sinks, is part of the stainless steel unit. The special 14 by 16 in. sterilizer is equipped with a removable basket, stainless steel lid, and burner, for use with either natural or manufactured gas.

Other features are a large cold storage compartment, corrugated drain board, soda and water draft arms, and syrup and crushed fruit facilities.

(Continued on page 176)

You will want this new NATCO Bulletin!

NATCO
CLAY PRODUCTS
SINCE-1889

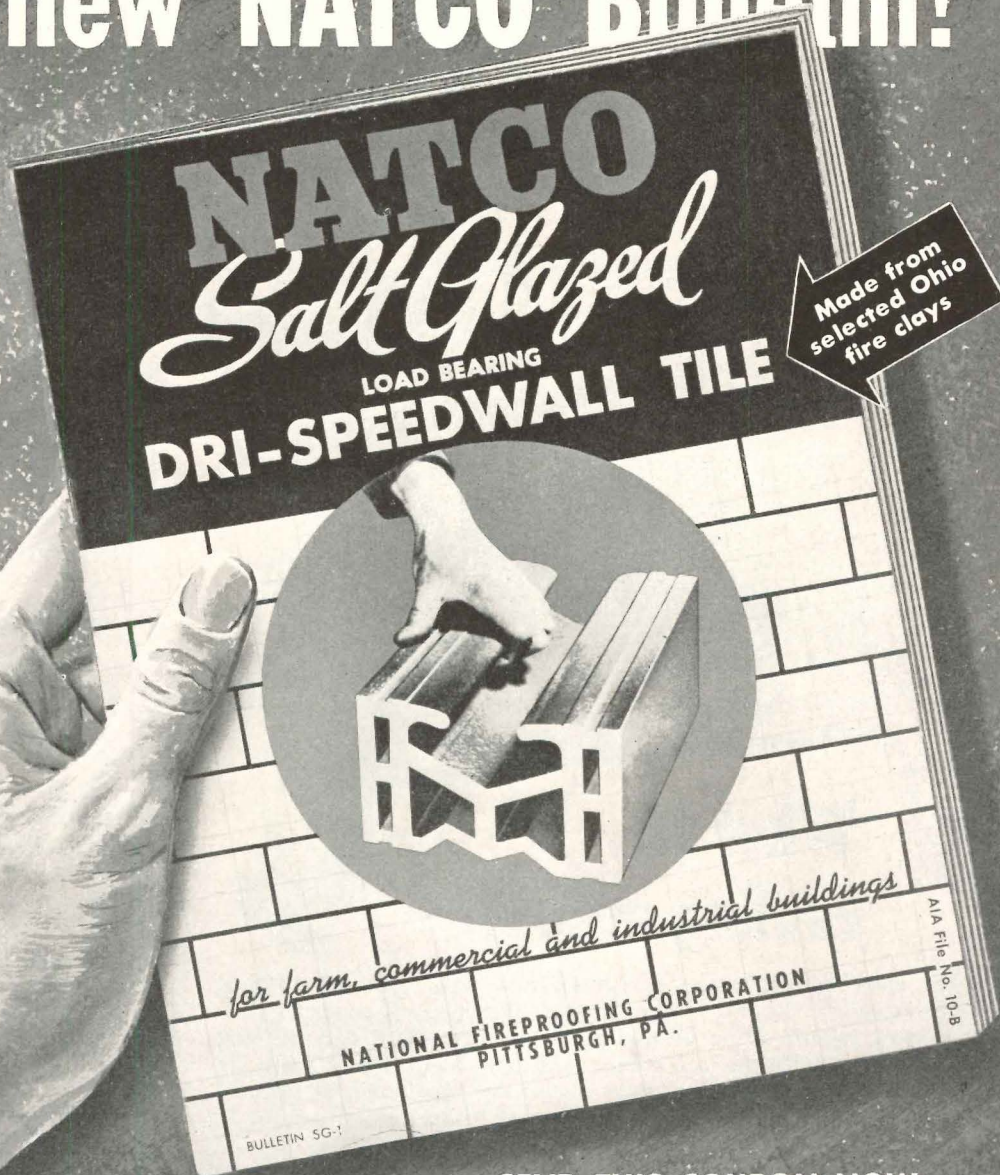

SEND THIS COUPON NOW

*.... contains details, specifications
and other practical information on
Natco Salt Glazed Dri-Speedwall Tile
for farm, commercial and industrial
buildings.*

NATIONAL FIREPROOFING CORPORATION

General Offices: 202 East Ohio Street, Pittsburgh 12, Pa.

Branches: New York · Chicago · Philadelphia · Detroit · Boston · Syracuse
North Birmingham

In Canada: National Fire Proofing Company of Canada, Ltd., Toronto, Ontario

NATIONAL FIREPROOFING CORPORATION
202 East Ohio Street—Pittsburgh 12, Pa.

Please send me a copy of your new Bulletin
"NATCO Salt Glazed Dri-Speedwall Tile"

Name & Title _____

Company _____

Address _____

541

(Continued from page 174)

The unit is 6 ft. 10 in. in length. The Redinger Corp., 20 S. 15th St., Philadelphia 2, Pa.

SAW FOR MASONRY

Briksaw is a masonry saw combining wet and dry cutting, portability, and rugged construction.

The saw may be bought equipped for standard dry cutting, and an inexpensive wet cutting kit can be installed later.

The cutting head is quickly adjustable for quarry tile, brick, partition tile, and concrete block, according to the manufacturer, who reports that speed and economy are both served by the "Toe-matic" feature which allows the operator to reset the cutting head at any desired angle and then press down to cut.

An automatic blade pressure spring automatically adjusts the blade pressure

to the hardness or softness of the material.

The pump used for wet cutting is designed to stay in place for dry cutting without damage to itself. Eveready Bricksaw Co., 1509 S. Mich. Blvd., Chicago 5, Ill.

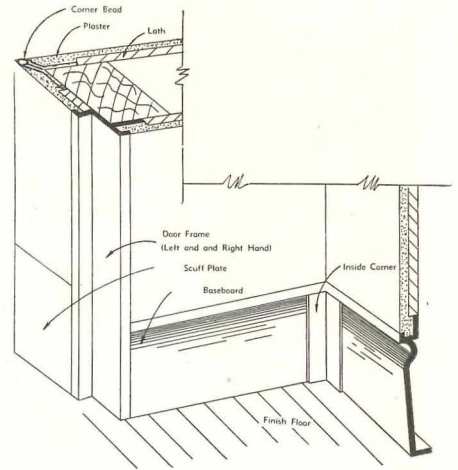

Aluminum interior trim, installed flush with plaster, eliminates dust-catchers

ALUMINUM INTERIOR TRIM

Extruded, aluminum alloy interior door frames, baseboard and window moldings are being offered in a new line to be used in place of the conventional type of wood trim around door openings, windows and room interiors.

Door frames prefabricated to any size opening come in three pieces — two side shafts and header — with hinge locations, lock striker, screw holes and nail holes incorporated during manufacture. Window molding, used with wood window construction, is attached to the window jamb, serving as a plaster ground. The ledge of the baseboard, which is installed and nailed to the studs before plastering, also becomes a plaster ground.

These interior trims are said to provide a surface as smooth as plaster from floor to ceiling, eliminating protruding dustcatchers. Alloy Trim Inc., 217 W. Mile Rd., Detroit 3, Mich.

DECORATIVE PLYWOOD PANELS

Plytex plywood decorative panels of Douglas fir, California redwood and Southern pine are furnished in a variety of hues and tones to blend with the chosen style of any room interior.

The panels are washable and guaranteed by the manufacturer for the life of the house.

Plytex panels measure 4 ft. by 8 ft.

(Continued on page 178)

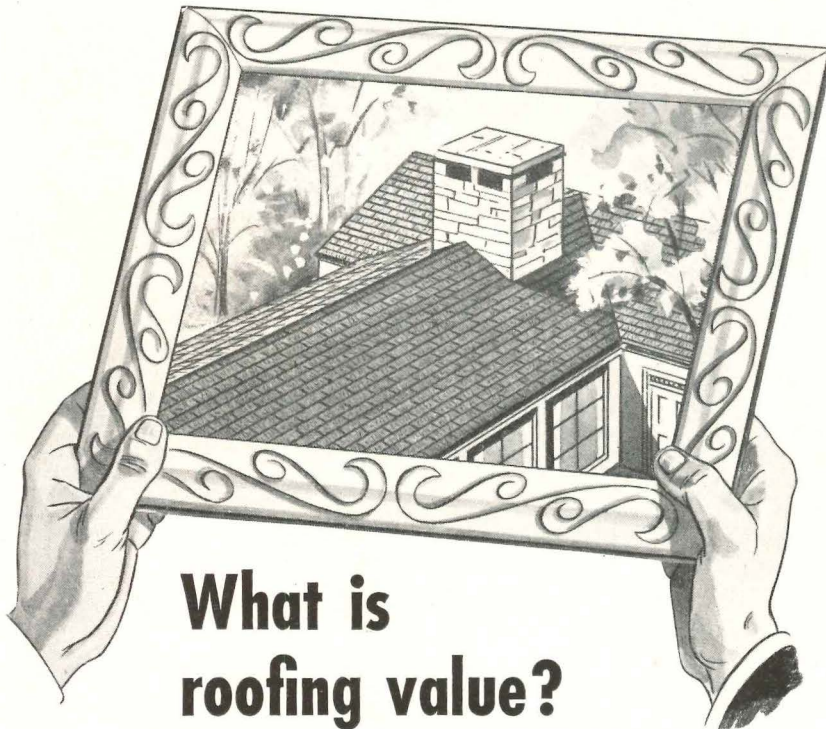

What is roofing value?

Long life, rich beauty, ease of application . . . and economy without sacrifice of quality: they are all important in determining roofing value.

When you specify Bird Master-Bilt® Shingles, you can be sure of a roof which contains *all* these elements. Master-Bilt's are an investment . . . an investment your customers can make at an economical price . . . and that is becoming more and more important as time goes on.

Master-Bilt Shingles offer more than economy. Thick-butt construction, heavy shadowlines, narrow cut-outs all reflect Bird experience since 1795. *Every* material is processed by Bird, another reason for the balanced composition and quality of Bird Master-Bilt Shingles. A roof of Master-Bilts adds inimitable beauty and texture, as well as protection, for they are available in a wide range of colors and blends, in more variety than is found in any other roofing material. Write us today for information about Master-Bilt and Master-Bilt Weather-Tex designs. Bird & Son, inc., 17 High Street, East Walpole, Mass.

BIRD *Master-Bilt* SHINGLES

East Walpole, Mass.
New York



Chicago
Shreveport, La.

Job sizes — no problem with the NEW RICHMOND TWIN UNITS!

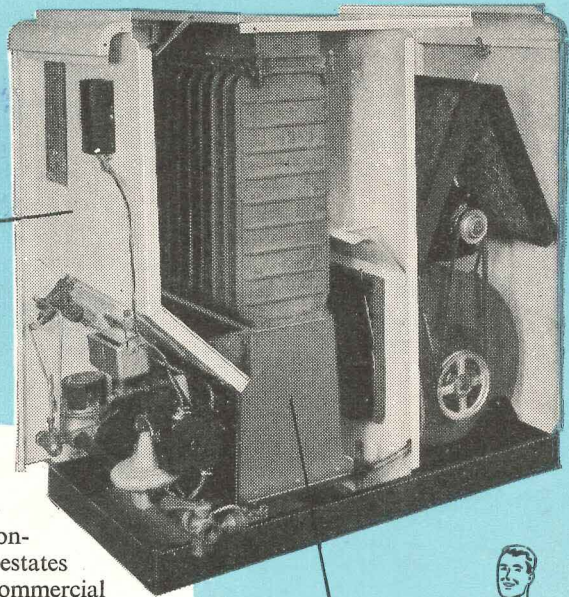
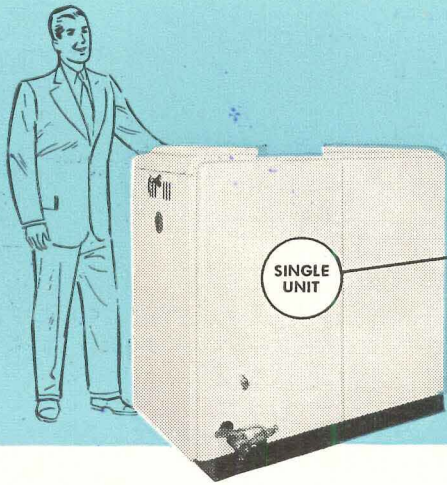

With the addition of three new "twin-units," Richmond's complete line of cast-iron Gas Winter Air Conditioners is able to fill most any warm air job. Large estates or compact cottages — medium size homes or commercial installations—there is a unit in the Richmond line to fill your need.

Check these capacities—they range from 66,000 to 280,000 BTU input. Models GHA 22-23-24 are paired up in a handsome "whiter-white" steel jacket with one set of controls—the GHA 1, 2, 3 and 4 are single units. All jackets are only 42" high—giving plenty of head and duct room. For jobs where floor space is at a premium, vertical units (same ratings as GHA 1, 2, 3 and 4) are available.

UNIT NO.	AGA RATINGS	
	INPUT BTU PER HR.	OUTPUT BTU PER HR.
GHA-1	66,000	52,800
GHA-2	90,000	72,000
GHA-3	115,000	92,000
GHA-4	140,000	112,000
GHA-22	180,000	144,000
GHA-23	230,000	184,000
GHA-24	280,000	224,000

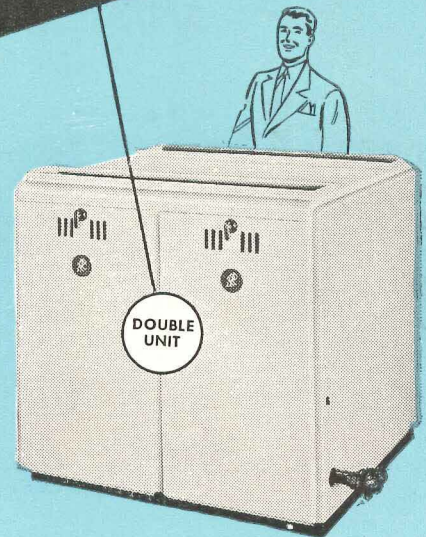

A unit designed with the TRADE in mind!

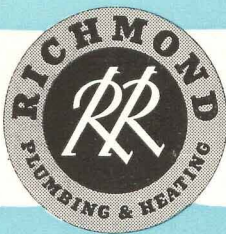

RICHMOND

RICHMOND RADIATOR CO.—AFFILIATE OF REYNOLDS METALS CO.

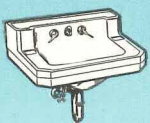

Vitreous China

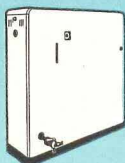

Gas Boilers

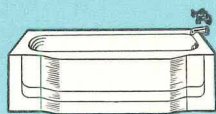

Enameled Cast Iron Ware

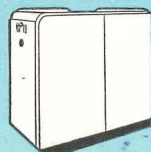

Winter Air Conditioners
Gas—Cast iron or steel
Oil—Steel

See your wholesaler or MAIL COUPON TODAY

AR-7

Richmond Radiator Company
19 East 47th Street, New York 17, N. Y.

Please send me complete information and illustrated folder on the new twin unit Richmond Gas Winter Air Conditioners. No obligations, of course.

Name

Company

Address

(Continued from page 176)

Aetna Plywood & Veneer Co., 1731 Elston Ave., Chicago, Ill. and Davis Plywood, 12555 Berea Rd., Cleveland, Ohio.

AIR RECOVERY UNIT

A self-contained, cell-type unit for air conditioning and ventilating systems has been designed to provide a simple, effective air purification device which the manufacturer says can be installed

and serviced "with the ease and facility of a dust filter."

Known as the *Type "C" Cell*, this unit has a capacity of 1000 cu. ft. of air per minute, with overall dimensions of 24 by 24 in. by 8 $\frac{3}{4}$ in.

A filter face area of 28 sq. ft. in a space of less than 3 cu. ft. is provided by the "accordion pleat" construction of the filter element.

The cell may be installed in multiple,

in either flat or "V" arrangement. For abnormal odor concentrations two cells in series per 1000 cfm are recommended. W. B. Connor Engineering Corp., 112 E. 32nd St., New York 16, N. Y.

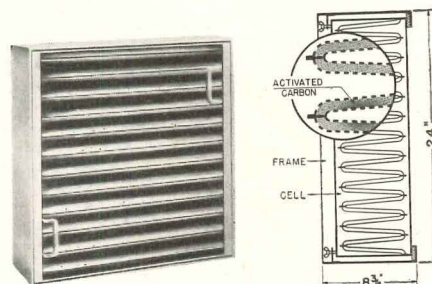

Air purifier, utilizing activated carbon filter cells, has capacity of 1000 cfm

Marble for Stability

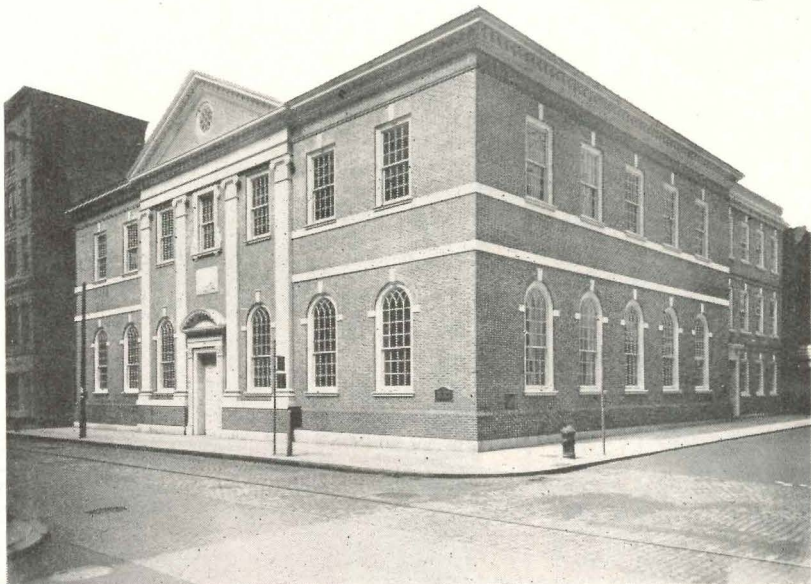

Real Estate Trust Company, Philadelphia, Pa.
Highland Danby Marble Exterior Trim, Sidney Martin and Associates, Architects,
John P. Hallahan Co., Contractor.

Today, the architect and owner should give even more careful consideration to the building material they employ. They should choose wisely, with an alert eye to stability, beauty, and low maintenance.

Vermont Marble is the answer. Whether to enhance entire exteriors with monumental character, or for the embellishment of structural materials, marble is unsurpassed. In either the interior or exterior phase of the building program marble most effectively embodies:

"Color • Character • Permanence • Low Maintenance"

Those structures which serve a purely monumental purpose, public or private, will also benefit by the stability, economy, and crystalline beauty of Vermont Marble.

VERMONT MARBLE

VERMONT MARBLE COMPANY • PROCTOR, VERMONT

Branch Offices:

Boston • Chicago • Cleveland • Dallas • Houston • Los Angeles • New York • Philadelphia • San Francisco
Ontario Marble Co., Toronto, Ont.



BUILDING LETTERS

Building letters of cast aluminum alloy and bronze, porcelain enamel steel and stainless steel are designed to enable the architect to work exterior sign identification of a building into the general design theme.

Letters of Depth, which can be aluminized to prevent tarnishing and corrosion, can be mounted free standing, projected or flush on the face of the building.

The letters are handcrafted to any size or style and are said to be easily adapted for direct or indirect illumination. They are also available in a large variety of stock patterns, ranging in size from 6 to 36 in. Nelson-Harkins Industries, 2023 N. Damen Ave., Chicago 47, Ill.

DIFFUSING FINISH

Described as an indestructible diffusing finish, the *Neo-Matte* alumilite finish is now available in the ML-2448 louvred ceiling.

The new finish, which is reported to be practical for either indoor or outdoor use, is achieved by an electrochemical treatment which gives the surface a permanent frosted silver finish. Neo-Ray Products Inc., 315 E. 22nd St., New York 10, N. Y.

FURNITURE FOR PUBLIC USE

Budget furniture for public spaces is offered in a new line which features a special design and construction intended to withstand the heavy punishment of public use.

The William Armbruster Budget Series includes a side chair of natural-

(Continued on page 180)

Famous Pentagon gets *replacement gutters...*

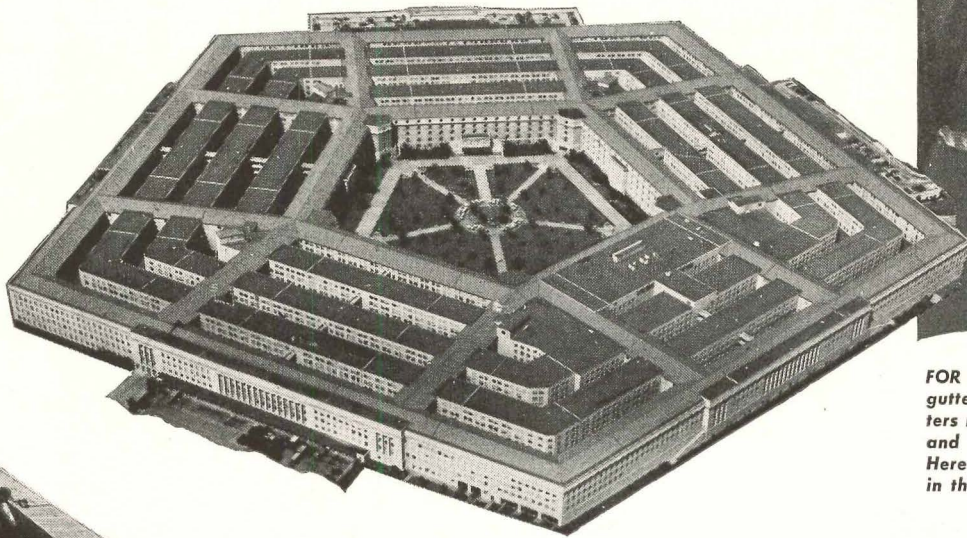

FOR PERMANENT PROTECTION, the old gutters have been replaced with gutters made of strong, corrosion-resistant and economical Monel Roofing Sheet. Here a worker solders a riveted seam in the gutter lining.

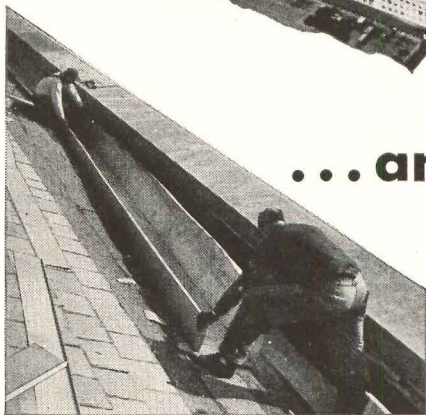

INSTALLING A RIVETED AND SOLDERED section of Monel Roofing Sheet in the built-in gutter of the Pentagon's outer perimeter. Fabricator, Rupertus Sheet Metal Works, Washington, D. C., reports: "Some of the gutters were 55 inches in girth, but Monel was easy to fabricate and install."

* * *

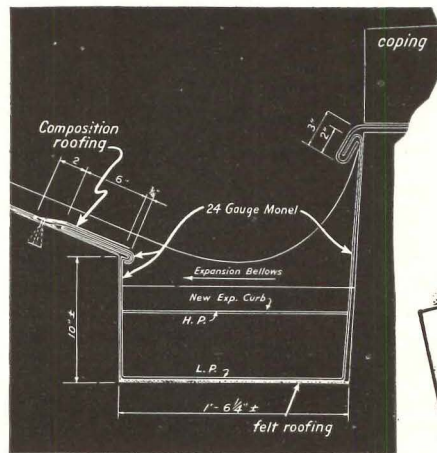

DETAIL OF SECTION of built-in gutter showing how Monel Roofing Sheet was used.

...and this time they're **MONEL!**

There were two reasons why it was decided to put new gutters on the Pentagon Building.

Repairs to the existing gutters would have been costly. And — more important — repairs would have provided only temporary relief.

Replacement was the only permanent solution.

So replacement it was. And this time the gutters were fabricated of Monel* Roofing Sheet.

Advantages of Monel

With its low expansion rate, its high strength and toughness, its resistance to fatigue and corrosion, Monel Roofing Sheet assures "life-of-the-building" protection for the Pentagon. The new gutters are safe from damage by heat, cold, rain, snow, ice and airborne corrosives.

Use light-gauge sheet

Cost-wise, too, there were advantages in using easy-to-form Monel Roofing

Sheet on the Pentagon Building. Because of this nickel-copper alloy's greater strength and rigidity, it was possible to use a lighter-gauge sheet for the gutters.

As a result, material cost and installation cost were both reduced.

Get NEW architects' bulletin

Other benefits, too, go hand in hand with the use of Monel Roofing Sheet. You'll find them covered in our brand new bulletin, *Basic Application Data — Monel Roofing Sheet*.

This new publication lists suggested gauges of Monel Roofing Sheet for principal building applications, reviews its characteristics, and tells about its relative cost and availability. Installation procedures are discussed and a sample specification wording provided.

Send for your copy — now.

*Reg. U.S. Pat. Off.

THE INTERNATIONAL NICKEL COMPANY, INC.
67 Wall Street, New York 5, N. Y.



MONEL...FOR THE LIFE OF YOUR BUILDING



Architectural Section
The International Nickel Company, Inc.
67 Wall Street, New York 5, N. Y.

I'd like to know more about durable, economical Monel Roofing Sheet. Please send me without obligation your new folder, *Basic Application Data — Monel Roofing Sheet*.

NAME.....

COMPANY.....

STREET.....

CITY.....ZONE.....STATE.....

AR-7-49

(Continued from page 178)

finish birch and an upholstered side chair and matching arm chair made of kiln-dried white oak in light, medium and dark finishes.

The upholstered side chair has straight sides so that it can be used in rows as well as singly, or can be alternated with the arm chair to provide arm chair seating at lower unit cost. Edgewood Furniture Co. Inc., 208 E. 27th St., New York 16, N. Y.

CIRCULAR FILE

Rota-File, which is adapted for card ledger files of any normal size, is a rotating file on a horizontal plane about 5 ft. in diameter.

Tiers of racks for cards are designed to aid in filing different types of cards, and there are no trays to pull and return. One or more operators sit in one position and can, in a few seconds, bring any

card to hand by turning the file.

Built to house the normal numerical and/or alphabetical arrangements, *Rota-File* is said to be practical for file loads of 5000 to 200,000 items.

The file can be closed and locked. The Wassell Organization, Westport, Conn.

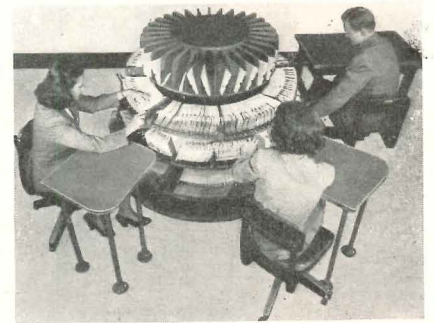

Rotating file holds up to 200,000 items

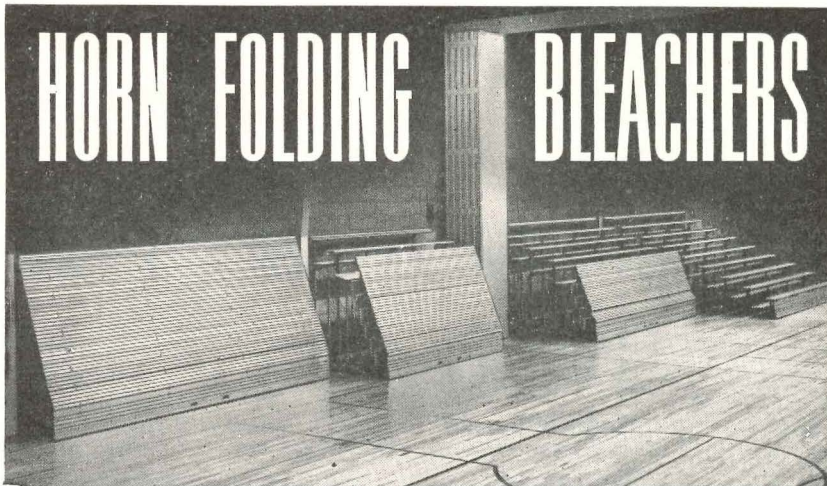

Horn Folding Bleachers and Horn Folding Partitions for Greater Space Utilization

ROWS	FLOOR SPACE		**HEIGHT
	IN USE	*CLOSED	
3	4 Ft. 9 in.	1 Ft. 8 3/4 in.	3 Ft. 0 in.
4	6 Ft. 7 in.	2 Ft. 0 1/4 in.	3 Ft. 9 in.
5	8 Ft. 5 in.	2 Ft. 3 1/2 in.	4 Ft. 6 in.
6	10 Ft. 3 in.	2 Ft. 6 1/4 in.	5 Ft. 3 in.
7	12 Ft. 1 in.	2 Ft. 10 1/4 in.	6 Ft. 0 in.
8	13 Ft. 11 in.	3 Ft. 1 1/2 in.	6 Ft. 9 in.
9	15 Ft. 9 in.	3 Ft. 5 in.	7 Ft. 6 in.
10	17 Ft. 7 in.	3 Ft. 8 3/4 in.	8 Ft. 3 in.
11	19 Ft. 5 in.	3 Ft. 11 3/4 in.	9 Ft. 0 in.
12	21 Ft. 3 in.	4 Ft. 3 1/4 in.	9 Ft. 9 in.
13	23 Ft. 1 in.	4 Ft. 6 1/2 in.	10 Ft. 6 in.
14	24 Ft. 11 in.	4 Ft. 9 3/4 in.	11 Ft. 3 in.
15	26 Ft. 9 in.	5 Ft. 1 1/4 in.	12 Ft. 0 in.
16	28 Ft. 7 in.	5 Ft. 4 3/4 in.	12 Ft. 9 in.
17	30 Ft. 5 in.	5 Ft. 8 in.	13 Ft. 6 in.
18	32 Ft. 3 in.	5 Ft. 11 3/4 in.	14 Ft. 3 in.
19	34 Ft. 1 in.	6 Ft. 2 3/4 in.	15 Ft. 0 in.
20	35 Ft. 11 in.	6 Ft. 6 1/4 in.	15 Ft. 9 in.

CHECK
YOUR
SPACE
REQUIRE-
MENTS

*Dimension includes 4 1/2 in. space between top seat and wall.
**Height in open position same as closed. For Bleachers higher than 20 Rows write for complete details and dimensions.

FOR SEATING CAPACITY FIGURE 16" PER PERSON. WRITE FOR COMPLETE DETAILS ON THE "3 IN 1 HORN GYM PLAN". NO OBLIGATION.

HORN BROTHERS CO.

A DIVISION OF HORN INDUSTRIES

FORT DODGE, IOWA



ESTABLISHED 1909

CEILING FAN FOR HOUSES

A ceiling fan for residences said to be ideal as a ventilating unit for rooms where the wall type installation is impractical is now on the market.

The *Ventrola 30-C* is powered to move 500 cu. ft. of free air per minute. Back draft and heat loss are prevented through the use of two self-acting shutters that open and close automatically with the starting and stopping of the fan.

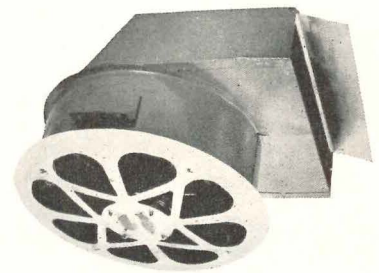

Fan for ceiling installation in houses

An induction-type motor operates with 110-120 volts, 60 cycle a-c. The motor is shielded to prevent radio or television interference.

The required ceiling opening is 11 1/4 in. National Appliance Co., 4814 W. Vernor, Detroit 9, Mich.

RADIANT HEAT PANELS

Radiant heating at a cost 25 per cent below average is the achievement claimed for the new *Electriglas* Radiant Heat Panels.

Increased efficiency of the panels is said to result from the special curved

(Continued on page 182)

Your school or college plans can include a fine, new field house like this

for much less than you think!



... because LURIA can meet your exact requirements
from a low-cost, standard line

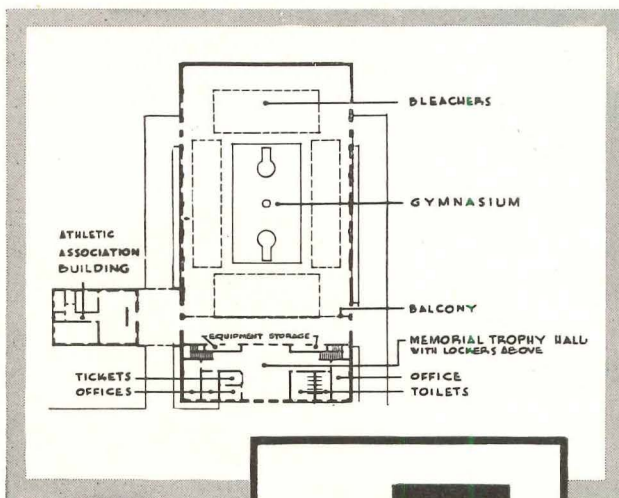

Plan includes two buildings—one 100 feet wide and 200 feet long with 20-foot eave height, the other 40 feet wide and 60 feet long with an eave height of 12 feet.

Luria buildings are available now—with clear spans of 40 to 100 feet, eave heights of 12 to 20 feet and any desired length in increments of 20 feet.

At first glance the imposing field house and athletic association building above may appear to be far beyond the average school or college budget. But, actually, they are low-cost Standard Buildings by Luria — permanent structures which more and more architects are using to trim today's high building costs.

These architects are finding that by using heavy steel-frame Luria buildings, they can design virtually any one-story unit for less money and at the same time meet the most exacting building codes. Moreover, Luria structures are easy to erect, economical to maintain and available now.

Far from limiting the imagination of the architect, Luria buildings create new opportunities for design, and widen the circle of his prospective clients. For here is a new and flexible medium to work with, offering the architect a wide choice of collateral materials, optional features and multiple arrangements.

And Luria buildings are by no means limited to schools. Shopping centers, bus terminals, churches, industrial buildings—these are just a few of hundreds of applications where the Luria line offers all the cost-saving advantages of standardization, along with the widest possible architectural freedom. Send the coupon below for our new 20-page catalog.

STANDARD BUILDINGS
BY
LURIA

LURIA ENGINEERING CORPORATION, Dept. D33
500 Fifth Ave., New York 18, N. Y.

Gentlemen: Please send me a copy of your new catalog (AIA File 14i).

NAME.....

COMPANY.....

ADDRESS.....

CITY..... STATE.....

(Continued from page 180)

construction and new composition of the glass, which is made of Temprex glass into which a metallic alloy grid has been fused.

Electriglas panels can be connected with conduit or cable to present a-c or d-c 110-volt, 220-volt circuits, and portable models are also available to provide quick heat for cold rooms, play rooms, rooms used only occasionally or rooms in use after the central heating

plant has been shut off for the night or for the summer.

The new heating element is guaranteed for life against structural defects. Appleman Glass Works, Bergenfield, N. J.

SLIDING SASH

Adaptable to the conventional window openings of any type building is a glass block window, with sliding vision

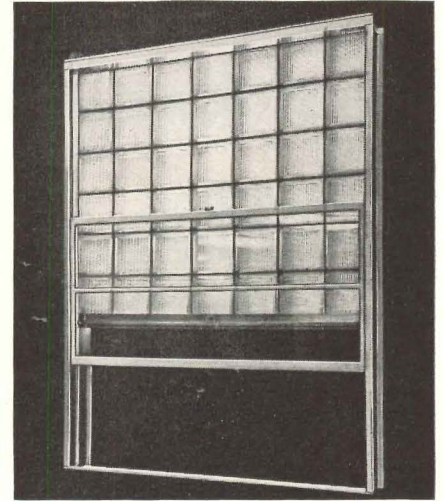

Sliding vision sash makes it possible to wash outside of this glass block window

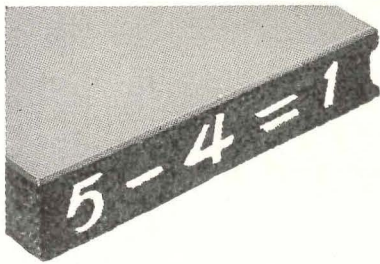

Save \$1

OUT OF EVERY \$5

by using

the Durisol Insulated Roof Plank

This roof plank combines so many functions in one material...all at one low installation cost...that \$4 does the work of \$5 as compared with other materials. Note the 3-in-1 advantages of this light-weight, precast, factory-coated plank:

- 1 Fireproof, reinforced, cement-surfaced, and ready for application of the built-up roofing.
- 2 Because Durisol itself is such an effective barrier against heat losses, no additional insulation is required.
- 3 Noise-deadening ceiling at no extra cost... distinctive and pleasing in appearance, with a sound absorption coefficient of 0.87 at 512 cycles.

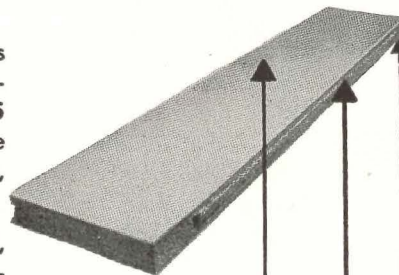

THE ROOF DECK

THERMAL INSULATION

ACOUSTICAL CEILING

DURISOL is made from chemically mineralized wood fibres bonded with Portland cement and moulded under pressure. It is unaffected by moisture and is proof against rot, mould, vermin, termites—proved incombustible by laboratory tests.

Thickness	Width	Maximum Span	Weight per sq. ft.	Long Edge	Load
3 1/4"	16"	6'8"	15 lbs.	Tongue and Groove	40 lbs. per sq. ft. live load with high safety factor.
4 1/4"		8'	18 lbs.		

For complete information, write for folder (A.I.A. File Number 4-K). Also see catalog 3c/13a, Sweet's File Architectural, 1949.

DURISOL, INC. 420 Lexington Avenue, N. Y. 17, N. Y.

strip sash, which is said to be strong and rigid enough to provide its own lintel.

The new windows, which may be used singly or in multiples, give vision and ventilation with single pane or double glazing. The sliding sash makes it possible to wash the outside of the window in the same manner as any conventional double-hung window.

Frames are shipped completely assembled ready for glazing and installation of the glass block. American Structural Products Co., Toledo 1, Ohio.

VENTILATING ROOFS

Wide "venturi-type" orifices and other features are said to provide maximum exhaust efficiency in the new *Agitair* "CNO" *Exhauster* for roof ventilating, vent flues and chimney tops.

Constructed of heavy gauge steel, the exhauster has a corrosion-resistant finish. It is described as weather proof under all conditions.

The exhauster is available in standard head sizes from 5 to 48 in. The 5 in. and 8 in. sizes are completely assembled, all welded construction. The larger sizes are supplied knocked down for quick assembly on the job. Air Devices Inc., 17 E. 42nd St., New York 17, N. Y.

ALL-ALUMINUM SCREEN DOOR

An all-aluminum screen door, fabricated of strong, hollow extruded aluminum sections, has been designed to eliminate the problem of fitting doors to house openings that have sagged or are otherwise out of line.

Fitting to house door opening is assured by having the door opening squared and adjusted to the proper size

(Continued on page 184)

DO YOU HAVE THIS FREE BOOK?

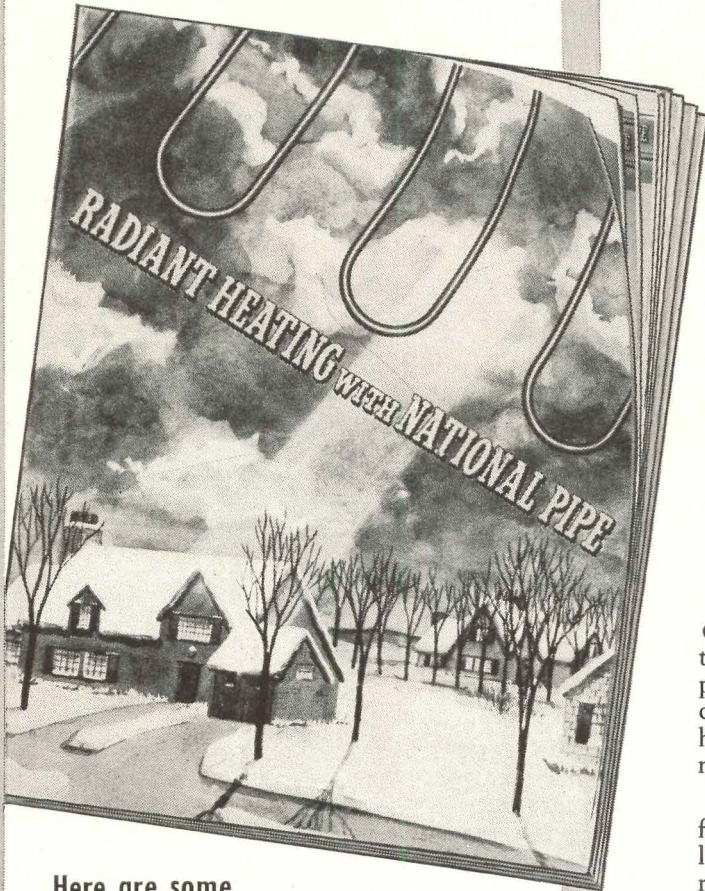

Here are some of the subjects covered:

- What is radiant heating?
- How radiant heating is designed for comfort.
- How to estimate heat losses.
- How to determine radiant heating coil requirements.
- Radiant heating comfort chart.
- What heating engineers claim for radiant heating.
- Methods of floor and ceiling installation.
- Typical pipe coil patterns.
- Questions and answers on radiant heating.
- Heat transmission tables.

It tells what you want to know about

Radiant Heating

● This 48-page book, "Radiant Heating with National Pipe" is one of the most authoritative books published on the subject. It brings you a complete, comprehensive story of radiant heating and gives helpful information as a practical basis for the planning and installing of an efficient system.

Architects, heating engineers and contractors will find the book valuable for use in planning new installations. It answers many important questions about radiant heating. For example —

What is the approximate cost of a radiant heating system?

Would it cost more or less to operate a radiant heating system than other types, and by how much?

What effect do rugs and rug pads have on heat transfer in a radiant heating system?

These and many other questions are competently answered. This book also shows you how to calculate pipe sizes for various conditions. Mail the coupon and a copy will be sent at once.

NATIONAL TUBE COMPANY, PITTSBURGH, PA.
 COLUMBIA STEEL COMPANY, SAN FRANCISCO,
 PACIFIC COAST DISTRIBUTORS
 UNITED STATES STEEL EXPORT COMPANY, NEW YORK

National Tube Company
 Frick Building
 Pittsburgh, Pa.

Gentlemen:

Please send me a copy of your FREE book, "Radiant Heating with National Pipe."

Name.....

Position.....

Company.....

Address.....



NATIONAL Steel PIPE

UNITED STATES STEEL

(Continued from page 182)

with wood stripping, which is then covered with an aluminum frame on which the door itself is hung.

Alumatic doors are made in all sizes, with 1 in. variations in width and height. Alumatic Corp. of America, 1229 S. 41st St., Milwaukee 4, Wis.

AWNING TYPE WINDOW

An aluminum, awning-type window which is designed for effective use in any climate features *Auto-Lok* hardware which closes the window automatically, tight enough to permit effective weathering.

When the vents reach closed position, a locking device engages and pulls the vents tight against the window frame, without any stress on pivotal points or excessive pressure on an operating bar, according to the manufacturer's description.

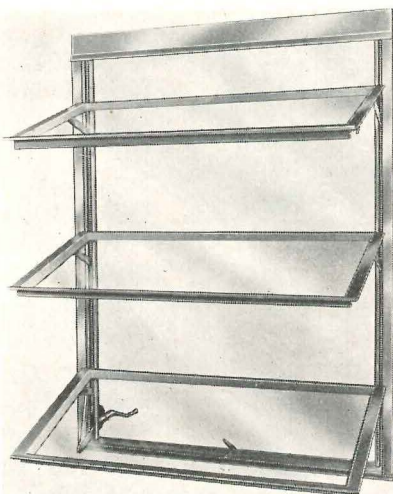

Special weather stripping and hardware enable window to be used in any climate

Cross-Over weathering also is an exclusive feature of the *Auto-Lok* window. A complete "seal" is said to be effected by bonding a specially designed section of plastic to the perimeter of the window so that when the window is closed the horizontal weatherstripping crosses over the vertical weatherstripping.

The window can be opened or closed from the locked position with only 5½ turns of the operator, and a special arrangement makes it possible to operate the window without removing the screen. Ludman Corp., 21 N. W. 21st St., Miami, Fla.

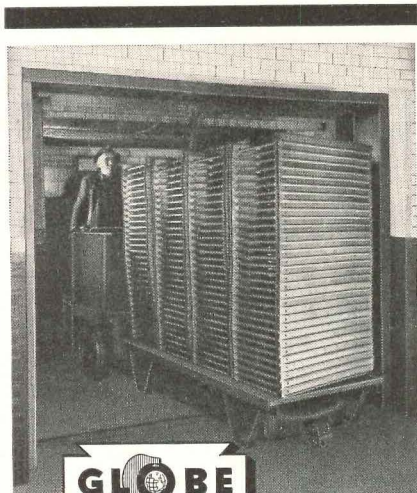

Specialized

Industrial Elevators

For plants, warehouses, industrial installations . . . you can give your clients many extra advantages with Globe Oil Hydraulic Industrial Elevators. No pent house or load bearing walls required, lower initial cost, advanced safety features, simplified installation. Best for heavy materials-handling trucks. Hold down or automatic push button control. Write for full data and specifications.

Globe's specialized Lifting Engineers offer you a broad service on all types of Industrial Lift problems, without obligation. Write today for Bulletin A749 giving illustrations and engineering specifications on

- Loading Ramps**
- Loading Lifts**
- Production Lifts**
- Sidewalks Lifts**
- Industrial Truck**
- Service Lifts**
- Elevators**

GLOBE HOIST COMPANY
Des Moines 6, Iowa; Philadelphia 18, Pa.

How to Capture the Weathered Charm of Old New England

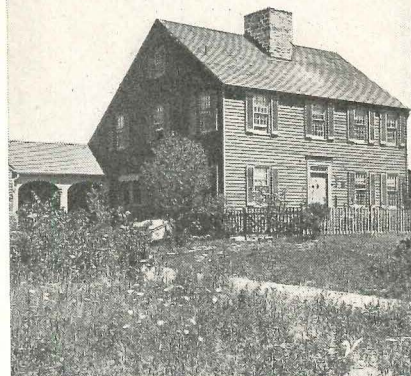

Architect: R. H. Dana, New Rochelle, N. Y.

Cabot's weathering brown and gray Creosote Stains produce the charming appearance of old New England houses, within six months after application! These stains penetrate deeply, bring out all the natural beauty of the wood . . . give a mellow weather-beaten effect after a short exposure to the elements!

WRITE TODAY for color card and complete information!

Besides weathering grays and browns, Cabot's Stains come in a variety of brilliant hues which maintain their true color, even after long exposure. Cabot's Creosote Stains are inexpensive . . . cost only *one-third* as much as good paint!

SAMUEL CABOT, INC.
722 Oliver Bldg., Boston 9, Mass.

CABOT'S CREOSOTE STAINS

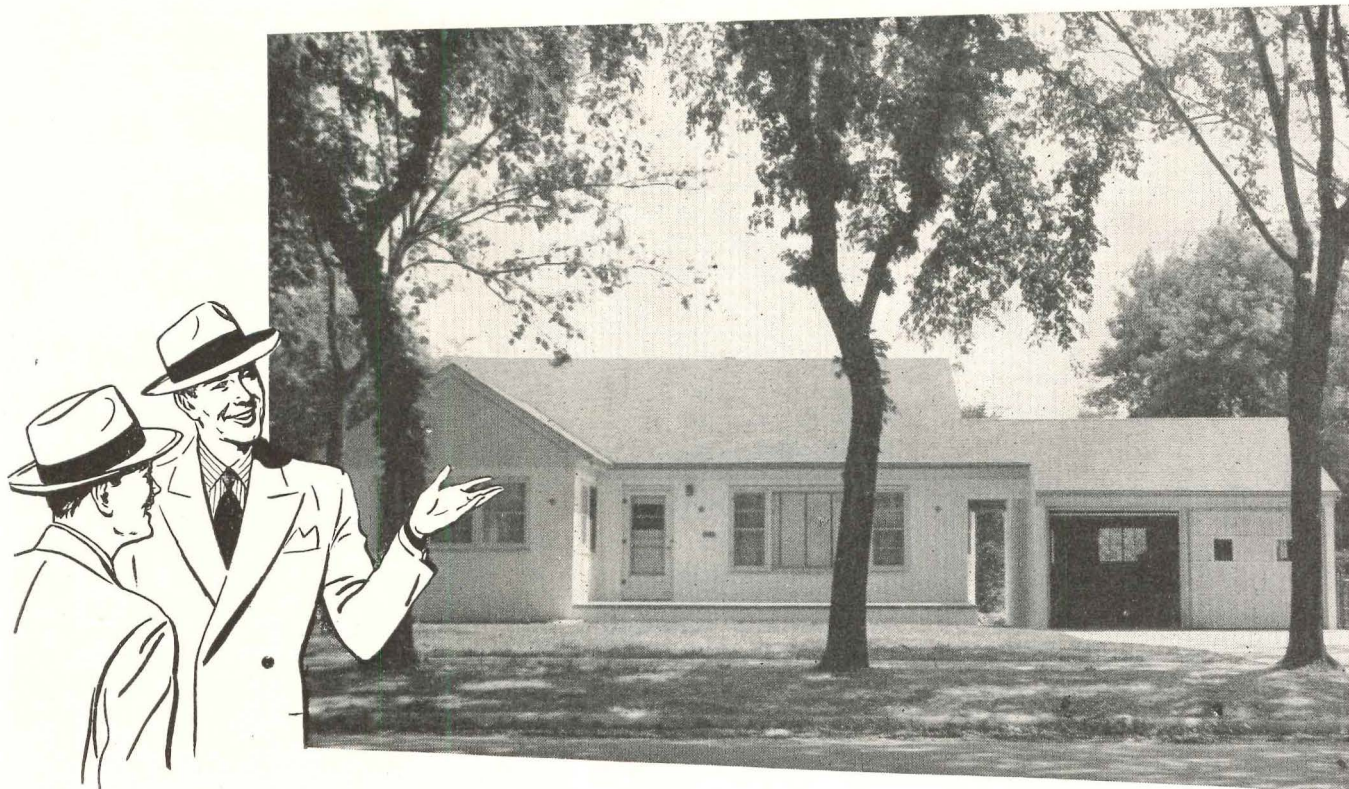

THIS DISTINCTIVE DESIGN IDEA CUTS COSTS

Unusually attractive exterior treatment and lower cost achieved with modern, reinforced concrete stucco. Durability insured with the Keystone System of Stucco Application.

When you think of modern concrete stucco as a design element, you realize more and more how it enhances the beauty of modern, traditional or ranch-type homes. That's especially true when you use stucco in combination with other materials.

Then compare the cost of portland cement with equivalent siding materials. That shows you why the use of concrete stucco substantially reduces building costs.

And, when you employ the Keystone System of Stucco Application, you see why modern, reinforced concrete stucco is a durable siding

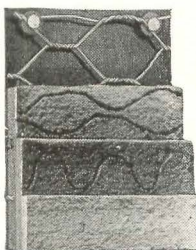

Get complete stucco specifications and all the facts about the Keystone System of Stucco Application. Simply write for your copy of "Specifications for Beautiful, Durable Stucco."

Keystone Steel & Wire Company
PEORIA 7, ILLINOIS

Manufacturers of Keymesh Reinforcing,
Welded Fabric, Tie Wire and Nails

for all climates. Every step in this system contributes to quality construction. The use of heavy-gauge, galvanized, cold-drawn steel Keymesh Reinforcing insures permanence. In the Keystone System, Keymesh is furred out $\frac{1}{4}$ " to $\frac{3}{8}$ " from the building felt—then deeply embedded in what becomes a strong, true, crack-resistant wall.

Now give your clients a pleasant surprise by designing with modern, reinforced stucco—for new homes and overcoating old homes. Be sure to specify Keymesh Reinforcing— $1\frac{1}{2}$ " hexagon mesh, 17-gauge steel wire, or 1" hexagon mesh, 18-gauge steel wire.

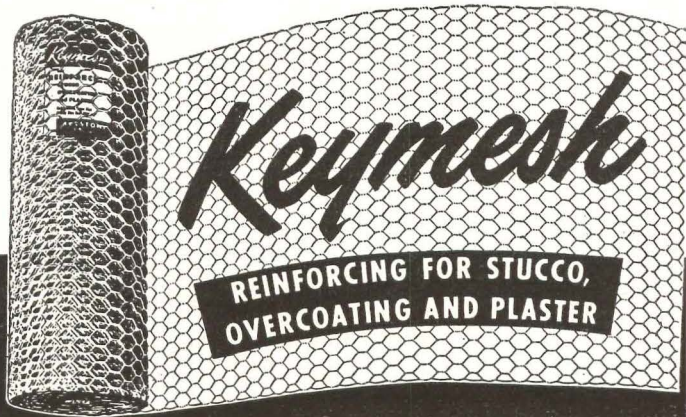

**Durable, Low-Cost Stucco
Calls for KEYMESH**

ARCHITECTURAL ENGINEERING

TECHNICAL NEWS AND RESEARCH

AIR SANITATION

(Continued from page 143)

Louvered fixtures are also suitable, but not essential, in rooms where there may be only part time occupancy and in rooms with ceilings over 10 ft. high. In such rooms open types of fixtures may be used so long as the ceiling reflectance is still down to 5-10 per cent. In such rooms and fixtures germicidal tubes up to a 6 ultraviolet watt rating may be safely used but tubes of a higher rating should be used only in louvered fixtures. Figs. 10, 11 and 12 show the spatial distribution, schematic installation suggestions and typical school installation. Such fixtures project 35-50 per cent of the ultraviolet output of the germicidal tube in a direction of maximum intensity 20-30° above the horizontal.

It is obvious that the ultraviolet reflectance of ceilings must always be considered and a meter to measure it directly is commercially available. Unpainted "white-coat" and acoustic ceilings containing gypsum products nearly always have an objectionable ultraviolet reflectance of 15-50 per cent, making operation and exposures of more than two to three hours impractical, regardless of the ceiling height. The "white-coat" should be painted with an oil paint and the acoustic ceiling should be given one or two light coats of Casco wall size or filler which will have little or no effect on its color or acoustic properties and will reduce the reflectance to 5-10 per cent.

Germicidal ultraviolet, like the sun's ultraviolet, will fade some wall paints and papers and drapery fabrics, especially where their upper ends extend into the directly irradiated upper parts of a room. Although there has been little such trouble, the possibility should always be anticipated, especially in offices and homes.

Paralleling the uses of air sanitation for human protection there are innumerable applications for the protection of products in processing and storage, in pharmaceutical factories, bakeries, breweries, wineries and meat processing and storage plants. In such applications the killing or growth prevention of yeasts and molds may be more important than the killing of bacteria. Nearly all such applications require individual custom made equipment and application engineering detail outside the scope of this paper.

AIR
CONDITIONING
UNITS

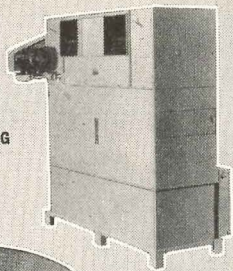

VERTICAL TYPE
UNIT HEATERS

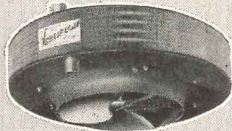

GABINET TYPE
UNIT HEATERS

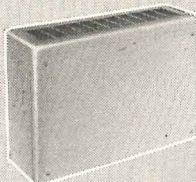

In Every Case...
SPECIFY

YOUNG

SPECIALISTS IN HEATING,
COOLING AND AIR CONDITIONING
EQUIPMENT FOR HOME AND INDUSTRY

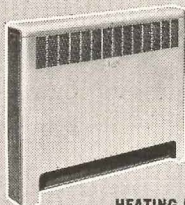

CONVECTORS

HEATING AND
COOLING COILS

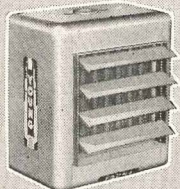
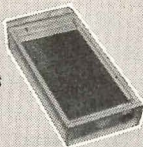

HORIZONTAL TYPE
UNIT HEATERS

BLOWER TYPE
UNIT HEATERS

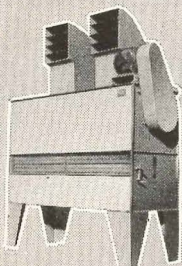

YOUNG



HEAT TRANSFER PRODUCTS

HEATING, COOLING AND
AIR CONDITIONING PRODUCTS

Convectors • Unit heaters • Heating coils • Cooling coils • Air conditioning units • Evaporative condensers

AUTOMOTIVE PRODUCTS

Gas, gasoline, Diesel engine cooling radiators • Heat exchangers • Intercoolers • Oil coolers • Supercharger intercoolers

OIL FIELD, HEAVY INDUSTRIAL, MUNICIPAL & CHEMICAL PROCESS COOLING EQUIPMENT

Engine jacket water coolers • Oil coolers • Steam and natural gas condensers • Natural gas coolers • Evaporative coolers and condensers • "VAD" Vertical air discharge cooling and condensing units.

AERONAUTICAL PRODUCTS

Oil coolers • Supercharger intercoolers • Radiators • Heat exchangers • Valves • Regenerators

YOUNG RADIATOR CO.

General Offices: Dept. 519-G, Racine, Wisconsin
Plants at Racine, Wisconsin, and Mattoon, Illinois

Sales and Engineering Offices in All Principal Cities

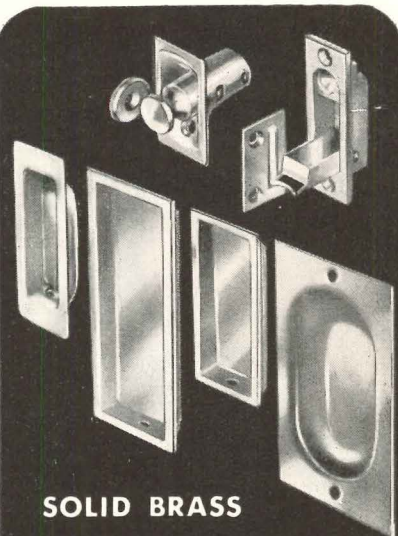

SOLID BRASS

SLIDING DOOR TRIM

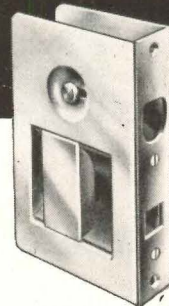

RITE TRIM has the *look* of quality... it *is* high quality, too, yet prices are modest! When you think of sliding doors remember

Adams-Rite can supply the proper trim from a cup pull to a completely modern lock. You'll especially admire our lock... it installs as a single assembly even in narrow stiles by a simple cut-out, no mortise. Two types fit all doors from 1 1/8" to 1 5/16" in thickness. Adaptable to doors of either hand with dead-lock either side and emergency unlocking feature opposite. For maximum security, pin tumbler cylinder operation in the escutcheon is optional. Escutcheon measures 4 1/2" x 2 7/8". A variety of 9 standard finishes available on all Adams-Rite items.

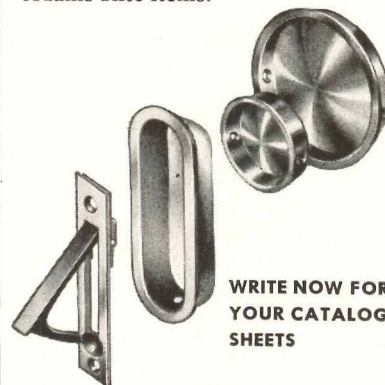

WRITE NOW FOR
YOUR CATALOG
SHEETS

**ADAMS-RITE
MANUFACTURING CO.**

540 WEST CHEVY CHASE DRIVE, GLENDALE 4
CALIFORNIA, U. S. A.



City Hall,
Rock Island, Illinois

for more than 9 years...

**ONLY THE WINDOW WASHER
HAS HAD TO TOUCH THESE WINDOWS!**

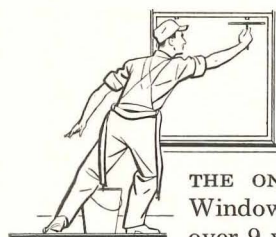

THE ONLY MAINTENANCE these Adlake Aluminum Windows have required since they were installed—over 9 years ago—is routine washing! Ultimately, by eliminating all maintenance costs, they will pay for themselves. *And they will last as long as the building!*

ONLY ADLAKE WINDOWS have the combination of woven-pile weather stripping and patented serrated guides that assures minimum air infiltration and absolute finger-tip control.

Adlake Windows never warp, rot, rattle, stick or swell. They retain their good looks and easy operation for the life of the building.

FOR THE WHOLE STORY on how Adlake Aluminum Windows wipe out maintenance costs during a lifetime of worry-free operation, drop us a post card today. Address The Adams & Westlake Company, 1102 North Michigan Avenue, Elkhart, Indiana. No obligation, of course.

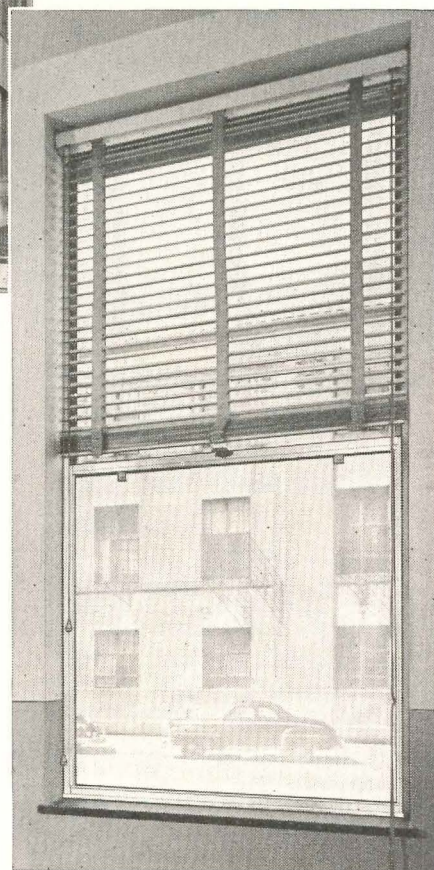

**ADLAKE
ALUMINUM WINDOWS**
have these "plus" features:

- Minimum Air Infiltration
- Finger-tip Control
- No Warp, Rot, Rattle, Stick
- No Painting or Maintenance
- Ease of Installation

THE Adams & Westlake COMPANY

Established 1857 • ELKHART, INDIANA • New York • Chicago



(Continued from page 152)

NEW — FASTER-DRYING
Sani-Dri

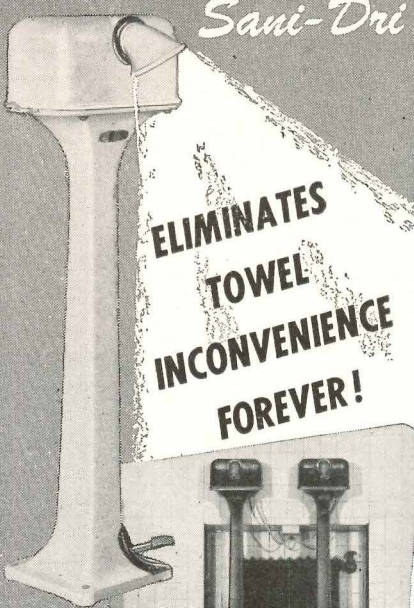

**ELIMINATES
TOWEL
INCONVENIENCE
FOREVER!**

Modernizes without
Structural Changes.
Approved by Under-
writer's Laboratories
for 18 years!

**DRYS HANDS OR FACE
25% FASTER
THAN EVER BEFORE**

Now you can provide 24-hour hand or face drying service in your washrooms, and eliminate your towel problem completely! The new, faster-drying Sani-Dri dries quickly and thoroughly with a stream of hot air, the most sanitary method known. A new heating element and faster-flow nozzle makes it the fastest drying machine of its kind . . . 25% faster than before! Sani-Driers are ideal for modernization of old washrooms or new installations. They have been installed and used in every civilized country and in every climatic condition. They have stood the test of time for 22 years!

SAVES 85% OF WASHROOM COSTS

Sani-Dri pays for itself out of savings. No buying or stocking of towels. No unsanitary litter . . . no fire hazard . . . no paper-clogged soil pipes . . . no servicing of empty towel cabinets —Sani-Dri gives years of continuous automatic drying service with little or no maintenance! Mail coupon for complete information.

USERS REPORT:

*"22 Years of
Continuous
Drying Service"*

"Our 60 Sani-Driers have been in continuous use since we installed them in 1927 and are still giving excellent service. We figure they paid for themselves in less than two years, and have made our washrooms neater and more sanitary at a very low cost."

(Names of Users Sent Upon Request)

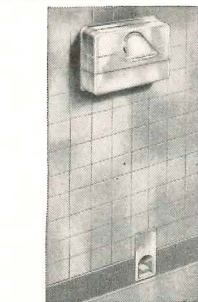

Built-in wall model for new installations.

Distributors in Principal Cities



GET THE LATEST FACTS!
New brochure 1082 shows both built-in wall and pedestal models of new faster-drying Sani-Dri electric hand and face dryer. Write today!
Distributors in Principal Cities

THE CHICAGO HARDWARE FOUNDRY CO.

"Dependable Since 1897"

874^c Commonwealth Avenue
NORTH CHICAGO, ILL.

for main, range and lighting circuit protection, with terminals for water heater connection. Important features are outlined and schematic drawings are included. 4 pp., illus. The Trumbull Electric Mfg. Co., Plainville, Conn.*

Planning Book for Electrical Living Homes. Information on fundamentals of kitchen and laundry planning and room lighting for utility and beauty. Kitchen and laundry layouts are given, designed to give maximum utility within an allotted space. Recommended minimum wiring requirements are outlined. Illustrations of exteriors and interiors, floor plans and wiring diagrams of four "Electrical Living Homes" are included. 24 pp., illus. Better Homes Bureau, Westinghouse Electric Corp., P. O. Box 868, Pittsburgh 30, Pa.*

Overhead Trolley Conveyors

Link-Belt Overhead Trolley Conveyors Make Ceilings Pay Dividends (No. 2330). A wide variety of actual installations are pictured to show the adaptability of the Link-Belt trolley conveyor. Among those conveyors shown is one type which is electrified with bus bars along the conveyor track to provide current for continuous testing of electric fans, etc.

Also illustrated are specially made hangers for suspending the product from the conveyor chain.

There are photos of the conveyors in warehouses, industrial plants, bakeries, textile mills, etc. 28 pp., illus. Link-Belt Co., 307 N. Michigan Ave., Chicago 1, Ill.

Spandrel Wall Construction

Development of a Spandrel Wall Construction System (PB 93481). A technical report telling how multi-story buildings can secure increased floor space with the same outside dimensions through the use of a new type of spandrel wall construction. Included are tables, graphs, photos and drawings. 54 pp., illus. Office of Technical Services, Dept. of Commerce, Washington, D. C. \$2.00.

Boilers

International Water Tube Power Boilers, Type "CR." Describes operating features of a type of boiler suitable for government buildings, manufacturing

(Continued on page 190)

**New SAFETY
RECEPTACLE
MAKES CONTACT ONLY
WHEN STANDARD
CAP IS INSERTED**



The *SAFETY-PLUS Receptacle

*Actual tests prove it to
be Safest Receptacle
ever designed*

- Makes contact **ONLY** when standard cap is inserted
- Conventional operation . . . double contact springs
- Back or side wired—shallower for more wire room
- Takes polarized or standard caps

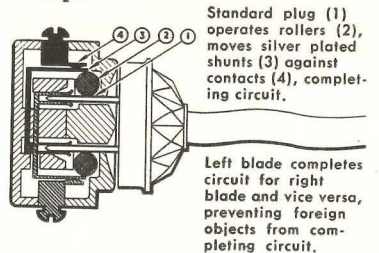

Featuring an entirely new principle, the Hubbell SP-49 Receptacle was designed to reduce the possibility of accidental shock and burn, makes contact **ONLY** when standard caps are inserted! Pins, wires or other foreign objects cannot energize the unit! The SP-49 provides easier wiring, more wire room, back wiring, washer ears, silver plated contact springs, interlocking bridge and takes standard caps.



For descriptive literature write

HARVEY HUBBELL, INC.

Dept. A-1 Bridgeport 1, Conn.

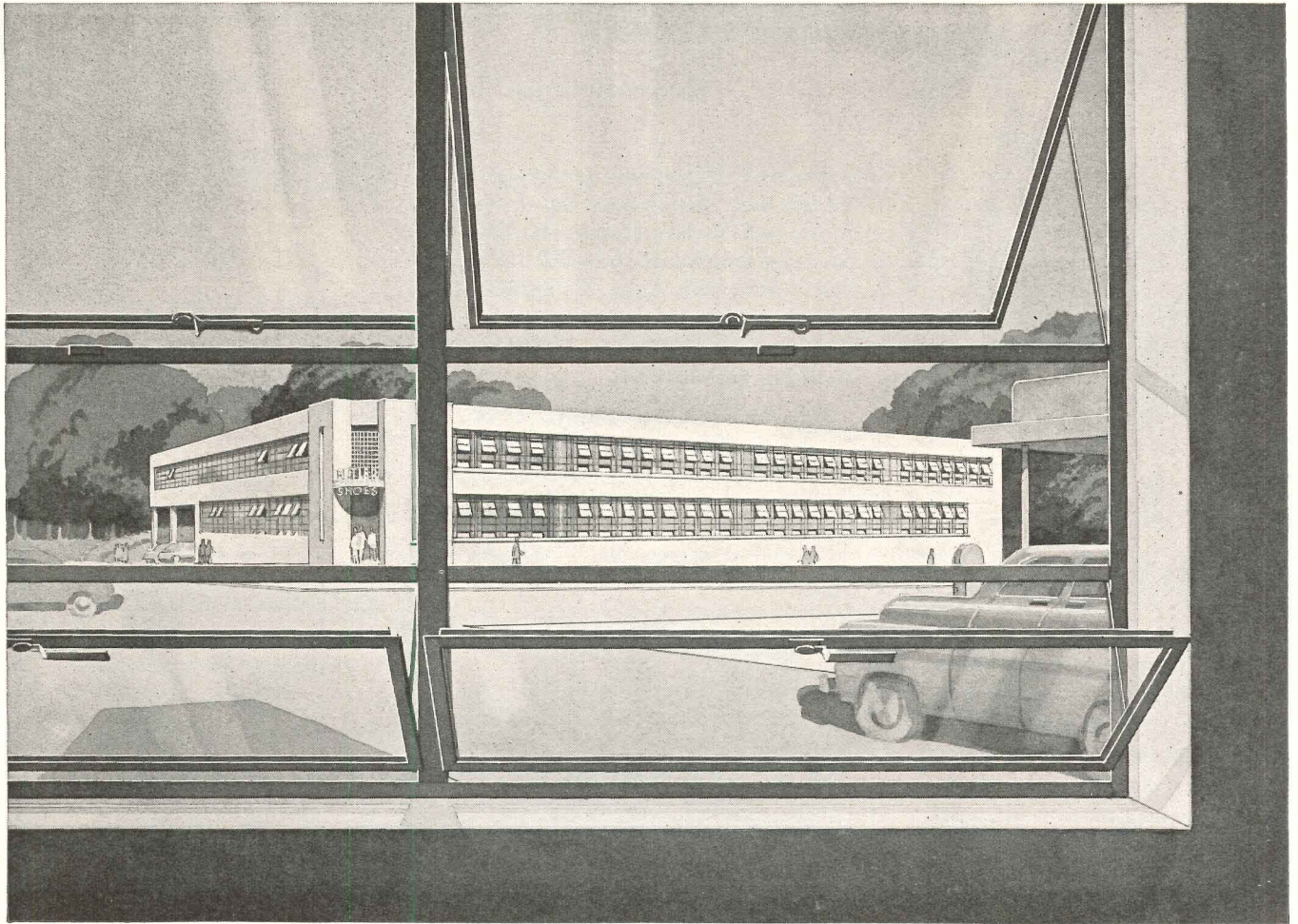

Butlers, Inc., Atlanta, Georgia.
Engineers and Contractors: L. B.
Jackson Co., Asheville, N. C.

In this modern office building and warehouse, Lupton Architectural Projected Windows complete the facilities for highest working efficiency. Air flow is easily controlled to supply exactly the correct amount of ventilation. Slender metal frames increase glass area . . . assure abundant, non-glare daylight. Will not warp, swell or shrink. Lupton Metal Windows are equipped with beautifully designed locking hardware. Bronze wire screens with narrow metal frames available for open-in or open-out ventilators. There is a Lupton Metal Window for every type of building — industrial, commercial, residential. Write for our catalog or see it in Sweet's.

MICHAEL FLYNN MANUFACTURING CO.
700 East Godfrey Avenue, Philadelphia 24, Penna.
Member of the Metal Window Institute

LUPTON METAL WINDOWS

(Continued from page 190)

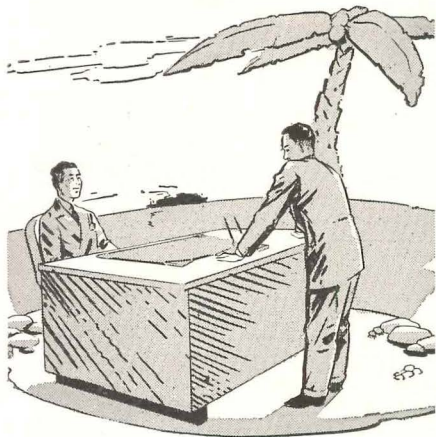

Talk it over . . . IN CONFIDENCE!

The privacy you get on a desert island is yours when you use a Couch private telephone system. Systems range from two-station lines to manual — or automatic — switchboard installations.

Whatever your inter-communicating problem, Couch equipment will solve it with quick, dependable and economical service. Talk it over in confidence with Couch equipment.

Couch



Send for
Free Illustrated
Catalog

S. H. COUCH CO., INC.
NORTH QUINCY 71, MASS.

PRIVATE TELEPHONES for HOME and OFFICE . . . HOSPITAL SIGNALING SYSTEMS . . . APARTMENT HOUSE TELEPHONES and MAILBOXES . . . FIRE ALARM SYSTEMS for INDUSTRIAL PLANTS and PUBLIC BUILDINGS.

The RESTORATION of COLONIAL WILLIAMSBURG

*A Reprint
of the December, 1935
Issue of*

ARCHITECTURAL RECORD

104 pages, bound in cloth
\$2.50 per copy



The Colonial Williamsburg Number of ARCHITECTURAL RECORD — issue of December 1935 — was sold out soon after publication but the entire editorial contents have been reprinted and bound in permanent book form with blue cloth covers.

Many thousands of these Williamsburg reprints have been sold but the demand continues unabated.

ARCHITECTURAL RECORD
119 W. 40th Street, New York, N. Y.

Enclosed is \$..... for which send..... copies of your reprint, *The Restoration of Colonial Williamsburg*, bound in cloth, at \$2.50 per copy. (Add 2% Sales Tax for New York City deliveries.)

Name.....

Address.....

City and State..... A.R. 7-49

or two-wall kitchen, the panel-type or straight-wall kitchen and the L-type or two-wall kitchen. Details and blueprint type drawings are provided. American Central Mfg. Corp., Connersville, Indiana.

Heating Equipment

Dependable Heating Equipment (Catalog No. 81). Revised catalog illustrates complete line of boilers, radiators, and radiant baseboards. Ratings and dimensions are included. 28 pp., illus. Burnham Corp., Boiler Div., Irvington, N. Y.

Corrosion-Resistant Iron

Acid-Proof Duriron (Bulletin No. 703). Illustrates the use of a special iron alloy said to resist the attack of most corrosives and to be unaffected by acid wastes normally encountered in industrial processes. Shows where it is used in waste disposal systems for chemical laboratories, industrial installations and engraving plants. Miscellaneous applications, installation instructions and specifications are covered. 12 pp., illus. The Duriron Co., Inc., Dayton 1, Ohio.*

LITERATURE REQUESTED

The following individuals and firms request manufacturers literature:

G. S. Alfredson, 12 Forest Ave., Meriden, Conn.

Jose R. Bonilla, Architect, 1642 Lexington Ave., New York 29, N. Y.

Gurnee Cape, 4736 Laurel Canyon Blvd., North Hollywood, Calif.

C. J. Kordys, Architect, 264 New York Ave., Newark 5, N. J.

Walter F. W. Maack, 26 Delaware Ave., Carneys Point, N. J.

Mondell Institute, Architectural Drafting, 25 South Broadway, White Plains, N. Y.

Parrott-Clark Construction Co., 201 S. 22nd St., Battle Creek, Mich.

Fay R. Spangler, Architect, 225 Anglo Bank Building, Fresno, Calif.

Savo Milan Stoshitch, Architect, 427 West Fifth St., Los Angeles 13, Calif.

Robert C. Turnbell, Architectural Engineer, 350 Kenilworth Rd., Bay Village, Ohio.

Zoller and Schweig, Designers, 1412 N. Broadway, Milwaukee 2, Wisc.

**Conservation of Space
Efficiency in Service**
both depend on

Streamline

TRADE MARK REG. U. S. PAT. OFFICE

The installation of STREAMLINE Copper Pipe and Solder Type Fittings under normal water conditions assures many, many years of trouble-free, efficient service at low cost. Copper and bronze do not rust. STREAMLINE Pipe is made from pure copper. STREAMLINE Fittings are manufactured in copper and bronze.

Conservation of space is a very important consideration, especially in large public buildings and hotels. The more space that can be utilized, the more income produced. Since STREAMLINE Fittings are not connected by flaring or threading, no room is required for wrench play to tighten the Fittings into place, nor need any allowance be made for protruding valve stems, which on threaded pipe, must be swung in an arc to secure. Valves and fittings are installed in a minimum of space, they are located exactly where required, and soldered.

Copper Pipe loses less heat by radiation than ferrous piping, particularly if the surface is kept polished, although copper itself is a very rapid conductor of heat. Therefore, it naturally follows that there is considerably less heat loss when the heated element, water or steam, is being conveyed from the point of generation to the points of distribution through copper pipe of uniform, unclogged, internal conducting area.

Plan on specifying and installing STREAMLINE Copper Pipe for new construction — or for replacement.

STREAMLINE
PIPE AND FITTINGS DIVISION
MUELLER BRASS CO.
PORT HURON, MICHIGAN

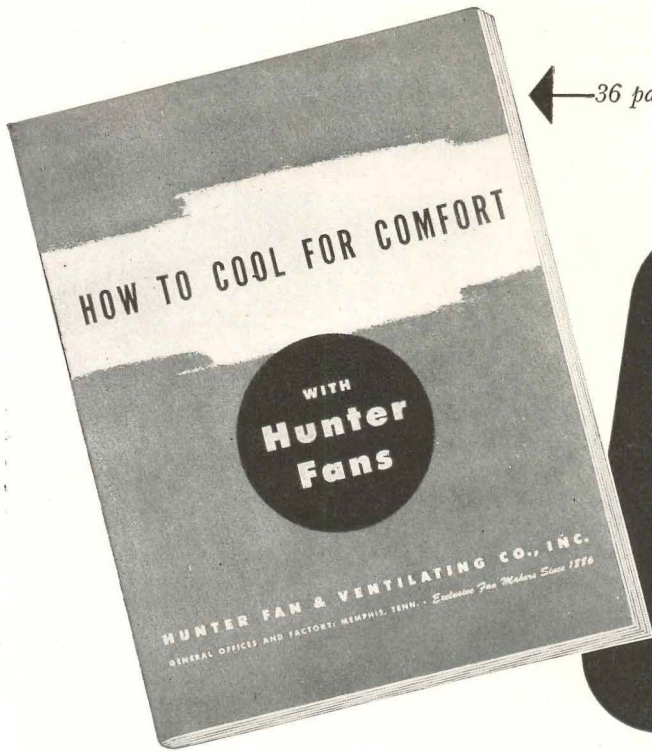

← 36 pages of technical data

New Handbook

on cooling and ventilating

This helpful new booklet gives the "how" and "why" of comfort cooling with moving air. It covers the selection and installation of ventilating and cooling systems for all types of homes, as well as commercial and industrial areas. Liberally illustrated with drawings, charts and photos, its 36 pages provide the latest engineering and architectural data on "How to Cool for Comfort." Mail coupon for your free copy.

Modern Hunter Methods

For over 63 years Hunter has been specializing in the manufacture of fans. Both the soundness of Hunter's engineering recommendations and the quality of Hunter Fans are recognized throughout the nation. In addition to the Package Attic Fan and Belt-Driven Fan (pictured here) Hunter also makes a complete line of Window, Pedestal, Ceiling, Oscillating and Exhaust Fans.

There's no finer fan than a Hunter . . . for residential, commercial or industrial cooling and ventilating. See our section in Sweet's Files.

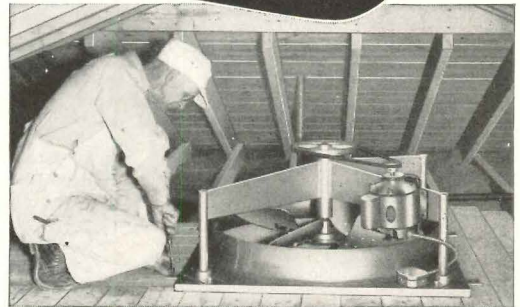

FOR HOME AND INDUSTRY

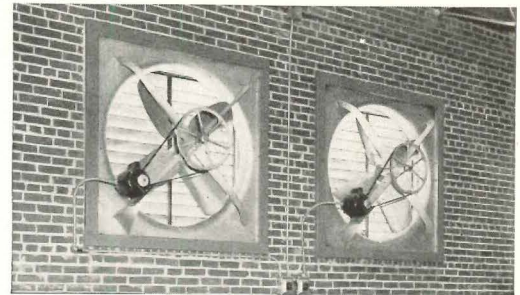

MAIL FOR YOUR COPY

Hunter Fan & Ventilating Co., Inc.
396 South Front St., Memphis 2, Tenn.

Send copy of your free handbook on "How to Cool for Comfort."

Also send data on Hunter Fans for homes for commercial areas for industry.

Name _____

Address _____

City & State _____

Hunter

Fan & Ventilating Co., Inc.

Exclusive Fan Makers Since 1886

396 South Front St., Memphis, Tenn.

Sales offices and distributors in principal cities



Prominent
in today's
ARCHITECTURAL
picture...

ENDURO-ASHLAR ARCHITECTURAL TERRA COTTA

Today's pronounced architectural preference for Enduro-Ashlar Architectural Terra Cotta is due to its remarkable plasticity of form, color and texture, giving you complete freedom of design—for monumental, industrial or mercantile construction or for modernization. The fire-hardened glazed surface may be had in any color, in units large or small. Its beauty endures... simple soap-and-water washings will retain its original richness indefinitely, even when subjected to big-city grime.

Today—send for information showing how Enduro-Ashlar Architectural Terra Cotta fits into your design picture. Construction detail, data, color samples, estimates, advice on preliminary sketches, will be furnished promptly without charge.



SAXONY HOTEL
Miami Beach, Florida

Roy F. France—*Architect*
Taylor Constr. Co.—*Builder*

In this ultra-modern \$5,000,000 resort hotel, the balcony panels of Enduro-Ashlar Architectural Terra Cotta, in a deep sea-green, provide striking vertical contrast to the dazzling white exterior of this magnificent structure.

FEDERAL SEABOARD TERRA COTTA CORP.



10 EAST 40th STREET, NEW YORK 16, N. Y.
PLANTS AT PERTH AMBOY AND SOUTH AMBOY, N. J.

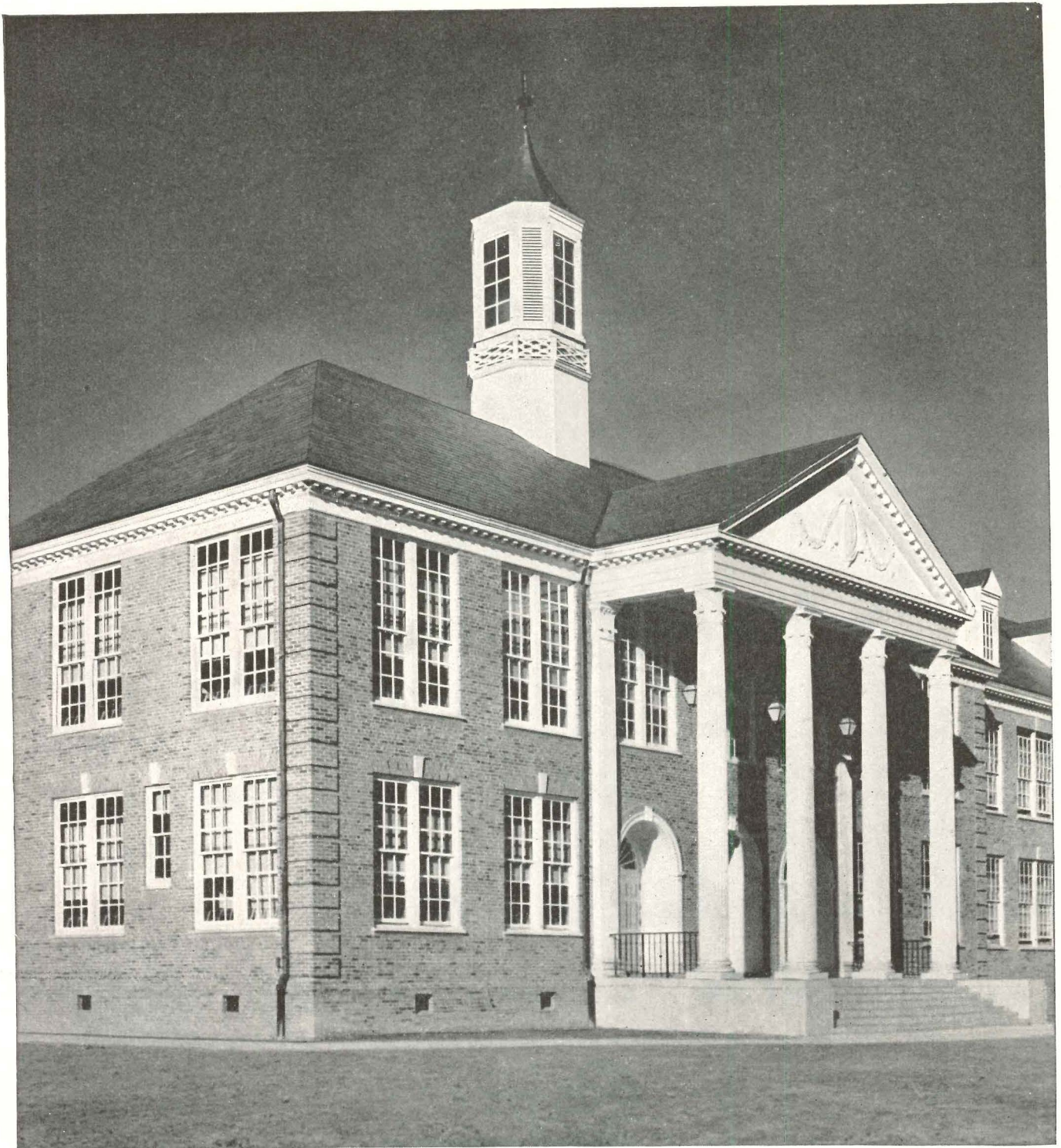

New School in Virginia Has Open-Web Steel Joists—Located at Bassett, Va., this two-story brick building, Bassett High School, has modern facilities for 600 students. The acoustically treated structure contains 45,320 sq ft of floor space, and offers many innovations, including a sound-system for communicating broadcasts to any or all rooms. Bethlehem Open-Web Joists were used in its construction, in combination with concrete floors and plaster ceilings. Floors built in this way help make schools fire-safe, for they prevent fire from spreading for two hours or more, depending upon the type of plaster used. They are also economical, sound-retardant, and shrink-proof, and in addition are immune to attack by vermin. See our catalog in Sweet's File for complete information about Bethlehem Open-Web Joists. . . . *Architects:* Dixon and Norman, Richmond, Va. *Contractor:* Mottley Construction Co., Inc., Farmville, Va.



WORTHINGTON

AIR CONDITIONING REPORT

WORTHINGTON PUMP AND MACHINERY CORPORATION
HARRISON, NEW JERSEY

Specialists in air conditioning
and refrigeration
for more than 50 years

Clinically-clean Air For Children's Hospital

As you can imagine, the air into which a baby is delivered and in which it passes its first few days must be scrupulously clean and its temperature accurately controlled. Too high a room temperature, for example, invites enteritis (inflammation of the intestines), which is common among babies.

In the Children's Hospital, Cincinnati, Worthington equipment is used to air condition the infants' ward, surgical ward and milk preparation room.

The equipment used for the infants' ward includes two Worthington package units, with hermetically-sealed compressors, to cool, dehumidify, clean, circulate and ventilate. Each occupies only eight square feet, but has a cooling capacity of 5 tons.

No case of enteritis has been reported since the installation was made.

In the surgical ward, which consists of five operating rooms and five auxiliary work rooms, a Worthington package air conditioner with conven-



Children's Hospital, Cincinnati—equipped with Worthington Air Conditioning

tional reciprocating compressor and evaporative condenser, is used for the comfort and efficiency of surgeons and nurses and, by humidity control, to prevent the hazard of static spark which exists where there are ether fumes.

Another 5-ton package unit with hermetically-sealed compressor provides filtered air to the room where milk formulas are prepared.

Engineering and installation by Henry Niemes, Inc., Cincinnati.

An Ideal Climate For World-Wide Explorations

Much of the exploration in the oil industry—the geo-physical laboratory type of exploration—is done by Rogers-Ray, Inc., in Houston, Texas, serving petroleum firms all over the world. In line with providing its staff with the best possible working conditions and to maintain constant air conditions in the laboratory, Rogers-Ray has installed Worthington Air Conditioning.

When the instruments are built, it is necessary to maintain tolerances which are so fine that they could be affected by variations in temperature and humidity. In the main offices, it is important to protect against shrinkage or expansion of blueprint and tracing paper carrying finely detailed drawings.

The engineer, H. E. Bovay, Jr., selected Worthington AHY and AVY

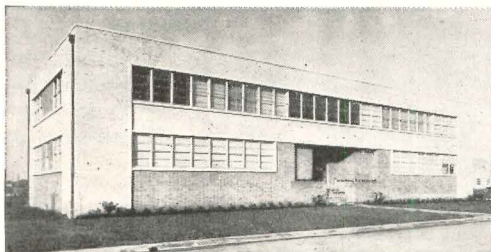

Office building of Rogers-Ray, Inc., Houston, Texas

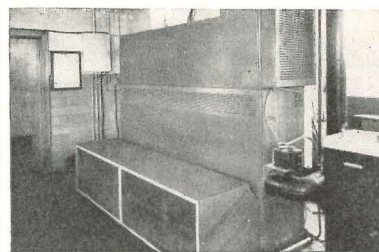

Worthington AVY Air Conditioning Unit at Rogers-Ray, Inc.

Pampering Paper

In the New York plant of General Aniline & Film Corporation's Ozalid Division, makers of white print and dry developing machines and sensitized papers, Worthington Air Conditioning is used to insure constant temperature and humidity conditions for the processing and storage of the film paper.

The equipment includes two horizontal-mounted central station air conditioners and two Freon-12 condensing units.

The compressors are equipped with automatic capacity control, light-weight automotive-type pistons and Worthington Feather* Valves, lightest, tightest, quietest ever made.

*U. S. Reg. Pat.

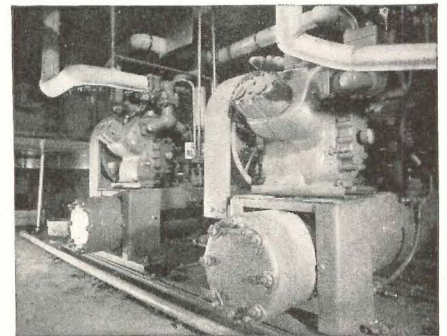

Worthington Freon-12 Condensing Units at Ozalid plant

central station air conditioners for complete year-round air conditioning. These units are designed essentially for installation remote from the place to be conditioned. Air distribution is handled in the shop building by one 4500 cfm unit, in the office building by two 4500 cfm units and a 2000 cfm unit. These units are sectionally-constructed, permitting ease of handling, interchangeability and flexibility of assembly. They are served by two Worthington four-cylinder V-type Freon-12 Compressors, both of which are connected to a single horizontal cleanable-type shell-and-tube condenser.

Installation was made by Gregory-Edwards, Inc. of Houston.

WORTHINGTON



AIR CONDITIONING AND REFRIGERATION

A complete line . . . in which *all* the vital components are *made*, not just assembled by Worthington. For more worth with Worthington, see your nearby Worthington distributor (consult Classified Telephone Directory).

2nd Printing

The Complete ...
Authoritative up-to-the-minute Handbook

"Hospital Planning"

by CHARLES BUTLER, F.A.I.A., and ADDISON ERDMAN, A.I.A.

A Case-Study Analysis of Modern Hospitals

With tremendous energy and insight Charles Butler and Addison Erdman, distinguished architects and hospital consultants, have made a nation-wide survey of the current adaptation of hospital architecture to changing practices in hospitalization.

The fruits of their study are set forth in "Hospital Planning" — a completely new treatise of present-day practices, based on a painstaking study of hundreds of institutions from which have been selected fifty-one modern hospitals, representing the creative efforts of more than thirty architectural firms, for illustration and discussion.

"Hospital Planning" presents a textual summation of the outstanding problems in hospital architecture and shows how these problems have been met in actual practice. Generous use of illustrations, including perspectives, floor plans, elevations and photographs, make solutions abundantly clear and afford sound, applicable principles for innumerable problems to come.

**For Hospital Administrators . . . Superintendents
. . . Doctors . . . Architects**

This 232-page, fully-illustrated volume, carefully organized for both reading and reference, is designed for architects and hospital groups alike. It will help trustees, administrators and doctors to visualize their problems in terms of their community needs . . . show how others are meeting similar problems . . . provide them with a basic understanding of hospital architecture so that they may intelligently discuss their problems with the architect.

It will help architects and engineers to learn of the great advances made in hospital architecture . . . to acquire a working knowledge of medical problems and hospital procedure . . . to avoid the many pitfalls which beset the hospital planner.

Order Your Copy Now

With this second printing "Hospital Planning" is again temporarily available at the price of \$15. It is offered with the full knowledge that it may be worth incomparably more to you than its cost — so much more that cost is no valid consideration.

So use the convenient coupon below to make sure to get your copy of "Hospital Planning" before the second printing is sold out. The book will be sent promptly, prepaid.

Mail this coupon today

ARCHITECTURAL RECORD BOOK DEPARTMENT
119 West 40th Street, New York 18, New York

Enter my order for copy(s) of the new printing of "Hospital Planning" by Charles Butler and Addison Erdman at the price of \$15 a copy. I enclose payment of \$ (For New York City delivery, add 30 cents for Sales Tax — \$15.30 in all.)

Name

Address

City Zone State

A FEW of the architectural firms whose works were selected for discussion and illustration include...

Coolidge, Shepley, Bulfinch and Abbott
Samuel Hannaford & Sons
Schmidt, Garden and Erickson

Jamieson and Spear
Charles B. Meyers
James Gamble Rogers
Mayers, Murray and Phillip
Eggers and Higgins
Crow, Lewis and Wick

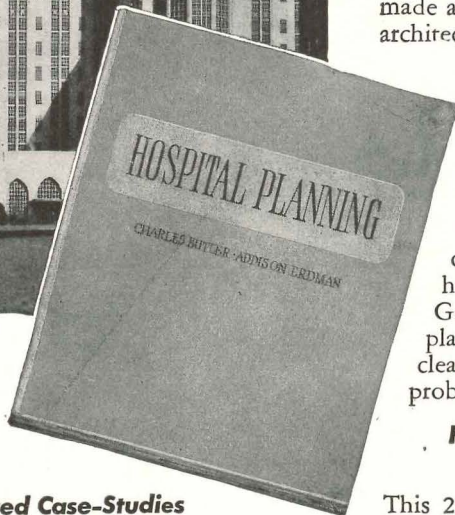
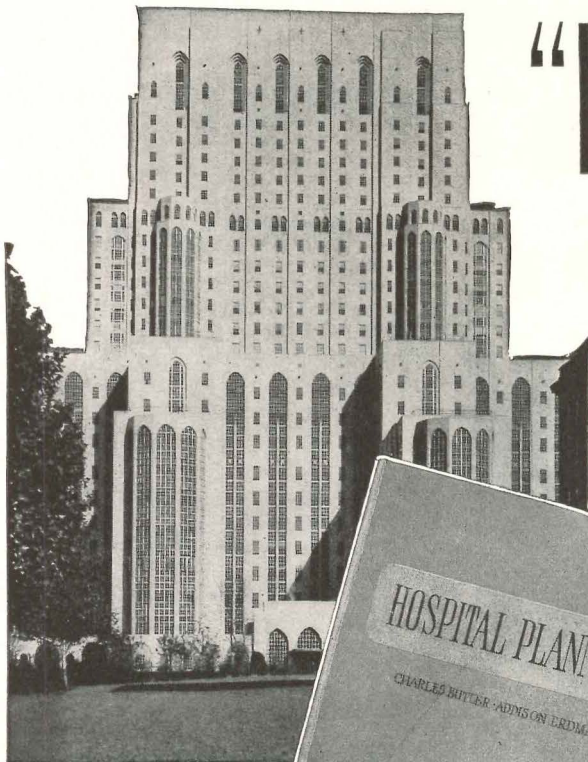

232 pages . . .
size 8 1/2 x 11 inches.
17 chapters . . .
profusely illustrated . . .
thoroughly indexed . . .
detailed table of contents . . .
stiff cloth binding . . .
Price \$15

Hundreds of Illustrated Case-Studies

"Hospital Planning" presents the plans of fifty-one selected modern hospitals . . . represents the creative efforts of 30 architects. Includes 32 photographs . . . 11 site plans . . . 187 floor plans . . . 38 special unit plans of rooms, wards and departments . . . numerous construction details.

THE AUTHORS—Perhaps no other two authors are so well qualified by background and experience to write a volume of such broad scope and magnitude as those selected for this authoritative and technically difficult work.



Charles Butler has been closely associated with hospital planning throughout his broad professional career. As architect or consultant, his works include St. Luke's International Medical Center, Tokyo; War Demonstration Hospital at Rockefeller Institute; Goldwater Memorial Hospital.



Addison Erdman, holder of the A.I.A.'s Langley Fellowship for two successive years, is a consultant on hospitals for a number of architectural firms. His works include the Mobile Hospital Unit for the British Army in Egypt, the Private Patient Pavilion, Methodist Hospital of Brooklyn. Recently appointed as one of the five architects consultants for the Veterans Administration.

HOSPITALS selected for illustration include — Cornell-New York Medical Center, New York; Goldwater Memorial Hospital, Welfare Island, New York; Methodist Hospital, Brooklyn; General Hospital, Cincinnati; Saint Vincent's Hospital, New York; Community Hospital, Battle Creek; Saint Mary's Hospital, Rochester, Minnesota; American Memorial Hospital, Reims, France; Mallinckrodt Institute of Radiology, Saint Louis; Royal Victoria Hospital, Montreal; Rochester Municipal Hospital, Rochester, New York; Potts Memorial Hospital, Livingston, New York; Fort Sill Hospital, Fort Sill, Oklahoma. Saint Luke's Hospital, Spokane, Washington; Massachusetts General Hospital, Boston and many more.

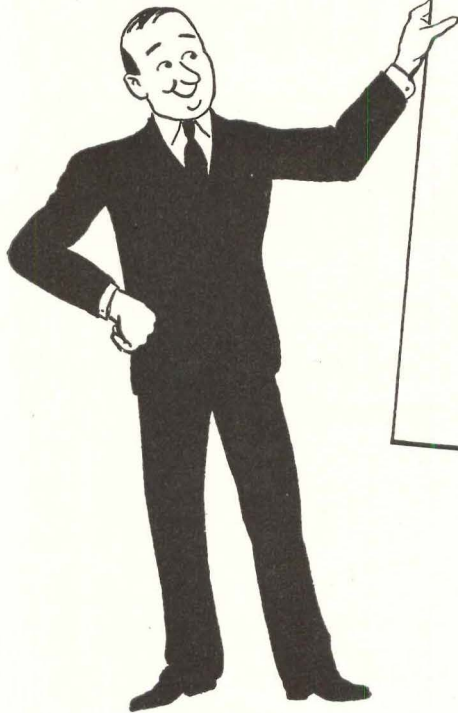

Announcing
GOLD BOND
TRAVACOUSTIC

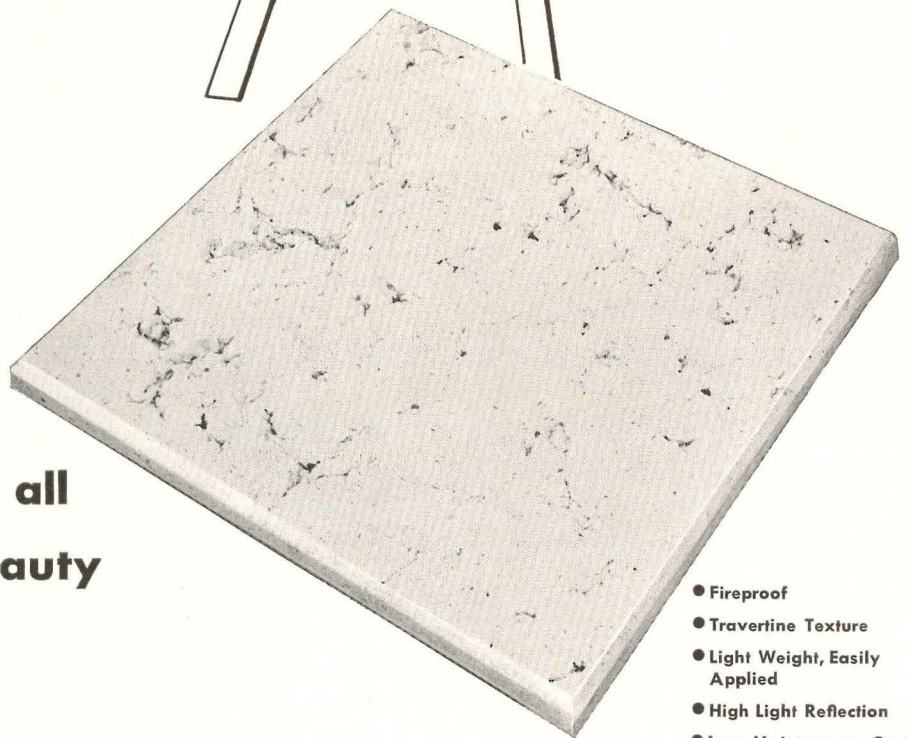

- Fireproof
- Travertine Texture
- Light Weight, Easily Applied
- High Light Reflection
- Low Maintenance Cost

**... a fireproof
 acoustical tile with all
 the dignity and beauty
 of travertine stone**

GOLD BOND Travacoustic meets all building codes. Rated not merely "fire-resistant" but **INCOMBUSTIBLE**. The pleasing random arrangement of the fissures gives an over-all ceiling pattern of endless variety. Extremely light in weight, easily installed. Factory-applied coating offers unusually high light reflection, but may be spray or brush painted without loss of sound absorption. Simple vacuum cleaner attachments keep Travacoustic clean and maintenance costs at a minimum.

This new top quality mineral wool Acoustical tile is now available

in two thicknesses— $\frac{5}{8}$ " and $\frac{3}{4}$ ". Panels are furnished in three sizes—6" x 12", 12" x 12", and 12" x 24". The noise reduction coefficient is .65 and .70 for the two thicknesses respectively. Its dignified natural beauty blends with all types of architectural design and interior decoration, including modern flush type lighting. Available in beveled, butt edges, or square butt edges.

Factory-appointed Gold Bond Acoustical Applicators insure expert workmanship. If none is listed in the phone directory under "Acoustical Contractors," write Dept. G-97.

**You'll build or
 remodel better with**

Gold Bond

Acoustical Products

A COMPLETE LINE FOR EVERY
 PURSE AND PURPOSE

*Acoustimetal • Acoustifibre
 Econacoustic • Travacoustic*

NATIONAL GYPSUM COMPANY, BUFFALO 2, N. Y.

Now Ready!

New, enlarged ninth edition

THE ENLARGED, revised ninth edition of "Design and Control of Concrete Mixtures" is now available. Write for your free copy today. It is distributed only in the United States and Canada.

This handbook has been a valuable aid to engineers, architects and contractors for more than 20 years. Packed with graphs, tables and illustrations, it helps you obtain quality concrete for any job.

In designing concrete mixtures strength frequently is overemphasized. **Strength** is important but it should not overshadow the other two essentials of quality concrete: **durability** and **workability**.

Quality concrete design achieves a balance between all these important requirements:

1. A workable mix that can be placed easily and quickly.
2. Durability to resist the wear of time and weather.
3. Finished concrete strong enough for the intended use.
4. Economical use of available materials.

Because of concrete's superior qualities and unusual versatility, it is used for more architectural and structural purposes than any other building material.

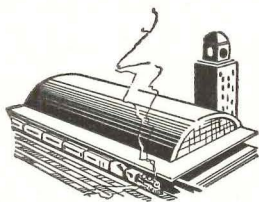

Concrete is firesafe, decay-proof, storm-proof and verminproof. It lasts so long and costs so little to maintain that it is truly **low-annual-cost** construction. With all its rugged structural properties, concrete also can be molded economically into distinctive edifices of lasting beauty.

To obtain the full measure of concrete's advantages requires the right design, proper selection of materials, careful on-the-job control of mixtures, correct placement and curing. "Design and Control of Concrete Mixtures" is a handy reference manual that helps you attain this result.

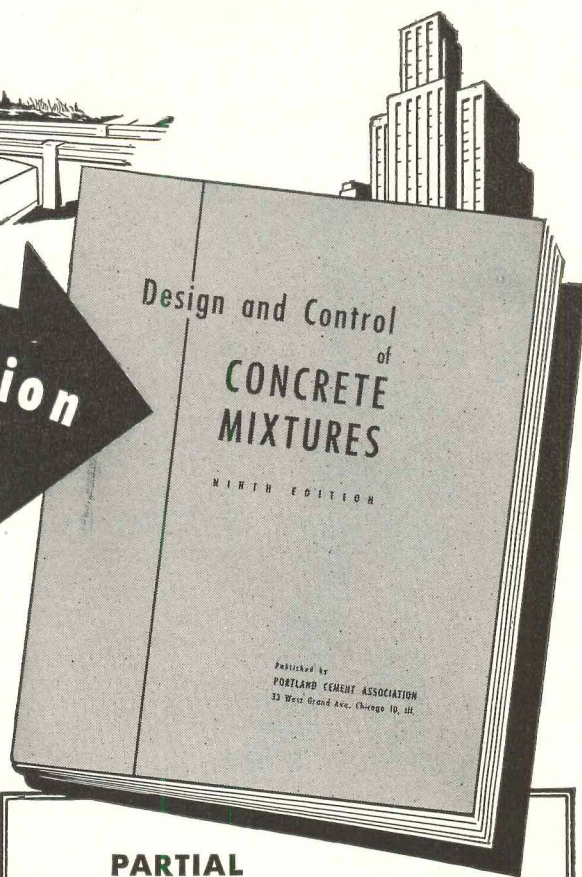

PARTIAL TABLE OF CONTENTS

Field Control Tests

Materials for Concrete

Fundamental Facts About Concrete

Mixing Concrete

Design of Concrete Mixtures

Handling and Transporting Concrete

Measuring Materials

Placing Concrete

Removal of Forms

Finishing Concrete

Curing and Protection

Joints, Construction, Expansion and Contraction

Special Types of Concrete

ASTM Specifications for Plain and Reinforced Concrete

Standards of the American Society for Testing Materials



PORTLAND CEMENT ASSOCIATION

DEPT. A7-8, 33 WEST GRAND AVENUE, CHICAGO 10, ILLINOIS

A national organization to improve and extend the uses of portland cement and concrete through scientific research and engineering field work

Ease of Fabrication is but one of TONCAN IRON's plus qualities. And no matter how severe the work, TONCAN IRON's rust-resistance—the highest of all ferrous materials in its price class—remains unaffected, because of the uniform effectiveness of copper and molybdenum throughout the metal.

For more than 40 years, these plus qualities have combined to make TONCAN IRON a leader in the sheet metal field . . . recognized everywhere for unsurpassed durability and economy. See Sweet's Architectural File or write for additional information. Republic Steel Corporation: General Offices, Cleveland 1, Ohio . . . Export Department: Chrysler Building., New York 17, N. Y.



20
TONCAN
COPPER
MO-LYB-DEN-UM
IRON
REPUBLIC STEEL CO.
CLEVELAND, OHIO



Republic

TONCAN COPPER MOLYBDENUM IRON

— for ducts, gutters, conductor pipes, roofing, siding, tanks, ventilators, skylights, hoods and other sheet metal applications requiring rust-resistance — and for corrugated metal drainage products.

Announcing... A New Store Book

Ben Schnall Photo

"Planning Stores That Pay"

by Dr. Louis Parnes, A.I.A.

for

Architects and Store Designers,
Department and Chain Store
Administrators

"The great majority of department stores today are not making the most efficient use of their space,"

says Dr. Louis Parnes, international authority on store planning.

"This is due to haphazard growth and bad planning . . . The tremendous occupancy costs, which absorb 6% or more of gross sales, can be cut down in relation to sales by good design."

In his new comprehensive study "Planning Stores that Pay," Dr. Parnes demonstrates the amazing degree to which architecture — as expressed in counter lengths, traffic flow, etc. — speeds and increases retail sales, not only for department stores but for specialty and chain stores. Point by point he conducts a tour of the store to illustrate the right and wrong aspects of profit-making design. He shows how to compute such diverse factors as, say, the ideal width of show windows and the optimum number of chairs in a shoe department.

With more than 500 illustrations, he explores every detail of the store and its arrangements — entrances, arcades, show windows, transportation systems, furniture and fixtures, receiving and shipping facilities, floor and department layouts, display arrangement and lighting, and all the hundreds of items that go to make up a modern merchandising machine. Everything is calculated from the viewpoint of efficiency, and the contribution of each part of the store to the process of selling goods profitably is the criterion of its recommended design. Diagrams, charts and scale drawings, from hundreds of leading stores and from the works of America's greatest store architects, prove each point graphically.

Why Every Department Store — Old or New — Now Needs an Architect's Service

Composite statistics of department store income and expense have long been put to invaluable use in stepping up store efficiency. Dr. Parnes shows how they also can be used as a precise basis for designs that automatically enhance sales . . . and reveals the enormous potential profits thus available. The first store to be thus fully engineered will have extraordinary advantages! *But meanwhile every department store in the country can begin at once to plan its architectural transformation.*

A Basic Textbook on Store Architecture

"Planning Stores That Pay" is a book of basic principles, but specific ideas flow from its pages in rapid succession. A single chapter has enough suggestions to launch a number of long-term projects in store layout, equipment,

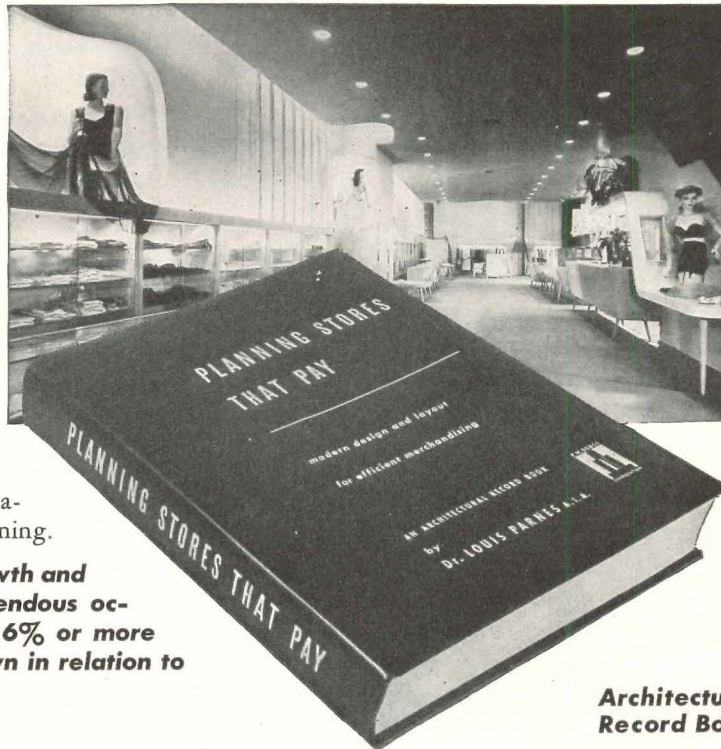

An
Architectural
Record Book

Over 500 photographs and diagrams of floor plans, store fronts and interiors.

Features 112 stores and shops . . . the work of more than 60 architects and designers.

300 pages; 8½ x 11¼; heavy, durable, cloth binding; 80 lb. coated stock; Detailed Table of Contents; Comprehensive Index.

TABLE OF CONTENTS

1. Introductory Survey
2. City Planning Considerations
3. The Selling Zone
4. The Customers' Zone
5. The Merchandise Zone
6. The Show Window
7. The Personnel Zone
8. Interior Lighting
9. Circulation and Transportation
10. Scientific Surveys and Data

CONTENTS OF A TYPICAL CHAPTER

To indicate how logically and thoroughly this book deals with its subject, here are the section headings of a single chapter (Chapter 3, entitled "The Selling Zone"):

Space Organization. Coordination and Arrangement of Central Sales Areas. Relative Size of Departments. Circulation on Selling Floors: Aisle Layout; Aisle Densities; Equipment Layout. Fixture Specifications. Self-Service Equipment. Flexible and Standardized Equipment. Service Stations. Interior Display. Interior Column Spacing. Productivity, Efficiency, and Equipment Layout. Special Sales Rooms. New Trends in Basements. Main Floor Layout.

A few of the architects and firms whose works are discussed are:
Carson & Lundin
Morris Lapidus
Shreve, Lamb & Harmon
Kenneth Franzheim
Fred N. Severud
Harry Devine
William Lescaze
H. Roy Kelley
John S. Redden
Albert C. Martin
John M. Hatton
Morris Ketchum, Jr.
Ernest J. Kump
Stiles O. Clemens

etc. Any department store administrator can see that it will pay him to call in private architects for immediate replanning, and that such replanning may well pay for itself a hundred times over.

Department stores have exhausted great resources of effort and ingenuity to maintain their life-line margin of profit. The fact that "Planning Stores That Pay" suddenly injects into this situation sensational new weapons for combatting competition makes this an extremely valuable, if not indispensable, book for architects and store administrators. With it they can speak each other's language, work together, and make the most of today's great opportunities.

Order Your Copy Now

"Planning Stores That Pay" is now available to you at the price of \$15 per copy. But because the demand for this book is exceeding even the most sanguine expectations, the initial printing may soon be exhausted. Therefore, to make sure of your copy of this new, basic text on advanced store design and planning, order your copy now.

Use the convenient coupon at the right. The book will be sent promptly on receipt of your order . . . postpaid.

BOOK DEPARTMENT, ARCHITECTURAL RECORD
119 West 40th Street, New York 18, N. Y.

Enclosed is \$..... for..... copy(s) of "Planning Stores That Pay," by Dr. Louis Parnes, A.I.A., at the price of \$15 per copy. For N. Y. C. add 2% sales tax.

Name.....

Address.....

City..... Zone..... State.....

A.I.A. medalist prefers oil heat for apartments

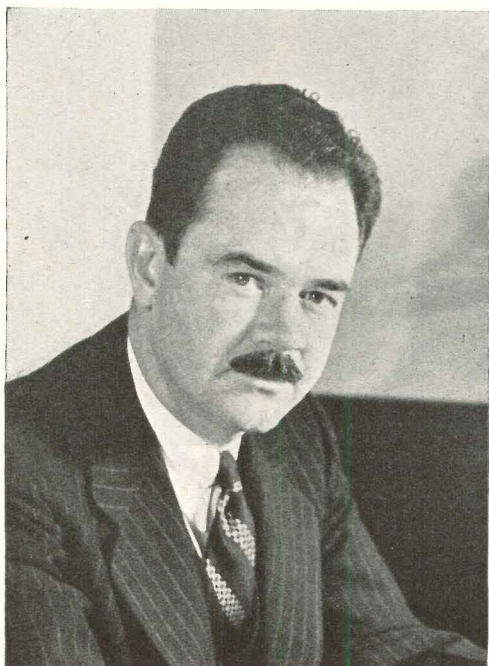

One of New York's outstanding architects, George Fred Pelham, 2nd, is the designer of many of the city's finest apartment houses. In 1941, he was awarded the A.I.A. medal for fireproof apartment structures.

Based on his many years' experience with oil heat in hundreds of buildings, Mr. Pelham makes these observations:

"I have found oil burners to be the most desirable method of heating modern apartment houses. The elimination of ash handling alone results in increased cleanliness and a substantial reduction in employee man-hours. I have found this method of heating to be the most satisfactory in performance for both the tenants and my clients."

NOTE in particular Mr. Pelham's timely comments on oil heat cleanliness. To this can be added elimination of noisy ash handling . . . minimum maintenance attention . . . release of employee man-hours for other duties . . . reliable, uniform heating that promotes the comfort and good health of the building occupants.

And when the oil-heating system is Petro, you can also count on another benefit . . . Petro's traditional economical operation. Petro equipment burns the lowest-cost fuel obtainable in any locality. And, because of Petro's exclusive Thermal Viscosity Control, it does so automatically — even with heavy pre-heated No. 6 Bunker C fuel oils. Fluctuations in heating load are instantly satisfied, at maximum combustion efficiency.

When you specify Petro, you are providing genuine heating dependability, backed by the resources of the country's largest, oldest, exclusive maker of oil-heating equipment.

INDUSTRIAL MODELS: No. 5 or No. 6 fuel oil; manual, semi-automatic or automatic operation; 8 sizes to 450 bhp. Thermal Viscosity preheating.

DOMESTIC MODELS: No. 3 or lighter oils; "conversion" and combination-unit types, 7 sizes. Patented "Tubular Atomization."

FULL DATA on Petro Industrial Burners are in catalog files of Sweet's and Domestic Engineering. Details on Petro Domestic Burners available in separate catalog. Copy of either sent gladly on request.

PETRO
REG.-U.S. PAT. OFF.

cuts steam costs

PETROLEUM HEAT AND POWER CO. • Makers of Good Oil Burning Equipment Since 1903 • Stamford, Connecticut

MODERN EQUIPMENT FOR MODERN BUILDINGS
or Modernization Programs

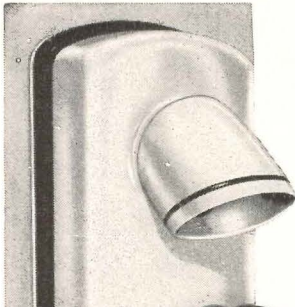

Hair Dryers

These are virtually a "MUST" in Dormitories, Hospitals, Sanitariums, Bath Houses, Country Clubs, Swimming Pools, etc.



The ELECTRIC-AIRE is engineered for hard, continuous service. Its larger volume of warm air, gently blown, dries hair in 3 to 5 minutes. *Reduces colds!* Speeds locker room traffic. Economical to install and operate. Gives many years of dependable service. Coin operated or free service types.



Hand Dryers

24-hour automatic service that provides thoro-dry and CHAP-FREE hands, completely eliminates towels with all their expense of handling, untidiness, fire and toilet-clogging hazards. They quickly pay for themselves in money saved (85% to 90% of towel costs!). Approved by Underwriters' Laboratories. Easy to install in both old and new buildings.

ELECTRIC-AIRE preserves your original conception of a well designed and tidy washroom.



Recess Type—
7 1/4" x 16"



Note towel litter and disposal unit. A fire hazard.

Same room with ELECTRIC-AIRE Hand Dryers. No litter.

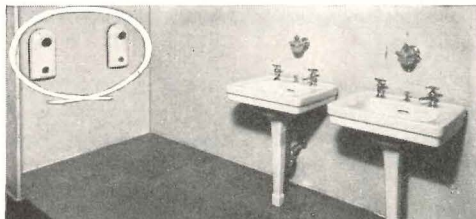

With ELECTRIC-AIRE Hand Dryers and Hair Dryers, in a new or remodeled old building, you add functional modernity. Besides installing the latest equipment of its kind, you include a service to occupants and the public that will be appreciated. AT THE SAME TIME YOU WILL MAKE IT POSSIBLE FOR BUILDING OPERATORS TO SAVE MONEY!

Our AIA File 31-L with illustrations and complete specifications gladly mailed on request

Electric-Aire Engineering Corp.

Phone WEbster 9-4564 CHICAGO 6, ILLINOIS 209 W. Jackson Boulevard

FITZGIBBONS

For 63 years, the right name in
STEEL BOILER HEAT



"400" SERIES

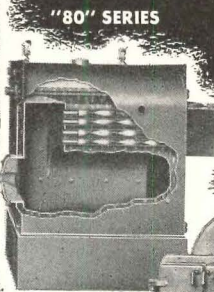

"80" SERIES

"D" TYPE

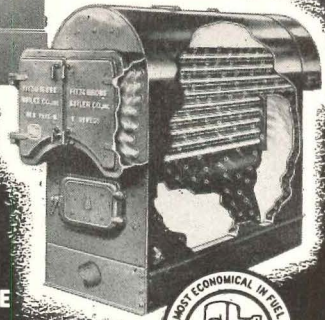

A.S.M.E. CODE
Constructed

HYDROSTATICALLY
Tested

HARTFORD INSURANCE
Inspected

S.B.I. CODE *rated*



Fitzgibbons Boiler Company, Inc. 101 PARK AVE. NEW YORK 17, N. Y.

CONNOR

Forest Products Since 1872

"LAYTITE" MAPLE FLOORING

MFMA Specifications

The World's Finest — Bar None

Write For Illustrated 75th Anniversary Booklet

CONNOR LUMBER AND LAND COMPANY

PHONE No. 3

Marshfield, Wisconsin P. O. Box 112-R

Behind the Mills — The Connor Timber Stands



“Everyone is happy with the Wurlitzer Organ”

REV. T. S. SAMPSON, Pastor
New Community Protestant Church of Mundelein, Illinois

STANLEY D. ANDERSON & ASSOCIATES,
Architects, Lake Forest, Illinois



New Community Protestant Church of Mundelein, Illinois, where a Wurlitzer Organ and two concealed tone cabinets distribute music in equal volume to all members of the congregation.

In planning this warm and friendly church for a suburban community, one of the primary requirements was the selection of an organ that would deliver traditional church organ music. This task was turned over to a committee charged with the responsibility of making the best possible use of available funds and space.

After consultation with their architects, and consideration of pipe organs as well as all the various makes of electronic organs, the pastor and his committee were unanimous in their selection of a Wurlitzer Organ.

“Everyone is happy we chose a Wurlitzer Electronic Organ,” reports Rev. T. S. Sampson. “As

you know, we investigated the organ field thoroughly and chose the Wurlitzer because of its superior tone.”

“It serves the purposes of this church well and with decided savings in both space and cost,” say Stanley D. Anderson & Associates, architects.

Wurlitzer Electronic Organs simplify planning, are easy to install, and there are models for every type of installation. May we send you complete information?



Series 21 Wurlitzer Organ—the model chosen by Rev. Sampson and his committee. There are four models in the Wurlitzer line—both double-manual and single-manual types. Prices range from \$1095 to \$3895, F.O.B., North Tonawanda, New York.

WURLITZER

WORLD'S LARGEST BUILDER OF ORGANS AND PIANOS
UNDER ONE NAME

THE RUDOLPH WURLITZER COMPANY, ORGAN DIVISION, NORTH TONAWANDA, NEW YORK

Safety
INSURED!

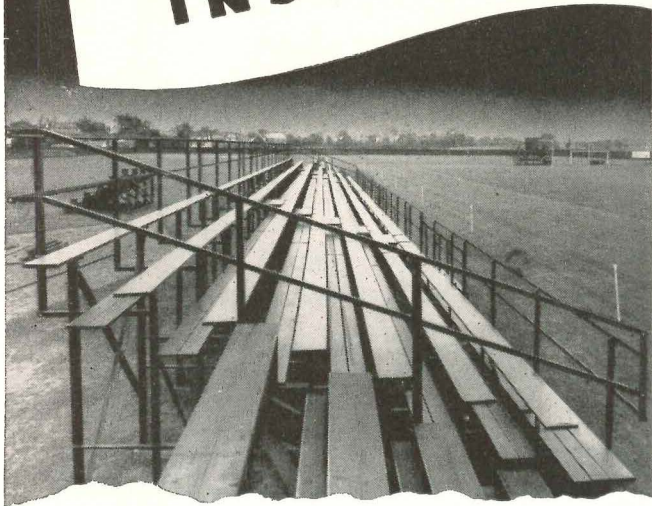

REST ASSURED—a Wayne Grandstand or Gymstand can be depended upon for safety. Their all-steel understructures are designed to carry full live load, plus impact and sway, with an ample factor of safety.

The Type "H", for example, is a safe, inexpensive, steel portable grandstand that meets almost every outdoor need. Note, in the photo below, that the construction permits base members to adjust themselves to uneven ground without straining the supporting members. Note, also, the strongly fabricated supporting structure and the comfortable seats and footrests.

Furnished in depths up to 15 rows and in 15 foot units, or as a continuous stand, the Type "H" presents a good appearance and is really economical. You can find out more about this grandstand by writing to:

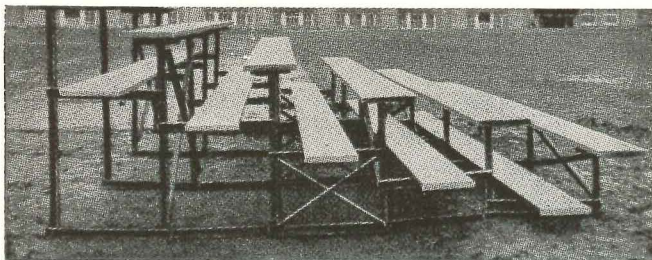

"Wayne Stands  for Safety"

WAYNE IRON WORKS

REPRESENTATIVES IN 42 CITIES

148 NORTH PEMBROKE AVE. • WAYNE, PENNA.

METAL FOR STORE FRONTS
FULLY EXTRUDED
ALUMILITED ALUMINUM

Matcor

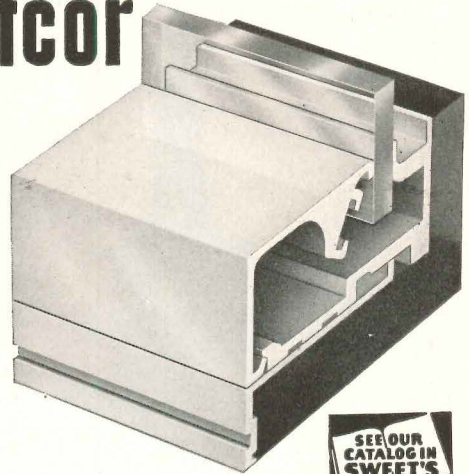

SEE OUR CATALOG IN SWEET'S

FOR DETAILS WRITE

Matcor **STORE FRONTS**
PROVIDENCE 9 RHODE ISLAND

BURPS and BUBBLES

are **DANGER**
SIGNS

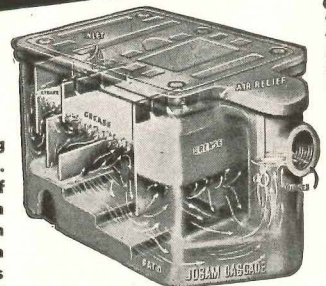

● Burps and bubbles coming from sinks indicate trouble. They may be the result of drain lines clogged with grease. Grease builds up in unprotected drain lines from sinks, dishwashers and drains . . . slowing up drainage and eventually causing costly repairs.

Why take chances on having this happen in the buildings you plan? Specify Josam Grease Interceptors. They catch the grease before it gets into the drain lines . . . keep them clear . . . eliminate repair bills. Their performance is proven through thousands of installations in restaurants, hotels, hospitals and other institutions. Write for free copy of Manual "A," the Authority on Grease Interception.

JOSAM MANUFACTURING COMPANY

Main Sales Office, 302 Josam Building, Cleveland 13, Ohio
Manufacturing Division, Michigan City, Indiana

Representatives In All Principal Cities

REV. 1. ACCESS. RAMP.
REMOVABLE. RAILING.
NOTE: SEE DETAIL 36. SHEET #10.

ARCHITECT—FREDERIC P. WIEDERSUM . . . ELEC. CONTRACTOR—GEECO ELECTRIC CONSTRUCTION CORP.

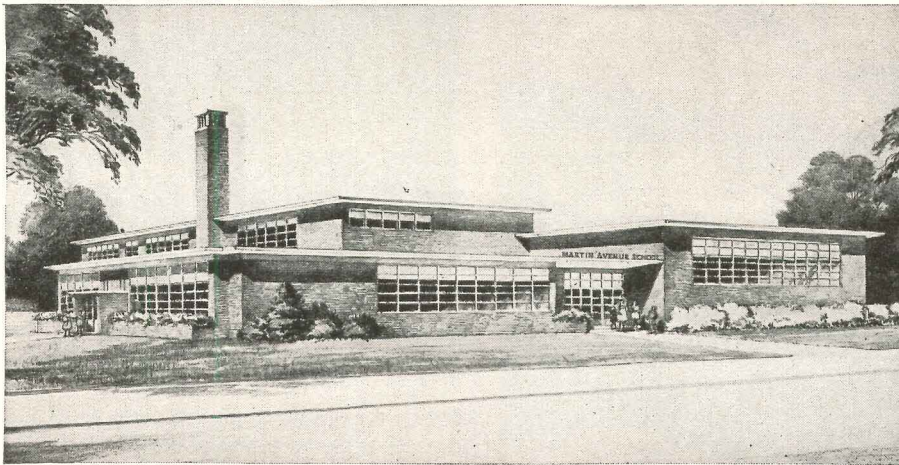

How do you specify 77 years of experience?

You're specifying signal and protection systems for a new school . . . you're conscious of how much depends on your recommendations . . .

The principal must be freed from the nuisance of clock-setting and bell-ringing. The maintenance staff must not be saddled with time-wasting regulations and adjustments.

Above all . . . parents must be secure in the knowledge their children are in a *safe, efficient* school.

In effect, then—you must specify

experience . . . Experience in design, manufacture . . . performance.

The new Martin Avenue School, at No. Bellmore, N. Y. is a case in point. Here, as in all school installations, Edwards' 77 years of *experience* fulfills the architect's responsibility by delivering the most efficient, trouble-free service possible.

You will find our special bulletins on signaling, protection and communication systems valuable reference aids. Send for them today.

For maximum program flexibility . . .

This 4-circuit program instrument controls signals automatically—according to predetermined schedules. If desired, signals can be operated at one-minute intervals 24 hours a day, 7 days a week!

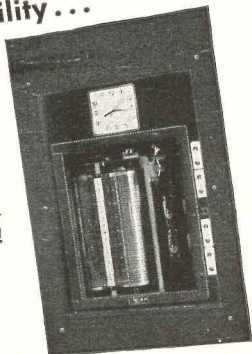
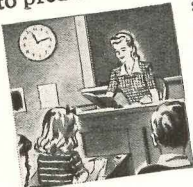

Edwards Co., Inc., Norwalk, Conn.
In Canada: Edwards of Canada, Ltd.

Electrical Signaling, Communication and Protection for Schools, Homes, Hospitals, Offices and Industry

EDWARDS

centrally-controlled
**CLOCK
SYSTEMS**

10-10-49. ELECTRICAL. YOUOUP. RUN.	47-1	JERRY P. DIMMICK	DRG. No.
10-2-49. GENERAL REVISIONS	DATE.	AREA 8007	A-3
	2-1-49	721 10. AMOD. ST.	SCALE
		BRUNSWICK H.H.	1/4"=1'-0"

ENDURING BEAUTY IN *Color*



The Ritz Carlton Hotel* Uses
PARKWOOD
Decorative
TABLE TOPS

Decorators,
Irving and
Casson,
Boston

*Boston, Mass.

Leading Establishments Everywhere Use Parkwood Decorative Wood Veneer Panels

For the last word
In New Designs,
Color and Beauty!



Parkwood Decorative offers the widest variety of decorative wood finishes.

NOW, PARKWOOD DECORATIVE PRESENTS . . .



PARKWOOD PEBBLE-TEX



PARKWOOD STARDUST

Get lasting color beauty. Save replacement costs with Parkwood Decorative . . . the colorful, carefree laminated plastic for finer furniture tops and wall panels.

Send today for complete specifications, applications and prices.

Parkwood Corporation
21 Water Street, Wakefield, Massachusetts

ARCHITECTS SPECIFY ROBERSON HEATSUM CABLE for their own radiant heated homes



Home of Mr. Clarence J. Felciano, a prominent California Architect at Santa Rosa, radiant heated throughout with ROBERSON HEATSUM CABLE.

Other Prominent architects who have radiant heated their own homes with ROBERSON HEATSUM CABLE include:

James J. Chiarelli Seattle, Wash.
Robert Gwinn Nashville, Tenn.
Paul Kirk Seattle, Wash.
Bliss Moore, Jr. Seattle, Wash.
Harry E. Nordquist Seattle, Wash.
Morgan Stedman Palo Alto, Calif.

HEATSUM CABLE

Manufactured by

L. N. ROBERSON COMPANY

1539 East 103rd Street

Seattle 55, Washington

Literature on request

for the home of airy distinction

LOUVERED DOORS
STYLED by TYLER

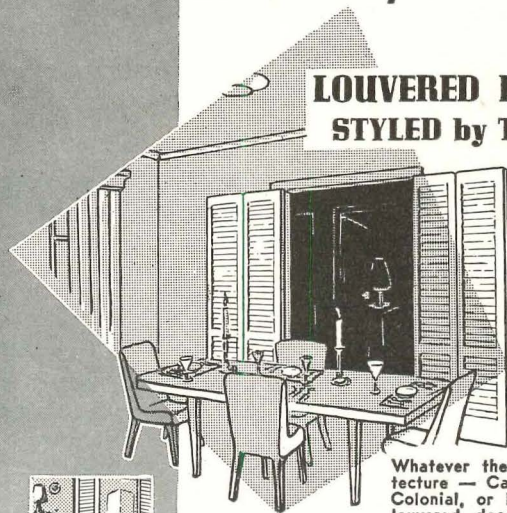

Whatever the style of architecture — Cape Cod, Ranch, Colonial, or Modern — TYLER louvered doors can heighten its appeal and give added living comfort.

For the DINING ROOM ENTRANCE . . .
distinctive grace and charm

For the BEDROOM DOOR . . .
privacy, with complete ventilation

For the SMALL EXTRA ROOM . . .
airiness as a dressing room, sewing room, or study



Write for catalog with detailed specifications of doors, blinds, & shutters styled by Tyler.

ARTHUR F. TYLER CO.

Established 1876

900 MAIN ST.

ATHOL, MASS.

Anteroom or auditorium . . .

There's a Frigidaire Air Conditioner to meet your specifications!

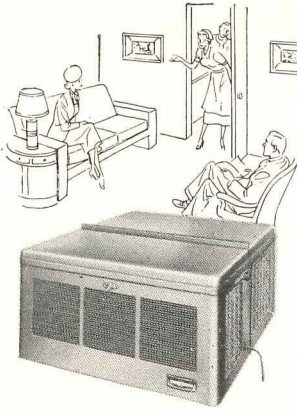

Frigidaire Room Air Conditioners

Easily installed, window-type air conditioners, powered by the famous Meter-Miser. Also floor-type models for remote installation singly or in multiple, with or without heating coil.

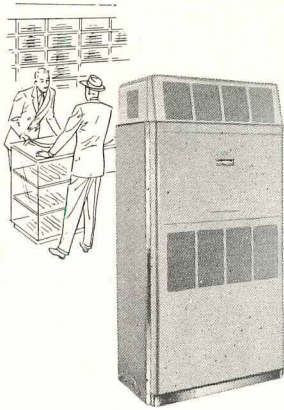

Frigidaire Self-Contained Store-Type Air Conditioners

Styled by Raymond Loewy, these handsome conditioners can be quickly installed right in the area to be conditioned. They can be used singly or in multiple, with or without heating coil.

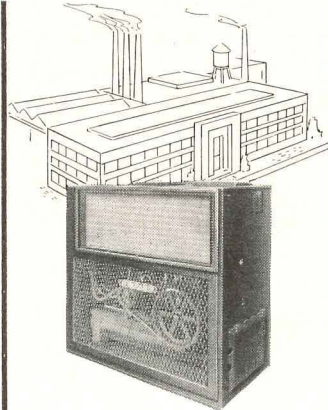

Frigidaire Heavy-Duty Self-Contained Air Conditioners

Large-capacity, self-contained units that can be quickly installed or moved. Available with evaporative condenser for use where water supply is restricted. Heating coil may be added.

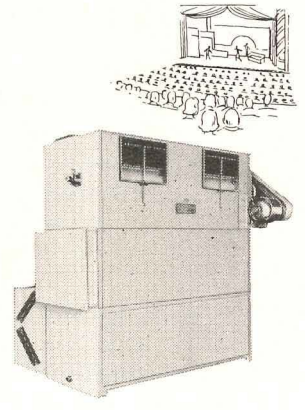

Frigidaire Central System Air Conditioners

These units are available in capacities, types and sizes to meet practically any type of air conditioning requirement. Heating coils and humidifiers are optional equipment.

Air conditioning problems are solved easily, quickly and correctly—when you specify Frigidaire. You'll find every major type of air conditioning unit in the Frigidaire line. And you'll find that each Frigidaire Conditioner has been skillfully designed for use in a wide range of applications.

You can be sure, too, of truly fine

performance. Frigidaire Air Conditioners are designed to operate at peak efficiency—with parts precision-matched to work together like a championship team. And they're built to give years and years of low-cost, trouble-free service.

For complete information about Frigidaire Air Conditioning or any of

the many other Frigidaire products for home and business, see your dependable Frigidaire Dealer. You'll find his name in the Classified Phone Directory, under "Air Conditioning" or "Refrigeration Equipment." Or write Frigidaire Division of General Motors, Dayton 1, Ohio. (In Canada, Leaside 12, Ontario.)

For detailed facts about Frigidaire Air Conditioning and other Frigidaire products, fill in and mail this coupon today.

FRIGIDAIRE



Air Conditioning

Over 400 Frigidaire commercial refrigeration and air conditioning products—most complete line in the industry

Frigidaire Division
General Motors Corporation
1380 Amelia Street
Dayton 1, Ohio

Please send me information about :

- Frigidaire Air Conditioning Frigidaire Home Appliances.
 Frigidaire Commercial Refrigeration Frigidaire Water Coolers

Name.....

Firm Name.....

City..... Zone.....

County..... State.....

Pick the wood preservative best suited for your needs

NEW DU PONT COPPERIZED CZC (Chromated Zinc Chloride)

This new, salt-type wood preservative offers all these advantages:

- LONGER-LASTING TERMITE REPELLENCE
- LONGER-LASTING DECAY RESISTANCE
 - Fire retardance
 - Cleanliness
 - Odorless
 - Safe to handle
 - Easy to paint

These six significant tests show the effectiveness of new Copperized CZC: leach block test, hardware corrosion test, accelerated service test, pilot plant treatments, strength tests and glow tests.

STANDARD DU PONT CZC (Chromated Zinc Chloride)

A favorite for many years, this time-tested wood preservative offers all these advantages:

- ECONOMICAL FIRE RETARDANCE
 - Decay resistance
 - Termite repellence
 - Cleanliness
 - Odorless
 - Safe to handle
 - Easy to paint

Regardless of what your wood preserving problem may be, we suggest consulting your nearby wood preserver. E. I. du Pont de Nemours & Co. (Inc.), Grasselli Chemicals Department, Wilmington 98, Delaware.

MAIL COUPON NOW

for complete facts about these two outstanding Du Pont wood preservatives.



BETTER THINGS FOR BETTER LIVING
... THROUGH CHEMISTRY

E. I. du Pont de Nemours & Co. (Inc.) A.R. 1
Grasselli Chemicals Department
Wilmington 98, Delaware

Please send me information on Copperized CZC and standard CZC.

Name _____ Title _____

Firm _____

Street _____

City _____ State _____

STOP

that **WATER**
with FORMULA # 640

A clear liquid which penetrates deeply into masonry surfaces.

The hydrocarbon solvent evaporates, leaving the pores filled with a balanced formula of seven different waxes and resins.

See our catalogs in SWEET'S Architectural Files $\frac{9a}{9}$ and Engineering Files $\frac{4f}{3}$ under Waterproofing and Dampproofing.

WRITE OUR ENGINEERING DEPARTMENT for office test kit, technical data, or regarding any special problem

J. Wilbur Haynes, Engineer

HAYNES PRODUCTS CO.

4007 FARNAM STREET • OMAHA 3, NEBRASKA

\$

PLANNING STORES THAT PAY

How America's outstanding stores and architects use simple but scientific new techniques to derive optimum store design from sales data and store statistics to facilitate maximum sales per square foot. Abounding in case histories. 500 illustrations.

500
ILLUSTRATIONS

This basic and comprehensive textbook, by Dr. Louis Parnes, A.I.A., covers every detail of modern stores and is applicable to the redesigning of myriads of stores now obsolete. 300 pages, 8 $\frac{3}{8}$ x 11 $\frac{1}{4}$. 80-lb. coated paper. Index. \$15.00. Use coupon.

Book Department, Architectural Record
119 West 40th Street, New York 18, N. Y.

Enclosed is \$..... for copy(s) of "Planning Stores That Pay," by Dr. Louis Parnes, A.I.A. @ \$15.00. (Add 2% sales tax for New York City delivery. Total \$15.30.)

Name _____

Address _____

City _____ Zone _____ State _____

How to catch a client's interest . . . and build greater satisfaction into homes

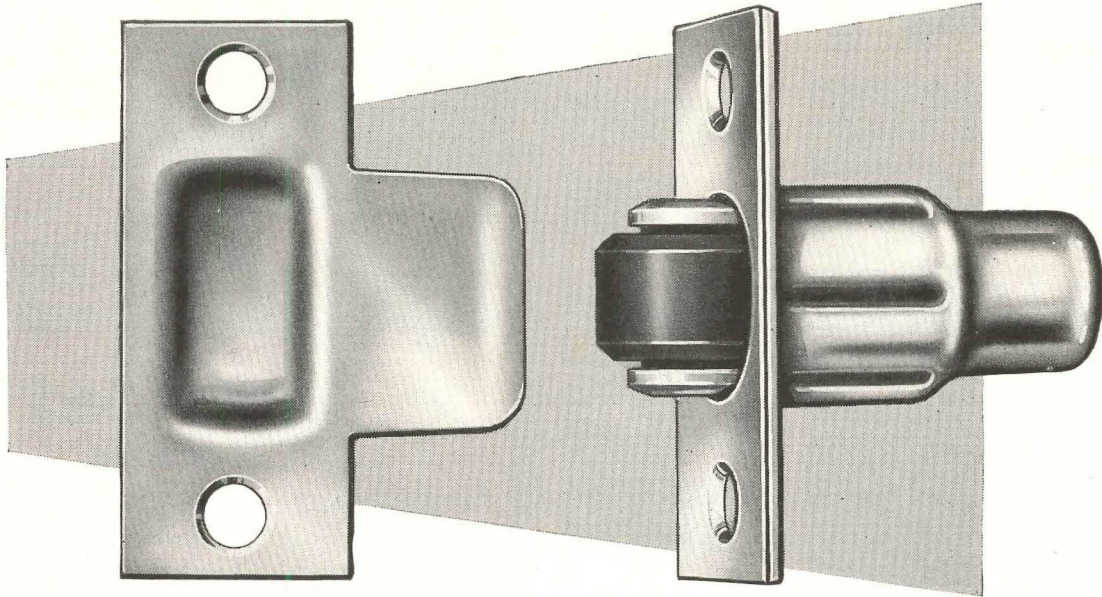

New Stanley **ROLLER CATCH** for Interior Doors

For years home buyers have wanted just such a convenience. Watch your clients' interest mount when you point out the advantages of the Stanley No. 23 Roller Catch—its smooth, silent operation . . . how it holds doors securely in closed position, and eliminates rattling.

It's the ideal catch for any interior house

door (closet, wardrobe, communicating) that does not require a lock. Case is of steel with rust-resistant finish. The strike and face-plate are furnished in standard finishes. Recommend and install the No. 23 Roller Catch, made by Stanley, a name your clients *know and trust*. The Stanley Works, New Britain, Connecticut.

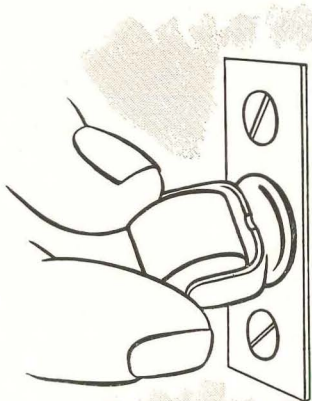

EASY TO ADJUST—No tools needed. For variance in distance between edge of door and casing, simply pull roller-plunger forward and turn with fingers. Each half-turn provides a 1/64" adjustment. Maximum adjustment 3/8".

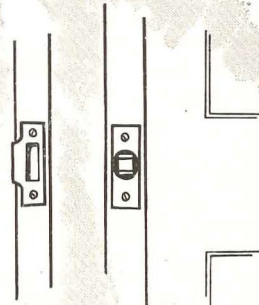

EASY TO APPLY—Simply bore a 7/8" hole, 2 3/8" deep, at desired location on the door.

STANLEY

Reg. U. S. Pat. Off.

HARDWARE • HAND TOOLS • ELECTRIC TOOLS • STEEL STRAPPING

WATER



ALWAYS
GOOD and COOL
with

fedders

ELECTRIC WATER COOLERS

● Men who design, equip, own and occupy commercial and industrial buildings appreciate the importance of providing cool drinking water. Fedders-built Electric Water Coolers have a background of satisfactory operation in every climate in every part of the world.

Men who design, equip, own and occupy commercial and industrial buildings appreciate the importance of providing cool drinking water. Fedders-built Electric Water Coolers have a background of satisfactory operation in every climate in every part of the world.

Complete Line of Popular

BOTTLE AND PRESSURE MODELS

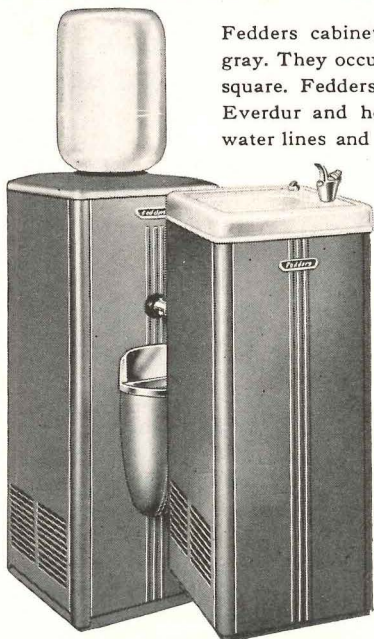

Fedders cabinets are finished in metallic gray. They occupy floor space less than 16" square. Fedders construction using Monel, Everdur and hot tin-alloy dipped copper water lines and tank meets sanitary codes.

Tested and rated in accordance with all requirements of U. S. Bureau of Standards, CS 127-45. Approved by Underwriters' Laboratories and Canadian Standards Association. Meets requirements of National Electrical Manufacturers' Association and National Board of Fire Underwriters.

Nationally distributed... write for full information.

FEDDERS-QUIGAN CORPORATION

Dept. AR-WCI BUFFALO 7, N. Y.

A Great Name Since 1896

fedders

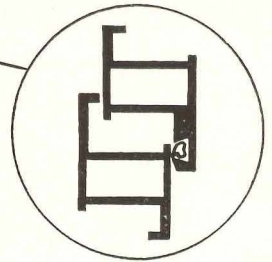
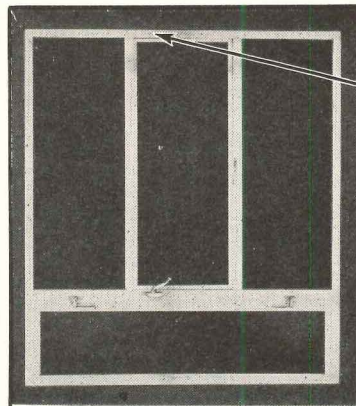

The only casing available today with metal weatherstripping, and tubular extrusions for greater strength.

SUNLIGHT ALUMINUM

- Intermediate Combination, Intermediate Projected windows for Hospitals, Schools, and office buildings.
- A Custom made, flash and Argon electric welded window, available in standard and special sizes to meet all requirements, at COMPETITIVE PRICES.
- ARCHITECTS: See our catalogue 16a/31 in Sweet's file, and send for full size installation detail.

Write Denver Office for Name of Representative in Your Territory.

SUNLIGHT METAL PRODUCTS CO.

2301 SOUTH DELAWARE

DENVER 10, COLO.



Stewart Iron Picket Fence

- Stewart Chain Link Wire as well as Plain and Ornamental Iron Fences are made in a wide range of types and sizes to cover the fencing requirements of all classes of property.

DON'T OVERLOOK STEWART
If your plans call for Iron or Wire fencing



Stewart Ornamental Iron Gates



Stewart 3TH Chain Link Wire Fence

In addition to fence, Stewart produces many other products for the protection and beautification of residential and industrial property. If you do not have a complete file of Stewart Catalogs, we suggest you write for them.

Stewart IRON and WIRE FENCES

THE STEWART IRON WORKS CO., INC.
1677 Stewart Block
CINCINNATI 1, O.
Experts in Metal Fabrications since 1886

NOW THE NEW Anthra-Flo FOR NEW HOMES



LOW COST

—competitively priced . . . meets all requirements for low cost housing.



BURNS CHEAPER SIZES OF ANTHRACITE

—pays for itself in fuel savings. Built-in tankless coil supplies low cost hot water.



FULLY AUTOMATIC

—coal feeds direct from bin . . . ashes discharge by gravity into container within unit.

RATINGS

—Model C-1, Steam 325 sq. ft.
Hot Water 515 sq. ft.
Model C-2, Steam 550 sq. ft.,
Hot Water 880 sq. ft.



ATTRACTIVE APPEARANCE

—jacket finished gleaming white and red enamel on steel.

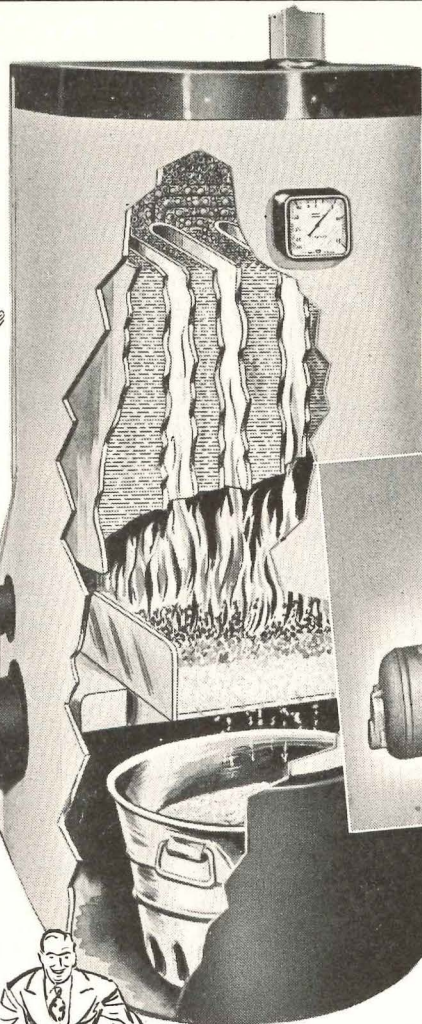

Completely Automatic Anthracite Boiler-Burner Unit

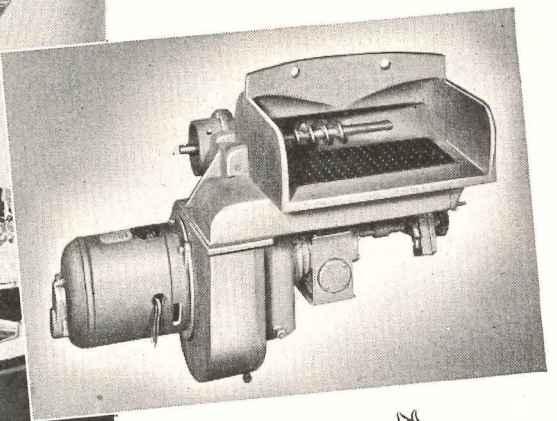

NEW PRINCIPLE

—featuring a new method of feeding and burning anthracite across a single, stationary, perforated plate. Burner and mechanism is attached by two bolts and all working parts are outside boiler.

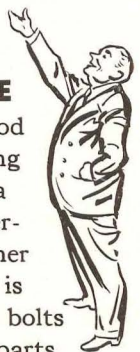

Dealerships Available—Write to Anthracite Institute for complete information about the "ANTHRA-FLO" and the names of the manufacturers who now have units available. Get details of the attractive dealer franchise plan for this exclusive type, low priced automatic heating unit.



ANTHRACITE INSTITUTE

101 Park Avenue • New York 17, New York

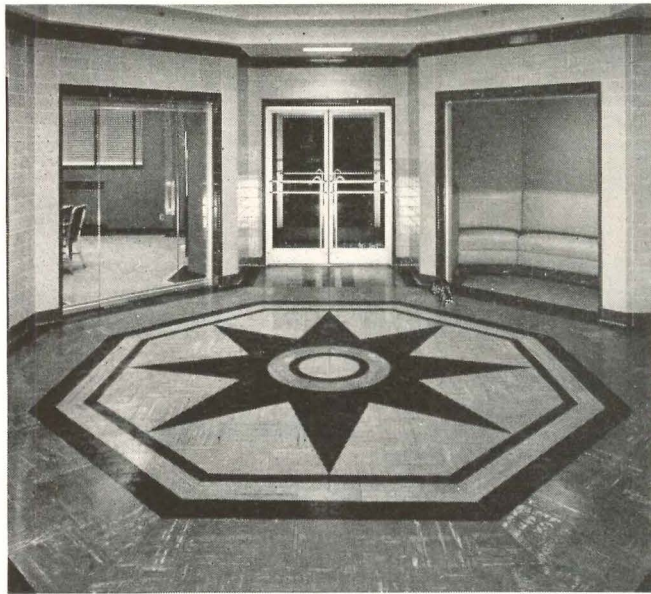

This Moultile floor makes a dramatic entrance at Radio Station KWK, St. Louis, Mo. RUSSELL, CROWELL, MULLGRADT & SCHWARZ, Architects

DESIGN YOUR FLOORS FOR DRAMATIC INTEREST ... starring Moultile

Here's freedom to design as you please! Here's a floor material that gives unfettered scope to your creative imagination. Laid tile by tile, Moultile enables you to employ all kinds of special patterns without resorting to costly special fabrication.

And the colors! Cool greens, clear blues, rich browns, stirring reds, satiny black . . . all deep-toned and true . . . all available with Thos. Moulding's characteristic crisp, distinct veining.

What you gain in floor beauty you also *keep* in Moultile's lasting durability. There's a toughness to Moultile that takes year after year of hard wear without visible effect. Moultile has ample firmness to resist indentation and strength to withstand subfloor vibration. Yet it is pleasantly buoyant underfoot, quiet and non-slippery. With all its virtues, the low cost of Moultile will come as a pleasant surprise to you . . . and to your clients. Write today for new color chart to: THOS. MOULDING FLOOR MFG. Co., 165 W. Wacker Drive, Dept. AR-7, Chicago 1, Ill.



Moultile
Flexible-Reinforced MASTER ASPHALT TILE

When it comes to FLOORS... come to

THOS. MOULDING

EMPLOYMENT OPPORTUNITIES AVAILABLE

Advertising rates on request

Positions Open

PROGRESSIVE LONG ESTABLISHED OFFICE: whose practice includes educational, hospital, church, and commercial work has immediate need for experienced architect or senior architectural draftsman, age around 35 to 45. Permanent position opportunity. State education, experience record, availability, salary and family status. Jameson & Harrison, Madison Theater Building, Peoria, Illinois.

WANTED: Good architectural designer-draftsman, someone who has had several years' experience in good offices after graduation from college. Position to be in one of the larger southern offices. Submit samples of recent work and give full particulars as to education and experience, with monthly salary desired. All replies will be treated strictly confidential. Box 422, *Architectural Record*, 119 W. 40th St., New York 18.

WANTED: Experienced architectural-draftsman, also experienced architectural-structural engineering draftsman, should be college graduate with several years' experience in good offices. Position to be in east central Oklahoma city. Submit print samples of recent work and give full particulars as to education and experience, with monthly salary desired. All replies will be held strictly confidential. Box 423, *Architectural Record*, 119 W. 40th St., New York 18.

Positions Sought

ARCHITECTURAL DESIGNER: Yale graduate with 15 years unusual experience in architecture and building construction. Excellent references. Seeks greater responsibility and future participation as principal with commensurate salary. Location North East. Box 424, *Architectural Record*, 119 W. 40th St., New York 18.

STRUCTURAL DESIGN WORK: in New York City Metropolitan area sought by experienced licensed professional engineer on a fee or hourly basis. Box 426, *Architectural Record*, 119 W. 40th St., New York 18.

For Sale

ARCHITECT'S OFFICE FOR SALE: Due to health, Architect will sell long, well established office and extensive practice in fast growing city which is capital of Western State. Practice consists of commercial, state, city, school, and industrial projects. An excellent opportunity for one or two architects with good training and ample experience. \$4,000 down and \$800 per year for five years. For further information write Box 425, *Architectural Record*, 119 W. 40th St., New York 18.

Prefabrication in Building

by RICHARD SHEPPARD, F.R.I.B.A.

No builder or architect who is seeking ways to economize on house construction can afford to miss this valuable guide — 148 pages printed in large clear type on heavy coated paper, well indexed and illustrated with 163 excellent photographs and diagrams. \$5.50 per copy.

Book Department, *Architectural Record*
119 West 40th Street, New York 18, N. Y.

I enclose \$..... Send me..... copy(s) of "PREFABRICATION IN BUILDING," by Richard Sheppard at \$5.50 per copy. (Add 2% Sales Tax for New York City delivery — \$5.61 in all.)

Name.....

Address.....

City..... Zone..... State.....



... a Moulding Kit

in Pittco Premier Store Front Metal

● The new basic mouldings in the Premier line of Pittco Store Front Metal may be truly called a Moulding Kit. They may be combined in a wide variety of attractive patterns, giving the architect fresh style and beauty, and great variety in design to help in the creation of distinctive, sales-winning store fronts.

Shown here with the same head and drip members are three of the many designs which may be formed with these new shapes. Cross sections of some of the new mouldings are shown at left.

Most of the shapes in the Premier Moulding Kit are interchangeable and may be used both horizontally and vertically. They make it easy to design several adjacent store fronts, giving each a distinctively different appearance through the proper selection and arrangement of mouldings.

This convenient Moulding Kit of Pittco Premier Store Front Metal, is another result of "Pittsburgh's" constant research, aimed at helping you solve architectural and building problems encountered in the field.

BASIC SHAPES OF MOULDING KIT (1/2 SIZE)

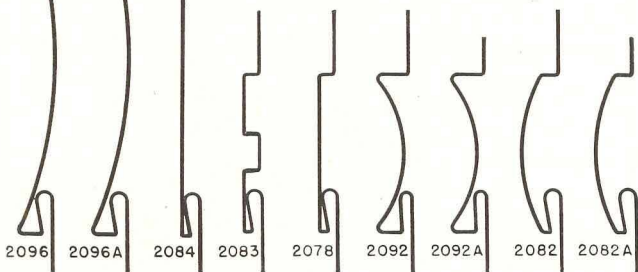

PITTCO STORE FRONT METAL

PAINTS • GLASS • CHEMICALS • BRUSHES • PLASTICS



PITTSBURGH PLATE GLASS COMPANY

New Efficiency Idea!

Rotary^(R)
LEVA-DOCK
SELF-LEVELING RAMP
FOR LOADING DOCKS



Leva-Dock moves up and down with truck bed level

Leva-Dock Permits Fast Direct Loading

Loading and unloading trucks and trailers presents a tough loading dock problem because (1) truck bed heights vary as much as 12 inches, and (2) the truck bed moves down or up as loading and unloading progresses. This problem has been made very serious by the use of platform and fork-lift trucks handling heavy unit loads.

The Leva-Dock makes it possible to load directly into or unload from all types of trucks or trailers . . . without using steel plates, bridge ramps, or other slow and frequently dangerous methods. Installation is simple and inexpensive.

Write for architect's data file
Rotary Lift Co., 1008 Kentucky, Memphis 2, Tenn.

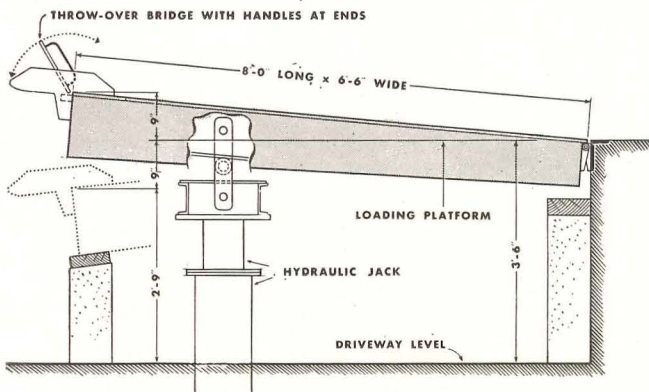

How the Leva-Dock Operates

The Leva-Dock is a hinged ramp, positioned by a hydraulic jack. Supporting arms and "throw-over" bridge connect ramp and truck bed. Platform automatically travels up or down as truck springs are relieved or compressed during loading and unloading.

Now off the press

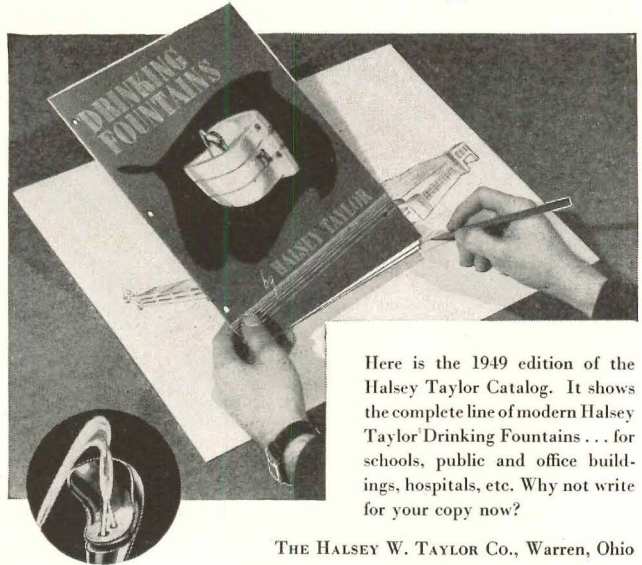

Here is the 1949 edition of the Halsey Taylor Catalog. It shows the complete line of modern Halsey Taylor Drinking Fountains . . . for schools, public and office buildings, hospitals, etc. Why not write for your copy now?

THE HALSEY W. TAYLOR Co., Warren, Ohio

Halsey Taylor

DRINKING FOUNTAINS

A-3

**SPEED CONSTRUCTION,
REDUCE COST
WITH ZONOLITE* VERMICULITE PLASTER**



LIGHTWEIGHT
sticks better,
fewer droppings



NOT BRITTLE
absorbs shock
and impact



LESS SETTLEMENT
eliminates source
of many cracks

**Only ZONOLITE Plaster Gives ALL
These Extra Advantages:**

- Three times lighter than ordinary plaster.
- Four times more fire resistant than ordinary plaster.
- Resists chipping and cracking.
- Fireproofs steel columns, beams, etc.
- Applies easier—less tiring to workmen.
- Ends plasterer's biggest headache—the frozen sand pile.

For FREE information about Zonolite Plaster, write to Dept. AR-79.



ZONOLITE COMPANY
135 South LaSalle Street
Chicago 3, Ill.

*Zonolite is a registered trademark of Zonolite Company

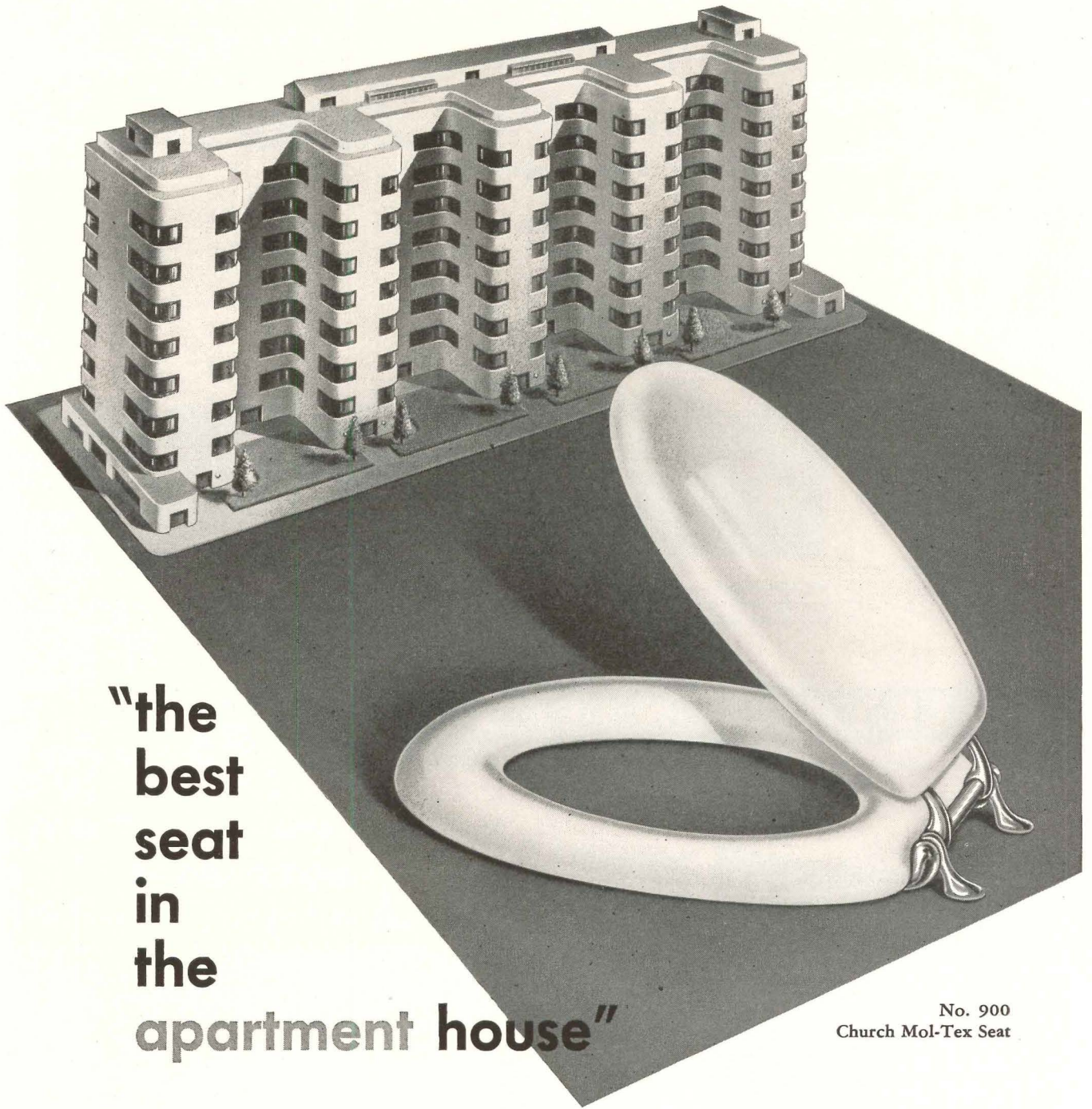

**"the
best
seat
in
the
apartment house"**

No. 900
Church Mol-Tex Seat

To the architect who measures value in terms of years of service rather than first cost, the wisdom of choosing quality is obvious.

Church Seats are made better . . . to last longer and to cost less per years of service.

Church Seats

C. F. CHURCH MFG. CO. HOLYOKE, MASS.

DIVISION OF AMERICAN RADIATOR & STANDARD SANITARY CORPORATION



Treat Floors Right... WITH HILLYARD Treatments!

★ **SPECIFY HILLYARD'S HI-QUALITY PRODUCTS** and you will be assured that one of our Floor Treatment Maintainers will be on hand to supervise application assuring a Class A job. This Nation-Wide Service costs you nothing and it saves a great deal of time ★ Hillyards manufacture Quality Products for every type of flooring installation. These Quality Products do an outstanding job and will constantly make you proud of their appearance.

SPECIFICATION FILE
FREE to all architects and specification writers—a new condensed file on all types of floors.

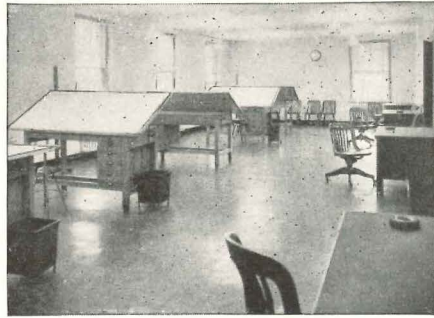

MAINTAINERS—a group of expertly trained men that know answers to vexing floor problems. Give them a chance to help you.

FLOORS 25G
FINISHING AND TREATMENTS

For Hillyard Personal Supervision ★

AIA Specifications

WOOD FLOORS... LINOLEUM... LINO TILE
TERRAZZO... TILE, QUARRY TILE
D.D. TERRAZZO... CERAMIC, FAIENCE
CEMENT FLOORS... AND STIPPLED TILE
MAGNETITE... BOWLING ALLEYS...
ASPHALT TILE...

HILLYARD SALES COMPANIES

470 Alabama St. San Francisco 10, Calif. **DISTRIBUTORS HILLYARD CHEMICAL CO. ST. JOSEPH, MO.** BRANCHES IN PRINCIPAL CITIES 1947 Broadway New York 23, N. Y.

Only **TRADE-WIND**
MAKES THE
CLIPPER
CEILING VENTILATOR



- ... better 5 ways because —
1. Mounts in ceiling directly above stove — instantly catches heat, grease and odors as they rise.
 2. Only an inconspicuous "dripless" ceiling grille is visible, yet unit easily installed.
 3. Powerful squirrel-cage blower (not a fan!) creates fast-moving stream of air to do job efficiently.
 4. Because of patented construction which isolates motor from greasy air stream, unit guaranteed 5 years.
 5. Available everywhere. Stocked by dealers coast to coast.

See Sweet's A. I. A. File 30-D-1 or mail coupon.

Trade-Wind Motors, Inc.
5707 S. Main St., Los Angeles 37, Calif.

Name _____

Address _____

New Electric Freight Elevator is Self-Supporting Inexpensive to Install

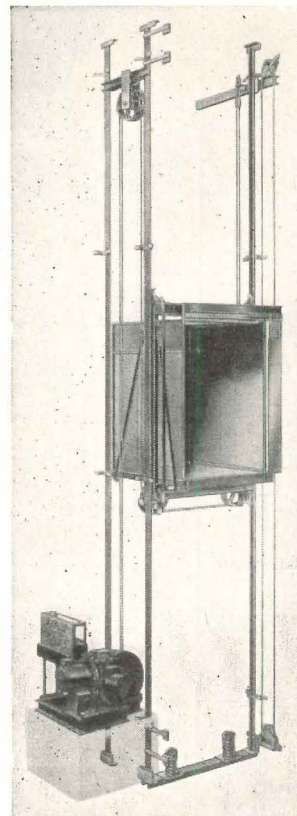

A new self-supporting elevator has been designed to provide a low-cost, electric elevator installation for every type of business and institution that requires vertical freight transportation, but does not need heavy-duty freight elevators. It fills a long-felt need by making materials handling considerably easier and less costly for small business. The elevator is being made in three standard sizes of 1,500, 2,000 and 2,500 pounds capacity. Vertical rise is limited to 35 feet—sufficient for a three story building.

As illustrated, the elevator is installed as a complete unit in a new or existing hoistway. Only 11 feet of headroom is needed above the top floor landing. Expensive construction, such as a penthouse on top of the building for the electric motors and other operating machinery, overhead supports, roof alteration and building reinforcement, is eliminated. As the elevator supports itself, no heavy strain is placed on the building. The weight of car, load, hoist ropes and sheaves is carried by three guide rails in the hoistway and transferred to the bottom of the shaft. The elevator can be operated by any employee without special training. For complete details, write for Bulletin B-720F. Address: Otis Elevator Company, 260 11th Avenue, New York 1, N. Y.



Helps safeguard lives and property when normal electric current fails

In stadia, recreational buildings, theaters and other places of public assembly, sudden lighting failure may have tragic consequences. This is equally true of hospitals, schools, stores . . . wherever crowds gather at night.

Such lighting failures are not uncommon. They can happen anywhere, at any time. For, despite all precautions of utility companies, accidents beyond their control can cause interruptions of normal electric current. Storms, floods, fires and collisions occur with little or no warning, and are a serious menace to electric power lines.

Safeguard the buildings you design against lighting failure. Exide Emergency Lighting provides safe, sure, modern protection. Batteries are always fully charged and respond *instantly* and *automatically* when needed.

1888 . . . DEPENDABLE BATTERIES FOR 61 YEARS . . . 1949

"Exide" Reg. Trade-mark U. S. Pat. Off.

THE ELECTRIC STORAGE BATTERY COMPANY, Philadelphia 32 • Exide Batteries of Canada, Limited, Toronto

Transparent Mirrors

... an opportunity to do **SOMETHING DIFFERENT**

Let your imagination go on the use of this unique glass. It enables you to provide a glass area that is either a mirror or a transparent window or partition. You change it from one to the other with the flick of a light switch. Here's how it works:

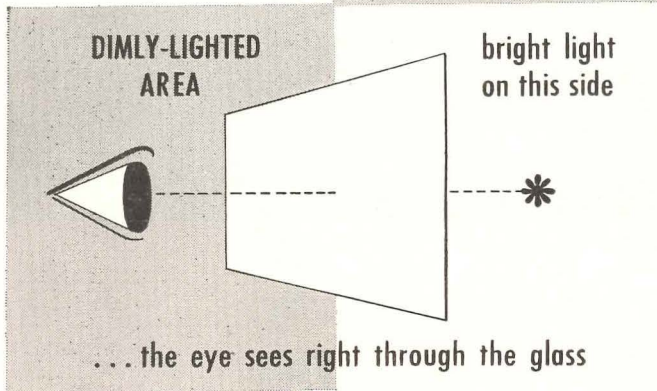
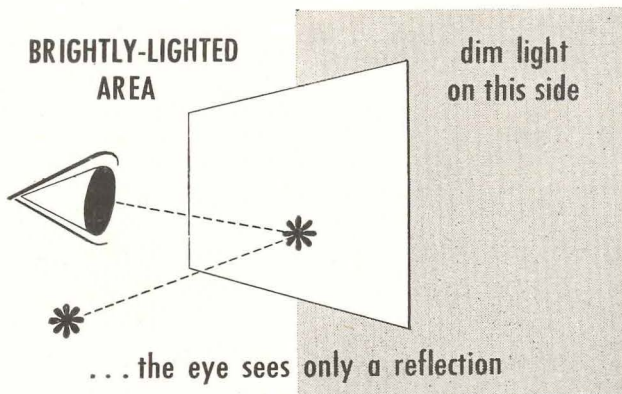

Already this unusual glass is being used for both practical purposes and purely decorative effects in hotels, theaters, restaurants, stores, mortuaries and homes. Sizes up to 30" x 60" available. Write for our folder that describes its function and shows examples of uses. Liberty Mirror Division, Libbey-Owens-Ford Glass Company, 6979 Nicholas Building, Toledo 3, Ohio. *T.M.

Mirropane*
TRANSPARENT MIRROR

LIBERTY MIRROR DIVISION
Libbey-Owens-Ford Glass Company

Here's Your **GUIDE TO BETTER LIGHTING**

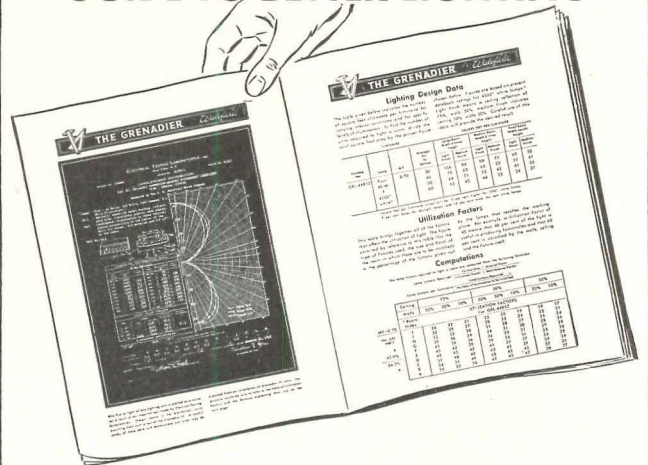

A factually written, fully illustrated 36-page catalog showing the complete Wakefield line of fluorescent and incandescent lighting equipment—with photographs, working drawings, design data and distribution curves. Write for your copy today.

THE F. W. *Wakefield* BRASS COMPANY
VERMILION, OHIO

J&C's the daisy!

... for your warm air heating problem

WHETHER it's an application of a *ceiling type or floor type unit*, or ...

WHETHER it's an application for *residential, commercial or industrial type building* or ...

WHETHER it's an application for *gas, oil or coal firing*, J&C has over 100 models from 52,500 to 3,800,000 Btu output. Write us today.



*Trademark Registered
U. S. Patent Office

A Product of
JACKSON & CHURCH COMPANY
Saginaw, Michigan



SCHOOLS . . .

A centralized sound system for announcements and bulletins, distribution of radio programs, educational recordings . . . to any or all rooms of a school.



HOTELS . . .

Voice-paging, entertainment in guest rooms and dining rooms, emergency announcing facilities.



DEPARTMENT STORES . . .

Music broadcasts, merchandise announcements, administrative control.



AIRPORTS and TERMINALS . . .

Voice-paging, announce system, entertainment, dispatching.

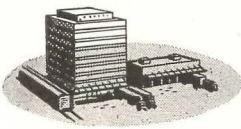

WAREHOUSES and GARAGES . . .

Traffic control, dispatching, voice-paging.

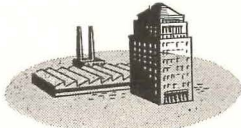

FACTORIES and OFFICES . . .

Voice-paging, work music from records or radio, news broadcasts, management talks, emergency control . . . plant-wide or at selected areas.

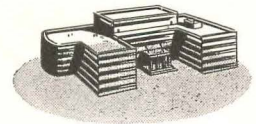
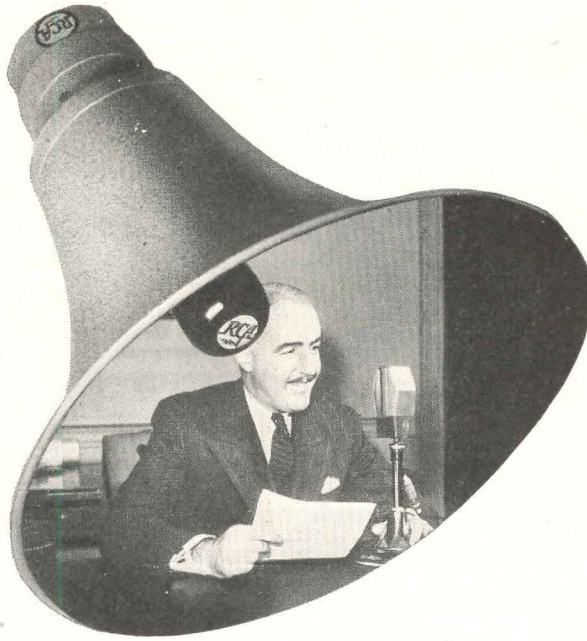

HOSPITALS . . .

Voice-paging, emergency announcements, convalescent entertainment, musical therapy.



AUDITORIUMS . . .

Complete sound distribution to all parts of the auditorium.



RECREATIONAL CENTERS . . .

Crowd and traffic control announcements, entertainment.

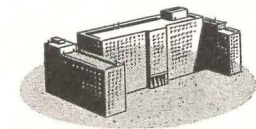

INSTITUTIONS . . .

Voice-paging, administrative control, entertainment, emergency control.



CHURCHES . . .

Complete sound distribution, belfry broadcast equipment.

RCA Plans and Engineers Sound Systems

...for every type of building

PRACTICAL HELP FOR ARCHITECTS. No matter what size or type of job you have on your drawing board, RCA will plan and engineer a sound system that will fit your architectural plan. Call upon RCA sound engineers to assist you with your sound system planning and specifications. No obligation, of course.

Contact your nearest RCA Sound System distributor or write: Sound and Visual Products, Dept. 3-G, RCA, Camden, New Jersey.

ORDER YOUR COPY NOW!

The Architects' Manual of Engineered Sound Systems

The most authoritative work book and reference manual published on sound systems. Typical plans and specifications for all types of buildings. 288 pages. Price \$5.00 (\$5.50 foreign).



SOUND PRODUCTS
RADIO CORPORATION of AMERICA
ENGINEERING PRODUCTS DEPARTMENT, CAMDEN, N.J.

In Canada: RCA VICTOR Company Limited, Montreal

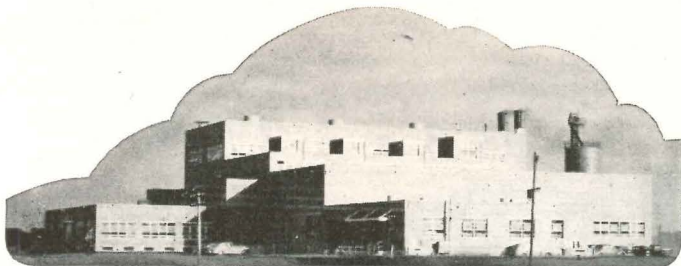

BIG NEW DAIRY PRODUCTS PLANT EQUIPPED WITH Frick Refrigeration

The M & R Dietetic Laboratories, Inc. will manufacture SIMILAC, the well-known baby formula, and TEN-B-LOW, a concentrate for making ice cream in the home, in their new plant at Sturgis, Michigan.

A complete Frick refrigerating system serves the great plant. Temperatures range from 10 deg.

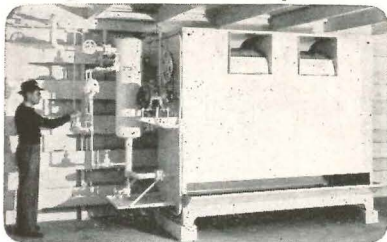

Frick Unit Cooler in One of the Freezer Storage Rooms

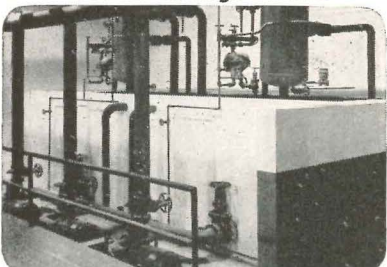

Cold Water Tanks, with Pumps and Ammonia Control Equipment

below zero to 40 above. Features of the cooling system are steam drive for two of the compressors, a booster compressor for low-temperature work, and two cold water tanks arranged for storing refrigeration by freezing ice on the pipe coils.

For that special cooling problem of yours, look to



Frick 11" by 10" Ammonia Compressors, with Steam Engine Drives

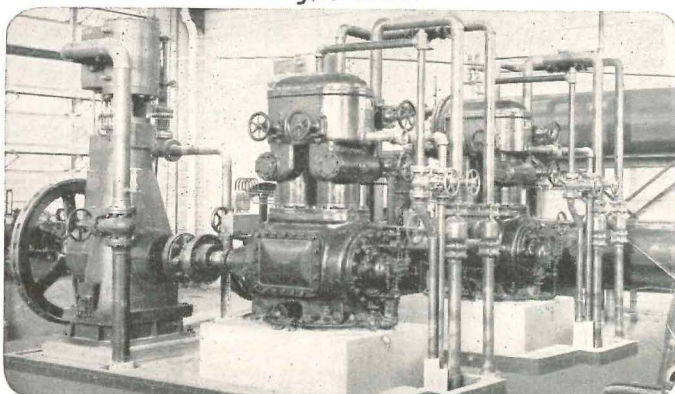

LONE STAR CEMENTS

COVER EVERY
CONSTRUCTION NEED

LONE STAR PORTLAND CEMENT

for concrete of outstanding quality in all types of construction

'INCOR' 24-HOUR CEMENT

America's FIRST high early strength Portland Cement — saves time, cuts costs

LONE STAR MASONRY CEMENT

The modern masonry cement, for really great job performance

*Reg. U. S. Pat. Off.

LONE STAR CEMENT CORPORATION

Offices: Albany • Birmingham • Boston • Chicago • Dallas • Houston
Indianapolis • Jackson, Miss. • Kansas City, Mo. • New Orleans • New York
Norfolk • Philadelphia • St. Louis • Washington, D. C.

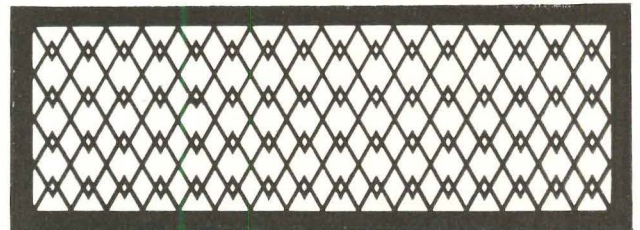

A Hendrick grille design (M No. 9) suitable for use with deflecting unit in Bulator combination

The Perfect Combination of a deflecting unit and ornamental grille

Now you can secure all the advantages of an adjustable deflecting vane grille — to control air flow — and an ornamental grille — to harmonize with the decorative scheme — by specifying the new dual-unit Hendrick BULATOR.

For this combination of deflecting unit and ornamental grille there's a wide selection of Hendrick ornamental grille designs which have ample open area so the air throw and spread are not appreciably affected. Write for full information.



Perforated Metals
Perforated Metal Screens
Architectural Grilles
Mitco Open Steel Flooring,
"Shur-Site" Treads and
Armorgrids

HENDRICK
Manufacturing Company
38 DUNDAFF STREET, CARBONDALE, PA.
Sales Offices in Principal Cities

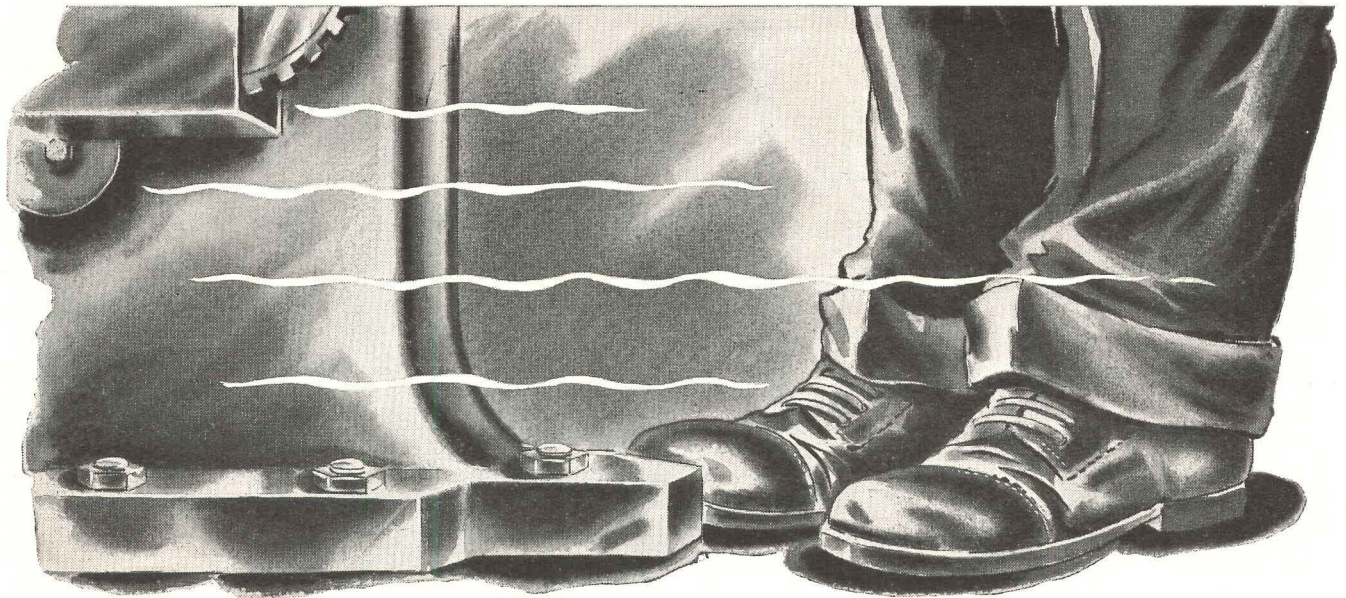

employee heating comfort is
measured "by the FOOT."

When it comes to keeping employees comfortable and at top efficiency, one Btu below the knees is worth 100 above the head. That's why it is good business to insist on

DRAVO *Counterflo* HEATERS

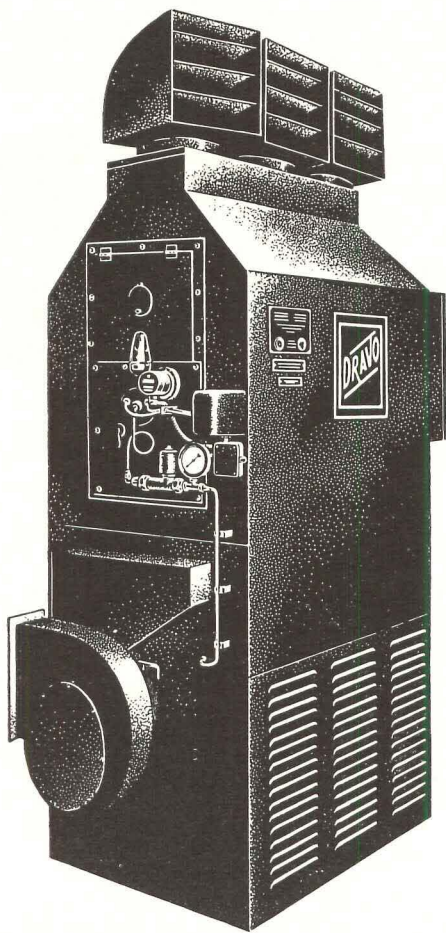

Dravo *Counterflo* Heaters banish floor chills; each unit blankets from 4,000 to 20,000 square feet of working area with warmth. The recirculation principle of Dravo *Counterflo* Heaters tends to hold the warm air at the working level, thus reducing roof heat loss and saving fuel dollars. Air throw 100-150 feet; no ducts needed for open areas. Users report first cost 50 to 66% less than wet-type systems. No fuel worries; oil or gas-fired, readily converted from one to other. 80-85% efficiency. Units furnish ventilating air in summer. Immediate deliveries, easy installation. Ask for Bulletin EG-523-57.

DRAVO
CORPORATION
DRAVO BUILDING, PITTSBURGH 22, PA.

Dravo also manufactures the DRAVO CRANE CAB COOLER for air conditioning hot-metal crane cabs.

PITTSBURGH • CLEVELAND • PHILADELPHIA • DETROIT • NEW YORK • CHICAGO • ATLANTA • BOSTON

Sales Representatives in Principal Cities. Mfd. and Sold in Canada by Marine Industries, Ltd., Sorel, Quebec.



CENTURY

The New Dramalite[®] is a simple, functional, carefully engineered lighting instrument for commercial or domestic applications.

- a...The functional form housing is designed to accommodate general service lamps as well as the PAR-38 and R-40 lamps, including the longer R-40 with the skirted base.
- b...A simple concealed swivel joint permits turning the light 115° from the vertical, while the base rotates a full 360°. This permits a maximum directional control never before attained in similar types of fixtures.
- c...The new egg-crate louver and color filter holder, available as an extra (\$3.00 list) gives positive cut-off at 45°, a feature unobtainable in comparable existing fixtures.
- d...The rotating base fits over any standard outlet box in either the wall or ceiling.

The New Dramalite is available in a variety of pendant, portable and flexarm models.

NEW DRAMALITE NO. 942 \$9.50 LIST U. S. PATENTS PENDING

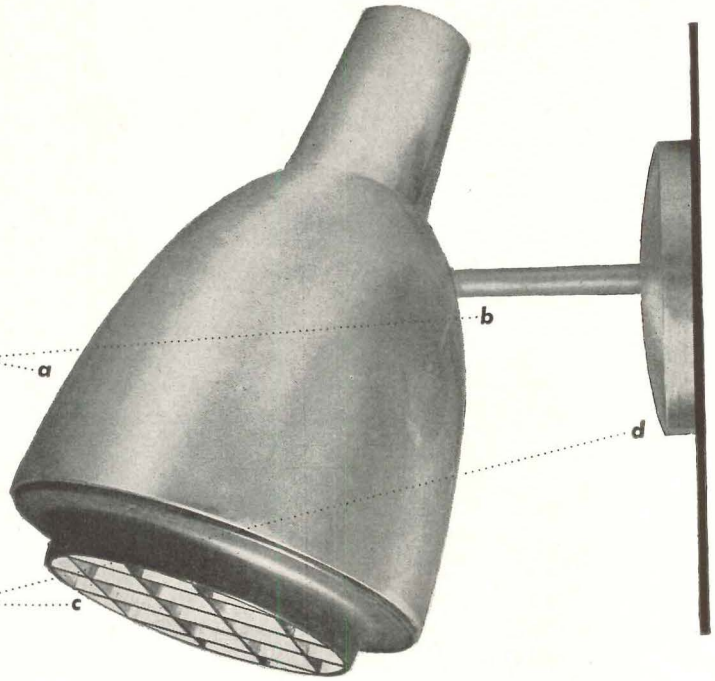

CENTURY LIGHTING INC 419 WEST 55 ST., NEW YORK 19, N. Y.
626 N. ROBERTSON BLVD., LOS ANGELES 46, CAL.

In Hospitals
For Sanitary and Germ Proof
Bath Tub Edges — **Specify Lucke**

Leak-Proof Bath-Tub Hangers

No Leaks • No Cracks • No Repair Expenses

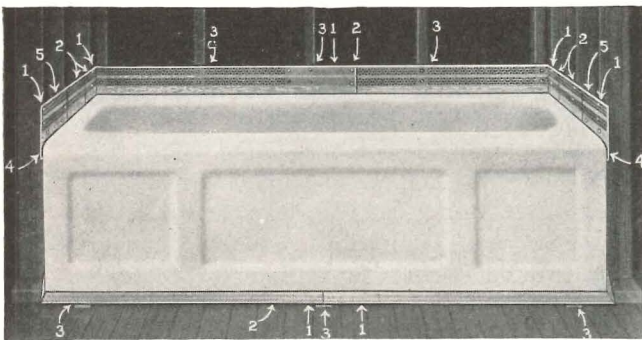

The Modern Way to Prevent Leaks

There is no excuse for cracks or leaks or repair expense in good building. Leading architects specify LUCKE to overcome this problem. Lucke Hangers build tubs into wall.

**Sold by Leading Plumbing
Supply Houses**

MANUFACTURED BY

W. B. LUCKE, Inc.

Wilmette

Illinois



Are you specifying
the **RIGHT CEMENT**
FOR THE JOB?

Reg. U. S. Pat. Off.

MEDUSA "JOB-FITTED" CEMENTS

- MEDUSA WATERPROOFED GRAY**
Produces concrete that repels water at the surface.
- MEDUSA WHITE**
Gives a beautiful white or colorful tinted effect.
Widely used for stucco.
- MEDUSA WATERPROOFED WHITE**
Unsurpassed for a sparkling white water-resisting surface.
- MEDUSA BRIKSET**
Gives a beautiful finish for brick mortar.
- MEDUSA "MEDCO" HIGH EARLY STRENGTH**
Prepared for rush jobs and cold weather construction.
- MEDUSA AIR-ENTRAINING PORTLAND CEMENT**
Protects driveways and sidewalks against the scaling action of salt.
- MEDUSA STONESET**
A non-staining waterproofed cement for laying up stone and face brick.

For further information on any of these cements, simply check this ad, attach to your business letterhead and mail to us.

MEDUSA

PORTLAND CEMENT CO.

1015 Midland Bldg. • Cleveland 15, Ohio

FIFTY-SEVEN YEARS OF CONCRETE PROGRESS



Foiled--

**It's Perfectly Matched Roddiscraft
Hardwood Plywood**

"No two thumbprints have identical whorls," says the sleuth. No two trees have identical grains either. That's why Roddiscraft careful cutting, classifying and matching of flitches is so important to architects who seek round-the-room continuity of grain and color.

Roddiscraft performance measures up to the promise of the sample. When you insist on Roddiscraft Hardwood Plywood for your job — that's one less worry for you. Roddiscraft Hardwood Plywood panels may be obtained in any design made to your specifications in any wood — domestic or foreign — selected for color, figure and continuity.

Ask your Roddiscraft representative to show you samples — he is always ready to give you full cooperation on any installation problem.

Roddiscraft warehouses throughout the nation can supply matched panels in many woods from stock.

Quality • Economy Roddiscraft Dependable Service

Cambridge 39, Mass.....	229 Vassar St.
Charlotte, N. C.....	123 E. 27th St.
Chicago 32, Ill.....	3865 W. 41st St.
Cincinnati 2, Ohio.....	457 E. Sixth St.
Dallas 10, Texas.....	2800 Medill St.
Detroit 14, Mich.....	11855 E. Jefferson St.
Kansas City 3, Kan.....	35-53 Southwest Blvd.
L. I. City, N. Y.....	Review & Greenpoint Ave.
Los Angeles 11, Calif.....	2860 E. 54th St.
Louisville 10, Ky.....	1201-5 S. 15th St.
Marshfield, Wis.....	115 S. Palmetto St.
Milwaukee 8, Wis.....	4601 W. State St.
New York 55, N. Y.....	920 E. 149th St.
Philadelphia, Pa.....	Pier 5, N. Delaware Ave.
Port Newark 5, N. J.....	103 Marsh St.
St. Louis, Mo.....	4453 Duncan Ave.
San Antonio, Texas.....	727 N. Cherry St.
San Francisco 24, Calif.....	345 Williams Ave.

Warehouses from Coast to Coast

Roddiscraft

RODDIS PLYWOOD CORPORATION

MARSHFIELD • WISCONSIN

CASTELL



World's
Finest
DRAWING
PENCIL

18 degrees 7B to 9H

Still at
Pre-war Price
15¢ ... less in quantity
A NAME FAMOUS
SINCE 1761

AW. FABER-CASTELL
PENCIL COMPANY INC., NEWARK 4, N.J.

Recognized Everywhere!

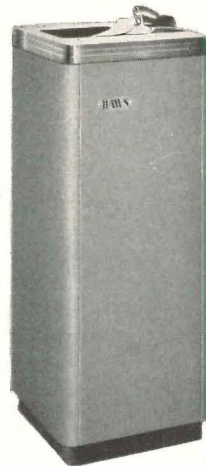

- Best Materials
- Finest Workmanship
- Trouble-free Valves and Fittings
- Complete Sanitation

Specify HAW'S—and be sure!

IT'S HAW'S FOR HIGHEST QUALITY

Write today for '49 HAW'S Catalog.

HAW'S SANITARY DRINKING FOUNTAINS
ELECTRIC WATER COOLERS

HAW'S DRINKING FAUCET CO.

1441 FOURTH STREET (Since 1909) BERKELEY 10, CALIFORNIA

Agents and Sales Representatives in All Principal Cities



Design 5162



A CUTLER MAIL CHUTE should be specified for every eligible office building, public building, hotel, apartment and hospital.

Cutler Mail Boxes are available in our standard design, as illustrated, or your own design.

Catalog in Sweet's

ESTABLISHED 1883

Cutler Mail Chute Co

ROCHESTER 7, N. Y.

Let's look it up!

Theatres and Auditoriums

by Harold Burris-Meyer & Edward C. Cole

(PROGRESSIVE ARCHITECTURE LIBRARY)



This new book shows the architect where to start and what steps to take in what order when planning any type of theatre or auditorium and covers: Traffic, Seeing, Hearing, Lighting, Acoustics, Power, Heat, Air Conditioning, Plumbing, Machinery, Orchestra, Acting Area, Backstage, Scenery, Service Rooms, Economics, Schools, Churches, Hospitals, Public Buildings, Etc.

230 pages • 9 x 12 • 300 photographs and illustrations • \$8.00

Shops and Stores . . .

by Morris Ketchum, Jr.

(PROGRESSIVE ARCHITECTURE LIBRARY)

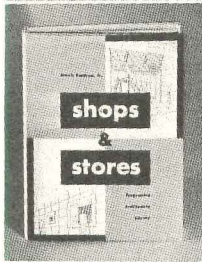

Combining outstanding illustrations and photographs with easy-to-understand language, the author discloses the formula for effective store planning. Successively he treats the various factors involved in designing and constructing a store: plans, equipment, materials and structure, store fronts, typical large and small shops and stores, economics, and shopping environment.

310 pages • 9 x 12 • illustrated • \$10.00

Hospitals

Integrated Design

by Isadore Rosenfield

(PROGRESSIVE ARCHITECTURE LIBRARY)



Covers: Planning, Functional Elements; The Nursing Unit; Diagnostic and Therapeutic Facilities; Laboratories; Operating, Maternity, Pediatric, Outpatient and Service Departments; Special Hospitals; The Small Hospital; Housing and Training Facilities; Daylighting; Artificial Illumination; The Mechanical Plant; Construction and Cost.

308 pages • 9 x 12 • illustrated • \$10.75

Apartment Houses . .

by Joseph H. Abel & Fred N. Severud

(PROGRESSIVE ARCHITECTURE LIBRARY)



Architectural design; landscaping; structural engineering; mechanical equipment; use of concrete, steel and wood framing; heating and ventilating, vertical transportation and cost analysis are among the subjects covered in this outstanding book.

280 pages • 9 x 12 • 400 illustrations • \$10.00

Architectural Practice

by Clinton H. Gowgill & Ben John Small



The professional, business and legal aspects of architectural practice are traced in terms of ready-to-use forms, ways and means, guides, advice, graphic illustrations, accounting procedures, bookkeeping systems, agreements of every nature, models, drawings, specifications, insurance and bond requirements and all presented in orderly sequence.

396 pages • 9 x 12 • illustrated • \$12.00

FREE EXAMINATION ORDER FORM

REINHOLD PUBLISHING CORP.

Dept. M-174, 330 W. 42nd St., New York 18, N. Y.

- Send books checked at right. (Remittance enclosed.)
- Send books on free 10-day examination.

Name.....

(PLEASE PRINT)

Address.....

City..... Zone..... State.....

NOTE: You save postage and delivery charges by sending payment with order. Same return privilege guaranteed. Include 2% sales tax on N.Y.C. orders.

Check here

- Theatres and Auditoriums... \$ 8.00
- Shops and Stores..... 10.00
- Hospitals..... 10.75
- Apartment Houses..... 10.00
- Architectural Practice..... 12.00

Part of Tim-Built portable bleachers which seats 5,000 people. Located at Oregon State College's Bell Field, Corvallis. Units available in any desired seating capacity.

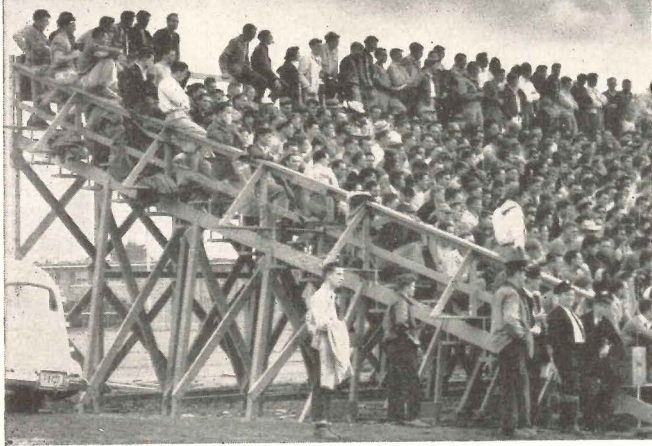

Tim-Built Portable Bleachers

...for Safety, Comfort and Lasting Service

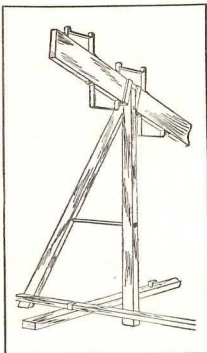

Here are bleachers you can recommend to your school clients with complete confidence, for they are engineered for safety, designed for comfort, and built for long, hard service... in all kinds of weather... indoors and out.

Built-In Safety. Designed to support several times the normal loads, Tim-Built bleachers are provided with a liberal safety factor which safeguards spectators at all times.

Structural members are of dry, straight-grained Doulgas Fir timbers. Weight of spectators is distributed evenly throughout the frame, and all parts of the structure are locked securely in place with non-rusting steel connectors to form a rigid sway-proof unit.

Comfort for Spectators. Spacing of seat and foot boards allows plenty of knee room. Edges of seats are rounded to prevent splinters, and every wood member is given two coats of weather-resisting paint. Through a patented joining device, overlapping of seat boards is eliminated.

Easily Erected—Compactly Stored

Even inexperienced workmen can erect Tim-Built bleachers quickly and easily, dismantle them still quicker. Pieces fit together compactly, and the entire unit may be stored in small space.

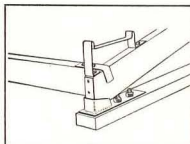

A catalog folder containing illustrated details of construction is yours for the asking. Get it from your nearest Timber Structures office or write us direct.

TIMBER STRUCTURES, INC.

P.O. BOX 3782, PORTLAND 8, OREGON

Offices in Boise, Idaho; Eugene, Oregon; Lawrenceville, N.J.; Chicago; Dallas; New York; Seattle; Spokane

TIMBER STRUCTURES, INC. OF CALIFORNIA • Oakland and Sacramento
Local representatives coast to coast.

GENERAL CONTROLS



Takes the MANUAL out of Controls

They're Automatic!

For all Pressure, Temperature, Level and Flow Control applications using all kinds of gases, liquids, and air.

It's profitable! Because antiquated automatic or manually operated controls hold down your profits! That's true whether you are a manufacturer, wholesaler, dealer or user.

- "ALL-GAS" CONTROL SYSTEMS
- AIRCRAFT CONTROLS, ELECTRIC
- AUTOMATIC SAFETY SHUT-OFF VALVES
- MOTOR OPERATED VALVES
- MAGNETIC GAS VALVES
- SOLENOID VALVES
- THERMOSTATIC CONTROLS & CONTROL SYSTEMS
- GOVERNOR-TYPE VALVES
- HI-LOW-OFF VALVES
- DIAPHRAGM VALVES
- LIMIT CONTROLS
- ELECTRIC TIME SWITCHES
- REFRIGERATION VALVES
- GAS REGULATORS
- LOW WATER CONTROLS
- STRAINERS, RELAYS
- TRANSFORMERS, SWITCHES
- PORTABLE EQUIPMENT CONTROLS
- MACHINE TOOL CONTROLS

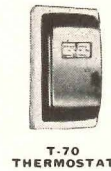

T-70 THERMOSTAT



G-1 MOTOR OPERATED VALVE



V-300 GAS REGULATOR



K-10 MAGNETIC LEVER VALVE



B-60 GAS VALVE



B-50 DIAPHRAGM VALVE

GENERAL CONTROLS

Manufacturers of Automatic Pressure, Temperature, Level & Flow Controls

Factory Branches: Birmingham (3), Boston (16), Chicago (5), Cleveland (15), Dallas (2), Denver (10), Detroit (8), Glendale (1), Houston (6), Kansas City (2), New York (17), Oklahoma City (1), Philadelphia (40), Pittsburgh (22), Seattle (1), San Francisco (7), St. Louis (12) • DISTRIBUTORS IN PRINCIPAL CITIES

SIMPLE TO INSTALL

EFFECTIVE

COMPLETELY CONCEALED

QUICK—EASY TO USE

FLEXIBLE TUBE

ECONOMICAL

CAR-MON SOLVES YOUR GARAGE VENTILATION PROBLEM

CAR-MON EXHAUST SYSTEMS

FOR CAR DEALERS, GARAGES AND REPAIR SHOPS

The newest and most effective way to remove dangerous carbon monoxide gas fumes from your garage or repair shop, for any number of cars. System completely concealed, easily and economically installed in present building or new constructions. Permits exhaust testing while in operation. Improves working conditions, safeguards employee's health. Widely used by Cadillac, Buick, Oldsmobile, Ford, Chevrolet and Chrysler dealers. Investigate Car-Mon today—write for details.

CAR-MON PRODUCTS CO.

4552 N. BROADWAY

CHICAGO 40, ILL.

MODERN LABORATORY

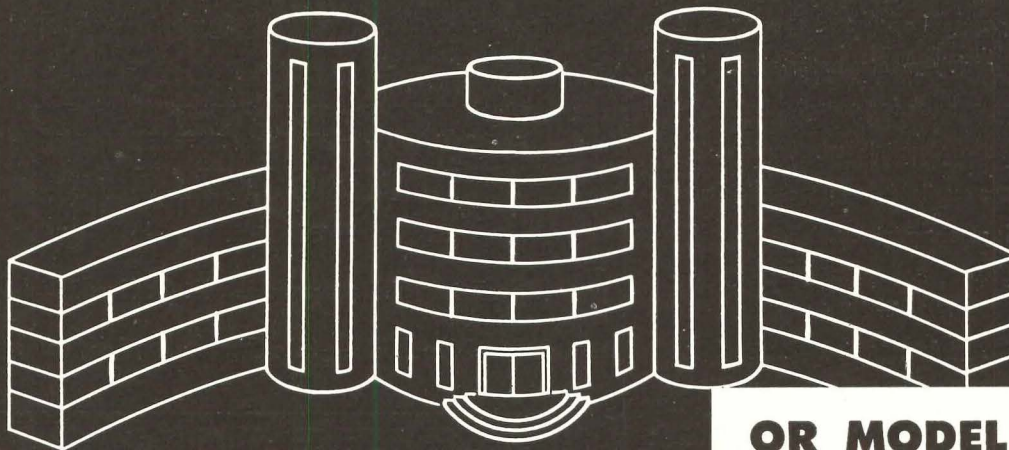
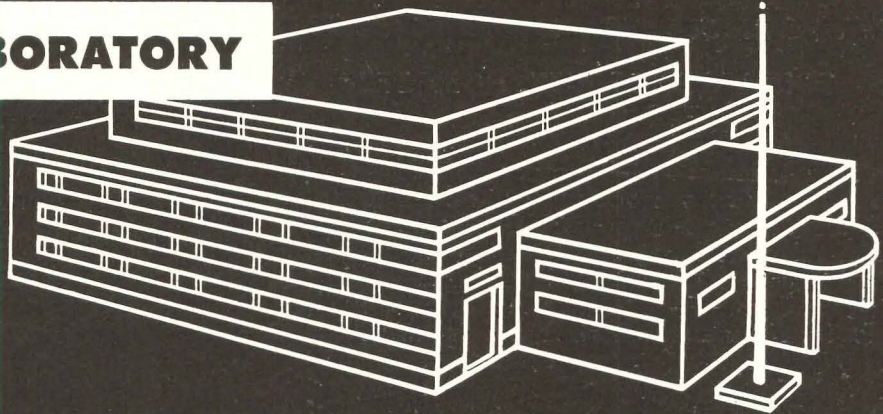

OR MODEL SCHOOL

Build it better with **DURAPLASTIC***

For added durability and improved appearance in modern concrete construction, a growing number of architects, engineers and contractors rely on Atlas Duraplastic air-entraining portland cement. Its advantages apply to all types of mass and structural concrete—for foundations, walls, columns, and floors in buildings, for paving and other construction. Duraplastic is ideal for slip-form, gunite, stucco and similar uses. It makes *better concrete at no extra cost.*

With Duraplastic, less mixing water is needed for a given slump of concrete. The mix that results is more plastic, more workable, more uniform and more cohesive. It's easy to place and finish. Water-

gain and segregation are effectively minimized. The concrete is highly resistant to the effects of freezing-thawing weather and exposure.

Atlas Duraplastic calls for no unusual changes in procedure and sells at the same price as regular cement. It complies with ASTM and Federal Specifications. Send for further information to Universal Atlas Cement Company (United States Steel Corporation Subsidiary), Chrysler Bldg, N. Y. 17, N. Y.

OFFICES: Albany, Birmingham, Boston, Chicago, Dayton, Des Moines, Kansas City, Minneapolis, New York, Philadelphia, Pittsburgh, St. Louis, Waco

*"Duraplastic" is the registered trade mark of the air-entraining portland cement manufactured by Universal Atlas Cement Company.

ATLAS DURAPLASTIC

AIR-ENTRAINING PORTLAND CEMENT

MAKES BETTER CONCRETE AT NO EXTRA COST

TRADE MARK REG.
U. S. PAT. OFF. U. S. DEPT. OF COMMERCE

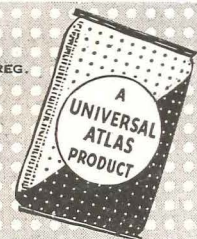

AR-D-89

NBC SUMMER SYMPHONY CONCERTS—Sponsored by U.S. Steel Subsidiaries—Sunday Evenings—June to September

Molded in One Piece

FOR ADDED BEAUTY, COMFORT
AND STRENGTH

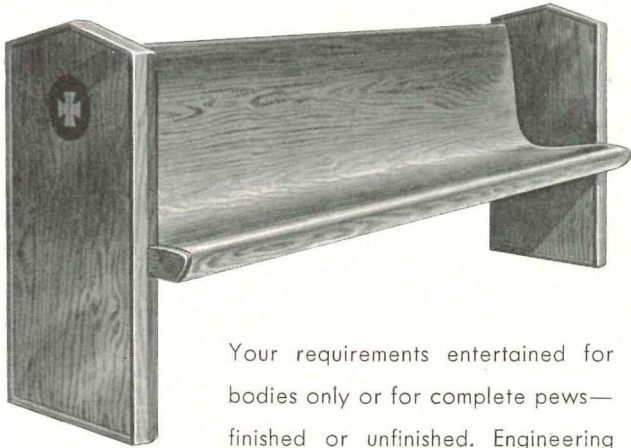

Your
Inquiry Is
Invited

Your requirements entertained for
bodies only or for complete pews—
finished or unfinished. Engineering
services available on production and
development projects.

Write for full details

THADEN-JORDAN FURNITURE CORPORATION

P. O. Box 1141, ROANOKE, VIRGINIA

**Insist
on this
Seal...**

when you specify
**ALUMINUM
WINDOWS**

This seal assures windows that, when
tested by the independent Pittsburgh
Testing Laboratory, meet the A.W.M.A.
quality specifications for materials,
construction, strength of sections, and
minimum air infiltration requirements.

For complete specs covering "Quality-
Approved" aluminum windows—
double-hung, casement and projected
—and names of approved manu-
facturers, consult Sweet's or write to
the address below, Dept. R.

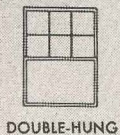

DOUBLE-HUNG

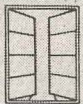

CASEMENT



PROJECTED

ALUMINUM WINDOW MANUFACTURERS ASSOCIATION
209 Cedar Avenue, Takoma Park, Washington 12, D. C.



A.W.M.A. Quality Specifications—Materials, Construc-
tion, Strength of sections and Air infiltration require-
ments—confirmed by PITTSBURGH TESTING LABORATORY.
MEMBER—ALUMINUM WINDOW MANUFACTURERS ASSOCIATION

CONNOR

Forest Products Since 1872

"LAYTITE" MAPLE FLOORING

MFMA Specifications
The World's Finest — Bar None

Write For Illustrated 75th Anniversary Booklet

CONNOR LUMBER AND LAND COMPANY

PHONE No. 3

Marshfield, Wisconsin P. O. Box 112-R

Behind the Mills—The Connor Timber Stands

Available Now!

**CHENEY
FLASHING**
3-Way Bond

16 OZ. COPPER

**CHENEY
FLASHING
REGLET**

16 OZ. COPPER

WRITE FOR
DESCRIPTIVE FOLDER Dept. R

CHENEY FLASHING CO. Trenton, N. J.

CHENEY FLASHING is again
being made by the origi-
nal inventor who pioneered
the art of thru-wall flashing
eighteen years ago.

No thru-wall flashing can
operate successfully unless it
has the two very important
features that are found in
CHENEY FLASHING—proven
weep-hole drainage and the
three-way bond, vertical as
well as longitudinal and
lateral.

Remember, the inferior two-
way flashings, crimped cop-
per and membranes, have
neither the vertical bond nor
do they drain moisture from
the wall fast enough. Further-
more, their first cost advan-
tage has disappeared be-
cause today Cheney Flashing
is no longer a specialty—it's
a standard commodity.

MAKE *Your Customers Happy!*



THRUSH WATER HEATER

THRUSH FLOW CONTROL VALVE



Install
THRUSH

**FORCED CIRCULATING
HOT WATER HEAT!**

WHETHER it is a new installation or the modernization of an old hot water heating plant, you can be sure of giving your customers the most efficient automatic heating comfort at lowest cost for fuel when you install a Thrush Water Circulator. Better still, sell the complete Flow Control System which also provides plenty of hot water for kitchen, laundry, and bath the whole year from one heating boiler. The Thrush Water Circulator has many features that assure finer performance and longer life. For more information, see our catalog in Sweet's or address Dept. J-7.



THRUSH WATER CIRCULATOR



This colorful booklet tells the whole story of Thrush Forced Circulating Flow Control System. It will also help you sell your customers.

H. A. THRUSH & COMPANY, PERU, INDIANA

INDEX TO ADVERTISEMENTS

MANUFACTURERS' PRE-FILED CATALOGS
 Symbols "a", "b", and "e" indicate that catalogs of firms so marked are available in Sweet's Files as follows:

a—Sweet's File, Architectural, 1949
 b—Sweet's File for Builders, 1949
 e—Sweet's File, Engineering, 1949

ab Accurate Metal Weatherstrip Co., Inc.....	172	a General Portland Cement Co.....	77	a Petroleum Heat & Power Company.....	203
abe Adam, Frank Electric Co.....	19	a Globe Hoist Company.....	184	abe Pittsburgh Plate Glass Company.....	60-215
Adams-Rite Mfg. Co.....	186	ae Grasselli Chemicals Department.....	210	a Pittsburgh Reflector Company.....	173
a Adams & Westlake Company.....	187	ae Grinnell Company, Inc.....	61	a Portland Cement Association.....	200
Aerofin Corporation.....	66	Guth, Edwin F. Company.....	30	a Powers Regulator Company.....	54
Alan Wood Steel Company.....	22	ae Hart & Hegeman Division.....	156	a Pyle-National Company.....	233
a Allegheny Ludlum Steel Corp.....	234	Haws Drinking Faucet Co.....	226	Radio Corporation of America.....	221
a Aluminum Company of America.....	63	ae Haynes Products Co.....	210	Reinhold Publishing Corp.....	227
a Aluminum Window Manufacturers Assn.....	230	ae Hendrick Manufacturing Co.....	222	a Republic Steel Corporation.....	50-150-201
ae American Abrasive Metals Co.....	174	a Herring-Hall Marvin Safe Co.....	148	abe Revere Copper & Brass, Inc.....	42
a American Brass Company.....	59	a Hillyard Sales Companies.....	218	a Reynolds Metals Company.....	13-166-177
ae American Structural Products Co.....	155	Hotel Cleveland.....	190	ab Richmond Radiator Company.....	177
American Trucking Associations.....	46	a Horn Brothers Co.....	180	Roberson, L. N. Company.....	208
a Anaconda Copper Mining Co.....	59	Hubbell, Harvey, Inc.....	188	ab Roddis Plywood Corporation.....	225
Anthracite Institute.....	213	abe Hunter Fan & Ventilating Co., Inc.....	194	a Rotary Lift Co.....	216
a Armco Steel Corporation.....	68	a Imperial Brass Mfg. Co.....	6	ae Ruberoid Co.....	82
ae Armstrong Cork Company.....	64-65	Infra Insulation, Inc.....	170	a Sanymetal Products Co., Inc.....	161
ae Arrow-Hart & Hegeman Electric Co.....	156	abe Inland Steel Products Co.....	39	Sarcotherm Controls, Inc.....	51
Bergen Cabinet Co.....	160	International Nickel Company, Inc.....	179	abe Schlage Lock Company.....	43
a Bethlehem Steel Company.....	196	a Jackson & Church Co.....	220	a Seaportel Metals, Inc.....	16
ab Bird & Son, Inc.....	176	ae Johns-Manville.....	33	a Sedgwick Machine Works.....	164
a Blank, Frederic & Co., Inc.....	24	ae Josam Manufacturing Co.....	206	e Serviced Products Corp.....	168
Books.....	192-198-202-210	a Kawneer Company.....	37	ae Sloan Valve Company.....	4th Cover
e Bradley Washfountain Co.....	20	ae Keasbey & Mattison Company.....	81	Sloane-Blabon Corporation.....	29
ab Bruce, E. L. Co.....	79	Kennebec, Inc.....	21	a Smith, A. O. Corp.....	71
ae Bulldog Electric Products Co.....	38	a Kennedy, David E. Co.....	40	a Stained Shingle & Shake Association.....	67
Burnham Corporation.....	69	Keawaunee Mfg. Co.....	162	abe Stanley Works.....	211
ae Burt Mfg. Co.....	158	Keweenaw Mfg. & Wire Company.....	185	ae Stewart Iron Works Co.....	212
Byers, A. M. Co.....	4	a L.C.N. Closter, Inc.....	31	ab Streamline Pipe & Fittings Div.....	193
ab Cabot, Samuel, Inc.....	184	Lees, James & Sons Company.....	48	a Sunlight Metal Products Co.....	212
a Cambridge Tile Mfg. Co.....	56-57	Liberty Mirror Division.....	220	ae Taylor, Halsey W. Co.....	216
Car-Mon Products Co.....	228	abe Libbey-Owens-Ford Glass Co.....	70-220	Thaden-Jordan Furniture Corp.....	230
Case, W. A. & Son Mfg. Co.....	3rd Cover	Litecontrol Corporation.....	167	ab Thrush, H. A. & Company.....	231
ab Caco Steel Products Corp.....	2-3	Lone Star Cement Corp.....	222	a Timber Structures, Inc.....	228
abe Celotex Corporation.....	44	a Louisville Cement Company, Inc.....	47	Tracy Manufacturing Co.....	78
a Century Lighting, Inc.....	224	Lucke, W. B., Inc.....	224	ab Trade-Wind Motorfans, Inc.....	218
Certified Ballast Manufacturers.....	25	Luria Engineering Corporation.....	181	abe Trane Company.....	165
a Cheney Flashing Co.....	230	a Macomber, Incorporated.....	55	a Trinity Portland Cement Division.....	77
Chicago Hardware Co.....	188	ae Mahon, R. C. Co.....	15	abe Truscon Steel Company.....	150
abe Church, C. F. Mfg. Co.....	217	Marlo Coil Co.....	74	a Tuttle & Bailey, Inc.....	17
a Columbia Mills, Inc.....	62	a Martin-Parry Corp.....	76	Tyler, Arthur F. Co.....	208
ab Connor Lumber & Land Co.....	204-230	a Medart, Fred Products, Inc.....	23	ae United States Steel Corporation Subsidiaries.....	183-229
Connor, W. B. Engineering Corp.....	157	a Medusa Portland Cement Co.....	224	a Universal Atlas Cement Company.....	229
Corning Glass Works.....	159	Michaels Art Bronze Co., Inc.....	18	ab Upson Company.....	36
Couch, S. H. Co., Inc.....	192	ae Mills Company.....	169	a Van Range, John Co.....	147
Crucible Steel Company of America.....	72	Minneapolis-Honeywell Regulator Co.....	27	a Vermont Marble Company.....	178
a Curtis Companies Service Bureau.....	73	ae Modine Mfg. Co.....	58	ae Wakefield, F. W. Brass Company.....	220
a Cutler Mail Chute Co.....	226	ae Moulding, Thos. Floor Mfg. Co.....	214	a Wayne Iron Works.....	206
a Day-Brite Lighting.....	49	ab Mueller Brass Co.....	193	ae Webster, Warren & Co.....	12
abe Detroit Steel Products Company.....	163	ab Natcor Store Fronts.....	206	abe Westinghouse Electric Corp.....	52-53-75
a Douglas Fir Plywood Assn.....	32	ae National Fireproofing Corporation.....	175	a Westinghouse Electric Corp.—Elevator Div.....	8-9
ae Dravo Corporation.....	223	a National Gypsum Company.....	199	ae Wing, L. J. Mfg. Co.....	14
ae Du Pont, E. I. de Nemours & Co.....	210	National Tube Company.....	183	Woodwork Corporation of America.....	189
a Durisol, Inc.....	182	e Nelson, Herman Corporation.....	171	a Worthington Pump & Machinery Corp.....	197
Edwards Co., Inc.....	207	Ohio Hydrate & Supply Co.....	190	Wright Manufacturing Co.....	154
Electric-Aire Engineering Corp.....	204	ae Okonite Company.....	80	Wurlitzer, Rudolph Company.....	205
Electric Storage Battery Co.....	219	ae Otis Elevator Company.....	41-218	a Young Radiator Co.....	186
Employment Opportunities.....	214	ae Owens-Corning Fiberglas Corp.....	34	abe Zanolite Company.....	216
Faber, A. W. Castell Pencil Co., Inc.....	226	ae Owens-Illinois Glass Co.....	155	a Zurn, J. A. Mfg. Co.....	35
e Fedders-Quigan Corporation.....	212	Ozalid Division.....	1		
Federal Seaboard Terra Cotta Corp.....	195	Parkwood Corporation.....	208		
a Fitzgibbons Boiler Company.....	204	Peitko Industries, Inc.....	11		
abe Flintkote Company.....	2nd Cover				
abe Flynn, Michael Manufacturing Co.....	191				
Frick Company.....	222				
ab Frigidaire Division.....	209				
General Aniline & Film Corp.....	1				
General Controls.....	228				
ae General Electric Co.—Apparatus Dept.....	45				
a General Electric Co.—Wiring.....	153				
ab General Motors Co.....	209				

NEW YORK—H. Judd Payne, Publishing Director; Robert F. Marshall, Business Manager; Tom Tredwell, Advertising Mgr.; Benton B. Orwig, Creative Service Manager; M. A. Murphy, Advertising Production Manager, 119 West 40th Street; BOSTON—Harry M. Horn, Jr., 855 Park Square Bldg.; CHICAGO—C. B. Riemersma, Robert T. Franden, John M. Cogan, 700 Merchandise Mart; CLEVELAND—John C. Jackson, 321 Hanna Bldg.; DALLAS—O. O. Paulsell, 412 Construction Bldg.; LOS ANGELES—Bob Wettstein, 672 South Lafayette Park Place; PHILADELPHIA—Tom Tredwell, 1321 Arch St.; PORTLAND—Bob Wettstein, 907 Terminal Sales Bldg.; SAN FRANCISCO—Bob Wettstein, 1003 TWA Bldg., 240 Stockton St.

"Continued mild..... fresh..... agreeable"

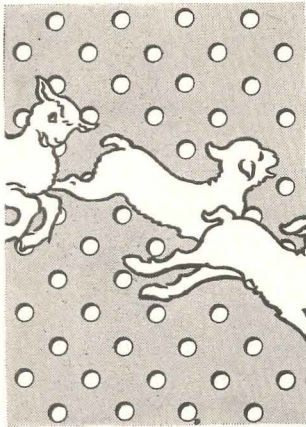

That is the constant forecast for any air-conditioned room having **MULTI-VENT LOW VELOCITY DIFFUSION**
Trademark

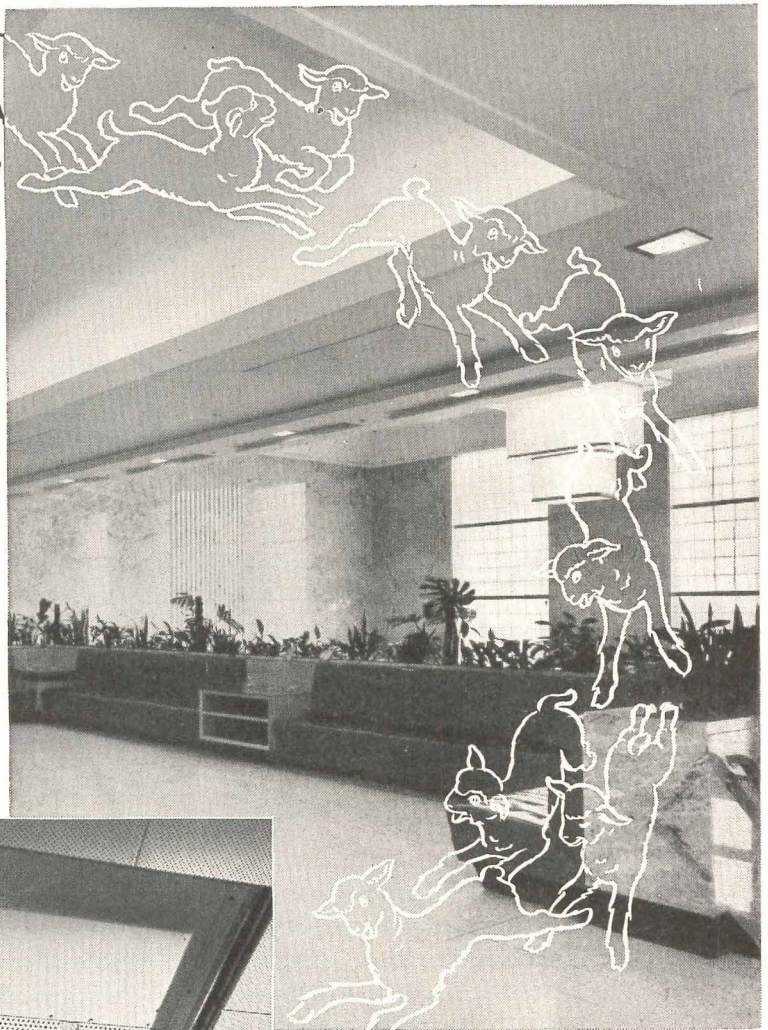

Truly superb air conditioning comfort is assured by the use of Multi-Vent perforated ceiling diffusion panels. Unlike all other diffusers on the market today, **MULTI-VENT** does not rely on "throw" or "blow" to distribute conditioned air. Duct velocities are so radically reduced within the panel itself . . . diffusion so thorough and rapid that no air movement in excess of ASHVE comfort zone requirements exists more than six inches below the ceiling! Therefore, all problems of outlet location, adjustments for throw and drop to avoid drafts are eliminated. Air Volume delivered through individual panels may be varied and supply reduced as much as 60% in zoned systems without disturbing the balance or affecting the desired spread and radius of diffusion. Moreover, Multi-Vent diffusion can handle greater amounts of air in proportion to room size than any other diffuser and still maintain the most exacting comfort zone requirements.

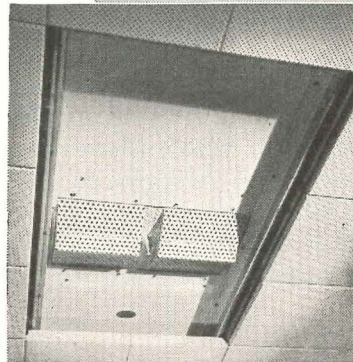

Concealed Multi-Vent Panel exposed by removal of six squares of metal acoustical ceiling.

Inconspicuous Multi-Vent panels installed flush in plaster ceiling around light cove above reception room on the foyer balcony of the Hibbard, Spencer, Bartlett & Co. Building, Evanston, Illinois. Architects and Engineers, Engineering Systems, Chicago.

SIMPLE TO INSTALL in virtually any type of building—new or old . . . quick to balance . . . easy and economical to clean. Complete information and selection data gladly sent in response to your inquiry.

THE PYLE - NATIONAL COMPANY

MULTI-VENT DIVISION
 1375 W. 37th ST.
 CHICAGO 9, ILLINOIS

How long

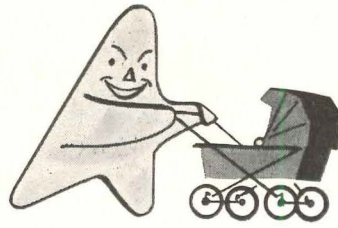

is a lifetime

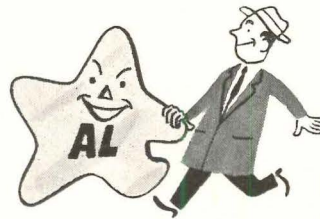

in Stainless Steel?



We call Allegheny Metal "the time-tested stainless steel" because it's the pioneer in America, but time hasn't really tested it yet. Neither we nor anyone else knows how long stainless steel will last. The earliest installations of Allegheny Metal—made more than 20 years ago—are just as bright, strong and resistant as when new. How can you defeat a metal that doesn't wear out and can't wear off?

- More important, how and where can you *use* it to advantage, *today*?

W&D 2175

Complete technical and fabricating data—engineering help, too—yours for the asking.

ALLEGHENY LUDLUM STEEL CORPORATION



The Nation's Leading Producer of Stainless Steel in All Forms

Pittsburgh, Penna. . . . Offices in Principal Cities

Allegheny Metal is stocked by all Jos. T. Ryerson & Son, Inc., Warehouses