

ARCHITECTURAL RECORD

A detailed architectural site plan of a hospital complex, rendered in white lines on a dark teal background. The plan shows a large central building with multiple wings, a parking lot with numerous spaces, and various courtyards and walkways. The drawing uses different line weights and patterns to represent walls, windows, and landscaping.

BUILDING TYPES STUDY

HOSPITALS

220

MARCH 1955



hospitals

General Hospital Neurological Building, Philadelphia, Penna. Archt.—Harbeson, Hough, Livingston & Larson; Contr.—McCloskey & Co., Inc.—both of Philadelphia. Pozzolith Ready-Mixed Concrete supplied by The Warner Co., Philadelphia.

St. Joseph's Hospital Addition, Burbank, Calif. Archt.—John W. Maloney, Seattle, Wash.; Contr.—Pozzo Construction Co., Los Angeles. Pozzolith Ready-Mixed Concrete supplied by Jewel City Ready-Mix Co., Beverly Hills.



Permanente Foundation Hospital, Los Angeles, Calif. Archt.—Wolff and Phillips, Portland, Oregon; Contr.—C. L. Peck, Los Angeles. Pozzolith Ready-Mixed Concrete supplied by Graham Brothers Co., Los Angeles.

Veteran's Hospital, New Orleans, La. Archts.—Favrot, Reed, Mathes & Bergman, New Orleans; Faulkner, Kingsbury & Stenhouse, Washington, D.C.; Contr.—Robert E. McKee, Dallas, Tex. Pozzolith Concrete batched at job site.

concrete produced with POZZOLITH

Contractors benefit from Pozzolith Concrete in faster, better, lower-cost construction because Pozzolith:

- improves plasticity . . . for easier placing
- increases cohesiveness . . . for reduced bleeding
- reduces shrinkage . . . for less cracking
- reduces segregation defects . . . for lower finishing costs

These are several of the reasons why 60,000,000 cubic yards of concrete were produced with Pozzolith in the past five years.

Full information on Pozzolith and "see-for-yourself" demonstration kit sent upon request.

The MASTER BUILDERS

LEVELAND 3, OHIO • TORONTO, ONT. Subsidiary of American-Marietta Company Cable Address, Mastmethod, New York

ARCHITECTURAL RECORD

March 1955 Vol. 117 No. 3

Copyright 1955 by F. W. Dodge Corporation, with all rights reserved. ARCHITECTURAL RECORD (combined with AMERICAN ARCHITECT and ARCHITECTURE) is published monthly by F. W. Dodge Corporation, 10 Ferry Street, Concord, New Hampshire, with editorial and executive offices at 119 West 40th Street, New York 18, New York. Western editorial office, 2877 Shasta Road, Berkeley 8, California.

STAFF OF ARCHITECTURAL RECORD



H. Judd Payne, *Publishing and Editorial Director*; John Knox Shear, A.I.A., *Editor-in-Chief*; Robert F. Marshall, *General Manager*; Marshall T. Ginn, *Circulation Manager*. . . Emerson Goble, *Managing Editor*; Frank G. Lopez, A.I.A., *Senior Editor*; James S. Hornbeck, A.I.A., *Senior Associate Editor*; Elisabeth Kendall Thompson, *Senior Associate Editor and Western Section Editor (Berkeley, California Office)*; Robert E. Fischer, *Associate Editor (Engineering)*, Florence A. van Wyck, *Associate Editor*; Jeanne M. Davern, *Associate Editor (News)*; Daniel M. Kelley, *Associate Editor (Engineering Assistant)*; Ernest Mickel, Dan Street (*Washington*), John Caulfield Smith, M.R.A.I.C. (*Canada*); *Contributing Editors*: Marjorie Blake, Grace M. Anderson, *Assistant Editors*; Ruth P. Watson, Helen E. Cook, *Editorial Assistants*; Peter Piening, *Consulting Design Director*; Eugene H. Hawley, Alfred Petersen, *Design*; Sigman-Ward *Drafting Consultants*; Thomas S. Holden, *Industry Relations Consultant*; Clyde Shute, *Statistical Consultant*; George Cline Smith, *Economics Consultant*; Clifford Dunnells, Jr., *Field Research Consultant*; Samuel C. Pace, *Public Relations Consultant*.

TABLE OF CONTENTS

The Record Reports

Perspectives	9
A Washington Report: Spotlight on Schools. <i>By Ernest Mickel</i>	10, 11
Meetings and Miscellany	15, 16
More than 25,000 Throng the Homebuilders' Big Show in Chicago	16
R.I.B.A. Gold Medallist Tours U. S. on visit from Australia	20
News from Canada. <i>By John Caulfield Smith</i>	26
Construction Cost Index	42
Required Reading	46
Current Trends in Construction	354

A Venerable Bank and its Architecture

In its 86-year history the Mellon Bank has had several occasions to solve architectural problems. The latest was by no means the simplest problem, for the bank expanded from its present building (vintage 1924) into the new U. S. Steel Building adjoining. How to develop the joint property produced an interesting solution; then of course there was the problem of modernizing the old building without sweeping out its identity, of joining it both to the past and the present.

The Mellon National Bank and Trust Company, Pittsburgh, Penna.; W. K. Harrison, M. Abramovitz, W. Y. Cocken, Associate Architects 145

Research Center

Houston Research Center for Humble Oil Company, Houston, Texas; MacKie and Kamrath, Architects 157

House with Rental Unit

House for Mr. and Mrs. Walter Costa, Lafayette, Calif.; Walter Costa, Architect 160

Economical School Building

So often it seems that the school district with the lowest tax valuations has the highest number of kids. This school was done for such a district, one which, moreover, was rapidly expanding. So the school has economy as a strong primary motif, and flexibility as another major requirement.

Normandy Park Elementary School, Seattle, Wash.; Waldron & Dietz, Architects 166

Stores

Foodland Supermarket, Kailua, Oahu, T. H.; Wimberly and Cook, Architects 170

Sommer & Kaufmann Shoe Store, San Francisco, Calif.; Campbell and Wong, Architects 173

Continued on next page

ARCHITECTURAL RECORD

Continued from page 5

Stores (Continued)

Sportland Store, Pasadena, Calif.; Douglas Honnold and John Rex, Architects	174
Cooperative Supermarket, Chicago, Ill.; George Fred Keck — William Keck, Architects	176

Building Types Study Number 220 — Hospitals

Facilities for Long-Term Patients	177
-----------------------------------	-----

With the Federal government beginning to offer financial assistance in the building of facilities for chronic patients, there has been a rush to refurbish the background thinking on planning such buildings. Particularly because the new buildings are new in concept, or at least partly so, to fit into new concepts of diagnosis, treatment, and rehabilitation of patients with a chronic handicap. The famous architectural section of Public Health Service rushes forward with at least a preliminary package of background planning information, on three types of facilities.

Rehabilitation Facilities for Multiple Disability in a General Hospital: Preliminary Type Plan by U. S. Public Health Service; Thomas Galbraith, Architect 178

Chronic Disease Hospital: Preliminary Type Plan by U. S. Public Health Service; Peter Jensen, Architect 181

Nursing Home As An Integrated Facility: Preliminary Type Plan by U. S. Public Health Service; Edwin B. Morris, Jr., Architect 184

Plain-Type Study Precedes Building of Large General Hospital: Long Island Jewish Hospital, Glen Oaks, L. I., N. Y.; Louis Allen Abramson, Architect 186

200-Bed Hospital Studied in Actual Use

Any architect might shudder at the thought that so complex a building as a hospital might be reviewed a year after construction with the idea of criticizing his work, especially if the review panel were the employees of the hospital. In this case it did happen, and the hospital personnel did find a lot of details to be crabby about. In general the architects came off quite well, but the record of the study, presented here in collaboration with *The Modern Hospital*, does raise some good points.

Rockford Memorial Hospital, Rockford, Ill.; Hubbard and Hyland, Perkins and Will, Architects 197

Architectural Engineering

Heating, Air Conditioning and Plumbing. By Nathan N. Wolpert	209
Product Reports	214
Roundup	215
Office Literature	216
Time-Saver Standards — Thermal Insulation: 6, U Factors for Frame Walls. By Laurence Shuman, Consulting Engineer	219

Index to Advertising

350

OFFICERS OF THE F. W. DODGE CORPORATION

James McV. Breed, Chairman of the Board; Paul Abbott and Thomas S. Holden: Vice Chairmen of the Board; Howard Barringer, President; Irving W. Hadsell, Chauncey L. Williams: Executive Vice Presidents; Howard M. Thompson, Vice President and Treasurer; Julius T. Little, Robert F. Marshall, T. Oliver Morgan, H. Judd Payne: Vice Presidents; Carl S. Bennett, Clinton C. Bennett, Ralph M. Hairston, Roy J. Hard, O. O. Paulsell, Richard H. Ray, John M. Williams: Regional Vice Presidents; Edwin H. Freed, Assistant Vice President and Comptroller; George Cline Smith, Assistant Vice President and Economist; Walter F. DeSaix, Clifford G. Dunnells, Jr., Clyde Shute, Marc Wayne: Assistant Vice Presidents; Sanford D. Stockton, Jr., Secretary; William C. Breed, Jr., George W. Morgan, Jr.: Assistant Secretaries; Irving B. Satin, Assistant Treasurer.

OTHER F. W. DODGE SERVICES:

Dodge Reports and Dodge Statistical Research Services — Sweet's Catalog Services — Chicago Construction News — Daily Pacific Builder — Denver Daily Journal — Real Estate Record & Builders' Guide.

Member of Audit Bureau of Circulations and Associated Business Publications. Architectural Record is indexed in Art Index, Industrial Arts Index and Engineering Index.

Every effort will be made to return material submitted for possible publication (if accompanied by stamped, addressed envelope), but the editors and the corporation will not be responsible for loss or damage.

Subscription rates in U. S., U. S. Possessions, and Canada: \$5.50 for one year, \$9.00 for two years, \$11.00 for three years. Elsewhere, subscriptions from those who by title are architects or engineers, \$6.50 for one year, \$11.50 for two years, \$15.00 for three years; subscriptions from all others outside U. S., U. S. Possessions and Canada, \$20.00 a year. Single copy price, \$2.00. Circulation Manager: Marshall T. Ginn. Change of Address: Subscribers are requested to furnish both old and new addresses, sending if possible the stencil impression from magazine wrapper. Allow four weeks for change.



THE RECORD REPORTS

P E R S P E C T I V E S

LATEST WORD FROM FREE CHINA to this office arrived not long before Formosa became the most important island in the world. It was in the form of another communication from the editors of *Architecture-Today*: the architectural students at the Taiwan College of Engineering who started a bimonthly magazine a year or so ago "as we do feel the lack of a magazine on architecture written in Chinese on this island." The editors offered their congratulations to the RECORD on its success in last year's A.I.A. journalism competition and their thanks "for appealing our association to the world in your April issue," asked if they could have tear sheets of Lewis Mumford's November 1951 article, "Function and Expression in Architecture," and enclosed the two latest issues of *their* magazine. These are 7½ x 10½-in. pamphlets of 60 pages or so which range the architectural world for their subject-matter and owe a good deal to all of the American architectural magazines for their material (largely reproduced therefrom). The work of LeCorbusier is a major feature of one issue (which has a photograph of Corbu on the cover) and the work of Frank Lloyd Wright of the other (with Falling Water for the cover). But each, to judge only from the illustrations, is a testimonial to architectural diversity. There is very little local material, and the editors apologize for this, and promise to make up for it in future issues: because "we know that you are interested in the architecture of the Far East and especially that of Free China." Especially Free China.

OTHER CLIENTS, OTHER PROBLEMS. Consider Willem Dudok, designing a small house at Hilversum for one Professor de Gruyter and his wife, the Princess Fatemah Khanoum of Persia (as described in a recent issue of the *Journal* of the Royal Institute of British Architects). "Though planned for a household of three or four persons," the *Journal* reports

gravely, "it had to be designed for the occasional entertaining of royalty and to house the professor's library of 3000 volumes." . . . Or, *much* closer to home, suppose you had to incorporate the grand staircase of the American Embassy in Luxembourg into the plans for remodeling a Pennsylvania Dutch farmhouse? Which, unless a "usually reliable" Washington source is all off, was what one lady client had in mind when the State Department got a rush call for a photograph of said staircase.

ARCHITECTURE AND COMMUNISM: The reputed prime mover behind the most recent Soviet upheaval and Stalin's successor as general secretary of the Communist Party's Central Committee has called for mass standardization of design and industrialization of building. In a recent speech before an all-union conference of builders in Moscow, as reported in *The New York Times*, Nikita S. Krushchev sharply criticized the waste he said was entailed in skyscraper construction and in "over-elaborate" designs. Mr. Krushchev had a specific "suggestion" (read directive?) for better building: hold a competition of architects to produce standard plans for every type of building and then conduct a mass construction program for, say, five years, based on these plans; after that, reconsider the plans, and if no better ones turn up, use them for another five years. Asked Mr. Krushchev, according to the *Times* account: "Is there anything wrong with this, comrades?" It is not recorded that anyone shouted "Yes!"

PLANNING, U. S. A.: Four criteria to guide city planning decisions were suggested by Dean G. Holmes Perkins, F.A.I.A., of the University of Pennsylvania College of Fine Arts, in a recent speech before the Philadelphia Housing Association. First, "that the social values to the individual and the community shall, in case of conflict, outweigh any temporary

financial advantage (and I am convinced that there is no conflict between social values and long-term financial advantage). Secondly, the plan must foster family life with widely diverse opportunities for social activities, for gregariousness and for privacy. The plan which fails to give asylum to the individual is guilty of as grievous a shortcoming as that which neglects the public parks and playgrounds. The third of these criteria is the effectiveness of the scheme in promoting friendliness among neighbors; the fourth — recognition of the rightful dominance of the pedestrian within the social unit which centers on the smaller elementary school." But the first prerequisites of the new community, said Dean Perkins, are adaptability and variety: "Specifically, we must provide for constant change, for rising standards, and for new needs — therefore adaptability to change. But secondly, we must provide variety. For variety and contrast are essential if the individual is to have true freedom in its deepest sense — a choice of home, of work, of church, of school, of recreation. This freedom of choice is the essence of democratic planning."

HOUSE DESIGN is "too difficult" for "The Boys with the \$5,000,000,000 Brains," as *The Saturday Evening Post* in a feature about them in its February 5 issue dubbed the redoubtable Detroit firm of Giffels & Vallet, Inc., L. Rossetti. Or, at any rate, so Vice President Edward X. Tuttle is quoted as saying, with flourishes: "The average home is a hotel, restaurant, factory, utility plant, and clubhouse all in one miniature package with a price limit on it. That's too tough." Just how difficult house design must be should be thoroughly apparent, for once, even to the most obtuse client, after *Post* author Arthur L. Baum is through describing the kind of thing that *is* simple enough for "GVR" — from automatic factories and atomic reactors to (once anyway) a doorknob.

PRESIDENT EISENHOWER WOULD HELP COMMUNITIES TO

THE EAGERLY-AWAITED Presidential message on Federal aid to school construction went to Congress last month a week ahead of schedule — perhaps reflecting increasing pressure from public and Congressional sources for early action.

In sum, the President proposed a four-part "plan of Federal cooperation with the States" which envisages Federal expenditures of approximately \$1.1 billion over the next three years for "a total of \$7 billion put to work building badly needed new schools."

The whole message, and the proposals it contained, scrupulously recognized the historic preëminence of state and local responsibility in school matters. "Federal aid in a form that tends to lead to Federal control of our schools," the President wrote, "could cripple education for freedom. In no form can it ever approach the mighty effectiveness of an aroused people. But Federal leadership can stir America to action."

The President's proposals:

1. Federal authority to purchase school bonds issued by local communities which are handicapped in selling bonds at a reasonable interest rate. Recommended appropriation — \$750 million for use over the next three years.

2. Federal participation with states in a "lease-purchase" scheme based on establishment of state school building agencies to construct schools and lease them to local school districts, which would "buy" its schools gradually in rentals paid over the years. "The local community under its lease gets a new school without borrowing," the message noted. Cost to the Federal government would be a contribution to the state school building agency's reserve fund; and the Federal share was estimated by the President's press secretary, James C. Hagerty, at about \$150 million. The President's message did not ask for an appropriation at this point, however.

3. Federal grants-in-aid where need and lack of local income are clearly

demonstrated. Federal and state matching funds would be sufficient to enable a school district to qualify under Proposals 1 or 2 for financing the remainder of the building costs. Said the President: "By authorizing this program of joint Federal-state aid to supplement the financing plans set forth in Proposals 1 and 2, a workable way will be provided for every community in the nation to construct classrooms for its children." Recommended appropriation — \$200 million for three years.

4. Federal assistance for the states in carrying out such recommendations as will be made by the state conferences on education. The Federal government would furnish one half of the administrative costs of state programs designed to overcome obstacles to local financing or to provide additional state aid to local school districts. Recommended authorization — \$20 million, with an appropriation of \$5 million for the first year of a three year program.

A.I.A. GETS ARCHITECTS' VIEWS ON THE RECORD WITH CONGRESS AND U. S. OFFICE OF EDUCATION

THE AMERICAN INSTITUTE OF ARCHITECTS found two opportunities to register its views on the school problem — one through a meeting of its School Buildings Committee with officials of the U. S. Office of Education and the other in the testimony of the Committee's vice chairman, John W. McLeod, of Washington, D. C., before the Senate's Labor and Public Welfare Committee during the committee's hearings on emergency school-aid legislation.

Warn Against Standardization

The dangers of standardization that might arise in any Federal assistance program got the main emphasis in the A.I.A. statement delivered by Mr. McLeod. The A.I.A. urged that no Federal regulations be imposed more restrictive than those already existing in the several states.

"The establishment of standards designed to raise the level of schoolhouse planning, while desirable in themselves, inevitably tend to become outmoded and thereby increase construction costs and hamper educational development," Mr.

McLeod warned. "Fixing of specific ceiling heights for classrooms and setting rigid requirements for the number of toilet fixtures per pupil are examples of the type of restrictive regulations which do not take into account the rapid changes and advances in technological and educational thinking."

Mr. McLeod stressed that changing educational concepts and continuing advancement in planning and construction techniques require "the widest latitude possible." Only in this way, he noted, can new materials and methods be turned to the advantage of the school district.

"Broad principles of purpose and performance, clearly stated and conscientiously followed, are more likely to produce better education and more adequate school buildings than the most detailed item-by-item outline of requirements and standards yet prepared," the legislators were told. "Determinations based on an accurate local knowledge of climate, local needs for specific educational programs and the availability of local labor and materials are more mean-

ingful and apt to be less costly than standards initiated at the national level."

The A.I.A. statement took cognizance of the great need for school facilities, noting that almost every school an architect designs is overfilled by the time it is completed. The statement also recognized the necessity of outside aid to communities to enable them to provide adequate facilities.

But A.I.A. support was reserved for those measures before the Congress which leave to states the establishment of standards for the locating, planning and construction of schools.

Office of Education Briefed

The conference with officials of the School Housing Section of the Office of Education was a highlight of the January meeting of the A.I.A. School Buildings Committee, of which Henry L. Wright of Los Angeles is chairman. Present besides education specialists of the Department of Health, Education and Welfare and members of the committee were local school officials and a visiting foreign "team," and the occasion was made an opportunity for a careful exposition of the architect's contribution to the solution of contemporary school problems.

HELP THEMSELVES

Democrats, and some Republicans, and school people all over the country, immediately criticized the program on the ground that it did not go far enough. Most of the critics would prefer a program of outright Federal grants to states for school construction — such a program as outlined in the bill proposed by Senator Lister Hill (D-Ala.), which would authorize \$500,000,000 in outright Federal grants for each of the next two years.

Early reaction from A.I.A. sources suggested members would have serious reservations about any proposals for school building authorities — state or Federal — as tending to imply, or at least to encourage, the development of strong controls over standards. As was indicated in A.I.A. testimony before the Hill committee (see across-page, below), the architects insist on local decisions on matters of standards as the only practical approach to the best and most economical schools.

There were three main topics of discussion: educational program effects on school architecture, relation of design to site and neighborhood and the current emphasis on the human factor — i.e., recognition of the fact that schools are designed for children. Some 40 slides were shown to illustrate current accomplishments of architects in school design. At one point, Dr. Ray Harmon of the Office of Education asked the meeting to note the absence of “belfries and towers” on the projects shown. “The architects have put the money into space and equipment,” he remarked.

The committee showed increasing concern over “cheap” schools, which it said are creating an environment for cheap education. It also recognized that the scope of its concerns must be enlarged to encompass the growing problem of facilities for institutions of higher education; its emphasis up to now has been almost entirely on public elementary and secondary schools. Publication of future issues of the committee’s “School Plant Studies” will be planned to reflect these considerations.

Future committee projects under consideration include studies on color, landscaping, food service, insurance, surety bonds and facilities for retarded children.

CONGRESS CONSIDERS SOLUTIONS ON ITS OWN AS HOPPERS ARE SHOWERED WITH SCHOOL AID BILLS

THE RISING TEMPERATURE of public concern with the school facilities problem was nowhere more clearly reflected than in the halls of Congress, where no fewer than 20 bills proposing various forms of Federal aid had been introduced within three weeks after the current session opened. The issue was, of course, very much in the political arena from the moment it became known the White House was ready to propose immediate action, abandoning its earlier insistence that any action on school aid should await the report from the White House Conference on Education scheduled for the end of this year.

The Senate had five bills to consider, including one proposed by Senator Lister W. Hill (D-Ala.), chairman of its Labor and Public Welfare Committee. In spite of Administration pleas to Congress to wait for the President’s message, the Hill committee held three days of hearings on emergency school-aid legislation late in January. Chairman Hill, after prodding from his Republican colleagues, promised to give the White House proposals “respectful and careful consideration,” but he would not promise to reopen the hearings.

A score of friendly witnesses, including the A.I.A.’s John W. McLeod (see across-page) appeared before the committee. The President’s recommendations — though their details were a closely guarded secret — appeared during the hearings to be being “tried” before their arrival on Capitol Hill, not only by witnesses but by some members of the committee. Rarely had so much interest been evidenced in a Presidential message prior to its delivery.

WHITE HOUSE CONFERENCE PLANNING CONTINUES

SIX MAJOR QUESTIONS have been selected for concentrated discussion at the White House Conference on Education — once the Administration’s major tool for dealing with school problems — and two of them are concerned with school buildings, one with need and the other with financing. The conference will be held November 28–December 1 in Washington.

The six questions: (1) What should our schools accomplish? (2) In what

In the House, fifteen bills on aid to school construction had been introduced and referred to committee, and more were to come. Most of the measures proposed “matching” funds. They fell into two general categories:

1. Those based on the so-called “Hill-Burton” approach. These would place allotment of Federal funds to states on a school population and per capita income basis, so that in its distribution the money would flow to poorer states in higher volume. Under this formula the proposed grants would range from \$7 to \$22 per school child.

2. Those which would make allotments to the states on the basis of school population only, with the provision that states match the money on a 50–50 basis. Under these proposals each state would get the same amount of money per child. Proponents justify this approach because of the “equalization” feature built into the tax structure. And it was being pointed out as well that one state may get much more for its construction dollars than another.

It is pretty generally agreed that no measure on straight Federal aid without matching fund provisions could be expected to succeed in the House. No such bill has been even able to get out of committee. At the same time, the House was expected to oppose any plan calling for insured-loan or direct-loan financing without direct Federal aid included. Some supporters of direct Federal aid, in fact, branded the loans-to-states approach as “delaying tactics,” pointing out that 13 states would have to change their constitutions to raise their borrowing powers before they could take loans.

ways can we organize our school systems more efficiently and economically? (3) What are our school building needs? (4) How can we get enough good teachers and keep them? (5) How can we finance our schools — build and operate them? (6) How can we obtain a continuing public interest in education?

By February 1, all but five of the 53 states and territories had taken some official action on conference plans, and six of the states had held their conferences.

MICHIGAN SCORES AN ATOMIC "FIRST"

THE UNIVERSITY OF MICHIGAN Research Reactor Facility, a vital part of the Phoenix Memorial Project, to be built on the North Campus in Ann Arbor, Michigan, will have the distinction of being the first civilian project to be licensed under the recently revised Atomic Energy Act. This project is the culmination of nearly a year's research and design by Smith, Hinchman & Grylls, the architects and engineers for the enclosing structure, and Babcock & Wilcox, designers and engineers for the nuclear reactor itself, working in close cooperation with the architectural and technical staffs of the University. Construction is expected to start early this year.

Outwardly, this building, housing the Nuclear Reactor, conforms in appearance with other school buildings on the campus. In contrast to the steel spheres which have been used on several similar governmental projects, this building will be constructed of reinforced concrete and brick veneer. Ordinary building materials have been used throughout.

The structure, however, is far from ordinary in its composition. It is windowless, gas-tight, and designed to afford complete protection to casual bystanders against escape of radiation or contaminated air from the building in the unlikely event of an operating failure.

In addition to the electrical and mechanical safety features incorporated into the reactor design, the building it-

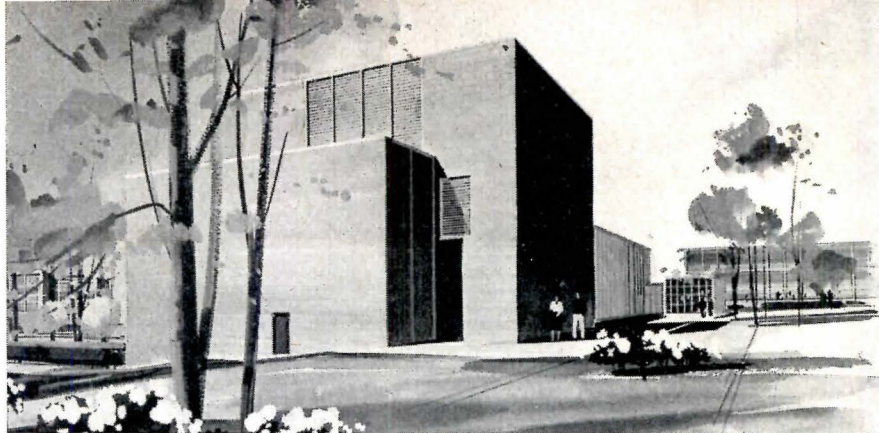

self becomes a secondary line of defense. The 12-in.-thick outer concrete walls plus brick veneer offer sufficient shielding from radiation to meet any contingency. Upon a moment's notice all openings in the building to the out-of-doors "fail safe" and are automatically and tightly sealed. Even the construction joints in the outer concrete walls are specially designed to prevent seepage of air from the building. Where doors were required, they were designed to be gas-tight and normally closed.

The reactor itself is located under 25 ft of water contained in a concrete "swimming pool" structure rising up through three floors. Where maximum shielding is required, walls of the reactor pool have been made 6½ ft thick. To provide the required degree of shielding, even with such thicknesses, it was necessary to use "heavy concrete" — a concrete made of Barytes ore and weighing approximately 50 per cent more than ordinary concrete.

The extensive controls required for this facility are centered in a control room located on the third floor where visual control can also be given to operations at top of reactor pool and in the adjoining operating areas. Also on the third floor are laboratories and seminar rooms.

The administrative offices, fan room,

and toilet rooms are located on the second floor.

Some of the structural problems encountered in the design of the building were out of the ordinary. Upper floors had to be designed to permit very heavy loadings. The lead "coffins," in which radioactive samples and materials are moved from place to place, and weigh as much as 10 tons, will be used on the third floor as well as the ground floor. At the same time, it was undesirable to obstruct operating areas by numerous columns. Accordingly, the main loads of the structure are carried on only two columns extending 60 ft to the roof. It was also deemed advisable, because of the unusual characteristics of Barytes concrete, to make the reactor pool structurally independent from the building. In the high bay of the building, a 10-ton crane will be installed to manipulate, through removable panels, the "coffins" and other heavy equipment which must be moved from floor to floor.

Adjacent to the crane bay, on the roof, but walled in for architectural appearance, are cooling towers. These are required to dissipate the very heavy but intermittent heat loads generated by the reactor. Louvres, seen on the upper portion of north wall of the high section of the building, identify tower location.

CONCRETE INDUSTRY BOARD GETS FULL-TIME MANAGER AND ARCHITECT DIRECTOR

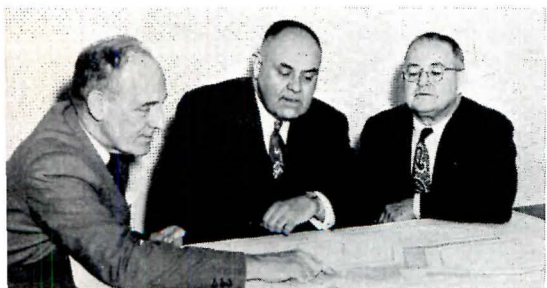

Mike Elkins

Concrete Industry Board Chairman Roger H. Corbetta, Corbetta Construction Company president (center) with new director Wallace K. Harrison (left), representing the Architects Council of Greater New York, and C.I.B.'s first full-time managing director, Vice Admiral John J. Manning (USN ret)

WITH THE APPOINTMENT OF ITS FIRST full-time managing director, the Concrete Industry Board of New York City has taken on a "giant step" toward implementing its program of improving the quality of concrete for buildings and engineering structures in the New York metropolitan area. The new appointee is Vice Admiral John J. Manning (CEC, USN, retired), former chief of the Bureau of Yards and Docks. Admiral Manning came to his new post after having recently served as technical director for Kelly & Gruzen, Architects and Engineers.

At the same time, Roger H. Corbetta, chairman of the C.I.B. Board of Di-

rectors, announced the election of Wallace K. Harrison of Harrison and Abramovitz, Architects, to the C.I.B. Board.

The C.I.B., the first association of its kind in the construction industry, was organized four years ago to improve the quality and techniques of concrete construction. It now has 161 members representing architects, engineers, contractors, cement manufacturers, ready-mix concrete plants, testing laboratories and material suppliers. It is sponsored by the Cement League, contractors specializing in concrete construction who are members of the Building Trades Employers' Association of New York City.

(Continued on page 282)

New Awards in the South

MORE THAN 100 ARCHITECTS gathered in Chapel Hill January 27-29 for the winter meeting of the North Carolina Chapter of the American Institute of Architects. The meeting saw the inauguration of the chapter's new awards program, which gave nine awards of merit with special commendation as follows: office building converted from a garage, Charlotte — A. G. Odell, architect; house in Greensboro — Lowenstein-Atkinson Associates, architects; house near Charlotte — A. G. Odell; Chapel at Wrightsville Beach — Lesley N. Boney, architect; First Federal Savings & Loan Building, Catawba County — Clemmer Horton & Rudisill, architects; elementary school in Greensboro — Lowenstein-Atkinson Associates; Double Oaks Elementary School, Charlotte, A. G. Odell; Student Union, North Carolina State College — Deitrich-Knight & Associates, architects; and the Farm Colony Building State Hospital (mental institution), Morganton — John E. Ramsey, architect. Five awards of merit went to: a Dairy Bar, Catawba County — Clemmer, Horton & Rudisill; North Carolina Sanatorium, McCain — F. Carter Williams, architect; Architects Office Building, Greensboro — Lowenstein-Atkinson Associates; Senior High School, Charleston — Graves and Toy, architects; the architect's house in Salisbury — John E. Ramsey. The award winners were on view at the meeting along with a chapter-sponsored exhibit of painting

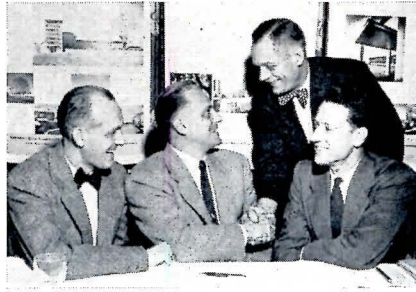

CENTRAL PENNSYLVANIA A.I.A. past president William J. Zalewski (standing) congratulates newly-elected president W. Robert Arnold, while the new vice president, Philip F. Hallock, and Clifford L. Coleman, reelected secretary, beam. Not present: the new treasurer, Francis R. Sullivan

and sculpture by North Carolina artists. Among the major addresses at the meeting was one by A.I.A. South Atlantic Regional Director Herbert C. Millkey, of Atlanta, who emphasized the importance of professional solidarity among architects. David C. Baer, A.I.A., Houston, talked to the delegates about the A.I.A. accounting system; this speech was supplemented by a panel discussion on the subject headed by Willard J. Graham, professor of accounting at the School of Business, University of North Carolina. Members elected F. Carter Williams to succeed A. G. Odell as president of the chapter; other officers elected were W. R. James Jr., vice president; J. W. Griffith, treasurer; Cyril H.

SOUTHWEST CLAY PRODUCTS Association has established a new scholarship for architecture students; and here the Association's executive secretary, Clayton T. Grimm, is shown presenting the program to R. Max Brooks, Texas Society of Architects vice president; looking on is the Society's executive director, John Flowers Jr.



Pfohl, secretary; Mr. Odell, R. Clemmer and E. D. Everhardt, directors.

Automation and Building Design

A SYMPOSIUM on "The Application of Automation to Building Design and Construction" will be held May 12-13 at Michigan State College, East Lansing, Mich. The symposium is sponsored by the Department of Civil Engineering as part of an overall School of Engineering symposium, "Automation — Engineering for Tomorrow," arranged as a feature of this year's Centennial celebration at Michigan State. As listed on the Civil Engineering's preliminary program, topics to be discussed will include the status of automation in the building industry, modular coordination, the architect and automation, automation techniques in the design of concrete buildings and of other than concrete buildings. The Civil Engineering group will join the larger session for a day devoted to two panel discussions — one on adaptation of automation in the manufacture of building materials and products, the other on adapting construction equipment to automation. The sessions are open to all interested.

Photographers on Parade

A SPECIAL EXHIBIT of architectural photography sponsored by the American Institute of Architects and planned with the cooperation of the Architectural Photographers Association will be held in the A.I.A. Gallery in Washington from May 20 through June 24. Entries are invited until May 2 from all professional photographers who have had their work

(Continued on page 16)

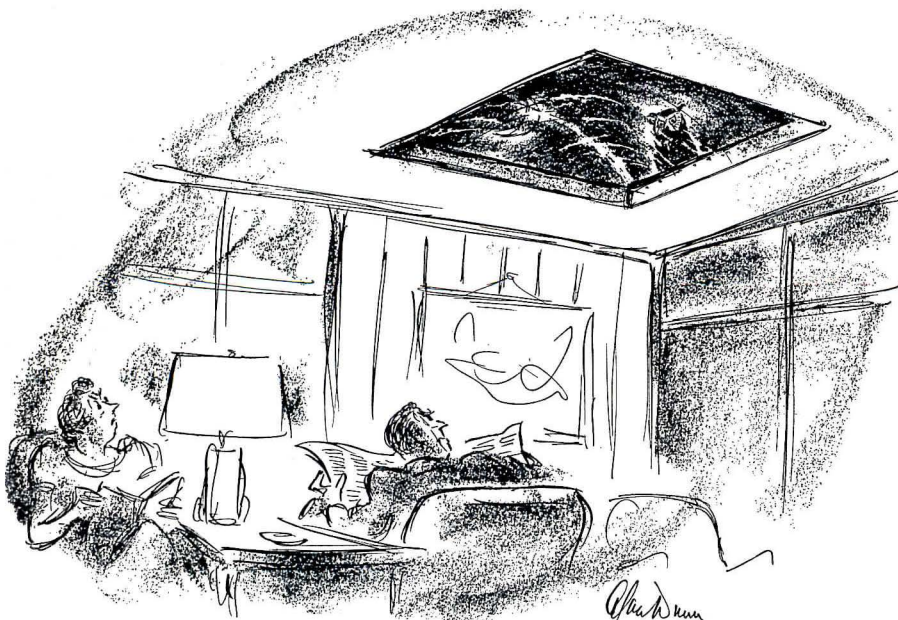

— Drawn for the RECORD by Alan Dunn

(Continued from page 15)

published in national publications within the last five years. Three awards of merit will be selected from the exhibit by Beaumont Newhall, curator of George Eastman House, Rochester, who has also consented to choose the prints for the exhibition. After its showing at the A.I.A. the exhibit will be circulated by the Traveling Exhibition Service of the Smithsonian Institution. Details on submission from: Mrs. Alice G. Korff, Curator of Gallery, The American Institute of Architects, 1735 New York Avenue N.W., Washington 6, D. C.

Hitchcock Award to Hitchcock

THE SOCIETY OF ARCHITECTURAL HISTORIANS, holding its eighth annual meeting January 27-30 in New York, presented its Alice Davis Hitchcock Medal to Henry-Russell Hitchcock for his two-

volume study of *Early Victorian Architecture in Britain* (see review, page 46). The medal, an annual award "for the outstanding contribution during the year to the history of architecture," was donated to the Society last year by Mr. Hitchcock in honor of his mother. One of the major panels on the Society's four-day program was "Architectural History and the Present-Day Architect," which was moderated by Carroll L. V. Meeks of Yale University; other panelists were Max Abramovitz of the New York architectural firm of Harrison and Abramovitz; Howard Dearstyne of Colonial Williamsburg; James Marston Fitch of Columbia University; Philip Johnson of the Museum of Modern Art; and Vincent Scully of Yale University. Delegates elected these new officers: James C. Van Derpool, Columbia University — presi-

dent; Richard H. Howland, Johns Hopkins University — vice president; Barbara Wriston — secretary; and Robert Walker, Swarthmore College — treasurer.

Houston in '59?

OPENING DATE of the Houston World's Fair, formerly tentatively set for 1956, has been postponed to "1959 at the earliest," on recommendation of Booz, Allen and Hamilton, management consultants who were engaged to make an exhaustive economic and feasibility survey. Also recommended was consideration of several other sites than the one originally leased, with the idea that more favorable public support might be realized if the Fair site could replace blighted or slum areas. Gosta Sjolín, A.I.A., is chairman of the Fair's Committee on Planning and Design.

MORE THAN 25,000 THROUGH THE HOMEBUILDERS' BIG SHOW IN CHICAGO

THE REAL BOOM IN HOME BUILDING in America lies ahead of us, not behind us," was the opening shot of retiring President R. G. ("Dick") Hughes at the eleventh annual convention of the National Association of Home Builders in Chicago from January 16 to 20. His optimism was echoed through the week in the various speeches and discussions and in the elaborate and sometimes spectacular displays of the approximately 350 manufacturers represented. In numbers alone the "biggest convention ever" mirrored the enthusiasm of more than 25,000 attending.

Emphasis on design and research pointed up the importance of the architect's role in house planning. Architect-builder Carl Koch, designer of the much-talked-about Techbuilt house, referred to "a new concept of a man's castle," which "cannot be new just to be different."

Stressing the importance of teamwork and mass production, he went on to say, "When mass-producing, there is more time and money for research and study. You can continue making even a simple drawer until you develop 'the' right drawer." Speaking on the same panel, Edward M. Fickett, A.I.A., of Los Angeles, espoused close cooperation between the architect and builder all the way from site selection to the selling program. Neil A. Conner, A.I.A., direc-

tor of the FHA Architectural Standards Division, reported that the FHA is devoting more and more consideration to better quality housing.

Two research villages were subjects of reports at the convention. U. S. Gypsum Company, sponsor of a Research Village at Barrington, Ill. (AR, March 1954, pp. 10-12), feted the architects of their six research houses, who viewed the finished products for the first time. Reportedly happy with the results of their objectives (among others, to contribute new design and construction ideas and to create new uses for building materials), they listened to supervising architect Morgan Yost outline to an SRO house the history of the "idea."

Ned Cole, N.A.H.B. project manager of the Air Conditioned Research Village in Austin, Tex., reported that all 22 families occupying the Village homes are happy with their air conditioning systems and would insist on air conditioning in any subsequent home they might purchase, provided it was included in the mortgage.

A technological research program would be a "wonderful thing" for the building industry, wished FHA Commissioner Norman P. Mason in his turn, conjecturing that \$1 per house from every builder would support such a program.

Home remodeling will be a \$6 billion program during 1955, experts on a panel discussing profits from same predicted. Sam Paul, A.I.A., of Long Island, suggested that a complete "diagnosis" of any house to be remodeled be completed by an architect and engineer before entering the planning or constructing phase.

One of the features of the convention was a model of the N.A.H.B. Home Center of America, the eight-story building nearing completion in Washington, which will house displays of materials and equipment used in house construction and the world's most complete reference library on home building.

Among award winners of the week were nine architect-builder teams, who were presented with N.A.H.B. Awards of Merit for producing the most outstanding new house designs of 1954, and ten architect-builder-land planner teams, who won N.A.H.B. Awards of Merit in the Neighborhood Development Competition.

Earl W. Smith of El Cerrito, Calif., was elected new N.A.H.B. president. Other officers-elect are Joseph B. Maverstick, Dayton, Ohio, first vice president; V. O. Stringfellow, Seattle, Wash., second vice president; Franklin L. Burns, Denver, Col., treasurer; and Carl Mitnick, Merchantsville, N. J., Secretary.

(More news on page 20)

client

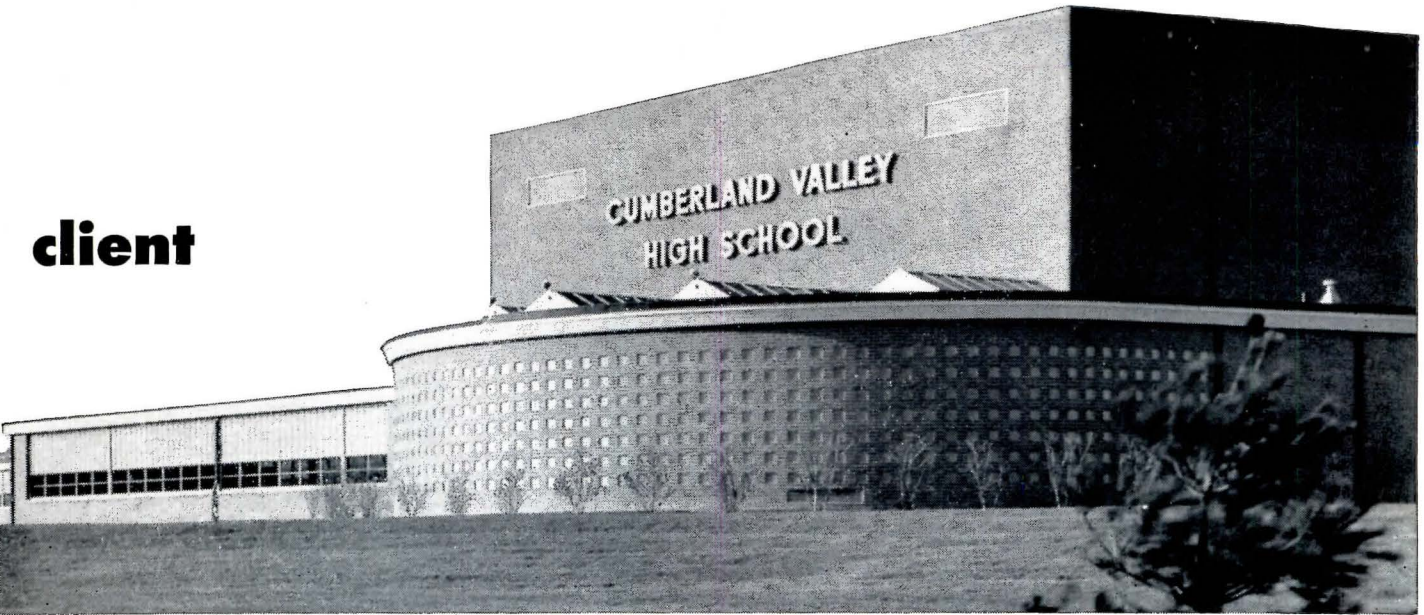

"Rambler" construction of Cumberland Valley Joint High School dramatically demonstrates need for Honeywell Customized Temperature Control.

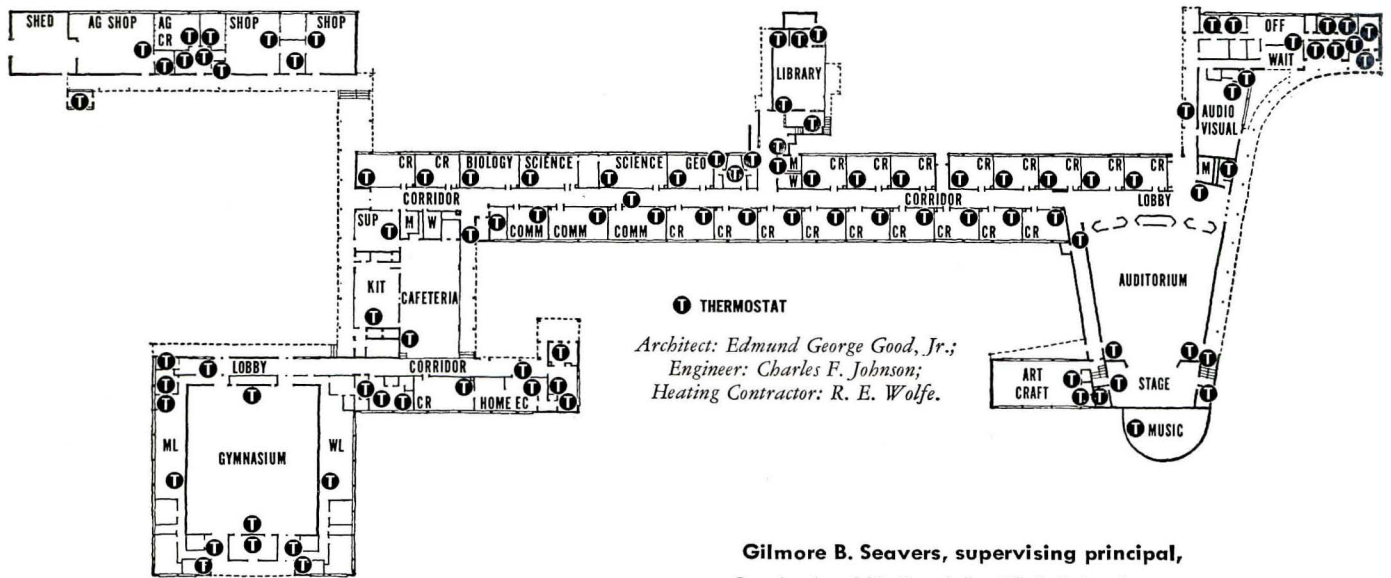

For comfortable, more productive temperature in new or existing buildings — of any size — specify Honeywell Customized Temperature Control

Whether it's a school, office, motel, hospital, factory—any building of any size—new or existing, Honeywell Customized Temperature Control can help meet your clients' heating, ventilating, air conditioning and industrial control problems.

You can give your clients more comfort and efficiency, and they'll save fuel, too.

For full facts on Honeywell Customized Temperature Control, and the economical Honeywell Periodic Maintenance Plan, call your local Honeywell office. Or write Honeywell, Dept. AR-3-29, Minneapolis 8, Minnesota.

Gilmore B. Seavers, supervising principal, Cumberland Valley Joint High School, says:

"It is our point of view that the thermal environment of a modern secondary school is a major factor in the interest of health, happiness and alertness of students and that the adequate and efficient control of a modern heating and ventilating system is therefore essential. Honeywell Customized Temperature Control has our sincere endorsement."



MINNEAPOLIS
Honeywell

Customized Temperature Control



112 offices across the nation

CONSTRUCTION COST INDEXES

Labor and Materials

U. S. average 1926-1929=100

Presented by Clyde Shute, manager, Statistical and Research Division, F. W. Dodge Corp., from data compiled by E. H. Boeckh & Assocs., Inc.

NEW YORK

ATLANTA

Period	Residential		Apts., Hotels Office Bldgs. Brick and Concr.	Commercial and Factory Bldgs. Brick and Concr.		Brick and Steel	Residential		Apts., Hotels Office Bldgs. Brick and Concr.	Commercial and Factory Bldgs. Brick and Concr.		Brick and Steel
	Brick	Frame		Brick	Brick		Brick	Frame		Brick	Brick	
1930	127.0	126.7	124.1	128.0	123.6		82.1	80.9	84.5	86.1	83.6	
1935	93.8	91.3	104.7	108.5	105.5		72.3	67.9	84.0	87.1	85.1	
1939	123.5	122.4	130.7	133.4	130.1		86.3	83.1	95.1	97.4	94.7	
1946	181.8	182.4	177.2	179.0	174.8		148.1	149.2	136.8	136.4	135.1	
1947	219.3	222.0	207.6	207.5	203.8		180.4	184.0	158.1	157.1	158.0	
1948	250.1	251.6	239.4	242.2	235.6		199.2	202.5	178.8	178.8	178.8	
1949	243.7	240.8	242.8	246.4	240.0		189.3	189.9	180.6	180.8	177.5	
1950	256.2	254.5	249.5	251.5	248.0		194.3	196.2	185.4	183.7	185.0	
1951	273.2	271.3	263.7	265.2	262.2		212.8	214.6	204.2	202.8	205.0	
1952	278.2	274.8	271.9	274.9	271.8		218.8	221.0	212.8	210.1	214.3	
1953	281.3	277.2	281.0	286.0	282.0		223.3	224.6	221.3	221.8	223.0	
1954	285.0	278.2	293.0	300.6	295.4		219.6	219.1	223.5	225.2	225.4	
Oct. 1954	285.4	278.0	294.1	302.3	296.7		220.2	219.7	225.0	226.6	227.1	
Nov. 1954	285.8	278.5	294.2	302.3	296.8		220.3	220.0	224.3	226.1	226.7	
Dec. 1954	285.8	278.5	293.1	301.6	294.6		220.9	220.6	225.1	226.7	227.3	
			% increase over 1939						% increase over 1939			
Dec. 1954	131.4	127.5	124.2	126.0	126.4		155.9	165.4	136.6	132.7	140.0	

ST. LOUIS

SAN FRANCISCO

1930	108.9	108.3	112.4	115.3	111.3	90.8	86.8	100.4	104.9	100.4	
1935	95.1	90.1	104.1	108.3	105.4	89.5	84.5	96.4	103.7	99.7	
1939	110.2	107.0	118.7	119.8	119.0	105.6	99.3	117.4	121.9	116.5	
1946	167.1	167.4	159.1	161.1	158.1	159.7	157.5	157.9	159.3	160.0	
1947	202.4	203.8	183.9	184.2	184.0	193.1	191.6	183.7	186.8	186.9	
1948	227.9	231.2	207.7	210.0	208.1	218.9	216.6	208.3	214.7	211.1	
1949	221.4	220.7	212.8	215.7	213.6	213.0	207.1	214.0	219.8	216.1	
1950	232.8	230.7	221.9	225.3	222.8	227.0	223.1	222.4	224.5	222.6	
1951	252.0	248.3	238.5	240.9	239.0	245.2	240.4	239.6	243.1	243.1	
1952	259.1	253.2	249.7	255.0	249.6	250.2	245.0	245.6	248.7	249.6	
1953	263.4	256.4	259.0	267.6	259.2	255.2	257.2	256.6	261.6	259.7	
1954	264.6	257.9	263.7	273.3	266.2	257.4	249.2	264.1	272.5	267.2	
Oct. 1954	265.5	258.8	265.1	274.9	268.2	260.6	252.6	266.8	276.0	270.3	
Nov. 1954	266.2	259.7	265.2	275.0	268.4	260.0	252.0	266.0	275.4	269.7	
Dec. 1954	266.2	259.7	265.3	275.1	268.6	260.6	252.6	266.9	276.1	270.6	
			% increase over 1939						% increase over 1939		
Dec. 1954	141.5	142.7	123.5	129.6	125.7	146.7	154.3	127.3	126.4	132.2	

The index numbers shown are for combined material and labor costs. The indexes for each separate type of construction relate to the United States average for 1926-29 for that particular type — considered 100.

Cost comparisons, as percentage differences for any particular type of construction, are possible between localities, or periods of time within the same city, by dividing the difference between the two index numbers by one of them; i.e.:

index for city A = 110
 index for city B = 95
 (both indexes must be for the same type of construction).
 Then: costs in A are approximately 16 per cent higher than in B.

$$\frac{110-95}{95} = 0.158$$

Conversely: costs in B are approximately 14 per cent lower than in A.

$$\frac{110-95}{110} = 0.136$$

Cost comparisons cannot be made between different types of construction because the index numbers for each type relate to a different U. S. average for 1926-29.

Material prices and wage rates used in the current indexes make no allowance for payments in excess of published list prices, thus indexes reflect minimum costs and not necessarily actual costs.

These index numbers will appear regularly on this page.

THE MELLON BANK, OLD AND NEW



A great tradition expressed in architectural terms unites the neo-classic of the twenties and contemporary forms

THE MELLON NATIONAL BANK AND TRUST is an American institution. Its 86-year history is closely tied to the country's economic and industrial growth; the bank's rise parallels the increasing importance of the city of Pittsburgh after the Civil War. Since 1952 the Mellon Bank has owned and occupied the lower floors of 525 William Penn Place, popularly known as the U. S. Steel-Mellon Building, as modern an architectural concept as building codes and technology permit. At the same time, the bank continues to occupy its conservatively modernized former building, a Pittsburgh landmark, impressively symbolic. The problems of joint ownership of the new building were great (525 William Penn Place Corp. actually owns the portion leased by U. S. Steel) but that is another story. The architectural difficulties of indissolubly joining the 1924 Mellon Bank and the 1952 U. S. Steel Building, while preserving the identity of each, were manifold. Underlying was the necessity for conservation, not merely conservatism but rather a conscious effort to capitalize on the traditional spirit, making it permeate the new and revivifying it in the old.



This architectural expression of the institution's continuity takes different forms within the two joined structures. In some of the new a human quality, reflecting today's increasing concern with humanity, is evident in the warm wood used where once marble would have been

1873

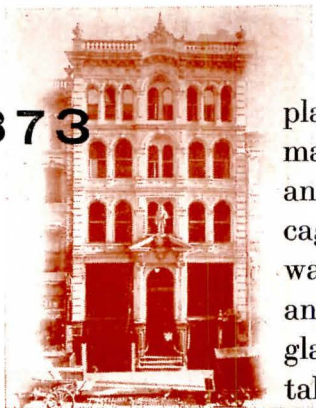

placed — marble as the ultimate and only really elegant material. But the main banking room's character is retained and even improved over the original: the fancy tellers' cages, reminiscent of the days before the classical building was erected, have been eliminated. The marble facings and counter tops, simplified, remain; the unpolished plate glass screens above are so much in character with the tall, stately room that one wonders why the fussy bronze work they replace was installed in the first place.

We have called the Mellon Bank Building and its sixty-five-foot-high main room "old." It is so only compara-

Mellon National Bank and Trust Company, Pittsburgh, Penna.

W. K. Harrison, M. Abramovitz, W. Y. Cocken, Associate Architects

Moran, Proctor, Freeman & Meuser, Foundation Engineers

Edwards & Hjorth, Structural Engineers

Meyer, Strong & Jones, Mechanical & Electrical Engineers

Ann Hatfield Associates, Interior Designers

Rudolf Wendel, Lighting Consultant

Turner Construction Co., General Contractors

1869



All photos printed in color: Trinity Court Studio

MELLON BANK

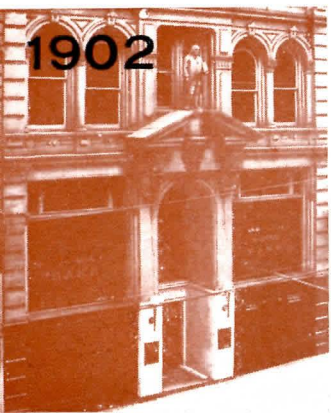

1902



1918



1924

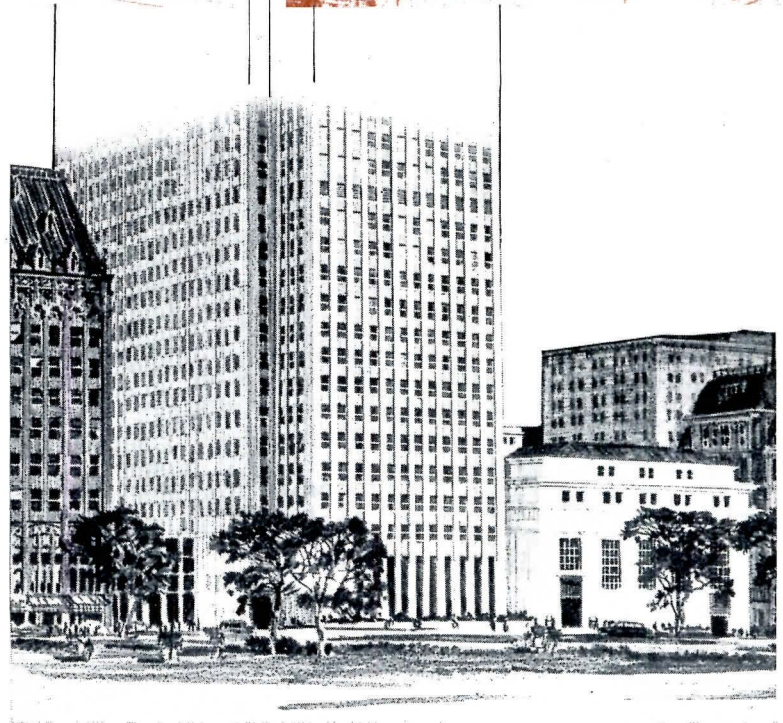
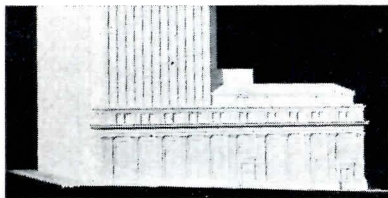
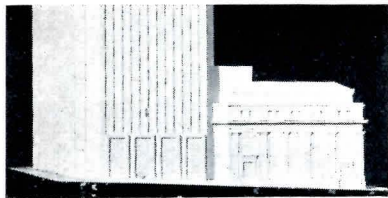

1869: the small, private bank of T. Mellon & Sons. 1873: new, cast-iron-fronted quarters. 1902: T. Mellon & Sons becomes the Mellon National Bank; the entrance was modernized. Late 1800's through 1918: adjoining buildings acquired and remodeled one by one. 1924: the neo-classical landmark. 1946: Mellon National Bank becomes the Mellon National Bank and Trust Co. Since 1952 the bank has again expanded into lower floors of 525 William Penn Pl. Models above are two of many studies of the joining of the two buildings





tively. Today's quarters are the fourth phase of architectural growth since 1869. The "old" building, dedicated in 1924, designed by Trowbridge and Livingston with E. P. Mellon associated, was preceded by an impressive assemblage of smaller buildings, covering half a city block bounded by Smithfield St., Fifth Ave. and Oliver Ave. This had grown by accretion and individual modernization in the ornamented cast iron and mahogany fashion that was then the architectural façade of successful American business, redolent of cigars and fully outfitted with cuspidors. The period of this expansion lasted until 1918; it had started when the bank's second home, a cast iron front building at 514 Smithfield St., was put up in 1873. The first home was even more humble; the bank was opened in a two-story frame structure on the other side of Smithfield in 1869.



There in reverse chronology is the bare architectural history. Implicit in it is much more. Just as parts of the newest quarters make evident an increasing concern with people, so the modest frame bank was appropriate for in-

Two illustrations above contrast tellers' cages in two architectural eras: during the age of Victorian expansion and in the neo-classic 1920's. Below, also from Victorian days: modernization did not impair the whimsical variety of design of the cast iron columns and capitals in adjacent buildings

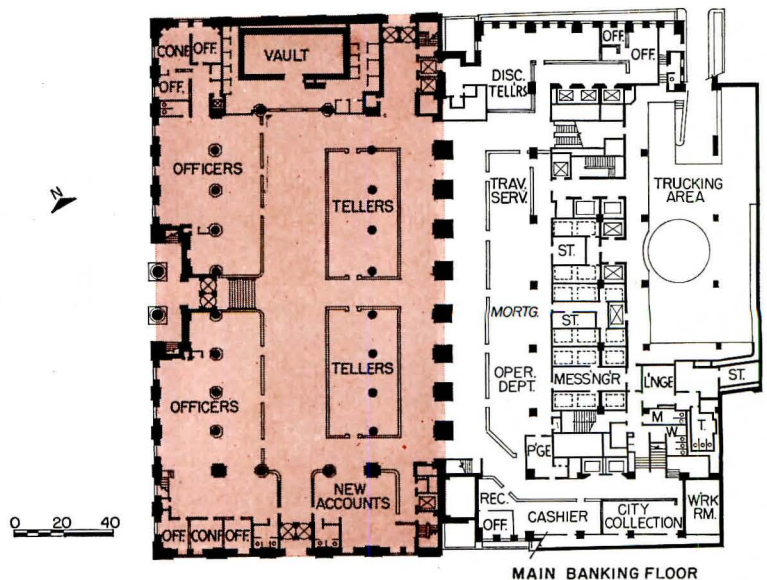

MAIN BANKING FLOOR

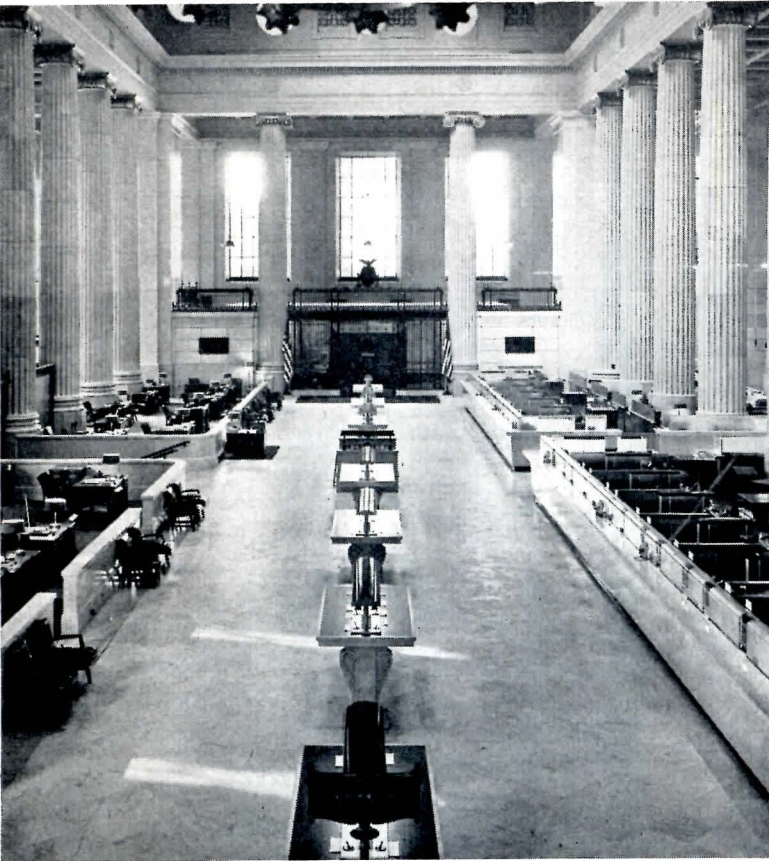

Lawrence S. Williams

Main banking room in the 1924 building has been cleaned up; marble railing around the officers' space remains, but tellers are grouped in two islands surrounded by new counters executed in marble matched to the old, with screens of bent, unpolished plate glass. At right, the totally new Trust Department in the new building; vice presidents' offices along right wall

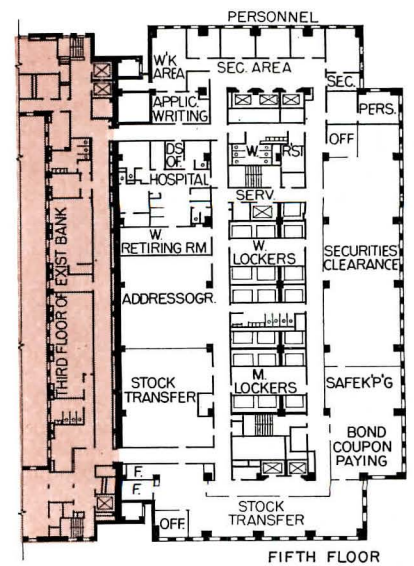
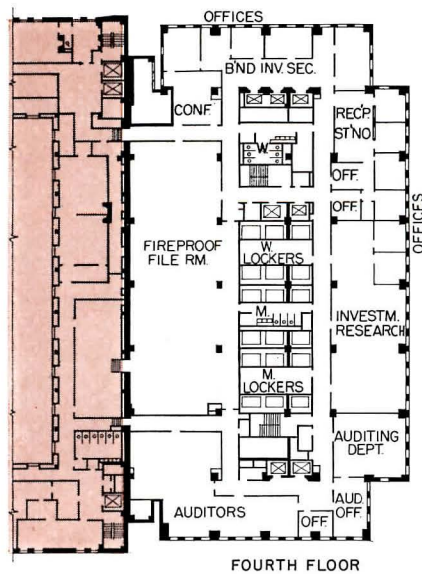
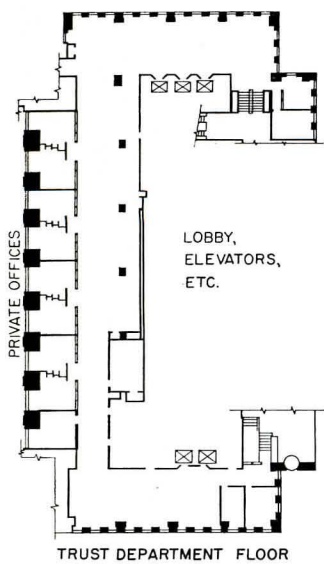



conspicuous beginnings at a time when steel, glass, coal, coke, oil and all types of industry were in need of banking facilities. It was never accidental that industrial growth and the bank's prosperity coincided. A continuing policy which combined careful conservation of resources and apparent daring in encouraging new industry made the coincidence inevitable.

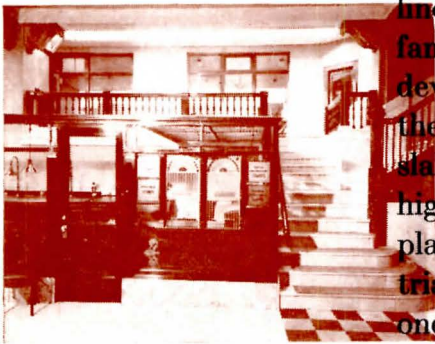

There is a parallel, too, between the bank's history and the city's. Pittsburgh's industrial growth since the Civil War is familiar; its sooty smog made newspaper headlines; so did the municipal decision — in which the Mellon family played an important part — to clean up and redevelop. It is not accidental, either, that the low mass of the 1924 structure is juxtaposed to the tall U. S. Steel slab: one towers, the other sits lower beside it, a situation highly desirable in a downtown area which, even with a plaza in front of the bank and the recently opened-up triangle at the junction of the rivers not far away, is still one of narrow streets and skyscrapers. The juxtaposition has financial value as well; the permanent low building permanently protects the tower floors, insuring their light, air, and occupancy.

We are accustomed to seeing buildings of different eras side by side on our streets. Whether or not uniform fa-

During the Victorian period of expansion the varying heights of the acquired buildings were arbitrarily unified; some had stories lopped off, others had their façades raised. The sign, MELLON NATIONAL BANK, bestrode their continuous cornice. In one building (top of page) was the Pittsburgh Clearing House. At right, the handsome old Fifth Ave. corridor

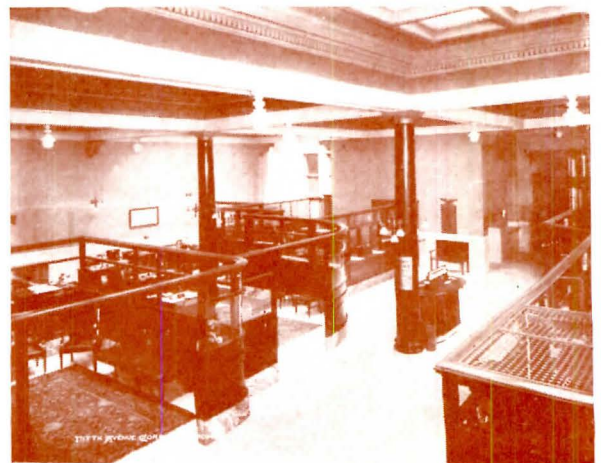

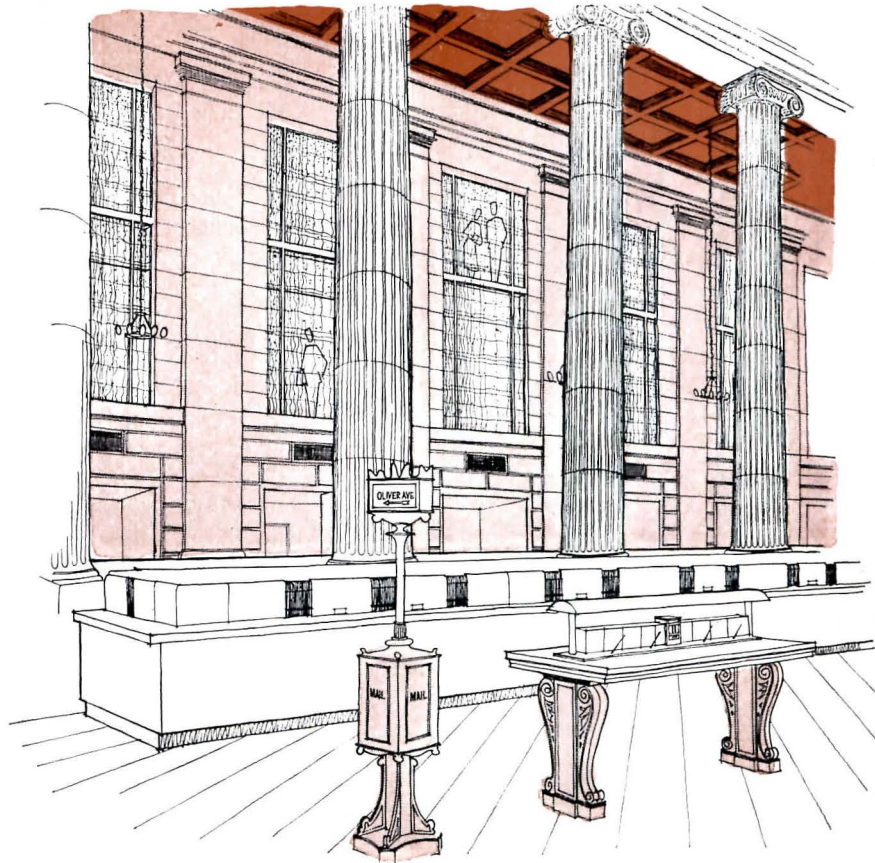

For a while the wall between the 1924 main banking room and the new building, filled with structural members and utilities, was a problem. Eventually, without interrupting bank business, the job of piercing it began. Thanks to the multistory penetrations, departments in the new buildings' lower floors now operate under the continuing influence of a very strong tradition

Drawing by Paul Wolfe

Lawrence S. Williams

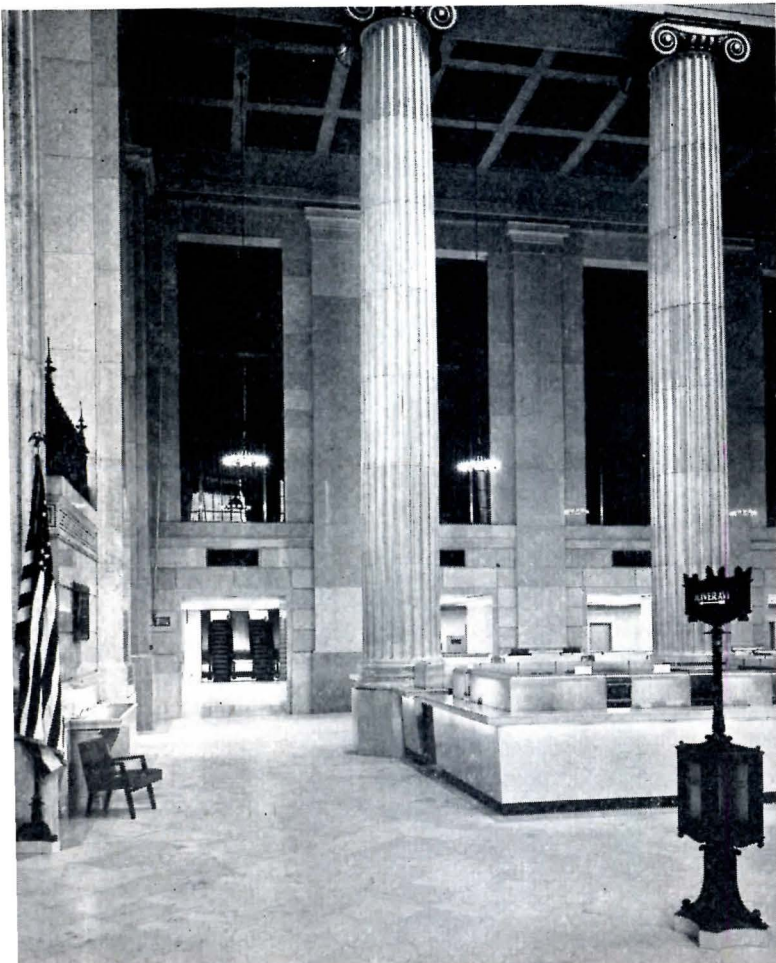



Above, Victorian office of Walter S. Mitchell, who started as the bank's first messenger and later became a director, serving as Vice President from 1916 until his death in 1930. Below, officers' quarters prior to 1924 and, right, after the neo-classic building was opened

...ades would be more satisfying esthetically (and, thinking of the dullness of conscious virtue, one wonders) to build everything alike is seldom possible economically. Inside these two structures, unlike though they are, there is a definite sense of unity architecturally achieved. The expansion into the lower stories of a new, different building is very similar to the earlier expansion from the cast iron building into all the buildings around it; at that time a duplication of decoration, furnishings and equipment, though perhaps with different capitals on the iron columns in different buildings, contributed to the unity of the entire establishment. Now, there is some new furniture, some old, in the 1924 building, some new, some old in the new space. The bank's traditions have been given the opportunity to affect even the operations carried on in the floors of the new structures. Ann Hatfield, who was the interior designer, says:



“The architects have pierced the old banking floor wall with 23-foot windows which open into the new Trust Department and recall original windows on the other three walls of the old bank. While the bronze cages have been swept away, the new islands are in marble matched to the



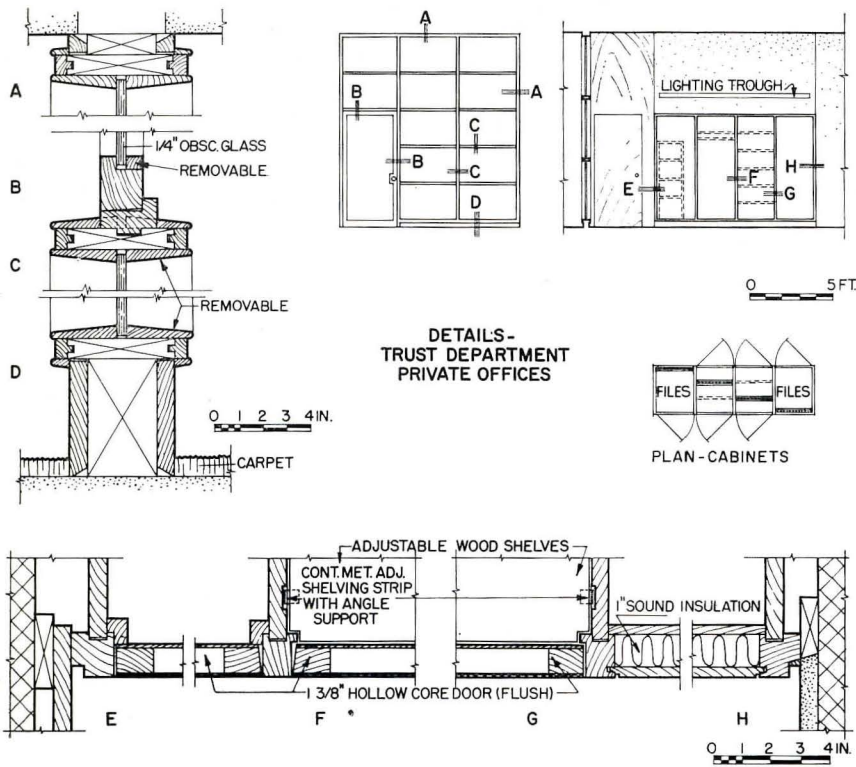

Lawrence S. Williams

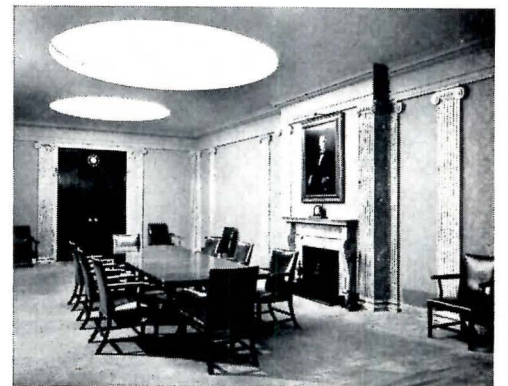

Left, present officers' quarters in the modernized 1924 building: contemporary furniture and appointments beneath a coffered ceiling adapted from the antique. Immediately above, modified traditional decor illuminated in ultra-modern fashion. Top of page, details of private offices in the Trust Department, in the new building



existing columns and partitions. The clutter is gone; the Ionic detail, the gold leaf, the coffered ceiling remain to assure depositors that there is to be no fundamental change." Of the upheaval in personnel she says: "Transplanting executives accustomed to 18th century panelled offices into smaller, neater work spaces is a delicate operation. Because it is the conviction of both the designers and the owners that human rights are important even in office decoration, conferences were endless. . . . Men moving to the new part often clung to past design, men staying in the old often decided to surround themselves with simple vertical panelling and ceiling-to-floor drapery at windows designed for roller shades. . . . Even in small public spaces, conference rooms where old customers may sit to read wills, there are relics of the old: cast aluminum chairs, circa 1903, reduced in embonpoint and reupholstered, their former walnut graining obliterated by dull black so they will look completely at home around a simple, specially designed table. . . . By using the best of the old and the most discreet of the new a natural transition was achieved. . . . The result is a bank that feels lived in, and not merely a vault for converting monies."

—Frank G. Lopez

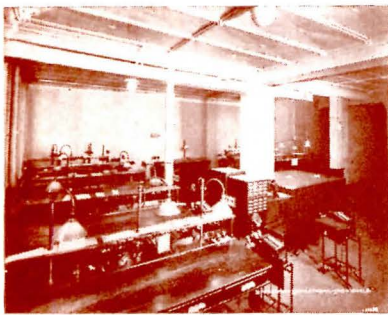

Top of page, clerical desks in bookkeeping department; center, accounting room; both in the assemblage of buildings that served the bank until the 1920's. Below, bronze tellers' cages and marble counters in the main banking room were replaced with the simply detailed, better proportioned marble and unpolished glass screens shown on facing page. The new enhances the room's classic proportions; the old obscured them. Photo at far right, facing page: loan department in new building

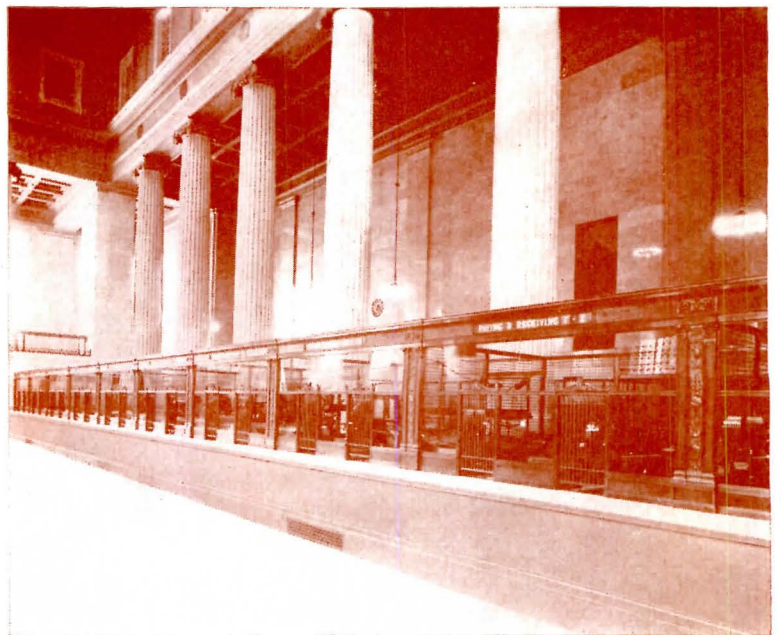

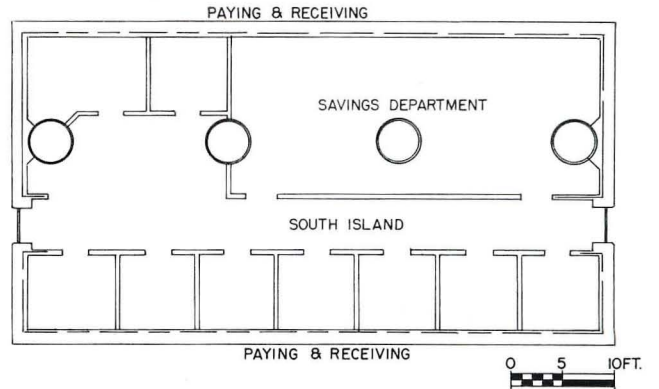
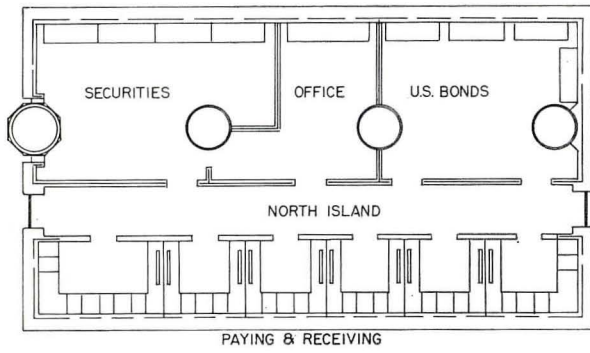

DETAILS-
MARBLE BANKING COUNTERS

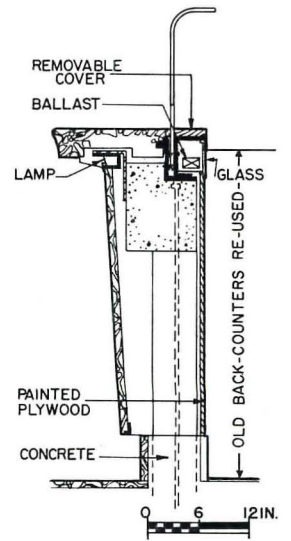
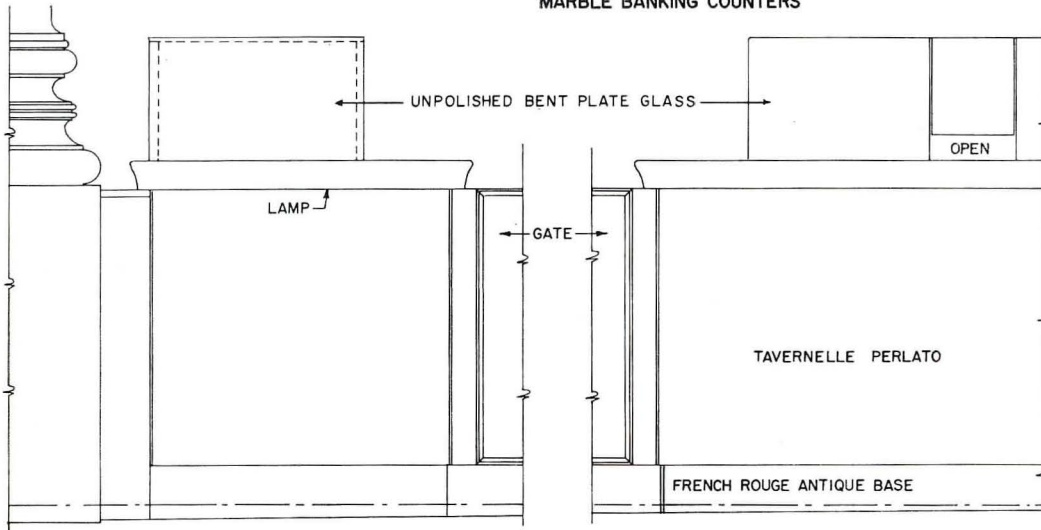

Lawrence S. Williams



John D. Schiff, Courtesy Wendel Artistic Lighting Corp.





Use of marble, as in the old building, is repeated in the new, in floors, column facings and bases; natural wood, softer and more pleasant, helps to humanize the loan department whose counters are detailed above. Open rail below, of ebonized wood set on isolated marble pedestals, separates public from bank areas without resort to the formal barrier which would once have been considered proper

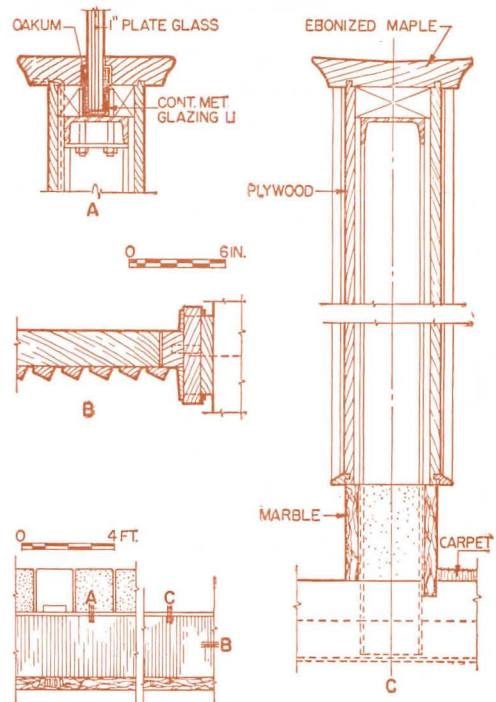

DETAILS- WOOD-PANELLED BANKING COUNTER

DETAILS- OPEN RAILING IN NEW PORTION

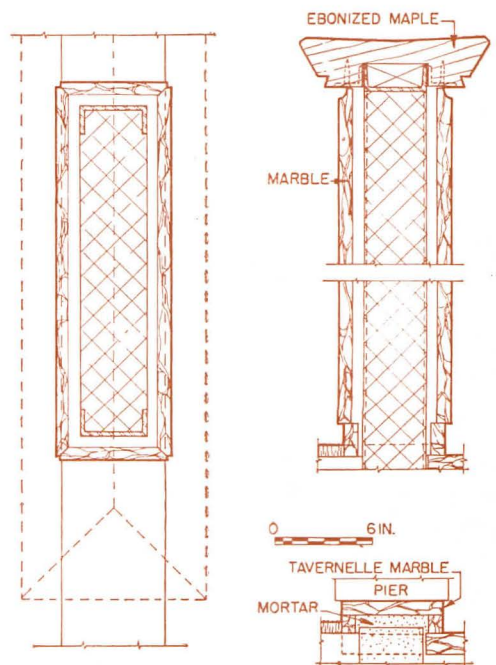
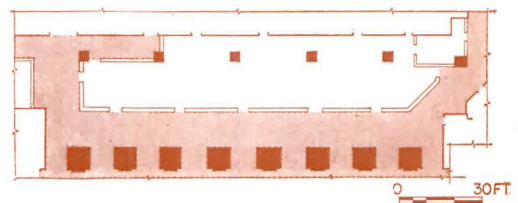

Lawrence S. Williams

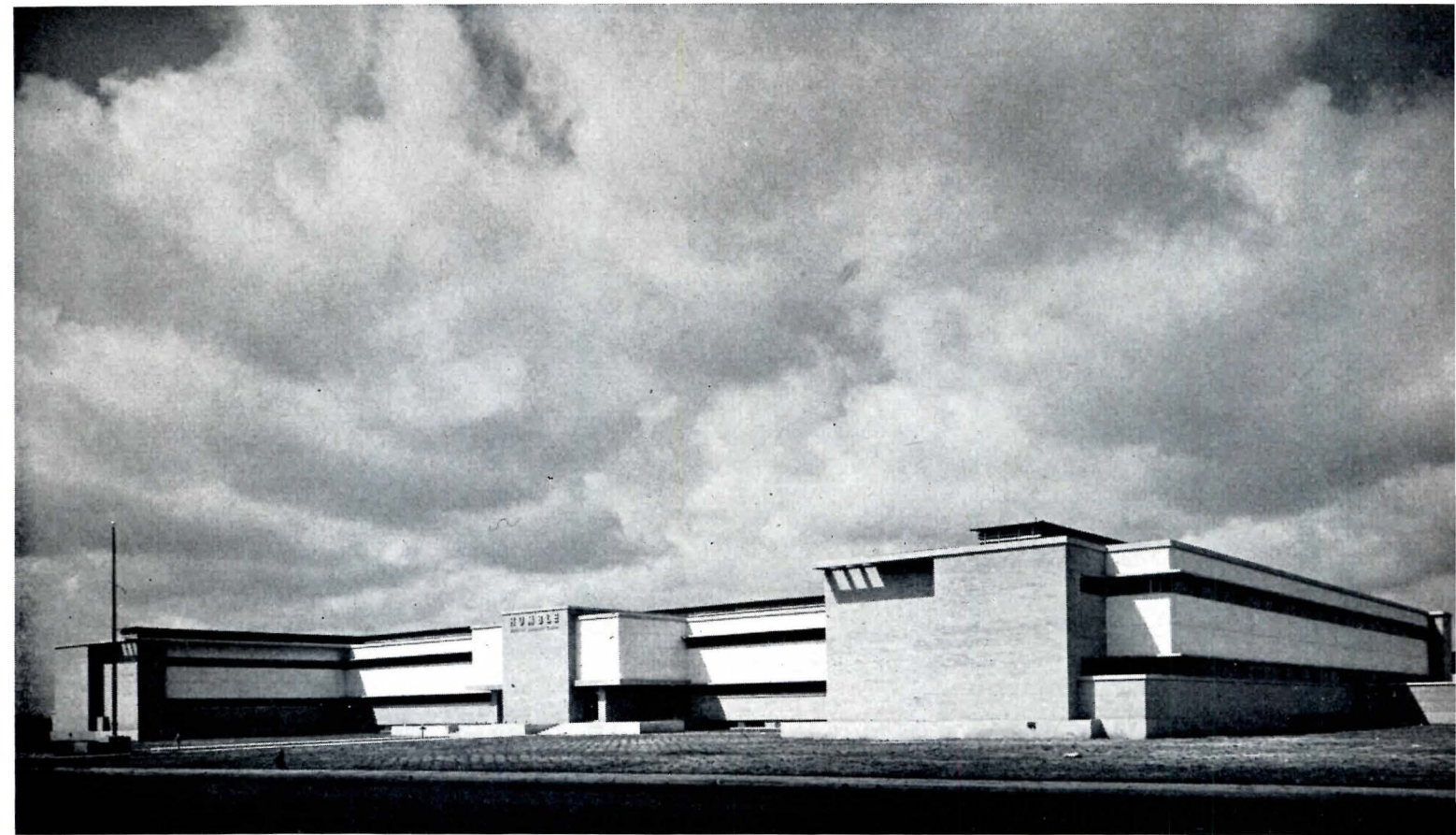

F. W. Seiders

HOUSTON RESEARCH CENTER FOR HUMBLE OIL CO.

*Mac Kie and Kamrath,
Architects*

*Walter P. Moore,
Structural Engineer*

*Howard and Johnson,
Mechanical Engineers*

*Linbeck Construction Corp.,
General Contractors*

BEFORE THIS CENTER was built, Humble Oil's research into exploration and production had been carried on by various teams and individuals in scattered and sometimes makeshift quarters. Now, for the first time, these groups have been brought together into an environment calculated both to increase their efficiency and to provide as much amenity as possible. The architectural problem was to organize a set of highly diverse yet closely related activities within such surroundings.

The 350-ft-long main structure is located on a 15-acre site facing east to a speedway; contains 300 rooms totaling 112,000 sq ft on three levels; cost approximately \$2,830,000. The structure is designed for a possible future third floor. Principal entrance is through a lobby slightly above grade, which is the intermediate of the three floors. There is ample parking for both employes and public.

A separate service building to the rear of the main structure furnishes a total of 30,000 sq ft devoted to field storage, general storage, receiving and stock rooms, certain shops and labs, and the cafeteria. There are exterior areas for testing and truck storage.

The main building is framed in steel and reinforced concrete and is faced with brick and cream colored stone. The windows are aluminum, glazed with 1/4-in polished plate; exterior doors and frames are also aluminum. Interior walls and partitions are painted plaster over structural tile; floors are finished with oxychloride cement or rubber tile; ceilings are finished with metal acoustical panels.

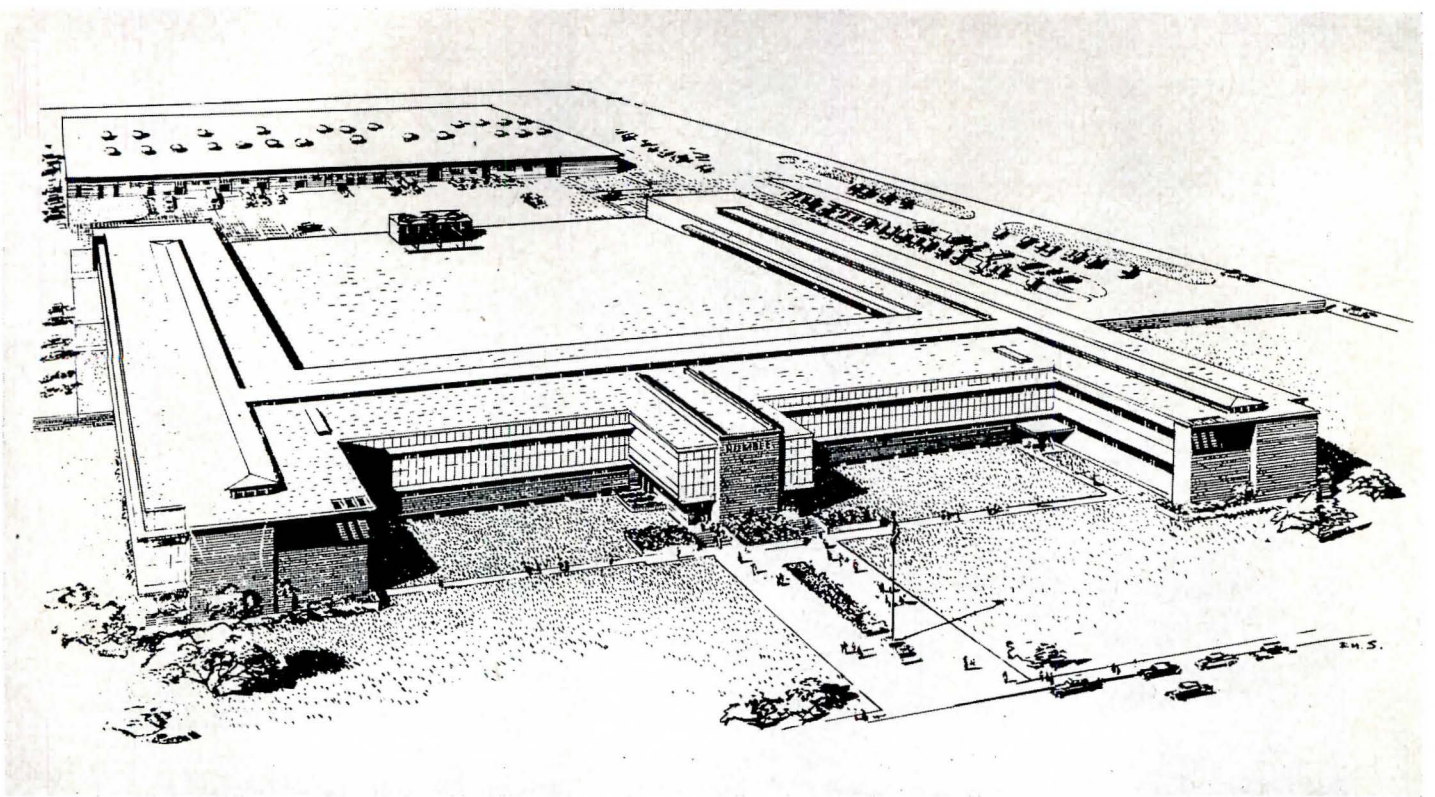

*Perspective, top, shows service building behind main structure,
Diagrammatic H-plan, below, shows principal functional groups*

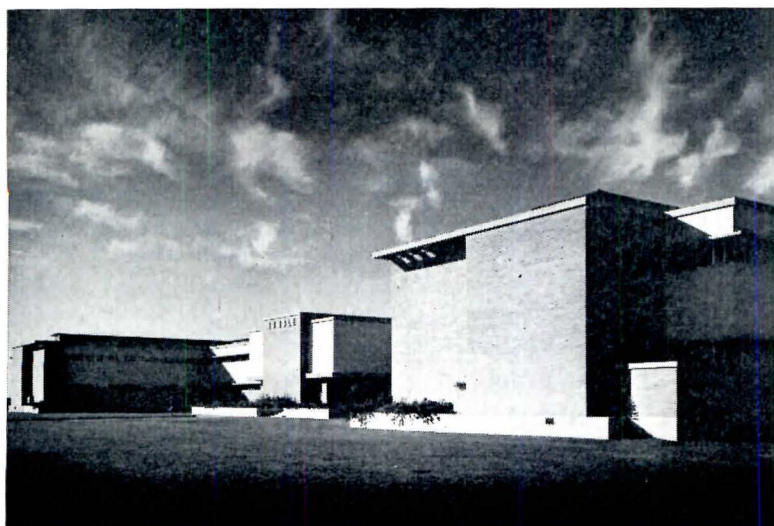
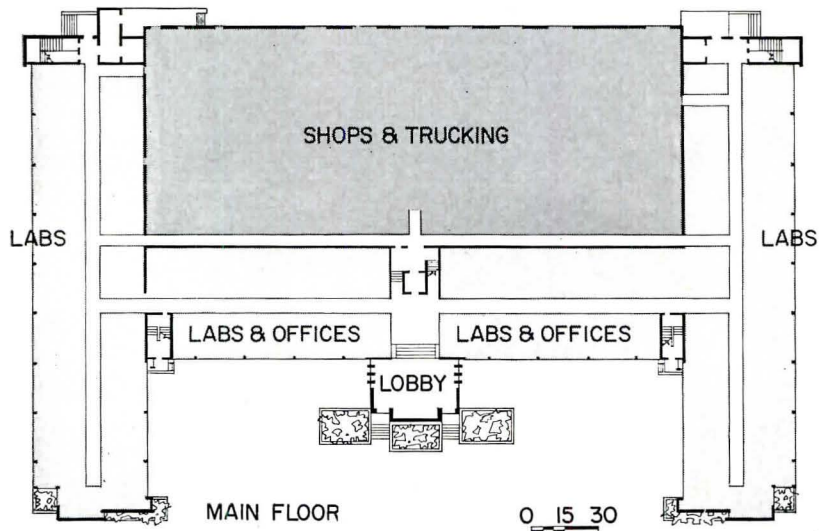

HOUSTON RESEARCH CENTER, HUMBLE OIL & REFINING CO.

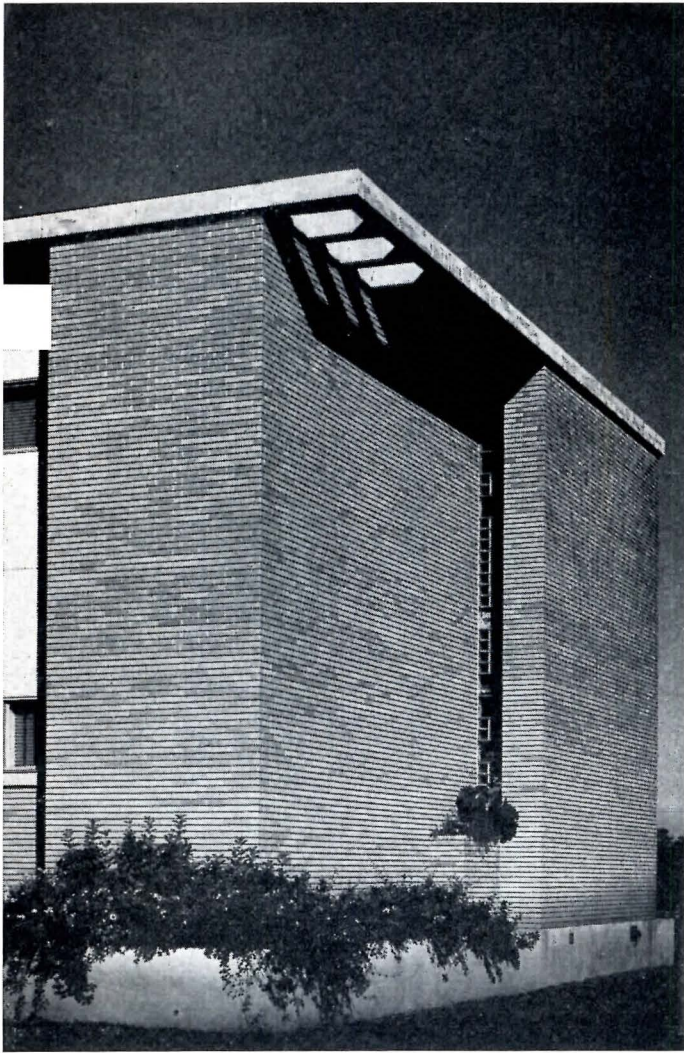

F. W. Seiders

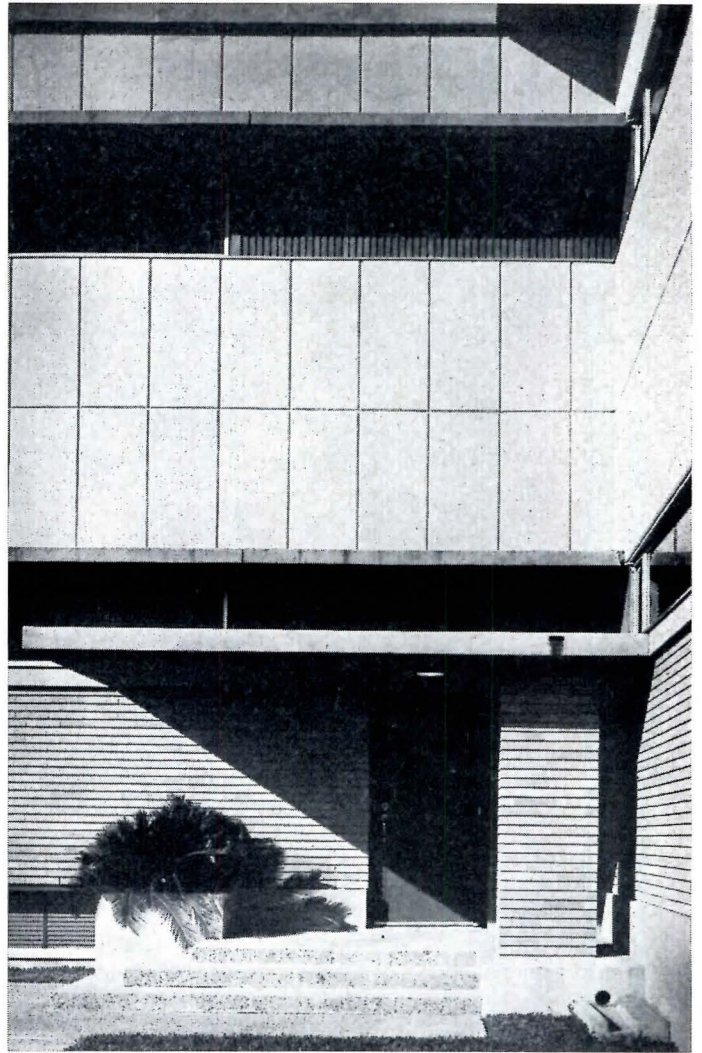

The two closeups above reveal the manner in which brick, stone, glass, and aluminum have been carefully juxtaposed for textural and color interest. Below, main lobby looking toward entrance

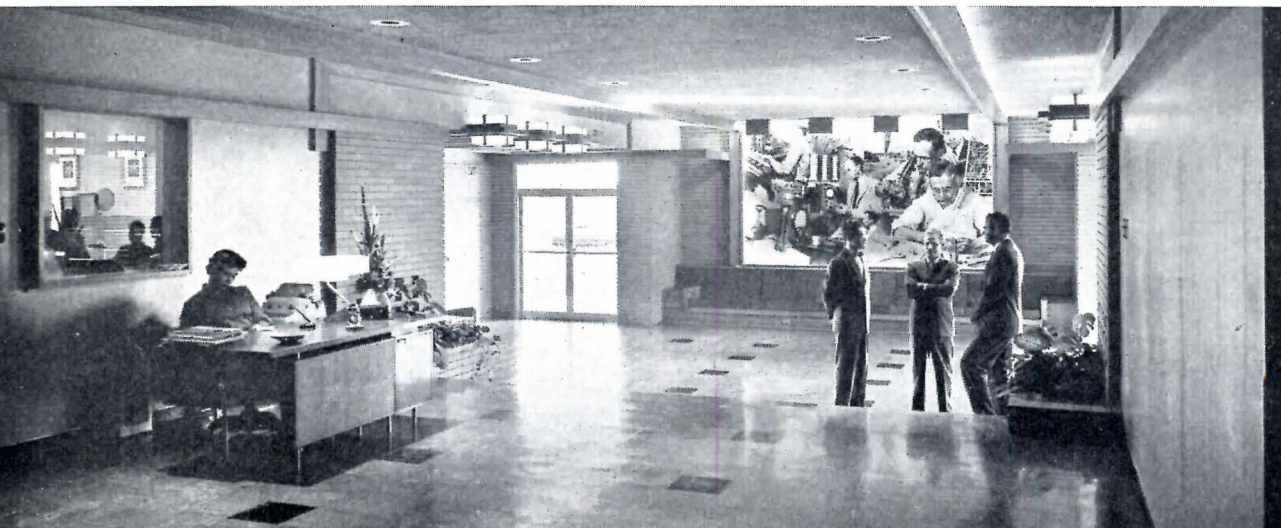

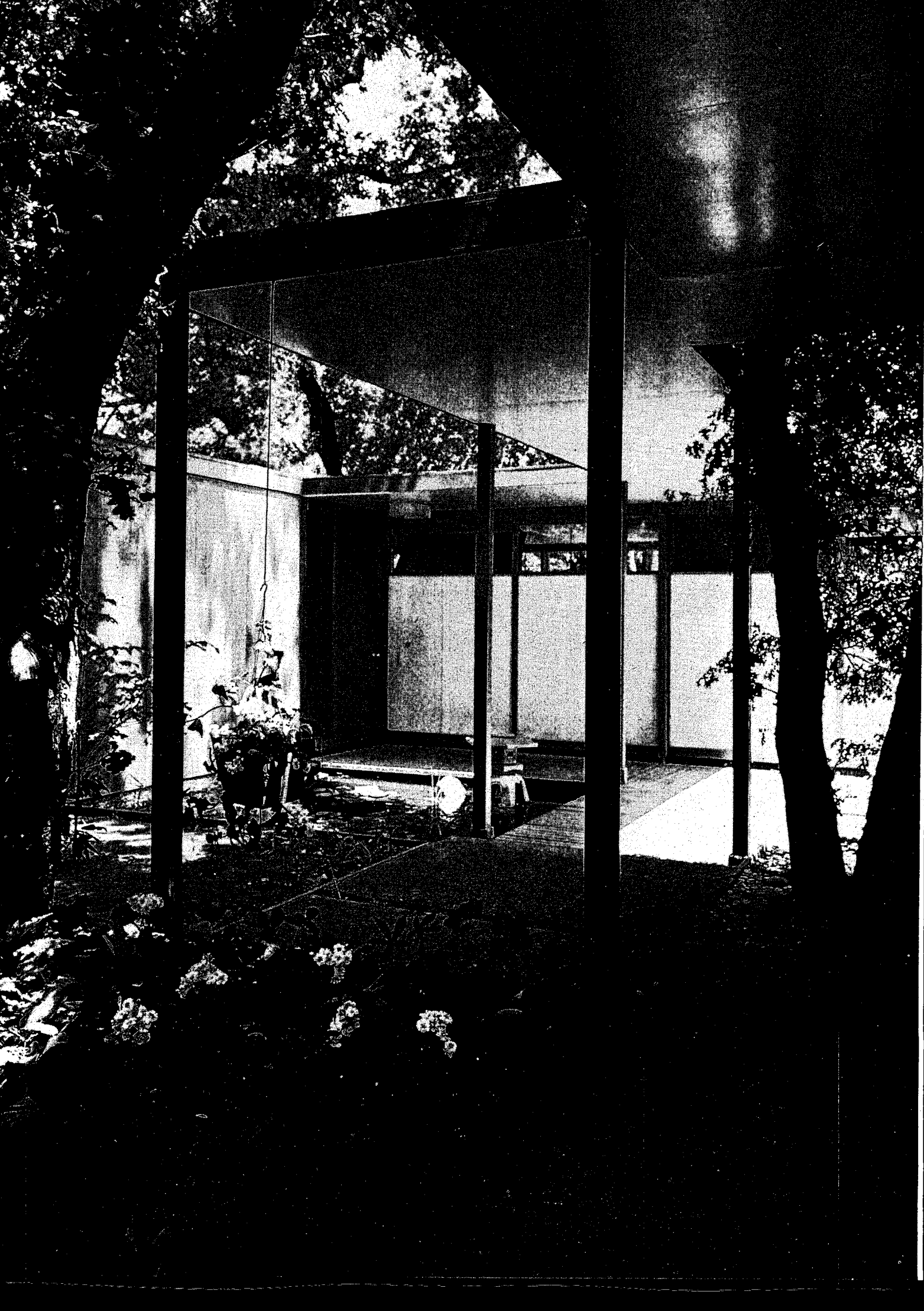

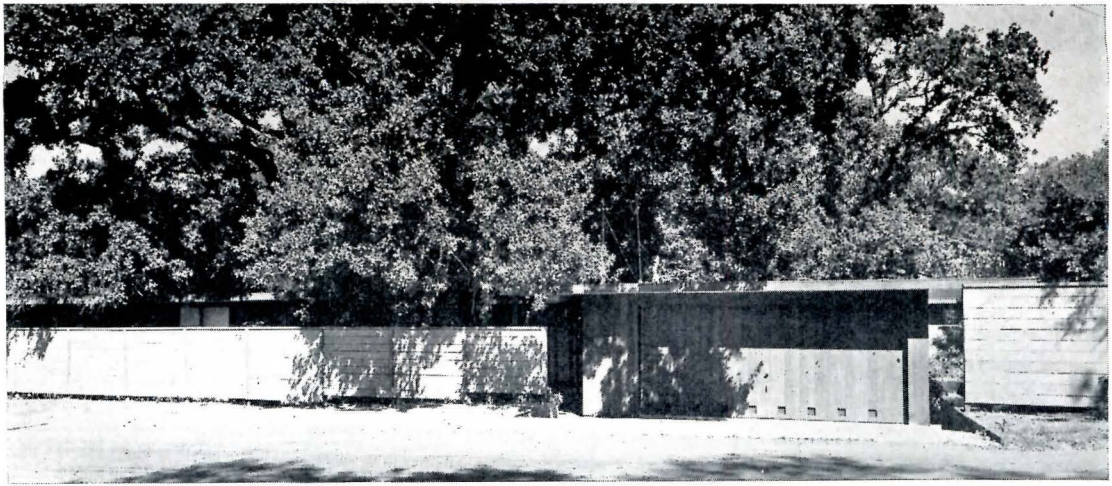

Morley Baer

TWO-FAMILY HOUSE WITH A DIFFERENCE—PRIVACY

House for Mr. and Mrs. Walter Costa

Lafayette, Calif.

Walter Costa, Architect

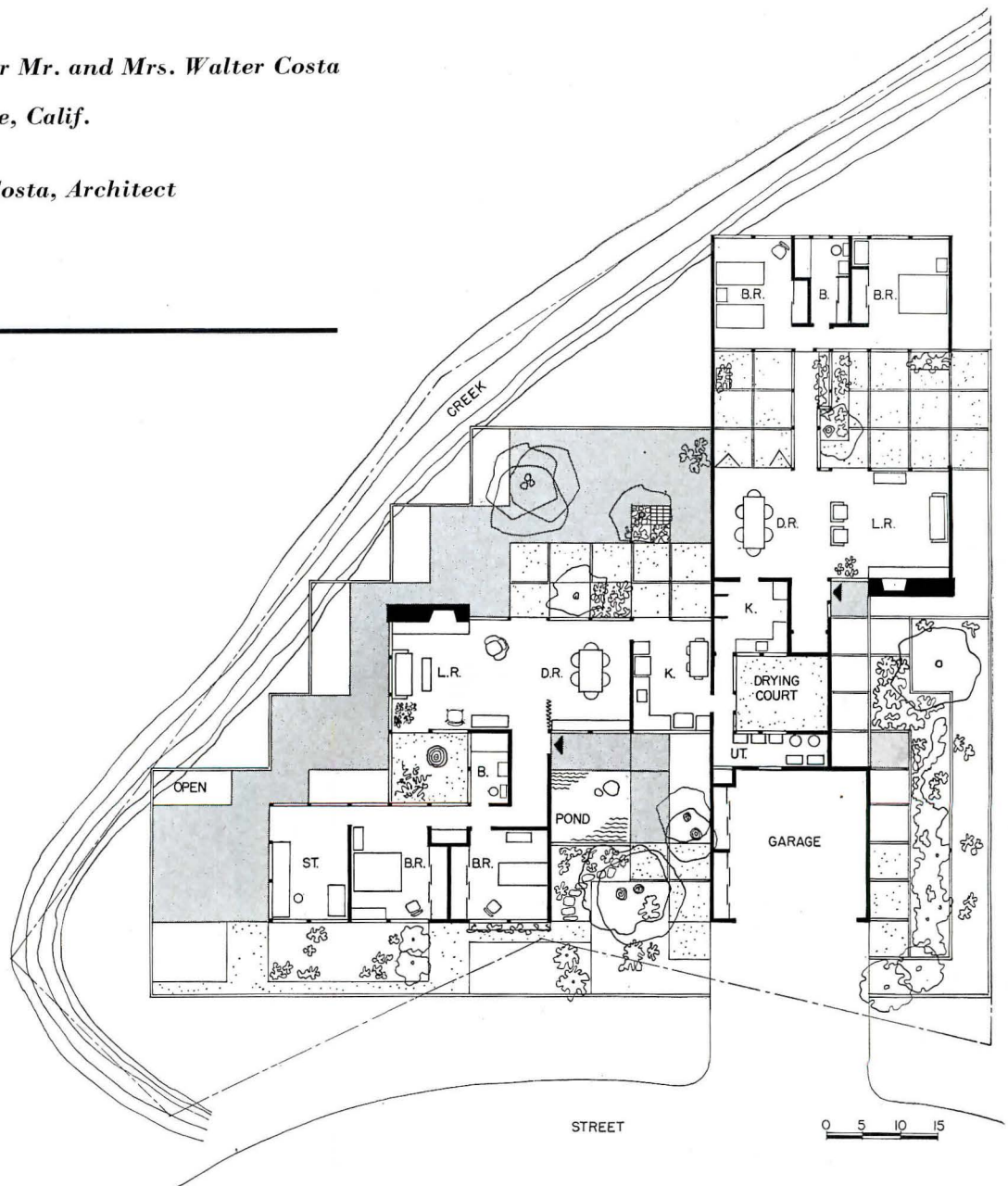

THE REASON HE BUILT A DUPLEX, Architect Walter Costa explains, is that the kind of house he and his wife wanted would not have been economically feasible without the income-producing rental unit.

The site they selected, not far outside San Francisco, was ideal for the purpose — handy to shopping, schools and transportation, almost wholly level, and triangular in shape with a brook running along the long leg. A dozen or more fine old oak trees, one of which the house literally was built around, and the location of the brook "presented the greatest challenge," the architect says "and were the primary influence on the building design."

As the plot plan on the preceding page shows, the triangularity of the lot was used to separate the two units as much as possible. Each of the two has two bedrooms, one bath, living-dining space and kitchen, and the owners' also has a combination studio and sewing room. Laundry, utility room and garage are common to the two units. A long, roof-height redwood

wall with only one opening (a door from the owners' kitchen to the utility room) separates the two and gives each an unusual amount of privacy.

The basis of the design, the architect says, was "to employ an inexpensive structural system and inexpensive materials, but to use them to their best advantage and use the funds available to acquire as much space as possible, arranged as interestingly as possible." Since the site was virtually flat, a concrete slab floor with colored cement finish was used except in the bedroom wing of the rental unit which has a wood floor, cantilevered over the creek. A 5 ft 4 in. modular grid was used with post and lintel framing and joist roof construction. Interior walls and ceilings are finished in 1/4-in. hardboard with 1/4-in. open joints between sheets; this made an inexpensive surface for painting, and the open joints created a paneled appearance which will not show cracked joints when settlement occurs. Exterior finish is glass, 1 by 6 redwood T&G applied vertically, or 1/2-in. waterproof plywood.

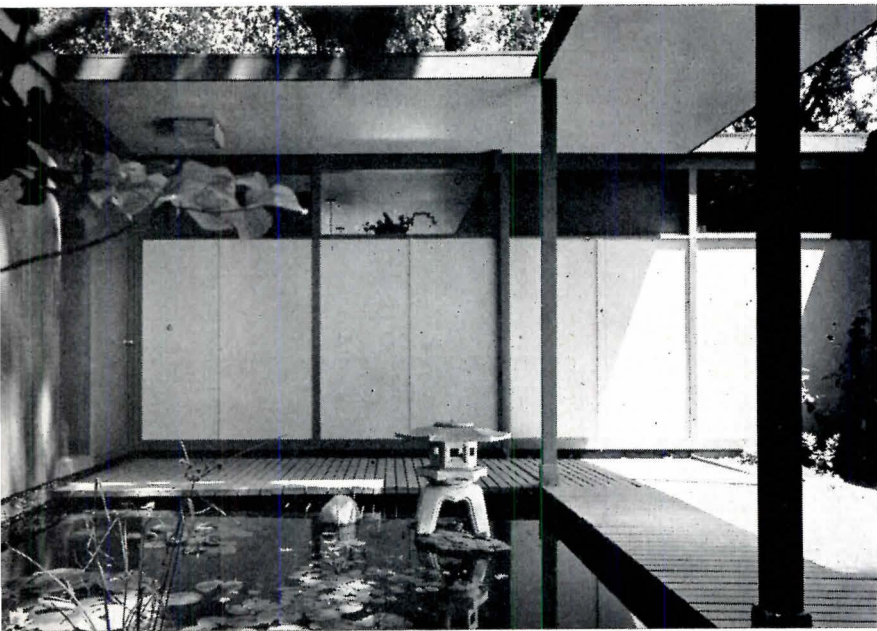

Entrance to owners' unit is through a landscaped court, along a covered walk and past a pool with an oriental lantern in one corner. The huge oak tree — 40 ft high, trunk diameter 3½ ft — around which house was built has its own glass-walled patio off living room (above right, and bottom opposite). Living-dining room and kitchen open to deck at rear, shielded by roof-high redwood fence



Morley Baer

COSTA HOUSE—OWNERS' UNIT

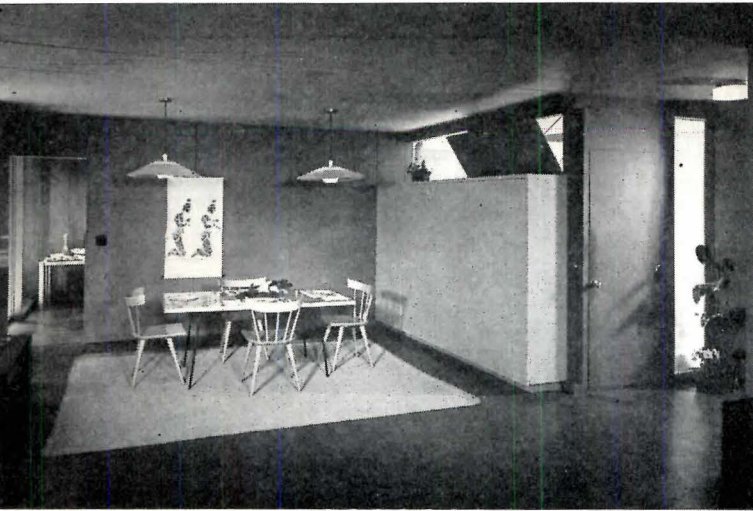

Dining area walls are less than ceiling height, increasing sense of spaciousness and improving both light and ventilation. Main entrance bypasses this area, leads almost directly to living room; rear terrace is visible from just inside door. In order to use part of lot sloping down to creek bed, an extensive deck, level with house floor and supported by concrete columns (visible in photo at bottom of page) was built. Continuation of this deck around end of living room creates secluded sunbathing areas outside bedroom and study. Japanese lanterns, prints and sculpture were acquired by owner during stay in Japan

Morley Boer



RENTAL UNIT

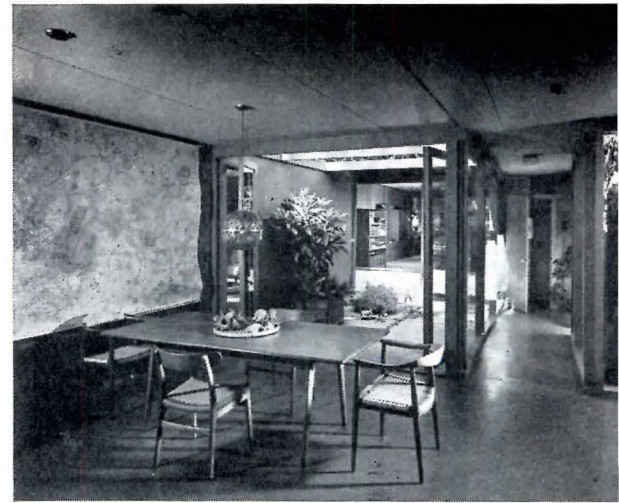

Rental unit has every bit as much privacy as owners' part of house. Entrance (left) is on opposite side of garage, with similar approach from street via court and covered walk. Unit has two inner courts, one off dining area (above) which is currently used as a child's play space and one off living room. Bedrooms (not shown) overlook the creek at rear of property

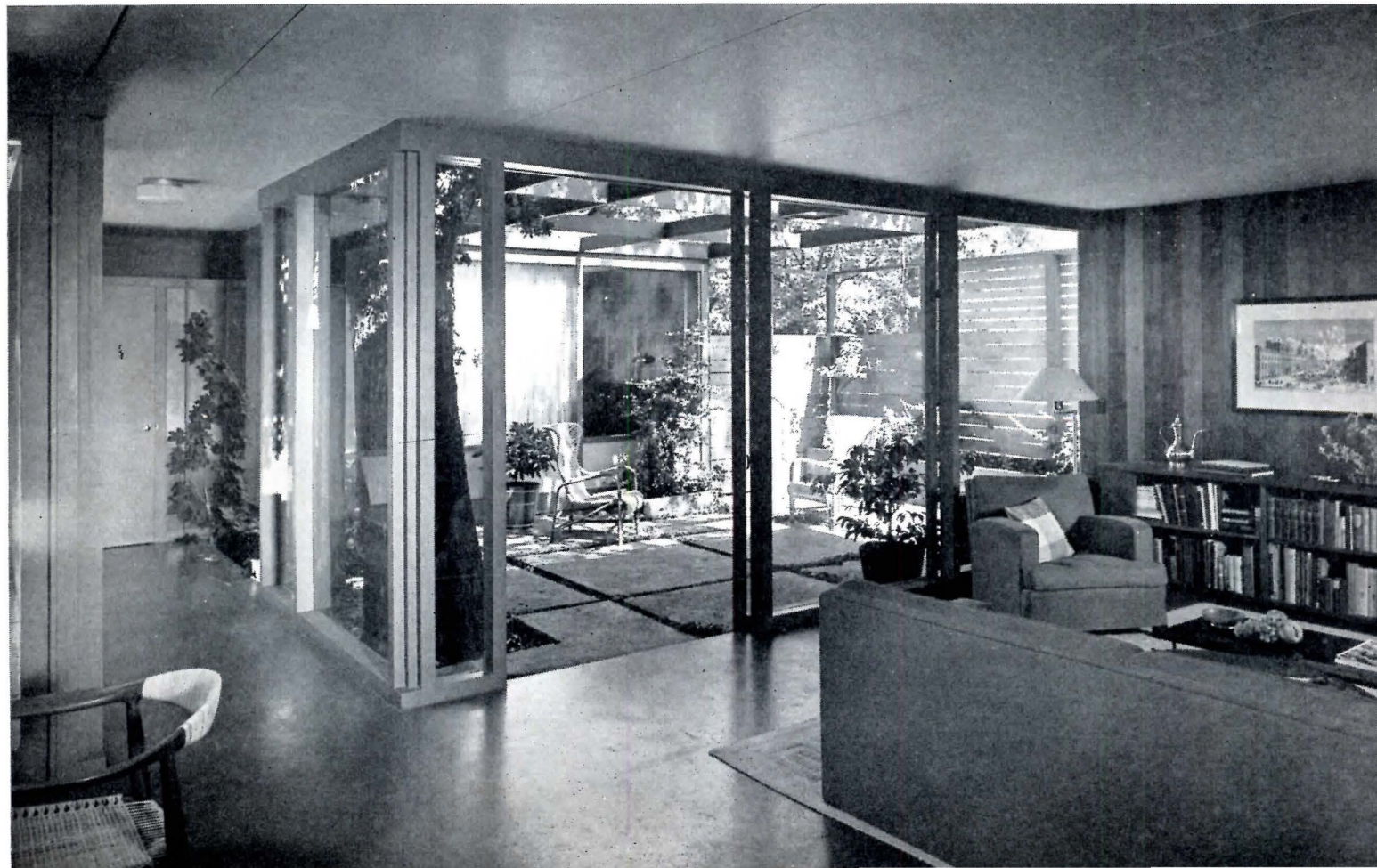



SKYLIGHTED WASHINGTON SCHOOL

NORMANDY PARK ELEMENTARY SCHOOL

Seattle, Washington

THE NORMANDY PARK Elementary School, for grades 1 through 6, has an ultimate capacity of 500 pupils (300 in first stage shown). The Highline School District No. 401, for which it was designed, has low tax evaluation; it is crowded and constantly growing. Accordingly economy and flexibility were essential. The site, in a residential area, was tree covered; buildings were adjusted to the contours in order to keep the original character of the terrain while providing good classroom-playground relationships.

The simple structure is devoid of complications, gadgets or tricks. Laminated wood girders are spaced on a 10 ft 8 in. module throughout the classroom area. Steel beams and columns are used in the gym-audi-

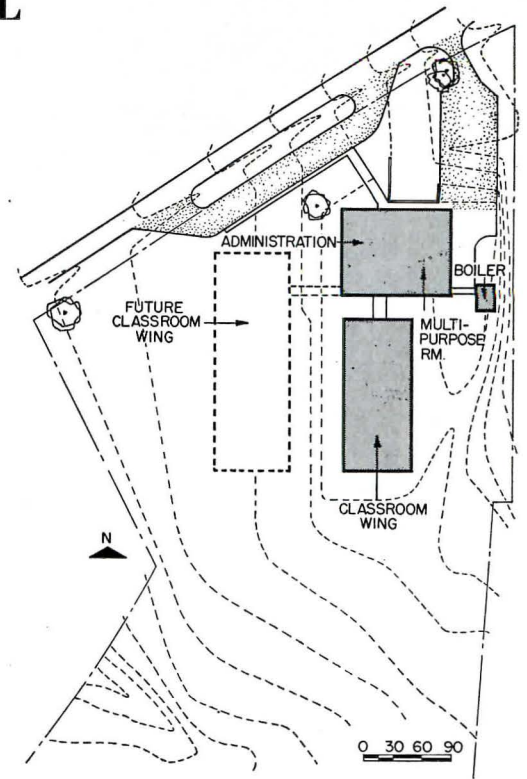

torium building. There are four units: gym-auditorium, containing also administrative offices, work areas, clinic, teachers' rooms, kitchen and toilet facilities; boiler room and janitor's storage space; two classroom wings, of which one was built at first. In order to avoid cumbersome fire walls, fire doors, flashings, etc., the units are separated yet connected by open passages. There are no vent hoods or chimney penetrating the roof; classroom wing toilets are accessible from out-

Waldron & Dietz, Architects

*Engineers: Stevenson & Rubens
(Struct.); Richard Stern (Mech.);
Beverly Travis (Elec.)*

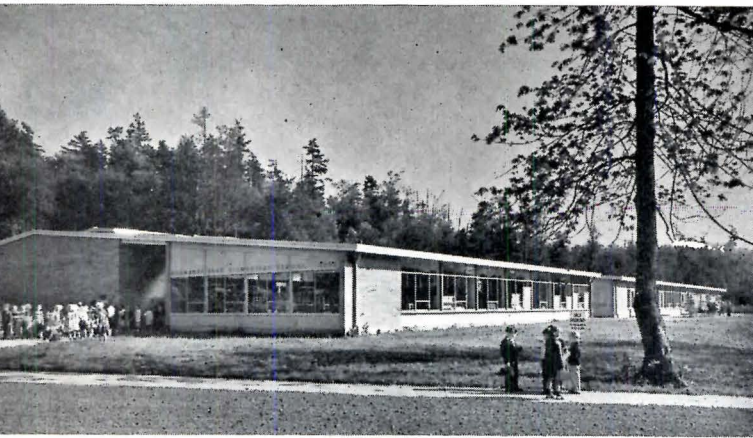

doors; exterior finishes are brick and asbestos-cement board, interior, natural wood, plaster and asbestos-cement board — all measures inducing economy. The skylights are simply designed and built. This care in design paid off, as the cost data show:

CONSTRUCTION COST		AREA: 20,946 sq ft	
General contract . . .	\$157,538	General, Cost per sq ft .	\$7.50
Mechanical	40,402	Mech., Cost per sq ft . . .	1.93
Electrical	15,244	Elec., Cost per sq ft. . . .	0.73
Architect's fee	14,791	Fees, Cost per sq ft.	0.72
<hr/>		<hr/>	
TOTAL	\$227,975	TOTAL PER SQ FT	\$10.88

Cost per classroom (10 rooms) \$22,800
 Cost per pupil (300) \$760

SEATTLE, WASH., SCHOOL

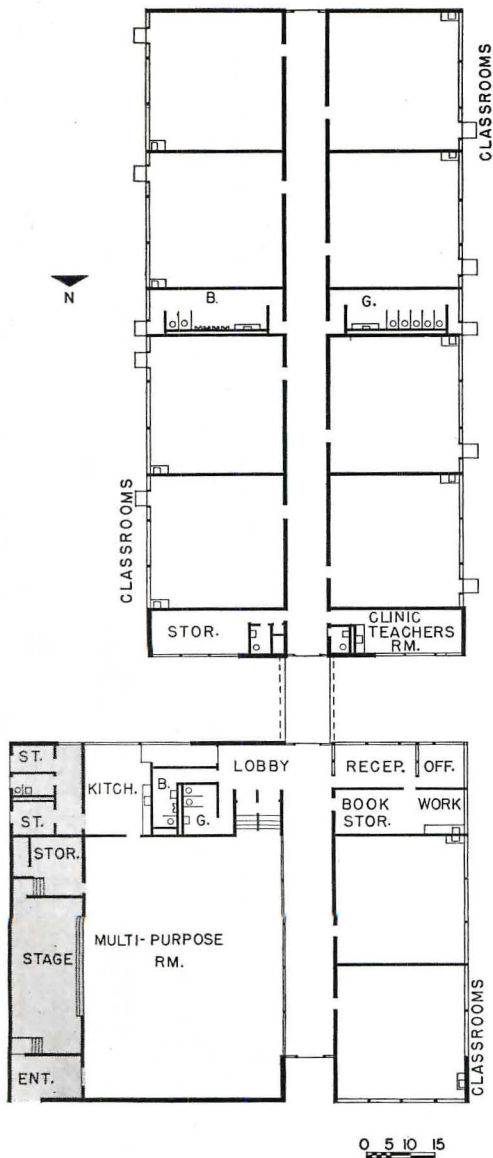

Photos above, left, administrative office; right, corridor beside gymnasium. Before construction of this building the community had no meeting room. Kitchen can serve equally the classroom lunch program now employed, cafeteria service in gymnasium if this is ever required, and adult functions. Shaded area of plan shows potential enlargement of these facilities which community growth may demand

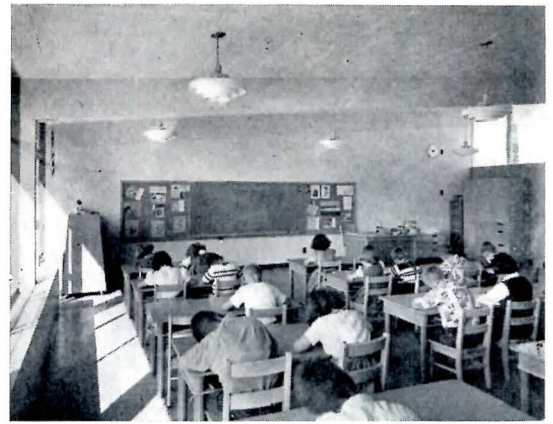
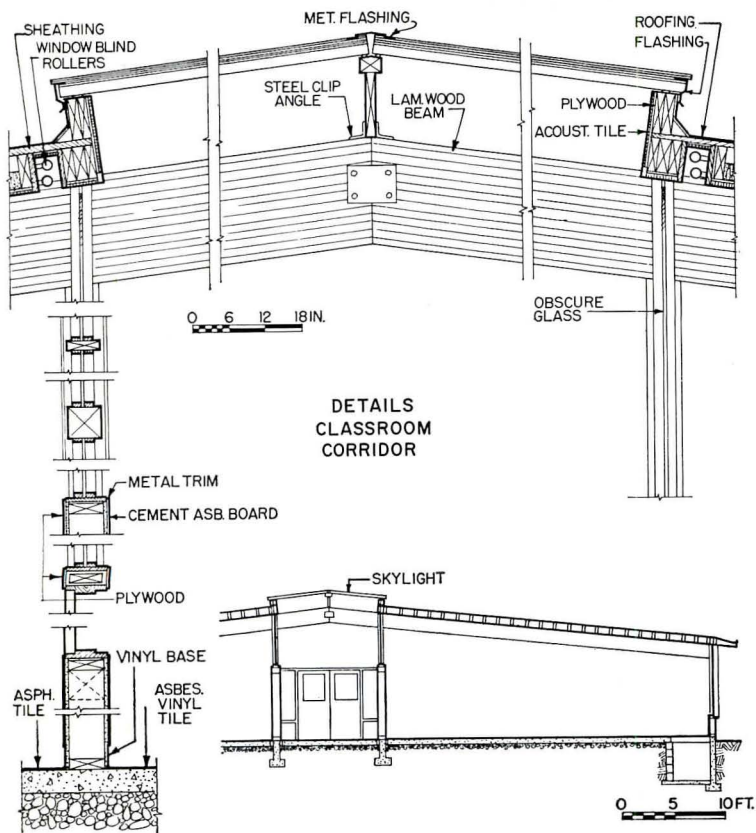

Classroom furnishings are portable for maximum flexibility. Heating is hot water along building's exteriors; air is supplied through a peripheral tunnel, exhausted through corridor; fresh air enters fan rooms over corridors through louvered walls





FISH DEPT.

7 2 2 3 3 10



S T O R E S



R. Wenkam

FOODLAND SUPERMARKET, KAILUA, OAHU, T.H.

THIS SUPERMARKET plan is four-part: an L-shaped service area wraps around two sides of the large sales space; a brick faced liquor shop flanks the corner entrance; two small rental stores form a rear wing on the parking area.

The 90-ft clear span is economically framed with precast arches and abutments; is the largest such structure in the Islands. The precast load-bearing grilles forming the end walls are 3 in. thick and glazed with blue heat-absorbing glass. The roof is laid on 2-in. T&G plank over timber purlins. The 18,100 sq ft structure cost slightly over \$9.50 per sq ft.

*Wimberly and Cook,
Architects*

*Richard R. Bradshaw,
Structural Engineer*

*Nordic Construction Co.,
Contractor*



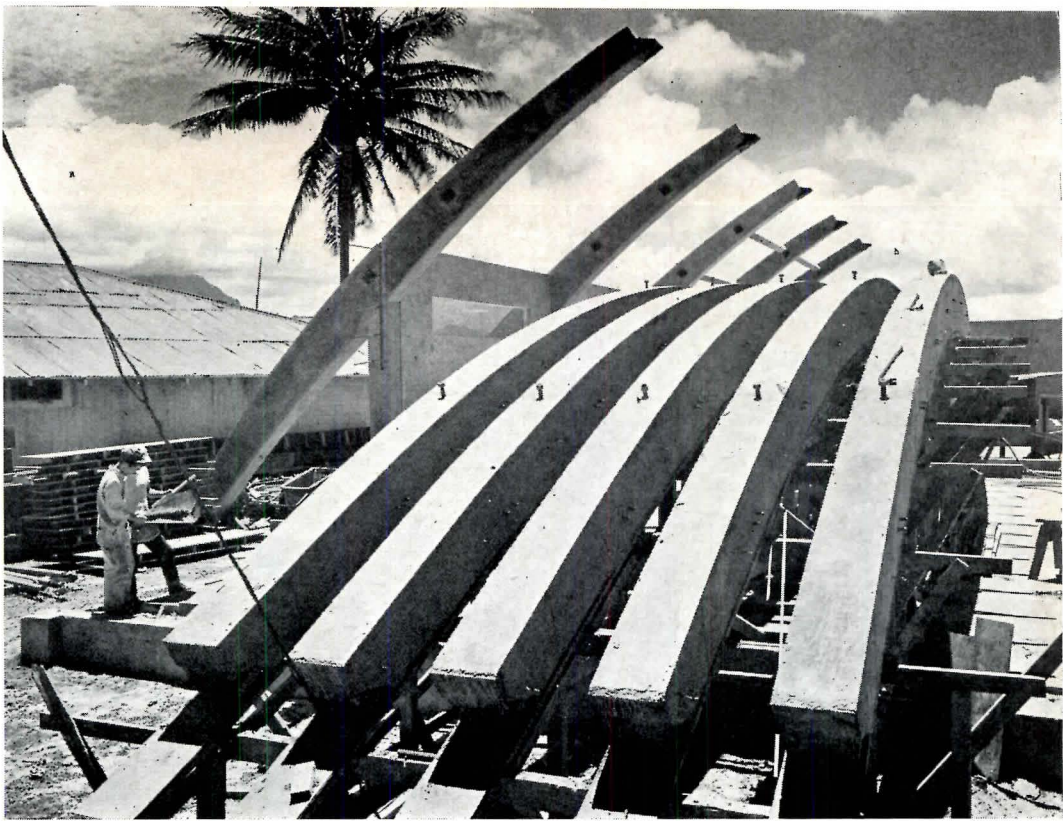

FOODLAND SUPER MARKET

After the precast abutments are anchored and laterally braced, the 65-ft-long precast two-hinged arches are dropped into place much like keystones. Heavy timber purlins are bolted to seat angles

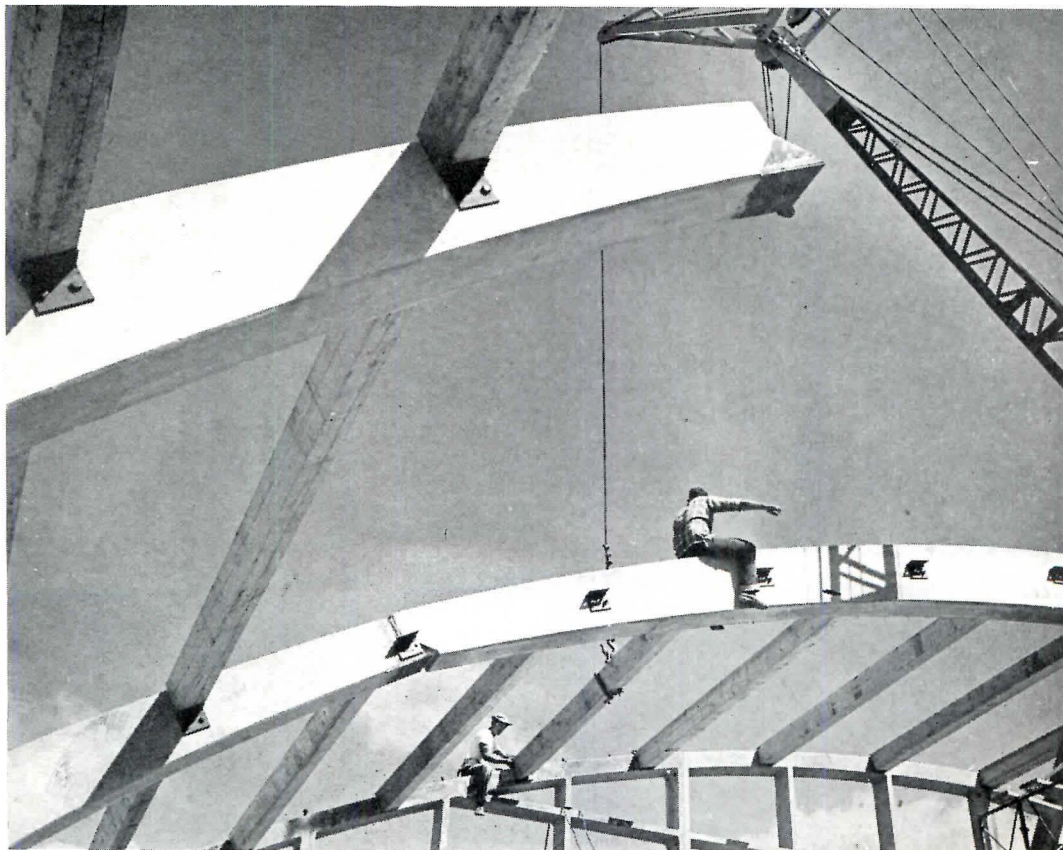

R. Wienkam

Sommer & Kaufmann

MEN'S SHOES

Johnston & Murphy

Oak Preserver

Whitehouse & Hardy

German

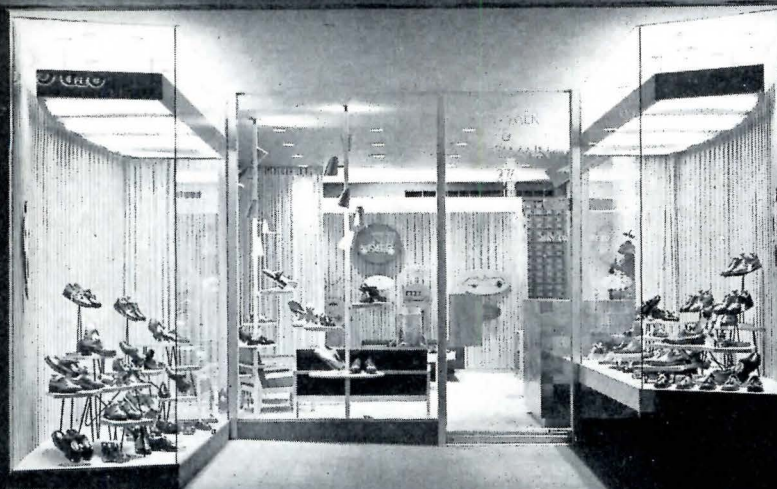

Morley Baer

A WEST COAST SHOP FOR MEN'S SHOES

Sommer & Kaufmann, San Francisco

Campbell & Wong, Architects

FOR THIS ATTRACTIVE branch store, the available space was limited: 17 ft wide by 50 ft deep. The usual three requirements had to be met: display, sales and storage. Office work and related activities are carried on in the nearby main store. The display area occupies the first 13 ft; the sales space is 22 ft deep; the rear portion of the first floor and the second floor are devoted to storage.

Shoe display is well handled: at one side the window is at floor level to show merchandise in true perspective; on the opposite side the raised window allows closer examination. Several ingenious adjustable display trees (right) are used to good advantage.

Materials and colors carry out the masculine note: quarry tiled entry; oak fixtures, furniture and vertical panel strips; leather on fixtures and furniture; tweed textured carpet; upholstery, blue linen or brown and copper fabric; blue ceiling; white walls. A space mural by Smith-Tepper-Sundberg lends further decorative interest.

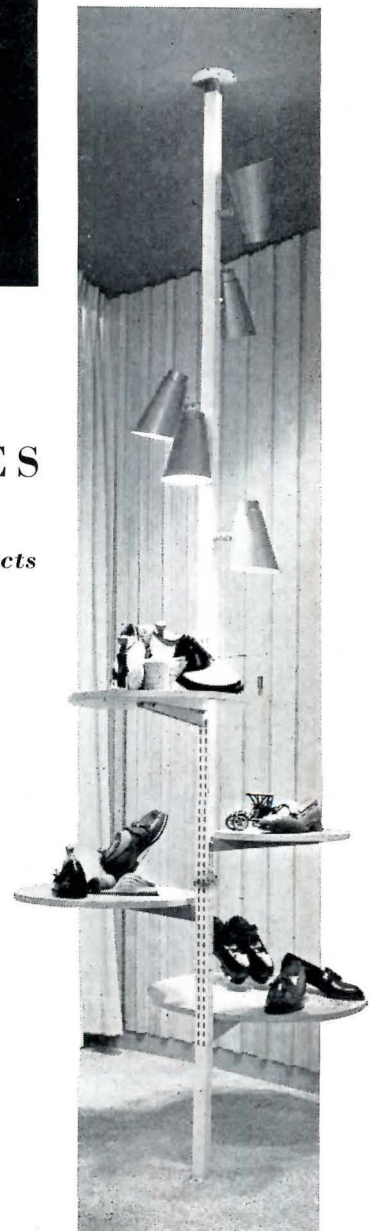

Julius Shulman



SPORTING GOODS STORE IN PASADENA

Douglas Honnold and John Rex, Architects

THIS UNUSUAL DESIGN sprang from an interesting set of requirements. The problem was to provide, under limited budget, an 8000-sq-ft air conditioned store possessing maximum flexibility for possible future rental. Also required: rear parking and display; a mezzanine for specialized sales; part basement for storage and work; sun control on street (west) front.

As the section (right) shows, the mezzanine shaped the structure, resulted in roof development as a design element, also provided the overhang for sun control. This shape reduced cubage and cost, located mezzanine and basement at rear for best access, and provided a clear span for flexibility. Built-in fixtures are on side walls, allowing the remaining units to be movable for store plan changes.



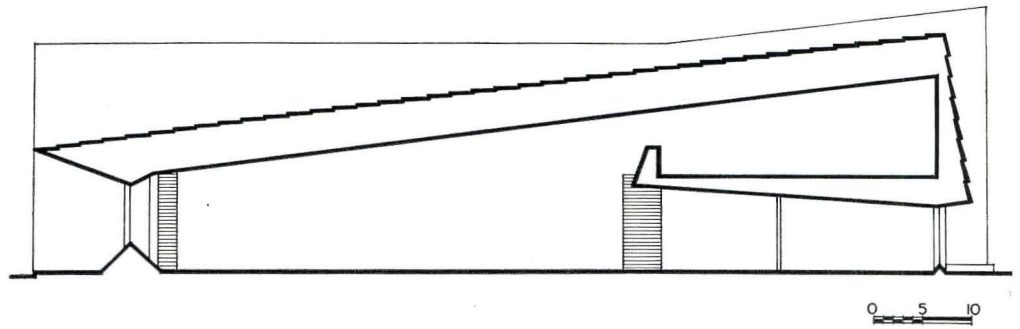



CHICAGO COOPERATIVE SUPERMARKET

George Fred Keck — William Keck, Architects

Telander Bros., General Contractors

LOCATED IN THE University of Chicago area, the Hyde Park Co-op Society has outgrown three locations; now grosses over 1½ million annually. Their newest structure is a remodeled manufacturing building. An adjacent run-down 3-story apartment was demolished to provide a 50-ft-wide parking area running through the block. On account of existing columns and the large area, corridors are diagonal to avoid long "tunnel" effects. The existing brick walls were faced with corrugated asbestos outside and painted gypsum plank inside. Interior walls are white for light reflection; color used at entrances.



Hube Henry Hodrich Blessing

Facilities for Long Term Patients

RECENT EXTENSION of the government's Hill-Burton program into new types of health facilities is presenting architects with some new fields of activity. The program, presented to the Congress a year ago by President Eisenhower and stressed again in his recent messages, includes four types of buildings: nursing homes, chronic hospitals, rehabilitation facilities and diagnostic centers. Federal money has already been appropriated for assisting the states in surveying their needs, developing state plans, and for construction programs.

Though some of those types sound fairly familiar, the concept of them in the objectives of the program is sufficiently new as to call for reexamination of planning techniques. It is not too strong to say that architects are presented with four virtually new building types. Actually there is a fifth — homes for the aged — which fits into the projected pattern but which is not nominally eligible for federal aid.

The newness of these types springs from the determination to extend and improve the health assistance offered to all kinds of people. The long-term, or chronic, patient has been neglected, not with intent but simply because the right facilities have not been available to treat him properly, or economically. A large proportion of beds in general hospitals is occupied with long-term patients, some of whom don't need so expensive an accommodation, others of whom need a type of therapy not generally available there. Rehabilitation is uppermost in the new thinking, and is a relatively new medical science. In a word, then, the idea is to build facilities for widely different types of care, so that persons handicapped with long-term illness may have proper diagnosis, treatment, rehabilitation (if possible). Also so that medical and nursing skill, and funds, are used to best advantage.

The Division of Hospital Facilities of the Public Health Service, under the direction of Dr. John W. Cronin, has bent its efforts in the direction of insuring that funds will be properly spent. The Technical Services Branch, under Marshall Shaffer, has had its architects studying planning techniques, with the intent, as before, of assisting private architects in the programming phase of their work. Incidentally, private architects will be called upon to do all of the actual planning, local initiative being the watchword in the whole Hill-Burton program.

The background study of Public Health has proceeded through only preliminary stages. The material in this Building Types Study is published here for the first time, in advance of final approval, in order to put some information before architects quickly. There will probably be revisions as new findings become available, but the essential approach is considered sound enough for this publication.

The Study also includes two general hospitals which were planned with exceptional thoroughness, one representing a critical analysis of the hospital after a year of operation.

— Emerson Goble

REHABILITATION FACILITIES

For Multiple Disability in a

NURSING UNIT FOR CHILDREN - 24 BEDS

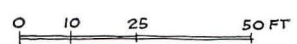
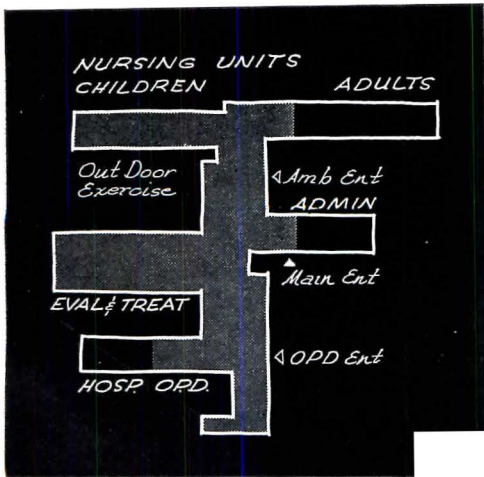
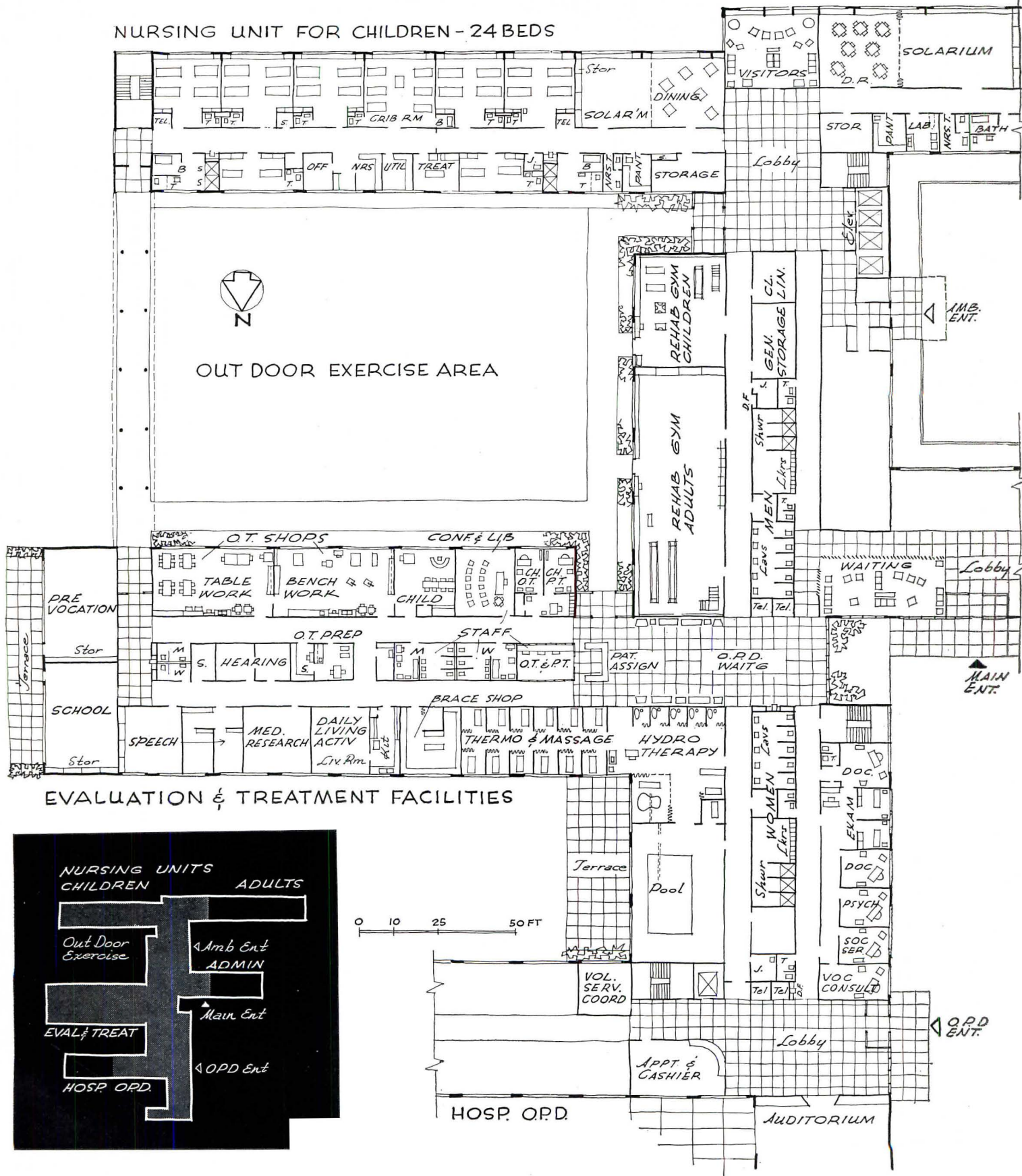

General Hospital

*Preliminary Type Plan by
U. S. Public Health Service,
Thomas Galbraith, Architect*

REHABILITATION is a big word in the country's new health program. Society realizes that civilization has progressed beyond the "survival of the fittest." Handicapped persons are not to be sloughed off as discards, to be tucked away some place with mere custodial care. So — rehabilitation, for continued usefulness, and a reasonable chance for rewarding activity.

Medical science of rehabilitation made rapid strides during the war. And the benefits of wartime techniques and training programs are now available for peacetime development. The need now is for the necessary physical facilities.

The plan here shown — a preliminary concept by the Public Health Service — is for rehabilitation facilities, for multiple disability, as part of a medical center. The rehabilitation facility might also be conceived as a separate center, for both in-patients and out-patients, again for multiple disability. Or there might be a facility for just out-patients. A fourth concept would be a rehabilitation unit for a single disability — blindness, cerebral palsy, retarded children, alcoholism, etc.

Under the program, priority is given to rehabilitation facilities providing multiple disability service, located in medical centers, medical schools or universities. Reasoning here is that a wide variety of medical specialists is usually required by a patient, especially in the early stages of rehabilitation. There is also a need for developing new techniques, and for training new personnel. Also, it is believed, such concentration of newly financed facilities would give the program the best start.

In official language, a rehabilitation service is defined as: "a facility providing community service which is operated for the primary purpose of assisting in the rehabilitation of disabled persons through an integrated program of medical, psychological, social and vocational evaluation and services under competent professional supervision. The major portion of such evaluation and services must be furnished within the facility; and the facility must be operated either in connection with a hospital or as a facility in which all medical and related health services are prescribed by, or are under the general direction of, persons licensed to practice medicine or surgery in the State."

It is quite clear — from the plan, if not from the legalistic language — that rehabilitation here represents an all-out attack. The "multiple disability" phrase means that the facility might serve patients with many different types of infirmities: orthopedic cases, disabilities from injuries, arthritis, diseases of the heart or arteries, and neurological problems. With children there might be also post-polio, congenital malformations, and children's neurological problems. A considerable range of physical facilities is therefore required, yet many of those facilities would be useful to several classi-

fications of patients. All-important is the availability of fairly complete medical services for such diverse patient groups.

As for planning the buildings, a considerable fund of data has been accumulated in the Public Health Service; for purposes of this preliminary presentation only general notes will be given.

Major elements of the rehabilitation unit include:

Administration Facilities

Evaluation and Treatment Facilities

1. Medical Facilities, including: Dental; Physical Therapy; Occupational Therapy; Teaching Activities of Daily Living; Speech and Hearing; Artificial Appliance Facilities; Nursing Units for Adults; Nursing Units for Children

2. Psychological Facilities

Social Service Facilities

Vocational Facilities

Wherever practicable, all of those elements should be located together within the department, for better coordination of the services and efficiency of operation. Some of the elements may already exist in a hospital,

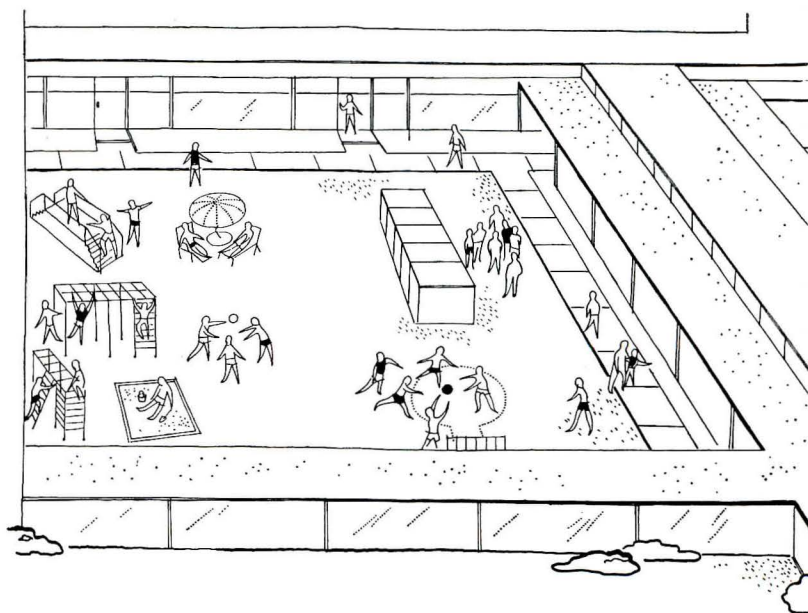

and would not necessarily have to be repeated. In addition to the services indicated, some patients might need additional facilities in the hospital, such as X-ray, laboratory, surgery, pharmacy, etc.

A ground floor location has several advantages. Access to outdoors and treatment areas without recourse to elevators is desirable, and out-patients would be well served.

The size of the facility will be based on the findings

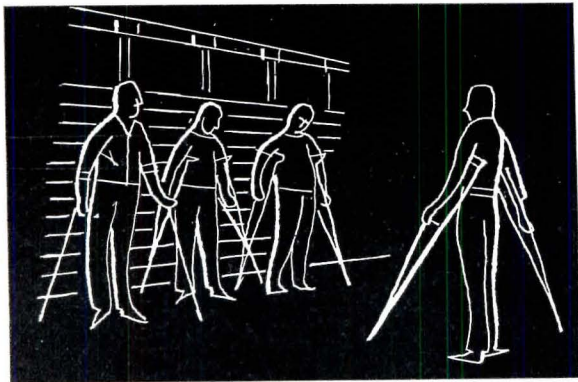

of the survey of needs of the region served. It should be remembered, in the study of size, that the out-patient load is usually much larger than the in-patient load. The service of the facility will probably extend beyond the boundaries of the local community, since a complete rehabilitation program is not feasible for most small hospitals.

The accompanying plans suggest an adult nursing unit of 38 beds and a unit for children of 24 beds and 6 cribs. Capacity of these units should not be considered a recommended ratio. It has been estimated that from 25 to 30 per cent of the total beds in the rehabilitation unit may be children's beds, with 14 years as the top age for children.

Grouping of disabled patients in a separate unit is psychologically advantageous. The morale of the individual is improved by knowing that admission to this unit indicates a good prognosis for recovery, and he tends to concentrate on showing maximum improvement. Grouping also facilitates more effective care. Moreover, requirements for housing such patients differ considerably from those of general hospital patients.

Many of the rehabilitation patients are up and active each day, getting around on crutches, wheel chairs and wheel stretchers. It should be recognized that such traffic requires greater clearances in bedrooms, day room, toilets, etc.

Although individual cases will vary widely, it is estimated that the length of stay will average approximately 60 days. The psychological needs of long-term patients should be considered in the general approach to design.

The number of beds in the adult unit may be greater than that usually recommended for medical and surgical units. Most patients will not need intensive bedside care and approximately 75 per cent may be ambulant or semi-ambulant. A capacity of 35 to 40 beds is recommended for economy and convenience in operation; 50 beds appears to be the maximum.

Need for flexibility in general medical and surgical units has resulted in the use of more single and two-bed rooms. In contrast, the requirements of rehabilitation patients appear to be best met with four-bed rooms. Social contact and opportunity to observe the progress of their roommates in bed exercises and other activities of daily living has a stimulating and therapeutic value. Competition arises in the group, and patients encourage and assist each other. Finally, the therapist's time is more efficiently utilized.

A few smaller rooms are desirable for the occasional use of a patient in need of a period of orientation, or one with a pronounced personality problem.

Accommodations for children in the rehabilitation facility of a hospital gives them access to essential medical services which often are not found in small specialized children's facilities, in no way impairs function, and results in better total service on a sound economical basis. It is essential to separate in-patient facilities from those for adults. Fourteen years is considered maximum age for children in the nursing unit; 30 beds including cribs is a good size.

CHRONIC DISEASE HOSPITAL

*Preliminary Type Plan by
U. S. Public Health Service,
Peter Jensen, Architect*

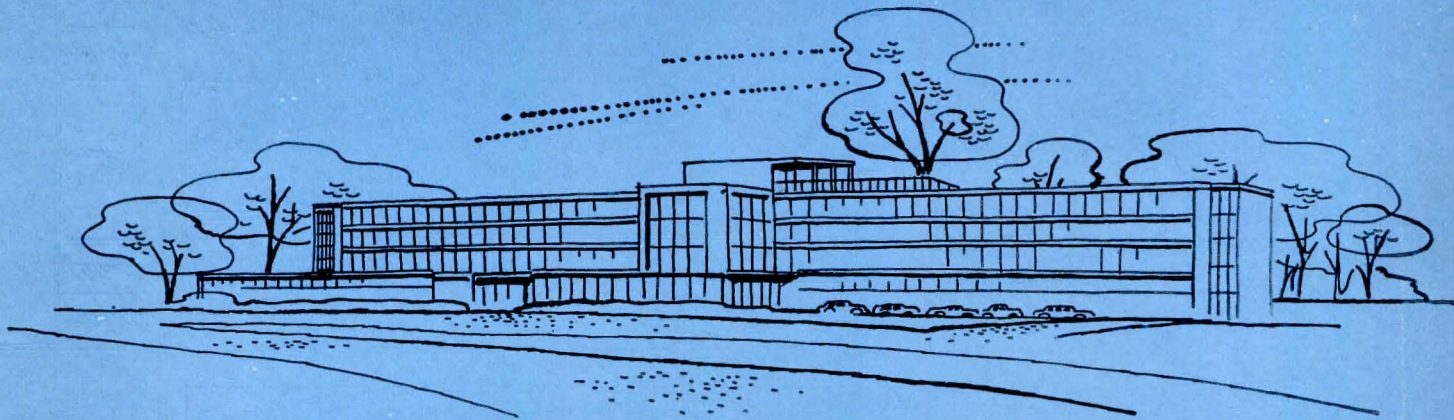

IN RECENT YEARS chronic disease hospitals have come in for new attention; in effect a new concept for such a hospital is being proposed. It has long been said that a high proportion of beds in most general hospitals are occupied by long-term patients, some of whom do not need such expensive quarters, such skilled medical attention, others of whom might require special services not available where they are. The broadening of the federal government's efforts in health facilities contemplate some sorting out of patients into chronic disease hospitals, rehabilitation centers, or nursing homes as new buildings can become available.

The Commission on Chronic Illness suggests that chronic patients should be treated and cared for at general hospitals or in special nursing units connected with general hospitals. However, many long-term patients are being treated and cared for in chronic disease hospitals.

Rehabilitation of long-term patients is a major part of this plan, whether in chronic disease hospitals or in separate rehabilitation centers. With the new skills in this area, it is said, many so-called chronic patients could be restored to active living, in some degree, and might not need hospital care at all.

These laudable objectives have led to serious study of the role of the chronic hospital, and perhaps some confusion. There is no difficulty, of course, in understanding the function of the specialized chronic hospital — for tuberculosis, for example, or heart cases. But the multiple disability type of chronic hospital, such as proposed now, has started some discussion as to medical facilities to be included, with an evident leaning toward the idea that very good medical facilities are required.

In federal regulations covering the state-aid program, the chronic disease hospital is defined: "a hospital for the treatment of chronic illness, including the degenerative diseases, in which treatment and care is administered by or under the direction of persons licensed to practice medicine or surgery in the State. The term does not include hospitals primarily for the care of the mentally ill or tuberculosis patients, nursing homes, and institutions the primary purpose of which is domiciliary care."

A chronic hospital provides services primarily to patients with non-acute illness for whom a prolonged period of hospitalization is anticipated, and whose principal care requirements are diagnosis, medication, nursing care, occupational therapy, medical social work, recreation and rehabilitation including some education and pre-vocational work.

The preliminary plan presented herewith illustrates space requirements and relationships of the various departments and services required in a 300-bed chronic disease hospital.

The first floor of this multi-story hospital contains complete rehabilitation facilities for in-patients and out-patients who can benefit most from these services. The rehabilitation portion shown closely follows the rehabilitation facility outlined for the medical center (page 178). It must be remembered that all chronic disease hospitals may not have such extensive facilities as shown in this plan.

This multi-story facility has two nursing units of 36 beds each on the first floor to accommodate those patients who can benefit most from the services provided on this floor, such as the departments of physical

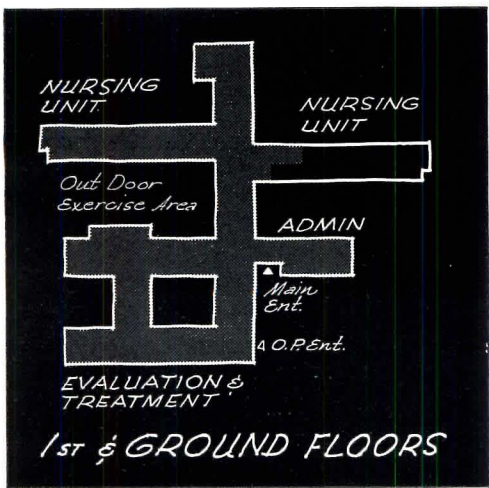

NURSING UNIT FOR ADULT REHAB PATIENTS

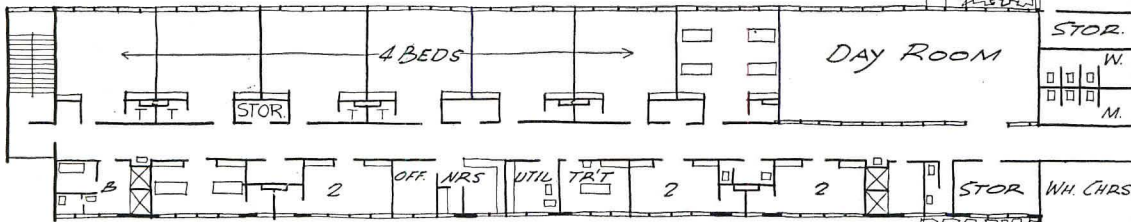

FIRST FLOOR

GROUND FLOOR SIMILAR
CONTAINING SERVICE FACILITIES

0 10 25 50 FT

PHYSICAL THERAPY

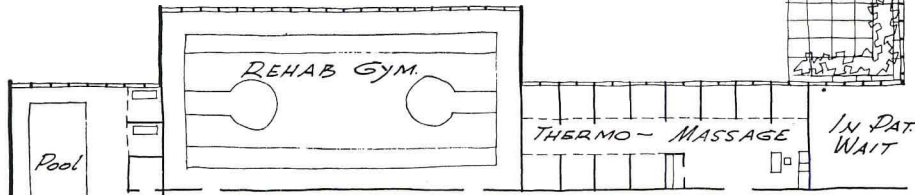

OUT DOOR
EXERCISE
AREA

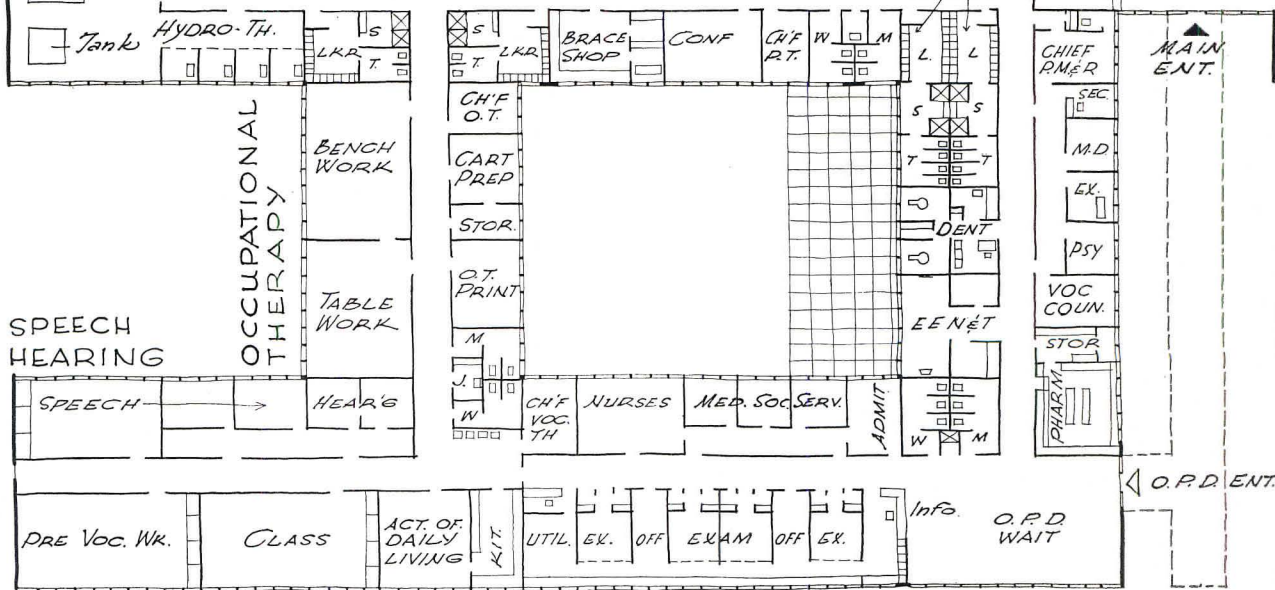

PRE VOCATIONAL TRAINING

OUT PATIENTS

EVALUATION & TREATMENT FACILITIES

NURSING UNIT FOR CHRONIC PATIENTS

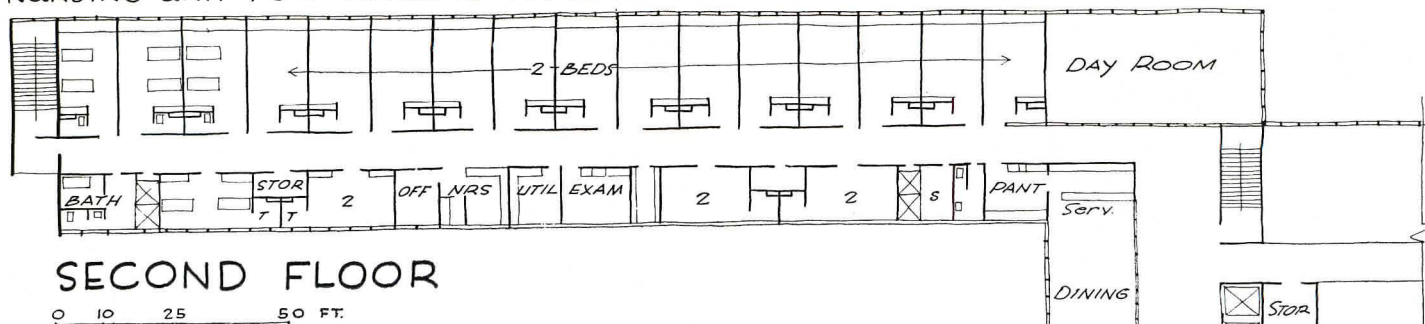

SECOND FLOOR

0 10 25 50 FT.

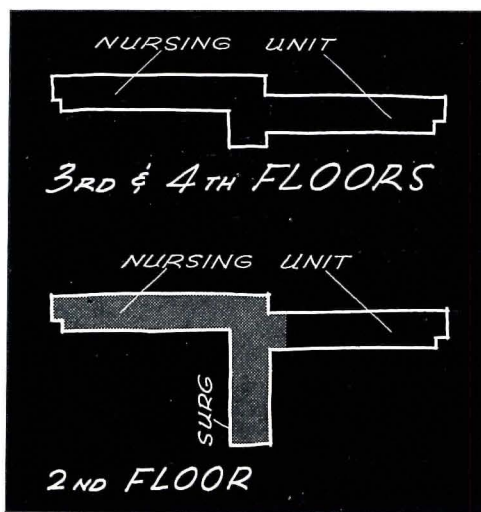

SURGERY

SERVICE COURT

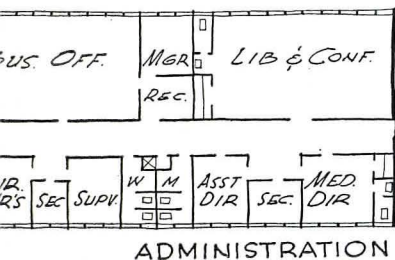

ADMINISTRATION

medicine, rehabilitation, occupational therapy and recreational facilities. About 75 per cent of the patients on this service are ambulant or semi-ambulant.

The remaining six nursing units of 37 and 38 beds each on the second, third and fourth floors would be occupied by the more acute patients. Some 60 to 75 per cent of these patients are ambulant or semi-ambulant and can ambulate to and from the day rooms, dining rooms and wash rooms provided on these floors. Diagnostic facilities, such as X-ray, laboratory, BMR and EKG are located in a separate wing on the second floor (available for out-patients) as are also the operating suite and central sterilizing and supply rooms.

The out-patient department, pharmacy and the administration department are, as is customary, located on the first floor. Dietary facilities, staff and help's dining rooms, help's locker rooms, nurses' locker rooms, store rooms, laundry, autopsy and morgue are on the ground floor (not shown).

The major departments and facilities of a chronic disease hospital are administration department, diagnostic and treatment facilities, nursing department, surgical department, service dietary and out-patient departments. Except for the rehabilitation nursing units and the treatment facilities of the department of physical medicine the function and locations of the other departments are basically the same as in the general hospital.



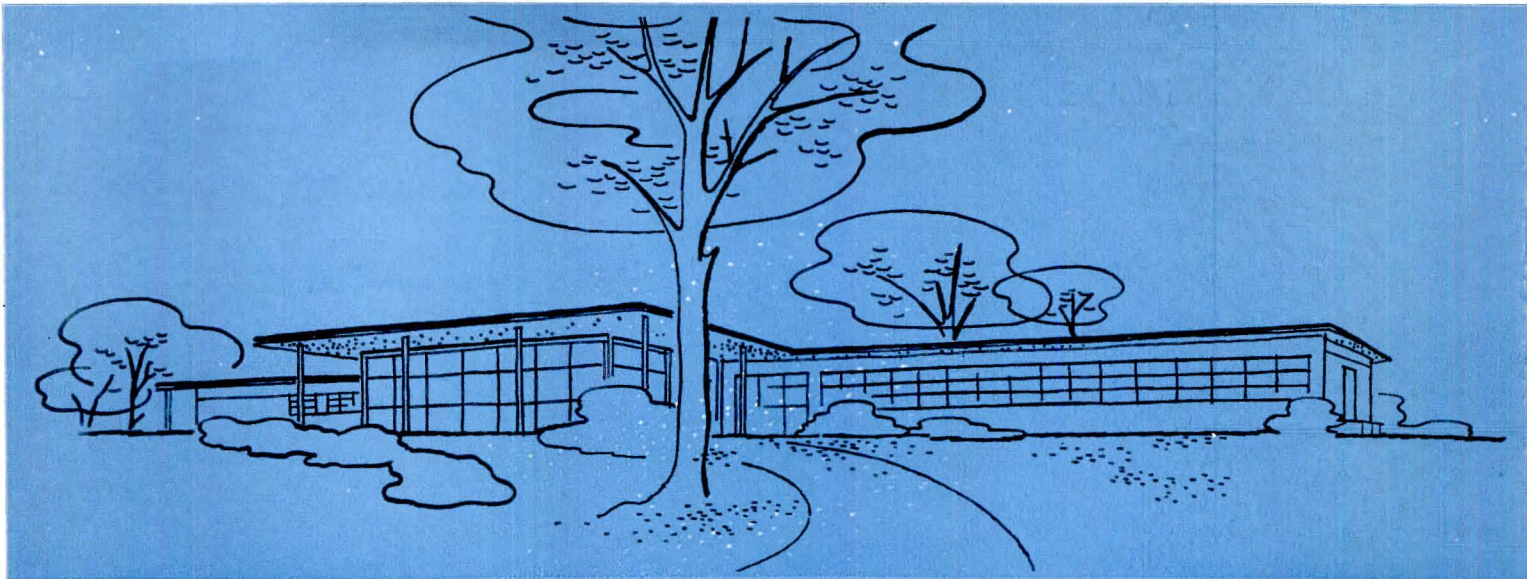

NURSING HOMES are a more or less familiar type of health facility now scheduled for some reexamination. They are included in types now eligible for federal aid, but there are a few provisos calculated to insure a high level of patient care.

Those conditions are stated in the official definition of a nursing home: "a facility which is operated in connection with a hospital, or in which nursing care and medical services are prescribed by or performed under the general direction of persons licensed to practice medicine or surgery in the State, for the accommodation of convalescents or other persons who are not acutely ill and not in need of hospital care, but who do require skilled nursing care and related medical services. The term 'nursing home' shall be restricted to those facilities, the purpose of which is to provide skilled nursing care and related medical services for a period of not less than 24 hours per day to individuals admitted because of illness, disease, or physical or mental infirmity and which provide a community service." They must also be operated by non-profit organizations.

The emphasis on medical care does not seriously strain the planning and equipping of the nursing home; it is not contemplated that the home have its own medical facilities. What is insisted upon is real medical supervision plus some tie-up with a hospital or other arrangement which would insure that medical attention was available on call. Implicit in that proviso are some factors influencing location of the home, and, of course, its organization.

Definitely the nursing home is for persons needing nursing care — not merely for somebody's Aunt Matilda who talks too much at home. Thus it is planned for

the needs of partially sick people, and in a few respects this fact does effect its planning. It is not designed primarily for old people, but the common infirmities that come with age will bring many such patients to the home.

As a planning assignment the nursing home should appeal to the small architectural office. It is definitely not in the hospital category as to complications, though medical considerations do enter into the planning. Most important, it is a minimum facility, small in scale and domestic in character. It is a neighborhood affair, closely identified with the life and needs of a community, and designed as such. It should settle into the community, so that patients have no feeling of moving into a strange and institutional environment, so that friends and relatives can visit frequently and informally. More specifically, it should not have more than fifty beds, preferably about half that.

Clearly the site should be suitable for attractive landscaping, with space for some outdoor activity, if only sitting in the sunshine. Most important of all, however, it should not be isolated from community interests and activities. Patients should be able to observe the comings and goings of the community, to maintain a feeling of participation and to keep interests outside themselves or their fellow patients. Many of them will be there for a lengthy stay, and boredom will be a constant threat to health and morale.

It should be made as easy as possible for visitors to come, and for patients to go out to stores, churches, and so on, as they are able.

The plan on the opposite page suggests a generally satisfactory arrangement. A one-story building is usually

*Preliminary Type Plan by
U. S. Public Health Service,
Edwin B. Morris, Jr., Architect*

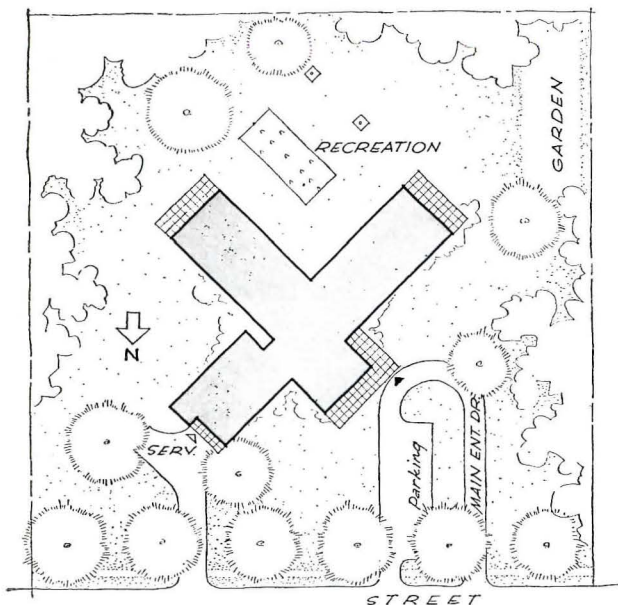

recommended, for obvious reasons. Here one wing takes all the services; wings for patients focus on the nurses' station as a control point. A large area combines for recreational and dining space, near the entrance, near the center of activities. It would be nice if the program afforded an additional solarium or lounge area, so that different groups or activities need not always be thrown together. Rooms are generally two-bed rooms, with each bed near the window. There are some single rooms, for the ill or poorly adjusted patients. There are scarcely any real medical facilities, but there are special toilets and baths designed to accommodate wheel chairs and arranged for the training of certain handicapped persons who must learn new methods of scrambling in and out of bathtubs.

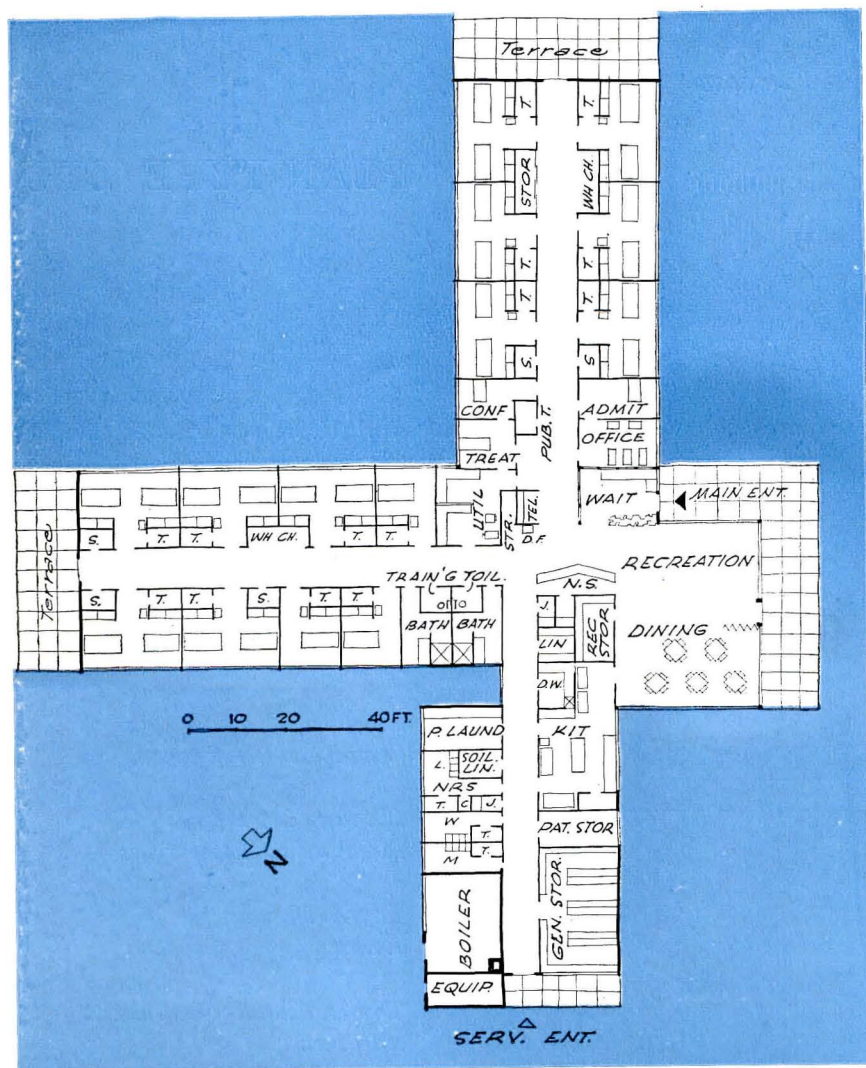

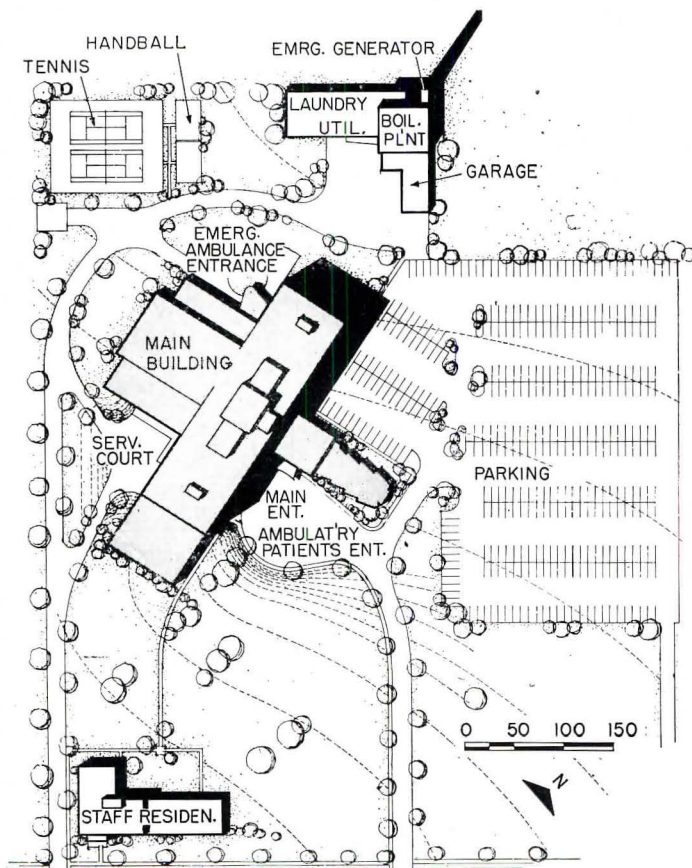

PLAN-TYPE STUDY

*Long Island Jewish Hospital
Glen Oaks, L. I., N. Y.*

*Louis Allen Abramson
Architect*

*Eugene D. Rosenfeld, M.D.
Consultant and Executive Director*

*Hoffberg & Ateshglou
Structural Engineers*

*Slocum & Fuller
Mechanical Engineers*

*Leo A. Novick
Landscape Architect*

*Turner Construction Co.
Builders*



Bee Schnall



PRECEDES BUILDING OF LARGE GENERAL HOSPITAL

ENTHUSIASTIC SUPPORT for this hospital project gave the architect and hospital consultant an exceptional opportunity. They had the kind of backing which, in their own words, "fosters an atmosphere in which imaginative planning and bold departures receive ready consideration if not enthusiastic backing."

Thus they were encouraged to undertake a thorough investigation of various plan types, however radical, to find the scheme that would best suit their purposes. In the end they settled upon a fairly simple form with double corridor arrangement, as this gave good performance in many important considerations, and the minimum perimeter per bed (see next two pages).

They were also encouraged to investigate progressive ideas in mechanical systems and innovations in medical service equipment, including an ingenious panel heating system in which cool well water is circulated for summer cooling (page 190).

The hospital was planned for construction in three stages, to reach an ultimate bed capacity of 500. All departments were either created at the 500-bed level or can be expanded to that level without disturbance to first installations. In the initial phase the building has sub-basement, ground and five floors; it will be expanded eventually by the addition of four floors and the exten-

sion of wings on three sides. Original per-bed costs are therefore somewhat high — \$23,094, will rise even higher in the second phase, in which will be added a laundry, staff residence building, premature nursery center, and auditorium. In the final stage, however, with the additional beds to warrant this total plant, the per-bed cost is estimated to come down to \$16,469 (see table, page 195).

The Long Island Jewish Hospital occupies a beautifully wooded eight-and-a-half acre site almost at the boundary between Queens and Nassau Counties. The site was made available by the adjoining Hillside Hospital, a voluntary psychiatric hospital for noncommitted patients, which is also affiliated with the Federation of Jewish Philanthropies. The two hospitals thus share 52 acres of contiguous land and enjoy joint landscaping. Perhaps more importantly, they have a rare opportunity for developing coordinated programs for the care of mentally and physically ill.

Funds for the building came from Hill-Burton disbursements, a grant from the Federation of Jewish Philanthropies and a local fund-raising campaign which brought more than \$4,000,000 initially. The hospital will serve the rapidly expanding population of Long Island on a non-sectarian basis.

ARCHITECTURAL RECORD MARCH 1955 187

The basic square was then studied in dumbbell form (Fig. 5), with nursing units joined by an elevator and

were actually sufficient to permit the inclusion of a system of air conditioning throughout the building.

ARCHITECTURAL RECORD MARCH 1955 189

HOSPITALS

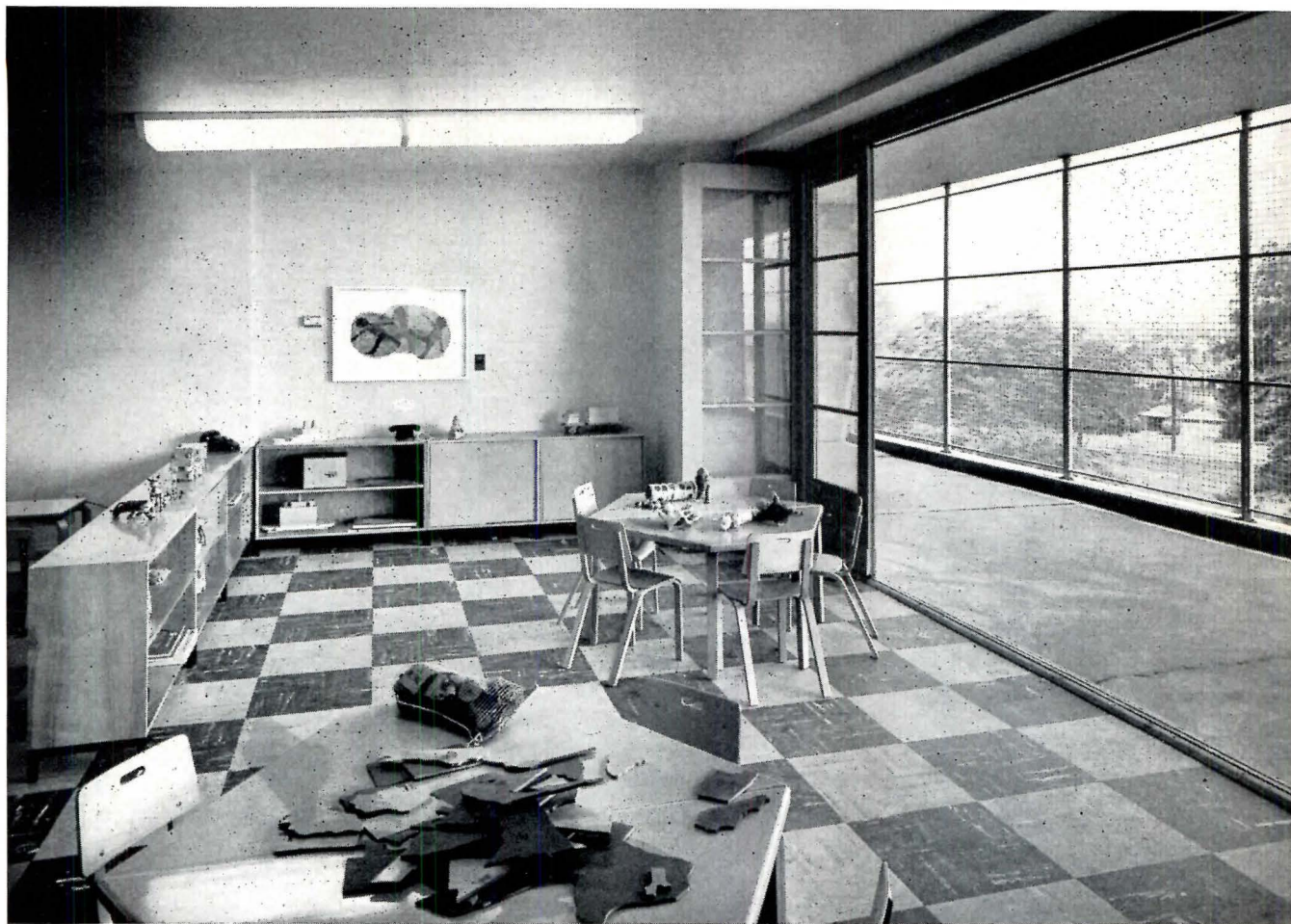

Above: day room in pediatrics department, fourth floor: notice that balcony has wire mesh to full height, for absolute safety. Below, left: dayroom in one of the other nursing units. Below, right: director's office, first floor. Many of the interiors were designed by Designs for Business, Inc.

All rooms in the hospital will have year-round air conditioning, through a unique system. Heating is by a panel system with hot water circulating in coils in the wall and the ceiling. In the interior rooms this heated air system is circulated by forced draft, and the ducts are used for circulated cooled air in summer. The panels in the exterior rooms are used in warm weather for the circulation of cool well water. This water is pumped to the coils through a modified heat pump arrangement, which is expected to reduce fuel bills. This heating system is controlled by an intricate system of indoor and outdoor thermostats, providing individual adjustment in separate areas.



Ben Schnoll

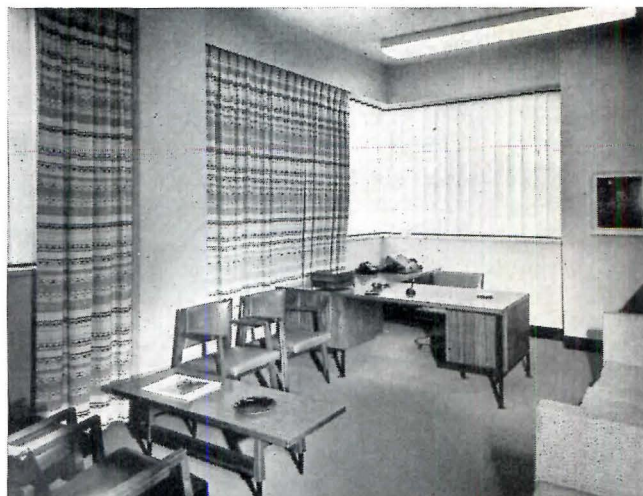

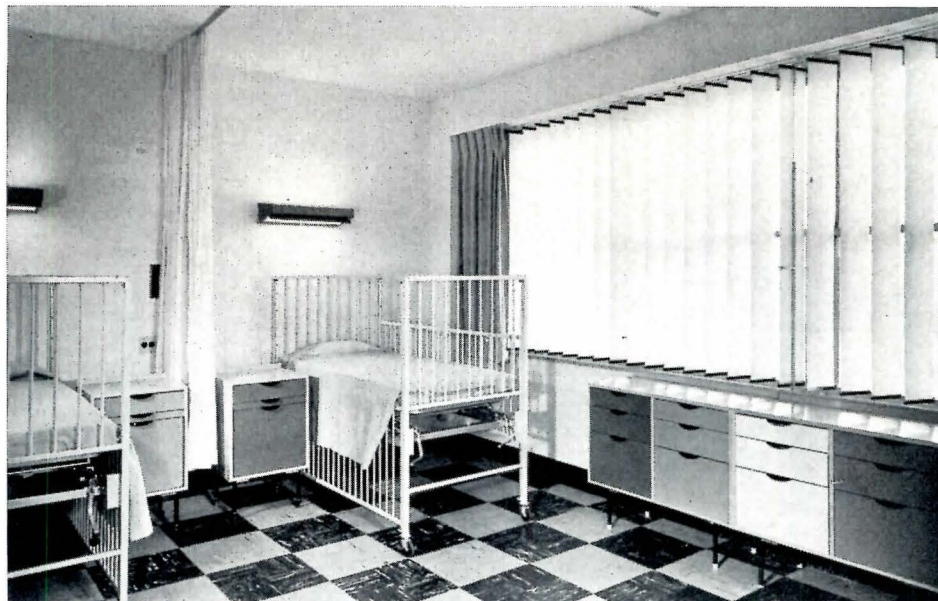

Above: four-bed ward in pediatrics department; below: four-bed ward for adults



Below: single bedroom at outside corner location looks like a hotel bedroom



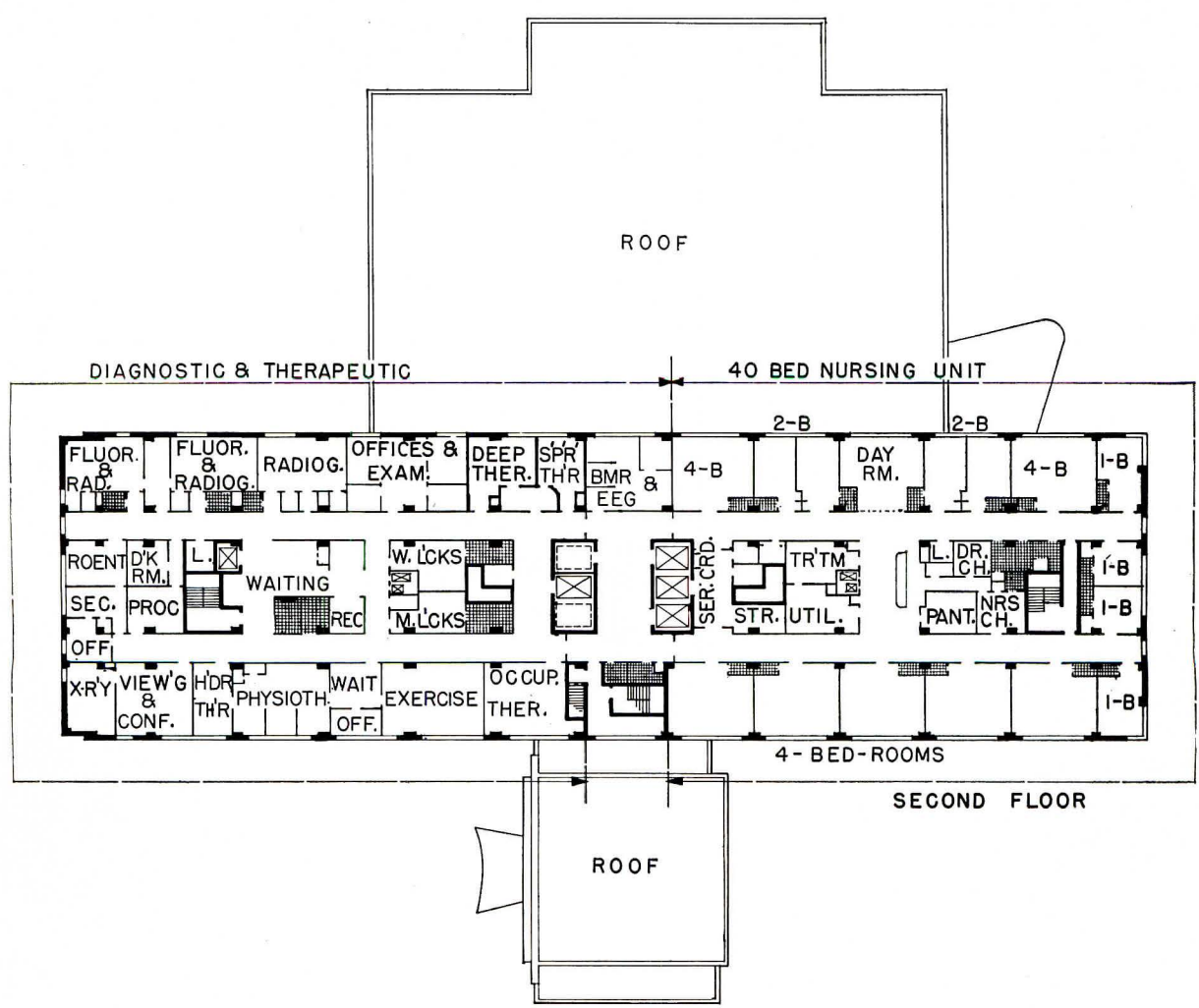
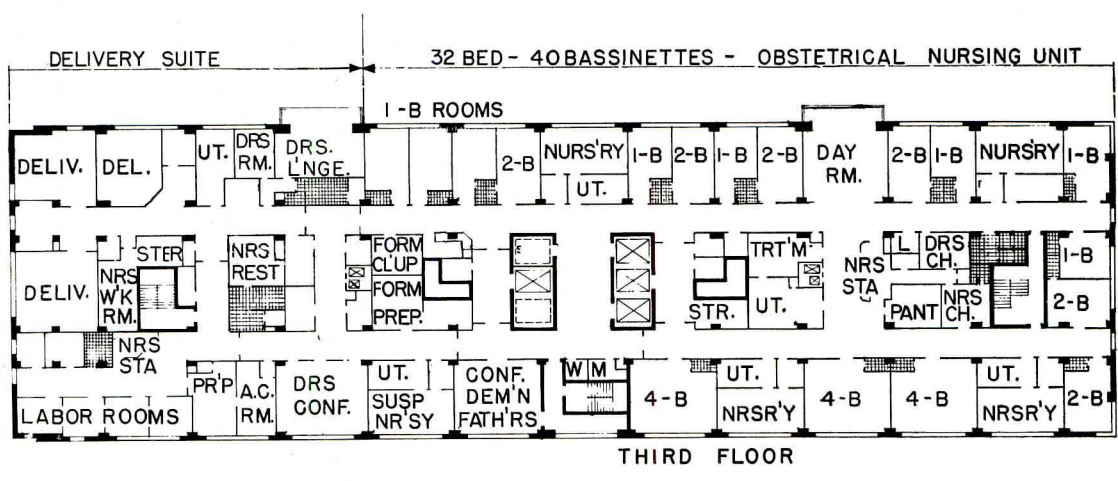
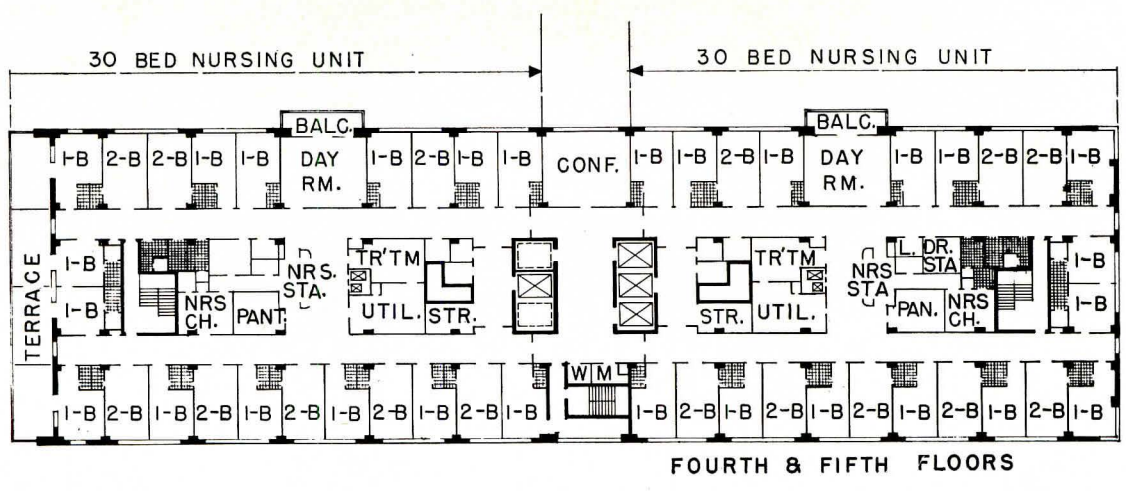

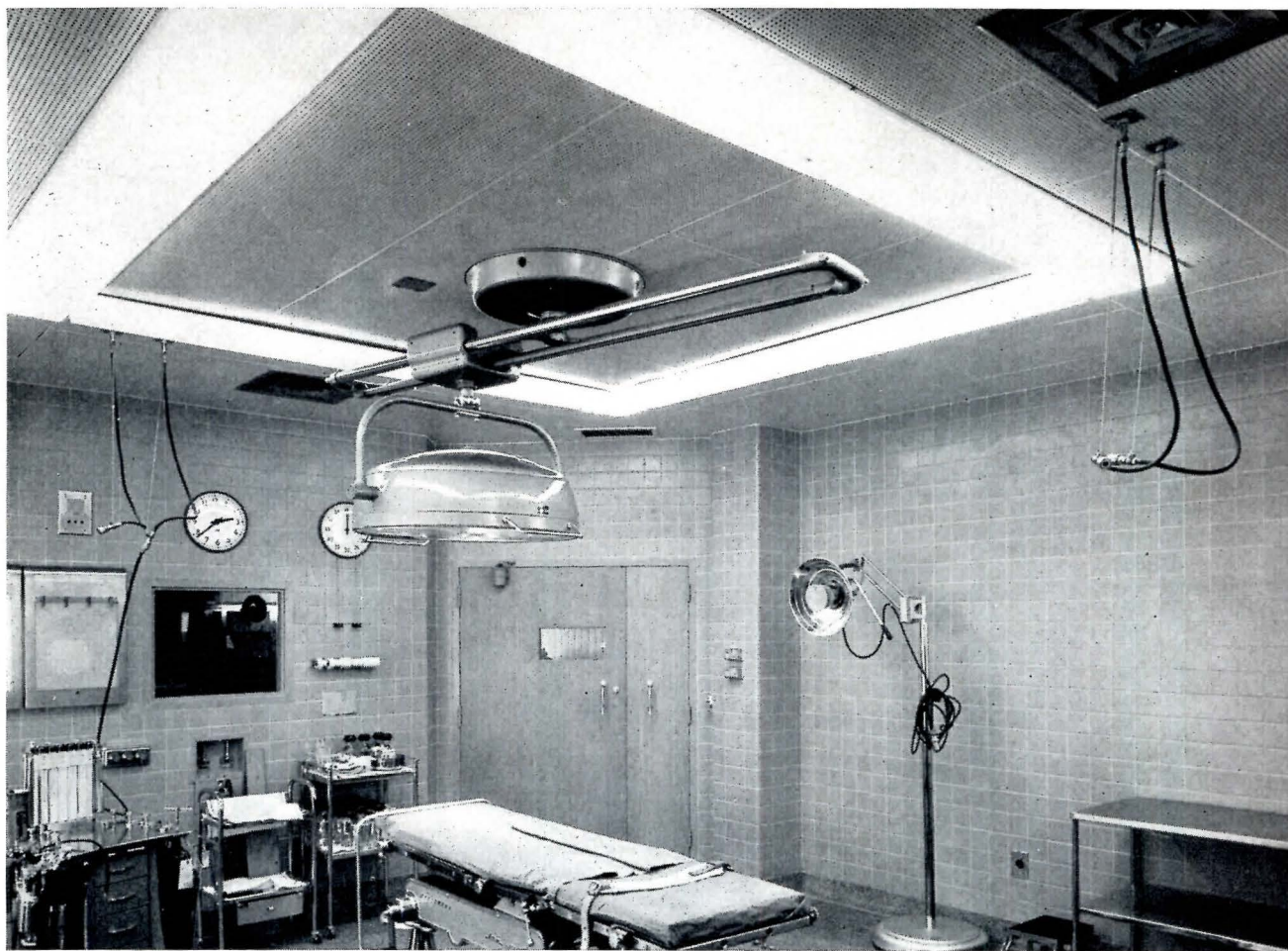

COST ANALYSIS

PHASE I	Cubage (Cu. Ft.)	Construction Costs (Includ. Fixed Equipmt., Arch. & Eng. Fees)	Cost Cu. Ft.	Cost/Bed (Excl. of Bassinets)	Additional Costs	
Main Building (214 beds)	2,287,000				Port. & disp. equipmt. & furn.	\$490,000
Utility building	83,000				Landscaping, gardening	88,000
					Administration, etc.	43,000
	<u>2,370,000</u>	<u>\$4,942,000</u>	<u>\$2.08</u>	<u>\$23,094</u>		<u>\$621,000</u>
PHASE II						
Laundry	78,000	192,000	2.45		Port. & disp. equipmt. & furn.	\$110,000
House staff residence	165,000	206,000	1.25		Miscellaneous costs	20,000
Premature nursery center	83,000	186,000	2.25			
Auditorium	162,000	243,000	1.50			\$130,000
	<u>488,000</u>	<u>\$ 827,000</u>	<u>\$1.70</u>			
TOTAL PHASE I & II	2,858,000	\$5,769,000	\$2.02	\$26,958		\$751,000
PHASE III (Estimated)						
4 additional floors (300 beds)	904,000	\$1,718,000	\$1.90		Port. & disp. equipmt. & furn.	\$410,000
Expanded O. R.	42,000	105,000	2.50		Miscellaneous costs	75,000
Expanded laboratories, OPD-Diagnostic services	270,000	675,000	2.50			\$485,000
Expanded utility building	24,000	48,000	2.00			
Expanded admin. wing	17,000	25,000	1.50			
Expanded house staff resid.	100,000	125,000	1.25			
	<u>1,357,000</u>	<u>\$2,696,000</u>	<u>\$1.98</u>			
TOTAL PHASE I, II & III	4,215,000 cu. ft.	\$8,465,000	\$2.01	\$16,469		\$1,236,000
						8,465,000
					TOTAL PROJECT COST	\$9,701,000



Above: cafeteria, first floor, and, below: lounge part of cafeteria

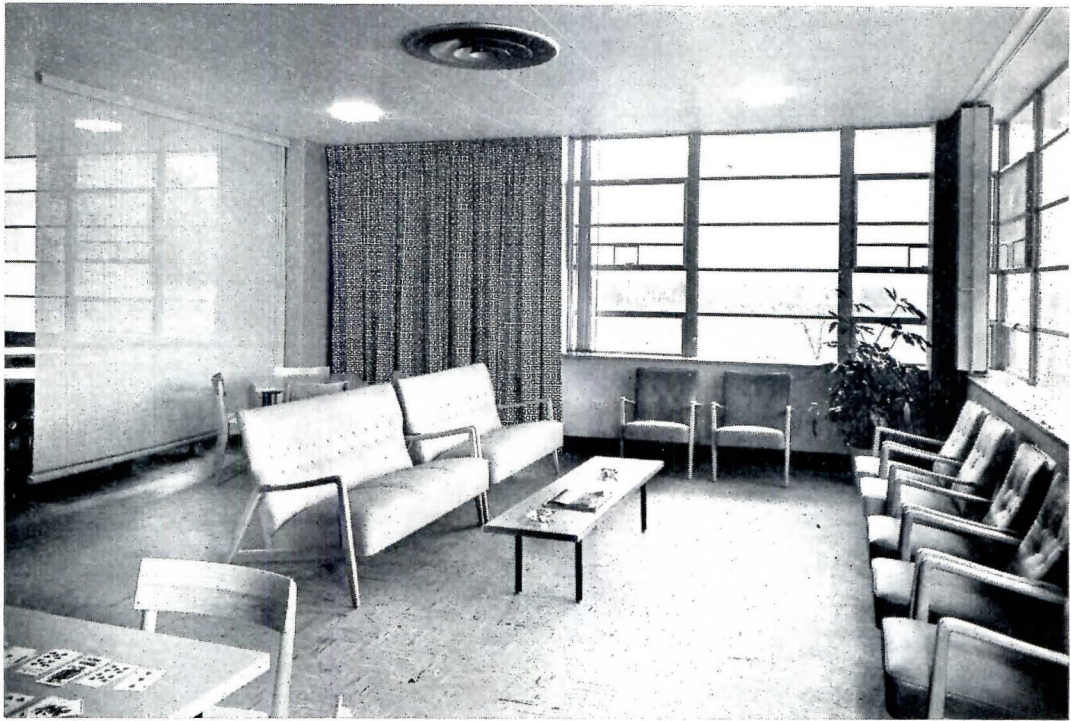

Below: coffee shop, near first floor elevators, serves public and employees

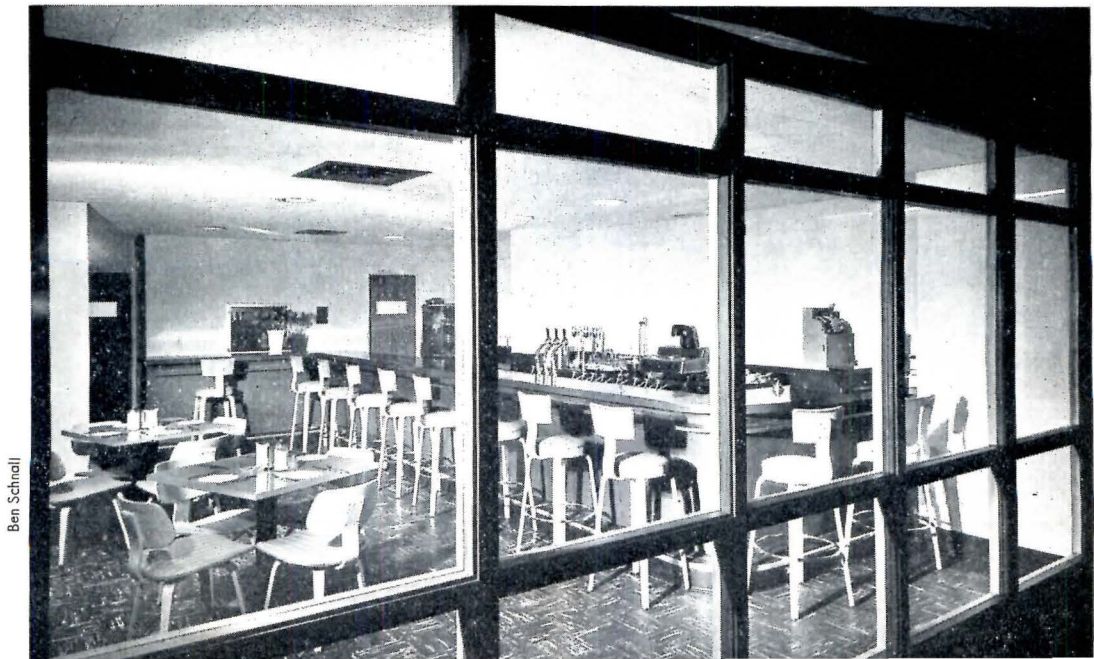

Ben Schnell

200-BED HOSPITAL STUDIED IN ACTUAL USE

*Rockford Memorial Hospital Analyzed after One Year's Operation —
A Study Presented in Collaboration with The Modern Hospital*

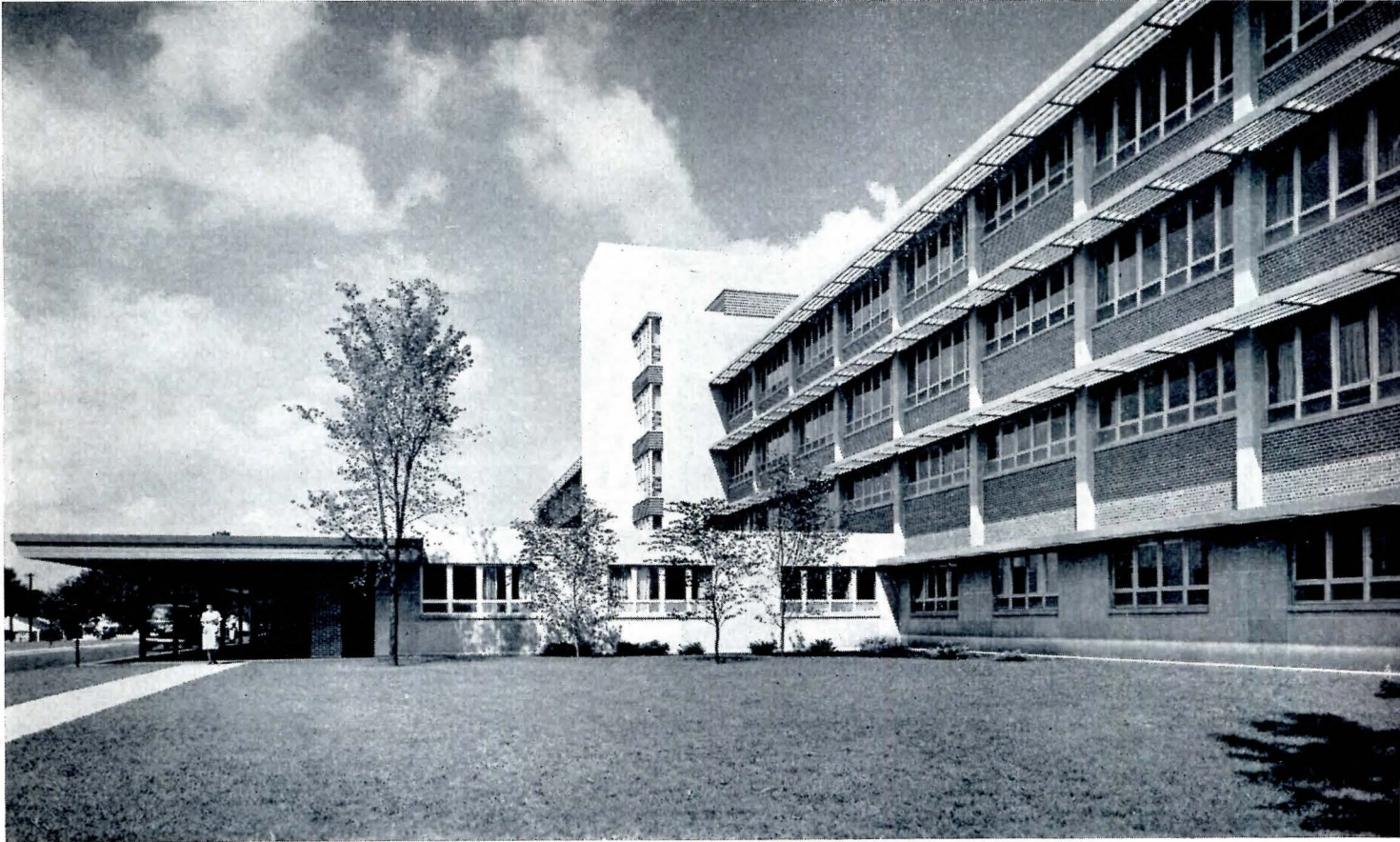

***Rockford Memorial Hospital
Rockford, Illinois***

***Hubbard & Hyland
Perkins & Will
Associated Architects
and Engineers***

***Hendrik P. Maas
Hospital Consultant***

***E. R. Gritschke & Associates
Mechanical Engineers***

***Paul F. Griffenhagen
Structural Engineer***

Review panel, led by Everett W. Jones of The Modern Hospital, included representatives of the architects, John L. Brown, director of the hospital, Paul J. Connor, Jr., associate director, George B. Caldwell, administrative resident, and virtually all department heads and supervisors

PLANNING OF THIS HOSPITAL was intensively studied both before it was built and after it was put in operation. This presentation will touch lightly on the pre-construction planning, and treat in more detail the findings of a review committee which studied plan and equipment features as tested in actual operation.

After a full year of operation the review committee held exhaustive interviews with hospital personnel to get criticisms and suggestions. Reports included major and minor items alike: plan features, equipment details, operating methods; altogether a fairly rough test of hospital planning after the fact. There were some nice compliments, some complaints, and a good quotient of education. And a photographer was present to record it visually; these pages are largely devoted to a picture-and-caption report of the investigation.

Original planning began when Hendrik P. Maas was



retained as architectural consultant and the determination was made to start with a fresh site and build a new plant. Two architectural firms teamed together. Hubbard and Hyland had performed many odd tasks in connection with the older buildings, were familiar

with the hospital's problems, and Perkins and Will joined up to contribute a fresh approach, "not inhibited by previous tenets." Their work together started with the basic hospital room in the effort to design "a hotel for people who are ill."

After primary research into room units and plan types the architects settled on a high percentage of private rooms, with two-bed rooms arranged with the longer dimension paralleling the window wall. Thus each of the two patients has a like share in the daylight and the view and in the facilities of the room. There is a private toilet for each double room, a connecting one for the single rooms; lavatories are in the rooms.

A T-shaped, four-story building resulted when all elements were accounted for, with each wing or unit offset to avoid transmission of sound and long tunnel-

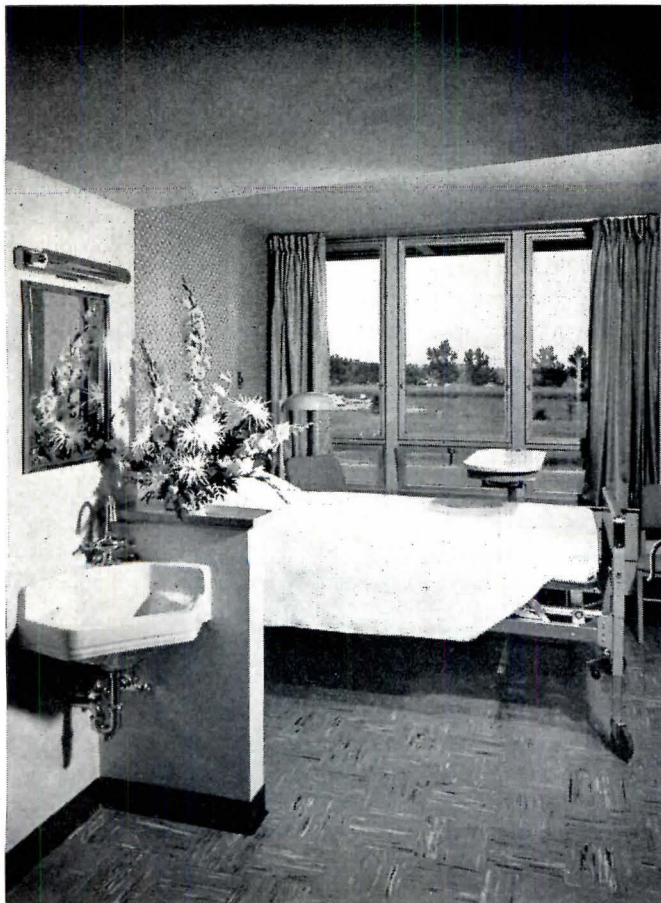

Out-patient waiting room, looking out on entrance court





Two views of main floor lobby; gift shop in background, below



Below: secretary's desk and waiting room on upper floor



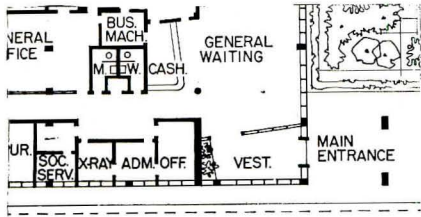

Room for chest X-ray at admittance not used as such — still some question of best procedure. X-ray room now used as admitting office; rooms so designated used for other purposes. X-ray room (now admitting office) should have glass partition looking into waiting area. May need more space for admitting, as hospital approaches full load.

● Would appreciate room near admitting offices to keep two wheel chairs

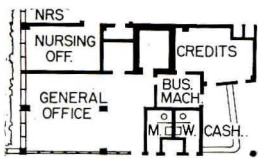

Originally no private office for credit manager; has taken space for business machine. Needed this space for private credit interviews; space still too small

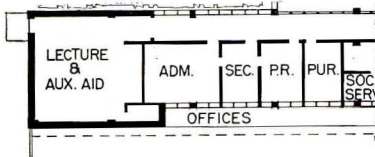

Original program did not provide office for administrative assistant, nor for administrative resident. These two have taken offices designated for public relations and purchasing.

● The combined board room and meeting room near administrator's office was considered very good

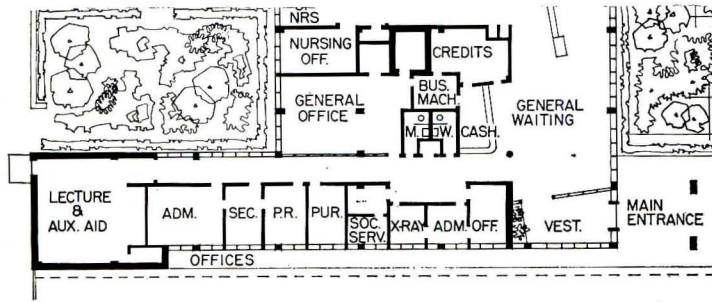
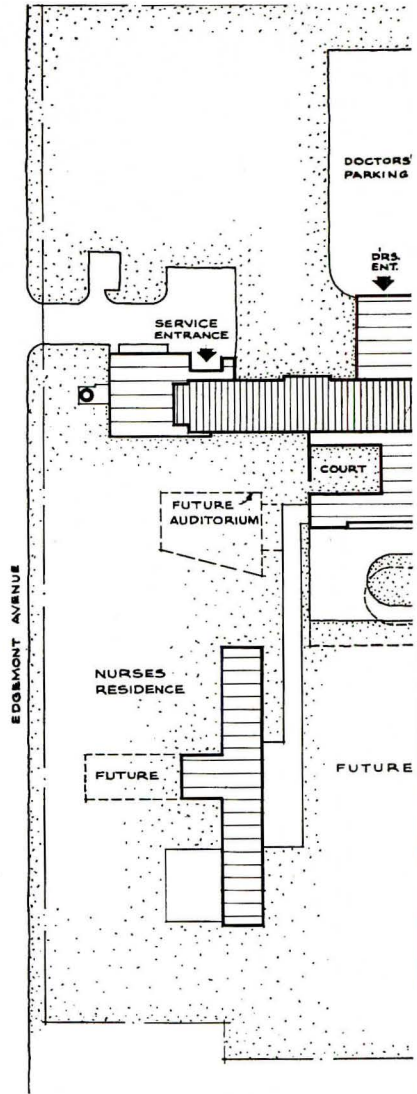

Relationships between admitting office, cashier's counter and cage, credit officer were considered excellent. Close proximity of these is important. Especially good is location of general accounting and business office near cashier's cage and across from administrator and his assistant



Hedrich-Blessing

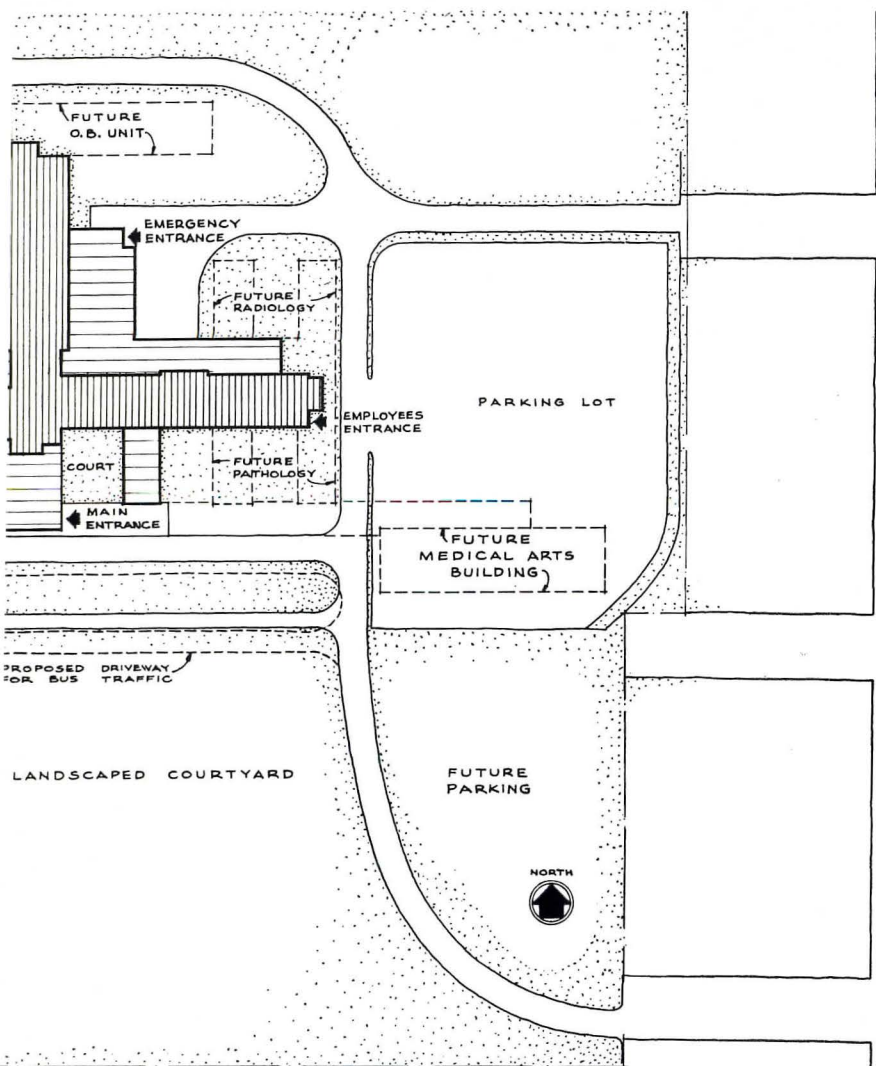

Main entrance area considered well planned. Good turn-around drive at entrance; good parking areas elsewhere. But later problem was buses coming to door: bus company insisted no parking at all near entrance. Really need space for short parking time for few cars; so suggest turn-around be enlarged. May then need doorman to control this new parking space

ROCK TON AVENUE THOROUGHFARE

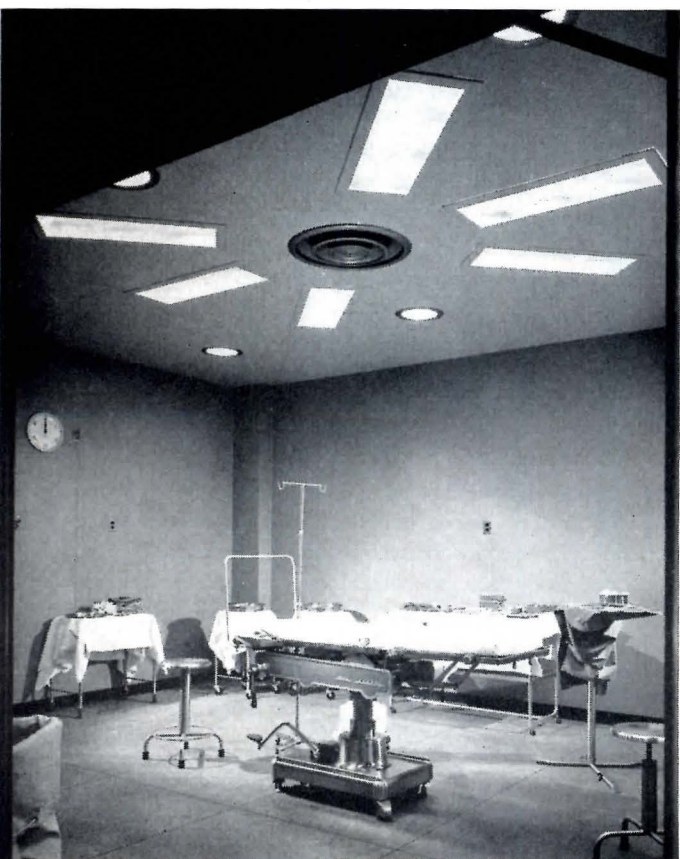
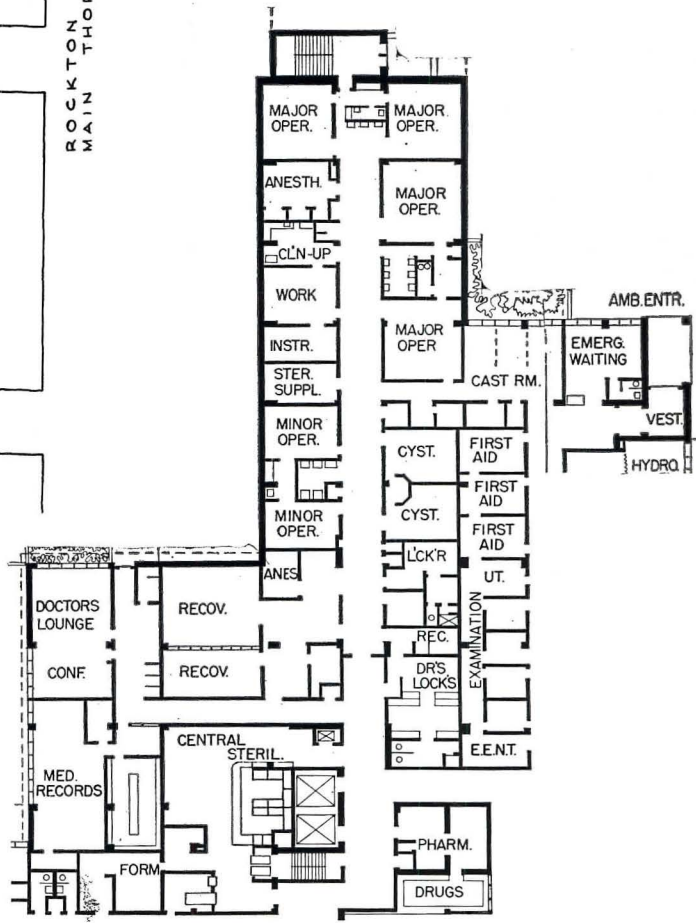

Heidrich-Blessing

The chief of surgical department said that the general layout and equipment of operating suite was excellent.

- Appreciation expressed for ten-foot corridors in operating suite: if occasionally patients need be left in corridor on stretcher, no congestion results.
- Some question of sufficient miscellaneous storage space in operating rooms: it would be nice to have separate room for equipment storage.
- Would also appreciate separate linen chute for laundry from the operating rooms.
- Doors should be installed to close off recovery room from operating corridor: some patients scream when coming out of anesthesia.
- There was criticism of location of air intake immediately over operating table.
- Room intended for anesthesia induction not used for that purpose, but proves ideal for storage of anesthesia equipment.
- General area around emergency entrance, cast room, operating suite considered very good. Main emergency room might have been a bit larger, and needs telephone.



Nurses' locker room in operating area was not intended as a smoking or lounge room, but is so used. Should be twice as large for this use.

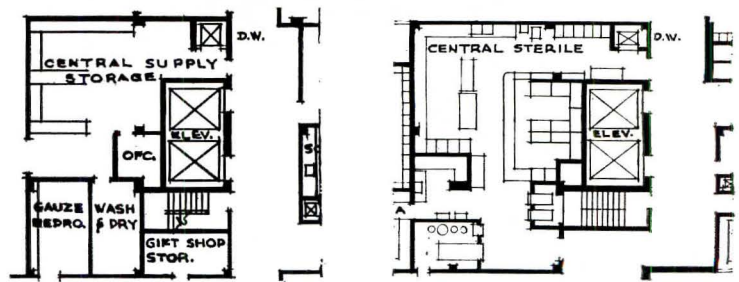

Lower level

Upper level



Gordon Coster

Appreciation expressed for dictating booths in medical records department. Portable file keeps records available to doctors at odd hours.

● *Medical records librarian needs a private office; five clerks work here.*



Two-level operation (ground and first floor) of central sterile supply department is most unusual. At this date nobody was sure how it came about. No real study of its feasibility yet made, but is yet to come. Meanwhile only one level now used, and certain troubles have arisen: No "retail storage area" to store few cases of materials right in room. Dumbwaiter presently overloaded, and is not well located. Inadequate loading space at the large sterilizer; bundle wrapping area too far from sterilizers. Need an office area for the supervisor. A sterilizer manufacturer is now studying plans for this area, hoping for a new layout which might yield a more efficient operation.

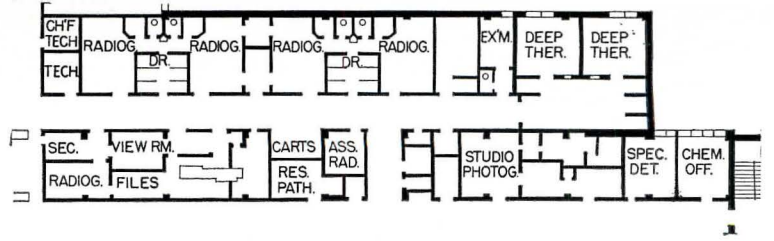

In radiology suite, technicians would appreciate a sub-corridor behind X-ray rooms, as in out-patient department. Here there were some of the usual expressions by the hospital personnel that certain rooms are too small, the toilet room doors are too confined. Most serious seems to be that one or two of the radioscopic rooms are too small, and the stretcher parking area too tight. They would have liked more storage area.



Maybe a sliding door?

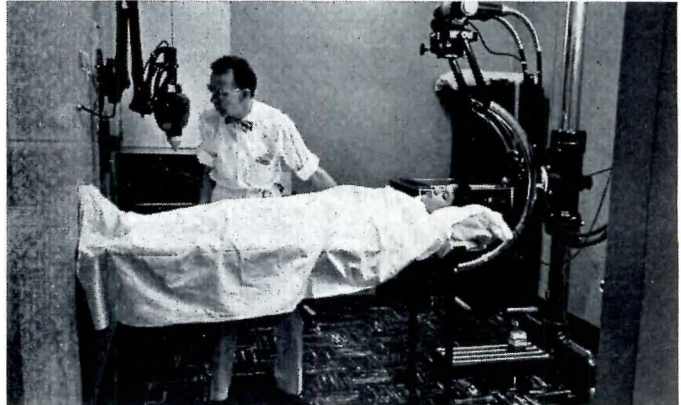

Head radioscopic room is too narrow

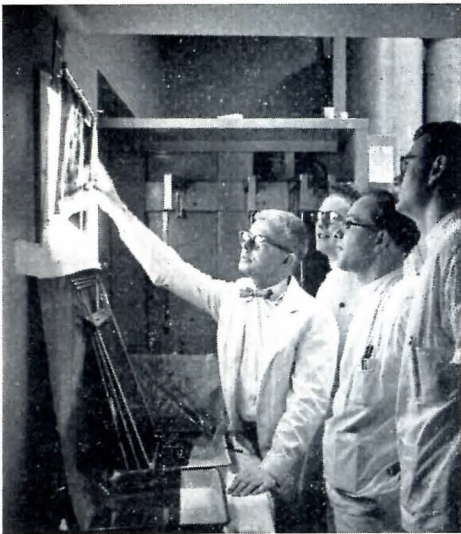

Designed for one — four's a crowd; viewing area in X-ray film developing area. Sometimes several want a quick look at a wet plate. Also, a small dark room for individual processing would be a nice idea.

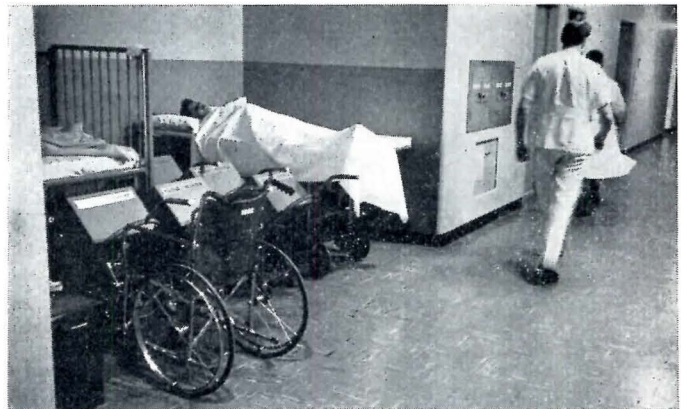

More parking space needed in X-ray corridor

Everybody concerned felt the cast room "was perfect"



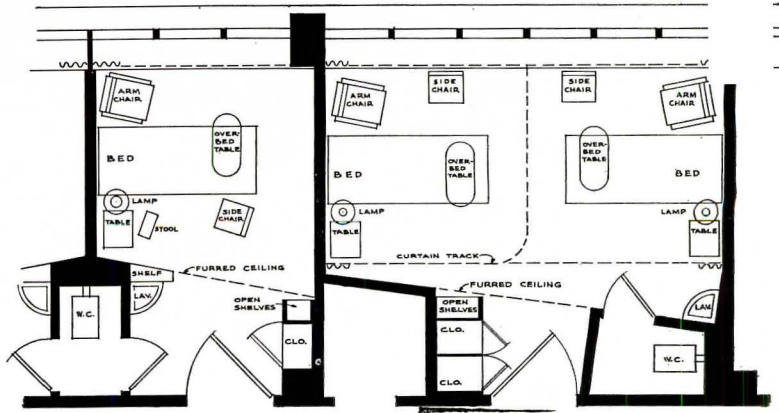
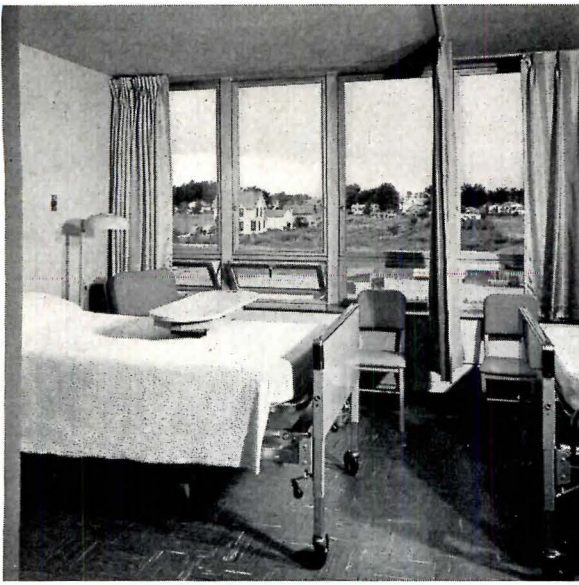

How did patients like the large window area? Reactions were mixed: 70 per cent liked them; 30 per cent said the light hurt their eyes

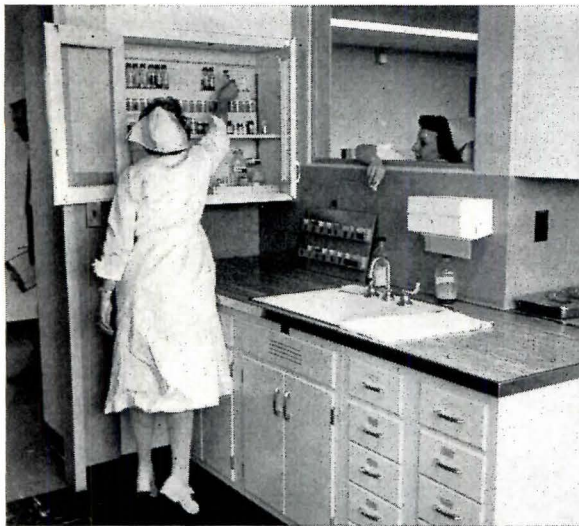

Location of medicine cabinet over sink board in nurses station utility room is awkward — also needs better light.

- A change in the architects' plans made a problem about bed

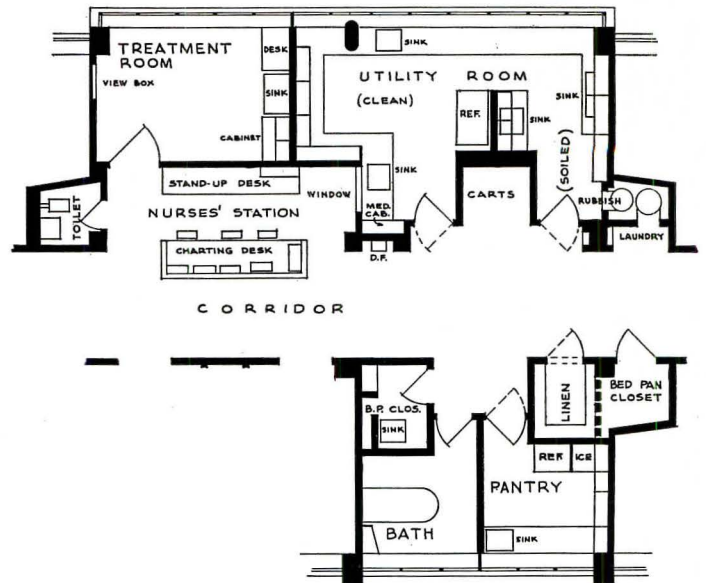

It was decided during construction not to include bed pan washing equipment in patients' toilets as planned; thus bed pan closets were afterthought, are poorly located and take space from linen room where space is at a premium

If the bedrooms were just a little larger, it would be easier to move patient's bed out into corridor, or to transfer patient from bed to stretcher-bed. Nurses have to move other furniture around to accomplish either method of moving patient

Nurses are always too small

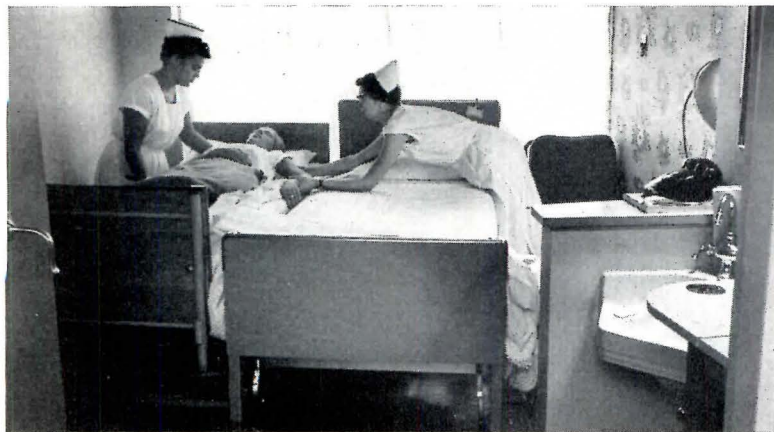

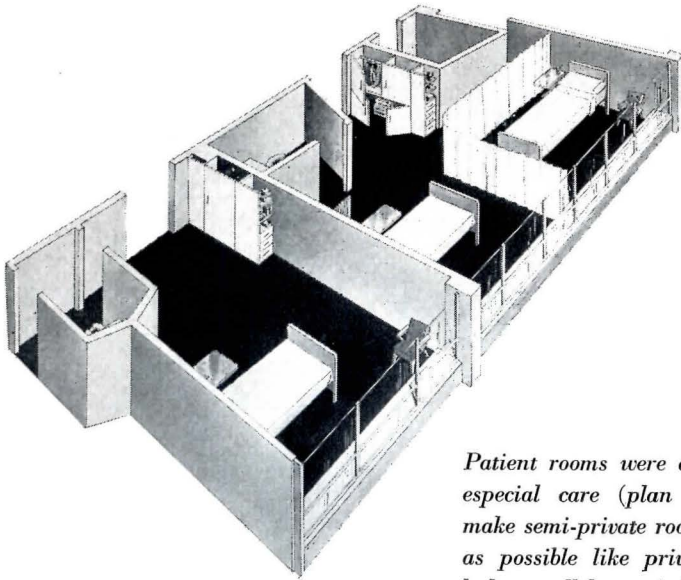

Patient rooms were designed with especial care (plan opposite) to make semi-private rooms as nearly as possible like private rooms — beds parallel to window, curtains for maximum privacy. Angled walls add some space to room, also have some acoustical value.

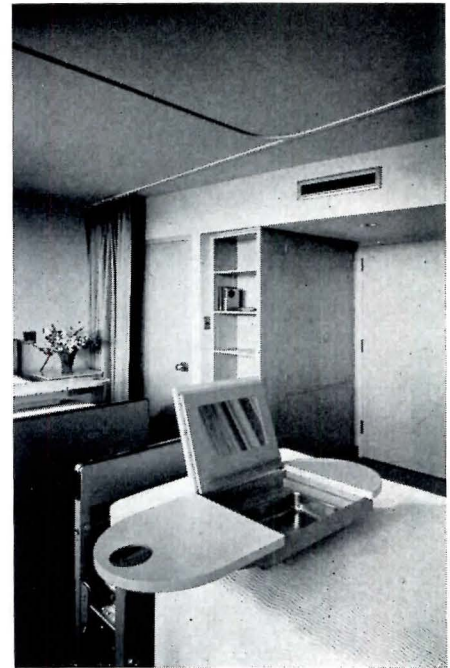

Heidrich-Blessing

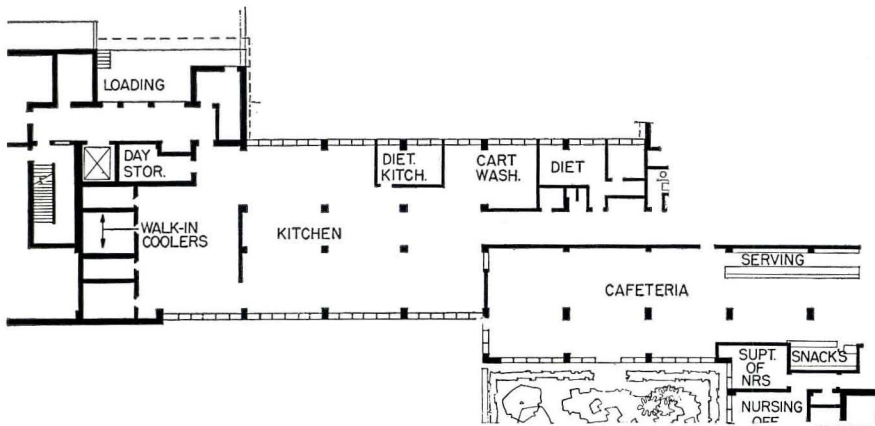

Gordon Coster

General arrangement of cafeteria and snack bar considered very good. Snack bar appreciated — might be larger, also needs more storage space

Kitchen employees think everything here is well laid out. Refrigerator boxes are well located for deliveries, as are bulk food storage and ice boxes. The assembly line for hot-pack type of meal service is working well. Patients gave their praise for the food service, and that is a rugged test in a hospital

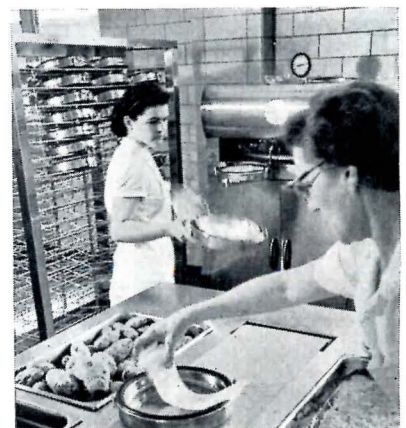

Gordon Coster

Gordon Coster

Gordon Coster



Nurses in the pediatrics department were well pleased with their suite and arrangements. They were especially pleased with the special diet kitchens, where all meals for youngsters are prepared, and with the pediatrics play room

Gordon Coster

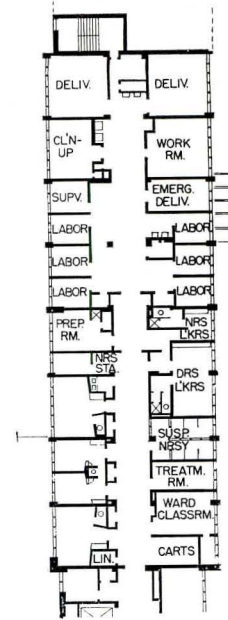
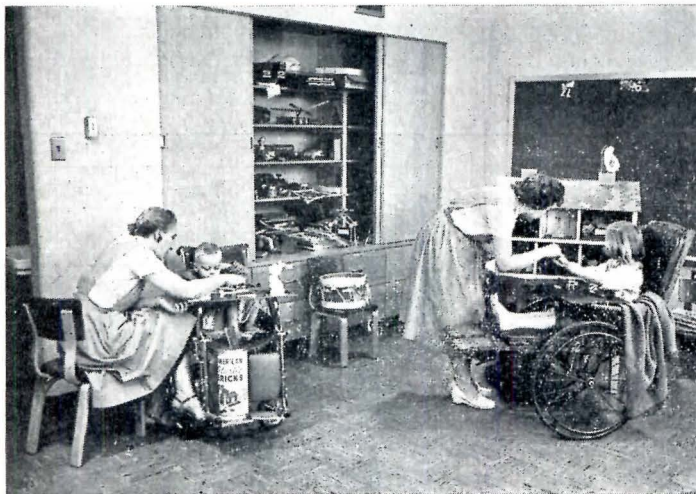

OBSTETRIC UNIT

Standard hospital doors in obstetrical department proved a bit narrow for moving labor room beds in and out, for here the labor room beds go right into delivery room for transfer of patients.

● *Patient rooms in this suite were designed for mothers whose babies were in suspect nursery; rooms not yet used for this purpose, might not ever be. Rooms might be assigned for normal use. Now being used for sleeping rooms for male nurses, doctors or residents on call*

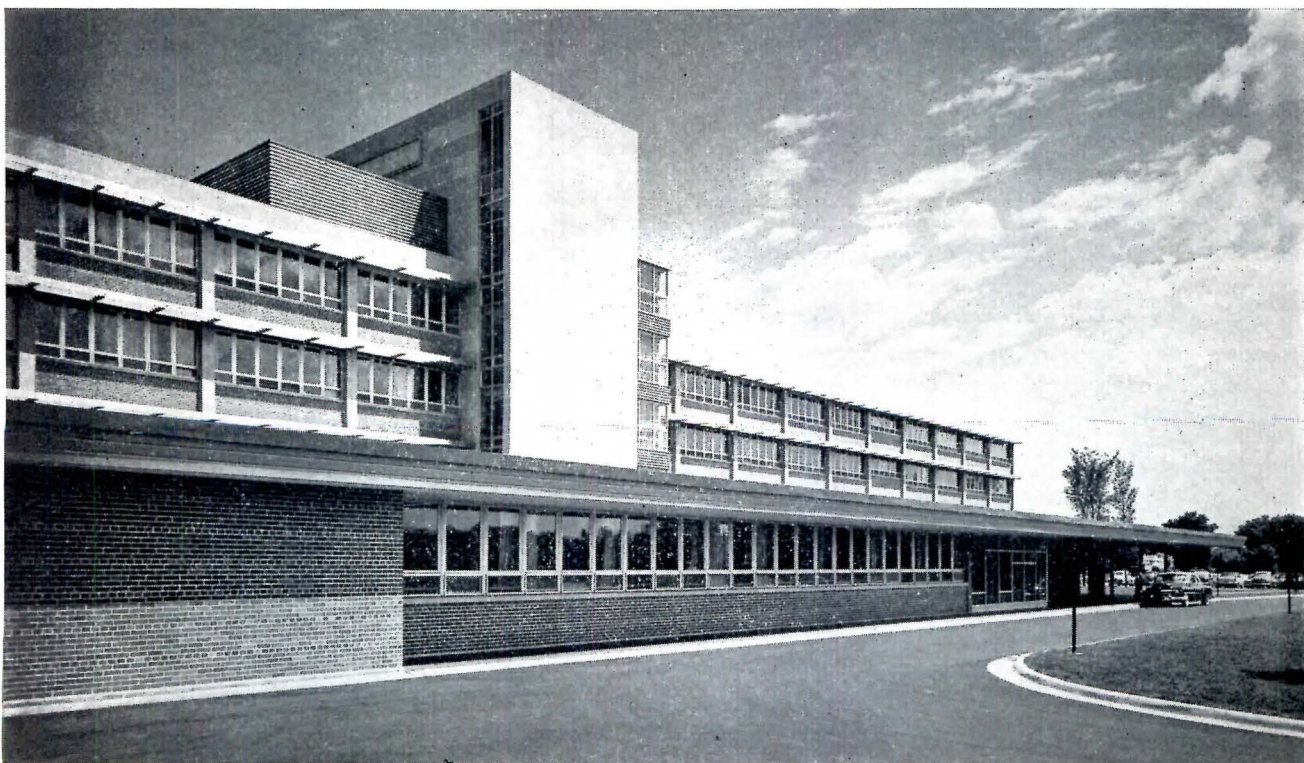

Hedrich-Blessing

HEATING AIR CONDITIONING PLUMBING

Trends and new developments

With building design being so complex, it's no wonder that the architect or engineer finds it difficult to recall, say, "a new type heating system" that would be "ideal for a certain job." Serving somewhat as a reminder, this two-part article covers a large number of items introduced in the last two years

WHILE there have been some new concepts introduced in the past two years, the main advances have taken place in the development of new equipment and refinement of older designs. In houses, for example, heating units are still more compact and flexible; air conditioning is more practical because of packaged units, whose components can be located in convenient spots, and because of inconspicuous, smaller water-saving devices.

The items described for various types of buildings were selected as being typical of new equipment, and such selection does not imply endorsement.

FUELS

Atomic Energy

There are some science writers and engineers who have mentioned the possibility of atomic energy as a means for space heating in addition to its use for generation of power. How much speculative thinking this represents, no one knows. It is known, however, that waste effluent heat from the operation of a reactor can be recovered by means of a system of heat exchangers. At the Hanford Atomic Products Operation, an estimate has been made that for the entire operation, an excess of 3 million cu ft per minute of outside air is required to dilute air in the plant to reduce the possibility of danger from radioactive material. To keep this air properly heated during an entire heating season would require 4,300,000 gallons of oil.

Gas

Natural gas products has grown from 2.5 trillion cu ft of gas in 1937 to an

estimated 9 trillion cu ft in 1952. During 1953, there were discovered 7.1 trillion cu ft of new natural gas reserves. It was reported that in the Appalachian area the demand for gas increased 50 per cent during 35 per cent of the year due to winter temperatures. Cross country pipe lines carrying gas from the Southwest cannot be operated economically with such fluctuating loads. The economical solution is to use underground storage areas as close as possible to the market areas.

By the end of 1953 there were 167 underground storage pools operating in 17 states compared with 50 pools operating in 11 states in 1944, according to figures of the American Gas Association.

This same association reports that the anticipated residential space heating load using gas as the fuel will, in 1957, exceed that of 1953 by 53 per cent. It will represent nearly one-fourth of the total annual demand of all customers in the industry in 1957. About 1.2 million additional families will heat with gas during each of the next 3 years.

Synthesis Gas

A process has been developed whereby pulverized coal is converted to synthesis gas in one step. The gas is a mixture of carbon monoxide and hydrogen. The new process produces this gas cheaper than by the old method and it also permits the use of a lower grade coal. Pulverized coal, oxygen and superheated steam are sprayed through a burner nozzle into a refractory lined furnace. Gases rise and are drawn off for further processing into chemicals. Two small plants, using this process, have been successfully operated.

By Nathan N. Wolpert

Associate Editor

Air Conditioning, Heating and Ventilating

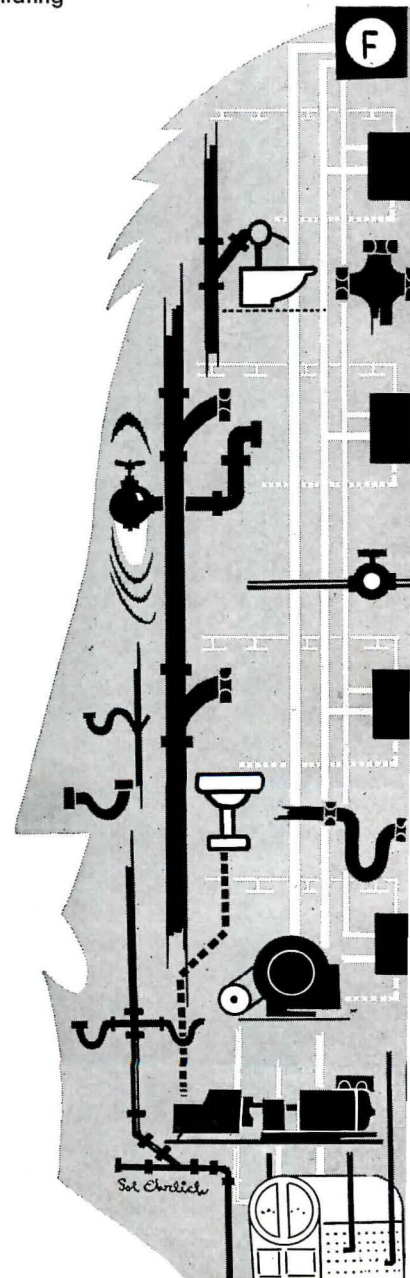

HEATING

Although much has been written about air conditioning, one must not slight heating, the one service that makes homes and buildings livable in most parts of the United States.

A new idea in heating a large number of rooms is the turbine driven heating system. Steam generated by a low pressure boiler is conducted through small copper tubes to compact individual room units which are normally recessed into the outer wall.

The heater consists of a copper heat exchanger, a steam-driven fan for circulating room air through the unit, an air filter and a self-contained thermostat. The non-electric thermostat modulates the flow of heat, controlling both steam supply and fan speed. Units come in three sizes with heat outputs of 6000, 12,000 and 18,000 Btu per hr.

An oil-fired duct heater is available for use with central air conditioning systems serving supermarkets, stores and other commercial applications. The heater has air intake louvers which balance the distribution of air over the heat exchanger and give correct air velocity. Units are available in 200,000, 300,000 and 400,000 Btu per hr output.

Also for the commercial field is a steel boiler, split into sections, so that the packaged parts can be taken through undersized doors and assembled to form two watertight sections by bolting the two halves together. It is available in 12 sizes from 876,000 to 5,100,000 Btu per hr, and can be either oil- or gas-fired.

A number of interesting units have been designed for the small or basementless type house. One type, for use in a utility room or closet, has a burner that operates within an insulating brick combustion chamber. Insulating fire brick heats to a red glow in a few seconds to provide clean combustion. This style furnace is available in six capacities from 75,000 to 144,000 Btu per hr.

A hot water steel boiler has a maximum gross output of 115,500 Btu per hr when oil- or gas-fired. The round boiler is 24 in. in diameter and stands a little over 5 ft high. Spinner blades break up the hot core of gases to provide greater heating efficiency. A unit rated at 3 gpm supplies domestic hot water without the need of a storage tank.

One space-saving furnace is placed within masonry walls of a 25-in. square chimney. The rustproof furnace, of the counterflow type with a heat exchanger about 9 ft high, is made of 302-18-8

stainless steel. An additional 2500 sq in. of radiation surface is provided by exhaust stacks within the chimney heat exchanger. If the chimney is centrally placed, as many as three rooms can be heated by grilles in the chimney. A gun type oil burner is provided although it is expected that a gas-fired unit will be available soon.

Gas-fired Units

In looking over the gas-fired field, let us first consider the kitchen. A counter height unit for kitchen installation in the small house with one bathroom has a gas input of 115,000 Btu per hr and it is rated at 440 sq ft of water radiation.

For use in small, basementless houses or individual apartments, there is a hot water, cast-iron, wet base, gas-fired boiler having self-cleaning tube construction. Because of the wet base construction, boilers can be installed directly on combustible floors. Sizes are 87,000, 115,000 and 150,000 Btu per hr.

Steam Generators

During the past two years, there has been added interest in the packaged steam generator — a unit which comes self-contained and completely wired.

An extra small steam generator has been designed which requires an installation space of only 9½ ft long, 6 ft wide and 6 ft 8 in. high. It is a 250 hp fire tube steam generator which burns either oil or gas and is designed for operation at 15 to 200 psi pressure. Under normal operating conditions, it delivers 6500 lb of steam per hr. This boiler can be operated from 30 to 100 per cent capacity.

Baseboard Heating

For the baseboard hot water system, there are two new types of equipment. One model has a heating element 2 by 2¾ in. in size and this unit projects 2¾ in. from the wall; the height to the top of the molding is 8¾ in. Where larger capacity is desired, there is a unit with heating elements that measure 2¾ by 4 in., projecting 3⅜ in. from the wall; the distance from floor to top of molding is 11⅞ in. The finned heating elements come in lengths from 1 to 6 ft. An enclosure consisting of back, front bracket and trim is 8 ft long.

For fin tube radiation, there is a hanger with a sliding cradle which allows expansion and contraction of the heating element. This cradle permits a maximum ¾ in. movement of the element.

Panel Heating, Cooling

A new idea in panel heating and cooling, using air as the cooling and heating medium, employs a double deck concrete floor construction. There are two thin concrete floors — the top slab forming the flooring surface. Thin metal forms which cover the entire floor, separate the two slab layers. Warm air passes through the floor system and is released through continuous baseboard registers to give both radiant and convection heating. This system has also been used for floor panel cooling in California. Controls provide single or multi-zone regulation. Because of the thin concrete slab, there is little heat lag.

Unit Ventilators

A new unit ventilator has been designed for school heating. It is mounted on the outside wall of the classroom and ducts run along this outside wall under the windows, at about sill height. Air travels along the ducts and blocks drafts from cold surfaces besides distributing heat and ventilation air to all parts of the room. Air is drawn into the unit from the room at floor level, or from the outside if ventilation is required. Unit ventilators are available with capacities ranging from 500 to 1250 cfm in floor type, semi-recessed and recessed models. Duct sections come in 5 ft lengths.

Heat Recovery

To be used with the larger heating installations, there is a heat recovery unit which the makers claim can recover 90 per cent of the heat in an exhaust air stream. The unit, which is like a wheel, is placed in the line of the air exhaust. Exhaust air is blown through the upper half of the unit and is then discharged outside the building. While exhaust passes through, metal wool in the unit extracts heat from it. At the same time, fresh air is blown through the bottom half and the wheel revolves slowly. Heat is picked up by the incoming air stream and is put to good use. All units are 26 in. deep and the size varies from 53 to 128 in. square for the five models which have capacities from 3000 to 20,000 cfm.

Vents

For gas-fired recessed wall heaters there is an asbestos-cement vent, approved by the Underwriters' Laboratories, which has an oval backbone of asbestos-cement pipe. Around this is a jacket of lightweight aluminum. The

two are separated the full length of the vent by spacers. This vent will handle flue gas temperature up to 550 F. Heat stays inside the vent and the outside jacket is cool. Another type, similar in design, uses aluminum for the inner pipe and galvanized iron for the outer pipe.

Electric Heating

Unless a house is located in an area where electric power is cheap, complete heating by electricity is too costly, although simple and convenient. Electric heating was installed initially in a number of houses in the Detroit area. Nearly all have been changed to more conventional heating because of the high cost.

In general, this form of heating is practical where there is a remote room in a house that has to be heated, where supplemental heating is required for a room, or perhaps where only a bathroom is heated by electricity.

Radiant heat can be supplied by an electric glass panel installed on the ceiling. The panel is insulated and is backed with reflective aluminum so that all of the heat is beamed downward into the room. Panels are installed in the room ceiling along the outside perimeter and are practically invisible. Each panel has a capacity of 500 watts or 1707 Btu per hr.

An electric cable designed for use in ceilings of homes is waterproof, non-corrosive and well insulated. A special feature of the cable is the seal said to eliminate streaks on the ceiling. When installed, the cable is stapled to the ceiling lath and then given several coats of plaster.

A special electrical ceiling heater has been designed for use in bathrooms. It is recessed between ceiling joists and is prewired to a built-in pull box. It directs heat from the ceiling to the floor and is available in 1- and 3-lamp units. No special circuiting is required.

Heaters for Construction Work

A number of small portable heaters, either oil or gas-fired, are produced for the comfort of men working on outdoor construction jobs, for drying out basements, and for heating warehouses.

One unit using LP gas is designed to give a heat output of 151,200 Btu per hr and consumes 7 lb of gas per hr. It comes in two models: One is 22 in. high, 19 in. wide and weighs 13 lb; the other is 20 in. high, 19 in. wide and weighs 14 lb (tank top model).

Iron Fireman Mfg. Co.

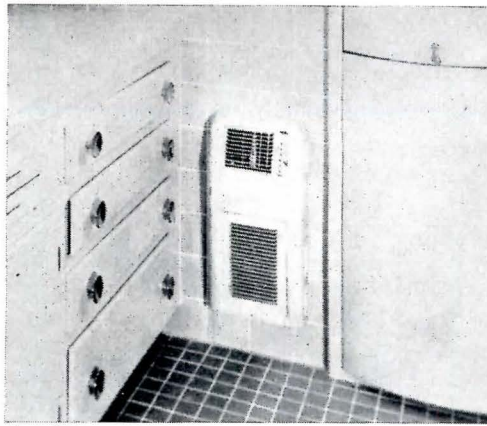

Steam serves as heating medium and drives fan as well in room units

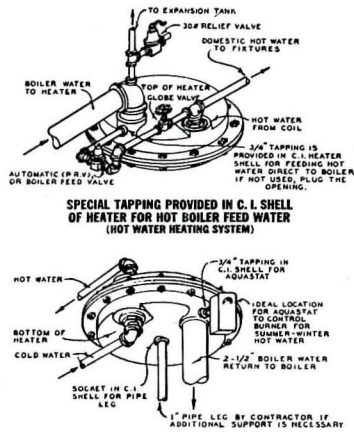
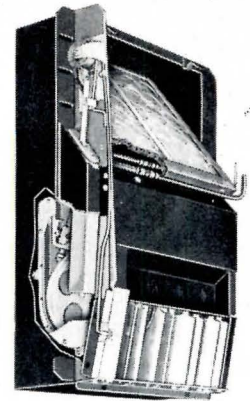

Lindy Heaters, Inc.

Tankless water heater comes in 4½ and 6½ gpm capacities

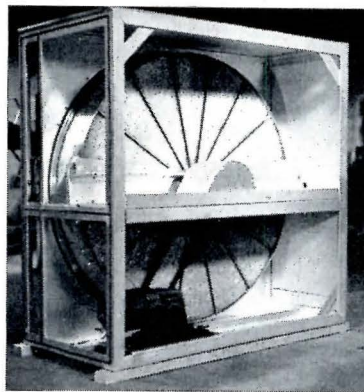

Therm-O-Wheel Inc.

Wheel recovers heat from air

Murd Boilers, Inc.

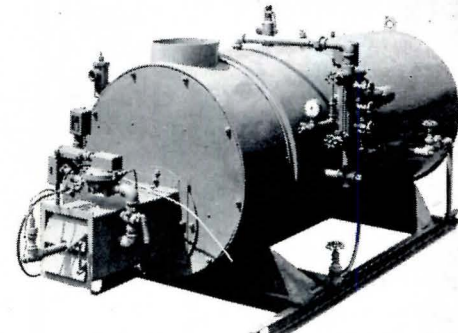

Commercial boiler has heating element immersed in storage tank



Moretemp Products Corp.

Furnace fits inside a 25-in. sq chimney

Cooling coils go above furnace, condenser outside in conversion unit

Typhoon Air Conditioning Co., Inc.

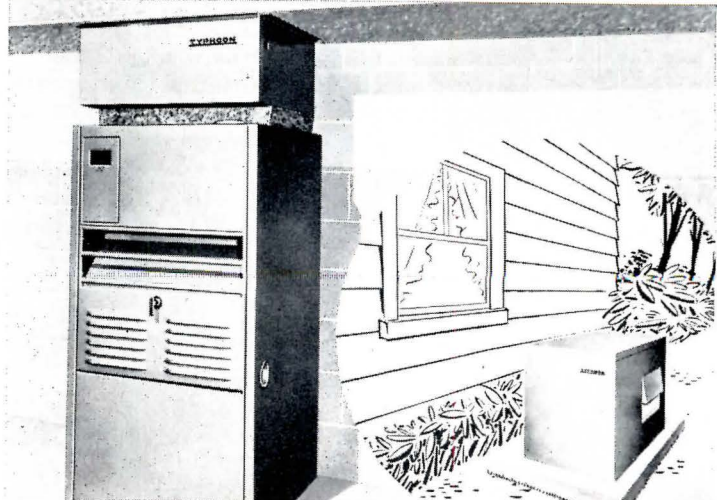

There is a self-contained, oil-fired portable heater mounted on wheels so that it can be moved easily. It burns No. 1 oil or kerosene and can be plugged into a 110-volt outlet. A blower on top of the heater forces air over a heat exchanger and out through outlets.

A portable space heater for use where electrical power is not available has a gasoline engine to power the oil burner and axial blower. A line from an oil drum feeds fuel to the burner. A standard make gasoline engine is used, and the entire unit is mounted on wheels. This heater is available in two sizes — 20,000 and 400,000 Btu per hr.

Service Hot Water Heaters

Up to now we have considered only space heating. Because of the growing demand for automatic washing appliances, manufacturers have given special attention to the design of small, efficient heaters for supplying service or domestic hot water.

Starting first with the small heater, there is an 11 gal., gas-fired water model designed for cottages, motels and garages. An electric ignition system eliminates the need for a constant-burning pilot light. It can be installed either within a building or outside. Exterior installation, with controls and venting systems outside, make it impossible for gas or fumes to get inside. Glass fiber insulation completely surrounds the inner tank and keeps the water hot long after the thermostat cuts off the heater.

Where space is a factor, a gas-fired water heater is available for installation in closets or similar locations. It comes in a 40 gal. size which has an overall height of 42 in., and a 30 gal. size which has an overall height of 39 in. Diameter is 26½ in. for both sizes.

For the larger house with from one to six bathrooms, there is a tankless water heater which looks like a thin section of a cylinder. The cast iron shell has ¾ in. tappings for a hot water connection to the feed boiler. Since the unit is self-venting, there is no worry about air binding. There is a concentration of copper coil heating surface in the hottest part of the boiler. For the 1- and 2-family house, there is a size which delivers 4½ gpm, and for the 2- to 6-family house, there is a unit which delivers 6½ gpm.

Designed specifically for the New England area, an electric water heater is lined with at least a ⅜ in. layer of hydraulic stone to insure protection against corrosion and rust. The thermo-

stat permits delivery of water from 120 to 170 F. The unit has direct immersion heating elements and fiberglass insulation to prevent heat loss. Both inlet and outlet connections are accessible for standard ¾ in. connections. It comes in 50, 66 and 80 gal. sizes.

For commercial kitchens which require 180 F water for dishwashers, there is a storage type water heater which can supply water of that temperature from one outlet and 140 F from another. Water temperature in the tank and at the top outlet is automatically maintained at 180 F. Tempered water at 140 F flows from the lower outlet. Unit is insulated with fiberglass.

There is an immersion type 2-pass hot water boiler for commercial use which combines the heating element and hot water storage so that there is a saving both in floor space and piping. The heating element is completely immersed in the water storage tank and it can easily be removed for inspection. The tank is fiberglass-insulated throughout and is protected by a metal cover. The boiler comes with either gas or oil firing or a combination, and in capacities from 250 to 5000 gph.

Tankless water heaters, for users of large amounts of hot service water, such as office buildings, schools and apartment houses, come either oil- or gas-fired. Submerged twin coils, connected together, are placed horizontal across the top section of the heater. One of the coils serves as a preheater. Water is maintained in the boiler at 227 F so that the unit can meet high, instantaneous demands. Both 140 F and 180 F water can be delivered from the same heater. Capacities range from 300 to 5000 gph.

COOLING

Air Conditioning

Air conditioning for comfort has become one of this country's most rapid-growing industries. At first in residences only window units were used, cooling one or more bedrooms at night. Now air conditioning is planned for the entire house including the basement. For one thing, this brings with it the problem of special devices such as evaporative condensers or air cooled coils to prevent the waste of large amounts of cooling water.

As far as industry is concerned, residential air conditioning has turned it topsy-turvy. Air conditioning manufacturers are selling heating units, and

companies who for years made only heating systems, have had to develop cooling systems. The objective is to have a single unit which will cool the house in summer and heat it in winter.

In the early days of year-round air conditioning, it was common to assemble the compressor unit in a self-contained package and install it alongside of the warm air furnace. The cooling unit used the same air distribution system installed for forced warm air.

Now, though, there is interest in an air conditioning system using water chillers. This differs from the conditioned air system in that heating and cooling is through pipes or tubes instead of ducts. Hot water is distributed from a central boiler through pipes to room units for heating in winter; chilled water from a central cooling unit runs through the same pipes for cooling in summer. Packaged chillers are described later.

For the home with a forced warm air system which is to be changed to year-round air conditioning, there is a conversion unit which consists of two parts. The cooling coil is normally installed in the ductwork at the top of the furnace. The air cooled condensing unit which can be placed anywhere outside of the living area, consists of a refrigeration compressor and an air cooled condenser which eliminates the need for an evaporative condenser and cooling water. The fan opening in the condensing unit has a wire grille for protection.

One air conditioner which comes in 2- and 3-hp sizes for cooling the average size house, is available as a self-contained unit or as a two-part system in which the refrigeration section is installed outside the house and cooling coils are placed in the main duct leading from the furnace. The two parts are connected by copper tubing. Both types are air cooled.

New in the 3-hp size are two different systems, both designed for residential cooling. For houses with 1400 to 2100 sq ft, operating under average climatic conditions, there is an air cooled 3-hp unit consisting of two cooling and dehumidifying systems. Under most conditions, operation of one unit is sufficient, and the other unit is held in reserve. The conditioner is installed in the attic and supplies cooled air to a dropped ceiling or plenum in the central hall.

Another 3-hp unit has three sections. The base unit which contains the cooling section is hermetically sealed and is mounted in a cabinet. In the second section, air passes over a 3-row aluminum

fin cooling unit and is discharged through the top of the unit. The third component is a blower, where required, mounted above the cooling section. A grille is placed above the blower for ductless installations and at an angle for maximum air distribution. The complete unit is 72 in. high.

One design employs a built-in evaporative condenser in the packaged unit. The section containing the cooling coil, blower and filter is detachable so that the packaged evaporative condenser may be installed in an outside garage or attic. The cooling coil can be suspended in the regular duct. While developed primarily for houses, the conditioner can also be used for commercial applications. Sizes available are 2, 3, 5 and 7½ tons.

There is a low priced 2-ton cooling system 62 in. high which occupies a floor space of only 37 in. square. The unit can be installed in a closet with an access door in front. Where municipal regulations dictate the use of cooling water, an air cooled condensing attachment is available. Return air can be brought to back, bottom or side of unit.

A split system provides forced hot water heat in winter and air conditioning in summer for residences and commercial applications. From a central unit, hot water is supplied to room conditioners in winter and cooled water in summer. Conditioners contain a finned tube heat exchanger, blower, filter and grilles. For chilling, refrigeration equipment or well water may be used. Domestic units have a heating capacity of 7200 Btu per hr using 180 F water; cooling capacity is 3750 Btu with 40 F inlet water flowing 1½ gpm. Fan operation is automatic. On the cooling cycle, a thermostat controls the booster and chiller starter in parallel circuits. The rate of air supply may be adjusted manually at each unit.

Packaged Water Chillers

One unit which is available in sizes from 2 to 15 hp supplies chilled water for air conditioning systems or drinking water. Chillers are furnished completely assembled and only require power and water connections. The circulating pump is of the non-overloading type with mechanical seal to eliminate danger of leaks. The 10- and 15-hp models have two separate refrigeration systems with thermostatic controls. When required, this permits operation at 50 per cent of capacity.

There is a chilled water unit for air conditioning system in 10- to 50-ton sizes. It comes completely assembled.

A multi-step reciprocating compressor automatically adjusts power and water consumption to the demand for cooling.

Condenser Water Coolers

Because of municipal regulations in some areas which require the use of water saving devices such as evaporative condensers, a number of such units have been developed for residences and small size commercial installations.

One system designed for use with a 3-hp packaged air conditioner provides a steady flow of cooled condensing water. The warm water is pumped through two automobile-type radiators.

Another air cooled unit for residences can be placed in an attic, garage or in the backyard. Condenser package is only 2 ft high, 3 ft deep and 2 to 3 ft wide, depending on capacity. Equipment is for use with 2-, 2½- and 3-ton compressors.

One line of evaporative condensers comes in six sizes from 7½ to 40 tons capacity. All sections are bolted together with rubber gaskets for tightness. Blowers can be rotated or reversed to blow vertically or horizontally to front or rear. It is suitable for outside installation.

Heat Pump

In principle and application, the heat pump is not new. It has been used in industry and installed in office buildings. What is new is that instead of an assembled system, there are several companies now producing packaged heat pumps in sizes for houses and small commercial applications.

The heat pump may draw heat from well water, the earth (through embedded pipe), or outside air. Field studies conducted by the Union Electric Company of St. Louis covering heat pump design, operating costs, heat sources and public acceptance indicated that while air-to-air operation of the heat pump was satisfactory for summer operation, the direct expansion ground coil was the more effective heat source in winter with respect to both first cost and coefficient of performance.

Industry is very optimistic about the heat pump. One manufacturer predicts that by 1964 there will be a yearly production of 100,000 heat pumps.

Another company now has a 10-hp heat pump available, designed for use in large homes and industrial buildings. It consists of two 5-hp compressors in completely sealed hermetic systems. In addition there are also 3- and 5-hp units.

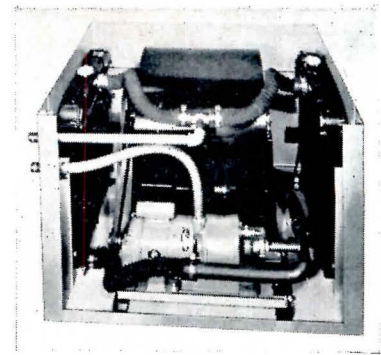

Airtemp Div., Chrysler Corp.

Automobile-type radiators cool condenser water for 3-hp conditioner

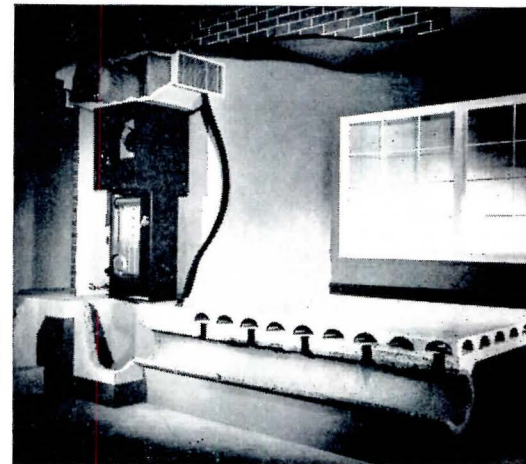

Leemhuis Air-floor Co.

Double-deck floor slab for panel heating

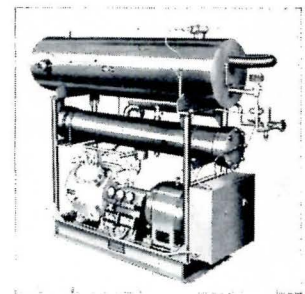

Packaged water chiller in 10 to 50 ton sizes supplies cooling to room units

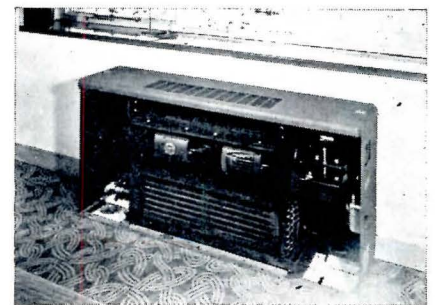

The Trane Co

3-hp air conditioner has three sections

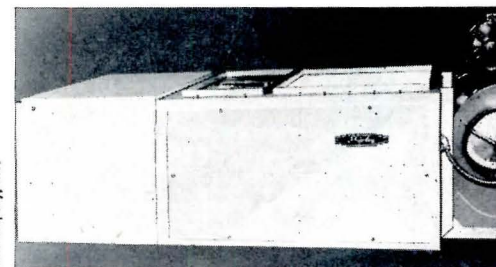

York-Shipley, Inc.

NEW HOME PRODUCTS AT NAHB SHOW

More than 300 manufacturers displayed their products at the 11th Annual Convention of the National Association of Home Builders in Chicago from January 16 to 20. Everything for the house, from the inside out, was on view. The keynote seemed to be not only to make

things easier for the homeowner and his wife through automatic, practical and easily handled and maintained devices, but also to make things easier and faster for the builder to erect and finish a house. Here are just a few of the new products of interest to architects.

PRE-PRIMED SIDINGS IN HARDBOARD AND ALUMINUM CUT INSTALLATION AND MAINTENANCE COSTS

Two new sidings will cut down both installation and maintenance costs, according to their manufacturers. A new *Masonite* siding, of pre-primed Presdwood, rests in aluminum strips which are nailed to insulation. The *Shadowvent* siding, which comes in 10- and 12-in. widths, can expand or contract without

buckling. The metal strip is vented at 8-in. intervals to allow accumulated moisture to escape. The photograph below left shows the siding sections resting in their aluminum channels. After one siding strip is placed, the next aluminum channel is nailed over it ready to receive the next length of siding. Metal corner plates fit into each other from the top. *Masonite Corp., Box 777, Chicago 90, Ill.*

3D-Inselum aluminum clapboard siding is finished in baked enamel (white, green, gray or yellow) to provide practically a maintenance-free exterior. As shown in the drawing at the right, asphalt-impregnated insulation board is nailed to the studs on a pre-scored nailing line. The aluminum siding is applied by inserting the lip of the lower edge

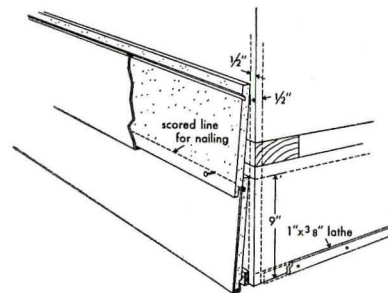

under the insulation and resting the top in a groove in the insulation board. The next piece of insulation board is rested on top of the aluminum siding, and the process is repeated. This wall can also expand and contract, has concealed nailing and is fire- and termite-resistant. *Jones & Brown, Inc., 439 Sixth Ave., Pittsburgh 19, Pa.*

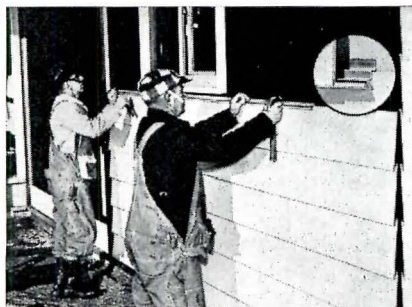

FOLDAWAY BURNERS FOR COOKING FREE COUNTER SPACE

Foldaway burners for surface cooking will be on the market next month from Frigidaire and Dixie Products. The burners, with adjustable heat ranges, rest on the working counter when in use and shut off automatically when folded away to leave the counter free as a working area. The *Dixie* burner, shown at right, is available for gas or electric operation from *Dixie Products, Inc., Cleveland, Tenn.*

Frigidaire, which produces the electric burner pictured right, is also marketing a new "French Door" oven to save kitchen space and give easy access to cooking foods. *Frigidaire, Dayton 1, Ohio.*

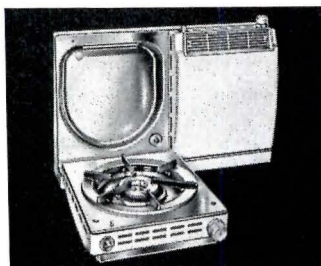

PLASTIC WALL STRIP CONTAINS WIRING FOR MOVABLE OUTLETS

Electrostrip, a rigid vinyl plastic strip containing wires and having flexibility enough to be hand-molded around cor-

ners, pipes and posts, eliminates the inconvenience of badly located or inadequate wall plugs and the necessity for long extension cords. Movable outlets can be snapped into the strip any place along its length. Listed by Underwriters' Laboratories, *Electrostrip* is produced in a natural ivory color which can be painted. *Bulldog Electric Products Co., Electrostrip Div., 7610 Joseph Campan Ave., Detroit 32, Mich.*

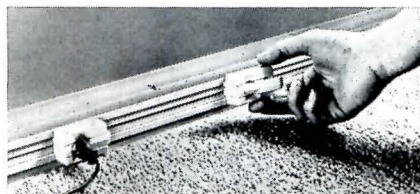

READY-HUNG PACKAGED DOORS

Ready Hung doors are packaged complete, with the door hung and locked and the frame trimmed on both sides ready to install in any rough opening. Furnished in a variety of door and trim styles, the packaged unit is made left and right in all standard sizes for inside doors and does not require special framing of the rough opening. Fasteners on mitre joints in the trim keep mitres tight indefinitely. Installation drawings below show the door and grooved half being fitted into the opening, the tongue of the opposite half of the frame being fitted into the grooved half, and the final nailing through the stop into jambs after the sections have been squeezed together at the top corners. *Ready Hung Door Corp., Neil P. Anderson Bldg., Fort Worth 2, Tex. (More products on page 226)*

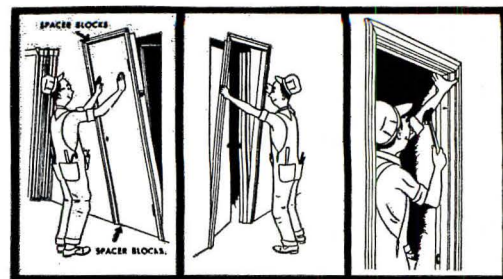

STAINLESS STEEL WALLS IN SOCONY-VACUUM BUILDING TO BE LARGEST APPLICATION

The new Socony-Vacuum Building now under construction on a 2-acre tract at 42nd Street and Lexington Avenue in New York City is being acclaimed with many titles, all of them different but all of them containing the word "largest."

1. The sixth *largest* office building in the world (1,300,000 sq ft of office space).
2. The *largest* building in the world to be sheathed in stainless steel.
3. The *largest* completely air-conditioned building in the world.
4. The *largest* office floor of any building in New York City (the second floor, with 75,000 sq ft).

The fourth through the forty-second floors of the 45-story skyscraper will be completely sheathed with 20-gauge stainless steel wall and window panels $\frac{1}{32}$ in. thick backed up by 4 in. of masonry and an air space. The first will be installed early this spring, following completion of the steel skeleton. A simple design by sculptor Anthony Dal Pino (shown in the photograph right with superintendent William Decker) is stamped on the panels with raised surfaces $1\frac{1}{2}$ in. high to reflect light and cast shadows. Except for a few special sizes, the panels will measure 11 ft 9 in. long by 4 ft 1 in. wide.

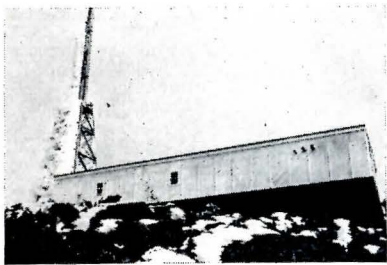

A prefabricated structure of stressed-skin plywood panels made in small, light sections met the unusual and stringent requirements of building a television transmitting station at the top of Mount Washington, New Hampshire. The building had to be —

1. *Strong*, to resist the wind velocities of 100 mph (common) and up to 230 mph and to withstand the impact loads of heavy pieces of ice falling from the tower onto the roof (see photo above).
2. *Ready-made in small sections and light* so that the road and cog-wheel railroad to the summit could haul them and so that the heavy, bulky parts of the transmitting system could be enclosed immediately after installation without being exposed to inclement weather.

More than 3200 windows in stainless steel frames 4 ft 8 in. wide by 6 ft 7 in. high will be incorporated in the exterior panels. The windows turn 360 deg in their mountings on vertical axes, so that all cleaning can be done from inside. A lock assembly in the frame ensures that the window will stay closed except when opened by key holders for maximum air conditioning efficiency. Double vinyl plastic gaskets are designed to be weathertight in winds of 100 mph. If any rain does get past the weatherstripping, it will be collected in a groove at the bottom of the frame from which it will be carried through a tube to an aperture in the vertical joint of the wall panel and allowed to run off. (See cross section of window at right.)

Galbreath Corp., owner of the building, has disclosed many reasons for the selection of stainless steel:

1. More office space (3 per cent more) because of reduced wall thickness, which also cuts wall weight to 40 psf.
2. Corrosion and fire resistance (320 stainless steel has high nickel content for weather resistance).
3. Low maintenance costs (panels can be washed).
4. Durability and lasting beauty.

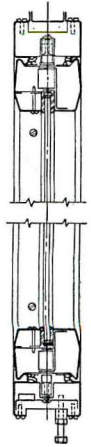
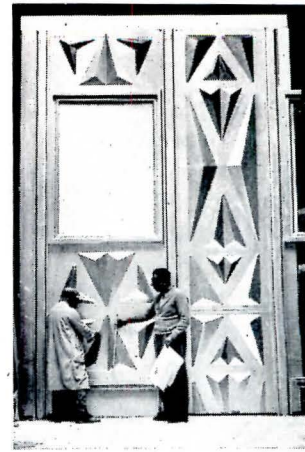

The lower three floors of the building will be faced with granite, glass and stainless steel. The top three floors, which will house machinery, will be sheathed with stainless steel louvers.

Harrison and Abramovitz, with John B. Peterkin as associate, are the architects; Edwards and Hjorth, structural engineers; Jaros Baum and Bolles, mechanical engineers; Edward A. Ashley, electrical engineer; Turner Construction Co., builder; Truscon Steel Div. of Republic Steel Corp., stainless steel fabricators. The air conditioning system will be considered in a later issue.

STRESSED SKIN PANELS CAN LICK 230 MPH WINDS

3. *Transparent to microwaves* on one side to house receivers for programs from Poland, Me., 50 miles away.

Stressed-skin panels of exterior-grade Douglas fir plywood on cellular grid cores were used for floors, walls, roof and principal cross partitions of the 35- by 78-ft one-story building. The walls resist bending pressures of 150 psf and the roof resists bending loads caused by uplift forces of about 150 psf and those caused by snow. Walls, roof and interior partitions act as stiffening diaphragms. All sections had to be securely anchored against sidewise pressures and uplift. Foundations, particularly the footings under a line of columns at the center of the building, had to be anchored



into the rock to prevent uplift. The roof construction, comprising a cover sheet of plywood, a cushion of balsa and an upper layer of plywood, was undamaged by a 200-lb block of ice which was dropped from a 50-ft height.

The microwave-transparent wall is formed of a single $\frac{3}{16}$ -in.-thick cover sheet of polyester resin reinforced with woven glass-fiber fabric on wood studs. The reinforced plastic sheet was blown halfway down the mountainside while it was being erected during one of the three major hurricanes last year, and was recovered with just a few bruises.

The structure has been steady and has vibrated little, in spite of its relatively light construction. Reception and transmission have been good, report Albert G. H. Dietz and William J. LeMessurier, consulting engineers on the project. Koehler and Isaacs, Manchester, N. H., were architects; Keller Products, Inc., fabricator and builder.

(Roundup continued on page 266)

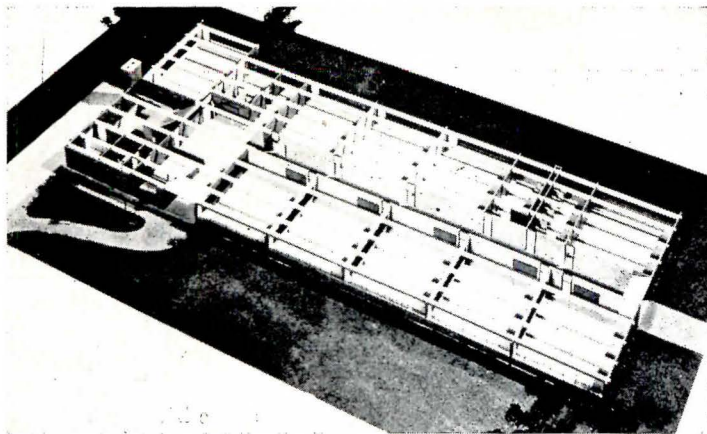

STRUCTURAL SYSTEMS

• *Comparative Costs of Low-Cost Schools* is a research report on the use of 'L'-shaped clay masonry interior walls as a basic structural element. The report states that in addition to being low in cost, structural clay masonry walls used as classroom partitions are effective in sound isolation, are fire resistant and are not subject to excessive dimensional change under varying temperature and moisture. 20 pp, illus. *Structural Clay Research Foundation, Chicago, Ill.*

• "Row Housing with Flexicore" is a four-page, illustrated folder outlining a simplified, fire-resistant, structural system for row housing, dorms, apartment and similar projects. *The Flexicore Co., 1932 E. Monument Ave., Dayton 1, Ohio.**

• The results of laboratory tests on allowable load values for joist hangers are disclosed in a four-page folder which includes descriptions, specifications and detail drawings. *Arch Rib Truss Corp., P. O. Box 6742, Los Angeles.*

• "The Fable of the Meticulous Engineer" points out in pictorial style how savings can be made by standardizing on beam and column sizes throughout a building. *The Concrete Reinforcing Steel Institute, 38 S. Dearborn St., Chicago 3, Ill.**

STRUCTURAL FACING TILE

• A four-page folder illustrates, describes and gives face and bed depth dimension tolerances of *Keramet* structural facing tile. *Metropolitan Brick, Inc., 1019 Renkert Bldg., Canton 2, Ohio.*

GRANITE CORNER ELLS AND FACINGS

• Structural details of granite corner ells, single-unit pilaster facings and radius face units are described in a folder issued by the *Cold Spring Granite Co., Cold Spring, Minn.**

LIMESTONE VENEERS

• A description of limestone veneer and photographs illustrating its use for houses is offered in a four-page folder. *Indiana Limestone Co., Inc., Bedford, Ind.**

* Other product information in *Sweet's Architectural File, 1954*

PLANNING SCHOOL SHOPS

• *School Shops for Today and Tomorrow* offers plans and descriptions of machine shops for schools (elementary through senior high and technical schools) and includes farm shops, occupational therapy and military recreational facilities. 42 pp, illus. *Delta Power Tool Div., Rockwell Mfg. Co., 400 N. Lexington Ave., Pittsburgh 8, Pa.*

WINDOWS, WINDOW ACCESSORIES

• *Koolshade Sunscreen*, which offers insect protection as well as protection from the sun, is described and illustrated in an eight-page booklet. *Ingersoll Products Division, Borg-Warner Corp., 310 S. Michigan Ave., Chicago 4, Ill.**

• An eight-page booklet gives specifications, descriptions and detail drawings of wood awning windows and includes loose-leaf price sheets. *General Woodcraft Co., Miami, Fla.*

• A manila file folder contains venetian blind information including a 20-page booklet describing style, size and color; a 16-page booklet describing mechanism and illustrating installation with detail drawings and a sample booklet of blind and ribbon colors and textures. *Hunter Douglas Corp., 150 Broadway, New York.**

• Illustrations of installation, construction details and specifications are contained in *Aluminum Windows Catalog 55-2* on church and chapel windows, ribbon windows and projected sash, curtain wall, glass block vents and aluminum wall of windows. *Marmet Corp., Wausau, Wis.**

PORCELAIN ENAMELED PANELS

• A six-page folder contains detailed information on architectural porcelain "double-wall" panel construction and installation illustrated with cross-sectional drawings and photos of actual installations. *Davidson Enamel Products, Inc., 1100 E. Kibby St., Lima, Ohio.**

• Porcelain enameled steel or aluminum panels, called *Porcelpanels*, are described in a 12-page brochure which includes specifications, data on color, finishes and other properties and construction details. *Ingram-Richardson Mfg. Co., Beaver Falls, Pa.**

FIBERGLAS BUILDING PANELS

• A four-page booklet contains a color chart, specifications, and installation information, on translucent fiberglass panels. *Alsynite Co. of America, 4654 De Soto St., San Diego 9, Calif.**

COOLING TOWERS

• Information on indoor installation of residential cooling towers is available in an 8-page, illustrated brochure issued by *Halstead and Mitchell, Bessemer Bldg., Pittsburgh 22, Pa.*

• Flow-cold cooling towers are described and illustrated in detail in an eight-page booklet. *Acme Industries, Inc., Jackson, Mich.**

HOME WIRING SYSTEMS

• A chart showing load and circuit requirements for home wiring systems can be obtained from *Kennecott Copper Corp., 161 E. 42nd St., New York 17, N. Y.**

(Continued on page 276)

THERMAL INSULATION — 6: U Factors for Frame Walls

By Laurence Shuman, Consulting Engineer

Legend:

- | | | | |
|--|--|--|--|
| Interior Finishes | | Sheathing | |
| A Metal lath and plaster | E Plywood 3/8" | 1 Gypsum 1/2" | |
| B Gypsum board, 3/8" decorated | F Insulating board, 1/2" plain or decorated | 2 Plywood 3/16" | |
| C Wood lath and plaster | G Insulating board, 1/2" and plaster | 3 Wood and building paper 2 3/32" | |
| D Gypsum lath, 3/8" and plaster | H Insulating board, 1" and plaster | 4 Insulating board 2 3/32" | |

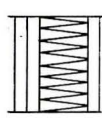
Wall Type	External Finish	Sheathing	Interior Finish							
			A	B	C	D	E	F	G	H
 Stud space filled with insulation	Wood Siding	1	.08	.08	.08	.08	.07	.07	.07	.06
		2	.08	.08	.08	.07	.07	.07	.07	.06
		3	.07	.07	.07	.07	.07	.06	.06	.06
		4	.07	.07	.06	.06	.06	.06	.06	.05
	Wood Shingle	1	.07	.07	.07	.07	.07	.06	.06	.06
		2	.07	.07	.07	.07	.07	.06	.06	.06
		3	.07	.07	.07	.07	.07	.06	.06	.06
		4	.06	.06	.06	.06	.06	.06	.05	.05
	Stucco	1	.08	.08	.08	.08	.08	.07	.07	.06
		2	.08	.08	.08	.08	.08	.07	.07	.06
		3	.08	.08	.07	.07	.07	.07	.07	.06
		4	.07	.07	.07	.07	.07	.06	.06	.06
Brick Veneer	1	.08	.08	.08	.08	.08	.07	.07	.06	
	2	.08	.08	.08	.08	.08	.07	.07	.06	
	3	.07	.07	.07	.07	.07	.07	.07	.06	
	4	.07	.07	.07	.07	.07	.06	.06	.05	

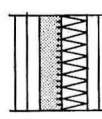
Wall Type	External Finish	Sheathing	Interior Finish							
			A	B	C	D	E	F	G	H
 2" bat or blanket insulation in stud space and reflective paper on cold side of insulation 1 air space	Wood Siding	1	.09	.09	.08	.08	.08	.08	.08	.07
		2	.09	.09	.08	.08	.08	.08	.08	.07
		3	.08	.08	.08	.08	.08	.07	.07	.06
		4	.07	.07	.07	.07	.07	.07	.07	.06
	Wood Shingle	1	.08	.08	.08	.08	.08	.07	.07	.06
		2	.08	.08	.08	.08	.08	.07	.07	.06
		3	.08	.08	.08	.08	.08	.07	.07	.06
		4	.07	.07	.07	.07	.07	.06	.06	.06
	Stucco	1	.09	.09	.09	.09	.09	.08	.08	.07
		2	.09	.09	.09	.09	.09	.08	.08	.07
		3	.08	.08	.08	.08	.08	.08	.08	.07
		4	.08	.08	.08	.08	.07	.07	.07	.06
Brick Veneer	1	.08	.08	.08	.08	.08	.08	.07	.07	
	2	.08	.08	.08	.08	.08	.08	.07	.07	
	3	.08	.08	.08	.08	.08	.07	.07	.06	
	4	.07	.07	.07	.07	.07	.07	.07	.06	

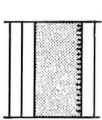
Wall Type	External Finish	Sheathing	Interior Finish							
			A	B	C	D	E	F	G	H
 Aluminum foil backup on cold side of lath. 1 air space	Wood Siding	1	.22	.22	.21	.21	.21	.17	.17	.13
		2	.22	.22	.21	.21	.21	.17	.17	.13
		3	.18	.18	.18	.18	.18	.15	.14	.12
		4	.15	.15	.14	.14	.14	.12	.12	.10
	Wood Shingle	1	.18	.18	.17	.17	.17	.14	.14	.11
		2	.18	.17	.17	.17	.17	.14	.14	.11
		3	.18	.18	.18	.18	.18	.15	.14	.12
		4	.13	.13	.13	.12	.12	.11	.11	.09
	Stucco	1	.27	.27	.26	.26	.25	.20	.19	.14
		2	.27	.26	.25	.25	.25	.20	.19	.14
		3	.21	.21	.21	.21	.20	.17	.16	.13
		4	.17	.17	.16	.16	.16	.14	.13	.11
Brick Veneer	1	.22	.22	.21	.21	.21	.17	.16	.13	
	2	.22	.22	.21	.21	.21	.17	.16	.13	
	3	.18	.18	.18	.18	.18	.15	.14	.11	
	4	.15	.15	.14	.14	.14	.12	.12	.10	

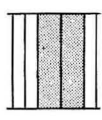
Wall Type	External Finish	Sheathing	Interior Finish							
			A	B	C	D	E	F	G	H
 1 sheet ordinary building paper placed to form 2 equal air spaces in stud space	Wood Siding	1	.24	.24	.23	.23	.23	.18	.18	.14
		2	.24	.24	.23	.23	.23	.18	.17	.14
		3	.20	.20	.19	.19	.19	.16	.16	.12
		4	.16	.16	.16	.16	.16	.13	.13	.11
	Wood Shingle	1	.19	.19	.19	.19	.19	.15	.15	.12
		2	.19	.19	.19	.19	.18	.15	.15	.12
		3	.20	.20	.19	.19	.19	.16	.16	.12
		4	.14	.14	.14	.14	.13	.12	.11	.10
	Stucco	1	.29	.29	.28	.27	.27	.21	.20	.15
		2	.29	.28	.27	.27	.27	.20	.20	.15
		3	.24	.23	.23	.22	.22	.18	.17	.14
		4	.18	.18	.18	.18	.17	.15	.14	.12
Brick Veneer	1	.24	.24	.23	.23	.23	.18	.17	.14	
	2	.24	.24	.23	.23	.22	.18	.17	.14	
	3	.20	.20	.19	.19	.19	.16	.16	.12	
	4	.16	.16	.16	.16	.16	.13	.13	.11	



Now it's possible to use one basic die-formed exit sign throughout an entire building. Quickly converted to single or double face use, The Perfectlite Surface Unit, is mounted from top, back, side, or from a pendant, depending on your requirements. Wiring is no problem. The wireway simply disengages through key slots. Two face styles available: hinged metal stencil face, 6" letters on fired green or red glass backing—or 6" letters on fired ceramic glass panel—in four color combinations.

**SURFACE TYPE UNIT
STENCIL FACE STYLE**

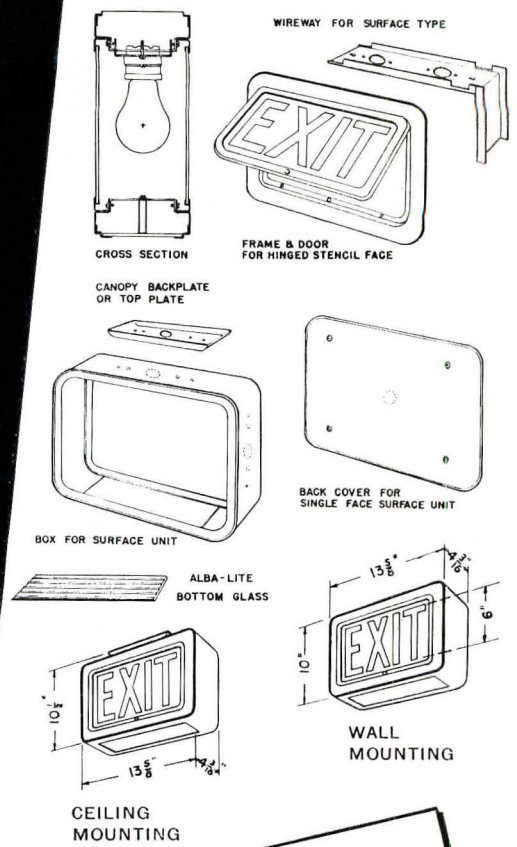

ADAPTABLE — is the word for PERFECTLITE'S new hinged exit unit

Specify Perfectlite Recessed Mounted Illuminated Exit Signs . . . die-formed, easy-to-install, easy-to-service. Two face styles: hinged metal stencil face, 6" letters on fired green or red glass backing, or 6" letters on fired ceramic glass panel—in four color combinations.

**RECESSED TYPE UNIT
GLASS FACE STYLE**

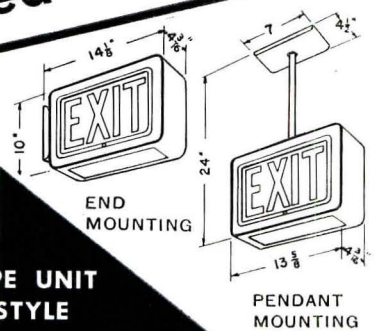

All signs are fired ceramic colors—unconditionally guaranteed. Units are Underwriters Laboratories, Inc., approved, and comply with National Electrical Code.



THE PERFECTLITE COMPANY

1457 East 40th Street
Cleveland 3, Ohio

Please send me The Perfectlite Data Folder EX-55A.

NAME

ADDRESS

CITY. STATE



THERMAL INSULATION — 7: U Factors for Frame Walls

By Laurence Shuman, Consulting Engineer

Legend:

Interior Finishes				Sheathing			
A Metal lath and plaster	E Plywood 3/8"	1 Gypsum 1/2"		2 Plywood 3/16"			
B Gypsum board, 3/8" decorated	F Insulating board, 1/2" plain or decorated	3 Wood and building paper 25/32"		4 Insulating board 25/32"			
C Wood lath and plaster	G Insulating board, 1/2" and plaster						
D Gypsum lath, 3/8" and plaster	H Insulating board, 1" and plaster						

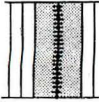
Wall Type	External Finish	Sheathing	Interior Finish								
			A	B	C	D	E	F	G	H	
 1 sheet reflective paper placed to form 2 equal air spaces in stud space	Wood Siding	1	.16	.16	.16	.16	.13	.13	.11		
		2	.16	.16	.16	.16	.13	.13	.11		
		3	.14	.14	.14	.14	.12	.12	.10		
		4	.12	.12	.12	.12	.10	.10	.09		
	Wood Shingle	1	.14	.14	.13	.13	.13	.12	.11	.10	
		2	.14	.14	.13	.13	.13	.11	.11	.10	
		3	.14	.14	.14	.14	.14	.12	.12	.10	
		4	.11	.11	.10	.10	.10	.09	.09	.08	
	Stucco	1	.19	.19	.18	.18	.18	.15	.14	.12	
		2	.19	.19	.18	.18	.18	.15	.14	.12	
		3	.16	.16	.16	.16	.15	.13	.13	.11	
		4	.13	.13	.13	.13	.13	.11	.11	.09	
Brick Veneer	1	.16	.16	.16	.16	.16	.13	.13	.11		
	2	.16	.16	.16	.16	.16	.13	.13	.11		
	3	.14	.14	.14	.14	.14	.12	.12	.10		
	4	.12	.12	.12	.12	.12	.10	.10	.09		

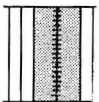
Wall Type	External Finish	Sheathing	Interior Finish							
			A	B	C	D	E	F	G	H
 1 sheet aluminum foil placed to form 2 equal air spaces in stud space	Wood Siding	1	.14	.14	.13	.13	.13	.11	.11	.09
		2	.14	.14	.13	.13	.13	.11	.11	.09
		3	.12	.12	.12	.12	.12	.10	.10	.09
		4	.10	.10	.10	.10	.10	.09	.09	.08
	Wood Shingle	1	.12	.12	.11	.11	.11	.10	.10	.08
		2	.12	.12	.11	.11	.11	.10	.10	.08
		3	.12	.12	.12	.12	.12	.10	.10	.09
		4	.09	.09	.09	.09	.09	.08	.08	.07
	Stucco	1	.16	.15	.15	.15	.15	.13	.12	.10
		2	.15	.15	.15	.15	.15	.13	.12	.10
		3	.13	.13	.13	.13	.13	.11	.11	.09
		4	.11	.11	.11	.11	.11	.10	.10	.08
Brick Veneer	1	.14	.14	.13	.13	.13	.11	.11	.09	
	2	.14	.13	.13	.13	.13	.11	.11	.09	
	3	.12	.12	.12	.12	.12	.10	.10	.09	
	4	.10	.10	.10	.10	.10	.09	.09	.08	

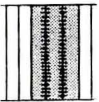
Wall Type	External Finish	Sheathing	Interior Finish							
			A	B	C	D	E	F	G	H
 2 sheets aluminum foil placed to form 3 equal air spaces in stud space	Wood Siding	1	.09	.09	.09	.09	.09	.08	.08	.07
		2	.09	.09	.09	.09	.09	.08	.08	.07
		3	.08	.08	.08	.08	.08	.07	.07	.06
		4	.07	.07	.07	.07	.07	.06	.06	.06
	Wood Shingle	1	.08	.08	.08	.08	.08	.07	.07	.06
		2	.08	.08	.08	.08	.08	.07	.07	.06
		3	.08	.08	.08	.08	.08	.07	.07	.06
		4	.06	.06	.06	.06	.06	.06	.06	.05
	Stucco	1	.09	.09	.09	.09	.09	.08	.08	.07
		2	.09	.09	.09	.09	.09	.08	.08	.07
		3	.09	.08	.08	.08	.08	.07	.07	.07
		4	.08	.07	.07	.07	.07	.07	.07	.06
Brick Veneer	1	.09	.09	.09	.09	.09	.08	.08	.07	
	2	.09	.09	.09	.09	.09	.08	.07	.07	
	3	.08	.08	.08	.08	.08	.07	.07	.06	
	4	.07	.07	.07	.07	.07	.06	.06	.06	

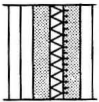
Wall Type	External Finish	Sheathing	Interior Finish							
			A	B	C	D	E	F	G	H
 1" blanket insulation placed to form 2 equal air spaces in stud space, and having aluminum foil on warm side of blanket	Wood Siding	1	.10	.10	.10	.10	.10	.09	.09	.08
		2	.10	.10	.10	.10	.10	.09	.09	.08
		3	.09	.09	.09	.09	.09	.08	.08	.07
		4	.08	.08	.08	.08	.08	.07	.07	.07
	Wood Shingle	1	.09	.09	.09	.09	.09	.08	.08	.07
		2	.09	.09	.09	.09	.09	.08	.08	.07
		3	.09	.09	.09	.09	.09	.08	.08	.07
		4	.08	.08	.07	.07	.07	.07	.07	.06
	Stucco	1	.11	.11	.11	.11	.11	.10	.09	.08
		2	.11	.11	.11	.11	.11	.09	.09	.08
		3	.10	.10	.10	.10	.10	.09	.09	.08
		4	.09	.09	.09	.09	.09	.08	.08	.07
Brick Veneer	1	.10	.10	.10	.10	.10	.09	.09	.08	
	2	.10	.10	.10	.10	.10	.09	.09	.08	
	3	.09	.09	.09	.09	.09	.08	.08	.07	
	4	.08	.08	.08	.08	.08	.07	.07	.06	

★ for the nation's newest and largest airports



AMON CARTER FIELD, FORT WORTH, TEX.
 Engineers: Yandel, Cowan & Love
 Mechanical Contractors: General Engineering Co.
 Architect: J. R. Pelich, P. M. Gerin



architects specify

usAIRco

modu-aire



GREATER PITTSBURGH AIRPORT, PITTSBURGH, PA.
 Mechanical Contractors: McGinness, Smith & McGinness Co.
 Consulting Mechanical Engineer: Theodore F. Rockwell
 Consulting Architect: Joseph Hoover



for individual room cooling and heating . . .

In the \$14,000,000 Fort Worth airport, 67 usAIRco Modu-aire units supply individually controlled cooling and heating to each office in the terminal building and in American Airline's combination hangar and office building. Hot or cold water is supplied from central supply source and is distributed to each unit through copper tubing within the walls.

Individually controlled Modu-aire units were also chosen for the huge \$33,000,000 Greater Pittsburgh Airport for installation in executive and ticket agents' offices, traffic control rooms and similar spaces, and in all 62 rooms of the unique hotel, which is the first especially designed for air commuters. A total of 225 Modu-aire units was installed.



For further details write R. R. McLain

UNITED STATES AIR CONDITIONING CORPORATION

MINNEAPOLIS 14, MINN. Export Dept.: 13 E. 40th St., New York 16, N. Y., U. S. A.

THERMAL INSULATION — 8: U Factors for Masonry Walls

By Laurence Shuman, Consulting Engineer

Legend:

Interior Finishes				Furring Space Treatment			
A No finish, plain wall	E Gypsum lath, 3/8", plastered			1 No furring			
B Plaster, 1/2", direct on masonry	F Insulation board, 1/2", plain or decorated			2 1" nominal furring, faced with ordinary materials			
C Metal lath and plaster	G Insulation board, 1/2", plastered			3 Same, faced with reflective coated paper 1 side			
D Gypsum board, 3/8" decorated	H Insulation board, 1", plastered			4 Same, faced with aluminum foil 1 side			
				5 Same, space filled with flexible insulation			

Masonry Material	Masonry Thickness	Furring Space	Interior Finish								Masonry Material	Masonry Thickness	Furring Space	Interior Finish																		
			A	B	C	D	E	F	G	H				A	B	C	D	E	F	G	H											
Brick	8"	1	.50	.46	Brick veneer plus hollow tile	4" brick 6" tile	1	.36	.34	4" brick 8" tile	1	.34	.32	
		231	.30	.29	.22	.21	.16			225	.24	.23	.19	.18	.14		224	.24	.23	.18	.18	.14	
		324	.23	.23	.18	.17	.13			320	.19	.19	.15	.15	.12		319	.19	.19	.15	.15	.12	
		421	.20	.20	.16	.15	.12			417	.17	.17	.14	.14	.11		417	.17	.17	.14	.13	.11	
		520	.20	.20	.16	.16	.13			518	.18	.17	.14	.14	.12		517	.17	.17	.14	.14	.11	
	12"	1	.36	.34		Brick veneer plus hollow block	4" brick 8" gravel	1	.44	.41	4" brick 8" cinder block	1	.34	.33
		225	.24	.23	.19	.18	.14				229	.29	.28	.21	.20	.15		224	.24	.23	.18	.18	.14
		320	.19	.19	.15	.15	.12				322	.22	.21	.17	.17	.13		319	.19	.19	.15	.15	.12
		417	.17	.17	.14	.14	.11				420	.20	.19	.15	.15	.12		417	.17	.17	.14	.13	.11
		518	.17	.17	.14	.14	.12				520	.20	.19	.16	.15	.12		517	.17	.17	.14	.14	.11
	16"	1	.28	.27		Hollow tile stucco exterior finish	8"	1	.40	.37	10"	1	.39	.37
		221	.20	.20	.16	.16	.13				227	.26	.25	.20	.19	.15		226	.25	.24	.19	.19	.14
		317	.17	.16	.14	.13	.11				321	.21	.20	.16	.16	.13		320	.20	.19	.16	.15	.12
		415	.15	.15	.12	.12	.10				419	.18	.18	.15	.14	.12		418	.18	.17	.14	.14	.11
		515	.15	.15	.13	.13	.11				519	.18	.18	.15	.15	.12		516	.16	.16	.13	.13	.11
Poured concrete	6"	1	.79	.71	Brick veneer plus poured concrete	4" brick 6" concrete	1	.59	.54	4" brick 8" concrete	1	.54	.50	
		240	.39	.37	.26	.25	.18			234	.34	.32	.23	.22	.17		232	.32	.30	.23	.22	.16	
		329	.29	.28	.20	.20	.15			326	.25	.24	.19	.18	.14		325	.24	.23	.18	.18	.14	
		425	.25	.24	.18	.18	.14			422	.22	.21	.17	.16	.13		422	.22	.21	.16	.16	.13	
		524	.24	.23	.18	.18	.14			522	.22	.21	.17	.17	.13		522	.22	.21	.16	.16	.13	
	8"	1	.70	.64		12"	1	.57	.53	16"	1	.24	.24	
		238	.37	.35	.25	.24	.17			234	.33	.31	.23	.22	.17		219	.18	.18	.15	.15	.12	
		328	.28	.26	.20	.19	.15			325	.25	.24	.19	.18	.14		315	.15	.15	.13	.12	.10	
		424	.23	.22	.18	.17	.13			422	.22	.21	.17	.16	.13		414	.14	.13	.12	.11	.10	
		523	.23	.22	.18	.17	.14			522	.21	.21	.17	.16	.13		514	.14	.14	.12	.12	.10	
	10"	1	.63	.58																						
		236	.35	.33	.24	.23	.17																						
		326	.26	.25	.19	.19	.14																						
		423	.23	.22	.17	.17	.13																						
		522	.22	.21	.17	.17	.13																						

HOW THE AVERAGE BUILDING'S USING G.E.'S "SYSTEM ENGINEERED" CAN BE EXTENDED

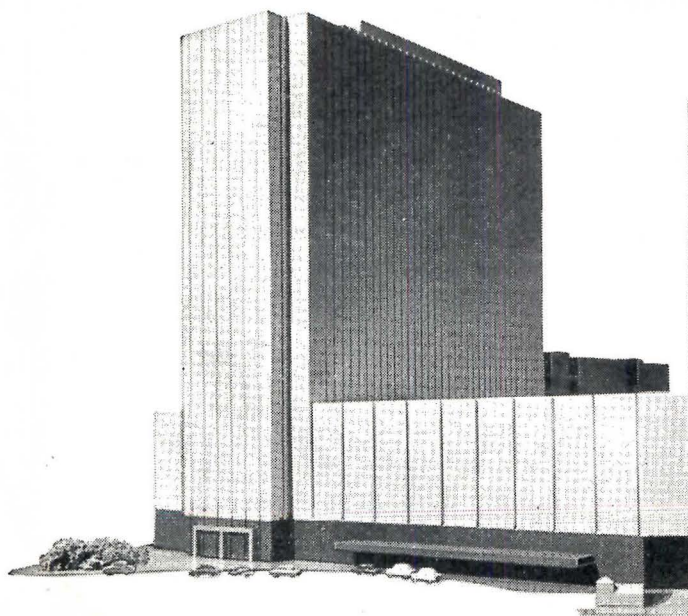

Artist's concept of the fabulous new Coliseum now under construction at Columbus Circle, New York City. More than 2 miles of General Electric's low-voltage-drop Type LVD busways will go into this unique building—one of the first and by far largest higher voltage 480Y/277 (460Y/265)-volt electrical distribution systems ever installed. The variety and flexibility of G-E equipment enable General Electric engineers to give important assistance to consulting engineers, architects and contractors in their planning of a complete system.



Built-in Future of G-E Systems is your answer to forecasts that power consumption in average building will be up 100% by 1965. Here's why: (1) G.E. achieves *true* extendability by designing components to be compact and accessible for addition or relocation. (2) They can be moved and reinstalled with practically 100% re-use of materials. (New Type DA7093 control center above, for example, needs 50% less floor space; has capacity to interrupt 50,000 amperes.) G-E "System Engineered" equipment means 1955 plans can fill future needs.

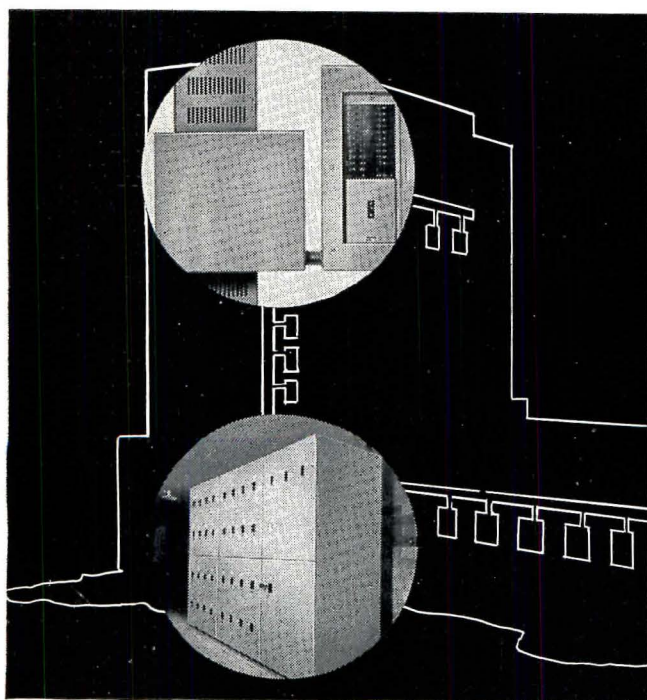

NEW YORK COLISEUM
CONSTRUCTED BY TRIBOROUGH BRIDGE AND TUNNEL AUTHORITY
HON. ROBERT MOSES, CHAIRMAN
ARCHITECTS—LEON AND LIONEL LEVY
MECHANICAL AND ELECTRICAL ENGINEER—GUY B. PANERO
ADVISORY ARCHITECTURAL COMMITTEE—AYMER EMBURY II, EGGERS &
HIGGINS, JOHN B. PETERKIN
GENERAL CONTRACTORS—WALSH-FULLER-SLATTERY (JOINT VENTURE)
ELECTRICAL CONTRACTORS—T. FREDERICK JACKSON AND J. LIVINGSTON CO.
(JOINT VENTURE)

Cutaway diagram shows tap-offs on risers at each floor of building. Their planned-in-advance accessibility assures flexibility to meet increasing future needs.

General Electric "System Engineered" equipment provides maximum safety, ease of relocating equipment, reserve power capacity for your future needs. For further details please contact your nearest General Electric Apparatus Sales or Assemblies and Components Sales representative. Or write—GENERAL ELECTRIC COMPANY, DISTRIBUTION ASSEMBLIES DEPARTMENT, PLAINVILLE, CONN.