

# ARCHITECTURAL RECORD

**12** DECEMBER 1962 • TWO DOLLARS PER COPY

BUILDING TYPES STUDY: BUILDINGS FOR THE AGING

YALE'S NEW COLLEGES DESIGNED BY EERO SAARINEN

AIR FORCE ACADEMY CHAPEL

"MEGALOPOLIS AS ANTI-CITY" BY LEWIS MUMFORD

### OPTICAL TRAIN

... In PAL Luminaires the prismatic glass reflector is precisely designed to coordinate with the Controlens (any one of three interchangeable contours). Prismatic control assures total luminosity, complete absence of glare.

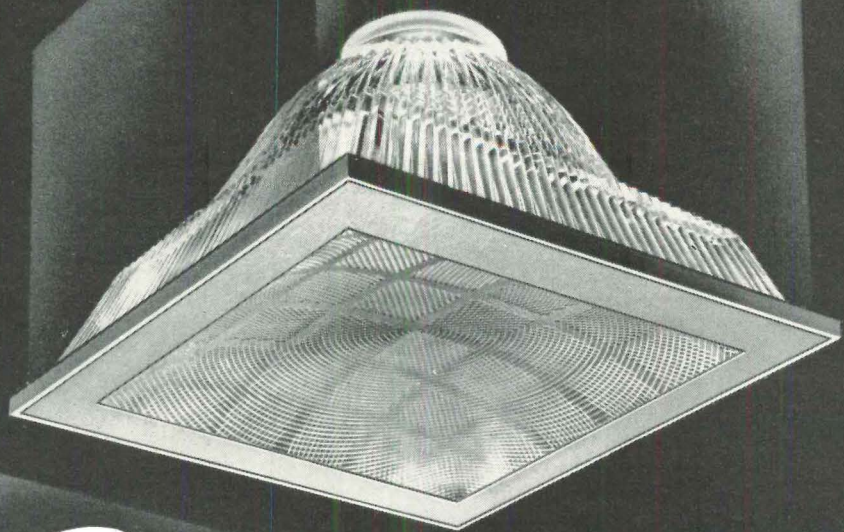

## Your Choice of **3** CONTROLENS® in Holophane \*PAL® Luminaires



\*Positive Automatic Latching

### Flexibility for Versatility

**Designer's Choice** . . . Three prismatic lenses with different contours — "concave", "dropped trim" and "plane"—permit an unusually broad scope of design expression. Luminaires can be applied as individual tile-fitting units or as matched combinations, 2 in line or 4 square.

**Engineer's Preference** . . . The optical train consistently produces the highest lighting performance, directing maximum illumination where it is most required. Wide range of possible lighting levels—choice of 150, 200 or 300 Watt lamps.

**Budget-Maker's Selection** . . . Positive Automatic Latching works simply for quick, low cost relamping and servicing—push against lens to open, push against trim to close. . . . Glass components are easy to clean, eliminate deterioration. PAL Luminaires are economical to install and maintain.

Write for engineering data.

### HOLOPHANE COMPANY, INC.

Lighting Authorities Since 1898

1120 Avenue of the Americas, New York 36

THE HOLOPHANE CO., LTD., 418 KIPLING AVE. SO., TORONTO 18, ONT.



For more data, circle 1 on Inquiry Card

For more data, circle 2 on Inquiry Card ➤

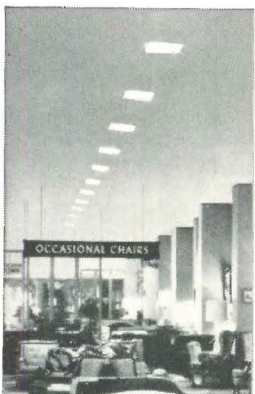

PAL Installation in  
MACY's, (N.Y. Dept. Store)



Positive Automatic  
Latching Works Simply

Everyone concerned with proper store illumination should send for a copy of Holophane's new 12-page bulletin:

"GOOD LIGHTING ADDS UP TO GOOD SELLING"

## Jacksonville, Florida

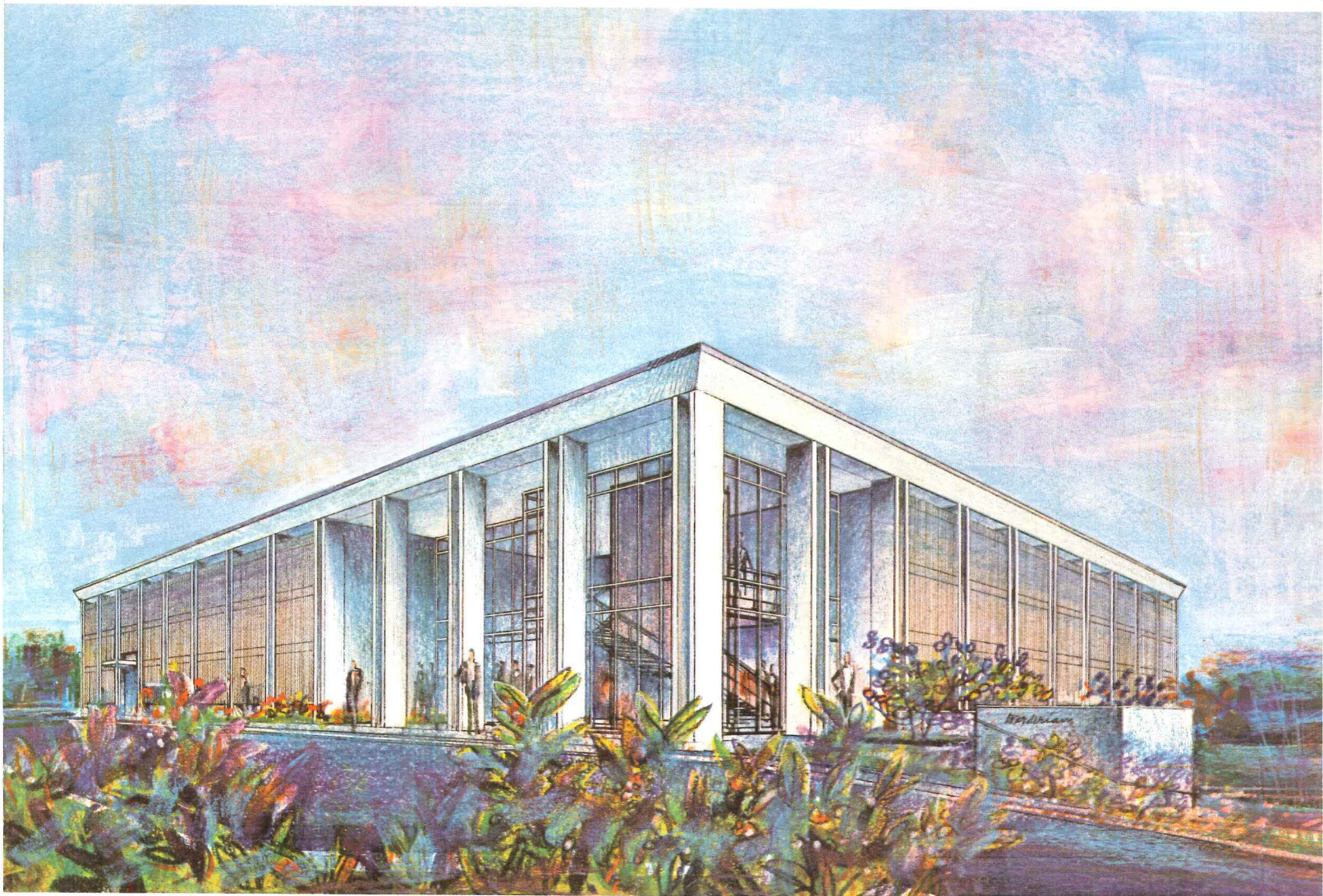

**where a bold new building uses a  
bold new idea: a ceiling that diffuses air**

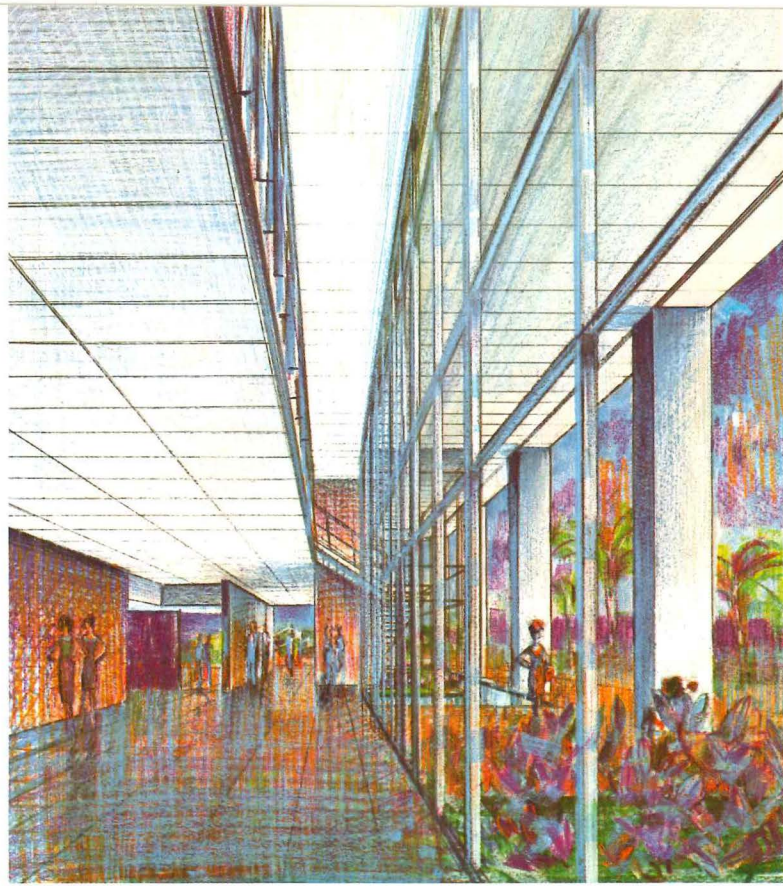
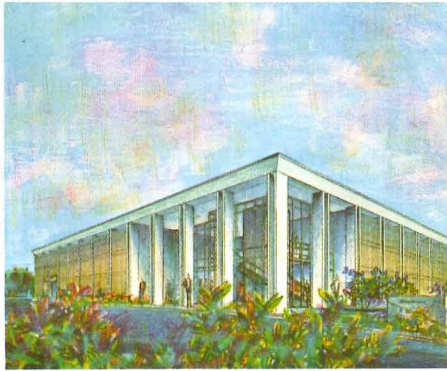

RENDERINGS BY ARA DERDERIAN

## Armstrong ventilating ceilings help air condition these "Sunshine State" offices comfortably, completely, and quietly



Comfortable air distribution and a clean, uncluttered appearance: these are the qualities which Armstrong Ventilating Ceilings bring to this new office building in Jacksonville, Florida.

In character with its bold design, they present a smooth and monolithic surface. This handsome ceiling treatment offers another important advantage, too: lighting fixtures and partitions can easily be rearranged under the ceiling without affecting the ventilating function and without the delay and cost of moving ducts and diffusers. And the Armstrong Ventilating Ceiling system (in which the sealed plenum acts as room duct and the perforated ceiling as diffuser) insures that conditioned air circulates everywhere—evenly, thoroughly and efficiently—without drafts or stagnant spots.

**DATA:** Armstrong Ventilating Ceilings have been thoroughly lab- and job-tested to assure proper performance; are available in five materials (both tile and

lay-in units), including Fire Guard, with three different patterns; and are compatible with all conventional supply-air systems. This ceiling system saves up to 30¢ per square foot by cutting supply ductwork and eliminating conventional diffusers. Ventilating Fire Guard offers one- to four-hour-rated fire protection for structural members; saves up to 30¢ per sq. ft. by eliminating intermediate fire protection, up to two months' construction time through dry installation; often earns lower insurance rates. Special plenum-engineering data is available, giving all factors and formulae for the correct design of this ventilating system, ensuring that it delivers the required cfm of conditioned air in the manner and quantity designated by the ventilating engineer. Contact your Armstrong Acoustical Contractor or Armstrong District Office. For general information about these ventilating ceilings, write Armstrong, 4212 Rock Street, Lancaster, Pa.

Koger Building, Boulevard Center, Jacksonville, Florida. Architects: Reynolds, Smith, and Hills, Jacksonville, Florida. General Contractor: O. P. Woodcock Co., Jacksonville, Florida. Mechanical Contractor: Thermodyne Corp., Jacksonville, Florida. Acoustical Contractor: Noise Reduction Corp., Jacksonville, Florida.

**Armstrong**  
**CEILINGS** / *acoustical  
fire-retardant  
ventilating*



# Architectural Engineering

## AIR CONDITIONING RESPONDS TO FLEXIBLE PLAN 126

In a school laid out for team teaching, the air-conditioning system provides individual temperature control for divisible spaces. The system can be modified easily in the event of future partition changes

## TIME-SAVER STANDARDS 129

Building and Facility Standards for Physically Handicapped. Four pages of data based on the new American Standards Association specifications on this subject and drawings from Building Standards of the University of Illinois Rehabilitation Center

## BUILDING COMPONENTS 137

Hard Coatings for Exterior Aluminum

## PRODUCT REPORTS 139

## OFFICE LITERATURE 140

## READER SERVICE INQUIRY CARD 181

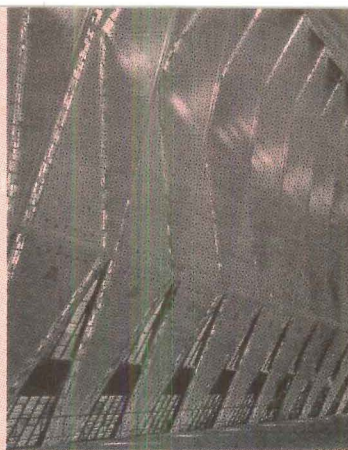

### Cover:

The Chapel, United States Air Force Academy, Colorado. Architects-engineers, Skidmore, Owings & Merrill. Photograph by Stewarts—C. G. Coil

### Advertising Index 216

ARCHITECTURAL RECORD December 1962 Vol. 132, No. 6. Published monthly, except May 1962, when semi-monthly, by F. W. Dodge Corporation, a McGraw-Hill Company. This issue is published in national and separate editions. Additional pages of separate edition numbered or allowed for as follows: Western section, (including *Western Architect and Engineer*), 32-1 through 32-32.

Executive, editorial, circulation and advertising offices: 119 West 40th Street, New York 18, N. Y. Western Editorial Office: 2877 Shasta Road, Berkeley 8, Calif. Office of Publication, 10 Ferry Street, Concord, N. H.; second-class mail postage paid at Concord, N. H.

Subscription rate for individuals in the field served \$5.50 per year in U. S., U. S. Possessions and Canada; single copies \$2.00, except Mid-May 1962 issue \$2.95. Further details on page 6. Postmaster: Please send Form 3579 to Circulation Manager, ARCHITECTURAL RECORD, 119 West 40th Street, New York 18, N. Y.

# ARCHITECTURAL

## Record Reports

### BEHIND THE RECORD 9

"Architects Abroad"  
By Emerson Goble

PEI DESIGNS STANDARD CONTROL TOWER FOR FAA  
U.S. APPROVES DESIGN FOR NEW YORK FAIR PAVILION 10

### BUILDINGS IN THE NEWS 12

"Redevelopment Plan for Lafayette Square"  
"TWA Terminal Gets C.I.B. Award"

### CURRENT TRENDS IN CONSTRUCTION 18

A monthly analysis prepared for the Record by  
George A. Christie, Economist, F. W. Dodge Corporation

### CONSTRUCTION COST INDEXES 20

BATES IS NEW BUILDING RESEARCH CHIEF

OF NATIONAL BUREAU OF STANDARDS 23

### REQUIRED READING 40

### CALENDAR AND OFFICE NOTES 198

### SEMI-ANNUAL INDEX 211

Buildings and building types, architects, authors and subjects featured in the last six months of 1962 are indexed for easy reference. The index is published each June and December for the half year ending with that issue

### Architects and Buildings

- BROWN, WILLIAM HOSKINS, ASSOC., INC. Needham Houses, Needham, Mass. .... 111
- GOODPASTOR, HERBERT E. Senior Citizens Building, Sacramento, Calif. .... 122
- GRAHAM, JOHN, AND CO. Bayview Manor, Seattle, Wash. .... 115
- LIND, KENNETH, ASSOC. Mount San Antonio Gardens, Pomona, Calif. .... 117
- KATZ WAISMAN BLUMENKRANZ STEIN WEBER ARCHITECTS ASSOC. Castle Hill Houses, Bronx, N.Y. .... 120
- LUDERS, J. EDWARD, & ASSOC. Springvale-on-the-Hudson, Cortlandt, N.Y. .... 113
- SAARINEN, EERO, & ASSOC. Samuel F. B. Morse and Ezra Stiles Colleges, Yale University, New Haven, Conn. .... 93
- SKIDMORE, OWINGS & MERRILL. Air Force Academy Chapel, Colo. .... 85; Peninsula Volunteers' Retirement Apartments, Menlo Park, Calif. .... 118
- WEISS, JOSEPH DOUGLAS. The Friedman Building, The Home for Aged and Infirm Hebrews of New York, N.Y. .... 123

### Authors and Articles

- BAKER, ROBERT W. "Hard Coatings for Exterior Aluminum" .... 137
- MATHIASSEN, GENEVA. "Trends in Housing for Older People" .... 110
- MUMFORD, LEWIS. "The Future of the City" .... 101
- VERMILYA, HOWARD P. "Building and Facility Standards for Physically Handicapped," Parts 1, 2, 3, 4 .... 129
- AIR CONDITIONING RESPONDS TO FLEXIBLE PLAN .... 126

AIR FORCE ACADEMY CHAPEL 85 *Deft fusion of color, form and structure makes new cadet chapel the visual dominant of the Academy*

NEW AND OLD AT YALE 93 *For the Yale residences, Saarinen's new idiom of rough stone polygonal masses, many-sided, curved and angled, creates a new kind of architecture that seems to belong at old Yale*

FLIGHT FROM THE CITY 101 *In the third article in his series "The Future of the City," Lewis Mumford discusses how two major concepts of urban design have for the last half century been distracting urban planners from the real objectives of city architecture*

## RECORD

CONTENTS  
*December 1962*

### *Building Types Study 314: Buildings for the Aging*

INTRODUCTION 109

TRENDS IN HOUSING FOR OLDER PEOPLE 110 *By Geneva Mathiasen, Executive Secretary, The National Council on the Aging*

COTTAGE-TYPE PUBLIC HOUSING ON A SMALL URBAN SITE 111  
*William Hoskins Brown Associates, Inc.; Needham (Mass.) Houses*

TWO-STORY SPECULATION, A POPULAR RULE BREAKER 113  
*J. Edward Luders & Associates; Springvale-on-the-Hudson, Cortlandt, N. Y.*

HIGH-RISE, NON-PROFIT, WITH CENTRAL SERVICES 115  
*John Graham and Company; Bayview Manor, Seattle, Washington*

A CONGREGATE VILLAGE OF ORGANIZED VARIETY 117  
*Kenneth Lind Associates; Mount San Antonio Gardens, Pomona, California*

RETIREMENT APARTMENTS ENCLOSE A QUIET QUADRANGLE 118  
*Skidmore, Owings & Merrill; Peninsula Volunteers' Apartments, Menlo Park, California*

CENTER FOR AGING AND CHILDREN SERVES PUBLIC HOUSING 120  
*Sidney L. Katz; Castle Hill Houses, Bronx, New York*

SOCIAL CENTER IN A CITY PARK 122  
*Herbert E. Goodpastor; Senior Citizens Building, Sacramento, California*

A BIG-CITY HOME SHOWS TRENDS IN LONG-TERM NURSING 123  
*Joseph Douglas Weiss; The Friedman Building, New York, N. Y.*

# Coming in the Record

## DESIGNING FOR THE SPACE AGE

*Complex programs and complex technologies are not new to architects, but the new dimensions of the space age are only beginning to affect architectural practice. Two of the most dramatic examples so far of architecture in the service of space technology—Earth Station No. 1, home of the Telstar experiment, and the Manned Spacecraft Center for the first U. S. moon-shot—offer some vivid indications of the scope and scale of future problems.*

## NEW WORK OF WILLIAM WILSON WURSTER

*The contribution to modern architecture in America of the eminent architect and architectural educator whose work will be featured next month has been both monumental and modest: the result of a highly sophisticated and perceptive architectural talent deliberately disciplined to the most sensitive respect for time, place and purpose. The talent and the discipline are equally evident in the three new buildings—a church, a house and a consulate. Such work has a special significance and interest in an architectural era which often seems over-preoccupied with stylistic innovation.*

## BUILDING TYPES STUDY: APARTMENTS

*More apartment buildings are being built, and more people are living in apartments, than ever before; and according to Dodge economists the trend will remain sharply upward for the rest of this decade at least. This spells opportunity for architects, and next month's Building Types Study reviews some of the contributions architects have been making to better apartment housing in presentations of a varied group of apartment buildings.*

ARCHITECTURAL RECORD (combined with AMERICAN ARCHITECT and ARCHITECTURE), title ® reg. in U. S. Patent office, © copyright 1962 by F. W. Dodge Corporation, a McGraw-Hill Company. Copyright not claimed in four-color illustrations on front cover and on pages 87 and 90. All rights reserved including the right to reproduce the contents of this publication either in whole or in part. Quotations on bulk reprints of articles available on request. Indexed in Reader's Guide to Periodical Literature, Art Index, Industrial Arts Index and Engineering Index.

Every effort will be made to return material submitted for possible publication (if accompanied by stamped, addressed envelope), but the editors and the corporation will not be responsible for loss or damage.

SUBSCRIPTIONS: Available only by paid subscription. Publisher reserves the right to refuse non-qualified subscriptions. Subscriptions to Architectural Record solicited only from architects and engineers. Position, firm connection, and type of firm must be indicated on subscription orders forwarded to Circulation Manager, Architectural Record, 119 West 40th Street, New York 18, N. Y. Subscription prices: U. S., U. S. Possessions and Canada: \$5.50 per year; other Western Hemisphere countries, to those who by title are architects and engineers, \$9.00 per year. Single copy price except Mid-May 1962 issue \$2.00; Mid-May 1962 issue \$2.95. Beyond Western Hemisphere, to those who by title are architects and engineers, \$9.00 per year for 12 monthly issues not including Mid-May 1962 issue. Subscriptions from all others outside U. S., U. S. Possessions and Canada for 12 monthly issues, not including Mid-May issue, \$24 per year.

CHANGE OF ADDRESS: Subscribers are requested to furnish promptly both old and new address, sending, if possible, stencil impression from magazine wrapper; new postal zone number, if any, should be included. Allow one month for change.

UNCONDITIONAL GUARANTEE: The publisher, upon written request, agrees to refund the part of the subscription price applying to the remaining unfiled portion of the subscription if service is unsatisfactory.

OTHER F. W. DODGE SERVICES: Dodge Reports—Dodge Construction Statistics—Sweet's Catalog Services—Dodge Mailing Service—Home Planners' Digest—The Modern Hospital—The Nation's Schools—College and University Business—Hospital Purchasing File—Chicago Construction News—Daily Pacific Builder (San Francisco)—The Daily Journal (Denver)—Real Estate Record & Builders Guide—Dow Building Cost Calculator.

Audit Bureau of Circulation



Associated Business Publications



## Staff of Architectural Record

### EDITOR

Emerson Goble, A.I.A.

### SENIOR EDITORS

Jeanne M. Davern, *Assistant to the Editor*  
Robert E. Fischer, *Engineering*  
James S. Hornbeck, A.I.A., *Features*  
William Dudley Hunt, Jr., A.I.A.  
Elisabeth Kendall Thompson, A.I.A., *West*

### ASSOCIATE EDITORS

Herbert L. Smith, Jr., A.I.A., *Houses*  
Mildred F. Schmertz, *Design*  
William B. Foxhall  
Anne Keffer, *Production*

### ASSISTANT EDITORS

Kathryn Gallant  
Jan Rahm

### DESIGN

Eugene H. Hawley, *Director*  
Alex H. Stillano, *Associate*  
Sigman-Ward, *Drafting*

### EDITORIAL CONSULTANTS

Robert Anshen, F.A.I.A.  
Edward Larrabee Barnes, A.I.A.  
Walter Gropius, F.A.I.A.  
Robert F. Hastings, F.A.I.A.  
Paul Rudolph, A.I.A.

### INDUSTRY CONSULTANTS

Gordon W. McKinley, *Economics*  
Clyde Shute, *Statistical*  
Clifford G. Dunnells, Jr., *Field Research*  
Daniel J. Howe, Jr., *Public Relations*  
Ernest Mickel, *Washington*

### PUBLISHER

Robert F. Marshall

### EDITORIAL DIRECTOR

Robert M. Cunningham, Jr.

### PUBLISHING ADVISER

H. Judd Payne

### CIRCULATION MANAGER

Marshall T. Ginn

## Officers of F. W. Dodge Corporation

HONORARY CHAIRMAN OF THE BOARD  
James McV. Breed

CHAIRMAN OF THE BOARD  
Paul Abbott

PRESIDENT  
Irving W. Hadsell

EXECUTIVE VICE PRESIDENTS  
Julius T. Little, Robert F. Marshall,  
T. Oliver Morgan, O. O. Paulsell

EXECUTIVE VICE PRESIDENT AND TREASURER  
Howard M. Thompson

VICE PRESIDENTS  
Robert M. Cunningham, Jr.,  
William H. Hatch, Jr., Gordon W. McKinley,  
Richard H. Ray

REGIONAL VICE PRESIDENTS  
George H. Atherton, Miles W. Beatty,  
Carl S. Bennett, Robert G. Bingham,  
Alton W. Kitchens, Sam L. Marshall, Jr.,  
Arthur D. Prior

CONTROLLER  
Stuart W. McLaughlin

ASSISTANT VICE PRESIDENTS  
Walter F. DeSaix, Clifford G. Dunnells, Jr.,  
Gault Eastman, Edwin H. Freed, Clyde Shute

SECRETARY  
John J. Cooke

ASSISTANT SECRETARIES  
William C. Breed, Jr., George W. Morgan

ASSISTANT TREASURER  
Irving B. Satin





ST. STEPHEN'S CHURCH, Washington, D. C. ■ Contractor: VICTOR R. BEAUCHAMP ASSOCIATES, Washington ■ Architects: JOHNSON AND BOUTIN, Washington ■ Precast Units Fabricated by: FORMIGLI CORPORATION, Philadelphia.

Center section is hoisted into place. The three pieces making up each leg were fastened together by cast-in weld plates, later covered with precast concrete filler strips. Legs were joined by means of cast-in Z-bars fastened together with a continuous welded plate and welded straps.

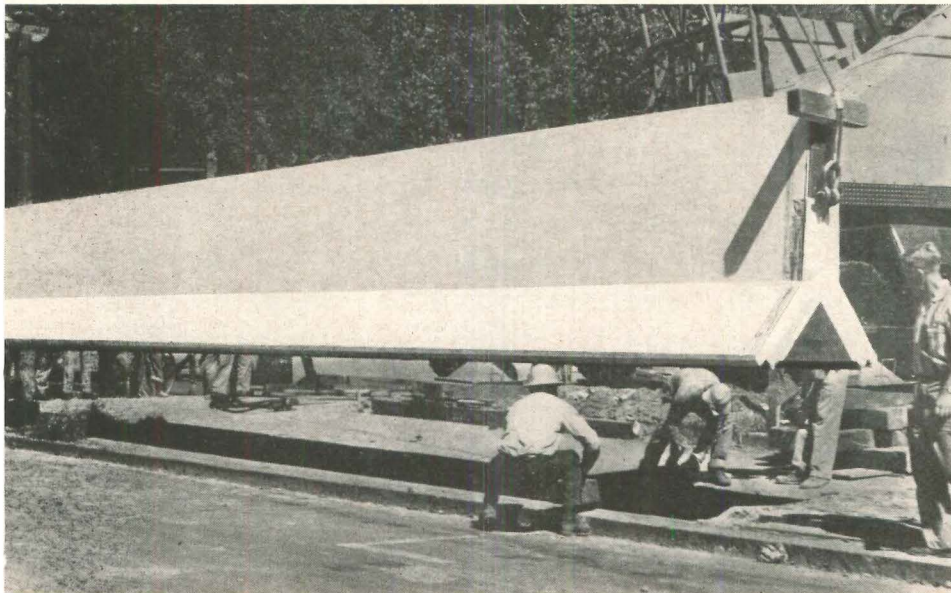

## TOWERING BEAUTY and EFFICIENCY from Precast Concrete and Incor®

One look at the results obtained with precast concrete for this 74-ft. 4½-in. bell tower and the adjacent arched window and you may well ask: "Why not precast concrete for my next job?"

**BEAUTY**—Strikingly apparent in the smooth, clean lines and surfaces of infinitely-adaptable concrete.

**SPEED OF ERECTION**—The tower is composed of only twelve precast sections, the arch of three—all easily handled by crane and assembled by simple methods. No expensive on-the-site delays. (Also precast were the ten window mullions supporting the arch, 5500 square feet of Spancrete floor, and 98 lineal feet of fascia beams.)

**SPEED OF FABRICATION**—No delays here, either. The precaster utilized "Incor," the nation's first high early strength portland cement, for all concrete requirements—made most efficient use of forms, time, money and manpower.

LONE STAR CEMENT CORPORATION, N. Y. 17, N. Y.

 **INCOR®**  
**24-HOUR**  
**CEMENT**

Placing of top sections for bell chamber. The four legs were joined at the top by overlapping hairpins which extend from the legs into a poured-in-place joint.

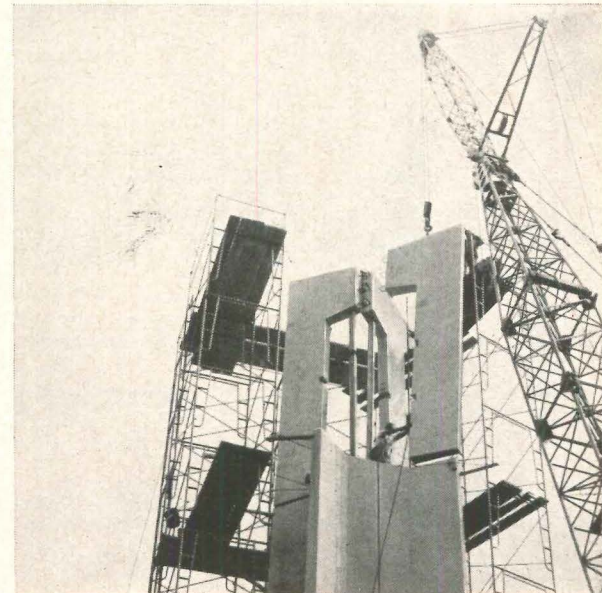

The best designs are more exciting in concrete

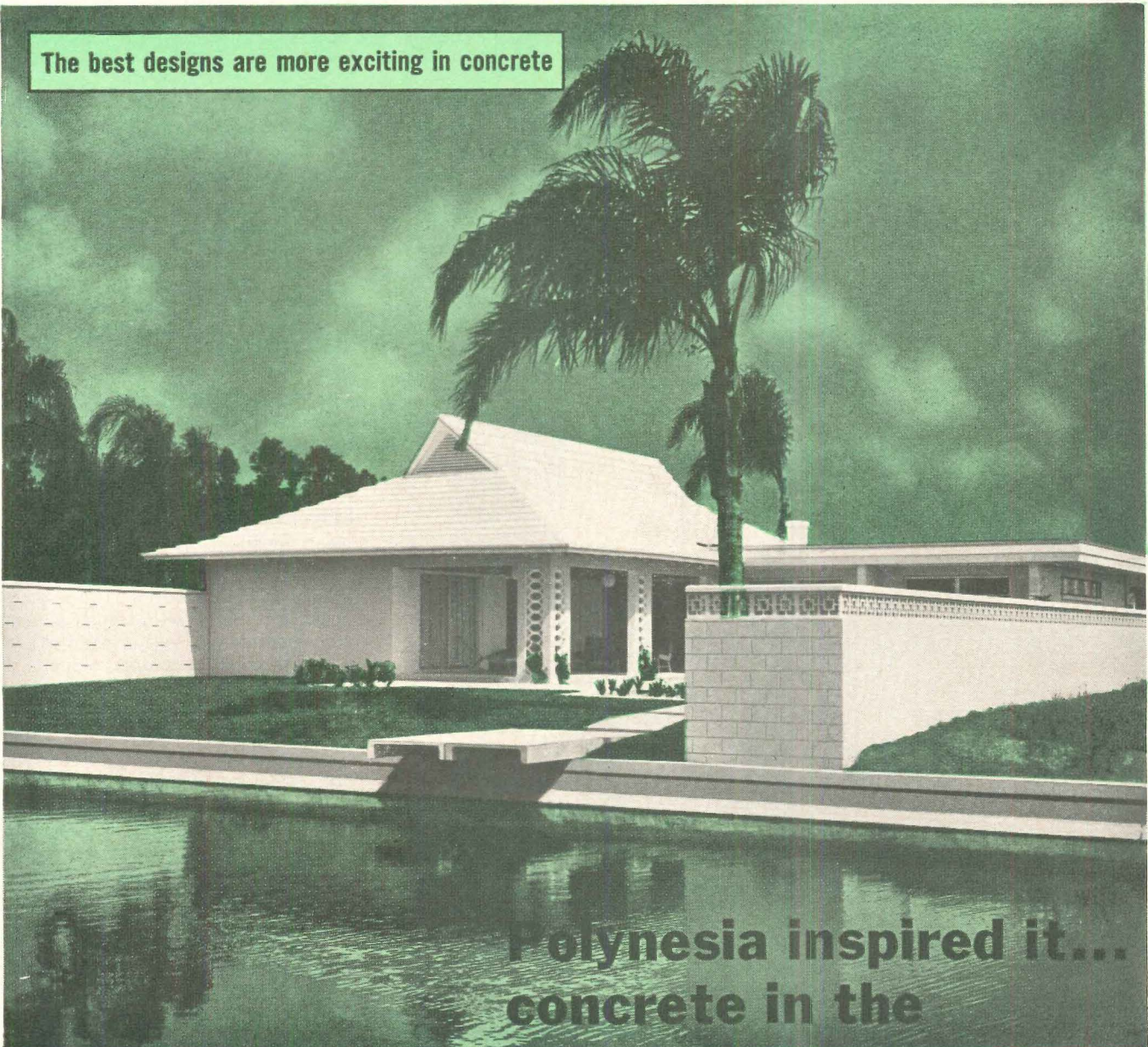

## Polynesia inspired it... concrete in the newest forms made it possible

Outstanding home design from the 1961 Concrete Industries Horizon Homes Program. Architect: John B. Langley, A.I.A., Winter Park, Florida.

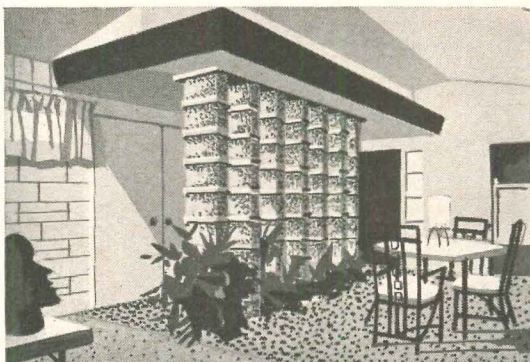

Floors are gleaming terrazzo. This masonry divider is laid in a distinctive pattern and painted in two tones. Here is a gracious, easy-to-care-for interior.

The warmth and livability of modern concrete is well demonstrated in this home in Orlando, Florida.

Its imaginative design has caught much of the form and spirit of South Seas architecture. Notice the distinctive roof, covered with concrete shingles. See how ingeniously the traditional symbols of the "Sign of the Turtle" and "Cloud of the North Wind" have been fashioned in concrete masonry and incorporated into the walls and pillars.

With unlimited shapes, colors and textures to choose from, concrete readily accommodates the newest concepts for modern living and provides opportunity for distinctive home design.



**PORTLAND CEMENT ASSOCIATION** *A national organization to improve and extend the uses of concrete*

For more data, circle 3 on Inquiry Card

## Architects Abroad

As American architects and engineers reach out to meet the opportunities in other parts of the world, they should, and do, enjoy tremendous advantages. Technology is rapidly spreading around the world, especially in Europe, and, yes, Africa, and what was once commonly called American know-how is still a very marketable commodity. At least the American characteristic of familiarity with technical matters and attitudes is a great advantage for American architects and engineers.

We have remarked before that if American designers think they have trouble keeping abreast of developments, they might remember their head start over practitioners in older parts of the world, at least in building materials, equipment and systems. They have more technology to keep abreast of, but they start much farther along.

Not the least important advantage of the American working abroad is the relatively simple one of the American position in time: if this country is not actually ahead in technical theory, it is certainly far ahead in the general acceptance of technical advancement. The standards and demands for which the architect or engineer must make provision are farther advanced, and mere observation of fast-moving trends can represent an important aspect of building design.

One American architect who is busy in the Common Market countries, Frank Whitney, president of Walter Kidde Constructors, Inc., had some comments along that line recently. While remarking on the rapid industrial development in these countries, he mentioned some gaps in European ideas about buildings which seem odd in American experience. "Generally speaking," he said, "Europeans are making the same mistakes now that we all did here 10

years ago, especially in inadequate provisions for mechanical and electrical services.

"In London they will tell you that we don't need to include air conditioning—it's just not necessary in London; there's really no call for it. They will become quite solemn about it. I ask them then to tell me the name of the newest, most important hotel, and when they tell me I ask them if it is air-conditioned. Of course they say yes, and then they must tell me why. Air conditioning is coming in London just as surely as in America; it's just a few years behind."

In the same way the Londoners, or Europeans, will insist on daylighting in industrial buildings. They will be equally solemn about the fact that all factory buildings must have daylight, with the sawtooth roofs and all the rest of it, going back quite far in American practice. Of course they need the daylight, says Whitney, because they only provide about 15 footcandles of artificial light.

The greatest mistake, he says, is the elementary one of thinking that they don't need help or advice in such matters. Until they can grasp the fundamental fact that their comparison with America is substantially a matter of time, they don't fully appreciate the help of American technical experience. But by the same token the architect or engineer who has kept himself responsive to American experience has a considerable contribution to make to the burgeoning economic and technical progress of European countries.

One odd little note in reverse. Europeans who try to switch to the English system of measurements have the very devil of a time. But Americans who are changing to the metric system find that it is easy to get used to it.

—Emerson Goble

## PEI DESIGNS STANDARD CONTROL TOWER FOR FAA

A standard design concept for all future air traffic control towers to be built by the Federal Aviation Agency at airports throughout the U.S. has been accepted by FAA Administrator N. E. Halaby.

The design was developed by I. M. Pei & Associates, Architects, of New York, who were commissioned by FAA last April to provide a design for a freestanding tower which would offer greater visibility from the tower cab, improved space for operating radio and radar equipment, and better environment for the air traffic control personnel.

Under a new program, future FAA towers will be built with FAA funds

beginning with fiscal 1963 appropriations. The Pei firm will receive a contract to proceed with construction drawings and specifications, and construction is expected to begin next summer.

The new concept takes into consideration the range of requirements from the smallest to the largest airports in the nation. It provides a tower of 50 to 150 feet from ground to prefabricated cab, to be set on a base structure containing radar room, communications and other equipment, both mechanical and electronic, ready room, administrative offices, maintenance workshops and a standby engine generator.



FAA Administrator N. E. Halaby and members of his Design Advisory Committee—which reviewed the Pei design before it was approved—gather around the model of the new air traffic control tower. From left: Mr. Halaby, Gordon Bunshaft, Mrs. Eero Saarinen, Harvey Wells, Mrs. George Y. Wheeler, Andrew C. Ritchie, and Mrs. James Douglas (committee members); Harvey R. Wendorf of FAA, Mr. Pei and James Freed of Pei firm

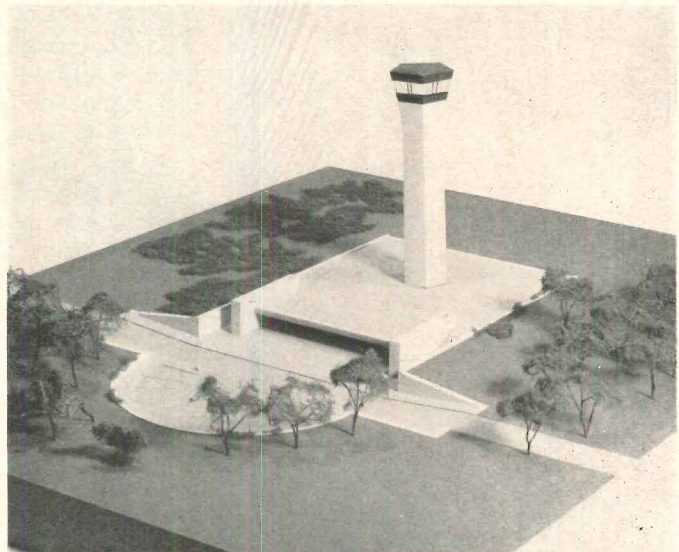

## U.S. APPROVES DESIGN FOR NEW YORK FAIR PAVILION

A design for the Federal Pavilion at the 1964-1965 New York World's Fair was approved last month by the U.S. Commission to the Fair, Commissioner Norman K. Winston announced.

"After reviewing four final concepts submitted by the architect," Mr. Winston said, "I am pleased to report we have a final building design which carries endorsement of all government agencies concerned."

The U.S. Commission had chosen the design, Mr. Winston added, "after developing sufficient engineering detail, traffic control studies, ex-

hibit space requirements and cost analyses in cooperation with the General Services Administration, the Department of Commerce and White House aides."

Charles Luckman Associates of New York are the architects. The design was not immediately released, but Commissioner Winston said detailed renderings and a model of the building were being prepared "to show to the public within about three weeks" (early December).

The Federal Pavilion will be erected on a circular site of four and a half acres on the Fair grounds at

Flushing Meadow Park in Queens. After long delay and much bickering, Congress last summer approved a \$17 million appropriation for the pavilion, and U.S. officials were finally able to go ahead with the appointment of a U.S. Commissioner for the Fair and selection of an architect. More bickering immediately developed, at least in the press, over the alleged unsuitability of an allegedly approved design (never published), but last month's announcement by Commissioner Winston was the first official announcement that any design had been selected.

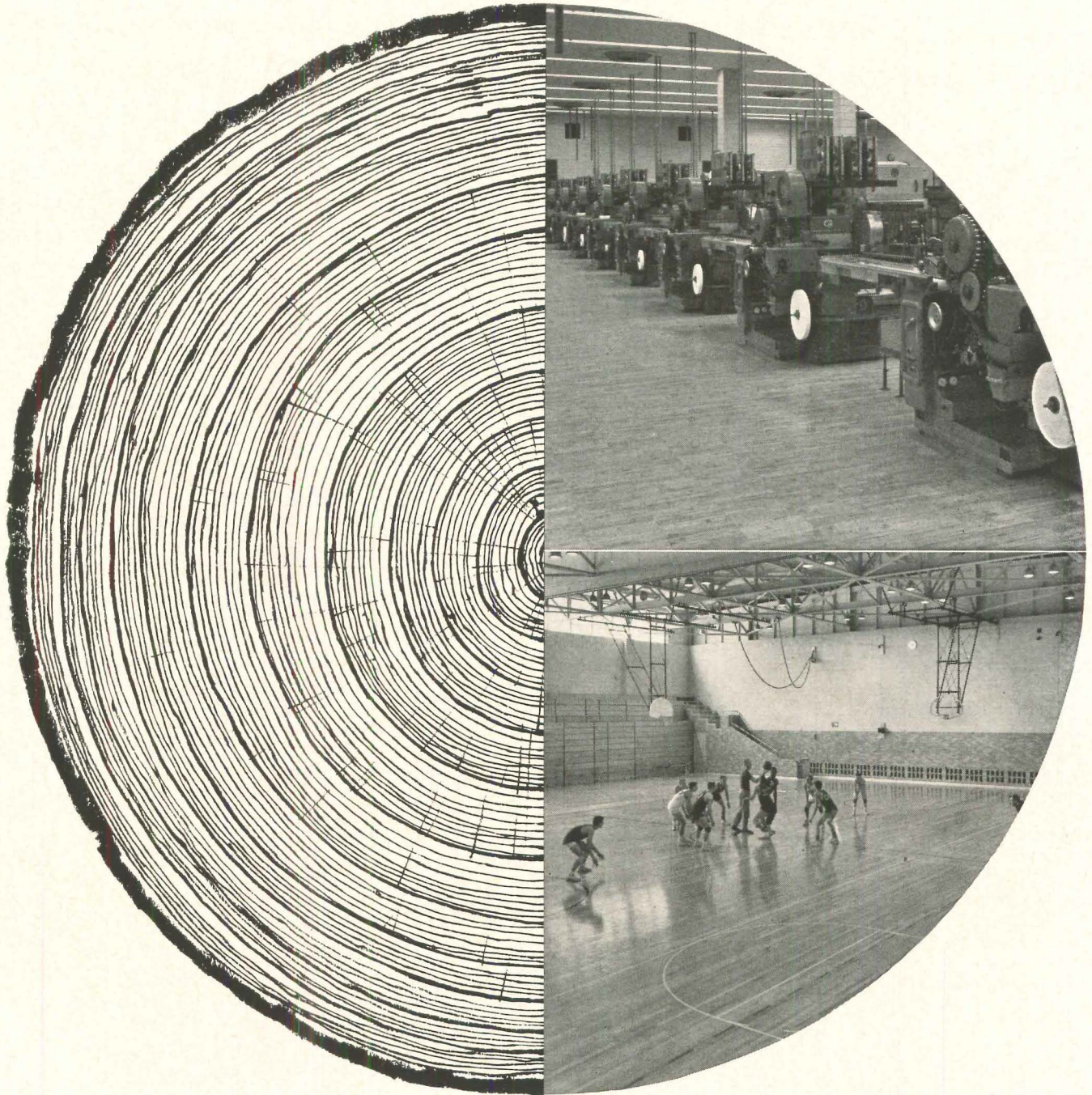

**IT TAKES 100 YEARS TO GROW A ROBBINS FLOOR...  
IMPROPER INSTALLATION CAN DESTROY IT IN A SEASON!**

A Robbins hardwood floor stands up to most any kind of punishment you throw at it. Reason? — *Northern Hard Maple*—world's finest flooring material, combined with time-tested installation systems and techniques.

However, even quality flooring and a Robbins-engineered floor system are no better than the men who install it. Accept any low bid for a "look-alike" substitute by an unqualified installer, and chances are your client will end up with an unsatisfactory floor.

To assure proper performance, insist on installa-

tion by an experienced, competent, and reliable floor contractor. A Robbins floor specification authorizes installation exclusively by approved installers. It's a planned program of putting quality flooring in the hands of reliable craftsmen. Of course, every competently installed Robbins floor is fully guaranteed by both the manufacturer and floor contractor.

*For information on Robbins floors and the name of your closest approved installer, write Robbins Flooring Company, Reed City, Michigan, attention Dept. AR-1262*

**ROBBINS**

MAKERS OF MODERN MAPLE FLOORS—Subsidiary of E. L. Bruce Company, (Incorporated), Memphis, Tennessee

For more data, circle 4 on Inquiry Card

## REDEVELOPMENT PLAN FOR LAFAYETTE SQUARE

Louis Checkman photos

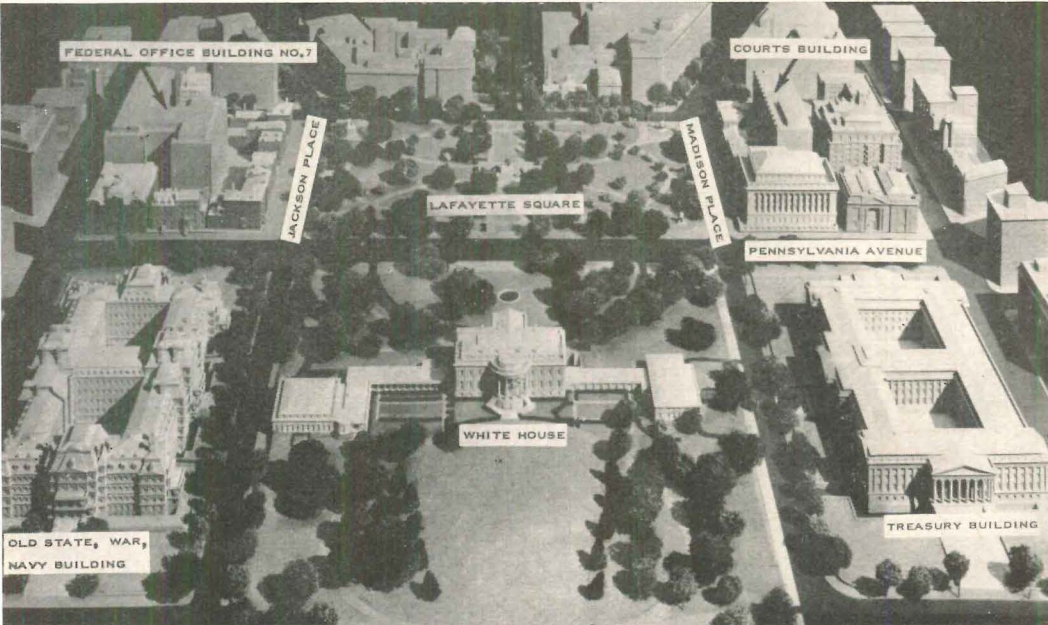

View of Lafayette Square shows how buildings relate to row houses and White House



View from front of White House looking toward west side of Lafayette Square. In the background is the new Executive Office Building

John Carl Warnecke & Associates have designed a new plan for redeveloping Washington, D.C.'s Lafayette Square which calls for two new buildings—an Executive Office Building and a building to house the Court of Claims and Court of Customs and Patent Appeals. Construction is estimated to start in the spring of 1963 with completion expected in the summer of 1965.

The problem involved providing space for Federal activities, preserving the residential scale and early 19th century character of the facades on the east and west sides of the Square and the creation of a "graceful and dignified setting for the White House."

The 10-story Executive Office Building, a modified "H," and the eight-story Courts Building, are to be constructed of masonry.

Trees and gardens help achieve the desired quiet, residential atmosphere in which a human scale, not the monumental, is emphasized.

President Kennedy, in expressing his views on the plan, said: "I believe the importance of Lafayette Square lies in the fact that we were not willing to destroy our cultural and historic heritage but that we were willing to find means of preserving it while still meeting the requirements of growth in government. I hope the same can be done in other parts of our country."

## TWA Terminal Gets First Award of Concrete Industry Board

Trans-World Airlines' terminal at Idlewild International Airport, Queens, N.Y., a major work of the late Eero Saarinen, last month received the first architectural award given by the Concrete Industry Board as an outstanding example of reinforced concrete construction. The photograph (right) is a montage of the interior: an attempt by Robert Galbraith to capture the character of the great space

Robert Galbraith

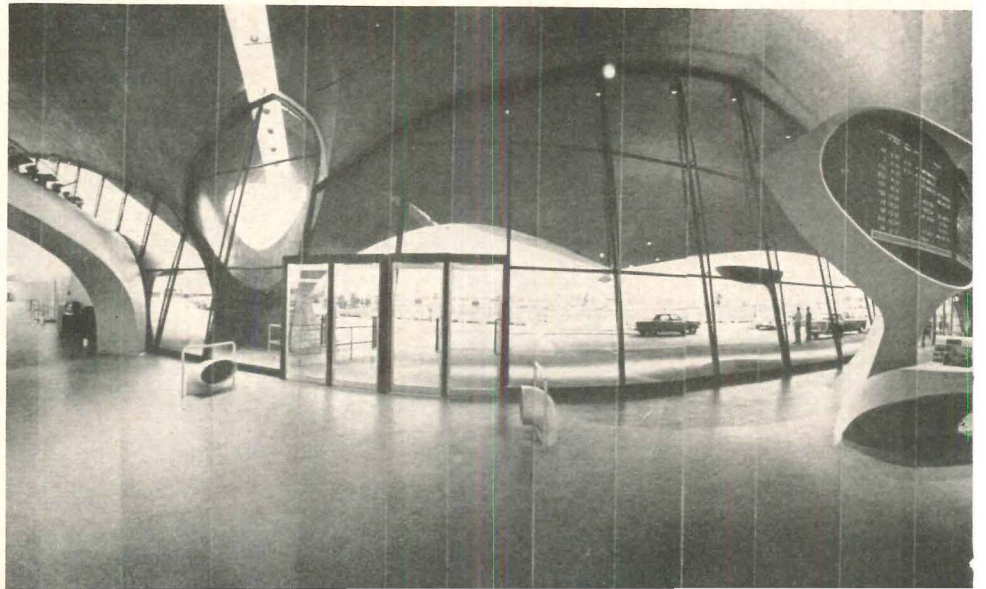



New Courts Building rises behind row of houses along Madison Place

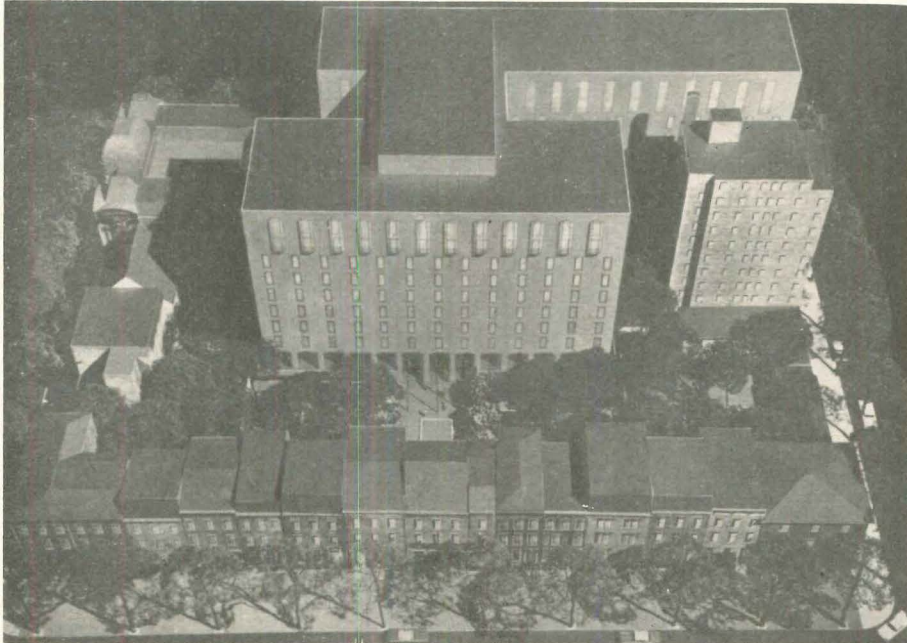

From the Jackson Place side of Lafayette Square the Executive Office Building is shown, separated from row of historic houses by landscaped courts and gardens

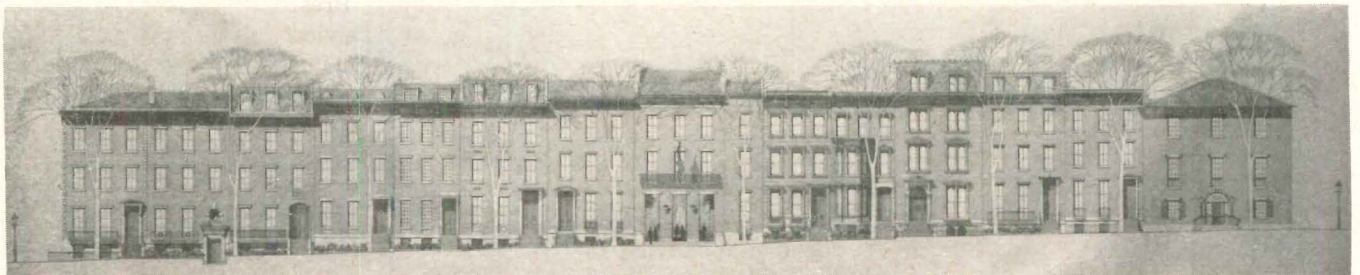

Drawing of the planned Jackson Place facade

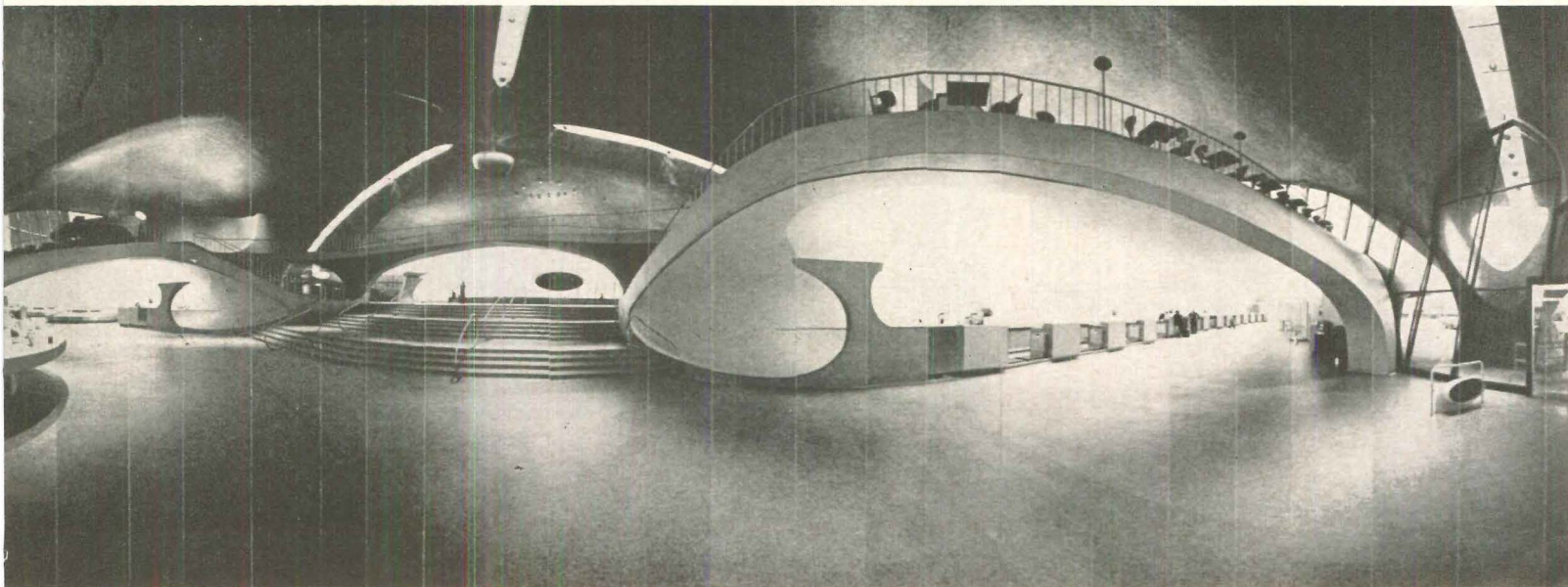

# LONGER SPANS, LIGHTER SLABS



**NATION'S LARGEST HYPERBOLIC PARABOLOID ROOF** keynotes the design of Edens Theatre, Northbrook, Illinois. This saddle shell roof (only 4 inches thick) stretches 159 ft. between working points at the abutments; 221 ft. from tip to tip. The entire shell is rotated about the abutment points so that one tip is 59°6" above lobby floor level; the other 39°6". Vertical Ryerson post-tensioning tendons prestress the abutment walls and these walls rest on post-tensioned foundation pads. To absorb horizontal thrust, the pads are connected by a post-tensioned tie beam. **Architect:** Perkins and Will, Chicago. **Engineer:** The Engineers Collaborative, Chicago. **Contractor:** Chell and Anderson, Chicago.

**SOUTHFIELD OFFICE PLAZA** in suburban Detroit uses Ryerson post-tensioning to give reduced structural depth despite long spans and relatively heavy loads. Sitting on a 4-ft. terrace the handsome building contains 137,000 sq. ft. of floor space in four rectangular units joined by a central service core under an arched roof. In the structural framing, 50 poured-in-place, post-tensioned beams are supported by double-legged columns placed to provide 24-ft. cantilevers. 5½ ft. overhangs at each level shade the continuous windows and conceal air-handling equipment. **Designed by** Samuel P. Havis, presently Havis, Glavinsky Assoc., Detroit. **Engineer:** McWilliam & Keckonen, Birmingham, Mich. **Contractor:** Harold Soble Construction Co., Southfield, Mich.

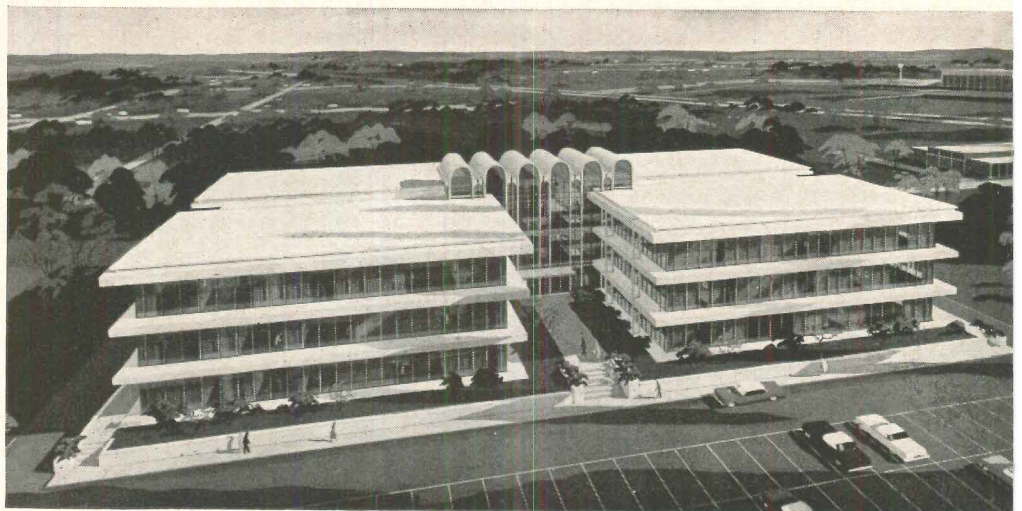



..LOWER COSTS...with

## RYERSON post-tensioning for prestressed concrete

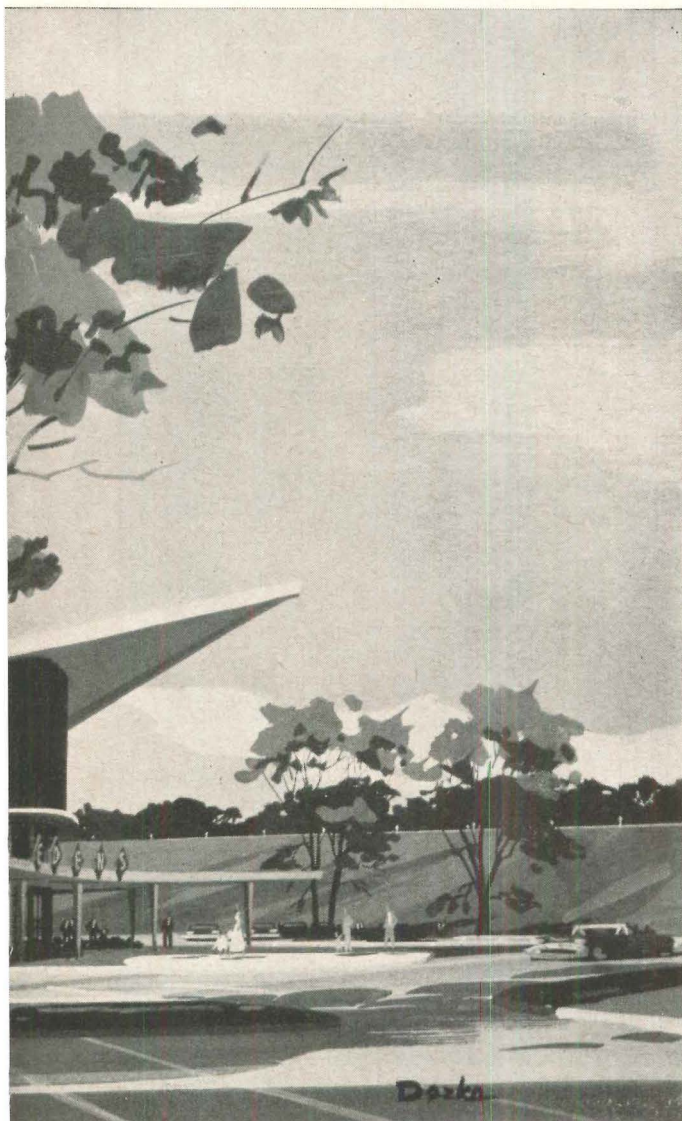

Here's one of the most useful and versatile tools at an architect's disposal...a service on post-tensioning concrete by the BBRV system that makes prestressing of cast-in-place concrete structures\* practical and economical.

Adaptable to almost any design concept, Ryerson post-tensioning permits greater column-free areas at reasonable cost...often achieves savings by reducing structural depth...and is widely used in lift-slab structures because it solves deflection control problems and lightens slab weight for easier lifting.

Architects and engineers from coast to coast specify Ryerson post-tensioning with confidence. Among the reasons: Ryerson is the nation's largest supplier of fabricated steel for concrete reinforcement, and Ryerson post-tensioning service can provide a complete package including everything from detailing and placement plans to technical help in placement, stressing and grouting of quality-controlled tendons.

Three current projects using Ryerson post-tensioning are shown here. On *your* next project consider the advantages of post-tensioning and get in touch with us for comparative cost data, preliminary layouts, force development calculations and any other information that would be of help.

\*Precast concrete members may also be economically prestressed by this system.

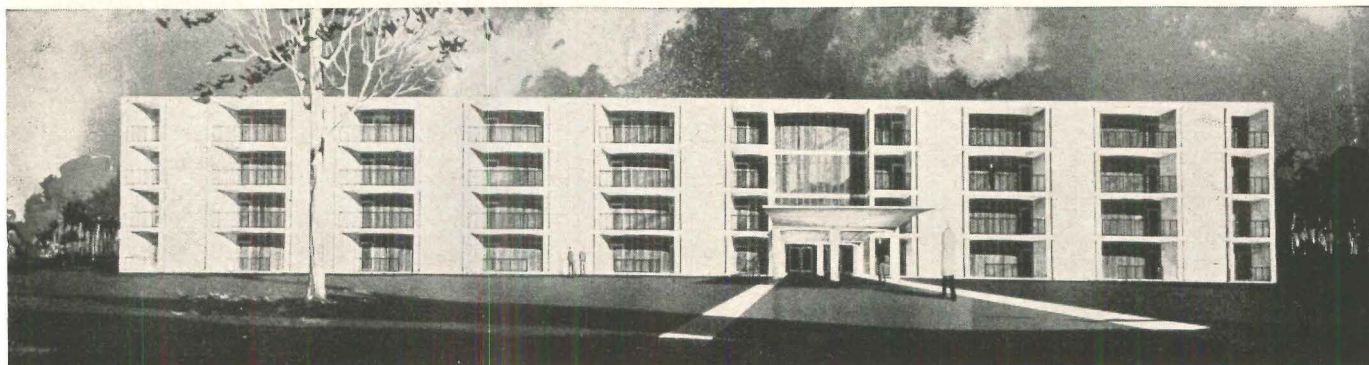

**NURSING CARE BUILDING**, Lyngblomsten Retirement Center, St. Paul, Minn., uses Ryerson post-tensioning to maximize the economies and efficiencies of lift-slab construction, and provide deflection control. Four-story structure has 2 lift-slabs (connected by a joining strip after lifting) on each of 5 levels. Each two-unit slab measures approx-

imately 250 ft. x 60 ft. and maximum column spacing is 28 ft., 8 in. x 18 ft., 10 in. **Architect:** Sovik, Mathre & Madson, Northfield, Minn. **Engineering Consultant:** Kolbjorn Saether & Assoc., Chicago. **General Contractor:** H. Halverson Construction Co., Minneapolis. **Lifting Contractor:** Northwest Lift Slab Co., Portland, Oregon.

# RYERSON

JOSEPH T. RYERSON & SON, INC., MEMBER OF THE  STEEL FAMILY

Re-Bars and Accessories • Post-Tensioning • Lift-Slab Service • Spirals • Wire Mesh • Open-Web Joists • Sheet Steel Piling and Bearing Piles • Structural Shapes and Tubing • Safety Plate • Stainless Steel • Aluminum Building Products • PVC Water Stops • Expanded Metal • Grating, etc.

For more data, circle 5 on Inquiry Card

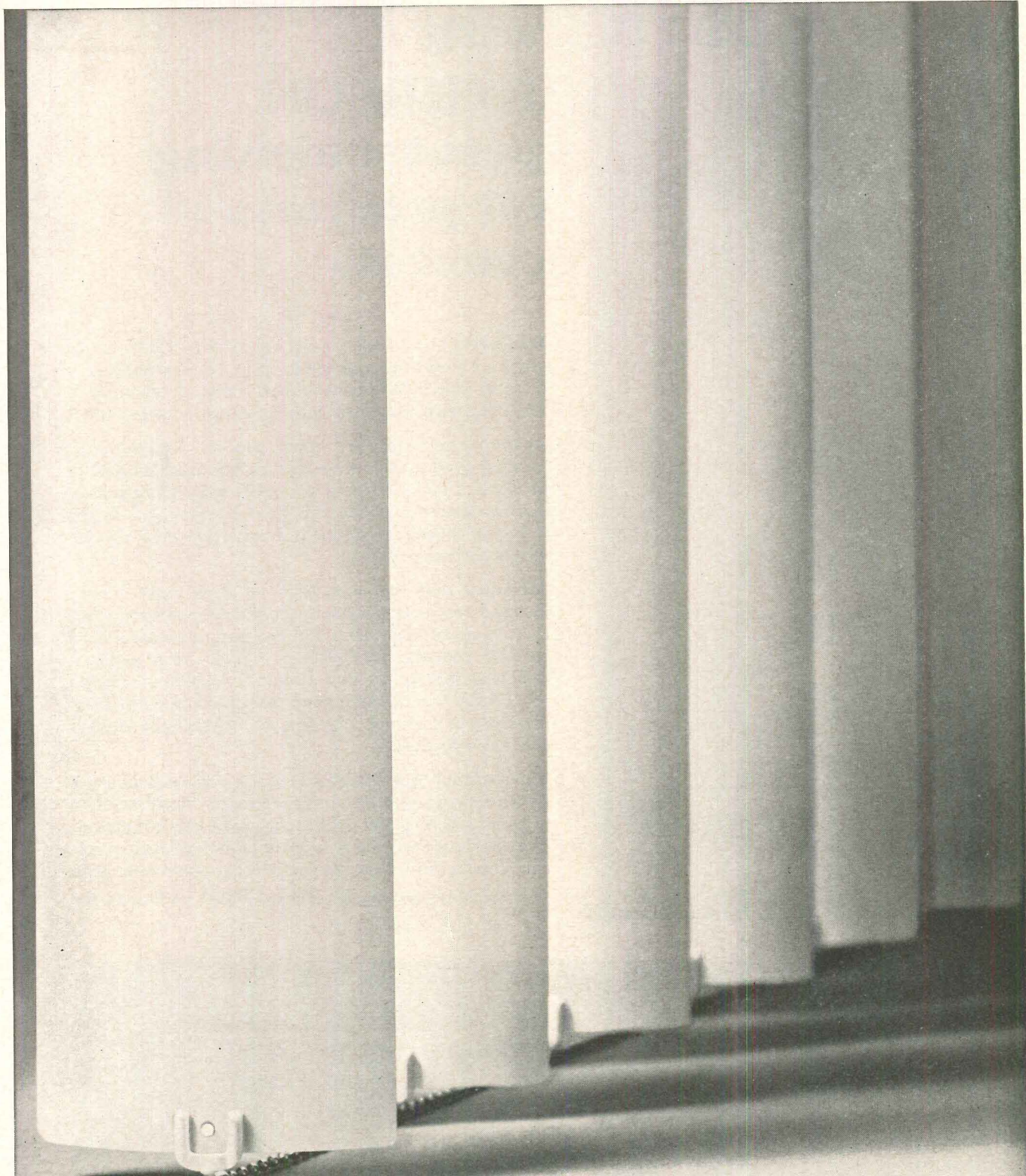

**This is the new, wider, aluminum louvered vertical** Flexalum's new, wider (3 $\frac{3}{8}$ " ) louvers are in perfect harmony with today's large glass areas. Because they have the reflective properties of aluminum, Flexalum Wide-Louver Verticals solve problems of sun and thermal control. As a year-round thermal curtain, they cut heating and air-conditioning costs. Closed, they assure privacy; open, they admit adjustable, glare-free light. Their baked enamel finish and perpendicular position make them practically dust-proof. Flexalum Verticals are available with both center or side pull. Completely integrated mechanism and hardware are guaranteed to give you years of maintenance-free service. *Flexalum* <sup>VERTICALS</sup>®

Write to Bridgeport Brass Company, Hunter Douglas Division, 30 Grand Street, Bridgeport 2, Conn. for descriptive literature and specifications, engineering assistance or cost estimates. See our insert in Sweet's Architectural File.

For more data, circle 6 on Inquiry Card

new "Wall-Guard" design eliminates cracked plaster ... chipped paint ... streaked walls ... peeled wallpaper!



# AIRTHERM Cabinetaires



WRITE FOR CATALOG!



Airtherm cabinet unit heaters—with new "Wall-Guard" design—keep walls neat and clean around seal *permanently!* For access to unit, front panel can be removed from "Wall-Guard" frame fast and easy—*without* marring or disturbing walls. Eliminates painting and wall repair around seal. For flush installations "Wall-Guard" frame can be used as a plaster stop.

Airtherm Cabinetaires have been installed in a wide range of installations throughout the United States—schools, churches, hospitals, public buildings, auditoriums, showrooms and offices. Eight handsomely designed models... wide choice of stunning colors (or prime coat for later field painting)... capacities from 375 to 1900 CFM and 25,100 to 160,000 BTU/HR at standard steam ratings.

Airtherm representatives in all principal cities will be happy to furnish you with more information and quote prices.

**AIRTHERM MANUFACTURING COMPANY**

P. O. Box 7039 • St. Louis 77, Mo.

*Heating equipment for steam & hot water; air conditioning equipment for chilled water or direct expansion*

**CENTRALAIRE UNITS • CABINET UNIT HEATERS • CABINET AIR CONDITIONING UNITS • VERTICAL & HORIZONTAL UNIT HEATERS • CONVECTORS**

For more data, circle 7 on Inquiry Card

## ECONOMISTS SURVEYED BY F. W. DODGE EXPECT SECOND HALF PICKUP IN 1963

Total business activity will show little change over the next six months, but at about midyear, all the major components of our economic system will begin moving ahead again. This is the composite opinion of nearly 200 of the nation's leading economists in reply to F. W. Dodge's annual survey.

Most respondents foresee a plateau of total spending at about the current \$560 billion level extending through the first two quarters of 1963. During these months, gains in consumer and government outlays will be offset by a cutback in business investment spending. Later on, in the second half, a turn-about in investment outlays, along with continued expansion of consumer and government spending, will lift total Gross National Product to \$565 billion for the full year—a gain of \$11 billion or 2 per cent over 1962.

Each year has its own special circumstances which can seriously affect the business outlook; and 1963 has, perhaps, more than its share. Not only is the economy itself at a cyclical turning point, but the recent Cuban crisis and the possibility of a major tax cut next year were frequently mentioned as factors which could alter the course of business activity.

The vast majority of economists replying to the survey commented on the desirability of an across-the-board tax cut in 1963, but owing to its uncertainty, few built it into their forecasts. There was general agreement that such a move by Congress would raise the level of business activity significantly. The stated estimates are, for the most part, conservative or minimum predictions.

The outlook for construction in 1963, as given by the survey participants, is for a modest gain. The median estimate of construction put in place next year is \$61 billion. Within the year, the economists expect a first quarter dip followed by a series of quarter-to-quarter gains reaching a \$62 billion rate late in the year. Residential building will be weaker in 1963, it was felt by the majority. New private nonfarm housing starts are expected to hit a seasonally adjusted low rate of 1,300,000 in the first quarter and reach a total for the year of 1,325,000—a 5 per cent decline from the 1962 total of starts. Many respondents ascribed the housing decline to a tapering off of the recent apartment boom.

Most of the economists polled see next year's developments in the money markets as a positive factor for the construction industry. Nine out of 10 expect interest rates to be unchanged or lower, with lower money costs getting the edge.

Consumers will continue to spend more in each successive quarter of 1963. For the year as a whole, the median estimate of consumer spending for goods and services is put at \$365 billion—just a billion dollars a day! Most economists feel that prices will continue to edge up in 1963 as they have in recent years. The gain next year, a shade under 1 per cent, will be a little less than the average for the past five years.

Industrial production, the composite forecast showed, will have its downs and ups in 1963. This highly volatile measure of physical output is expected to decline during the first two quarters to 116 (FRB Index Scale) and then bounce back in the third and fourth quarters to 120 by year's end.

The consensus of these economists is that, if there is no income tax reduction early next year, business activity in 1963 will show only a modest gain—so modest, in fact, that the percentage of the labor force unemployed will increase to 6 per cent during the year. Most respondents emphasized, however, that a tax cut could significantly improve the outlook.

*George A. Christie, Economist  
F. W. Dodge Corporation  
A McGraw-Hill Company*

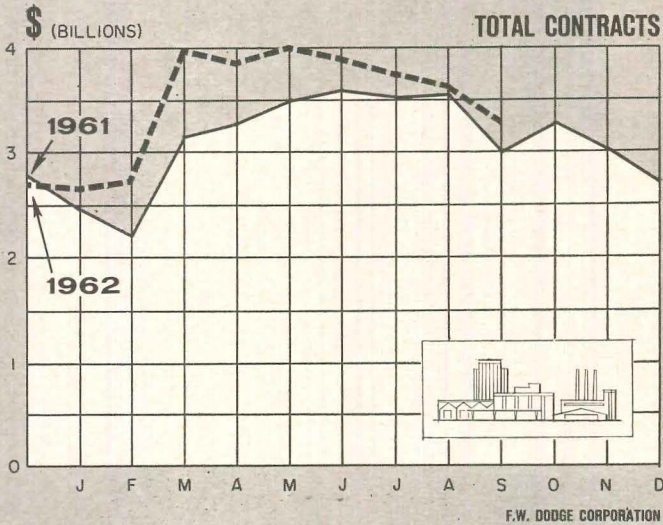

Total contracts include residential, nonresidential, heavy engineering contracts

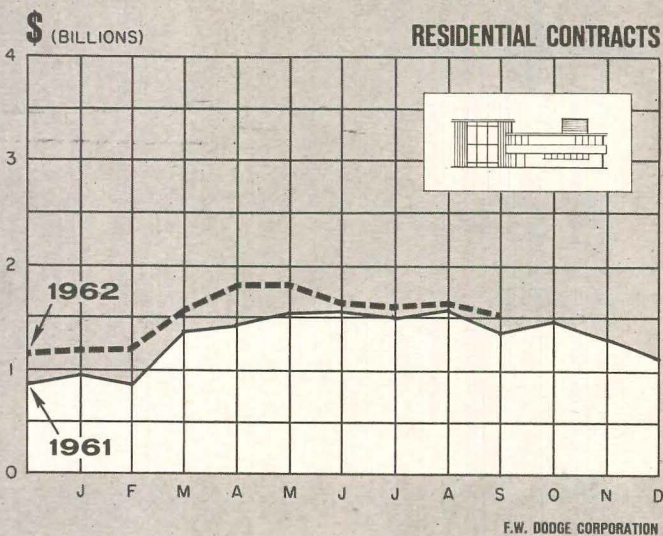
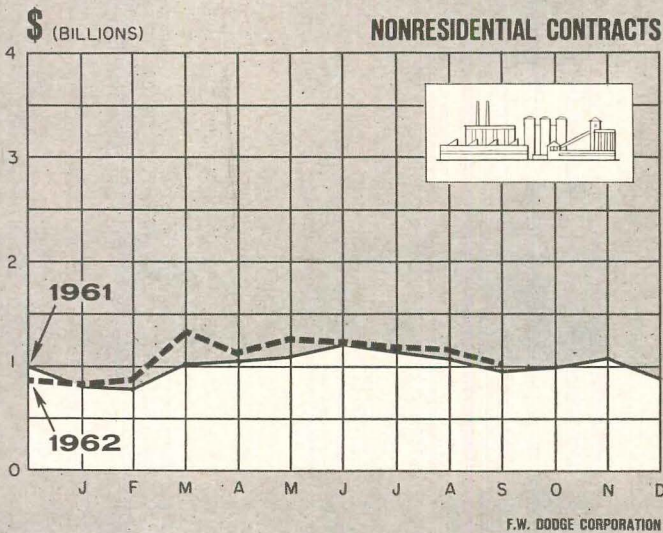



**DUR-O-WAL'S  
TRUSS DESIGN  
STANDS AT  
THE HEAD OF  
THE CLASS**

## Impartial tests by university research engineers prove DUR-O-WAL adds 71% flexural strength to masonry walls

We sent Dur-o-wal masonry wall reinforcement to school—for evaluation by independent university research engineers. Here are the facts: Dur-o-wal increases the flexural strength of a masonry wall from 71 to 261 percent, depending upon weight Dur-o-wal used, number of courses, type of mortar. When used in lieu of brick headers for composite masonry walls, Dur-o-wal can increase compressive strength in the ratio of 115 psi to 40 psi. Repair-free years are added to masonry wall life. Please pass the evidence? Write to nearest address below for new comprehensive Dur-o-wal data file.

# **DUR-O-WAL<sup>®</sup>**

**The Original Masonry Wall Reinforcement with the Truss Design**

#### DUR-O-WAL MANUFACTURING PLANTS

- Cedar Rapids, Iowa, P.O. Box 150
- Baltimore, Md., 4500 E. Lombard St.
- Birmingham, Ala., P.O. Box 5446
- Syracuse, N.Y., P.O. Box 628
- Toledo, Ohio, 1678 Norwood Ave.
- Pueblo, Colo., 29th and Court St.
- Phoenix, Ariz., P.O. Box 49
- Aurora, Ill., 260 S. Highland Ave.
- Seattle, Wash., 3310 Wallingford Ave.
- Minneapolis, Minn., 2653 37th Ave. So.
- Hamilton, Ont., Canada, 789 Woodward Ave.

For more data, circle 8 on Inquiry Card

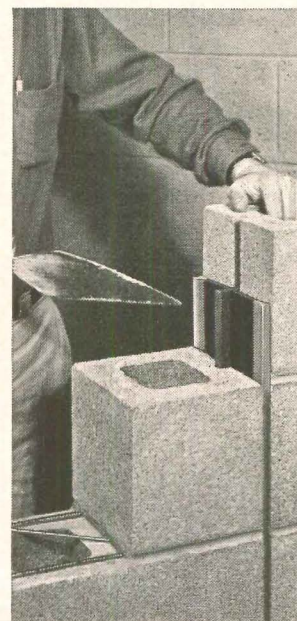

*Strength with flexibility—the two basic factors for a repair-free masonry wall are assured by combining the use of Dur-o-wal with its equally well-engineered companion product, the ready-made Rapid Control Joint, indicated by trowel. With its neoprene compound flange, this flexes with the wall, keeps itself sealed tight, cuts caulking costs.*

# Construction Cost Indexes

Presented by Clyde Shute, Director of Statistical Policy, Construction News Div., F. W. Dodge Corp., from data compiled by E. H. Boeckh & Assoc. Inc.

Labor and Materials: U.S. average 1926-1929=100

## NEW YORK

## ATLANTA

PERIOD	RESIDENTIAL		APTS., HOTELS, OFFICE BLDGS.	COMMERCIAL AND FACTORY BLDGS.		RESIDENTIAL		APTS., HOTELS, OFFICE BLDGS.	COMMERCIAL AND FACTORY BLDGS.	
	Brick	Frame	Brick and Concrete	Brick and Concrete	Brick and Steel	Brick	Frame	Brick and Concrete	Brick and Concrete	Brick and Steel
1935	93.8	91.3	104.7	108.5	105.5	72.3	67.9	84.0	87.1	85.1
1939	123.5	122.4	130.7	133.4	130.1	86.3	83.1	95.1	97.4	94.7
1949	243.7	240.8	242.8	246.6	240.0	189.3	189.9	180.6	180.8	177.5
1950	256.2	254.5	249.5	251.5	248.0	194.3	196.2	185.4	183.7	185.0
1951	273.2	271.3	263.7	274.9	271.8	212.8	214.6	204.2	202.8	205.0
1952	278.2	274.8	271.9	265.2	262.2	218.8	221.0	212.8	210.1	214.3
1953	281.3	277.2	281.0	286.0	282.0	223.0	224.6	221.3	221.8	223.0
1954	285.0	278.2	293.0	300.6	295.4	219.6	219.1	233.5	225.2	225.4
1955	293.1	286.0	300.0	308.3	302.4	225.3	225.1	229.0	231.5	231.8
1956	310.8	302.2	320.1	328.6	324.5	237.2	235.7	241.7	244.4	246.4
1957	318.5	308.3	333.1	345.2	339.8	241.2	239.0	248.7	252.1	254.7
1958	328.0	315.1	348.6	365.4	357.3	243.9	239.8	255.7	261.9	262.0
1959	342.7	329.0	367.7	386.8	374.1	252.2	247.7	266.1	272.7	273.1
1960	351.6	337.2	377.7	395.8	380.6	259.2	253.3	274.7	282.5	278.8
1961	362.5	343.0	398.2	422.4	397.0	256.7	249.7	275.8	284.5	275.8
July 1962	375.6	351.2	418.8	449.4	418.4	264.7	257.0	285.2	295.4	283.5
August 1962	379.2	356.6	422.2	450.1	420.1	265.1	257.4	285.7	295.8	283.9
September 1962	378.4	356.2	421.8	449.7	419.6	264.9	257.2	285.4	295.6	283.7
	% increase over 1939					% increase over 1939				
September 1962	206.4	191.0	222.7	237.1	222.5	206.9	209.5	200.1	203.5	199.6

## ST. LOUIS

## SAN FRANCISCO

1935	95.1	90.1	104.1	108.3	105.4	89.5	84.5	96.4	103.7	99.7
1939	110.2	107.0	118.7	119.8	119.0	105.6	99.3	117.4	121.9	116.5
1949	221.4	220.7	212.8	215.7	213.6	213.0	207.1	214.0	219.8	216.1
1950	232.8	230.7	221.9	225.3	222.8	227.0	223.1	222.4	224.5	222.6
1951	252.0	248.3	238.5	240.9	239.0	245.2	240.4	239.6	243.1	243.1
1952	259.1	253.2	249.7	255.0	249.6	250.2	245.0	245.6	248.7	249.6
1953	263.4	256.4	259.0	267.0	259.2	255.2	257.2	256.6	261.0	259.7
1954	266.6	260.2	263.7	273.3	266.2	257.4	249.2	264.1	272.5	267.2
1955	273.3	266.5	272.2	281.3	276.5	268.0	259.0	275.0	284.4	279.6
1956	288.7	280.3	287.9	299.2	293.3	279.0	270.0	288.9	298.6	295.8
1957	292.0	283.4	295.2	307.1	302.9	286.3	274.4	302.9	315.2	310.7
1958	297.0	278.9	304.9	318.4	313.8	289.8	274.9	311.5	326.7	320.8
1959	305.4	296.4	315.0	329.8	323.9	299.2	284.4	322.7	338.1	330.1
1960	311.4	301.0	322.2	337.2	329.2	305.5	288.9	335.3	352.2	342.3
1961	315.1	302.0	329.0	346.8	332.2	308.7	290.2	345.1	362.9	350.2
July 1962	323.6	308.9	342.4	361.9	343.3	316.0	295.7	356.3	375.9	360.3
August 1962	324.4	309.7	343.5	362.3	343.7	317.0	296.7	357.6	376.9	361.3
September 1962	324.4	309.7	343.5	362.3	343.7	324.2	305.1	366.3	383.6	368.1
	% increase over 1939					% increase over 1939				
September 1962	194.4	189.4	189.4	202.4	188.8	207.0	207.2	212.0	214.7	216.0

Cost comparisons, as percentage differences, for any particular type of construction, are possible between localities, or periods of time within the same city, by dividing the difference between the two index numbers by one of them; i.e.:

$$\frac{\text{index for city A} - 110}{\text{index for city B} - 95}$$

(both indexes must be for the same type of construction).

Then: costs in A are approximately 16 per cent higher than in B.

$$\frac{110 - 95}{95} = 0.158$$

Conversely: costs in B are approximately 14 per cent lower than in A.

$$\frac{110 - 95}{110} = 0.136$$

Cost comparisons cannot be made between different types of construction because the index numbers for each type relate to a different U. S. average for 1926-29.

Material prices and wage rates used in the current indexes make no allowance for payments in excess of published list prices, thus indexes reflect minimum costs and not necessarily actual costs.



## **BORDEN ARCHITECTURAL DECOR PANELS**

Now Borden brings a new building component to the architect—durable light-weight aluminum panels which can be custom-styled in an infinite variety of forms and designs. For example, the extruded type shown here can be had with design punchings of squares, circles, ovals or combinations of curves and straight lines.

The new Architectural Decor Panels by Borden are an extremely flexible medium, allowing the architect a rare freedom of expression in designing facades to blend with the nature of the building, its setting, and the preferences of his client. The dramatic effects achieved with

this new material are being discovered daily; additionally, these panels are unexcelled for sturdiness, economy, ease of handling and installation, and ventilation.

Not limited to facades, the Borden Architectural Decor Panels are used as interior partitions, grilles, window guards, stair rails, doors, entryways, sunshades, and are especially adaptable in the refacing of existing buildings.

Write today for our folder on Borden Architectural Decor Panels.

*another fine product line of*

## **BORDEN METAL PRODUCTS CO.**

MAIN OFFICE: 822 GREEN LANE, ELIZABETH, NEW JERSEY • Elizabeth 2-6410

PLANTS AT: LEEDS, ALABAMA; UNION, NEW JERSEY; CONROE, TEXAS

For more data, circle 9 on Inquiry Card

# GUARANTEED AIRTIGHT, WATERTIGHT...PERMANENTLY

## New Twin Dome® Skylight Insulates as it Daylights

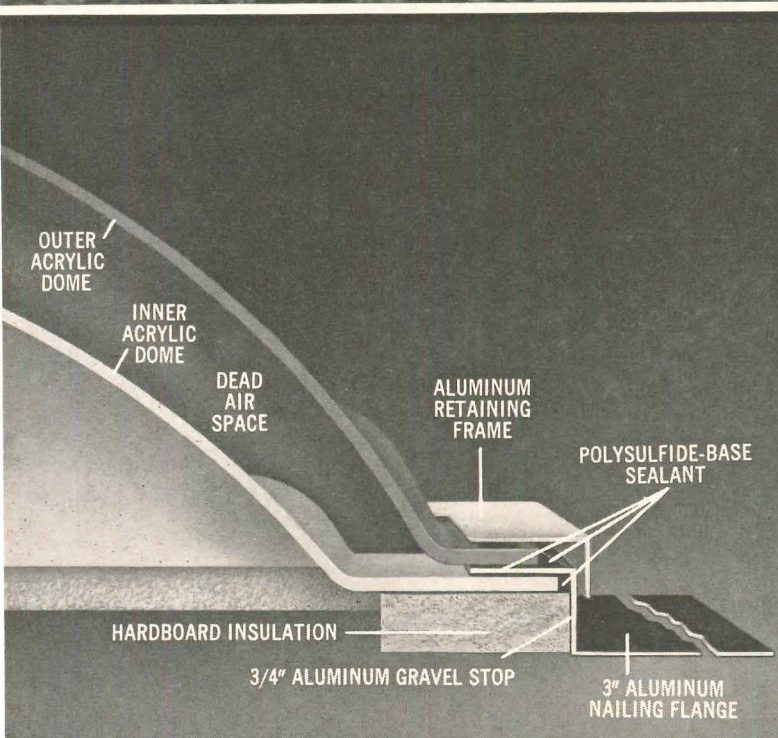
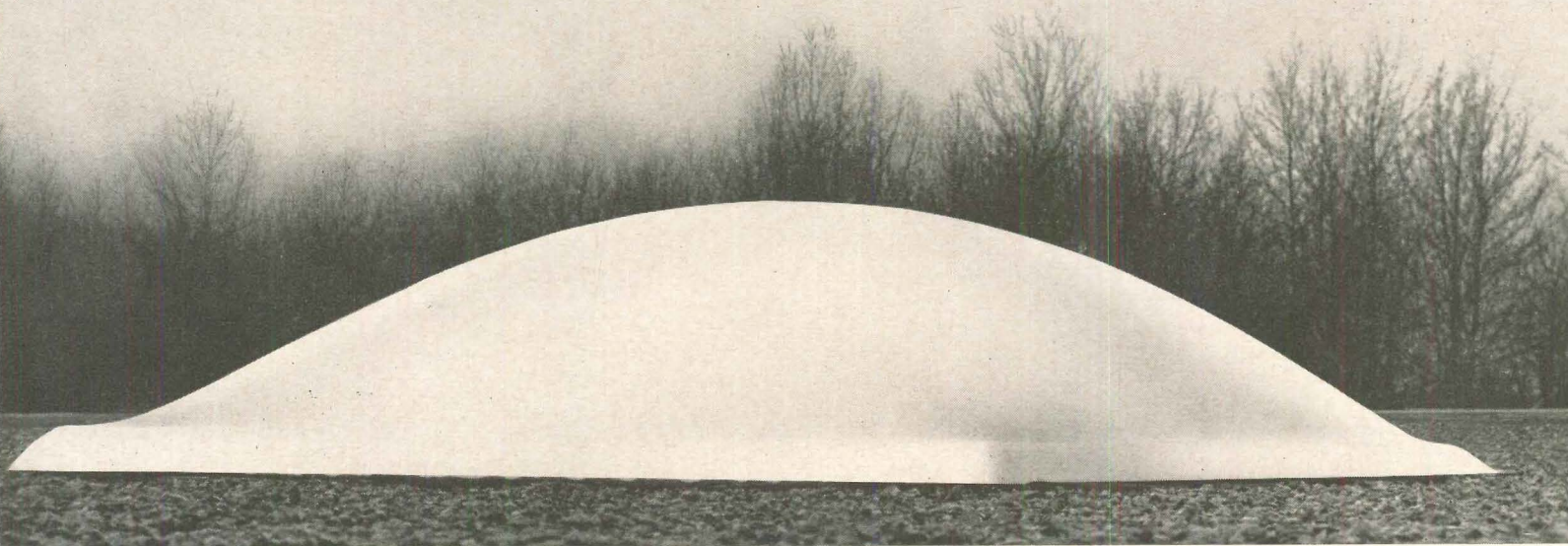

Cutaway Section — New Self-Flashing Wasco Twin Dome

N. Attleboro (Mass.) Jr. H.S.—Arch: Haldeman & Jacoby, Brockton, Mass.

Wasco's field-proven self-flashing Twin Dome acrylic skylights enable the architect to make fuller use of evenly-diffused, glare-free natural daylighting without concern as to heat gain or loss, or condensation.

This first totally-proven dome-within-dome design uses a permanent polysulfide-base sealant to bond an inner and outer acrylic dome to an aluminum nailing flange. The uniform, hermetically sealed 1-inch dead air space between the domes acts as a highly efficient thermal barrier and eliminates condensation. The U-factor remains constant at 0.57 in any geographic area regardless of light level.

A complete range of 19 self-flashing and curb-mounted sizes permits the architect to blend Twin Dome units with any roof design. Choice of clear, white translucent or dense white inner and outer domes allows him to regulate light levels. Twin Dome units are shatterproof, maintenance-free, weather-perfect. The self-flashing model can be installed in 15 minutes. For full details, see Sweet's Architectural File 20a/Wa or write Cyanamid.

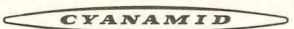

BUILDING PRODUCTS DIVISION  5 BAY STATE ROAD, CAMBRIDGE 39, MASS.

For more data, circle 123 on Inquiry Card



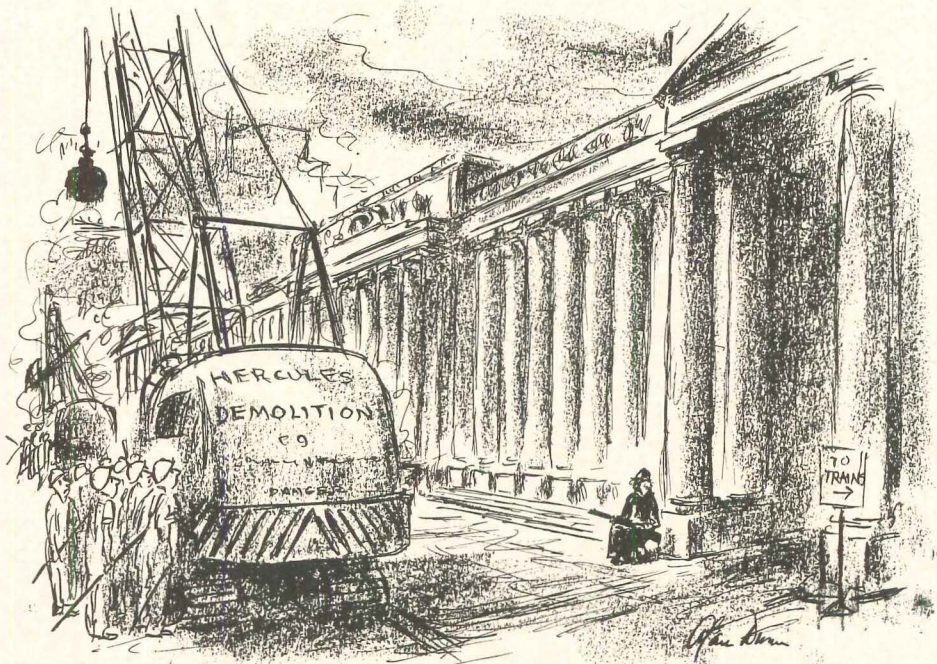

Drawn for the RECORD by Alan Dunn

## BATES IS NEW BUILDING RESEARCH CHIEF OF NATIONAL BUREAU OF STANDARDS

Dr. A. Allan Bates is new chief of the Building Research Division, National Bureau of Standards, Department of Commerce, Washington, D.C. He will have charge of a program of building research and development which for a number of years has been carrying on fundamental studies related to all aspects of construction.

He succeeds Douglas O. Parsons, who joined the bureau in 1923 as an associate civil engineer and who has been chief of the building research division since 1947. Mr. Parsons will continue as a full-time consultant to the bureau.

Dr. Bates, formerly director of New York University's 1,000-acre research and educational center in Sterling Forest, N.Y., was vice president of the Portland Cement Association from 1946 to 1961. His background includes having been manager of chemical, metallurgical and ceramic research at Westinghouse Electric Corporation in Pittsburgh and professor of metallurgical engineering at Case Institute of Technology.

In addition to arts and sciences degrees from Ohio Wesleyan University and Case Institute of Technol-

ogy, he holds a doctorate in science from the University of Nancy, France, and honorary doctorates from Rose Polytechnic Institute and Stevens Institute of Technology.

Dr. Bates is director of the American Society for Testing Materials and a director of the American Concrete Institute.

One of the inheritances of Dr. Bates in his new position is the recent report to the bureau made by a special Building Research Advisory Board committee of which he was a

member. Titled "A Program for Building Research in the United States" (August 1962, page 10), the report calls for creation of a National Institute of Building Research to stimulate and sustain a correlated and continuing national program of building research. The retiring bureau division chief said he hoped to see the report given strong consideration in one form or another during the next year so building research could be coordinated and directed from one source.

Mike Elkins



Dr. Bates (second from right) as he appeared at the recent award dinner of the Concrete Industry Board, Inc., in New York. Others (from left) are John G. Dinkeloo, partner, Eero Saarinen & Associates; Roger H. Corbetta, a director of the Concrete Industry Board; and Bruno Caneva, president, Concrete Industry Board

Mass produced in the least possible time, the prestressed concrete units were erected quickly and easily in winter weather. Double-Tees are bolted to metal bearing and ledger angles.

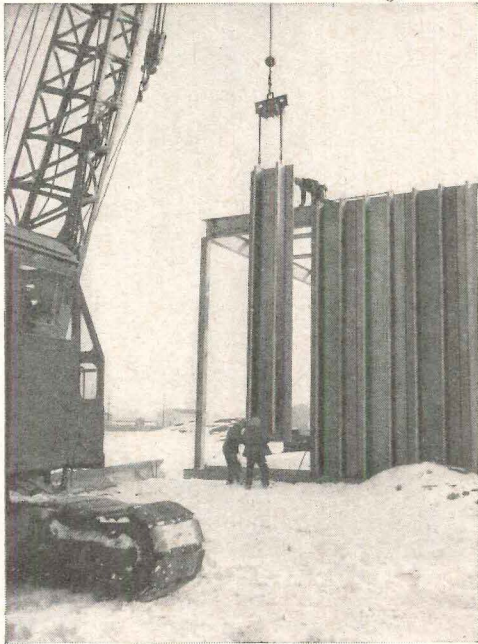

**occupancy  
in shortest  
possible  
time at  
lowest  
possible  
cost with**

Window openings were cored in the Double-Tee slabs and windows of double-strength glass were glazed with an extruded neoprene "zipper-type" glazing strip, fitting over and adhering to concrete tongue of cored section.

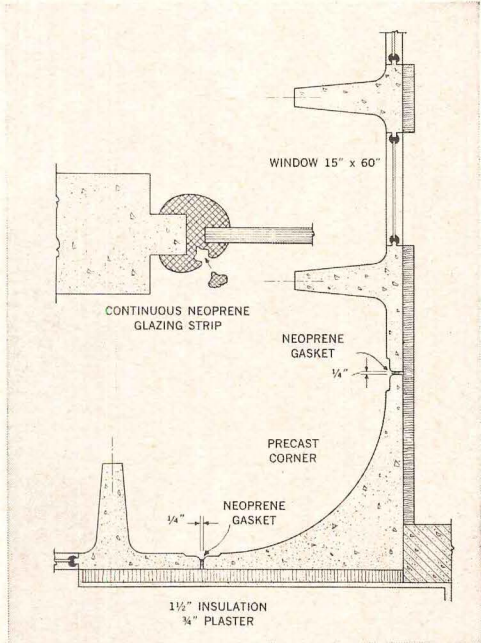

# PRESTRESSED CONCRETE

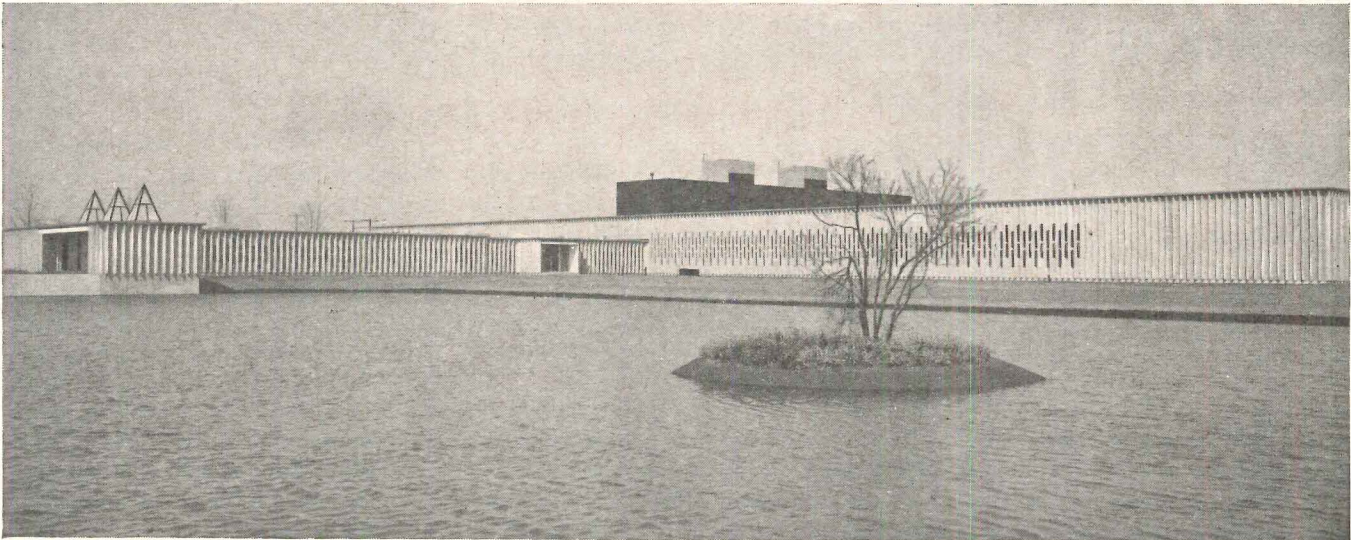

These were two of many advantages achieved by use of prestressed concrete Double-Tee units in the construction of this modern office-plant building.

With these units the architects also created a strikingly aesthetic and functional design with a strong vertical accent and an interesting window pattern that offers sunshade protection and helps reduce air-conditioning costs. Exterior painting and maintenance costs are virtually eliminated.

Furthermore, the prestressed Double-Tees, insulated, plastered or painted as required, offer the greatest amount of usable space and can be quickly and easily removed and reused as additional areas are needed.

This structure, covering a gross area of 106,000 square feet, was completed and occupied within 11 months — an outstanding application of functional design and construction concept for industrial buildings.

Ask Roebing, pioneer in prestressed concrete methods and leading producer of prestressing wire and strand, for technical information and the name of your nearest prestressed concrete fabricator. The Colorado Fuel and Iron Corp., Roebing Construction Materials Div., Trenton 2, New Jersey.

New plant and office building for Columbus Divisions of Thompson Ramo Wooldridge, Inc., at Worthington, Ohio. Architects: Brooks & Coddington, Columbus. Structural Engineers: Barber, Magee & Hoffman, Cleveland. General Contractor: The Albert M. Higley Co., Cleveland. **Prestressed Concrete Fabricator: Permaconcrete Products Corp., Columbus.**



**ROEBLING  
PRESTRESSING  
WIRE & STRAND**

For more data, circle 10 on Inquiry Card

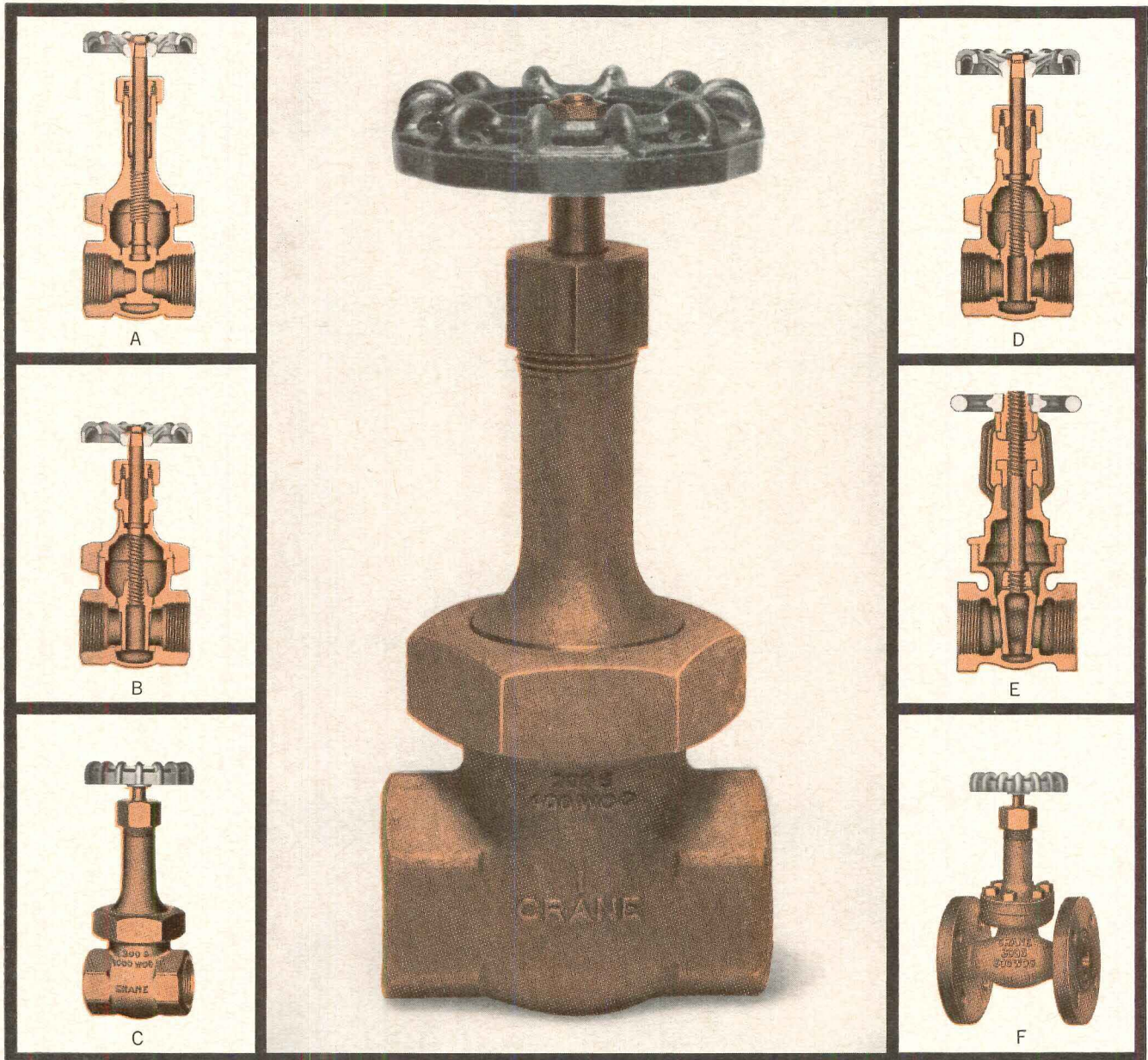

## There's extra value for you in these bronze gate valves

Crane's complete line of 200 and 300-pound bronze gate valves are designed for rugged and trouble-free service.

Look at the streamlined valve body. It's cylindrical for extra strength . . . and precision-made from Crane Special Bronze, as are bonnet, bonnet-ring and disc.

You can rely on Crane's exclusive "Exelloy" body seat rings, too. They're heat-treated for highest resistance to wear, temperature, galling and scoring.

These sturdy valves also feature an extra deep stuffing box that can be re-packed while valve is wide open and under pressure; easily accessible wedge disc; bolted bonnet design in 2½ and 3-inch sizes.

They're recommended for water, steam, oil, air, gas, gasoline, light oils, volatile fluids, etc.; maximum pressures up to

300 psi steam and 1000 psi WOG. (No. 424 valves are also Underwriter's approved for branch or by-pass lines handling liquefied petroleum gases, such as butane, propane, etc. at pressures up to 250 psi.)

These valves come in the following sizes: **200-pound** (A) No. 424, Rising Stem and (B) No. 426, Non-Rising Stem ¼"-3"; **300-pound** (C) No. 634E, Rising Stem and (D) No. 636E Non-Rising Stem ¼"-3".

Also included in the 200 and 300-pound Bronze Gate Valve line are **200-pound**, (E) No. 459 OS & Y Underwriter's approved ½"-3" which are ideally used where action of fluid in line might affect inside stem threads; **300-pound**, (F) No. 623½E Rising Stem, flanged, 1"-3" which are recommended for high pressure service. Materials and service recommendations for these two valves vary slightly

from those specified for valves A, B, C, and D.

For complete details contact your Crane Distributor, or write to Crane Co., Dept. AR, Industrial Products Group, 4100 So. Kedzie Ave., Chicago 32, Ill. In Canada, Crane Canada, Ltd., P.O. Box 70, Montreal.

AT THE  
HEART  
OF HOME AND  
INDUSTRY



VALVES • PIPING • PUMPS  
PLUMBING • HEATING • AIR CONDITIONING  
WATER TREATMENT  
ELECTRONIC CONTROLS • FITTINGS

For more data, circle 11 on Inquiry Card



*GLIDE PEOPLE WHERE YOU WANT THEM SMOOTHLY, EVENLY, DIRECTLY ON...*

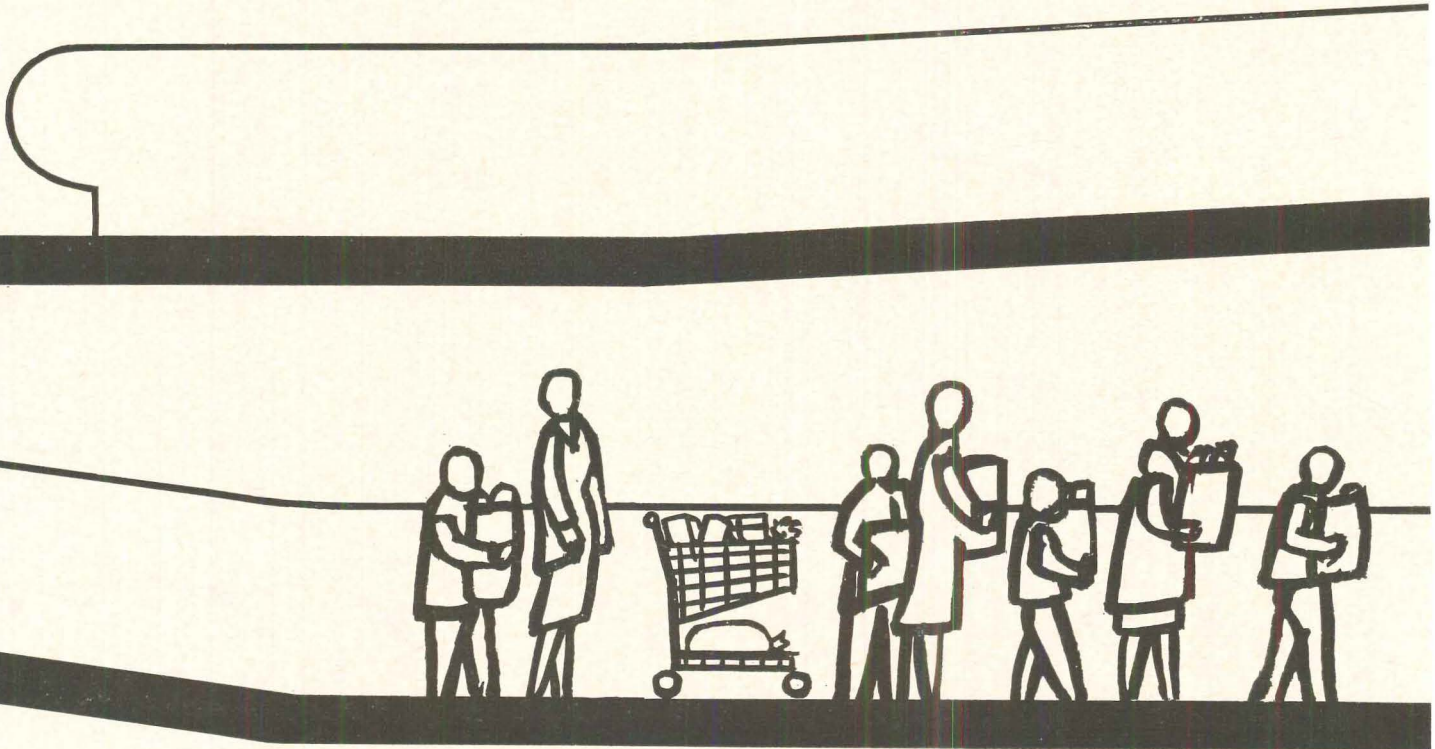

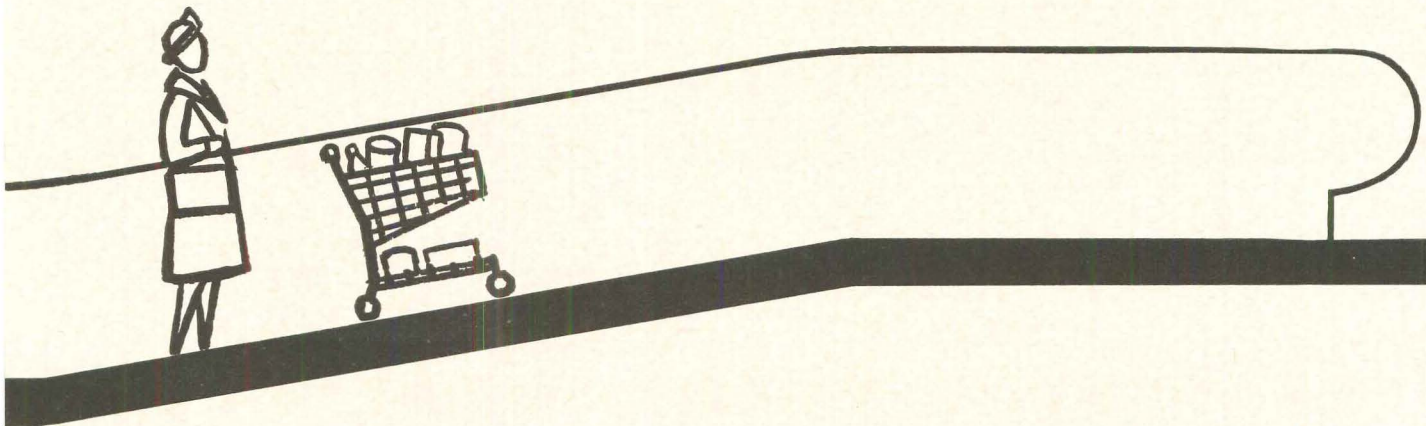

## ***ELECTRIC WALKS BY WESTINGHOUSE***

Electric Walks move people indoors and out, up slopes and down, along the horizontal... wherever traffic is heavy, comfort and safety important. The Walk starts level, finishes level, rigidly follows any contour up to 15 degrees. Metal treads, specially grooved for secure footing, form a continuous moving treadway.

How long is it? As long or short as you need. It doesn't take up much space; doesn't use much power. Ask us about the new Electric Walk... from the company with continuous research and development in mass transport systems. Westinghouse Electric Corporation, Elevator Division, 150 Pacific Avenue, Jersey City, New Jersey. You can be sure... if it's **Westinghouse**



J-98808BA

For more data, circle 12 on Inquiry Card

**"NO VACANCIES"**

**with a Roommate II  
in every room!**

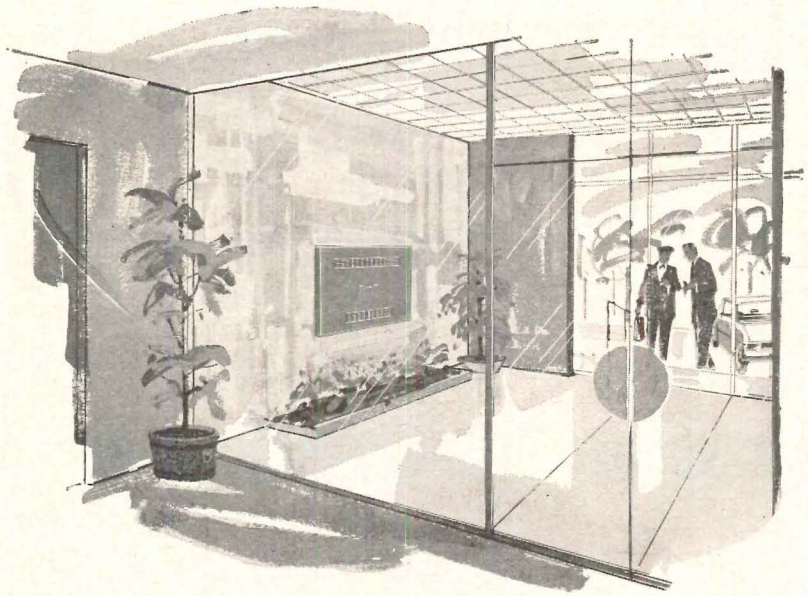
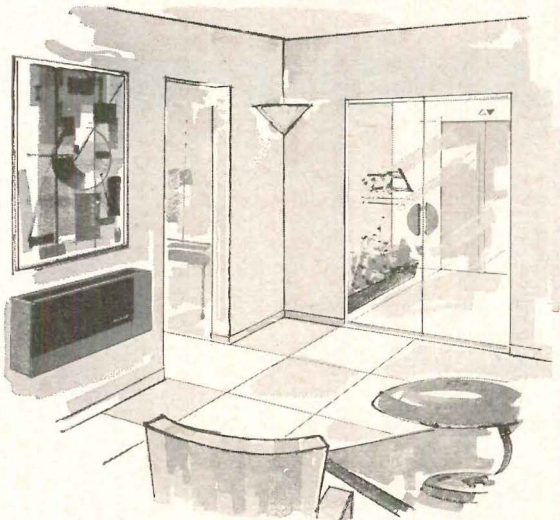

Air conditioning is for *individuals in individual spaces*; and Roommate II cabinet air conditioners are the most flexible "personal weather" units ever designed for motels, apartments, offices, hospitals, and similar buildings.

Roommate II speaks for itself with contemporary lines and decorator colors that lend distinction — in the restraint or dominance desired — while it goes about its business in a quiet and efficient manner that bespeaks its good grooming and excellent name. Clients will find rooms with "Roommates" easy to rent!

You'll want to know about the broad range of sizes and capacities, flexible mounting arrangements, profusion of color treatments — and the exclusive HUMID-A-GUARD system that assures *progressively accurate control of heating, cooling and dehumidifying from full flow of water down to positive shut-off!* Send for a full color brochure that includes Roommate capacities, dimensions and available arrangements.

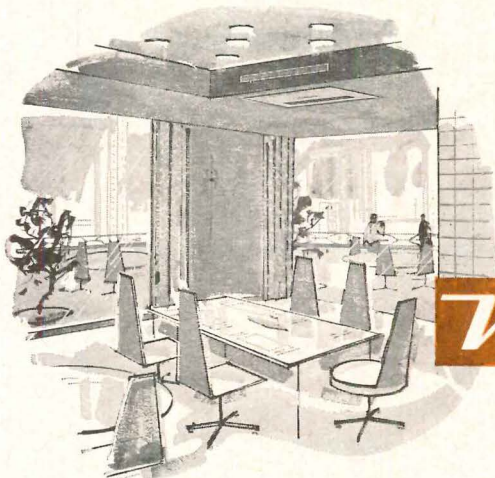

**Nesbitt**

**Roommate II®**

*dramatic new concept in year-round air conditioners*

JOHN J. NESBITT, INC., PHILA. 36, PA. • MANUFACTURING PLANTS IN PHILA., PA. AND COLUMBUS, OHIO • SALES OFFICES IN PRINCIPAL CITIES



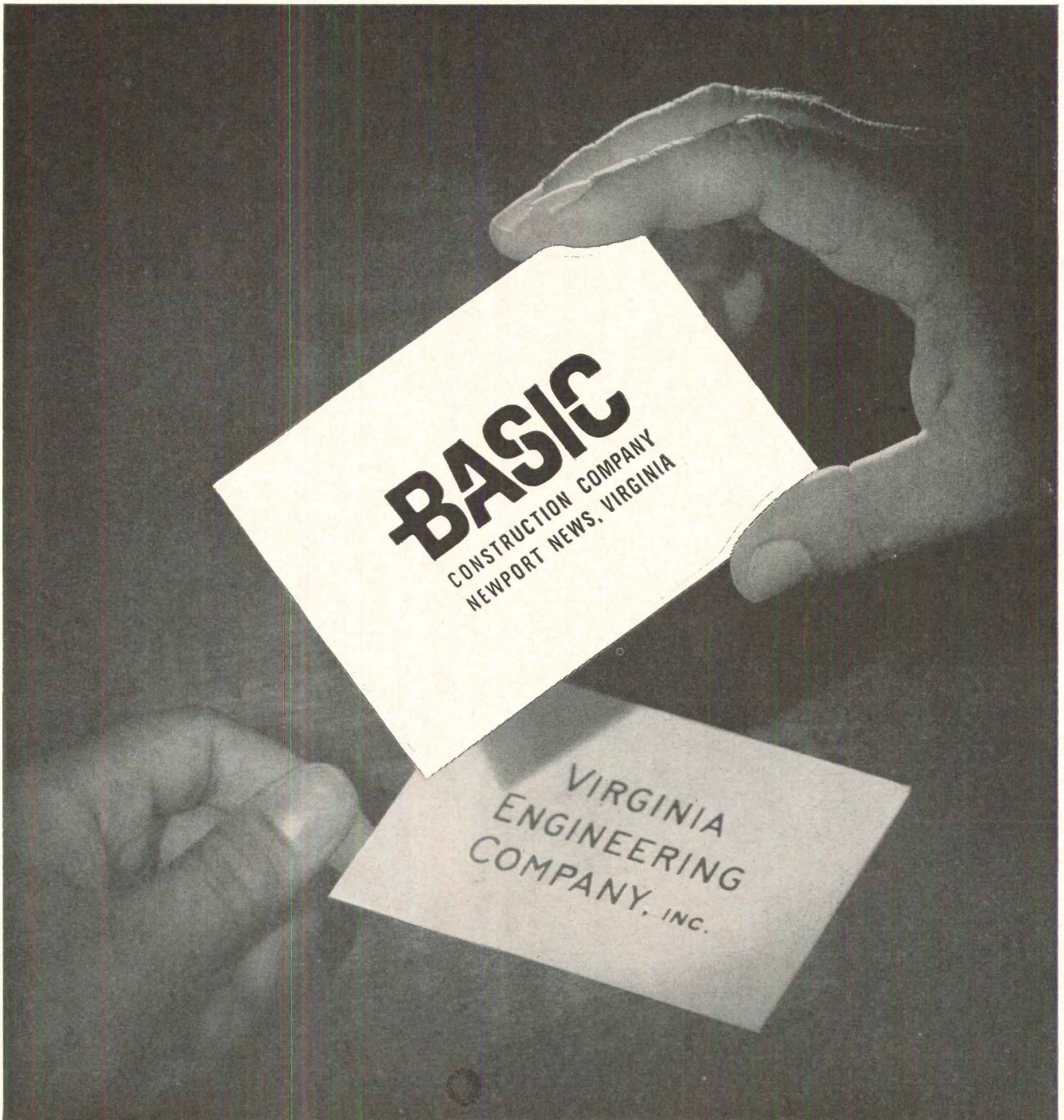

## A NEW NAME FOR A 47 YEAR OLD REPUTATION...BUILT BY NEARLY A BILLION DOLLARS IN CONSTRUCTION EXPERIENCE

. . . a change in name only — made necessary by the continuing expansion of our facilities for meeting the basic construction requirements of the most exacting industrial, commercial, and institutional organizations virtually anywhere in America.

---

← For more data, circle 13 on Inquiry Card

For more data, circle 14 on Inquiry Card

**NEW HOURS**

G-E mercury floodlights  
at the Alma Golf Course, San Jose, Calif.

**NEW SAFETY**

PMA-115 mercury units  
at Bryant Park, New York City

**NEW BEAUTY**

P-1000 Powerflood\* mercury  
units at the South Carolina capitol

**NEW CHARM**

PMC-116 colonial mercury units  
at the Hendersonville, N.C., Country Club

**NEW BUSINESS**

A-4000 Powerglow† mercury units  
at Lazarus West, Columbus, Ohio



**NEW ATTRACTION**

PMF-104A fluorescent units  
at the Seattle World's Fair

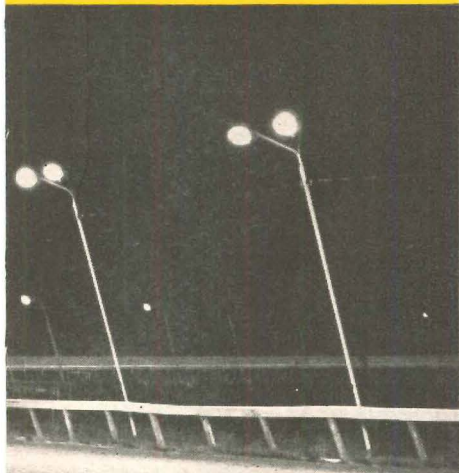
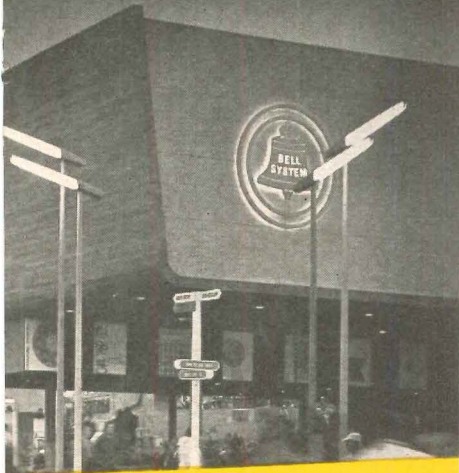

**NEW THRILLS**

QF-1500 Quartz-flood\* units  
at Scarborough Downs Track,  
Portland, Me.

# 7 ways to add new value with light

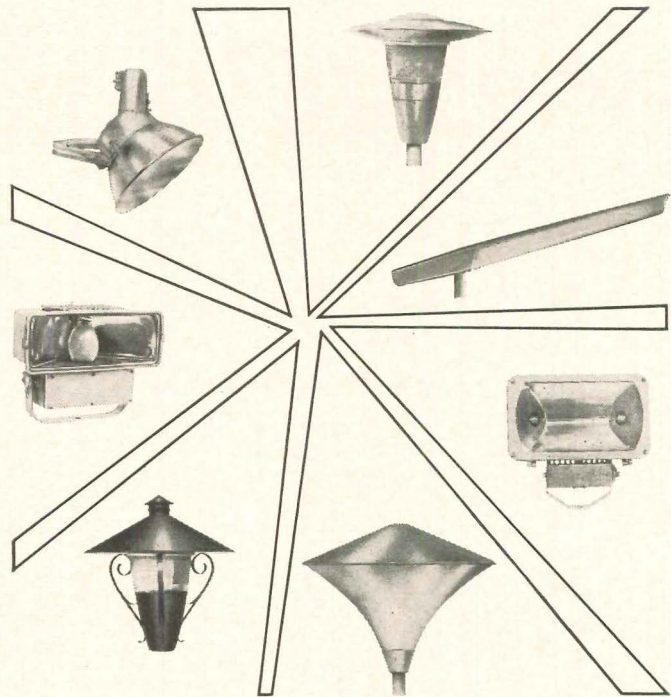

 **ACCENT** The General Electric luminaires that added the values  
*ON VALUE*

Seven examples of how imaginative planners are using good-looking General Electric luminaires to add value to their projects. For more information on the industry's most complete line of luminaires and poles, see your G-E Area Lighting Agent or write for our new designer's and buyer's guide to Sect. 460-19, General Electric Co., Schenectady, N.Y. *Outdoor Lighting Department, Hendersonville, North Carolina*

\*Trade-mark of General Electric Co. †Brand name of General Electric Co.

*Progress Is Our Most Important Product*

**GENERAL  ELECTRIC**

For more data, circle 15 on Inquiry Card



IN SWEET'S  
ARCHITECTURAL  
FILE

## Why damage before dedication?

Chances are this floor will receive more abuse during construction than in the next 5 years combined. As the building goes up, we forget to look down...but it's a very critical time for new floors.

The Hillyard floor treatment program will do the job better than "KEEP OFF" signs...and for a longer time. Your Hillyard Maintainer will show you how to protect all floors during construction, and he will be pleased to draft a plan that will cut maintenance costs by 50% when the owner takes over. You'll like the way flooring complaints will be eliminated. No matter what type of floor you specify—Hillyard seals and finishes are manufacturer approved.

Plan protection for your floors, with your Hillyard Maintainer...the man who follows through for you. At your request, he will survey your finished floors, and recommend proper maintenance procedures at no cost to you. District offices are listed in Sweet's, or call collect.

*"On your staff, not your payroll"* / PROPRIETARY CHEMISTS SINCE 1907



**HILLYARD  
FLOOR  
TREATMENTS**

St. Joseph,  
Missouri,  
U.S.A.  
Passaic, New Jersey  
San Jose, California

For more data, circle 16 on Inquiry Card

For more data, circle 17 on Inquiry Card ➔

For inherent economies of block . . .

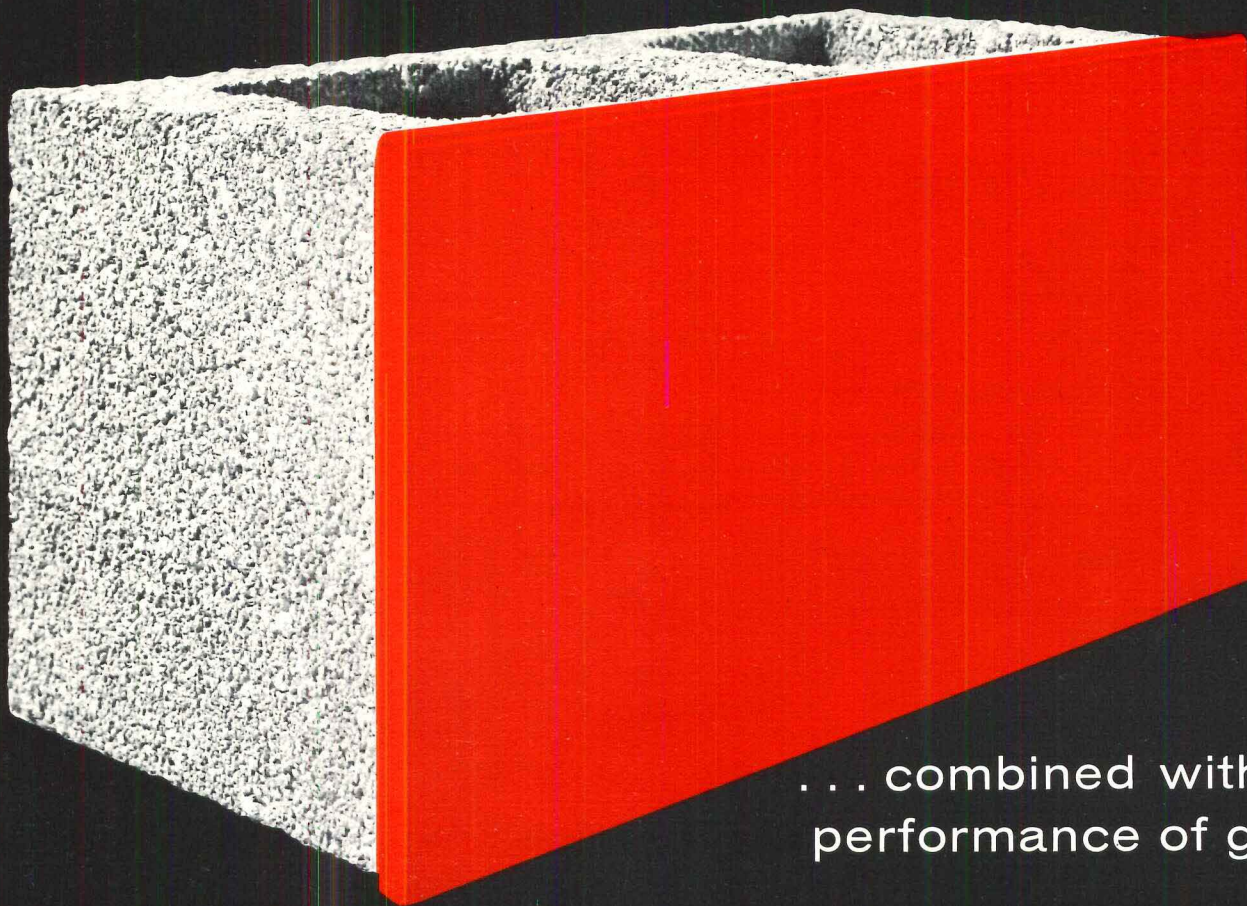

. . . combined with the performance of glaze

**Spectra-Glaze**

Reg. U.S. Pat. Off., Canada and other foreign countries by THE BURNS & RUSSELL COMPANY

® **GLAZED CONCRETE UNITS** meet performance requirements for fire safety (ASTM E-84); resistance to crazing (ASTM C-426); dimensional tolerances ( $\pm \frac{1}{16}$ " ) and chemical resistance (ASTM C-126, Grade G).

Internationally manufactured in 27 locations to a single code of quality control standards.

SEE SWEET'S CATALOG 4g/Bu for details or write direct:

The Burns & Russell Company  
Box 6063 Baltimore 31, Maryland

# OZALID NEWSLETTER

NEW IDEAS TO HELP YOU WITH ENGINEERING REPRODUCTION AND DRAWING

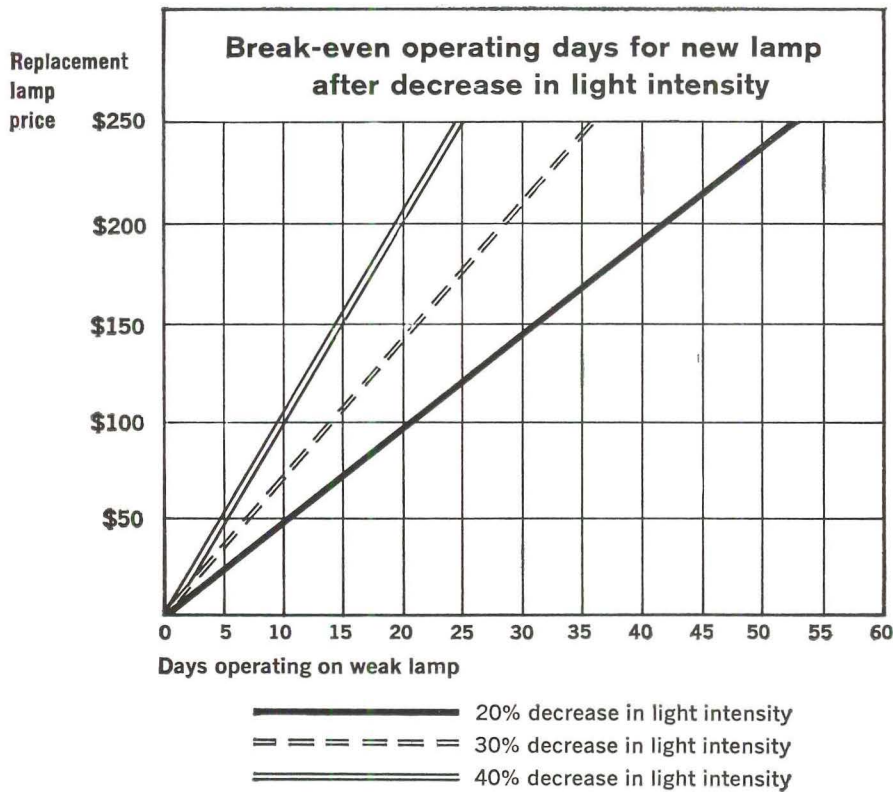

## Prompt replacement of weak printing lamps doesn't cost, it pays!

Operating a diazo machine with a weak printing lamp is like bailing water with a sieve. You're working, but the lamp isn't. Install new lamps and pay for them with the dollars you would have lost had you tried to get the last little flicker from your old lamp.

Sound incredible? Consider expensive operator time, lower machine output, below-par copy quality, and you see why money is lost. How big a loss? Check the solid line on the graph above. Run a machine for just 21 days with a lamp that's 20% off full strength, and you've let \$100 slip through your fingers. And if lamp intensity falls off 30% or 40%, your losses are all the more serious.

Pushing a weak lamp is not sound

economics. Eking the last bit of light from a lamp is a costly mistake that adversely affects the operation of a reproduction department or commercial shop.

Replace weak printing lamps promptly. *It pays.*

### How do you know when the "break-even point" is reached?

Easiest way, of course, is to use a new test sheet which Ozalid supplies. This sheet, reproduced on your diazo machine, will show lamp efficiency. Merely compare the present machine speed necessary for a good print with the original speed at which a print of like quality was produced.

Copy the test sheet periodically

on all your machines to keep abreast of the light intensity fall-off on each diazo printer. The Ozalid test sheet, and the instruction bulletin that comes with it, will help you determine proper replacement times.

### Whose printing lamps are the best buy?

In all cases, the best possible lamp replacement will come from the original manufacturer of your machine. Here's why:

1. A manufacturer balances lamp and transformer for each machine model. Any imbalance caused by use of another lamp could result in shorter lamp life, fluctuating light intensity, or a burned out transformer.

2. The cooling system of a machine model is designed for use with a particular lamp to maintain lamp temperature at the optimum level for long life and even print quality.

The cardinal rule: Depend on the machine manufacturer for your lamp replacements. His lamp guarantee puts money in your pocket.

### Ozalid announces new low prices on printing lamps!

Buying replacements could never be more attractive than it is right now! Even if your machines won't need replacements for a while, now would still be a good time to buy them. Keep spares on hand and hold machine down-time to a bare minimum.

Before it slips your mind, send in for that test sheet and instruction bulletin we spoke of earlier. Use it regularly to keep track of your machines' lamp intensity.

For your valuable test sheet and the companion bulletin just write to OZALID, Dept. 236, Binghamton, New York.

Ozalid, General Aniline & Film Corporation. In Canada: The Hughes-Owens Co. Ltd., Montreal

For more data, circle 18 on Inquiry Card

For more data, circle 19 on Inquiry Card ➤

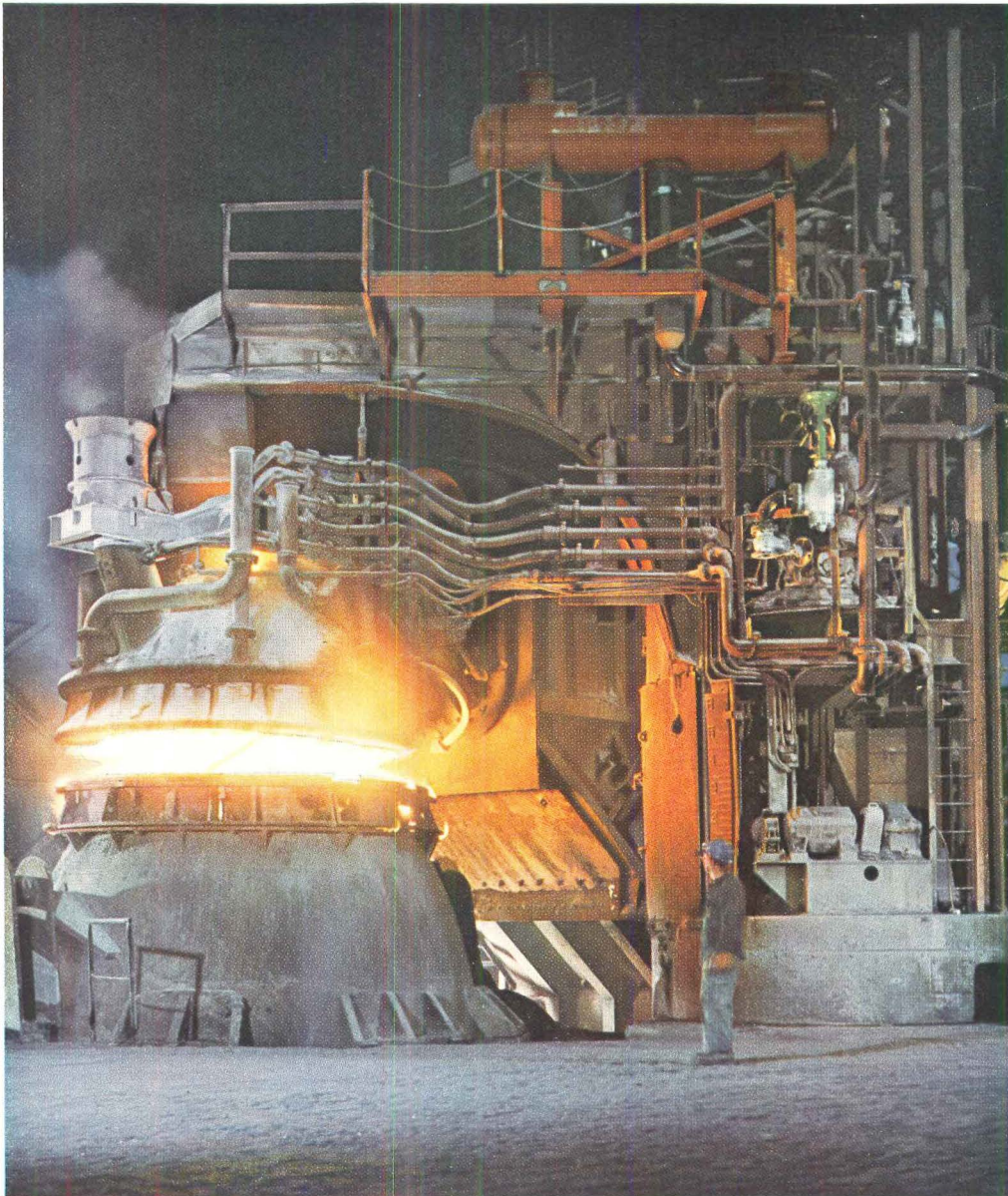

The finish of a heat in one of McLouth's six oxygen steelmaking vessels.

## **McLOUTH STEEL** *progress through pioneering*

In 1954 McLouth installed the first oxygen steelmaking process in the United States. High purity oxygen is blown on molten iron converting it to steel of high quality and ductility. McLouth has one of the largest oxygen steelmaking installations in the industry. To supply these vessels, three oxygen making plants produce 12 million cubic feet (540 tons) daily of 99.5% pure oxygen. McLouth has pioneered many new and better ways of steelmaking to supply you with the finest carbon and stainless steels.

**McLOUTH STEEL**  
McLOUTH STEEL CORPORATION/DETROIT 17, MICHIGAN



Charging molten iron into the vessel.

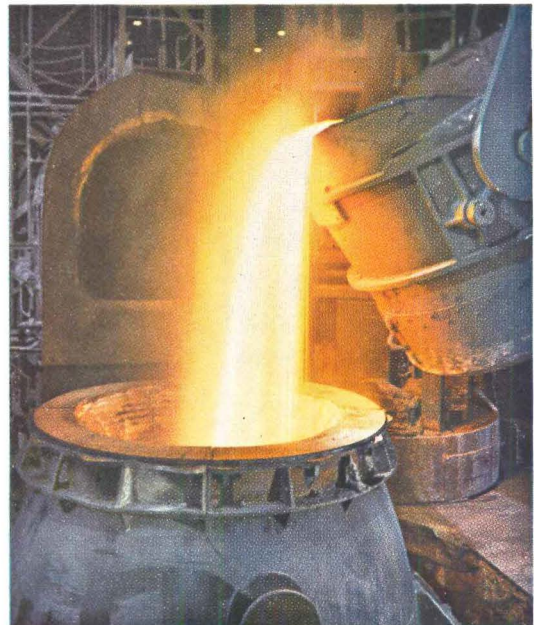

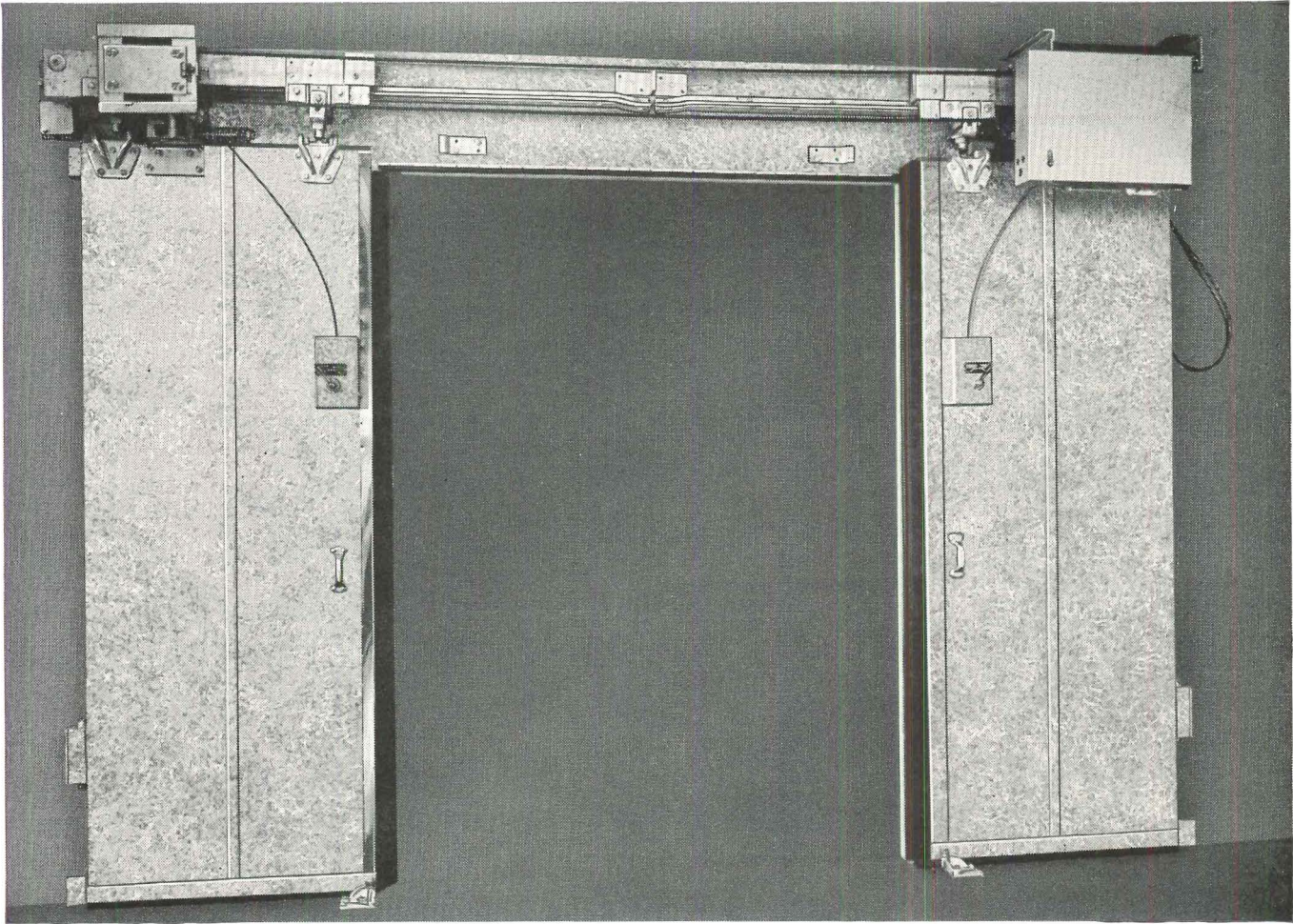

New Electroglide Mark II for cooler, freezer and industrial service is available in thicknesses of 2", 4" and 6". (exposed head view shows simplified track and wedge system)

## NEW JAMISON ELECTROGLIDE® MARK II

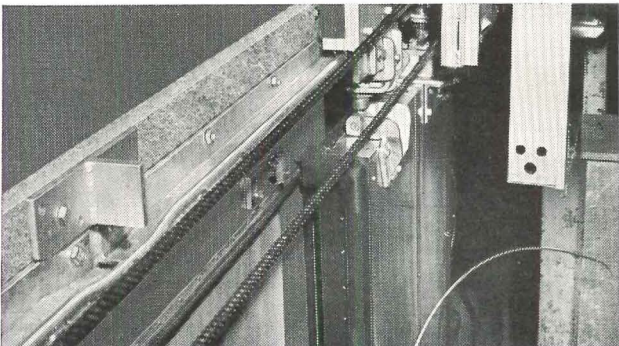

NEW DROP RAIL TRACK DESIGN. Replaces bulky brackets, provides more rigid support in less space.

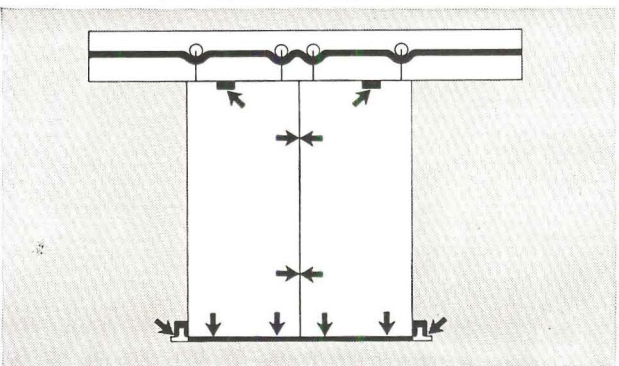

SIMPLIFIED CLOSING OPERATION. Compact, pivoted head wedge plus new drop rail design assures positive, all-points seal with all gaskets visible.

...lighter, smaller,  
power-operated doors

ELECTROGLIDE MARK II electric doors for high volume traffic are now available in a new, simplified construction to meet the need for lighter, more compact automatic doors. Mark II horizontal sliding doors provide smooth, effortless opening and closing and operate with less power. New foamed-in-place polyurethane insulation increases insulating efficiency to a K factor of 0.135 at 75°F. It adds rigidity and strength by adhering permanently to outer door surfaces, reduces weight by eliminating extensive internal bracing. Personnel passage and electric eye guarded closing operation available.

For new bulletin describing this rugged, trouble-free door, write to Jamison Cold Storage Door Co., Hagerstown, Md.

# JAMISON

COLD STORAGE DOORS

For more data, circle 20 on Inquiry Card

For more data, circle 21 on Inquiry Card ➔

**Friendly footing for little feet** And equally friendly to the school budget that calls for the lowest floor maintenance costs. It's hard to imagine a school, whether designed for either total excellence or for lowest long-range cost, without quarry tile prominently employed in its important hard-traffic areas. Possibly no other flooring so well combines utter toughness with colorful beauty. It is well known that Carlyle Quarry Tile is the quarry tile with the most in color selection and in coast-to-coast service. Colors and surface textures give wide choice. Available just about everywhere. Pattern possibilities are practically limitless but there's nothing richer in the world of building than a solid area of just one quarry tile color. And both regular and abrasive-surface tile can now be ordered four-square ground (after firing) to permit narrower than usual joints. For full-size high-fidelity printed sample sheets of all Carlyle Quarry Tile (Ironton) colors, ask your Mosaic Representative or write The Carlyle Tile Company, Ironton, Ohio. For literature on Carlyle Quarry Tile made in California by Jordan Tile Mfg. Co., write The Mosaic Tile Company, 131 N. Robertson Blvd., Beverly Hills, Calif.

For free estimates on Mosaic Tile, see the yellow pages for your Tile Contractor, Ceramic



Flowers School, Montgomery, Ala. Architect: Samuel D. Collier. Tile Contr.: Robert F. Henry Tile Co.



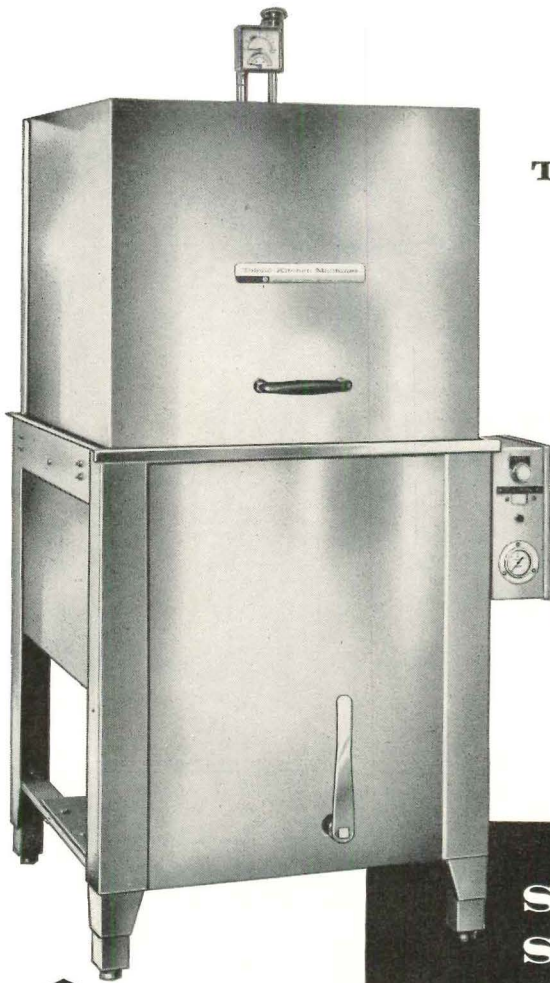

Toledo Model TDA27 complete with stainless steel front enclosure panel. (Door lock not shown.)

Soiled tableware enters TCU96 at right, emerges onto clean dish table at left. Disposer is under prescrap compartment at right.

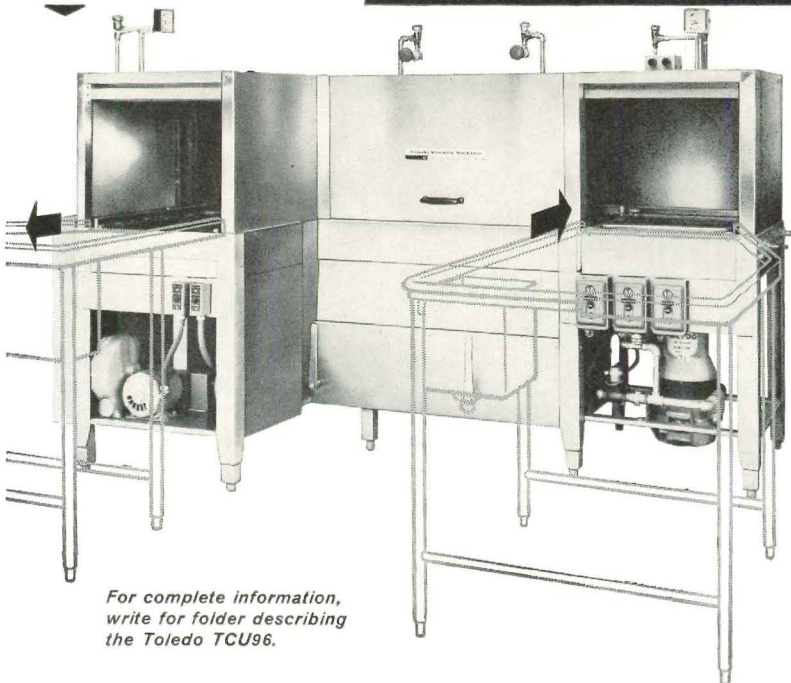

For complete information, write for folder describing the Toledo TCU96.

## The Custom-27... by TOLEDO

Here's a real achievement in compact, economical efficiency. The Custom-27 is the industry's most advanced dishwasher, customized and priced for individual needs. Look at these exclusive standard equipment features . . .

- Stainless steel inside and out, including the manifold.
- Complete manifold assembly locks into vertical position for easy cleaning.
- New Quik-Flip device on spray tubes permits one-hand removal and replacement.
- Toledo's exclusive 3-way door, now with 4-way suspension, raises and lowers with pressure of one finger.
- Converts easily and quickly for corner installation.

The Custom-27 is designed for the utmost in adaptability, to suit specific needs and financial conditions. Optional features include boosters and thermostats for electric, gas and steam heat, door safety switches and locks, a timed fill, automatic self-starting switches and many others. In addition, stainless steel front enclosure panels, round stainless steel feet and other accessories are available.

For complete information, write for folder describing Toledo Model TDA27.

so new today, they'll still be new in 1967!

These new dishwashers, by Toledo, give you design features years ahead of the industry, years ahead of their time. Ask your Toledo dealer about them today!

Toledo Kitchen Machines



A DIVISION OF TOLEDO SCALE CORPORATION • 245 HOLLENBECK ST., ROCHESTER, NEW YORK

## The Contin-U-matic ... by TOLEDO

The Contin-U-matic is a complete dishwashing system, designed for one-man operation and economical use of space. This new conveyor machine, including all the outstanding features for which Toledo is known, is built to combine with soiled dish and clean dish tables so that a single attendant, standing in front of the machine and between the two tables, can handle the complete operation without moving. The Contin-U-matic as an optional feature, includes a built-in disposer for automatic disposal of grease and table scraps. Because of its "U" shape and its front feed and unload features, the Contin-U-matic requires far less kitchen space than conventional conveyor dishwashers.

For more data, circle 22 on Inquiry Card

For more data, circle 23 on Inquiry Card →



*Apply it like paint...*

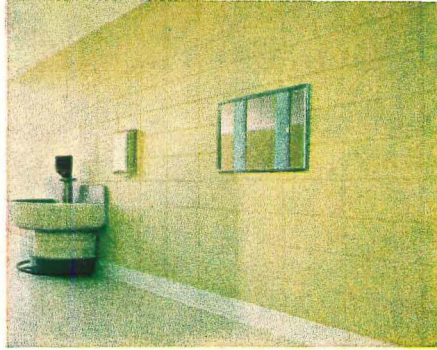

Washroom of nonporous, completely water and soap-resistant Glid-Tile offers lasting durability.

## GET COLORFUL, TILE-HARD SURFACES WITH GLID-TILE



Classroom application of rugged Glid-Tile reduces school maintenance costs.

These walls can lick any kid in the school. And their beauty won't fade; surfaces won't chip or abrade. The walls are protected by Glid-Tile.

Glid-Tile plastic resin coatings can bring bright color, tile-like, life-long protection to your masonry block walls—economically. Glid-Tile can be applied as easily as paint, by spraying, brushing, or rolling it on. The finish is rock-hard. Stands up to the scuffing, hitting and scrubbing you know it will have to take. And Glid-Tile eliminates the need for exposed mortar joints.

Impervious to the action of many chemicals, Glid-Tile is ideal for use in laboratories. It can be cleaned with strong soaps and detergents without harming the beauty and durability of its finish.

Glid-Tile has proved its value in many schools, factories and public buildings. A wide choice of colors is available. Write for descriptive literature.



Stairwell is protected from heavy traffic by Glid-Tile.

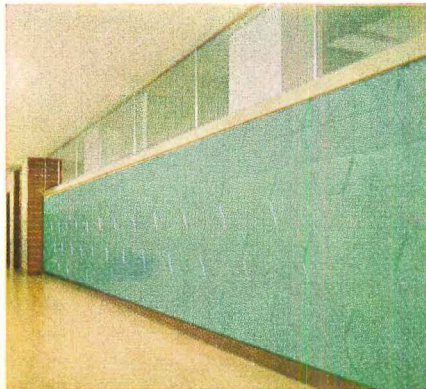

Corridor is dramatic in Glid-Tile in the Riverside Elementary School, Hammond, Indiana.

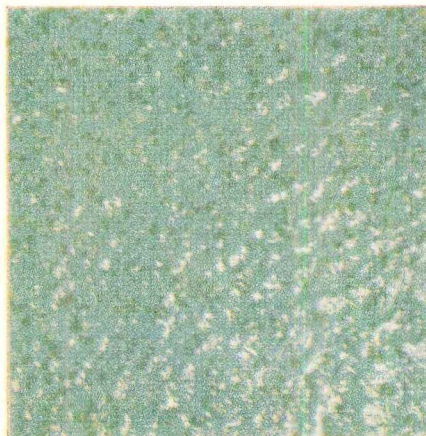

Glistening Glid-Tile is available in a broad range of pastel colors.



### THE GLIDDEN COMPANY

COATINGS AND RESINS DIVISION  
900 Union Commerce Building • Cleveland 14, Ohio  
In Canada: The Glidden Company, Ltd., Toronto, Ontario

### NOT A FIRE HAZARD

Glid-Tile has been evaluated by a recognized, independent testing laboratory according to ASTM-E-84-59T, tunnel test.

Glid-Tile's extremely low flame-spread rating means it won't create a fire hazard in your building. Test reports available on request.

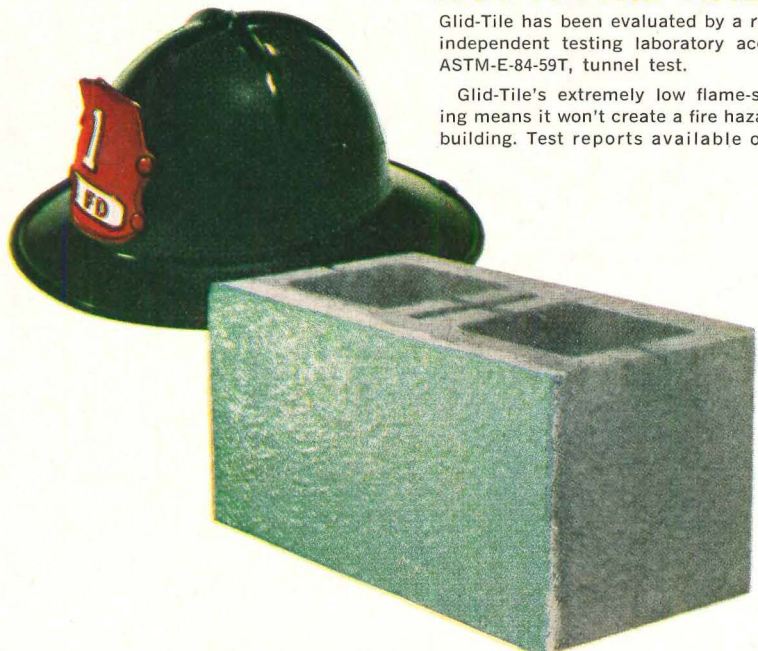

Sketch, Albi Cathedral, by Sir Basil Spence  
—from "Phoenix at Coventry"

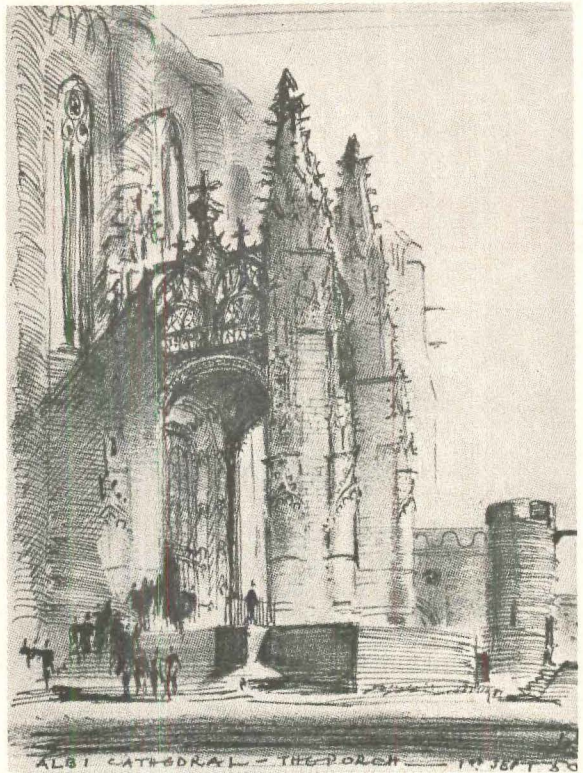

## Neutra's Autobiography

LIFE AND SHAPE. By Richard Neutra. Appleton-Century-Crofts, 60 E. 42d St., New York 17. 366 pp., illus. \$7.95.

Of all literary genres, autobiographies are perhaps the most interesting. Much of their fascination for the reader may be morbid, as he wonders how much the writer will tell or how much he will reveal. For the writer, it is an acid test of his nerve. Mr. Neutra acquits himself quite well, revealing himself, with only a rather charming trace of hornblowing, as a man of enormous curiosity about his fellow man and an abiding love for his profession.

Mr. Neutra is also, of course, an architect, and no architectural autobiography is complete without an explanation of the author's philosophy of his profession. Mr. Neutra's philosophy, drawing heavily on the facts of human physiology, occasionally leads him into extravagance. If, for instance, the jurist, legislator, businessman, censor and art critic are not able to effect good urban design, how, one wonders, can the naturalist, so unknown to the public as to be virtually without power of persuasion, convince the public that it should insist upon it? It is nonethe-

less encouraging to find that at least one writer can urge man's ancient physical needs without suspecting and rejecting the 20th century. Mr. Neutra indicates he will accept anything it offers, trees or acoustic tile, if it will help preserve man's biological integrity.

Mr. Neutra's approach to architecture was described fully in his "Survival Through Design," published in 1954. Here he has interlineated its development with a narrative of the life's experience which led to it.

The book is illustrated by sketches made on the author's trips about the world.

## Biography of a Cathedral

PHOENIX AT COVENTRY: *The Building of a Cathedral.* By Sir Basil Spence. Harper & Row, Publishers, 49 E. 33d St., New York 16. 141 pp., illus. \$6.95.

A contemporary biography of a cathedral is as rare a thing as a new cathedral itself. The building of the new Coventry Cathedral Church of St. Michael was a remarkable performance: a substantially complete

cathedral in 11 years' time. Even in the 20th century, the technical accomplishment is impressive. The human accomplishment is even more impressive, however, and it is this that occupies much of Sir Basil's attention in this book.

If this achievement is perhaps a matter of faith moving mountains, Sir Basil's faith supplied a great deal of the motivating power. He is certainly not the only architect to yearn to build a cathedral, nor was he the only one to grieve over the loss of old Coventry Cathedral; but his was the highly unusual opportunity to build a modern cathedral.

The architect's was not the only faith evident in this undertaking, as Sir Basil is quick to point out with engaging simplicity and enthusiasm. The Coventry clergy—including two bishops and a provost of the cathedral—were insistent on a modern building from the beginning, and supported the design with energy through all its vicissitudes. And though the coordination of artists was not entirely without difficulty, Sir Basil makes it sound like a wonder of cooperation. He has virtually nothing but good to report of the artistry, skill and effort of Graham Sutherland, Jacob Epstein, the weavers or the building workmen.

*continued on page 45*



Supermarket floor in new Kentile® Architectural Marbles Vinyl Asbestos Tile with Green Feature Strips. Alternating Milano (Green) and Rheims (Beige) colors aid traffic flow. Black Wall Base and Counter Base are Vinyl KenCove®. Décor, courtesy Food Fair Stores, Inc.

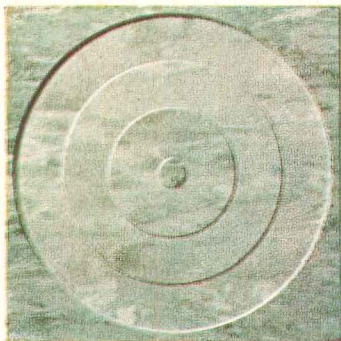

Ground-down tile shows how random design goes all the way through.

## Here's a vinyl tile floor perfect for heavy traffic!

Reason? The marble design of new Kentile Architectural Marbles Vinyl Asbestos Tile goes through and through each tile. It can't wear off! Greaseproof and easy to clean... 8 versatile colors. You get all these extras—at no extra cost!

VINYL **KENTILE** FLOORS

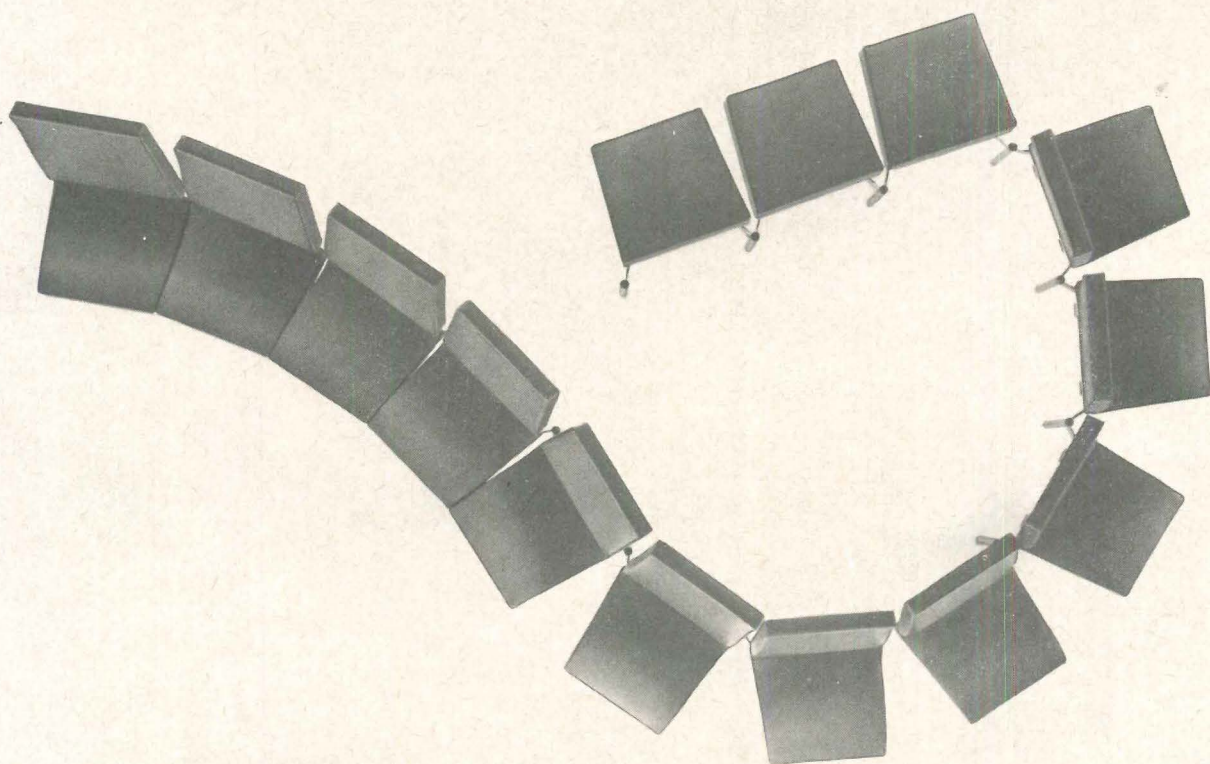

Curves, twists, bends, goes anywhere.

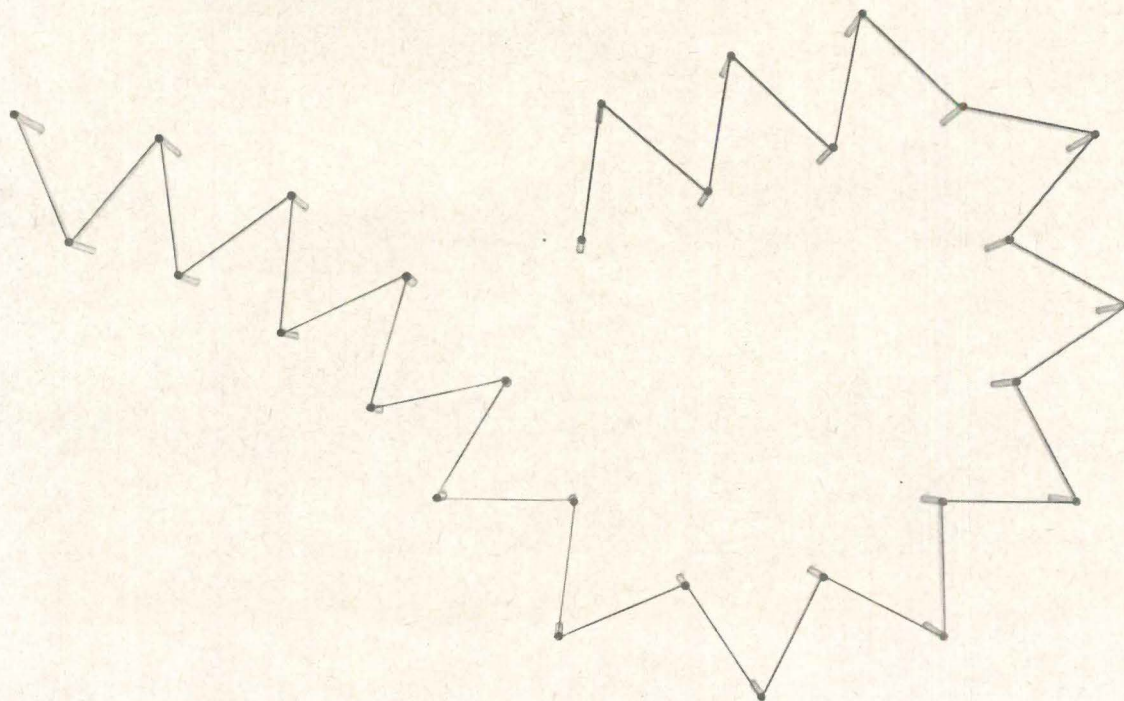

Here's why.

Royalmetal's new Viscount 65 seating is based on an entirely new idea, an entirely new kind of base: one that actually flexes. Viscount 65 can wrap around a column. Turn a right angle. Circle a square. Square a circle. Or hold an arrow-straight line. Think what this means. New freedom to design interiors, to realize ideas that could never



work with ordinary lounge seating. And if you never tax Viscount 65 to its full capabilities, you'll still have the most beautiful seating ever designed. The most unique, too, since only Viscount 65 has "floating seat" styling. Sound interesting? Write today for full information. ROYALMETAL CORPORATION, Dept. 10-L, One Park Ave., New York 16, N.Y.

PAT. PEND.

**ROYALMETAL** T.M.

What's illustrated below? An AUTOTRONIC elevator penthouse. And the endless perfecting of the elevator's automatic performance. With oscilloscopes. A method pioneered by OTIS.

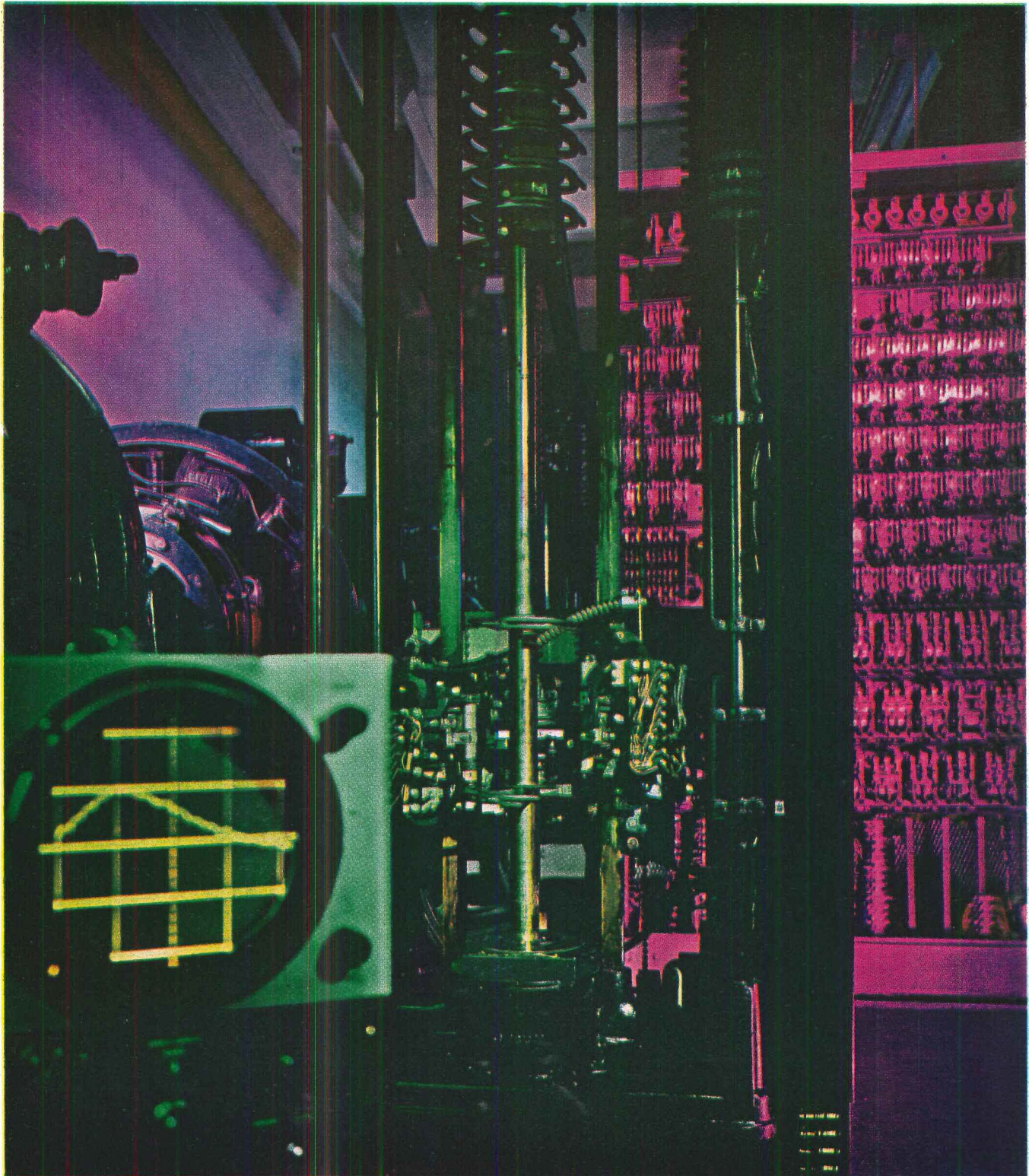

## Today it's unlimited elevator automation

—a still further advance in AUTOTRONIC® elevating. By the leader in elevator automation—OTIS. It's unexcelled! What does it mean to you? As an elevator rider: almost instant service. Anytime. Anywhere in the building. As a building owner: unequalled service. With the least number of cars.



**OTIS ELEVATOR COMPANY**

260 11th Avenue, New York 1, N. Y.  
Offices in 448 cities around the world

• For more data, circle 24 on Inquiry Card



**"CERAMIC TILE...A DURABLE MATERIAL**

**...A DECORATIVE EXTERIOR COVERING"**

*KAHN & JACOBS*

*P.A.B.*

Design project: a commercial office building entrance. The designers: the New York architectural firm of Kahn & Jacobs. Here's another vivid reflection of architectural awareness of ceramic tile's growing role: for beautiful exterior walls, distinctive floors, colorful spandrels.

Ageless ceramic tile will enhance any commercial or institutional project you may have on the boards. And it will pay its way over the years for your clients with savings on maintenance.

**THE MODERN STYLE IS .**

For more data, circle 26 on Inquiry Card

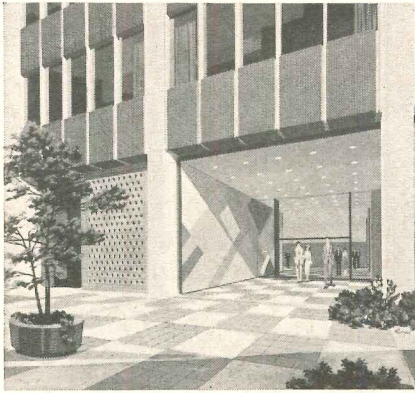

*Design for a commercial office building entrance by Kahn & Jacobs*

Inside or outside, ceramic tile surfaces give your clients *more* beauty, less maintenance. Improved lower cost installation methods are leading the way to even wider use of this quality product.

The many benefits of ceramic tile will make sense for both you and your clients in any residential, institutional or commercial project you undertake. Consult your tile contractor for up-to-date information, including all the details on the new lower cost installation methods and the new dry-set portland cement mortar.

#### PARTICIPATING COMPANIES

American Olean Tile Company  
 Atlantic Tile Mfg. Co.  
 Cambridge Tile Mfg. Co.  
 Carlyle Tile Co.  
 Continental Ceramics Corporation  
 General Tile Co.  
 Gladding, McBean & Co.  
 Jackson Tile Mfg. Co.  
 Jordan Tile Mfg. Co.  
 Lone Star Ceramics Co.  
 Monarch Tile Mfg. Inc.  
 Mosaic Tile Co.  
 Murray Tile Co., Inc.  
 National Tile & Mfg. Co.  
 Oxford Tile Company  
 Pomona Tile Mfg. Co.  
 Redondo Tile Company  
 Ridgeway Tile Co.  
 Robertson Mfg. Co.  
 Stylon Corp.  
 Summitville Tiles, Inc.  
 Texeramics, Inc.  
 Wenzel Tile Co.  
 Winburn Tile Mfg. Co.

#### TILE COUNCIL OF AMERICA, INC.

800 Second Avenue, New York 17, N. Y.;  
 900 Wilshire Boulevard,  
 Los Angeles 17, Calif.;  
 Room 207, 5738 North Central  
 Expressway, Dallas, Texas



## Required Reading

*continued from page 40*

This is not to say that the undertaking was all clear sailing. It initially met a great deal of opposition from both the general press and sections of the architectural press. Not to mention, on a different level, quantities of anonymous letters of a shocking nature.

But this is essentially a sunny chronicle, written before memories receded or the sense of accomplishment palled. Architects reading it should receive, at the least, the vicarious thrill of cathedral building, and, at the most, an insight into the generosity of the human spirit.

## Letters and Signs

LETTERING FOR ARCHITECTS AND DESIGNERS. *By Milner Gray and Ronald Armstrong. Reinhold Publishing Corporation, 430 Park Ave., New York 22. 160 pp., illus. \$12.75.*

There is very little good graphic design for architecture in the U.S.A. and the few distinguished examples which do exist are familiar to those architects who are interested in the subject. This book has fresh examples of excellent graphic design, some of the best of it by the authors.

While the book has many additional merits, its section called "The Traditional Vernacular" is by itself enough to recommend it. Here the authors have collected photographs of wonderful old signs.

In a valuable chapter on selecting the right letterform for the purpose, the authors say: "With the exception of the monumental inscriptions of the antique world, the prototypes which have come down to us from the past, while developed by artists of sensibility and talent into very beautiful forms, have been solutions to problems with which we are not primarily concerned, as for instance with the rapidity of their execution or the appearance of the written or printed page. Displayed lettering with which we are principally concerned—that is, the display of single words and of isolated lines of lettering—demands a specially close attention to the individual form of the

*continued on page 56*



*is designed to your exact application requirements for:*

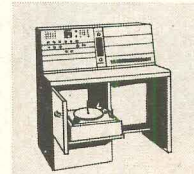

#### SCHOOLS

A wide selection of systems with complete functional programming facilities in every price range.

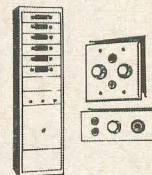

#### MOTELS • HOTELS

Complete systems for music and sound distribution, paging; message indicator, maid locator and room status features.

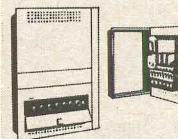

#### CHURCHES • AUDITORIUMS

Unique in-wall, transistorized amplifiers for inconspicuous, space-saving installation.

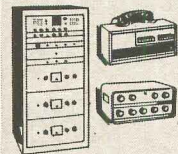

#### INDUSTRIAL

Systems for every requirement, including specialized paging and intercom.

- **complete engineering help**  
Expert RAULAND engineering help is at your command so that you can specify with confidence.
- **proof of quality**  
Thousands of RAULAND Sound Systems 10 years old or over, are still in satisfactory daily use —proof of quality and years-ahead design.
- **distributors everywhere**  
There is an experienced RAULAND Engineering Distributor in your area, ready to work closely with you.



ask for our

#### SPECIFICATIONS MANUAL

Detailed specifications of RAULAND Sound Equipment are available to you. Ask for our manual on your letterhead. We specialize in cooperation with architects and consulting engineers.

**RAULAND-BORG CORPORATION**  
 3535-R Addison St., Chicago 18, Ill.

For more data, circle 27 on Inquiry Card

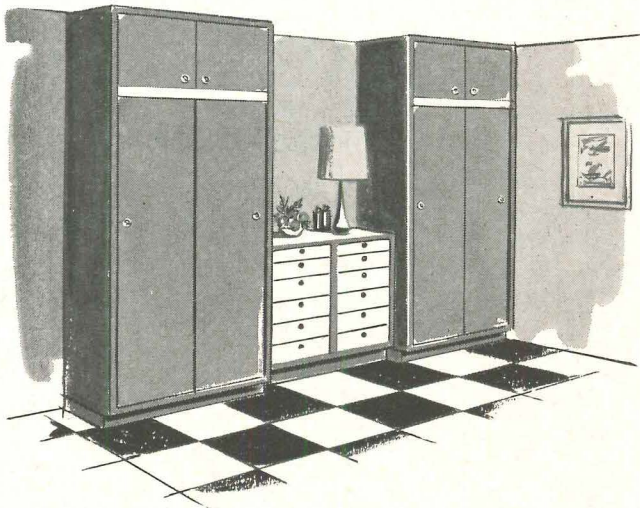

## build up...in...

Gain floor-to-ceiling storage space with compact, sturdy Dorm Line wardrobes. Save time and expense of constructing closets or handmade wardrobes.

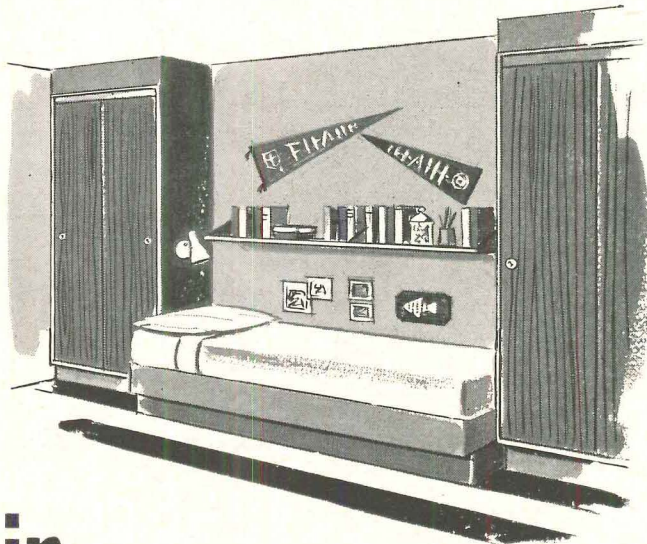

Dorm Line units including beds can be built in—thus qualifying for long-term government financing. "Student-proof" construction means long-term service.

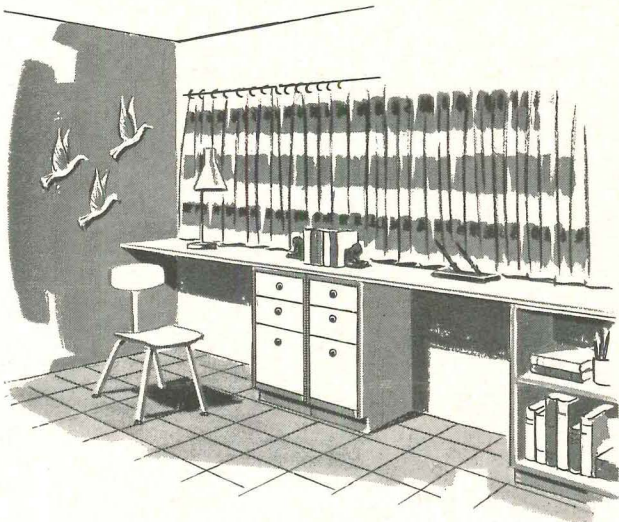

Dorm Line helps put every inch of space to work—makes even small rooms comfortable. Bookcases, chests, drawer units utilize space from the floor up.

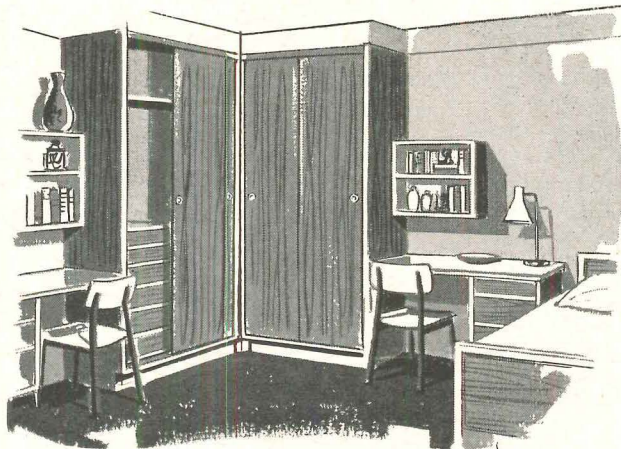

Follow contours of odd-sized rooms, jutting corners or other construction with versatile Dorm Line. You achieve maximum sitting-studying-sleeping comfort.

## ...under...around...

### with DORM LINE by SIMMONS

Gain now and for years to come—plan your rooms with Dorm Line by Simmons. Complete catalog available, or see Sweet's File.



**SIMMONS COMPANY**  
CONTRACT DIVISION

Merchandise Mart • Chicago 54, Illinois

DISPLAY ROOMS: Chicago • New York • Atlanta  
Columbus • Dallas • San Francisco • Los Angeles

For more data, circle 28 on Inquiry Card

For more data, circle 29 on Inquiry Card ➤





PLANTS AND FLOWERS FLOURISH UNDER...

# Skies of Glass



In construction said to represent the first of its type, Polished Misco wire glass provides a protective canopy for thriving plant life in Milwaukee's new Mitchell Park Horticultural Conservatory. A classic example of the design flexibility of glass, these strikingly attractive enclosures clearly point up the advantages of glass as to its chemical stability, permanence of finish, color, shape, surface hardness, and fire retardance . . . characteristics available to a degree found in no other glazing material. For the proven performance needed for better daylighting at ultimately the lowest cost, specify glass. See your Mississippi glass distributor.

**MISSISSIPPI**  
**GLASS COMPANY**

ST. LOUIS • NEW YORK • CHICAGO • FULLERTON, CALIF.





Close-up detail of complete skylight section. Rugged, Polished Misco wire glass combines the utmost in safety with modern beauty . . . affords approved yet inconspicuous fire and breakage protection wherever installed.

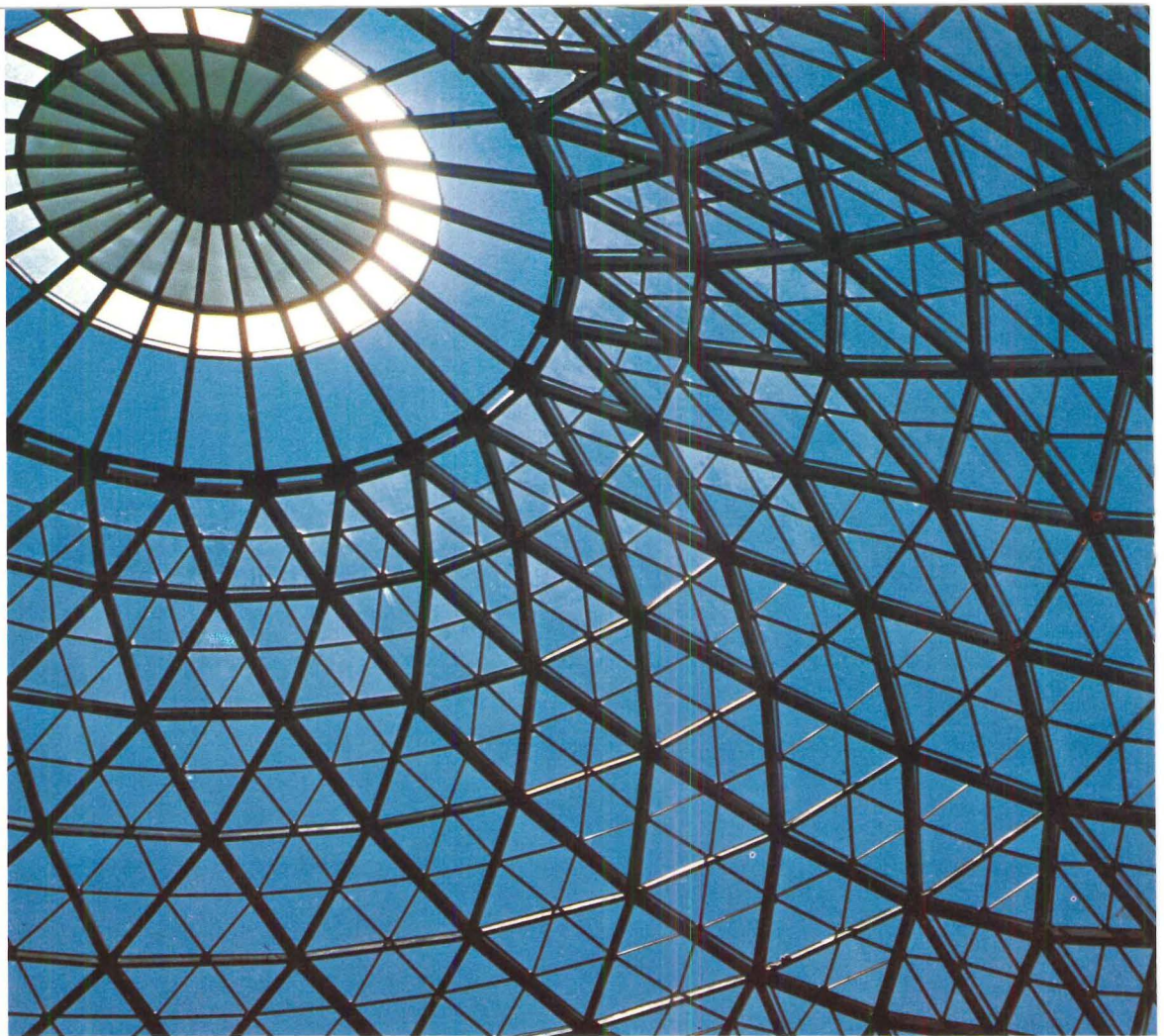

Glass, metal and concrete unite in a geometric masterpiece of skylight construction. Again glass demonstrates its ability to contribute dramatic impact while achieving functionality.

Free Catalog.  
Send for your copy today.

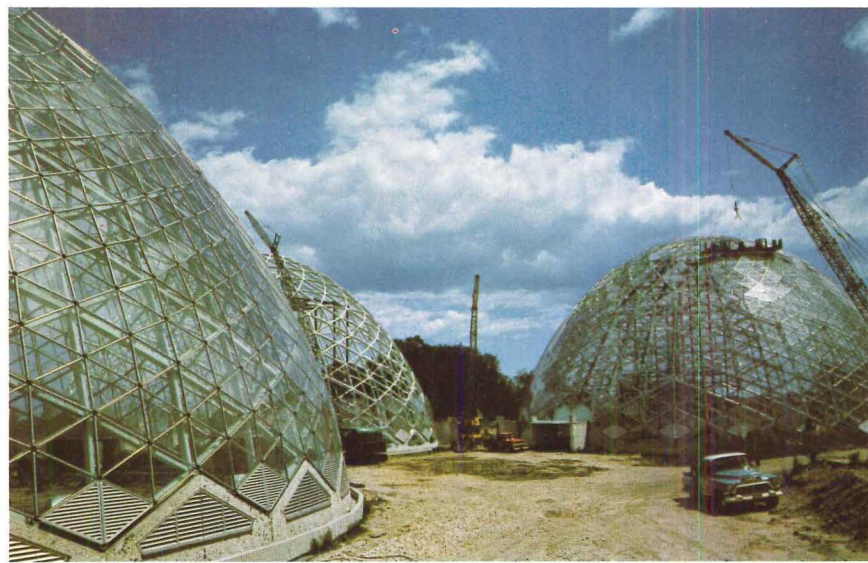

3 Dome skylights glazed with 9,438 precision-cut triangular lights of Polished Misco present an arresting geometric pattern in Mitchell Park Horticultural Conservatory, Milwaukee County Park Commission. Donald L. Grieb & Assoc., Architects; Ammann & Whitney, Structural Engineers; complete manufacture and contract for erection and glazing by Super Sky Products Co., Thiensville, Wis.; 1/4" Polished Misco supplied by Patek Glass Co., Milwaukee.

# MISSISSIPPI GLASS COMPANY



88 Angelica Street • St. Louis 7, Missouri

Distributors in Principal Cities of the United States and Canada

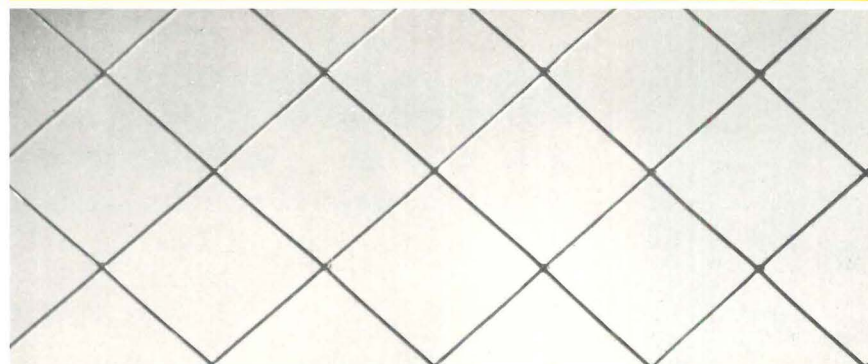

The trade name MISCO is Mississippi's designation for its diamond-shaped, welded wire netting.

To accent your  
creative  
design...

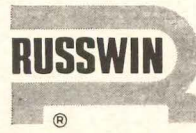

*...the doorware  
that lives up to your reputation*

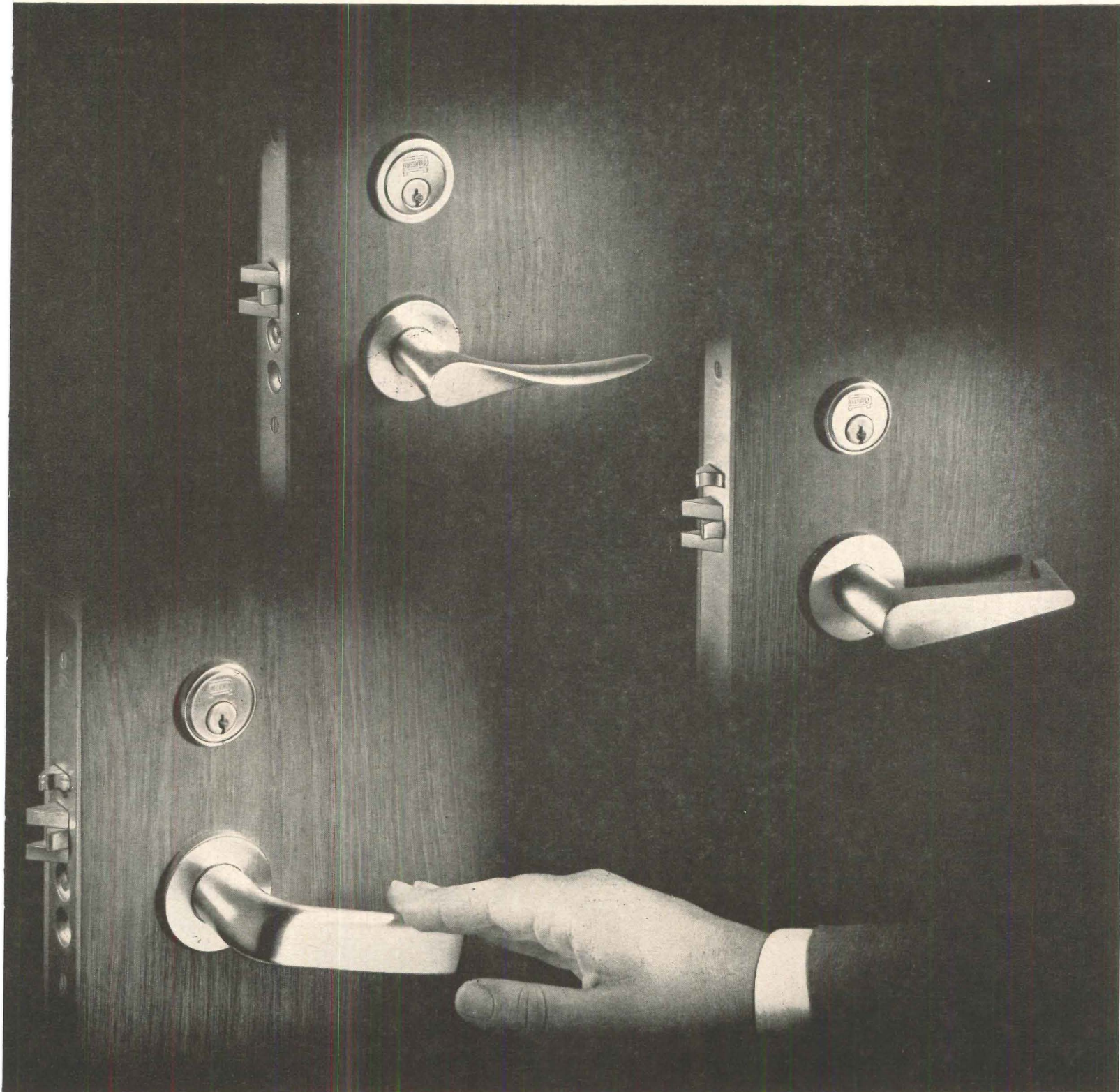

**New designs in doorware!** Three striking new lever handles bring Continental flair to Russwin Ten-Strike Mortise Locks. From left: Citation, Royale, Tornay. Unique sag-proof construction. See your Russwin distributor.

For more data, circle 30 on Inquiry Card



Steel's Symbol of strength, long life, and economy.

## STEEL DESIGN SOLVES PROBLEM FOR MEMPHIS APARTMENTS

Owners planning a new 5-story apartment in Memphis were faced with the problem of utilizing a limited building site to the best advantage. Their solution?

They designed with steel to save space and provide a light modern appearance, a requirement for today's luxury dwellings.

Ellers & Reaves, Structural Engineers, recommended this approach to Jay Realty Company of Memphis for their interesting new Park Terrace Apartments and won enthusiastic approval from the owners.

The all-welded steel frame is supported on two rows of first floor reinforced concrete columns spaced 42 ft. on center. Floor girders span the columns and cantilever 11'-6" on each side to provide balconies for each apartment and shelter for off-street parking.

Economy in floor construction was accomplished by welding Junior Beams as continuous members to the top of girders. Bay lengths varied from 12'-6" to 16'-6" and since 8" Junior Beams were used on the longer spans, it was necessary to notch their ends 2" to bring the top flange to the same height as the 6" Junior Beams. Metal deck was welded to the Junior Beams to support the 2 1/2" concrete floor slab. The 6" space between the deck and the girders provided room for mechanical lines along the entire length of building.

For more complete information on Jones & Laughlin Junior Beams and Junior Channels, see our catalog in Sweet's File or call our local sales office.

**Jones & Laughlin Steel Corporation**

3 Gateway Center, Pittsburgh 30, Pennsylvania

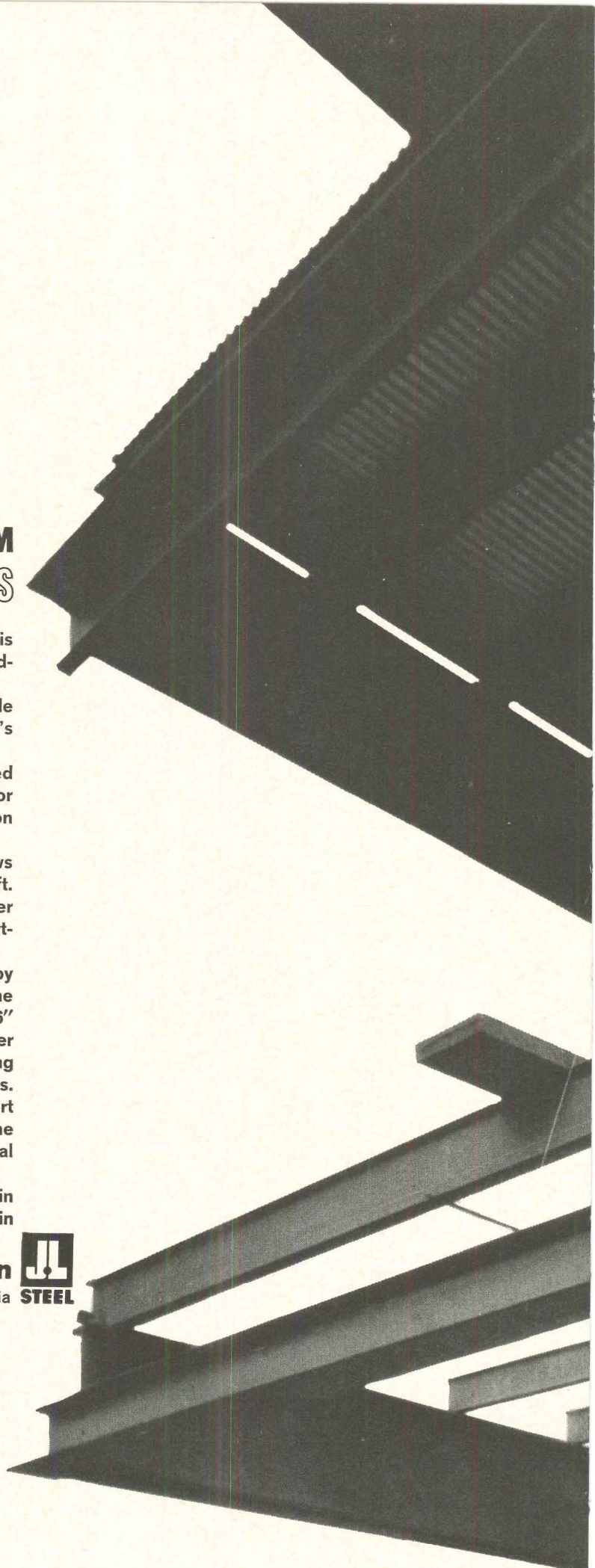





(After 10 years of this)

**Terrazzo costs 58¢ less per square foot than vinyl... 20¢ less than asphalt tile**

COMPARISON OF TOTAL COST OF TERRAZZO AND ASPHALT TILE FLOORS OVER 10-YEAR PERIOD			
ASPHALT TILE FLOOR*		TERRAZZO FLOOR	
Total installation cost per sq. ft. for 10 years (average original installation cost of \$.31 per sq. ft.; must be replaced every 5 years)	.62	Total installation cost per sq. ft. for 10 years (average original installation cost of \$1.40. Replacement not required)	1.40
Total cleaning cost per sq. ft. for 10 years (total daily cleaning cost per sq. ft. of \$.000466 x 365 days x 10 years. Includes daily cost per sq. ft. of \$.000366 for labor, \$.000100 for supplies)	1.70	Total cleaning cost per sq. ft. for 10 years (total daily cleaning cost per sq. ft. of \$.000399 x 365 days x 10 years. Includes daily cost of \$.000366 for labor, \$.000033 for supplies)	1.46
Cost per sq. ft. of stripping, waxing, buffing of floor every 90 days for 10 years (cost per sq. ft. of \$.02 x 4 times yearly x 10 years)	.80	Cost per sq. ft. of stripping floor 3 times in 10 years	.06
Total cost per sq. ft. including installation and maintenance over 10-year period	3.12	Total cost per sq. ft. including installation and maintenance over 10-year period	2.92

No, not hopeful thinking! These figures are the result of a study carried out by a Chicago-area chain of self-service stores: Sun Self-Serv Stores, a division of General Stores Corporation. After a hard-headed look at *total* cost—the only cost that really counts—installation and maintenance proved again that Terrazzo is not only the most beautiful floor but the most economical floor. The study revealed savings of 20¢ per sq. ft. with Terrazzo: asphalt tile costs 6.8% more, vinyl 19.8% more, over a ten-year period. Look at the chart, compare costs, and remember—later years will show an even greater saving.

\*Vinyl tile used in some Sun Self-Serv Stores has a total cost over a 10-year period of 38¢ per square foot more than asphalt tile and 58¢ per square foot more than Terrazzo. Free AIA kit upon request. Field representatives available for consultation. Catalogued in Sweet's. Member, The Producers' Council, Inc.

**NATIONAL TERRAZZO & MOSAIC ASSOCIATION**

Suite 503-G, 2000 K Street, N. W., Washington 6, D. C.

*"Use Members of NTMA for Quality Terrazzo"*

For more data, circle 31 on Inquiry Card

36 YEARS LATER, AND AGAIN  
NEW YORK LIFE INSURANCE CO.  
SELECTS **GENERAL BRONZE**

... for its new  
home office building

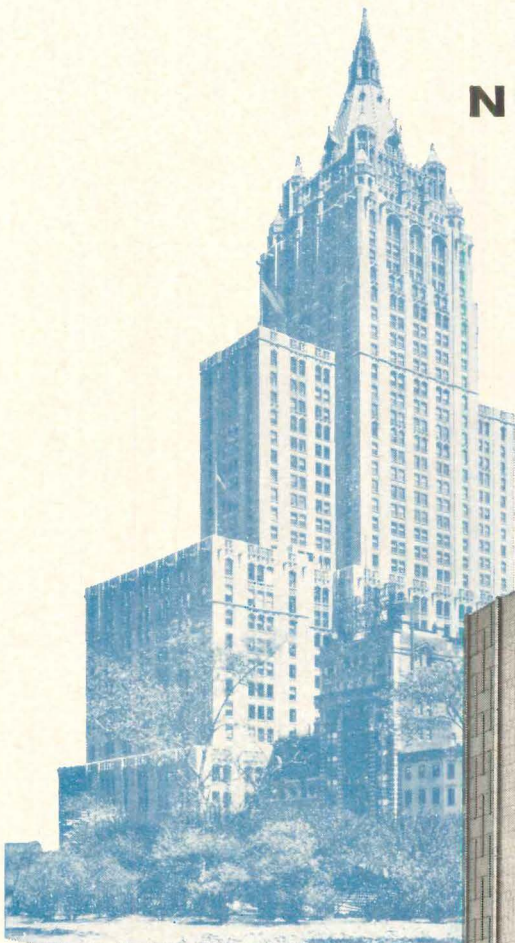

1926  
New York Life Insurance Co.  
Home Office, New York, N. Y.  
Architect: Cass Gilbert

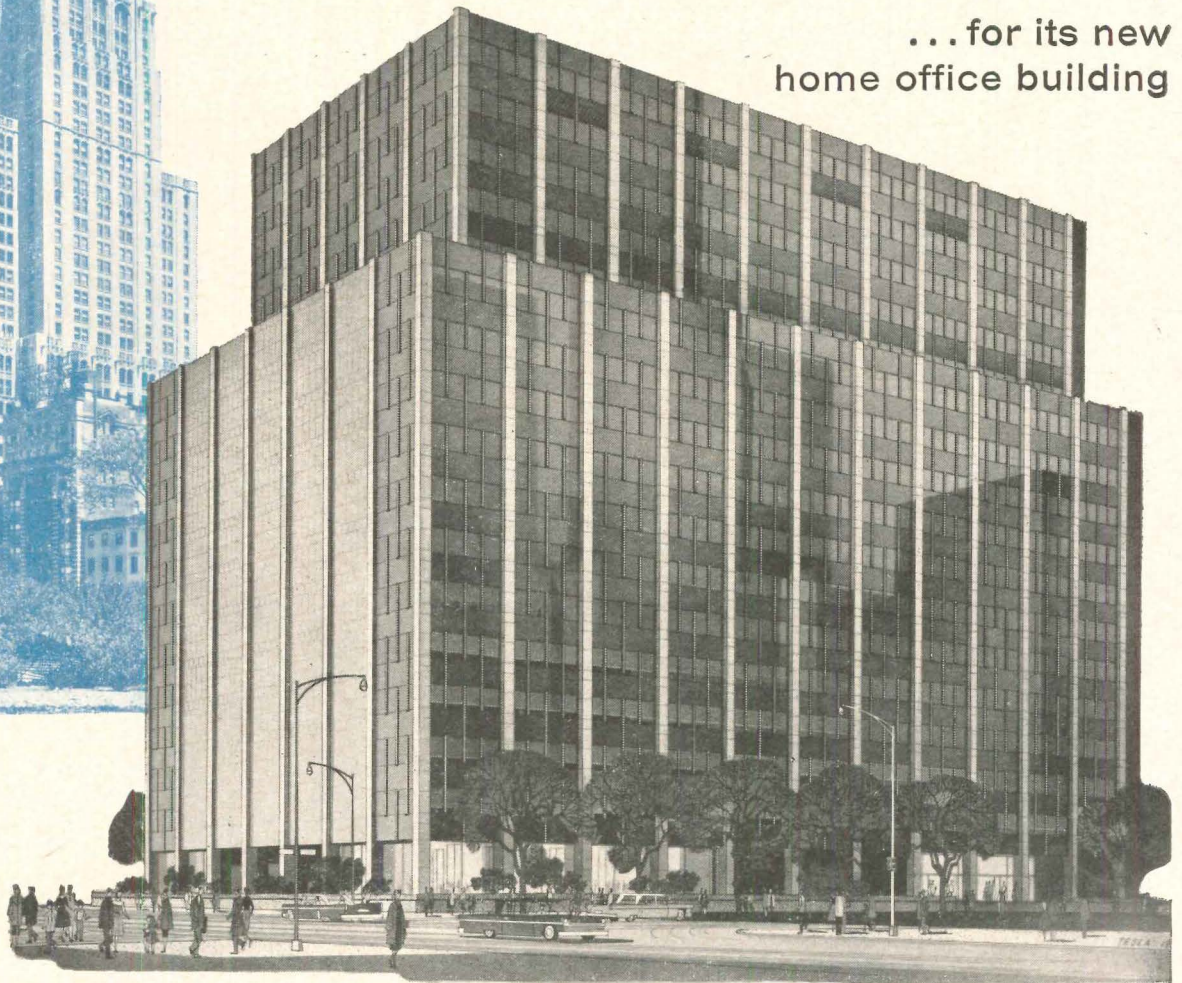

1962  
New Office Building, New York, N. Y.  
Architects: Carson & Lundin  
Contractor: Turner Construction Co.

There's no better endorsement of a product or service than to have it repeatedly specified by satisfied architects and owners.

In 1926, the renowned architect, Cass Gilbert, designed a new Home Office Building for the New York Life Insurance Co. and specified Permatite windows "by General Bronze." Now, 36 years later, the New York Life plans a new, modern curtain wall building to house its ever expanding operations and, once again, "General Bronze" has been specified. This time by the architects, Carson & Lundin.

Reflecting the modern trend in architectural design, the new building will feature a glass and aluminum grid curtain wall system set in 21 ft. bays between full height stone piers. Horizontal mullions of dark gray anodized finish give emphasis to the staggered vertical mullions which are finished in natural color anodized aluminum. All details were designed to permit setting the glass in pre-moulded channels with pressure glazing stops. Aluminum track guides for window cleaning equipment are designed into the jambs.

As the country's foremost producer of curtain walls, windows and architectural metalwork in either aluminum, bronze or stainless steel, General Bronze is anxious and ready to serve you, too. Call us in on your next job. Our Catalogs are filed in Sweet's.

**GENERAL BRONZE**  
CORPORATION · GARDEN CITY, N. Y.  
SALES OFFICE: 100 PARK AVE., NEW YORK 17, N. Y.

PERMATITE DIVISION—Windows, Curtain Walls, Architectural Metal Work.  
ALWINTITE DIVISION—Stock-size Aluminum Windows and Doors.  
BRACH MFG. CO. DIVISION—Radio, Television and Electronic Equipment.  
STEEL WELDMENTS, INC. DIVISION—Custom fabrication in Steel and Iron.



For more data, circle 32 on Inquiry Card

# another new school chooses *Modine*

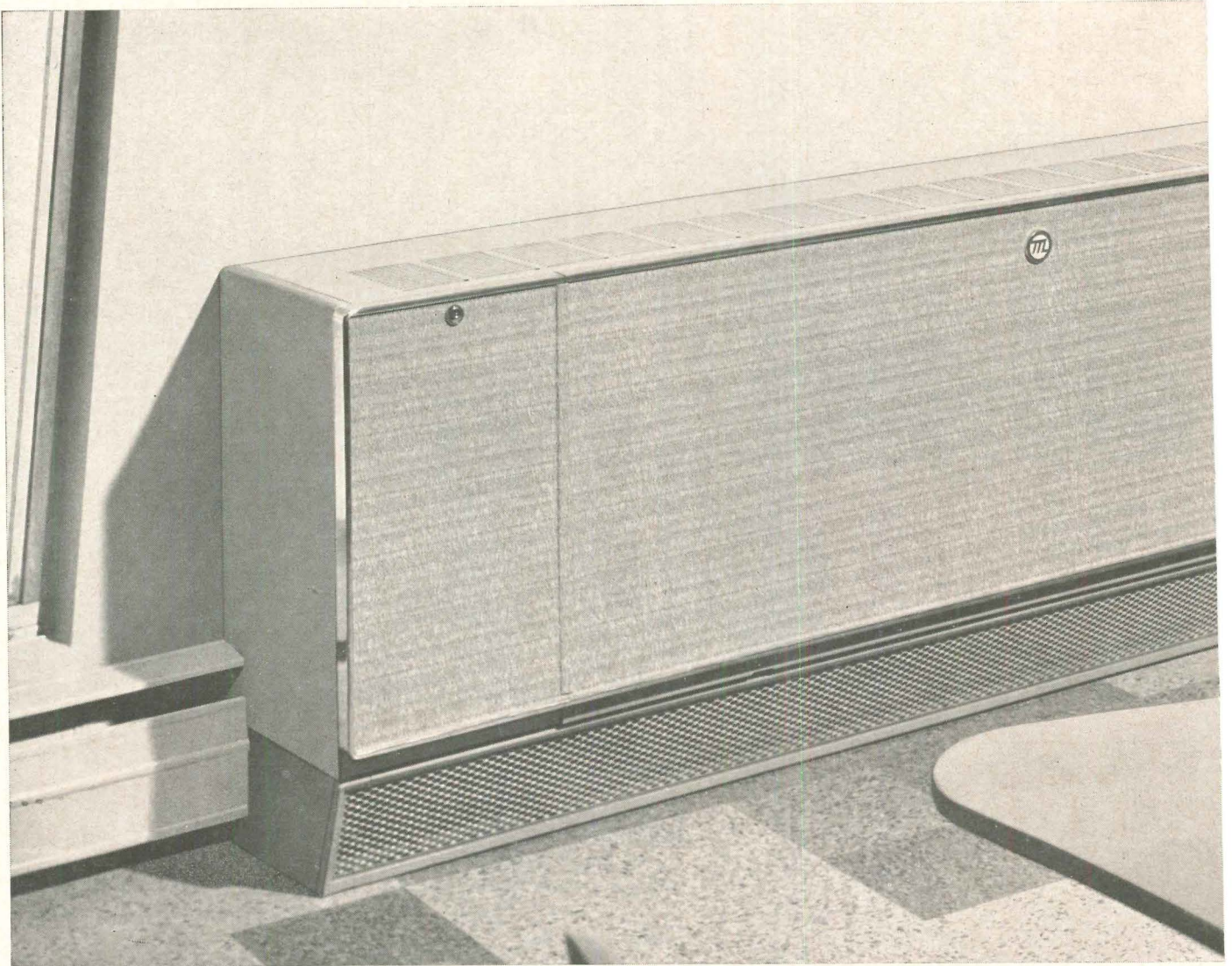

## school-vent's roll call is growing fast!

- St. Monica's School, Indianapolis, Ind.
- Carver County School, Mayer, Minn.
- Mt. Pleasant School, Racine, Wis.
- St. Stephans's School, Monona, Wis.
- Janes School, Racine, Wis.
- Riverside-Brookfield High School, Riverside, Ill.
- Erlanger School, Erlanger, Ky.
- Rolling Meadows School, Rolling Meadows, Ill.
- Carthage College, Kenosha, Wis.
- A. O. Marshall School, Joliet, Ill.
- Triton Central High School, Shelby County, Ind.
- Goodland School, Racine, Wis.
- Ringwood Elementary, Ringwood, Ill.
- Anderson College, Anderson, Ind.
- Marquette Jr. High School, Madison, Wis.
- Waterloo Township School, Indianapolis, Ind.
- Beth Israel School, Milwaukee, Wis.

- Middletown High School, Middletown, Ind.
- Harlem Jr. High School, Rockford, Ill.
- No. Shore County Bay School, Skokie, Ill.
- Plum Grove School, Palatine, Ill.
- Pachelle High School, Columbus, Ga.
- Marion College, Fond du Lac, Wis.
- New Cass Township School, Dugger, Ind.
- Geo. C. Marshall School, Vancouver, Wash.
- Grand Rapids School, Grand Rapids, Minn.
- Lake Shore Elementary, Vancouver, Wash.
- Glendale Jr. High School, Salt Lake City, Utah
- Lakeview Elementary, Lakeside, Cal.
- Washington Township School, Westwood, N.J.
- San Jacinto College, Houston, Texas
- Brooklyn School, Portland, Ore.
- Olivet Community School, Olivet, Mich.
- Hamilton School, Salt Lake City, Utah

- W. Lamar High School, Houston, Texas
- East High School, Bremerton, Wash.
- Cross Lutheran School, Pigeon, Mich.
- Arcadia Elementary School, Olympia Fields, Ill.
- Washington Elementary School, Westfield, Ind.
- Florence State College, Florence, Ala.
- North High School, Vancouver, Wash.
- Mitchell Jr.-Sr. High School, Mitchell, Ind.
- Negro School for the Blind, Jackson, Miss.
- Mirror Lake School, Federal Way, Wash.
- Horace Mann Jr. High School, Salt Lake City, Utah
- Horlick High School, Racine, Wis.
- Dewey Intermediate School, Bremerton, Wash.
- Thelma Buffey School, Flint, Mich.
- Mississippi Delta Jr. College, Moorehead, Miss.
- Lewis & Clark College, Portland, Ore.
- Bly Elementary School, Bly, Ore.



# school-vent<sup>®</sup>

UNIT VENTILATOR for heating, cooling and ventilating

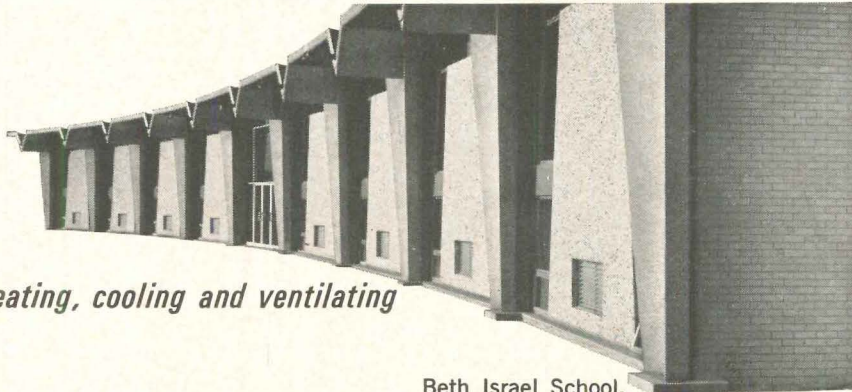

Beth Israel School,  
Milwaukee, Wisconsin

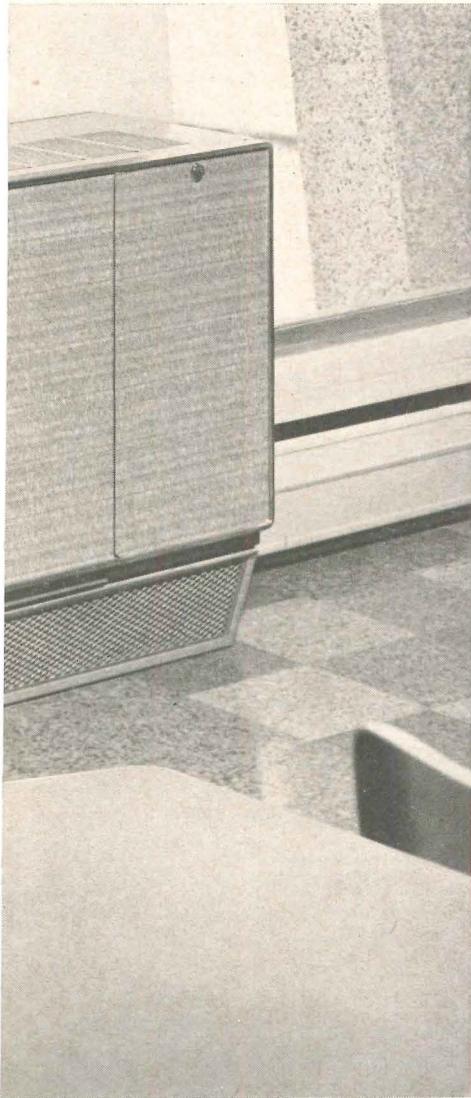

Modern schools coast-to-coast are choosing Modine SCHOOL-VENT unit ventilators. And for good reason! These units are the result of more than five years of research, engineering and testing . . . are *specifically designed* to meet specifications of architects, engineers and school officials.

SCHOOL-VENT units have a unique *air-control* system that automatically adjusts to temperature and fresh air requirements. An ideal "educational climate" is *quietly* maintained . . . summer, winter, spring and fall. Operation is economical. So is maintenance, thanks to such user benefits as pushbutton lubrication and slide-out filters.

Important too, of course, is SCHOOL-VENT's modern, attractive styling . . . together with design simplicity and installation flexibility. Units are thinner and lower than most other equipment of this type . . . 13" x 28" compared to the normal 18" x 32".

Seven handsome colors to choose from! And SCHOOL-VENT beauty is virtually student-proof. Heavily-reinforced, welded-steel cabinets defy abuse. Front panels have scuff-resistant vinyl inserts.

Modine SCHOOL-VENT unit ventilators heat with steam or hot water . . . cool with central-source chilled water. Five sizes: 500 to 1500 cfm. Bulletin 1261 has full data. Mail the coupon today!

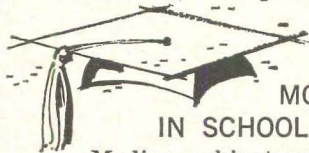

## MODINE HAS EARNED "HIGHEST GRADES" IN SCHOOL COMFORT FOR MORE THAN 30 YEARS!

Modine cabinet unit heaters, convectors and conventional unit heaters have served schools—large and small—for more than three decades. Thousands of schools throughout the country are currently enjoying the economical comfort provided by these units.

- Endicott College, Beverly Farms, Mass.
- Rehabilitation Center Ellis School, Ellisville, Miss.
- Frank White Elementary School, Park Rapids, Minn.
- Wauseon Elementary School, Wauseon, Ohio
- Union High School District #2, Franklin, Wis.
- Hebrew Teachers College, Brookline, Mass.
- Maplewood Academy, Hutchinson, Minn.
- Glens Valley Elementary School, Marion County, Ind.
- Kempton Elementary School, Saginaw, Mich.
- Vose Elementary School, Beaverton, Ore.
- East Gate School, Ft. Rucker, Ala.
- Happy Camp School, Happy Camp, Cal.
- Perry Elementary School, Southport, Ind.
- Johnson Elementary School, London, Ky.
- Camp Ground Elementary School, London, Ky.
- Oscoda Elementary School, Oscoda, Mich.
- Walterville Grade School, Walterville, Ore.



V-1470



### MODINE MANUFACTURING COMPANY 1510 DeKoven Avenue, Racine, Wisconsin

Please send SCHOOL-VENT Bulletin 1261 ; also data on Modine's other school comfort equipment .

Name .....

Address .....

City ..... State .....

In Canada: Sarco Canada, Ltd., Toronto 8, Ontario

For more data, circle 33 on Inquiry Card

Directs  
protects  
instructs  
stimulates  
entertains.  
New Bogen  
School  
Console

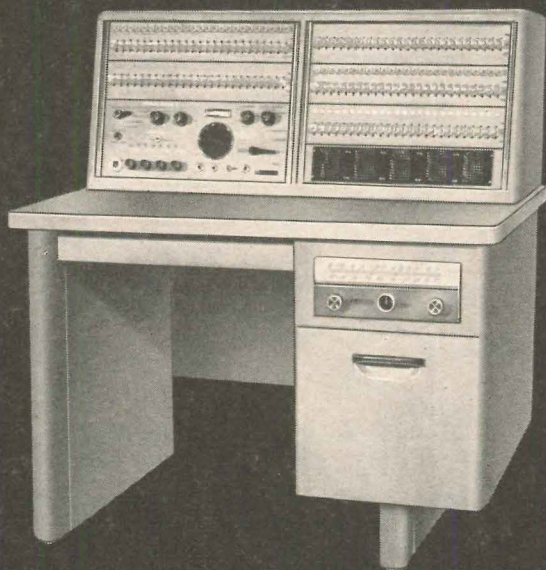

This is the most versatile aid to education since the blackboard. Playground activities, fire drills, announcements, music, current events . . . these are just some of the sound sources you can distribute through BOGEN's new School Console. From a central location, channel programs to any or all classrooms, gym, cafeteria, library or study hall. Handsomely styled and precision crafted, the BOGEN School Console includes powerful amplifier, high fidelity AM/FM tuner, superb 4-speed record player, intercom/auxiliary channel, selection and control unit for programming or communications, one or more switchbanks for room speaker selection, and exclusive BOGEN "Expand-As-You-Grow" engineering features. The new School Console from BOGEN—for 30 years the world's leading designer/producer of quality sound products.

**BOGEN**  LEAR SIEGLER, INC.  
COMMUNICATIONS DIVISION  
DESK RD., PARAMUS, N. J.

For more data, circle 34 on Inquiry Card

## Required Reading

*continued from page 45*

letters used as well as to the legibility of the message to be conveyed."

More practical than other recent books on architectural lettering which are limited to design considerations only, this book includes a technical section on fabrication, illumination and execution; and for architects who may try to design their own signs (not recommended), there are several pages of type specimens which the authors consider suitable, with modification, for architectural lettering.

—Mildred F. Schmertz

## Germany: Crisis and Boom

CONTEMPORARY ARCHITECTURE IN GERMANY. *Introduction by Ulrich Conrads. Frederick A. Praeger, Publisher, 64 University Place, New York 3. 231 pp., illus. \$16.50.*

In his rather gloomy introduction to the architecture of Germany during the past five years, Mr. Conrads draws a picture of architecture beset by critical housing shortage on one hand, and a boom mentality on the other. The first, he says, has placed so many financial and government restrictions upon design, in an effort to house Germans in a hurry, that it has not produced much in the way of good design. The second, he goes on, has produced an architectural clientele which prefers self-assertive, even flashy, buildings which will, it hopes, express a confidence not wholly felt by the people.

The illustrations do not entirely bear out so dreary a picture. The architecture is firmly rooted in the international tradition, and by the standards of other Western countries seems conservative. At the same time, it is—as nearly as one can judge from photographs—meticulously executed. And in at least two fields—music auditoriums and churches—there appears to be enough money and public approval for a less constricted design.

A great many buildings are illustrated, briefly but adequately, with four or five photographs each, plans, site plans and descriptions in both German and English.



ARCHITECTS: Skidmore, Owings & Merrill  
 GENERAL CONTRACTOR: Cahill Brothers  
 SEALANT APPLICATOR: D. Zelinsky and Sons

## "not a single leak!"

San Francisco's new John Hancock Building utilizes black granite panels and solid bronze fenestration in its outstanding design. All joints are sealed and windows glazed inside and out with PRC Rubber Calk. Sealing was completed in December 1959, just before the heavy winter wind and rain storms. For the first time in his 30 years' experience, said the construction superintendent, "not a single leak" developed. Today, after over 2 years' exposure, it remains *weather tight*.

PRC Rubber Calk cures at normal temperatures to a flexible, firm rubber, retains its tight bond and elasticity for years in any climate. Thirty-two colors are available, to blend with all building materials.



### PRODUCTS RESEARCH COMPANY

CORPORATE OFFICES AND WESTERN  
 MANUFACTURING DIVISION  
 2919 Empire Ave., Burbank, Calif. • Victoria 9-3992  
 EASTERN SALES AND MANUFACTURING DIVISION  
 410 Jersey Ave., Gloucester City, N.J. • GLenview 6-5700

**PRODUCTS RESEARCH COMPANY,**  
 2919 Empire Ave., Burbank, Calif.  
 Dept. AR-1262

Please send me complete information regarding  
 PRC Rubber Calk.

NAME \_\_\_\_\_

TITLE \_\_\_\_\_

FIRM NAME \_\_\_\_\_

ADDRESS \_\_\_\_\_

CITY \_\_\_\_\_ ZONE \_\_\_\_\_ STATE \_\_\_\_\_

DEALER INQUIRIES INVITED

For more data, circle 35 on Inquiry Card

# Architect makes decorative use of Revere Copper in functional roof design

*Unique roof drainage system accomplished with copper-covered gutters; stepped-down roof faced with copper combination fascia and gravel stop.*

The Pasadena Community Church is a striking example of how an edifice can be functional as well as architecturally attractive.

In creating this design, the architect had to consider: 1—Seating 2,200 people on one floor without benefit of balconies, and at the same time maintaining good acoustics. 2—Protecting the glass window wall. 3—Carrying away the run-off from the roof. 4—Breaking up the roof line so that it could be more readily installed, and without making a single, large plane area that would be monotonous in appearance.

The roof construction shown makes the inside of the structure almost perfect, acoustically. Bringing the roof out to an 18' overhang shields the tremendous expanse of glass. The step-down or shingle effect was brought about by the use of Revere Copper face flashing. This enabled the contractor to work on

the roof in sections and also gave a "truer" roof, breaking up the roof silhouette against the sky into an interesting pattern.

The problem of roof run-off was handled by continuing the fascia border design, in the form of copper-covered gutters running into a pool, in which semi-tropical plants are arranged. How this was accomplished is shown in the various photos on the opposite page.

"Design with copper in mind" is no idle catch-phrase. The daring architects of today are doing just that . . . more and more, and, as you can see, with most striking effects. You'll find copper doubly effective when you wish to combine utility with beauty.

The manner in which copper is applied in this structure is typical of its easy workability, its practically unlimited possibilities in design. This "Metal of the Centuries" is as modern in its construction possibilities as today's newest materials.

Revere's Technical Advisory Service will be glad to help you in creating the unusual with copper and its alloys. Get in touch with the Revere Office nearest you today.

*Pasadena Community Church, St. Petersburg, Fla.*

*Architect: HARVARD+JOLLY, St. Petersburg, Fla.*

*General Cont.: DE WITT, FURNELL & SPICER, INC., St. Petersburg, Fla.*

*Roofing & Sheet Metal Cont.: GIFFEN INDUSTRIES, Miami, Fla.*

*Revere Distributor: HORNE-WILSON, INC., Miami, Fla.*

SEND TODAY for free copy of "Copper and Common Sense," Revere's 140-Page Brochure illustrating the design principals and techniques of sheet copper construction. Also free companion piece, "The Revere System of Copper Flashing," for the complete weatherproofing of masonry buildings. Address Dept. "P-8" at address below.

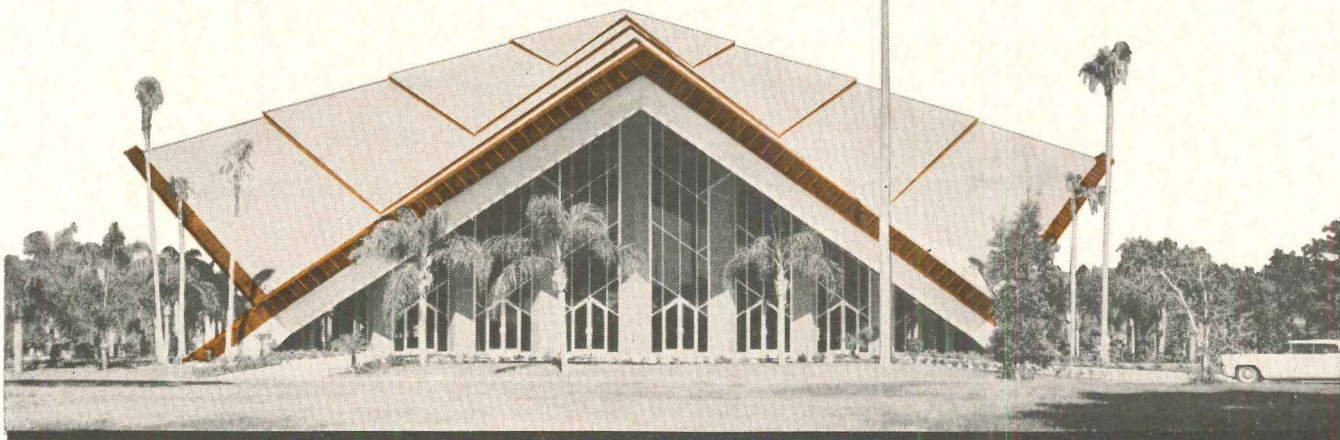

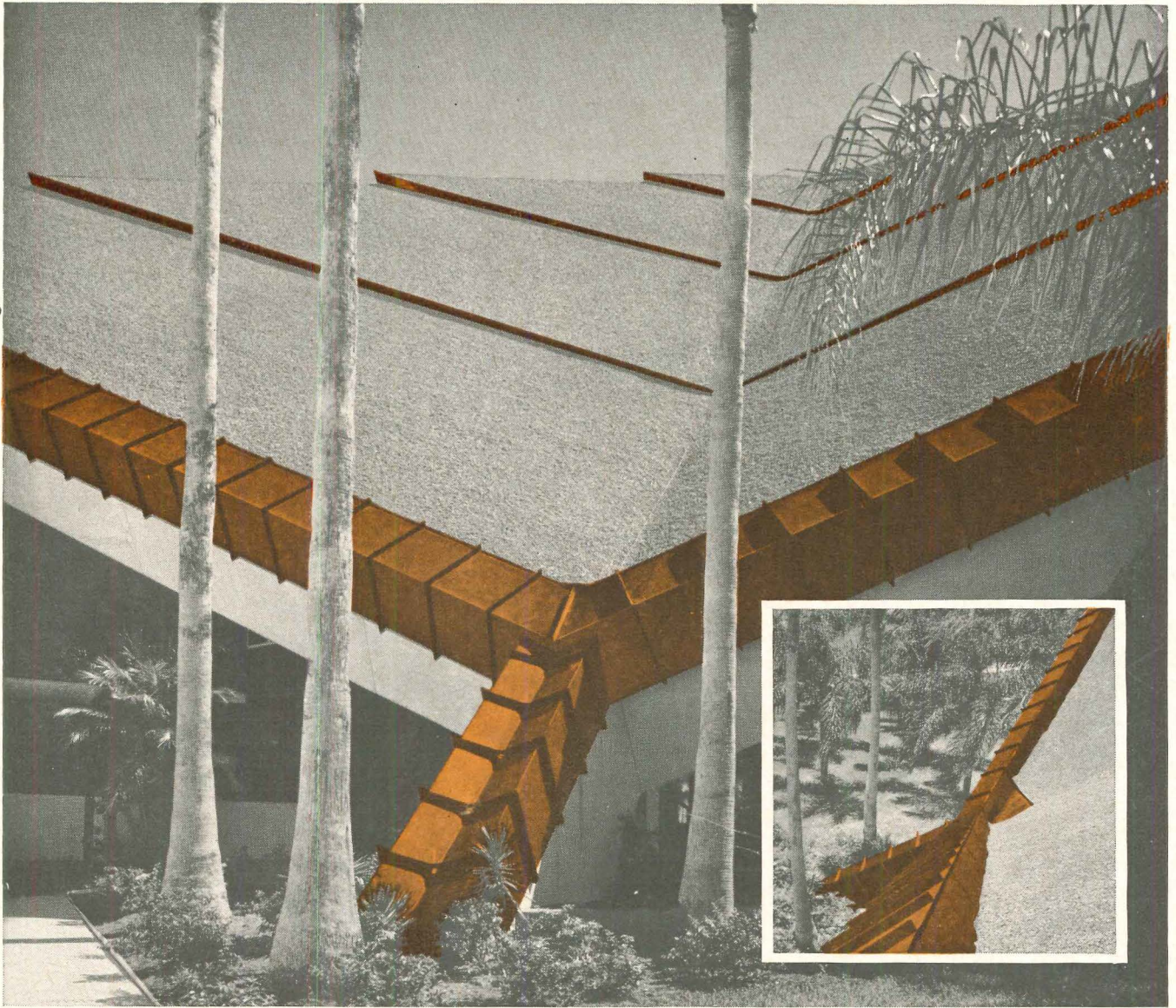

ONE OF THE copper-covered gutters which take care of roof run-off and direct the water into pool (see below). This gutter is a closed trough which is also an extension of the fascia. Note holes in standing seam to take care of water. 12,000 lbs. of Revere 16 oz. Cold Rolled Copper were used on this structure.

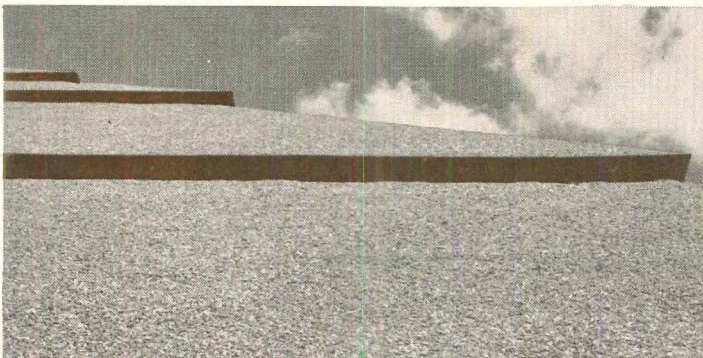

FACE FLASHING of Revere Sheet Copper also acts as gravel stop on stepped-down roof panels. This design permitted contractor to work on roof in sections.

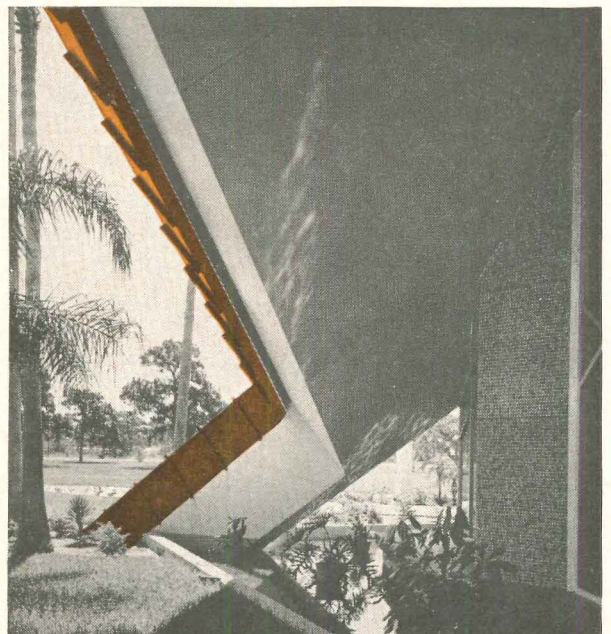

FASCIA was prefabricated in the sheet metal contractor's shop in 4' sections with a 2" standing seam.



## REVERE COPPER AND BRASS INCORPORATED

Founded by Paul Revere in 1801

Executive Offices: 230 Park Ave., New York 17, N. Y.

Mills: Rome, N.Y.; Baltimore, Md.; Chicago and Clinton, Ill.;  
Detroit, Mich.; Los Angeles, Riverside and Santa Ana, Calif.; New  
Bedford and Plymouth, Mass.; Brooklyn, N.Y.; Newport, Ark.;  
Ft. Calboun, Neb. Sales Offices in Principal Cities.

Distributors Everywhere

For more data, circle 36 on Inquiry Card



# 1 1/2"

There is no "or equal" for this 1 1/2" of protection

When you write a specification for 1 1/2" FOAMGLAS-BOARD® Roof Insulation, you are calling for the constant insulation value insured only by vaporproof cellular glass . . . and PC's FOAMGLAS is the only cellular glass insulation. **Nothing but FOAMGLAS** Roof Insulation delivers

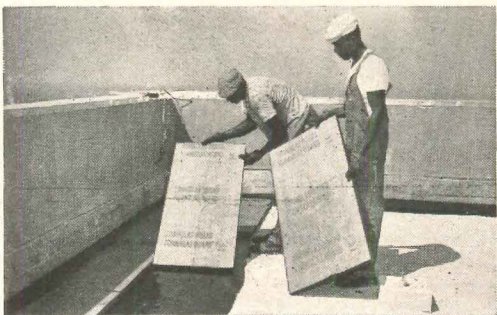

moisture-proof protection for the life of the installation. It's unaffected by water and vapor and is incombustible. Ten years later, it's as effective as the day it was installed. And new FOAMGLAS-BOARD because of its 2' x 4' size saves labor costs . . . speeds construction. Both FOAMGLAS and FOAMGLAS-BOARD may be applied on steel decks with hot asphalt for Class I construction. For a free copy of our new FOAMGLAS Building Insulation catalog, write Pittsburgh Corning Corporation, Department B-122, One Gateway Center, Pittsburgh 22, Pa.



For more data, circle 37 on Inquiry Card

now  
available  
on the  
new  
slimline  
5

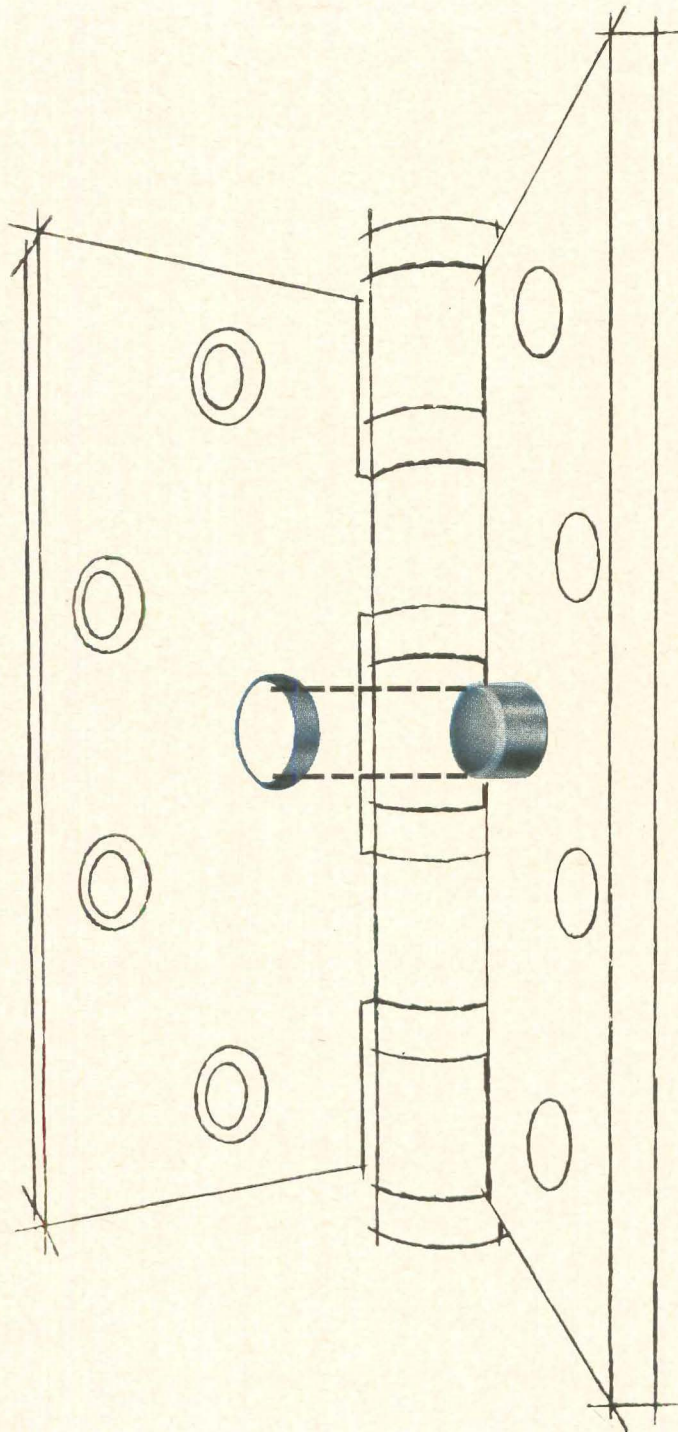

## HAGER'S SYNCRETIZED SAFETY STUD

Brings the beauty and flawless performance of the new Slimline 5 into security job specifications. Drive out the pin! Knock off the knuckles! The Hager Safety Stud stays "buried" beyond the prowler's reach . . . holds fast. The hinge leaves never part until the door is unlocked.

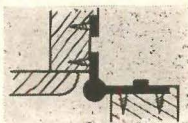

1. Door open. Stud is unnoticed.  
2. Door closed. Leaves interlock. Metal stud prevents door movement in any direction.

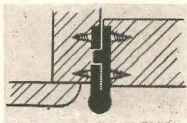

### NEW SLIMLINE 5 WITH 4 BALL BEARINGS

Five knuckles (greater strength both vertical and lateral) . . . Four ball bearings (doubles the bearing surface in either hinge position) . . . Slimline barrel dimension (design preference in today's architecture)

Write Hager, or contact your Hager representative

**C. HAGER & SONS HINGE MFG. CO.**  
ST. LOUIS 4, MISSOURI  
HAGER HINGE CANADA, LIMITED  
61 Laurel Street East • Waterloo, Ontario

Everything hinges on Hager®



For more data, circle 38 on Inquiry Card

# SPACE

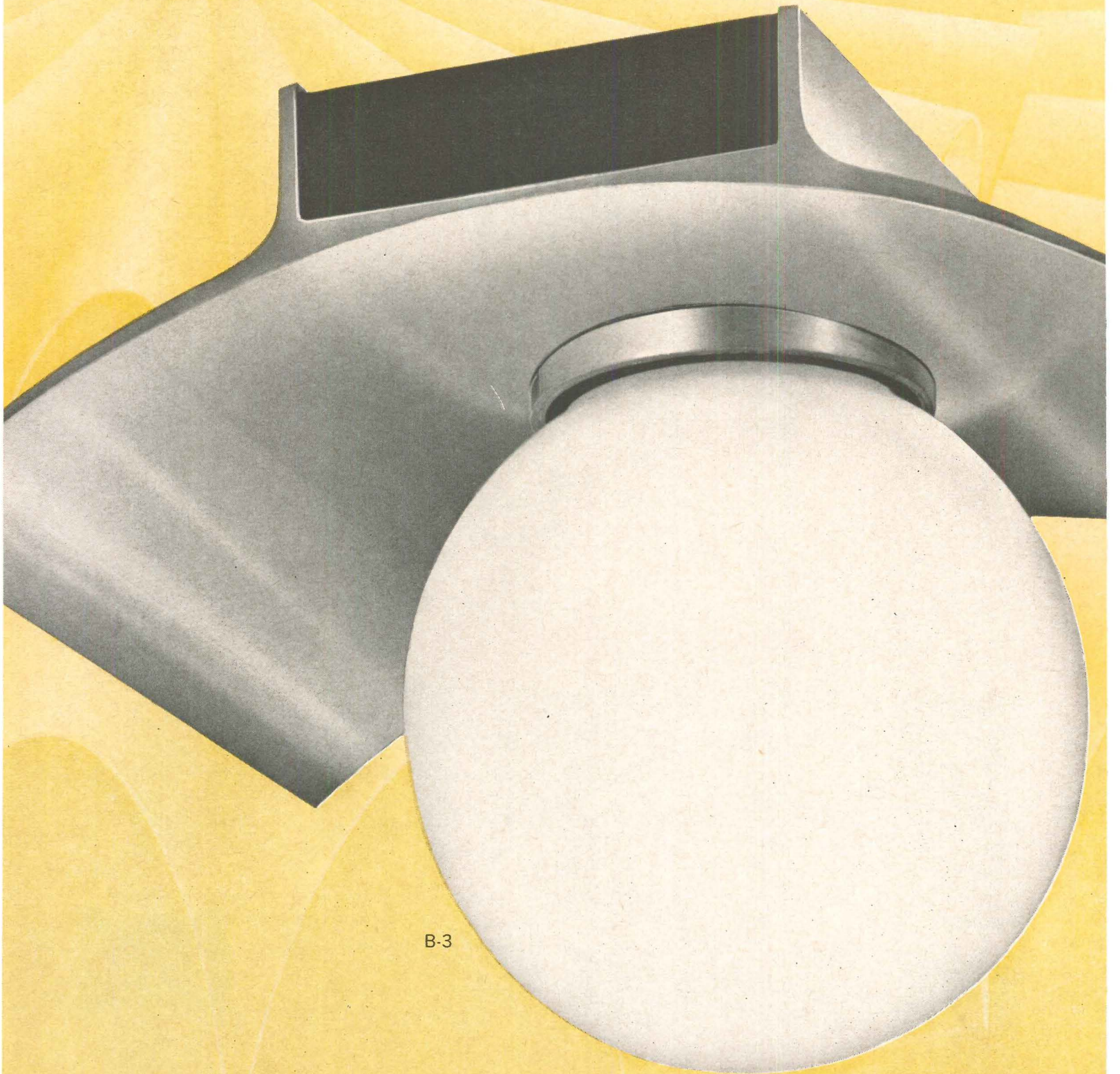

B-3



# SHAPES

from the new lighting line by  
**EMERSON-PRYNE**

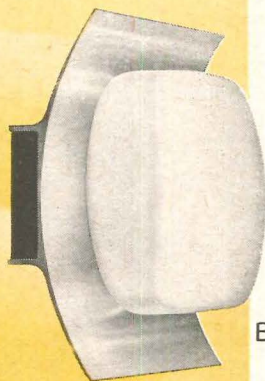

B-1

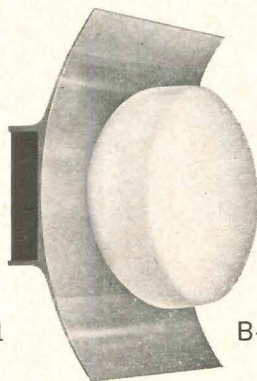

B-2

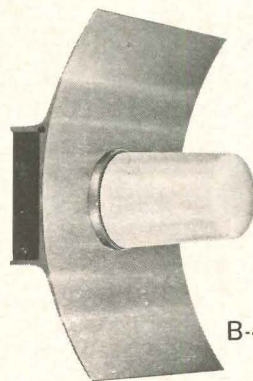

B-4

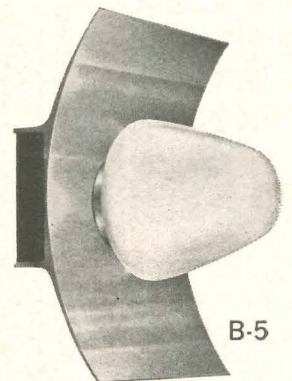

B-5

**NEW LINE!** Over 515 styles, types, fronts and finishes. Everything from recessed to pendants!

**NEW IDEAS!** Like the beautiful Space Shapes previewed here. Sculptural forms in extruded anodized aluminum. Versatile brackets for wall or ceiling (indoors or out).

**NEW CATALOG!** Complete specification data. Full-color photos. Everything organized for quick reference.

PREVIEW BROCHURE SHOWS YOU SAMPLES OF THE NEW FIXTURES IN EMERSON-PRYNE'S SPACE SHAPES LINE.

## MAIL COUPON NOW!

EMERSON ELECTRIC,  
8100 Florissant Ave.,  
St. Louis 36, Mo.

Dept. AR-12

PLEASE RUSH ...  
Emerson-Pryne "Space Shapes Preview" Brochure.

Name \_\_\_\_\_

Firm \_\_\_\_\_

Street \_\_\_\_\_

City \_\_\_\_\_ Zone \_\_\_\_\_ State \_\_\_\_\_

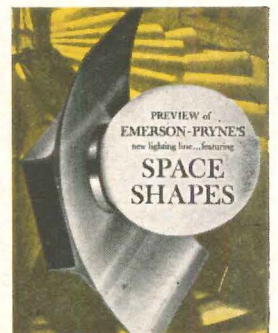

**EMERSON**  **ELECTRIC**

**BUILDER PRODUCTS DIVISION**

EMERSON ELECTRIC • EMERSON-PRYNE • EMERSON-IMPERIAL • EMERSON-RITTENHOUSE

For more data, circle 39 on Inquiry Card

## NERVI, BACON RECEIVE HONORS; OTHER AWARDS

Pier Luigi Nervi of Rome, Italy has been awarded the 1962 Alfred E. Lindau Award by the American Concrete Institute during its 15th fall convention held in late September at the Seattle Century 21 Exposition. The citation read "... in recognition of Professor Nervi's outstanding contributions as designer and master builder, exemplified by the lacework of his long-span concrete structures."

Edmund N. Bacon, executive director of the Philadelphia City Planning Commission, was awarded the Frank P. Brown Medal by the Franklin Institute, Philadelphia, in October. He was cited for "his leadership in developing organized city planning as a continuing function of urban development and particularly for his contribution to Philadelphia's redevelopment . . ."

Julian Clarence Levi, architect, F.A.I.A., New York, was one of the recipients of the 1962 Columbia Architectural Alumni Association Medal for "standard and constructiveness of tasks performed, with special consideration of their relationship to the good of the university . . . and the length and continuity of these services."

Fred N. Severud of Severud-Elstad-Krueger Associates, has been made an honorary associate member of the New York Chapter of the American Institute of Architects.

James S. Daley, Stillwater, Okla., has won the \$3,000 LeBrun Traveling Scholarship, granted biennially by the New York Chapter of the American Institute of Architects. The grant, to be used for study of architecture outside the United States, was given on the basis of a nationwide competition calling for the design of an architect's headquarters building. Runners-up in the competition were Dale R. Johnson, Newton, Mass., and Bruno Ast, Champaign, Ill.

J. Byers Hays, F.A.I.A., has received a \$500 Cleveland Arts Prize for his contributions in the field of architecture, a presentation of the Women's City Club of Cleveland.

Denis Charles Schmiedeke, instructor at the University of Detroit, has been awarded the \$5,000 Arnold W. Brunner Scholarship, an annual award by the New York Chapter of the American Institute of Architects. The scholarship will be used "to investigate and develop more efficient means of visual communication which will implement and facilitate architectural design, preparation of construction documents, and the process of construction."

# BURGLARY & MALICIOUS MISCHIEF...

## How You Can Protect Your Clients From Forced Entry

The inherent weakness of the narrow stile glass door, from the standpoint of illegal entry, has been totally overcome by the Adams Rite MS lock. Police officials and insurance companies, while unable to publicly endorse the lock, privately recommend it. Leading door manufacturers install the lock as preferred equipment.

**THE ESSENTIAL DIFFERENCE** The flexibility of the narrow stile glass door is such that it can be pried away from jamb with tire iron or crowbar enough to permit a conventional ( $\frac{1}{2}$ " to  $\frac{3}{4}$ ") bolt to slip out of its strike with no visible marks of forced entry. The Adams Rite MS lock is designed to pivot its bolt into place, securing a  $1\frac{3}{8}$ " laminated steel bar into the strike and leaving an equal amount of laminated steel within the stile, firmly locking this massive barrier in place.

**ADDITIONAL SECURITY** Thwarted in use of tire iron and crowbar, professional burglars have discovered the pipe wrench as a means of

drawing the entire cylinder from door and lock. The answer has been found in the Adams Rite *cylinder guard*, a circlet of hardened steel firmly anchored within the lock to prevent contact with lock cylinder by wrench, chisel, or sledge. This latest security measure was demonstrated at the 1962 convention of locksmiths where it resisted all efforts of an expert group to forcibly remove the cylinder.

**ACTION YOU CAN TAKE** Consult with your police and insurance officials to verify the need for protection from burglary and malicious mischief. Make certain that those in your organization who specify exterior doors and door hardware are aware of the special security requirements of narrow stile glass doors. Let us send you the complete Adams Rite *maximum security* story. Write Adams Rite Manufacturing Company, Maximum Security, 540 West Chevy Chase Drive, Glendale 4, California.

**ADAMS  RITE**

For more data, circle 40 on Inquiry Card



# ON THE MARCH!

Figurine: Grenadier, La Garde Impériale

Tile: Series 2050, Turquoise

"Soldier Course" shown is just one example of Misceramic's wide range of patterns and colors in a complete line of genuine ceramic floor and wall tile, trim, fixtures and accessories. Catalogs, suggested applications, custom design information, specification details and actual tile samples are available for your consideration now. Check the Yellow Pages for your distributor or write Misceramic directly today:



**Misceramic Tile**

CLEVELAND, MISSISSIPPI

## DOUBLE GRIPPING ACTION WITH A NEW NAILABLE STEEL STUD FOR METAL LATH

Anything that will help get a plastering job done faster and better is important to you and your client. And nothing will do *that* like Gold Bond's new, nailable, steel stud with the *double flange*. The unique second flange, *inside* the stud, grips nails or staples tightly. And they stay in place. No time lost for repairs. And you end up with a strong, integral wall that *stays* that way.

Like a free sample?

Write to National Gypsum Company,  
Dept. AR-122, Buffalo 13, New York.



Stud shown actual size.

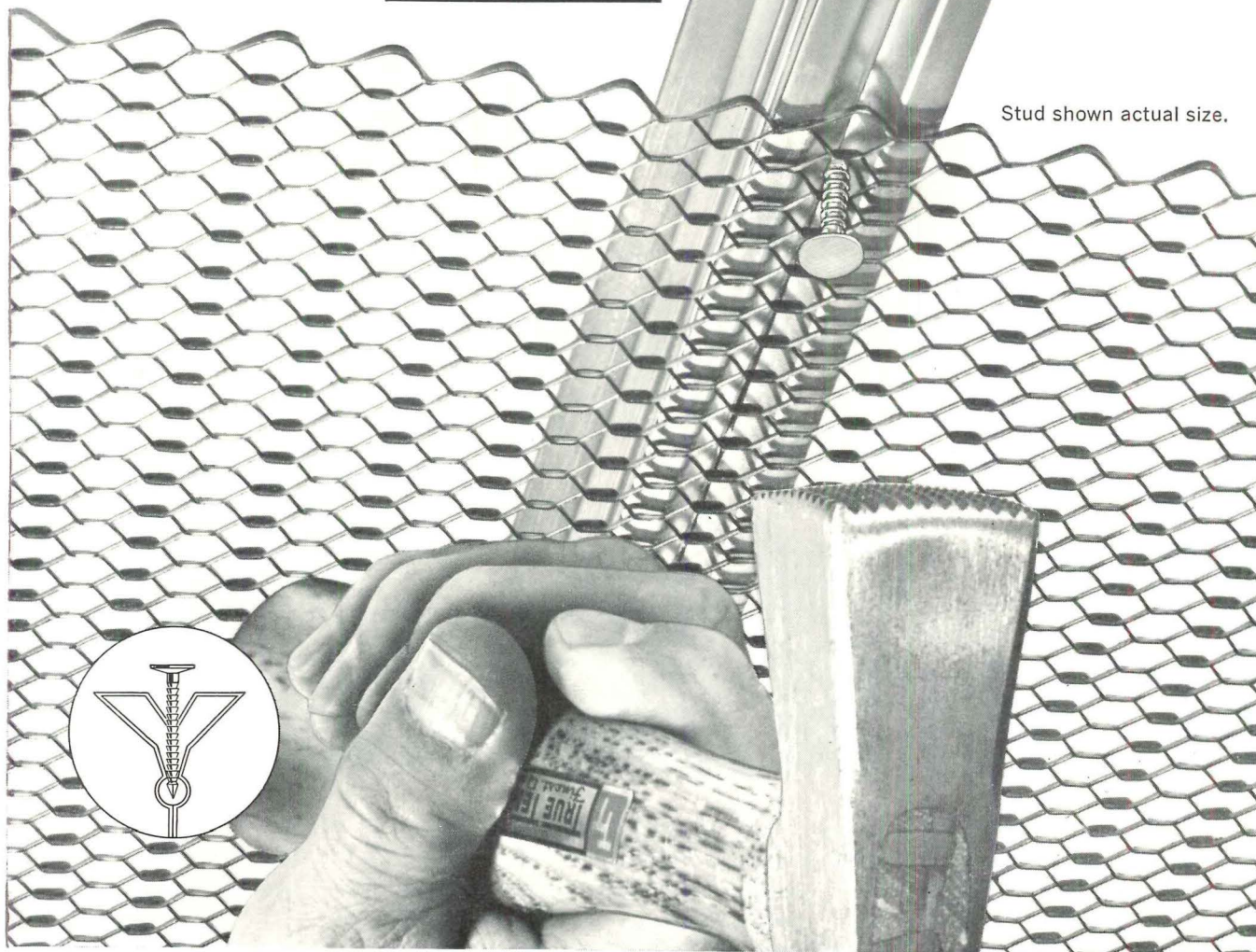

For more data, circle 42 on Inquiry Card

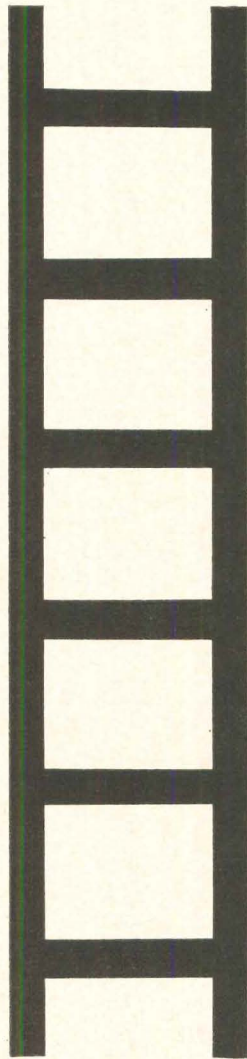

**Needed to  
check operation  
of a packaged  
water chiller**

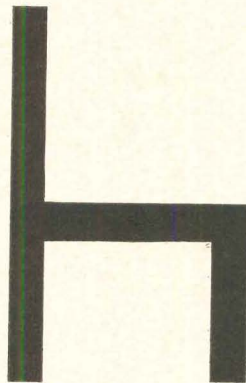

**unless it's the  
revolutionary  
new water chiller  
from Chrysler Airtemp!  
See it at the  
ASHRAE Exposition  
February 11-14  
New York Coliseum  
Booth No. 586**

**AIRTEMP DIVISION**



**CHRYSLER  
CORPORATION**

For more data, circle 43 on Inquiry Card

# Announcing Another New LCN Compact Overhead Concealed Door Closer

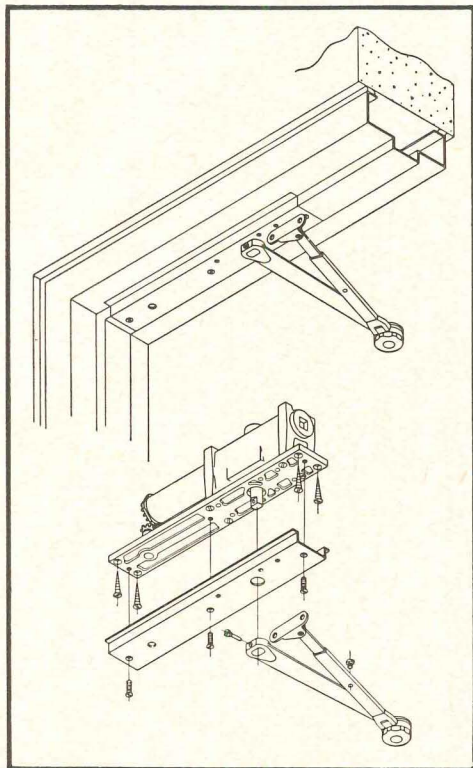

Installation of Series 5000 Closer

## Series 5000—Small in Size, High in Power

Here is a new LCN Overhead Concealed Door Closer, small in size, but powered to handle a wide range of door sizes (exterior and interior) including those subject to unusually difficult drafts and traffic conditions.

## Five Adjustments Provide Full Control

There are five means of adjusting to conditions: (1) a valve to adjust the main door swing; (2) a valve to adjust the latching speed; (3) a valve to adjust the hydraulic back-check, which cushions the swing of the door, if thrown open violently, in proportion to the force applied; (4) an ingenious spring power adjustment by means of a screw driver; (5) reversing the arm shoe position additionally adjusts the latching power.

## No Winter-Summer Adjustments Required

Closer operation is highly uniform, thanks to the stable LCN hydraulic fluid developed by research and long experience. Temperature changes have little or no effect.

## Send for Special Folder on Series 5000

For further details, door capacities, installation drawings, we invite you to write for Folder 5000, sent promptly on request.

## LCN CLOSERS, PRINCETON, ILLINOIS

A Division of Schlage Lock Company

Canada: LCN Closers of Canada, Ltd., P. O. Box 100, Port Credit, Ontario

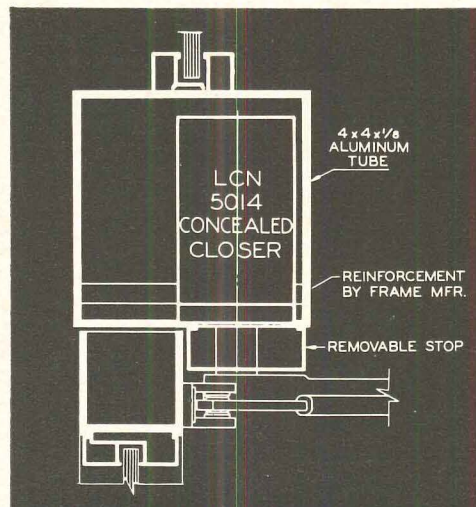
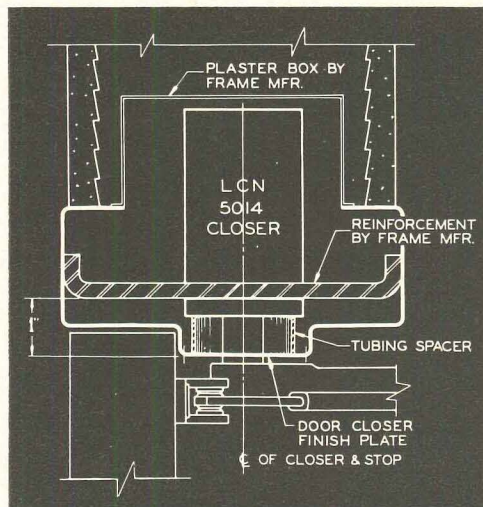

Above: Typical Head Frame Details

For more data, circle 44 on Inquiry Card

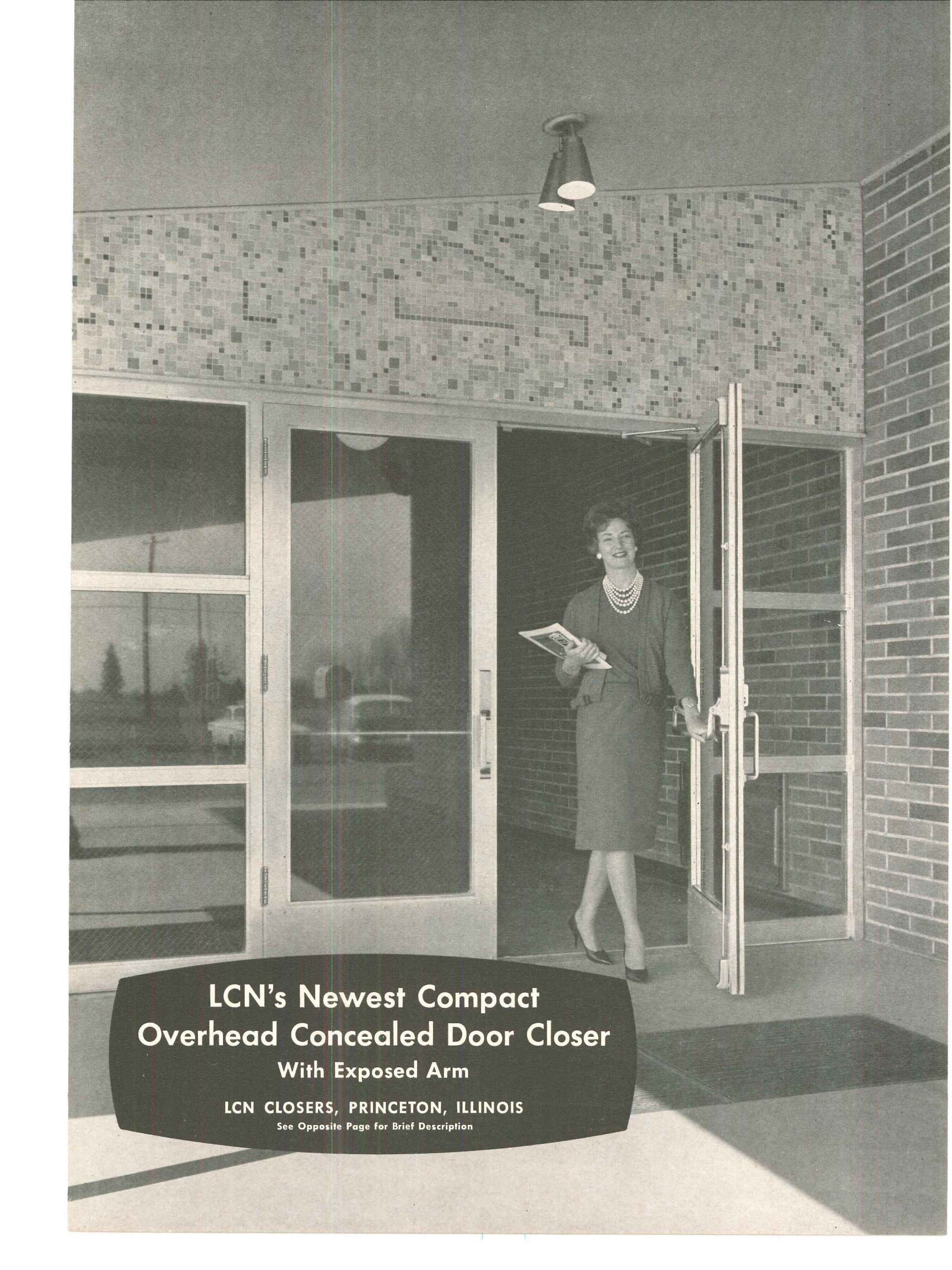

**LCN's Newest Compact  
Overhead Concealed Door Closer  
With Exposed Arm**

**LCN CLOSERS, PRINCETON, ILLINOIS**

See Opposite Page for Brief Description

## OFFICE OF THE YEAR AWARDS GIVEN TO SIX BUILDINGS

Office of the Year Awards as chosen this year by the editors of Administrative Management cited six outstanding buildings in two categories—those designed for 300 employes or more and those designed for less than 300 employes. Photographs of the top building and the two winners of the Award of Merit in each category are shown here.

### For Offices Designed for 300 Employes or More



Alexandre Georges

Office of the Year Award: Chase Manhattan Bank, New York. Architects, Skidmore, Owings & Merrill (July 1961, page 141)



Award of Merit: Georgia Power Company, Atlanta. Architects, Finch, Alexander, Barnes, Rothschild & Paschal



Award of Merit: Scott Paper Company, Philadelphia. Architect, Welton Becket  
*continued on page 78*

### WHEN YOU SPECIFY DUMBWAITERS

... the name to remember is

# Sedgwick

Sedgwick manufactures a complete line of dumbwaiter equipment for all types of service, including—schools and institutions, hospitals and hotels, restaurants and clubs, offices and banks, residences and public buildings, factories and stores.

There are nine distinct types of Sedgwick dumbwaiters, each individually engineered and designed for capacities of 5 to 500 pounds.

When you use Sedgwick engineering (based on experience since 1893)

and specify Sedgwick equipment, your clients will be assured of dumbwaiters that exactly fit the needs and will give many years of safe, dependable and trouble-free service.

Other Sedgwick Products

- ★ SIDEWALK ELEVATORS
- ★ FREIGHT WAITERS
- ★ RESIDENCE ELEVATORS
- ★ "STAIR-CHAIRS"®

Nationwide Service

## Sedgwick

**MACHINE WORKS**

142 WEST 15th STREET  
NEW YORK 11, NEW YORK

See standard specifications and layouts in SWEETS 24c/Se



For more data, circle 45 on Inquiry Card



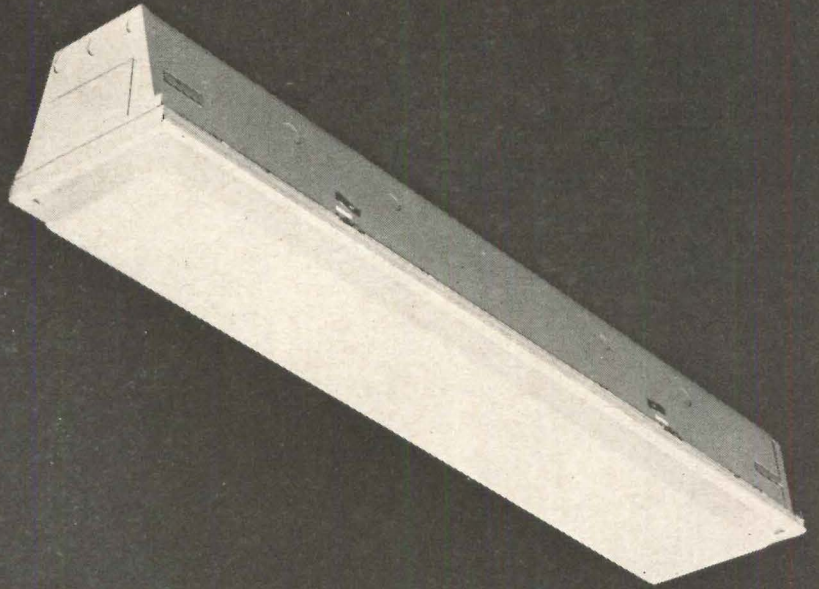
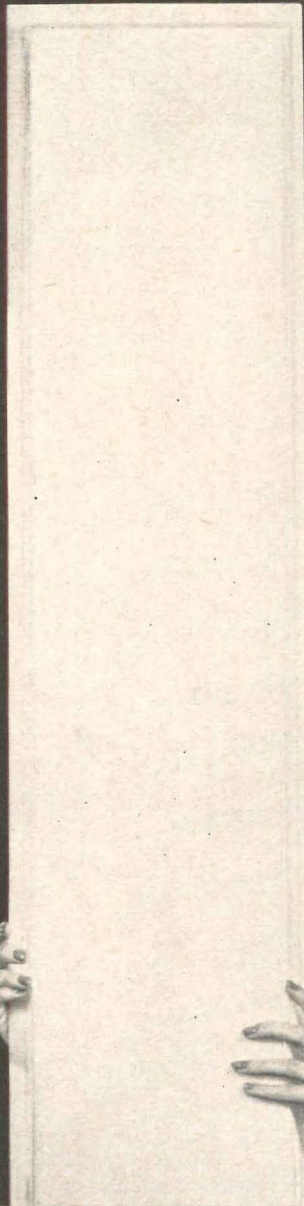

## NO YELLOWING PROBLEM

When you specify acrylic shields made from LUCITE\* acrylic monomer for the lighting fixtures in your building, you can expect service life three to five times greater than that of non-acrylic plastic materials. You virtually eliminate the problem of "yellowing". And maintenance costs are reduced to a minimum. In short, shields made from LUCITE make possible the most efficient—and attractive—lighting you can buy.

Fluorescent lighting fixture by The Frink Corporation, Brooklyn, New York, has lighting shield formed by Dura Plastics of New York, Westport, Connecticut, from cast acrylic sheet made by **The Polycast Corporation**, Stamford, Connecticut.

\*DU PONT TRADEMARK

PLASTICS DEPARTMENT

BETTER THINGS FOR BETTER LIVING . . . THROUGH CHEMISTRY



# LUCITE\*

For more data, circle 46 on Inquiry Card

SEND FOR MORE INFORMATION

E. I. du Pont de Nemours & Co. (Inc.)  
Dept. AR-12, Room 2507L, Nemours Bldg., Wilmington 98, Delaware

Please send your lighting booklet.

Please ask an acrylic-sheet manufacturer to contact me.

Name.....

Position.....

Company.....

Address.....

City.....State.....

# new

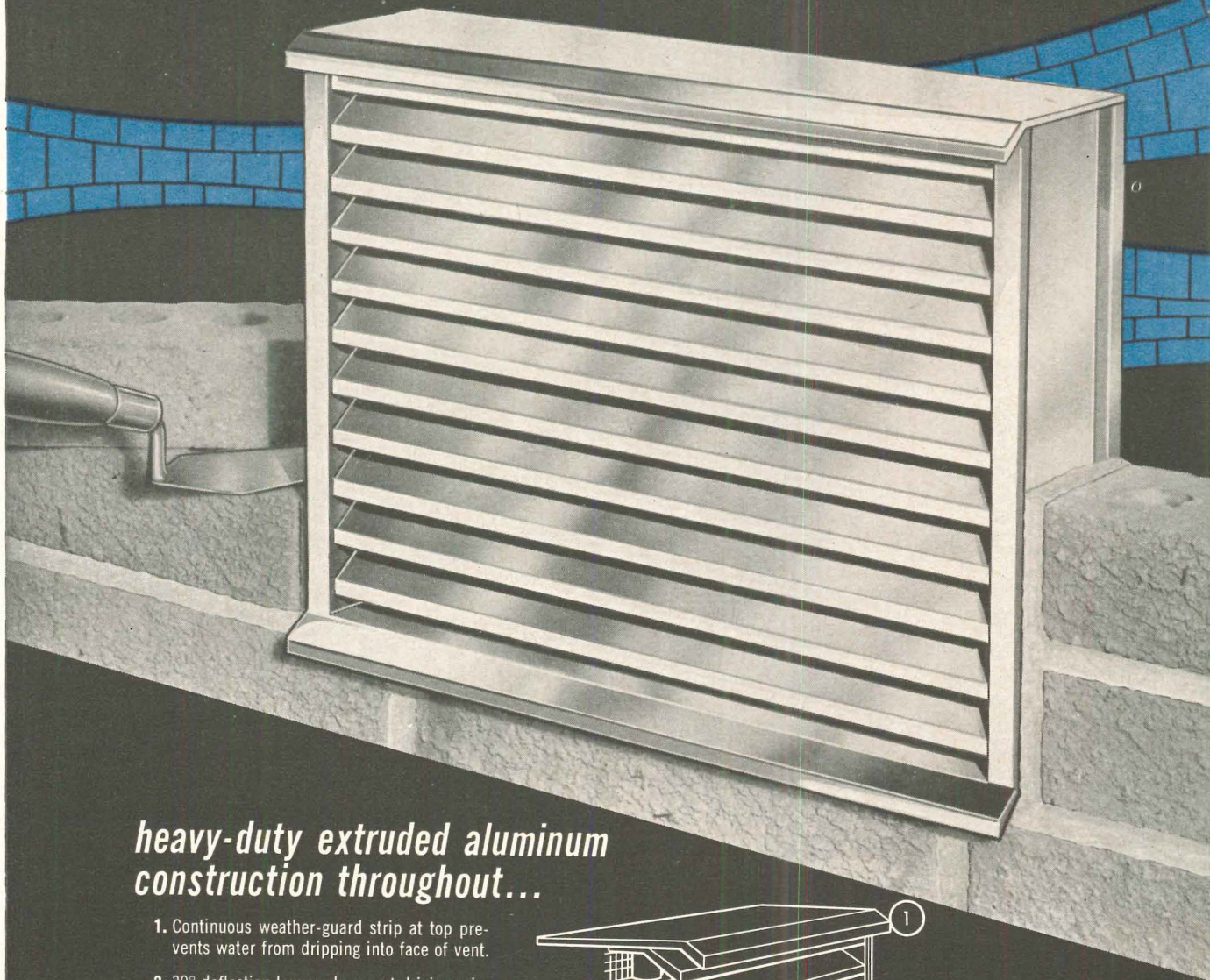

## *heavy-duty extruded aluminum construction throughout...*

1. Continuous weather-guard strip at top prevents water from dripping into face of vent.
2. 30° deflection louvers keep out driving rain, yet permit free flow of air.
3. Heavy-duty, extruded aluminum  $\frac{3}{8}$ " rod vertical supports with spacers between each louver.
4. Aluminum screen directly behind louvers, keeps out insects, birds, animals.
5. Integral water stop helps to keep water from running into duct.
6. Continuous weather-guard strip at bottom drains water out and away from wall.

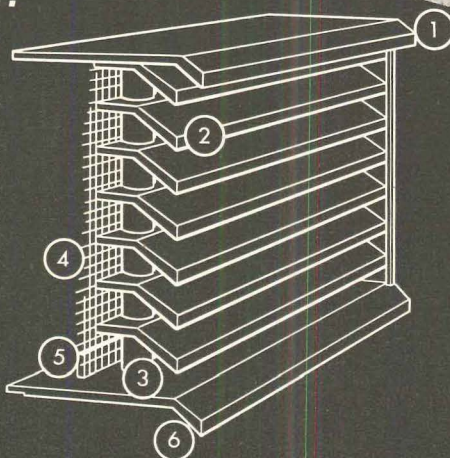

..architecturally designed of extruded aluminum

# brick'n·block vents

Here, now, from Titus, is *the highest plateau of excellence in vent design and performance ever achieved!*

The all-new, ultra-modern, *extruded design* of Titus Brick 'n Block vents eliminates completely the many restrictions encountered when using cast-type vents. Size, for example, is no longer a problem. The new Titus vents are available in ANY SIZE TO FIT ANY EXTERIOR WALL MODULAR UNIT.

They are built *extra rugged*, are *extremely versatile* and *adaptable* to all types of modern building. They fit neatly into the exterior wall modules of standard or jumbo brick, concrete or cinder block construction.

Titus Brick 'n Block vents are the perfect units to use for air intake or air exhaust through exterior walls—as well as for ventilating air spaces.

by **TITUS**<sup>®</sup>

**MAIL  
COUPON  
FOR  
NEW  
CATALOG**

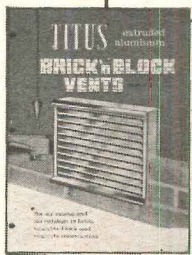

**TITUS MFG. CORP., WATERLOO, IOWA**

Branch Mfg. Plants: Hialeah, Fla.; Terrell, Texas; Phoenix, Ariz.

Please rush Catalog on Titus' new, complete line of extruded aluminum BRICK 'N BLOCK VENTS.

Also send literature on Titus Outside Louvers and Louver Penthouses.

NAME \_\_\_\_\_

COMPANY \_\_\_\_\_

ADDRESS \_\_\_\_\_

CITY \_\_\_\_\_ STATE \_\_\_\_\_

For more data, circle 47 on Inquiry Card

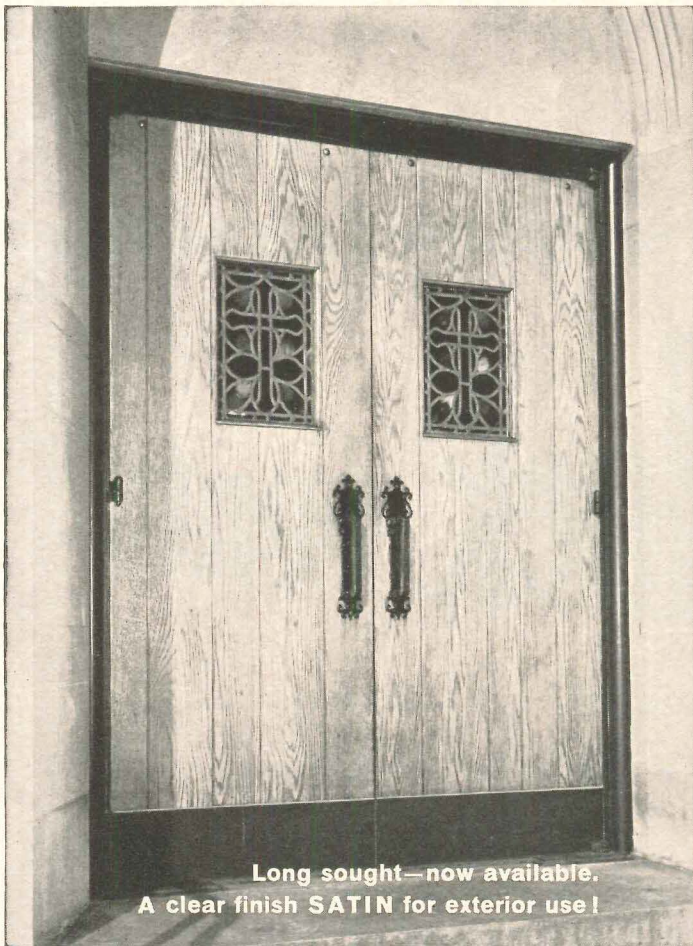

Long sought—now available.  
A clear finish SATIN for exterior use!

At last—a clear finish in SATIN luster  
sufficiently durable for outdoor use!

# VARMOR

Clear Finish Gloss or Satin by Pratt & Lambert

Recently acclaimed as an extraordinary development, Varmor Clear Finish Gloss now has a companion in Varmor Clear Finish Satin. Both are exceedingly durable and will withstand wear and weather up to 100% longer than other types of clear finishes.

Prestige areas like fine wood entrance doors can be well protected and yet display the elegance heretofore possible only on interior surfaces.

For complete information and recommended specifications, ask your P & L representative or write Pratt & Lambert-Inc., 75 Tonawanda St., Buffalo 7, N.Y.

**Pratt & Lambert-Inc.**

*The Paint of Professionals for Over a Century*



NEW YORK • BUFFALO • CHICAGO • FORT ERIE, ONTARIO

For more data, circle 48 on Inquiry Card

When Requirements Call  
for a Growth Room

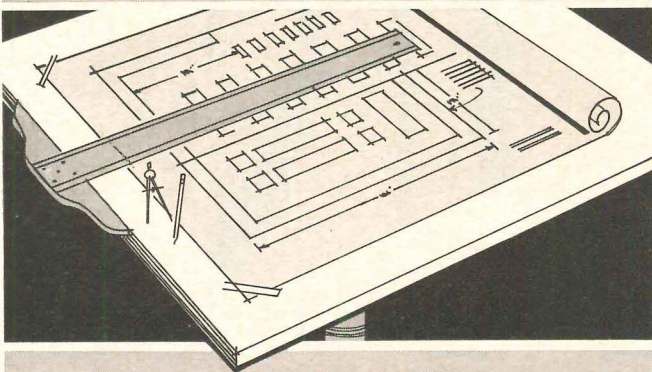

**Sherer-Gillett Makes  
Specification Easy!**

Presently used in schools and universities throughout the country, Sherer-Gillett Packaged Controlled Environment Labs are known for their quality construction . . . dependable performance . . . and advanced design. Designed with the aid of leading biologists, they provide precise control of heat, light, humidity and air distribution. New schools deserve the finest in basic research equipment . . . Sherer has it!

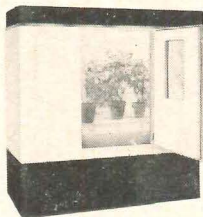

Send for a detailed  
brochure and spec-  
ifications today!



**SHERER-GILLETT CO.**

Marshall 8, Michigan

For more data, circle 25 on Inquiry Card

**CAPTURE THE HOUSEWIFE  
GUARANTEE THE SALE!**

**Vacu-FLO®**

**BUILT-IN HOME  
VACUUM CLEANING...**

. . . The Built-In Vacuum  
that's a Fire Alarm  
and Burglar Pro-  
tection System,  
all in one.

**BOOTHS  
531-532  
OUR 8TH  
N. A. H. B.  
SHOW**



MANUFACTURED BY:

**H-P PRODUCTS, INC.**  
LOUISVILLE, OHIO

**DISTRIBUTORS:  
SOME AREAS OPEN**

For more data, circle 80 on Inquiry Card



Architects & Engineers:  
John Graham and Company  
Owner-Contractor:  
Hawaiian Land Company, Ltd.  
Sun Controls by Brown  
of Oklahoma City

## SUN CONTROL FOR HAWAIIAN HIGH-RISER...

Rising 22 stories above an elaborate shopping center in Honolulu, the Ala Moana Building stands out dramatically in the island sun. And it's the island sun that makes most important the louvered "skin" of this building...louvers that open and close automatically as the sun moves around the four walls.

The sun control system is by Brown Manufacturing Company of Oklahoma City...using Reynolds Aluminum. It is made up of 3,120 vanes, each 2'-6" wide and up to 14'-3" in height. The vanes are formed from .064" embossed aluminum sheet gold anodized on one side and plain finish clear anodized on the other...with extruded aluminum beams, edge nosings, and cast aluminum end brackets.

This system cut exterior wall cost almost in half and eliminated 170 tons of air conditioning equipment. This resulted in lower initial construction cost and will reduce future operational and maintenance expenses. Yet maximum comfort is assured for all occupants of the building—even those next to the windows.

For full information on this or any other architectural use of aluminum... call the nearest Reynolds sales office. Or write to Reynolds Metals Company, Richmond 18, Va.

Where New Ideas take shape in Aluminum-



# REYNOLDS ALUMINUM

Watch Reynolds exciting TV programs on NBC: "The Dick Powell Reynolds Aluminum Show" Tuesday nights; "Say When", weekdays; "All Star Golf"—in living color—starting January 5.

For more data, circle 49 on Inquiry Card

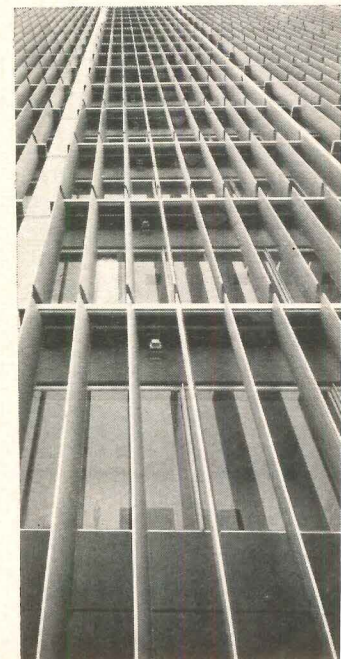

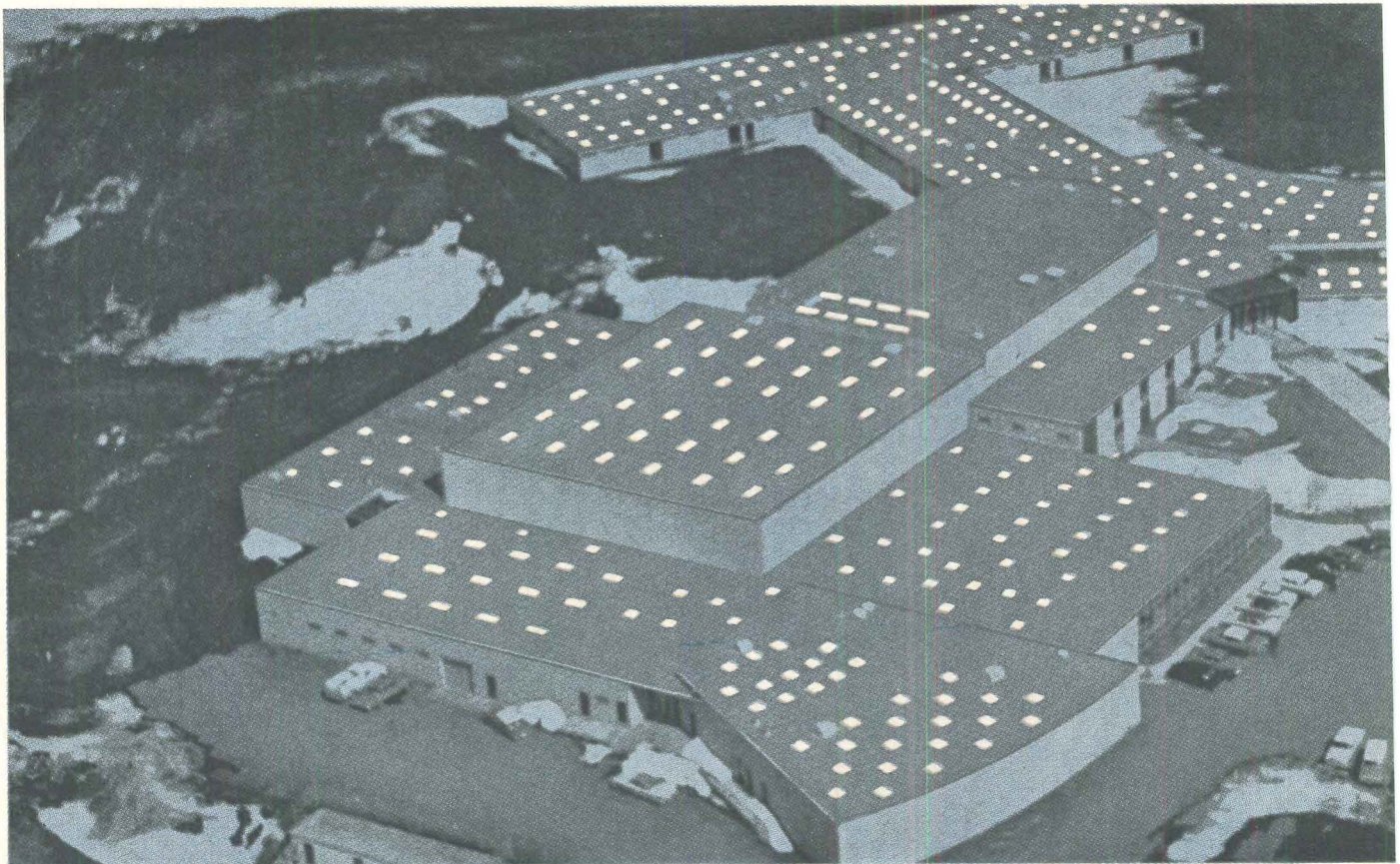

Architect: Howard Parezo and Associates, AIA, Sioux Falls

## Quality lighting and operating economy with

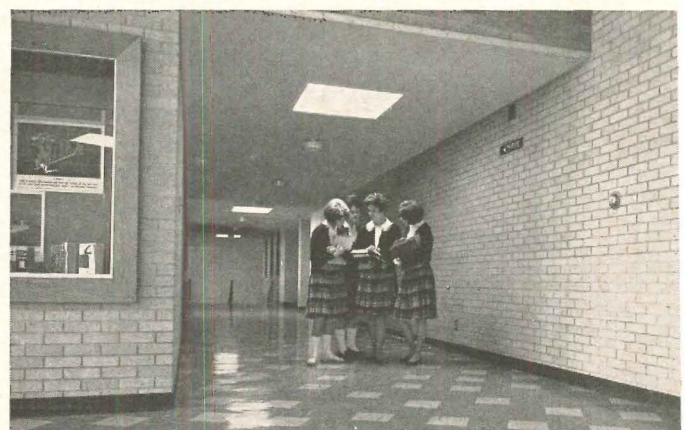
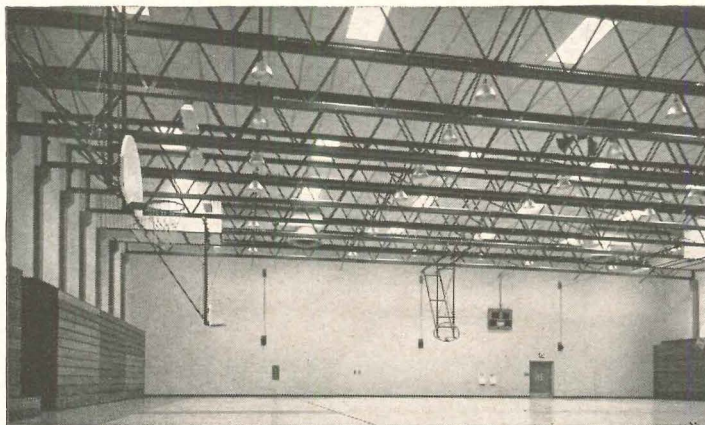

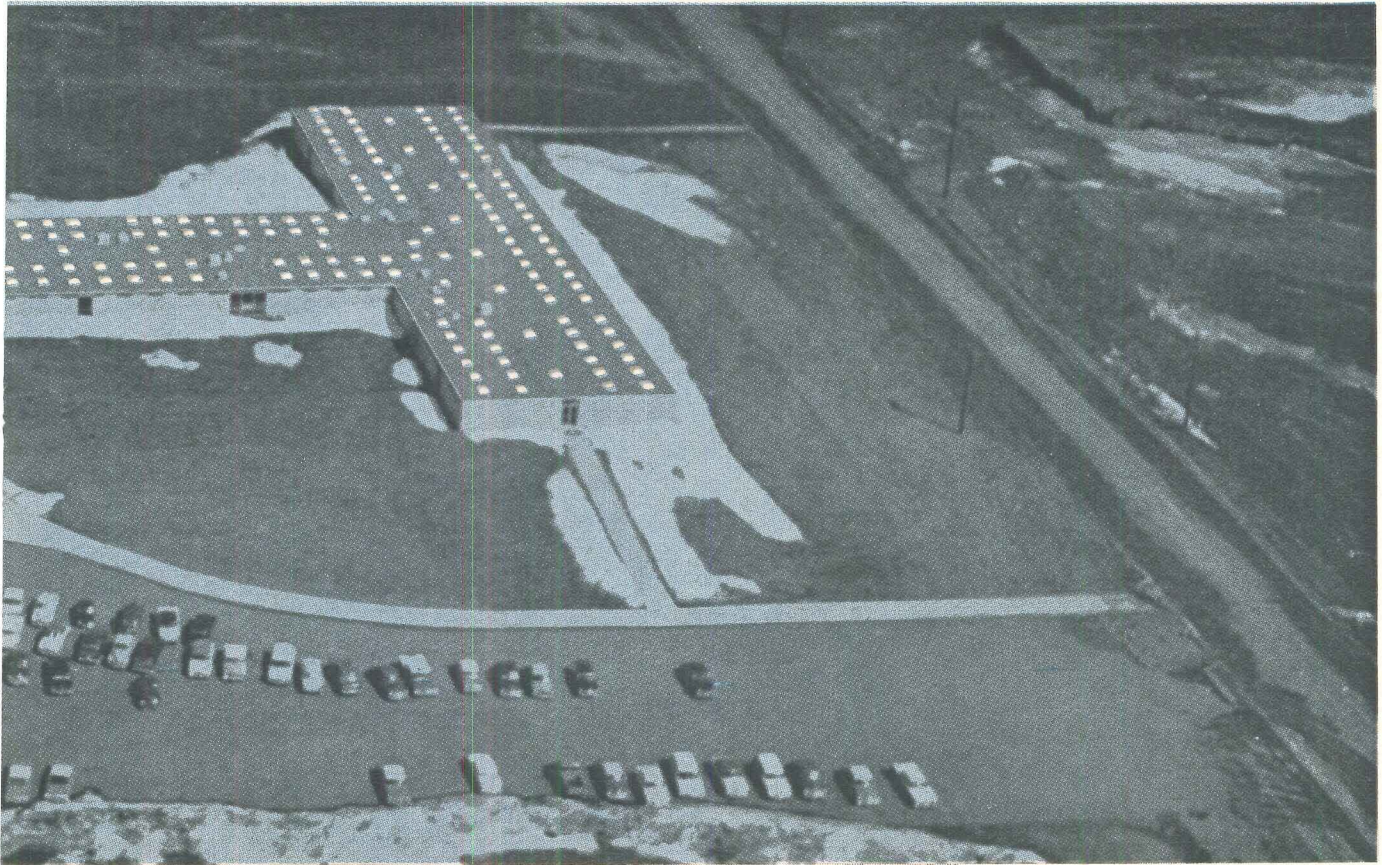

## 570 Dome Skylights of **PLEXIGLAS**<sup>®</sup>

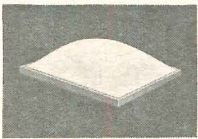

Dome skylights of PLEXIGLAS acrylic plastic provide natural lighting of the highest quality at the O'Gorman High School, Sioux Falls, South Dakota. In classrooms, corridors, gymnasium,

auditorium, cafeteria, library and lobby, the high-level daylighting is uniform in distribution and free of glare. In addition, an appreciable saving in electric power costs is realized because the school's incandescent and fluorescent lighting is needed only on the relatively few days when the sky is totally cloudy.

This daylighting installation was engineered to control the sky and sun conditions of its geographical location—through selection of the proper density of white translucent PLEXIGLAS for the diffusing domes of the skylights. *Five densities of white translucent PLEXIGLAS are available for skylights*, a choice that insures successful daylighting under any sky and solar conditions.

Through the use of the proper density of white translucent PLEXIGLAS, the following interior lighting goals were achieved at O'Gorman High School:

- The predetermined light level for the visual task involved—an average reading of 60 foot candles in the case of classrooms—is attained during at least 75% of the school year through the skylights alone.
- Daylight is distributed uniformly throughout the skylighted areas.
- Brightness of the light source—the skylight opening in the ceiling—is controlled to insure visual comfort.
- Output of heat per foot candle is lower with the skylights than the output produced by either incandescent or fluorescent light alone.

You can obtain these advantages through Daylight Engineering with dome skylights of PLEXIGLAS. Our engineering services and those of skylight manufacturers are available to help you. We will be pleased to send you the names of dome skylight manufacturers who use PLEXIGLAS.

**ROHM  
&  
HAAS**

PHILADELPHIA, PA.



In Canada: Rohm & Haas Company of Canada, Ltd., West Hill, Ontario

PLEXIGLAS is a trademark, Reg. U.S. Pat. Off. and in other principal countries in the Western Hemisphere.

For more data, circle 50 on Inquiry Card

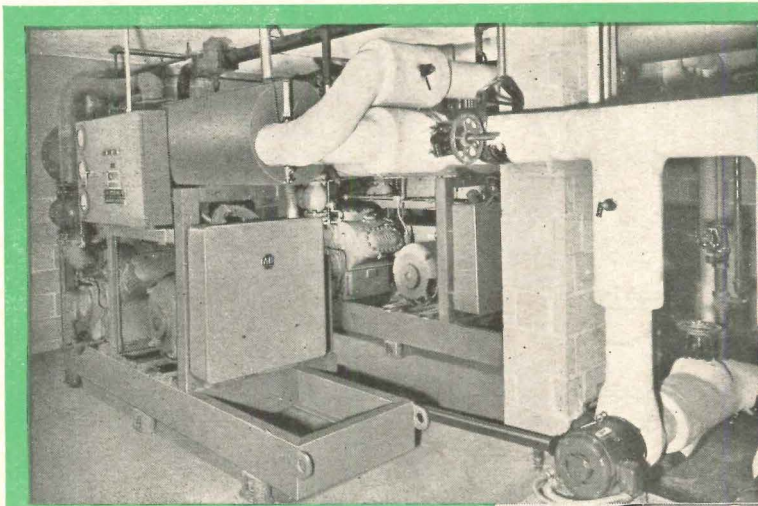

**ABOVE** — Two Vilter R-22 Uni-Chillers air condition Deaconess Hospital's new addition and have been cross-connected to an earlier purchased Uni-Chiller to provide an integrated, flexible air conditioning system.

**RIGHT** — Two separate Vilter evaporative condensers, complete with liquid receivers, fulfill condensing requirements for the new Uni-Chillers.

System installed by Weninger Co. Inc., Milwaukee, Wis.



Deaconess Hospital  
expands Vilter  
air conditioning system

## ... GAINS FLEXIBILITY and RELIABLE STANDBY CAPACITY

With exacting control of temperature and humidity prerequisites for patient comfort, today's hospitals place a premium upon an air conditioning system offering *flexibility and adequate standby capacity*.

The practical answer to the requirements of many hospitals is the Vilter Uni-Chiller, a packaged water chiller offered in capacities up to 200 tons. Uni-Chillers are built around durable and easily serviced VMC reciprocating compressors. The entire package is exceptionally compact enabling its installation on upper floors, in penthouses or basements. It is often practical to install two or more separate units, thereby gaining optimum flexibility in case of shutdown.

Deaconess Hospital, Milwaukee, Wis., is now benefiting from this approach to the air conditioning of its new wing. Seven years ago the hospital installed a 75-ton Uni-Chiller. It has now added two additional R-22 Uni-Chillers each incorporating a 6-cylinder VMC compressor to air condition its new wing, and supplement the earlier installation. The new equipment has been interconnected with the older water chilling system to achieve an integrated system which provides *ample standby capacity and optimum flexibility*.

Why not let Vilter help you the next time you require flexibility and efficient performance in an air conditioning system. See your nearest Vilter representative or distributor, or write direct.

Ask for Bulletins 220 and 143.



**MANUFACTURING CORPORATION**  
2217 SOUTH FIRST STREET • MILWAUKEE 7, WIS.

REFRIGERATION AND AIR CONDITIONING

- Air Units • Ammonia and Halocarbon Compressors • Two-Stage and Booster Compressors • Water and Brine Coolers
- Blast Freezers • Evaporative and Shell and Tube Condensers • Pipe Coils • Liquid Transfer Systems
- Valves and Fittings • Pakice and Polarflake Ice Machines • Air Agitated Ice Builders

For more data, circle 51 on Inquiry Card

## Office Awards

continued from page 70

For Offices Designed for  
Less Than 300 Employees



© Ezra Stoller Associates

Office of the Year Award: Upjohn Company Administration Building, Kalamazoo, Mich. Architects, Skidmore, Owings & Merrill (December 1961, page 101)

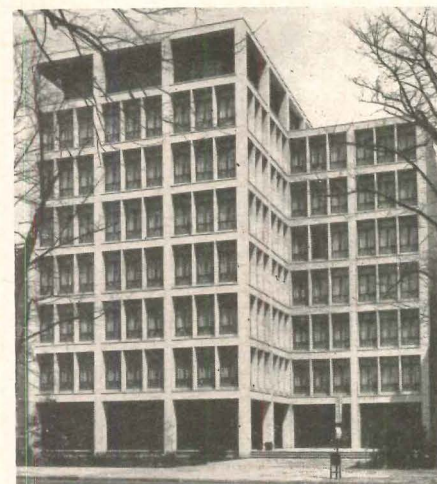

Award of Merit: Forest Industries Building, Washington, D.C. Architects, Keyes, Lethbridge and Condon



Virginia McIntire

Award of Merit: American Cement Building, Los Angeles. Architects, Paul Bennett & Associates



# WOBBLE? NEVER!

## TURN after TURN after TURN

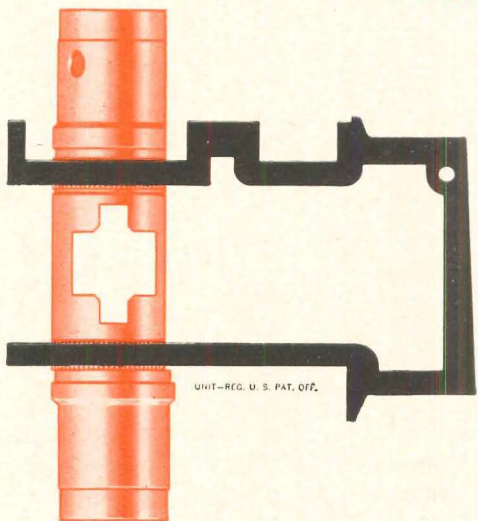

A unique CORBIN feature—solid brass Frame Tube goes all the way through the chassis to provide direct drive for spindle. Makes the UNIT Lockset by CORBIN absolutely wobble-free.

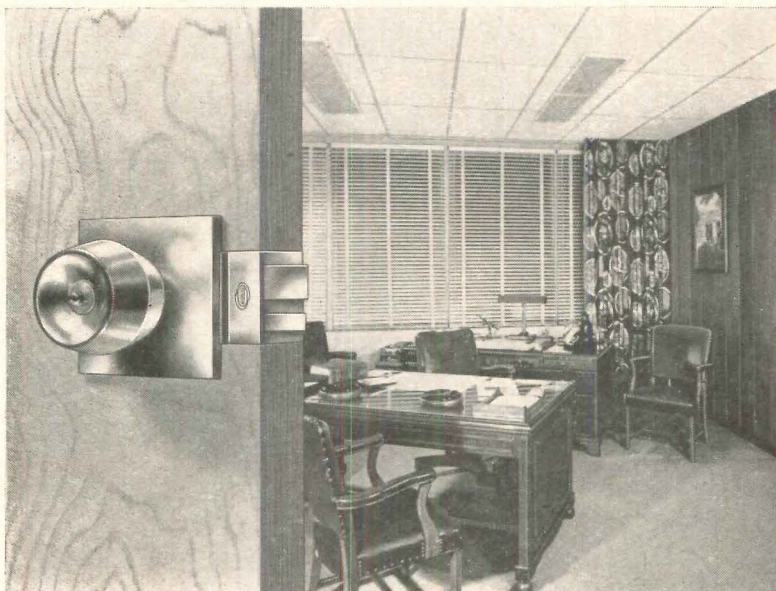

UNIT®  
Lockset  
by  
CORBIN

Finest available! Ideal wherever traffic is heavy: hospitals . . . schools . . . institutions . . . commercial buildings of all types. The solid brass Frame Tube is *staked* to the frame, making frame and tube a permanent unit. Also, it provides a complete, full-length bearing surface for the very heart of the lockset, insures minimum wear and long life—guarantees wobble-free performance for the life of the building. Almost limitless masterkeying flexibility and security with Master Ring Cylinder. In brass, bronze, aluminum or stainless steel.

It pays to make it CORBIN—throughout!



**P. & F. CORBIN DIVISION**

THE AMERICAN HARDWARE CORPORATION  
NEW BRITAIN CONNECTICUT

For more data, circle 52 on Inquiry Card



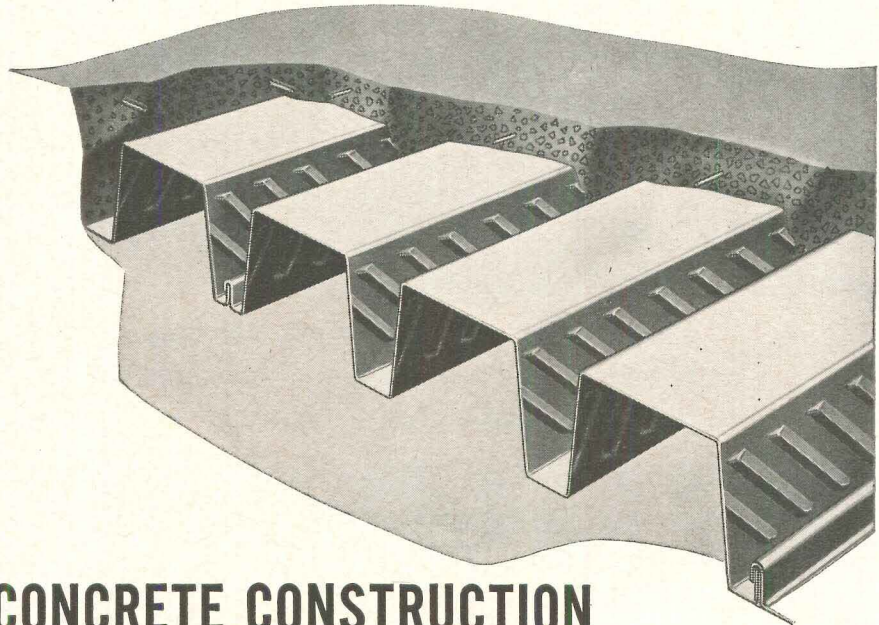

## NOW: REINFORCED CONCRETE CONSTRUCTION WITHOUT REBARS, TEMPORARY FORMS, OR SHORING

*Inland Hi-Bond Floor Deck cuts slab cost 10%-20%*

Today, a new system has eclipsed the low cost of traditional reinforcing materials and methods for concrete floor slabs. On a recent typical job, a complete Inland Hi-Bond Floor, including deck and poured slab, cost \$90.00 per square; a comparable traditional concrete slab would have cost \$101.00.

Here's how you save, using Hi-Bond deck: You don't need steel reinforcing bars (except temperature mesh). You don't need temporary forms or shoring; Hi-Bond deck is a permanent form for wet concrete.

Raised lugs in the webs of Hi-Bond panels provide a positive lateral and vertical mechanical bond between steel and concrete, causing them to act as a composite unit.

Hi-Bond floor deck is available in a number of profiles. Where electrification is desirable, Hi-Bond can be furnished as a cellular floor.

For further information on Hi-Bond — or other Inland floor systems — ask an Inland sales engineer. Write for catalog 270, or see Sweet's, section 2j/In.

*There's an Inland floor system to meet every span requirement economically.*

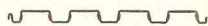

**Type B Hi-Bond Floor Deck**  
24" wide, 1½" deep.



**Type BR Hi-Bond Floor Deck**  
24" wide, 1½" deep.

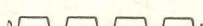

**Type BF Cellufloor**  
24" wide, 1½" deep.

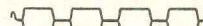

**Type BB Cellufloor®**  
24" wide, 3" deep.



**Type N Hi-Bond Floor Deck**  
24" wide, 3" deep.



**Type NF Cellufloor**  
24" wide, 3" deep.



**Type 3HF Cellufloor**  
12" wide, 4½" deep.



**Type 4.5H Floor Deck**  
12" wide, 4½" deep.

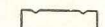

**Type 4.5H Cellufloor**  
12" wide, 4½" deep.



**Ribform®**  
Permanent steel centering,  
28" coverage.

Member of the



**Inland Steel Products Company** *Engineered Products Division*  
DEPT. L, 4033 WEST BURNHAM STREET • MILWAUKEE 1, WISCONSIN

**HI-BOND FLOOR DECK IS AVAILABLE IN CANADA THROUGH ROSCO METAL PRODUCTS LTD., TORONTO 4, ONT.**

ALBANY, ATLANTA, BALTIMORE, BOSTON, BUFFALO, CHICAGO, CINCINNATI, CLEVELAND, COLUMBUS, DALLAS, DENVER, DETROIT, FREMONT, CALIF., HOUSTON, INDIANAPOLIS, KANSAS CITY, MO., LOS ANGELES, NEW ORLEANS, NEW YORK, OMAHA, PHILADELPHIA, PITTSBURGH, SALT LAKE CITY, SAN FRANCISCO, SEATTLE, ST. LOUIS, ST. PAUL, TULSA

For more data, circle 53 on Inquiry Card

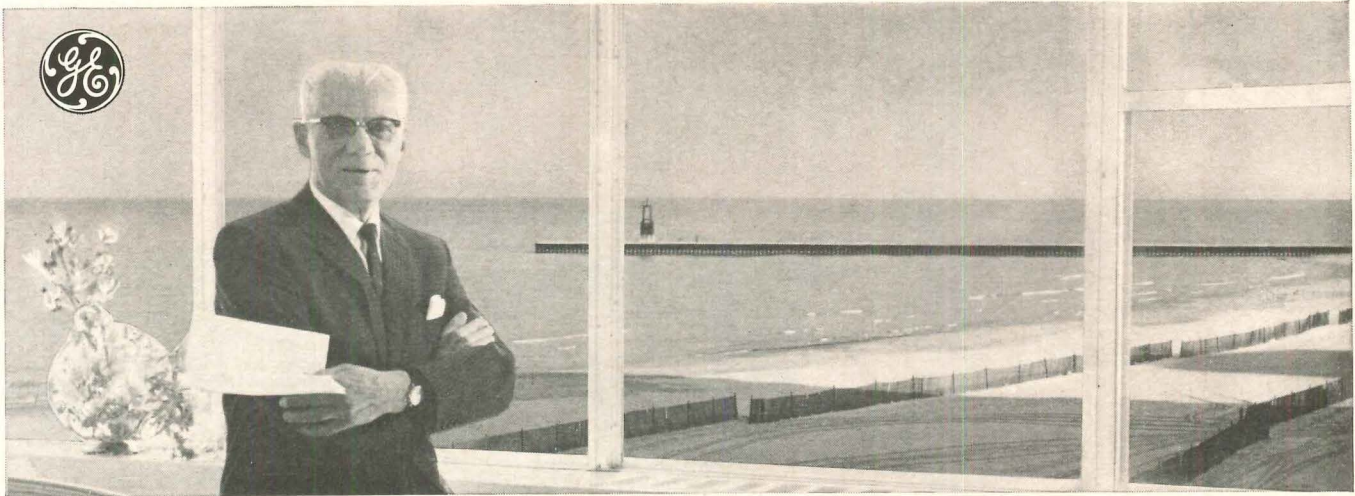

**“What we wanted were air conditioners that would go through the wall, give good cooling, be quiet, dependable, good-looking—and tie in with a hot-water heating system.”**

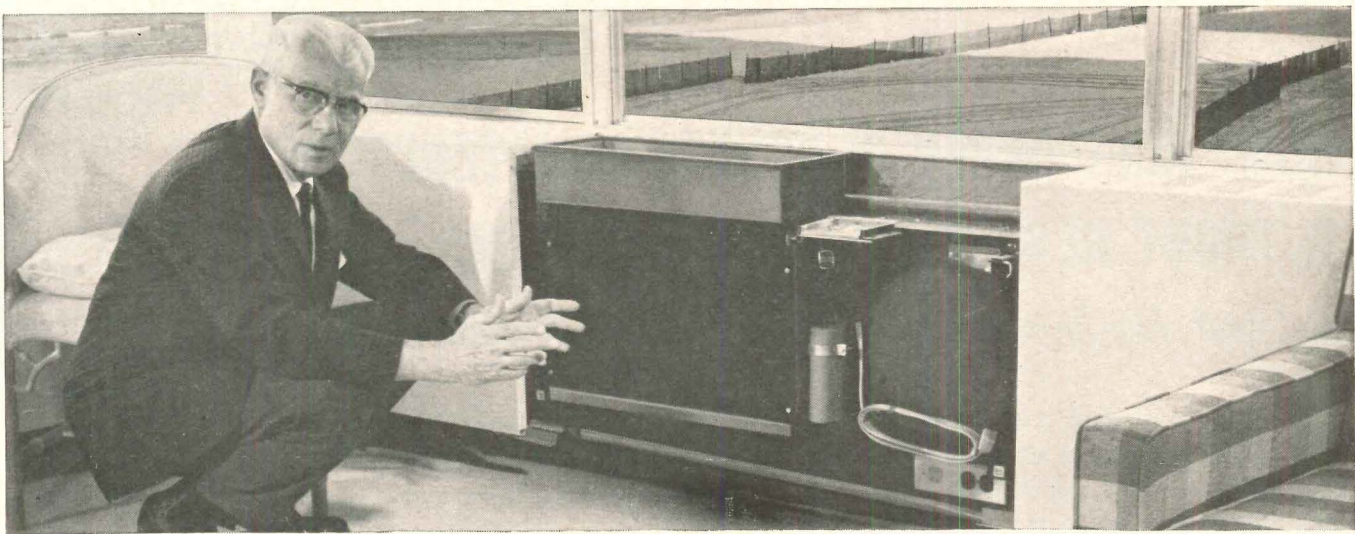

**“What we wanted, we got — 475 General Electric Zonline 42’s.”**



**Listen to Max Schreiber, co-owner of 5757 Sheridan—20-story luxury apartment overlooking Chicago’s Lake Michigan beach front:**

“We’re completely sold on zonal air conditioning systems. They let tenants control their own temperature. They can bring in fresh, filtered air without opening windows, too. And, of course, if a central-plant system goes out, the whole building suffers. No danger of that with a zonal system.

“And we’re completely sold on General Electric. We’ve used their window units in our other apartments and found them most dependable and efficient.

“So when our architects, Loewenberg & Loewenberg,

recommended the new Zonline ‘42’ for 5757 Sheridan, we agreed right away. It was simple to build in these convactor cabinets with the air conditioner above, the hot water pipes below. The cabinet itself doubles as a window seat and shelf. Our tenants have heating and cooling in one good-looking, easy-to-get-at unit.

“And, in talking to our tenants, we found that they are very, very pleased with the *quietness* of the Zonline ‘42’. And that, of course, pleases *us*.”

Add the flexibility of zonal air conditioning to your next building with General Electric’s Zonline ‘42’. Build it in for cooling alone — or combine it with hot water or electric heating. For complete information, write to the General Electric Company, Room Air Conditioner Dept., Building 104A, Louisville 1, Kentucky.

By any measure...There is nothing just as good as General Electric

*Progress Is Our Most Important Product*

**GENERAL  ELECTRIC**

For more data, circle 54 on Inquiry Card

For more data, circle 55 on Inquiry Card ➤



## Stairway for the STARS

When this little "star of the show" is the grand old lady of the theatre... the star-studded stairway will be as bright and sparkling as today.

Stark Structural Glazed Tile has reached new heights in beauty and versatility. The stage facing, illustrated, is a combination of Stark's standard units and "Galaxy" Sculptured Tile used as decorative inserts. This combination offers unlimited design possibilities as well as permanent color, structural strength, initial economy, fire resistance and the lowest possible maintenance.

"Galaxy"\* is just one of a series of contemporary sculptured patterns... write for full story.

\*PATENT APPLIED FOR

# STARK

**CERAMICS, INC.**  
CANTON 1, OHIO



The versatile glazed structural line:  
Glazed Facing Tile, Sculptured Glazed  
Tile, Starkustic (acoustical  
ceramic tile), Glazed Brick.



◀ A typical laboratory in the Center with its Ruberoid/Matico floor

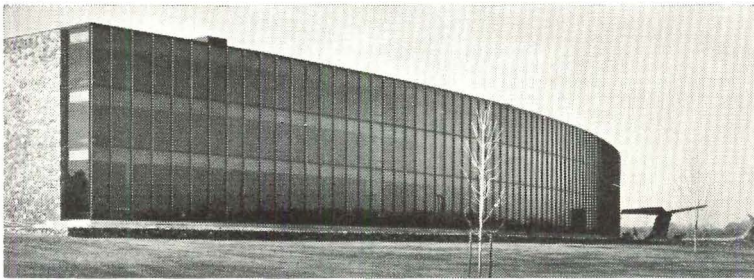

▲ The Research Center, in a 240 acre setting, looks out on wooded rolling country-side.

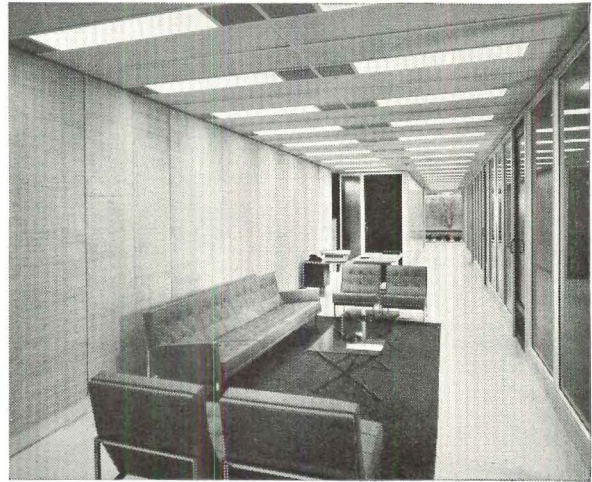

◀ The floor tile in corridors and offices is Ruberoid/Matico Vinyl Asbestos. Over 300,000 sq. feet were installed.



*The resilient flooring in IBM's Thomas J. Watson Research Center at Yorktown, New York, is Ruberoid/Matico Vinyl Asbestos Floor Tile*

International Business Machines Corporation's Thomas J. Watson Research Center at Yorktown is one of the most advanced laboratories in the world for the study of computer science. Its design has evoked wide interest.

The floor tile is beautiful practical Ruberoid/Matico Vinyl Asbestos. Have you seen the entire *new* line of Vinyl Asbestos by Ruberoid/Matico? For samples call your Ruberoid Architectural representative.

*Architect: Eero Saarinen Associates  
General Contractor: William L. Crow Const. Co.  
Flooring Contractor: Circle Floor Co.*



**RUBEROID MATICO**  
*Vinyl Asbestos Floor Tile.*  
The RUBEROID Co., 733 Third Avenue  
New York 17, New York

For more data, circle 56 on Inquiry Card

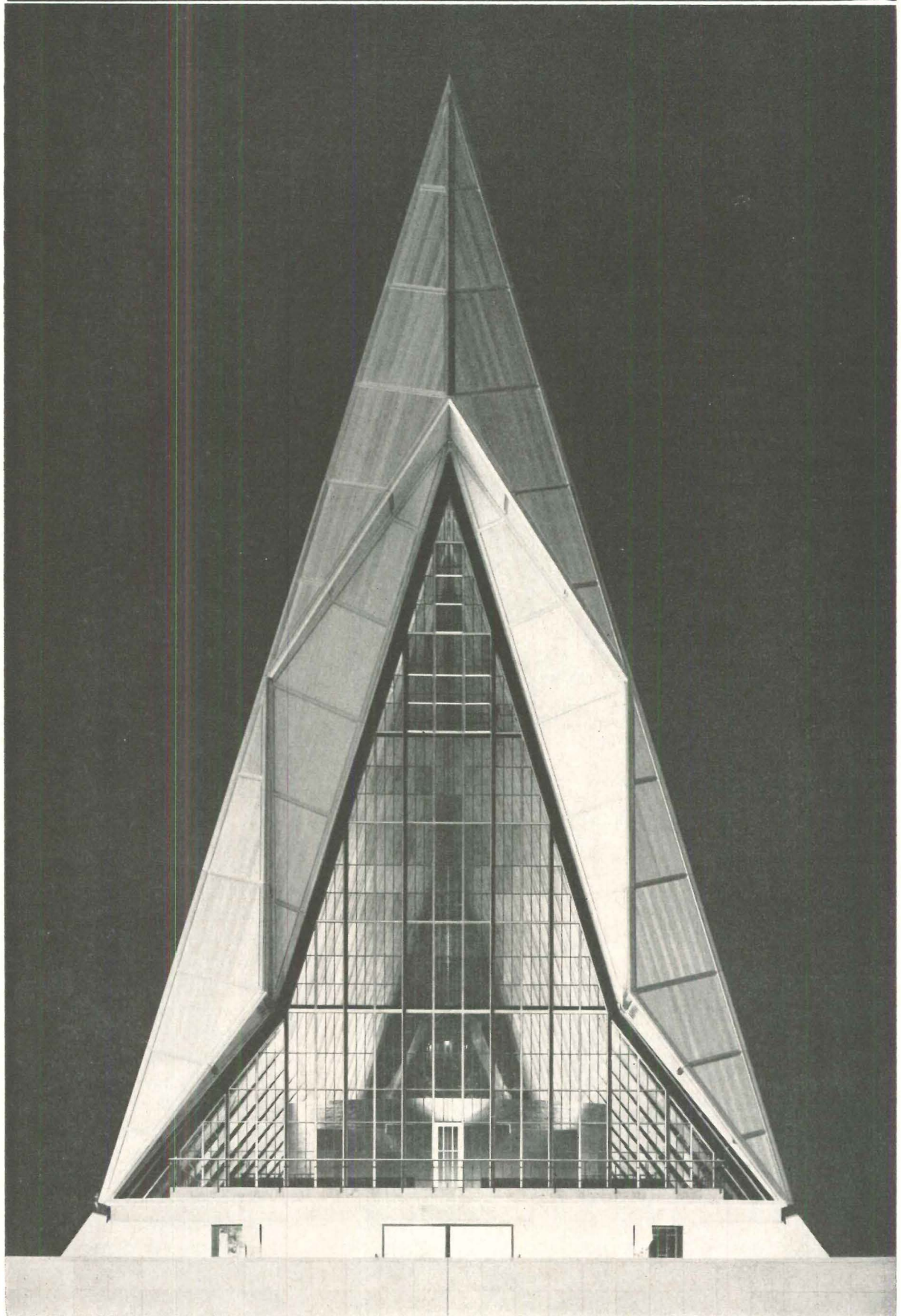

## AIR FORCE ACADEMY CHAPEL

Deft fusion of color, form and structure  
makes new cadet chapel the visual dominant of the Academy

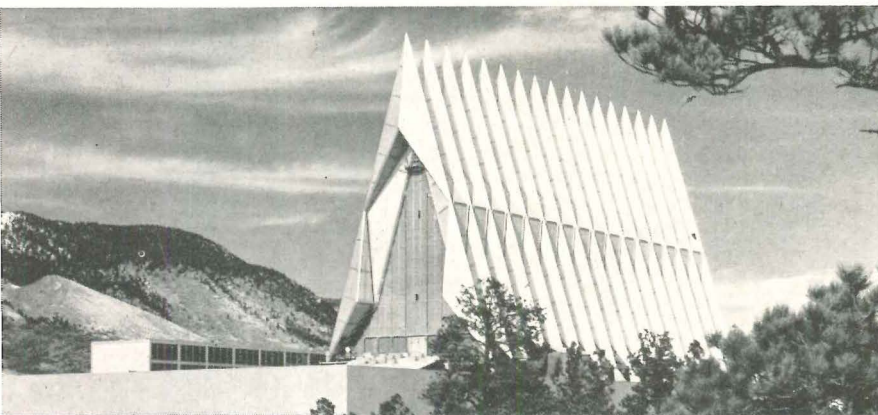
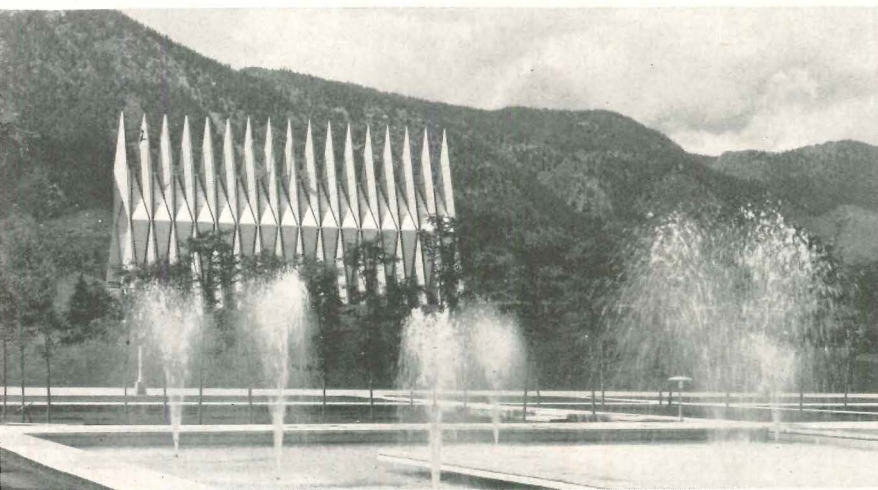
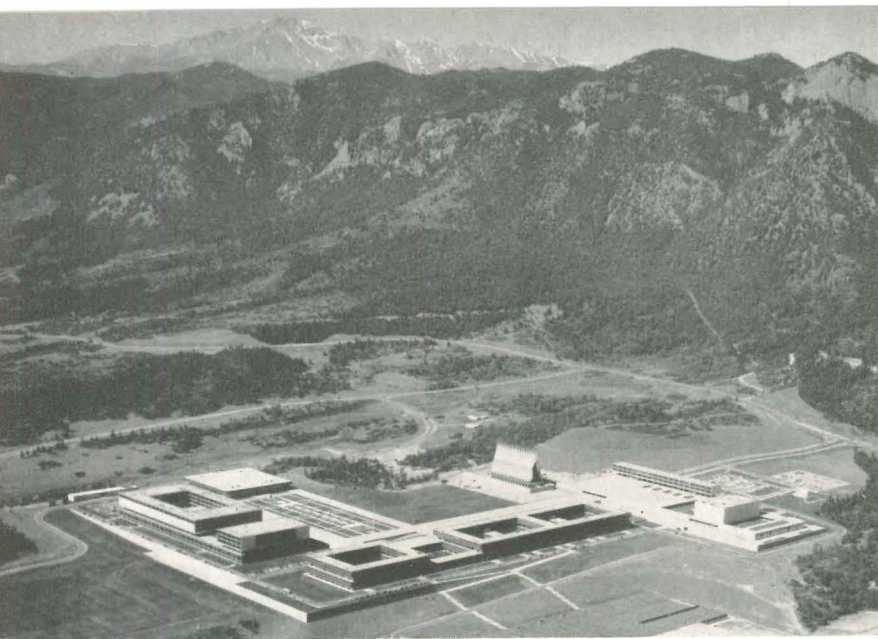

The new chapel at the Air Force Academy creates a compelling focal point for the entire complex in its mountain setting, reminiscent of the dominance of the cathedral over a medieval town.

Form—as developed through structure—and color—here fused with formal structure to create a total symbol—work together to produce a dramatic architecture for worship which is equally effective by day or night. The chapel's 17 spires soar in striking fashion over the long horizontals of the other buildings; the glistening, machine-made perfection of their aluminum surfaces and the verticality of their upward reaching pointedness make appropriate contrast with the ruggedness of the surrounding Rockies. This enclosing space frame was made by assembling 100 tetrahedrons—each 75 feet long and constructed of steel pipe—into a 17-spired wedge. Its interstices are glazed with narrow strips of stained glass in a studied progression of 24 bold colors, in a pattern derived from a conventionalized visualization of the transformation of Saul, who became the Apostle Paul. Architect Walter Netsch, the designer, describes it as “a strong story, not sweet.” Such a concept seems to call for strong, earthy color. By day, color makes the chapel interior come alive in an ambience of glowing, changing hues; at night, the effect is of molten color running in fiery streams over the sides of the building. By means of a different kind of architecture, and at a different time, this chapel appears likely to become a national shrine, as did the chapel at West Point.

Individual chapels for each of the three faiths are provided in the building. Its lower, or ground floor, space houses the Catholic and Jewish chapels and is constructed of reinforced concrete; its upper level space frame encloses the Protestant chapel, larger by force of numbers. Each chapel has a completely separated entrance; each chapel has its own character and identity. The problem of creating a symbolic building encompassing enough to include three faiths, yet particular enough to give each identity, was a challenging one; but it has been handled here with notable architectural skill and taste. The cohesiveness of the resulting chapel has brought into being a unifying symbol for its several creeds that is particularly appropriate for our democracy in a world of conflict.



*Stewarts—C.G. Coil photos*

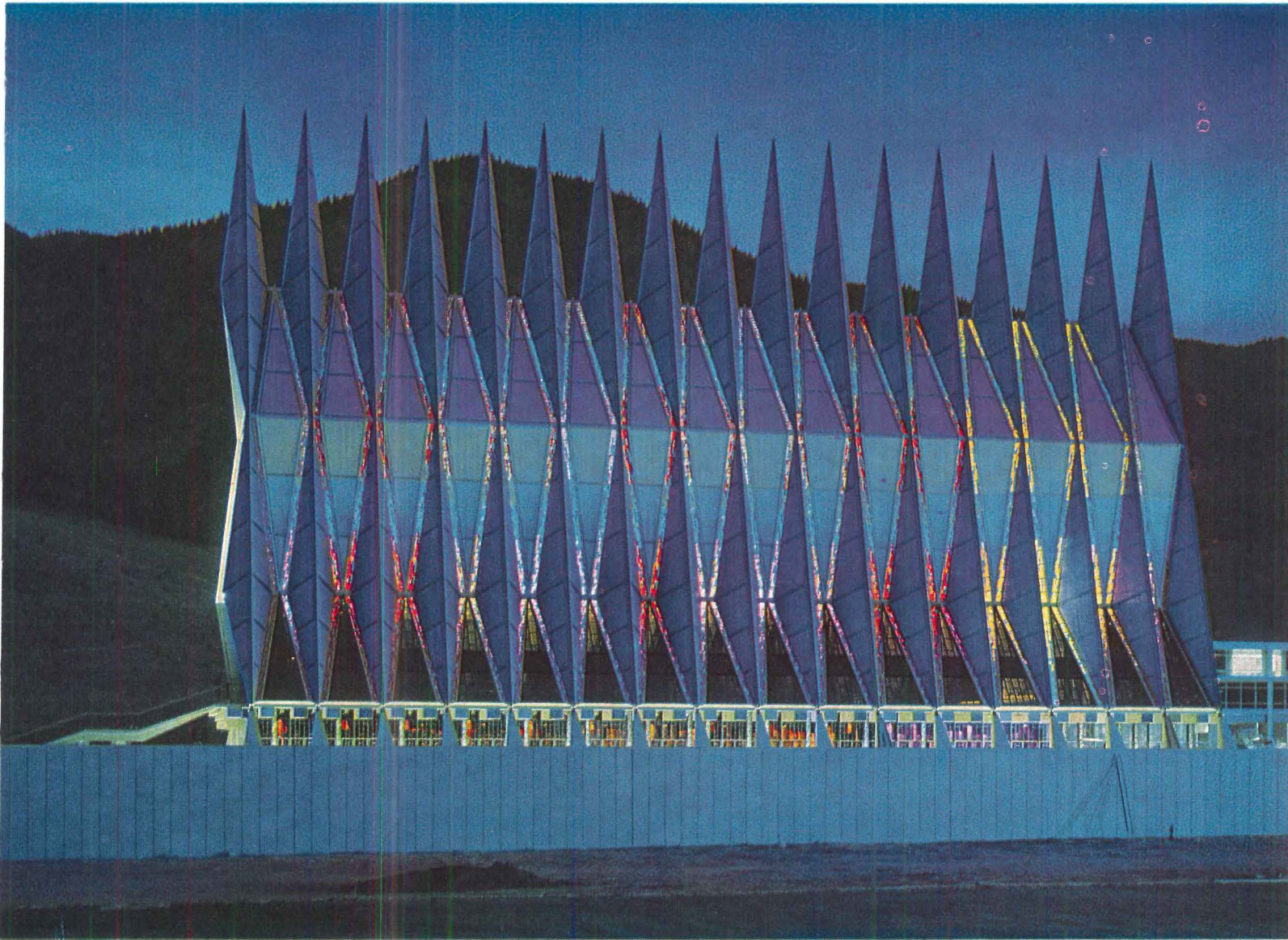

*The Chapel, United States Air Force Academy, Colorado*

ARCHITECTS-ENGINEERS: *Skidmore, Owings & Merrill*

PARTNER-IN-CHARGE AND DESIGNER: *Walter A. Netsch Jr.*

ACOUSTICAL CONSULTANT: *Bolt, Beranek and Newman, Inc.*

ORGAN CONSULTANT: *Walter Holtkamp*

GENERAL CONTRACTOR: *Robert E. McKee, Inc.*

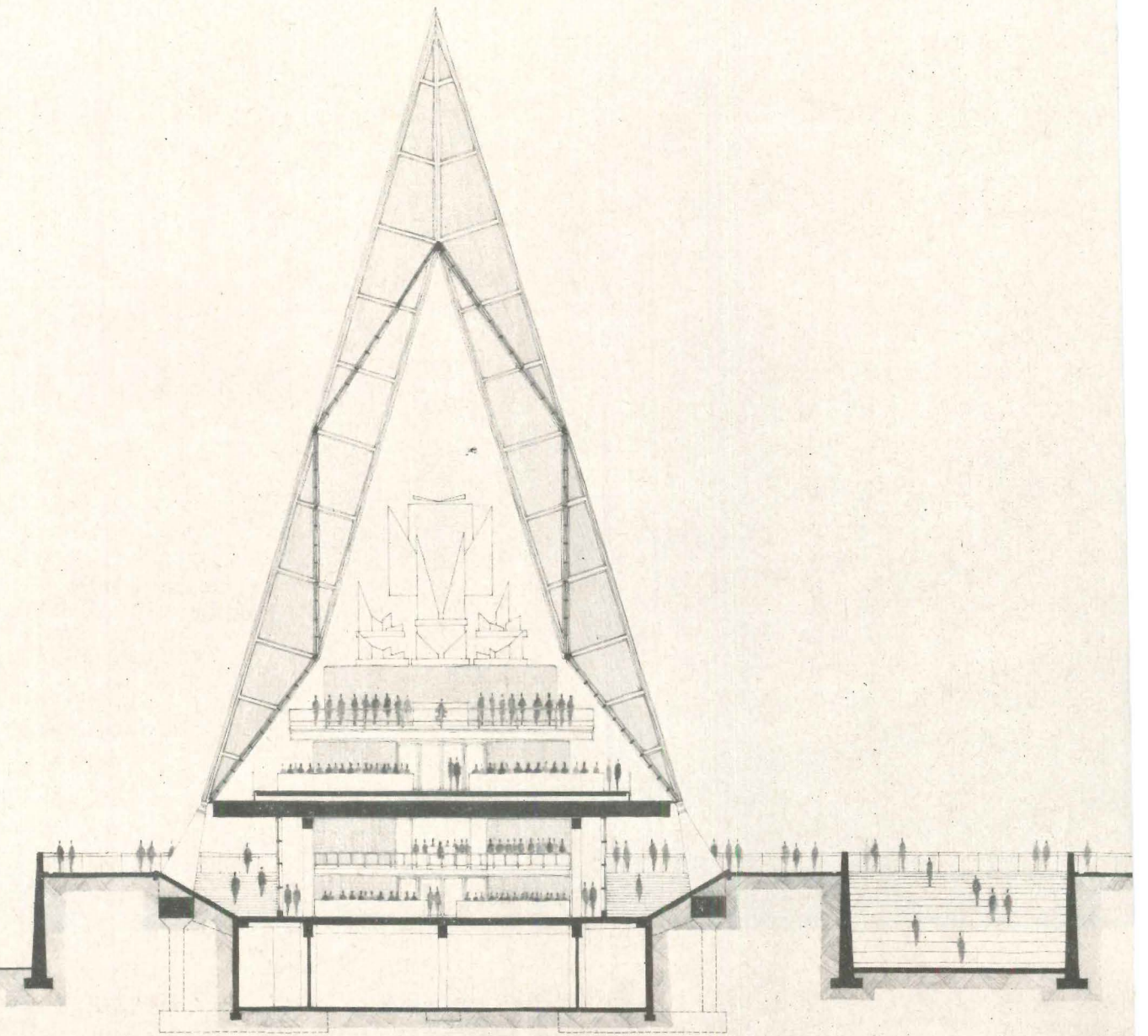

**THE CATHOLIC CHAPEL**, with its soft arches, scale and masonry look, is subtly reminiscent of the Early Christian; its interior structural expression serves to give it strong visual identity. Forty-two pews provide seats for 500. The sash is glazed with amber glass in three hues; the vertical, glazed precast panels are in five colors

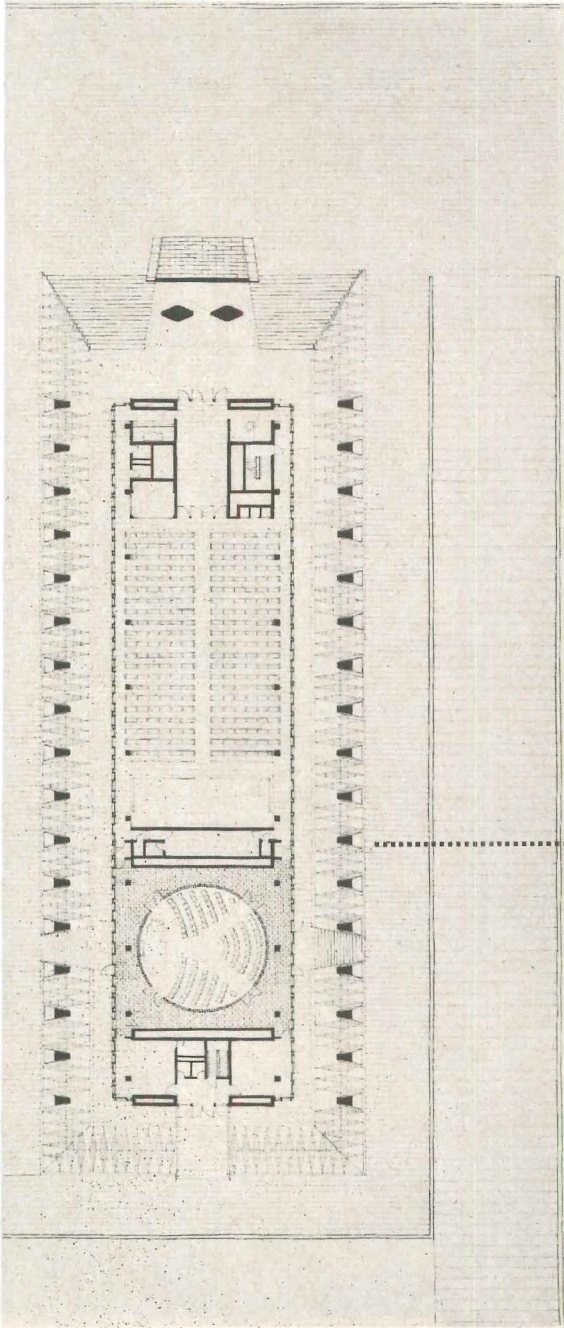

LOWER LEVEL

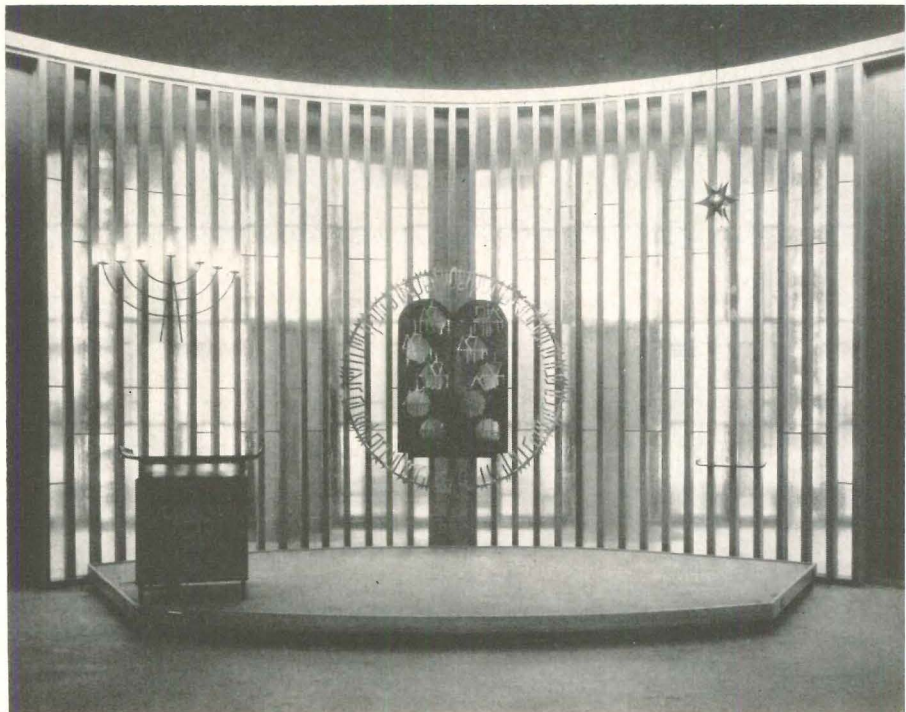
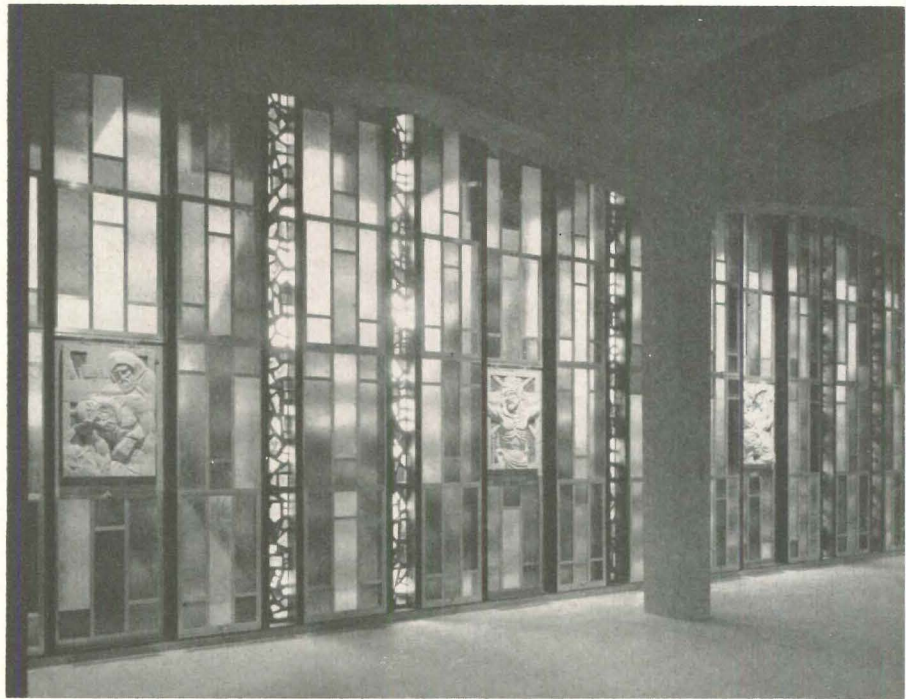
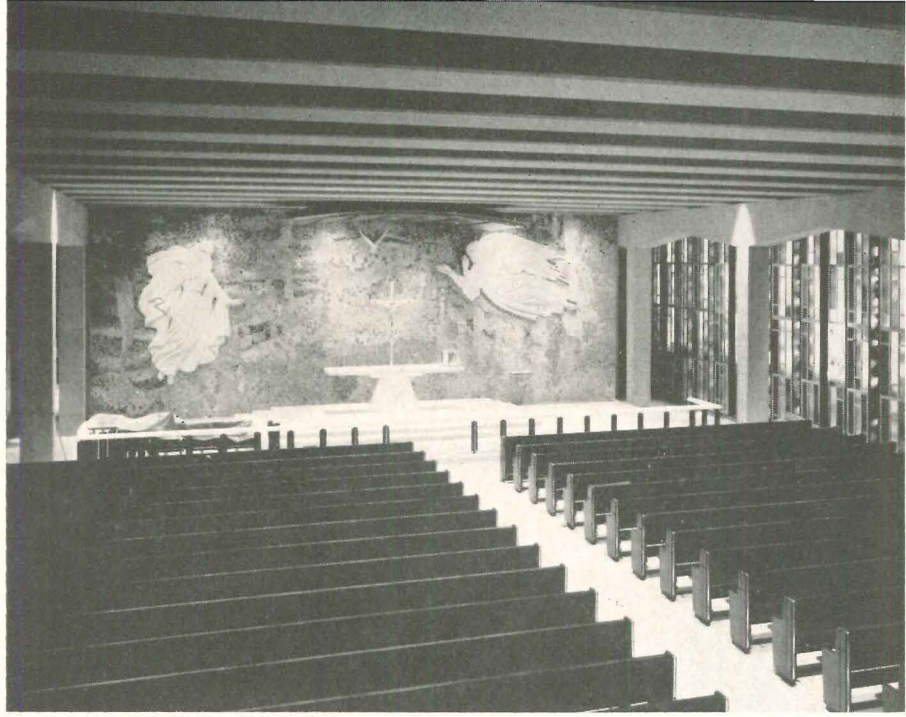

**THE JEWISH CHAPEL** consists of a circular, non-structural form set within a square. This round, carpeted sanctuary is enclosed by milky-white glass held in cypress uprights and opens at four points to the outer vestibules, floored with polished Israeli stone and lighted by glazing in rich tones of purple and blue. The three groups of pews will accommodate a convocation of 100

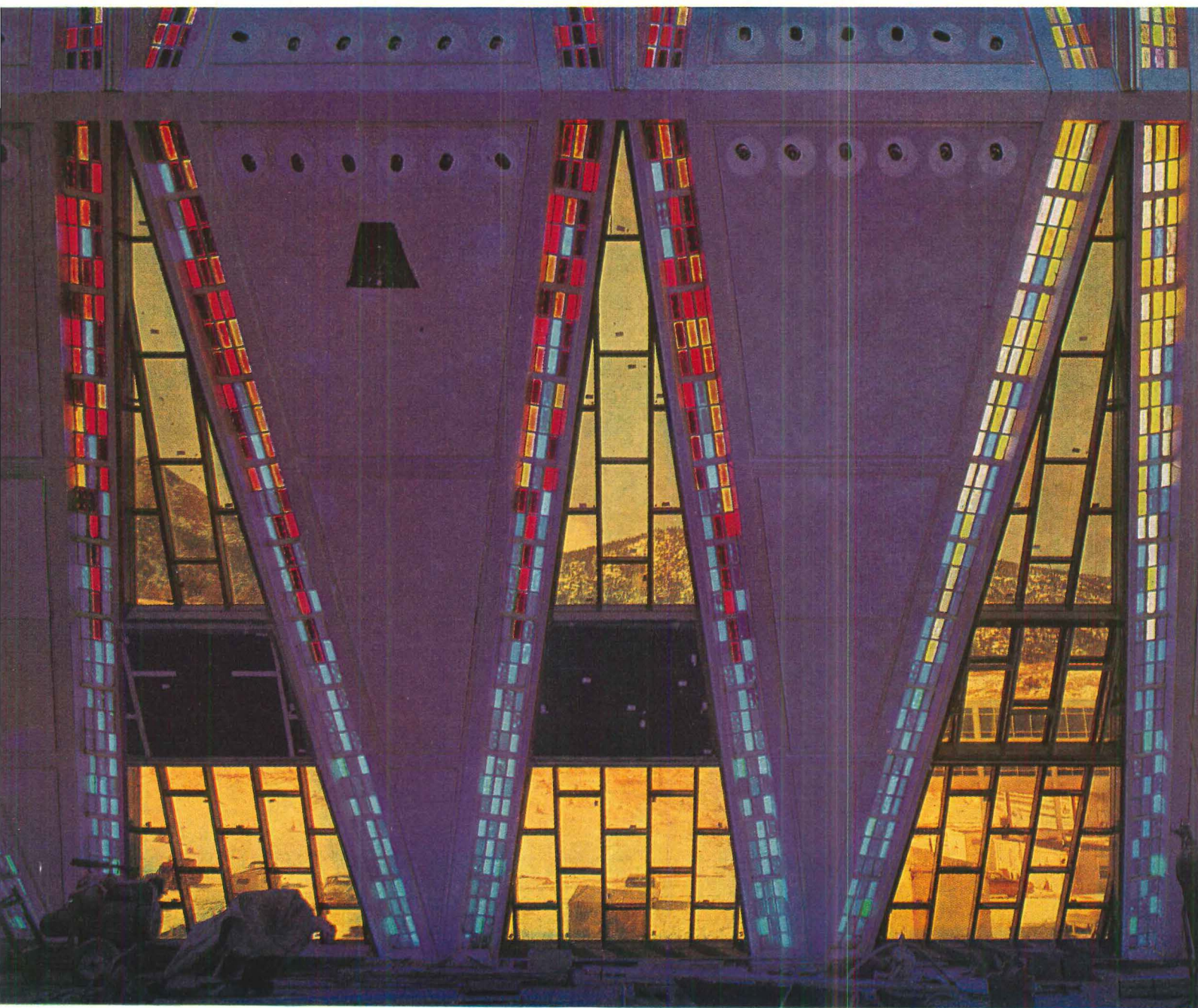

**THE PROTESTANT CHAPEL** will seat 900 in 72 pews; has a raised floor of brown terrazzo on a slab meticulously separated from the lower structure (see section, page 88). The faiths symbolically and structurally come together in a white terrazzo memorial border strip not to be trod upon. The black railing has an aluminum cap

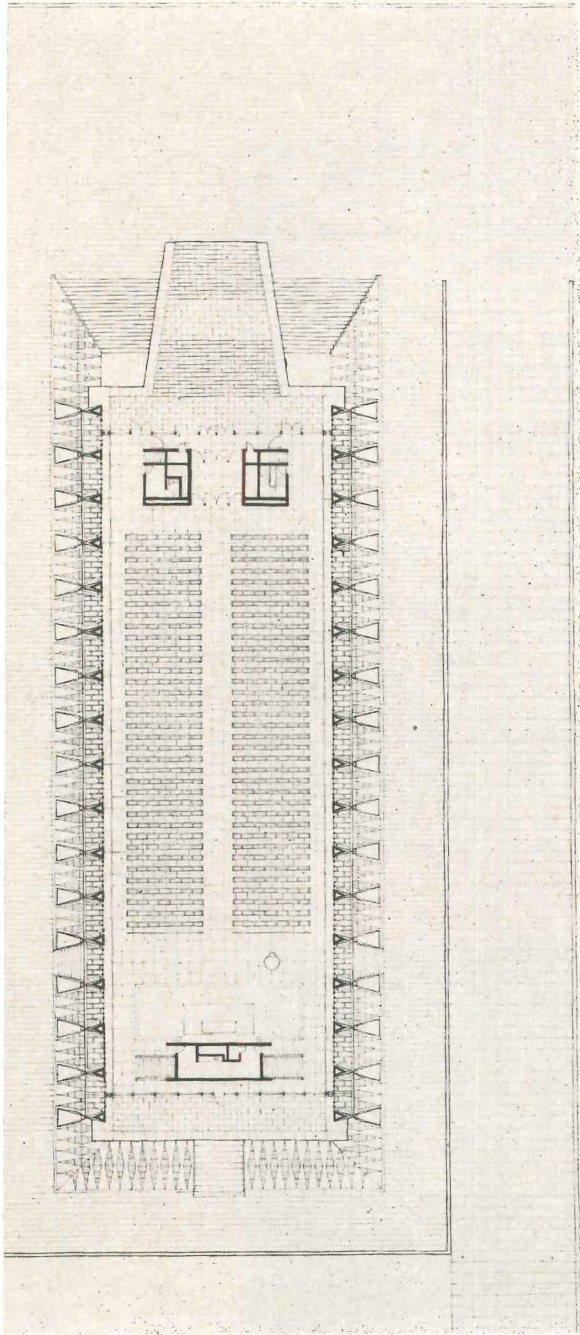

UPPER LEVEL

**THE COLORED GLASS** strips are composed of 24 hues (no greens), and range in general tonality from violet at the narthex through blues and reds to a golden glow at the reredos and altar. The gable ends and triangular base windows are glazed with a luminated, tempered, amber glass containing a reflective layer of antique silver which reduces both radiant heat and glare

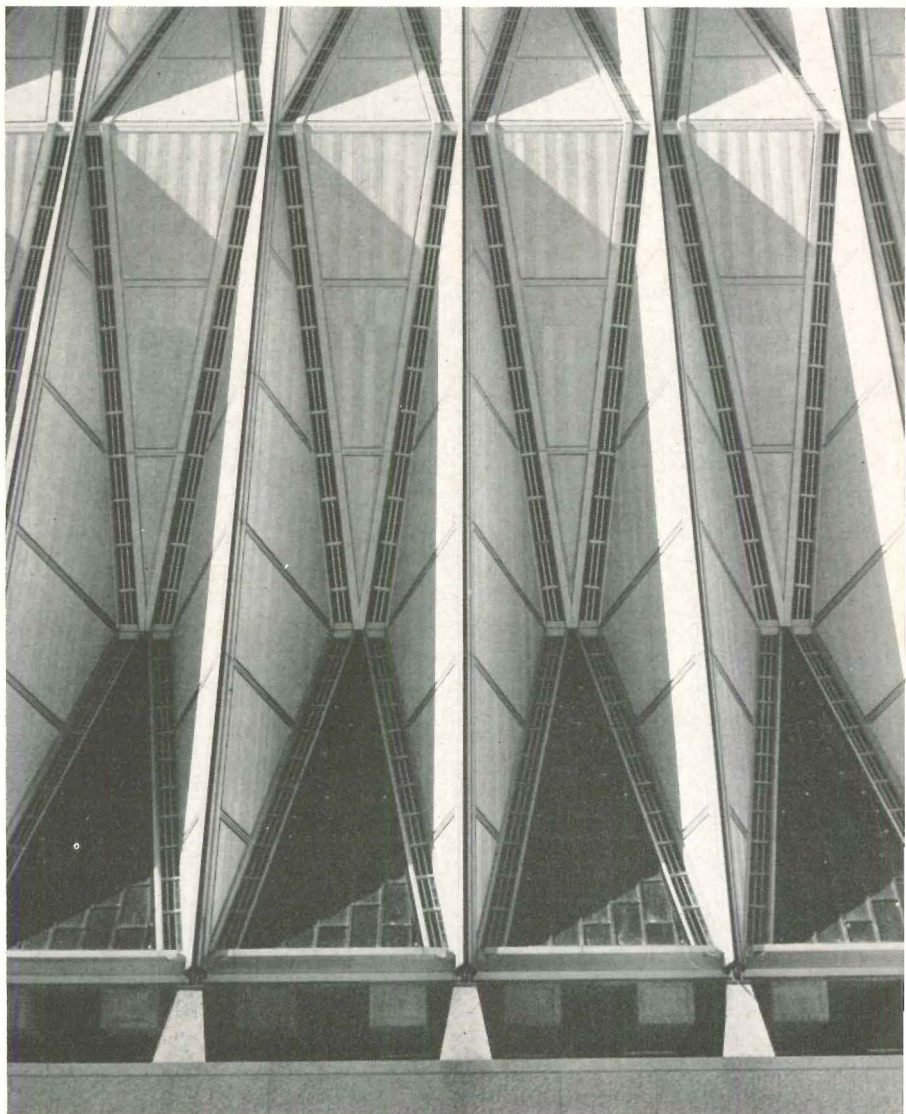
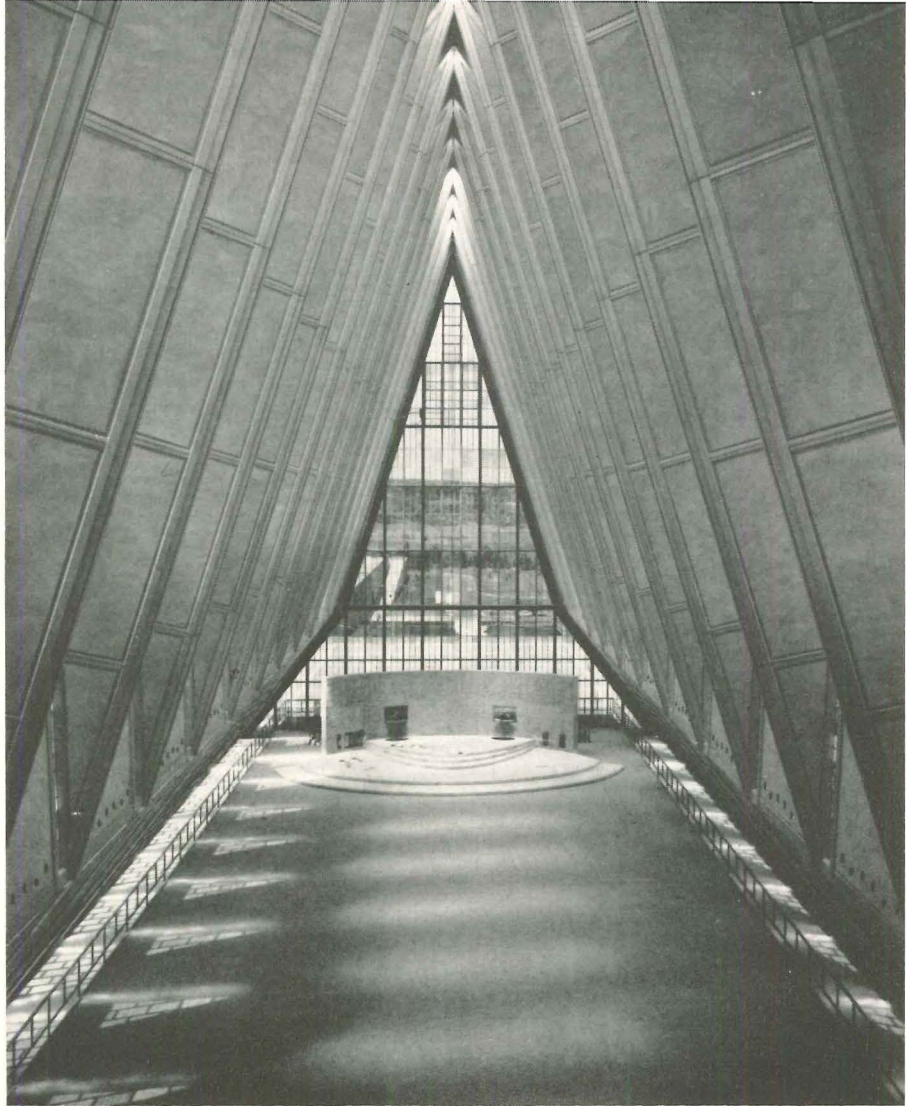

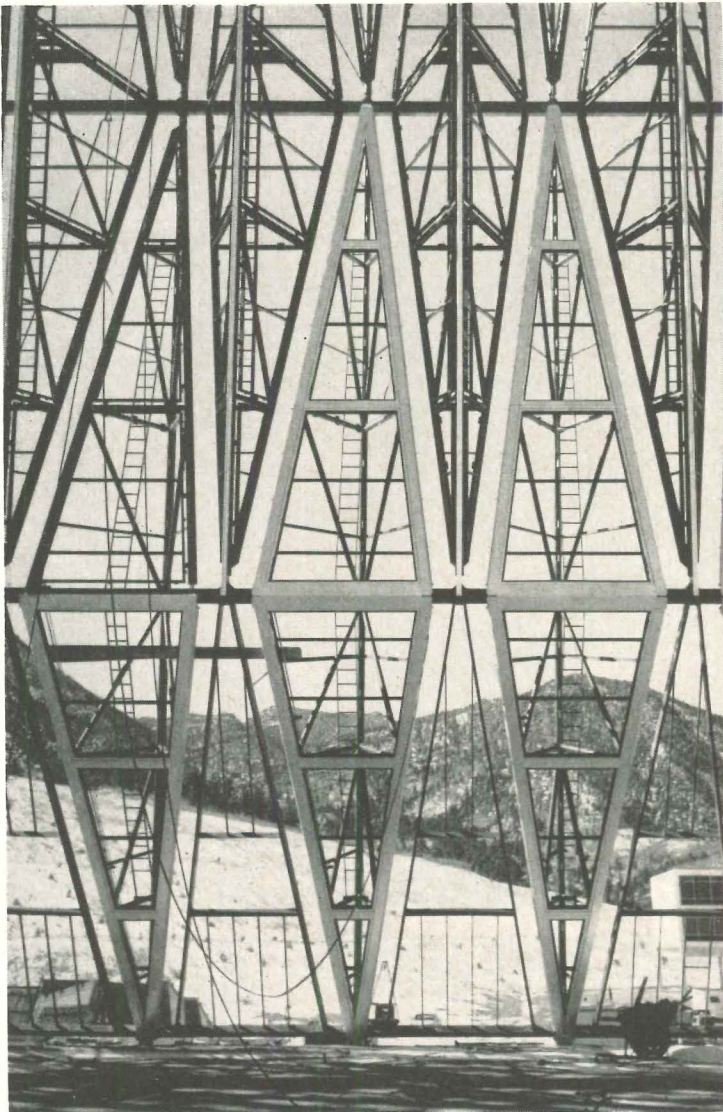

**THE 100 TETRAHEDRONS** shown on this page in detail and in various stages of assembly, are each 75 feet long; have a structural skeleton of steel pipe; and are clad with aluminum sheets outside, while their interior finish is plaster on precast panels held in aluminum surrounds. The primary members are 6-inch pipe; secondary cross-braces are 4-inch pipe. Pipes were mitered at intersections, welded into units off the site and shipped by rail and truck. Cranes lifted the tetrahedron units into place; bolting was used for field erection; the structural assembly was then welded. Steel angle frames support the skin; aluminum frames carry the interior finish and sash.

The fuss over weather leakage at joints is being resolved to the satisfaction of all; double glazing (originally called for in the architect's detail and then eliminated for economy's sake) will be provided and should solve the problem

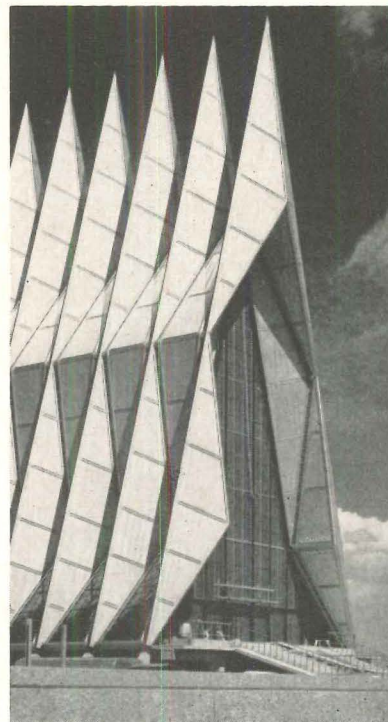
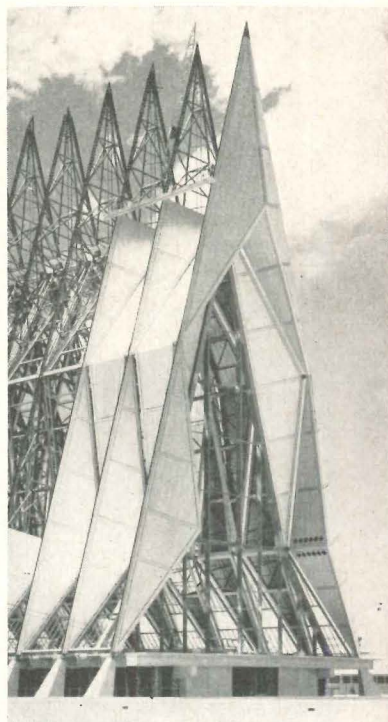
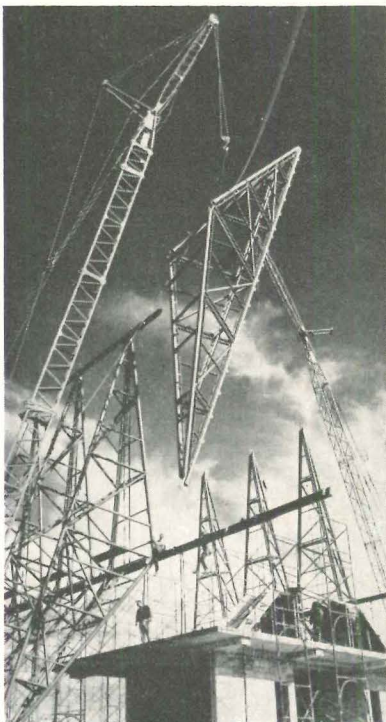

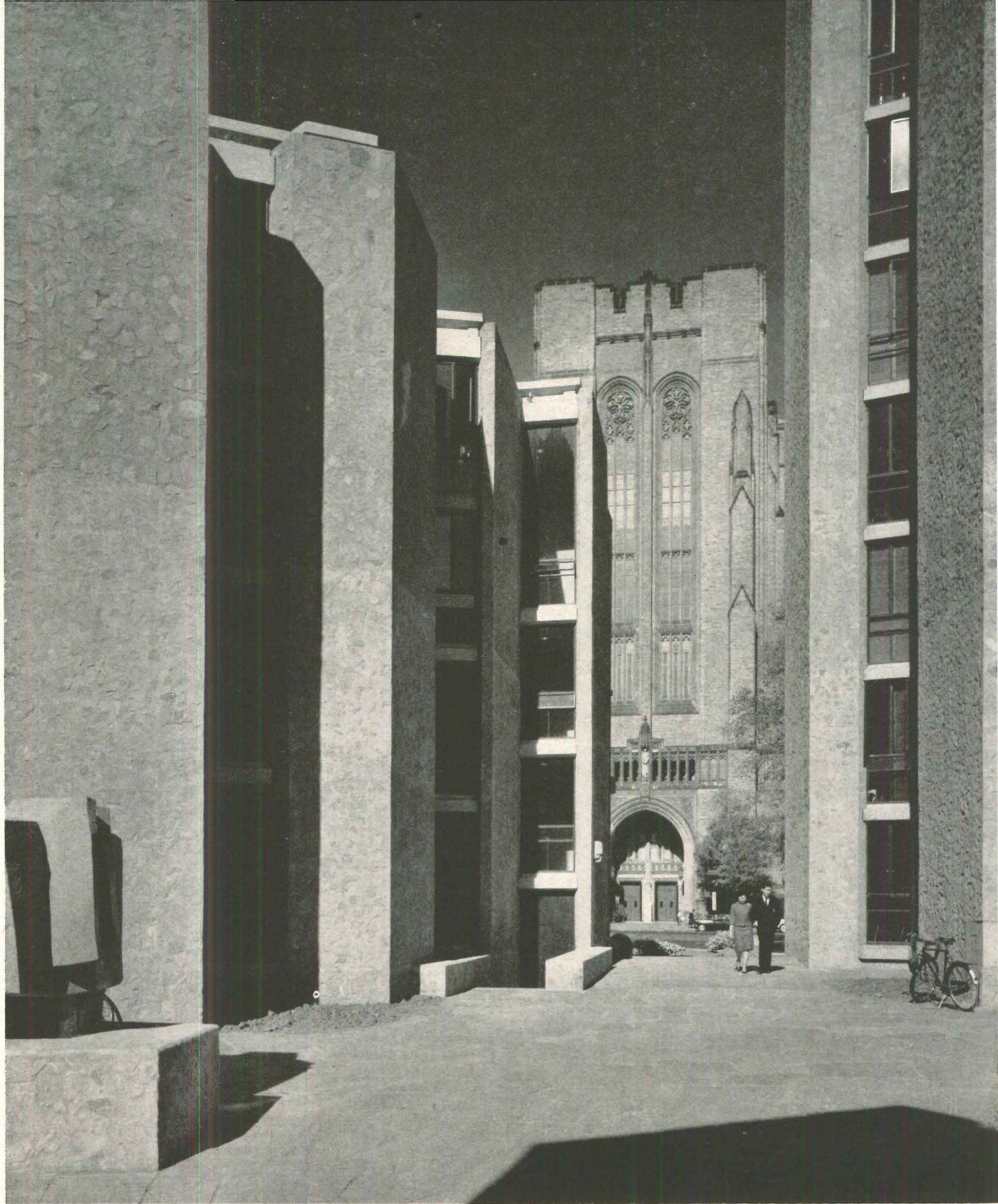

# NEW AND OLD AT YALE

For the Yale residences, Saarinen's architecture of rough stone polygonal masses, many-sided, curved, angled; a new kind of architecture that seems to belong at old Yale

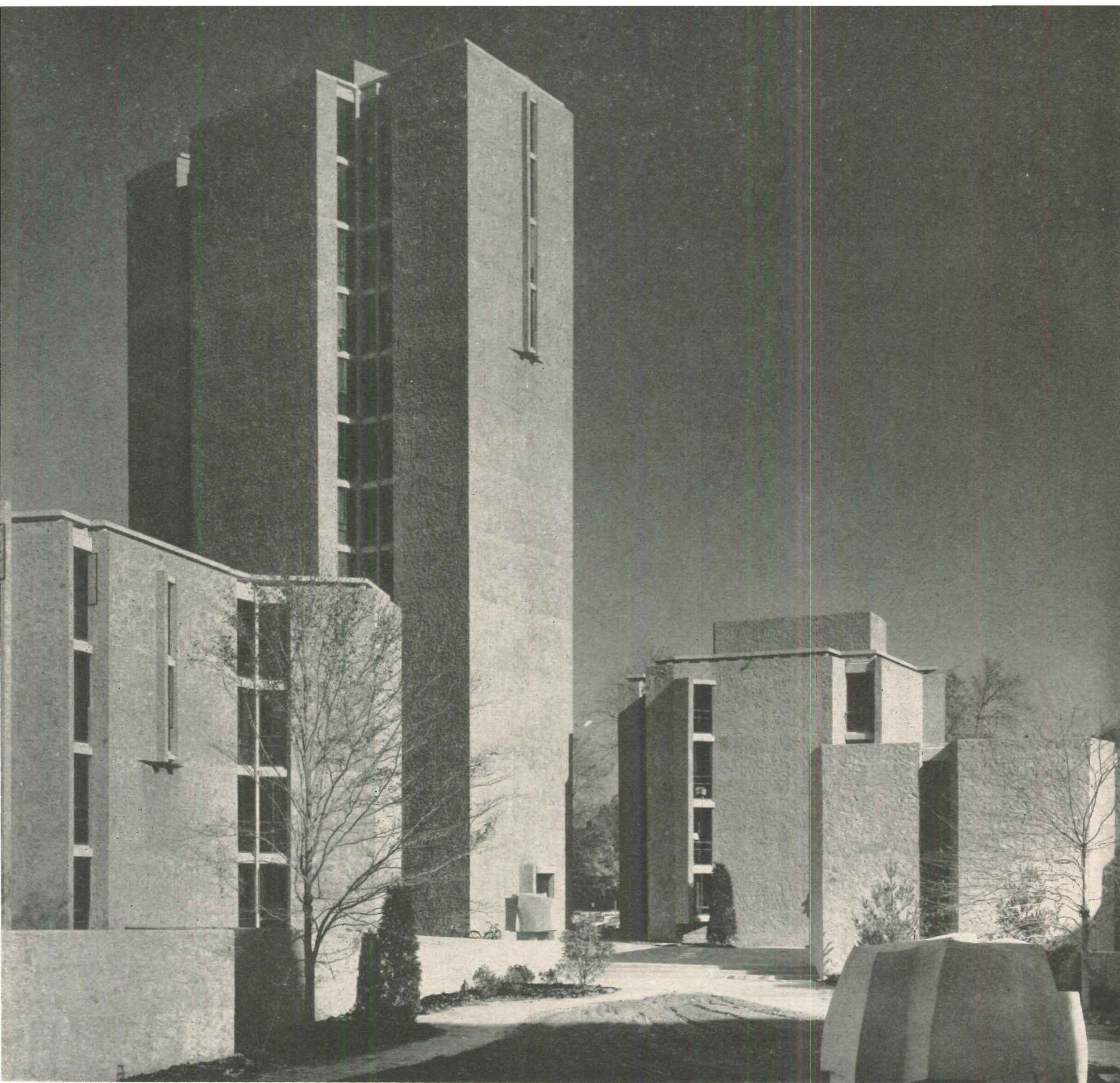

Joseph W. Molitor photos

*Samuel F. B. Morse and Ezra Stiles Colleges  
Yale University, New Haven, Connecticut*

ARCHITECT: *Eero Saarinen and Associates*

LANDSCAPE ARCHITECT: *Dan Kiley*

SCULPTOR: *Constantino Nivola*

STRUCTURAL ENGINEER: *Henry A. Pfisterer*

MECHANICAL AND ELECTRICAL ENGINEERS:

*Van Zelm, Heywood and Shadford*

FOOD SERVICE CONSULTANT: *Howard L. Post*

CONTRACTOR: *E & F Construction Company*

*Saarinen's way of solving the problem at Yale of providing new residential colleges that would seem at home among the existing neo-Gothic buildings was to create a new, yet traditional, architectural idiom: modern architecture that King Arthur would like. The finished colleges achieve—with distinction—the qualities the architect was seeking: ruggedness, masculinity, diversity and individuality. If one were to try ranking Saarinen's achievements, this project would be at or near the top of the list.*

*In 1960, when the design was made, Saarinen explained: "As we studied the dual challenges of site and meaning, we realized these problems could not be solved with the current vocabulary of modern*



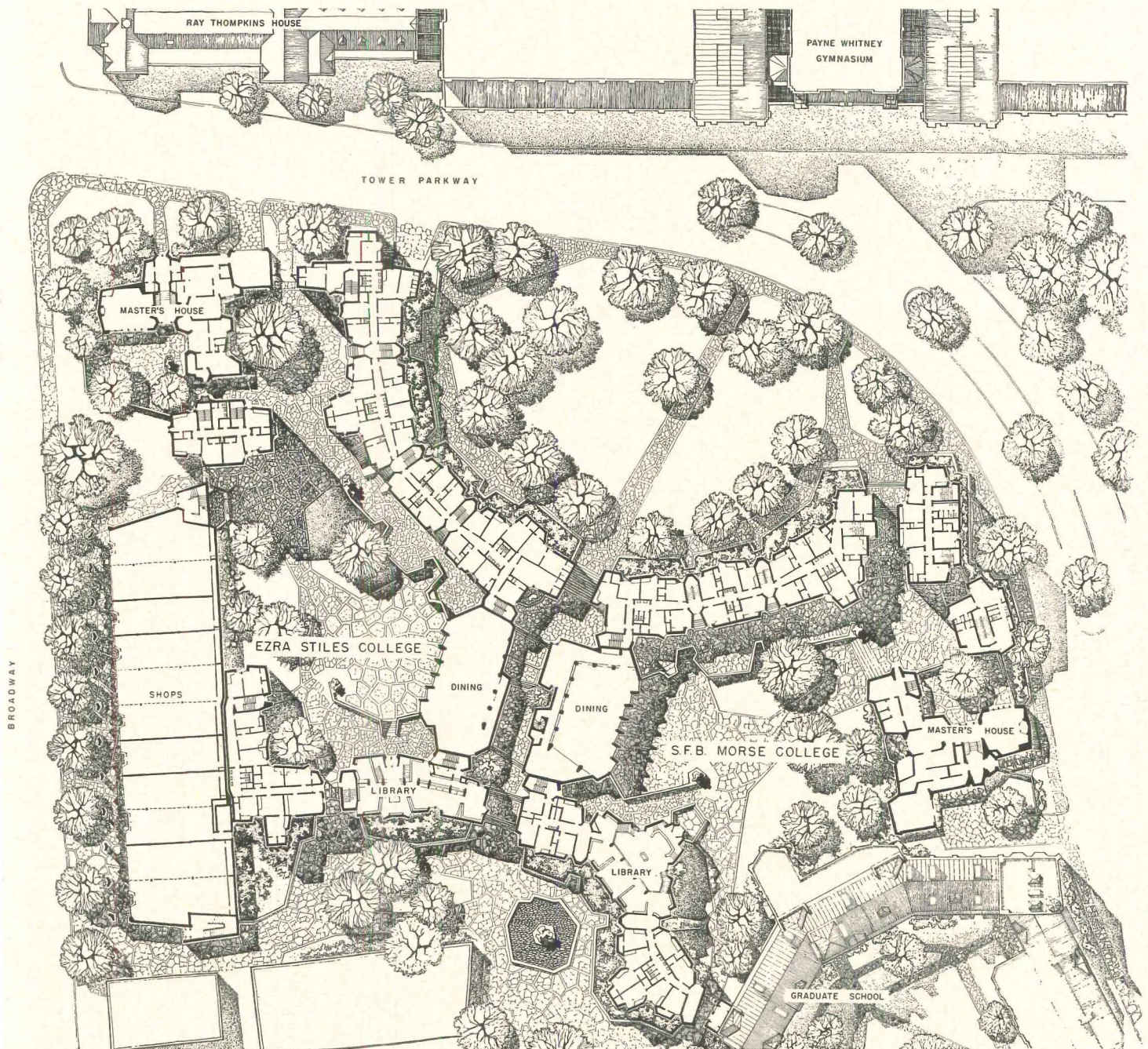

architecture. The familiar systems, elements and materials of modern architecture—regularity, uniformity, standardization—were at odds with the diversity and individuality we wanted. Flatness, lightness, glistening metal and glass—smoothness instead of rough texture and chiaroscuro—all these failed to express the spirit we were after. Rectangles and cubes seemed ill-suited to the irregular site, bounded by buildings at a variety of angles.

“Thus, we made the buildings polygonal; their shapes calculated to provide a diversity of student rooms, answer site needs and give a variety of spatial experiences in the courts. A large-scale bending of walls will give the buildings appropriate scale.

Most significantly, we conceived these colleges as citadels of earthy, monolithic masonry—whose interiors of stone, dark oak and plaster would further their spirit of strength and simplicity.

“Conventional masonry requires anachronistic handcraft methods, so we devised a new technology for stonework. Crushed granite ranging from 6 to 12 inches is dumped into regular concrete formwork containing the necessary reinforcement; high-strength cement grout is then pumped in through vertical hoses placed 4 feet apart. The following day the form is removed and the excess surface grout cleaned away, revealing the stone as a large-scale exposed aggregate integral with the surface.”

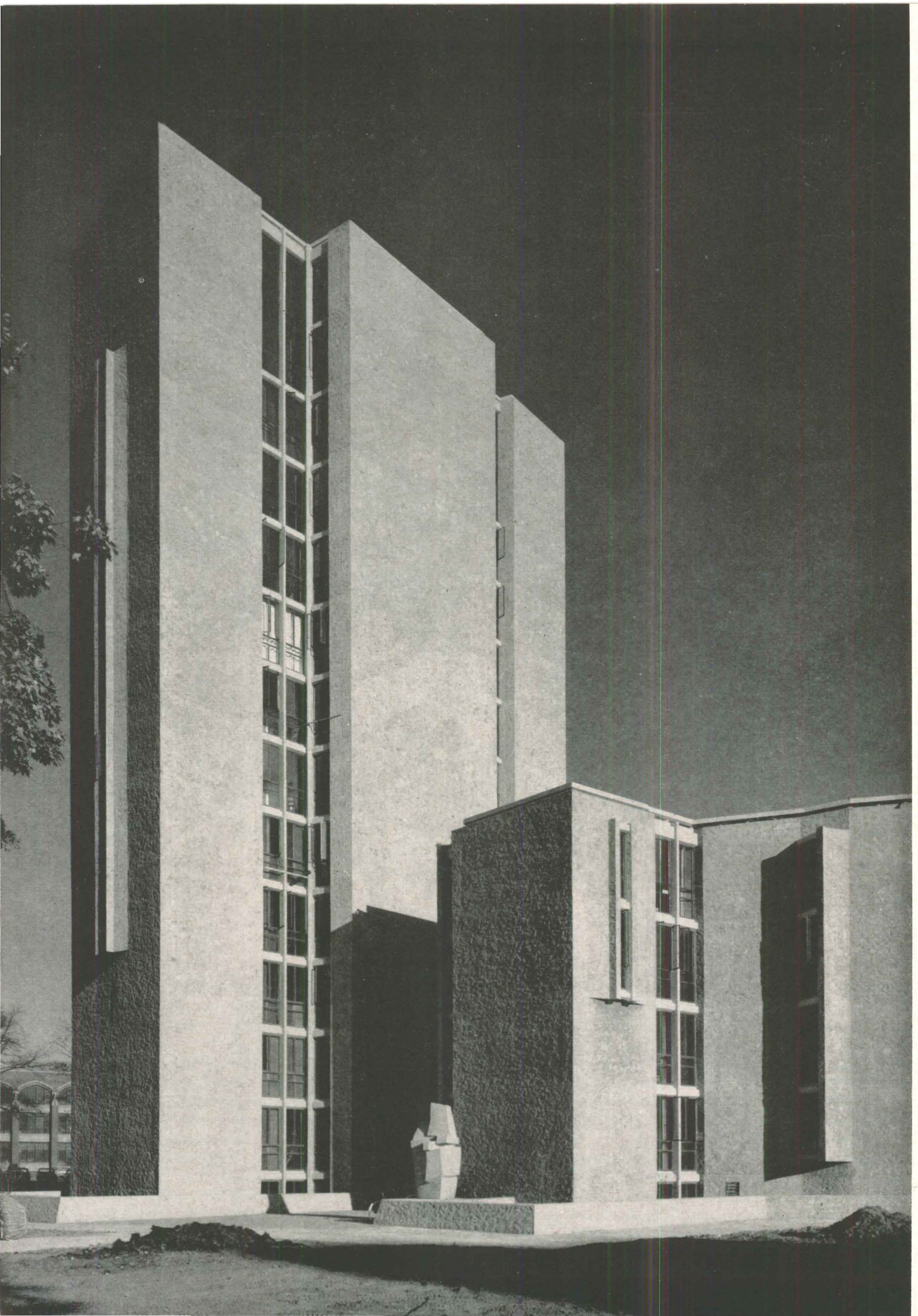

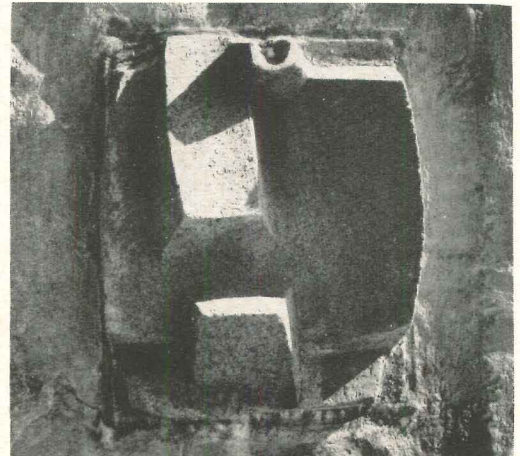
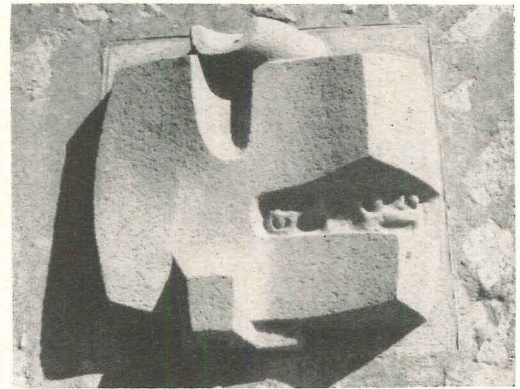
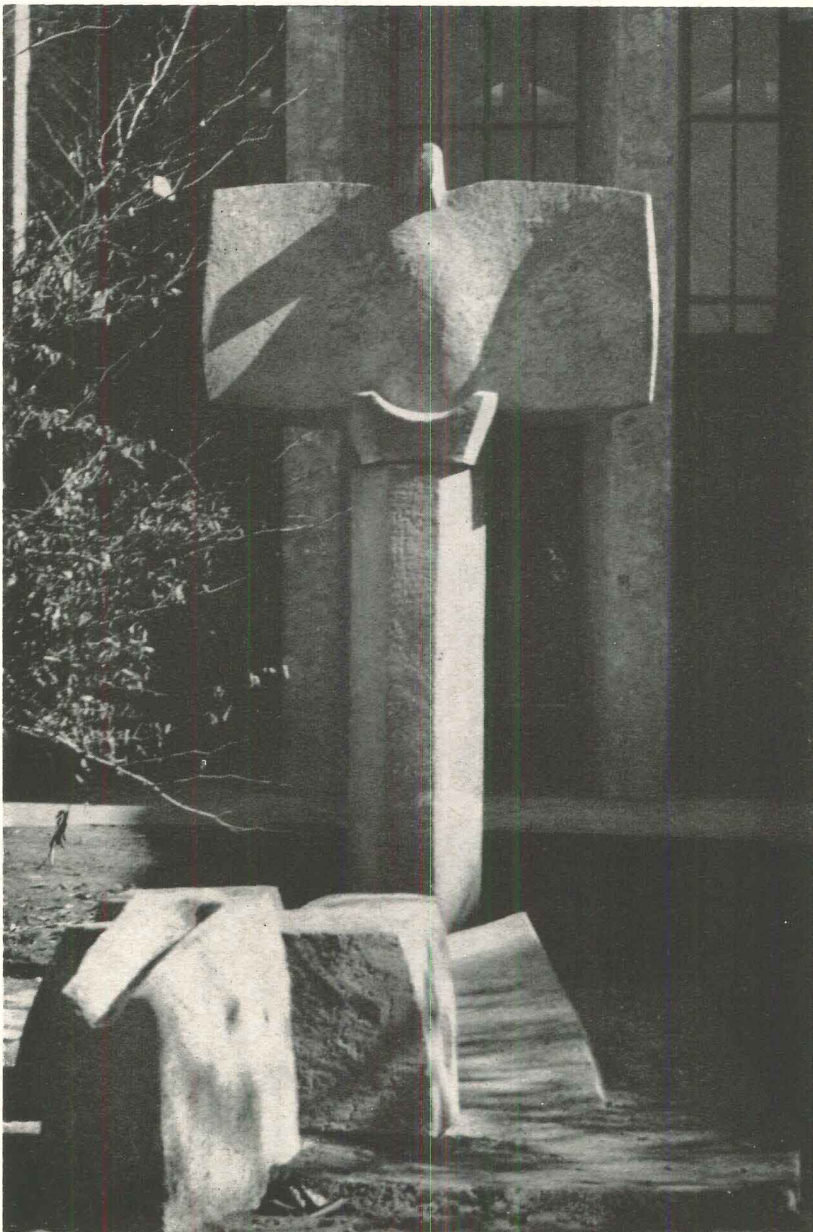

**CONSTANTINO NIVOLA'S SCULPTURE** of concrete opposes a whimsical and captivating note to the stylized planes and angles of the buildings. Inserts enliven walls here and there; one turns a corner and is pleasantly surprised by a free-standing work engagingly confronting one. Nivola feels that sculpture and architecture must be consistent in their techniques and materials if they are to live happily together. For him, sculpture must have a scale that suggests where it belongs. Note the "right for its place" feeling the work at left has as it rests appropriately in the corner of a vertical wall and a tower. Students will probably take delight in walking over the prone Prometheus (*photo above*) as a menacing, spread-winged eagle hovers commandingly overhead.

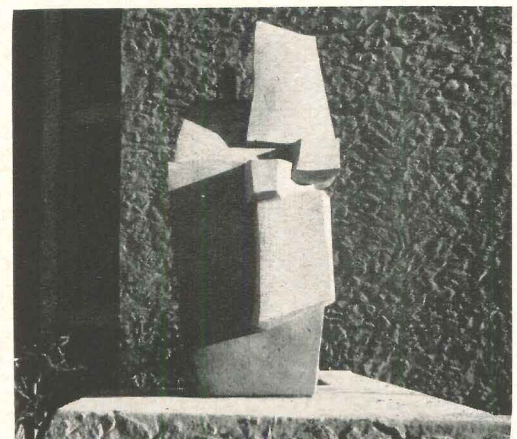

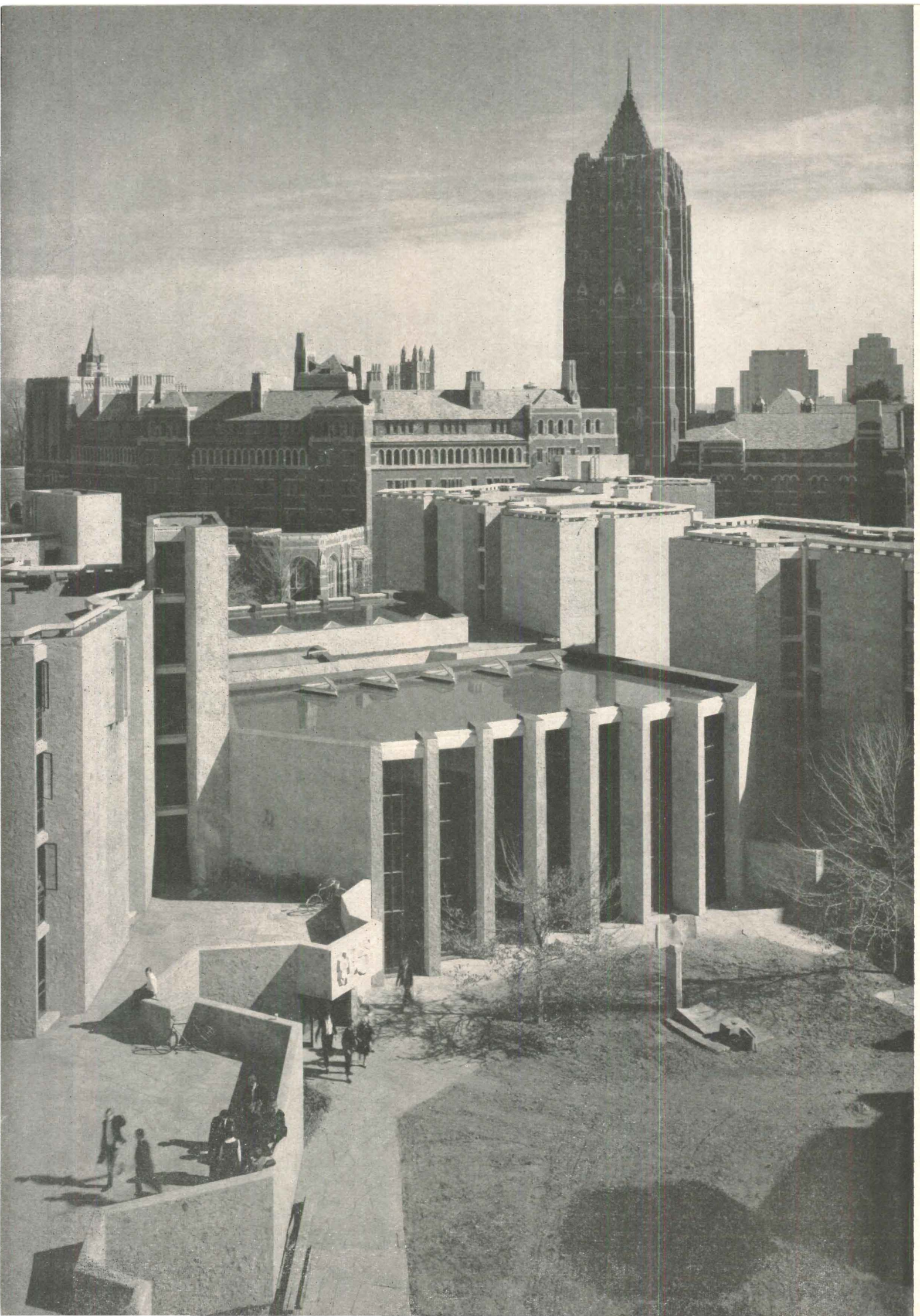



**DINING HALLS** are provided for each of the colleges, as well as lounges, library and buttery (snack bar) shown at right. A birdseye view of a dining hall and adjacent landscaped courtyard is shown on the left page, with neo-Gothic spires rising in the background; a dining hall interior is shown above. The exposed aggregate walls are carried inside and combined with dark stained oak to create dining interiors of uncommon masculinity and great style. The diagonal trusses are of precast concrete left natural; daylighting is balanced by means of triangular skylights between trusses (*left*); floors are of dark oak. Each college will house 250 undergraduates, plus offices and quarters for faculty fellows and a separate master's house looking out to its own, walled garden.



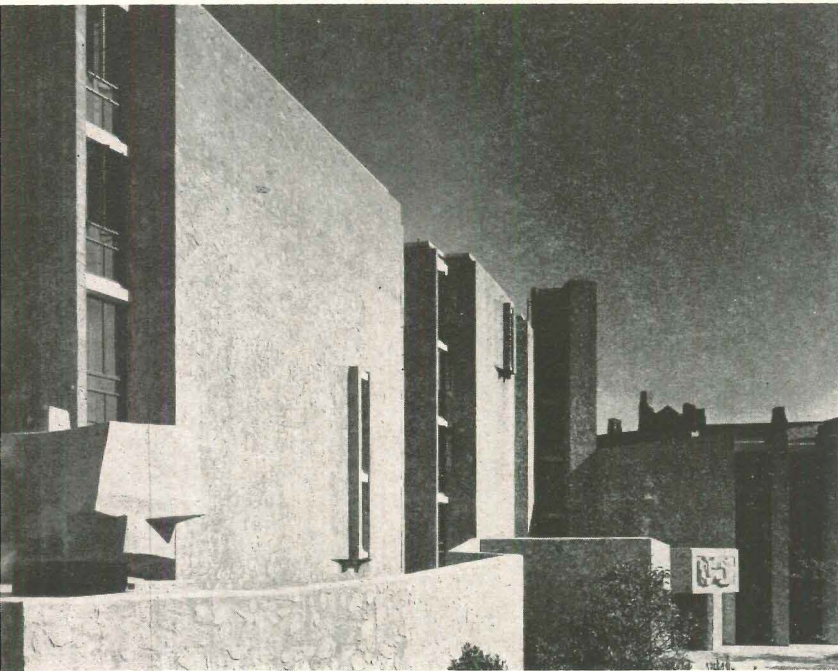

This view of a typical courtyard facade points up the great variety of form and fenestration used; shows also the appropriate character of Nivola's sculpture



Commercial buildings for retailing were required along Broadway, and they were designed as a rectangular block that acts as a barrier between street and colleges and serves also to define one edge of the Stiles College courtyard. Bronze letters will identify each shop

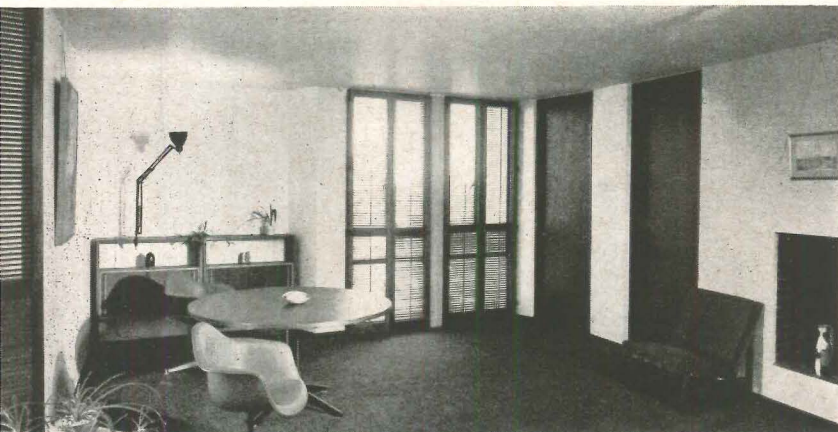

Here one sees a photo of the living room of one of the faculty fellows, located high in one of the towers. Adjustable slatted screens of this type are used throughout to shade (or throw open) characteristic floor-to-ceiling windows

### 3. MEGALOPOLIS AS ANTI-CITY

#### FLIGHT FROM THE CITY

The bureaucratic ideals of standardization, regimentation and centralized control have left their mark on all our urban planning for the last half century: the city, to paraphrase Aristotle, has become Organization Man writ large.

In reducing the realities of living organisms and human societies to calculable financial abstractions—square feet of rentable space, acres of traffic interchanges, miles of superhighways, millions of taxable real estate—the constructors and administrators of our modern, machine-conditioned metropolises have overlooked the essential task of the city. That task is to provide the maximum number of favorable opportunities for large populations to intermingle and interact, to interchange their human facilities and aptitudes as well as their economic goods and services, to stimulate and intensify by frequent contact and collaboration many common interests that would otherwise languish.

This neglect of the corporate activities and personal participations of the city, derives from a new situation. Except for the extractive industries, production and consumption can now be carried on almost anywhere. The more mechanized and automatic the economic operations, the less need they have of the city's human abundance and cultural variety. More than half a century ago the prophetic eye of H. G. Wells pointed out in "Anticipations" that, with the railroad and the motor car—and soon, he foresaw, the airplane—the population would become "delocalized" and mobile. He pictured detached villas and factories spread all over the countryside, entirely released from the gravitational field of the big city.

This pressure toward total dispersion has been embodied in two different concepts of urban design that still keep on cropping up. The earliest was that of the Spanish engineer, Soria y Mata: he proposed in the eighties to create a continuous "linear city" by extending the existing centers systematically along their major routes of transportation, to form continuous urban belts. This idea was revived in

1910 by an American engineer, Edgar Chambless, in a book called "Roadtown", and the notion in turn was reformulated once more by Le Corbusier, before it was given a grim practical expression in some of the Soviet Russian industrial settlements of the thirties.

In an entirely undirected but diagrammatic fashion, Roadtown has automatically grown up along the major highways of America; an incoherent and purposeless urbanoid nonentity, which dribbles over the devastated landscape and destroys the coherent smaller centers of urban or village life that stands in its path. Witness among a thousand other examples the Bay Highway between San Francisco and Palo Alto. Roadtown is the line of least resistance; the form that every modern city approaches when it forgets the functions and purposes of the city itself and uses modern technology only to sink to a primitive social level.

#### THE BROADCAST "CITY"

The other model for urban dispersion was that put forward by Frank Lloyd Wright in his design for Broadacre City, with the square western section and quarter-section doing duty for the purely linear traffic-road. This plan took a self-sufficient family dwelling as the unit of urban development, and placed it on a plot of from one to three acres, repeating this unit, as one might easily do on the flat prairie, with similar rectangular plots spatially regimented to serve such minimal social institutions as might survive. On the scale of Broadacre City, less than 800 families—at most some 3,000 people—would occupy a site as large as New York's Central Park.

This fantasy of Wright's was based on both his wholesome appreciation of the hygienic and domestic values of rural life, and his Jeffersonian contempt for the many-sided corporate and institutional life of the city. In the name of the first, he was ready to shrink the acreage of productive soils and break down the special human values of the rural

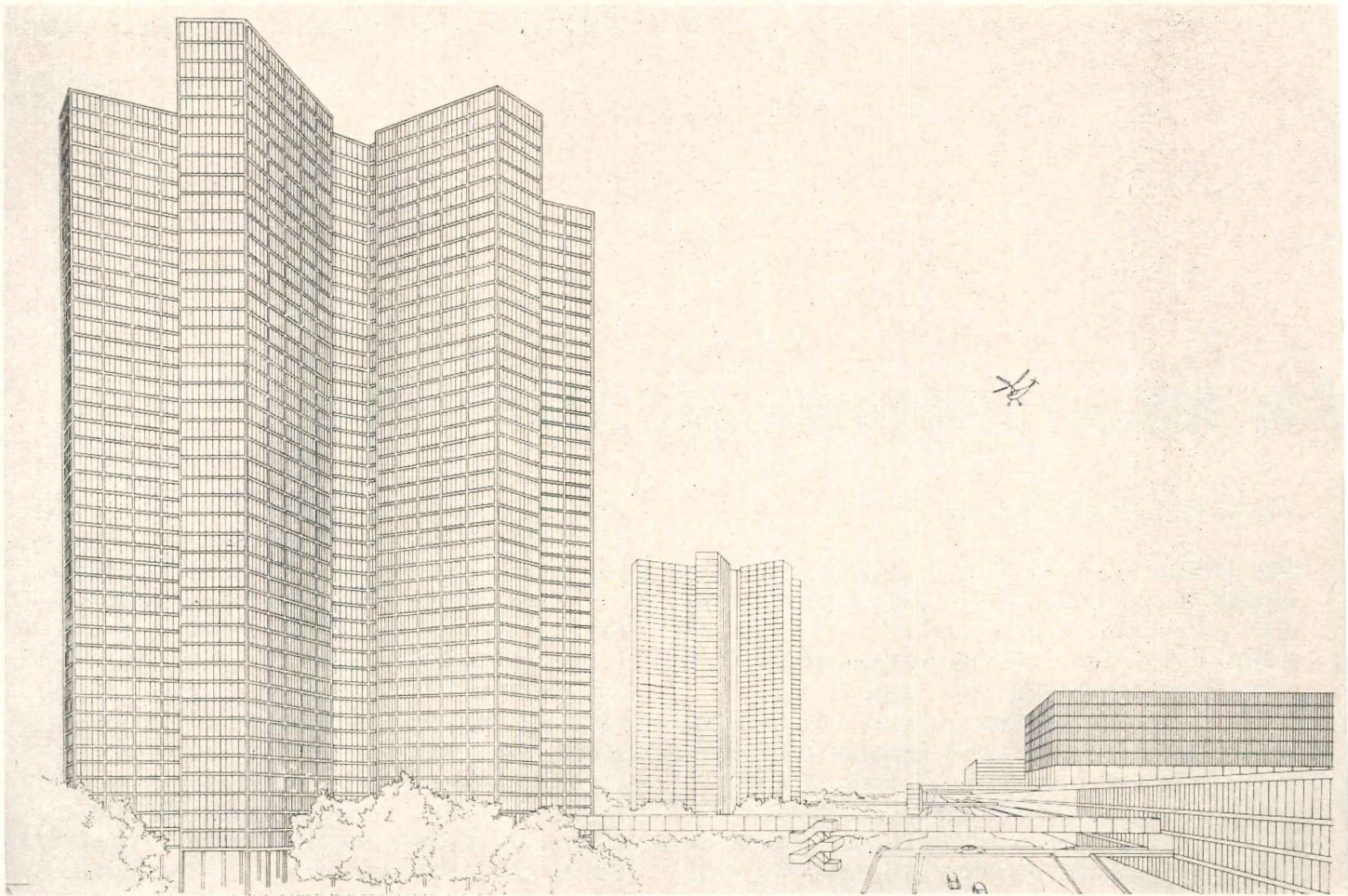

Metro-Linear: Reginald F. Malcolmson's recent study based on linear principles

landscape, with the functional divisions of meadow, pasture, and woodland, of cultivated land and wild land, in order to give every house and family a subsistence garden; and he was no less ready to break down the natural coagulations of life in villages and country towns, in a new fashion that made every social activity call for long distance transportation and therefore the incessant use of the motor car.

Wright's handsome disciplined designs for Broadacre City were never carried out except in piecemeal form. But the idea itself has indirectly had a devastating success, since it merely represented in a coherent pattern the random forces, mechanical and financial, that have been disintegrating the city.

In short, what Wright proposed as "the City of the Future" proved to be what his countrymen, during the next thirty years, would turn into our dismal sub-suburban present, abetted as they have been by exuberant highway building and expansive motor car production. The upper income group image of urban dispersion is the green ghetto of the exurban community, just far enough beyond the metropolitan center and its spreading suburban belt to be able to zone its territory for housing at a mini-

mum density of one family to the acre. The high price of such remote lots automatically turns the farmer into a real-estate speculator, and results, as in California, in the slaughter of the orchards, vineyards, and market gardens that once gave both health and delight—to say nothing of fresh food—to the nearby urban communities. Every year, according to Dr. Marion Clawson, a million acres of agricultural land are taken over for housing, largely scattered in green acres, and another million acres are withheld from farming through speculation and social erosion.

The result is not a new kind of city on a super-metropolitan scale, but an anti-city; not merely destitute of urban attributes, but inimical to the most important of them—the unification of specialized vocations and interests in order to produce a more stimulating and creative common life. And instead of producing the maximum amount of freedom and spontaneity, this scattering of the metropolitan population over the remoter parts of the countryside confines its working members for ever longer periods to a mobile cell, traveling ever longer distances to the place of work or to achieve even a few of the



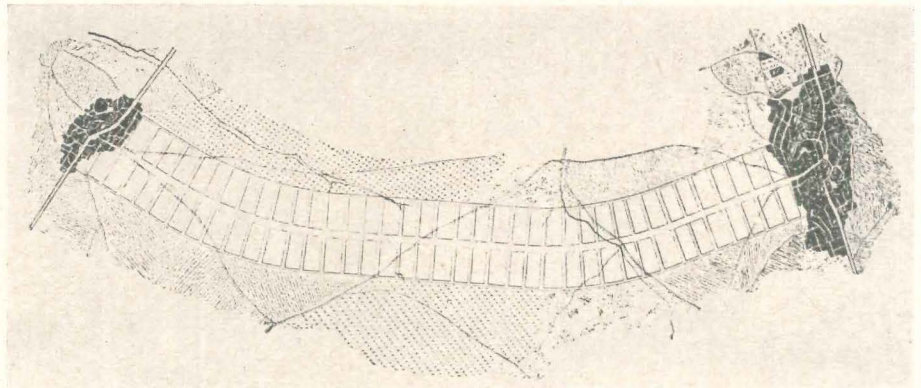

Soria y Mata's plan for a "linear city" in the 1880's

Courtesy, Museum of Modern Art, New York

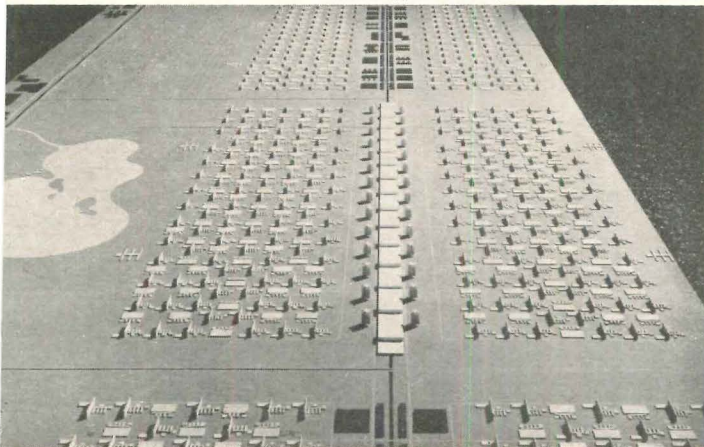

*"Roadtown is the line of least resistance; the form that every modern city approaches when it forgets the functions and purposes of the city itself and uses modern technology only to sink to a primitive social level."*

social and interpersonal relations that the city once provided at one's elbow.

On the surface Frank Lloyd Wright's ideal of the self-sufficient rural household in a thinned-out pattern of settlement might seem to be a large-scale domesticated fulfillment of Thoreau's Walden; but actually he had projected in elegant geometric form a regime as antithetic to Walden as Skinner's "Walden Two" or his own later "skyscraper a mile high." Walden was at least attached to Concord, and Concord in turn to Cambridge and Boston: so even in isolation Thoreau partook of the multi-dimensional social life of the city.

## ARCHITECTURAL LURE OF THE ANTI-CITY

The anti-city that is now being produced by the reckless extension of standardized expressways, standardized roadside services, and standardized residential subdivisions—all greedily devouring land—dilutes to the point of complete insolvency all the valuable urban functions that require a certain den-

sity of population, a certain mixture of activities, a certain interweaving of economic necessities and social occasions. Despite all that, this negative image has proved, especially during the last two decades, to be a highly attractive one; so powerful that many people already identify it, despite its brief history and meager promise, with the "American way of life."

The reason is not far to seek, for the anti-city combines two contradictory and almost irreconcilable aspects of modern civilization: an expanding economy that calls for the constant employment of the machine (motor car, radio, television, telephone, automated factory and assembly line) to secure both full production and a minimal counterfeit of normal social life; and as a necessary offset to these demands, an effort to escape from the over-regulated routines, the impoverished personal choices, the monotonous prospects of this regime by daily withdrawal to a private rural asylum, where bureaucratic compulsions give way to exurban relaxation and permissiveness, in a purely family environment as much unlike the metropolis as possible. Thus the anti-city produces an illusory image of freedom at

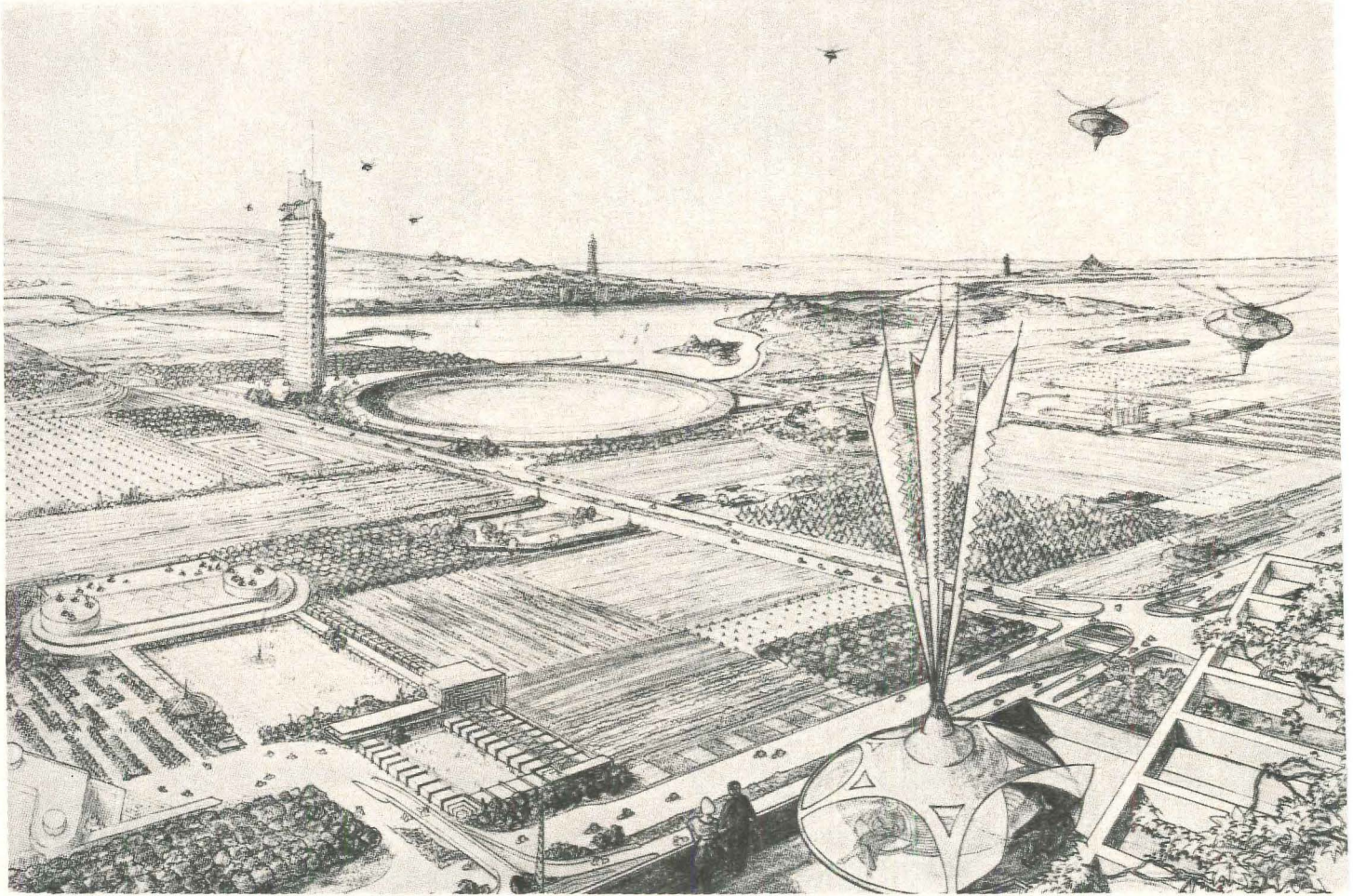

Frank Lloyd Wright's Broadacre City

the very moment all the screws of organization are being tightened.

Though the anti-city, almost by definition, is hardly imageable, its scattered parts are often esthetically attractive and humanly rewarding. Moreover, as a practical expedient, the anti-city has at its disposal the combined forces of highway engineers, motor car manufacturers, real estate developers, and lending institutions: all the more favored because its very randomness avoids the need for disciplined cooperation and municipal coordination. Because the anti-city is by nature fragmentary, any part can be built by anybody anywhere at any time. This is the ideal formula for promoting total urban disintegration.

Not the least factor in this development, certainly in America, is the persistent residue of the curious pioneer belief in space and mobility as a panacea for the ills of social life. In a recent discussion of the siting of a new university in California, which has been endowed with thousands of acres at the outskirts of a small, well-situated coastal town, I found I was almost alone in favoring a compact development in close proximity to the existing facil-

ities of the town. Most of the administrators, under the current doctrine of space for space's sake, favored a much looser grouping of buildings, miles away from the center of the town, with a faculty housing subdivision even more remote and more segregated. Characteristically, this scattering would necessitate the building of a special motor road and the sacrifice of valuable university land to parking.

When the sense of the city's reason for existence is lacking, there is nothing to keep the parts from spreading ever further away, not merely from the metropolitan centers but from each other. This has become the "space age" with a vengeance: in architecture space has become a substitute for urbane design. In opting for the anti-city, the architect and the business man play into each other's hands. Great business enterprises tend more and more to operate like self-sufficient feudal enclaves, watchfully regulating the activities of their employes in the interest of their health, working efficiency, and future promotion. By moving into the open country, a corporation can plan self-contained facilities, on land hitherto unbuilt on, and occupy acres at a lower price than the city demands for square feet. In this new

Photo of drawing from "The Drawings of Frank Lloyd Wright"  
by Arthur Drexler, published for the Museum of Modern Art by Horizon Press

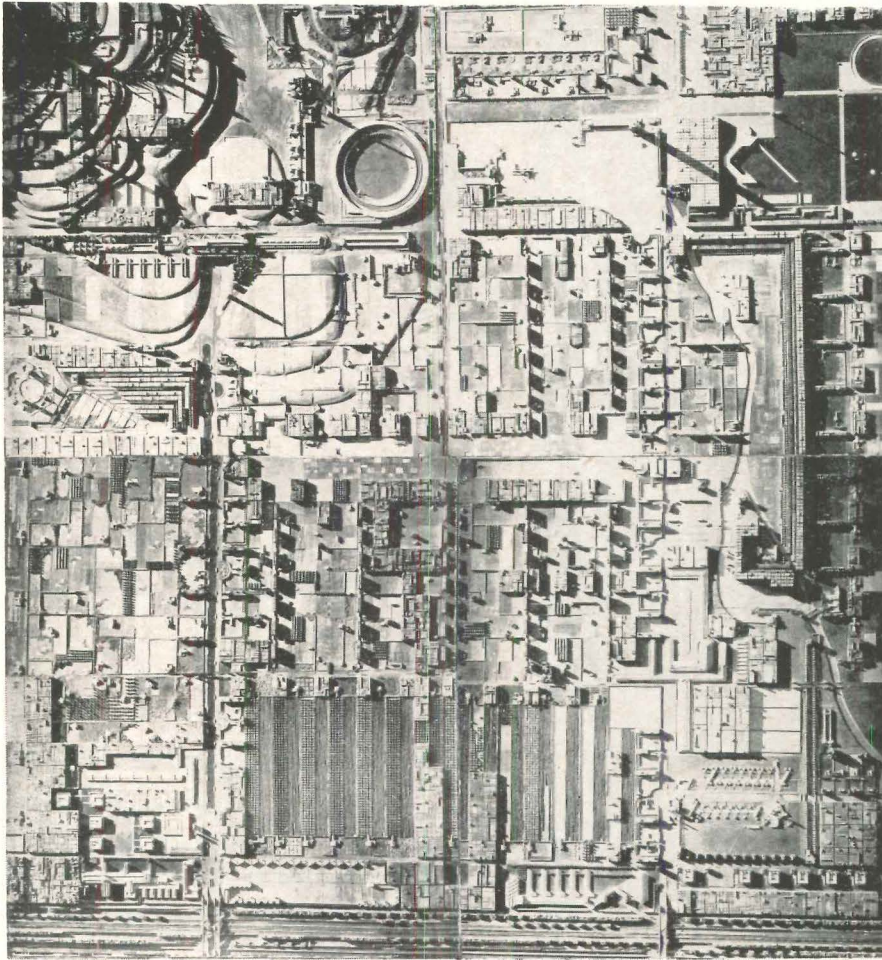

*"Wright's handsome disciplined designs for Broadacre City were never carried out except in piecemeal form. But the idea itself has indirectly had a devastating success, since it merely represented in a coherent pattern the random forces . . . that have been disintegrating the city."*

anti-urban pattern, each agency has its own self-contained plant, surrounded by broad acres of parking lot, often with its own bowling alley, its own medical clinic, its own hospital; while its employees draw upon the marketing facilities of a shopping center equally insulated in space.

These conditions have proved highly attractive to the architect, too. Even if he does not share Frank Lloyd Wright's delight in the rural background as such, he too easily falls for the attraction of empty acres upon which his individual creation will stand gloriously alone: no longer cramped by inadequate frontages, by insufficient land, or by too exacting urban building codes and zoning regulations; no longer in danger, either, of being defaced or obliterated by the building next door. The archetypal model for this overspaced existence is the airport.

This lonely eminence is a powerful lure; all the more so because the new rural office buildings, the new industrial parks, sometimes even the new shopping centers, above all the new schools and college campuses can in fact often show a much higher level of design than their constricted metropolitan equivalents. Apart from the architect's freedom, one of

the reasons for his readiness to desert the city is that with land so cheap, a proportionately greater part of the budget can be spent on the building and the landscaping. Unfortunately, this distinction too often is nullified by the immense paved void of parking lot, and the esthetic result is sullied by regiments of motor cars in the foreground.

Actually, the conditions provided by the anti-city are not so favorable in the long run for any purpose as either the architect or the business man imagines. This spatial openness, on close examination, proves to be social enclosure and constriction; and too often the architect himself, in obedience to the dominant bureaucratic principle, nullifies the advantages of his ample acres by designing a sealed-in, air-conditioned building, whose blank, Venetian-blinded facade turns its back on the landscape and mocks its very openness with a tightly closed inner court. Alternately, the plethora of space may go to the architect's head and cause him to produce loose, rambling plans and vacuous incoherent structures, as overspaced as his parking lots. What the modern architect needs for a better model is an image of variety and multiformity and social complexity and con-



*“Not the least factor in this development, certainly in America, is the persistent residue of the curious pioneer belief in space and mobility as a panacea for the ills of social life.”*

centration that neither the bull-dozed landscape of Roadtown nor the systematic dispersal of Broadacre City provides. Only the city can bring him back this image or the life that it stands for.

## HOMOGENIZED URBANITY

Both Roadtown and Broadacre City have provided such persistent images for the “City of the Future” that one must pause for a moment to show how, despite their professions of spatial and social liberation, and their effort to bring urban settlements closer to the agricultural and recreational areas of the countryside, they actually have only introduced the typical vices of the overgrown and over-regimented metropolis in a new form. For first of all, both concepts attempt to break down the most fundamental of all organic limitations: the functional limits of growth. Every organic form has, as Aristotle pointed out, an upper and lower limit of growth; and this applies, as he also pointed out, even to purely physical utilities, like ships, because if a ship is too big it is not maneuverable or seaworthy, and

if it is too small it cannot carry a sufficient cargo. In the case of cities, this natural limitation had, until the 17th century, rarely been overpassed: except for a few Romes and Babylons, the city by its very size and form expressed the need for social concentration.

Not merely do these anti-urban concepts destroy the social forms of the city, they likewise destroy the natural variety in the size and architectural structure of communities, a variety determined by a multitude of conditions: local population, agriculture, topography, productive industry, transportation, and cultural affiliations. There is a great choice in the style of life as between a solitary villa, an agricultural hamlet, a country village, and a country town on one side, though they all have the common attribute of ample areas for gardens and for play, and these in turn are different from the more urban styles of the small industrial town, the suburb, the seaport, the small provincial city with a base of its own, the satellite town, dependent upon the metropolis, and the metropolis itself, with its historic concentrations of culture. As long as this wide range of settlement is maintained, with its cor-



Connecticut General Life Insurance Company headquarters outside Hartford, Conn. Architects, Skidmore, Owings & Merrill

responding assortment of sizes, all limited by function and need, every type of human character, every kind of industrial and cultural interest, can be satisfied somewhere. To concentrate on a single urban type, even though it be as big and far-reaching as a New York, a London, or a Tokyo, is to wipe out a valuable store of human potentialities.

Since form is conditioned by these other factors, the greatest wealth of architectural and town planning forms is possible. The anti-city image has only one form: a negation of complexity, ecological variety, and intimate social cooperation. Each fragment duplicates, with massive monotony, the limited premises upon which the negative image was based.

Finally, these images of total urban dispersal destroy by their very premises another significant organic characteristic, which in the city takes a special institutional form: the power of the attractive nucleus to serve as a magnet for concentrating a diversity of functions and purposes. Without such a nucleus, aided by many sub-nuclei, urban life lacks organs for mixing, meeting, mobilization. The essence of the city is its ability by its very form to focus human activities, and to make visible by sym-

bolic magnification the true nature of the human condition and the human prospect. Historic cities, above all great metropolises, thanks to the accumulations of time and sentiment, have powerful nuclei, which magnetize not merely their own inhabitants but people from distant regions. For many occasions their magnetic field has now become planetary. The absence of such social foci in the anti-city actually puts an end to necessary urban functions and imposes a uniform pattern of life, derived at second or third hand from some distant metropolitan center that still retains the surviving vestiges of the city's social properties.

The total result of these defects is to do away with natural variety, with urban individuality, with human choice. But from the standpoint of the other essential function of the city, as a container of human culture, the diluted and homogenized environment of the anti-city proves an even greater sociological absurdity. For the capacity of the urban container should vary with the total amount of experience and culture that must be transmitted from generation to generation. Part of this heritage is carried forward in institutional and symbolic

form, represented by buildings, archives, records, libraries, for which the city serves as permanent storehouse; and an even larger part of it is transmitted directly through human agents, by daily face-to-face transactions and conversations, by direct observations and imitations, and by chance encounters as well as deliberate meetings. The size and design of the urban container must vary directly with the size and complexity of this total heritage.

If our civilization is worth while maintaining, with all its vocational differentiation and cultural variety—historic, scientific, religious, humanistic—two urban conditions must be laid down: one, a many-dimensional container capable of maintaining this richness and complexity and of distributing, over wider areas in space and time and over larger populations, the cultural wealth that urbanization both stores and helps to increase. The other condition is the creation of highly attractive focal points—cities in the historic sense, striking in form and character—where a diversity of organizations, institutions, associations, along with primary family and neighborhood groups, necessary to maintain this complex social order, can come together and profit by the constant give-and-take.

No secondary modes of intercourse, neither the printed page, the telephone, nor television, can take the place of that direct face-to-face intercourse whose occasions the city, when it remains close to the human scale, multiplies. Without an urban container deliberately planned for such intercourse, the dominant economic and technical pressures of our time tend to form a multitude of over-specialized, non-cooperating, and non-communicating enclaves, whose spatial remoteness and social segregation favor the totalitarian automatism of our time.

As an instrument for disrupting the processes of culture and ultimately arresting human development, the anti-city seems little less than a slow-acting equivalent for a nuclear catastrophe. The reduction of organic social complexity in the anti-city makes its scattered population incapable of carrying on its tasks with greater mental stimulus than that of a village: the mechanical conformity that this life exacts, by its utter dependence upon remote centrally controlled and secondary modes of intercourse, is quite as deadening as the social conformity of the tradition-bound village—and much harder to escape.

Even if the anti-city embraces a population as numerous as Gottman's Megalopolis—that is, the whole population of the Atlantic seaboard—the total cultural capacity of this atomized container would still be less than that of any single metropolis in a healthy state. Though the isolated institutional parts might be as hyper-productive as those computers whose data is already too abundant to be assembled and interpreted, the cultural creativity that fosters further human development is bound to drop, within a generation or two, toward zero.

The first institutions to feel the effect of this failure will be the great corporations that are now so often, singlehandedly, escaping from the overgrown metropolis. Not least does this hold for the various research agencies whose members, from day to day, see only their own kind, hear only echoes of their own ideas, and more and more live in a mental isolation-ward inhabited only by other specialists, equally cut off from human realities. In sheer self-defense, the directors of these institutions will have to send their staffs periodically, as the Bell Telephone Company has been sending its too sedulously trained junior executives, back to the university, to have a therapeutic injection of dynamic ideas that the city once spontaneously generated.

In view of all this, the nature of the modern city needs to be re-examined: a new pattern of urban integration more capable of utilizing the immense energies that modern man now commands must be invented. We can no longer think, in old-fashioned terms, of a "metropolis of three million people," for that no longer corresponds to the range of urban cooperation; nor shall we improve the situation by thinking of a pseudo-metropolis of thirty million, for such an agglomeration would effectually wipe out one of the most important components of the city: the natural landscape and all its appropriate cultural and recreational uses. We must rather seek a new over-all pattern for both the small-scale and the large-scale unit.

The large unit must be on a regional scale: sufficiently big to stabilize the essential rural occupations and provide a permanent green matrix, within which further urban colonization may take place. This concept, not of a *metropolitan* region dominated by a single center and continuous in structure with it, but of a regional framework capable of embracing cities of many sizes, including the central metropolitan center and giving each urban unit the advantages of the whole, has still to be worked out. But I have sketched in its main outlines under the title, "The Invisible City," in "The City in History." This larger structure, unlike the present clumsy magnification of the old Stone Age container, is rather an open network, comparable to the electric power grid, which utilizes both small and big units to form a greater interdependent system.

With a regional grid, the smallest urban unit will be able to make demands and draw on all the resources of the largest unit in a two-way system of intercourse and cooperation. But to create such a larger system, one must begin with a reorganization of small units, by introducing balance, self-government, organic growth, and a dynamic, self-renewing form into the neighborhood, the precinct, the city, and into all the institutional components of the city, which have become clumsy and disorganized through unregulated over-expansion. The first effective steps toward creating such local units have already been made; and I shall consider them next.

# BUILDINGS FOR THE AGING

BUILDING TYPES  
®  
STUDY 314

The article and exhibits on the following pages demonstrate two characteristics of buildings for the aging: variety and evolution. Architects are contributing to both of these; but no one claims the ultimate solution.

There are three kinds of building occupancy which develop out of the natural continuum of aging. They are: residential, social and medical. The problem of the architect is the judicious separation or combination of these for the longest term, total comfort of occupants who cannot be neatly categorized on the basis of age alone.

The background of social, physiological and financial factors affecting current trends in housing for the aging is outlined in the following article by Geneva Mathiasen. Examples facing text pages were selected to show the kinds of buildings these factors engender. They are followed by various architectural solutions of the three-phase occupancy problem.

Community centers, the social phase, have a special aptness in facilities for the aging. They are demonstrating over-all human values which are being translated into centers which serve for all ages.

Medical facilities for the aging are acquiring definition as long-term nursing establishments with built-in flexibility for a wide range of relatively independent residential occupancy.

It is this need for flexibility and an even greater need for full-spectrum attention to the potentials as well as to the frailties of aging that will set the pace and direction of architectural and social evolution. "The goal," says Dr. Abraham J. Heschel in "Aging," February 1961, "is not to keep the old man busy but to remind him that every moment is an opportunity for greatness."

# TRENDS IN HOUSING FOR OLDER PEOPLE

Social, financial and physiological factors affecting the design of shelter for the elderly

*By Geneva Mathiasen, Executive Secretary, The National Council on the Aging*

Five factors which affect the extent and nature of the substantial and growing market for housing for older people are: population trends; marital status; income; state of health and vigor; social and personal standards of living. The effect of these upon planning the residential environment, site selection, building design and financing will be discussed.

## POPULATION TRENDS

If we consider the ages 62 and 65 (at which social security benefits become payable) as significant age landmarks, the following figures indicate a population trend relevant to planning housing for people of those ages and older: The net yearly increase in the age group 65 and over is nearly 400,000 per year. It is estimated that by 1970 there will be some 20 million and by 1980, 26 million people 65 and over compared with 16.6 million in April, 1960. There are now 21 million people 62 and over and by 1980 it is estimated there will be at least 30 million.

Another important consideration is that the number of persons 85 years and over has increased 92 per cent since 1920. It has been pointed out that already one out of three persons reaching the age of 60 has a parent or close relative to be concerned about and that in 40 years the ratio will rise to two out of three.

## MARITAL STATUS

The older population is almost equally divided between married couples living together and those who are widowed, separated, divorced or single. About eight million are now living without a spouse. Since women tend to live longer than their husbands, there is a large number of elderly females living alone.

This situation affects, of course, the size of dwelling units and also indicates the need of living arrangements which guard against loneliness.

## INCOME

All income brackets are represented among the elderly, though the average of incomes of people in retirement tends to be low or moderate. About half

of the families headed by a person 65 or over have incomes below \$3,000. About half the single elderly persons have incomes of less than \$1,050 per year.

At present, social security benefits are the only significant source of regular income for more than half the beneficiaries and the major source of income for the great majority of the others. In 1960, the average amount of social security benefits received by husband and wife was \$1,447.92. A couple with maximum benefits would receive \$2,300. One out of every 10 persons between the ages of 65 and 69 must apply for old-age assistance through a means test to meet his basic needs, and among those over 80 years of age, one out of three is a recipient of assistance.

However, there are two factors which will affect the income picture favorably in the future. First, with today's high wage levels and wider coverage, more and more workers and their spouses will receive maximum benefits. Second, private pensions will increasingly add to retirement income. Although at present only about 8 per cent of persons over 65 are receiving benefits from private pensions, more than 40 per cent of the current work force are covered by such plans.

The greatest financial asset of the older population is home ownership. About two-thirds live in their own homes which they own outright or in which they have a substantial equity. However, we know from a study by the Cornell University Center for Housing and Environmental Studies that 40 per cent of persons receiving social security benefits in 1960 were living in houses built 51 or more years ago and another 40 per cent in houses built 30 to 50 years ago, and that approximately 45 per cent were classified as being "in need of better accommodations."

## STATE OF HEALTH AND VIGOR

Generalizations about the physical state of elderly people have been contradictory and misleading. Early developers of retirement villages scoffed at any unusual need for health facilities, while homes for the aged increasingly see the necessity of providing infirmary care as a normal service.

This seeming discrepancy stems in part from the usual age of the residents in the two types of housing. Individuals seeking accommodations in retirement villages were apt to be in their early or middle



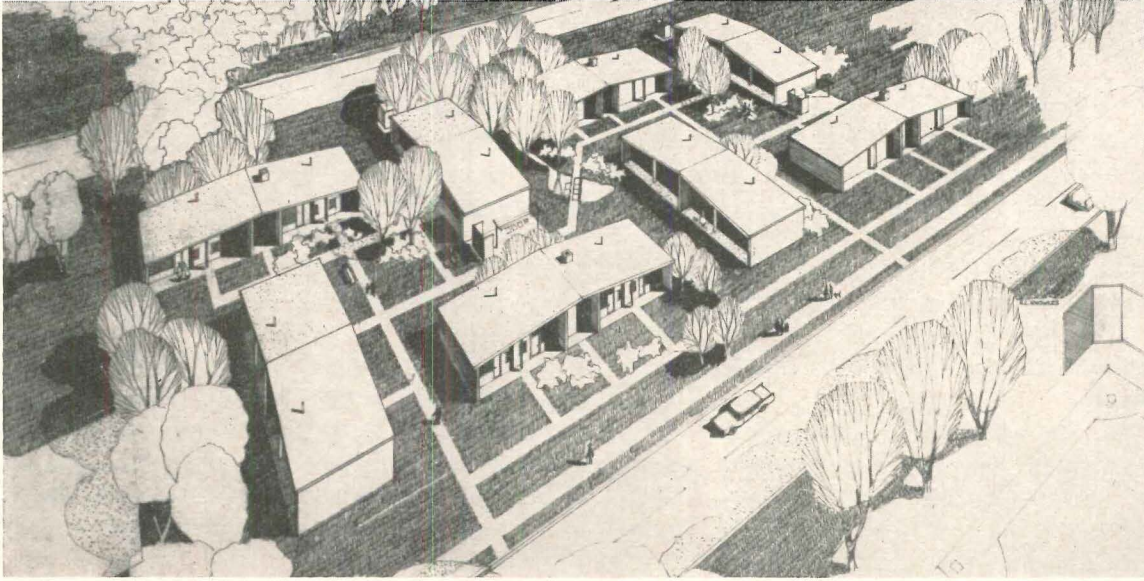

## COTTAGE-TYPE PUBLIC HOUSING ON A SMALL URBAN SITE

*Needham Houses, Needham, Massachusetts*

OWNER: *City of Needham, Massachusetts*

ARCHITECTS: *William Hoskins Brown Associates, Inc.*

William Hoskins Brown, one of the early and articulate designers for the aging, has made of this small urban New England site a place of privacy and quiet sociability. The arrangement of eight, one-story buildings, each containing two, one-bedroom apartments, is such that a rather cozy garden atmosphere is engendered between buildings while landscaping and orientation provide maximum privacy.

Living rooms are small, reflecting perhaps both the accustomed quarters of low-income New Englanders and the limitations of the public housing budget. This solution nevertheless represents more of the amenities than were a matter of course at the time of its design in the late fifties; and the partial divider between living room and bedroom helps to overcome claustrophobia. Recreational, medical and shopping facilities are nearby.

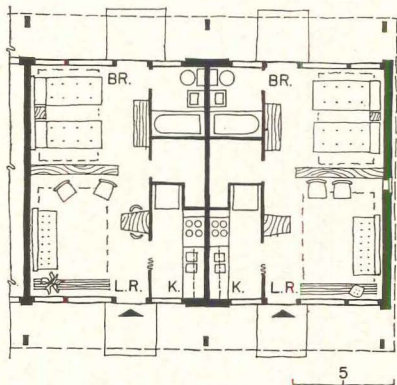

*Robert L. Newbert*



60's and gave every evidence of health and vigor. On the other hand, the current average age of admission to homes for the aged is between 75 and 80, and often the motivating factor in seeking admission to such a facility is a sense of declining vigor.

National health surveys tend to deal with a wide age span, "those 65 and over," rather than with more significant five-year units, but they do help to establish certain important generalizations which provide useful guides for housing.

First of all, less than 5 per cent of all aged people live in institutional settings. The rest live in some sort of independent setting, mostly in their own homes. Although one survey has indicated that 80 to 85 per cent of persons 65 and over have some kind of illness, most of them, nevertheless, can continue to reside at home, given good housing and certain visiting social and health services. Another study indicated that about one-fourth of the 65 and over group are restricted by reasons of health to their dwelling and surrounding outdoor space.

Regardless of disease, it is of utmost importance that planners of housing recognize that inevitably vigor and strength decline with the years. Elderly people are more accident prone than the young and broken bones heal slowly.

However, there is emerging a new respect for the recuperative powers of the aging body. Modern rehabilitation measures following an accident or a stroke have restored many to self care.

This new information and changing philosophy have an important bearing on housing. Just as eyeglasses and hearing aids have helped elderly people overcome the handicaps of diminished eyesight and hearing, so can housing and furniture design help them overcome the other infirmities of age.

## A CHANGING PHILOSOPHY

There is gradually emerging a new philosophy about life in the later years. Partly this is due to the fact that the ages when social security benefits begin (62 and 65) have become the ages which constitute the dividing line. At this age most people retain a high degree of health and vigor. They retain their ability to take part in social activities, their interest in learning new skills, their keen zest in living even into extreme old age.

When older people have been asked their own desires for their later years, "independence" has almost invariably headed the list. At the same time most older people are realists. They recognize that the desire for independence must be healthily tempered by the need for certain kinds of security and aids to easier living.

The three-generation household, which has all but disappeared, and the three-generation family are not synonymous. Family ties between the generations re-

main strong, and the desire to be near other family members remains an important factor in determining how and where older people live.

The self-image of elderly people has also undergone a significant change in the last few decades. Most people who approach the centenary mark, apparently do not, themselves, feel "aged." Hence, those factors in housing which make for easier and safer living in the later years will be generally more acceptable if they are not unduly conspicuous.

The ways in which the social and personal factors outlined affect the quantity and variety of housing for older people are obvious. They will be discussed briefly as they affect details of environment, site selection, design and financing.

## ENVIRONMENTAL FACTORS

In the early days of concern about housing for older people there was necessary concentration on certain architectural and equipment features, such as grab bars, stairs and thresholds. These considerations\* are now incorporated in a much larger concept of housing which provides as far as possible a continuum of life, without abrupt changes in pattern and habits of daily living. This principle indicates the need for a wide range of choice of living arrangements that provide for adaptation to changes which will inevitably occur in the individual as he grows older. As George Kassabaum said at the July, 1962 Institute on Housing as a Living Environment for Older People: "Since there is a rigidity and permanence about bricks and mortar and walls that discourage change, and since the needs of the person being housed will change, the design of housing for our older people requires more orderly planning, and more compensation for events in the future than the planning for any other group in our society."

Ollie A. Randall told the same Institute in Glenwood Spring, Colorado: "Older people, given the means of doing so, will continue to do most of the things in their daily lives they have always enjoyed doing, and the environment should be an enabling one. People go on waking, sleeping, shopping, cooking, eating, going out for many purposes. . . . Ease of access to these (outside) facilities . . . helps to lengthen the period of self-sufficiency. So transportation that . . . serves older people safely and courteously becomes an essential component.

"For those who can negotiate their own affairs, whether it be financial, social or personal, everything should be geared to encouraging this."

It is important in this connection to deal briefly with a question of some controversy. In the early days of special housing for elderly people, there was a tendency to close the eyes to any responsibility for care of the ill by sponsors of non-institutional hous-

\* See this month's Time Saver Standards.



## TWO-STORY SPECULATION, A POPULAR RULE BREAKER

*Springvale-on-the-Hudson, Cortlandt, New York*  
 OWNER: Van Cortlandt Avenue Corp.  
 ARCHITECT: J. Edward Luders & Associates

Philosophers may quarrel (indeed, many have already definitely quarreled) with this two-story, elevatorless, apartment development of some 21, 12-unit buildings variously grouped on a rather steeply rolling, 67-acre, wooded site in New York's Westchester County. It is, nevertheless, a physically attractive solution, by unsubsidized, profit-seeking, private enterprise, of a wide need of the active retired for moderate rentals. One-bedroom and two-bedroom units are \$70 to \$126. Doctors, dentists, light shopping and recreational facilities are on the site, and free bus transportation to churches and nearby towns is provided. Residents are somewhat isolated from the surrounding communities, but they like it that way. Construction is wood frame with concrete block fire walls between each pair of apartments.

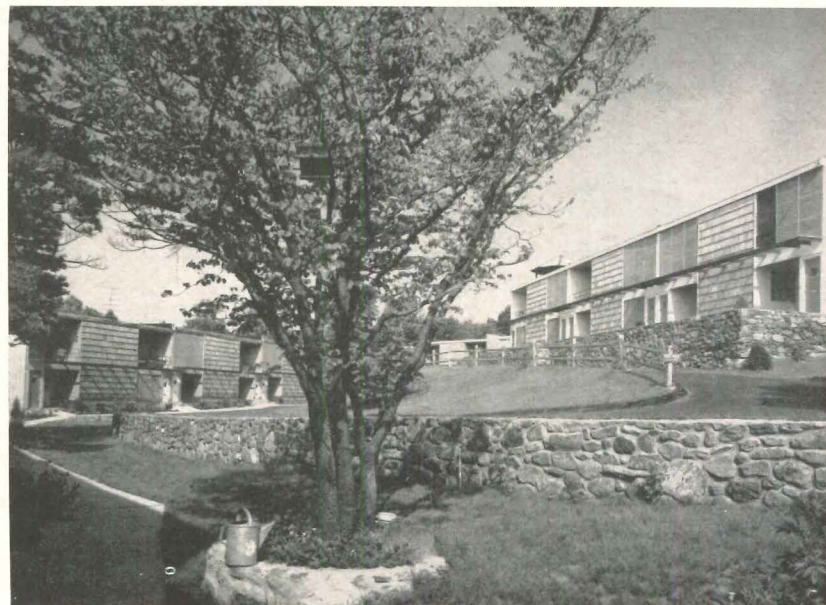
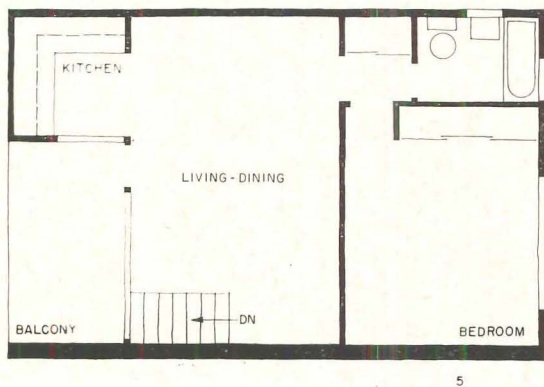

ing. Indeed, many homes for the aged also limited their residents to the so-called "well-aged." No longer can persons who accept responsibility for housing large numbers of elderly people ignore the problem of illness. An ardent spokesman for this point of view is Ernest J. Bohn, director, Metropolitan Housing Authority, Cleveland, Ohio who believes that even public housing must provide some care for the elderly who become ill. He said, at a 1960 seminar at Lake Mohawk, New York: "Public housing people are not in the health business nor do they wish to get into it. However, when health problems arise (and they invariably do) and there is no program for their solution, some of us refuse to sit smugly by and say 'this is not my business'. I believe that a local housing authority which has any kind of program worthy of the name will of necessity have to build some facility with the assistance of public subsidy to meet this inevitable situation."

Most newly built institutions for elderly people now provide for an infirmary as well as diagnostic and other health services, except for acute illnesses requiring hospital care. One new building is designed so that the nursing and other health care now provided in the top floor infirmary can be extended to all the other floors.

On the other hand there is a point of view that a sharp distinction should be made between housing and health facilities and that when elderly residents become ill they should be removed to a nursing home or other medical facility both to insure high standards of care and to protect the other residents from the depressing sight of sick people. However, even those holding this point of view usually concur in the opinion that there is a responsibility to see that appropriate health facilities are nearby and to make the necessary arrangements for admission.

This situation points up the problem of making a clean cut distinction between independent housing for the elderly and institutional housing.

Recognition of the failing health factor and the reluctance of elderly people to move has led to the development of a type of living facility apparently unique to the United States. This provides as a part of a single complex under a single corporate management a variety of living arrangements from individual houses to complete infirmary care which allows for the kinds of dwelling, service and care which may be required as the family situation and state of health of individuals change.

## SITE SELECTION

The implications are obvious that housing should be close to adequate shopping, educational and cultural centers, places of worship, opportunities for recreation and public service. Easy accessibility to social and health services is essential. If the site se-

lection is appropriate, there is little room for argument as to whether a housing facility should be planned exclusively for the use of older people or for all age groups. There is considerable evidence that elderly people, like those of any age group, enjoy the companionship of their peers. But the important consideration is that there be no *isolation* by age of any group. All persons, but particularly the elderly, need to feel a part of a total community, although the elderly also need a certain amount of protection from the noises and displays of energy of youth.

The need for a wide choice of site selection cannot be over-emphasized. In general, older people prefer the familiar, and this preference increases with age and disability. This has particular significance for redevelopment programs in downtown metropolitan areas where so many elderly people reside.

On the other hand, there are the truly venturesome, as well as those who need a change of climate, who seek out new places. Once the newness wears off, however, or ill-health occurs, loneliness and homesickness sometimes set in. This too emphasizes the need for built-in resources for social contact.

It is often necessary to secure modification of zoning regulations regarding parking space. In general, elderly people own fewer cars than the rest of the population and the usual parking space, used as garden or recreation area, will provide more enjoyment.

## DESIGN AND MATERIALS

In the early days of planning housing for older people there were two over-riding criteria: low cost and safety. These are important factors and will remain so, but they are not enough.

Thoughtful and imaginative architects attempt to avoid monotony in both exterior and interior. They provide for small intimate sitting areas in garden or building, often at the expense of impressive formal gardens and living rooms. They give a thought to the arrangement of essential living areas to provide movement from one to another in a straight line avoiding right angles and any changes in floor level. They plan wall space in relation to placement of furniture, for example, permitting three-sided access to beds for ease in housekeeping and nursing care. They consider the possibility of a variety of views from windows strategically placed in relation to dining table, bed or easy chair. They plan unobtrusively for such potential exigencies as blindness, mental confusion or life in a wheelchair.

## FINANCING

There is little doubt that the current expansion in housing for older people has been greatly stimulated by Federal programs for financing such hous-



## HIGH-RISE, NON-PROFIT, WITH CENTRAL SERVICES

*Bayview Manor, Seattle, Washington*  
 OWNER: *Seattle First Methodist Homes, Inc.*  
 ARCHITECTS: *John Graham and Company*

This high-rise retirement apartment building is one way to keep the aging within the same urban community as family and friends. Sponsored by the First Methodist Church of Seattle, the building is nonprofit and non-denominational. Each apartment contains a small kitchen, and there is a public dining-room seating 300. Apartments are one-room and two-room units. There is a large solarium on each residential floor. Lounges, library, meeting room, wood-working shops and recreational rooms are provided. There is a convalescent wing with facilities for minor surgery and apartments for patients who will have nurses and doctors in attendance. Residents must be 60 or older. Founders' fees are from \$8,750 to \$9,350 for single units, and a monthly charge of about \$112 includes all meals served in the dining-room, utilities, cleaning and linen service.

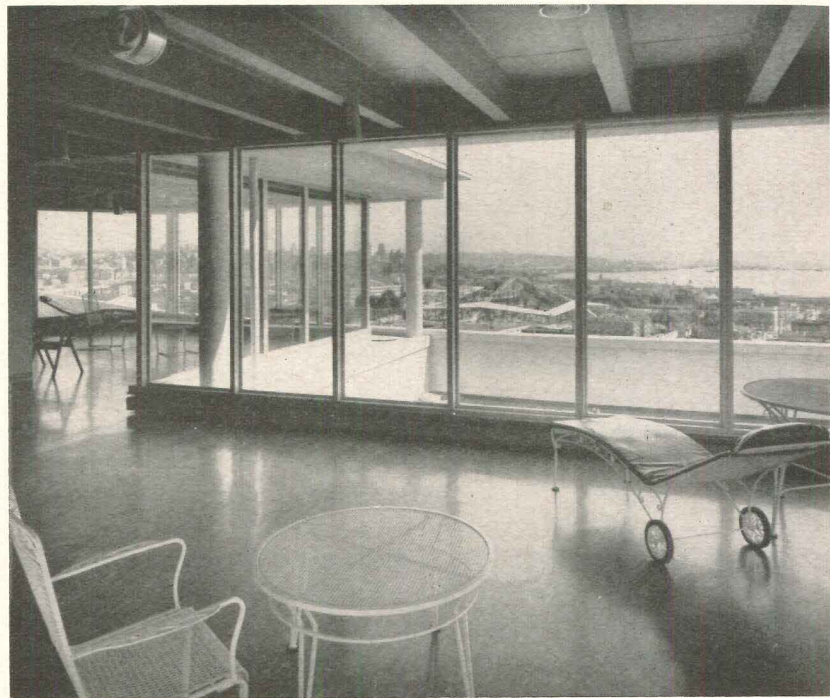
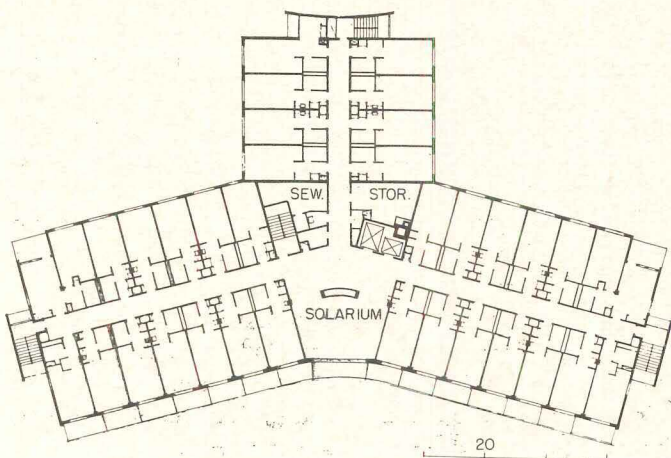

ing. There are three major programs, each of which is administered by a different constituent agency of the Housing and Home Finance Agency. This has caused some confusion, in spite of the recent establishment of a central Office of Housing for Senior Citizens.

*Low Rent Public Housing* is administered by the Public Housing Administration. Public housing is subsidized by the Federal government through its assumption of deficits incurred by local housing authorities. In the case of public housing for older people, the cost of construction per unit and the annual subsidy may be greater than for conventional public housing. At present more than 20 per cent of all public housing dwellings are occupied by elderly families. Fifty-three per cent of all public housing dwelling units placed under contributions contracts during fiscal 1962 are designed specifically for the elderly. Public housing for the elderly may also include activity centers in great variety for recreation, education and health services. There is evidence of more imaginative design, particularly in the activity center areas, than has been generally true.

*FHA Mortgage Insurance* is administered by the Federal Housing Administration. The major program provides mortgage insurance for construction or rehabilitation of multiple housing rental units for the elderly, under Section 231 of the Housing Act. It is available to both non-profit (voluntary and public) and profit-motivated sponsors. For non-profit sponsors of new construction FHA will insure the mortgage for as much as 100 per cent of estimated replacement cost. The mortgage loan may be repaid over a period of 40 years at a prescribed rate of interest, at present  $5\frac{1}{4}$  per cent plus  $\frac{1}{2}$  per cent mortgage insurance premium. For profit-motivated sponsors the mortgage is insured for up to 90 per cent of estimated value or replacement cost.

There are limitations on insurable amounts per room and dwelling unit. However, since this program is generally designed to provide housing for the relatively well-to-do, sponsors are permitted through gifts and founders' fees to construct housing costing more than the amount of the insured mortgage. Such housing developments may include special features and amenities such as infirmaries, chapels, social rooms and recreation facilities. There is also a FHA mortgage insurance program for the construction of commercial nursing homes.

A *Direct Loan Program* is administered by the Community Facilities Administration for rental housing sponsored by private non-profit corporations, consumer cooperatives and certain public bodies. This program is intended to meet the needs of older persons whose incomes are too high for public housing and too low for what is available in the housing market. This is the Senior Citizens Housing Loan program established by Section 202 of the Housing Act.

Loans for 100 per cent of development cost are available for periods up to 50 years at a prescribed rate of interest which is currently  $3\frac{1}{2}$  per cent. Because this program involves investment of the government's own funds at a sub-market rate of interest for a long period of time, the requirements are stricter than under the FHA program. Sponsors must provide evidence of permanency, business competence, and ability to deal with the needs of elderly persons. They must be broadly representative of public interest groups in the community. No founders fees or any payment or contribution (other than rent) may be required. There can be no discrimination on the basis of race or religion.

The Housing Act of 1961 authorized \$125 million for this program. This session of Congress increased the amount to \$250 million. Applications up to June 1, 1962 totaled 254 in number for \$284 million. Loan agreements executed as of that date totaled 34 in number for \$29 million.

*Founders' Fees* constitute a method of providing capital funds for housing older people used by a number of philanthropic groups, notably churches. Prospective residents are asked to make a gift which represents the cost of the unit they will occupy plus a proportionate share of the common facilities. Residents often pay an additional monthly charge which covers specific services such as food, cleaning and limited health service. In a few instances the entire cost of building is financed in this way. Usually these funds provide additional amenities or are used to reduce the amount of the mortgage. Upon the death of the "founder," several kinds of arrangements are made. In some instances the succeeding occupants are asked to make a similar gift, the money going into a reserve fund to finance additional buildings, or to buttress the financial position of the housing development. In other instances part or all of the units are made available to members of lower income groups unable to pay the founders' fee.

This type of financing is more apt to apply to facilities for congregate living which provide certain services such as food and health care, rather than completely independent rental housing.

*Conventional Financing* has met some resistance from lending institutions which have been reluctant to make loans to older people for long-term home financing, or to organizations sponsoring multiple-unit dwellings. However, lending institutions tend to make no rigid policy determinations but to decide each application on the individual's capacity to pay. It has been suggested that with the current market for well-designed and well-located units, it is not necessary for the life expectancy of the borrower to be coterminous with the loan.

It should be increasingly recognized that the major design features recommended for housing older people are equally appropriate for general housing. Hence, in the long run, housing for the elderly may become just good housing for everyone.



## A CONGREGATE VILLAGE OF ORGANIZED VARIETY

*Mount San Antonio Gardens, Pomona, California*

OWNER: *Congregational Homes, Corp.*

ARCHITECTS: *Kenneth Lind Associates*

Design concept of Mount San Antonio Gardens was for a group of residential buildings on a 14-acre site offering accommodations of great variety including cottages and apartments for both independent and congregate residency. There are 276 units. Three congregate buildings in the center of the property each contain common living and recreational space. Each has a circular wing surrounding a patio, and each is connected by a covered walkway to the main building. The latter contains central dining and recreational facilities as well as a medical establishment of 20 rooms and the administrative offices. Extensive use of glass takes advantage of mountain views and regional preferences for communion with outdoors. Sponsored by the Congregational Conference of California and the Southwest, Mount San Antonio Gardens is a non-profit, non-sectarian village for the aging financed under FHA, Section 231. Founders' Fees are from \$7,500 to \$20,000. Monthly charges of \$200 per person cover all meals, utilities, maintenance, linens and comprehensive medical care.

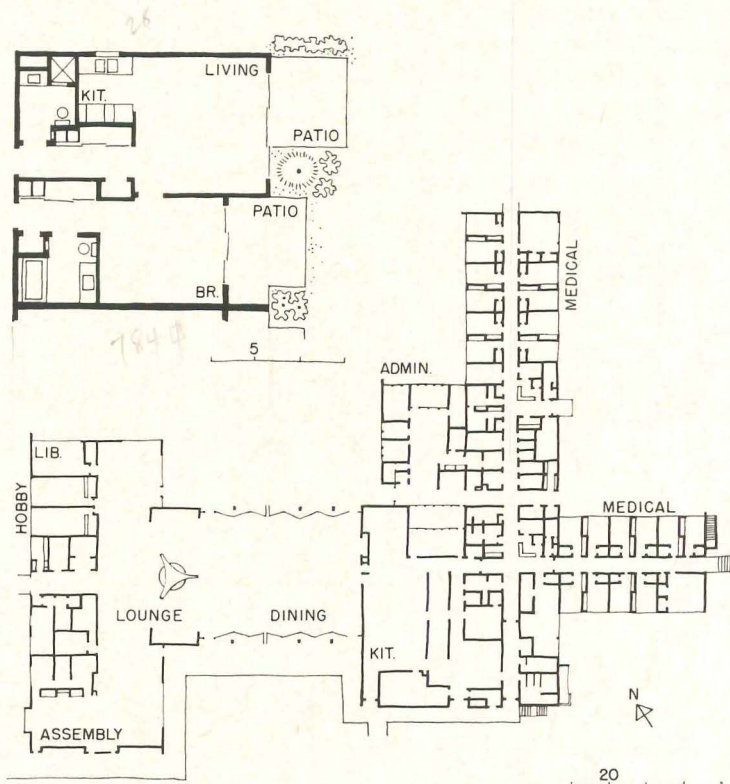
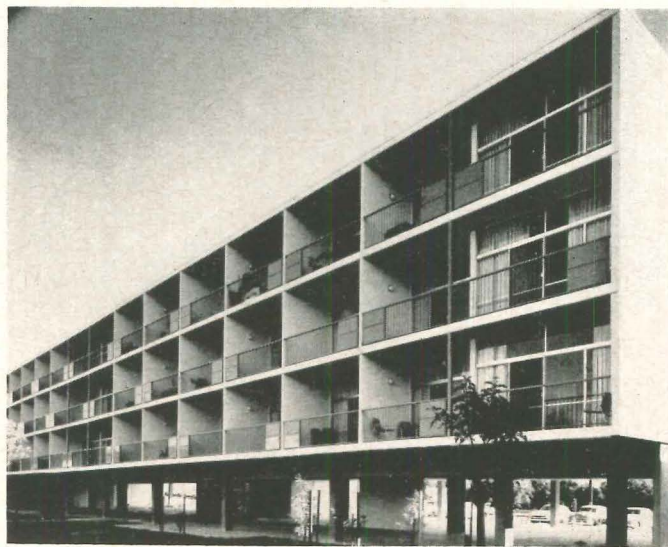

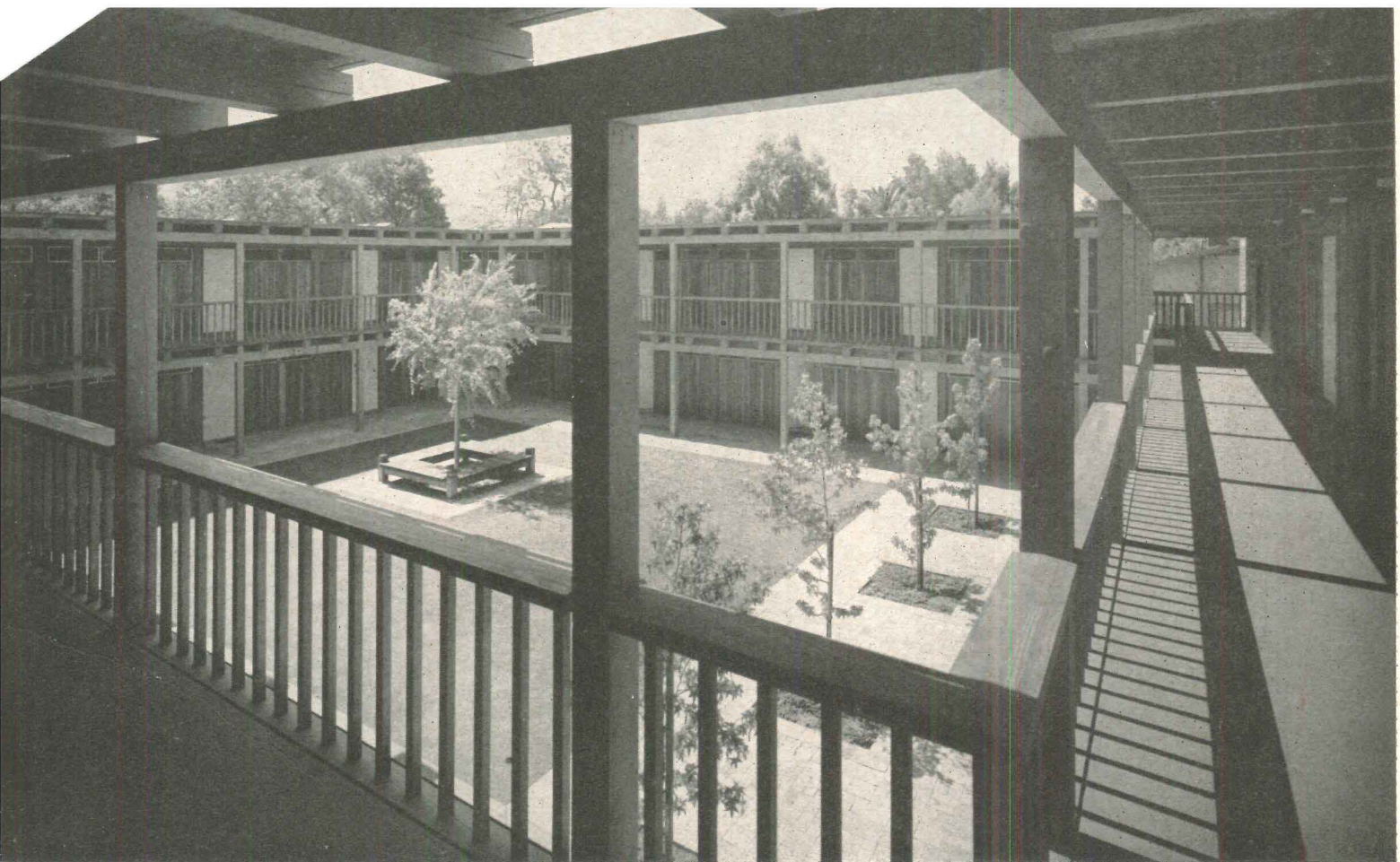

Morley Baer photos

## RETIREMENT APART- MENTS ENCLOSE A QUIET QUADRANGLE

*Peninsula Volunteers' Retirement Apartments*

*Menlo Park, California*

OWNER: *Peninsula Volunteers Properties, Inc.*

ARCHITECTS: *Skidmore, Owings & Merrill*

The concept of this retirement apartment complex is an outgrowth of the owners' experience at nearby Little House, a pioneering, non-profit community center for the aging.

The apartments comprise 30 units grouped on a two-thirds-acre site in four, two-story structures around a landscaped quadrangle and connected by a two-story arcade. The second story is reached by low-riser, wide-tread stairways at corners of the quadrangle and by a self-service elevator near the main entry. Exteriors are natural redwood siding and cedar shingles with exposed wood framing.

Apartments are of three sizes from singles of 296 square feet to one-bedroom units of 520 square feet. Garages for 10 cars are on the first floor, front.

Each apartment has two exposures with a private balcony or patio off the living area and with access from arcades on the court side. Special features include: complete electric kitchens, flush thresholds, oversized doors, safety glass shower stalls with built-in seats, electric heating designed for 80 degrees if necessary, high intensity lighting, extra strength toilet accessories and flame retardant interiors.

Funds for the project were donations totaling \$105,000 and a direct HHFA loan of \$280,000. Rentals are from \$65 to \$100 per month.



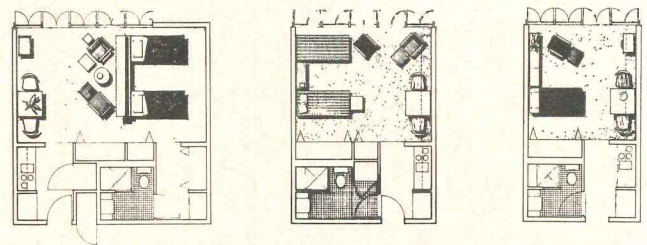
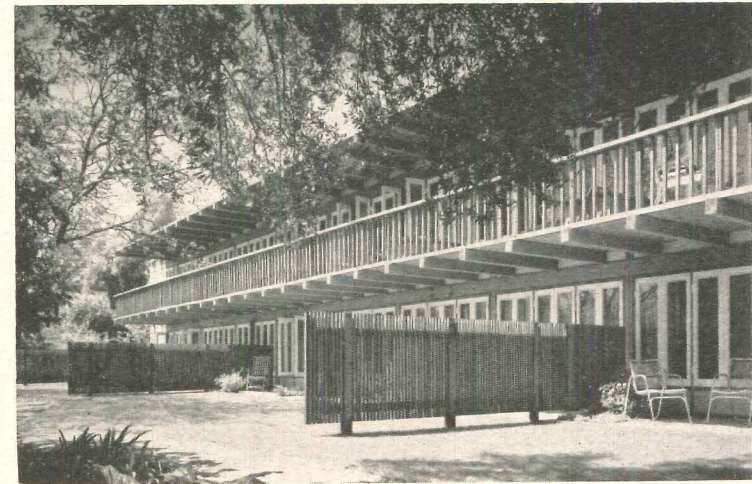
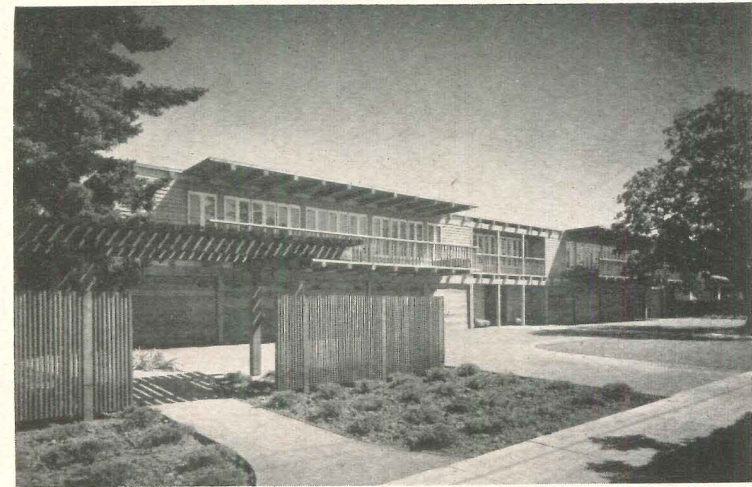
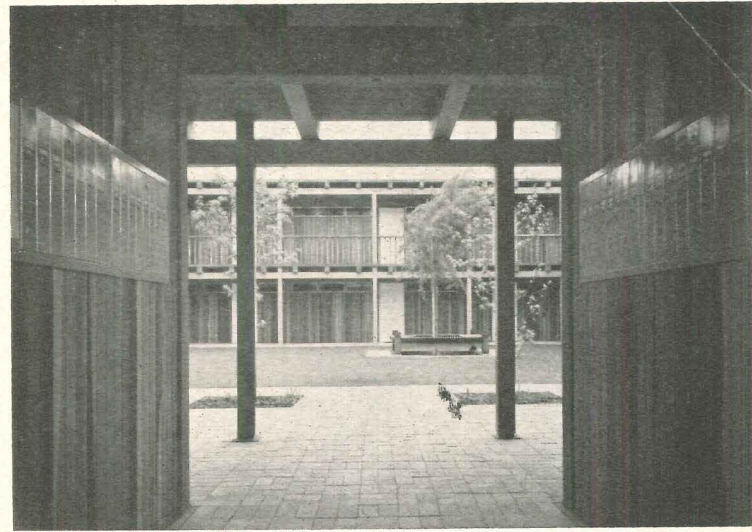
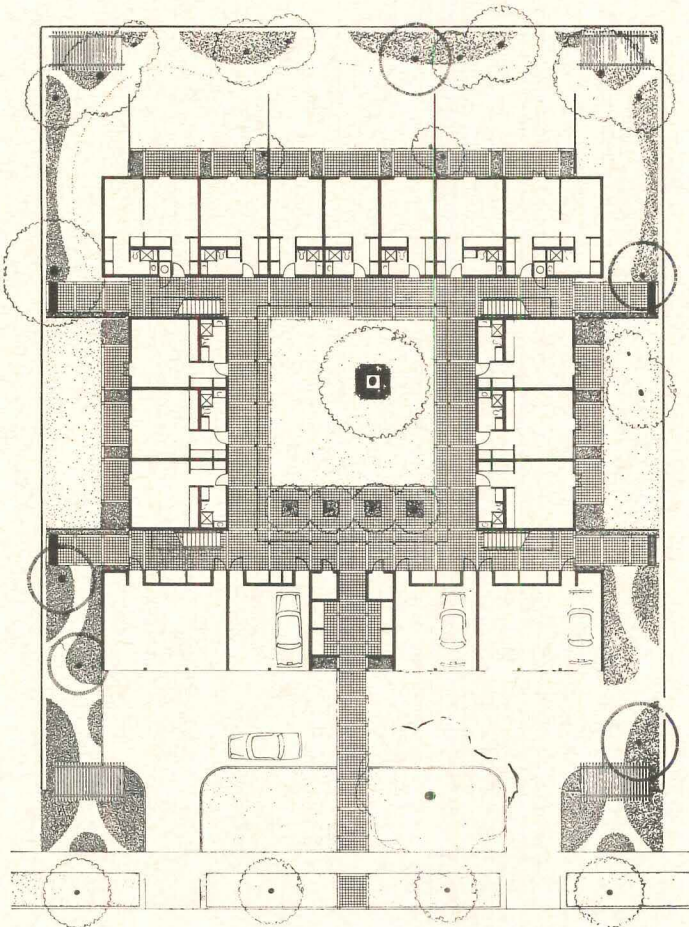
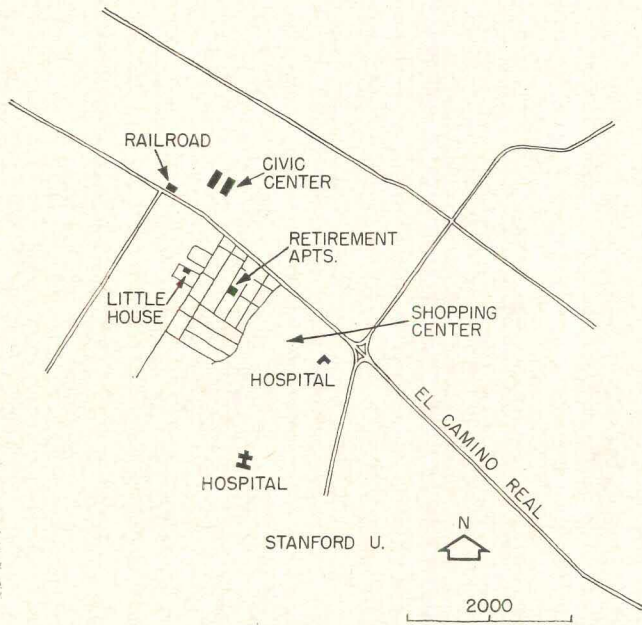



Robert Galbraith photos

## CENTER FOR AGING AND CHILDREN SERVES PUBLIC HOUSING

*Castle Hill Houses, Bronx, New York*  
OWNER: New York City Housing Authority  
ARCHITECTS: Katz, Waisman, Blumenkranz,  
Stein, Weber Architects Associated;  
partner in charge, Sidney L. Katz, F.A.I.A.

Castle Hill Houses is a neighborhood of 2,300 families. Within its boundaries are facilities for shopping, recreation and community activities. Schools and transportation are adjacent. The project was constructed by the New York City Housing Authority with the aid of New York State funds. Apartments include many designed for the aging. Outstanding feature, however, is the community center. By planning and coordinating the various age-group activities (nursery, family health, teenage and aged) in one building, the architect says, a vital relationship has been established that allows a constant flow of emotions and ideas that establish roots in a community. Isolation of the elderly, he believes, should not be encouraged. The attempt was to create a happy environment by the use of color, form and economical materials that still are possible within the strict budgets of government regulations. The building has access from four sides. An entrance at one end is to a children's center which occupies the first floor. Entry from the opposite end and from the rear gives access to the second floor which contains meeting space and various group and shop rooms for the aging.

Medical and social services on the first floor are available to all ages on pre-arranged schedule, as are certain rooms on the second floor.

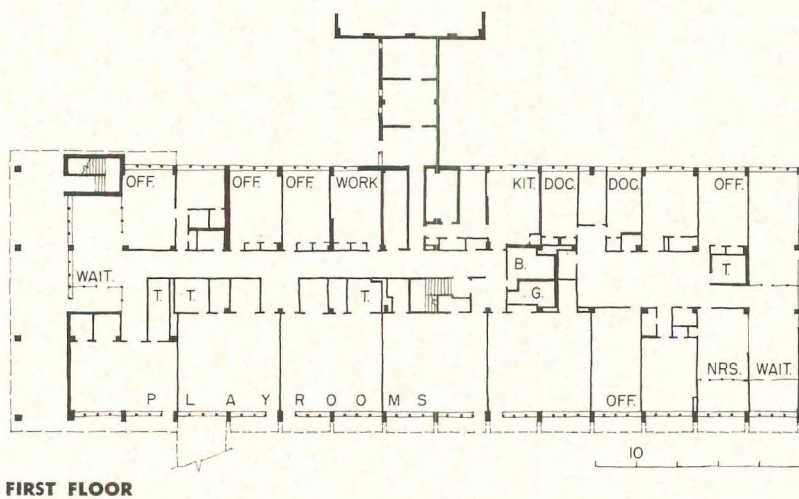
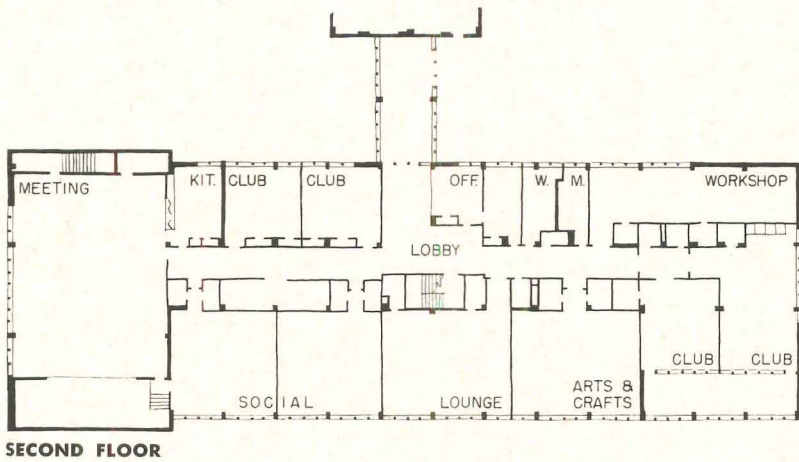
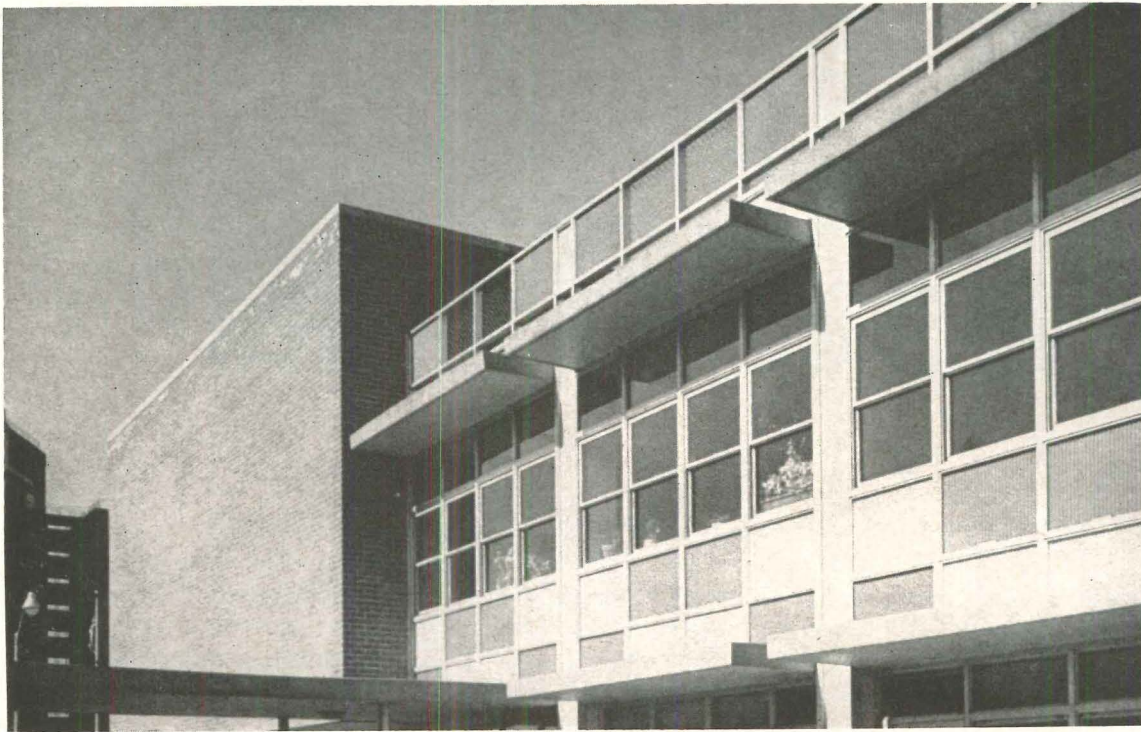

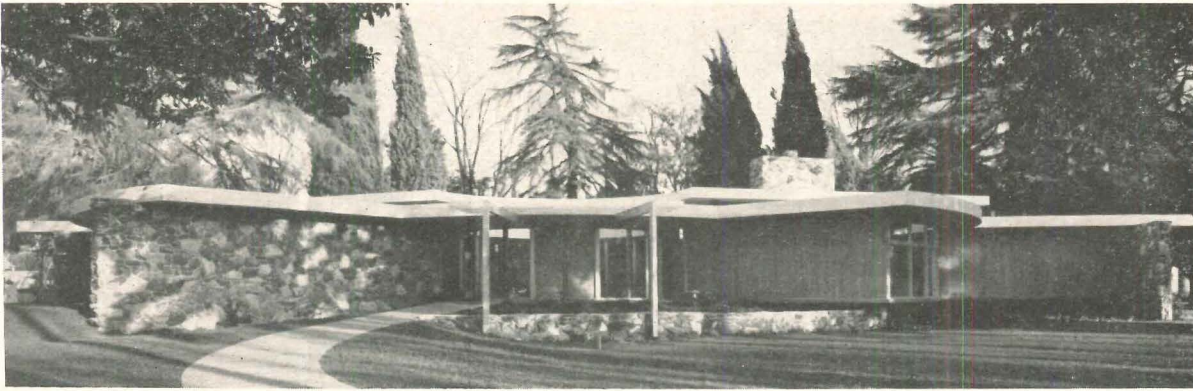

Glen Fishback

## SOCIAL CENTER IN A CITY PARK

*Senior Citizens Building  
Sacramento, California*

OWNER: *City of Sacramento*

ARCHITECT: *Herbert E. Goodpastor, A.I.A.*

This is a social and recreational center without residential or clinical facilities. The building was designed in the round to be viewed from all directions in its block-square park. Three club rooms can be expanded into one, with a large fieldstone fireplace at one end. A kitchen serves the club room, for occasional dinners, and a snack bar with pass-through counter opening onto an outdoor terrace.

Wall construction is stone and vertical fir siding, repeated on the interior. Fascias are porcelain enamel panels. Central core is a planted court viewed from a surrounding corridor through safety glass panel walls. Two-level roof, wide overhang, and changing exterior radius provide variety of facade and relate interior to outside spaces.

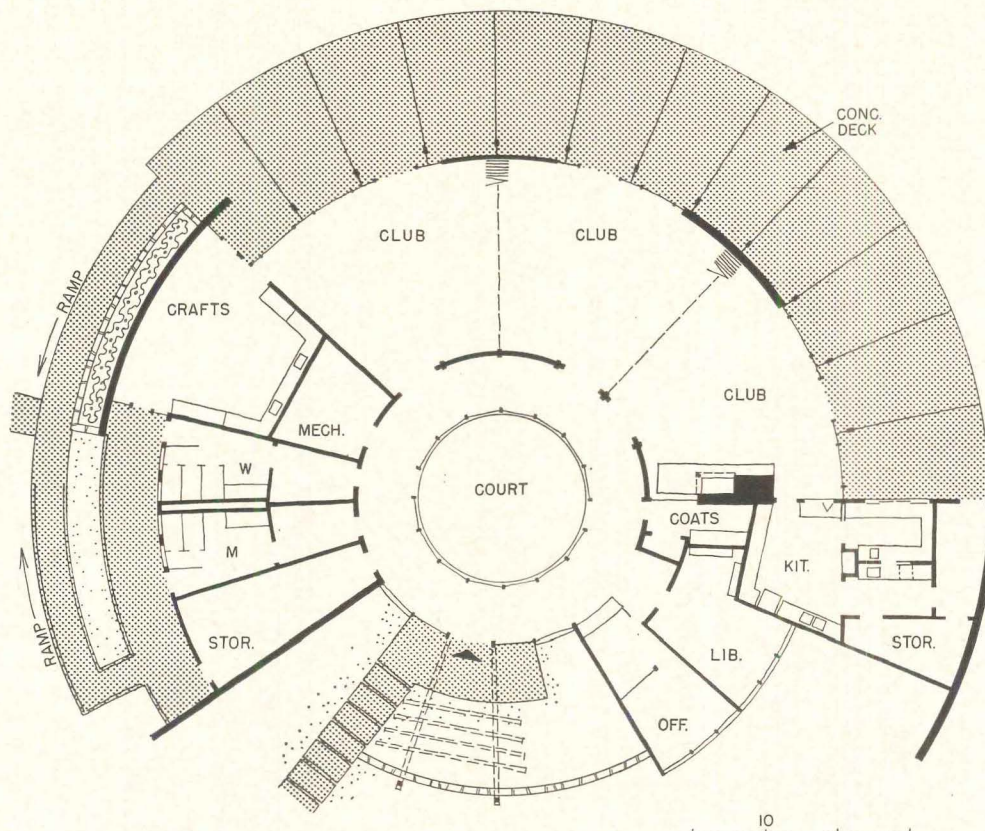



## A BIG-CITY HOME SHOWS TRENDS IN LONG-TERM NURSING

*The Friedman Building, New York, N.Y.*  
**OWNER:** *The Home for Aged and Infirm Hebrews of New York*  
**ARCHITECT:** *Joseph Douglas Weiss, A.I.A.*

This metropolitan nursing home demonstrates a design trend in so-called homes for the aged. Its principles apply to such homes of any size, although components and ancillary facilities in smaller homes would naturally vary.

A big city nursing home for the aged, says Joseph Douglas Weiss, is not really a home. It is an institution and as such poses two special problems to the designer. First, its basic function of prolonged nursing care increases its cost. Second, its residents inevitably lose individual freedom by its institutional character, although some of them may be ambulatory and to a considerable degree physically and mentally unimpaired.

Plan requirements affecting costs are quite close to those of a general hospital. They include 8-foot corridors, treatment rooms, nursing stations, extra wide doors to rooms, etc. Although a single nursing station can handle up to 40 beds, there are extra costs not common to hospitals: larger day rooms and dining rooms, closets and dressers in pa-

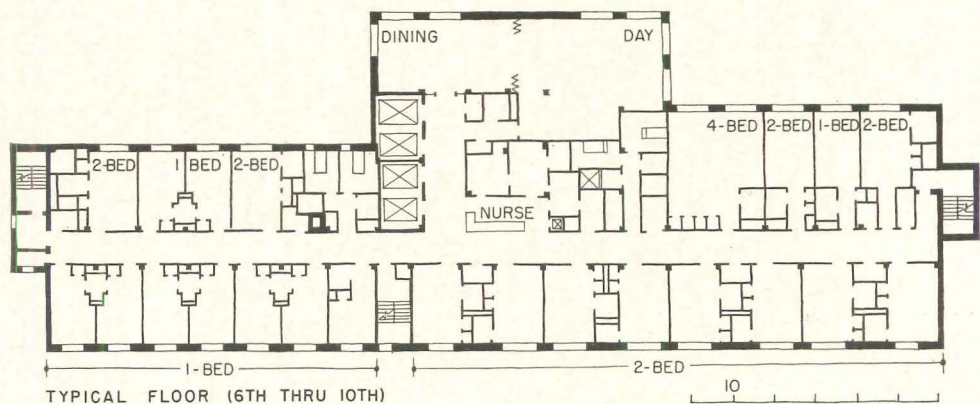

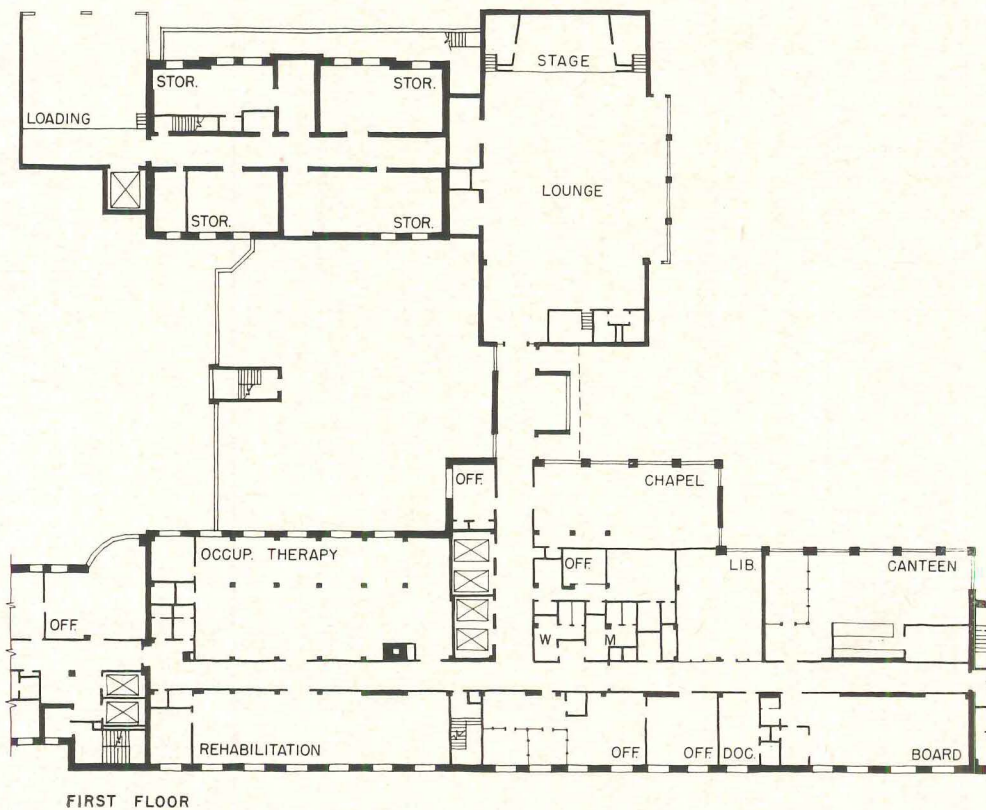

FIRST FLOOR

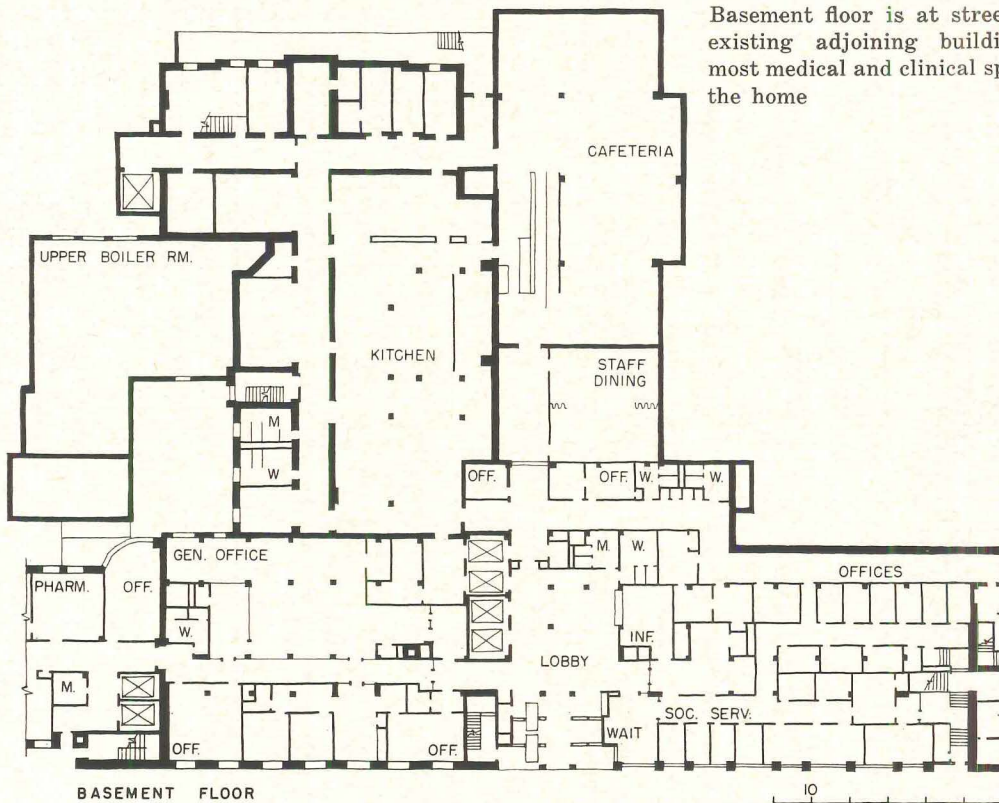

BASEMENT FLOOR

Basement floor is at street level. Pre-existing adjoining buildings contain most medical and clinical spaces used by the home

tients' rooms and larger rooms because of long-term occupancy and wheel chair traffic.

The institutional character should be relieved somewhat by rooms for family visits, occasional small living rooms, some without radio or TV. About 30 per cent of the accommodations should be convertible from residential to bed care use; although, since the

average age of occupants is over 80, a 100 per cent infirmary use is likely to develop.

The architect, says Mr. Weiss, must take special pains in programming. Not only are criteria less standardized than those for hospitals, but they are constantly changing with new concepts, population trends and geriatric developments.

# Architectural Engineering

## Lab Tests on a Steel Hyperbolic Paraboloid

Construction and testing of a hyperbolic paraboloid shell using standard light gage steel roof deck panels, welded intermittently along their seams, and at the external edges to light perimeter members is described by Arthur H. Nilson in the *Journal of the Structural Division, Proceedings of the American Society of Civil Engineers*, October, 1962. The light gage roof deck panels are given a slight warp to follow the double curvature of the shell. The tests indicate that light gage steel shells can carry normal roof loads on spans of 30 feet or more. A potential problem cited in the article is the temporary indentation of the surface due to foot traffic which might rupture the waterproofing membranes. This might be prevented, Nilson believes, by use of a layer of "semi-rigid" insulation or by welding transverse angles or channels to the metal deck panels.

## Model Tests on Concrete Structures

A saving of approximately 15 per cent in the slab reinforcing steel was made possible in a group of 28-story apartment buildings at the Carl Sandburg Center in Chicago, Illinois by revising final construction plans on the basis of structural model tests. These model tests are described in an article, "Structural Model Testing—Theory and Applications," by Alan H. Mattock in the *Journal of the PCA [Portland Cement Association] Research and Development Laboratories*, September 1962.

These apartment buildings are Z-shaped in plan and feature flat plate floor slabs and irregularly spaced columns; shear walls are provided in the lower 15 stories. The Engineers Collaborative of Chicago, who conducted the model tests, studied the effect of lateral and gravity loads on the structure by load testing the 1/35 scale acrylic plastic model (5 feet 9 inches high).

Topics discussed in the 12-page article include model testing methods, types of structural models, materials for structural models, the scaling of loads and applications of model testing research in structural design.

The usefulness of models in research is exemplified in the article by a discussion of a research program at the University of Illinois to study the behavior of reinforced concrete slab floor systems. One-quarter scale reinforced mortar models of five different types of slabs were made and tested. These models predicted closely deflections, crack patterns, bending moments, modes of failure and ultimate load-bearing capacities.

## Making Smog in a Lab

Generation of Los Angeles type smog by a new "smog chamber" is the objective of scientists at the General Motors Research Laboratories. The new facility will be used to: (1) probe into the complex mechanisms governing smog formation, and (2) determine the influence of fuel composition, engine design and car operation upon smog reactions and eye irritation. Also the chamber can be used to evaluate proposed control devices.

## Human Stereo

"Cocktail party effect," that phrase describing the phenomenon of people at noisy parties being able to catch the sound of their own name or the drift of a topic that interests them, has been described on this page before. Now Dr. Maurice Rappaport of the Stanford Research Institute suggests that perhaps the reason for this is the stereo effect given by the two ears and the human brain's capability for selectively listening to one of several simultaneous messages. He suggests that a number of messages could be sent over a voice circuit, increasing the capacities of aircraft communications, radio dispatched taxis and trucks. A message intended for a particular individual would come to him through both of his earphones, messages for others would be heard in only one earphone.

## This Month's AE Section

*AIR CONDITIONING RESPONDS TO FLEXIBLE PLAN*, page 126. *TIME-SAVER STANDARDS: Building and Facility Standards for Physically Handicapped*, page 129. *BUILDING COMPONENTS: Hard Aluminum Finishes*, page 137. *Products*, page 139. *Literature*, page 140.

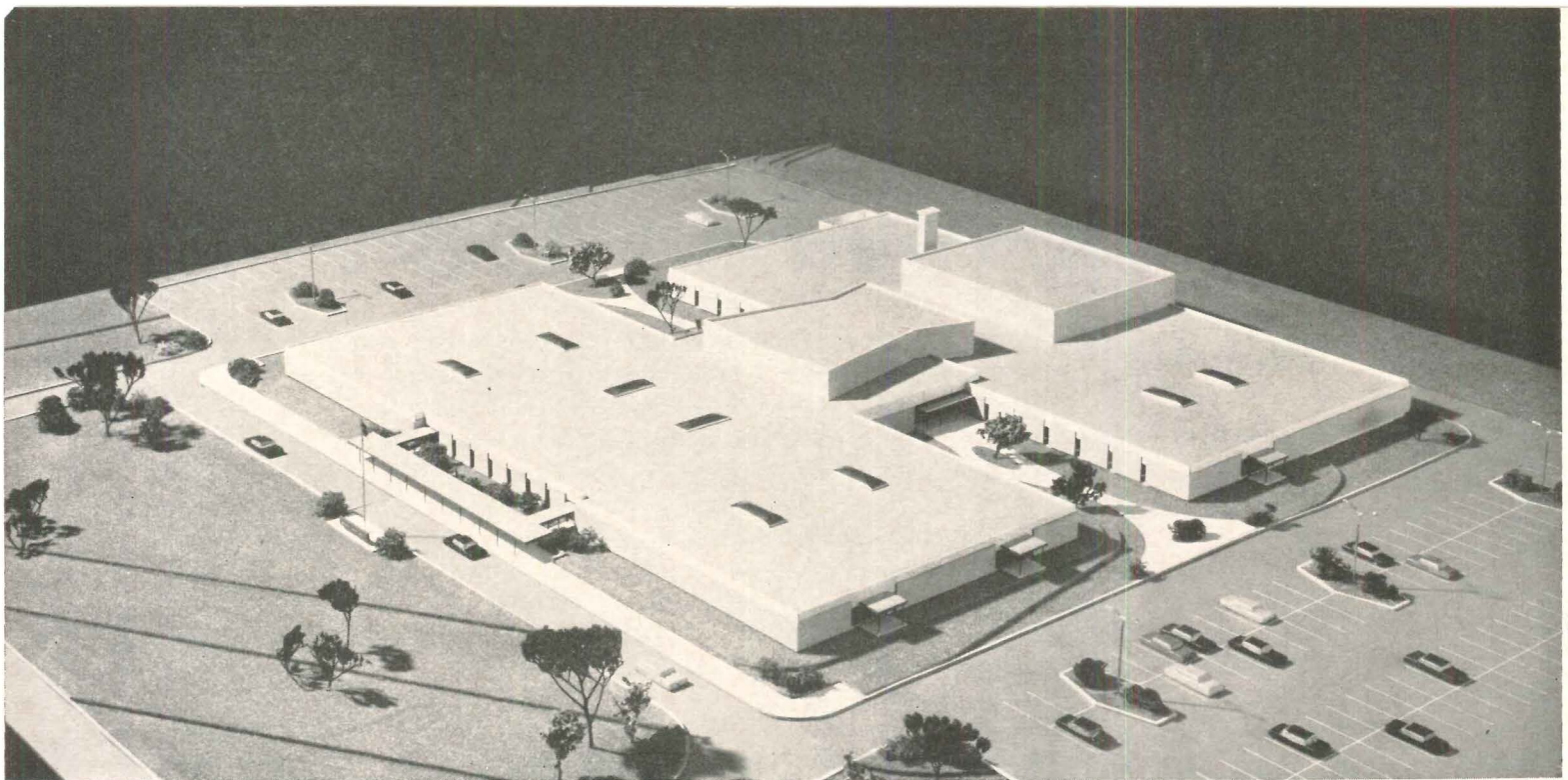

Lawrence S. Williams

View of model, looking southeast, shows administration area in front; auditorium is in center followed by gymnasium

## AIR CONDITIONING RESPONDS TO FLEXIBLE PLAN

Council Rock school near Philadelphia is designed for team teaching. The air-conditioning system gives individual temperature control for divisible spaces; can be adapted to any change in plan

Advanced educational and air conditioning concepts go hand-in-hand in the architecture for the new Council Rock Intermediate High School, Richboro, Pennsylvania, a few miles north of Philadelphia.

This school, which will accommodate 900 seventh-grade and eighth-grade pupils, is designed for team teaching. Classrooms can be subdivided via folding partitions and still have individual temperature control. Other classrooms marked for future subdivision by partitions are set up for individual temperature control. In the event of rearrangement of rooms, ductwork run above the dropped acoustical panels of the corridors is easily accessible for al-

teration of the air conditioning system to conform with changes in room layout.

A year-round climate-controlled building was considered desirable due to the increased use of school buildings for adult and summer educational programs, to anticipate the possibility of a 10-month or 11-month school year, and to preclude the uncomfortable conditions that occur in non-air-conditioned schools during many spring and fall days.

### Sources of Daylight

Most of the glass in this school is in the interior.

In the three classroom wings of this compact plan, the classrooms

are grouped around skylighted reference centers which provide carrels for individual study and serve as open-ended corridors. There are two elongated skylights for each reference center, and directly underneath each skylight is a planting bed and a glass display case.

In the reference centers and the library, the bar joists are left exposed which gives greater height to the rooms. The roof consists of perforated metal deck with sound absorptive treatment above. Typical classrooms have suspended plaster ceilings with 5-ft by 22-ft acoustical panels attached. In a 32-ft by 26-ft classroom, for example, there are two such panels.

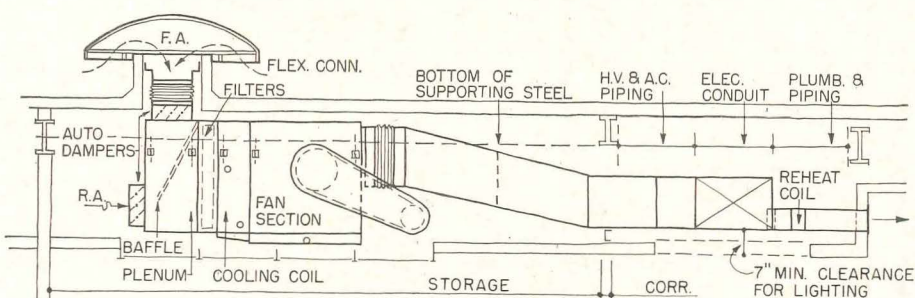

### AIR HANDLING STATION

This air handling station is typical of units 3 and 4 in the mechanical plan across page. (Only ductwork is shown; not piping for cold and hot water.) There are 24 stations in all. Cool air is tempered to suit various spaces by reheat coils which get their heat from condenser water of the refrigeration system



The plan is organized so that each classroom either "looks" into a reference center, or is adjacent to a glass-doored entrance. Thus there always is some contact with the outdoors. In addition, four science classrooms each have a small skylight. Also the arts and crafts room has a skylight which is supplemented by suspended incandescent fixtures. The library has two elongated skylights located over planting beds. Classrooms generally have one or two 7½ ft high by 3 ft wide wired glass panels to give a view into daylighted areas, as well as 2-ft-high safety glass vision strips at the tops of walls bordering reference center space or corridors. The corridors get daylight from the skylighted reference centers and from entrances.

Vertical strip windows are used in the exterior for the administrative offices, the cafeteria and the music rooms.

The Pennsylvania State Council of Education was petitioned for a modification in the school code to permit the use of a "compact plan" which reduced the exterior glass area in order to minimize the solar load, and the request was granted.

The walls and roof of the structure are insulated to minimize heat loss or gain. The cavity walls have an outer wythe of brick, inner wythe of concrete masonry, a 1-in. air space and 1 in. of expanded polystyrene insulation. The roof has 2 in. of rigid insulation.

#### Air-Conditioning System

Conditioned air, cooled or heated, is fed to the various spaces from 24 air handling stations (contain fans, filters, cooling coils) spotted in storage rooms throughout the building. The air moves through ducts run above the corridor ceilings, and is discharged through side-wall grilles into the classrooms.

A 240-ton central chilled water system, and a hot water system are looped throughout the building over the main corridor ceilings with run-outs to air handling stations.

Tempering of cooled air or heating of the air, when necessary, as called for by various thermostats is provided by reheat coils which are located immediately before the supply grilles.

While the single duct reheat

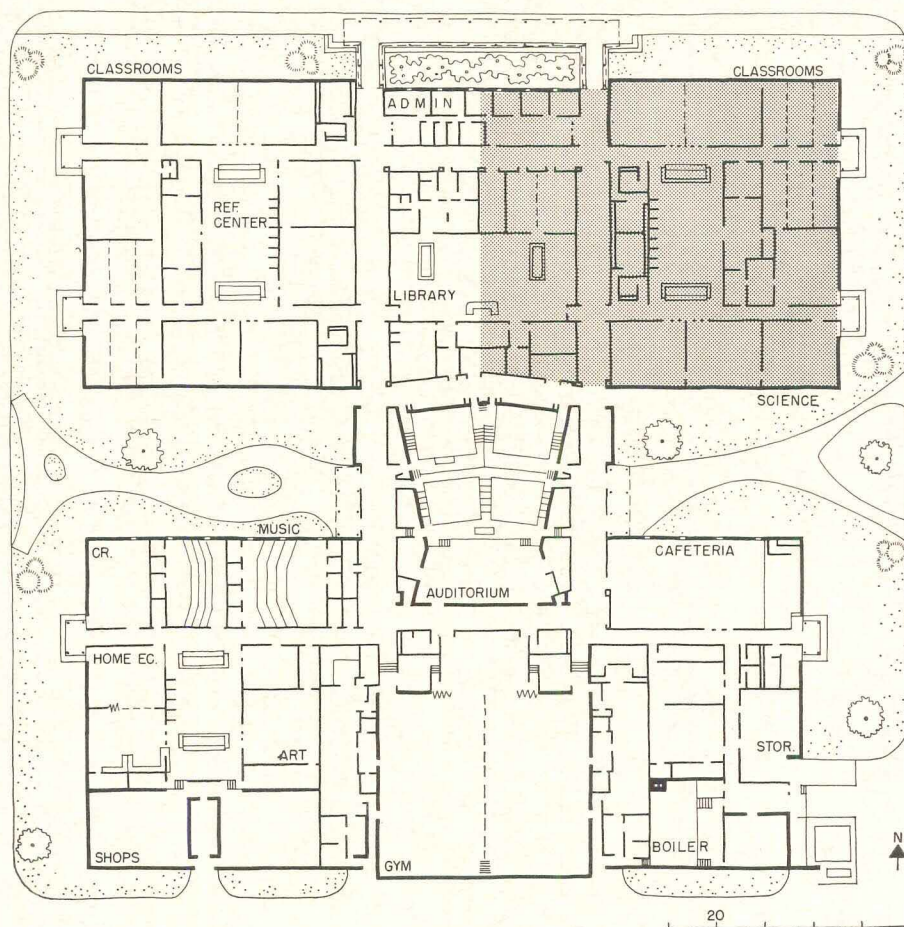

#### AIR CONDITIONING TO SUIT TEAM TEACHING CONCEPT

Shaded portion in plan above indicates area of mechanical plan below. Unit 1 serves the administrative wing; unit 2, conference, work rooms and library; unit 3, mathematics classrooms, team room; unit 4, science classrooms, lab preparation room. Note separate thermostats and supply take-offs for divisible classrooms

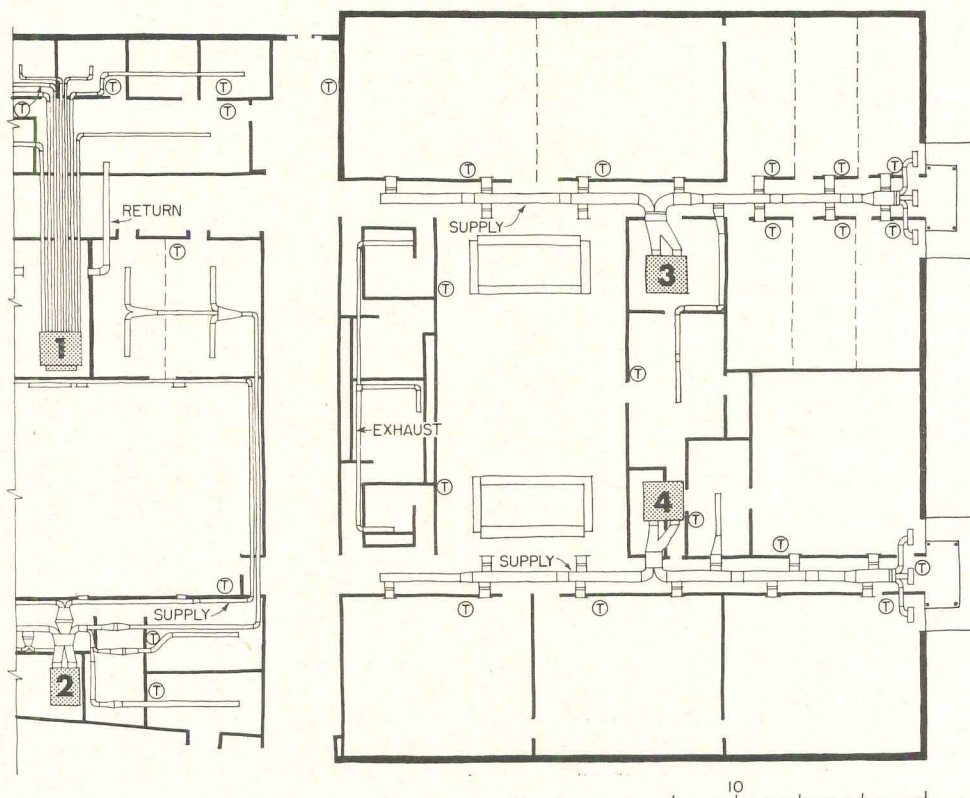

Council Rock Intermediate High School,  
Richboro, Pennsylvania

ARCHITECTS: Haag and d'Entremont

MECHANICAL-ELECTRICAL ENGINEERS:

Valley Engineering Company

STRUCTURAL ENGINEERS:

McCormick-Taylor

OWNER: Council Rock School District,  
Regional Superintendent,

Dr. George E. Taylor

GENERAL CONTRACTOR: James Turzo

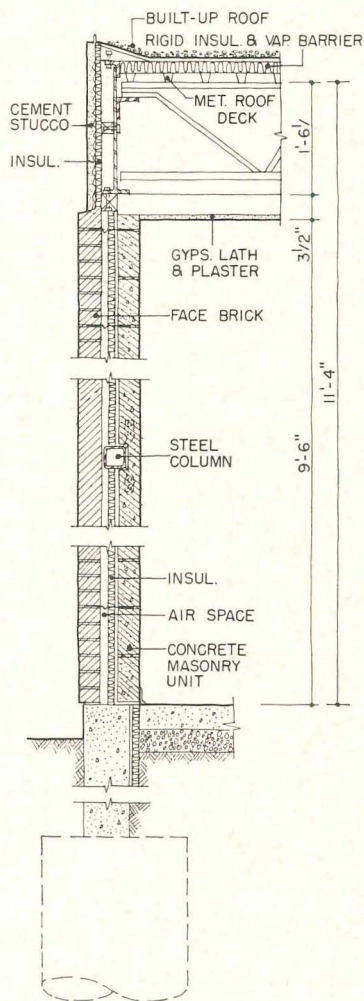

### WALL AND ROOF STRUCTURES

Exterior wall is of cavity construction with a 1-in. air space and 1-in.-thick expanded polystyrene insulation, giving a U factor of about 0.15. The roof has rigid insulation over open-web joists

### THE AIR SYSTEM

Air handling units hang from the roof structure down into the upper portion of storage rooms. This is an elevation of the arts and crafts spaces

method can control air temperatures within close limits, and can give individual temperature control for as many spaces as are provided reheat coils, it is not considered economical for some applications because (in a seeming paradox) you have to provide hot water to reheat the cooled air.

The reheat system used in the Council Rock School utilizes a novel technique which the engineer has termed "bootstrapping." The hot water for reheat actually is provided by the refrigeration apparatus, operating in effect like a heat pump. The condenser in the refrigeration system, whose purpose is to liquify gaseous refrigerant after it has picked up heat and been compressed by the centrifugal compressor, has two sets of water tubes. Through one set, cooling tower water is circulated. Through the other set, the water necessary for reheat is circulated.

The reason for the two bundles of tubes in the condenser is to keep the cooling tower water from possibly contaminating the domestic water system.

If the weather is warm, then the reheat coils cannot utilize sufficient heat from the condenser to cool the refrigerant; in fact, the bulk of this heat must be rejected to the cooling tower water.

If in winter weather only a few of the spaces may need cooling while the rest need heating, then only a small amount of heat can be provided by the refrigeration system, and the balance must be made up by the hot water boilers.

The two cast iron hot water boilers provide winter heating and heat for the domestic hot water.

Why not a complete heat pump system? A water-source heat pump was considered by the engineers, but the idea had to be abandoned because a dependable well for heat

pump use could not be obtained at this particular site.

Two control refinements have been incorporated to keep spaces which are at times unoccupied in readiness comfort-wise.

To prevent the 6½-ft square practice rooms from being chilly when a person first enters (55 F air supplied when in use), electric strip heaters have been provided in the supply ducts.

Larger spaces which might be temporarily unoccupied, such as the food or clothing laboratories, are kept up to temperature by means of booster heaters.

### Electrical System

Primary service is transformed through school-owned transformers to a 480-volt system. Fluorescent lighting of 50 footcandles is provided throughout the building, with 120-volt convenience outlets served from dry transformers. A three channel communication system is provided throughout the building. An internal telephone system is available in all classrooms. Conduit for television is installed for future addition of receivers.

### COST ANALYSIS

(Based on construction bids awarded September 1962)

General construction	\$ 969,900.00
Heating & air conditioning construction	240,000.00
Plumbing & drainage construction (includes subsurface drain fields)	159,295.00
Electrical construction	153,000.00
Drilling well	4,588.00
Test borings	966.00
<b>Total construction costs</b>	<b>\$1,527,749.00</b>
Total area, sq ft	90,000
Construction cost per sq ft	\$ 16.97
Classified student capacity	900
Per student cost	\$ 1,697.49

Costs not included in this analysis: (1) land costs, (2) site development, (3) movable equipment, (4) architectural and legal fees

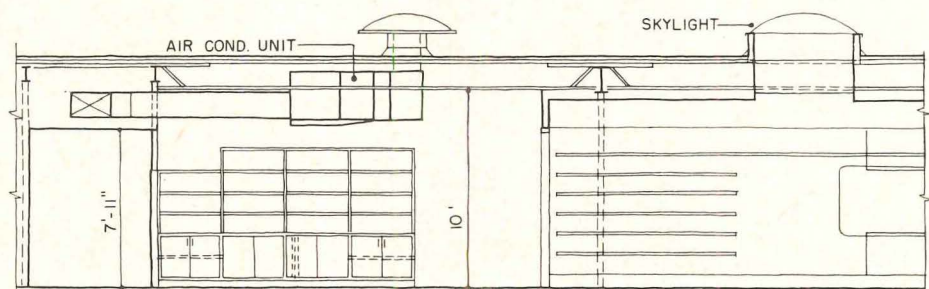

BUILDING AND FACILITY STANDARDS FOR PHYSICALLY HANDICAPPED: 1

By Howard P. Vermilya, A.I.A.

If the physically handicapped are to be rehabilitated, they must be able to move about as freely, and with as little assistance as possible. Further, since useful and gainful employment is an essential part of rehabilitation programs, the buildings in which the handicapped may work should be designed to permit use by them. Recreational and educational buildings as well as other buildings used by the public should have similar provisions.

The problems of design of buildings are largely concerned with movement or circulation and the use of facilities with ease and safety. The American Standards Association has recently issued A.S.A. Standard A 117.1—1961, "Making Buildings and Facilities Accessible to, and Usable By, the Physically Handicapped," sponsored by the National Society for Crippled Children and Adults and the President's Committee on Employment of the Physically Handicapped. This standard is comprehensive and includes much of the essential data required by architects to meet the basic needs of the physically handicapped. The following text is based primarily on A.S.A. Standard A 117.1—1961. The drawings are taken from Building Standards of the University of Illinois Rehabilitation Center, Timothy J. Nugent, director.

**Definition of Handicapped**

The physically handicapped represent one out of seven persons, and where capable of movement may be classified as:

1. Confined to wheel chairs
2. Walk with difficulty (require braces or crutches)
3. Blind or see with difficulty
4. Deaf or hear poorly
5. Badly coordinated or subject to palsy or
6. Infirm from age.

**Wheel Chair Dimensions**

The wheel chair is the basic vehicle for the non-ambulatory

person and establishes the fundamental access and use design requirements. Crutch- or brace-supported semi-ambulatory persons are capable of maneuvering within the limitations demanded by the wheel chair. The most commonly used type is collapsible, made of tubular metals with upholstered back and seat.

**1. WHEEL CHAIR LIMITS (standard model, collapsible)**

- a. *Length*: 42 in.
  - b. *Width*: open 25 in.; collapsed 11 in.
  - c. *Height*: seat 19½ in.; armrest 29 in.; pusher handles 36 in.
- 2. FIXED TURNING RADIUS, wheel to wheel (i.e., tracking of caster wheels and large wheels when pivoting on a spot): 18 in.**
- 3. FIXED TURNING RADIUS, front structure to rear structure, measured diagonally from one end of foot platform to opposite rear wheel, when pivoted on a spot: 31.5 in.**

4. **TURNING AND PASSING SPACE**
  - a. *Area required for 180 degree and 360 degree turns*: average 60 in. by 60 in. Rectangular area 63 in. by 56 in. often preferred to square area.
  - b. *Minimum corridor width for turning 360 degrees*: 54 in. Minimum corridor width for passing of two wheel chairs: 60 in.
  - c. *The distance between crutch tips at normal gait is*: average 5 ft 6 in. person—31 in.; average 6 ft 0 in. person—32.5 in.

**FURNITURE**

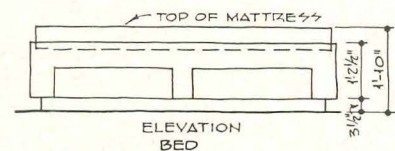
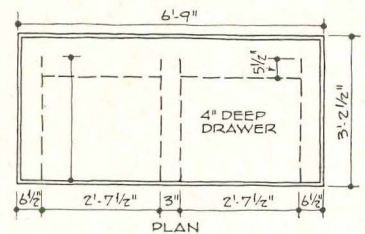
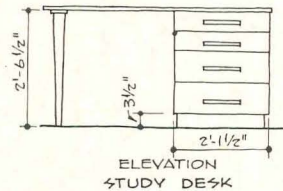
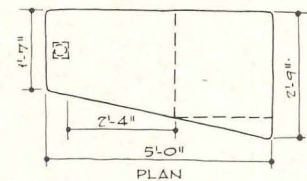

**WHEEL CHAIR**

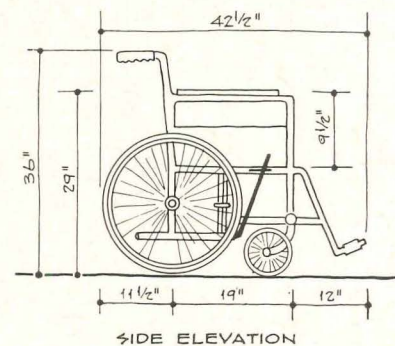

**INDIVIDUAL FUNCTIONING IN WHEEL CHAIR**

	Average	Range
Unilateral vertical reach	60 in.	54-78 in.
Horizontal working reach (table)	30.8 in.	28-33.2 in.
Bilateral horizontal reach (both arms extended to each side, shoulder high)	64.5 in.	54-71 in.
Diagonal reach to object on wall (height on wall)	48 in.	

**BUILDING AND FACILITY STANDARDS FOR PHYSICALLY HANDICAPPED: 2**

By Howard P. Vermilya, A.I.A.

**Design Guides to Permit Use of Wheel Chairs (Exterior)**

**1. ENTRANCES**

a. Service either on grade or by ramp with recommended incline.  
 b. Entrance should lead to an elevator in multi-story structures.

**2. ENTRANCE PLATFORMS.** Should be used with each door, extending 5 ft out from and 1 ft each side of door if door swings out, or 3 ft out from door and 5 ft wide if door swings in.

**3. WALKS**

a. *Minimum width:* 48 in.

b. *Maximum grade:* 5 per cent

Note: Level walks at intersections. Avoid abrupt changes in level and surface materials. Avoid long continued grades by providing level sections at inter-

vals. Bring walk gradually to level of driveways and parking lots. Provide means for blind to recognize intersection of walk with driveway or street (may be done with raised strips in concrete walks).

**4. PARKING SPACES** (*special and identified*). Should be 12 ft wide to permit room at side of car for wheel chair access to or from spaces. Should avoid need to pass behind parked cars.

**5. RAMPS**

a. *Surface:* non-slip.

b. *Grade:* maximum slope 1 in 12, or 8.33 per cent.

c. *Length:* not over 30 ft of continuous slope between level platforms.

d. *Platforms (level):* should be provided at top, bottom and at locations where changes in di-

rection occur. Size where doors occur, same as for entrance platforms. In other locations, **minimum length 3 ft** except at bottom straight clearance shall be 6 ft.

e. *Guard rails or walls:* both sides if ramp is free standing.

f. *Handrails:* minimum, 1 side; preferably on 2 sides.

Height: 32 in. (Provide additional rails at lower heights where children will use the facility.)

Extend 1 ft beyond top and bottom of ramp on side of continuing wall or guard rails.

g. *Width:* same as walk or corridor. Where serving as required exit, shall comply with current Building Exits Code of National Fire Protection Association.

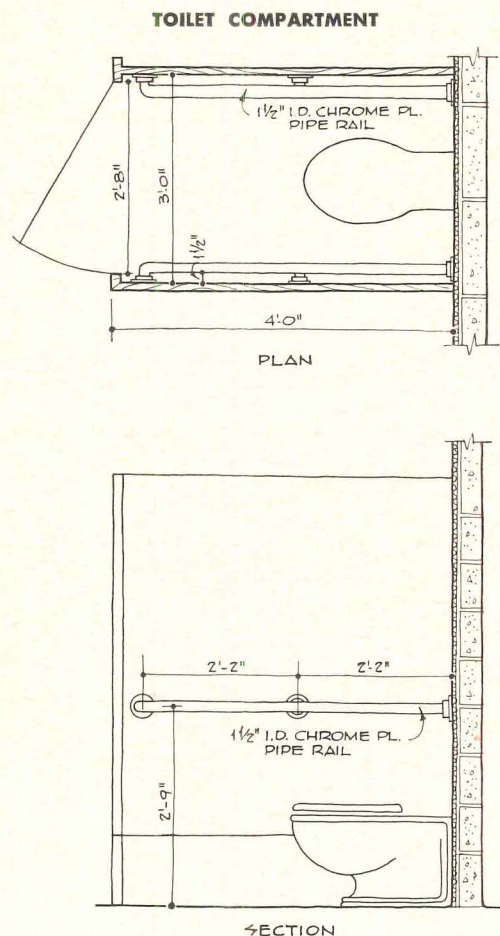
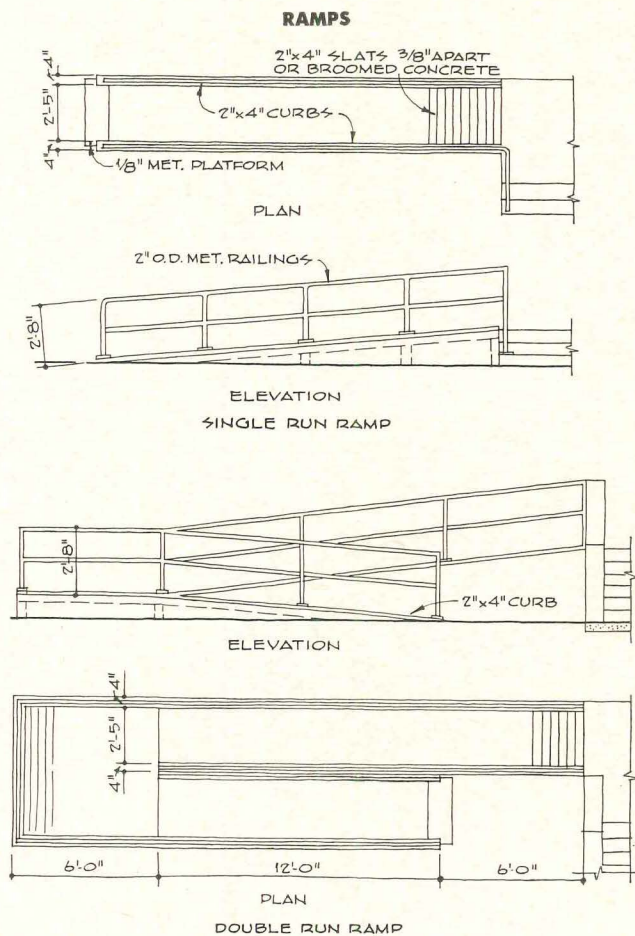

**BUILDING AND FACILITY STANDARDS FOR PHYSICALLY HANDICAPPED: 3**

By Howard P. Vermilya, A.I.A.

**Interior**

**1. DOORS**

- a. *Width*: minimum 32 in. opening when door is open.
  - b. *Operation*: single-effort, (two leaf doors are inoperable by non-ambulatory and semi-ambulatory persons unless they open with single effort or each leaf provides minimum opening.)
  - c. *Door closers*: locate so as not to prevent use by disabled. Time-delay type desirable.
  - d. *Thresholds*: flush or very low.
  - e. *Platforms (level)*: on each side of every door (same dimensions as for entrance platforms). Recess doors equal to width of door when they swing into halls.
- 2. RAMPS**: see exterior.

**3. STAIRS** for use of semi-ambulatory persons.

- a. *Risers*: 7 in. maximum height.
  - b. *Nosing*: avoid projecting nosings (see illustrations).
  - c. *Handrail*: at least one, 32 in. high, extending 18 in. beyond top and bottom risers.
  - d. *Width*: minimum 36 in. between handrails; when stairs serve as a required exit, comply with Building Exits Code of National Fire Protection Assoc. Note: Open stairs should provide means of warning blind of their existence. One device is the insertion of slightly raised abrasive strips in floor at approach to stair.
- 4. ELEVATORS**. *Essential for multi-story building*. Accessible at entrance level and each floor.
- a. *Doors*: minimum 32-in.-wide

opening desirable (see wheel chair dimensions if this is not feasible).

- b. *Cab area*: minimum 5-ft square or 63 in. by 56 in. Automatic control panel not over 48 in. high.

**5. CORRIDORS**

- a. *Width*: should be minimum 60 in.
- b. *Doors opening into corridors*: should be recessed where the traffic is likely to be heavy or where corridor is used by blind people.

**Toilet Rooms, Showers  
Water Fountains**

**1. TOILET COMPARTMENT**

- a. *Width*: 3 ft 0 in. *Depth*: 4 ft 8 in. minimum, preferably 5 ft 0 in.
- (this section continued on next page)

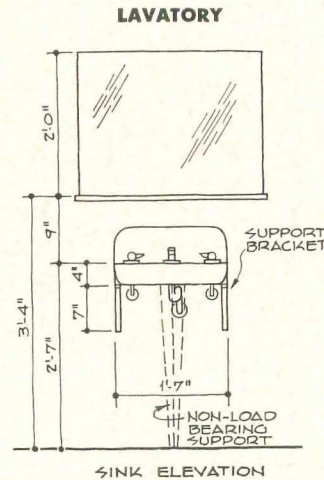
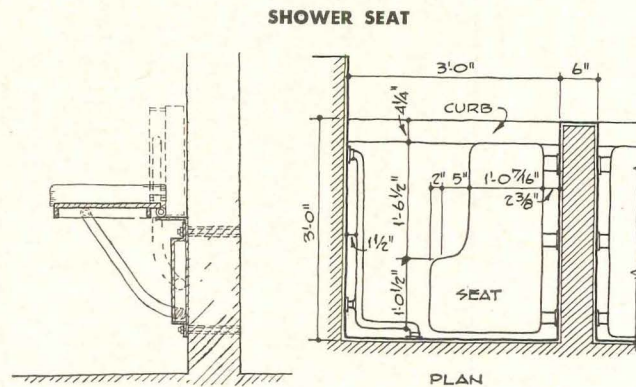
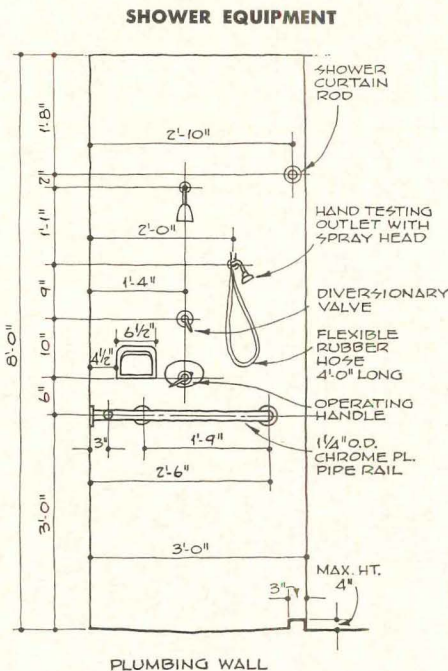

**BUILDING AND FACILITY STANDARDS FOR PHYSICALLY HANDICAPPED: 4**

By Howard P. Vermilya, A.I.A.

b. *Door*: 32 in. wide, opening out.

c. *Handrails*: each side, 33 in. high, parallel with floor; strong and well-supported.

**2. WATER CLOSET**

Seat 20 in. high. Wall-hung type most desirable. If floor supported, under-structure should not interfere with close approach of chair.

**3. LAVATORIES**

Aprons narrow to permit close approach. Place hot water pipes (or insulate them) so they cannot burn wheel chair occupant, particularly those without sensation.

**4. URINALS**

Wall hung, opening 19 in. above floor; floor mounted, at same level as floor.

**5. SHOWERS**

a. *Size*: 3 ft by 3 ft.

b. *Opening*: full width.

c. *Curb*: maximum height, 4 in., preferably lower.

d. *Seat*: folding, along one side, height 1 ft 9 in.

e. *Handrail*: folding along one side and part of rear wall. Height 3 ft 0 in.

f. *Testing spray*: desirable (using hose attachment).

**6. MIRRORS**

Over lavatories as low as possible, not over 40 in. above floor.

**7. TOWEL RACKS, DISPENSERS, SHELVES**

Not over 40 in. from floor.

**8. WATER FOUNTAINS**

*Height* (hand operated or hand and foot operated): floor-mounted side fountain, 30 in.; wall-hung basin, 36 in. Recessed not recommended. Alcoves should be wider than wheel chair.

usable by most disabled persons. Dial and handset should be within reach of person in wheel chair (see illustrations). Confer with local telephone company. Some phones may be especially equipped for those with hearing disabilities (these may be used by all).

**Identification for Blind**

**1. RAISED LETTERS OR NUMBERS for room identification:**

place 4 ft 6 in. to 5 ft 6 in. high, to side of door.

**2. HAZARDOUS OPENINGS**

Knurled hardware for door.

**3. AUDIBLE SIGNALS**

To provide warning.

**4. FLOORING MATERIALS**

Can aid in directing and locating blind occupants of buildings.

**Identification for Deaf**

1. Visible signals as warnings.

**TELEPHONE BOOTH**

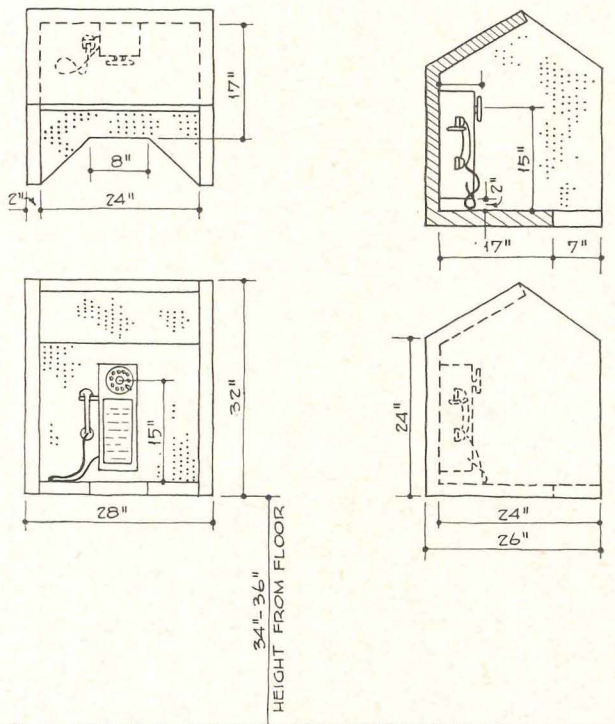

**STEP RISERS**

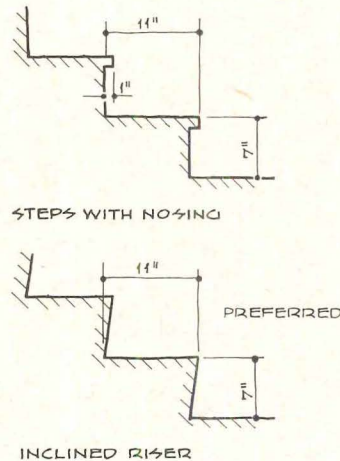

**HARDWARE IDENTIFICATION**

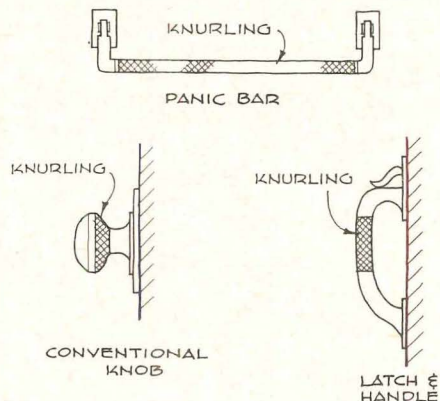

The drawings were prepared for use by the University of Illinois Rehabilitation Center, and to facilitate development of an American Standards Association Standard. The dimensions shown thus do not in all cases correspond to those stipulated in the published A.S.A. Standard A 117.1-1961. In all cases, however, the drawings demonstrate principles to keep in mind in designing facilities for the handicapped

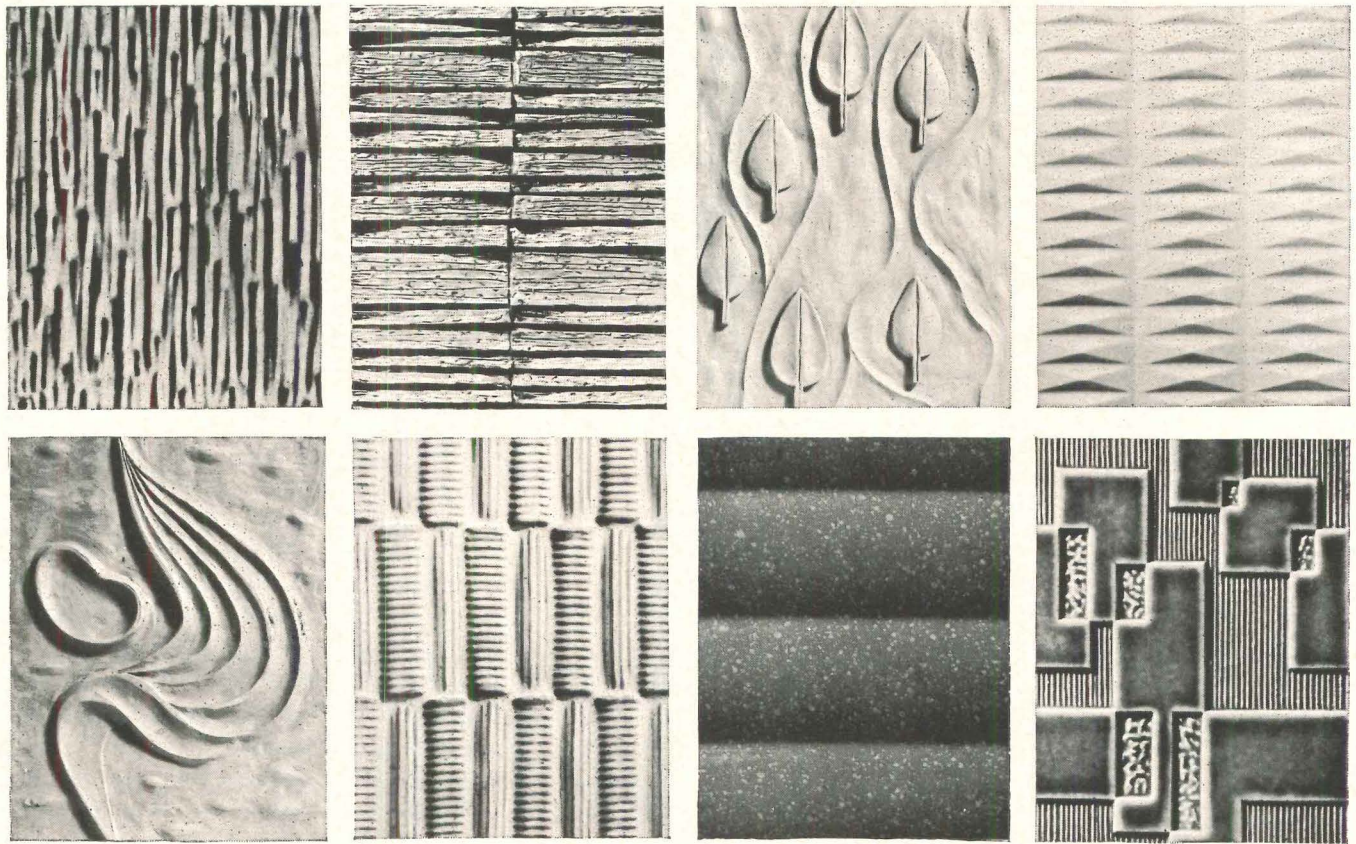

Design your own...or choose a sculptured pattern from the  
**CV DURATHIN<sup>®</sup> Design Series**

Reproduced here are eight of more than a score of CV Durathin patterns illustrated in Federal Seaboard's new Design Series brochure. They are helpful in visualizing the handsome effects you can create with low-relief ceramic walls of  $\frac{3}{8}$ " CV Durathin. There is no limit to the design possibilities . . . practically no restrictions on your choice of colors. You can select a gloss, satin or unglazed finish and specify unit sizes up to  $17\frac{3}{4}$ " x  $23\frac{3}{4}$ ". Used repetitively or in combination with CV Durathin smooth surfaces, the design you select or create will enable you to give the desired architectural expression. Though every unit is custom-made, the cost is much less than you would expect, for walls of individualized beauty, quality and appearance. Detailed information on CV Durathin will be sent on request.

FEDERAL  
 SEABOARD  
 TERRA COTTA  
 CORPORATION



10 E. 40th St., New York 16, N. Y.  
 Plant at Perth Amboy, New Jersey

*Driftwood Cafeteria, St. Petersburg, Fla.  
 Thomas T. Mayo, Jr.—architect. CV Durathin  
 white diamond pattern (CVD-10 in Design Series)  
 was specified for column facing.  
 Unit size is  $17\frac{3}{4}$ " x  $23\frac{3}{4}$ ".*

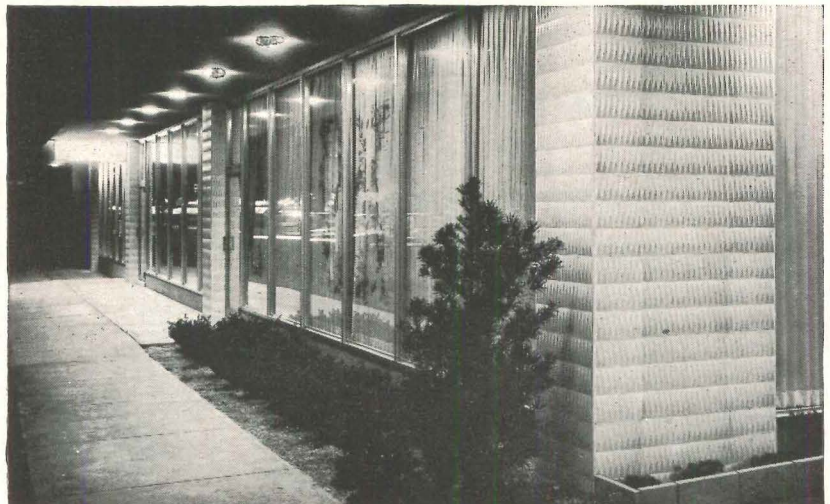

This mark tells you a product is made of modern, dependable Steel.



Favor Road High School, Cobb County, Georgia  
Architect: Bothwell & Nash, Marietta, Georgia  
Fabricator: Steel, Inc., Scottdale, Georgia

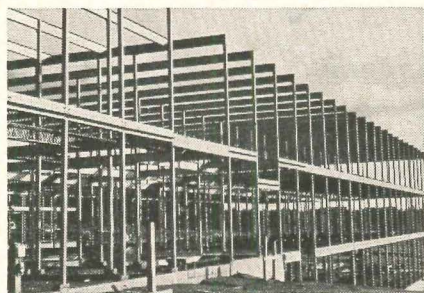

Rand Development Center, Mt. Prospect, Illinois  
Architect: Leichenko & Associates, Inc., Chicago, Illinois  
Fabricator: Lally Column Company, Chicago, Illinois



Union National Bank, Youngstown, Ohio  
Architect: P. Arthur D'Orazio, A.I.A., Youngstown, Ohio  
Fabricator: Allied Metals Company, Niles, Ohio

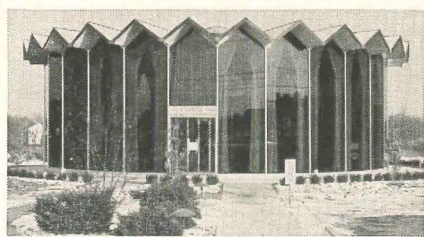

## Progress Report: National Hollow Structural Tubing

Here are just a few of the buildings where architects and engineers have specified USS National Hollow Structural Tubing. It was specified for its attractive appearance, compactness and workability. It has reduced the weight of the structural frames because of its excellent strength-to-weight ratio, and contributed to better appearance because it can be left exposed and painted.

USS National Hollow Structural Tubing can be used as columns or beams. It can be used to form a complete structure, and it can be used in combination with other structural shapes. It meets the physical and chemical requirements of ASTM specifications: Grade 1 meets specifications for A7, Grade 2 meets specifications for A36. Hollow Structural Tubing is highly efficient in compression, or where there is bending stress in more than one direction. It can be joined by all the usual fabricating methods. Tensile strength: up to 80,000 psi; minimum yield strength: 33,000 or 36,000 psi.

USS National Hollow Structural Tubing is available in squares up to 40" perimeters; rectangular tubing is available up to 32" in perimeter. Wall thickness to 1/2 inch. All tubing is available in random lengths, 36' to 42', and in cut lengths. For more information, see your National Tube Distributor, or write National Tube Division, 525 William Penn Place, Pittsburgh 30, Pennsylvania. USS and National are registered trademarks.



**National Tube  
Division of  
United States Steel**

Columbia-Geneva Steel Division, San Francisco  
United States Steel Export Company, New York

Palm Springs Spa Hotel, Palm Springs, California. Architect: William F. Cody, A.I.A., Palm Springs, California. Associate Architect: Philip Koenig, A.I.A. Fabricator: Riverside Steel Construction, South Gate, California



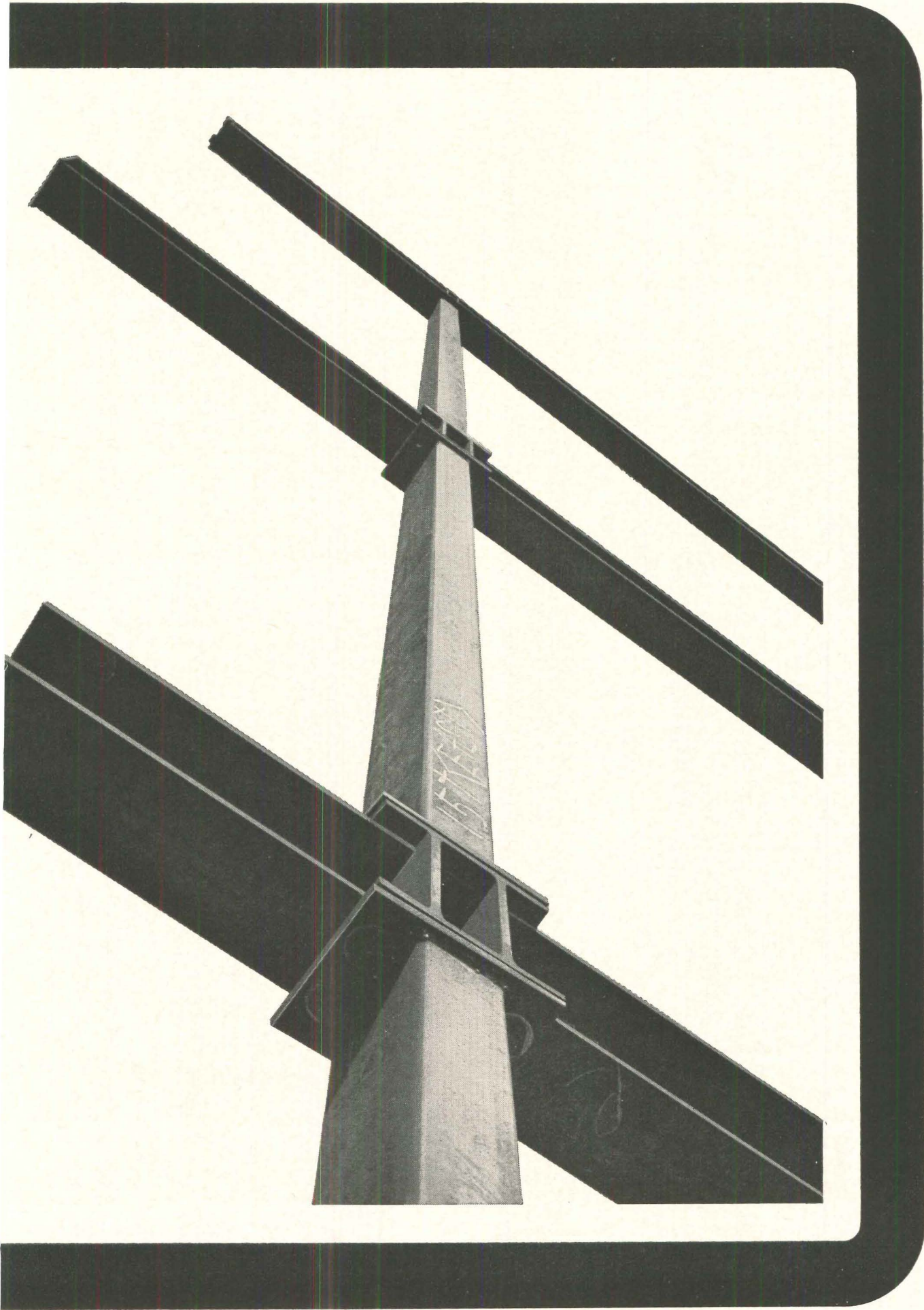

For more data, circle 58 on Inquiry Card



## DID HE SAY ONE...OR NONE?

How well people hear each other in a building depends upon how clearly they speak...how closely they listen...and quite frequently—how good is the sound and communications equipment. The best sound and communications systems bear the name STROMBERG-CARLSON.® ■ All of the components that will be used in any STROMBERG-CARLSON system you specify are custom-matched...designed right from the beginning to work together to minimize engineering and installation time. ■ You can pick from the widest line of components—or systems—because STROMBERG-CARLSON is the most complete line of communication products for business, industry and institutions. ■ Field and factory technical assistance will be readily available...anytime...any place. ■ A system with the name STROMBERG-CARLSON is backed by more than 60 years of unsurpassed competence in sound engineering. ■ Want more details or data sheets? Or do you have specific questions? Write to General Dynamics/Electronics-Rochester, Box A, 1412 N. Goodman Street, Rochester 1, N.Y.

# G|||||D

**GENERAL DYNAMICS | ELECTRONICS — ROCHESTER**

For more data, circle 59 on Inquiry Card



Marine Bazaar in Long Beach, California uses hard anodic coatings for aluminum columns, wall framing members and for sun-screen. Architects, George M. Montierth and Jack J. Strickland

## HARD COATINGS FOR EXTERIOR ALUMINUM

By Robert W. Baker

The growing number of ways in which aluminum can be used on building exteriors has been greatly expanded by the recent addition of hard anodic coatings for exterior applications. These new finishes offer rich shades of aluminum in deep gold, bronze, black and gray and provide extreme resistance to abrasion and corrosion.

The new hard anodic architectural finishes help to extend still further the already wide range of integral and impregnated colored anodic finishes available in aluminum for exterior use.

To be fully understood hard anodized architectural coatings must be reviewed in relation to existing anodized finishes for exterior use.

### Standard Anodic Finishes

Aluminum finishes standard in the architectural field today include buffed (A1), etched (R1) or satin finished (C1 or C3) pretreatments followed by a protective anodizing treatment. Color has been achieved through anodizing in two basic ways. The first common method for producing colored anodic coatings is by ano-

dizing aluminum alloys of controlled chemical composition and temper. These are referred to as integral colors because the alloying elements and oxidation products remain in the anodic coating, imparting color to it. The color, therefore, is introduced directly by anodizing through proper selection of the aluminum alloy. A series of light to dark gray shades, based on the use of a silicon-bearing alloy, has been on the market for about 10 years.

The Alcoa Building, erected in 1951 in Pittsburgh, was the first major building in this country to use an aluminum curtain wall. One of the wrought silicon alloys was used for this job, producing a uniform gray color when anodized. Since then, over 1,000 buildings throughout the United States have been erected which employ gray finishes for building panels, mullions, louvers and window frame applications.

The second common method of producing color anodized surfaces is through the use of organic dyes and mineral pigments. It is possible to color anodize aluminum by absorbing or precipitating organic dyes and mineral pigments into the porous anodic coating. This technique has been used for at least 30 years on exterior applications such as giftware,

appliances and furniture accessories. Unfortunately, the range of light-fast coloring agents satisfactory for exterior use is very limited.

At present, there are very few organic dyes or mineral pigments that are suitable for outdoor architectural applications. After extensive evaluation, Alcoa has selected two organic dyes and one mineral pigment which have a high degree of exterior color retention and permanency. Sometimes the integral color of the base alloy is combined with the impregnated color of the organic dye or mineral pigment to produce soft intermediate tones.

### Hard Anodic Coating Background

In 1952, Alcoa and The Martin Company introduced a hard anodic coating for functional applications. These extremely hard, dense, anodic surface coatings were especially interesting to the aircraft industry where a light aluminum alloy with a hard, wear-resistant surface offered a valuable replacement for parts fabricated from heavier metals.

Hard coatings have since found widespread use as protective coatings for aluminum in many other cases where extreme wear and abrasion resistance are required.

In order to appreciate the tech-

ROBERT W. BAKER is with Alcoa Process Development Laboratories, Aluminum Company of America, New Kensington, Pa.

nique involved in producing the hard anodic type coatings, it is necessary to review some basic fundamentals relating to anodizing.

All of the processes for producing a hard anodic coating on aluminum and its alloys are electrochemical in nature and result in the formation of a thick layer of aluminum oxide. The theory of anodic oxidation of aluminum is rather complex and beyond the scope of this article.

In general, however, the aluminum oxide coating is formed by anodic oxidation of the surface when aluminum is made anodic in a suitable electrolyte. Oxygen liberated at the surface of the anode combines with the aluminum forming essentially aluminum oxide.

This oxidation is a conversion process; therefore, the oxide coating grows into the metal, and the last formed oxide is an extremely thin, nonporous layer at the interface which is known as the barrier layer. The first formed oxide is relatively porous because it has been subject to the solvent action of the electrolyte from the beginning of the anodizing cycle. The concentration and temperature of the electrolyte, in addition to the time of treatment, determine the amount of solvent action. A delicate balance exists between the formation (electrochemical) of the oxide and solvent action (chemical). The characteristics of the coating can be accurately predicted by proper selection of electrolyte operating conditions. The primary difference between the conventional anodizing process and the hard coating process is that the latter utilizes higher current densities, higher formation voltages and lower electrolyte temperature with resultant decreased solvent action.

Aluminum hard coatings are so called because they are considerably thicker and more resistant to abrasion and wear than the more common anodic coatings. The increased thickness, weight and density of the coating accounts for the greatly increased wear and corrosion resistance.

Because of decreased solution, the constituents and their oxidation products remain in the coating to impart color. From an architectural standpoint, these hard coatings possess inherent, attractive bronze, brownish-gray and black shades when applied on commercial architectural alloys. These alloys, which remain

relatively colorless or are only slightly tinted by conventional anodic coatings, can produce deep shades when hard coated. The depth of color as well as abrasion and corrosion-resistance increases with increased oxide coating thickness. It is possible and practical with the hard coating process to produce anodic coating of 2-4 mils thickness, whereas the practical limiting oxide coating thickness with the conventional process is about 1.5 mils.

#### Hard Coating Processes

Alcoa, after extensive testing in commercial size architectural anodizing installations, introduced a modified form of the hard coating treatment in the spring of 1959. This modified hard coating process now called Duranodic 100 is a licensed, royalty-free process. Under this system, light, medium and dark architectural finishes were developed which represent .001-in., .002-in., and .003-in.-thick oxide coatings, respectively.

An advantage of this method for achieving integral colors with anodized aluminum is the ability to utilize commercial architectural alloys rather than specialty products. The latter type product, although extremely useful and very uniform in color after anodizing, may in some instances necessitate delivery and/or inventory problems.

The color range prepared from production material is agreed upon by the architect, building owner and finisher. For many installations, being able to utilize stock material has been an advantage to the architectural fabricating industry. Of course, the use of specialty alloys permits the process to achieve its best potential, and these have been specified for buildings where design considerations warrant their use.

From the commercial finisher's standpoint, another advantage of the Duranodic 100 process is that simple changes in operating conditions utilizing a single anodizing tank are the only modifications required to convert from the natural or clear anodized finish to the Duranodic 100 bronze and black shades. This is in contrast to the new Duranodic 300 treatments that require the installation of a separate anodic tank and solution. Thus, the finisher must install two anodizing systems when it is desired to produce both the conventional finishes and Duranodic 300 on

the commercial architectural alloys.

Since the Duranodic 100 Process requires a substantial investment in refrigeration capacity, in order to maintain low operating temperatures, our research laboratories recently developed an entirely new system for producing the hard, abrasion and corrosion-resistant integral colored architectural finishes. This new process, called Duranodic 300, utilizes a new electrolyte and operates at or near room temperature, requiring only a moderate investment in refrigeration equipment as compared to the Duranodic 100 process.

The Duranodic 300 process is a licensed, royalty-bearing process requiring contract signatures of Alcoa and the processor. Commercial finishing firms throughout the United States have already been licensed and others are anticipated to accommodate the capacity of the current market.

As in all anodic oxidation processes, operating conditions of electrolyte concentration, electrolyte temperature, current density and voltage are interrelated in Duranodic 300. However, Duranodic 300 is more flexible in process than Duranodic 100 in the ability to adjust the above conditions to meet specific requirements. In most instances with Duranodic 300, the desired color can be achieved with thinner anodic coatings than with Duranodic 100. For unmaintained exterior surfaces, a minimum of .0007-in. oxide coating thickness and 32 mg per sq in. coating weight is required. For maintained exterior surfaces such as store fronts or interior surfaces a minimum .0004-in. oxide coating thickness and 17 mg per sq in. oxide coating weight is quite adequate.

The Duranodic 300 process has good possibilities for color control; however, an important factor is the use of controlled alloys to permit the process to realize its best potential. Three new alloys have been developed for Duranodic 300 providing light medium and dark bronze, medium gray and black.

During the past 10 years, finishes for architectural aluminum have mushroomed from fairly simple mechanical and chemical pretreatments, protected by clear anodic coatings, to integral colors based on specialty alloys and the use of dyes and pigments. The hard anodic coatings for exterior aluminum expands its dynamic field even further.

For more information circle selected item numbers on Reader Service Inquiry Card, pages 181-182

## TRANSLUCENT PANELS FOR WALLS AND CEILINGS

Exterior wall panels, room dividers and skylights are some of the applications for a large-cell rigid foam board that transmits light and provides insulation. *Styrocel*, a copolymer of styrene and methyl methacrylate, is produced in 2-inch, 1½-inch and 2-inch-thick boards, 16 inches wide and 96 inches long.

The luminous ceiling panels shown were made by extruding *Styrocel* resin onto the foam, resulting in a sandwich stronger than the foam itself. The entry sidelight has colored transparent acrylic sheets ¼ inch thick inserted between the foam and the outside glass panes.

In one-inch thickness, the light transmission is about 65 per cent and the k factor is .48 to .52. Several standard adhesive systems can be used to bond the *Styrocel* to skin materials. *The Dow Chemical Co., Midland, Mich.*

CIRCLE 300 ON INQUIRY CARD

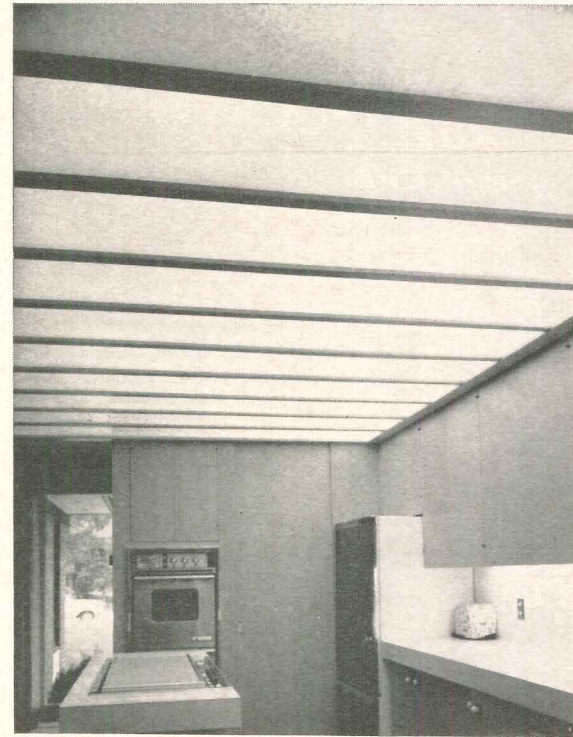
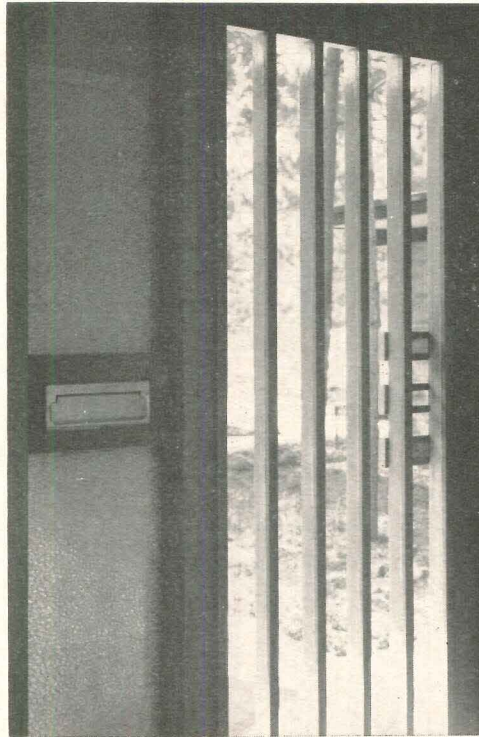

## HAND-CRAFTED MURALS, FURNITURE, SCULPTURE

Hand-carved wood, metal and stone murals, with both representational and abstract designs are made to specifications. A large number of stock patterns are available. A matte appearance is achieved on wood murals by using oil-base finishes. A variety of woods and colors can be supplied and assembled into panels four feet square without extra cost.

In addition to the murals, Hand-Made Interiors offers handmade furniture made with hand tools and sculptor's chisels. Handmade pottery, ceramics of every description and ceramic sculpture are made to specifications. Industrial carvings, such as trade marks, can also be ordered. *Hand-Made Interiors, 883 E. 21st St., Brooklyn 10, N.Y.*

CIRCLE 301 ON INQUIRY CARD

more products on page 146

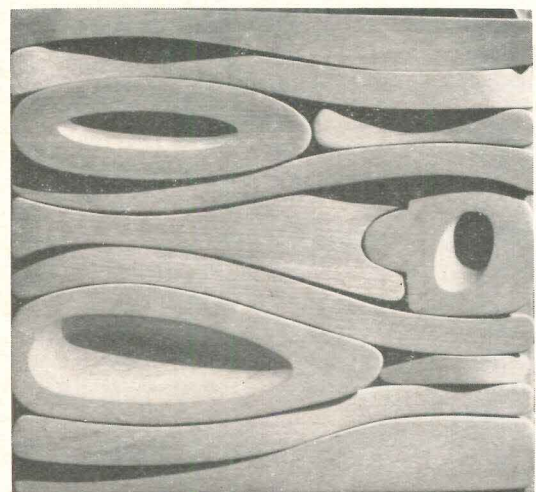
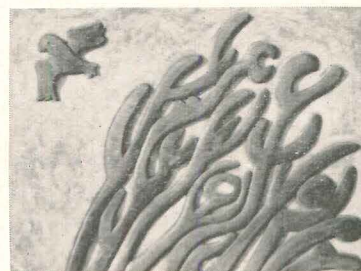
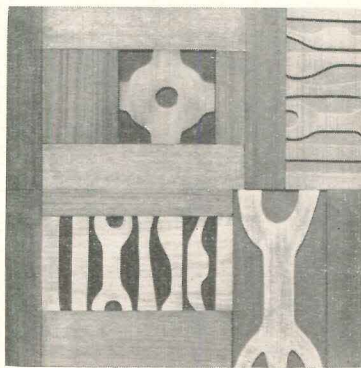

# Office Literature

For more information circle selected item numbers on Reader Service Inquiry Card, pages 181-182

## PLASTIC LAMINATE DOORS



(A.I.A. 19-E-13) Doors clad with *Formica* laminated plastic are illustrated in eight-page booklet. Solid core, hollow core, mineral core and lead-lined doors

are included. *Formica Corp., 4614 Spring Grove Ave., Cincinnati 32, Ohio\**

CIRCLE 400 ON INQUIRY CARD

## EXTERIOR COATING

(A.I.A. 25-C-2-28-C) Folder has details on *Textane*, a textured exterior coating made with polyurethane resins and aggregates. *Desco International Assoc., Box 74, Buffalo, N.Y.\**

CIRCLE 401 ON INQUIRY CARD

## MOVABLE PARTITIONS

Detail sheets for two lines of movable partitions show solid panel and glass assemblies. *Architectural Systems, Inc., 4300 36th St., S.E., Grand Rapids, Mich.\**

CIRCLE 402 ON INQUIRY CARD

## ACOUSTICAL PRODUCTS

(A.I.A. 39-B, 31-F, 30-F) More than 475 acoustical products, including simple perforated tiles, metal panels, sound insulating doors and complex integrated acoustical-ventilating-luminous ceiling systems, etc., are included in a 44-page catalog. *Elof Hansson, Inc., Acoustical Div., 711 Third Ave., New York 17, N.Y.\**

CIRCLE 403 ON INQUIRY CARD

## TRUSS CONSTRUCTION

(A.I.A. 19-B-3) Use of truss construction for farm buildings, commercial buildings, churches and homes is outlined in 24-page booklet. *Sanford Truss, Inc., P.O. Box 1177, Pompano Beach, Fla.*

CIRCLE 404 ON INQUIRY CARD

## HOME LIGHTING

*Honeycomb* series of lighting fixtures uses a plastic cellular material in various colors. *Moe Light Div., Thomas Industries Inc., 207 E. Broadway, Louisville 2, Ky.\**

CIRCLE 405 ON INQUIRY CARD

## PLYWOOD FACTS

Vest-pocket-size "Facts About Plywood" has detailed information on Douglas fir and western softwood plywood. *Douglas Fir Plywood Assoc., Tacoma 2, Wash.\**

CIRCLE 406 ON INQUIRY CARD

## SOUND CONTROL

Folder describes *Soundike*, a lamination of fiberboard and gypsum wallboard for use in apartment wall and floor construction. In walls it may be used with standard or staggered studing with or without air space. In floors it may be used in two-layer and three-layer construction. *Johns-Manville, 22 E. 40th St., New York 16, N.Y.\**

CIRCLE 407 ON INQUIRY CARD

## VINYL PANELS



*is 66, Mo.*

Product data and specifications are given in installation guide for rigid vinyl building panels. *Monsanto Chemical Co., 800 N. Lindbergh Blvd., St. Louis*

CIRCLE 408 ON INQUIRY CARD

## ELECTRIC STAIRWAY

(A.I.A. 19-E-41) Folder gives details on electrically operated retractable stairways which fit into ceiling enclosures. *Precision Parts Corp., Nashville, Tenn.\**

CIRCLE 409 ON INQUIRY CARD

## FOLDING CLASSROOM WALLS

Folding classroom walls to meet functional and sound-retarding requirements of various situations are presented in eight-page booklet. *Richards-Wilcox Mfg. Co., 800 Third St., Aurora, Ill.\**

CIRCLE 410 ON INQUIRY CARD

## STEEL SHAPES AND PLATES

Revised edition of the U.S.S. "Shapes and Plates" manual gives complete properties and dimensions for all currently produced structural and plate products. *United States Steel Co., 525 Wm. Penn Place, Pittsburgh 30, Pa.\**

CIRCLE 411 ON INQUIRY CARD

## FIRE PROTECTION



(A.I.A. 29-E-2) Fire hoses, valves and cabinets for protection equipment inside all types of buildings are illustrated in Catalog #62. Simplified specifications are given. *Elkhart Brass Mfg. Co., Inc., Elkhart, Ind.\**

CIRCLE 412 ON INQUIRY CARD

## HEAVY-DUTY LIGHTING

Industrial and commercial lighting fixtures for indoor and outdoor use are described in a 48-page loose-leaf catalog. Complete technical information, specifications, and illustrations are given for each fixture. *Wheeler Reflector Co., Inc., Hanson, Mass.*

CIRCLE 413 ON INQUIRY CARD

## LOUDSPEAKERS

"Auditorium Speaker Arrangements" is a selection guide for specifying sound reinforcement systems in auditoriums ranging in size from 300 to 2,000 seats. *RCA, Audio Products, Meadow Lands, Pa.*

CIRCLE 414 ON INQUIRY CARD

## TEXTURED CEDAR

(A.I.A. 19-D) Western red cedar saw-textured products in a variety of patterns, including clear channel, clear tongue and groove, V-joint, etc., are illustrated in a four-page color folder. *Western Red Cedar Lumber Assoc., 4403 White-Henry-Stuart Bldg., Seattle 1, Wash.\**

CIRCLE 415 ON INQUIRY CARD

## SWITCHBOARDS

Engineering and layout manual for I-T-E *Uni-Power* switchboards shows how standardized sections can be applied to commercial and industrial low voltage systems. Bulletin 9200-1A. *I-T-E Circuit Breaker Co., Walker Div., P.O. Box 2384, Station D, Atlanta, Ga.*

CIRCLE 416 ON INQUIRY CARD

\*Additional product information in *Sweet's Architectural File* more literature on page 176



Colors: V-352 French Walnut with black and white accents

## *Vina-Lux*<sup>®</sup> WOOD TONES

*mellow floor beauty that won't "walk off". . .*

. . . because the distinctive wood-grain pattern is distributed through the full thickness of the tile. Wood Tones in Vina-Lux vinyl asbestos tile retain their beauty and pattern under the heaviest concentrations of traffic . . . deliver so much more value than surface patterns . . . yet cost no more. Specify Vina-Lux Wood Tones, for installation over concrete — above, on or below grade, or over wood or plywood subfloors. Consult Sweet's Catalog — or let us send you samples, color charts and detailed architectural specifications. Azrock Floor Products Division, Uvalde Rock Asphalt Company, 517A Frost Building, San Antonio.

Magnified view shows pattern distribution through full thickness of tile. Available in 1/8" 3/32", 1/16" gauges.

*another fine floor by* **AZROCK**

For more data, circle 60 on Inquiry Card

# How do you select

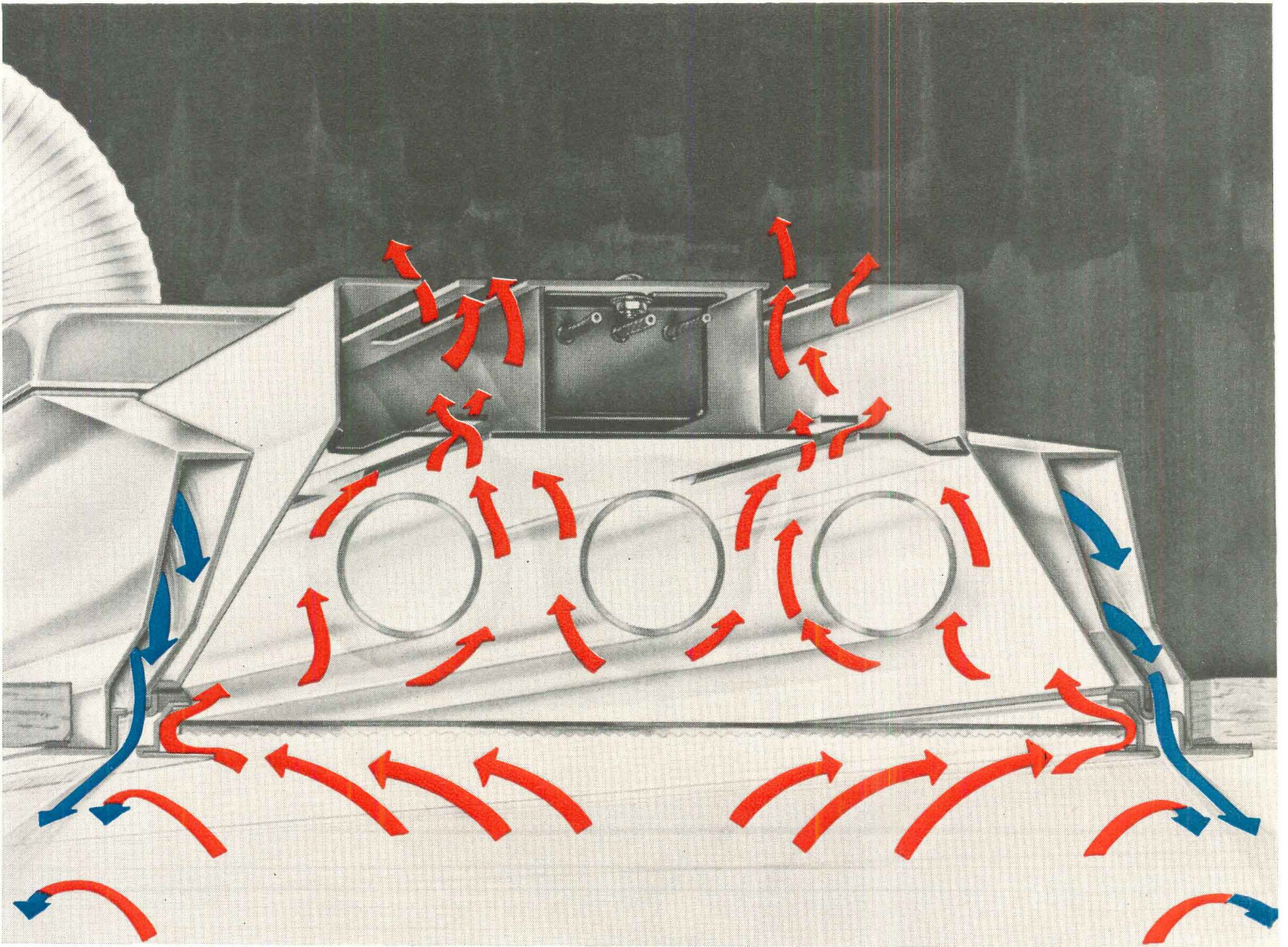

Fig. 1. Benjamin Lumi-Flo Troffer with Heat Removal Feature.



# air-handling troffers?

By esthetics? Efficiency? Either way, Lumi-Flo Troffers offer you an entirely new design freedom. Read how:



Esthetically, the crisp, symmetrical styling of Benjamin Lumi-Flo Troffers creates a "clean" ceiling, functionally and visually handsome.

Technically speaking, the most important single benefit of Lumi-Flo Troffers is *complete design flexibility*. For, with the wide selection of styles and types Lumi-Flo offers, you can create the exact air-conditioning-lighting system you need for any job. Here's what we mean:

**Three styles available.** Each fits a specific design need. In the standard Triple-Shell Lumi-Flo Troffer (Fig. 2), full-length diffusers distribute air flow evenly at capacities from 0 to 200 CFM. An insulating air gap separates the closed lamp chamber from the air flow. End result is increased air capacity plus maintained lamp chamber ambient guarding against color shift and flicker.

**The new Benjamin Heat Removal Troffer (Fig. 3),** removes up to 400 btu/hr. of excess fixture heat before it enters the room. It can cut cooling system operating costs appreciably by lowering CFM requirements and minimizing ductwork investment.

**The Combination Lumi-Flo Troffer (Fig. 1),** combines the advantages of both designs. It works as a supply air diffuser, and evacuates fixture heat too.

Any one, or any combination can give you the precise system you need. So, you can design for economy *or* efficiency, yet still realize the results of both.

**Premium lighting efficiency.** Because the Lumi-Flo Triple-Shell design insulates lamps from air flow, lighting efficiency can increase as high as 15%. And, you'll get longer lamp and ballast life as well.

**Simple installation.** You can reduce installation time up to 50% with Lumi-Flo. Special swivel bar hangers eliminate cumbersome yokes commonly used. Snap-in socket plates and drop-in hinges also speed the job, yet require no tools.

Send for technical manual. It's impossible to generalize about specific installations. But, the new 40-page Lumi-Flo Manual can help. You can design the exact system you need from the technical material contained in it. Send for it today. Or, if you need immediate information, enclose specifics and we'll work out the Lumi-Flo data for you.

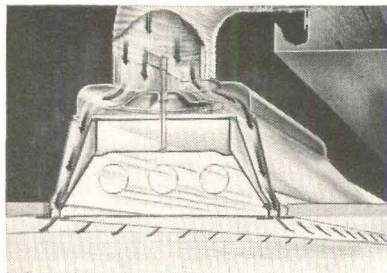

Fig. 2. Triple-Shell Lumi-Flo Troffer.

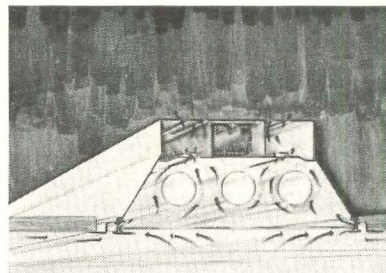

Fig. 3. Benjamin Heat Removal Troffer.



**BENJAMIN**  
DIVISION  
**THOMAS INDUSTRIES INC.**  
207 East Broadway, Louisville 2, Kentucky  
Benjamin • Moe Light • Star Light • Enchante

Air-handling components by Tuttle & Bailey Division of Allied Thermal Corporation.

Manager Architectural Products  
BENJAMIN DIVISION, THOMAS INDUSTRIES INC., Dept. AR-12  
207 E. Broadway, Louisville 2, Kentucky

**YES, I WANT MORE INFORMATION ON LUMI-FLO TROFFERS**

- Send me the new 40-page Lumi-Flo Manual.  
 Give me advance technical information on heat removal.  
 Have your sales engineer call.

NAME \_\_\_\_\_

FIRM \_\_\_\_\_

ADDRESS \_\_\_\_\_

CITY \_\_\_\_\_ ZONE \_\_\_\_\_ STATE \_\_\_\_\_

For more data, circle 61 on Inquiry Card

Chrysler Building, New York City. Architect: William Van Alen.  
General Contractor: Fred T. Ley & Company. Sheet Metal Contractor:  
Benjamin Riesner, Inc.

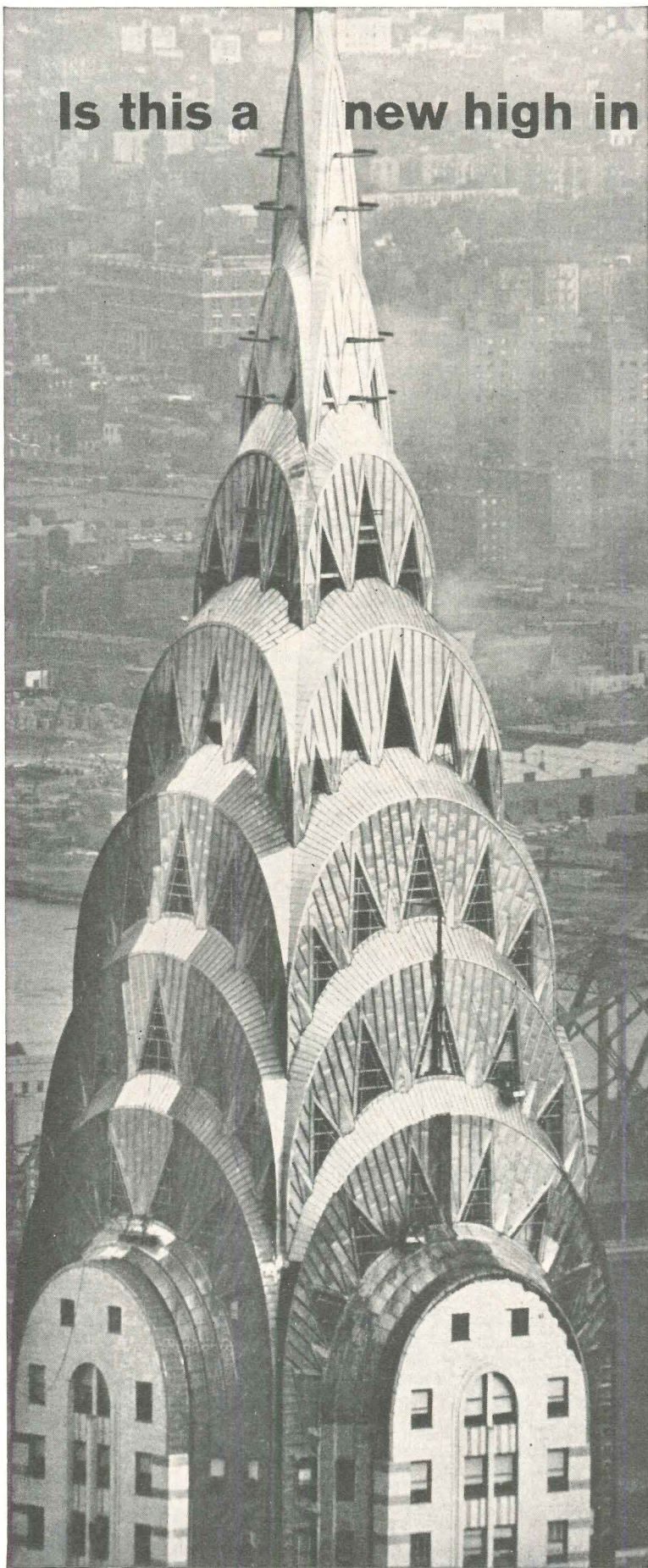

## Is this a new high in low maintenance?



**You're looking at** the start of the first face-washing ever given this famous Nickel Stainless Steel tower. The sheathing is still as good as new—after 31 years of sooty proximity to a battery of New York City power plants.

**When the Chrysler Building** was finished in 1930, ten large sheets of Nickel Stainless Steel, similar to Composition AISI Type 302, were kept on hand, just in case New York's weather and smoke proved damaging to the gleaming tower and gargoyles. Recently these spares went to the scrap pile. They were never needed.

**Maintenance savings have multiplied** year after year because the building's entrance, window frames, store fronts and flashings are all Nickel Stainless Steel. No architectural metal can match its record of maintenance dollars saved. It's corrosion resistant all the way through...needs no paint or other coating. It's compatible with adjacent materials, and won't stain them—even under long exposure to an electrolyte. Other advantages? They're detailed in the booklet *Architect's Guide to Nickel Stainless Steel Flashings*. A copy is yours for the asking.

**THE INTERNATIONAL NICKEL COMPANY, INC.**

67 Wall Street



New York 5, N.Y.

# INCO NICKEL

**MAKES STAINLESS STEEL PERFORM BETTER LONGER**

For more data, circle 62 on Inquiry Card



"The Gizmo", Students' Snack Room, Knox College. Architects: Perkins & Will. Plate 451.

## What to use for a "Gizmo" Floor?

Murray Quarry Tile was selected for this student eating area because of its warm earthy colors and its well-known durability. These new Ember Flash tiles give a pleasing mottled effect, and the 8" x 3<sup>7</sup>/<sub>8</sub>" size was used to achieve a subdued feeling of pattern. Quarry tile was preferred, too, in this heavy traffic area, because it is rugged, yet so easy to keep clean. Write for Murray Quarry Tile catalog 861.



MURRAY TILE COMPANY, INC. • 153 MELANIE DRIVE • LEWISPORT, KENTUCKY

For more data, circle 65 on Inquiry Card

## Product Reports

continued from page 139

### ADJUSTABLE SHELVING FOR MATERIALS LIBRARY

Convenient, easy-to-adjust steel shelving is used in the materials library of Welton Becket and Associates, Architects and Engineers. Shelves are changed quickly using brackets with two locking clips attached. No tools are needed to unlock and lock the clips. Beaded-post design permits straight-



out withdrawal and repositioning of shelves without tilting. *Standard*

Pressed Steel Co., Columbia-Hallowell Div., Jenkintown, Pa.

CIRCLE 302 ON INQUIRY CARD

### ONE-PLY ROOFING

*Last-O-Roof*, a prefabricated single-ply roofing is suitable for almost any service, for most slopes and all climates. The principal membrane (called *Last-O-Bestos*) has an elastic and highly durable weathering face of compounded polyisobutylene welded to an elastomer bonded asbestos support. For flashings another mem-



brane (*Last-O-Flash*) is used in which a woven glass scrim is substituted for the asbestos support. Cold-applied adhesives can be poured, brushed or troweled on. A special metallic coating is applied to the finished roof with hand brush, roller or spray. The plastic face of the *Last-O-Roof*, although new to this country, has been used in Germany for over a decade. No signs of deterioration or surface degradation have been noted. *Johns-Manville, 22 E. 40th St., New York 16, N.Y.*

CIRCLE 303 ON INQUIRY CARD

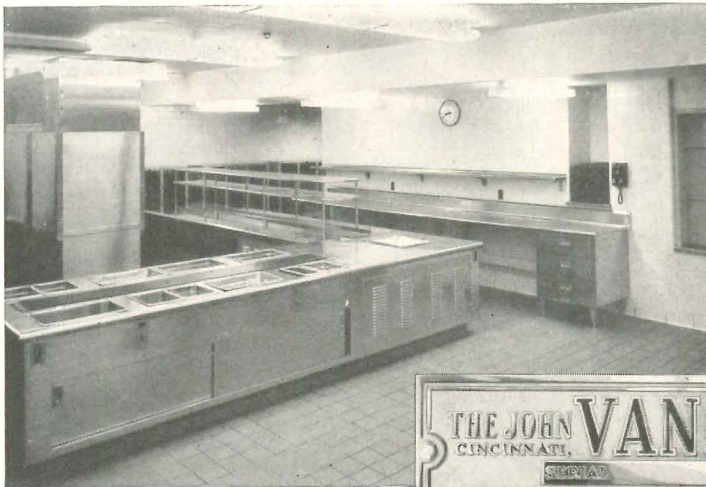

ARCHITECT: DAN A. CARMICHAEL

★  
GOOD SAMARITAN  
HOSPITAL  
ZANESVILLE, OHIO

•  
CAFETERIA

•  
SISTER M. ANGELO  
CHIEF DIETITIAN



# nearly million meals a year from Van equipment

★ Van is proud to have assisted in the engineering, designed and fabricated the food service equipment for this all stainless kitchen and cafeteria, serving 2400 meals a day to patients and Good Samaritan Hospital personnel.

★ Included in the installation is an L-shaped stainless steel mechanical serving table in which the patients' trays are made up complete except for drink, ready for waiting trucks which transport them to patients' floors.

★ Good Samaritan Hospital reports: "We have found Van equipment very good in design and construction, reflecting Van's many years of experience . . . more than a century."

★ Let Van help you with food service equipment improvements.

Write

THE JOHN VAN RANGE CO., 429 Culvert St., Cincinnati 2, Ohio.

**VAN**

**FOOD SERVICE EQUIPMENT**

For more data, circle 64 on Inquiry Card

### OFFICE PARTITION AND DESK UNITS

A combination pole, movable partition and desk unit allows accommodation of more people in any given area.



The pole unit is a double channel which can carry both phone and power lines through an overhead feed. The panels are not required for structural stability and are used to give separation. *Detroit Partition Co., Detroit, Mich.*

CIRCLE 304 ON INQUIRY CARD

more products on page 152



SMOOTH GREEN

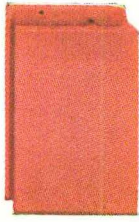

SMOOTH CORAL



SMOOTH GRAY



WEATHERED GREEN



SMOOTH BUFF

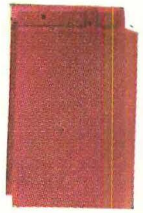

WEATHERED RED



WEATHERED BLACK

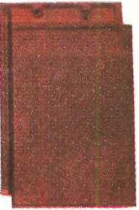

WEATHERED BROWN



SMOOTH WHITE

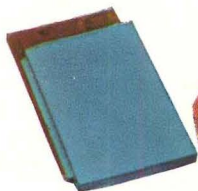

BLUE GLAZE ON DESIGNER PATTERN



YELLOW GLAZE ON SPANISH PATTERN



GREEN GLAZE ON DESIGNER PATTERN



Rowsey Memorial Chapel, Muskogee, Oklahoma—Archts.: Bennett & Crittenden, Dallas, Texas—Tile by Ludowici: Early American Gray Range

## RELIGIOUS, RESIDENTIAL, INSTITUTIONAL and COMMERCIAL...Ludowici Roofing Tiles Adapt to All

*Our representatives are always available to assist you on your special roofing problems*

### BRANCH OFFICES & REPRESENTATIVES:

565 Fifth Avenue  
New York 17, New York  
OXford 7-8090 or 8091

740-15th Street, N.W.  
Washington 5, D. C.  
NAtional 8-8932

12734 Woodland Avenue  
Cleveland, Ohio  
771-7777

8428 Kate Street  
Dallas 25, Texas  
EMerson 1-5013

• 1412 Sharon-Amity Road N  
Charlotte, North Carolina  
EMerson 6-3149

• 1717 Section Road  
Cincinnati 37, Ohio  
MElrose 1-7945

• 7909 Big Bend  
St. Louis 19, Missouri  
WOODland 2-0200

• 2240 Coral Way  
Miami 46, Florida  
445-2214

• Pittsburgh, Pa.  
Dial Operator  
ZENith-0779

**WEST COAST REPRESENTATIVES:** Gladding, McBean

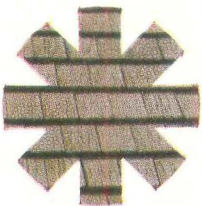

**LUDOWICI-CELADON CO.** 75 EAST WACKER DRIVE • CHICAGO 1, ILL. • RANdolph 6-6740

*Manufacturers of quarry tile, the nation's largest producer of roofing tile and NAILON Facing Brick*

For more data, circle 63 on Inquiry Card

SEE SWEET'S FILE NO. <sup>8f</sup> Lu

A.I.A. FILE 12-E

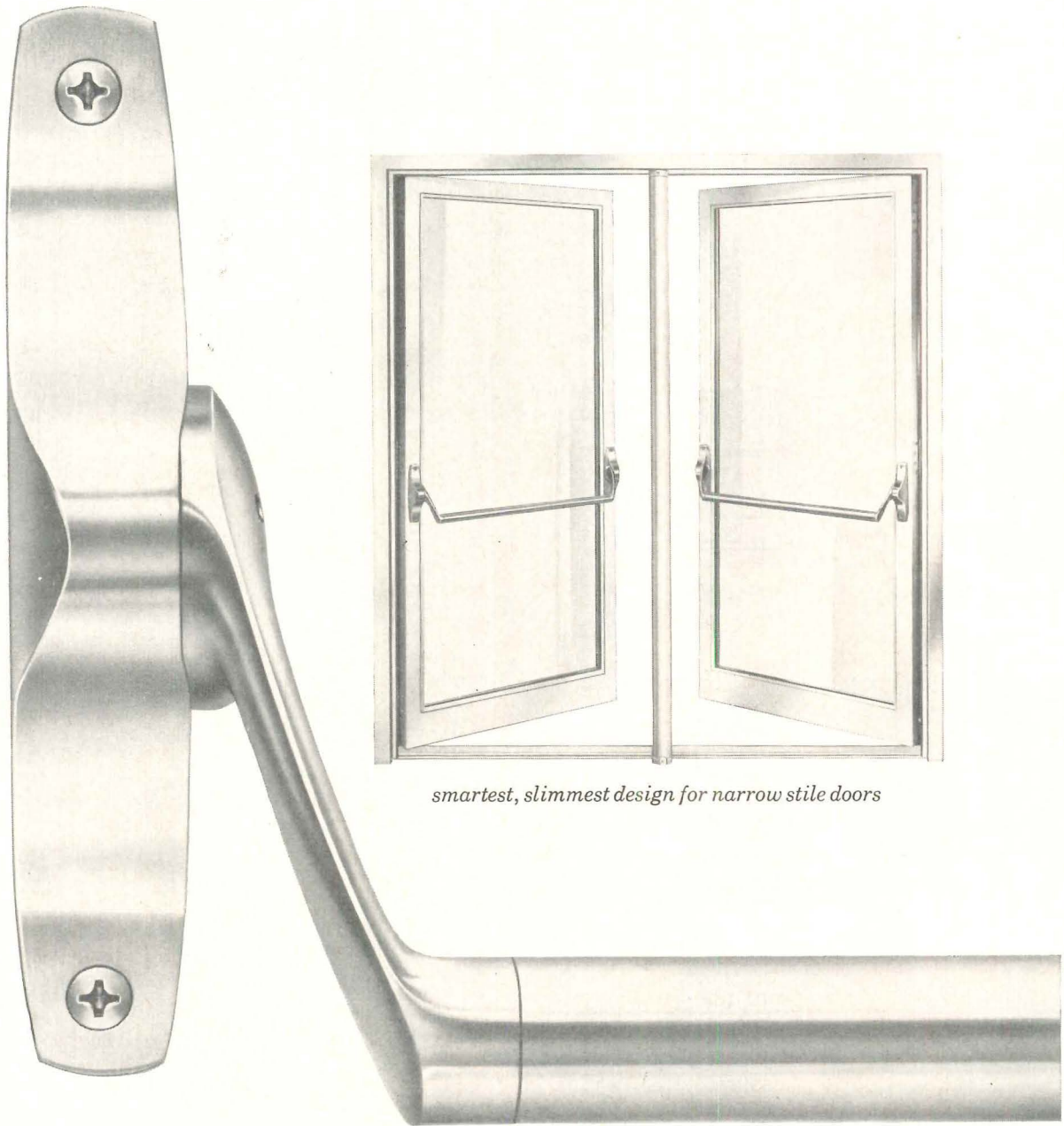

*smartest, slimmest design for narrow stile doors*

## Von Duprin® 55 exit devices

● All new styling . . . rim or concealed vertical rod devices in stainless steel, bronze or aluminum. New side mounted crossbar concept gives slimmest possible appearance, even when used on pairs of

doors with new triple core mullion. Cases are only 1 $\frac{3}{16}$ " wide! Write today for Bulletin 628.

VON DUPRIN DIVISION • VONNEGUT HARDWARE CO.  
402 WEST MARYLAND • INDIANAPOLIS 25, INDIANA

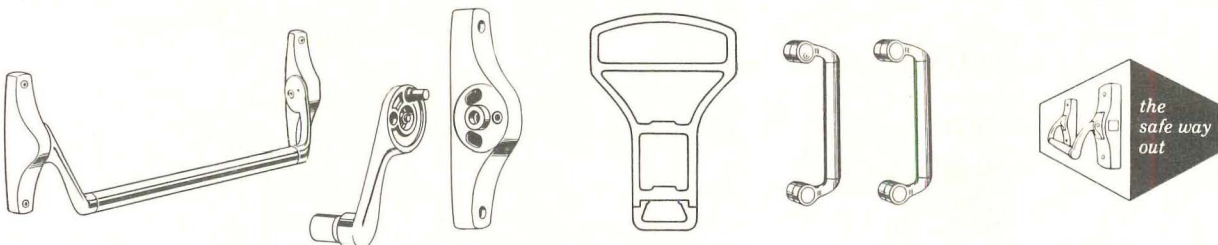

*NEW! slim styling . . . side mounted lever arms . . . triple core mullion . . . modern trims*

For more data, circle 66 on Inquiry Card

# compaction\*

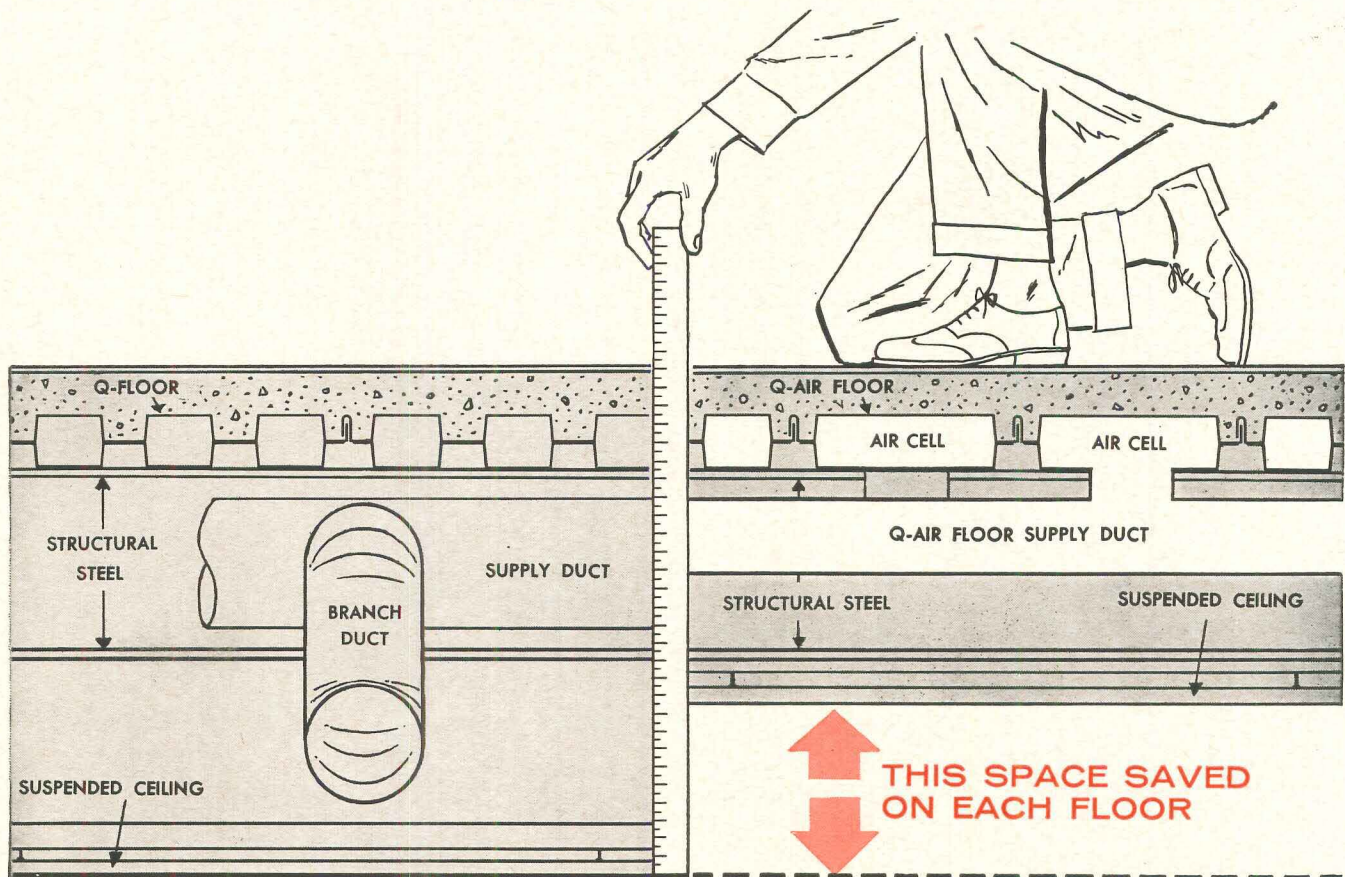

**\*** **Compaction** is the word that describes the space saved in a modern air conditioned building when Robertson Q-Air Floor is used. Because the cellular steel structural floor distributes hot and cold air as well as power and communications wiring, the distance between floor and ceiling below can be reduced as much as a foot. Compaction is assured **because the secondary ducts go over the beams**. This feature alone can save as much as 5% of the material cost of a building. Use the coupon below to obtain the latest Q-Air Floor Catalog.

## ROBERTSON Q-AIR FLOOR

**H. H. ROBERTSON COMPANY**  
FARMERS BANK BUILDING • PITTSBURGH, PA.

*In England—*  
Robertson Thain Limited, Ellesmere Port, Cheshire  
*In Canada—*  
Robertson-Irwin Limited, Hamilton, Ontario



*Sales Offices In Principal Cities Throughout The World*  
Plants In: Ambridge, Pa. • Connersville, Ind. • Stockton, Cal.

H. H. Robertson Company  
2400 Farmers Bank Bldg., Pittsburgh 22, Pa.

I would like to have more information on Q-Air Floor.  
Please send me your Q-Air Floor Catalog.

Name

Title

Firm

Address

City  Zone  State

For more data, circle 67 on Inquiry Card

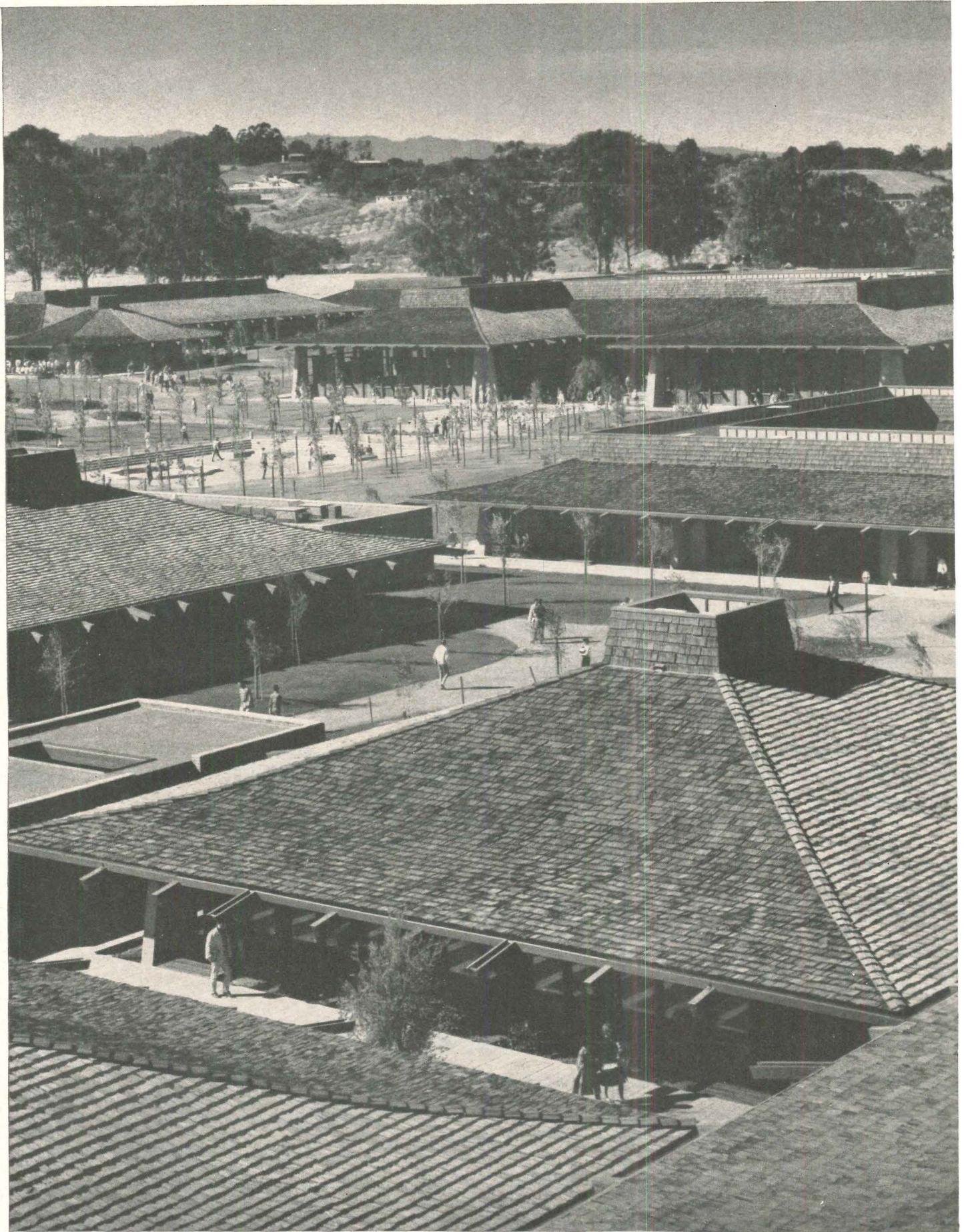

From 382 designs, 1962's First Honor Award in the A.I.A. 14th annual Honor Awards Program went to Foothill College, Los Altos, California, for its "individual and artistic expression," and the environment for learning it creates. Architects: Ernest J. Kump and Masten & Hurd, Architects Associated.



*For new lessons in school design*  
use **WOOD** . . . and your imagination

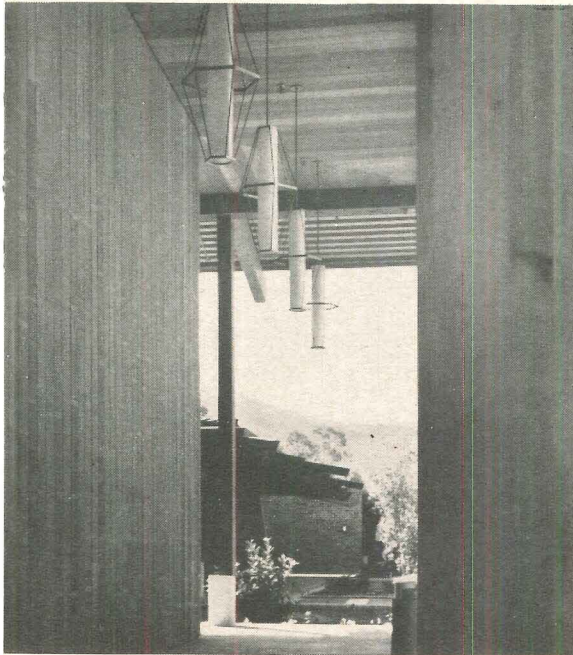

The out-of-doors is effectively framed in wood by this corridor's planked walls and ceiling. Exposed posts and supporting members for the roof-overhang show more of wood's predominance in Foothill College's award-winning design.

Wood's adaptability helps win awards for many schools of design. But just as important, wood's familiarity helps win the acceptance of students, faculties, and communities in schools of any design. No matter what shape or form it's in—shingle roofing, exposed framing, solid paneling—wood makes a classroom a friendly place for learning and teaching alike . . . a gymnasium spectacularly spacious for sports, an auditorium acoustically sound for listening.

The economy of wood begins with your original plans . . . extends into future alterations needed for growing enrollments on non-budging budgets. Wood has the capacity to welcome other materials, too; the inherent strength to stand up under generations of classes to come. For more information on designing schools with wood, write:

**NATIONAL LUMBER MANUFACTURERS ASSOCIATION**  
*Wood Information Center, 1619 Massachusetts Ave., N.W., Washington 6, D.C.*

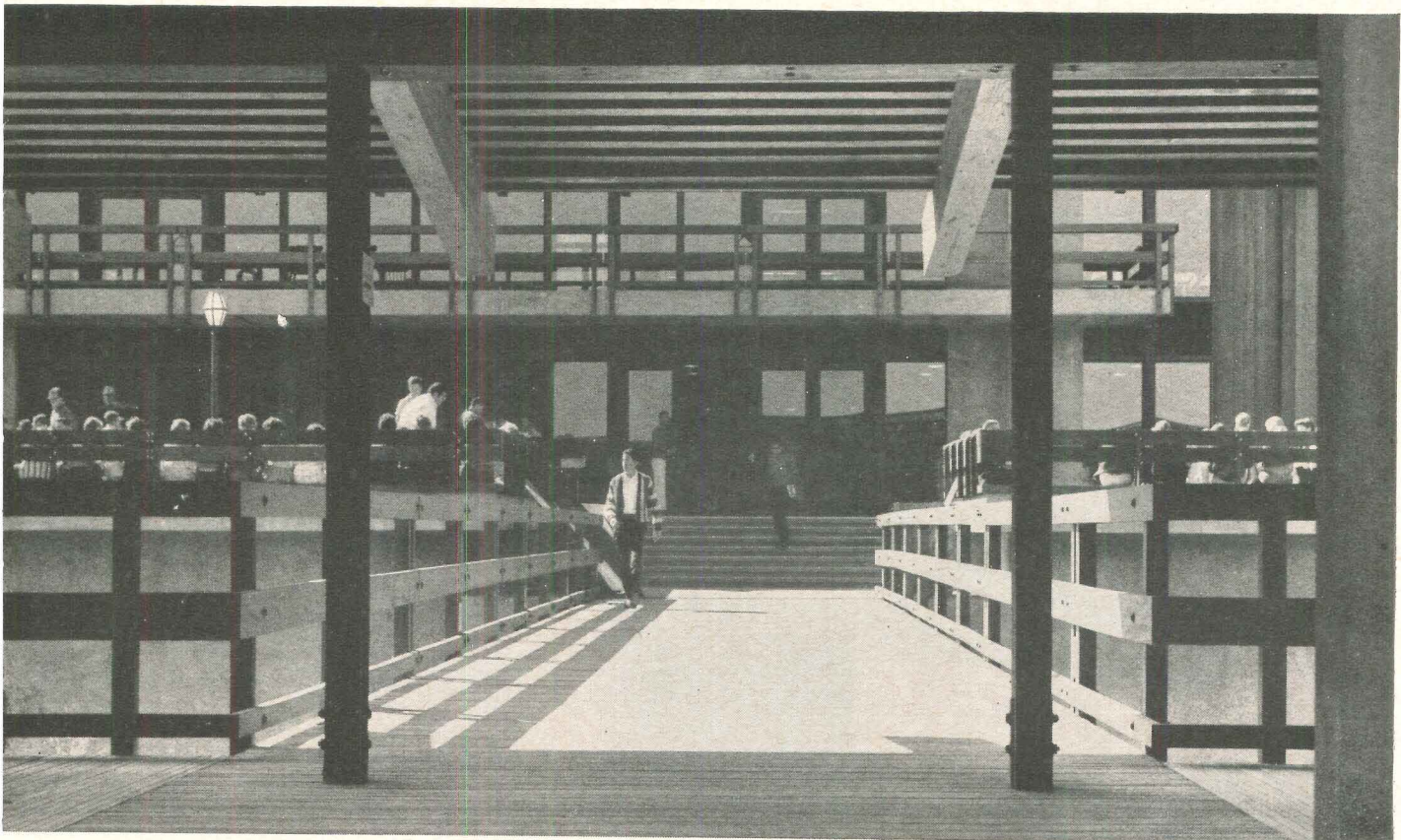
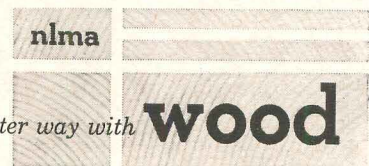

Virtually all wood, this entranceway to the space module unit makes extensive use of naturally finished posts and beams. Note, too, the wood decking and railing that join these Foothill College buildings beautifully and purposefully.

For more data, circle 68 on Inquiry Card

# FRESH!

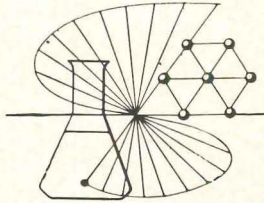

## IMAGINATIVE USE OF STIMULATING MATERIALS

You can select distinctive Haws fountain designs that keep pace with your *own* architectural ideas. They're fresh! Here are a few for your appraisal: detailed specs are yours for the asking.

### Fiberglass

**HDFC** electric water cooler, AIR COOLED! Semi-recessed wall model, molded in strong fiberglass. In 3 colors or white.

### Hard Anodized Aluminum

**7L** wall fountain in cast Tenzaloy aluminum, hard anodized to rich bronze finish that stands up under rough usage. Here's a real beauty: and practical, too!

**7J** wall model with same hard anodized finish as 7L, above. Features Haws easy-action push-button valve.

### Stainless Steel

**10V** multiple wall fountain, *new* from every angle, featuring push-button valves.

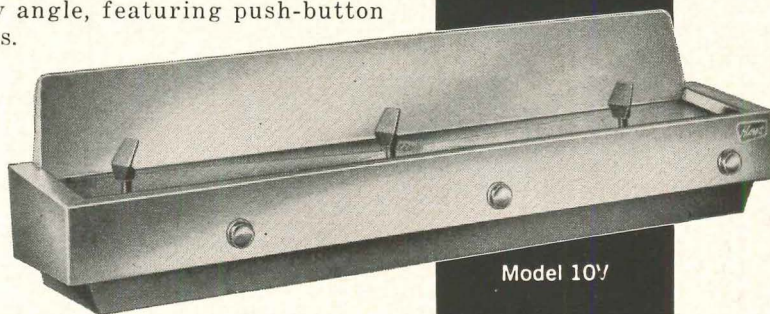

Model 10V

Model HDFC

Model 7L

Model 7J



products of

**HAWS DRINKING FAUCET COMPANY**  
1441 Fourth Street • Berkeley 10, Calif.

Since 1909

For more data, circle 69 on Inquiry Card

## Product Reports

*continued from page 146*

### STAINLESS STEEL SLIDING GLASS DOOR

Carmel Steel Products announces the first production model stainless steel sliding glass door. It is expected to be



of particular interest in coastal areas, where salt corrosion is a problem with other metals. *Carmel Steel Products, 9738 E. Firestone Blvd., Downey, Calif.*

CIRCLE 305 ON INQUIRY CARD

### TEXTURED ALUMINUM PANELS WITH CONCEALED JOINTS

Textured aluminum building panels interlock to form roof and wall surfaces without obvious joints. The deep-formed, 12-in.-wide units are available in nine finishes. The interlocking joints form a weather-tight seal, so caulking is not required. Three thicknesses are available, with purlin spacing depending on the thickness of the panels used and the applied load. *Reynolds Metals Co., 19 E. 47th St., New York 17, N.Y.*

CIRCLE 306 ON INQUIRY CARD

### CERAMIC TILE

The beauty of glazed tile and the non-slip properties of unglazed ceramic tile are combined in *Vico Glazed Sculptile Pavers*. The portions to be

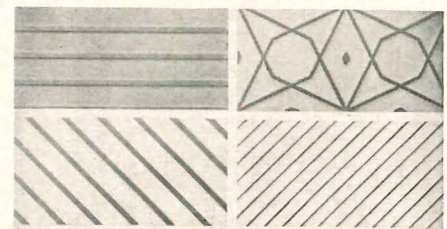

glazed are depressed leaving unglazed raised lines which give a safety no-slip treading surface. *Amsterdam Corp., 285 Madison Ave., New York 17, N.Y.*

CIRCLE 307 ON INQUIRY CARD  
*more products on page 157*

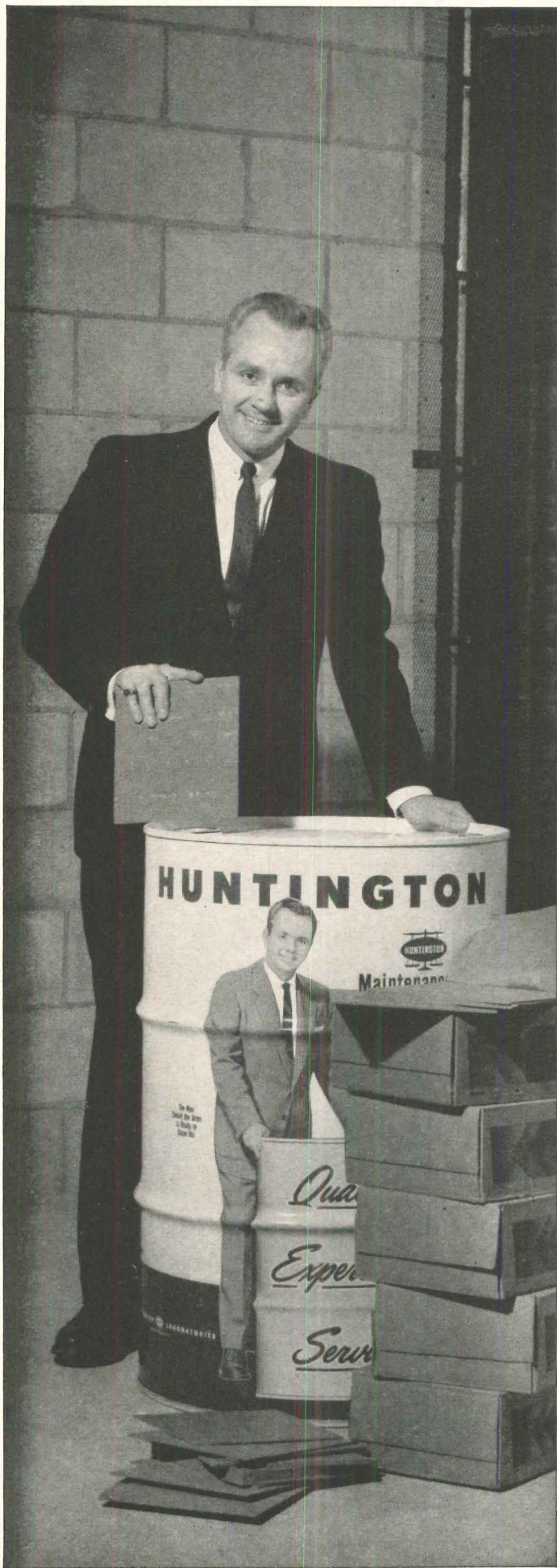

YOU SPECIFY THE FLOORING!

# He'll make sure it lives up to your reputation

People will be walking on your reputation, beginning the day this building goes into use.

They'll be digging into it with their shoes. Dragging abrasive dirt and dust across it. Tracking moisture. For your reputation will rest on the flooring you specify as well as on the overall architectural design.

Yet, the flooring you specify can be drawing raves years from now with proper care and maintenance. Without any headaches or effort on your part. Just turn its maintenance over to our representative . . . the Man Behind the Huntington Drum.

Flooring care has been his province for an average of 19 years. Give him the green light—and he'll come up with a floor maintenance program covering every area and every flooring material.

Call in the Man Behind the Huntington Drum. Put the burden of floor maintenance on his shoulders right now.

## HUNTINGTON

*... where research leads to better products*

**HUNTINGTON LABORATORIES**

Huntington, Indiana

Philadelphia 35, Pennsylvania • In Canada: Toronto 2, Ontario

-- FILL OUT AND MAIL THIS COUPON --



**Huntington Laboratories, Inc.**  
P. O. Box 710, Huntington, Indiana

**Gentlemen:** I would like a Man Behind the Huntington Drum to call on me to discuss floor maintenance.

( Ask him to leave his drum outside.)

NAME \_\_\_\_\_ TITLE \_\_\_\_\_

FIRM \_\_\_\_\_

ADDRESS \_\_\_\_\_

CITY \_\_\_\_\_ ZONE \_\_\_\_\_ STATE \_\_\_\_\_

For more data, circle 70 on Inquiry Card





# \$26,000+

## HUNG IN THE BALANCE!

When the North Star Bowling Lanes in St. Paul burned to the ground just prior to the opening of the Fall bowling season, the building owner and the lessee were faced with considerable financial loss.

Mr. Pietruszewski, the lessee, had already contracted with twelve different bowling leagues at \$3,000 each. Failure to fulfill his obligations would mean loss of a major portion of his entire year's revenue.

For the owner, Mr. Drkula, whose income depended upon leasing the building at \$980 per week, the problem was to construct a new building in time for the Fall opening. Laminated wood trusses were considered for the main supports, but when calculations showed they would cost \$20,000 more than steel and require an additional month in construction, the decision went to steel.

Starting with the existing footings at ground level, the new building was erected in only 40 working days. Twenty alleys, restaurant and cocktail lounge were completed in time for the bowling season. The owner's continued income was assured and Mr. Pietruszewski's business was saved.

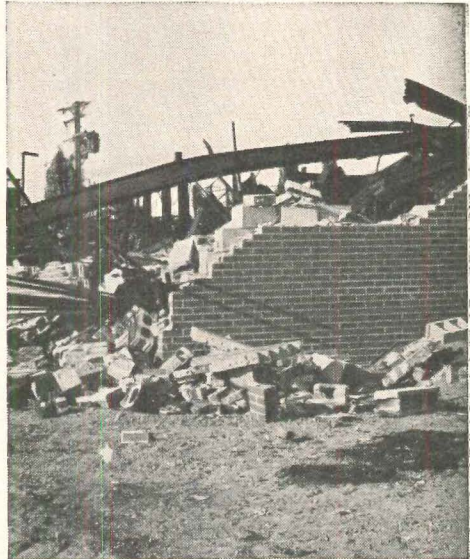

THIS IS ANOTHER EXAMPLE OF THE MONEY-SAVING POSSIBILITIES INHERENT IN THE USE OF STEEL. STEEL DOES THE JOB BETTER, FASTER, MORE ECONOMICALLY, THAN ANY OTHER CONSTRUCTION MATERIAL.



**IS ECONOMY**



## STEEL CONSTRUCTION

meets the needs of architect and client alike... permitting the creation of an endless variety of buildings—from those expressive of dignity and strength to breath-taking examples of airiness and grace.

## SPEEDS BUILDING

Another plus factor, more than welcome to owners concerned with the earliest possible utilization of their properties. With steel, work goes on regardless of weather—makes installation of plumbing, air-conditioning and power lines easier and faster.

## SAVES MONEY

Steel is economical in its conservation of space between floors. What's more, because of its lightness in proportion to strength, it is the least costly material to transport and handle at the job site. Using the new AISC Specifications and taking advantage of the new light-weight, high-strength steels, surprising economies are possible.

## FREES DESIGN

New plastic design, composite design, plate and girder construction, all contribute to freedom of expression. Steel blends with or can accent almost any other component or building material, making function and beauty one.



**INLAND STEEL COMPANY**  
30 West Monroe Street, Chicago 3, Illinois

Wide Flange Beams—Steel Plates—Bearing Piles and Steel Sheet Piling—Ti-Co® Galvanized Sheets—4-Way® Safety Plate—Enameling Iron—Sub-Purlins.

For more data, circle 72 on Inquiry Card

## Product Reports

continued from page 152

### PLASTIC FILM FOR EXTERIORS

*Tedlar* polyvinyl fluoride film is a tough, chemically stable finishing material which can be applied to wood, aluminum, galvanized steel, plastics, asbestos felt and other substrates. Because of its toughness and high degree of elongation, *Tedlar* can take much expansion and contraction without fracturing. It can be bonded to metal and plastics before formation into components, assuring complete protection of the finished duct. The pigmented film is expected to last about 25 years under average outdoor exposure with only slight color change. *E. I. Du Pont de Nemours & Co., Wilmington, Del.*

CIRCLE 308 ON INQUIRY CARD

### COMPACT, SECTIONAL AIR CONDITIONER

A compact year-around air-conditioning system for use in apartments, hotels, offices and institutions, is only 48 in. long and 17 in. high for cooling capacities up to 11,500 Btu per hr.

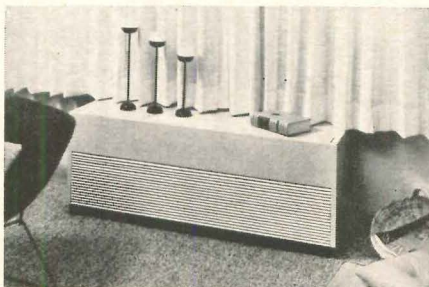

The complete chassis is in sections so that heating and cooling systems that are tailored to fit the specific installation requirements can be installed in the cabinet. *Westinghouse Electric Corp., 200 Readville St., Hyde Park, Boston 36, Mass.*

CIRCLE 309 ON INQUIRY CARD

### STRIP FLOORING

*Forrest Wood-Strip* flooring, a high density material made of reconstituted wood and resins, consists of tongue and grooved strips 3½ in. wide, ¾ in. thick and 8 ft long. It can be installed using conventional nailing equipment at costs much lower than conventional hardwood flooring. *Forrest Industries, Inc., P.O. Box 78, Dillard, Ore.*

CIRCLE 310 ON INQUIRY CARD

more products on page 164

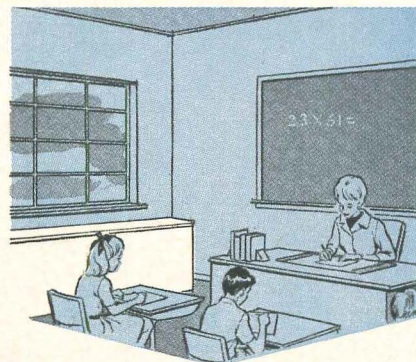

**HOW TO ADD**  
*Usable*  
**MORE FLOOR SPACE**  
to classrooms, labs, offices

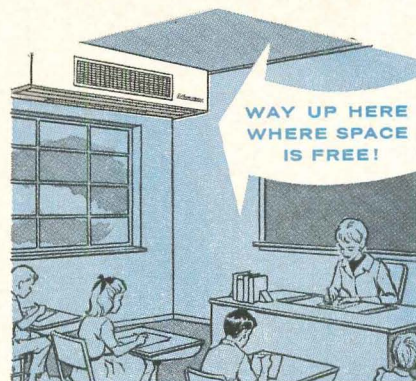

## SCHEMENAUER Ceiling Unit Ventilators

These beautifully styled heater-coolers automatically yield floor space—enough footage to add an extra row of desks or to keep a room from being crowded. The same efficient, climate control as in the renowned "60" Series floor units. Six CFM capacities for hot or chilled water or electric heating... ventilation, ventilation cooling, air conditioning or combinations thereof. Decorator colors. To add increased floor space when the budget won't bulge, specify Schemenauer ceiling unit ventilators.

### CHOICE OF APPLICATION

Fully enclosed horizontal units may be left exposed, recessed or concealed behind a soffit.

### REDUCED MAINTENANCE

#### UNIQUE 3-YEAR FILTER

Spool holds 10 to 20 filter changes (enough for three full years)! Maximum efficiency and dust arrestance.



#### SIMPLIFIED DESIGN

No fan shaft bearings to oil or replace. Just change filter spool every three years when the motor is oiled!



## SCHEMENAUER MANUFACTURING COMPANY

UNIT VENTILATORS • FINNED TUBE PRODUCTS  
COMMERCIAL RADIATION

Schemenauer Mfg. Co. • Dept. 23 • Holland, Ohio  
**SEND COUPON TODAY.** Get all the facts on the finest classroom unit ventilators made.

NAME \_\_\_\_\_  
COMPANY \_\_\_\_\_  
ADDRESS \_\_\_\_\_  
CITY \_\_\_\_\_ ZONE \_\_\_\_\_ STATE \_\_\_\_\_

For more data, circle 73 on Inquiry Card

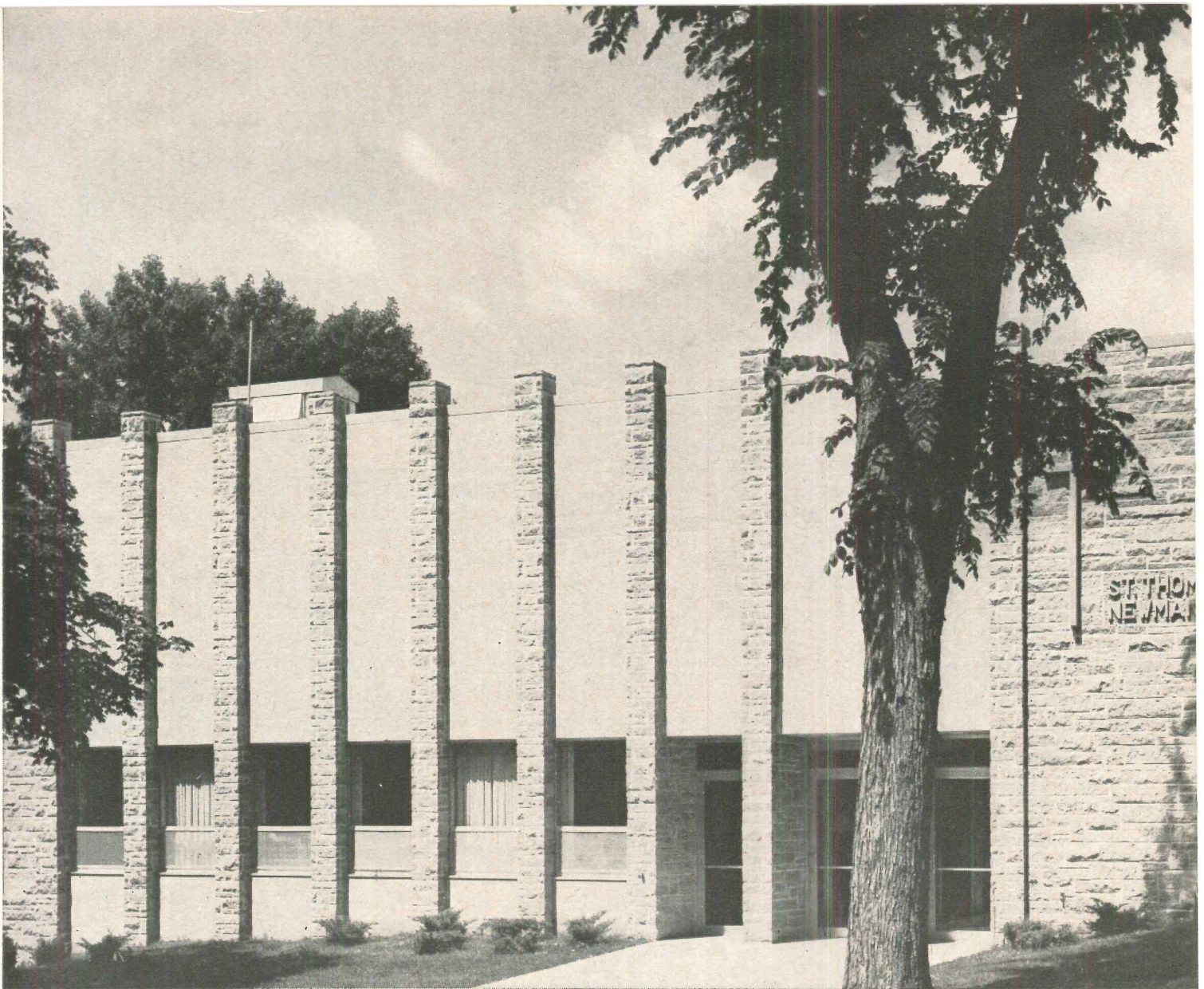

## How Bastian-Blessing helps St. Thomas More Newman Center handle between-class counter attack

"We could never handle the traffic without the efficiency of our Bastian-Blessing equipment," says Marcel Fredericks, partner of the veteran restaurant management team of Fredericks brothers who supervise the new St. Thomas More Newman Center food service facility at Mankato State College. "When we took over, we expected a routine cafeteria operation—we didn't know we would be pressured to serve 80 people in 20 minutes several times a day as students swarmed in on us between classes. We realized we needed real efficiency so we travelled 4 states and checked-out several top lines of equipment before making our decision: Bastian-Blessing *Fiesta* won out, hands down."

Working with their local Bastian-Blessing distributor, the Fredericks brothers worked out an ingenious *Fiesta*

food service arrangement best described by themselves as a "glorified indoor drive-in set-up" which permits only 3 personnel to handle the tremendous between-class traffic bursts with singular speed and lack of confusion.

And, because the *Fiesta* equipment blends with and enhances the overall decor, there is no need for a separate closed-off kitchen with its attendant bottle-necks, extra personnel requirements and waste space. Secondly, *Fiesta's* easy "damp-cloth" maintenance keeps the installation looking tip-top with a minimum of effort. Says Fredericks: "I've always maintained that a piece of equipment that is easy to keep clean will be kept clean. *Fiesta's* stainless steel and plastic laminate surface together with the rounded corners and edges cut clean-up to a matter of minutes."

Write for Brochure F-100 for further information about FIESTA food service equipment.

**BASTIAN-BLESSING**

4201 West Peterson Avenue, Chicago 46, Illinois, Dept. 4-L  
World's largest manufacturer of Fountain-Food Service Equipment

For more data, circle 74 on Inquiry Card

Listed under "Restaurant  
Equipment and Supplies"  
in all cities over 25,000  
population.





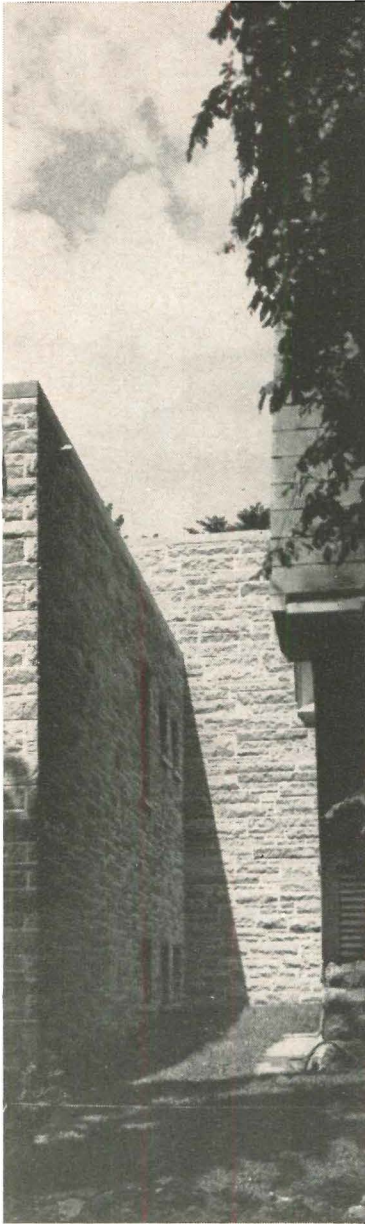

Dramatic contrasts in texture between rough stone and smooth concrete, and interesting use of vertical elements lend dignity and beauty to the 25,000 sq. ft. Thomas More Newman Center at Mankato State College, Mankato, Minnesota. Designed and planned by the Diocese in conjunction with J. Ross and Associates, Mankato architects.

Distributors: Palm Brothers Company, Minneapolis, Minnesota.



Uniquely effective contemporary sculptured screen and ceramic pillars set apart the food service area without obstructing its view from any part of the 145-capacity combination dining-recreation area. In one swift pass-through, students first receive their meat course from the griddle or Vapormatic® moist-heat food warmer, a second counter man dispenses french-fries, bread, salads and vegetables—finally, the third employee takes care of ice cream and beverages. In effect, a complete hot meal is served in no more time than an ordinary sandwich-only operation. No wonder it's a favorite gathering place on the Mankato campus.

Planned for most efficient use of space and labor, the *Fiesta* equipment offers dozens of "hidden" bonuses: Hair-Line seam construction provides a smooth, easy-to-clean surface and saves money in terms of linen and uniforms (often torn when equipment has wide seams and sharp corners); easy-to-remove cutting boards make it simple to maintain highest sanitary standards. Magnetic doors are easy to open—positive closing, recessed "flare" handles and concealed hinges can't reach out at and snag pant legs, aprons. All-in-all, *Fiesta* is THE best buy . . . from any point of view; customer, attendant or owner.



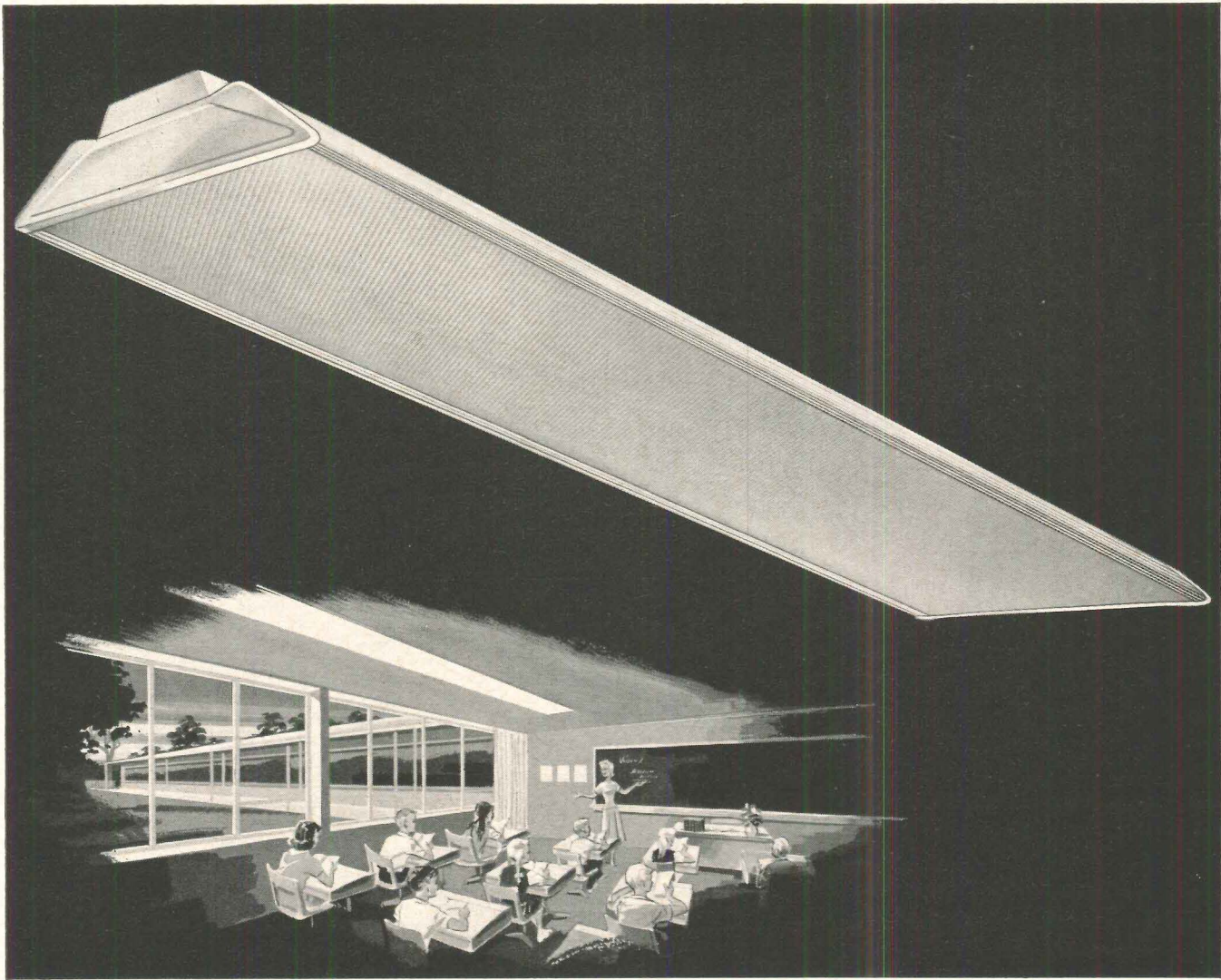

## *Litecontrol's New, Modern Design* **"Jamaica"**

### **Gives High Efficiency — Good Brightness Control**

The new Litecontrol "Jamaica" — series 5000 — fixture is designed to give you rugged construction and flexibility in use, whether in schools or in commercial applications.

Put these important advantages to work for you:

#### **"JAMAICA" FLEXIBILITY**

- Features the Holophane #6150 acrylic Controlens® as an integral part of its plastic enclosure. Also available with Litecontrol's Stylux panel, made either of polystyrene or acrylic plastic, in place of the lens
- Available in 3 lamp or 2 lamp models — either 4' or 8' long. Areas can be designed with great accuracy for almost any footcandle requirements

#### **"JAMAICA" CONSTRUCTION**

- A plastic enclosed fixture with contemporary styling
- Lens is fitted in the extruded acrylic side panels to make a one-piece enclosure that can be installed to hinge from either side

- Two spring catches easily release enclosure for cleaning and relamping, hold it securely so it can't be knocked off accidentally

- Prismatic side panels are designed to illuminate the ceiling and combine with the lens to provide high efficiency, excellent brightness control, and widespread distribution, thus requiring fewer rows of fixtures

- Fixtures are die-formed and welded of zinc-coated steel for rust prevention and long life. The finish is 90% reflectance baked white enamel

- Can be pendant or surface mounted, singly or in rows

Write now, for complete information.



**LITECONTROL**  
**LIGHTING**

**LITECONTROL CORPORATION,**

36 Pleasant Street, Watertown 72, Massachusetts

DESIGNERS, ENGINEERS AND MANUFACTURERS OF FLUORESCENT LIGHTING EQUIPMENT DISTRIBUTED ONLY THROUGH ACCREDITED WHOLESALERS

For more data, circle 75 on Inquiry Card

NEW APPROACH TO

# Air Conditioning for Apartments!

**AN INDEPENDENT SYSTEM  
FOR EACH TENANT**

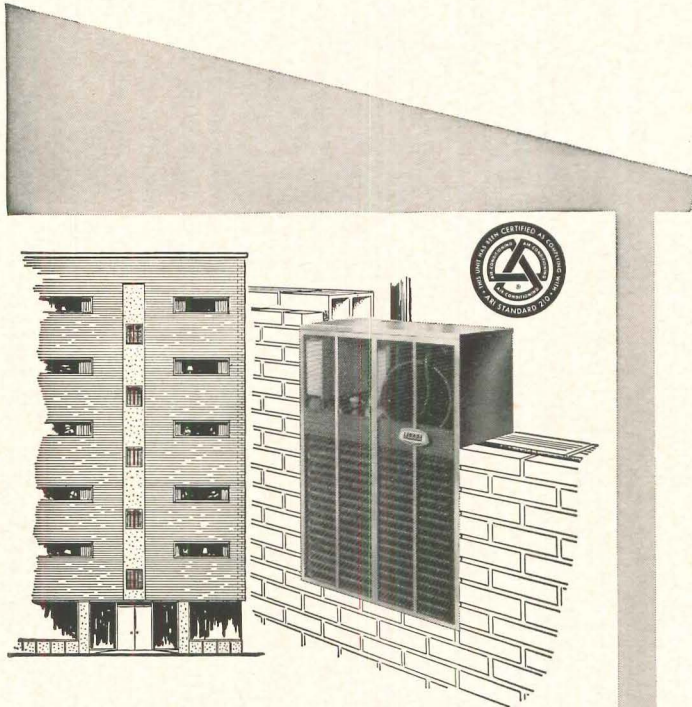

**THIN ENOUGH TO FIT IN A WALL!**

The only condensing unit of its kind. Refrigerant lines can run in wall. Serviceable from indoors.

**COOLING-HEATING UNIT GOES ANYWHERE!**

Cooling coil and gas furnace are in one handsome, compact cabinet . . . quiet. Can go anywhere in apartment. Capacities to meet varying needs. Shown here built into a storage area.

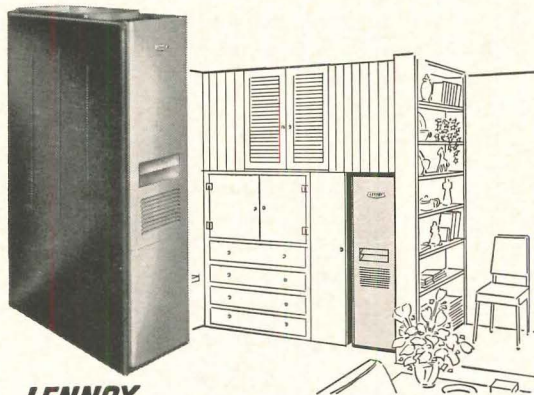

**LENNOX**  
**QC BUILDER-PAC** T.M.

Air conditioning is a "must" for top-flight apartments. The problem has been to get equipment to meet apartment needs *exactly*. The Lennox QC-BUILDER PAC solves the problem. Here's how:

**Application unlimited.** Cooling-heating unit can go anywhere in apartment . . . closet, alcove, utility room—you name it. Condensing unit fits in a wall and can be serviced from indoors—*ideal for high rise buildings!* (Or it can go on a slab or rooftop.) No other equipment has all this flexibility!

**An individual system for each apartment.** Gives you the sales feature of control for each tenant.

**Saves money.** Expensive refrigeration labor is not needed on the job. Refrigerant lines are pre-charged and sealed at the factory. Gives you the dependability of a hermetically sealed system with the flexibility of a split system. Special couplers permit these lines to be hooked up with a twist of a wrench. Another money saver is the efficient operation . . . maximum cooling per watt of electricity used. And you'll like the low initial cost!

**Cuts service problems.** There is no expensive fall shut-down . . . or spring start-up . . . as with most large central systems. A minor service problem does not disrupt comfort for the entire building. Lennox has earned the reputation of requiring less servicing than other brands of cooling and heating equipment.

For details, write Lennox, 517 S. 12th Ave., Marshalltown, Iowa.

*Don't be satisfied with less than*  
**LENNOX**  
HEATS, COOLS, TREATS AND MOVES AIR

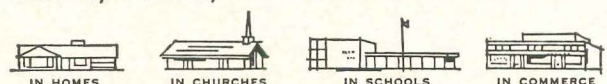

LENNOX INDUSTRIES INC., EST. 1895—MARSHALLTOWN, IOWA; COLUMBUS, OHIO; SYRACUSE, NEW YORK; DECATUR, GEORGIA; FORT WORTH, TEXAS; SALT LAKE CITY, UTAH; LOS ANGELES, CALIFORNIA. LENNOX INDUSTRIES (CANADA) LTD.—TORONTO, MONTREAL, CALGARY, VANCOUVER, WINNIPEG

For more data, circle 76 on Inquiry Card

**NO. 7**

**modern concrete forming**

a.i.a. file: 4-a

Prepared as a service to architects by Portland Cement Association

Clip along dotted line

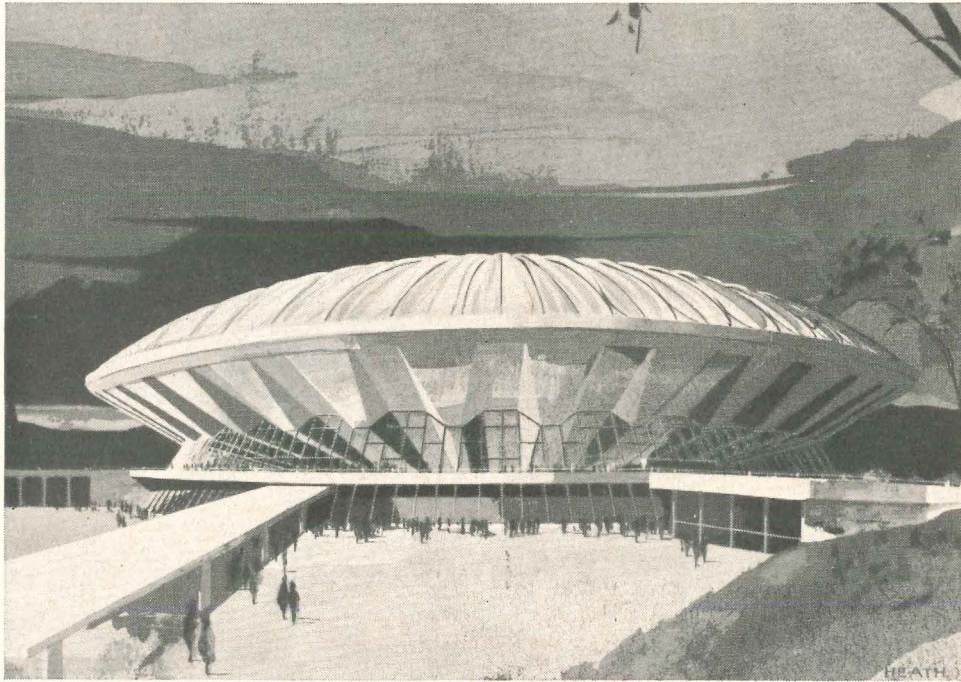

Movable forms were used for world's largest concrete dome. University of Illinois Assembly Hall. Architect: Harrison & Abramovitz. Structural Engineers: Ammann & Whitney, New York



Fig. 1

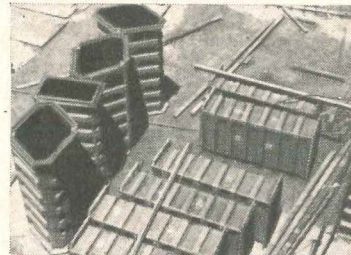

Fig. 2

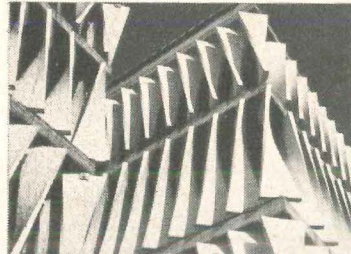

Fig. 3

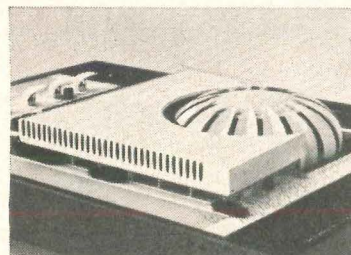

Fig. 4

New forming and casting methods, as well as advanced building techniques, encourage dramatic increase in use of sculptured concrete. The advantage of rapid form removal (in some cases forms can be stripped after one day and reused immediately) has given concrete an economical and esthetic design versatility. In addition, new forming methods and materials permit the higher reuse of forms, sometimes as high as sixty times. An example of one method of new form construction is shown in Fig. 1. The master mold is draped with fiber glass reinforcement, which will be firmly embedded in a thick coating of polyester resin. (Photo: Engineered Concrete Form Corp., Chicago.) Fig. 2 shows completed forms for Marina City, Chicago. Fig. 3: True hyperbolic paraboloids were used in the Henry Ford Hospital parking structure, Detroit. The 7-ft. 4½-in. concrete panels have a 90° twist, are 24 in. wide top and bottom and 18 in. at waist. (Architect: Albert Kahn.) Fig. 4: The Wyoming National Bank at Casper, Wyoming, illustrates the complete freedom possible in concrete. (Architect: Marvin E. Knedler, Designer: C. Deaton.)

Write for free information. (U.S. and Canada only.)

STRENGTH OF CONCRETE FOR SAFE FORM REMOVAL		AVERAGE TIME TO OBTAIN STRENGTH*
Concrete not subject to bending (tops of sloping surfaces)	500 psi	24 hours
Concrete subject to bending caused by: 1. dead load only 2. dead and live load	750 psi 1500 psi	36 hours 3 days
Concrete subject to high stresses (roof or floor slabs and beams)	2000 psi	4½ days

\*Concrete with Type I portland cement: 6½ gallons/bag at about 70° F.

**PORTLAND CEMENT ASSOCIATION**

Dept. 12-8, 33 West Grand Ave., Chicago 10, Ill.

A national organization to improve and extend the uses of concrete

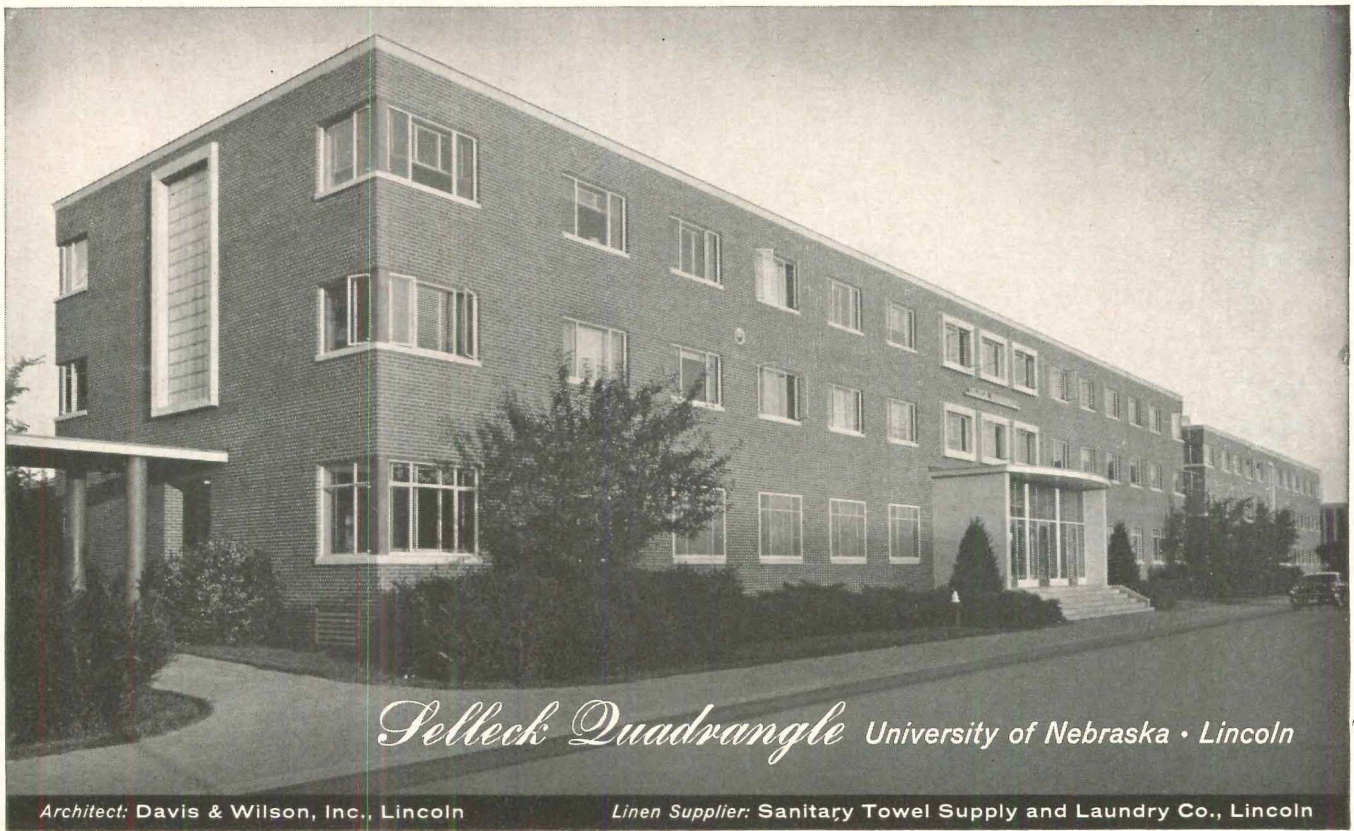

*Selleck Quadrangle* University of Nebraska • Lincoln

Architect: Davis & Wilson, Inc., Lincoln

Linen Supplier: Sanitary Towel Supply and Laundry Co., Lincoln

Linen supplier provides  
key space-and-cost-saving  
service for University  
of Nebraska



Linen Exchange Center

In designing this 1,000 student dormitory, the architect provided convenient space and location for a linen exchange. This was an important consideration for the University of Nebraska because money spent to establish a laundry, equip, stock and operate it could be better used for other needed construction. And the problems of supplying bed linens, towels, staff uniforms, etc., were more efficiently solved by local linen supply rental.

Architects perform a valuable service in discussing linen provision details before completing building designs . . . because nearly every structure will require linen service! Your local linen supplier will be pleased to help by offering expert counsel on the economics of linen service, traffic, storage and related needs. Call on him for assistance. He is listed in the Yellow Pages under "Linen Supply" or "Towel Supply."

**FREE DESIGN GUIDES . . .**

give case histories and suggestions for providing more efficient linen supply service in motels, schools, restaurants and hospitals. Write today.



**Linen Supply**

Association of America

and National Cotton Council • P.O. Box 2427, 975 Arthur Godfrey Road,  
Miami Beach 40, Florida



For more data, circle 77 on Inquiry Card



For their own buildings . . .

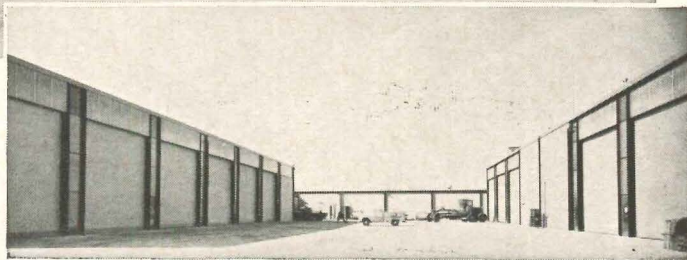

## Businesses That Depend on Efficient Equipment Use

# KINNEAR

## ROLLING DOORS

Men in any branch of building or construction take an extra hard look at the equipment they use. They make it their business to know which equipment performs best and withstands long hard use at lowest cost. That's why builder's own buildings so often feature Kinnear Rolling Doors.

The coiling upward action of the interlocking steel-slat door curtain (*originated by Kinnear*) makes all space around door openings, *inside and outside the building*, fully usable at all times.

Kinnear Motor operators add push-button convenience to this efficiency. You can control any number of doors from a single point.

Or you can control each door from any number of convenient points.

This speeds doorway traffic. It avoids bottlenecks. And it promotes prompt door closure — cuts heating and air-cooling costs.

In addition, Kinnear Rolling Doors give added all-metal protection against wind, weather, fire, intrusion and vandalism. *Extra heavy galvanizing* plus the special Kinnear Paint Bond extend this protection through extra years!

Kinnear Rolling Doors, *built to fit any opening*, are easily installed in old or new buildings. Write today for new catalog, or for specific recommendations.

**The KINNEAR Manufacturing Co.**  
**FACTORIES:** 1860-80 Fields Avenue, Columbus 16, Ohio  
 1742 Yosemite Avenue, San Francisco 24, California  
*Offices and Representatives in All Principal Cities*

For more data, circle 78 on Inquiry Card

## Product Reports

*continued from page 157*

### LOAD-BEARING ALUMINUM COLUMNS

Aluminum columns that carry live and dead vertical loads plus horizon-

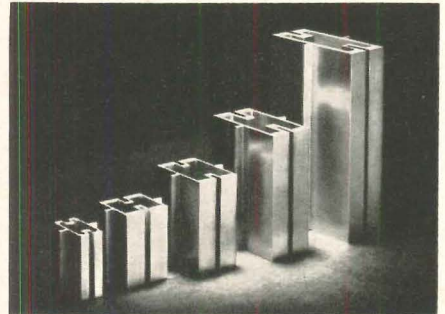

tal wind loads carry glazing and paneling directly without additional framing. They come in 14 shapes and 5 sizes. *Functional Structures, Inc., 478 N.W. Highway, Des Plaines, Ill.*

CIRCLE 311 ON INQUIRY CARD

### PATTERNED GLASS BLOCK

Contour patterned glass block comes in a new size, 12 in. by 6 in., and in a new glass color: royal gray. The construction of prismatic block provides for transmission of natural light, but eliminates vision insuring privacy. *Kimble Glass Co., Owens-Illinois, Toledo 1, Ohio*

CIRCLE 312 ON INQUIRY CARD

### GUTTER HANG

An Alcoa 5-in. OG gutter hanger was developed for attaching aluminum gutters to roofs with crown moldings or sloping fascias which prevent the use of standard hangers. The hanger has an aluminum plate that locks

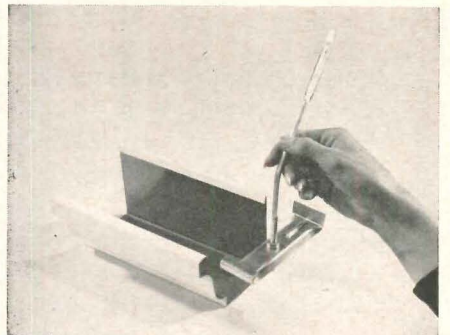

firmly and easily into the gutter and is secured by bending back a special locking tab. *Aluminum Co. of America, 718 Alcoa Bldg., Pittsburgh 19, Pa.*

CIRCLE 313 ON INQUIRY CARD  
*more products on page 168*

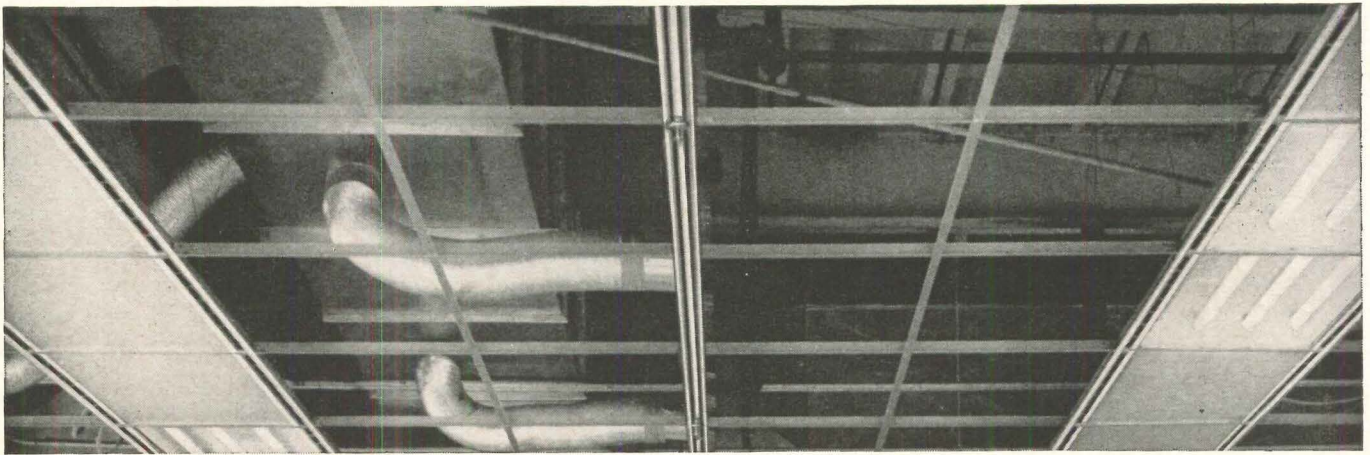

LINEARITY





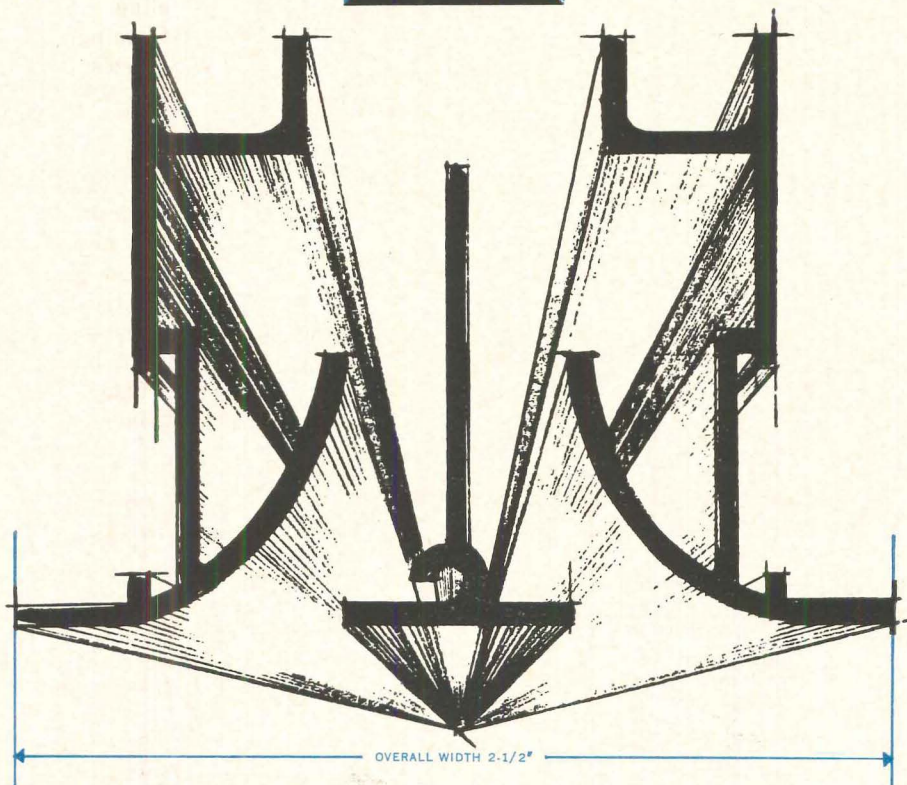

UNLIMITED



## ANEMOSTAT AIRMODULE™

*Support your ceilings in style with this new modular diffuser.*

First, this modern modular unit *works* — and works with proved Anemostat efficiency. It distributes air horizontally — 60 draft-free cfm per linear foot. And it helps support the ceiling.  Study its cross section: those angular side channels hold ceiling panels in a dozen different ways — an *Airmodule* unit can be combined with almost any ceiling system. Its flat underside blends smoothly with the ceiling architecture. Special linking devices enable you to combine active and inactive units for uninterrupted linearity.  Centered in the photograph is a row of Anemostat®*Airmodule* units flanked by inverted T-bar

structural members and CLD lighting troffer diffusers. And note the sprinkler heads: you see air, light, ceiling support and fire protection systems — all superbly integrated. (This is an actual installation shown before ceiling panels were installed.)  And that's only one way to do it. You'll have your own *Airmodule* ideas. There's a new Anemostat bulletin ready — with performance data, installation information, and dimensions. For your copy, call your Anemostat representative or write for Bulletin AM-862 to:  Anemostat Corporation of America, Scranton, Pa. (A Subsidiary of Dynamics Corporation of America).

For more data, circle 79 on Inquiry Card



This mark tells you a product is made of modern, dependable Steel.



**Home Federal Savings & Loan Association Building, Des Moines, Iowa**

Architect: Mies van der Rohe, F.A.I.A., Chicago, Illinois. Associated Architect: Architects Associated, Des Moines, Iowa.  
Structural Engineer: Nelson, Ostrom, Baskin, Berman and Assoc., Chicago, Illinois. Contractor: Ringland-Johnson, Inc., Des Moines, Iowa.  
Structural Fabricator: Des Moines Steel Company, Des Moines, Iowa. Structural Erector: Price Erecting Company, Milwaukee, Wisconsin.

Workmen weld spandrels fabricated of carbon steel plates and angles, which, together with column cover plates and exposed structural beams, form the exterior walls of building.



### Window Detail

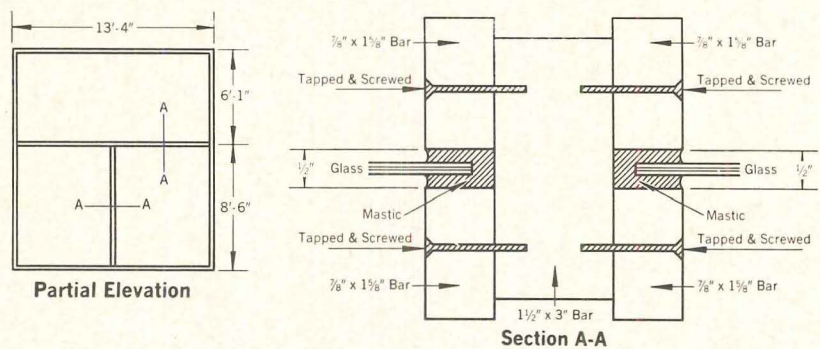





## Exposed Steel...

## Economical 40' Bays...

## Fast Erection

The three-story Home Federal Savings & Loan Association Building in Des Moines, Iowa, is a typical work as designed by Mies van der Rohe, whose basic philosophy of design evolves in the "expression of structure." This has been most clearly stated, architecturally, in his use of steel.

Specifically on this structure, Mies van der Rohe's use of steel:

- made possible the economical construction of 40-foot square bays.
- permitted the utilization of composite design for a portion of the third floor where heavy mechanical equipment caused higher loadings.
- permitted large open areas for the banking floor as well as offices above.
- provided maximum speed in erecting the building.

The building's beam and column framework is mainly USS A7 Structural Carbon Steel that has a minimum yield point of 33,000 psi. However, all framing beams 24 or more inches deep are made of USS A36 Steel, a weldable structural carbon steel with a 10% higher yield point and correspondingly higher allowable stresses than A7 steel.

The entire exterior of the building is carbon steel, a technique that is often employed by Mies van der Rohe. Exposed steel was first sand-blasted, then shopcoated, field-welded, and finally painted black in accordance with the design.

The recessed first floor walls are made up of large window panels, framed in cold-finished steel bars which provide sharp architectural detail, excellent surface finish and the strong, slim profile possible only with steel. Field-welded structural carbon steel was used in the drive-in canopy and penthouse. Doors, too, are steel . . . either stainless or carbon.

Investigate the advantages of USS Structural Steels. Just call or write United States Steel, 525 William Penn Place, Pittsburgh 30, Pa. USS is a registered trademark.

United States Steel Corporation • Columbia-Geneva Steel Division • Tennessee Coal and Iron Division • United States Steel Supply Division • United States Steel Export Company

Mullion Detail

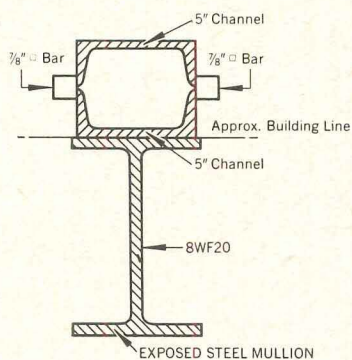

Spandrel Detail

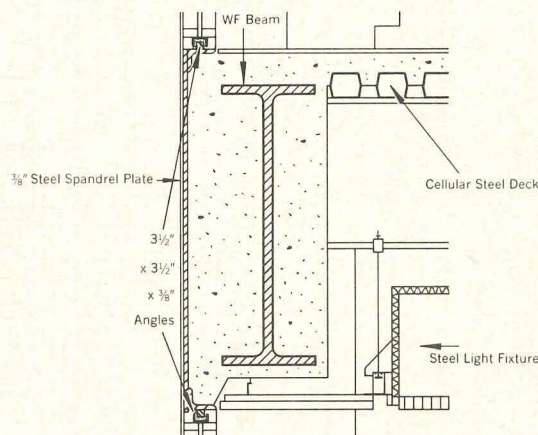

**United States Steel**



**40 Years  
of Walking  
Safety . . . in the  
CLEVELAND AUDITORIUM  
. . . and still**

**NON-SLIP!**

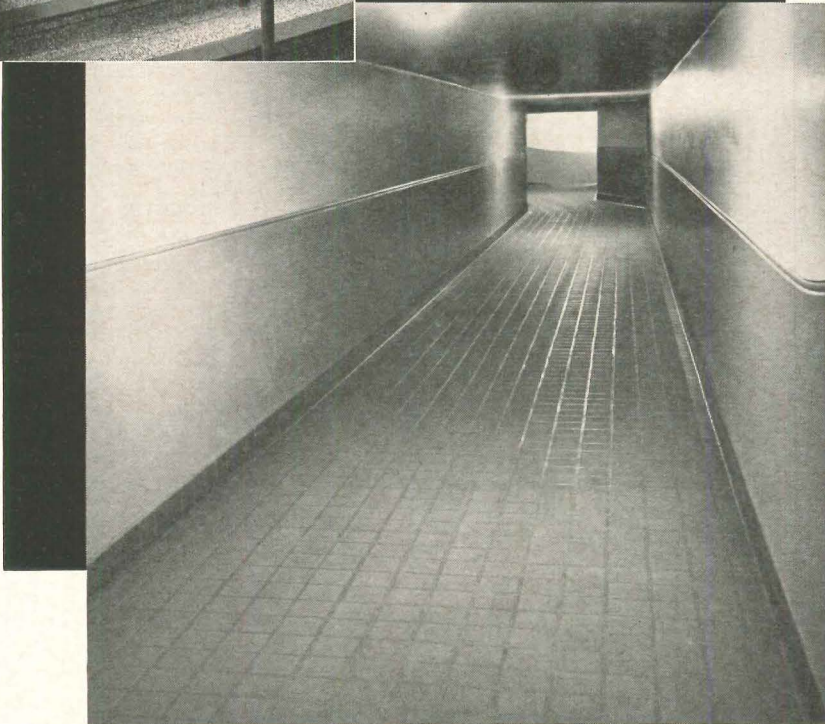

**thanks to ALUNDUM  
STAIR and FLOOR TILE**

Since 1922, when Cleveland's magnificent Public Auditorium was completed, stair nosings and ramps of Norton ALUNDUM Stair and Floor Tile have provided walking safety for its millions of patrons. Today, **after 40 years of extremely heavy foot traffic**, these same stairs and ramps are still non-slip, wet or dry, and — as the unretouched photos prove — show no signs of wear.

The extremely hard, tough ALUNDUM (aluminum oxide) abrasive is a homogeneous part of the entire structure of each tile, providing walking surfaces which are permanently non-slip, extremely wear-resistant and free from grooves and corrugations that can catch heels and cause tripping accidents.

Send for catalog on Norton Products for WALKING SAFETY. Ask for Form 1935-AR.

**NORTON COMPANY  
WORCESTER 6, MASS.**



ALUNDUM AGGREGATE for Terrazzo and Cement • ALUNDUM STAIR and FLOOR TILE  
ALUNDUM and CRYSTOLON Non-slip Abrasives

For more data, circle 81 on Inquiry Card

*Product Reports*

*continued from page 164*

**LOW-COST CURTAIN WALL**

A *Glasweld* curtain wall panel that can be fabricated for as little as \$1 per sq ft, has a loose fiber glass core

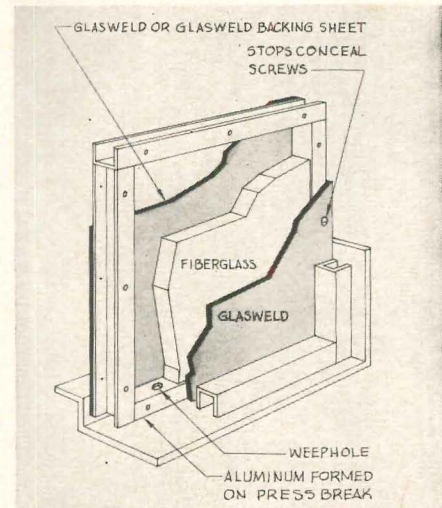

for insulation between faces of *Glasweld*, an asbestos-reinforced panel with a permanently colored mineral surface. An aluminum frame to keep the skins equidistant completes the system. *U.S. Plywood Corp., 55 W. 44th St., New York 36, N.Y.*

CIRCLE 314 ON INQUIRY CARD

**CONTRACT CHAIR**

A John Stuart chair which will be used in the new New York Statler



Hilton hotel is made of Royal Danish beech with a hand-rubbed oil finish and plastic upholstery. *John Stuart, Park Ave. & 32d St., New York 16, N.Y.*

CIRCLE 315 ON INQUIRY CARD  
*more products on page 172*

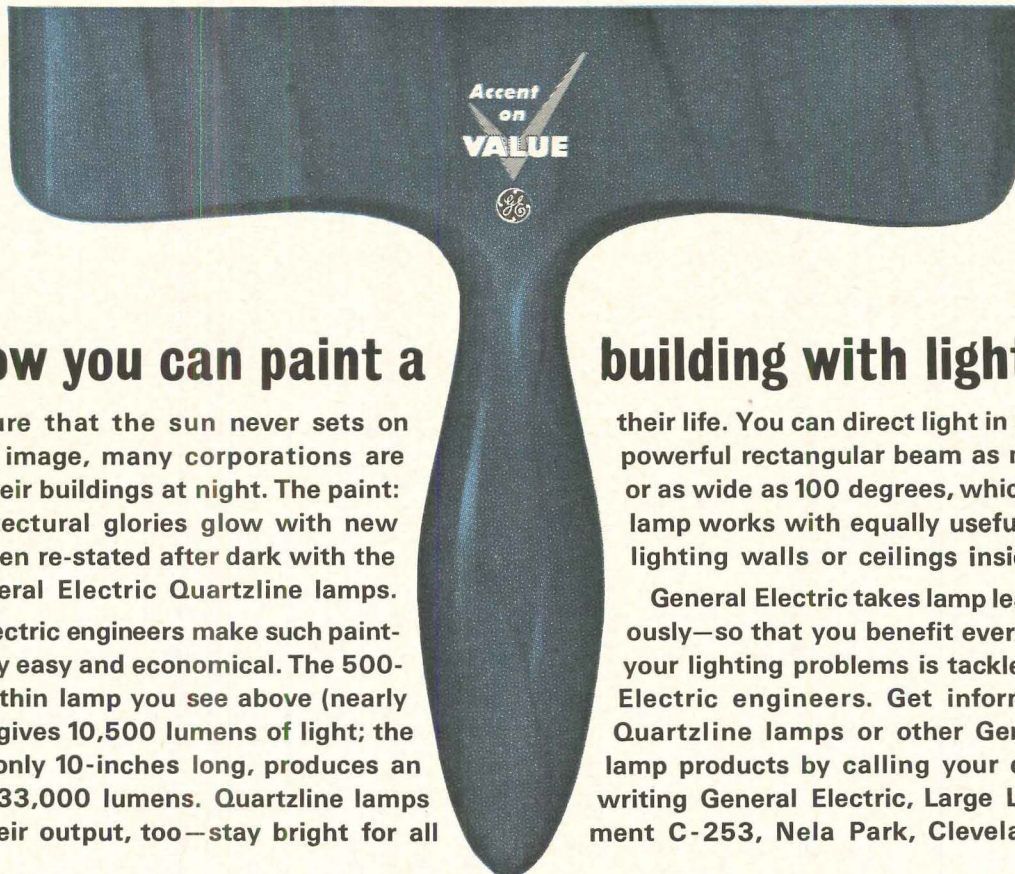
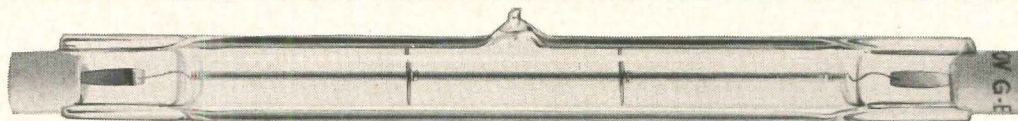

## Now you can paint a

To make sure that the sun never sets on their public image, many corporations are "painting" their buildings at night. The paint: light. Architectural glories glow with new splendor when re-stated after dark with the help of General Electric Quartzline lamps.

General Electric engineers make such painting unusually easy and economical. The 500-watt pencil thin lamp you see above (nearly actual size) gives 10,500 lumens of light; the 1500-watt, only 10-inches long, produces an astounding 33,000 lumens. Quartzline lamps maintain their output, too—stay bright for all

## building with light

their life. You can direct light in a precise and powerful rectangular beam as narrow as six or as wide as 100 degrees, which is why this lamp works with equally useful effect highlighting walls or ceilings inside buildings.

General Electric takes lamp leadership seriously—so that you benefit every time one of your lighting problems is tackled by General Electric engineers. Get information about Quartzline lamps or other General Electric lamp products by calling your distributor or writing General Electric, Large Lamp Department C-253, Nela Park, Cleveland 12, Ohio.

*Progress Is Our Most Important Product*

**GENERAL  ELECTRIC**

For more data, circle 82 on Inquiry Card

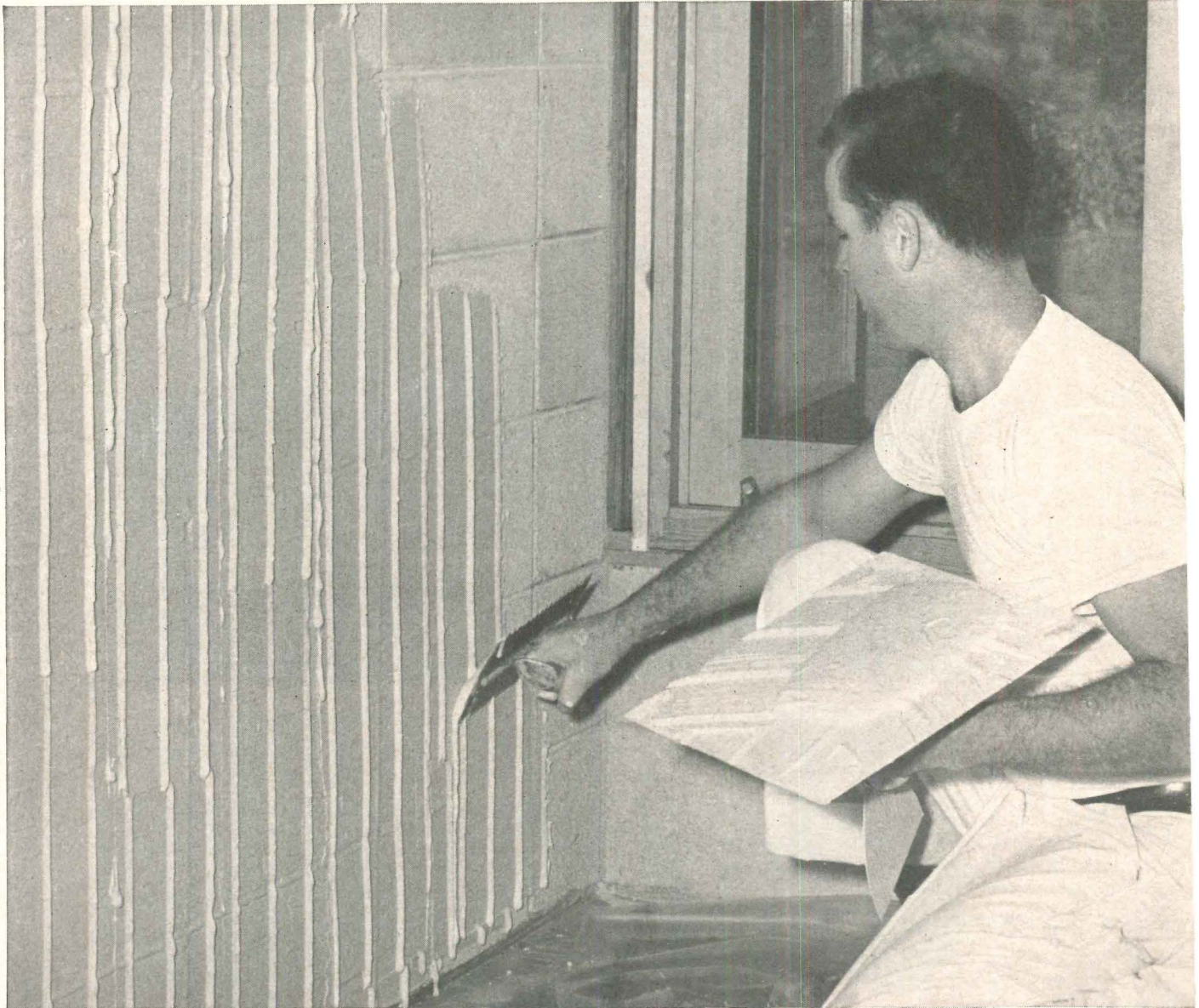

After Styrotac™ bonding cement is applied to either the wall or to Styrofoam, the insulation is pressed in place (center). After overnight setting, gypsum wallboard is either spot-coated or notch-trowelled with Styrotac and pressed in place over the Styrofoam insulation (right).

# STYROFOAM®

Here's a new step-saving, cost-saving method using Styrofoam insulation for insulating masonry structures which produces permanently high insulating values, provides a solid base for wallboard, and eliminates the problem of nail-popping . . . all in a single operation.

This new method makes use of Styrotac to bond Styrofoam brand insulation board directly to the inside face of the masonry wall, as illustrated. After the bonding cement has set overnight, gypsum wallboard is then adhered to the Styrofoam insulation using the same material.

Using this method, furring and lathing are eliminated, producing a solid insulated wall with no hollows. There is no wood present for insects to feed on, no nail holes to fill and "pop," and the completely-supported wallboard will

not bow in or warp. This new insulating method, developed by Dow, offers architects a means of building-in the quality of double-laminate walls, using only a single thickness of wallboard.

Styrotac can be applied to dry absorbent masonry surfaces without first wetting the surface, or it can be applied to the Styrofoam. Either spot application or full coverage using a notched trowel is recommended. Only firm hand pressure against the boards of Styrofoam is required to bond them solidly to the wall.

For wet plaster installations, Styrofoam insulation is first bonded to the masonry wall with Styrocrete® or portland cement mortar. Wet plaster is then applied directly to the face of the Styrofoam. The cellular structure of Styrofoam

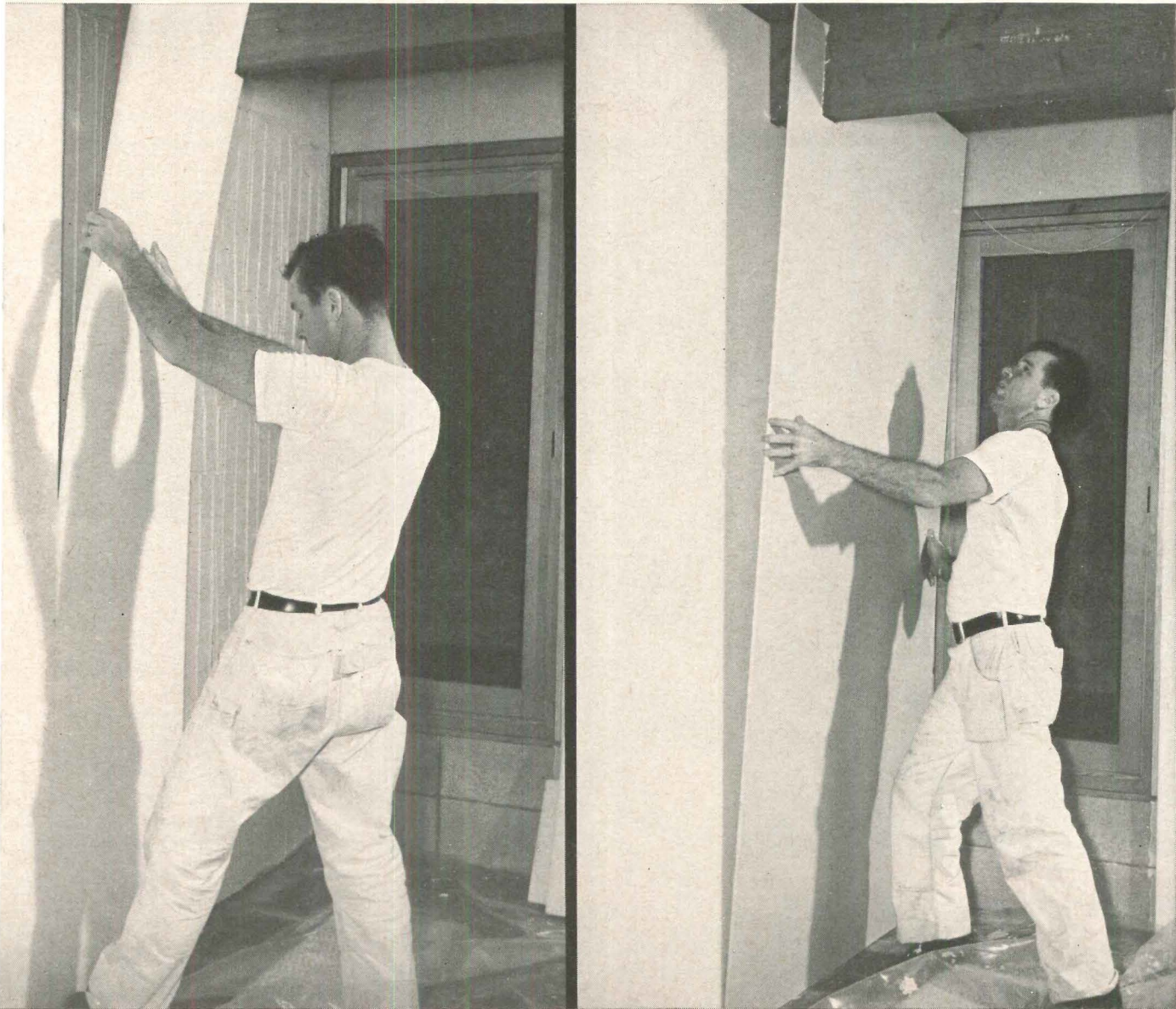

## New insulating method saves money, saves steps in masonry construction

insulation provides positive keying action to the plaster, producing maximum bond strength.

STYROFOAM insulation board provides permanent insulating values for masonry buildings because of its high resistance to moisture, and its low "K" factor. Styrofoam rigid foam insulation contains millions of tiny non-interconnecting air cells which don't soak up water or moisture, don't rot or mildew. *No separate vapor barrier is needed!* And because Styrofoam insulation has no food value, it doesn't attract insects or vermin. In addition, the high insulating efficiency of this insulation keeps heating and cooling costs to a

minimum, year in, year out.

For more information on the time-saving, cost-saving advantages of using Styrofoam insulation and this new insulating method for masonry construction, write THE DOW CHEMICAL COMPANY, Midland, Michigan, Plastics Sales Dept. 1301N12.

*Styrofoam is a registered trademark of The Dow Chemical Company. It is applied only to the homogeneous expanded polystyrene made according to an exclusive Dow process. Styrofoam brand insulation board is available only from Dow and its authorized representatives.*

**THE DOW CHEMICAL COMPANY**



Midland, Michigan

For more data, circle 83 on Inquiry Card

NEEDED FOR YEARS...to prevent perplexing predicaments in the bathroom...AND HERE IT IS

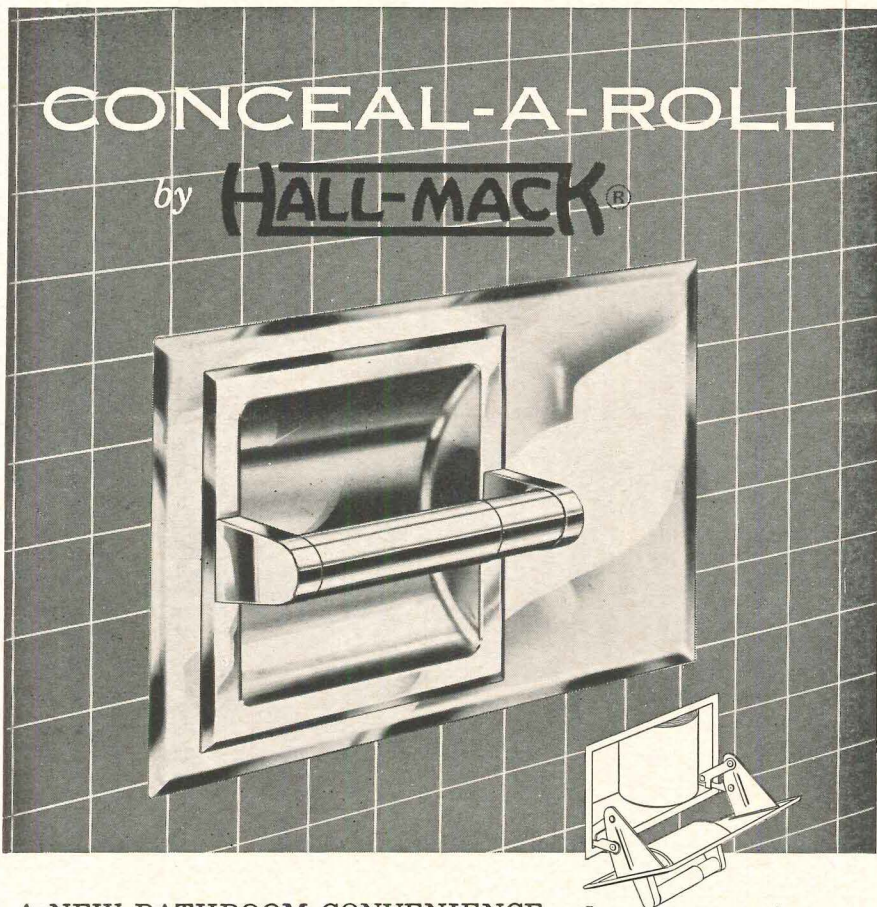

**A NEW BATHROOM CONVENIENCE** Just a cover-opening way is the spare...insurance against embarrassment. Closed it's one of the most attractive accessories a modern bathroom can have. Beautifully chromed and precisely made in every detail, it combines a new and original idea with Hall-Mack's fine styling.

The smoothly operating door which conceals the extra roll is a sparkling, chrome plated brass panel—compact and flush with the wall—that blends pleasingly with any decor.

For new homes or remodeling, you're sure to make friends and influence new customers when you specify, sell or install built-in features by Hall-Mack—especially Conceal-A-Roll with the "spare" compartment that solves a delicate problem,

shower recess unit

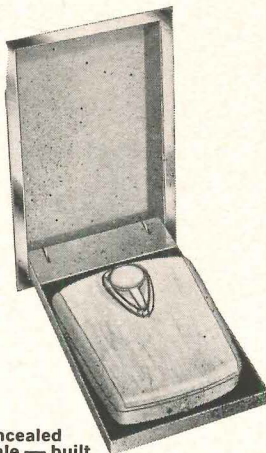

concealed scale — built in the wall for utmost safety and convenience



— handy, safe spot for shampoo bottles, etc.



### HALL-MACK COMPANY

a **Textron** company AR-1262  
1380 W. Washington Blvd., Los Angeles 7, California

- Please send free color booklet on bathroom planning.
- Include complete information on Conceal-A-Roll.

Name \_\_\_\_\_ (PLEASE PRINT)

Address \_\_\_\_\_

City \_\_\_\_\_ Zone \_\_\_\_\_ State \_\_\_\_\_

For more data, circle 84 on Inquiry Card

## Product Reports

continued from page 168

### EPOXY COATING

An epoxy coating, called *Mira-Plate*, can be applied over almost any interior surface by brush, roller or spray. The coating has the appearance of a glazed, tile-like material. Flecks, in



contrasting or complementary colors, can be spatter-sprayed over the background wall color. Estimated life is about 15 years. *O'Brien Corp., South Bend 21, Ind.*

CIRCLE 316 ON INQUIRY CARD

### LOAD-BEARING PANELS

*Jiffy-Wall* load-bearing partitions for walls and inside partitions have a stressed-skin-sandwich construction using hardboard skins and honeycomb cores. The load-bearing capacity of these self-supporting panels exceeds that for standard 2-in. by 4-in. studded walls. Raceways are integral parts of the panels. The 4-ft-wide panels are available in 8-ft, 10-ft, 12-ft and 16-ft heights. *Cored Panels, Inc., Liberty Industrial Park, Motor Ave., Farmingdale, L.I., N.Y.*

CIRCLE 317 ON INQUIRY CARD

### SOFFIT AND FASCIA

A three-piece baked enamel aluminum soffit and fascia system installs perpendicular to the wall, with a minimum of waste. Each 16-in. soffit panel is fully ventilated with lanced

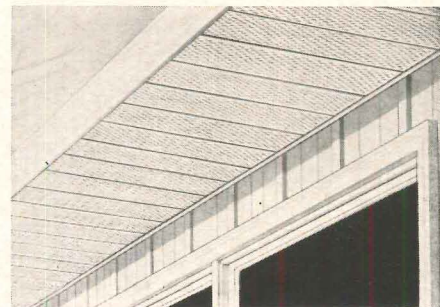

openings instead of holes, for greater rigidity. *Alside, Inc., P. O. Box 1261, Akron 9, Ohio*

CIRCLE 318 ON INQUIRY CARD

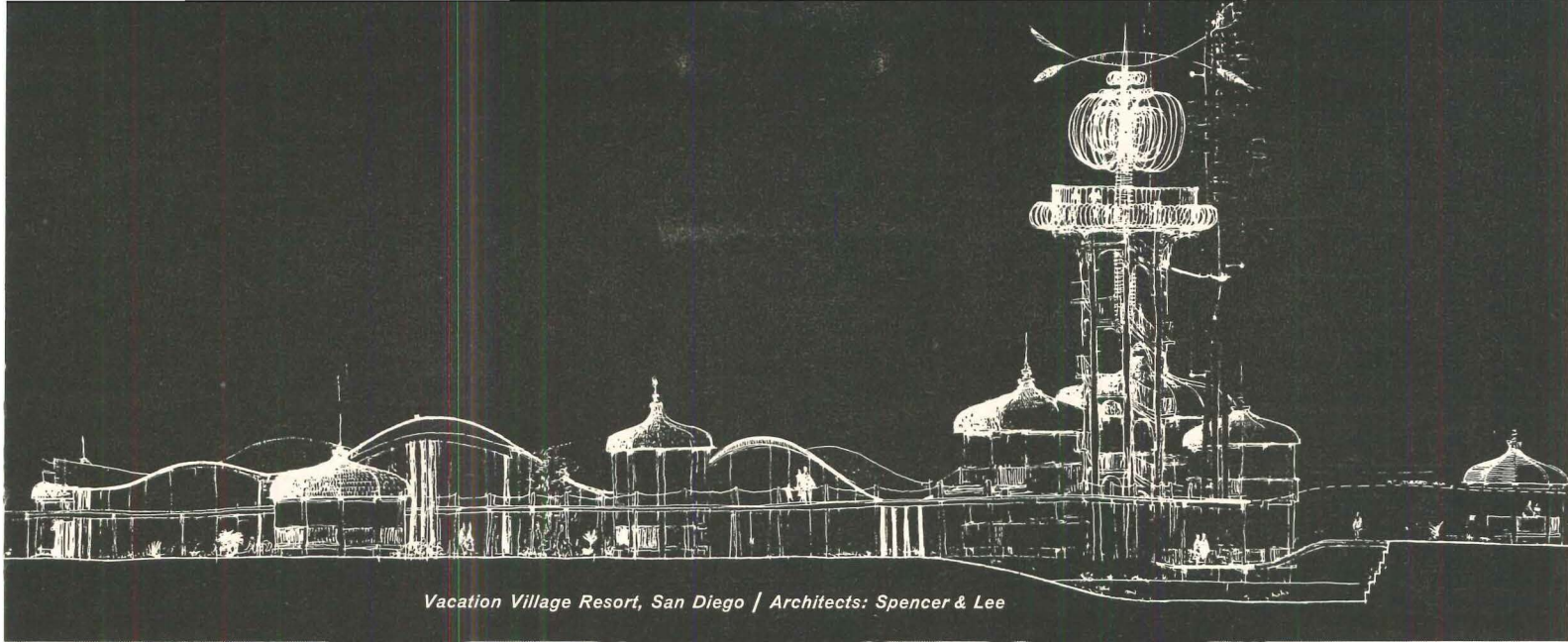

## The good nature of Red Cedar Shingles

Imaginative application comes naturally to this unique material, and the beauty is more than skin-deep. Red Cedar Shingles are light-weight and strong. They offer superior wind and weather resistance, insulation and durability. Maintenance free, a roof of Red Cedar ages

gracefully and gains character with the years. For complete information about applications or specifications: write Red Cedar Shingle Bureau, 5510 White Building, Seattle, Washington. (In Canada: 550 Burrard Street, Vancouver 1, B. C.) **RED CEDAR SHINGLES**

For more data, circle 85 on Inquiry Card

STEEL ...

TALLER THAN THE GREAT PYRAMIDS OF EGYPT!



**ST. LOUIS GATEWAY ARCH** Architect Eero Saarinen hurls this  $\frac{1}{4}$ -mile satin-finished ribbon of stainless steel upright to sweep the horizon as a softly shining beacon of Westward expansion . . . as a shrine to Thomas Jefferson commemorating his Louisiana Territory Purchase.

What can be made of STEEL? Saarinen has made it magnitude, drama, tribute . . . fellow architects call this catenary arch — taller than the Washington Monument — Saarinen's simplest and greatest triumph.

Under fabrication at this moment by a Central Fabricator Association Member it takes still further skill and "know-how" to precisely fashion its geometrical shape plus the ingenuity of trained men and machines to build and erect its tough steel body.

Seventy members of CFA help to fabricate mid-America's steel. One or more is close to you. Fabrication nearby cuts time and shipping costs; high speed erection cuts building time and costs; new higher strength steels reduce dead weight. *STEEL saves time and costs!*

At the planning stage — Think about speed. Steel goes up fast! Steel pays off in early occupancy . . . makes a rental or manufacturing production return quicker.

**CENTRAL FABRICATORS ASSOCIATION**  
53 West Jackson Blvd., Chicago 4, Illinois

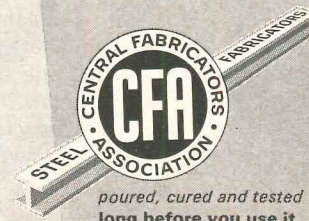

For more data, circle 91 on Inquiry Card





**Bigelow Carpets**  
 lend charm to  
 wining and dining at  
**CHARTER HOUSE HOTEL**  
 Braintree, Massachusetts

A specially designed Bigelow Wilton with a charming Early American motif gives a warm welcome to diners in this friendly inn. Cocktail lounge boasts special "cloud-effect" Bigelow.

Bigelow Carpet is selected by leading designers for their most important hotel

and motel installations. Reasonable price, long economical service, and top performance under traffic—as well as beauty — are prime considerations in every Bigelow Carpet designed for use in public areas. Special designs, colors and textures available. If you plan an

installation, consult Bigelow's Carpet specialists concerning colors, patterns, weaves, at prices you can afford. No charge for this service. Contact Bigelow through the nearest sales office by writing or telephoning the Bigelow Contract Dept., 140 Madison Ave., N. Y. 16, N. Y.

PEOPLE WHO KNOW...BUY



**Bigelow**

RUGS • CARPETS  
 SINCE 1825

Bigelow sales offices are located in the following cities: Atlanta, Ga.; Boston, Mass.; Buffalo, N.Y.; Chicago, Ill.; Cincinnati, Ohio; Cleveland, Ohio; Dallas, Texas; Denver, Colo.; Detroit, Mich.; Hartford, Conn.; High Point, N.C.; Kansas City, Mo.; Los Angeles, Calif.; Minneapolis, Minn.; New York, N.Y.; Philadelphia, Pa.; Pittsburgh, Pa.; St. Louis, Mo.; San Francisco, Calif.; Seattle, Wash.

For more data, circle 86 on Inquiry Card

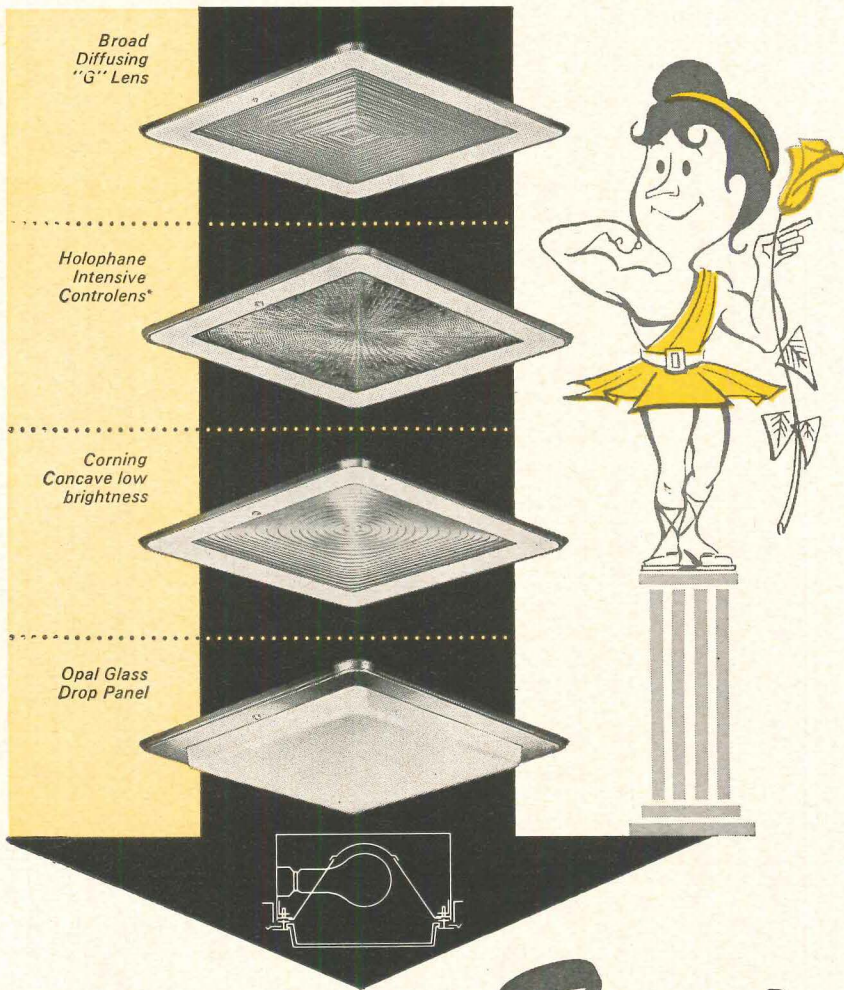

# BRAWN 'N Beauty

## brascolite square recess units

Designed to outlast commercial and institutional buildings.  
A Master Creation of strength, lighting efficiency and beauty!

Sturdy • well-engineered • functional • all horizontal lamp units have Alzak Aluminum Reflectors for permanency and optimum light control.



doors — 300° acrylic snow-white finish  
trim — attractive silvan

\*©HOLOPHANE CO., INC.

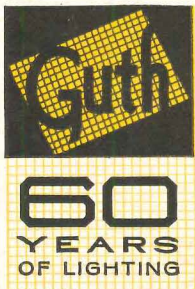

The Edwin F. Guth Co. • 2615 Washington Blvd. • Box 7079 • St. Louis 77, Mo.

# brascolite

For more data, circle 88 on Inquiry Card

## Office Literature

continued from page 140

### CONCRETE CONSTRUCTION

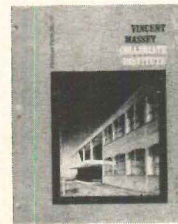

(A.I.A. 4-K) Detail drawings and photographs show how *Flexicore* concrete floor and roof slabs were used in the Vincent Massey Collegiate Institute of Toronto. *The Flexicore Co., Inc.*, 1932 E. Monument Ave., Dayton 1, Ohio \*  
CIRCLE 417 ON INQUIRY CARD

### WHIRLPOOL BATH

A whirlpool bath for permanent installation in homes, motels, apartment houses and hotels is described in a six-page folder. *Jacuzzi Research Inc.*, 1440 San Pablo Ave., Berkeley 2, Calif.

CIRCLE 418 ON INQUIRY CARD

### LAMINATED STRUCTURES

(A.I.A. 19-B-3) Technical design data on laminated wood structural members is given in 24-page booklet which includes graphs and tables on properties, loads, etc. Standard specifications and a color selection chart are included. *Unit Structures*, P.O. Box 129, Peshtigo, Wis.

CIRCLE 419 ON INQUIRY CARD

### FLOOR HARDENERS

(A.I.A. 3-B-1 and 3-B-2) *Durafax* and *Duratop* abrasive non-metallic floor hardeners to provide resistant floors both inside and outside are described in a six-page catalog. *Sun Chemical Corp.*, 2133 85th St., North Bergen, N. J.\*

CIRCLE 420 ON INQUIRY CARD

### RESIDENTIAL PLUMBING

(A.I.A. 29-H) An eight-page, full-color booklet shows selection of water closets, lavatories and bathtubs. *Case Mfg.*, Robinson, Ill.\*

CIRCLE 421 ON INQUIRY CARD

### UNIT HEATERS

Overhead revolving-discharge heaters are illustrated in a 20-page bulletin, HCR-62. Included are selection and application information, as well as cost and comfort advantages. *L. J. Wing Mfg. Co.*, Linden, N. J.

CIRCLE 422 ON INQUIRY CARD

\*Additional product information in *Sweet's Architectural File*

more literature on page 186

Fischbach and Moore makes possible the ultimate . . .

# *the \*CYBERTRONIC concept*

. . . for the first time the simplicity, reliability and reduced maintenance looked for in solid-state temperature control systems.

In making this contribution to more efficient and economical temperature control systems, Fischbach and Moore engineers have succeeded in bringing you these long sought advantages of the CYBERTRONIC System:

- A system that incorporates the recognized efficiency of solid-state electronics with a minimum of maintenance.
- A system with a unique actuator . . . only the shaft moves in response to the thermostat . . . provides infinite resolutions . . . requires 3 watts power.
- A system that offers maximum proven reliability, simplicity and top performance at reasonable cost.

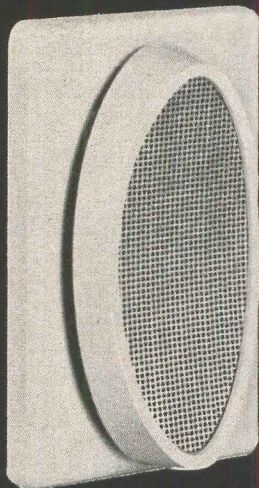

One of the components of the CYBERTRONIC System is the Fischbach and Moore ET Series Thermostat . . . a completely self contained solid-state bridge amplifier providing the advantages of: single or two stage proportional controller; 55-85° (F) standard control range; 0 to 10% throttling range; 1°F sensitivity; and .6 watt power requirement.

The Fischbach and Moore Power Actuator provides infinite resolutions and requires only 3 watts nominal power. Only the shaft moves in response to the thermostat. Thrust is 150 lbs. Noise level is zero db.

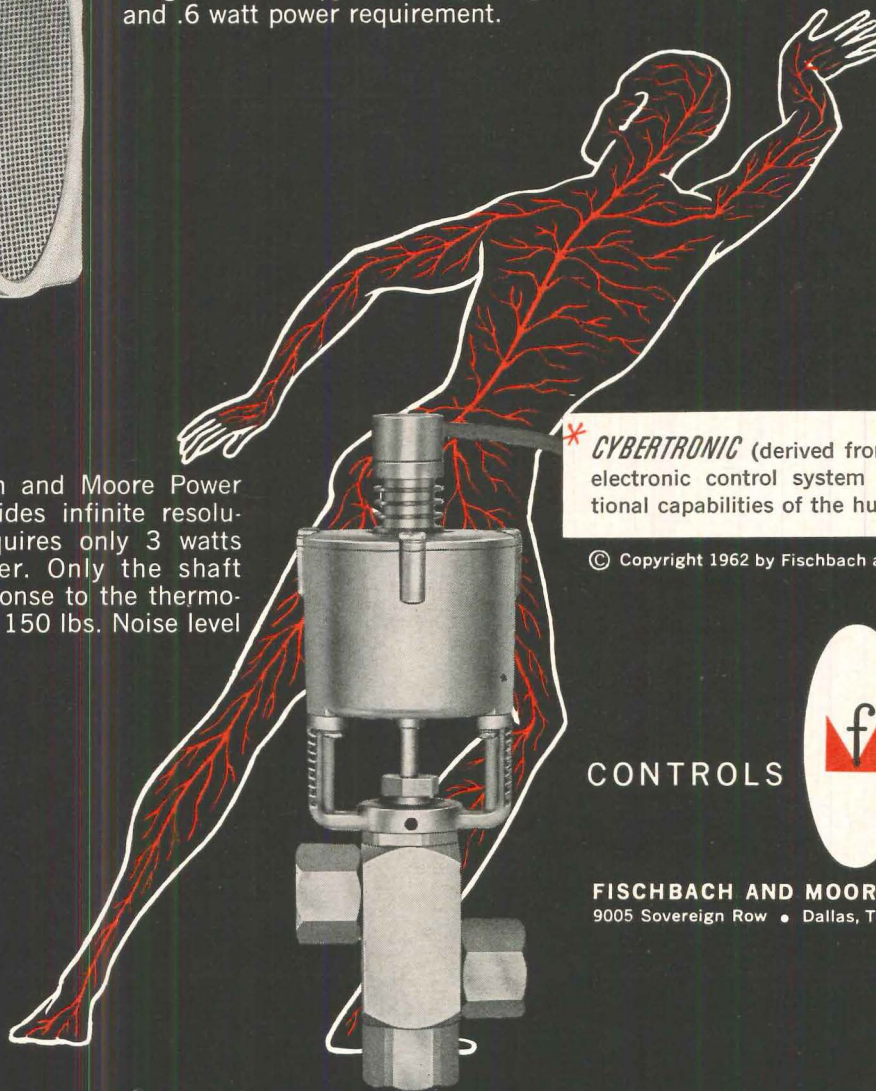

\* **CYBERTRONIC** (derived from cybernetics) . . . an electronic control system simulating the functional capabilities of the human nervous system.

© Copyright 1962 by Fischbach and Moore, Incorporated

CONTROLS



DIVISION

**FISCHBACH AND MOORE, INCORPORATED**  
9005 Sovereign Row • Dallas, Texas • Phone: ME 1-8520

# Step up

to advanced water service with sanitary, efficient foot control systems...



## PEDAL VALVES & SERVICE FITTINGS



Hospitals,  
Doctors,  
Dentists



Maintenance

Laboratories



Fountains

Washrooms



Meat  
Handling,  
Kitchens

*Sanitary water flow—at the touch of a toe*

The forward-thinking systems for forward-thinking planners

Architects, engineers, specifiers, plumbing contractors, fabricators... all experienced professionals, who take a hand in the design of water service, have taken the progressive step forward with T & S foot control systems. They're sanitary! They're quick! They're automatic! A simple touch of the toe activates the T & S system for rapid filling, cleaning or spraying in literally hundreds of commercial, industrial and institutional applications. Sensitive, variable flow control with positive, automatic shut-off improves efficiency and water conservation. System layouts accommodate any combination for wall, floor or deck mounting. Learn why leading planners today recommend and specify T & S quality-built pedal valves and service fittings for their newest, most advanced design water flow installations. Investigate the advantages for your organization now. A T&S field man will gladly discuss it with you. Write or call for Catalog No. 442PV.



**T & S BRASS AND BRONZE WORKS, INC.**  
134 Magnolia Avenue, Westbury, L.I., N.Y.  
Area Code: 516 / EDgewood 4-5104

NATIONWIDE SALES AND STOCK COVERAGE

PRE-RINSE • GLASS FILLERS • WATER STATIONS • FAUCETS • PEDAL VALVES & SERVICE FITTINGS • POT FILLERS • KETTLE KADDIES • SPRAY HOSES • ACCESSORIES • LAB-FLO LAB. SERVICE FIXTURES

For more data, circle 92 on Inquiry Card

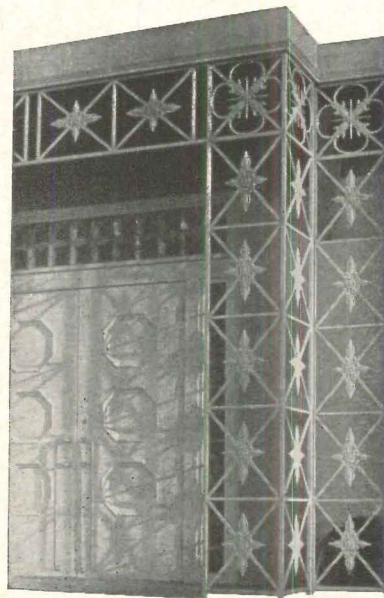

Smith, Kratz & Strong

Architects

B.P.O.E. Elks Lodge No. 682

Jacksonville, Ill.



*For Enduring Charm*  
... Specify  
Architectural METAL WORK  
by Fiske

Aluminum, Bronze, Stainless Steel and Iron

For over 100 years, Architects have relied upon Fiske for the widest choice of artistic designs, materials, craftsmanship and dependability. Now, more than ever, Architectural Metal Work by Fiske... in Aluminum, Bronze, Stainless Steel and Iron... represents the finest obtainable.

Write for our catalog of designs or send blueprints for quotations.

**J. W. Fiske ARCHITECTURAL METALS, Inc.**

113-115 Pennsylvania Avenue, Paterson 3, New Jersey

ESTABLISHED 1838

For more data, circle 93 on Inquiry Card

*The CASE #3000 One Piece Closet is mounted off the floor. You can hardly hear its "Whispering Flush".*

*Like all Case one-piece closets it positively will not overflow.*

*The elongated contour seat is more comfortable and more hygienic—especially for public use.*



\*We will be happy to send you our catalog and "Look of Luxury" brochure, as well as a complete list of representatives. Also refer to Sweet's Catalog (26A) for additional information.



**CASE MANUFACTURING**

Division of Ogden Corporation  
1082 PINE ST., ROBINSON, ILLINOIS

For more data, circle 94 on Inquiry Card

# ONE RESPONSIBILITY

from manufacture through erection

Frame type wall panels for the Leader Federal Savings and Loan were manufactured, delivered, and erected by Martin Marietta. One source — one responsibility.

## MARZAIC<sup>®</sup> CURTAIN WALL PANELS

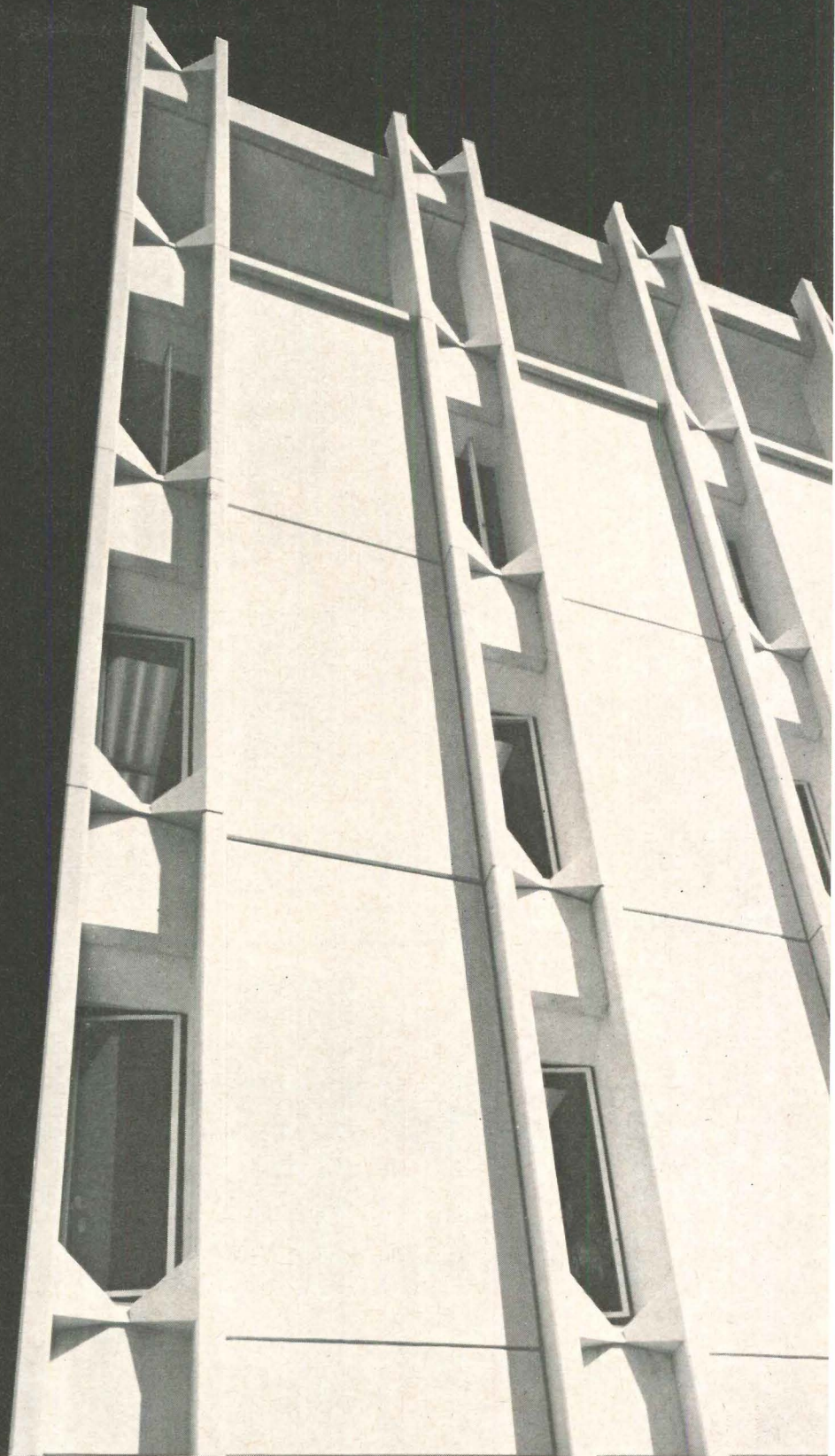

Architect:  
Walk C. Jones, Jr.;  
Contractors:  
Dougherty-Liddell  
Construction Company;  
Consulting Engineer:  
Clarke Mann of Merrill  
and Mann Associates;  
all of Memphis, Tenn.



### CONCRETE PRODUCTS

A CONSTRUCTION MATERIALS DIVISION OF



## MARTIN MARIETTA

101 EAST ONTARIO STREET, CHICAGO 11, ILLINOIS, PHONE: WHITEHALL 4-5600

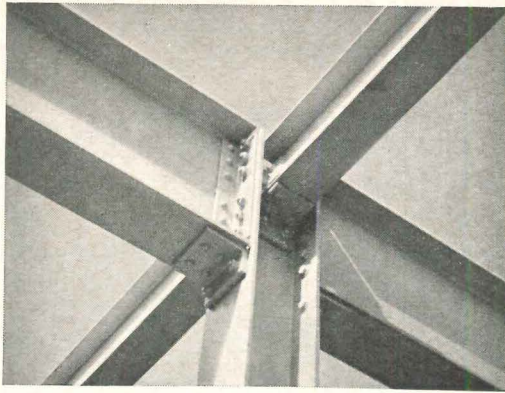

*Structural steel*

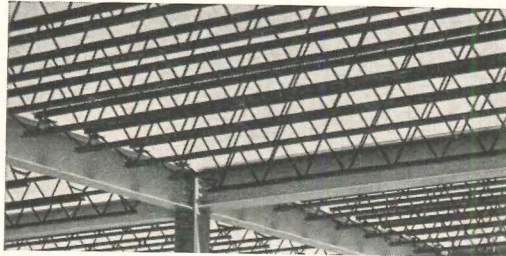

*+ steel joists*

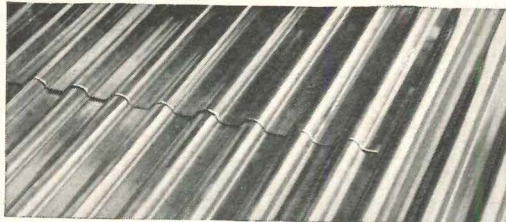

*+ Bethlehem Slabform*

*add up to  
a strong,  
economical  
framework*

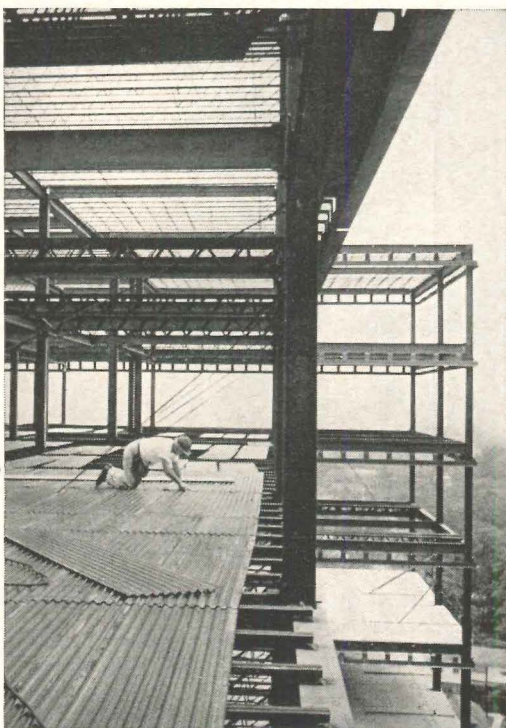

A framework of structural steel; Bethlehem joists; and Slabform, our solid steel centering, is ideal for a shopping center, apartment, or school. Here's why:

- Shop-fabricated structurals and joists arrive ready to go up. No falsework, no weather delays.
- Steel has strength to spare. Non-warp, non-sag construction holds down maintenance costs. Fire-safety is up.
- Steel joists allow for easy passage of pipe, wire, and conduit through the open webs—in any direction.
- Slabform saves both time and money compared to flexible-type centerings. It's a safe working platform, too.

We'll be glad to discuss your next building with you. Perhaps we can show you ways you can save time and money with today's steels for construction.

BETHLEHEM STEEL COMPANY, BETHLEHEM, PA.  
Export Sales: Bethlehem Steel Export Corporation



for Strength  
... Economy  
.. Versatility

**BETHLEHEM STEEL**



For more data, circle 90 on Inquiry Card



**AVOID  
CHALKBOARD GLARE...  
PERMANENTLY**

## J-M Colorlith won't slick or shine... ever

Most chalkboard materials look good when they're new. But, after years of use and abuse, the colors may fade, the surfaces turn slick and shiny and impose a visibility-impairing glare. With Johns-Manville Colorlith®, this *can't* happen because the color is an integral part of the sheet and retains its soft shade indefinitely.

Available in three eye-pleasing, research-proved shades (Spruce Green, Cameo Brown and Charcoal Gray), Colorlith offers superior

visibility. Made of asbestos and cement, it takes chalk easily providing excellent visual contrast. Further, it erases cleanly without "ghosting."

For full details on J-M Colorlith, write to J. B. Jobe, Vice President, Johns-Manville, Box 14, New York 16, N. Y. In Canada: Port Credit, Ontario. Cable: Johnmanvil.

**JOHNS-MANVILLE**

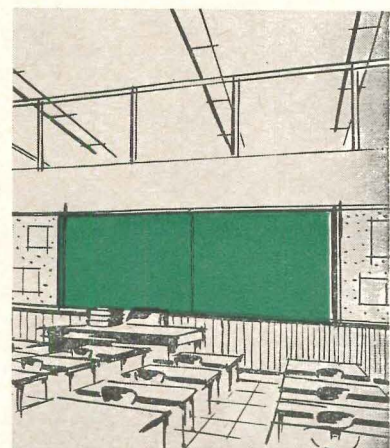

For more data, circle 96 on Inquiry Card

Arroyo Viejo Children's Theater, Oakland, Calif.  
 Architect: Irwin Luckman  
 Fabricator: Berkeley Plywood Co.  
 Builder: Karl Ronkvist

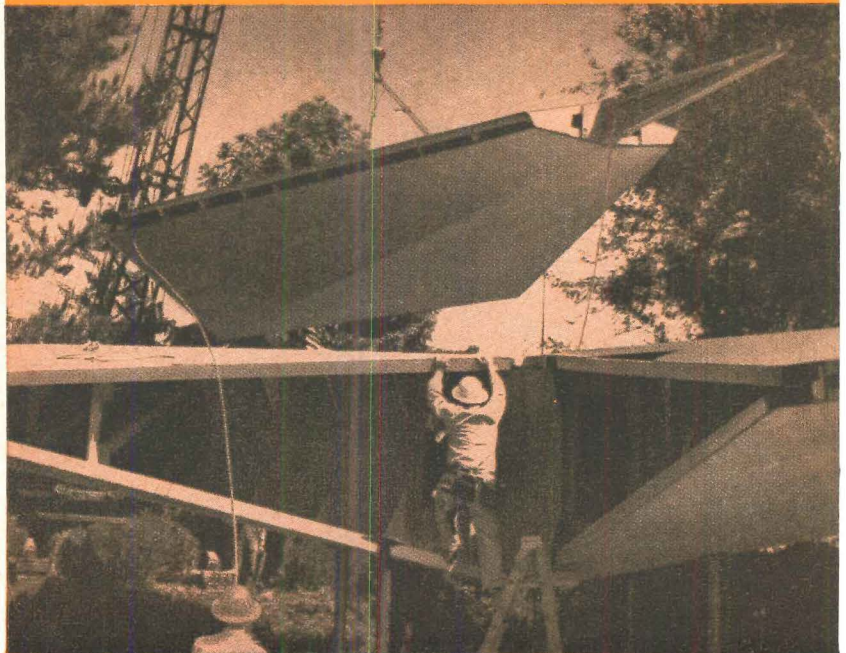
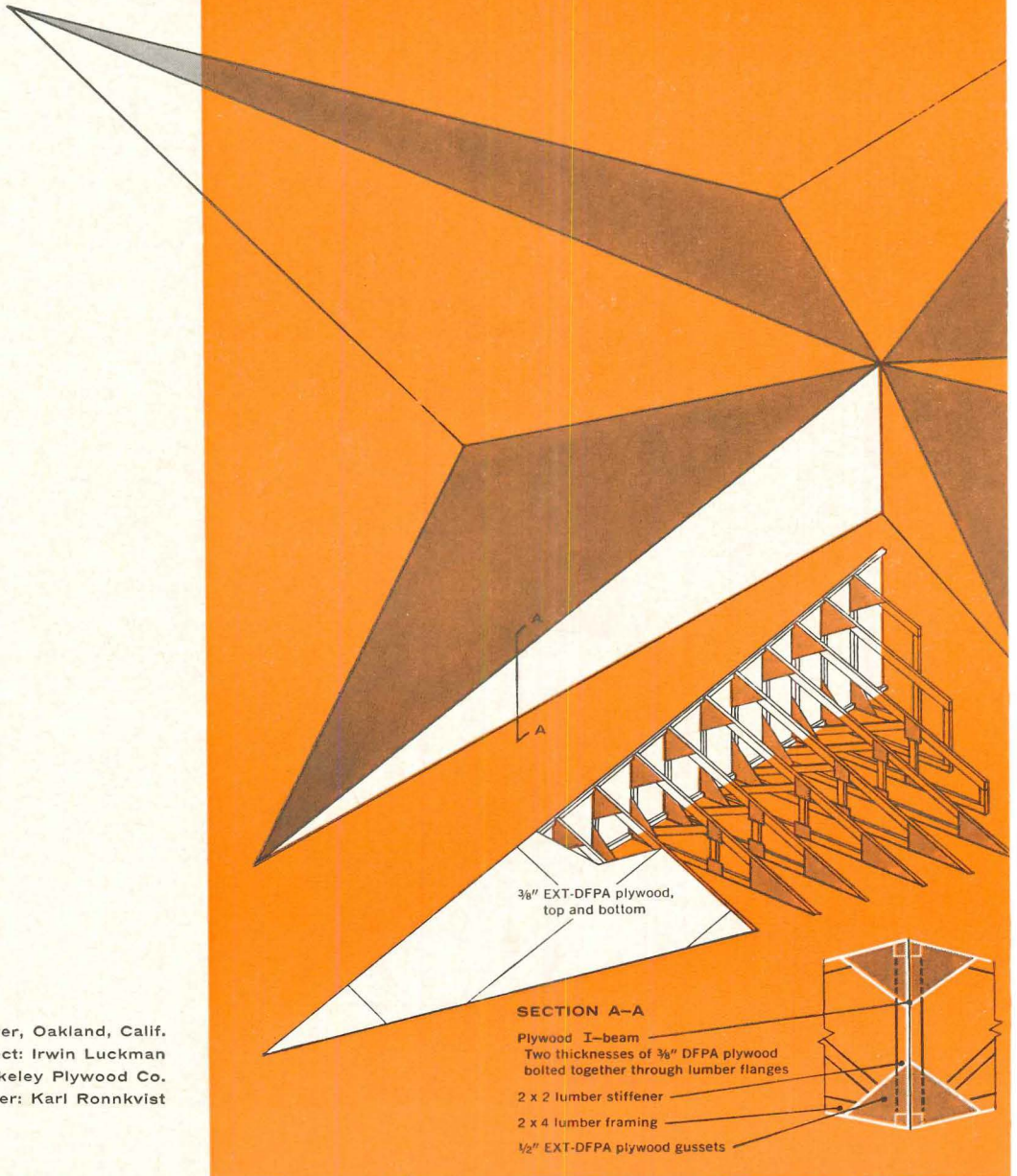



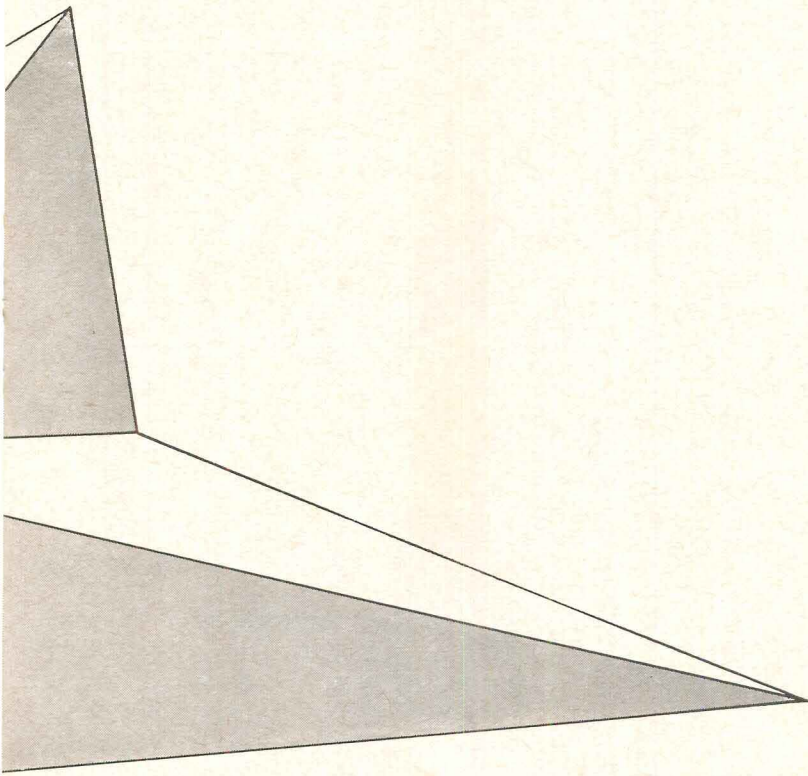

## the most exciting ideas take shape in fir plywood



THIS INGENUOUS STAR-SHAPED ROOF demonstrates the remarkable structural forms that can be achieved with plywood. Deceptively simple, the design bears more resemblance to airplane wings than a conventional roof, with interacting plywood and lightweight lumber members forming skeleton and structural skin.

Four plywood I-beams radiate from the center to form the spines of the 22 x 38-foot wings. Trusses cantilever off both sides of the beams and plywood skins form a rigid diaphragm that provides structural integrity for the entire assembly. The roof is supported by only eight steel columns. Components were temporarily bolted together by the fabricator to check tolerances, then trucked to the site for installation.

For further information on plywood and other new plywood structural systems, including folded plates, space planes, Delta structures, components, etc., write (USA only) Douglas Fir Plywood Association, Tacoma 2, Washington.



ALWAYS SPECIFY BY  
DFPA TRADEMARKS

## Office Literature

continued from page 176

### VINYL BUILDING PANELS

(A.I.A. 26-A-5) A 12-page technical brochure illustrates a number of uses for vinyl building panels and gives architectural specifications and physical characteristics. *Barrett Div., Allied Chemical Corp., 40 Rector St., New York 6, N.Y.\**

CIRCLE 423 ON INQUIRY CARD

### HOSPITAL PLUMBING



"Hospital Plans Book" is a 24-page guide to special purpose plumbing fixtures. It has 15 floor plans developed for individual hospital units by the U.S. Public Health Service. Plans refer to 100- and 200-bed hospitals and can be adapted for hospitals of all sizes. *Crane Co., Plumbing, Heating, Air*

*Conditioning Group, P.O. Box 780, Johnstown, Pa.\**

CIRCLE 424 ON INQUIRY CARD

### SURFACE ANCHORS

(A.I.A. 37-A) Adhesive surface anchors of all types are illustrated and described in Data Sheet 12. *Miracle Adhesives Corp., 250 Pettit Ave., Bellmore, L.I., N.Y.\**

CIRCLE 425 ON INQUIRY CARD

### PORCELAIN ENAMEL

Cut-away drawings and specifications on porcelain enamel curtain wall panel details and fascia details are included in four-page booklet, "Porcelain Enamel in Architecture." *Challenge Stamping & Porcelain Co., Grand Haven, Mich.\**

CIRCLE 426 ON INQUIRY CARD

### LIBRARY INTERIORS

(A.I.A. 35-B-2) Library bookstacks, special shelving, carrels, tables and other library equipment are illustrated in 12-page color catalog. *Estey Corp., One Catherine St., Red Bank, N.J.\**

CIRCLE 427 ON INQUIRY CARD

### GLASS MANUAL

"Glass for Construction" is a 32-page booklet with current information on polished plate glass, safety glass, spandrel glass for curtain walls, *Tufflex* doors, etc. Technical details are included. *Libbey, Owens, Ford Glass Co., 811 Madison Ave., Toledo 1, Ohio*

CIRCLE 428 ON INQUIRY CARD

### GASKET CATALOG

(A.I.A. 17-J) Schematic drawings, property tables and application methods on a full line of seals, gaskets and waterstops for masonry and concrete construction are given in an eight-page color catalog. *Williams Seals and Gaskets, 486 W. Eight Mile Road, Hazel Park, Mich.\**

CIRCLE 429 ON INQUIRY CARD

### STEEL DOORS AND FRAMES

(A.I.A. 16-B) The complete Amweld line of hollow metal doors and frames, including fire doors, are presented in a 20-page catalog. Also included are steel folding doors and steel frames for residential construction. *Amweld Building Products, 100 Plant St., Niles, Ohio\**

CIRCLE 430 ON INQUIRY CARD

\*Additional product information in *Sweet's Architectural File*

# ZERO HAS THE WEATHER STRIPPING YOU NEED

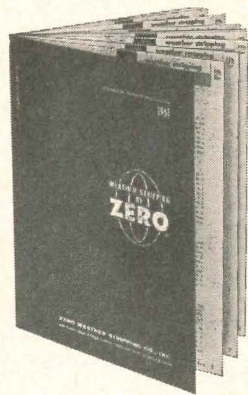

Get ZERO'S new Catalog, with full size details of the complete line of saddles & weather stripping. Write for your copy today!

ZERO Weather Stripping for:

- Doors
- Windows
- Lightproofing

- Soundproofing
- Sliding Doors
- Saddles
- Saddles for Floor Hinged Doors

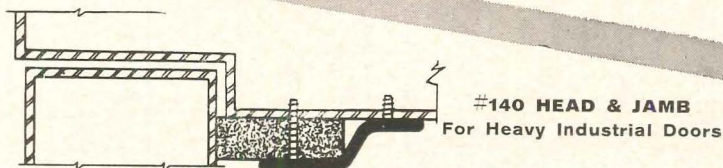

**FOR LIGHT, SOUND, DRAFT PROOF DOORS WITH HEAD AND JAMB PROTECTORS**

Solid or sponge neoprene, or felt air-tight door seals. Retainers of extruded bronze or aluminum.

For sill protection see p. 18, Zero Catalog

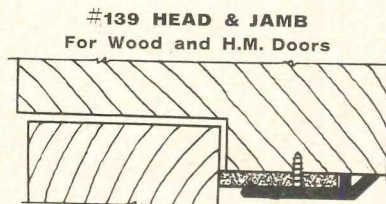
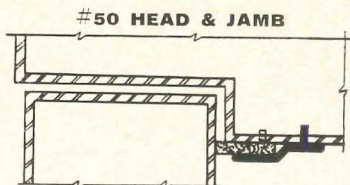

18b-ZER



**ZERO WEATHER STRIPPING CO., INC.**

451 East 136th St., New York 54, N.Y. • LUdlow 5-3230

For more data, circle 98 on Inquiry Card

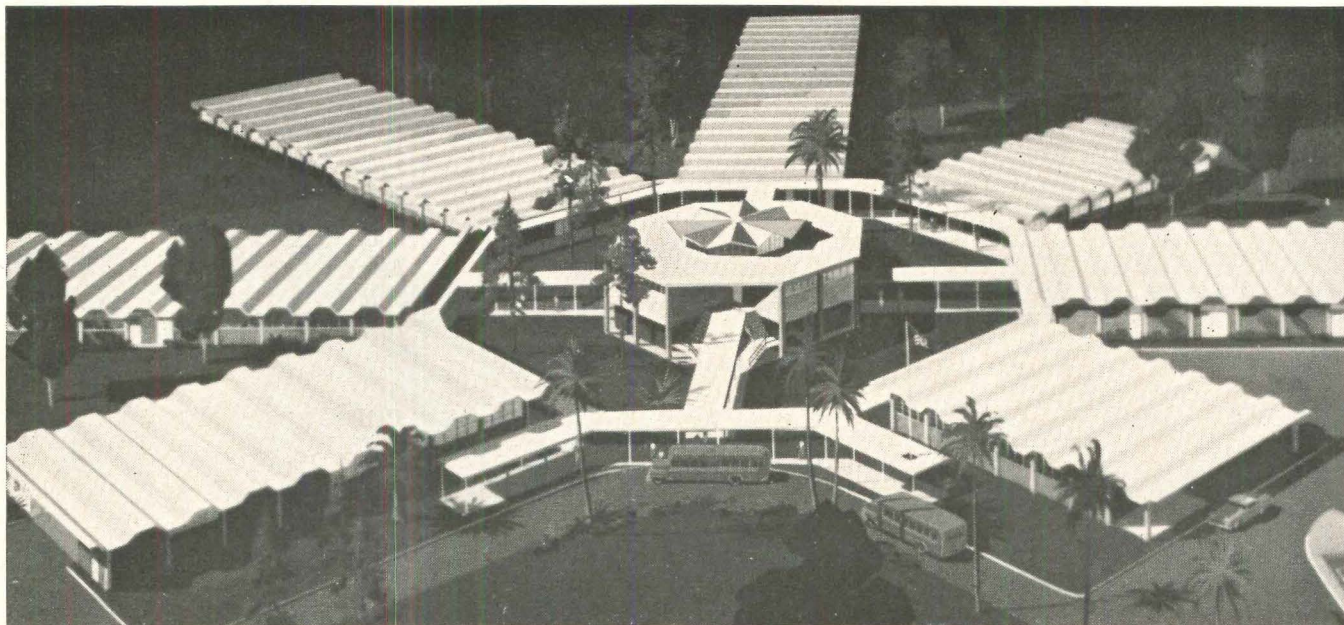

Forrest Senior High School #207, Duval County, Florida • Architect: Hardwick & Lee, Jacksonville, Florida • Engineer: Frank B. Wilder & Assoc., Jacksonville, Florida • General Contractor: Wesley of Florida, Inc., Jacksonville, Florida • Plumbing Contractor: Walter Denson, Inc., Jacksonville, Florida • Distributor: All State Pipe Supply Co., Inc., Jacksonville, Florida

## Schools of Thought

There are many schools of thought regarding school architecture, and shown here are two handsome and different examples. When it came to choosing plumbing fixtures and fittings for these schools, the school of thought that places importance on quality prevailed—Kohler was installed.

### KOHLER OF KOHLER

Kohler Co., Established 1873 • Kohler, Wis.

ENAMELED IRON AND VITREOUS CHINA PLUMBING FIXTURES • ALL-BRASS FITTINGS  
ELECTRIC PLANTS • AIR-COOLED ENGINES • PRECISION CONTROLS

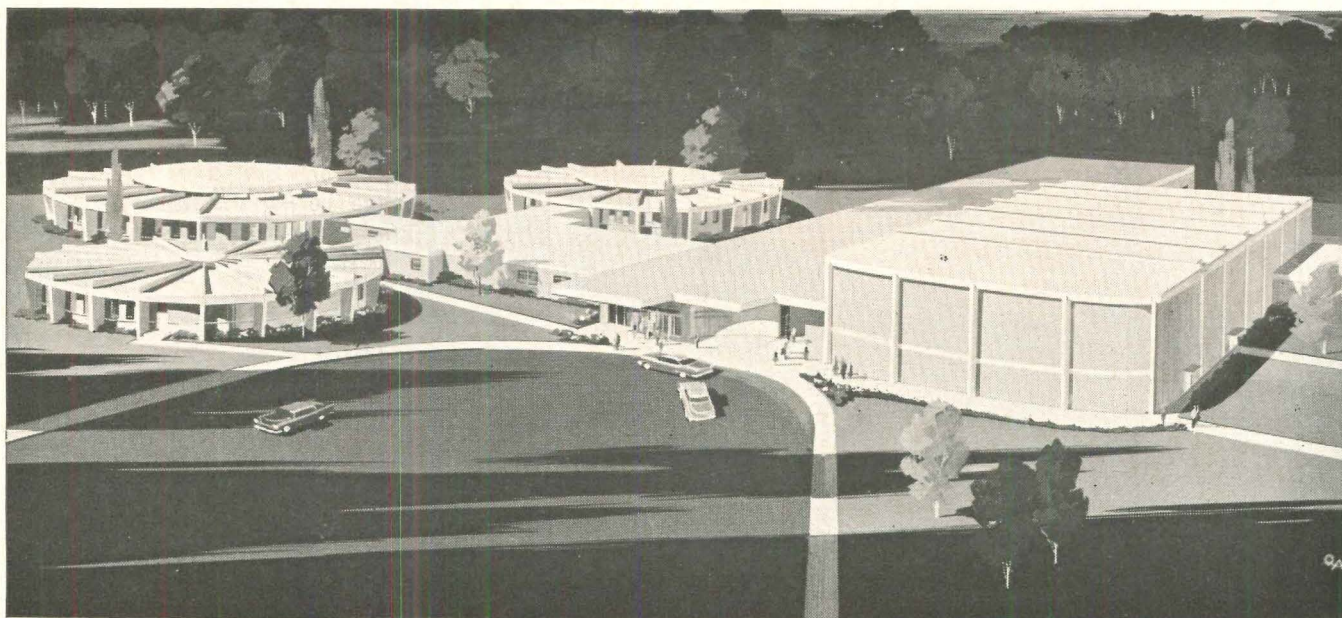

Charles City Community High School, Charles City, Iowa • Architect: The Griffith Company, Ft. Dodge, Iowa • Consulting Engineer: E. H. Pietsch, Des Moines, Iowa • General Contractor: Jens Oleson Construction Co., Waterloo, Iowa • Plumbing Contractor: E. L. Secory, Clear Lake, Iowa • Distributor: A. Y. McDonald Mfg. Co., Des Moines, Iowa

For more data, circle 99 on Inquiry Card

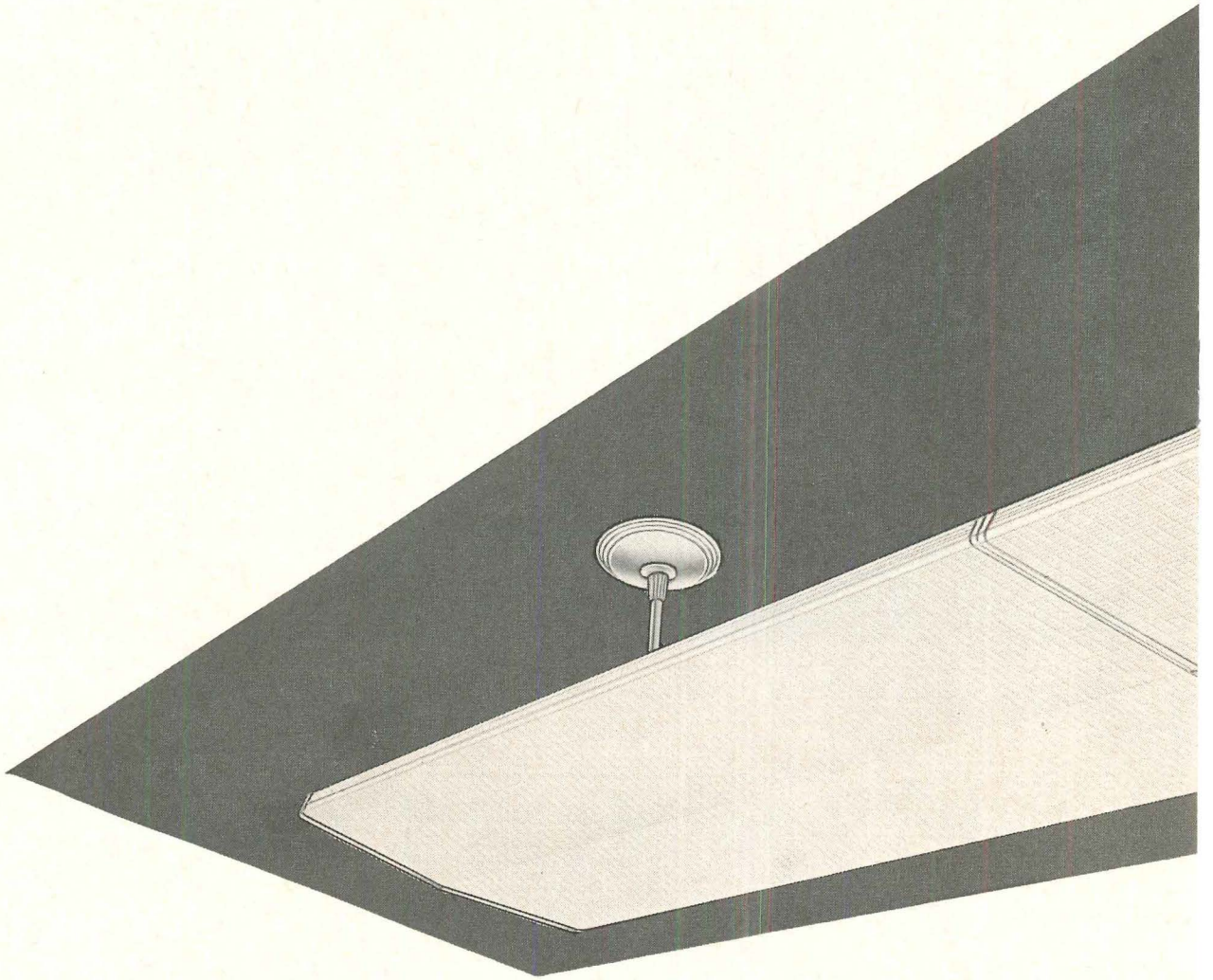

New Day-Brite

# **MARKSMAN<sup>®</sup>**

...superb choice for schools and offices.

On target for low-brightness comfort,  
sleek appearance, easy servicing.

*Wm. B. Ittner, Inc.  
Architects and Engineers*

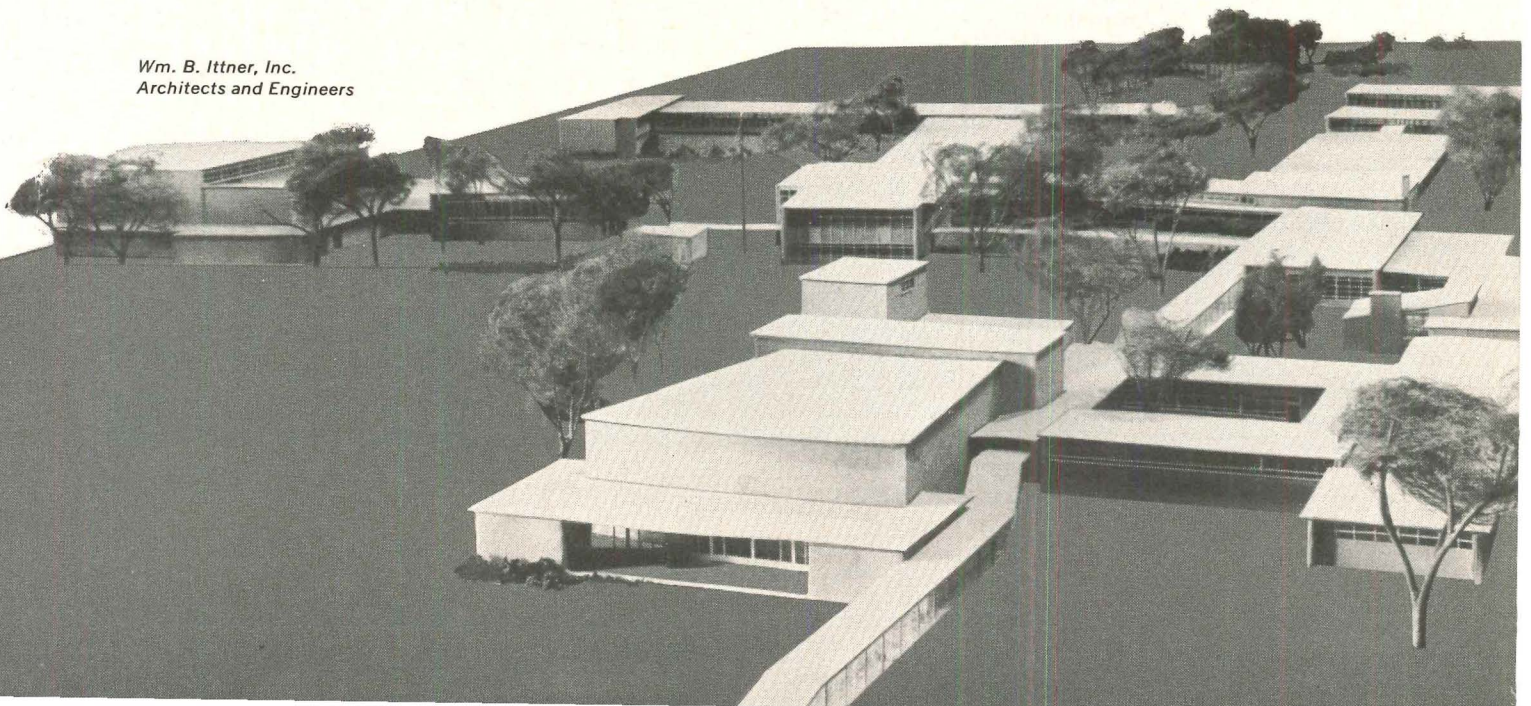

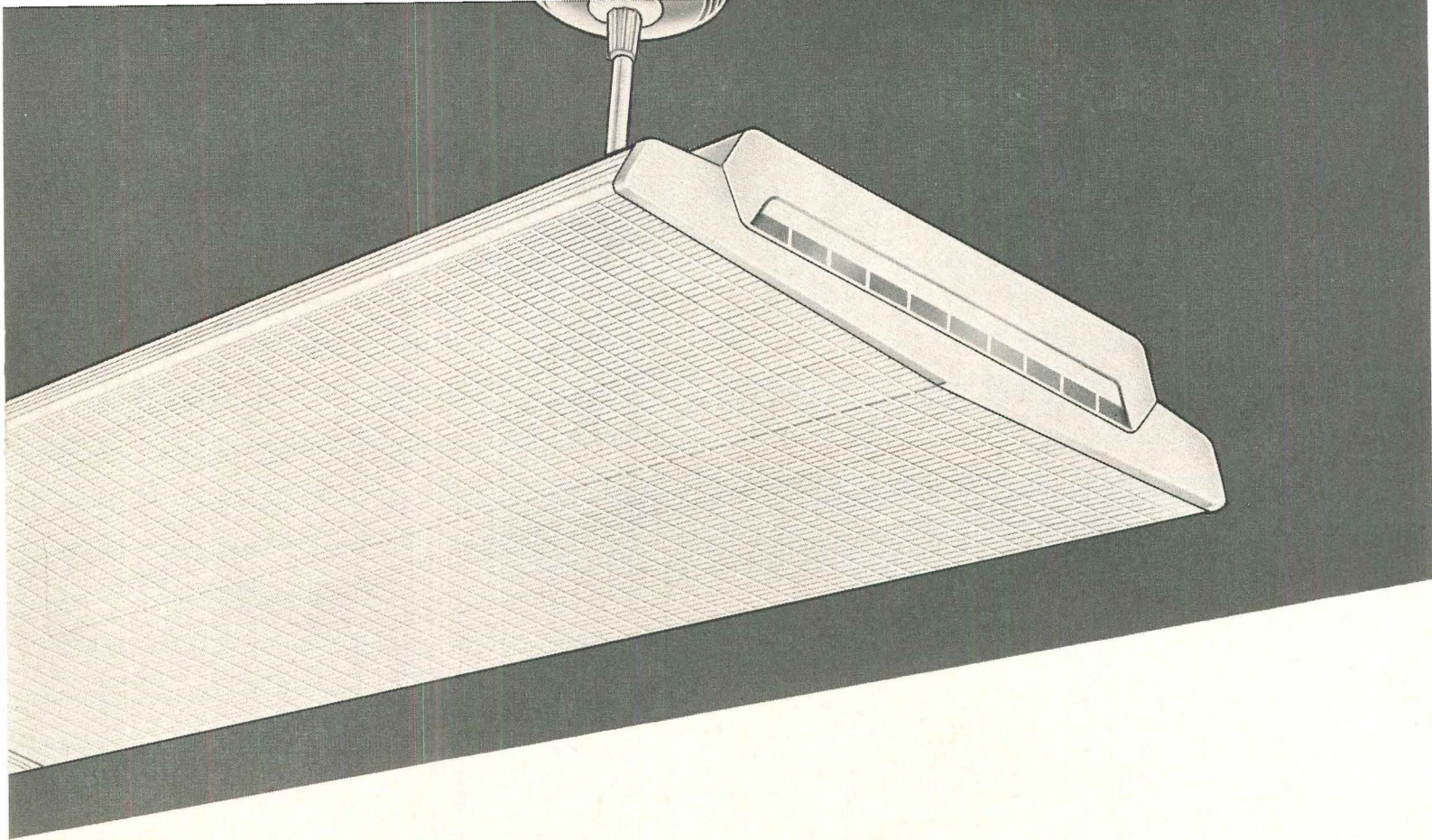

## Above all...specify Day-Brite

We set out to design and build a moderately-priced fixture that would deliver high footcandle levels with truly low-brightness eye comfort.

This modern, commercial fixture has approximately 50% uplighting to softly bathe the ceiling in light, reduce contrasts, and minimize shadows at the task. And because air circulates freely around the lamps, they operate more efficiently at cooler temperatures.

A new version of Day-Brite's exclusive Cleartex<sup>®</sup> was used in the prismatic enclosures to control glare.

The result is the new Day-Brite Marksman . . . an eye-pleasing, low-brightness fixture that in the 2-lamp version meets "scissors curve" brightness requirements.

And you get this great performance with no sac-

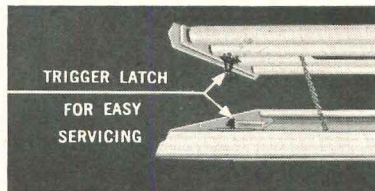

rifice in appearance or Day-Brite's traditional installation and maintenance economies.

Less than 3 inches thin overall, the Marksman has the slim, modern lines today's interiors demand. Apparent depth when viewed from side is less than 1½".

And in keeping with the trim design of the fixture, the Marksman is suspended with new attractive small-diameter stems that go up incredibly fast.

To facilitate relamping and cleaning, the enclosure opens easily with an inconspicuous trigger latch.

The Day-Brite Marksman is available now in 2- or 4-lamp units, 4 or 8 feet in length (8 feet in 2-lamp only). Be sure to get full details on it before your next school or office lighting job. Call your Day-Brite representative or write Day-Brite.



**DAY-BRITE LIGHTING**

*St. Louis, Mo., Tupelo, Miss. and Santa Clara, Calif.  
Amalgamated Electric Corp., Ltd., Toronto 6, Ont.*

**NATION'S LARGEST MANUFACTURER OF COMMERCIAL AND INDUSTRIAL LIGHTING EQUIPMENT**

For more data, circle 100 on Inquiry Card

D-381



CONDENSER MICROPHONE



STEREO CONTROL CONSOLE

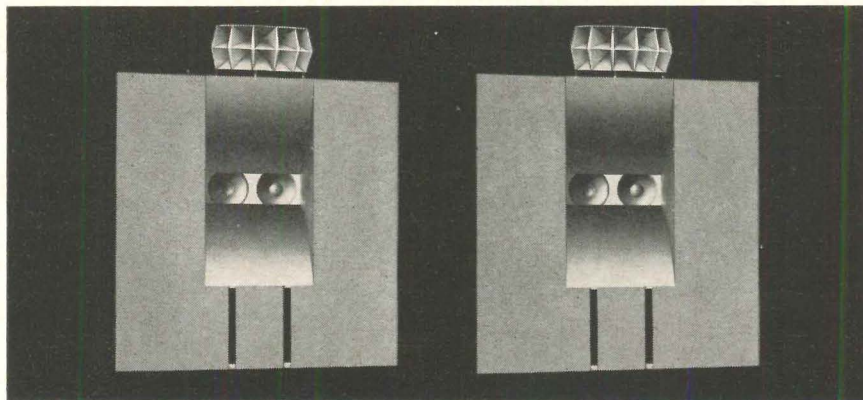

"VOICE OF THE THEATRE"® SPEAKER SYSTEMS

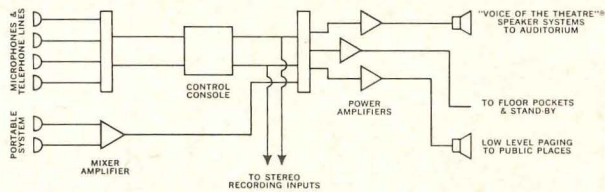

Designed and installed by:  
Harrison & Abramowitz,  
Architects  
Bolt, Beranek & Newman, Inc.,  
Consulting Engineers  
Sound Systems, Inc.,  
Altec Sound Contractors

## AT LINCOLN CENTER'S PHILHARMONIC HALL THE ENTIRE SOUND SYSTEM IS BY



© 1962 ALTEC LANSING CORPORATION

## ALTEC LANSING CORPORATION

LTV A subsidiary of Ling-Temco-Vought, Inc.  
ANAHEIM, CALIFORNIA

If your sound project also calls for audio perfection, won't you call the Altec Sound Contractor in your area, or for complete information, write Dept. AR-12

For more data, circle 101 on Inquiry Card

## TWO COMPETITIONS: REYNOLDS AND KINGSBERRY

The competition for the third annual \$5,000 Reynolds Aluminum Prize for Architectural Students—\$2,500 for scholarship purposes for the student or group of students originating the design and \$2,500 for the winner's school—has been announced, and the suggestion made that student designs be prepared for judging by individual schools no later than December 14. Recognizing the "best original design for a building component in aluminum," the prize will be awarded at the A.I.A. Student Convention in Miami, Fla. in May.

Eligible for participation is any school in the United States which is a member or associate member of the American Association of Collegiate Schools of Architecture or which has a student chapter, A.I.A. and all students in the participating schools who have completed a minimum of two years of an architectural design curriculum.

For information, write the American Institute of Architects, Attn: Reynolds Aluminum Prize, 1735 New York Ave., N.W., Washington 6, D.C.

Architects, builders, engineers, draftsmen and architectural and engineering students are invited to participate in a national design competition sponsored by Kingsberry Homes Corporation, Chamblee, Ga. First prize is \$1,000.

The problem involves an original design for a typical family of five.

On the jury are James T. Lendrum, A.I.A., dean, School of Architecture, University of Florida; Quinton S. King, home builder, Atlanta; Robert Sherman, A.I.D., president, Model Interiors; John King, Research Institute, National Association of Home Builders; and John Odegaard, director of Research and Development, Kingsberry Homes Corporation. Herman H. York, A.I.A., is professional advisor.

Write for applications for the competition, which continues until March 15, to Kingsberry Home Design Competition, 5096 Peachtree Rd., Chamblee, Ga.

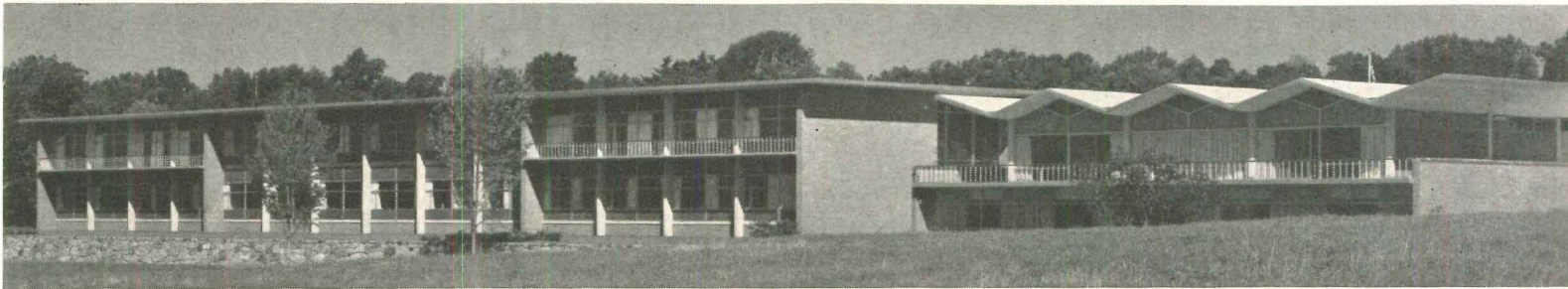
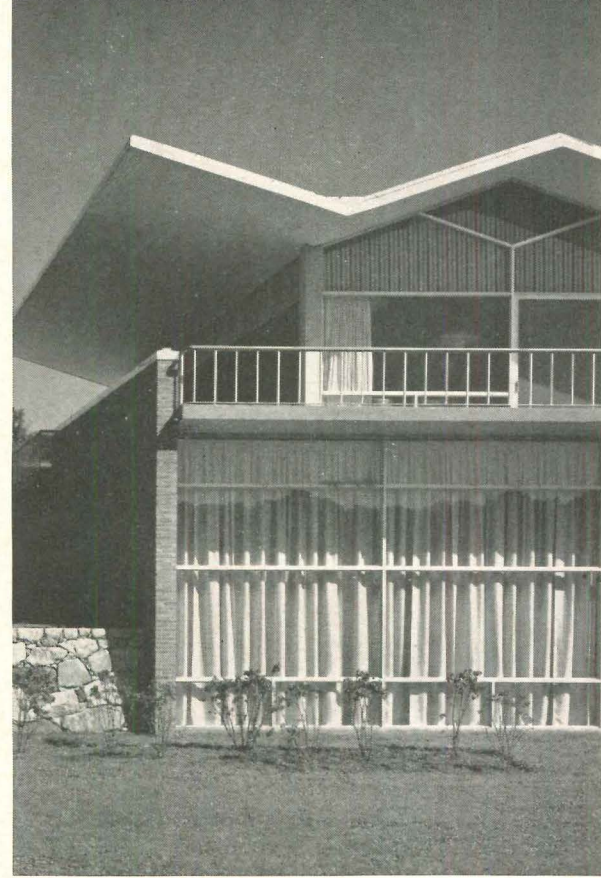
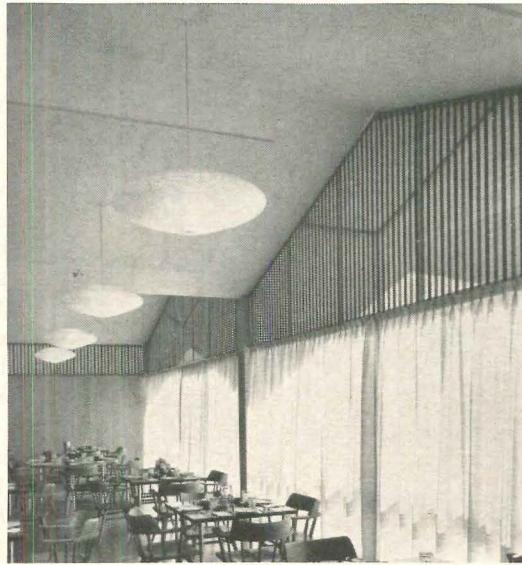
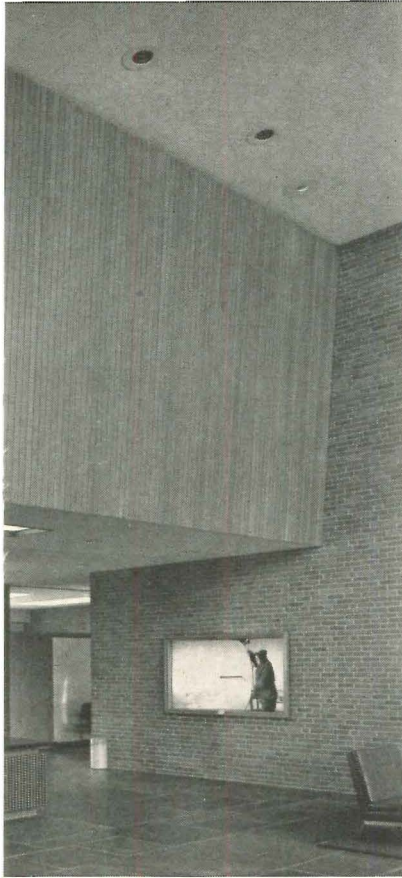

New Executive Office Building at 119-acre Raytheon Center accommodates 500 key people formerly housed in ten separate locations. All offices overlook either courtyard or country. Interior walls and floors are in soft green.

Architect: Anderson, Beckwith & Haible; General Contractor: George A. Fuller Construction Company, both of Boston, Mass.; Painting Contractor: M. L. McDonald Co., Watertown, Mass.

## *Color accents a corporate image . . . with technical help from the "Man from Devoe"*

Both the site and the plans for this new Executive Office Building of the Raytheon Company at Lexington, Mass. were chosen with a critical eye to quiet dignity in a quiet, semi-rural setting. Every detail was designed to accent the image of the outstanding company it represents, including the subtle and imaginative use of color.

When technical considerations of paint came up, the Man from Devoe was invited to cooperate with the architects who had previously selected their colors. He supplied the data needed on the application and performance of paints which helped in the selection of these Devoe finishes: Chemfast 500 and Bloxfil for masonry surfaces . . . Devoe Vinyl Wonder-Tones for interior walls . . . and enamels, glosses and stains used

elsewhere throughout the building.

This comprehensive, capable Devoe service is also available to you on any problem involving paint in commercial, residential or industrial applications. Without obligation, the Man from Devoe will gladly assist in color selection, with over 1,000 colors in the Devoe Library of Colors® system. Or advise on cost, use, maintenance, durability or performance of coatings. Or draw up complete painting schedules. Or check on paint application at your building site, however far from your office.

We invite you to call on the Devoe Architectural Representative in your area. To contact him, write or phone the Devoe Architectural Service Dept. of your nearest Devoe office.

Write us direct for a free Rainbow Selection of 300 colors from the Devoe Library of Colors . . . a useful reference collection.



H. E. Farrier, the "Man from Devoe" in Boston, serving architects in the Massachusetts area.



# DEVOE

DEVOE & RAYNOLDS CO., INC.

A Subsidiary of Merritt-Chapman & Scott Corp.

Atlanta • Boston • Charlotte, N.C. • Chicago • Cincinnati  
Dallas • Denver • Detroit • Houston • Los Angeles • Louisville  
Moonachie, N.J. • New Orleans • New York • Philadelphia  
Stamford, Conn. Warehouses in all principal cities, coast to coast.



Office building and part of banking facilities at Denver U.S. National Center. Third building (not shown) at right rear.



Motor Bank Building now under construction across the street. Architect is James D. Sudler Associates.

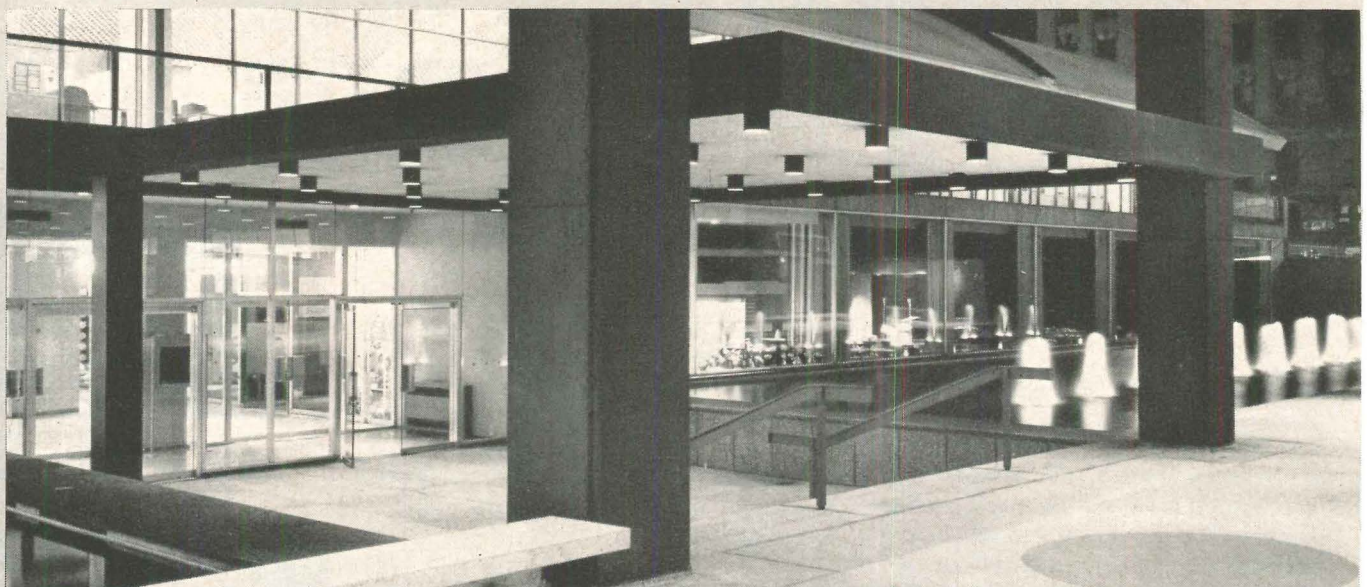

Courtyard between buildings at top. One Honeywell control center will supervise heating-cooling equipment throughout complex.



# How much automation is practical for your buildings?

Centralized automated control will save \$17,000 per year at Denver U.S. National Center.

**Installed as Center adds fourth building  
Honeywell automation will return 19% yearly  
on investment, pay for itself in 5¼ years,  
in savings on labor, power, depreciation**

Whether you are considering automation as an item in planning new construction, or as an improvement to an already existing structure, the experience of the Denver U.S. National Center could be helpful.

Three buildings have been in service for from three to seven years. A fourth is now under construction.

At an early stage in planning the newest building, Honeywell engineers and F. E. Stark, consulting mechanical engineer, made a cost comparison analysis of previous operating methods as against automated centralized control for all four buildings.

The study showed that under the old methods 3,874 manhours per year would be needed just to turn heating and air conditioning equipment on and off, to check temperatures and make adjustments.

But, with a Honeywell Selectographic\* DataCenter installed this time would be cut to just 376 manhours per year—saving \$10,320 in labor costs alone.

Further, the centralized control system would save \$1,728 in electricity and steam each year, plus \$5,000 in replacement and depreciation costs.

**Altogether, a saving of \$17,048 per year—a 19% return on investment—or enough to pay for the control center and installation in just 5¼ years.**

Using only present manpower, the Honeywell Selectographic\* DataCenter will start and stop all air handling

equipment in all four buildings; check and adjust temperatures; give instant reports of machinery operation (with an audible alarm for malfunction); and provide inter-com to every mechanical equipment room.

**So helpful in this instance,** central control is a basic step in automating *any* building's mechanical-electrical systems to wring maximum efficiency from equipment, cut a surprising waste in manhours, and plug needless leaks in fuel and power costs.

Today, however, central control is only the *beginning* of automation—ranging up to computer-guided systems that digest scores of variables, then instantly allocate the load to equipment for optimum results at minimum cost.

You'll want to keep abreast of the newest Honeywell developments, many of them offering your clients operational savings through concepts that were unavailable a few years ago.

**Honeywell automation specialists** will gladly discuss them with you, or work with you to make an automation analysis of any building.

Phone your nearest Honeywell office, check coupon, or write: W. N. Wray, Honeywell, Dept. AR6-92, Minneapolis 8, Minn. In Canada, write Honeywell Controls Ltd., Toronto 17, Ont.

\*Trademark

## Honeywell



*First in Control*

**7 new planning guides for your clients! Mail coupon today**

**Authoritative.  
Latest developments  
in automation.  
Valuable data.  
Mail coupon  
today.**



AUTOMATION TECHNIQUES



AUTOMATIC FIRE PROTECTION



CLOCK PROGRAMMING SYSTEMS



TEMPERATURE CONTROL



SECURITY AND EQUIPMENT SURVEILLANCE SYSTEMS



ELECTRONIC AIR CLEANING



PREVENTIVE MAINTENANCE PROGRAMS

**Honeywell, Dept. AR12-92  
Minneapolis 8, Minn.**

Without obligation, please send Honeywell Planning Guides checked.

- |   |  |
|---|--|
| <input type="checkbox"/> Automation Techniques                                    | <input type="checkbox"/> Temperature Control             |
| <input type="checkbox"/> Automatic Fire Protection                                | <input type="checkbox"/> Security and Surveillance       |
| <input type="checkbox"/> Clock Programming Systems                                | <input type="checkbox"/> Electronic Air Cleaning         |
|   | <input type="checkbox"/> Preventive Maintenance Programs |
| <input type="checkbox"/> I'm interested in an AUTOMATION ANALYSIS of my building. |  |

NAME \_\_\_\_\_

TITLE, COMPANY \_\_\_\_\_

ADDRESS \_\_\_\_\_

CITY, ZONE, STATE \_\_\_\_\_

For more data, circle 103 on Inquiry Card

# GLIDORAMA HORIZONTAL GLIDING ALUMINUM WINDOWS

**FOR GREATER BEAUTY,  
MORE UTILITY AND COMPLETE  
CUSTOMER SATISFACTION**

**...in your next Residential or  
Commercial job—here's why:**

➤ Glidorama is recognized as the ultimate in *undisturbed fenestration* by leading builders.

➤ Glidorama enhances and complements today's *modern architectural styling*.

➤ Glidorama has these engineered features which assure lasting quality: • "invisible" hardware • stainless steel ball bearing rollers • complete perimeter seal • twin, V-shape, metal interlock-rail and jamb • easy inside removal of panes and screens.

➤ Glidorama windows won't rust, warp or rot—never need painting. Adaptable to all types of construction and available in a wide range of standard sizes.

*Give your clients the beauty and the economy of Glidorama Horizontal Gliding Aluminum Windows. Write for details.*

**Glidorama**  
ALUMINUM  
GLIDING WINDOWS

for Commercial, Institutional, Industrial and Residential buildings.

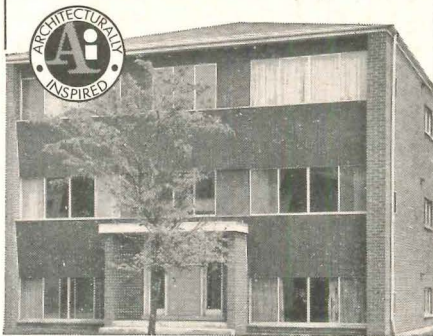

GLIDORAMA DIVISION, WHIZZER INDUSTRIES, INC., 352 SOUTH SANFORD, PONTIAC, MICHIGAN

For more data, circle 104 on Inquiry Card

## EDUCATION NEWS: LEONARD WOLF DIES AT 54; AWARDS

Leonard Wolf, head of the department of architecture and architectural engineering at Iowa State University, died on October 17 at the age of 54 after a long illness.

A member of the Iowa State staff since 1937, Mr. Wolf served as college architect and department head since 1953. Throughout his career he served in executive capacity with many professional societies and public agencies. At the time of his death he was chairman of Governor Erbe's committee on Housing and Institutional Care for the Aged, and chairman of the housing survey committee and national secretary of the Association of Collegiate Schools of Architecture. A Fellow in the American Institute of Architects, Mr. Wolf was past president of the Iowa Chapter of A.I.A. and a member of the Iowa Engineering Society, American Society for Engineering Education. He is survived by his wife, a son and two daughters.

Named acting head of the department following the death of Dean Wolf, is **Dr. John E. Lagerstrom**, formerly assistant dean of the College of Engineering. Dr. Lagerstrom has been on the staff of Iowa State since 1946.

**Mario G. Dalvadori**, professor of civil engineering and architecture at Columbia University, was honored this year when Columbia University's Society of Older Graduates presented him with a Great Teacher award.

**Ralph Knowles**, Auburn University architecture professor, has received a grant of \$7,500 as a 1962 Fellow of the Graham Foundation for Advanced Studies in the Fine Arts.

Professor Knowles, who will conduct his year's independent study at Auburn, seeks to devise a structural system in which the supporting material becomes the enclosing surface or skin of the spaces within the building, thus eliminating the need of the column and beam system of construction.



*Progress in Concrete*  
A complete form for concrete house being lifted by crane. The unit, of Symons Forms, has 5,000 square feet of surface.

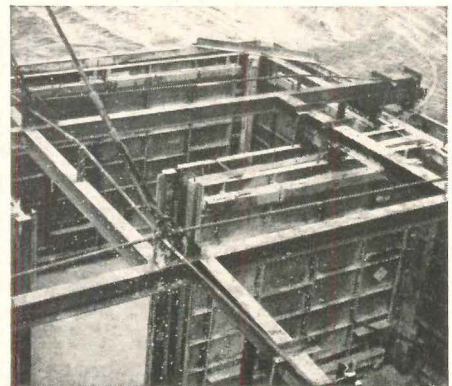

Lifting pads are welded to 8" I-beams that tie assembly together. Tension rods strengthen unit and keep it square.

## INGENIOUS METHOD FORMS 2 COMPLETE CONCRETE HOUSES EVERY 3 DAYS

Carroll C. Martin, president of Monowall Homes, Inc., Baltimore, started a 200-house development near Dorsey, Maryland using Symons Steel-Ply Forms in the conventional manner, stripping after each use. Because of mounting costs, he sought a way of forming a complete house in one operation—not only outside walls but interior partitions and closets.

Martin found the answer by ganging Symons Steel-Ply Forms. By using this forming method, he was able to pour the 24' by 40' houses in one continuous two-hour pour. Just 8 hours later, the 18-ton form was lifted by crane and placed on the next slab. The slabs were formed in advance. Two houses were poured every three days.

Complete story available on request. Symons Steel-Ply Forms can be rented with purchase option.

**CONCRETE FORMING EQUIPMENT  
SYMONS MFG. COMPANY**  
122 EAST TOUHY AVE., DES PLAINES, ILL.

**MORE SAVINGS FROM SYMONS**

For more data, circle 105 on Inquiry Card

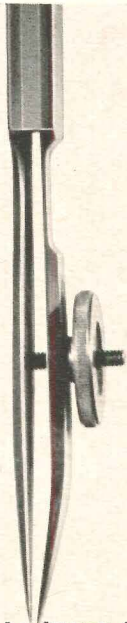

**We'd be happy to do your laundry.** Because designing laundries is a specialized activity at American. Our extensive background in planning and equipping laundries will guarantee your clients the most favorable economics in terms of investment, operating costs, production and quality of work. When your building project includes a laundry department . . . it's a job for American. Call one of our nearby offices or representatives (see the yellow pages), or write for complete information.

You get more from **American**  
 American Laundry Machinery Industries, Cincinnati 12, Ohio  
 See our catalog in Sweet's

**We'd be happy to do your laundry.**

Because helping architects plan laundries is a specialized activity at American. We provide you with a complete service that includes survey engineering, detailed plans and specifications, supervision of equipment installation, plus nationwide service facilities to guarantee your clients continuous fine performance of all laundry equipment.

When your building project includes a laundry department . . . it's a job for American. Call one of our nearby offices or representatives (see the yellow pages), or write for complete information.

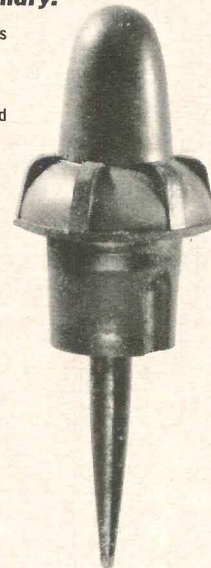

You get more from

**American**  
 American Laundry Machinery Industries  
 Cincinnati 12, Ohio  
 See our catalog in Sweet's

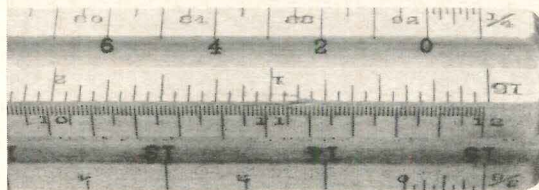
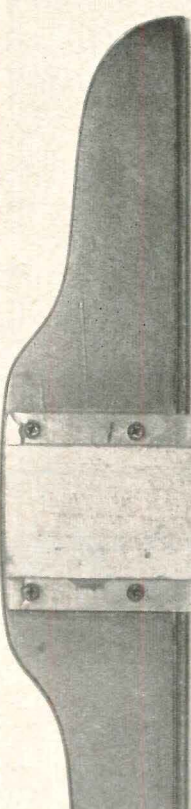
**We'd be happy to do your laundry.** Because designing laundries is our business at American. We are intimately familiar with the many important factors which determine size, layout, cost, personnel and type of equipment best suited for any proposed laundry facility. More important, we will furnish every bit of information you need to incorporate an efficient, space-saving laundry into your overall building design.

When your building project includes a laundry department . . . it's a job for American. Call one of our nearby offices or representatives (see the yellow pages), or write for complete information.

You get more from **American**  
 American Laundry Machinery Industries  
 Cincinnati 12, Ohio  
 See our catalog in Sweet's

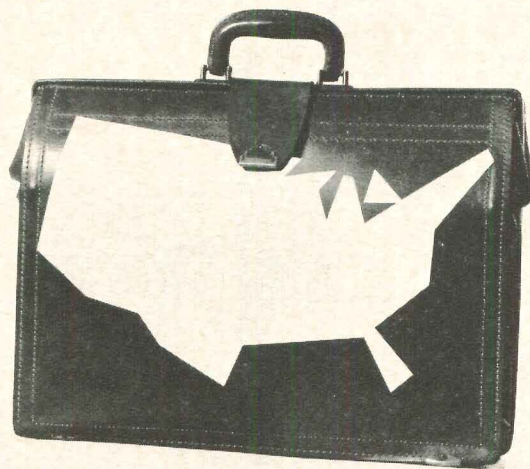

**American's service adds value to every dollar your clients invest in laundry equipment.**

Ours is a never-ending, personal service based on a staff of experienced, direct-from-the-factory representatives, working out of local offices throughout the country. These men are backed by a corps of survey engineers and field service engineers as well as nine strategically located parts depots. • We at American have specialized in planning, equipping and servicing laundries for over 93 years. With American you are secure in the knowledge that there will always be an experienced hand nearby, ready to assist you or your clients with any laundry problem that may arise.

You get more from **American**  
 American Laundry Machinery Industries • Cincinnati 12, Ohio  
 See our catalog in Sweet's

For more data, circle 106 on Inquiry Card

When planning industrial buildings . . .

## will you study these 8 areas to anticipate and prevent the high cost of inadequate overhead-type door performance?

Plant doors affect operating profit . . . they can make money or lose money for your client. They directly affect flow of material, productivity of people and machines, environmental control, and maintenance.

*What are the main causes of door failure and inefficiency?* Field studies of existing industrial plants and exhaustive door-performance testing program by Barber-Colman Company clearly identify the following key factors:

1. Door sealing efficiency
2. Door section construction
3. Door counterbalance reliability

#### 4. Method of door operation or control

Basic performance requirements of these key factors should be established in preliminary investigation, building programming, and door equipment specifications . . . to protect your client from thousands of dollars of *unnecessary* operating expenses . . . and protect yourself!

Barber-Colman's Door System Analysis accurately establishes the performance standards required . . . identifies the penalty of *not* having it . . . fully justifies maximum door quality . . . assure your clients the best possible return on door investment dollar.



**1 MATERIAL HANDLING** comes to a sudden stop when a "most important" door breaks down. Productivity of handling equipment and operators is a complete loss during this time. Let Barber-Colman show you how to anticipate and prevent with guaranteed 100,000 cycle springs.

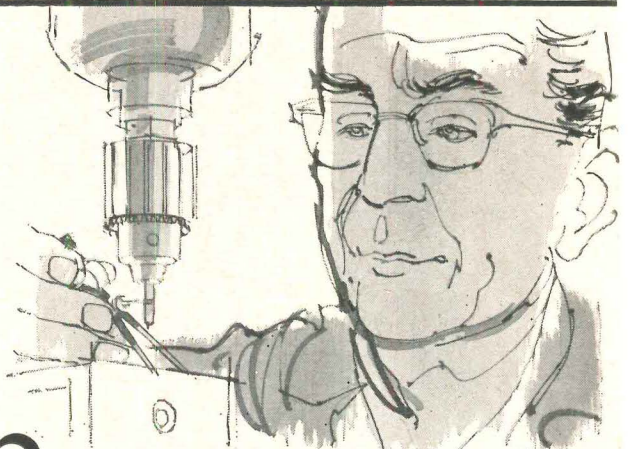

**2 PRODUCTION** slows down or stops when materials are delayed due to door breakdown. Cost of lost production plus downtime of machine and operator can be high. Let your Barber-Colman door specialist help analyze and eliminate this.

**Barber-Colman's Door System Analysis** is the first organized plan for establishing specific performance requirements related to the operating function of all doors and door-operating equipment used in a building . . . a complete checklist for *planning* a highly efficient door system, *anticipating and preventing* operating problems that can result from door failure.

For example: How will air leakage at door perimeter affect environmentally controlled areas? How much heat loss? Should door sections be insulated? What section construction meets minimum wind-loading requirements? What motor and special control requirements are needed to peak operating efficiency of vital doors? How can spring life be determined to anticipate unexpected failure and prevent expensive downtime? What spring design is needed on high-use doors? . . . and many other important factors.

Your Barber-Colman Door Specialist can help protect your clients from door inefficiencies, reasons for excessive door repair and maintenance, bottlenecks in material handling, and possible unnecessary loss of productive manpower. Call him today (see yellow or white pages) . . . or write us direct.

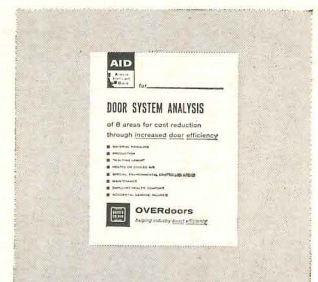

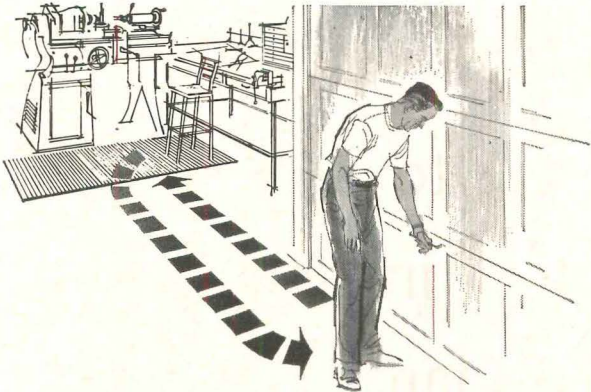

**3** **"WALKING LABOR"** costs mount up fast. When a man leaves a production job or material-handling unit simply to open/close doors your client has another indirect cost. Barber-Colman strategically located switch controls and job-engineered electric operators provide the solution.



**4** **HEATED OR COOLED AIR** is expensive to make, important to save. Do doors seal tightly, or are profits leaking out through "holes" you don't see? Seal the "holes" with Barber-Colman Cam Action doors and specially insulated sections.

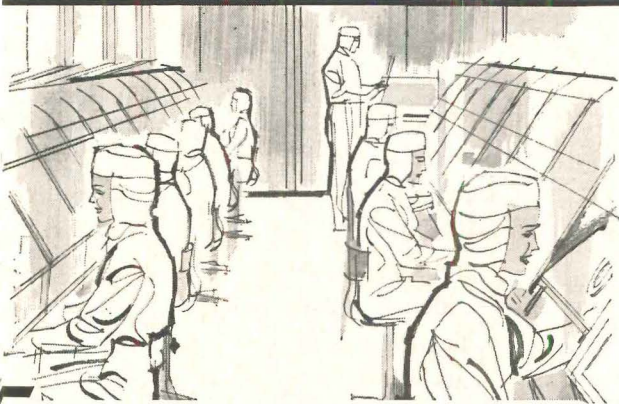

**5** **DUST-FREE, DEHUMIDIFIED OR OTHER SPECIAL CONDITIONED AIR** may be necessary to maintain accurate quality control for a product. Provide complete sealing protection with Barber-Colman Cam Action doors.



**6** **MAINTENANCE** costs go down . . . drafts, contaminated air, dirt, dust, grit are sealed out with Barber-Colman controlled operation and tight sealing.

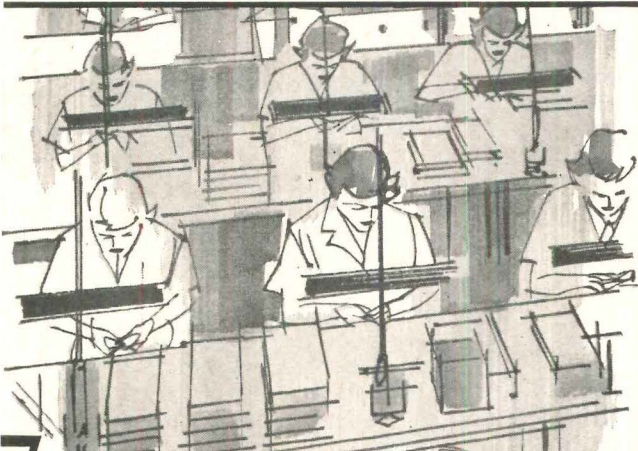

**7** **EMPLOYEE HEALTH, COMFORT** are affected by the efficiency of a plant's doors. The Door System Analysis assures employee protection and increased productivity for your client.

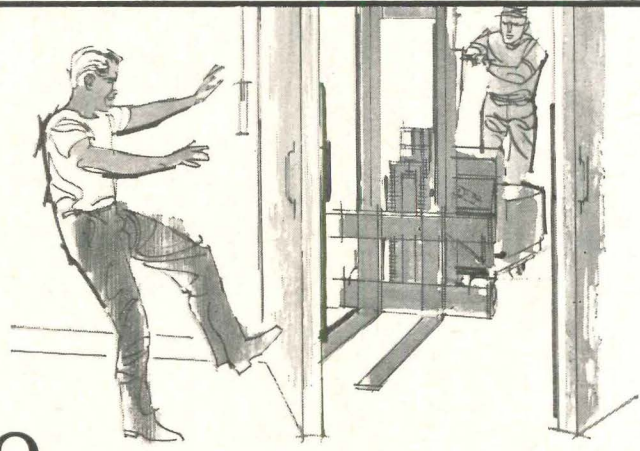

**8** **ACCIDENTAL DAMAGE, INJURIES** are caused when doors are inefficiently planned or operated. Anticipate and prevent these dangerous occurrences and unnecessary costs with the Barber-Colman Door System Analysis.

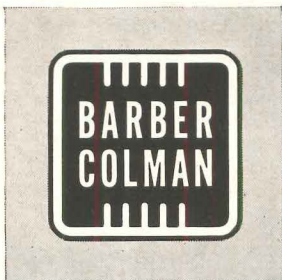

BARBER-COLMAN COMPANY, DEPT. P212, ROCKFORD, ILLINOIS

# OVERdoors

*... one source, one responsibility*

For more data, circle 107 on Inquiry Card

The sign  
of

**ADT**<sup>®</sup>

What does it stand for? For 1,880 criminals last year, it meant "jail." For countless thousands more, it warned, "Keep Off!" For 74,000 service subscribers, it stood for many things: peace of mind, lower protection costs, better management control, safety to employee life, continuity of business operations, and the preservation of property and profits. All our systems are flexible, versatile, and adaptable to *any* plant security requirement.

There are ADT central stations in principal cities. Systems can also be connected direct to fire and police headquarters, or to in-plant guard centers.

Your nearest ADT office is listed in the Yellow Pages. Call us, or write our executive office, Dept. A. No obligation for free survey.

**COMPLETE PROTECTION  
through  
AUTOMATIC DETECTION**

**ALARMS FOR:**

Fire Burglary Sabotage  
Holdup Smoke Intrusion

**SUPERVISION OF:**

Sprinkler Systems  
Industrial Processes  
Heating Systems  
Pumps and Power  
Watchmen and Guards

**AMERICAN DISTRICT  
TELEGRAPH COMPANY**  
155 Sixth Avenue, New York 13, N. Y.

*On the Calendar*

**December**

12-16 19th annual convention-exposition, National Association of Home Builders; theme: "Prophets and Profits"—McCormick Place, Chicago

**January**

22-25 19th annual technical conference, sponsored by the Society of Plastics Engineers—Ambassador Hotel, Los Angeles

**February**

11-14 Semi-annual meeting and 16th International Heating and Air-Conditioning Exposition, American Society of Heating, Refrigerating and Air-Conditioning Engineers—Statler-Hilton Hotel and New York Coliseum, New York City

16-20 American Association of School Administrators—Atlantic City

16-20 School Facilities Council, Inc.—Atlantic City

18-20 13th national conference, American Standards Association—Biltmore Hotel, New York City

25-28 Environmental Engineering Conference and Exhibition, American Society of Civil Engineers—Atlanta

26ff 19th annual technical conference, Society of Plastics Engineers, sponsored by Southern California Section; through March 1—Statler-Hilton and Biltmore Hotels, Los Angeles

*Office Notes*

**Offices Opened**

**Dimitri Demopules**, formerly partner and chief of design with the architectural firm of Golemon and Rolfe, Houston, Tex., has opened an office for the practice of architecture at 2418 Bank of the Southwest Building, Houston.

**Marvin E. Williams** has opened an office for the practice of architecture and landscape architecture at 41 East Main St., Mesa, Ariz.

**Bill J. Blair and Associates**, Oklahoma City architectural firm, has established an office in Phoenix, Ariz. Associate in charge of the office is M. L. Vanlandingham.

**Bodrell Joer'dan Smith**, formerly of William L. Pereira & Associates, announces the opening of his own offices for the practice of architec-

*continued on page 202*

**You'll find  
NEW IDEAS,  
NEW METHODS,  
NEW PRODUCTS**

**ONE SHOW**

Serving industry since 1930, the International Heating and Air-Conditioning Exposition is the only exposition where you can see and compare the new and improved products of over 450 manufacturers of heating, refrigerating, air conditioning and ventilating equipment.

**ONE PLACE**

As a business center, New York is second to none, and you will find the Coliseum is an ideal, easily reached location for this concentration of fact-filled exhibits.

**ONE TIME**

February 11-14, 1963

In just four days you can bring yourself up-to-date on all the new developments that will affect your day-to-day business.

In no other way can you secure as much vital information in such a short time. You'll find the time well spent.

3267

**16<sup>th</sup> INTERNATIONAL  
HEATING &  
AIR-CONDITIONING  
EXPOSITION**

**Auspices ASHRAE**

**NEW YORK COLISEUM  
FEB. 11-14, 1963**

Management:  
INTERNATIONAL EXPOSITION COMPANY  
480 Lexington Ave., New York 17, N.Y.

For more data, circle 108 on Inquiry Card

For more data, circle 109 on Inquiry Card

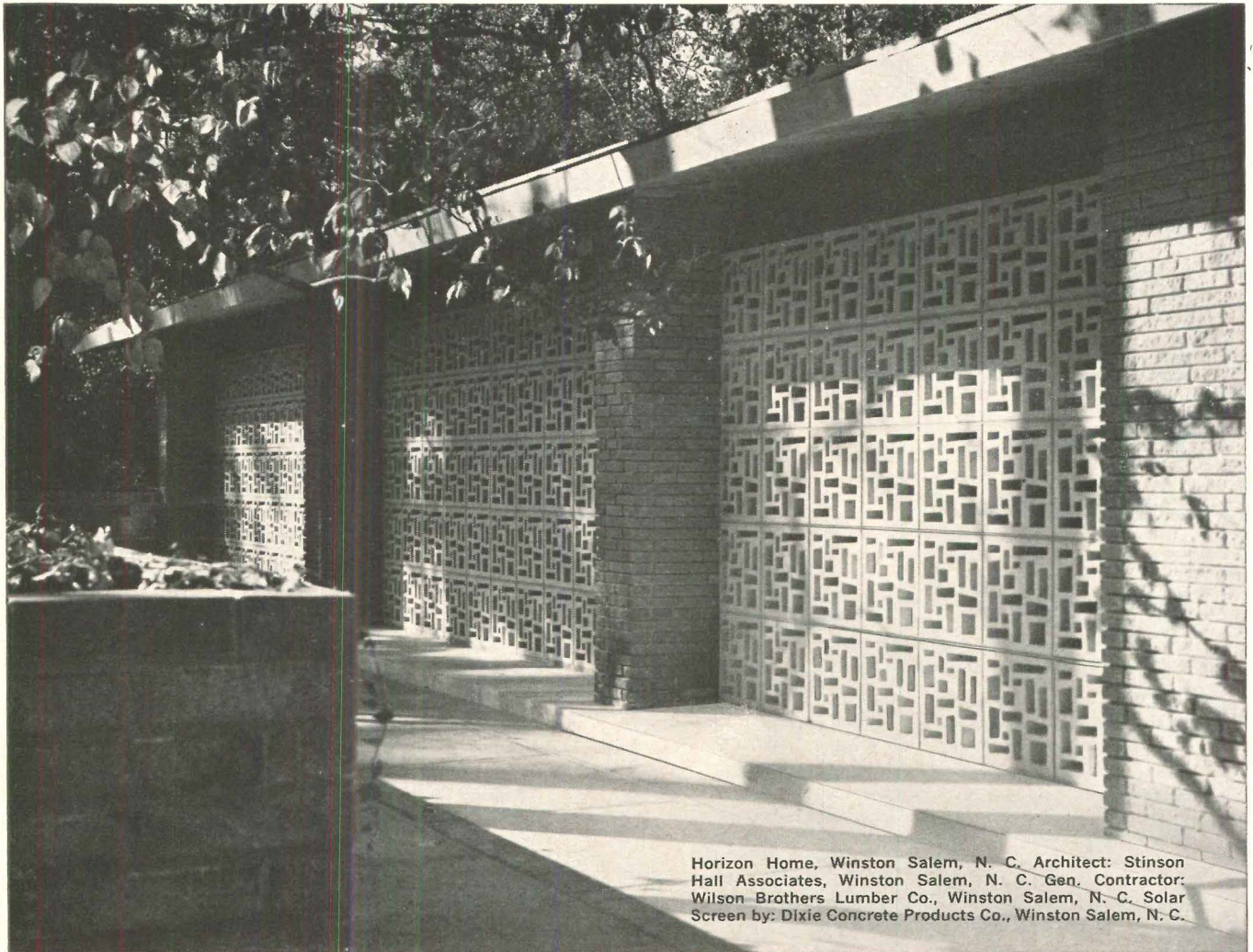

Horizon Home, Winston Salem, N. C. Architect: Stinson Hall Associates, Winston Salem, N. C. Gen. Contractor: Wilson Brothers Lumber Co., Winston Salem, N. C. Solar Screen by: Dixie Concrete Products Co., Winston Salem, N. C.

# MEDUSA WHITE

## PREFERRED FOR PRECAST PANELS AND SCREEN BLOCK

Today there's a growing preference for Medusa (the original) White Portland Cement in making precast concrete panels and decorative screen block to satisfy a fast growing market. Architects and concrete product manufacturers believe that Medusa White best meets their need for a dependable white cement with a *true white color* that can be relied upon to make beautiful white or tinted products true to color specifications. They also appreciate the dependability of Medusa White Cement, whose strength and use properties have been proved by more than half a century of use.

For setting decorative block the most popular mortar choice is Medusa StoneseT White Masonry Cement. A card or letter brings details and specifications on any or all of the eleven Medusa Portland Cements for all types of precast concrete units.

General James White Auditorium & Coliseum, Knoxville, Tenn. Architect: Painter, Weeks, McCarty A.I.A. and Morton & Sweetser A.I.A., Knoxville, Tenn. Gen. Contractor: Johnson & Galyon, Knoxville, Tenn. Panels by: Southern Cast Stone Co., Knoxville, Tenn.

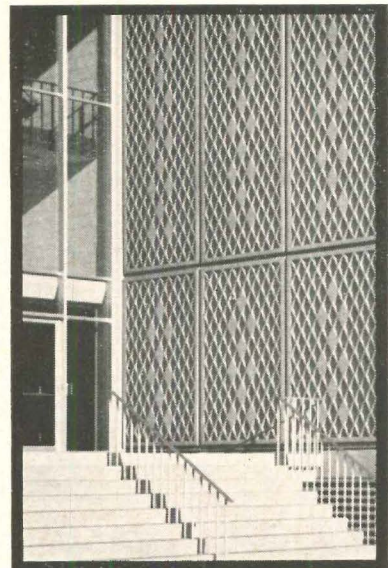

## MEDUSA PORTLAND CEMENT COMPANY

P.O. BOX 5668 • CLEVELAND 1, OHIO

For more data, circle 110 on Inquiry Card

**IN DESIGNING  
ONE-STORY  
BUILDINGS**

**Get Extra Cubage  
Without  
Extra Cost**

Ducts and pipes and all the wasteful space requirements and clutter that go with conventional heating and cooling systems are unnecessary in the Atmos-Pak roof-mounted, pre-fabricated, heating and cooling system.

Atmos-Pak is a roof-mounted, low-silhouette, pre-fabricated heating and/or cooling system specifically engineered for large one-story buildings. It has innumerable advantages for shopping centers, supermarkets, discount houses, bowling alleys, schools, post offices, churches, and industrial buildings. The only interior fitting is an inconspicuous, although good-looking, diffuser, integral with the unit. The one-piece apparatus can be delivered and in operation the same day. Optional colors and housing designs.

Dispensing with boiler and apparatus rooms, Atmos-Pak saves space. Pre-fabrications reduces on-site installation to three quick connections. The supply and return air distribution chambers do away with ductwork. Air-cooling makes water-towers, evaporative condensers, miles of pipe, and other appurtenances unnecessary.

The 50 standard Atmos-Pak models range in individual cooling capacity from 5 to 35 tons. As many units as are needed to add up to the total requirements, are installed. Heating capacity provided as required.

Specify Atmos-Pak for the assurance of problem-free comfort. Write for additional information.

ATMOS-PAK, INC., 88 North Highland Avenue, Ossining, N. Y. Pioneer, Designer, and Manufacturer of Roof-Mounted Heating and/or Cooling Systems.

*There's always room on top for  
the original low silhouette*



Patent No. 2886955

**ATMOS-PAK, Inc.**  
88 North Highland Avenue  
Ossining, N. Y.

*Pioneer, Designer, and Manufacturer of  
Roof-Mounted Heating and/or Cooling Systems*

For more data, circle 111 on Inquiry Card

**This Instalite®  
mounting ring  
revolutionized  
recessed incandescent  
lighting!**



**Here's why:**

Century's new line of Instalite fixtures enables you to install interchangeably a fresnelens unit, an accentlite, a wall washer, a reflector downlite, or a conelite in the same mounting ring and through the same size ceiling aperture. Installation is fast and easy. The fixture body or reflector snaps into place with the twist of a screwdriver. Instalite fixtures are engineered for precise optical performance. Die cast fixture trim gives ceilings a clean, open appearance. Write for brochure.

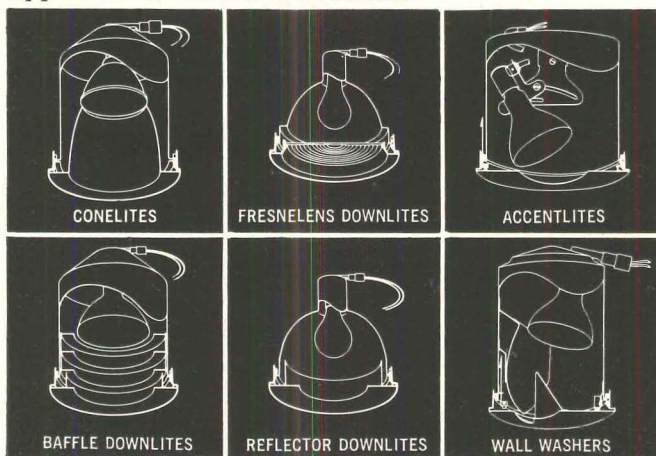

**CENTURY  
ARCHITECTURAL  
LIGHTING**

New York: 521 West 43rd St., N.Y. 36  
Calif: 1820 Berkeley St., Santa Monica

For more data, circle 112 on Inquiry Card



To those people who  
take uncommon pleasure  
in good books, music, and  
other works of art...  
an uncommon offer

**A \$79.50 VALUE FOR \$24.95  
WHEN YOU BECOME A CHARTER MEMBER  
OF THE COLLECTOR'S BOOK SOCIETY**

The first three volumes in the magnificent Council of Europe Series PLUS a year's subscription to a new periodical, the Collector's Quarterly Report, priced at \$6.00.

**THE ROCOCO AGE** by Arno Schönberger and Halldor Soehner. 394 pages, 316 black and white illustrations, 49 color plates, 10½" by 13½". Publisher's price \$23.50. A huge, lavishly illustrated study of the 18th century in France, Italy, Austria, Spain, and Germany, which covers all the arts of the period. "A majestic piece of publishing." *The Reporter*.

**ROMANTIC ART** by Marcel Brion. 240 pages, 166 gravure plates, 64 color plates, 11½" by 13½". Publisher's price \$25.00. The first book to assess the whole of the romantic phenomenon in all its aspects—painting, sculpture, and architecture. "... excellently written, as precise as it is provocative, as clear as it is scholarly." *Emily Genauer, N.Y. Herald Tribune*.

**GATEWAY TO THE TWENTIETH CENTURY** by Cassou, Langui, and Pevsner. 362 pages, 332 black and white illustrations, 52 color plates, 10½" by 13½". Publisher's price \$25.00. Brings together all the disparate forces which ultimately exploded into modern art as it is today. "Probably never before have these pioneer efforts been brought together so comprehensively nor interpreted so conscientiously." *S. F. Chronicle*.

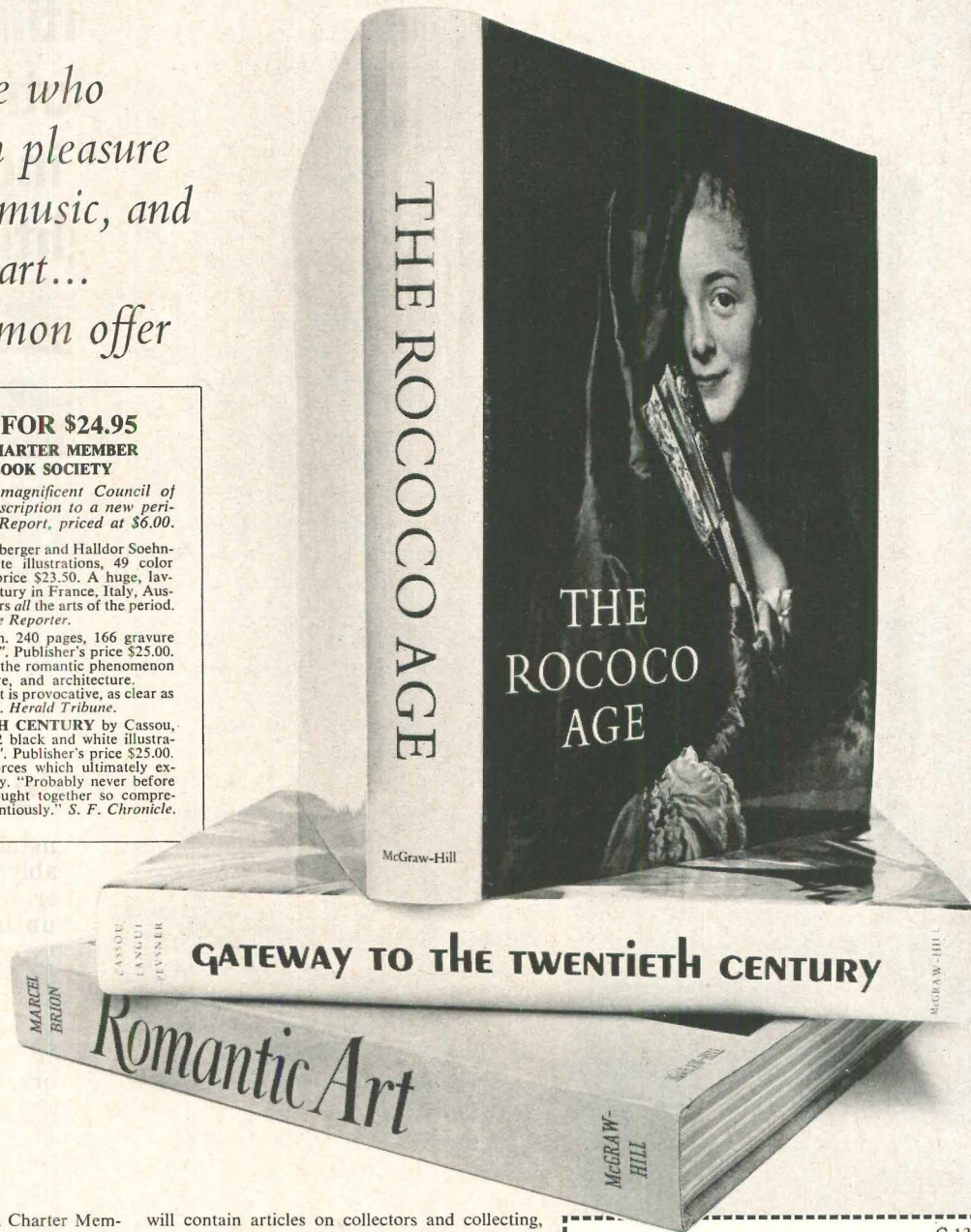

You are invited to become a Charter Member of the Collector's Book Society by accepting the introductory offer shown here, which represents a saving of \$54.55, and demonstrates the service the Society can provide for you.

The books offered are the first three volumes in an extraordinary series originating in major international art exhibitions sponsored by the Council of Europe. Although each of them has been lavishly praised, the series as a whole has been little publicized. Here, then, is a good example of how the Collector's Book Society aims to serve its members—by calling attention to projects like this one which result in today's major cultural products.

The Collector's Quarterly Report, a unique cultural information service covering all the arts, is sent to members four times a year. In it, the Society provides a careful and critical compilation of recent projects and products that merit special attention. Books and series of books, original print editions, records, and sculpture—all of these come within its compass. And all are available for purchase through the Society, often at substantial savings.

In format, the Report is a handsome, 32-page magazine with a wealth of color illustration. Its editorial range is considerable. Forthcoming issues

will contain articles on collectors and collecting, a superb new group of demountable picture frames, a little-known collection of baroque recordings, and a series of children's books printed today from woodblocks cut in 1870. Major fine arts publications of the preceding three months will be regularly described and often illustrated.

**The Quarterly Choice.** Each issue of the Quarterly Report will highlight one product which is felt to be of special interest to members. Most often, this Quarterly Choice will be a book or a series of books relating to art. Members have the option of receiving the Quarterly Choice for examination without any obligation. They may return it within ten days if it fails to meet with their approval.

**No Minimum Purchase Requirements.** At no time are members required to make purchases. They may order what they want—and when—often at sizeable savings, and almost always with bonus credit which may be applied to additional acquisitions.

Initial supplies of the Council of Europe volumes are limited. To take advantage of this Charter Membership offer, fill out the membership coupon at the right. You may pay now and receive the special gift book or, if you wish, the Society will bill you.

**COLLECTOR'S BOOK SOCIETY**  
327 West 41st Street, New York 36, New York

YOU MAY ENROLL ME as a Charter Member of the Collector's Book Society; enter my one-year subscription to the Collector's Quarterly Report (Value \$6.00) beginning with the Winter 1962 issue; and send me the three volumes: *The Rococo Age*, *Romantic Art* and *Gateway to the Twentieth Century* (Value \$73.50)—all for \$24.95. In accepting the Charter Membership offer, I understand that I am under no obligation to purchase anything more from the Society during my membership. Purchases I do make will earn special bonus credit which can be applied to selected books, records, prints, etc. Each quarter, I will receive the Quarterly Choice for examination and approval unless I decline in advance by means of a convenient reply card. If I decide not to keep the Quarterly Choice I may return it within ten days with no obligation. If I am not satisfied with my first copy of the Collector's Quarterly Report or the three Council of Europe volumes, I may return them for a full refund and my membership will be cancelled automatically.

Note: Enclose Payment Now... and receive a copy of "Portrait + Atelier" (Value \$4.95) as a gift!

I enclose \$24.95 in payment.  Please bill me \$24.95 (We pay postage and handling.) plus postage and handling. (New York City residents please add 3% sales tax.)

Name \_\_\_\_\_  
Address \_\_\_\_\_  
City \_\_\_\_\_ Zone \_\_\_\_\_ State \_\_\_\_\_

You can subscribe to the COLLECTOR'S QUARTERLY REPORT at \$6.00 annually without reference to this special Charter Member offer. To enter your subscription, fill in name and address above, mark coupon "subscription only," and enclose check or money order for \$6.00.

# Da-Lite<sup>®</sup> ELECTROL<sup>®</sup>

The projection  
screens most  
often specified



for schools...

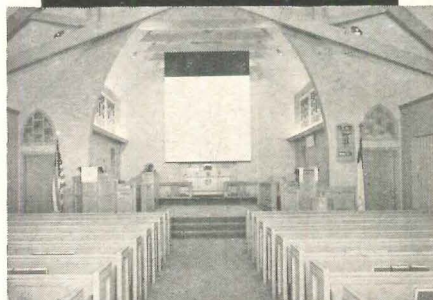

for churches...



for industry!

Da-Lite Electrols are the big, permanent, electrically operated screens most architects prefer and specify for auditoriums, meeting and conference rooms. Finest quality picture reproduction on Da-Lite's famous screen surfaces. Ruggedly constructed for trouble-free service. Remote control operation with automatic up-down stops. Sizes to 20'x20'. Send for new Electrol Data File.

The only projection screen listed by Underwriters' Laboratories, Inc., and Canadian Standards Association Testing Laboratories.



SINCE 1909  
**DA-LITE**  
DA-LITE Screen Co., Inc.  
WARSAW, INDIANA

For more data, circle 113 on Inquiry Card

## Office Notes

continued from page 198

ture and planning at 8426 Sunset Blvd., Los Angeles 69, Calif.

Eugene Schonwald has opened a new office for the practice of architecture and interior design at 78-27 37th Ave., Jackson Heights 72, N.Y.

Chancy Miles Lott, A.I.A., has announced the opening of new offices located at 7188 Sunset Blvd., Hollywood, Calif. The new firm offers architectural designing and planning and retains consultants in engineering, graphics and landscaping.

Smith, Hinchman & Grylls Associates of Detroit, have opened an office in Buenos Aires, Argentina, to provide professional services in the fields of architecture and engineering. The address is Maipu 631, 5° Piso. Active partners are: architects Federico A. Ugarte, Carlos L. Onetto, Horacio Ballvé Canás and Ricardo Garcia Uriburu; engineers Bernard L. Miller, Gerardo M. Lassalle, Ludovico Fusco and Emilio F. A. Contartesi.

### New Firms, Firm Changes —

John B. Ferguson and John Hutchison have formed a partnership under the name of Ferguson-Hutchison, A.I.A. and Associates. The address is 14606 Victory Blvd., Van Nuys, Calif. New offices for drafting facilities have been opened at 14640 Victory Blvd.

Clark & Enersen, a Lincoln, Neb. architectural firm, and Olsson & Burroughs, a Lincoln firm of consulting engineers, have merged to form the new firm of Clark & Enersen-Olsson, Burroughs & Thomsen.

Donald J. Lawrence has been appointed associate architect in the firm of Vincent R. Bonfanti, A.I.A., architects and engineers of Santa Fe Springs, Calif.

David C. Martin has been elected vice president of Hammel and Green, Inc., St. Paul, Minn., architectural and engineering firm.

Sasaki, Walker and Associates, Inc., Watertown, Mass., site planners and landscape architects, design and planning consultants, announced the appointment of Masao Kinoshita as an associate, and the following as senior staff: Katherine DeMay, James E. Robinson III, John Adelberg, Richard F. Galehouse and Richard H. Rogers.

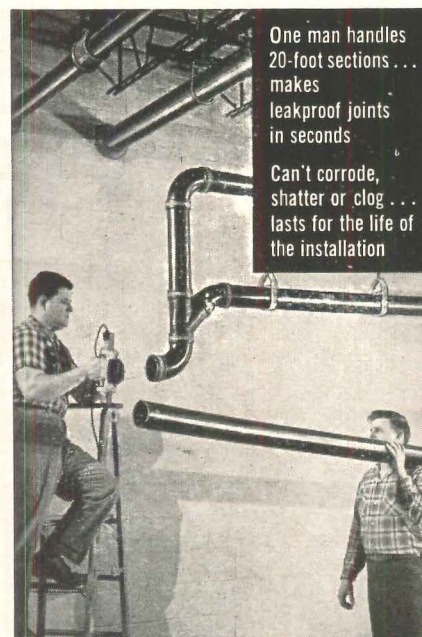

One man handles  
20-foot sections...  
makes  
leakproof joints  
in seconds

Can't corrode,  
shatter or clog...  
lasts for the life of  
the installation

## Vulcathene<sup>®</sup> ...the lowest-cost way to drain corrosive wastes

Users report Vulcathene costs up to 40% less to buy and install than any other acid-resistant drainline material. And that's just the beginning. You save maintenance costs, because Vulcathene is made of virgin polyethylene—acid-proof, alkali-proof, scale-proof, clog-proof, shatter-proof. You save replacement costs because Vulcathene is good for the life of the building, plus new additions are easily tied in. Ask for our complete new Vulcathene catalog of sinks, traps, fittings and pipe, in sizes from 1/2" to 6". Just write Dept. 3724.



DIVISION OF THE NALGE CO., INC.

### NALGENE PIPING SYSTEMS

P.O. BOX 387, ROCHESTER 2, NEW YORK  
formerly American Vulcathene

First with polyolefins for  
corrosion-resistant drainline systems.



For more data, circle 114 on Inquiry Card

TO SERVE YOU  
**BETTER**

OUR NEW  
PLANT IS IN

**FULL**

PRODUCTION

Moving and growing pains are finally behind us . . . "On-schedule" deliveries are once again standard procedure.

A **five-time increase** in production capacity has enabled us to keep up with the tremendous nation-wide demand for GLOBAL'S tested superior products.

**GLOBAL products are better** . . . the new plant embodies the latest advances in specially-designed equipment, plant-engineering and fabrication methods.

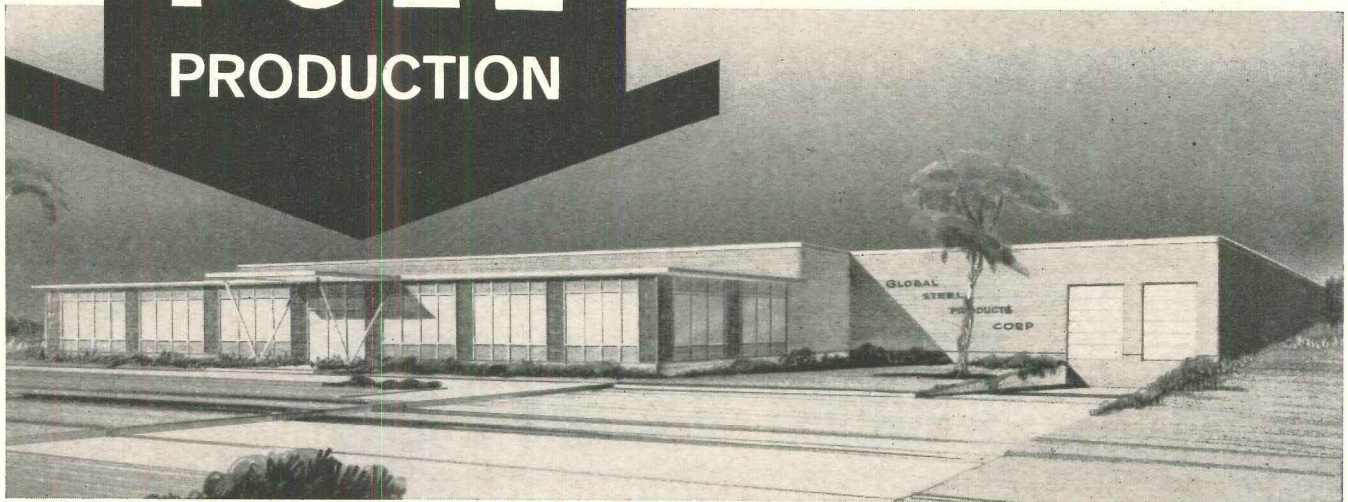

*When only THE FINEST is good enough*

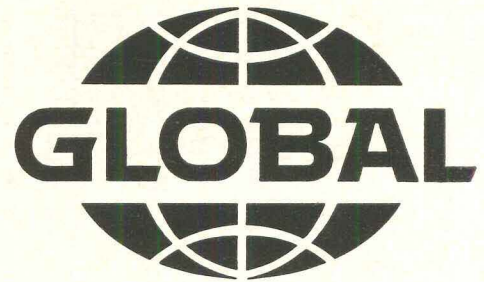

**TOILET COMPARTMENTS • SHOWER STALLS • DRESSING ENCLOSURES**

**Baked Enamel • Porcelain Enamel**

See SWEETS 22b/GL and send for large sized detail and specification sheets.

REPRESENTATIVES: Some choice territories still open. Representatives in most states of the Nation including Hawaii.

**GLOBAL STEEL PRODUCTS CORP.**

88 SMITH STREET  
FARMINGDALE, N. Y.

For more data, circle 115 on Inquiry Card

**BIG CAPACITY**  
 IN *Small* SPACE

**AEROFIN** *Smooth-Fin*  
 Heating and Cooling Coils

High ratio of surface area  
 to face area

High air velocities without excessive  
 friction or turbulence

Write for Bulletin S-55

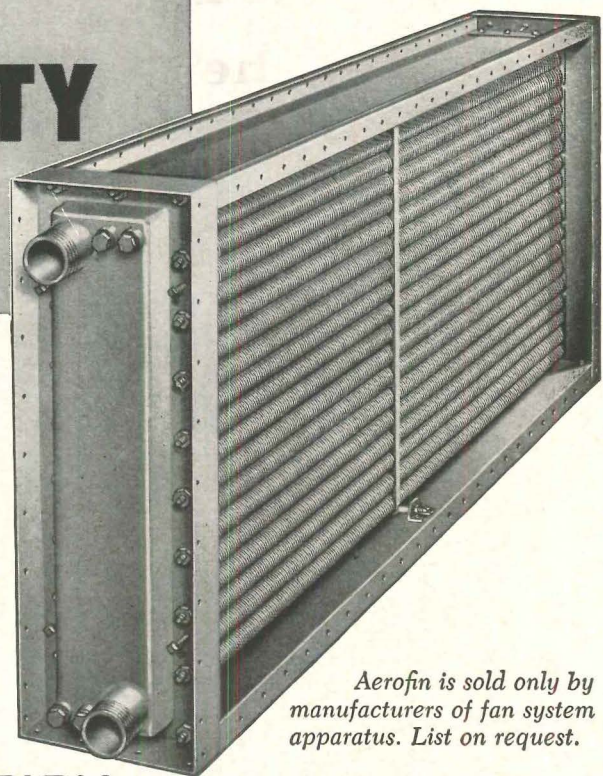

*Aerofin is sold only by  
 manufacturers of fan system  
 apparatus. List on request.*

**AEROFIN CORPORATION**

101 Greenway Ave., Syracuse 3, N. Y.

Engineering Offices in Principal Cities

For more data, circle 116 on Inquiry Card

**TRIM TROFFER**<sup>®</sup>

**REGRESSED EXTRUDED ALUMINUM**

SLIM TRIM OR ACCENT TRIM with FEATURE STRIP

7½"x48" — 1x4 — 2x2 — 2x4 — 3x3 — 4x4

naturally by **NEO-RAY**  
**PRODUCTS, INC.**

MANUFACTURERS OF LIGHTING PRODUCTS

315 EAST 22nd STREET • NEW YORK 10, N. Y.

WRITE FOR OUR NEW TRIM TROFFER CATALOG

For more data, circle 117 on Inquiry Card

# How the Dodge Reporter helped erect this unusual garden apartment

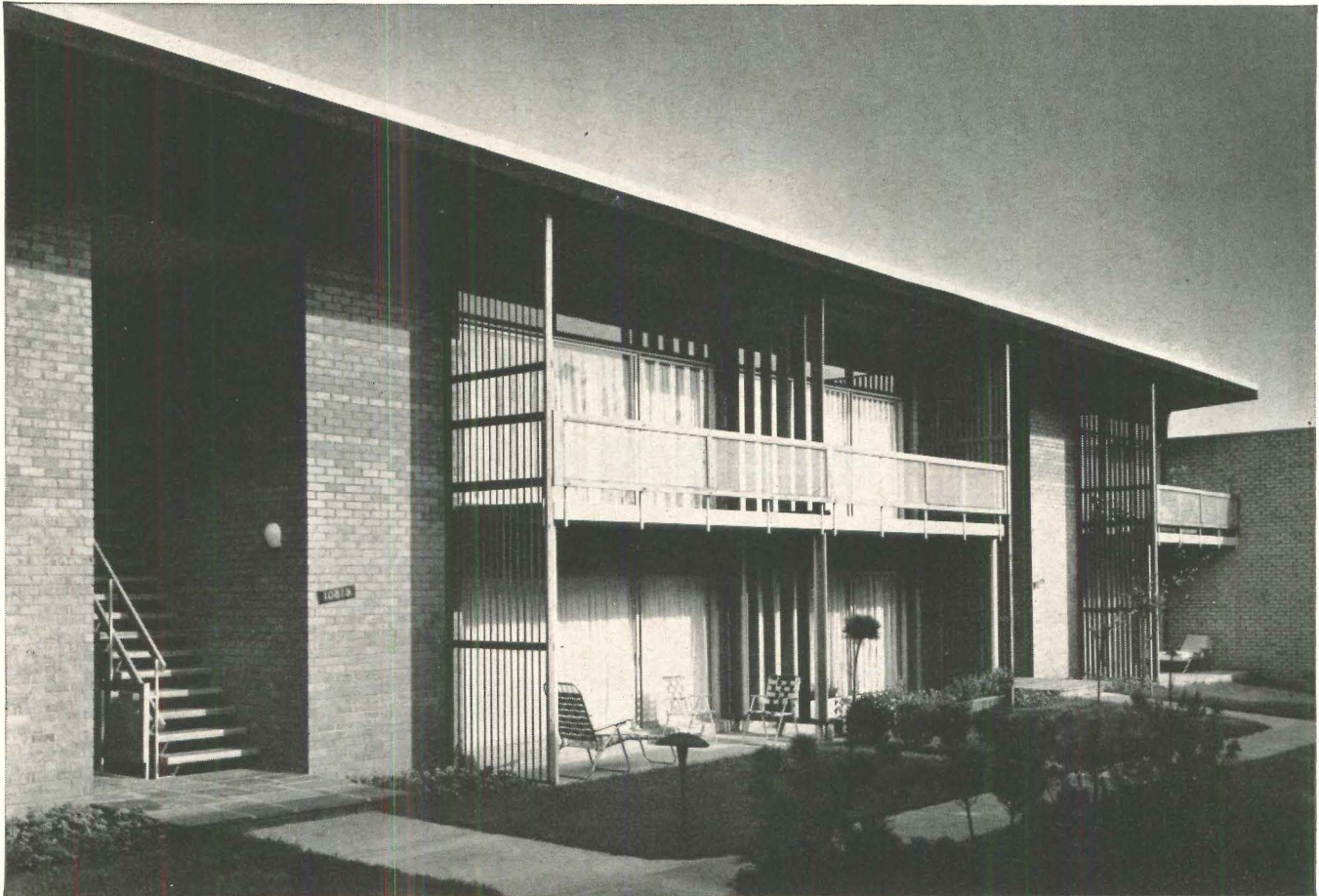

By staggering units around the periphery of a sloping site filled with locust trees, Architects Cohen, Haft and Associates were able to give these apartments in Wheaton, Maryland, a homey, residential character. They designed through-units instead of back-to-back types, which made it possible for all apartments to face onto the spacious inner court with windows and balconies, and also provided cross ventilation.

"The Dodge Reporter was extremely helpful in making contractors and suppliers aware of our needs," says Jack C. Cohen. "On one of his regular visits we informed him of the project, and during subsequent visits we filled him in on details. Then, when we filed our plans in the Dodge Plan Room in Washington, D. C., suppliers and trades who called on us were already educated to our requirements. They took less of our time, and bidding period traffic was smoothed.

"The Dodge Reporter helped us in other ways. For example, he helped us review the work loads of available contractors, so we were able to schedule bid dates to reduce conflicts. From a practical standpoint, it's always good business to keep the Dodge Reporter constantly informed, and make him welcome in our offices."

Wheaton House Apartments, Wheaton, Md.

Architects: Cohen, Haft & Associates

Contractor: Marcal Construction Co.

The architects for this ingenious plan avoided long, typical, space-wasting halls by arranging attractive open entries for each group of units, with flagstone stairs, brick walls, and stairs protected from the weather. All entrances are on the high side of the sloping site. Low side provides private views of wooded inner areas.



## DODGE REPORTS

CONSTRUCTION NEWS SERVICE

119 W. 40th St., New York 18, N. Y.

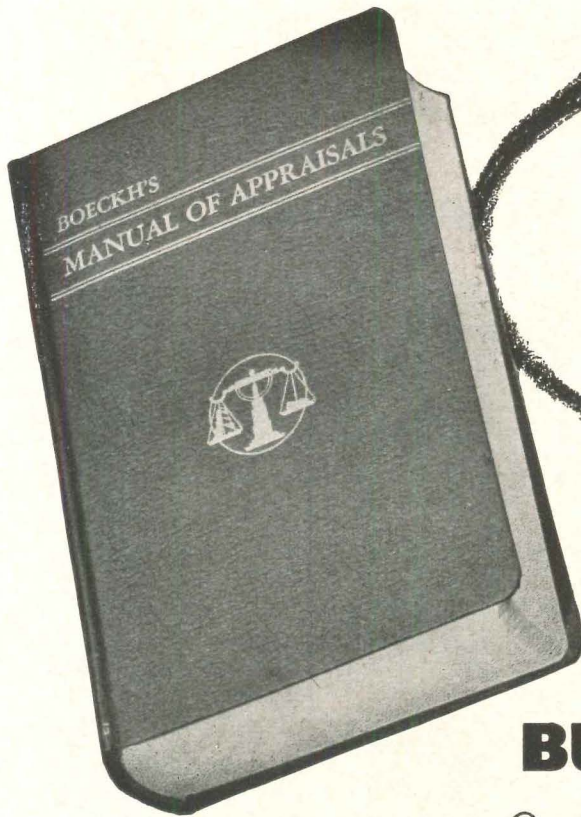

**FIFTH EDITION—Just Published**  
**BOECKH'S MANUAL OF APPRAISALS**

If advance cost planning is a part of your architectural problem, then this book and its supplement service "Building Costs" should be part of your "Kit of Tools." Here is a service program that has been helping architects and builders develop costs of proposed projects for more than a quarter of a century.

**YOU CAN FIGURE**  
**BUILDING COSTS**  
*Quickly and Accurately*

For laymen or experts, the most comprehensive and quick method yet published, over 100,000 individual unit costs, more than 300 buildings with hundreds of variations, all easily convertible to local conditions through "Building Costs!"

**BUILDING COSTS**

A comprehensive monthly supplementary service giving you up to the minute news and analysis of market conditions, plus the latest cost indexes for the major metropolitan areas of America and Canada to convert the estimating Manual to local cost conditions.

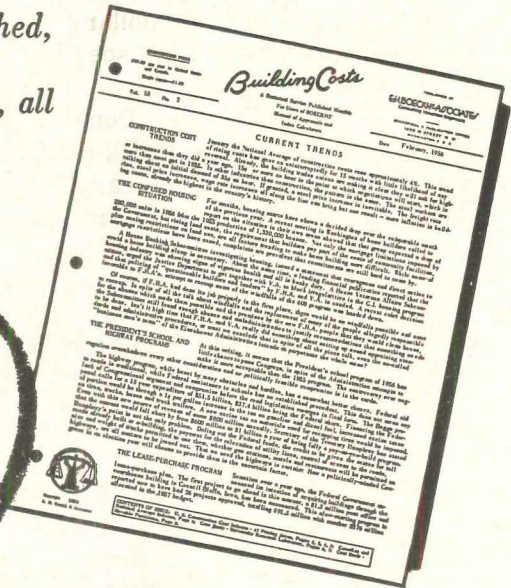

SEND TODAY FOR BROCHURE TO

**E. H. BOECKH & ASSOCIATES**  
 Consulting Valuation Engineers  
 1406 M Street, N. W.  
 Washington 5, D. C.

Please send me full descriptive literature on your estimating and cost planning services.

NAME \_\_\_\_\_  
 FIRM NAME \_\_\_\_\_  
 STREET \_\_\_\_\_  
 CITY \_\_\_\_\_ ZONE \_\_\_\_\_ STATE \_\_\_\_\_

You do a world of good when you  
send \$1 Food Crusade packages  
please care — *hunger hurts!*

**how** do you answer the hunger in a child's eyes, if he lives thousands of miles away? By joining CARE's Food Crusade, you span the world to help feed hungry school children, orphans, refugees, disaster victims, the aged and sick, poor families.

**what** you do is share our farm abundance—staples donated by the U. S. Food for Peace program. CARE adds other foods, packs various units to match country needs. Every \$1 you give sends one package—delivered with your name and address, to bring a personal message of friendship from the American people.

**where** need is urgent, CARE delivers your gifts. Multiply the dollars to your heart's content. You cannot specify persons, but you may choose any of these places: Colombia, Cyprus, Dominican Republic, Ecuador, Greece, Haiti, Hong Kong, Iran, Israel, Jordan, Korea, Macau, Mexico, Pakistan, Poland, Sierra Leone, Turkey, West Berlin, Vietnam, Yugoslavia.

EVERY \$1 SENDS A FOOD PACKAGE  
IN YOUR NAME — A PERSONAL GIFT

**CARE** New York 16, New York  
or your nearest CARE office

Here is \$..... for the Food Crusade.  
(Make checks payable to CARE, Inc.)

.....  
(Your name)

.....  
(Address)

- CARE to choose country; or  
 I prefer .....

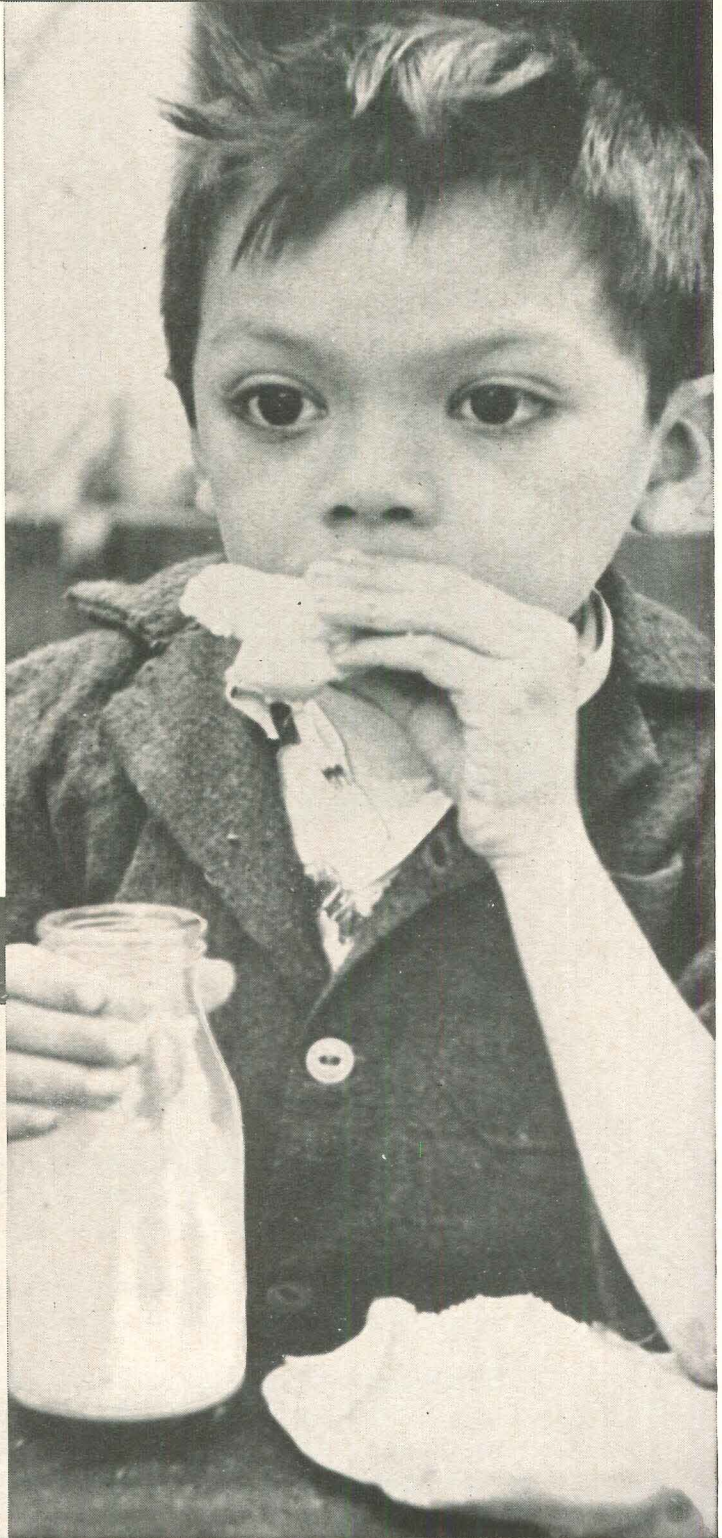

*Space contributed by this publication as a public service*

# BEST WAY TO MAKE A MAGAZINE IS TO MAKE IT WORTH



**M**ore architects—and more engineers—pay to read *Architectural Record* than any other architectural magazine.\*

**More Record subscribers renew their subscriptions.**

**More architects and engineers prefer *Architectural Record***—a preference steadily recorded in 167 out of 184 studies sponsored by building product manufacturers and their advertising agencies.

Leadership in paid architect and engineer circulation, highest renewal rate, strong reader preference—all reflect the great worth of the Record to its readers.

**Small wonder more advertisers value the Record most.**—For fifteen consecutive years they have placed more pages of advertising in *Architectural Record* than in any other magazine in the field. They're doing it again in 1962 by a margin of better than 50 per cent over the second place magazine.

\*The Record has the right ones, too, the **active** ones — responsible for over 88% of all architect-planned building—a fact documented by **Dodge Reports!**



# WORTH ITS ADVERTISING RATE ITS SUBSCRIPTION PRICE

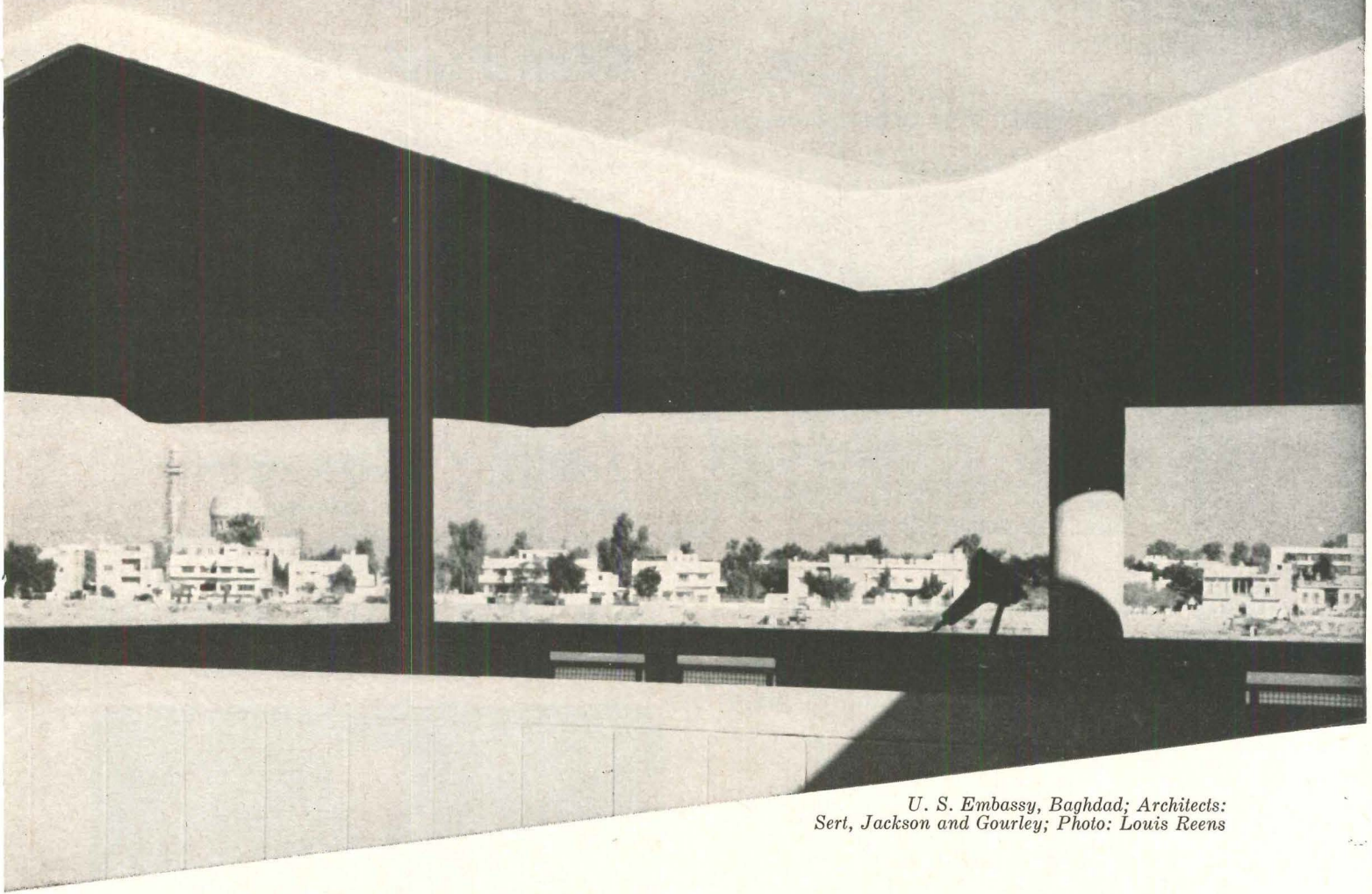

*U. S. Embassy, Baghdad; Architects: Sert, Jackson and Gourley; Photo: Louis Reens*

## Here's Why Architects and Engineers Value Architectural Record Most . . .

- It's the one magazine edited specifically for—and sold to—architects and engineers.
- Its 15 full-time editors and ten editorial consultants are impressively qualified in the fields of architecture, engineering, education and journalism.
- Its editors are attuned to the interests of architects and engineers by (a) the most intensive editorial research in the field, including Eastman Readership Research, and (b) the unique building industry informational facilities and services of F. W. Dodge Corporation, including *Dodge Reports* and *Dodge Construction Statistics*.
- Its unequalled number of editorial pages cover the full range of architect and engineer practice both nonresidential and residential, large and small—thoroughly serving today's needs—and tomorrow's.
- Finally, Architectural Record's advertising pages constitute the most comprehensive monthly report to architects and engineers on building product features, applications and developments.

**Architectural Record**

F. W. DODGE CORPORATION  
A McGraw-Hill Company

119 West 40th St.  
New York 18, N. Y.

ABC  
AIA

"stimulus to creative architectural and engineering design"

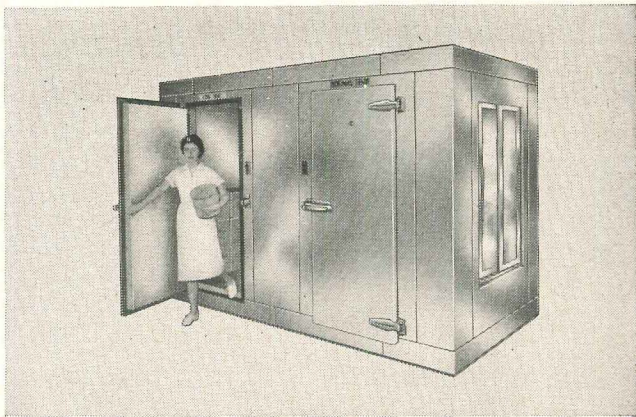

This was the world's most advanced design.

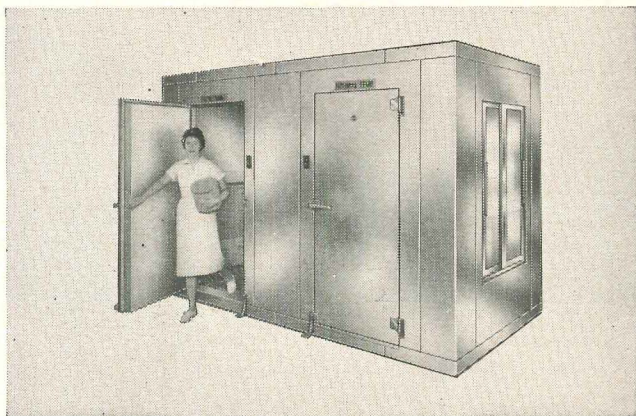

Until we made this one.

## Bally Walk-In Coolers and Freezers are now made with science's wonder insulation... Urethane "foamed-in-place"

The advantages of this new insulation represent a major design achievement that obsoletes all conventional insulated Walk-Ins ♦ With 97% closed cells it cannot absorb moisture . . . maintains peak efficiency, indoors or outdoors ♦ Insulating value is double . . . Bally 4" urethane equals 8½" of conventional insulation. Standard models ideal for use as minus 30° freezers ♦ Urethane, poured as a liquid, foams in place and binds tenaciously to the metal for great strength. Eliminates need for structural members. Replaces that space with insulation ♦ Lightweight urethane reduces weight to one-third for big freight savings . . . makes erection fast and easy ♦ Foamed door is extremely light in weight to open and close with little effort. Magnetic gasket provides positive seal ♦ Thinner walls increase usable space.

Your choice of Aluminum or Galvanized as standard finishes. Sections have Bally's Speed-Lok for quick and accurate assembly. Easy to add sections to increase size . . . easy to disassemble for relocation. Hermetically sealed refrigeration systems eliminate installation problems . . . reduce service costs.

Write for free Architect's Fact File, complete with new Specification Guide, descriptive literature and technical booklet. Also see Sweet's Architect File 25a/Ba.

**Bally**

Bally Case and Cooler, Inc.  
Bally, Pennsylvania  
Write Department A.R.

For more data, circle 120 on Inquiry Card

For "Start-to-Finish" responsibility, specify

# AUTOMATIC TUBE SYSTEMS

BY

## Standard Conveyor

Standard Conveyor takes full responsibility for your automatic tube system from start to finish. Standard Conveyor has over 40 years of experience in the pneumatic tube business.

Call your local Standard Conveyor representative . . . he's listed in the Yellow Pages of major cities under PNEUMATIC TUBES. Or, call our main office listed below for information.

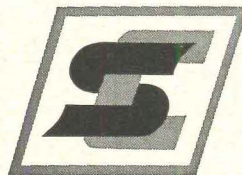

**Standard  
Conveyor  
COMPANY**

312-M Second St., North St. Paul 9, Minn., Telephone: SPring 7-1355

For more data, circle 119 on Inquiry Card

## WATER SCULPTURE FOUNTAIN SYSTEMS



Units in architecturally styled bowls of all sizes or custom units designed and built to specification. For more information write to:

**ROMAN FOUNTAINS — JABON STUDIOS**  
14847 Bessemer Street Van Nuys, California

For more data, circle 57 on Inquiry Card

# ARCHITECTURAL RECORD

Published by F.W. Dodge Corporation. 119 West 40th Street, New York 18. ©1962. All rights reserved.

## SEMI-ANNUAL INDEX VOLUME 132 JULY-DEC. 1962

ABBREVIATIONS: BTS—Building Types Study; AE—Architectural Engineering; TSS—Time-Saver Standards; BC—Building Components

### A

- Abramovitz, Max, archt.; Philharmonic Hall, Lincoln Center, N.Y.—Sept. 1962, pp. 133-139
- Acoustics. "Acoustics of Philharmonic Hall," by Leo L. Beranek—Sept. 1962, AE, pp. 196-204. See also Schools.
- Aging, Buildings for the. Building Types Study 314—Dec. 1962, pp. 109-124. Bayview Manor, Seattle, Wash.; John Graham and Co., archts.—Dec. 1962, BTS, p. 115. Castle Hill Houses, Bronx, N.Y.; Katz Waisman Blumenkranz Stein Weber Architects Assoc., archts.—Dec. 1962, BTS, pp. 120-121. The Friedman Bldg., The Home for Aged and Infirm Hebrews of New York, N.Y.; Joseph Douglas Weiss, archt.—Dec. 1962, BTS, pp. 123-124. Mount San Antonio Gardens, Pomona, Calif.; Kenneth Lind Assoc., archts.—Dec. 1962, BTS, p. 117. Needham Houses, Needham, Mass.; William Hoskins Brown Assoc., Inc., archts.—Dec. 1962, BTS, p. 111. Peninsula Volunteers' Retirement Apartments, Menlo Park, Calif.; Skidmore, Owings & Merrill, archts.—Dec. 1962, BTS, pp. 118-119. Senior Citizens Bldg., Sacramento, Calif.; Herbert E. Goodpastor, archt.—Dec. 1962, BTS, p. 122. Springvale-on-the-Hudson, Cortlandt, N.Y.; J. Edward Luders & Assoc., archts.—Dec. 1962, BTS, p. 113. "Trends in Housing for Older People," by Geneva Mathiasen—Dec. 1962, BTS, pp. 110-116.
- Air Conditioning. "Air Conditioning Hotels and Motels," by Alfred Greenberg—Aug. 1962, AE, pp. 152-155. "Air Conditioning Responds to Flexible Plan"; Council Rock Intermediate High School, Richboro, Pa.; Haag and d'Entremont, archts.—Dec. 1962, AE, pp. 126-128. "Hospital Air Conditioning," by Alfred Greenberg—Sept. 1962, AE, pp. 205-210
- Air Force Academy Chapel, Colorado Springs, Colo.; Skidmore, Owings & Merrill, archts.—Dec. 1962, pp. 85-92
- Airports. See Transportation Buildings.
- All Souls Unitarian Church, Schenectady, N.Y.; Edward Durell Stone, archt.—Oct. 1962, pp. 142-144
- Aluminum. "Hard Coatings for Exterior Aluminum," by Robert W. Baker—Dec. 1962, BC, pp. 137-138
- American Baptist Churches, National Offices, Valley Forge, Pa.; Vincent G. Kling, archt.—July 1962, pp. 139-146
- American Center: (American National Bank, Parking Bldg. and Petroleum Bldg.), Beaumont, Tex.; Harrell & Hamilton, archts.; Wallace B. & Tom B. Livesay, assoc. archts.—Aug. 1962, pp. 115-118
- Andrews High School, Andrews, Tex.; "The Acoustics of the Andrews High School," by John Lyon Reid—July 1962, BTS, pp. 152-153
- Apartments. Jackson Lake Apartments, Oakland, Calif.; Wurster, Bernardi and Emmons, archts.—Sept. 1962, pp. 155-157. Park Westwood Tower, Los Angeles, Calif.; Victor Gruen Assoc., archts.—Sept. 1962, pp. 160-162. Wheaton House Apartments, Wheaton, Md.; Cohen, Haft & Assoc., archts.—Sept. 1962, pp. 158-159. See also Aging, Buildings for the.
- Architect in Practice, The. "Working with Commercial Developers," 50 Pearl Office Bldg., Boston; Pearl Street Assoc. (F.A. Stahl & Assoc., Inc.; Hugh Stubbins & Assoc., Inc.; Wm. J. LeMessurier & Assoc., Inc.), archts.—Oct. 1962, pp. 157-164
- "Architects Abroad." Editorial by Emerson Goble—Dec. 1962, p. 9
- Architects Collaborative, The, archts.; Hillside Elementary School, Needham, Mass.—July 1962, BTS, pp. 156-157
- Architects' Offices, 777 Summer Street Bldg., Stamford, Conn.; Sherwood, Mills and Smith, archts.—Aug. 1962, pp. 119-122
- Architectural Engineering. "Acoustics of Philharmonic Hall," by Leo L. Beranek—Sept. 1962, pp. 196-204. "Air Conditioning Hotels and Motels," by Alfred Greenberg—Aug. 1962, pp. 152-155. "Air Conditioning Responds to Flexible Plan"; Council Rock Intermediate High School, Richboro, Pa.; Haag and d'Entremont, archts.—Dec. 1962, pp. 126-128. "Composite Construction in a New Light," by Robert E. Rapp—Nov. 1962, pp. 187-190. "Dual-Purpose Glazing Roofs Conservatory"; Mitchell Park Horticultural Conservatory, Milwaukee, Wis.; Donald L. Grieb, archt.—Nov. 1962, pp. 191-192. "Electrical Loads in Large Buildings," by Louis A. Bello—July 1962, pp. 172-174. "Hospital Air Conditioning," by Alfred Greenberg—Sept. 1962, 205-210. "Precast Joinery: Many Lessons to Learn," by Laurence Cazaly; Grosvenor House, Winnipeg, Manitoba, Canada; Libling, Michener and Assoc., archts.—Oct. 1962, pp. 186-189. "Research Looks Into Roofing Failures," by Foster C. Wilson and Miles E. Jacoby—Oct. 1962, pp. 190-192. "The Return of the Bearing Wall," by Wm. J. LeMessurier—July 1962, pp. 168-171. "Steel Plate Exterior Serves as Cover for Fireproofing"; Continental Center, Chicago; Naess & Murphy, archts.—Aug. 1962, p. 156. "The Steel Will Weather Naturally," by John Dinkeloo; John Deere Administration Center, Moline, Ill.; Eero Saarinen and Assoc., archts.—Aug. 1962, pp. 148-150. "Structure Can Move if Soil Swells"; Warehouse, Sasolburg, Orange Free State, South Africa—Nov. 1962, pp. 184-186. "Wire Fabric Reinforces Jail Walls"; Isabella County Jail, Mt. Pleasant, Mich.; Cuthbert and Cuthbert, archts.—Aug. 1962, p. 151
- Athens Airport. Terminal Building, Athens, Greece; Eero Saarinen & Assoc., archts.—Aug. 1962, pp. 111-114
- Auditoriums. See Recreational Structures Awards. "American Institute of Steel Construction Awards Cite 14 Buildings"—July 1962, News, pp. 16-17. "Eight Churches Cited in Awards"—Sept. 1962, News, pp. 14-15. "Office of the Year Awards Given to Six Buildings"—Dec. 1962, News, pp. 70, 78. "Three Entries Share Top Prize in This Year's Ruberoid Awards"—Sept. 1962, News, pp. 12-13. "Three Columbia Faculty Members Win Boston City Hall Competition"—July 1962, News, pp. 14-15
- ### B
- Baker, Joseph, and Assoc., archts.; Brookfield Senior High School, Brookfield, Ohio—July 1962, BTS, pp. 162-163
- Banks. The American Center, Beaumont, Tex.; Harrell & Hamilton, archts.; Wallace B. and Tom B. Livesay, assoc. archts.—Aug. 1962, pp. 115-118
- Barancik, Conte and Assoc., archts.; Lodge Bldg., Illinois Beach State Park, Zion, Ill.—Aug. 1962, BTS, pp. 134-135
- Bayview Manor, Seattle, Wash.; John Graham and Co., archts.—Dec. 1962, BTS, p. 115
- Bearing Walls. "The Return of the Bearing Wall," by Wm. J. LeMessurier—July 1962, AE, pp. 168-171
- Beaumont, Vivian, Repertory Theater, Lincoln Center, N.Y.; Eero Saarinen & Assoc., archts.—Sept. 1962, pp. 134-135, 142-145
- Becket, Welton, and Assoc., archts.; Veterans Administration Hospital, Palo Alto, Calif.—Sept. 1962, BTS, pp. 191-194
- Bell Telephone Laboratories, Holmdel, N.J.; Eero Saarinen and Assoc., archts.—Oct. 1962, pp. 145-152
- Belluschi, Pietro, archt.; Juilliard School of Music, Lincoln Center, N.Y.; Catalano and Westernman, assoc. archts.—Sept. 1962, pp. 134-135, 148
- Beranek, Leo L., "Acoustics of Philharmonic Hall"—Sept. 1962, AE, pp. 196-204
- "Better Federal Architecture?," Editorial by Emerson Goble—Aug. 1962, p. 9
- Boissonas House, Cap Benat, France; Philip Johnson Assoc., archts.—July 1962, p. 128
- Boulder City High School, Boulder City, Nev.; Zick and Sharp, archts.—July 1962, BTS, pp. 150-151
- Brookfield Senior High School, Brookfield, Ohio; Joseph Baker and Assoc., archts.—July 1962, BTS, pp. 162-163
- Brown University, Computing Laboratory, Providence, R. I.; Philip Johnson Assoc., archts.—July 1962, pp. 124-125
- Brown, William Hoskins, Assoc., Inc., archts.; Needham Houses, Needham, Mass.—Dec. 1962, BTS, p. 111
- Building Components. "Characteristics of Aluminized Steel," by W. H. Withey and H. H. Lawson—Nov. 1962, pp. 197-198, 208. "Finishes for Cabinet Work," Part 1—Aug. 1962, pp. 161-162; Part 2—Sept. 1962, pp. 215-216. "A Guide to Glass for Architecture," Part 2, by Richard W. Rigg—July 1962, pp. 181-182. "Hard Coatings for Exterior Aluminum," by Robert W. Baker—Dec. 1962, pp. 137-138. "Standard for Wood Laboratory Equipment," by L. N. Nelson—Oct. 1962, pp. 197-198
- ### C
- Cabinet Work. "Finishes for Cabinet Work," Part 1—Aug. 1962, BC, pp. 161-162; Part 2—Sept. 1962, BC, pp. 215-216
- California Institute of Technology, Beckman Auditorium, Pasadena, Calif.; Edward Durell Stone, archt.—Oct. 1962, pp. 132-135
- "Can He Write?," Editorial by Emerson Goble—July 1962, p. 9
- Carlton Beach Hotel, Southampton, Bermuda; William B. Tabler, archt.—Aug. 1962, BTS, pp. 132-133
- Castle Hill Houses, Bronx, N.Y.; Katz Waisman Blumenkranz Stein Weber Architects Associated, archts.—Dec. 1962, BTS, pp. 120-121
- Catalano & Westernman, assoc. archts.; Pietro Belluschi, archt.; Juilliard School of Music, Lincoln Center, N.Y.—Sept. 1962, pp. 134-135, 148.
- Charlotte Memorial Hospital, Charlotte, N.C.; A. G. Odell Jr. & Assoc., archts.—Sept. 1962, BTS, pp. 182-190
- Churches. See Religious Buildings.
- City and Regional Planning. "The Future of the City," by Lewis Mumford; Part 1: The Disappearing City—Oct. 1962, pp. 121-128; Part 2: Yesterday's City of To-

morrow—Nov. 1962, pp. 139-144; Part 3: Megalopolis as Anti-City—Dec. 1962, pp. 101-108. Lincoln Center, N.Y.—Sept. 1962, pp. 133-148

"Claustrophobia for the Aged," Editorial by Emerson Goble—Nov. 1962, p. 9

Cohen, Haft and Assoc., archts.; Wheaton House Apartments, Wheaton, Md.—Sept. 1962, pp. 158-159

College Bldgs. Air Force Academy Chapel, Colorado Springs, Colo.; Skidmore, Owings & Merrill, archts.—Dec. 1962, pp. 85-92. Computing Laboratory, Brown University, Providence, R.I.; Philip Johnson Assoc., archts.—July 1962, pp. 124-125; Beckman Auditorium, California Institute of Technology, Pasadena, Calif.; Edward Durell Stone, archt.—Oct. 1962, pp. 132-135. Juilliard School of Music, Lincoln Center, N.Y.; Pietro Belluschi, archt.; Catalano & Westerman, assoc. archts.—Sept. 1962, pp. 134-135, 148. Sheldon Art Gallery, University of Nebraska, Lincoln, Neb.; Philip Johnson Assoc., archts.—July 1962, pp. 122-123. Dormitories, Sarah Lawrence College, Bronxville, N.Y.; Philip Johnson Assoc., archts.—July 1962, pp. 118-119. Johnson Hall, Temple University, Philadelphia, Pa.; Nolen and Swinburne and Assoc., archts.—Nov. 1962, pp. 145-150. Kline Science Center, Yale University, New Haven, Conn.; Philip Johnson Assoc., archts.—July 1962, pp. 113-115. Samuel F. B. Morse and Ezra Stiles Colleges, New Haven, Conn.; Eero Saarinen and Assoc., archts.—Dec. 1962, pp. 93-100

Composite Construction. "Composite Construction in a New Light," by Robert E. Rapp—Nov. 1962, AE, pp. 187-190

Concrete, Precast. "Precast Joinery: Many Lessons to Learn," by Laurence Cazaly; Grosvenor House, Winnipeg, Manitoba; Libling, Michener and Assoc., archts.—Oct. 1962, AE, pp. 186-189

Concrete, Reinforced. "Wire Fabric Reinforces Jail Walls"; Isabella County Jail, Mt. Pleasant, Mich.; Cuthbert and Cuthbert, archts.—Aug. 1962, AE, p. 151

Continental Center, Chicago; Naess & Murphy, archts.—Aug. 1962, AE, p. 156

Council Rock Intermediate School, Richboro, Pa.; Haag and d'Entremont, archts.—Dec. 1962, AE, pp. 126-128

Coventry Cathedral. Cathedral Church of St. Michael, Coventry, England; Sir Basil Spence, archt.—Aug. 1962, pp. 101-110

Cuthbert & Cuthbert, archts.; Isabella County Jail, Mt. Pleasant, Mich.—Aug. 1962, AE, p. 151

## D

Daisley, R. H., House, Inlet Cay, Fla.; Paul Rudolph, archt.; Richard T. Hanna, supervising archt.—Nov. 1962, pp. 129-131

Deere, John, Administration Center, Moline, Ill.; Eero Saarinen and Assoc., archts.—Aug. 1962, AE, pp. 148-150

"Design-Oriented Education," Editorial by Emerson Goble—Sept. 1962, p. 9

Dinkeloo, John, "The Steel Will Weather Naturally"; John Deere Administration Center, Moline, Ill.; Eero Saarinen and Assoc., archts.—Aug. 1962, AE, pp. 148-150

Domes. "Dual-Purpose Glazing Roofs Conservatory"; Mitchell Park Horticultural Conservatory, Milwaukee, Wis.; Donald L. Grieb, archt.—Nov. 1962, AE, pp. 191-192

Dorman, Richard, & Assoc., archts. Office Bldg., Beverly Hills, Calif.—Sept. 1962, pp. 163-166

Dumbarton Oaks Museum. Addition, Washington, D.C.; Philip Johnson Assoc., archts.—July 1962, pp. 120-121

Dundee Elementary School, Greenwich, Conn.; Perkins and Will, archts.—July 1962, BTS, pp. 158-159

## E

East Junior High School, Walpole, Mass.; Shepley, Bulfinch, Richardson and Abbott, archts.—Oct. 1962, BTS, pp. 182-184

Eggers & Higgins, archts.; Guggenheim Bandshell & Damrosch Park, Lincoln Center, N.Y. Sept. 1962, pp. 134-135, 148

Electrical Systems. "Electrical Capacities of Building Equipment," Parts 1, 2, by

Louis A. Bello—July 1962, TSS, pp. 175-176. "Electrical Loads in Large Buildings," by Louis A. Bello—July 1962, AE, pp. 172-174

## F

50 Pearl Office Bldg., Boston; Pearl Street Assoc. (F. A. Stahl & Assoc., Inc.; Hugh Stubbins & Assoc., Inc., Wm. J. LeMessurier & Assoc., Inc.), archts.—Oct. 1962, pp. 157-164

Finishes. "Finishes for Cabinet Work," Part 1—Aug. 1962, BC, pp. 161-162; Part 2—Sept. 1962, BC, pp. 215-216. "Hard Coatings for Exterior Aluminum," by Robert W. Baker—Dec. 1962, BC, pp. 137-138

Fire Protection. "Steel Plate Exterior Serves as Cover for Fireproofing"; Continental Center, Chicago; Naess & Murphy, archts.—Aug. 1962, p. 156

"Future of the City, The," by Lewis Mumford; Part 1: The Disappearing City—Oct. 1962, pp. 121-128; Part 2: Yesterday's City of Tomorrow—Nov. 1962, pp. 139-144; Part 3: Megalopolis as Anti-City—Dec. 1962, pp. 101-108

## G

Garages. See Parking Garages.

General Electric Valley Forge Space Technology Center, King of Prussia, Pa.; Vincent G. Kling, archt.—Nov. 1962, BTS, pp. 171-175

Glass. "A Guide to Glass for Architecture," Part 2, by Richard W. Rigg—July 1962, BC, pp. 181-182

Glazing. "Dual-purpose Glazing Roofs Conservatory"; Mitchell Park Horticultural Conservatory, Milwaukee, Wis.; Donald L. Grieb, archt.—Nov. 1962, AE, pp. 191-192

Goble, Emerson. "Architects Abroad," Editorial—Dec. 1962, p. 9; Better Federal Architecture?, Editorial—Aug. 1962, p. 9; "Can He Write?," Editorial—July 1962, p. 9; "Claustrophobia for the Aged," Editorial—Nov. 1962, p. 9; "Design-Oriented Education," Editorial—Sept. 1962, p. 9; "Mediocrity by Fiat," Editorial—Oct. 1962, p. 9

Goodpastor, Herbert E., archt.; Senior Citizens Bldg.; Sacramento, Calif.—Dec. 1962, BTS, p. 122

Graham, John, and Co., archts.; Bayview Manor, Seattle, Wash.—Dec. 1962, BTS, p. 115

Green, Alan C., "The Auditorium as Instructional Space"—Oct. 1962, BTS, pp. 169-171

Grieb, Donald L., archt.; Mitchell Park Horticultural Conservatory, Milwaukee, Wis.—Nov. 1962, AE, pp. 191-192

Grosvenor House, Winnipeg, Manitoba, Canada; Libling, Michener and Assoc., archts.—Oct. 1962, AE, pp. 186-189

Gruen, Victor, Assoc., archts.; Park Westwood Apartment Bldg., Los Angeles, Calif.—Sept. 1962, pp. 160-162. White Winrock Hotel, Winrock Center, Albuquerque, N.M.—Aug. 1962, BTS, pp. 142-143

Guggenheim Bandshell & Damrosch Park, Lincoln Center, N.Y.; Eggers & Higgins, archts.—Sept. 1962, pp. 134-135, 148

Gunma Music Center, Takasaki, Japan; Antonin Raymond and L. L. Rado, archts.—Nov. 1962, pp. 157-162

## H

Haag and d'Entremont, archts.; Council Rock Intermediate School, Richboro, Pa.—Dec. 1962, AE, pp. 126-128

Handicapped, Facilities for the. "Building and Facility Standards for Physically Handicapped," Parts 1, 2, 3, 4, by Howard Vermilya—Dec. 1962, TSS, pp. 129-132

Harborfields Central High School, Greenlawn, L.I., N.Y.; Ketchum and Sharp, archts.—Oct. 1962, BTS, pp. 178-179

Harrell & Hamilton, archts.; Wallace B. & Tom B. Livesay, assoc. archts.; The American Center (American National Bank, Parking Bldg. and Petroleum Bldg.) Beaumont, Tex.—Aug. 1962, pp. 115-118

Harrison and Abramovitz, archts.; Robert

E. Rasche, assoc. archt.; Marine Plaza, Milwaukee, Wis.—Oct. 1962, pp. 153-156. Underground Garage and Plazas, Lincoln Center, N.Y.—Sept. 1962, pp. 134-135, 148

Harrison, Wallace K., archt.; Metropolitan Opera House, Lincoln Center, N.Y.—Sept. 1962, pp. 134-135, 140-141

Hausner and Macsai, archts.; Water Tower Inn, Chicago—Aug. 1962, BTS, pp. 144-146

Hester, Henry H., archt.; House, La Jolla, Calif.—Aug. 1962, pp. 123-126

Hillside Elementary School, Needham, Mass.; The Architects Collaborative, archts.—July 1962, BTS, pp. 156-157

Hilton Inn, Seattle-Tacoma Airport, Wash.; Skidmore, Owings & Merrill, archts.—Aug. 1962, BTS, pp. 138-141

Hoffman Science Center, Santa Barbara, Calif.; William L. Pereira & Assoc., archts.—Nov. 1962, BTS, pp. 180-182

Home for Aged and Infirm Hebrews of New York, The, Friedman Bldg., N.Y.; Joseph Douglas Weiss, archt.—Dec. 1962, BTS, pp. 123-124

Homsey, Victorine & Samuel, archts.; Beekley Bldg., The Tatnall School Inc., Wilmington, Del.—Oct. 1962, BTS, pp. 176-177

Hospitals. Building Types Study 311—Sept. 1962, pp. 171-194. Charlotte Memorial Hospital, Charlotte, N.C.; A. G. Odell Jr. & Assoc., archts.—Sept. 1962, BTS, pp. 182-190. Veterans Administration Hospital, Palo Alto, Calif.; Welton Becket and Assoc., archts.—Sept. 1962, BTS, pp. 191-194. "Hospital Air Conditioning," by Alfred Greenberg—Sept. 1962, AE, pp. 205-210. "Planning the Patient Care Unit in the General Hospital," by the U.S. Public Health Service—Sept. 1962, BTS, pp. 172-181

Hotel America, Prudential Center, Boston; Charles Luckman Assoc., archts.—Aug. 1962, BTS, p. 129

Hotels. Building Types Study 310: Hotels-Motels—Aug. 1962, pp. 127-146. Hotel America, Prudential Center, Boston; Charles Luckman Assoc., archts.—Aug. 1962, BTS, p. 129. Carlton Beach Hotel, Southampton, Bermuda; William B. Tabler, archt.—Aug. 1962, BTS, pp. 132-133. Lodge Bldg., Illinois Beach State Park, Zion, Ill.; Barancik, Conte and Assoc., archts.—Aug. 1962, BTS, pp. 134-135. Water Tower Inn, Chicago; Hausner and Macsai, archts.—Aug. 1962, BTS, pp. 144-146. "Air Conditioning Hotels and Motels," by Alfred Greenberg—Aug. 1962, AE, pp. 152-155. "Hotel Architecture: A Management View," by Roger P. Sonnabend—Aug. 1962, BTS, pp. 127-128. "A Punch List for Good Hotel Planning," by Walter Rooney—Aug. 1962, BTS, pp. 130-131. See also Motels.

Houses. Boissonas House, Cap Benat, France; Philip Johnson Assoc., archts.—July 1962, p. 128. R. H. Daisley House, Inlet Cay, Fla.; Paul Rudolph, archt.; Richard T. Hanna, supervising archt.—Nov. 1962, pp. 129-131. Architect's House, La Jolla, Calif.; Henry H. Hester, archt.—Aug. 1962, pp. 123-126. Arthur W. Milam House, St. John's County, Fla.; Paul Rudolph, archt.; Robert Ernest, supervising archt.—Nov. 1962, pp. 126-128. Carlo Paterno House, North Salem, N.Y.; Edward Durell Stone, archt.—Oct. 1962, pp. 138-141. Residence, Palm Beach, Fla.; Paul Rudolph, archt.—Nov. 1962, pp. 123-125. Marshall Safir House, Kings Point, L.I., N.Y.; George Nemeny, archt.—Sept. 1962, pp. 167-170. Architect's House, Siesta Key, Sarasota, Fla.; Edward J. Seibert, archt.—July 1962, pp. 135-138. N. Leslie Silvas House, Greenwich, Conn.; Paul Rudolph, archt.—Nov. 1962, pp. 134-135. John Wallace House, Athens, Ala.; Paul Rudolph, archt.—Nov. 1962, pp. 132-133. Barnet Yanofsky House, Newton, Mass.; Paul Rudolph, archt.—Nov. 1962, pp. 136-138

## I

I.B.M. Data Systems Laboratory, Poughkeepsie, N.Y.; Sherwood, Mills and Smith, archts.—Sept. 1962, pp. 149-154

Illinois Beach State Park. Lodge Bldg., Zion, Ill.; Barancik, Conte and Assoc.,

archs.—Aug. 1962, BTS, pp. 134-135  
Image of the Architect in Practice. "Working with Commercial Developers"; 50 Pearl Office Bldg., Boston; Pearl Street Assoc., archts.—Oct. 1962, pp. 157-164  
Industrial Buildings. Yardley Office, Manufacturing and Warehouse Bldg., Totowa, N.J.; Edward Durell Stone, archt.—Oct. 1962, pp. 129-131. See also Research Buildings.  
Isabella County Jail, Mt. Pleasant, Mich.; Cuthbert & Cuthbert, archts.—Aug. 1962, AE, p. 151  
Ithaca Senior High School, Ithaca, N.Y.; Perkins & Will, archts.—Oct. 1962, BTS, pp. 180-181

## J

Jackson Lake Apartments, Oakland, Calif.; Wurster, Bernardi and Emmons, archts.—Sept. 1962, pp. 155-157  
Johnson, Philip, Assoc., archts., Current Work: Kline Science Center, Yale University, New Haven, Conn.; St. Anselm's Abbey, Washington, D.C.; Dormitories, Sarah Lawrence College, Bronxville, N.Y.; Addition, Dumbarton Oaks Museum, Washington, D.C.; Computing Laboratory, Brown University, Providence, R.I.; Pavilion for the Architect, New Canaan, Conn.; Boissonas House, Cap Benat, France—July 1962, pp. 113-128. Expansion, Museum of Modern Art, N.Y.—Nov. 1962, News, p. 14. New York State Theater, Lincoln Center, N.Y.—Sept. 1962, pp. 134-135, 146-147  
Juilliard School of Music, Lincoln Center, N.Y.; Pietro Belluschi, archt.; Catalano & Westerman, assoc. archts.—Sept. 1962, pp. 134-135, 148

## K

Katz Waisman Blumenkranz Stein Weber Architects Assoc., archts.; Castle Hill Houses, Bronx, N.Y.—Dec. 1962, BTS, pp. 120-121  
Ketchum and Sharp, archts.; Haborfields Central High School, Greenlawn, L.I., N.Y.—Oct. 1962, BTS, pp. 178-179  
King, Jonathan, "The Sound of Change in the American Schoolhouse"—July 1962, BTS, pp. 147-149  
Klarich, Leonard, archt., Tolleston High School Addition, Gary, Ind.—July 1962, BTS, pp. 160-161  
Kling, Vincent G., archt.; National Offices, American Baptist Churches, Valley Forge, Pa.—July 1962, pp. 139-146. General Electric Valley Forge Space Technology Center, King of Prussia, Pa.—Nov. 1962, BTS, pp. 171-175

## L

Laboratory Equipment. "Standard for Wood Laboratory Equipment," by L. N. Nelson—Oct. 1962, BC, pp. 197-198  
LeMessurier, Wm. J., "The Return of the Bearing Wall"—July 1962, AE, pp. 168-171  
LeMessurier, Wm. J., & Assoc., Inc., part of Pearl Street Assoc. (F. A. Stahl & Assoc., Inc.; Hugh Stubbins & Assoc., Inc.; LeMessurier), archts.; 50 Pearl Office Bldg., Boston—Oct. 1962, pp. 157-164  
Libling, Michener and Assoc., archts.; Grosvenor House, Winnipeg, Manitoba, Canada—Oct. 1962, AE, pp. 186-189  
Library-Museum of the Performing Arts, Lincoln Center, N.Y.; Skidmore, Owings & Merrill, archts.—Sept. 1962, pp. 134-135, 142-145  
Lincoln Center, N.Y.; Philharmonic Hall, Max Abramovitz, archt.; Metropolitan Opera House, Wallace K. Harrison, archt.; Vivian Beaumont Repertory Theater, Eero Saarinen & Assoc., archts.; Library-Museum of the Performing Arts, Skidmore, Owings & Merrill, archts.; New York State Theater, Philip Johnson Assoc., archts.; Juilliard School of Music, Pietro Belluschi, archt.; Guggenheim Bandshell and Damrosch Park, Eggers & Higgins, archts.—Sept. 1962, pp. 133-148. "Acoustics of Philharmonic Hall," by Leo L. Beranek—Sept. 1962, AE, pp. 196-204

Lind, Kenneth, Assoc., archts.; Mt. San Antonio Gardens, Pomona, Calif.—Dec. 1962, BTS, p. 117  
Livesay, Wallace B. & Tom B., assoc. archts.; Harrel & Hamilton, archts.; The American Center, Beaumont, Tex.—Aug. 1962, pp. 115-118  
Luckman, Charles, Assoc., archts.; Hotel America, Prudential Center, Boston—Aug. 1962, BTS, p. 129  
Luders, J. Edward, & Assoc., archts.; Springvale-on-the-Hudson, Cortlandt, N.Y.—Dec. 1962, BTS, p. 113

## M

Marin County Civic Center, San Rafael, Calif.; Frank Lloyd Wright, archt.—Nov. 1962, News, p. 12  
Marine Plaza, Milwaukee, Wis.; Harrison and Abramovitz, archts.; Robert E. Rasche, assoc. archt.—Oct. 1962, pp. 153-156  
Martin, Albert C., and Assoc., archts.; Space Technology Laboratories Headquarters, Redondo Beach, Calif.—Nov. 1962, BTS, pp. 176-179  
Mathiasen, Geneva, "Trends in Housing for Older People"—Dec. 1962, BTS, pp. 110-116  
"Mediocrity by Fiat," Editorial by Emerson Goble—Oct. 1962, p. 9  
Metropolitan Opera House, Lincoln Center, N.Y.; Wallace K. Harrison, archt.—Sept. 1962, pp. 134-135, 140-141  
Milam, Arthur W., House, St. John's County, Fla.; Paul Rudolph, archt.; Robert Ernest, supervising archt.—Nov. 1962, pp. 126-128  
Mitchell Park Horticultural Conservatory, Milwaukee, Wis.; Donald L. Grieb, archt.;—Nov. 1962, AE, pp. 191-192  
Motels. Building Types Study 310: Hotels-Motels—Aug. 1962, pp. 127-146. Hilton Inn, Seattle-Tacoma Airport, Wash.; Skidmore, Owings & Merrill, archts.—Aug. 1962, BTS, pp. 138-141. White Winrock Hotel, Winrock Center, Albuquerque, N.M.; Victor Gruen Assoc., archts.—Aug. 1962, BTS, pp. 142-143. Motel, Burlington, Mass.; F. A. Stahl & Assoc., Inc., archts.—Aug. 1962, BTS, pp. 136-137. See also Hotels.  
Mount Saint Joseph Academy and Convent, Springfield Township, Pa.; Nolen, Swinburne and Assoc., archts.—July 1962, BTS, pp. 164-166  
Mount San Antonio Gardens, Pomona, Calif.; Kenneth Lind Assoc., archts.—Dec. 1962, BTS, p. 117  
Mumford, Lewis, "The Future of the City": Part 1: The Disappearing City—Oct. 1962, pp. 121-128; Part 2: Yesterday's City of Tomorrow—Nov. 1962, pp. 139-144; Part 3: Megalopolis as Anti-City—Dec. 1962, pp. 101-108  
Museum of Modern Art, N.Y., Expansion; Philip Johnson Assoc., archts.—Nov. 1962, News, p. 14  
Museums. Library-Museum of the Performing Arts, Lincoln Center, N.Y.; Skidmore, Owings & Merrill, archts.—Sept. 1962, pp. 134-135, 142-145. Expansion, Museum of Modern Art, N.Y.; Philip Johnson Assoc., archts.—Nov. 1962, News, p. 14. Ponce Museum of Art, Ponce, Puerto Rico; Edward Durell Stone, archt.—Oct. 1962, pp. 136-137. Sheldon Art Gallery, University of Nebraska; Philip Johnson Assoc., archts.—July 1962, pp. 122-123

## N

Naess & Murphy, archts.; Continental Center, Chicago—Aug. 1962, AE, p. 156  
Needham Houses, Needham, Mass.; William Hoskins Brown Assoc., Inc., archts.—Dec. 1962, BTS, p. 111  
Nemeny, George, archt.; Marshall Safir House, Kings Point, L.I., N.Y.—Sept. 1962, pp. 167-170  
New York State Theater, Lincoln Center, N.Y.; Philip Johnson Assoc., archts.—Sept. 1962, pp. 134-135, 146-147  
Newman, Robert B., "Some Common Sense for School Acoustics"—July 1962, BTS, pp. 154-155  
Nolen and Swinburne and Assoc., archts.; Johnson Hall, Temple University, Philadelphia, Pa.—Nov. 1962, pp. 145-150

Mount Saint Joseph Academy and Convent, Springfield Township, Pa.—July 1962, BTS, pp. 164-166

## O

Odell, A. G., Jr. & Assoc., archts.; Charlotte Memorial Hospital, Charlotte, N.C.—Sept. 1962, BTS, pp. 182-190  
Office Buildings. National Offices, American Baptist Churches, Valley Forge, Pa.; Vincent G. Kling, archt.—July 1962, pp. 139-146. The American Center, Beaumont, Tex.; Harrel & Hamilton, archts.; Wallace B. & Tom B. Livesay, assoc. archts.—Aug. 1962, pp. 115-118. Office Building, Beverly Hills, Calif.; Richard Dorman & Assoc., archts.—Sept. 1962, pp. 163-166. John Deere Administration Center, Moline, Ill.; Eero Saarinen and Assoc., archts.—Aug. 1962, AE, pp. 148-150. 50 Pearl Office Bldg., Boston, Mass.; Pearl Street Assoc., archts.—Oct. 1962, pp. 157-164. Marine Plaza, Milwaukee, Wis.; Harrison and Abramovitz, archts.; Robert E. Rasche, assoc. archt.—Oct. 1962, pp. 153-156. 777 Summer Street Bldg., Stamford, Conn.; Sherwood, Mills and Smith, archts.—Aug. 1962, pp. 119-122. Yardley Office, Manufacturing and Warehouse Bldg., Totowa, N.J.; Edward Durell Stone, archt.—Oct. 1962, pp. 129-131. See also Awards.

## P

Park Westwood Tower, Los Angeles, Calif.; Victor Gruen Assoc., archts.—Sept. 1962, pp. 160-162  
Parking Garages. The American Center, Beaumont, Tex.; Harrel & Hamilton, archts.; Wallace B. & Tom B. Livesay, assoc. archts.—Aug. 1962, pp. 115-118. Underground Garage and Plazas, Lincoln Center, N.Y.; Harrison & Abramovitz, archts.—Sept. 1962, pp. 134-135, 148  
Paterno, Carlo, House, North Salem, N.Y.; Edward Durell Stone, archt.—Oct. 1962, pp. 138-141  
Peninsula Volunteers' Retirement Apartments, Menlo Park, Calif.; Skidmore, Owings & Merrill, archts.—Dec. 1962, BTS, pp. 118-119  
Pereira, William L., & Assoc., archts.; Hoffman Science Center, Santa Barbara, Calif.—Nov. 1962, BTS, pp. 180-182  
Perkins and Will, archts.; Dundee Elementary School, Greenwich, Conn.—July 1962, BTS, pp. 158-159. Ithaca Senior High School, Ithaca, N.Y.—Oct. 1962, BTS, pp. 180-181  
Philharmonic Hall, Lincoln Center, N.Y.; Max Abramovitz, archt.—Sept. 1962, pp. 133-139. "Acoustics of Philharmonic Hall," by Leo L. Beranek—Sept. 1962, AE, pp. 196-204  
Ponce Museum of Art, Ponce, Puerto Rico; Edward Durell Stone, archt.—Oct. 1962, pp. 136-137  
Public Buildings. Marin County Civic Center, San Rafael, Calif.; Frank Lloyd Wright, archt.—Nov. 1962, News, p. 12

## R

Rapp, Robert E., "Composite Construction in a New Light"—Nov. 1962, AE, pp. 187-190  
Raymond, Antonin, and Rado, L. L., archts.; Gunma Music Center, Takasaki, Japan—Nov. 1962, pp. 157-162  
Recreational Buildings. Gunma Music Center, Takasaki, Japan; Antonin Raymond and L. L. Rado, archts.—Nov. 1962, pp. 157-162. See also Lincoln Center.  
Reid, John Lyon, "The Acoustics of the Andrews High School"; Andrews High School, Andrews, Tex.—July 1962, BTS, pp. 152-153  
Religious Buildings. Air Force Academy Chapel, Colorado Springs, Colo.; Skidmore, Owings & Merrill, archts.—Dec. 1962, pp. 85-92. All Souls Unitarian Church, Schenectady, N.Y.; Edward Durell Stone, archt.—Oct. 1962, pp. 142-144. Cathedral Church of St. Michael, Coventry, England; Sir Basil Spence, archt.—Aug. 1962, pp. 101-110. Mount Saint Joseph Academy and Convent, Springfield

Township, Pa.; Nolen, Swinburne and Assoc., archts.—July 1962, BTS, pp. 164-166. St. Anselm's Abbey, Washington, D.C.; Philip Johnson Assoc., archts.—July 1962, pp. 116-117. St. Mark's Church, New Canaan, Conn.; Sherwood, Mills and Smith, archts.—Nov. 1962, pp. 151-156

Research Buildings. Building Types Study 313—Nov. 1962, pp. 163-182. Bell Telephone Laboratories, Holmdel, N.J.; Eero Saarinen and Assoc., archts.—Oct. 1962, pp. 145-152. Computing Laboratory, Brown University, Providence, R.I.; Philip Johnson Assoc., archts.—July 1962, pp. 124-125. General Electric Valley Forge Space Technology Center, King of Prussia, Pa.; Vincent G. Kling, archt.—Nov. 1962, BTS, pp. 171-175. Hoffman Science Center, Santa Barbara, Calif.; William L. Pereira & Assoc., archts.—Nov. 1962, BTS, pp. 180-182. I.B.M. Data Systems Laboratory, Poughkeepsie, N.Y.; Sherwood, Mills & Smith, archts.—Sept. 1962, pp. 149-154. Space Technology Laboratories Headquarters, Redondo Beach, Calif.; Albert C. Martin and Assoc., archts.—Nov. 1962, BTS, pp. 176-179. "Planning Industrial Research Facilities," by Frank L. Whitney—Nov. 1962, BTS, pp. 163-170

Roofs. "Dual-Purpose Glazing Roofs Conservatory"; Mitchell Park Horticultural Conservatory, Milwaukee, Wis.; Donald L. Grieb, archt.—Nov. 1962, AE, pp. 191-192. "Research Looks into Roofing Failures," by Foster C. Wilson and Miles E. Jacoby—Oct. 1962, AE, pp. 190-192

Rudolph, Paul, archt.; Six New Houses: Residence, Palm Beach, Fla.; Arthur W. Milam House, St. John's County, Fla.; R. H. Daisley House, Inlet Cay, Fla.; John Wallace House, Athens, Ala.; N. Leslie Silvas House, Greenwich, Conn.; Barnet Yanofsky House, Newton, Mass.—Nov. 1962, pp. 123-138

## S

Saarinen, Eero, & Assoc., archts.; Terminal Bldg., Athens Airport, Athens, Greece—Aug. 1962, pp. 111-114. Vivian Beaumont Repertory Theater, Lincoln Center, N.Y.—Sept. 1962, pp. 134-135, 142-145. Bell Telephone Laboratories Development Center, Holmdel, N.J.—Oct. 1962, pp. 145-152. John Deere Administration Center, Moline, Ill.—Aug. 1962, AE, pp. 148-150. TWA Flight Center, Idlewild, New York International Airport, N.Y.—July 1962, pp. 129-134. Samuel F. B. Morse and Ezra Stiles Colleges, Yale University, New Haven, Conn.—Dec. 1962, pp. 93-100

Safir, Marshall, House, Kings Point, L.I., N.Y.; George Nemeny, archt.—Sept. 1962, pp. 167-170

St. Anselm's Abbey, Washington, D.C.; Philip Johnson Assoc., archts.—July 1962, pp. 116-117

St. Mark's Church, New Canaan, Conn.; Sherwood, Mills and Smith, archts.—Nov. 1962, pp. 151-156

St. Michael, Cathedral Church of, Coventry, England; Sir Basil Spence, archt.—Aug. 1962, pp. 101-110

Sarah Lawrence College, Dormitories, Bronxville, N.Y.; Philip Johnson, archt.—July 1962, pp. 118-119

Schools. Building Types Study 309: Acoustics—July 1962, pp. 147-166. Building Types Study 312: Auditoriums—Oct. 1962, pp. 165-184. Brookfield Senior High School, Brookfield, Ohio; Joseph Baker and Assoc., archts.—July 1962, BTS, pp. 162-163. Dundee Elementary School, Greenwich, Conn.; Perkins and Will, archts.—July 1962, BTS, pp. 156-159. East Junior High School, Walpole, Mass.; Shepley, Bulfinch, Richardson and Abbott, archts.—Oct. 1962, BTS, pp. 182-184. Harborfields Central High School, Greenlawn, L.I., N.Y.; Ketchum and Sharp, archts.—Oct. 1962, BTS, pp. 178-179. Hillside Elementary School, Needham, Mass.; The Architects Collaborative, archts.—July 1962, BTS, pp. 156-157. Ithaca Senior High School, Ithaca, N.Y.; Perkins & Will, archts.—Oct. 1962, BTS, pp. 180-181. Mount Saint Joseph Academy and Convent, Springfield Township, Pa.; Nolen, Swinburne and Assoc., archts.—July 1962, BTS, pp. 164-166.

Beekley Bldg., The Tatnall School Inc.; Wilmington, Del.; Victorine and Samuel Homsey, archts.—Oct. 1962, BTS, pp. 176-177. Tolleston High School Addition, Gary, Ind.; Leonard Klarich, archt.—July 1962, BTS, pp. 160-161. "Audio-Visual Systems for Large Group Instruction," by Hubert Wilke—Oct. 1962, BTS, pp. 172-175. "The Auditorium as Instructional Space," by Alan C. Green—Oct. 1962, BTS, pp. 169-171. "The Acoustics of the Andrews High School," by John Lyon Reid—July 1962, BTS, pp. 152-153. "Air Conditioning Responds to Flexible Plan"; Council Rock Intermediate High School, Richboro, Pa.; Haag and d'Entremont—Dec. 1962, AE, pp. 126-128. "Boulder City, Nevada, Builds Its Divisible Instruction Center"; High School Auditorium, Boulder City, Nev.; Zick and Sharp, archts.—July 1962, BTS, pp. 150-151. "School Auditorium Planning Considerations," by J. Stanley Sharp—Oct. 1962, BTS, pp. 165-168. "Some Common Sense for School Acoustics," by Robert B. Newman—July 1962, BTS, pp. 154-155. "The Sound of Change in the American Schoolhouse," by Jonathan King—July 1962, BTS, 147-149

Seibert, Edward J., House, Siesta Key, Sarasota, Fla.—July 1962, pp. 135-138

Senior Citizens Building, Sacramento, Calif.; Herbert E. Goodpastor, archt.—Dec. 1962, BTS, p. 122

777 Summer Street Bldg., Stamford, Conn.; Sherwood, Mills and Smith, archts.—Aug. 1962, pp. 119-122

Sharp, J. Stanley, "School Auditorium Planning Considerations"—Oct. 1962, BTS, pp. 165-168

Shepley, Bulfinch, Richardson and Abbott, archts.; East Junior High School, Walpole, Mass.—Oct. 1962, BTS, pp. 182-184

Sherwood, Mills & Smith, archts.; I.B.M. Data Systems Laboratory, Poughkeepsie, N.Y.—Sept. 1962, pp. 149-154. St. Mark's Church, New Canaan, Conn.—Nov. 1962, pp. 151-156. 777 Summer Street Bldg., Stamford, Conn.—Aug. 1962, pp. 119-122

Silvas, N. Leslie, House, Greenwich, Conn.; Paul Rudolph, archt.—pp. 134-135

Skidmore, Louis. Obituary—Nov. 1962, News, p. 10

Skidmore, Owings & Merrill, archts.; Air Force Academy Chapel, Colorado Springs, Colo.—Dec. 1962, pp. 85-92. Library-Museum of the Performing Arts, Lincoln Center, N.Y.—Sept. 1962, pp. 134-135, 142-145. Hilton Inn, Seattle-Tacoma Airport, Wash.—Aug. 1962, BTS, pp. 138-141. Peninsula Volunteers' Retirement Apartments, Menlo Park, Calif.—Dec. 1962, BTS, pp. 118-119

Space Technology Laboratories Headquarters, Redondo Beach, Calif.; Albert C. Martin and Assoc., archts.—Nov. 1962, BTS, pp. 176-179

Spence, Sir Basil, archt.; Cathedral Church of St. Michael, Coventry, England—Aug. 1962, pp. 101-110

Springvale-on-the-Hudson, Cortlandt, N.Y.; J. Edward Luders & Assoc., archts.—Dec. 1962, BTS, p. 113

Stahl, F. A., & Assoc., archts.; Motel, Burlington, Mass.—Aug. 1962, BTS, pp. 136-137. Part of Pearl Street Assoc. (Stahl; Hugh Stubbins & Assoc., Inc.; Wm. J. LeMessurier & Assoc., Inc.), archts.; 50 Pearl Office Bldg., Boston, Mass.—Oct. 1962, pp. 157-164

Stahl, Frederick A.; subject of "The Architect in Practice: Working with Commercial Developers"—Oct. 1962, pp. 157-164

Steel. "Characteristics of Aluminized Steel," by W. H. Withey and H. H. Lawson—Nov. 1962, BC, pp. 197-198. "Steel Plate Exterior Serves as Cover for Fireproofing"; Continental Center, Chicago; Naess & Murphy, archts.—Aug. 1962, AE, p. 156. "The Steel Will Weather Naturally," by John Dinkeloo; John Deere Administration Center, Moline, Ill.; Eero Saarinen and Assoc., archts.—Aug. 1962, AE, pp. 148-150

Stone, Edward Durell, archt.; New Work: Office, Manufacturing and Warehouse Bldg. for Yardley of London, Inc., Totowa, N.J.; Beckman Auditorium, California Institute of Technology, Pasadena, Calif.; Ponce Museum of Art, Ponce, Puerto Rico; Carlo Paterno House, North

Salem, N.Y.; All Souls Unitarian Church, Schenectady, N.Y.—Oct. 1962, pp. 129-144

Structure. "The Return of the Bearing Wall," by Wm. J. LeMessurier—July 1962, AE, pp. 168-171

Stubbins, Hugh, & Assoc., Inc., archts.; part of Pearl Street Assoc. (F. A. Stahl & Assoc., Inc.; Stubbins; Wm. J. LeMessurier & Assoc., Inc.), archts.; 50 Pearl Office Bldg., Boston—Oct. 1962, pp. 157-164

## T

Tabler, William B., archt.; Carlton Beach Hotel, Southampton, Bermuda—Aug. 1962, BTS, pp. 132-133

Tatnall School Inc., The; Beekley Bldg., Wilmington, Del.; Victorine and Samuel Homsey, archts.—Oct. 1962, BTS, pp. 176-177

Temple University, Johnson Hall, Philadelphia, Pa.; Nolen and Swinburne and Assoc., archts.—Nov. 1962, pp. 145-150

Thin Shells. "Structure Can Move if Soil Swells"; Warehouse, Sasolburg, Orange Free State, South Africa—Nov. 1962, AE, pp. 184-186

Time-Saver Standards. "Building and Facility Standards for Physically Handicapped," Parts 1, 2, 3, 4, by Howard P. Vermilya—Dec. 1962, pp. 129-132. "Electrical Capacities of Building Equipment," Parts 1, 2, by Louis A. Bello—July 1962, pp. 175-176

Tolleston High School Addition, Gary, Ind.; Leonard Klarich, archt.—July 1962, BTS, pp. 160-161

Transportation Buildings. Terminal Bldg., Athens Airport, Athens, Greece; Eero Saarinen & Assoc., archts.—Aug. 1962, pp. 111-114. TWA Flight Center, Idlewild, New York International Airport, N.Y.; Eero Saarinen and Assoc., archts.—July 1962, pp. 129-134

TWA Flight Center, Idlewild, New York International Airport, N.Y.; Eero Saarinen and Assoc., archts.—July 1962, pp. 129-134

## V

Vermilya, Howard, "Building and Facility Standards for Physically Handicapped," Parts 1, 2, 3, 4—Dec. 1962, TSS, pp. 129-132

Veterans Administration Hospital, Palo Alto, Calif.; Welton Becket and Assoc., archts.—Sept. 1962, BTS, pp. 191-194

## W

Wallace, John, House, Athens, Ala.; Paul Rudolph, archt.—Nov. 1962, pp. 132-133

Water Tower Inn, Chicago; Hausner and Macsai, archts.—Aug. 1962, BTS, pp. 144-146

Weiss, Joseph Douglas, archt.; The Friedman Bldg., The Home for Aged and Infirm Hebrews of New York, N.Y.—Dec. 1962, BTS, pp. 123-124

Wheaton House Apartments, Wheaton, Md.; Cohen, Haft & Assoc., archts.—Sept. 1962, pp. 158-159

White Winrock Hotel, Winrock Center, Albuquerque, N.M.; Victor Gruen Assoc., archts.—Aug. 1962, BTS, pp. 142-143

Wright, Frank Lloyd, archt.; Marin County Civic Center, San Rafael, Calif.—Nov. 1962, News, p. 12

Wurster, Bernardi and Emmons, archts.; Jackson Lake Apartments, Oakland, Calif.—Sept. 1962, pp. 155-157

## X Y Z

Yale University. Kline Science Center, New Haven, Conn.; Philip Johnson Assoc., archts.—July 1962, pp. 113-115. Samuel F. B. Morse and Ezra Stiles Colleges, New Haven, Conn.; Eero Saarinen and Assoc., archts.—Dec. 1962, pp. 93-100

Yanofsky, Barnet, House, Newton, Mass.; Paul Rudolph, archt.—Nov. 1962, pp. 136-138

Yardley Office, Manufacturing and Warehouse Bldg., Totowa, N.J.; Edward Durell Stone, archt.—Oct. 1962, pp. 129-131

Zick and Sharp, archts.; High School Auditorium, Boulder City, Nev.—July 1962, BTS, pp. 150-151

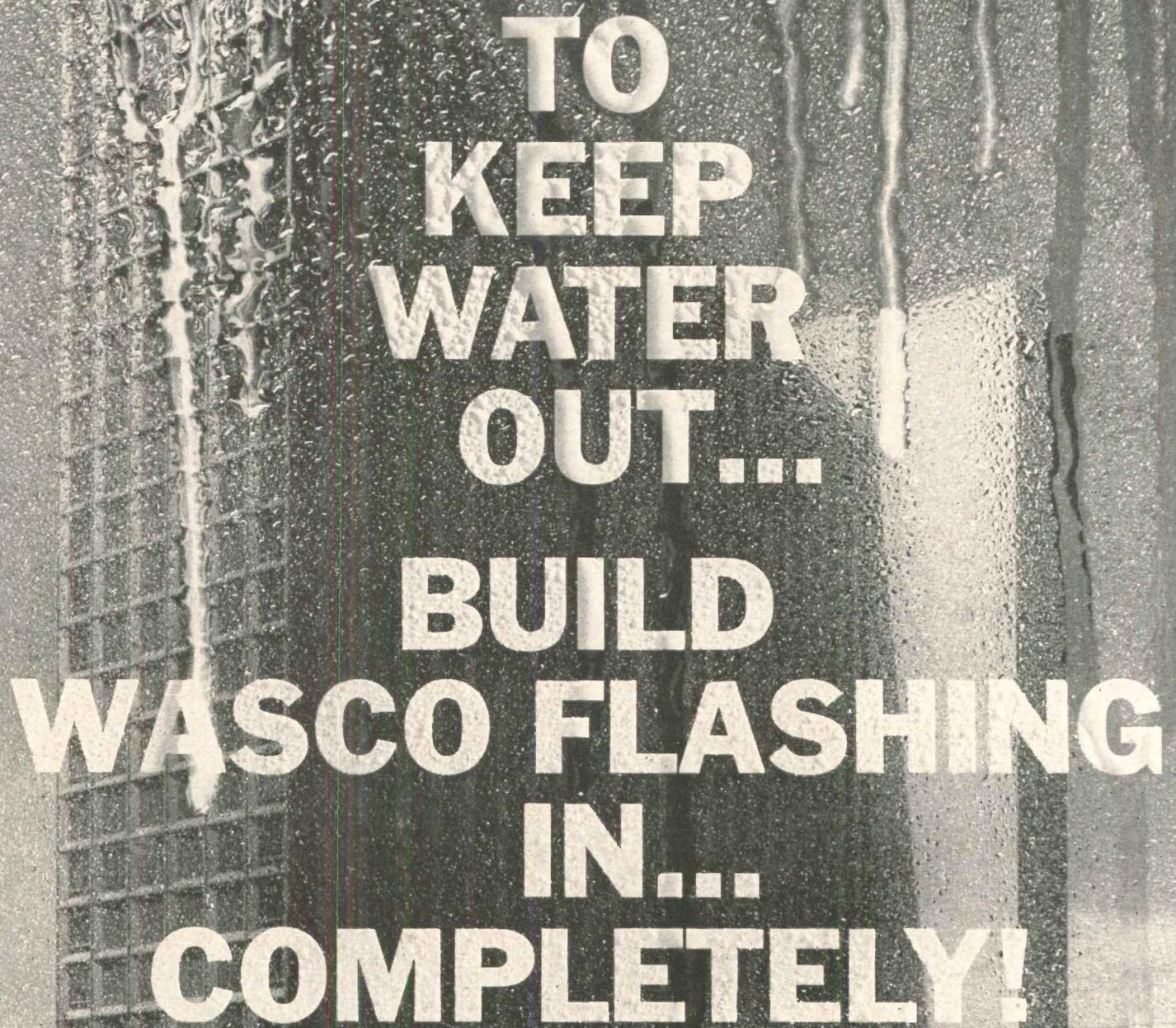

**TO  
KEEP  
WATER  
OUT...  
BUILD  
WASCO FLASHING  
IN...  
COMPLETELY!**

Moisture constantly seeks a point of access into every type of construction. It will never find weak spots if you have the right flashing in all the right places. ■ WASCO flashing, properly installed, is permanent insurance against water damage in all types of building design including curtain wall and pre-cast concrete construction.

Yet the cost of this complete WASCO protection is generally less than 1/20 of 1% of total construction investment. ■ Only Cyanamid offers every kind of thru-wall and spandrel flashing



**WASCO<sup>®</sup>  
FLASHING**

you need to keep water out — from parapet to foundation. You can specify 14 types of flashings including copper-fabric, copper-asphalt, copper-lead, fabric, plastic and aluminum. For exceptional flashing problems, you are invited to consult the Cyanamid Engineering staff. For full details, see Sweet's Architectural File 8g/Wa.

For more data, circle 121 on Inquiry Card

AMERICAN CYANAMID COMPANY, BUILDING PRODUCTS DIVISION, 5 BAY STATE ROAD, CAMBRIDGE 38, MASS.

**CYANAMID**

# Index to Advertising

PRE-FILED CATALOGS of the manufacturers listed below are available in the 1962 Sweet's Catalog File as follows: (A) Architectural File (green), IC Industrial Construction File (blue), (LC) Light Construction File (yellow).

A Adams Rite Manufacturing Company	64	A Fiske Architectural Metals, Inc., J. W.	178	IC Nalgene Piping Systems	202
Aerofin Corporation	204	A-IC-LC Floor Tile Division of the Ruberoid Company	84	A-IC-LC National Gypsum Co.	66
A Airtherm Mfg. Co.	17			National Lumber Manufacturers Association	150-151
A-IC Altec Lansing Corporation	190			A National Terrazzo & Mosaic Association	52
A American Cyanamid Company (Bldg. Prods. Div.)	22, 215	A General Bronze Corp.	53	A National Tube Div.	134-135
A-IC American District Telegraph Co.	198	A General Dynamics/Electronics—Rochester	136	Neo-Ray Products, Inc.	204
A American Laundry Machinery Industries	195	A-IC-LC General Electric Company 30-31, 82, 169		Nesbitt, Inc., John J.	28
A American Olean Tile Company	145	Glidden Co., The	39	A-IC Norton Company	168
Anemostat Corp. of America	165	A-IC-LC Glidorama Div., Whizzer Ind., Inc.	194		
Architectural Record	208-209	A Global Steel Products Corp.	203		
A-IC-LC Armstrong Cork Company	1 to 3, 218, 3rd Cover	Guth Company, The Edwin F.	176		
Atmos-Pak, Inc.	200			A Otis Elevator Co.	43
A-LC Azrock Floor Products Div.	141			Ozalid Div. of General Aniline & Film Corp.	34
A Bally Case and Cooler, Inc.	210	Hager & Sons Hinge Mfg. Co., C.	61	A-IC Pittsburgh Corning Corp.	60
A-IC Barber-Colman Company	196-197	A Hall-Mack Co.	172	A-IC-LC Portland Cement Association	8, 162
Basic Construction Company	29	A Haws Drinking Faucet Co.	152	A Pratt & Lambert, Inc.	74
A Bastian Blessing Co.	158-159	Heating & Air Conditioning Exposition	198	A Products Research Co.	57
IC Benjamin Division, Thomas Industries, Inc.	142-143	A Hillyard Chemical Co.	32		
A-IC Bethlehem Steel Company	180	Holophane Company, Inc.	2nd Cover		
Bigelow-Sanford Carpet Co.	175	H-P Products, Inc.	74	Rauland-Borg Corporation	45
Boeckh & Associates, E. H.	206	A Hunter Douglas Div., Bridgeport Brass Co.	16	A-LC Red Cedar Shingle Bureau	173
Bogen Communications Div., Lear Siegler, Inc.	56	A Huntington Laboratories, Inc.	153	A-IC-LC Revere Copper & Brass, Inc.	58-59
A-IC Borden Metal Products Co.	21			A-IC-LC Reynolds Metals Co.	75
A Borroughs Manufacturing Co.	217	IC Inland Steel Company	156-157	A Robbins Flooring Company	11
A-IC Burns & Russell Co.	33	A-IC-LC Inland Steel Products Co.	80-81	A-IC Robertson Co., H. H.	149
		International Nickel Company, Inc.	144	Roebing's Sons Div., John A., Colorado Fuel & Iron Corp.	24
				A Rohm & Haas Company	76-77
A Case Mfg. Div., Ogden Corp.	178	Jabon Studios	210	A Royalmetal Manufacturing Co.	42
Central Fabricators Association	174	A Jamison Cold Storage Door Co.	36	Russell & Erwin Div.	49
A Century Lighting Co.	200	A-IC-LC Johns-Manville	183	A-IC Ryerson & Son, Inc., Joseph T.	14-15
A-IC-LC Chrysler Corporation	67	A-IC-LC Jones & Laughlin Steel Corp.	50-51		
Collector's Book Society	201			Schemenauer Mfg. Co.	157
Corbin Division, P. & F.	79	A-LC Kentile, Inc.	41	A Sedgwick Machine Works	70
A Crane Co.	25	A-IC Kinneair Mfg. Co., The	164	Sherer-Gillett Company	74
		A-IC Kohler Co.	187	A Simmons Company	46
				A-IC Sloan Valve Company	4th Cover
Da-Lite Screen Co., Inc.	202	A LCN Closers, Inc.	68-69	A-IC Standard Conveyor Company	210
A-IC Day-Brite Lighting Company	188-189	Lear Siegler, Inc., Bogen Communications Div.	56	A-IC Stark Ceramics, Inc.	83
A-LC Devoe & Reynolds Company, Inc.	191	Lennox Industries, Inc.	161	Sweet's Catalog Service	217
Dodge Reports	205	A Linen Supply Association of America	163	A-LC Symons Mfg. Co.	194
A-IC-LC Douglas Fir Plywood Association	184-185	Litecontrol Corporation	160		
A-IC-LC Dow Chemical Company, The	170-171	Lone Star Cement Corp.	7	A T & S Brass and Bronze Works, Inc.	178
Du Pont de Nemours & Co., E. I.	71	A Ludowici-Celadon Co.	147	A Tile Council of America, Inc.	44-45
A-IC-LC Dur-O-Wal, Inc.	19			A Titus Mfg. Corp.	72-73
		A-IC Martin Marietta Corporation	179	A Toledo Scale Co.	38
Emerson Electric Mfg. Co.	62-63	McLouth Steel Corp.	35		
A Federal Seaboard Terra Cotta Corp.	133	Medusa Portland Cement Co.	199	IC United States Steel Corp. (Subs)	134-135, 166-167
Fischbach & Moore, Inc.	177	IC-LC Minneapolis-Honeywell	192-193	A-LC Uvalde Rock Asphalt Co.	141
		A-LC Misceramic Tile	65		
		A-IC-LC Mississippi Glass Co.	47-48	A-IC Van Range Co., John	146
		Mordine Manufacturing Co.	54-55	Vilter Manufacturing Co.	78
		LC Moe Light Div., Thomas Ind., Inc.	154-155	A "Von Duprin" Division	148
		A Mosaic Tile Company	37		
		IC Murray Tile Co., Inc.	145	A-IC-LC Westinghouse Electric Corp.	26-27
				A Zero Weather Stripping Co., Inc.	186

NEW YORK—James E. Boddorf, Sales Mgr.; Tom Tredwell, Advertising Mgr.; Blake Hughes, Marketing Mgr.; Richard Crabtree, Business Mgr.; Benton B. Orwig, Director of New Business Development; Joseph R. Wunk, Advertising Production Mgr.; Harry M. Horn, Jr., Michael J. Davin, 119 W. 40 St.; BOSTON—Harry M. Horn, Jr., 855 Park Square Bldg.; BUFFALO—Benton B. Orwig, James E. Ryan, 310 Delaware Ave.; CHICAGO—Robert T. Franden, James A. Anderson, Robert Kliesch, Douglas S. Brodie, 1050 Merchandise Mart; CLEVELAND—John C. Jackson, Louis F. Kutscher, James B. Ryan, 321 Hanna Bldg.; DETROIT—Louis F. Kutscher, 527 Free Press Bldg.; LOS ANGELES—Robert L. Clark, 1709 West Eighth St.; MIAMI—Michael J. Davin, 802 N. W. First St.; PHILADELPHIA—Tom Tredwell, Michael J. Davin, Broad & Locust Streets; PITTSBURGH—John C. Jackson, 411 Seventh Ave.; ST. LOUIS—Richard Grater, Robert T. Franden, 3842 W. Pine Blvd.; SAN FRANCISCO—John I. Howell, 255 California St.



# A-IC-LC\*

TELLS YOU WHERE TO REACH  
FOR BUYING INFORMATION!

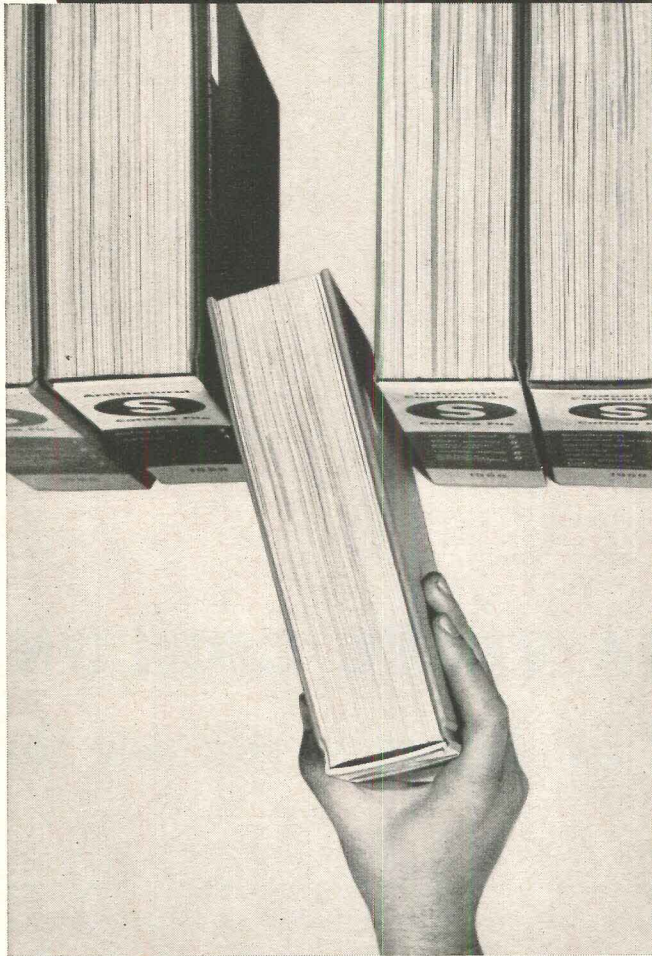

\*These symbols are used in the facing index to tell you which advertisers make their catalogs instantly accessible in Sweet's Catalog Files. The letters stand for the Architectural, Industrial Construction and Light Construction Catalog Files.



**SWEET'S CATALOG SERVICE**  
Division of F. W. Dodge Corporation  
119 West 40th Street, New York 18, N. Y.  
A McGraw-Hill Company

there's always a  
"BETTER"  
in everything!

send today for illustrated literature



the rack with the exclusive "wonder bar"

## BORROUGHS OF KALAMAZOO

*Century* LINE  
OF FINE CHECK RACKS

### has features to prove it!

COMPARE the merits of Borroughs "Century" Check Racks and you'll specify this fine line for your planned checking facility. In design, styling and construction, the "Century" line is all-quality. Coats hang clear and free — hats hold their shape on apex-ridged shelves — Borroughs' exclusive "Wonder Bar" reverses for extra hanger capacities. Borroughs offers a range of standard models and combinations to meet any requirement. Choice of 5 colors for perfect decor harmony.

## BORROUGHS MANUFACTURING COMPANY

A SUBSIDIARY OF THE AMERICAN METAL PRODUCTS COMPANY OF DETROIT  
3082 NORTH BURDICK ST. **amp**® KALAMAZOO, MICHIGAN

For more data, circle 122 on Inquiry Card

*Higbee Westgate Store, Cleveland, Designers and Planners: Raymond Loewy/William Snaith, Inc., N. Y. C., Engineers of Record: Strobel and Rongved, N. Y. C.*

## A FLOOR OF TESSERA VINYL CORLON— an elegant, monolithic background for displays in this new store



The picture on the opposite page shows how a floor of Tessera Vinyl Corlon enhances and unifies the interior of the Higbee Westgate Store, Cleveland, Ohio. A gray-white styling in Tessera (#86542) was chosen to form a neutral background for the colorful store displays. Because it

comes in long rolls 6 ft. wide, Tessera forms a virtually seam-free floor. With its relative seamlessness, fine-scale design, textured surface and vinyl formulation, Tessera maintains good appearance, minimizes heel indentations, and simplifies upkeep. It will give years of service in any busy store or other interiors subjected to heavy foot traffic.

### Technical Data on Tessera:

**uses:** heavy-duty commercial and deluxe residential interiors, above, on, or below grade; **grease and alkali resistance:** excellent; **dimensions:** .090" gauge in rolls 6 ft. wide and lengths up to 90 ft.; **dimensional stability:** ex-

clusive Hydrocord Back gives Tessera exceptional stability; **stylings:** colored vinyl chips set in translucent vinyl in monochromatic and multicolor designs, 18 colorings.

The Armstrong Architect-Builder Consultant in your area can help you solve any flooring problems you encounter. He will provide you with samples and specifications and, if you desire, will get you the assistance of technical, design, and installation experts at Armstrong. Call him at your Armstrong District Office. Or write Armstrong, 312 Rock St., Lancaster, Pa.

CORLON, HYDROCORD AND TESSERA ARE REGISTERED TRADEMARKS OF ARMSTRONG CORK COMPANY



**Armstrong VINYL FLOORS**